

# **Developer's Guide to Oracle™ Solaris Security**

Beta

Copyright © 2000, 2010, Oracle and/or its affiliates. All rights reserved.

This software and related documentation are provided under a license agreement containing restrictions on use and disclosure and are protected by intellectual property laws. Except as expressly permitted in your license agreement or allowed by law, you may not use, copy, reproduce, translate, broadcast, modify, license, transmit, distribute, exhibit, perform, publish, or display any part, in any form, or by any means. Reverse engineering, disassembly, or decompilation of this software, unless required by law for interoperability, is prohibited.

The information contained herein is subject to change without notice and is not warranted to be error-free. If you find any errors, please report them to us in writing.

If this is software or related software documentation that is delivered to the U.S. Government or anyone licensing it on behalf of the U.S. Government, the following notice is applicable:

U.S. GOVERNMENT RIGHTS Programs, software, databases, and related documentation and technical data delivered to U.S. Government customers are "commercial computer software" or "commercial technical data" pursuant to the applicable Federal Acquisition Regulation and agency-specific supplemental regulations. As such, the use, duplication, disclosure, modification, and adaptation shall be subject to the restrictions and license terms set forth in the applicable Government contract, and, to the extent applicable by the terms of the Government contract, the additional rights set forth in FAR 52.227-19, Commercial Computer Software License (December 2007). Oracle America, Inc., 500 Oracle Parkway, Redwood City, CA 94065.

This software or hardware is developed for general use in a variety of information management applications. It is not developed or intended for use in any inherently dangerous applications, including applications which may create a risk of personal injury. If you use this software or hardware in dangerous applications, then you shall be responsible to take all appropriate fail-safe, backup, redundancy, and other measures to ensure its safe use. Oracle Corporation and its affiliates disclaim any liability for any damages caused by use of this software or hardware in dangerous applications.

Oracle and Java are registered trademarks of Oracle and/or its affiliates. Other names may be trademarks of their respective owners.

AMD, Opteron, the AMD logo, and the AMD Opteron logo are trademarks or registered trademarks of Advanced Micro Devices. Intel and Intel Xeon are trademarks or registered trademarks of Intel Corporation. All SPARC trademarks are used under license and are trademarks or registered trademarks of SPARC International, Inc. UNIX is a registered trademark licensed through X/Open Company, Ltd.

This software or hardware and documentation may provide access to or information on content, products, and services from third parties. Oracle Corporation and its affiliates are not responsible for and expressly disclaim all warranties of any kind with respect to third-party content, products, and services. Oracle Corporation and its affiliates will not be responsible for any loss, costs, or damages incurred due to your access to or use of third-party content, products, or services.

# Contents

---

<b>Preface</b> .....	15
<b>1 Oracle Solaris Security for Developers (Overview)</b> .....	21
Overview of Oracle Solaris Security Features for Developers .....	21
System Security .....	21
Network Security Architecture .....	22
<b>2 Developing Privileged Applications</b> .....	25
Privileged Applications .....	25
About Privileges .....	26
How Administrators Assign Privileges .....	26
How Privileges Are Implemented .....	26
Compatibility Between the Superuser and Privilege Models .....	28
Privilege Categories .....	28
Programming with Privileges .....	29
Privilege Data Types .....	29
Privilege Interfaces .....	30
Privilege Coding Example .....	32
Guidelines for Developing Privileged Applications .....	35
About Authorizations .....	36
<b>3 Writing PAM Applications and Services</b> .....	39
Introduction to the PAM Framework .....	39
PAM Service Modules .....	40
PAM Library .....	41
PAM Authentication Process .....	41
Requirements for PAM Consumers .....	42

PAM Configuration .....	42
Writing Applications That Use PAM Services .....	42
A Simple PAM Consumer Example .....	42
Other Useful PAM Functions .....	46
Writing Conversation Functions .....	47
Writing Modules That Provide PAM Services .....	51
Requirements for PAM Service Providers .....	51
Sample PAM Provider Service Module .....	52
<b>4 Writing Applications That Use GSS-API .....</b>	<b>57</b>
Introduction to GSS-API .....	57
Application Portability With GSS-API .....	59
Security Services in GSS-API .....	59
Available Mechanisms in GSS-API .....	60
Remote Procedure Calls With GSS-API .....	60
Limitations of GSS-API .....	61
Language Bindings for GSS-API .....	61
Where to Get More Information on GSS-API .....	61
Important Elements of GSS-API .....	62
GSS-API Data Types .....	62
GSS-API Status Codes .....	71
GSS-API Tokens .....	72
Developing Applications That Use GSS-API .....	74
Generalized GSS-API Usage .....	74
Working With Credentials in GSS-API .....	75
Working With Contexts in GSS-API .....	76
Sending Protected Data in GSS-API .....	86
Cleaning Up a GSS-API Session .....	94
<b>5 GSS-API Client Example .....</b>	<b>95</b>
GSSAPI Client Example Overview .....	95
GSSAPI Client Example Structure .....	96
Running the GSSAPI Client Example .....	96
GSSAPI Client Example: <code>main()</code> Function .....	97
Opening a Connection With the Server .....	98

---

Establishing a Security Context With the Server .....	99
Translating a Service Name into GSS-API Format .....	100
Establishing a Security Context for GSS-API .....	100
Miscellaneous GSSAPI Context Operations on the Client Side .....	104
Wrapping and Sending a Message .....	105
Reading and Verifying a Signature Block From a GSS-API Client .....	107
Deleting the Security Context .....	108
<b>6 GSS-API Server Example .....</b>	<b>109</b>
GSSAPI Server Example Overview .....	109
GSSAPI Server Example Structure .....	109
Running the GSSAPI Server Example .....	110
GSSAPI Server Example: main() Function .....	110
Acquiring Credentials .....	112
Checking for inetd .....	115
Receiving Data From a Client .....	116
Accepting a Context .....	117
Unwrapping the Message .....	121
Signing and Returning the Message .....	122
Using the test_import_export_context() Function .....	122
Cleanup in the GSSAPI Server Example .....	124
<b>7 Writing Applications That Use SASL .....</b>	<b>125</b>
Introduction to Simple Authentication Security Layer (SASL) .....	125
SASL Library Basics .....	125
Steps in the SASL Cycle .....	130
SASL Example .....	138
SASL for Service Providers .....	142
SASL Plug-in Overview .....	142
SASL Plug-in Development Guidelines .....	147
<b>8 Introduction to the Oracle Solaris Cryptographic Framework .....</b>	<b>149</b>
Oracle Solaris Cryptography Terminology .....	149
Overview of the Cryptographic Framework .....	150

Components of the Cryptographic Framework .....	152
What Cryptography Developers Need to Know .....	153
Requirements for Developers of User-Level Consumers .....	153
Requirements for Developers of User-Level Providers .....	154
Requirements for Developers of Kernel-Level Consumers .....	154
Requirements for Developers of Kernel-Level Providers .....	154
Avoiding Data Cleanup Collisions in User-Level Providers .....	155
<b>9 Writing User-Level Cryptographic Applications and Providers .....</b>	<b>157</b>
Overview of the Cryptoki Library .....	157
PKCS #11 Function List .....	158
Functions for Using PKCS #11 .....	158
Extended PKCS #11 Functions .....	164
User-Level Cryptographic Application Examples .....	165
Message Digest Example .....	165
Symmetric Encryption Example .....	168
Sign and Verify Example .....	172
Random Byte Generation Example .....	179
<b>10 Introduction to the Oracle Solaris Key Management Framework .....</b>	<b>183</b>
Oracle Solaris Key Management Framework Features .....	183
Oracle Solaris Key Management Framework Components .....	184
KMF Key Management Tool .....	184
KMF Policy Enforcement Mechanisms .....	185
KMF Application Programming Interfaces .....	186
Oracle Solaris Key Management Framework Example Application .....	187
KMF Headers and Libraries .....	187
KMF Basic Data Types .....	187
KMF Application Results Verification .....	188
Complete KMF Application Source Code .....	188
<b>A Sample C-Based GSS-API Programs .....</b>	<b>195</b>
Client-Side Application .....	195
Server-Side Application .....	206

---

Miscellaneous GSS-API Sample Functions .....	215
<b>B GSS-API Reference .....</b>	<b>223</b>
GSS-API Functions .....	223
Functions From Previous Versions of GSS-API .....	225
GSS-API Status Codes .....	225
GSS-API Major Status Code Values .....	226
Displaying Status Codes .....	228
Status Code Macros .....	229
GSS-API Data Types and Values .....	229
Basic GSS-API Data Types .....	229
Name Types .....	230
Address Types for Channel Bindings .....	231
Implementation-Specific Features in GSS-API .....	232
Sun-Specific Functions .....	232
Human-Readable Name Syntax .....	233
Implementations of Selected Data Types .....	233
Deletion of Contexts and Stored Data .....	233
Protection of Channel-Binding Information .....	233
Context Exportation and Interprocess Tokens .....	234
Types of Credentials Supported .....	234
Credential Expiration .....	234
Context Expiration .....	234
Wrap Size Limits and QOP Values .....	234
Use of <i>minor_status</i> Parameter .....	234
Kerberos v5 Status Codes .....	235
Messages Returned in Kerberos v5 for Status Code 1 .....	235
Messages Returned in Kerberos v5 for Status Code 2 .....	236
Messages Returned in Kerberos v5 for Status Code 3 .....	237
Messages Returned in Kerberos v5 for Status Code 4 .....	239
Messages Returned in Kerberos v5 for Status Code 5 .....	240
Messages Returned in Kerberos v5 for Status Code 6 .....	242
Messages Returned in Kerberos v5 for Status Code 7 .....	243

<b>C</b>	<b>Specifying an OID</b> .....	247
	Files with OID Values .....	247
	/etc/gss/mech File .....	247
	/etc/gss/qop File .....	248
	gss_str_to_oid() Function .....	248
	Constructing Mechanism OIDs .....	249
	createMechOid() Function .....	250
	Specifying a Non-Default Mechanism .....	251
<b>D</b>	<b>Source Code for SASL Example</b> .....	253
	SASL Client Example .....	253
	SASL Server Example .....	261
	Common Code .....	269
<b>E</b>	<b>SASL Reference Tables</b> .....	273
	SASL Interface Summaries .....	273
<b>F</b>	<b>Packaging and Signing Cryptographic Providers</b> .....	279
	Packaging Cryptographic Provider Applications and Modules .....	279
	Complying with U.S. Government Export Laws .....	279
	Packaging User-Level Provider Applications .....	280
	Packaging Kernel-Level Provider Modules .....	281
	Adding Signatures to Providers .....	282
	▼ To Request a Certificate for Signing a Provider .....	282
	▼ To Sign a Provider .....	283
	▼ To Verify That a Provider Is Signed .....	284
	▼ To Generate an Activation File for Retail Export .....	284
	<b>Glossary</b> .....	287
	<b>Index</b> .....	291



# Figures

---

FIGURE 3-1	PAM Architecture .....	40
FIGURE 4-1	GSS-API Layer .....	58
FIGURE 4-2	RPCSEC_GSS and GSS-API .....	60
FIGURE 4-3	Internal Names and Mechanism Names .....	65
FIGURE 4-4	Comparing Names (Slow) .....	67
FIGURE 4-5	Comparing Names (Fast) .....	69
FIGURE 4-6	Exporting Contexts: Multithreaded Acceptor Example .....	85
FIGURE 4-7	<code>gss_get_mic()</code> versus <code>gss_wrap()</code> .....	87
FIGURE 4-8	Message Replay and Message Out-of-Sequence .....	91
FIGURE 4-9	Confirming MIC Data .....	92
FIGURE 4-10	Confirming Wrapped Data .....	94
FIGURE 7-1	SASL Architecture .....	126
FIGURE 7-2	SASL Life Cycle .....	131
FIGURE 7-3	SASL Session Initialization .....	134
FIGURE 7-4	SASL Authentication: Sending Client Data .....	135
FIGURE 7-5	SASL Authentication: Processing Server Data .....	137
FIGURE 8-1	Overview of the Oracle Solaris Cryptographic Framework .....	151
FIGURE B-1	Major-Status Encoding .....	226



# Tables

---

TABLE 2-1	Interfaces for Using Privileges .....	30
TABLE 2-2	Privilege Set Transition .....	34
TABLE B-1	GSS-API Calling Errors .....	226
TABLE B-2	GSS-API Routine Errors .....	227
TABLE B-3	GSS-API Supplementary Information Codes .....	228
TABLE B-4	Channel Binding Address Types .....	231
TABLE B-5	Kerberos v5 Status Codes 1 .....	235
TABLE B-6	Kerberos v5 Status Codes 2 .....	236
TABLE B-7	Kerberos v5 Status Codes 3 .....	238
TABLE B-8	Kerberos v5 Status Codes 4 .....	239
TABLE B-9	Kerberos v5 Status Codes 5 .....	240
TABLE B-10	Kerberos v5 Status Codes 6 .....	242
TABLE B-11	Kerberos v5 Status Codes 7 .....	243
TABLE E-1	SASL Functions Common to Clients and Servers .....	273
TABLE E-2	Basic SASL Client-only Functions .....	274
TABLE E-3	Basic SASL Server Functions (Clients Optional) .....	274
TABLE E-4	SASL Functions for Configuring Basic Services .....	274
TABLE E-5	SASL Utility Functions .....	275
TABLE E-6	SASL Property Functions .....	275
TABLE E-7	Callback Data Types .....	276
TABLE E-8	SASL Include Files .....	276
TABLE E-9	SASL Return Codes: General .....	276
TABLE E-10	SASL Return Codes: Client-Only .....	277
TABLE E-11	SASL Return Codes: Server-Only .....	277
TABLE E-12	SASL Return Codes – Password Operations .....	278



# Examples

---

EXAMPLE 2-1	Superuser Privilege Bracketing Example .....	32
EXAMPLE 2-2	Least Privilege Bracketing Example .....	33
EXAMPLE 2-3	Checking for Authorizations .....	37
EXAMPLE 3-1	Sample PAM Consumer Application .....	44
EXAMPLE 3-2	PAM Conversation Function .....	47
EXAMPLE 3-3	Sample PAM Service Module .....	53
EXAMPLE 4-1	Using Strings in GSS-API .....	62
EXAMPLE 4-2	Using <code>gss_import_name()</code> .....	64
EXAMPLE 4-3	OIDs Structure .....	70
EXAMPLE 4-4	OID Set Structure .....	70
EXAMPLE 5-1	<code>gss-client</code> Example: <code>main()</code> .....	97
EXAMPLE 5-2	<code>connect_to_server()</code> Function .....	99
EXAMPLE 5-3	<code>client_establish_context()</code> – Translate Service Name .....	100
EXAMPLE 5-4	Loop for Establishing Contexts .....	102
EXAMPLE 5-5	<code>gss-client</code> : <code>call_server()</code> Establish Context .....	104
EXAMPLE 5-6	<code>gss-client</code> Example: <code>call_server()</code> – Wrap Message .....	105
EXAMPLE 5-7	<code>gss-client</code> Example – Read and Verify Signature Block .....	108
EXAMPLE 5-8	<code>gss-client</code> Example: <code>call_server()</code> – Delete Context .....	108
EXAMPLE 6-1	<code>gss-server</code> Example: <code>main()</code> .....	111
EXAMPLE 6-2	Sample Code for <code>server_acquire_creds()</code> Function .....	114
EXAMPLE 6-3	<code>sign_server()</code> Function .....	116
EXAMPLE 6-4	<code>server_establish_context()</code> Function .....	118
EXAMPLE 6-5	<code>test_import_export_context()</code> .....	123
EXAMPLE 8-1	<code>Supplying_fini()</code> to PKCS #11 Libraries .....	155
EXAMPLE 9-1	Creating a Message Digest Using PKCS #11 Functions .....	166
EXAMPLE 9-2	Creating an Encryption Key Object Using PKCS #11 Functions .....	169
EXAMPLE 9-3	Signing and Verifying Text Using PKCS #11 Functions .....	173
EXAMPLE 9-4	Generating Random Numbers Using PKCS #11 Functions .....	179

EXAMPLE A-1	Complete Listing of <code>gss-client.c</code> Sample Program .....	195
EXAMPLE A-2	Complete Code Listing for <code>gss-server.c</code> Sample Program .....	206
EXAMPLE A-3	Code Listings for Miscellaneous GSS-API Functions .....	216
EXAMPLE B-1	Displaying Status Codes with <code>gss_display_status()</code> .....	228
EXAMPLE C-1	The <code>/etc/gss/mech</code> File .....	248
EXAMPLE C-2	The <code>/etc/gss/qop</code> File .....	248
EXAMPLE C-3	<code>createMechOid()</code> Function .....	250
EXAMPLE C-4	<code>parse_oid()</code> Function .....	251

# Preface

---

The *Developer' Guide to Oracle Solaris Security* describes the public application programming interfaces (API) and service provider interfaces (SPI) for the security features in the Oracle Solaris operating environment. The term *service provider* refers to components that are plugged into a framework to provide security services, such as cryptographic algorithms and security protocols.

---

**Note** – This Solaris release supports systems that use the SPARC and x86 families of processor architectures. The supported systems appear in the [Solaris OS: Hardware Compatibility Lists \(http://www.sun.com/bigadmin/hcl\)](http://www.sun.com/bigadmin/hcl). This document cites any implementation differences between the platform types.

In this document these x86 related terms mean the following:

- “x86” refers to the larger family of 64-bit and 32-bit x86 compatible products.
- “x64” relates specifically to 64-bit x86 compatible CPUs.
- “32-bit x86” points out specific 32-bit information about x86 based systems.

For supported systems, see the *Solaris OS: Hardware Compatibility Lists*.

---

## Who Should Use This Book

The *Developer' Guide to Oracle Solaris Security* is intended for C-language developers who want to write the following types of programs:

- Privileged applications that can override system controls
- Applications that use authentication and related security services
- Applications that need to secure network communications
- Applications that use cryptographic services
- Libraries, shared objects, and plug-ins that provide or consume security services

---

**Note** – For Java-language equivalents to the Oracle Solaris features, see <http://java.sun.com/javase/technologies/security/>.

---

## Before You Read This Book

Readers of this guide should be familiar with C programming. A basic knowledge of security mechanisms is helpful but not required. You do not need to have specialized knowledge about network programming to use this book.

## How This Book Is Organized

This book is organized into the following chapters.

- [Chapter 1, “Oracle Solaris Security for Developers \(Overview\),”](#) provides an introduction to the Oracle Solaris security.
- [Chapter 2, “Developing Privileged Applications,”](#) describes how to write privileged applications that use process privileges.
- [Chapter 3, “Writing PAM Applications and Services,”](#) explains how to write a pluggable application module (PAM).
- [Chapter 4, “Writing Applications That Use GSS-API,”](#) provides an introduction to the Generic Security Service Application Programming Interface (GSS-API).
- [Chapter 5, “GSS-API Client Example,”](#) and [Chapter 6, “GSS-API Server Example,”](#) each provide a walk-through of GSS-API examples.
- [Chapter 7, “Writing Applications That Use SASL,”](#) describes how to write applications for the Simple Authentication Security Layer (SASL).
- [Chapter 8, “Introduction to the Oracle Solaris Cryptographic Framework,”](#) provides an overview of the Oracle Solaris cryptographic framework, both at the user level and kernel level.
- [Chapter 9, “Writing User-Level Cryptographic Applications and Providers,”](#) describes how to write consumers and providers for the user level of the Oracle Solaris cryptographic framework.
- [Chapter 10, “Introduction to the Oracle Solaris Key Management Framework,”](#) describes programming interfaces and administrative tools for managing Public Key Infrastructure (PKI) objects in Oracle Solaris.
- [Appendix A, “Sample C-Based GSS-API Programs,”](#) provides complete code listings for the GSS-API examples.
- [Appendix B, “GSS-API Reference,”](#) provides reference information for various items in the GSS-API.



- [Appendix C, “Specifying an OID,”](#) describes how to specify a mechanism. This technique is used in cases where a mechanism other than the default mechanism is to be used.
- [Appendix D, “Source Code for SASL Example,”](#) provides complete code listings for the SASL examples.
- [Appendix E, “SASL Reference Tables,”](#) provides brief descriptions of the major SASL interfaces.
- [Appendix F, “Packaging and Signing Cryptographic Providers,”](#) describes how to package and sign cryptographic providers.
- [Glossary](#) provides definitions for security terms that are used throughout the manual.

## Related Documentation

For other information on security features, see the following sources:

- *System Administration Guide: Security Services* provides descriptions of Oracle Solaris security features from the system administrator's point of view.
- *Application Packaging Developer's Guide*.
- [Generic Security Service Application Program Interface](#) document (<ftp://ftp.isi.edu/in-notes/rfc2743.txt>) provides a conceptual overview of the GSS-API.
- [Generic Security Service API Version 2: C-Bindings](#) document (<ftp://ftp.isi.edu/in-notes/rfc2744.txt>) discusses the specifics of the C-language-based GSS-API.
- *ONC+ Developer's Guide* provides information on remote procedure calls.

## Documentation, Support, and Training

See the following web sites for additional resources:

- [Documentation](http://docs.sun.com) (<http://docs.sun.com>)
- [Support](http://www.oracle.com/us/support/systems/index.html) (<http://www.oracle.com/us/support/systems/index.html>)
- [Training](http://education.oracle.com) (<http://education.oracle.com>) – Click the Sun link in the left navigation bar.

## Oracle Welcomes Your Comments

Oracle welcomes your comments and suggestions on the quality and usefulness of its documentation. If you find any errors or have any other suggestions for improvement, go to <http://docs.sun.com> and click Feedback. Indicate the title and part number of the documentation along with the chapter, section, and page number, if available. Please let us know if you want a reply.

Oracle Technology Network (<http://www.oracle.com/technetwork/index.html>) offers a range of resources related to Oracle software:

- Discuss technical problems and solutions on the [Discussion Forums](http://forums.oracle.com) (<http://forums.oracle.com>).
- Get hands-on step-by-step tutorials with [Oracle By Example](http://www.oracle.com/technology/obe/start/index.html) (<http://www.oracle.com/technology/obe/start/index.html>).
- Download [Sample Code](http://www.oracle.com/technology/sample_code/index.html) ([http://www.oracle.com/technology/sample\\_code/index.html](http://www.oracle.com/technology/sample_code/index.html)).

## Typographic Conventions

The following table describes the typographic conventions that are used in this book.

TABLE P-1 Typographic Conventions

Typeface	Meaning	Example
AaBbCc123	The names of commands, files, and directories, and onscreen computer output	Edit your <code>.login</code> file. Use <code>ls -a</code> to list all files. <code>machine_name% you have mail.</code>
<b>AaBbCc123</b>	What you type, contrasted with onscreen computer output	<code>machine_name% su</code> Password:
<i>aabbcc123</i>	Placeholder: replace with a real name or value	The command to remove a file is <i>rm filename</i> .
<i>AaBbCc123</i>	Book titles, new terms, and terms to be emphasized	Read Chapter 6 in the <i>User's Guide</i> . <i>A cache</i> is a copy that is stored locally. Do <i>not</i> save the file. <b>Note:</b> Some emphasized items appear bold online.

---

## Shell Prompts in Command Examples

The following table shows the default UNIX system prompt and superuser prompt for shells that are included in the Oracle Solaris OS. Note that the default system prompt that is displayed in command examples varies, depending on the Oracle Solaris release.

TABLE P-2 Shell Prompts

Shell	Prompt
Bash shell, Korn shell, and Bourne shell	\$
Bash shell, Korn shell, and Bourne shell for superuser	#
C shell	machine_name%
C shell for superuser	machine_name#



# Oracle Solaris Security for Developers (Overview)

---

This manual documents the public application programming interfaces (APIs) and service provider interfaces (SPIs) for the security features in the Oracle Solaris Operating System (Oracle Solaris OS).

This chapter covers the following areas:

- “System Security” on page 21
- “Network Security Architecture” on page 22

## Overview of Oracle Solaris Security Features for Developers

This manual covers the public APIs and public SPIs to security features in the Oracle Solaris operating system. For information on how these security features operate from the system administrator's viewpoint, see *System Administration Guide: Security Services*.

The Oracle Solaris OS provides a network security architecture that is based on standard industry interfaces. Through the use of standardized interfaces, applications that consume or provide cryptographic services should need no modification as security technologies evolve.

## System Security

For system security, the Oracle Solaris OS provides process privileges. *Process privileges* are an alternative to the standard, superuser-based UNIX model for granting access to privileged applications. The system administrator assigns users a set of process privileges that permit access to privileged applications. A user does not need to become superuser to use a privileged application.

Privileges enable system administrators to delegate limited permission to users to override system security instead of giving users complete root access. Accordingly, developers who create new privileged applications should test for specific privileges instead of checking for UID = 0. See Chapter 2, “Developing Privileged Applications.”

For highly stringent system security, the Trusted Extensions feature of the Oracle Solaris is also provided, which is outside of the scope of this book. The Trusted Extensions feature enables system administrators to specify the applications and files that a particular user can access. See [http://www.sun.com/software/solaris/ds/trusted\\_extensions.jsp](http://www.sun.com/software/solaris/ds/trusted_extensions.jsp) for more information.

## Network Security Architecture

The network security architecture works with standard industry interfaces, such as PAM, GSS-API, SASL, and RSA Security Inc. PKCS#11 Cryptographic Token Interface (Cryptoki). Through the use of standardized protocols and interfaces, developers can write both consumers and providers that need no modification as security technologies evolve.

An application, library, or kernel module that uses security services is called a *consumer*. An application that provides security services to consumers is referred to as a *provider* and also as a *plug-in*. The software that implements a cryptographic operation is called a *mechanism*. A mechanism is not just an algorithm but includes the manner in which the algorithm is to be applied. For example, one mechanism might apply the DES algorithm to authentication. A different mechanism might apply DES to data protection with block-by-block encryption.

The network security architecture eliminates the need for developers of consumers to write, maintain, and optimize cryptographic algorithms. Optimized cryptographic mechanisms are provided as part of the architecture.

The Oracle Solaris OS provides the following public interfaces for security:

- **PAM** – Pluggable authentication modules. PAM modules are mainly used for the initial authentication of a user to a system. The user can enter the system by GUI, command line, or some other means. In addition to authentication services, PAM provides services for managing accounts, sessions, and passwords. Applications such as `login`, `rlogin`, and `telnet` are typical consumers of PAM services. The PAM SPI is supplied services by security providers such as Kerberos v5. See [Chapter 3, “Writing PAM Applications and Services.”](#)
- **GSS-API** – Generic security service application program interface. The GSS-API provides secure communication between peer applications. The GSS-API provides authentication, integrity, and confidentiality protection services as well. The Oracle Solaris implementation of the GSS-API works with Kerberos v5, SPNEGO, and Diffie-Hellman encryption. The GSS-API is primarily used to design or implement secure application protocols. GSS-API can provide services to other kinds of protocols, such as SASL. Through SASL, GSS-API provides services to LDAP.

GSS-API is typically used by two peer applications that are communicating over a network after the initial establishment of credentials has occurred. GSS-API is used by login applications, NFS, and ftp, among other applications.

See Chapter 4, “Writing Applications That Use GSS-API,” for an introduction to GSS-API. Chapter 5, “GSS-API Client Example,” and Chapter 6, “GSS-API Server Example,” provides the source code descriptions of two typical GSS-API applications. Appendix A, “Sample C-Based GSS-API Programs,” presents the code listings for the GSS-API examples. Appendix B, “GSS-API Reference,” provides reference material for GSS-API. Appendix C, “Specifying an OID,” demonstrates how to specify a mechanism other than the default mechanism.

- **SASL** – Simple authentication and security layer. SASL is used largely by protocols, for authentication, privacy, and data integrity. SASL is intended for higher-level network-based applications that use dynamic negotiation of security mechanisms to protect sessions. LDAP is one of the better-known consumers of SASL. SASL is similar to GSS-API. SASL is on a somewhat higher level than GSS-API. SASL consumes GSS-API services. See Chapter 7, “Writing Applications That Use SASL.”
- **Cryptographic framework** – The cryptographic framework is the backbone of cryptographic services in the Oracle Solaris OS. The framework provides standard PKCS #11 interfaces to accommodate consumers and providers of cryptographic services. The framework has two parts: the user cryptographic framework for user-level applications and the kernel cryptographic framework for kernel-level modules. Consumers that are connected to the framework need no special knowledge of the installed cryptographic mechanisms. Providers plug into the framework with no special code necessary for the different types of consumers.

The consumers of the cryptographic framework include security protocols, certain mechanisms, and applications that need to perform cryptography. The providers to the framework are cryptographic mechanisms as well as other mechanisms in hardware and software plug-ins. See Chapter 8, “Introduction to the Oracle Solaris Cryptographic Framework,” for an overview of the cryptographic framework. See Chapter 9, “Writing User-Level Cryptographic Applications and Providers,” to learn how to write user-level applications that consume services from the framework.

The library for the cryptographic framework is an implementation of the RSA PKCS#11 v2.11 specification. Both consumers and providers communicate with the user-level cryptographic framework through standard PKCS #11 calls.

- **Java API** – Java security technology includes a large set of APIs, tools, and implementations of commonly used security algorithms, mechanisms, and protocols. The Java security APIs span a wide range of areas, including cryptography, public key infrastructure, secure communication, authentication, and access control. Java security technology provides the developer with a comprehensive security framework for writing applications, and also provides the user or administrator with a set of tools to securely manage applications. See <http://java.sun.com/javase/technologies/security/>.





# Developing Privileged Applications

---

This chapter describes how to develop privileged applications.

The chapter covers the following topics:

- “Privileged Applications” on page 25
- “About Privileges” on page 26
- “Programming with Privileges” on page 29
- “About Authorizations” on page 36

## Privileged Applications

A *privileged application* is an application that can override system controls and check for specific user IDs (UIDs), group IDs (GIDs), authorizations, or privileges. These access control elements are assigned by system administrators. For a general discussion of how administrators use these access control elements, see [Chapter 8, “Using Roles and Privileges \(Overview\),” in \*System Administration Guide: Security Services\*](#).

The Oracle Solaris operating system provides developers with two elements that enable a finer-grained delegation of privileges:

- **Privileges** - A *privilege* is a discrete right that can be granted to an application. With a privilege, a process can perform an operation that would otherwise be prohibited by the Oracle Solaris OS. For example, processes cannot normally open data files without the proper file permission. The `file_dac_read` privilege provides a process with the ability to override the UNIX file permissions for reading a file. Privileges are enforced at the kernel level.
- **Authorizations** - An *authorization* is a permission for performing a class of actions that are otherwise prohibited by security policy. An authorization can be assigned to a role or user. Authorizations are enforced at the user level.

The difference between authorizations and privileges has to do with the level at which the policy of who can do what is enforced. Privileges are enforced at the kernel level. Without the proper privilege, a process cannot perform specific operations in a privileged application. Authorizations enforce policy at the user application level. An authorization might be required for access to a privileged application or for specific operations within a privileged application.

## About Privileges

A privilege is a discrete right that is granted to a process to perform an operation that would otherwise be prohibited by the Oracle Solaris operating system. Most programs do not use privileges, because a program typically operates within the bounds of the system security policy.

Privileges are assigned by an administrator. Privileges are enabled according to the design of the program. At login or when a profile shell is entered, the administrator's privilege assignments apply to any commands that are executed in the shell. When an application is run, privileges are turned on or turned off programmatically. If a new program is started by using the `exec(1)` command, that program can potentially use all of the parent process's inheritable privileges. However, that program cannot add any new privileges.

## How Administrators Assign Privileges

System administrators are responsible for assigning privileges to commands. For more information on privilege assignment, see “[Privileges \(Overview\)](#)” in *System Administration Guide: Security Services*.

## How Privileges Are Implemented

Every process has four sets of privileges that determine whether a process can use a particular privilege:

- Permitted privilege set
- Inheritable privilege set
- Limit privilege set
- Effective privilege set

### Permitted Privilege Set

All privileges that a process can ever potentially use must be included in the permitted set. Conversely, any privilege that is never to be used should be excluded from the permitted set for that program.

When a process is started, that process inherits the permitted privilege set from the parent process. Typically at login or from a new profile shell, all privileges are included in the initial set of permitted privileges. The privileges in this set are specified by the administrator. Each child

process can remove privileges from the permitted set, but the child cannot add other privileges to the permitted set. As a security precaution, you should remove those privileges from the permitted set that the program never uses. In this way, a program can be protected from using an incorrectly assigned or inherited privilege.

Privileges that are removed from the permitted set are automatically removed from the effective set.

## Inheritable Privilege Set

At login or from a new profile shell, the inheritable set contains the privileges that have been specified by the administrator. These inheritable privileges can potentially be passed on to child processes after an `exec(1)` call. A process should remove any unnecessary privileges to prevent these privileges from passing on to a child process. Often the permitted and inheritable sets are the same. However, there can be cases where a privilege is taken out of the inheritable set, but that privilege remains in the permitted set.

## Limit Privilege Set

The limit set enables a developer to control which privileges a process can exercise or pass on to child processes. A child process and the descendant processes can only obtain privileges that are in the limit set. When a `setuid(0)` function is executed, the limit set determines the privileges that the application is permitted to use. The limit set is enforced at `exec(1)` time. Removal of privileges from the limit set does not affect any other sets until the `exec(1)` is performed.

## Effective Privilege Set

The privileges that a process can actually use are in the process's effective set. At the start of a program, the effective set is equal to the permitted set. Afterwards, the effective set is either a subset of or is equal to the permitted set.

A good practice is to reduce the effective set to the set of basic privileges. The basic privilege set, which contains the core privileges, is described in [“Privilege Categories” on page 28](#). Remove completely any privileges that are not needed in the program. Toggle off any basic privileges until that privilege is needed. For example, the `file_dac_read` privilege, enables all files to be read. A program can have multiple routines for reading files. The program turns off all privileges initially and turns on `file_dac_read`, for appropriate reading routines. The developer thus ensures that the program cannot exercise the `file_dac_read` privilege for the wrong reading routines. This practice is called *privilege bracketing*. Privilege bracketing is demonstrated in [“Privilege Coding Example” on page 32](#).

## Compatibility Between the Superuser and Privilege Models

To accommodate legacy applications, the implementation of privileges works with both the superuser and privilege models. This accommodation is achieved through use of the `PRIV_AWARE` flag, which indicates that a program works with privileges. The `PRIV_AWARE` flag is handled automatically by the operating system.

Consider a child process that is not aware of privileges. The `PRIV_AWARE` flag for that process would be false. Any privileges that have been inherited from the parent process are available in the permitted and effective sets. If the child sets a UID to 0, the process's effective and permitted sets are restricted to those privileges in the limit set. The child process does not gain full superuser powers. Thus, the limit set of a privilege-aware process restricts the superuser privileges of any non-privilege-aware child processes. If the child process modifies any privilege set, then the `PRIV_AWARE` flag is set to true.

## Privilege Categories

Privileges are logically grouped on the basis of the scope of the privilege, as follows:

- Basic privileges – The core privileges that are needed for minimal operation.
  - `PRIV_FILE_LINK_ANY` – Allows a process to create hard links to files that are owned by a UID other than the process's effective UID.
  - `PRIV_PROC_EXEC` – Allows a process to call `execve()`.
  - `PRIV_PROC_FORK` – Allows a process to call `fork()`, `fork1()`, or `vfork()`.
  - `PRIV_PROC_SESSION` – Allows a process to send signals or trace processes outside its session.
  - `PRIV_PROC_INFO` – Allows a process to examine the status of processes outside of those processes to which the inquiring process can send signals. Without this privilege, processes that cannot be seen in `/proc` cannot be examined.

In general, the basic privileges should be assigned as a set rather than individually. This approach ensures that any basic privileges that are released in an update to the Oracle Solaris OS will be included in the assignment. On the other hand, a privilege that is known not to be needed by a program should be explicitly turned off. For example, the `proc_exec` privilege should be turned off if the program is not intended to `exec(1)` sub-processes.

- File system privileges.
- System V Interprocess Communication (IPC) privileges.
- Network privileges.
- Process privileges.
- System privileges.

See the [privileges\(5\)](#) man page for a complete list of the Oracle Solaris privileges with descriptions.

---

**Note** – Oracle Solaris provides the zones facility, which lets an administrator set up isolated environments for running applications. See [zones\(5\)](#). Since a process in a zone is prevented from monitoring or interfering with other activity in the system outside of that zone, any privileges on that process are limited to the zone as well. However, if needed, the `PRIV_PROC_ZONE` privilege can be applied to processes in the global zone that need privileges to operate in non-global zones.

---

## Programming with Privileges

This section discusses the interfaces for working with privileges. To use the privilege programming interfaces, you need the following header file.

```
#include <priv.h>
```

An example demonstrating how privilege interfaces are used in a privileged application is also provided.

## Privilege Data Types

The major data types that are used by the privilege interfaces are:

- **Privilege type** – An individual privilege is represented by the `priv_t` type definition. You initialize a variable of type `priv_t` with a privilege ID string, as follows:
 

```
priv_t priv_id = PRIV_FILE_DAC_WRITE;
```
- **Privilege set type** – Privilege sets are represented by the `priv_set_t` data structure. Use one of the privilege manipulation functions shown in [Table 2-1](#) to initialize variables of type `priv_set_t`.
- **Privilege operation type** – The type of operation to be performed on a file or process privilege set is represented by the `priv_op_t` type definition. Not all operations are valid for every type of privilege set. Read the privilege set descriptions in [“Programming with Privileges” on page 29](#) for details.

Privilege operations can have the following values:

- `PRIV_ON` – Turn the privileges that have been asserted in the `priv_set_t` structure on in the specified file or process privilege set.
- `PRIV_OFF` – Turn the privileges asserted in the `priv_set_t` structure off in the specified file or process privilege set.

- `PRIV_SET` – Set the privileges in the specified file or process privilege set to the privileges asserted in the `priv_set_t` structure. If the structure is initialized to empty, `PRIV_SET` sets the privilege set to none.

## Privilege Interfaces

The following table lists the interfaces for using privileges. Descriptions of some major privilege interfaces are provided after the table.

TABLE 2-1 Interfaces for Using Privileges

Purpose	Functions	Additional Comments
Getting and setting privilege sets	<code>setppriv(2)</code> , <code>getppriv(2)</code> , <code>priv_set(3C)</code> , <code>priv_ineffect(3C)</code>	<code>setppriv()</code> and <code>getppriv()</code> are system calls. <code>priv_ineffect()</code> and <code>priv_set()</code> are wrappers for convenience.
Identifying and translating privileges	<code>priv_str_to_set(3C)</code> , <code>priv_set_to_str(3C)</code> , <code>priv_getbyname(3C)</code> , <code>priv_getbynum(3C)</code> , <code>priv_getsetbyname(3C)</code> , <code>priv_getsetbynum(3C)</code>	These functions map the specified privilege or privilege set to a name or a number.
Manipulating privilege sets	<code>priv_allocset(3C)</code> , <code>priv_freeset(3C)</code> , <code>priv_emptyset(3C)</code> , <code>priv_fillset(3C)</code> , <code>priv_isemptyset(3C)</code> , <code>priv_isfullset(3C)</code> , <code>priv_isequalset(3C)</code> , <code>priv_issubset(3C)</code> , <code>priv_intersect(3C)</code> , <code>priv_union(3C)</code> , <code>priv_inverse(3C)</code> , <code>priv_addset(3C)</code> , <code>priv_copyset(3C)</code> , <code>priv_delset(3C)</code> , <code>priv_ismember(3C)</code>	These functions are concerned with privilege memory allocation, testing, and various set operations.
Getting and setting process flags	<code>getpflags(2)</code> , <code>setpflags(2)</code>	The <code>PRIV_AWARE</code> process flag indicates whether the process understands privileges or runs under the superuser model. <code>PRIV_DEBUG</code> is used for privilege debugging.

TABLE 2-1 Interfaces for Using Privileges (Continued)

Purpose	Functions	Additional Comments
Low-level credential manipulation	<code>ucred_get(3C)</code>	These routines are used for debugging, low-level system calls, and kernel calls.

## setppriv(): for Setting Privileges

The main function for setting privileges is `setppriv()`, which has the following syntax:

```
int setppriv(priv_op_t op, priv_ptype_t which, \
const priv_set_t *set);
```

*op* represents the privilege operation that is to be performed. The *op* parameter has one of three possible values:

- `PRIV_ON` – Adds the privileges that are specified by the *set* variable to the set type that is specified by *which*
- `PRIV_OFF` – Removes the privileges that are specified by the *set* variable from the set type that is specified by *which*
- `PRIV_SET` – Uses the privileges that are specified by the *set* variable to replace privileges in the set type that is specified by *which*

*which* specifies the type of privilege set to be changed, as follows:

- `PRIV_PERMITTED`
- `PRIV_EFFECTIVE`
- `PRIV_INHERITABLE`
- `PRIV_LIMIT`

*set* specifies the privileges to be used in the change operation.

In addition, a convenience function is provided: `priv_set()`.

## priv\_str\_to\_set() for Mapping Privileges

These functions are convenient for mapping privilege names with their numeric values.

`priv_str_to_set()` is a typical function in this family. `priv_str_to_set()` has the following syntax:

```
priv_set_t *priv_str_to_set(const char *buf, const char *set, \
const char **endptr);
```

`priv_str_to_set()` takes a string of privilege names that are specified in *buf*.

`priv_str_to_set()` returns a set of privilege values that can be combined with one of the four privilege sets. *\*\*endptr* can be used to debug parsing errors.

Note that the following keywords can be included in buf:

- “all” indicates all defined privileges. “all, !priv\_name, . . .” enables you to specify all privileges except the indicated privileges.

---

**Note** – Constructions that use “priv\_set, !priv\_name, . . .” subtract the specified privilege from the specified set of privileges. Do not use “!priv\_name, . . .” without first specifying a set because with no privilege set to subtract from, the construction subtracts the specified privileges from an empty set of privileges and effectively indicates no privileges.

---

- “none” indicates no privileges.
- “basic” indicates the set of privileges that are required to perform operations that are traditionally granted to all users on login to a standard UNIX operating system.

## Privilege Coding Example

This section compares how privileges are bracketed using the superuser model and the least privilege model.

### Privilege Bracketing in the Superuser Model

The following example demonstrates how privileged operations are bracketed in the superuser model.

#### EXAMPLE 2-1 Superuser Privilege Bracketing Example

```
/* Program start */
uid = getuid();
setuid(uid);

/* Privilege bracketing */
setuid(0);
/* Code requiring superuser capability */
...
/* End of code requiring superuser capability */
setuid(uid);
...
/* Give up superuser ability permanently */
setreuid(uid,uid);
```

### Privilege Bracketing in the Least Privilege Model

This example demonstrates how privileged operations are bracketed in the least privilege model. The example uses the following assumptions:

- The program is setuid 0.
- The permitted and effective sets are initially set to all privileges as a result of setuid 0.



- The inheritable set is initially set to the basic privileges.
- The limit set is initially set to all privileges.

An explanation of the example follows the code listing.

---

**Note** – The source code for this example is also available through the Sun download center. See <http://www.sun.com/download/products.xml?id=41912db5>.

---

#### EXAMPLE 2-2 Least Privilege Bracketing Example

```

1 #include <priv.h>
2 /* Always use the basic set. The Basic set might grow in future
3  * releases and potentially restrict actions that are currently
4  * unrestricted */
5 priv_set_t *temp = priv_str_to_set("basic", "", NULL);

6 /* PRIV_FILE_DAC_READ is needed in this example */
7 (void) priv_addset(temp, PRIV_FILE_DAC_READ);

8 /* PRIV_PROC_EXEC is no longer needed after program starts */
9 (void) priv_delset(temp, PRIV_PROC_EXEC);

10 /* Compute the set of privileges that are never needed */
11 priv_inverse(temp);

12 /* Remove the set of unneeded privs from Permitted (and by
13  * implication from Effective) */
14 (void) setppriv(PRIV_OFF, PRIV_PERMITTED, temp);

15 /* Remove unneeded priv set from Limit to be safe */
16 (void) setppriv(PRIV_OFF, PRIV_LIMIT, temp);

17 /* Done with temp */
18 priv_freeset(temp);

19 /* Now get rid of the euid that brought us extra privs */
20 (void) seteuid(getuid());

21 /* Toggle PRIV_FILE_DAC_READ off while it is unneeded */
22 priv_set(PRIV_OFF, PRIV_EFFECTIVE, PRIV_FILE_DAC_READ, NULL);

23 /* Toggle PRIV_FILE_DAC_READ on when special privilege is needed*/
24 priv_set(PRIV_ON, PRIV_EFFECTIVE, PRIV_FILE_DAC_READ, NULL);

25 fd = open("/some/restricted/file", O_RDONLY);

26 /* Toggle PRIV_FILE_DAC_READ off after it has been used */
27 priv_set(PRIV_OFF, PRIV_EFFECTIVE, PRIV_FILE_DAC_READ, NULL);

28 /* Remove PRIV_FILE_DAC_READ when it is no longer needed */
29 priv_set(PRIV_OFF, PRIV_ALLSETS, PRIV_FILE_DAC_READ, NULL);

```

The program defines a variable that is named *temp*. The *temp* variable determines the set of privileges that are not needed by this program. Initially in line 5, *temp* is defined to contain the

set of basic privileges. In line 7, the `file_dac_read` privilege is added to `temp`. The `proc_exec` privilege is necessary to `exec(1)` new processes, which is not permitted in this program. Therefore, `proc_exec` is removed from `temp` in line 9 so that the `exec(1)` command cannot execute new processes.

At this point, `temp` contains only those privileges that are needed by the program, that is, the basic set plus `file_dac_read` minus `proc_exec`. In line 11, the `priv_inverse()` function computes the inverse of `temp` and resets the value of `temp` to the inverse. The inverse is the result of subtracting the specified set, `temp` in this case, from the set of all possible privileges. As a result of line 11, `temp` now contains those privileges that are never needed by the program. In line 14, the unneeded privileges that are defined by `temp` are subtracted from the permitted set. This removal effectively removes the privileges from the effective set as well. In line 16, the unneeded privileges are removed from the limit set. In line 18, the `temp` variable is freed, since `temp` is no longer needed.

This program is aware of privileges. Accordingly, the program does not use `setuid` and can reset the effective UID to the user's real UID in line 20.

The `file_dac_read` privilege is turned off in line 22 through removal from the effective set. In a real program, other activities would take place before `file_dac_read` is needed. In this sample program, `file_dac_read` is needed for to read a file in line 25. Accordingly, `file_dac_read` is turned on in line 24. Immediately after the file is read, `file_dac_read` is again removed from the effective set. When all files have been read, `file_dac_read` is removed for good by turning off `file_dac_read` in all privilege sets.

The following table shows the transition of the privilege sets as the program progresses. The line numbers are indicated.

TABLE 2-2 Privilege Set Transition

Step	<i>temp</i> Set	Permitted Privilege Set	Effective Privilege Set	Limit Privilege Set
Initially	–	all	all	all
Line 5 – <i>temp</i> is set to basic privileges	basic	all	all	all
Line 7 – <code>file_dac_read</code> is added to <i>temp</i> .	basic + <code>file_dac_read</code>	all	all	all
Line 9 – <code>proc_exec</code> is removed from <i>temp</i> .	basic + <code>file_dac_read</code> – <code>proc_exec</code>	all	all	all
Line 11 – <i>temp</i> is reset to the inverse.	all – (basic + <code>file_dac_read</code> – <code>proc_exec</code> )	all	all	all

TABLE 2-2 Privilege Set Transition (Continued)

Step	<i>temp</i> Set	Permitted Privilege Set	Effective Privilege Set	Limit Privilege Set
Line 14 – The unneeded privileges are turned off in the permitted set.	all – (basic + file_dac_read – proc_exec)	basic + file_dac_read – proc_exec	basic + file_dac_read – proc_exec	all
Line 16 – The unneeded privileges are turned off in the limit set.	all – (basic + file_dac_read – proc_exec)	basic + file_dac_read – proc_exec	basic + file_dac_read – proc_exec	basic + file_dac_read – proc_exec
Line 18 – The <i>temp</i> file is freed.	–	basic + file_dac_read – proc_exec	basic + file_dac_read – proc_exec	basic + file_dac_read – proc_exec
Line 22 – Turn off file_dac_read until needed.	–	basic – proc_exec	basic – proc_exec	basic + file_dac_read – proc_exec
Line 24 – Turn on file_dac_read when needed.	–	basic + file_dac_read – proc_exec	basic + file_dac_read – proc_exec	basic + file_dac_read – proc_exec
Line 27 – Turn off file_dac_read after read() operation.	–	basic – proc_exec	basic – proc_exec	basic + file_dac_read – proc_exec
Line 29 – Remove file_dac_read from all sets when no longer needed.	–	basic – proc_exec	basic – proc_exec	basic – proc_exec

## Guidelines for Developing Privileged Applications

This section provides the following suggestions for developing privileged applications:

- **Use an isolated system.** You should never debug privileged applications on a production system, as an incomplete privileged application can compromise security.
- **Set IDs properly.** The calling process needs the `proc_setid` privilege in its effective set to change its user ID, group ID, or supplemental group ID.
- **Use privilege bracketing.** When an application uses privilege, system security policy is being overridden. Privileged tasks should be bracketed and carefully controlled to ensure that sensitive information is not compromised. See “[Privilege Coding Example](#)” on page 32 for information on how to bracket privileges.
- **Start with the basic privileges.** The basic privileges are necessary for minimal operation. A privileged application should start with the basic set. The application should then subtract and add privileges appropriately.

A typical start-up scenario follows.

1. The daemon starts up as root.
  2. The daemon turns on the basic privilege set.
  3. The daemon turns off any basic privileges that are unnecessary, for example, `PRIV_FILE_LINK_ANY`.
  4. The daemon adds any other privileges that are needed, for example, `PRIV_FILE_DAC_READ`.
  5. The daemon switches to the daemon UID.
- **Avoid shell escapes.** The new process in a shell escape can use any of the privileges in the parent process's inheritable set. An end user can therefore potentially violate trust through a shell escape. For example, some mail applications might interpret the `!` command line as a command and would execute that line. An end user could thus create a script to take advantage of any mail application privileges. The removal of unnecessary shell escapes is a good practice.

## About Authorizations

Authorizations are stored in the `/etc/security/auth_attr` file. To create an application that uses authorizations, take the following steps:

1. Scan the `/etc/security/auth_attr` for one or more appropriate authorizations.
2. Check for the required authorization at the beginning of the program using the `chkauthattr(3SECDB)` function.

The `chkauthattr()` function searches for the authorization in order in the following locations:

- `AUTHS_GRANTED` key in the `policy.conf(4)` database – `AUTHS_GRANTED` indicates authorizations that have been assigned by default.
- `PROFS_GRANTED` key in the `policy.conf(4)` database – `PROFS_GRANTED` indicates rights profiles that have been assigned by default. `chkauthattr()` checks these rights profiles for the specified authorization.
- The `user_attr(4)` database – This database stores security attributes that have been assigned to users.
- The `prof_attr(4)` database – This database stores rights profiles that have been assigned to users.

If `chkauthattr()` cannot find the right authorization in any of these places, then the user is denied access to the program.

3. Let the administrator know which authorizations are required for this application. You can inform the administrators through man pages or other documentation.

**EXAMPLE 2-3** Checking for Authorizations

The following code snippet demonstrates how the `chkauthattr()` function can be used to check a user's authorization. In this case, the program checks for the `solaris.job.admin` authorization. If the user has this authorization, the user is able to read or write to other users' files. Without the authorization, the user can operate on owned files only.

```
/* Define override privileges */
priv_set_t *override_privs = priv_allocset();

/* Clear privilege set before adding privileges. */
priv_set(PRIV_OFF, PRIV_EFFECTIVE, PRIV_FILE_DAC_READ,
         priv_FILE_DAC_WRITE, NULL);

priv_addset(override_privs, PRIV_FILE_DAC_READ);
priv_addset(override_privs, PRIV_FILE_DAC_WRITE);

if (!chkauthattr("solaris.jobs.admin", username)) {
    /* turn off privileges */
    setppriv(PRIV_OFF, PRIV_EFFECTIVE, override_privs);
}
/* Authorized users continue to run with privileges */
/* Other users can read or write to their own files only */
```



# Writing PAM Applications and Services

---

Pluggable authentication modules (PAM) provide system entry applications with authentication and related security services. This chapter is intended for developers of system entry applications who wish to provide authentication, account management, session management, and password management through PAM modules. There is also information for designers of PAM service modules.

The following topics are discussed:

- “Introduction to the PAM Framework” on page 39
- “PAM Configuration” on page 42
- “Writing Applications That Use PAM Services” on page 42
- “Writing Modules That Provide PAM Services” on page 51

PAM was originally developed at Sun. The PAM specification has since been submitted to X/Open, which is now the Open Group. The PAM specification is available in *X/Open Single Sign-On Service (XSSO) - Pluggable Authentication*, Open Group, UK ISBN 1-85912-144-6 June 1997. The Oracle Solaris implementation of PAM is described in the [pam\(3PAM\)](#), [libpam\(3LIB\)](#), and [pam\\_sm\(3PAM\)](#) man pages.

## Introduction to the PAM Framework

The PAM framework consists of four parts:

- PAM consumers
- PAM library
- The [pam.conf\(4\)](#) configuration file
- PAM service modules, also referred to as providers

The framework provides a uniform way for authentication-related activities to take place. This approach enables application developers to use PAM services without having to know the semantics of the policy. Algorithms are centrally supplied. The algorithms can be modified

independently of the individual applications. With PAM, administrators can tailor the authentication process to the needs of a particular system without having to change any applications. Adjustments are made through `pam.conf`, the PAM configuration file.

The following figure illustrates the PAM architecture. Applications communicate with the PAM library through the PAM application programming interface (API). PAM modules communicate with the PAM library through the PAM service provider interface (SPI). Thus, the PAM library enables applications and modules to communicate with each other.

FIGURE 3-1 PAM Architecture

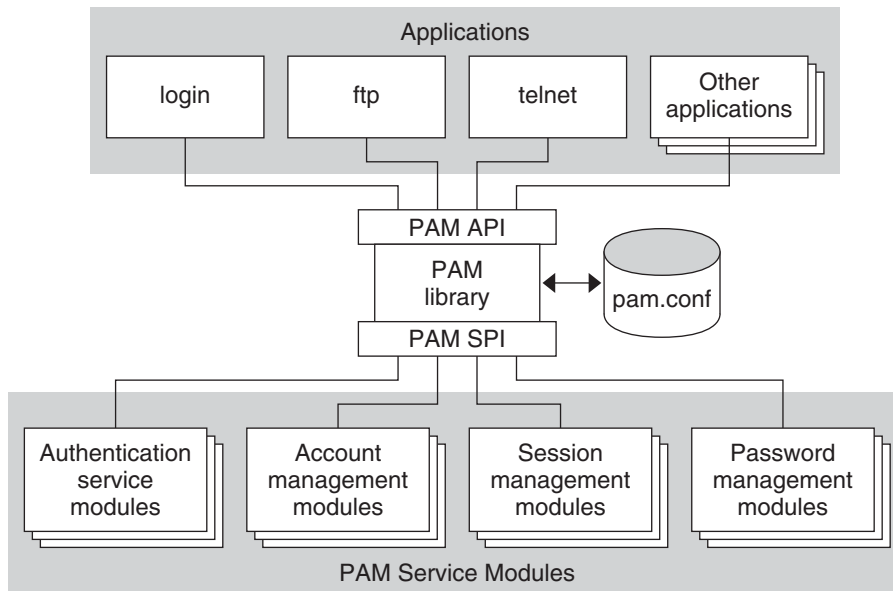

## PAM Service Modules

A PAM service module is a shared library that provides authentication and other security services to system entry applications such as `login`, `rlogin`, and `telnet`.

The four types of PAM services are:

- **Authentication service modules** – For granting users access to an account or service. Modules that provide this service authenticate users and set up user credentials.
- **Account management modules** – For determining whether the current user's account is valid. Modules that provide this service can check password or account expiration and time-restricted access.
- **Session management modules** – For setting up and terminating login sessions.



- **Password management modules** – For enforcing password strength rules and performing authentication token updates.

A PAM module can implement one or more of these services. The use of simple modules with well-defined tasks increases configuration flexibility. PAM services should thus be implemented in separate modules. The services can then be used as needed as defined in the `pam.conf(4)` file.

For example, the Oracle Solaris OS provides the `pam_authtok_check(5)` module for system administrators to configure the site's password policy. The `pam_authtok_check(5)` module checks proposed passwords for various strength criteria.

For a complete list of Oracle Solaris PAM modules, see *man pages section 5: Standards, Environments, and Macros*. The PAM modules have the prefix `pam_`.

## PAM Library

The PAM library, `libpam(3LIB)`, is the central element in the PAM architecture:

- `libpam` exports an API, `pam(3PAM)`. Applications can call this API for authentication, account management, credential establishment, session management, and password changes.
- `libpam` imports a master configuration file `pam.conf(4)`. The PAM configuration file specifies the PAM module requirements for each available service. `pam.conf` is managed by a system administrator.
- `libpam` imports an SPI, `pam_sm(3PAM)`, which is exported by the service modules.

## PAM Authentication Process

As an example of how consumers use the PAM library for user authentication, consider how `login` authenticates a user:

1. The `login` application initiates a PAM session by calling `pam_start(3PAM)` and by specifying the `login` service.
2. The application calls `pam_authenticate(3PAM)`, which is part of the PAM API that is exported by the PAM library, `libpam(3LIB)`.
3. The library searches for `login` entries in the `pam.conf` file.
4. For each module in `pam.conf` that is configured for the `login` service, the PAM library calls `pam_sm_authenticate(3PAM)`. The `pam_sm_authenticate()` function is part of the PAM SPI. The `pam.conf` control flag and results of each call determine whether the user is allowed access to the system. This process is described in more detail in “PAM Configuration (Reference)” in *System Administration Guide: Security Services*.

In this way, the PAM library connects PAM applications with the PAM modules that have been configured by the system administrator.

## Requirements for PAM Consumers

PAM consumers must be linked with the PAM library `libpam`. Before an application can use any service that is provided by the modules, the application must initialize its instance of the PAM library by calling `pam_start(3PAM)`. The call to `pam_start()` initializes a handle that must be passed to all subsequent PAM calls. When an application is finished with the PAM services, `pam_end()` is called to clean up any data that was used by the PAM library.

Communication between the PAM application and the PAM modules takes place through *items*. For example, the following items are useful for initialization:

- `PAM_USER` – Currently authenticated user
- `PAM_AUTHTOK` – Password
- `PAM_USER_PROMPT` – User name prompt
- `PAM_TTY` – Terminal through which the user communication takes place
- `PAM_RHOST` – Remote host through which user enters the system
- `PAM_REPOSITORY` – Any restrictions on the user account repository
- `PAM_RESOURCE` – Any controls on resources

For a complete list of available items, see `pam_set_item(3PAM)`. Items can be set by the application through `pam_set_item(3PAM)`. Values that have been set by the modules can be retrieved by the application through `pam_get_item(3PAM)`. However, `PAM_AUTHTOK` and `PAM_OLDAUTHTOK` cannot be retrieved by the application. The `PAM_SERVICE` item cannot be set.

## PAM Configuration

The PAM configuration file, `pam.conf(4)`, is used to configure PAM service modules for system services, such as `login`, `rlogin`, `su`, and `cron`. The system administrator manages this file. An incorrect order of entries in `pam.conf` can cause unforeseen side effects. For example, a badly configured `pam.conf` can lock out users so that single-user mode becomes necessary for repair. For information on PAM configuration, see “[PAM Configuration \(Reference\)](#)” in *System Administration Guide: Security Services*.

## Writing Applications That Use PAM Services

This section provides a sample application that uses several PAM functions.

### A Simple PAM Consumer Example

The following PAM consumer application is provided as an example. The example is a basic terminal-lock application that validates a user trying to access a terminal.

The example goes through the following steps:

1. Initialize the PAM session.

PAM sessions are initiated by calling the `pam_start(3PAM)` function. A PAM consumer application must first establish a PAM session before calling any of the other PAM functions.

The `pam_start(3PAM)` function takes the following arguments:

- `plock` – Service name, that is, the name of the application. The service name is used by the PAM framework to determine which rules in the configuration file, `/etc/pam.conf`, are applicable. The service name is generally used for logging and error-reporting.
- `pw->pw_name` – The username is the name of the user that the PAM framework acts on.
- `&conv` – The conversation function, `conv`, which provides a generic means for PAM to communicate with a user or application. Conversation functions are necessary because the PAM modules have no way of knowing how communication is to be conducted. Communication can be by means of GUIs, the command line, a smart card reader, or other devices. For more information, see “[Writing Conversation Functions](#)” on page 47.
- `&pamh` – The PAM handle, `pamh`, which is an opaque handle that is used by the PAM framework to store information about the current operation. This handle is returned by a successful call to `pam_start()`.

---

**Note** – An application that calls PAM interfaces must be sufficiently privileged to perform any needed operations such as authentication, password change, process credential manipulation, or audit state initialization. In this example, the application must be able to read `/etc/shadow` to verify the passwords for local users.

---

2. Authenticate the user.

The application calls `pam_authenticate(3PAM)` to authenticate the current user.

Generally, the user is required to enter a password or other authentication token depending on the type of authentication service. The PAM framework invokes the modules listed for the authentication service, `auth`, in `/etc/pam.conf`. The service name `plock` is used to determine which `pam.conf` entries are to be used. If there are no entries for `plock`, then the entries in `other` are used by default. If NULL passwords are explicitly disallowed in the application configuration file, then the `PAM_DISALLOW_NULL_AUTHTOK` flag should be passed. Oracle Solaris applications check the `PASSREQ=YES` setting in `/etc/default/login`.

3. Check account validity.

The example uses the `pam_acct_mgmt(3PAM)` function to check the validity of the authenticated user's account. In this example, `pam_acct_mgmt()` checks for expiration of the password.

The `pam_acct_mgmt()` function also uses the `PAM_DISALLOW_NULL_AUTHTOK` flag. If `pam_acct_mgmt()` returns `PAM_NEW_AUTHTOK_REQD`, then `pam_chauthtok(3PAM)` should be called to allow the authenticated user to change the password.

4. Force the user to change passwords if the system discovers that the password has expired.

The example uses a loop to call `pam_chauthtok()` until success is returned. The `pam_chauthtok()` function returns success if the user successfully changes his or her authentication information, which is usually the password. In this example, the loop continues until success is returned. More commonly, an application would set a maximum number of tries before terminating.

5. Call `pam_setcred(3PAM)`.

The `pam_setcred(3PAM)` function is used to establish, modify, or delete user credentials. `pam_setcred()` is typically called when a user has been authenticated. The call is made after the account has been validated, but before a session has been opened. The `pam_setcred()` function is used with the `PAM_ESTABLISH_CRED` flag to establish a new user session. If the session is the renewal of an existing session, such as for `lockscreen`, `pam_setcred()` with the `PAM_REFRESH_CRED` flag should be called. If the session is changing the credentials, such as using `su` or assuming a role, then `pam_setcred()` with the `PAM_REINITIALIZE_CRED` flag should be called.

6. Close the PAM session.

The PAM session is closed by calling the `pam_end(3PAM)` function. `pam_end()` frees all PAM resources as well.

The following example shows the source code for the sample PAM consumer application.

---

**Note** – The source code for this example is also available through the Sun download center. See <http://www.sun.com/download/products.xml?id=41912db5>.

---

#### EXAMPLE 3-1 Sample PAM Consumer Application

```
/*
 * Copyright 2005 Sun Microsystems, Inc. All rights reserved.
 * Use is subject to license terms.
 */

#include <sys/types.h>
#include <stdio.h>
#include <unistd.h>
#include <stdlib.h>
#include <strings.h>
#include <signal.h>
#include <pwd.h>
#include <errno.h>
#include <security/pam_appl.h>

extern int pam_tty_conv(int num_msg, struct pam_message **msg,
    struct pam_response **response, void *appdata_ptr);
```

## EXAMPLE 3-1 Sample PAM Consumer Application (Continued)

```

/* Disable keyboard interrupts (Ctrl-C, Ctrl-Z, Ctrl-\) */
static void
disable_kbd_signals(void)
{
    (void) signal(SIGINT, SIG_IGN);
    (void) signal(SIGSTP, SIG_IGN);
    (void) signal(SIGQUIT, SIG_IGN);
}

/* Terminate current user session, i.e., logout */
static void
logout()
{
    pid_t pgroup = getpgrp();

    (void) signal(SIGTERM, SIG_IGN);
    (void) fprintf(stderr, "Sorry, your session can't be restored.\n");
    (void) fprintf(stderr, "Press return to terminate this session.\n");
    (void) getchar();
    (void) kill(-pgroup, SIGTERM);
    (void) sleep(2);
    (void) kill(-pgroup, SIGKILL);
    exit(-1);
}

int
/*ARGSUSED*/
main(int argc, char *argv)
{
    struct pam_conv conv = { pam_tty_conv, NULL };
    pam_handle_t *pamh;
    struct passwd *pw;
    int err;

    disable_kbd_signals();
    if ((pw = getpwuid(getuid())) == NULL) {
        (void) fprintf(stderr, "plock: Can't get username: %s\n",
            strerror(errno));
        exit(1);
    }

    /* Initialize PAM framework */
    err = pam_start("plock", pw->pw_name, &conv, &pamh);
    if (err != PAM_SUCCESS) {
        (void) fprintf(stderr, "plock: pam_start failed: %s\n",
            pam_strerror(pamh, err));
        exit(1);
    }

    /* Authenticate user in order to unlock screen */
    do {
        (void) fprintf(stderr, "Terminal locked for %s. ", pw->pw_name);
        err = pam_authenticate(pamh, 0);
        if (err == PAM_USER_UNKNOWN) {
            logout();
        } else if (err != PAM_SUCCESS) {

```

**EXAMPLE 3-1** Sample PAM Consumer Application (Continued)

```

        (void) fprintf(stderr, "Invalid password.\n");
    }
} while (err != PAM_SUCCESS);

/* Make sure account and password are still valid */
switch (err = pam_acct_mgmt(pamh, 0)) {
case PAM_SUCCESS:
    break;
case PAM_USER_UNKNOWN:
case PAM_ACCT_EXPIRED:
    /* User not allowed in anymore */
    logout();
    break;
case PAM_NEW_AUTHTOK_REQD:
    /* The user's password has expired. Get a new one */
    do {
        err = pam_chauthtok(pamh, 0);
    } while (err == PAM_AUTHTOK_ERR);
    if (err != PAM_SUCCESS)
        logout();
    break;
default:
    logout();
}

if (pam_setcred(pamh, PAM_REFRESH_CRED) != PAM_SUCCESS){
    logout();
}

(void) pam_end(pamh, 0);
return(0);
/*NOTREACHED*/
}

```

## Other Useful PAM Functions

The previous example, [Example 3-1](#), is a simple application that demonstrates only a few of the major PAM functions. This section describes some other PAM functions that can be useful.

The [pam\\_open\\_session\(3PAM\)](#) function is called to open a new session after a user has been successfully authenticated.

The [pam\\_getenvlist\(3PAM\)](#) function is called to establish a new environment. `pam_getenvlist()` returns a new environment to be merged with the existing environment.

# Writing Conversation Functions

A PAM module or application can communicate with a user in a number of ways: command line, dialog box, and so on. As a result, the designer of a PAM consumer that communicates with users needs to write a *conversation function*. A conversation function passes messages between the user and module independently of the means of communication. A conversation function derives the message type from the *msg\_style* parameter in the conversation function callback `pam_message` parameter. See `pam_start(3PAM)`.

Developers should make no assumptions about how PAM is to communicate with users. Rather, the application should exchange messages with the user until the operation is complete. Applications should display the message strings for the conversation function without interpretation or modification. An individual message can contain multiple lines, control characters, or extra blank spaces. Note that service modules are responsible for localizing any strings sent to the conversation function.

A sample conversation function, `pam_tty_conv()`, is provided below. The `pam_tty_conv()` takes the following arguments:

- *num\_msg* – The number of messages that are being passed to the function.
- *\*\*mess* – A pointer to the buffer that holds the messages from the user.
- *\*\*resp* – A pointer to the buffer that holds the responses to the user.
- *\*my\_data* – Pointer to the application data.

The sample function gets user input from `stdin`. The routine needs to allocate memory for the response buffer. A maximum, `PAM_MAX_NUM_MSG`, can be set to limit the number of messages. If the conversation function returns an error, the conversation function is responsible for clearing and freeing any memory that has been allocated for responses. In addition, the conversation function must set the response pointer to `NULL`. Note that clearing memory should be accomplished using a zero fill approach. The caller of the conversation function is responsible for freeing any responses that have been returned to the caller. To conduct the conversation, the function loops through the messages from the user application. Valid messages are written to `stdout`, and any errors are written to `stderr`.

---

**Note** – The source code for this example is also available through the Sun download center. See <http://www.sun.com/download/products.xml?id=41912db5>.

---

## EXAMPLE 3-2 PAM Conversation Function

```

/*
 * Copyright 2005 Sun Microsystems, Inc. All rights reserved.
 * Use is subject to license terms.
 */

#pragma ident      "@(#)pam_tty_conv.c    1.4    05/02/12 SMI"

#define      __EXTENSIONS__      /* to expose flockfile and friends in stdio.h */

```

## EXAMPLE 3-2 PAM Conversation Function (Continued)

```
#include <errno.h>
#include <libgen.h>
#include <malloc.h>
#include <signal.h>
#include <stdio.h>
#include <stdlib.h>
#include <strings.h>
#include <stropts.h>
#include <unistd.h>
#include <termio.h>
#include <security/pam_appl.h>

static int ctl_c; /* was the conversation interrupted? */

/* ARGSUSED 1 */
static void
interrupt(int x)
{
    ctl_c = 1;
}

/* getinput -- read user input from stdin abort on ^C
 * Entry noecho == TRUE, don't echo input.
 * Exit User's input.
 * If interrupted, send SIGINT to caller for processing.
 */
static char *
getinput(int noecho)
{
    struct termio tty;
    unsigned short tty_flags;
    char input[PAM_MAX_RESP_SIZE];
    int c;
    int i = 0;
    void (*sig)(int);

    ctl_c = 0;
    sig = signal(SIGINT, interrupt);
    if (noecho) {
        (void) ioctl(fileno(stdin), TCGETA, &tty);
        tty_flags = tty.c_lflag;
        tty.c_lflag &= ~(ECHO | ECHOE | ECHOK | ECHONL);
        (void) ioctl(fileno(stdin), TCSETAF, &tty);
    }

    /* go to end, but don't overflow PAM_MAX_RESP_SIZE */
    flockfile(stdin);
    while (ctl_c == 0 &&
           (c = getchar_unlocked()) != '\n' &&
           c != '\r' &&
           c != EOF) {
        if (i < PAM_MAX_RESP_SIZE) {
            input[i++] = (char)c;
        }
    }
    funlockfile(stdin);
}
```



## EXAMPLE 3-2 PAM Conversation Function (Continued)

```

    input[i] = '\0';
    if (noecho) {
        tty.c_lflag = tty_flags;
        (void) ioctl(fileno(stdin), TCSETAW, &tty);
        (void) fputc('\n', stdout);
    }
    (void) signal(SIGINT, sig);
    if (ctl_c == 1)
        (void) kill(getpid(), SIGINT);

    return (strdup(input));
}

/* Service modules do not clean up responses if an error is returned.
 * Free responses here.
 */
static void
free_resp(int num_msg, struct pam_response *pr)
{
    int i;
    struct pam_response *r = pr;

    if (pr == NULL)
        return;

    for (i = 0; i < num_msg; i++, r++) {

        if (r->resp) {
            /* clear before freeing -- may be a password */
            bzero(r->resp, strlen(r->resp));
            free(r->resp);
            r->resp = NULL;
        }
    }
    free(pr);
}

/* ARGSUSED */
int
pam_tty_conv(int num_msg, struct pam_message **mess,
             struct pam_response **resp, void *my_data)
{
    struct pam_message *m = *mess;
    struct pam_response *r;
    int i;

    if (num_msg <= 0 || num_msg >= PAM_MAX_NUM_MSG) {
        (void) fprintf(stderr, "bad number of messages %d\n",
            num_msg, PAM_MAX_NUM_MSG);
        *resp = NULL;
        return (PAM_CONV_ERR);
    }
    if ((*resp = r = calloc(num_msg,
        sizeof (struct pam_response))) == NULL)
        return (PAM_BUF_ERR);
}

```

## EXAMPLE 3-2 PAM Conversation Function (Continued)

```

/* Loop through messages */
for (i = 0; i < num_msg; i++) {
    int echo_off;

    /* bad message from service module */
    if (m->msg == NULL) {
        (void) fprintf(stderr, "message[%d]: %d/NULL\n",
            i, m->msg_style);
        goto err;
    }

    /*
     * fix up final newline:
     * removed for prompts
     * added back for messages
     */
    if (m->msg[strlen(m->msg)] == '\n')
        m->msg[strlen(m->msg)] = '\0';

    r->resp = NULL;
    r->resp_retcode = 0;
    echo_off = 0;
    switch (m->msg_style) {

    case PAM_PROMPT_ECHO_OFF:
        echo_off = 1;
        /*FALLTHROUGH*/

    case PAM_PROMPT_ECHO_ON:
        (void) fputs(m->msg, stdout);

        r->resp = getinput(echo_off);
        break;

    case PAM_ERROR_MSG:
        (void) fputs(m->msg, stderr);
        (void) fputc('\n', stderr);
        break;

    case PAM_TEXT_INFO:
        (void) fputs(m->msg, stdout);
        (void) fputc('\n', stdout);
        break;

    default:
        (void) fprintf(stderr, "message[%d]: unknown type "
            "%d/val=\"%s\"\n",
            i, m->msg_style, m->msg);
        /* error, service module won't clean up */
        goto err;
    }
    if (errno == EINTR)
        goto err;

    /* next message/response */

```

**EXAMPLE 3-2** PAM Conversation Function (Continued)

```

        m++;
        r++;
    }
    return (PAM_SUCCESS);

err:
    free_resp(i, r);
    *resp = NULL;
    return (PAM_CONV_ERR);
}

```

## Writing Modules That Provide PAM Services

This section describes how to write PAM service modules.

### Requirements for PAM Service Providers

PAM service modules use `pam_get_item(3PAM)` and `pam_set_item(3PAM)` to communicate with applications. To communicate with each other, service modules use `pam_get_data(3PAM)` and `pam_set_data(3PAM)`. If service modules from the same project need to exchange data, then a unique data name for that project should be established. The service modules can then share this data through the `pam_get_data()` and `pam_set_data()` functions.

Service modules must return one of three classes of PAM return code:

- `PAM_SUCCESS` if the module has made a positive decision that is part of the requested policy.
- `PAM_IGNORE` if the module does not make a policy decision.
- `PAM_error` if the module participates in the decision that results in a failure. The *error* can be either a generic error code or a code specific to the service module type. The error cannot be an error code for another service module type. See the specific man page for `pam_sm_module-type` for the error codes.

If a service module performs multiple functions, these functions should be split up into separate modules. This approach gives system administrators finer-grained control for configuring policy.

Man pages should be provided for any new service modules. Man pages should include the following items:

- Arguments that the module accepts.
- All functions that the module implements.

- The effect of flags on the algorithm.
- Any required PAM items.
- Error returns that are specific to this module.

Service modules are required to honor the `PAM_SILENT` flag for preventing display of messages. The `debug` argument is recommended for logging debug information to `syslog`. Use `syslog(3C)` with `LOG_AUTH` and `LOG_DEBUG` for debug logging. Other messages should be sent to `syslog()` with `LOG_AUTH` and the appropriate priority. `openlog(3C)`, `closelog(3C)`, and `setlogmask(3C)` must not be used as these functions interfere with the applications settings.

## Sample PAM Provider Service Module

A sample PAM service module follows. This example checks to see if the user is a member of a group that is permitted access to this service. The provider then grants access on success or logs an error message on failure.

The example goes through the following steps:

1. Parse the options passed to this module from the configuration line in `/etc/pam.conf`.

This module accepts the `nowarn` and `debug` options as well as a specific option group. With the `group` option, the module can be configured to allow access for a particular group other than the group `root` that is used by default. See the definition of `DEFAULT_GROUP` in the source code for the example. For example, to allow `telnet(1)` access by users that belong to group `staff`, one could use the following line, which is in the `telnet` stack in `/etc/pam.conf`:

```
telnet account required pam_members_only.so.1 group=staff
```

2. Get the username, service name and hostname.

The username is obtained by calling `pam_get_user(3PAM)` which retrieves the current user name from the PAM handle. If the user name has not been set, access is denied. The service name and the host name are obtained by calling `pam_get_item(3PAM)`.

3. Validate the information to be worked on.

If the user name is not set, deny access. If the group to be worked on is not defined, deny access.

4. Verify that the current user is a member of the special group that allows access to this host and grant access.

In the event that the special group is defined but contains no members at all, `PAM_IGNORE` is returned to indicate that this module does not participate in any account validation process. The decision is left to other modules on the stack.

5. If the user is not a member of the special group, display a message to inform the user that access is denied.

Log a message to record this event.

The following example shows the source code for the sample PAM provider.

---

**Note** – The source code for this example is also available through the Sun download center. See <http://www.sun.com/download/products.xml?id=41912db5>.

---

**EXAMPLE 3-3** Sample PAM Service Module

```

/*
 * Copyright 2005 Sun Microsystems, Inc. All rights reserved.
 * Use is subject to license terms.
 */

#include <stdio.h>
#include <stdlib.h>
#include <grp.h>
#include <string.h>
#include <syslog.h>
#include <libintl.h>
#include <security/pam_appl.h>

/*
 * by default, only users who are a member of group "root" are allowed access
 */
#define    DEFAULT_GROUP "root"

static char *NOMSG =
    "Sorry, you are not on the access list for this host - access denied.";

int
pam_sm_acct_mgmt(pam_handle_t * pamh, int flags, int argc, const char **argv)
{
    char *user = NULL;
    char *host = NULL;
    char *service = NULL;
    const char *allowed_grp = DEFAULT_GROUP;
    char grp_buf[4096];
    struct group grp;
    struct pam_conv *conversation;
    struct pam_message message;
    struct pam_message *pmessage = &message;
    struct pam_response *res = NULL;
    int i;
    int nowarn = 0;
    int debug = 0;

    /* Set flags to display warnings if in debug mode. */
    for (i = 0; i < argc; i++) {
        if (strcasecmp(argv[i], "nowarn") == 0)
            nowarn = 1;
        else if (strcasecmp(argv[i], "debug") == 0)
            debug = 1;
        else if (strncmp(argv[i], "group=", 6) == 0)
            allowed_grp = &argv[i][6];
    }
}

```

## EXAMPLE 3-3 Sample PAM Service Module (Continued)

```

if (flags & PAM_SILENT)
    nowarn = 1;

/* Get user name, service name, and host name. */
(void) pam_get_user(pamh, &user, NULL);
(void) pam_get_item(pamh, PAM_SERVICE, (void **) &service);
(void) pam_get_item(pamh, PAM_RHOST, (void **) &host);

/* Deny access if user is NULL. */
if (user == NULL) {
    syslog(LOG_AUTH|LOG_DEBUG,
        "%s: members_only: user not set", service);
    return (PAM_USER_UNKNOWN);
}

if (host == NULL)
    host = "unknown";

/*
 * Deny access if vuser group is required and user is not in vuser
 * group
 */
if (getgrnam_r(allowed_grp, &grp, grp_buf, sizeof (grp_buf)) == NULL) {
    syslog(LOG_NOTICE|LOG_AUTH,
        "%s: members_only: group \"%s\" not defined",
        service, allowed_grp);
    return (PAM_SYSTEM_ERR);
}

/* Ignore this module if group contains no members. */
if (grp.gr_mem[0] == 0) {
    if (debug)
        syslog(LOG_AUTH|LOG_DEBUG,
            "%s: members_only: group %s empty: "
            "all users allowed.", service, grp.gr_name);
    return (PAM_IGNORE);
}

/* Check to see if user is in group. If so, return SUCCESS. */
for (; grp.gr_mem[0]; grp.gr_mem++) {
    if (strcmp(grp.gr_mem[0], user) == 0) {
        if (debug)
            syslog(LOG_AUTH|LOG_DEBUG,
                "%s: user %s is member of group %s. "
                "Access allowed.",
                service, user, grp.gr_name);
        return (PAM_SUCCESS);
    }
}

/*
 * User is not a member of the group.
 * Set message style to error and specify denial message.
 */
message.msg_style = PAM_ERROR_MSG;
message.msg = gettext(NOMSG);

```

## EXAMPLE 3-3 Sample PAM Service Module (Continued)

```
/* Use conversation function to display denial message to user. */
(void) pam_get_item(pamh, PAM_CONV, (void **) &conversation);
if (nowarn == 0 && conversation != NULL) {
    int err;
    err = conversation->conv(1, &pmessage, &res,
        conversation->appdata_ptr);
    if (debug && err != PAM_SUCCESS)
        syslog(LOG_AUTH|LOG_DEBUG,
            "%s: members_only: conversation returned "
            "error %d (%s).", service, err,
            pam_strerror(pamh, err));

    /* free response (if any) */
    if (res != NULL) {
        if (res->resp)
            free(res->resp);
        free(res);
    }
}

/* Report denial to system log and return error to caller. */
syslog(LOG_NOTICE | LOG_AUTH, "%s: members_only: "
    "Connection for %s not allowed from %s", service, user, host);

return (PAM_PERM_DENIED);
}
```





# Writing Applications That Use GSS-API

---

The Generic Security Service Application Programming Interface (GSS-API) provides a means for applications to protect data to be sent to peer applications. Typically, the connection is from a client on one machine to a server on a different machine.

This chapter provides information on the following subjects:

- [“Introduction to GSS-API” on page 57](#)
- [“Important Elements of GSS-API” on page 62](#)
- [“Developing Applications That Use GSS-API” on page 74](#)

## Introduction to GSS-API

GSS-API enables programmers to write applications generically with respect to security. Developers do not have to tailor the security implementations to any particular platform, security mechanism, type of protection, or transport protocol. With GSS-API, a programmer can avoid the details of protecting network data. A program that uses GSS-API is more portable with regards to network security. This portability is the hallmark of the Generic Security Service API.

GSS-API is a framework that provides security services to callers in a generic fashion. The GSS-API framework is supported by a range of underlying mechanisms and technologies, such as Kerberos v5 or public key technologies, as shown in the following figure.

FIGURE 4-1 GSS-API Layer

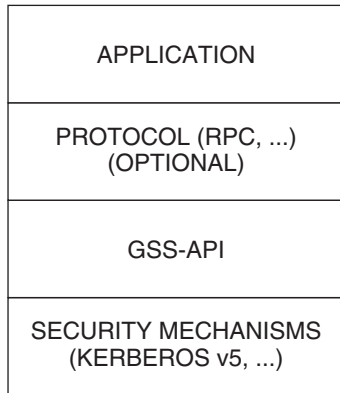

Broadly speaking, GSS-API does two main things:

1. GSS-API creates a security *context* in which data can be passed between applications. A context is a state of trust between two applications. Applications that share a context recognize each other and thus can permit data transfers while the context lasts.
2. GSS-API applies one or more types of protection, known as *security services*, to the data to be transmitted. Security services are explained in [“Security Services in GSS-API” on page 59](#).

In addition, GSS-API performs the following functions:

- Data conversion
- Error checking
- Delegation of user privileges
- Information display
- Identity comparison

GSS-API includes numerous support and convenience functions.

## Application Portability With GSS-API

GSS-API provides several types of portability for applications:

- **Mechanism independence.** GSS-API provides a generic interface for security. By specifying a default security mechanism, an application does not need to know the mechanism to be applied nor any details about that mechanism.
- **Protocol independence.** GSS-API is independent of any communications protocol or protocol suite. For example, GSS-API can be used with applications that use sockets, RCP, or TCP/IP.

RPCSEC\_GSS is an additional layer that smoothly integrates GSS-API with RPC. For more information, see [“Remote Procedure Calls With GSS-API” on page 60](#).

- **Platform independence.** GSS-API is independent of the type of operating system on which an application is running.
- **Quality of Protection independence.** Quality of Protection (QOP) refers to the type of algorithm for encrypting data or generating cryptographic tags. GSS-API allows a programmer to ignore QOP by using a default that is provided by GSS-API. On the other hand, an application can specify the QOP if necessary.

## Security Services in GSS-API

GSS-API provides three types of security services:

- **Authentication** – The basic security offered by GSS-API is *authentication*. Authentication is the verification of an identity. If a user is authenticated, the system assumes that person is the one who is entitled to operate under that user name.
- **Integrity** – *Integrity* is the verification of the data's validity. Even if data comes from a valid user, the data itself could have become corrupted or compromised. Integrity ensures that a message is complete as intended, with nothing added and nothing missing. GSS-API provides for data to be accompanied by a cryptographic tag, known as a Message Integrity Code (MIC). The MIC proves that the data that you receive is the same as the data that the sender transmitted.
- **Confidentiality** – *Confidentiality* ensures that a third party who intercepted the message would have a difficult time reading the contents. Neither authentication nor integrity modify the data. If the data is somehow intercepted, others can read that data. GSS-API therefore allows data to be encrypted, provided that underlying mechanisms are available that support encryption. This encryption of data is known as confidentiality.

## Available Mechanisms in GSS-API

The current implementation of GSS-API works with the following mechanisms: Kerberos v5, Diffie-Hellman, and SPNEGO. For more information on the Kerberos implementation, see [Chapter 21, “Introduction to the Kerberos Service,” in \*System Administration Guide: Security Services\*](#) for more information. Kerberos v5 should be installed and running on any system on which GSS-API-aware programs are running.

## Remote Procedure Calls With GSS-API

Programmers who use the RPC (Remote Procedure Call) protocol for networking applications can use RPCSEC\_GSS to provide security. RPCSEC\_GSS is a separate layer that sits on top of GSS-API. RPCSEC\_GSS provides all the functionality of GSS-API in a way that is tailored to RPC. In fact, RPCSEC\_GSS serves to hide many aspects of GSS-API from the programmer, making RPC security especially accessible and portable. For more information on RPCSEC\_GSS, see [“Authentication Using RPCSEC\\_GSS” in \*ONC+ Developer’s Guide\*](#).

The following diagram illustrates how the RPCSEC\_GSS layer sits between the application and GSS-API.

FIGURE 4-2 RPCSEC\_GSS and GSS-API

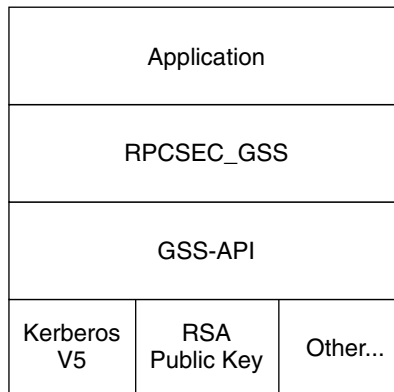

## Limitations of GSS-API

Although GSS-API makes protecting data simple, GSS-API avoids some tasks that would not be consistent with GSS-API's generic nature. Accordingly, GSS-API does *not* perform the following activities:

- Provide security credentials for users or applications. Credentials must be provided by the underlying security mechanisms. GSS-API *does* allow applications to acquire credentials, either automatically or explicitly.
- Transfer data between applications. The application has the responsibility for handling the transfer of *all* data between peers, whether the data is security-related or plain data.
- Distinguish between different types of transmitted data. For example, GSS-API does not know whether a data packet is plain data or encrypted.
- Indicate status due to asynchronous errors.
- Protect by default information that has been sent between processes of a multiprocess program.
- Allocate string buffers to be passed to GSS-API functions. See “[Strings and Similar Data in GSS-API](#)” on page 62.
- Deallocate GSS-API data spaces. This memory must be explicitly deallocated with functions such as `gss_release_buffer()` and `gss_delete_name()`.

## Language Bindings for GSS-API

This document currently covers only the C language bindings, that is, functions and data types, for GSS-API. A Java-bindings version of GSS-API is now available. The Java GSS-API contains the Java bindings for the Generic Security Services Application Program Interface (GSS-API), as defined in RFC 2853.

## Where to Get More Information on GSS-API

These two documents provide further information about GSS-API:

- [Generic Security Service Application Program Interface](ftp://ftp.isi.edu/in-notes/rfc2743.txt) document (<ftp://ftp.isi.edu/in-notes/rfc2743.txt>) provides a conceptual overview of GSS-API.
- [Generic Security Service API Version 2: C-Bindings](ftp://ftp.isi.edu/in-notes/rfc2744.txt) document (<ftp://ftp.isi.edu/in-notes/rfc2744.txt>) discusses the specifics of the C-language-based GSS-API.

# Important Elements of GSS-API

This section covers the following important GSS-API concepts: principals, GSS-API data types, status codes, and tokens.

- “GSS-API Data Types” on page 62
- “GSS-API Status Codes” on page 71
- “GSS-API Tokens” on page 72

## GSS-API Data Types

The following sections explain the major GSS-API data types. For information on all GSS-API data types, see “GSS-API Data Types and Values” on page 229.

### GSS-API Integers

Because the size of an `int` can vary from platform to platform, GSS-API provides the following integer data type: `OM_uint32` which is a 32-bit unsigned integer.

### Strings and Similar Data in GSS-API

Because GSS-API handles all data in internal formats, strings must be converted to a GSS-API format before being passed to GSS-API functions. GSS-API handles strings with the `gss_buffer_desc` structure:

```
typedef struct gss_buffer_desc_struct {
    size_t    length;
    void      *value;
} gss_buffer_desc *gss_buffer_t;
```

`gss_buffer_t` is a pointer to such a structure. Strings must be put into a `gss_buffer_desc` structure before being passed to functions that use them. In the following example, a generic GSS-API function applies protection to a message before sending that message.

#### EXAMPLE 4-1 Using Strings in GSS-API

```
char *message_string;
gss_buffer_desc input_msg_buffer;

input_msg_buffer.value = message_string;
input_msg_buffer.length = strlen(input_msg_buffer.value) + 1;

gss_generic_function(arg1, &input_msg_buffer, arg2...);

gss_release_buffer(input_msg_buffer);
```

Note that `input_msg_buffer` must be deallocated with `gss_release_buffer()` when you are finished with `input_msg_buffer`.

The `gss_buffer_desc` object is not just for character strings. For example, tokens are manipulated as `gss_buffer_desc` objects. See “[GSS-API Tokens](#)” on page 72 for more information.

## Names in GSS-API

A *name* refers to a principal. In network-security terminology, a *principal* is a user, a program, or a machine. Principals can be either clients or servers.

Some examples of principals are:

- A user, such as `user@machine`, who logs into another machine
- A network service, such as `nfs@machine`
- A machine, such as `myHost@eng.company.com`, that runs an application

In GSS-API, names are stored as a `gss_name_t` object, which is opaque to the application. Names are converted from `gss_buffer_t` objects to the `gss_name_t` form by the `gss_import_name()` function. Every imported name has an associated *name type*, which indicates the format of the name. See “[GSS-API OIDs](#)” on page 69 for more about name types. See “[Name Types](#)” on page 230 for a list of valid name types.

`gss_import_name()` has the following syntax:

```
OM_uint32 gss_import_name (
    OM_uint32      *minor-status,
    const gss_buffer_t  input-name-buffer,
    const gss_OID      input-name-type,
    gss_name_t       *output-name)
```

<i>minor-status</i>	Status code returned by the underlying mechanism. See “ <a href="#">GSS-API Status Codes</a> ” on page 71.
<i>input-name-buffer</i>	The <code>gss_buffer_desc</code> structure containing the name to be imported. The application must allocate this structure explicitly. See “ <a href="#">Strings and Similar Data in GSS-API</a> ” on page 62 as well as <a href="#">Example 4–2</a> . This argument must be deallocated with <code>gss_release_buffer()</code> when the application is finished with the space.
<i>input-name-type</i>	A <code>gss_OID</code> that specifies the format of <i>input-name-buffer</i> . See “ <a href="#">Name Types in GSS-API</a> ” on page 70. Also, “ <a href="#">Name Types</a> ” on page 230 contains a table of valid name types.
<i>output-name</i>	The <code>gss_name_t</code> structure to receive the name.

A minor modification of the generic example shown in [Example 4–1](#) illustrates how `gss_import_name()` can be used. First, the regular string is inserted into a `gss_buffer_desc` structure. Then `gss_import_name()` places the string into a `gss_name_t` structure.

**EXAMPLE 4-2** Using `gss_import_name()`

```
char *name_string;
gss_buffer_desc input_name_buffer;
gss_name_t      output_name_buffer;

input_name_buffer.value = name_string;
input_name_buffer.length = strlen(input_name_buffer.value) + 1;

gss_import_name(&minor_status, input_name_buffer,
               GSS_C_NT_HOSTBASED_SERVICE, &output_name);

gss_release_buffer(input_name_buffer);
```

An imported name can be put back into a `gss_buffer_t` object for display in human-readable form with `gss_display_name()`. However, `gss_display_name()` does not guarantee that the resulting string will be the same as the original due to the way the underlying mechanisms store names. GSS-API includes several other functions for manipulating names. See [“GSS-API Functions” on page 223](#).

A `gss_name_t` structure can contain several versions of a single name. One version is produced for each mechanism that is supported by GSS-API. That is, a `gss_name_t` structure for *user@company* might contain one version of that name as rendered by Kerberos v5 and another version that was given by a different mechanism. The function `gss_canonicalize_name()` takes as input an internal name and a mechanism. `gss_canonicalize_name()` yields a second internal name that contains a single version of the name that is specific to that mechanism.

Such a mechanism-specific name is called a *mechanism name* (MN). A mechanism name does not refer to the name of a mechanism, but to the name of a principal as produced by a given mechanism. This process is illustrated in the following figure.



FIGURE 4-3 Internal Names and Mechanism Names

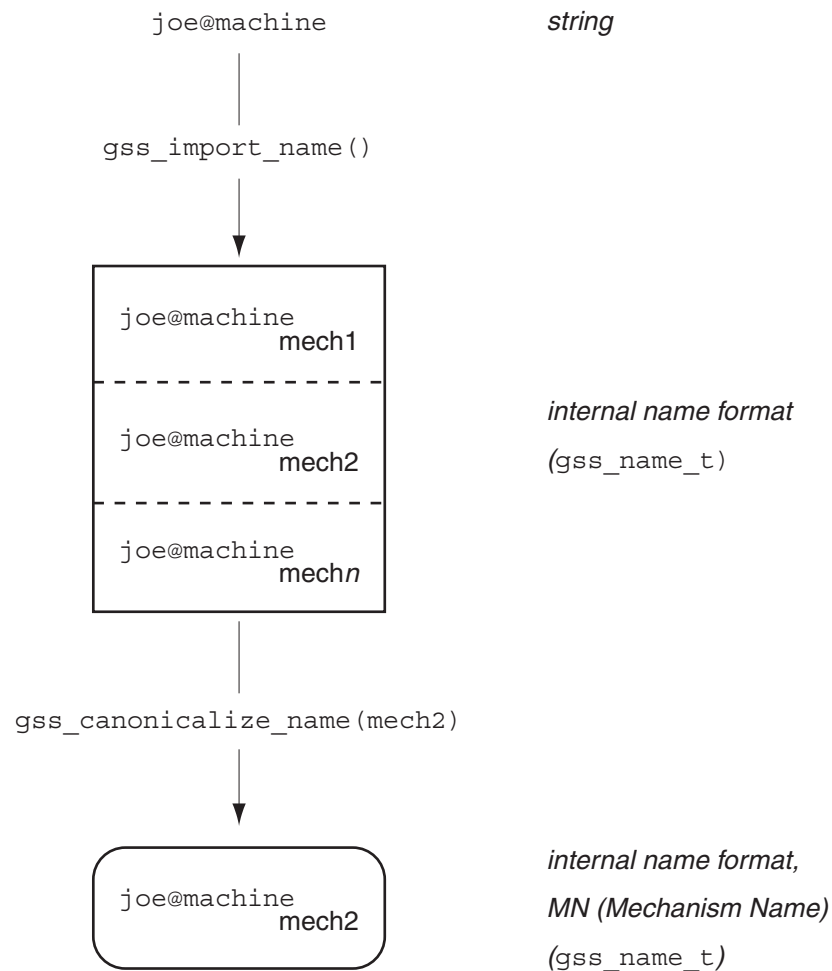

## Comparing Names in GSS-API

Consider the case where a server has received a name from a client and needs to look up that name in an access control list. An *access control list*, or ACL, is a list of principals with particular access permissions.

One way to do the lookup would be as follows:

1. Import the client name into GSS-API internal format with `gss_import_name()`, if the name has not already been imported.

In some cases, the server will receive a name in internal format, so this step will not be necessary. For example, a server might look up the client's own name. During context initiation, the client's own name is passed in internal format.

2. Import each name in the ACL with `gss_import_name()`.
3. Compare each imported ACL name with the imported client's name, using `gss_compare_name()`.

This process is shown in the following figure. In this case, Step 1 is assumed to be needed.

FIGURE 4-4 Comparing Names (Slow)

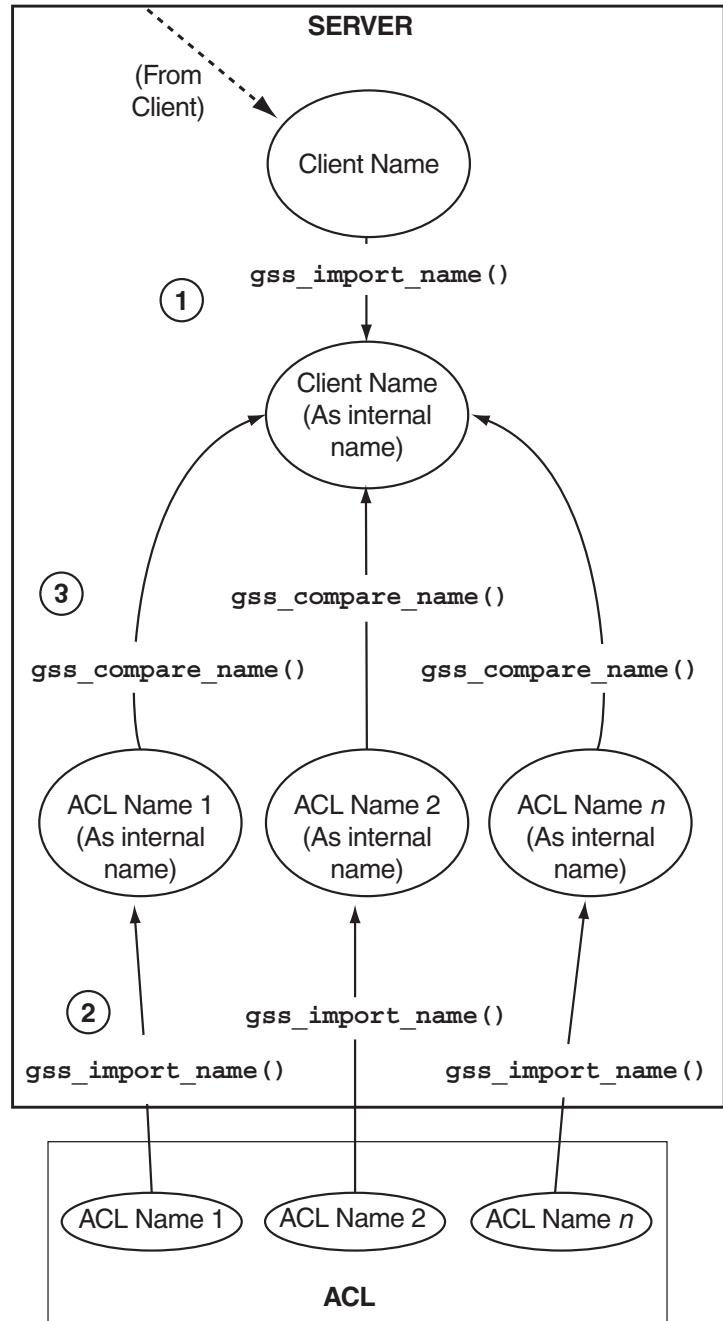

The previous approach of comparing names individually is acceptable when there are only a few names. When there are a large number of names, using the `gss_canonicalize_name()` function is more efficient.

This approach uses the following steps:

1. Import the client's name with `gss_import_name()`, if the name has not already been imported.  
As with the previous method of comparing names, if the name is already in internal format, this step is unnecessary.
2. Use `gss_canonicalize_name()` to produce a mechanism name version of the client's name.
3. Use `gss_export_name()` to produce an exported name, which is the client's name as a contiguous string.
4. Compare the exported client's name with each name in the ACL by using `memcmp()`, which is a fast, low-overhead function.

This process is shown in the following figure. Again, assume that the server needs to import the name that is received from the client.

FIGURE 4-5 Comparing Names (Fast)

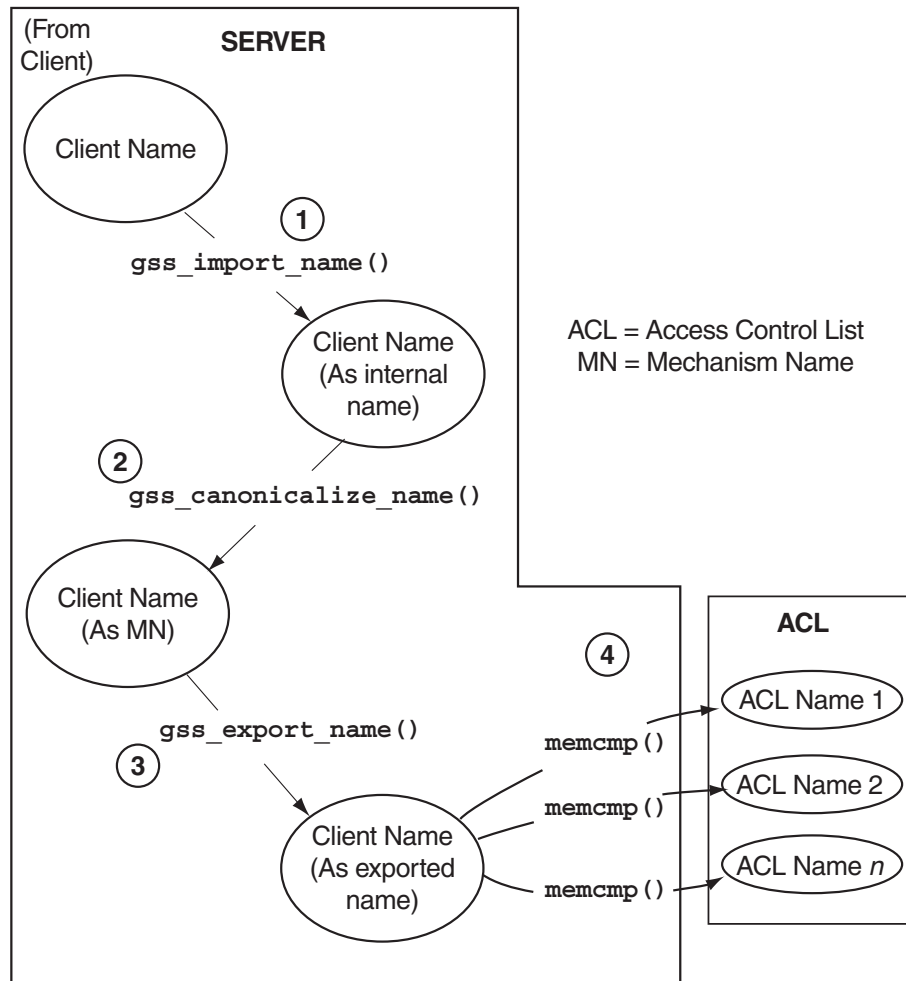

Because `gss_export_name()` expects a mechanism name (MN), you *must* run `gss_canonicalize_name()` on the client's name first.

See the [gss\\_export\\_name\(3GSS\)](#), [gss\\_import\\_name\(3GSS\)](#), and [gss\\_canonicalize\\_name\(3GSS\)](#) for more information.

## GSS-API OIDs

Object identifiers (OIDs) are used to store the following kinds of data:

- Security mechanisms
- QOPs – Quality of Protection values

- Name types

OIDs are stored in GSS-API `gss_OID_desc` structure. GSS-API provides a pointer to the structure, `gss_OID`, as shown in the following example.

EXAMPLE 4-3 OIDs Structure

```
typedef struct gss_OID_desc_struct {
    OM_uint32   length;
    void        *elements;
} gss_OID_desc, *gss_OID;
```

Further, one or more OIDs might be contained in a `gss_OID_set_desc` structure.

EXAMPLE 4-4 OID Set Structure

```
typedef struct gss_OID_set_desc_struct {
    size_t      count;
    gss_OID     elements;
} gss_OID_set_desc, *gss_OID_set;
```



**Caution** – Applications should not attempt to deallocate OIDs with `free()`.

---

## Mechanisms and QOPs in GSS-API

Although GSS-API allows applications to choose underlying security mechanisms, applications should use the default mechanism that has been selected by GSS-API if possible. Similarly, although GSS-API lets an application specify a Quality of Protection level for protecting data, the default QOP should be used if possible. Acceptance of the default mechanism is indicated by passing the value `GSS_C_NULL_OID` to functions that expect a mechanism or QOP as an argument.



**Caution** – Specifying a security mechanism or QOP explicitly defeats the purpose of using GSS-API. Such a specific selection limits the portability of an application. Other implementations of GSS-API might not support that QOP or mechanism in the intended manner. Nonetheless, [Appendix C, “Specifying an OID,”](#) briefly discusses how to find out which mechanisms and QOPs are available, and how to choose one.

---

## Name Types in GSS-API

Besides QOPs and security mechanisms, OIDs are also used to indicate name types, which indicate the format for an associated name. For example, the function `gss_import_name()`, which converts the name of a principal from a string to a `gss_name_t` type, takes as one

argument the format of the string to be converted. If the name type is, for example, `GSS_C_NT_HOSTBASED_SERVICE`, then the function knows that the name being input is of the form `service@host`. If the name type is `GSS_C_NT_EXPORT_NAME`, then the function expects a GSS-API exported name. Applications can find out which name types are available for a given mechanism with the `gss_inquire_names_for_mech()` function. A list of name types used by GSS-API is provided in [“Name Types” on page 230](#).

## GSS-API Status Codes

All GSS-API functions return two types of codes that provide information on the function's success or failure. Both types of status codes are returned as `OM_uint32` values.

The two types of return codes are as follows:

- **Major status codes**

Major status codes indicate the following errors:

- Generic GSS-API routine errors, such as giving a routine an invalid mechanism
- Call errors that are specific to a particular GSS-API language binding, such as a function argument that cannot be read, cannot be written, or is malformed
- Both types of errors

Additionally, major status codes can provide supplementary information about a routine's status. For example, a code might indicate that an operation is not finished, or that a token has been sent out of order. If no errors occur, the routine returns a major status value of `GSS_S_COMPLETE`.

Major status codes are returned as follows:

```
OM_uint32 major_status ;    /* status returned by GSS-API */
major_status = gss_generic_function(arg1, arg2 ...);
```

Major status return codes can be processed like any other `OM_uint32`. For example, consider the following code.

```
OM_uint32 maj_stat;
maj_sta = gss_generic_function(arg1, arg2 ...);
if (maj_stat == GSS_CREDENTIALS_EXPIRED)
    <do something...>
```

Major status codes can be processed with the macros `GSS_ROUTINE_ERROR()`, `GSS_CALLING_ERROR()`, and `GSS_SUPPLEMENTARY_INFO()`. [“GSS-API Status Codes” on page 225](#) explains how to read major status codes and contains a list of GSS-API status codes.

### ■ Minor status codes

Minor status codes are returned by the underlying mechanism. These codes are not specifically documented in this manual.

Every GSS-API function has as a first argument an `OM_uint32` type for the minor code status. The minor status code is stored in the `OM_uint32` argument when the function returns to the calling function. Consider the following code.

```
OM_uint32 *minor_status ;    /* status returned by mech */  
  
major_status = gss_generic_function(&minor_status, arg1, arg2 ...);
```

The `minor_status` parameter is always set by a GSS-API routine, even if a fatal major status code error is returned. Note that most other output parameters can remain unset. However, output parameters that are expected to return pointers to storage that has been allocated by the routine are set to `NULL`. `NULL` indicates that no storage was actually allocated. Any length field associated with such pointers, as in a `gss_buffer_desc` structure, are set to zero. In such cases, applications do not need to release these buffers.

## GSS-API Tokens

The basic unit of “currency” in GSS-API is the *token*. Applications that use GSS-API communicate with each other by using tokens. Tokens are used for exchanging data and for making security arrangements. Tokens are declared as `gss_buffer_t` data types. Tokens are opaque to applications.

Two types of tokens are *context-level tokens* and *per-message tokens*. Context-level tokens are used primarily when a context is established, that is, initiated and accepted. Context-level tokens can also be passed afterward to manage a context.

Per-message tokens are used after a context has been established. Per-message tokens are used to provide protection services on data. For example, consider an application that wants to send a message to another application. That application might use GSS-API to generate a cryptographic identifier to go along with that message. The identifier would be stored in a token.

Per-message tokens can be considered with regard to messages as follows. A *message* is a piece of data that an application sends to a peer. For example, the `ls` command could be a message that is sent to an `ftp` server. A *per-message token* is an object generated by GSS-API for that message. A per-message token could be a cryptographic tag or the encrypted form of the message. Note that this last example is mildly inaccurate. An encrypted message is still a message and not a token. A token is *only* GSS-API-generated information. However, informally, *message* and *per-message token* are often used interchangeably.



An application is responsible for the following activities:

1. Sending and receiving tokens. The developer usually needs to write generalized read and write functions for performing these actions. The `send_token()` and `recv_token()` functions in “Miscellaneous GSS-API Sample Functions” on page 215.
2. Distinguishing between types of tokens and manipulating the tokens accordingly.

Because tokens are opaque to applications, the application does not distinguish between one token and another. Without knowing a token's contents, an application must be able to distinguish the token's type to pass that token to an appropriate GSS-API function.

An application can distinguish token types through the following methods:

- By state. Through the control-flow of a program. For example, an application that is waiting to accept a context might assume that any received tokens are related to context establishment. Peers are expected to wait until the context is fully established before sending message tokens, that is, data. After the context is established, the application assumes that new tokens are message tokens. This approach to handling tokens is a fairly common way to handle tokens. The sample programs in this book use this method.
- By flags. For example, if an application has a function for sending tokens to peers, that application can include a flag to indicate the kind of token. Consider the following code:

```
gss_buffer_t token;      /* declare the token */
OM_uint32 token_flag    /* flag for describing the type of token */

    <get token from a GSS-API function>

token_flag = MIC_TOKEN; /* specify what kind of token it is */
send_a_token(&token, token_flag);
```

The receiving application would have a receiving function, for example, `get_a_token()`, that would check the `token_flag` argument.

- Through explicit tagging. Applications can use *meta-tokens*. A meta-token is a user-defined structure that contain tokens that have been received from GSS-API functions. A meta-token includes user-defined fields that signal how the tokens that are provided by GSS-API are to be used.

## Interprocess Tokens in GSS-API

GSS-API permits a security context to be passed from one process to another in a multiprocess application. Typically, an application has accepted a client's context. The application then shares the context among that application's processes. See “Exporting and Importing Contexts in GSS-API” on page 83 for information on multiprocess applications.

The `gss_export_context()` function creates an interprocess token. This token contains information that enables the context to be reconstituted by a second process. The application is

responsible for passing the interprocess token from one process to the other. This situation is similar to the application's responsibility for passing tokens to other applications.

The interprocess token might contain keys or other sensitive information. Not all GSS-API implementations cryptographically protect interprocess tokens. Therefore, the application must protect interprocess tokens before an exchange takes place. This protection might involve encrypting the tokens with `gss_wrap()`, if encryption is available.

---

**Note** – Do not assume that interprocess tokens are transferable across different GSS-API implementations.

---

## Developing Applications That Use GSS-API

This section shows how to implement secure data exchange using GSS-API. The section focuses on those functions that are most central to using GSS-API. For more information, see [Appendix B, “GSS-API Reference,”](#) which contains a list of all GSS-API functions, status codes, and data types. To find out more about any GSS-API function, check the individual man page.

The examples in this manual follow a simple model. A client application sends data directly to a remote server. No mediation by transport protocol layers such as RPC occurs.

### Generalized GSS-API Usage

The general steps for using GSS-API are as follows:

1. Each application, both sender and recipient, acquires credentials explicitly, unless credentials have been acquired automatically.
2. The sender initiates a security context. The recipient accepts the context.
3. The sender applies security protection to the data to be transmitted. The sender either encrypts the message or stamps the data with an identification tag. The sender then transmits the protected message.

---

**Note** – The sender can choose not to apply either security protection, in which case the message has only the default GSS-API security service, that is, authentication.

---

4. The recipient decrypts the message if needed and verifies the message if appropriate.
5. (Optional) The recipient returns an identification tag to the sender for confirmation.
6. Both applications destroy the shared security context. If necessary, the allocations can also deallocate any remaining GSS-API data.



---

**Caution** – The calling application is responsible for freeing all data space that has been allocated.

---

Applications that use GSS-API need to include the file `gssapi.h`.

## Working With Credentials in GSS-API

A *credential* is a data structure that provides proof of an application's claim to a principal name. An application uses a credential to establish that application's global identity. Additionally, a credential may be used to confirm an entity's privileges.

GSS-API does not provide credentials. Credentials are created by the security mechanisms that underly GSS-API, before GSS-API functions are called. In many cases, a user receives credentials at login.

A given GSS-API credential is valid for a single principal. A single credential can contain multiple elements for that principal, each created by a different mechanism. A credential that is acquired on a machine with multiple security mechanisms is valid if that credential is transferred to a machine with a subset of those mechanisms. GSS-API accesses credentials through the `gss_cred_id_t` structure. This structure is called a *credential handle*. Credentials are opaque to applications. Thus, the application does not need to know the specifics of a given credential.

Credentials come in three forms:

- `GSS_C_INITIATE` – Identifies applications that only initiate security contexts
- `GSS_C_ACCEPT` – Identifies applications that only accept security contexts
- `GSS_C_BOTH` – Identifies applications that can initiate or accept security contexts

## Acquiring Credentials in GSS-API

Before a security context can be established, both the server and the client must acquire their respective credentials. A credential can be reused until that credential expires, after which the application must reacquire the credential. Credentials that are used by the client and credentials that are used by the server can have different lifetimes.

GSS-API-based applications can acquire credentials in two ways:

- By using the `gss_acquire_cred()` or `gss_add_cred()` function
- By specifying the value `GSS_C_NO_CREDENTIAL`, which indicates a default credential, when the context is established

In most cases, `gss_acquire_cred()` is called only by a context acceptor, that is, a server. A context initiator, that is, a client, typically receives credentials at login. A client, therefore, can usually specify the default credential. The server can also bypass `gss_acquire_cred()` and use that server's default credential instead.

A client's credential proves that client's identity to other processes. A server acquires a credential to enable that server to accept a security context. So when a client makes an `ftp` request to a server, that client might already have a credential from login. GSS-API automatically retrieves the credential when the client attempts to initiate a context. The server program, however, explicitly acquires credentials for the requested service (`ftp`).

If `gss_acquire_cred()` completes successfully, then `GSS_S_COMPLETE` is returned. If a valid credential cannot be returned, then `GSS_S_NO_CRED` is returned. See the `gss_acquire_cred(3GSS)` man page for other error codes. For an example, see “Acquiring Credentials” in Chapter 8.

`gss_add_cred()` is similar to `gss_acquire_cred()`. However, `gss_add_cred()` enables an application to use an existing credential to create a new handle or to add a new credential element. If `GSS_C_NO_CREDENTIAL` is specified as the existing credential, then `gss_add_cred()` creates a new credential according to the default behavior. See the `gss_add_cred(3GSS)` man page for more information.

## Working With Contexts in GSS-API

The two most significant tasks for GSS-API in providing security are to create security contexts and to protect data. After an application acquires the necessary credentials, a security context must be established. To establish a context, one application, typically a client, initiates the context, and another application, usually a server, accepts the context. Multiple contexts between peers are allowed.

The communicating applications establish a joint security context by exchanging authentication tokens. The security context is a pair of GSS-API data structures that contain information to be shared between the two applications. This information describes the state of each application in terms of security. A security context is required for protection of data.

### Initiating a Context in GSS-API

The `gss_init_sec_context()` function is used to start a security context between an application and a remote peer. If successful, this function returns a *context handle* for the context to be established and a context-level token to send to the acceptor.

Before calling `gss_init_sec_context()`, the client should perform the following tasks:

1. Acquire credentials, if necessary, with `gss_acquire_cred()`. Typically, the client receives credentials at login. `gss_acquire_cred()` can only retrieve initial credentials from the running operating system.
2. Import the name of the server into GSS-API internal format with `gss_import_name()`. See [“Names in GSS-API” on page 63](#) for more information about names and `gss_import_name()`.

When calling `gss_init_sec_context()`, a client typically passes the following argument values:

- `GSS_C_NO_CREDENTIAL` for the *cred\_handle* argument, to indicate the default credential.
- `GSS_C_NULL_OID` for the *mech\_type* argument, to indicate the default mechanism.
- `GSS_C_NO_CONTEXT` for the *context\_handle* argument, to indicate an initial null context. Because `gss_init_sec_context()` is usually called in a loop, subsequent calls should pass the context handle that was returned by previous calls.
- `GSS_C_NO_BUFFER` for the *input\_token* argument, to indicate an initially empty token. Alternatively, the application can pass a pointer to a `gss_buffer_desc` object whose length field has been set to zero.
- The name of the server, imported into internal GSS-API format with `gss_import_name()`.

Applications are not bound to use these default values. Additionally, a client can specify requirements for other security parameters with the *req\_flags* argument. The full set of `gss_init_sec_context()` arguments is described below.

The context acceptor might require several handshakes to establish a context. That is, an acceptor can require the initiator to send more than one piece of context information before the context is fully established. Therefore, for portability, context initiation should always be done as part of a loop that checks whether the context has been fully established.

If the context is not complete, `gss_init_sec_context()` returns a major status code of `GSS_C_CONTINUE_NEEDED`. Therefore, a loop should use the return value from `gss_init_sec_context()` to test whether to continue the initiation loop.

The client passes context information to the server in the form of the *output token*, which is returned by `gss_init_sec_context()`. The client receives information back from the server as an *input token*. The input token can then be passed as an argument in subsequent calls of `gss_init_sec_context()`. If the received input token has a length of zero, however, then no more output tokens are required by the server.

Therefore, besides checking for the return status of `gss_init_sec_context()`, the loop should check the input token's length. If the length has a nonzero value, another token needs to be sent

to the server. Before the loop begins, the input token's length should be initialized to zero. Either set the input token to `GSS_C_NO_BUFFER` or set the structure's length field to a value of zero.

The following pseudocode demonstrates an example of context establishment from the client side.

```
context = GSS_C_NO_CONTEXT
input token = GSS_C_NO_BUFFER

do

    call gss_init_sec_context(credential, context, name, input token,
                             output token, other args...)

    if (there's an output token to send to the acceptor)
        send the output token to the acceptor
        release the output token

    if (the context is not complete)
        receive an input token from the acceptor

    if (there's a GSS-API error)
        delete the context

until the context is complete
```

A real loop would be more complete with more extensive error-checking. See [“Establishing a Security Context With the Server” on page 99](#) for a real example of such a context-initiation loop. Additionally, the `gss_init_sec_context(3GSS)` man page provides a less generic example.

In general, the parameter values returned when a context is not fully established are those values that would be returned when the context is complete. See the `gss_init_sec_context()` man page for more information.

If `gss_init_sec_context()` completes successfully, `GSS_S_COMPLETE` is returned. If a context-establishment token is required from the peer application, `GSS_S_CONTINUE_NEEDED` is returned. If errors occur, error codes are returned as shown in the `gss_init_sec_context(3GSS)` man page.

If context initiation fails, the client should disconnect from the server.

## Accepting a Context in GSS-API

The other half of context establishment is context acceptance, which is done through the `gss_accept_sec_context()` function. In a typical scenario, a server accepts a context that has been initiated by a client with `gss_init_sec_context()`.

The main input to `gss_accept_sec_context()` is an input token from the initiator. The initiator returns a context handle as well as an output token to be returned to the initiator. Before `gss_accept_sec_context()` can be called, however, the server should acquire credentials for the service that was requested by the client. The server acquires these credentials with the `gss_acquire_cred()` function. Alternatively, the server can bypass explicit acquisition of credentials by specifying the default credential, that is, `GSS_C_NO_CREDENTIAL`, when the server calls `gss_accept_sec_context()`.

When calling `gss_accept_sec_context()`, the server can set the following arguments as shown:

- *cred\_handle* – The credential handle returned by `gss_acquire_cred()`. Alternatively, `GSS_C_NO_CREDENTIAL` can be used to indicate the default credential.
- *context\_handle* – `GSS_C_NO_CONTEXT` indicates an initial null context. Because `gss_init_sec_context()` is usually called in a loop, subsequent calls should pass the context handle that was returned by previous calls.
- *input\_token* – The context token received from the client.

The full set of `gss_accept_sec_context()` arguments is described in the following paragraphs.

Security context establishment might require several handshakes. The initiator and acceptor often need to send more than one piece of context information before the context is fully established. Therefore, for portability, context acceptance should always be done as part of a loop that checks whether the context has been fully established. If the context is not yet established, `gss_accept_sec_context()` returns a major status code of `GSS_C_CONTINUE_NEEDED`. Therefore, a loop should use the value that was returned by `gss_accept_sec_context()` to test whether to continue the acceptance loop.

The context acceptor returns context information to the initiator in the form of the output token that was returned by `gss_accept_sec_context()`. Subsequently, the acceptor can receive additional information from the initiator as an input token. The input token is then passed as an argument to subsequent `gss_accept_sec_context()` calls. When `gss_accept_sec_context()` has no more tokens to send to the initiator, an output token with a length of zero is returned. Besides checking for the return status `gss_accept_sec_context()`, the loop should check the output token's length to see whether another token must be sent. Before the loop begins, the output token's length should be initialized to zero. Either set the output token to `GSS_C_NO_BUFFER`, or set the structure's length field to a value of zero.

The following pseudocode demonstrates an example of context establishment from the server side.

```
context = GSS_C_NO_CONTEXT
output token = GSS_C_NO_BUFFER

do

    receive an input token from the initiator

    call gss_accept_sec_context(context, cred handle, input token,
                               output token, other args...)

    if (there's an output token to send to the initiator)
        send the output token to the initiator
        release the output token

    if (there's a GSS-API error)
        delete the context

until the context is complete
```

A real loop would be more complete with more extensive error-checking. See [“Establishing a Security Context With the Server” on page 99](#) for a real example of such a context-acceptance loop. Additionally, the `gss_accept_sec_context()` man page provides an example.

Again, GSS-API does not send or receive tokens. Tokens must be handled by the application. Examples of token-transferring functions are found in [“Miscellaneous GSS-API Sample Functions” on page 215](#).

`gss_accept_sec_context()` returns `GSS_S_COMPLETE` if it completes successfully. If the context is not complete, the function returns `GSS_S_CONTINUE_NEEDED`. If errors occur, the function returns error codes. For more information, see the `gss_accept_sec_context(3GSS)` man page.

## Using Other Context Services in GSS-API

The `gss_init_sec_context()` function enables an application to request additional data protection services beyond basic context establishment. These services are requested through the `req_flags` argument to `gss_init_sec_context()`.

Not all mechanisms offer all these services. The `ret_flags` argument for `gss_init_sec_context()` indicates which services are available in a given context. Similarly, the context acceptor examines the `ret_flags` value that is returned by `gss_accept_sec_context()` to determine the available services. The additional services are explained in the following sections.



## Delegating a Credential in GSS-API

If permitted, a context initiator can request that the context acceptor act as a proxy. In such a case, the acceptor can initiate further contexts on behalf of the initiator.

Suppose someone on Machine A wants to `rlogin` to Machine B, and then `rlogin` from Machine B to Machine C. Depending on the mechanism, the delegated credential identifies B either as A or B as proxy for A.

If delegation is permitted, *ret\_flags* can be set to `GSS_C_DELEG_FLAG`. The acceptor receives a delegated credential as the *delegated\_cred\_handle* argument of `gss_accept_sec_context()`. Delegating a credential is not the same as exporting a context. See “[Exporting and Importing Contexts in GSS-API](#)” on page 83. One difference is that an application can delegate that application's credentials multiple times simultaneously, while a context can only be held by one process at a time.

## Performing Mutual Authentication Between Peers in GSS-API

A user who transfers files to an `ftp` site typically does not need proof of the site's identity. On the other hand, a user who is required to provide a credit card number to an application would want definite proof of the receiver's identity. In such a case, *mutual authentication* is required. Both the context initiator and the acceptor must prove their identities.

A context initiator can request mutual authentication by setting the `gss_init_sec_context()` *req\_flags* argument to the value `GSS_C_MUTUAL_FLAG`. If mutual authentication has been authorized, the function indicates authorization by setting the *ret\_flags* argument to this value. If mutual authentication is requested but not available, the initiating application is responsible for responding accordingly. GSS-API does not automatically terminate a context when mutual authentication is requested but unavailable. Also, some mechanisms always perform mutual authentication even without a specific request.

## Performing Anonymous Authentication in GSS-API

In normal use of GSS-API, the initiator's identity is made available to the acceptor as a part of context establishment. However, a context initiator can request that its identity not be revealed to the context acceptor.

For example, consider an application that provides unrestricted access to a medical database. A client of such a service might want to authenticate the service. This approach would establish trust in any information that is retrieved from the database. The client might not want to expose its identity due to privacy concerns, for example.

To request anonymity, set the *req\_flags* argument of `gss_init_sec_context()` to `GSS_C_ANON_FLAG`. To verify whether anonymity is available, check the *ret\_flags* argument to `gss_init_sec_context()` or `gss_accept_sec_context()` to see whether `GSS_C_ANON_FLAG` is returned.

When anonymity is in effect, calling `gss_display_name()` on a client name that was returned by `gss_accept_sec_context()` or `gss_inquire_context()` produces a generic anonymous name.

---

**Note** – An application has the responsibility to take appropriate action if anonymity is requested but not permitted. GSS-API does not terminate a context in such a case.

---

## Using Channel Bindings in GSS-API

For many applications, basic context establishment is sufficient to assure proper authentication of a context initiator. In cases where additional security is desired, GSS-API offers the use of *channel bindings*. Channel bindings are tags that identify the particular data channel that is used. Specifically, channel bindings identify the origin and endpoint, that is, the initiator and acceptor of the context. Because the tags are specific to the originator and recipient applications, such tags offer more proof of a valid identity.

Channel bindings are pointed to by the `gss_channel_bindings_t` data type, which is a pointer to a `gss_channel_bindings_struct` structure as shown below.

```
typedef struct gss_channel_bindings_struct {
    OM_uint32      initiator_addrtype;
    gss_buffer_desc initiator_address;
    OM_uint32      acceptor_addrtype;
    gss_buffer_desc acceptor_address;
    gss_buffer_desc application_data;
} *gss_channel_bindings_t;
```

The first two fields are the address of the initiator and an address type that identifies the format in which the initiator's address is being sent. For example, `initiator_addrtype` might be sent to `GSS_C_AF_INET` to indicate that `initiator_address` is in the form of an Internet address, that is, an IP address. Similarly, the third and fourth fields indicate the address and address type of the acceptor. The final field, `application_data`, can be used by the application as needed. Set `application_data` to `GSS_C_NO_BUFFER` if `application_data` is not going to be used. If an application does not specify an address, that application should set the address type field to `GSS_C_AF_NULLADDR`. The “[Address Types for Channel Bindings](#)” on page 231 section has a list of valid address type values.

The address types indicate address families rather than specific addressing formats. For address families that contain several alternative address forms, the `initiator_address` and `acceptor_address` fields must contain sufficient information to determine which form is used. When not otherwise specified, addresses should be specified in network byte-order, that is, native byte-ordering for the address family.

To establish a context that uses channel bindings, the `input_chan_bindings` argument for `gss_init_sec_context()` should point to an allocated channel bindings structure. The structure's fields are concatenated into an octet string, and a MIC is derived. This MIC is then

bound to the output token. The application then sends the token to the context acceptor. After receiving the token, the acceptor calls `gss_accept_sec_context()`. See [“Accepting a Context in GSS-API” on page 79](#) for more information. `gss_accept_sec_context()` calculates a MIC for the received channel bindings. `gss_accept_sec_context()` then returns `GSS_C_BAD_BINDINGS` if the MIC does not match.

Because `gss_accept_sec_context()` returns the transmitted channel bindings, an acceptor can use these values to perform security checking. For example, the acceptor could check the value of *application\_data* against code words that are kept in a secure database.

---

**Note** – An underlying mechanism might not provide confidentiality for channel binding information. Therefore, an application should not include sensitive information as part of channel bindings unless confidentiality is ensured. To test for confidentiality, an application can check the *ret\_flags* argument of `gss_init_sec_context()` or `gss_accept_sec_context()`. The values `GSS_C_CONF_FLAG` and `GSS_C_PROT_READY_FLAG` indicate confidentiality. See [“Initiating a Context in GSS-API” on page 76](#) or [“Accepting a Context in GSS-API” on page 79](#) for information on *ret\_flags*.

---

Individual mechanisms can impose additional constraints on the addresses and address types that appear in channel bindings. For example, a mechanism might verify that the *initiator\_address* field of the channel bindings to be returned to `gss_init_sec_context()`. Portable applications should therefore provide the correct information for the address fields. If the correct information cannot be determined, then `GSS_C_AF_NULLADDR` should be specified as the address types.

## Exporting and Importing Contexts in GSS-API

GSS-API provides the means for exporting and importing contexts. This ability enables a multiprocess application, usually the context acceptor, to transfer a context from one process to another. For example, an acceptor might have one process that listens for context initiators and another that uses the data that is sent in the context. The [“Using the `test\_import\_export\_context\(\)` Function” on page 122](#) section shows how a context can be saved and restored with these functions.

The function `gss_export_sec_context()` creates an interprocess token that contains information about the exported context. See [“Interprocess Tokens in GSS-API” on page 73](#) for more information. The buffer to receive the token should be set to `GSS_C_NO_BUFFER` before `gss_export_sec_context()` is called.

The application then passes the token on to the other process. The new process accepts the token and passes that token to `gss_import_sec_context()`. The same functions that are used to pass tokens between applications can often be used to pass tokens between processes as well.

Only one instantiation of a security process can exist at a time. `gss_export_sec_context()` deactivates the exported context and sets the context handle to `GSS_C_NO_CONTEXT`. `gss_export_sec_context()` also deallocates any process-wide resources that are associated with that context. If the context exportation cannot be completed, `gss_export_sec_context()` leaves the existing security context unchanged and does not return an interprocess token.

Not all mechanisms permit contexts to be exported. An application can determine whether a context can be exported by checking the *ret\_flags* argument to `gss_accept_sec_context()` or `gss_init_sec_context()`. If this flag is set to `GSS_C_TRANS_FLAG`, then the context can be exported. (See [“Accepting a Context in GSS-API” on page 79](#) and [“Initiating a Context in GSS-API” on page 76](#).)

[Figure 4–6](#) shows how a multiprocess acceptor might use context exporting to multithread. In this case, Process 1 receives and processes tokens. This step separates the context-level tokens from the data tokens and passes the tokens on to Process 2. Process 2 deals with data in an application-specific way. In this illustration, the clients have already obtained export tokens from `gss_init_sec_context()`. The clients pass the tokens to a user-defined function, `send_a_token()`, which indicates whether the token to be transmitted is a context-level token or a message token. `send_a_token()` transmits the tokens to the server. Although not shown here, `send_a_token()` would presumably be used to pass tokens between threads as well.

FIGURE 4-6 Exporting Contexts: Multithreaded Acceptor Example

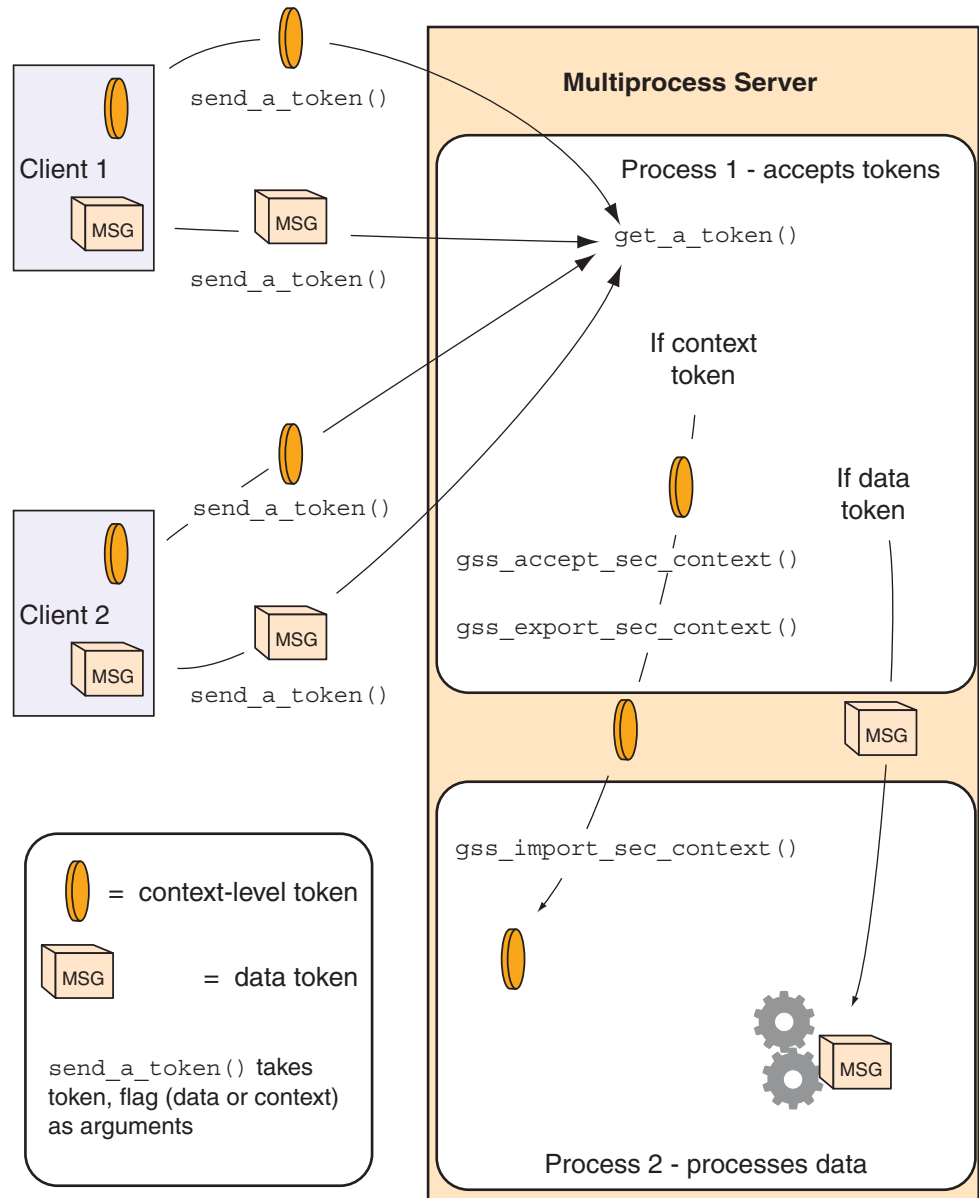

## Obtaining Context Information in GSS-API

GSS-API provides a function, `gss_inquire_context(3GSS)`, that obtains information about a given security context. Note that the context does not need to be complete.

Given a context handle, `gss_inquire_context()` provides the following information about context:

- Name of the context initiator.
- Name of the context acceptor.
- Number of seconds for which the context is valid.
- Security mechanism to be used with the context.
- Several context-parameter flags. These flags are the same as the *ret\_flags* argument of the `gss_accept_sec_context(3GSS)` function. The flags cover delegation, mutual authentication, and so on. See “Accepting a Context in GSS-API” on page 79.
- A flag that indicates whether the inquiring application is the context initiator.
- A flag that indicates whether the context is fully established.

## Sending Protected Data in GSS-API

After a context has been established between two peers, a message can be protected before that message is sent.

Establishing a context only uses the most basic GSS-API protection: *authentication*. Depending on the underlying security mechanisms, GSS-API provides two other levels of protection:

- **Integrity** – A message integrity code (MIC) for the message is generated by the `gss_get_mic()` function. The recipient checks the MIC to ensure that the received message is the same as the message that was sent.
- **Confidentiality** – In addition to using a MIC, the message is encrypted. The GSS-API function `gss_wrap()` performs the encryption.

The difference between `gss_get_mic()` and `gss_wrap()` is illustrated in the following diagram. With `gss_get_mic()`, the receiver gets a tag that indicates the message is intact. With `gss_wrap()`, the receiver gets an encrypted message and a tag.

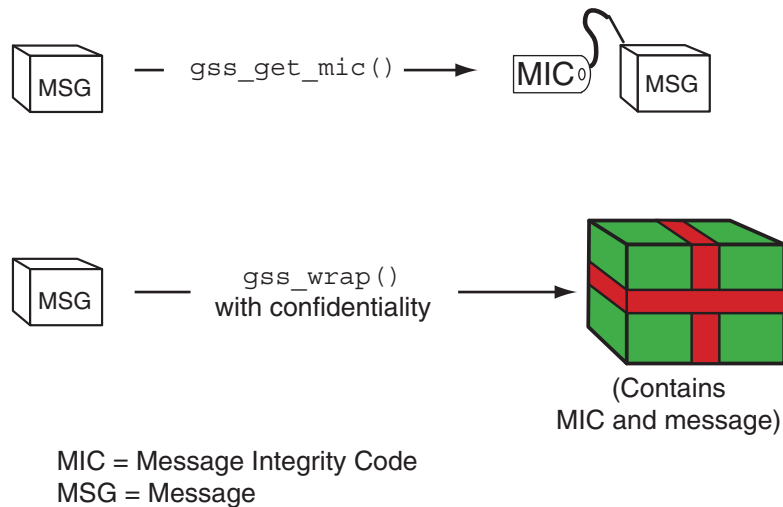
FIGURE 4-7 `gss_get_mic()` versus `gss_wrap()`

The function to be used depends on the situation. Because `gss_wrap()` includes the integrity service, many programs use `gss_wrap()`. A program can test for the availability of the confidentiality service. The program can then call `gss_wrap()` with or without confidentiality depending on the availability. An example is “[Wrapping and Sending a Message](#)” on page 105. However, because messages that use `gss_get_mic()` do not need to be unwrapped, fewer CPU cycles are used than with `gss_wrap()`. Thus a program that does not need confidentiality might protect messages with `gss_get_mic()`.

### Tagging Messages With `gss_get_mic()`

Programs can use `gss_get_mic()` to add a cryptographic MIC to a message. The recipient can check the MIC for a message by calling `gss_verify_mic()`.

In contrast to `gss_wrap()`, `gss_get_mic()` produces separate output for the message and the MIC. This separation means that a sender application must arrange to send both the message and the accompanying MIC. More significantly, the recipient must be able to distinguish between the message and the MIC.

The following approaches ensure the proper processing of message and MIC:

- Through program control, that is, state. A recipient application might know to call the receiving function twice, once to get a message and a second time to get the message's MIC.
- Through flags. The sender and receiver can flag the kind of token that is included.

- Through user-defined token structures that include both the message and the MIC.

GSS\_S\_COMPLETE is returned if `gss_get_mic()` completes successfully. If the specified QOP is not valid, GSS\_S\_BAD\_QOP is returned. For more information, see [gss\\_get\\_mic\(3GSS\)](#).

## Wrapping Messages With `gss_wrap()`

Messages can be wrapped by the `gss_wrap()` function. Like `gss_get_mic()`, `gss_wrap()` provides a MIC. `gss_wrap()` also encrypts a given message if confidentiality is requested and permitted by the underlying mechanism. The message receiver unwraps the message with `gss_unwrap()`.

Unlike `gss_get_mic()`, `gss_wrap()` wraps the message and the MIC together in the outgoing message. The function that transmits the bundle need be called only once. On the other end, `gss_unwrap()` extracts the message. The MIC is not visible to the application.

`gss_wrap()` returns GSS\_S\_COMPLETE if the message was successfully wrapped. If the requested QOP is not valid, GSS\_S\_BAD\_QOP is returned. For an example of `gss_wrap()`, see [“Wrapping and Sending a Message” on page 105](#).

## Handling Wrap Size Issues in GSS-API

Wrapping a message with `gss_wrap()` increases the amount of data to be sent. Because the protected message packet needs to fit through a given transportation protocol, GSS-API provides the function `gss_wrap_size_limit()`. `gss_wrap_size_limit()` calculates the maximum size of a message that can be wrapped without becoming too large for the protocol. The application can break up messages that exceed this size before calling `gss_wrap()`. Always check the wrap-size limit before actually wrapping the message.

The amount of the size increase depends on two factors:

- Which QOP algorithm is used for making the transformation
- Whether confidentiality is invoked

The default QOP can vary from one implementation of GSS-API to another. Thus, a wrapped message can vary in size even if the QOP default is specified. This possibility is illustrated in the following figure.



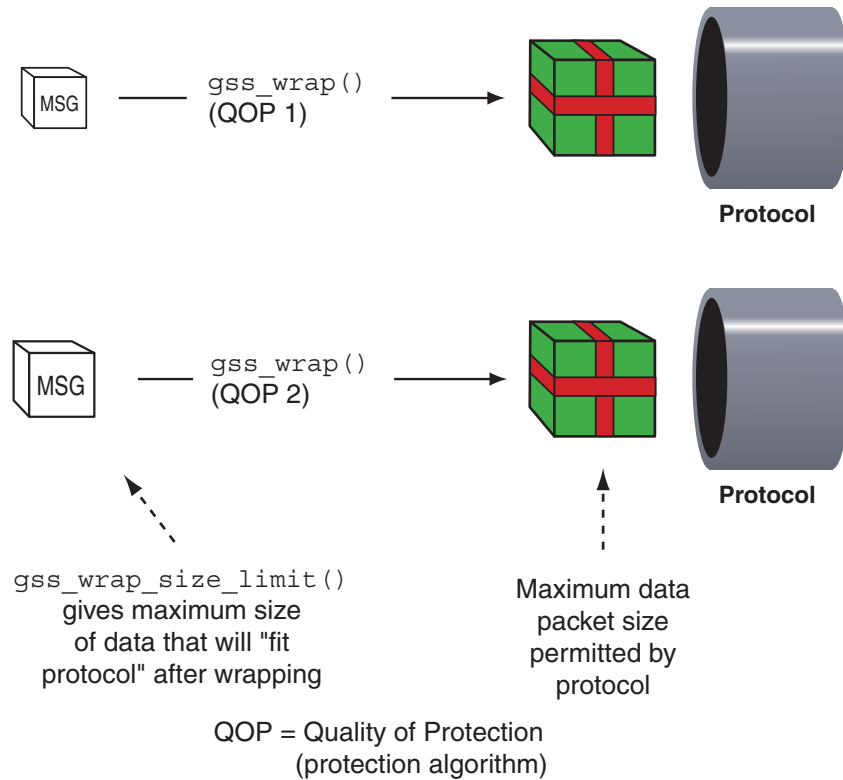

Regardless of whether confidentiality is applied, `gss_wrap()` still increases the size of a message. `gss_wrap()` embeds a MIC into the transmitted message. However, encrypting the message can further increase the size. The following figure shows this process.

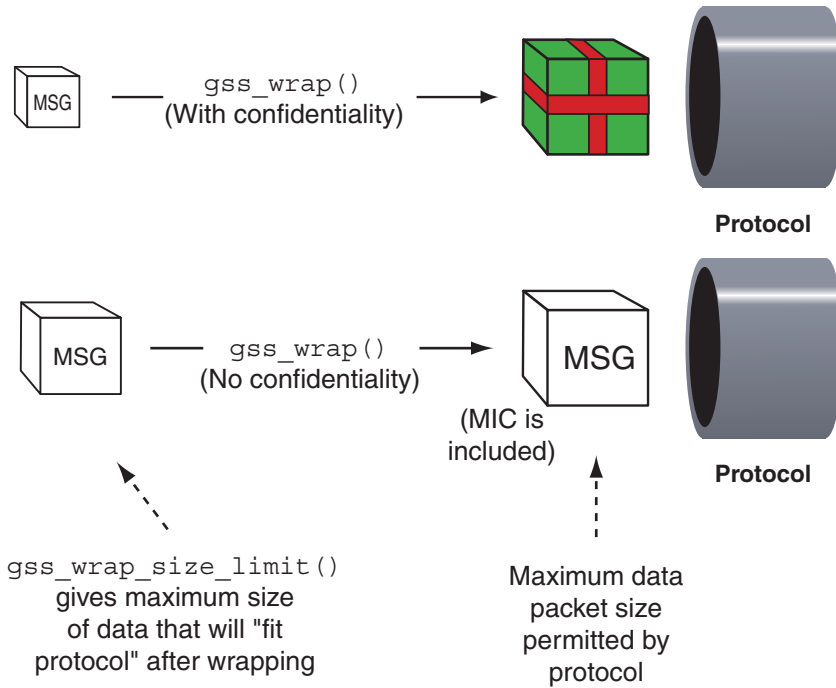

`GSS_S_COMPLETE` is returned if `gss_wrap_size_limit()` completes successfully. If the specified QOP is not valid, `GSS_S_BAD_QOP` is returned. “[Wrapping and Sending a Message](#)” on page 105 includes an example of how `gss_wrap_size_limit()` can be used to return the maximum original message size.

Successful completion of this call does not necessarily guarantee that `gss_wrap()` can protect a message of length *max-input-size* bytes. This ability depends on the availability of system resources at the time that `gss_wrap()` is called. For more information, see the `gss_wrap_size_limit(3GSS)` man page.

## Detecting Sequence Problems in GSS-API

As a context initiator transmits sequential data packets to the acceptor, some mechanisms allow the context acceptor to check for proper sequencing. These checks include whether the packets arrive in the right order, and with no unwanted duplication of packets. See following figure. An acceptor checks for these two conditions during the verification of a packet and the unwrapping of a packet. See “[Unwrapping the Message](#)” on page 121 for more information.

FIGURE 4-8 Message Replay and Message Out-of-Sequence

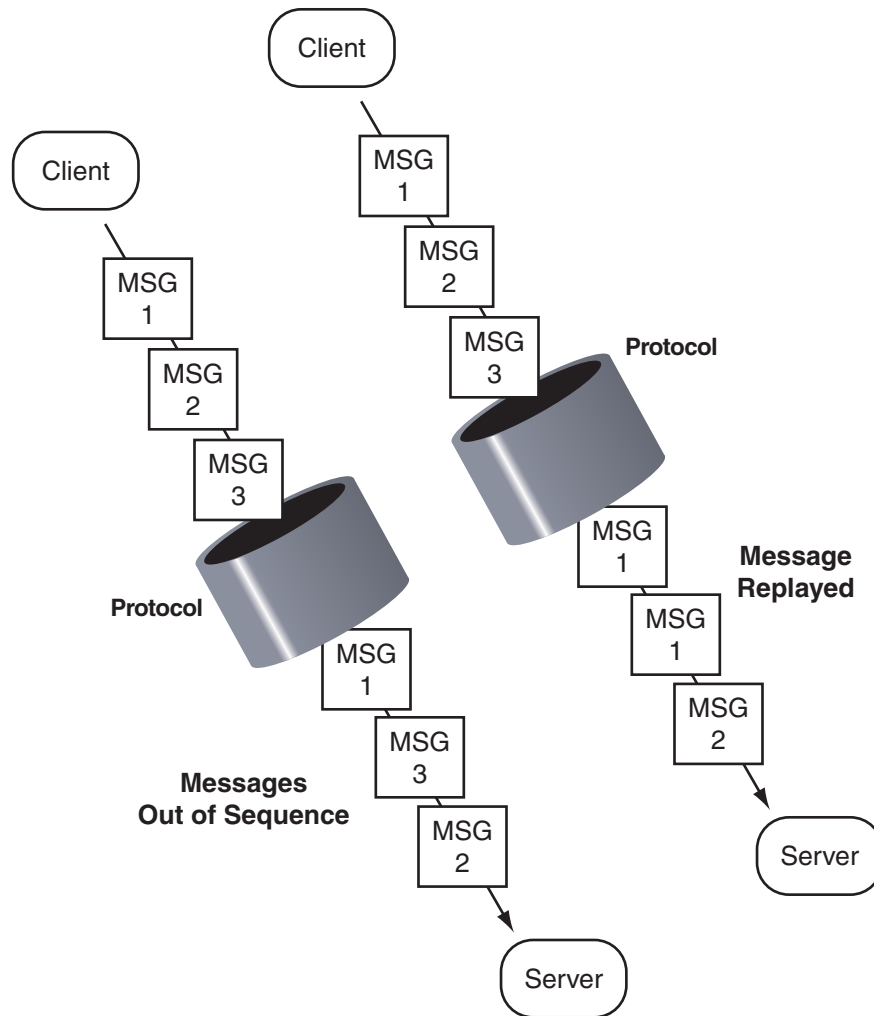

With `gss_init_sec_context()`, an initiator can check the sequence by applying logical OR to the `req_flags` argument with either `GSS_C_REPLAY_FLAG` or `GSS_C_SEQUENCE_FLAG`.

## Confirming Message Transmission in GSS-API

After the recipient has unwrapped or verified the transmitted message, a confirmation can be returned to the sender. This means sending back a MIC for that message. Consider the case of a message that was not wrapped by the sender but only tagged with a MIC with `gss_get_mic()`.

The process, illustrated in Figure 4–9, is as follows:

1. The initiator tags the message with `gss_get_mic()`.
2. The initiator sends the message and MIC to the acceptor.
3. The acceptor verifies the message with `gss_verify_mic()`.
4. The acceptor sends the MIC back to the initiator.
5. The initiator verifies the received MIC against the original message with `gss_verify_mic()`.

FIGURE 4–9 Confirming MIC Data

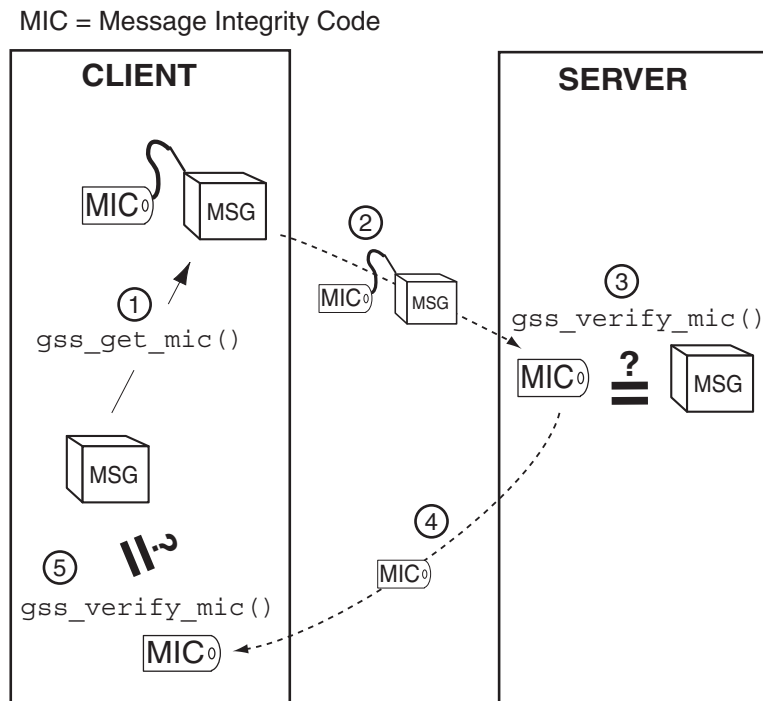

In the case of wrapped data, the `gss_unwrap()` function never produces a separate MIC, so the recipient must generate it from the received and unwrapped message.

The process, illustrated in [Figure 4–10](#), is as follows:

1. The initiator wraps the message with `gss_wrap()`.
2. The initiator sends the wrapped message.
3. The acceptor unwraps the message with `gss_unwrap()`.
4. The acceptor calls `gss_get_mic()` to produce a MIC for the unwrapped message.
5. The acceptor sends the derived MIC to the initiator.
6. The initiator compares the received MIC against the original message with `gss_verify_mic()`.

Applications should deallocate any data space that has been allocated for GSS-API data. The relevant functions are `gss_release_buffer(3GSS)`, `gss_release_cred(3GSS)`, `gss_release_name(3GSS)`, and `gss_release_oid_set(3GSS)`.

FIGURE 4-10 Confirming Wrapped Data

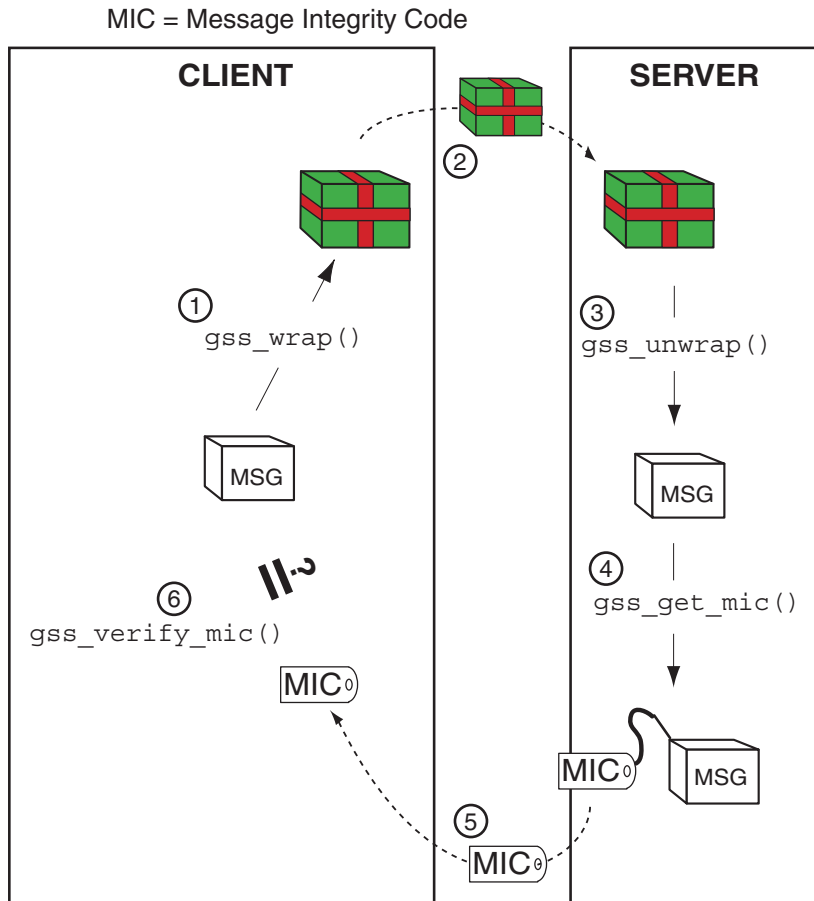

## Cleaning Up a GSS-API Session

Finally, all messages have been sent and received, and the initiator and acceptor applications have finished. At this point, both applications should call `gss_delete_sec_context()` to destroy the shared context. `gss_delete_sec_context()` deletes local data structures that are associated with the context.

For good measure, applications should be sure to deallocate any data space that has been allocated for GSS-API data. The functions that do this are `gss_release_buffer()`, `gss_release_cred()`, `gss_release_name()`, and `gss_release_oid_set()`.

## GSS-API Client Example

---

This chapter presents a walk-through of a typical GSS-API client application.

The following topics are covered:

- “GSSAPI Client Example Overview” on page 95
- “GSSAPI Client Example: `main()` Function” on page 97
- “Opening a Connection With the Server” on page 98
- “Establishing a Security Context With the Server” on page 99
- “Miscellaneous GSSAPI Context Operations on the Client Side” on page 104
- “Wrapping and Sending a Message” on page 105
- “Reading and Verifying a Signature Block From a GSS-API Client” on page 107
- “Deleting the Security Context” on page 108

### GSSAPI Client Example Overview

The sample client-side program `gss-client` creates a security context with a server, establishes security parameters, and sends the *message* string to the server. The program uses a simple TCP-based sockets connection to make the connection.

The following sections provide a step-by-step description of how `gss-client` works. Because `gss-client` is a sample program that has been designed to show off GSSAPI functionality, only relevant parts of the program are discussed in detail. The complete source code for the two applications appears in the appendix and can be downloaded from:

<http://developers.sun.com/prodtech/solaris/downloads/index.html>

## GSSAPI Client Example Structure

The `gss-client` application performs the following steps:

1. Parses the command line.
2. Creates an object ID (OID) for a mechanism, if a mechanism is specified. Otherwise, the default mechanism is used, which is most commonly the case.
3. Creates a connection to the server.
4. Establishes a security context.
5. Wraps and sends the message.
6. Verifies that the message has been “signed” correctly by the server.
7. Deletes the security context.

## Running the GSSAPI Client Example

The `gss-client` example takes this form on the command line:

```
gss-client [-port port] [-d] [-mech mech] host service-name [-f] msg
```

- *port* – The port number for making the connection to the remote machine that is specified by *host*.
- `-d` flag – Causes security credentials to be delegated to the server. Specifically, the *deleg-flag* variable is set to the GSS-API value `GSS_C_DELEG_FLAG`. Otherwise, *deleg-flag* is set to zero.
- *mech* – The name of the security mechanism, such as Kerberos v5 to be used. If no mechanism is specified, the GSS-API uses a default mechanism.
- *host* – The name of the server.
- *service-name* – The name of the network service requested by the client. Some typical examples are the `telnet`, `ftp`, and `login` services.
- *msg* – The string to send to the server as protected data. If the `-f` option is specified, then *msg* is the name of a file from which to read the string.

A typical command line for client application program might look like the following example:

```
% gss-client -port 8080 -d -mech kerberos_v5 erebos.eng nfs "ls"
```

The following example does not specify a mechanism, port, or delegation:

```
% gss-client erebos.eng nfs "ls"
```



## GSSAPI Client Example: main() Function

As with all C programs, the outer shell of the program is contained in the entry-point function, `main()`. `main()` performs four functions:

- Parses command-line arguments and assigns the arguments to variables.
- Calls `parse_oid()` to create a GSS-API OID, object identifier, if a mechanism other than the default is to be used. The object identifier comes from the name of the security mechanism, provided that a mechanism name has been supplied.
- Calls `call_server()`, which does the actual work of creating a context and sending data.
- Releases the storage space for the OID if necessary, after the data is sent.

The source code for the `main()` routine is shown in the following example.

---

**Note** – The source code for this example is also available through the Sun download center. See <http://www.sun.com/download/products.xml?id=41912db5>.

---

### EXAMPLE 5-1 gss-client Example: main()

```
int main(argc, argv)
    int argc;
    char **argv;
{
    char *msg;
    char service_name[128];
    char hostname[128];
    char *mechanism = 0;
    u_short port = 4444;
    int use_file = 0;
    OM_uint32 deleg_flag = 0, min_stat;

    display_file = stdout;

    /* Parse command-line arguments. */

    argc--; argv++;
    while (argc) {
        if (strcmp(*argv, "-port") == 0) {
            argc--; argv++;
            if (!argc) usage();
            port = atoi(*argv);
        } else if (strcmp(*argv, "-mech") == 0) {
            argc--; argv++;
            if (!argc) usage();
            mechanism = *argv;
        } else if (strcmp(*argv, "-d") == 0) {
            deleg_flag = GSS_C_DELEG_FLAG;
        } else if (strcmp(*argv, "-f") == 0) {
            use_file = 1;
        } else
            break;
        argc--; argv++;
    }
}
```

EXAMPLE 5-1 gss-client Example:main() (Continued)

```
    }
    if (argc != 3)
        usage();

    if (argc > 1) {
        strcpy(hostname, argv[0]);
    } else if (gethostname(hostname, sizeof(hostname)) == -1) {
        perror("gethostname");
        exit(1);
    }

    if (argc > 2) {
        strcpy(service_name, argv[1]);
        strcat(service_name, "@");
        strcat(service_name, hostname);
    }

    msg = argv[2];

    /* Create GSSAPI object ID. */
    if (mechanism)
        parse_oid(mechanism, &g_mechOid);

    /* Call server to create context and send data. */
    if (call_server(hostname, port, g_mechOid, service_name,
        deleg_flag, msg, use_file) < 0)
        exit(1);

    /* Release storage space for OID, if still allocated */
    if (g_mechOid != GSS_C_NULL_OID)
        (void) gss_release_oid(&min_stat, &gmechOid);

    return 0;
}
```

## Opening a Connection With the Server

The `call_server()` function uses the following code to make the connection with the server:

```
    if ((s = connect_to_server(host, port)) < 0)
        return -1;
```

`s` is a file descriptor, the `int` that is initially returned by a call to `socket()`.

`connect_to_server()` is a simple function outside GSS-API that uses sockets to create a connection. The source code for `connect_to_server()` is shown in the following example.

---

**Note** – The source code for this example is also available through the Sun download center. See <http://www.sun.com/download/products.xml?id=41912db5>.

---

**EXAMPLE 5-2** connect\_to\_server() Function

```
int connect_to_server(host, port)
    char *host;
    u_short port;
{
    struct sockaddr_in saddr;
    struct hostent *hp;
    int s;

    if ((hp = gethostbyname(host)) == NULL) {
        fprintf(stderr, "Unknown host: %s\n", host);
        return -1;
    }

    saddr.sin_family = hp->h_addrtype;
    memcpy((char *)&saddr.sin_addr, hp->h_addr, sizeof(saddr.sin_addr));
    saddr.sin_port = htons(port);

    if ((s = socket(AF_INET, SOCK_STREAM, 0)) < 0) {
        perror("creating socket");
        return -1;
    }
    if (connect(s, (struct sockaddr *)&saddr, sizeof(saddr)) < 0) {
        perror("connecting to server");
        (void) close(s);
        return -1;
    }

    return s;
}
```

## Establishing a Security Context With the Server

After the connection is made, `call_server()` uses the function `client_establish_context()` to create the security context, as follows:

```
if (client_establish_context(s, service-name, deleg-flag, oid, &context,
                            &ret-flags) < 0) {
    (void) close(s);
    return -1;
}
```

- *s* is a file descriptor that represents the connection that is established by `connect_to_server()`.
- *service-name* is the requested network service.
- *deleg-flag* specifies whether the server can act as a proxy for the client.
- *oid* is the mechanism.

- *context* is the context to be created.
- *ret-flags* is an int that specifies any flags to be returned by the GSS-API function `gss_init_sec_context()`.

The `client_establish_context()` performs the following tasks:

- Translates the service name into internal GSSAPI format
- Performs a loop of token exchanges between the client and the server until the security context is complete

## Translating a Service Name into GSS-API Format

The first task that `client_establish_context()` performs is to translate the service name string to internal GSS-API format by using `gss_import_name()`.

**EXAMPLE 5-3** `client_establish_context()` – Translate Service Name

```

/*
 * Import the name into target_name. Use send_tok to save
 * local variable space.
 */

send_tok.value = service_name;
send_tok.length = strlen(service_name) + 1;
maj_stat = gss_import_name(&min_stat, &send_tok,
                          (gss_OID) GSS_C_NT_HOSTBASED_SERVICE, &target_name);
if (maj_stat != GSS_S_COMPLETE) {
    display_status("parsing name", maj_stat, min_stat);
    return -1;
}

```

`gss_import_name()` takes the name of the service, which is stored in an opaque GSS-API buffer `send_tok`, and converts the string to the GSS-API internal name `target_name`. `send_tok` is used to save space instead of declaring a new `gss_buffer_desc`. The third argument is a `gss_OID` type that indicates the `send_tok` name format. This example uses `GSS_C_NT_HOSTBASED_SERVICE`, which means a service of the format *service@host*. See “Name Types” on page 230 for other possible values for this argument.

## Establishing a Security Context for GSS-API

Once the service has been translated to GSS-API internal format, the context can be established. To maximize portability, establishing context should always be performed as a loop.

Before entering the loop, `client_establish_context()` initializes the context and the `token_ptr` parameter. There is a choice in the use of `token_ptr`. `token_ptr` can point either to `send_tok`, the token to be sent to the server, or to `recv_tok`, the token that is sent back by the server.

Inside the loop, two items are checked:

- The status that is returned by `gss_init_sec_context()`  
The return status catches any errors that might require the loop to be aborted. `gss_init_sec_context()` returns `GSS_S_CONTINUE_NEEDED` if and only if the server has another token to send.
- The size of token to be sent to the server, which is generated by `gss_init_sec_context()`  
A token size of zero indicates that no more information exists that can be sent to the server and that the loop can be exited. The token size is determined from `token_ptr`.

The following pseudocode describes the loop:

```
do
  gss_init_sec_context()
  if no context was created
    exit with error;
  if the status is neither "complete" nor "in process"
    release the service namespace and exit with error;
  if there is a token to send to the server, that is, the size is nonzero
    send the token;
    if sending the token fails,
      release the token and service namespaces. Exit with error;
      release the namespace for the token that was just sent;
  if the context is not completely set up
    receive a token from the server;
while the context is not complete
```

The loop starts with a call to `gss_init_sec_context()`, which takes the following arguments:

- The status code to be set by the underlying mechanism.
- The credential handle. The example uses `GSS_C_NO_CREDENTIAL` to act as a default principal.
- `gss-context`, which represents the context handle to be created.
- `target-name` of the service, as a `GSS_API` internal name.
- `oid`, the ID for the mechanism.
- Request flags. In this case, the client requests that the server authenticate itself, that message-duplication be turned on, and that the server act as a proxy if requested.
- No time limit for the context.
- No request for channel bindings.
- `token_ptr`, which points to the token to be received from the server.
- The mechanism actually used by the server. The mechanism is set to `NULL` here because the application does not use this value.
- `send_tok`, which is the token that `gss_init_sec_context()` creates to send to the server.

- Return flags. Set to NULL because they are ignored in this example.

---

**Note** – The client does not need to acquire credentials before initiating a context. On the client side, credential management is handled transparently by the GSS-API. That is, the GSS-API *knows* how to get credentials that are created by this mechanism for this principal. As a result, the application can pass `gss_init_sec_context()` a default credential. On the server side, however, a server application must explicitly acquire credentials for a service before accepting a context. See “[Acquiring Credentials](#)” on page 112.

---

After checking that a context or part of one exists and that `gss_init_sec_context()` is returning valid status, `connect_to_server()` checks that `gss_init_sec_context()` has provided a token to send to the server. If no token is present, the server has signalled that no other tokens are needed. If a token has been provided, then that token must be sent to the server. If sending the token fails, the namespaces for the token and service cannot be determined, and `connect_to_server()` exits. The following algorithm checks for the presence of a token by looking at the length:

```
if (send_tok_length != 0) {
    if (send_token(s, &send_tok) < 0) {
        (void) gss_release_buffer(&min_stat, &send_tok);
        (void) gss_release_name(&min_stat, &target_name);
        return -1;
    }
}
```

`send_token()` is not a GSS-API function and needs to be written by the user. The `send_token()` function writes a token to the file descriptor. `send_token()` returns 0 on success and -1 on failure. GSS-API does not send or receive tokens itself. The calling applications are responsible for sending and receiving any tokens that have been created by GSS-API.

The source code for the context establishment loop is provided below.

---

**Note** – The source code for this example is also available through the Sun download center. See <http://www.sun.com/download/products.xml?id=41912db5>.

---

#### EXAMPLE 5-4 Loop for Establishing Contexts

```
/*
 * Perform the context establishment loop.
 *
 * On each pass through the loop, token_ptr points to the token
 * to send to the server (or GSS_C_NO_BUFFER on the first pass).
 * Every generated token is stored in send_tok which is then
 * transmitted to the server; every received token is stored in
 * rcv_tok, which token_ptr is then set to, to be processed by
 * the next call to gss_init_sec_context.
 */
```

## EXAMPLE 5-4 Loop for Establishing Contexts (Continued)

```

* GSS-API guarantees that send_tok's length will be non-zero
* if and only if the server is expecting another token from us,
* and that gss_init_sec_context returns GSS_S_CONTINUE_NEEDED if
* and only if the server has another token to send us.
*/

token_ptr = GSS_C_NO_BUFFER;
*gss_context = GSS_C_NO_CONTEXT;
123456789012345678901234567890123456789012345678901234567890123456

do {
    maj_stat =
        gss_init_sec_context(&min_stat, GSS_C_NO_CREDENTIAL,
            gss_context, target_name, oid,
            GSS_C_MUTUAL_FLAG | GSS_C_REPLAY_FLAG | deleg_flag,
            0, NULL, /* no channel bindings */
            token_ptr, NULL, /* ignore mech type */
            &send_tok, ret_flags, NULL); /* ignore time_rec */
    if (gss_context == NULL){
        printf("Cannot create context\n");
        return GSS_S_NO_CONTEXT;
    }
    if (token_ptr != GSS_C_NO_BUFFER)
        (void) gss_release_buffer(&min_stat, &recv_tok);
    if (maj_stat!=GSS_S_COMPLETE && maj_stat!=GSS_S_CONTINUE_NEEDED) {
        display_status("initializing context", maj_stat, min_stat);
        (void) gss_release_name(&min_stat, &target_name);
        return -1;
    }

    if (send_tok.length != 0){
        fprintf(stdout, "Sending init_sec_context token (size=%ld)...",
            send_tok.length);
        if (send_token(s, &send_tok) < 0) {
            (void) gss_release_buffer(&min_stat, &send_tok);
            (void) gss_release_name(&min_stat, &target_name);
            return -1;
        }
    }
    (void) gss_release_buffer(&min_stat, &send_tok);

    if (maj_stat == GSS_S_CONTINUE_NEEDED) {
        fprintf(stdout, "continue needed...");
        if (recv_token(s, &recv_tok) < 0) {
            (void) gss_release_name(&min_stat, &target_name);
            return -1;
        }
        token_ptr = &recv_tok;
    }
    printf("\n");
} while (maj_stat == GSS_S_CONTINUE_NEEDED);

```

For more information on how `send_token()` and `recv_token()` work, see [“Miscellaneous GSS-API Sample Functions”](#) on page 215.

## Miscellaneous GSSAPI Context Operations on the Client Side

As a sample program, `gss-client` performs some functions for demonstration purposes. The following source code is not essential for the basic task, but is provided to demonstrate these other operations:

- Saving and restoring the context
- Displaying context flags
- Obtaining the context status

The source code for these operations is shown in the following example.

---

**Note** – The source code for this example is also available through the Sun download center. See <http://www.sun.com/download/products.xml?id=41912db5>.

---

### EXAMPLE 5-5 `gss-client: call_server()` Establish Context

```

/* Save and then restore the context */
maj_stat = gss_export_sec_context(&min_stat,
                                &context,
                                &context_token);

if (maj_stat != GSS_S_COMPLETE) {
    display_status("exporting context", maj_stat, min_stat);
    return -1;
}
maj_stat = gss_import_sec_context(&min_stat,
                                &context_token,
                                &context);

if (maj_stat != GSS_S_COMPLETE) {
    display_status("importing context", maj_stat, min_stat);
    return -1;
}
(void) gss_release_buffer(&min_stat, &context_token);

/* display the flags */
display_ctx_flags(ret_flags);

/* Get context information */
maj_stat = gss_inquire_context(&min_stat, context,
                              &src_name, &targ_name, &lifetime,
                              &mechanism, &context_flags,
                              &is_local,
                              &is_open);

if (maj_stat != GSS_S_COMPLETE) {
    display_status("inquiring context", maj_stat, min_stat);
    return -1;
}

if (maj_stat == GSS_S_CONTEXT_EXPIRED) {
    printf(" context expired\n");
    display_status("Context is expired", maj_stat, min_stat);
    return -1;
}

```



## Wrapping and Sending a Message

The `gss-client` application needs to wrap, that is, encrypt the data before the data can be sent. The application goes through the following steps to wrap the message:

- Determines the wrap size limit. This process ensures that the wrapped message can be accommodated by the protocol.
- Obtains the source and destination names. Translates the names from object identifiers to strings.
- Gets the list of mechanism names. Translates the names from object identifiers to strings.
- Inserts the message into a buffer and wraps the message.
- Sends the message to the server.

The following source code wraps a message.

---

**Note** – The source code for this example is also available through the Sun download center. See <http://www.sun.com/download/products.xml?id=41912db5>.

---

### EXAMPLE 5-6 gss-client Example: `call_server()` – Wrap Message

```

/* Test gss_wrap_size_limit */
maj_stat = gss_wrap_size_limit(&min_stat, context, conf_req_flag,
    GSS_C_QOP_DEFAULT, req_output_size, &max_input_size);
if (maj_stat != GSS_S_COMPLETE) {
    display_status("wrap_size_limit call", maj_stat, min_stat);
} else
    fprintf(stderr, "gss_wrap_size_limit returned "
        "max input size = %d \n"
        "for req_output_size = %d with Integrity only\n",
        max_input_size , req_output_size , conf_req_flag);

conf_req_flag = 1;
maj_stat = gss_wrap_size_limit(&min_stat, context, conf_req_flag,
    GSS_C_QOP_DEFAULT, req_output_size, &max_input_size);
if (maj_stat != GSS_S_COMPLETE) {
    display_status("wrap_size_limit call", maj_stat, min_stat);
} else
    fprintf(stderr, "gss_wrap_size_limit returned "
        "max input size = %d \n" "for req_output_size = %d with "
        "Integrity & Privacy \n", max_input_size , req_output_size );

maj_stat = gss_display_name(&min_stat, src_name, &name, &name_type);
if (maj_stat != GSS_S_COMPLETE) {
    display_status("displaying source name", maj_stat, min_stat);
    return -1;
}

maj_stat = gss_display_name(&min_stat, targ_name, &name,
    (gss_OID *) NULL);
if (maj_stat != GSS_S_COMPLETE) {
    display_status("displaying target name", maj_stat, min_stat);
}

```

## EXAMPLE 5-6 gss-client Example: call\_server() – Wrap Message (Continued)

```

    return -1;
}
fprintf(stderr, "\\%.*s\\" to "\\%.*s\\", lifetime %u, flags %x, %s, %s\\n",
        (int) sname.length, (char *) sname.value, (int) tname.length,
        (char *) tname.value, lifetime, context_flags,
        (is_local) ? "locally initiated" : "remotely initiated",
        (is_open) ? "open" : "closed");

(void) gss_release_name(&min_stat, &src_name);
(void) gss_release_name(&min_stat, &targ_name);
(void) gss_release_buffer(&min_stat, &sname);
(void) gss_release_buffer(&min_stat, &tname);

maj_stat = gss_oid_to_str(&min_stat, name_type, &oid_name);
if (maj_stat != GSS_S_COMPLETE) {
    display_status("converting oid->string", maj_stat, min_stat);
    return -1;
}
fprintf(stderr, "Name type of source name is %.*s\\n", (int) oid_name.length,
        (char *) oid_name.value);
(void) gss_release_buffer(&min_stat, &oid_name);

/* Now get the names supported by the mechanism */
maj_stat = gss_inquire_names_for_mech(&min_stat, mechanism, &mech_names);
if (maj_stat != GSS_S_COMPLETE) {
    display_status("inquiring mech names", maj_stat, min_stat);
    return -1;
}

maj_stat = gss_oid_to_str(&min_stat, mechanism, &oid_name);
if (maj_stat != GSS_S_COMPLETE) {
    display_status("converting oid->string", maj_stat, min_stat);
    return -1;
}
mechStr = (char *)__gss_oid_to_mech(mechanism);
fprintf(stderr, "Mechanism %.*s (%s) supports %d names\\n", (int) oid_name.length,
        (char *) oid_name.value, (mechStr == NULL ? "NULL" : mechStr),
        mech_names->count);
(void) gss_release_buffer(&min_stat, &oid_name);

for (i=0; i < mech_names->count; i++) {
    maj_stat = gss_oid_to_str(&min_stat, &mech_names->elements[i], &oid_name);
    if (maj_stat != GSS_S_COMPLETE) {
        display_status("converting oid->string", maj_stat, min_stat);
        return -1;
    }
    fprintf(stderr, " %d: %.*s\\n", i, (int) oid_name.length, (
        char *) oid_name.value);

    (void) gss_release_buffer(&min_stat, &oid_name);
}
(void) gss_release_oid_set(&min_stat, &mech_names);

if (use_file) {
    read_file(msg, &in_buf);
} else {

```

EXAMPLE 5-6 gss-client Example: call\_server() – Wrap Message (Continued)

```

    /* Wrap the message */
    in_buf.value = msg;
    in_buf.length = strlen(msg) + 1;
}

if (ret_flag & GSS_C_CONF_FLAG) {
    state = 1;
} else
    state = 0;
}
maj_stat = gss_wrap(&min_stat, context, 1, GSS_C_QOP_DEFAULT, &in_buf,
    &state, &out_buf);
if (maj_stat != GSS_S_COMPLETE) {
    display_status("wrapping message", maj_stat, min_stat);
    (void) close(s);
    (void) gss_delete_sec_context(&min_stat, &context, GSS_C_NO_BUFFER);
    return -1;
} else if (!state) {
    fprintf(stderr, "Warning! Message not encrypted.\n");
}

/* Send to server */
if (send_token(s, &out_buf) < 0) {
    (void) close(s);
    (void) gss_delete_sec_context(&min_stat, &context, GSS_C_NO_BUFFER);
    return -1;
}
(void) gss_release_buffer(&min_stat, &out_buf);

```

## Reading and Verifying a Signature Block From a GSS-API Client

The `gss-client` program can now test the validity of the message that was sent. The server returns the MIC for the message that was sent. The message can be retrieved with the `recv_token()`.

The `gss_verify_mic()` function is then used to verify the message's *signature*, that is, the MIC. `gss_verify_mic()` compares the MIC that was received with the original, unwrapped message. The received MIC comes from the server's token, which is stored in `out_buf`. The MIC from the unwrapped version of the message is held in `in_buf`. If the two MICs match, the message is verified. The client then releases the buffer for the received token, `out_buf`.

The process of reading and verifying a signature block is demonstrated in the following source code.

**Note** – The source code for this example is also available through the Sun download center. See <http://www.sun.com/download/products.xml?id=41912db5>.

---

**EXAMPLE 5-7** gss-client Example – Read and Verify Signature Block

```
/* Read signature block into out_buf */
    if (recv_token(s, &out_buf) < 0) {
        (void) close(s);
        (void) gss_delete_sec_context(&min_stat, &context, GSS_C_NO_BUFFER);
        return -1;
    }

/* Verify signature block */
    maj_stat = gss_(&min_stat, context, &in_buf,
                   &out_buf, &qop_state);
    if (maj_stat != GSS_S_COMPLETE) {
        display_status("verifying signature", maj_stat, min_stat);
        (void) close(s);
        (void) gss_delete_sec_context(&min_stat, &context, GSS_C_NO_BUFFER);
        return -1;
    }
    (void) gss_release_buffer(&min_stat, &out_buf);

    if (use_file)
        free(in_buf.value);

    printf("Signature verified.\n");
```

## Deleting the Security Context

The `call_server()` function finishes by deleting the context and returning to the `main()` function.

**Note** – The source code for this example is also available through the Sun download center. See <http://www.sun.com/download/products.xml?id=41912db5>.

---

**EXAMPLE 5-8** gss-client Example: `call_server()` – Delete Context

```
/* Delete context */
    maj_stat = gss_delete_sec_context(&min_stat, &context, &out_buf);
    if (maj_stat != GSS_S_COMPLETE) {
        display_status("deleting context", maj_stat, min_stat);
        (void) close(s);
        (void) gss_delete_sec_context(&min_stat, &context, GSS_C_NO_BUFFER);
        return -1;
    }

    (void) gss_release_buffer(&min_stat, &out_buf);
    (void) close(s);
    return 0;
```

## GSS-API Server Example

---

This chapter presents a walk-through of the source code for the `gss-server` sample program.

The following topics are covered:

- “GSSAPI Server Example Overview” on page 109
- “GSSAPI Server Example: `main()` Function” on page 110
- “Acquiring Credentials” on page 112
- “Checking for `inetd`” on page 115
- “Receiving Data From a Client” on page 116
- “Cleanup in the GSSAPI Server Example” on page 124

### GSSAPI Server Example Overview

The sample server-side program `gss-server` works in conjunction with `gss-client`, which is described in the previous chapter. The basic purpose of `gss-server` is to receive, sign, and return the wrapped message from `gssapi-client`.

The following sections provide a step-by-step description of how `gss-server` works. Because `gss-server` is a sample program for demonstrating GSSAPI functionality, only relevant parts of the program are discussed in detail. The complete source code for the two applications appears in the appendix and can be downloaded from:

<http://developers.sun.com/prodtech/solaris/downloads/index.html>

### GSSAPI Server Example Structure

The `gss-structure` application performs the following steps:

1. Parses the command line.
2. If a mechanism is specified, translates the mechanism name to internal format.

3. Acquires credentials for the caller.
4. Checks to see whether the user has specified using the `inetd` daemon for connecting.
5. Makes a connection with the client.
6. Receives the data from the client.
7. Signs and returns the data.
8. Releases namespaces and exits.

## Running the GSSAPI Server Example

`gss-server` takes this form on the command line

```
gss-server [-port port] [-verbose] [-inetd] [-once] [-logfile file] \  
          [-mech mechanism] service-name
```

- *port* is the port number to listen on. If no port is specified, the program uses port 4444 as the default.
- `-verbose` causes messages to be displayed as `gss-server` runs.
- `-inetd` indicates that the program should use the `inetd` daemon to listen to a port. `-inetd` uses `stdin` and `stdout` to connect to the client.
- `-once` indicates a single-instance connection only.
- *mechanism* is the name of a security mechanism to use, such as Kerberos v5. If no mechanism is specified, the GSS-API uses a default mechanism.
- *service-name* is the name of the network service that is requested by the client, such as `telnet`, `ftp`, or `login` service.

A typical command line might look like the following example:

```
% gss-server -port 8080 -once -mech kerberos_v5 erebos.eng nfs "hello"
```

## GSSAPI Server Example:main() Function

The `gss-server main()` function performs the following tasks:

- Parses command-line arguments and assigns the arguments to variables
- Acquires the credentials for the service corresponding to the mechanism
- Calls the `sign_server()` function, which performs the work involved with signing and returning the message
- Releases the credentials that have been acquired
- Releases the mechanism OID namespace

- Closes the connection if the connection is still open

---

**Note** – The source code for this example is also available through the Sun download center. See <http://www.sun.com/download/products.xml?id=41912db5>.

---

**EXAMPLE 6-1** gss-server Example:main()

```
int
main(argc, argv)
    int argc;
    char **argv;
{
    char *service_name;
    gss_cred_id_t server_creds;
    OM_uint32 min_stat;
    u_short port = 4444;
    int s;
    int once = 0;
    int do_inetd = 0;

    log = stdout;
    display_file = stdout;

    /* Parse command-line arguments. */
    argc--; argv++;
    while (argc) {
        if (strcmp(*argv, "-port") == 0) {
            argc--; argv++;
            if (!argc) usage();
            port = atoi(*argv);
        } else if (strcmp(*argv, "-verbose") == 0) {
            verbose = 1;
        } else if (strcmp(*argv, "-once") == 0) {
            once = 1;
        } else if (strcmp(*argv, "-inetd") == 0) {
            do_inetd = 1;
        } else if (strcmp(*argv, "-logfile") == 0) {
            argc--; argv++;
            if (!argc) usage();
            log = fopen(*argv, "a");
            display_file = log;
            if (!log) {
                perror(*argv);
                exit(1);
            }
        } else
            break;
        argc--; argv++;
    }
    if (argc != 1)
        usage();

    if ((*argv)[0] == '-')
        usage();

    service_name = *argv;
```

EXAMPLE 6-1 gss-server Example: main() (Continued)

```
/* Acquire service credentials. */
if (server_acquire_creds(service_name, &server_creds) < 0)
    return -1;

if (do_inetd) {
    close(1);
    close(2);
    /* Sign and return message. */
    sign_server(0, server_creds);
    close(0);
} else {
    int stmp;

    if ((stmp = create_socket(port)) >= 0) {
        do {
            /* Accept a TCP connection */
            if ((s = accept(stmp, NULL, 0)) < 0) {
                perror("accepting connection");
                continue;
            }
            /* This return value is not checked, because there is
               not really anything to do if it fails. */
            sign_server(s, server_creds);
            close(s);
        } while (!once);

        close(stmp);
    }
}

/* Close down and clean up. */
(void) gss_release_cred(&min_stat, &server_creds);

/*NOTREACHED*/
(void) close(s);
return 0;
}
```

## Acquiring Credentials

Credentials are created by the underlying mechanisms rather than by the client application, server application, or GSS-API. A client program often has credentials that are obtained at login. A server always needs to acquire credentials explicitly.

The `gss-server` program has a function, `server_acquire_creds()`, to get the credentials for the service to be provided. The `server_acquire_creds()` function takes as input the name of the service and the security mechanism to be used. The `server_acquire_creds()` function then returns the credentials for the service. The `server_acquire_creds()` function uses the GSS-API function `gss_acquire_cred()` to get the credentials for the service that the server provides.



Before `server_acquire_creds()` accesses `gss_acquire_cred()`, `server_acquire_creds()` must complete the following two tasks:

1. Checking for a list of mechanisms and reducing the list to a single mechanism for the purpose of getting a credential.

If a single credential can be shared by multiple mechanisms, the `gss_acquire_cred()` function returns credentials for all those mechanisms. Therefore, `gss_acquire_cred()` takes as input a *set* of mechanisms. (See “[Working With Credentials in GSS-API](#)” on [page 75](#).) In most cases, however, including this one, a single credential might not work for multiple mechanisms. In the `gss-server` program, either a single mechanism is specified on the command line or else the default mechanism is used. Therefore, the first task is to make sure that the set of mechanisms that was passed to `gss_acquire_cred()` contains a single mechanism, default or otherwise, as follows:

```
if (mechOid != GSS_C_NULL_OID) {
    desiredMechs = &mechOidSet;
    mechOidSet.count = 1;
    mechOidSet.elements = mechOid;
} else
    desiredMechs = GSS_C_NULL_OID_SET;
```

`GSS_C_NULL_OID_SET` indicates that the default mechanism should be used.

2. Translating the service name into GSS-API format.

Because `gss_acquire_cred()` takes the service name in the form of a `gss_name_t` structure, the name of the service must be imported into that format. The `gss_import_name()` function performs this translation. Because this function, like all GSS-API functions, requires arguments to be GSS-API types, the service name has to be copied to a GSS-API buffer first, as follows:

```
name_buf.value = service_name;
name_buf.length = strlen(name_buf.value) + 1;
maj_stat = gss_import_name(&min_stat, &name_buf,
    (gss_OID) GSS_C_NT_HOSTBASED_SERVICE, &server_name);
if (maj_stat != GSS_S_COMPLETE) {
    display_status("importing name", maj_stat, min_stat);
    if (mechOid != GSS_C_NO_OID)
        gss_release_oid(&min_stat, &mechOid);
    return -1;
}
```

Note again the use of the nonstandard function `gss_release_oid()`.

The input is the service name as a string in `name_buf`. The output is the pointer to a `gss_name_t` structure, `server_name`. The third argument, `GSS_C_NT_HOSTBASED_SERVICE`, is the name type for the string in `name_buf`. In this case, the name type indicates that the string should be interpreted as a service of the format `service@host`.

After these tasks have been performed, the server program can call `gss_acquire_cred()`:

```
maj_stat = gss_acquire_cred(&min_stat, server_name, 0,
    desiredMechs, GSS_C_ACCEPT,
```

```
server_creds, NULL, NULL);
```

- *min\_stat* is the error code returned by the function.
- *server\_name* is the name of the server.
- 0 indicates that the program does not need to know the maximum lifetime of the credential.
- *desiredMechs* is the set of mechanisms for which this credential applies.
- GSS\_C\_ACCEPT means that the credential can be used only to accept security contexts.
- *server\_creds* is the credential handle to be returned by the function.
- NULL, NULL indicates that the program does not need to know either the specific mechanism being employed or the amount of time that the credential will be valid.

The following source code illustrates the `server_acquire_creds()` function.

---

**Note** – The source code for this example is also available through the Sun download center. See <http://www.sun.com/download/products.xml?id=41912db5>.

---

**EXAMPLE 6-2** Sample Code for `server_acquire_creds()` Function

```
/*
 * Function: server_acquire_creds
 *
 * Purpose: imports a service name and acquires credentials for it
 *
 * Arguments:
 *
 *     service_name    (r) the ASCII service name
 *     mechType        (r) the mechanism type to use
 *     server_creds    (w) the GSS-API service credentials
 *
 * Returns: 0 on success, -1 on failure
 *
 * Effects:
 *
 * The service name is imported with gss_import_name, and service
 * credentials are acquired with gss_acquire_cred. If either operation
 * fails, an error message is displayed and -1 is returned; otherwise,
 * 0 is returned.
 */
int server_acquire_creds(service_name, mechOid, server_creds)
    char *service_name;
    gss_OID mechOid;
    gss_cred_id_t *server_creds;
{
    gss_buffer_desc name_buf;
    gss_name_t server_name;
    OM_uint32 maj_stat, min_stat;
    gss_OID_set_desc mechOidSet;
    gss_OID_set desiredMechs = GSS_C_NULL_OID_SET;

    if (mechOid != GSS_C_NULL_OID) {
        desiredMechs = &mechOidSet;
    }
}
```

EXAMPLE 6-2 Sample Code for `server_acquire_creds()` Function (Continued)

```

        mechOidSet.count = 1;
        mechOidSet.elements = mechOid;
    } else
        desiredMechs = GSS_C_NULL_OID_SET;

    name_buf.value = service_name;
    name_buf.length = strlen(name_buf.value) + 1;
    maj_stat = gss_import_name(&min_stat, &name_buf,
        (gss_OID) GSS_C_NT_HOSTBASED_SERVICE, &server_name);
    if (maj_stat != GSS_S_COMPLETE) {
        display_status("importing name", maj_stat, min_stat);
        if (mechOid != GSS_C_NO_OID)
            gss_release_oid(&min_stat, &mechOid);
        return -1;
    }

    maj_stat = gss_acquire_cred(&min_stat, server_name, 0,
        desiredMechs, GSS_C_ACCEPT,
        server_creds, NULL, NULL);

    if (maj_stat != GSS_S_COMPLETE) {
        display_status("acquiring credentials", maj_stat, min_stat);
        return -1;
    }

    (void) gss_release_name(&min_stat, &server_name);

    return 0;
}

```

## Checking for inetd

Having acquired credentials for the service, `gss-server` checks to see whether the user has specified `inetd`. The main function checks for `inetd` as follows:

```

if (do_inetd) {
    close(1);
    close(2);
}

```

If the user has specified to use `inetd`, then the program closes the standard output and standard error. `gss-server` then calls `sign_server()` on the standard input, which `inetd` uses to pass connections. Otherwise, `gss-server` creates a socket, accepts the connection for that socket with the TCP function `accept()`, and calls `sign_server()` on the file descriptor that is returned by `accept()`.

If `inetd` is not used, the program creates connections and contexts until the program is terminated. However, if the user has specified the `-once` option, the loop terminates after the first connection.

## Receiving Data From a Client

After checking for `inetd`, the `gss-server` program then calls `sign_server()`, which does the main work of the program. `sign_server()` first establishes the context by calling `server_establish_context()`.

`sign_server()` performs the following tasks:

- Accepts the context
- Unwraps the data
- Signs the data
- Returns the data

These tasks are described in the subsequent sections. The following source code illustrates the `sign_server()` function.

---

**Note** – The source code for this example is also available through the Sun download center. See <http://www.sun.com/download/products.xml?id=41912db5>.

---

### EXAMPLE 6-3 `sign_server()` Function

```
int sign_server(s, server_creds)
    int s;
    gss_cred_id_t server_creds;
{
    gss_buffer_desc client_name, xmit_buf, msg_buf;
    gss_ctx_id_t context;
    OM_uint32 maj_stat, min_stat;
    int i, conf_state, ret_flags;
    char *cp;

    /* Establish a context with the client */
    if (server_establish_context(s, server_creds, &context,
        &client_name, &ret_flags) < 0)
return(-1);

    printf("Accepted connection: \"%s*\n",
        (int) client_name.length, (char *) client_name.value);
    (void) gss_release_buffer(&min_stat, &client_name);

    for (i=0; i < 3; i++)
        if (test_import_export_context(&context))
            return -1;

    /* Receive the sealed message token */
    if (recv_token(s, &xmit_buf) < 0)
return(-1);

    if (verbose && log) {
        fprintf(log, "Sealed message token:\n");
        print_token(&xmit_buf);
    }
}
```

EXAMPLE 6-3 `sign_server()` Function (Continued)

```

    maj_stat = gss_unwrap(&min_stat, context, &xmit_buf, &msg_buf,
        &conf_state, (gss_qop_t *) NULL);
    if (maj_stat != GSS_S_COMPLETE) {
display_status("unsealing message", maj_stat, min_stat);
return(-1);
    } else if (! conf_state) {
fprintf(stderr, "Warning! Message not encrypted.\n");
    }

(void) gss_release_buffer(&min_stat, &xmit_buf);

fprintf(log, "Received message: ");
cp = msg_buf.value;
if ((isprint(cp[0]) || isspace(cp[0])) &&
    (isprint(cp[1]) || isspace(cp[1]))) {
fprintf(log, "\\%. *s\\n", msg_buf.length, msg_buf.value);
    } else {
printf("\\n");
print_token(&msg_buf);
    }

/* Produce a signature block for the message */
maj_stat = gss_get_mic(&min_stat, context, GSS_C_QOP_DEFAULT,
    &msg_buf, &xmit_buf);
if (maj_stat != GSS_S_COMPLETE) {
display_status("signing message", maj_stat, min_stat);
return(-1);
    }

(void) gss_release_buffer(&min_stat, &msg_buf);

/* Send the signature block to the client */
if (send_token(s, &xmit_buf) < 0)
return(-1);

(void) gss_release_buffer(&min_stat, &xmit_buf);

/* Delete context */
maj_stat = gss_delete_sec_context(&min_stat, &context, NULL);
if (maj_stat != GSS_S_COMPLETE) {
display_status("deleting context", maj_stat, min_stat);
return(-1);
    }

fflush(log);

return(0);
}

```

## Accepting a Context

Establishing a context typically involves a series of token exchanges between the client and the server. Both context acceptance and context initialization should be performed in loops to

maintain program portability. The loop for accepting a context is very similar to the loop for establishing a context, although in reverse. Compare with “Establishing a Security Context With the Server” on page 99.

The following source code illustrates the `server_establish_context()` function.

---

**Note** – The source code for this example is also available through the Sun download center. See <http://www.sun.com/download/products.xml?id=41912db5>.

---

**EXAMPLE 6-4** `server_establish_context()` Function

```

/*
 * Function: server_establish_context
 *
 * Purpose: establishes a GSS-API context as a specified service with
 * an incoming client, and returns the context handle and associated
 * client name
 *
 * Arguments:
 *
 *     s                (r) an established TCP connection to the client
 *     service_creds   (r) server credentials, from gss_acquire_cred
 *     context         (w) the established GSS-API context
 *     client_name     (w) the client's ASCII name
 *
 * Returns: 0 on success, -1 on failure
 *
 * Effects:
 *
 * Any valid client request is accepted. If a context is established,
 * its handle is returned in context and the client name is returned
 * in client_name and 0 is returned. If unsuccessful, an error
 * message is displayed and -1 is returned.
 */
int server_establish_context(s, server_creds, context, client_name, ret_flags)
    int s;
    gss_cred_id_t server_creds;
    gss_ctx_id_t *context;
    gss_buffer_t client_name;
    OM_uint32 *ret_flags;
{
    gss_buffer_desc send_tok, recv_tok;
    gss_name_t client;
    gss_OID doid;
    OM_uint32 maj_stat, min_stat, acc_sec_min_stat;
    gss_buffer_desc oid_name;

    *context = GSS_C_NO_CONTEXT;

    do {
        if (recv_token(s, &recv_tok) < 0)
            return -1;

        if (verbose && log) {
            fprintf(log, "Received token (size=%d): \n", recv_tok.length);

```

## EXAMPLE 6-4 server\_establish\_context() Function (Continued)

```

    print_token(&recv_tok);
}

maj_stat =
    gss_accept_sec_context(&acc_sec_min_stat,
                          context,
                          server_creds,
                          &recv_tok,
                          GSS_C_NO_CHANNEL_BINDINGS,
                          &client,
                          &doid,
                          &send_tok,
                          ret_flags,
                          NULL, /* ignore time_rec */
                          NULL); /* ignore del_cred_handle */

(void) gss_release_buffer(&min_stat, &recv_tok);

if (send_tok.length != 0) {
    if (verbose && log) {
        fprintf(log,
                "Sending accept_sec_context token (size=%d):\n",
                send_tok.length);
        print_token(&send_tok);
    }
    if (send_token(s, &send_tok) < 0) {
        fprintf(log, "failure sending token\n");
        return -1;
    }

    (void) gss_release_buffer(&min_stat, &send_tok);
}
if (maj_stat!=GSS_S_COMPLETE && maj_stat!=GSS_S_CONTINUE_NEEDED) {
    display_status("accepting context", maj_stat,
                  acc_sec_min_stat);
    if (*context == GSS_C_NO_CONTEXT)
        gss_delete_sec_context(&min_stat, context,
                               GSS_C_NO_BUFFER);

    return -1;
}

if (verbose && log) {
    if (maj_stat == GSS_S_CONTINUE_NEEDED)
        fprintf(log, "continue needed...\n");
    else
        fprintf(log, "\n");
    fflush(log);
}
} while (maj_stat == GSS_S_CONTINUE_NEEDED);

/* display the flags */
display_ctx_flags(*ret_flags);

if (verbose && log) {
    maj_stat = gss_oid_to_str(&min_stat, doid, &oid_name);
    if (maj_stat != GSS_S_COMPLETE) {

```

**EXAMPLE 6-4** `server_establish_context()` Function (Continued)

```

        display_status("converting oid->string", maj_stat, min_stat);
        return -1;
    }
    fprintf(log, "Accepted connection using mechanism OID %.*s.\n",
           (int) oid_name.length, (char *) oid_name.value);
    (void) gss_release_buffer(&min_stat, &oid_name);
}

maj_stat = gss_display_name(&min_stat, client, client_name, &doid);
if (maj_stat != GSS_S_COMPLETE) {
    display_status("displaying name", maj_stat, min_stat);
    return -1;
}
maj_stat = gss_release_name(&min_stat, &client);
if (maj_stat != GSS_S_COMPLETE) {
    display_status("releasing name", maj_stat, min_stat);
    return -1;
}
return 0;
}

```

The `sign_server()` function uses the following source code to call `server_establish_context()` to accept the context.

```

/* Establish a context with the client */
if (server_establish_context(s, server_creds, &context,
                            &client_name, &ret_flags) < 0)
    return(-1);

```

The `server_establish_context()` function first looks for a token that the client sends as part of the context initialization process. Because, GSS-API does not send or receive tokens itself, programs must have their own routines for performing these tasks. The server uses `recv_token()` for receiving the token:

```

do {
    if (recv_token(s, &recv_tok) < 0)
        return -1;
}

```

Next, `server_establish_context()` calls the GSS-API function `gss_accept_sec_context()`:

```

maj_stat = gss_accept_sec_context(&min_stat,
                                context,
                                server_creds,
                                &recv_tok,
                                GSS_C_NO_CHANNEL_BINDINGS,
                                &client,
                                &doid,
                                &send_tok,
                                ret_flags,
                                NULL, /* ignore time_rec */
                                NULL); /* ignore del_cred_handle */

```

- *min\_stat* is the error status returned by the underlying mechanism.



- *context* is the context being established.
- *server\_creds* is the credential for the service to be provided (see “Acquiring Credentials” on page 112).
- *recv\_tok* is the token received from the client by `recv_token()`.
- `GSS_C_NO_CHANNEL_BINDINGS` is a flag indicating not to use channel bindings (see “Using Channel Bindings in GSS-API” on page 82).
- *client* is the ASCII name of the client.
- *oid* is the mechanism (in OID format).
- *send\_tok* is the token to send to the client.
- *ret\_flags* are various flags indicating whether the context supports a given option, such as message-sequence-detection.
- The two NULL arguments indicate that the program does not need to know the length of time that the context will be valid, or whether the server can act as a client's proxy.

The acceptance loop continues, barring any errors, as long as `gss_accept_sec_context()` sets *maj\_stat* to `GSS_S_CONTINUE_NEEDED`. If *maj\_stat* is not equal to that value or to `GSS_S_COMPLETE`, a problem exists and the loop exits.

`gss_accept_sec_context()` returns a positive value for the length of *send\_tok* whether a token exists to send back to the client. The next step is to see a token exists to be sent, and, if so, to send the token:

```

if (send_tok.length != 0) {
    . . .
    if (send_token(s, &send_tok) < 0) {
        fprintf(log, "failure sending token\n");
        return -1;
    }

    (void) gss_release_buffer(&min_stat, &send_tok);
}

```

## Unwrapping the Message

After accepting the context, the `sign_server()` receives the message that has been sent by the client. Because the GSS-API does not provide a function for receiving tokens, the program uses the `recv_token()` function:

```

if (recv_token(s, &xmit_buf) < 0)
    return(-1);

```

Because the message might be encrypted, the program uses the GSS-API function `gss_unwrap()` for unwrapping:

```
maj_stat = gss_unwrap(&min_stat, context, &xmit_buf, &msg_buf,
                    &conf_state, (gss_qop_t *) NULL);
    if (maj_stat != GSS_S_COMPLETE) {
        display_status("unwrapping message", maj_stat, min_stat);
        return(-1);
    } else if (! conf_state) {
        fprintf(stderr, "Warning! Message not encrypted.\n");
    }

    (void) gss_release_buffer(&min_stat, &xmit_buf);
```

`gss_unwrap()` takes the message that `recv_token()` has placed in `xmit_buf`, translates the message, and puts the result in `msg_buf`. Two arguments to `gss_unwrap()` are noteworthy. `conf_state` is a flag to indicate whether confidentiality, that is, encryption, has been applied to this message. The final NULL indicates that the program does not need to know that the QOP that was used to protect the message.

## Signing and Returning the Message

At this point, the `sign_server()` function needs to sign the message. Signing a message entails returning the message's Message Integrity Code or MIC to the client. Returning the message proves that the message was sent and was unwrapped successfully. To obtain the MIC, `sign_server()` uses the function `gss_get_mic()`:

```
maj_stat = gss_get_mic(&min_stat, context, GSS_C_QOP_DEFAULT,
                    &msg_buf, &xmit_buf);
```

`gss_get_mic()` looks at the message in `msg_buf`, produces the MIC, and stores the MIC in `xmit_buf`. The server then sends the MIC back to the client with `send_token()`. The client verifies the MIC with `gss_verify_mic()`. See [“Reading and Verifying a Signature Block From a GSS-API Client” on page 107](#).

Finally, `sign_server()` performs some cleanup. `sign_server()` releases the GSS-API buffers `msg_buf` and `xmit_buf` with `gss_release_buffer()`. Then `sign_server()` destroys the context with `gss_delete_sec_context()`.

## Using the `test_import_export_context()` Function

GSS-API allows you to export and import contexts. These activities enable you to share a context between different processes in a multiprocess program. `sign_server()` contains a proof-of-concept function, `test_import_export_context()`, that illustrates how exporting and importing contexts works. `test_import_export_context()` does not pass a context between processes. Instead, `test_import_export_context()` displays the amount of time to export and then import a context. Although an artificial function, `test_import_export_context()` does indicate how to use the GSS-API importing and exporting functions. `test_import_export_context()` also shows how to use timestamps with regard to manipulating contexts.

The source code for `test_import_export_context()` is shown in the following example.

**Note** – The source code for this example is also available through the Sun download center. See <http://www.sun.com/download/products.xml?id=41912db5>.

```
EXAMPLE6-5 test_import_export_context()
int test_import_export_context(context)
    gss_ctx_id_t *context;
{
    OM_uint32      min_stat, maj_stat;
    gss_buffer_desc context_token, copied_token;
    struct timeval tm1, tm2;

    /*
     * Attempt to save and then restore the context.
     */
    gettimeofday(&tm1, (struct timezone *)0);
    maj_stat = gss_export_sec_context(&min_stat, context, &context_token);
    if (maj_stat != GSS_S_COMPLETE) {
        display_status("exporting context", maj_stat, min_stat);
        return 1;
    }
    gettimeofday(&tm2, (struct timezone *)0);
    if (verbose && log)
        fprintf(log, "Exported context: %d bytes, %7.4f seconds\n",
            context_token.length, timeval_subtract(&tm2, &tm1));
    copied_token.length = context_token.length;
    copied_token.value = malloc(context_token.length);
    if (copied_token.value == 0) {
        fprintf(log, "Couldn't allocate memory to copy context token.\n");
        return 1;
    }
    memcpy(copied_token.value, context_token.value, copied_token.length);
    maj_stat = gss_import_sec_context(&min_stat, &copied_token, context);
    if (maj_stat != GSS_S_COMPLETE) {
        display_status("importing context", maj_stat, min_stat);
        return 1;
    }
    free(copied_token.value);
    gettimeofday(&tm1, (struct timezone *)0);
    if (verbose && log)
        fprintf(log, "Importing context: %7.4f seconds\n",
            timeval_subtract(&tm1, &tm2));
    (void) gss_release_buffer(&min_stat, &context_token);
    return 0;
}
```

## Cleanup in the GSSAPI Server Example

Back in the `main()` function, the application deletes the service credential with `gss_release_cred()`. If an OID for the mechanism has been specified, the program deletes the OID with `gss_release_oid()` and exits.

```
(void) gss_release_cred(&min_stat, &server_creds);
```

# Writing Applications That Use SASL

---

SASL (Simple Authentication and Security Layer) is a security framework. SASL, pronounced “sassel,” provides authentication services and optionally integrity and confidentiality services to connection-based protocols.

This chapter covers the following topics:

- “Introduction to Simple Authentication Security Layer (SASL)” on page 125
- “SASL Example” on page 138
- “SASL for Service Providers” on page 142

## Introduction to Simple Authentication Security Layer (SASL)

SASL provides developers of applications and shared libraries with mechanisms for authentication, data integrity-checking, and encryption. SASL enables the developer to code to a generic API. This approach avoids dependencies on specific mechanisms. SASL is particularly appropriate for applications that use the IMAP, SMTP, ACAP, and LDAP protocols, as these protocols all support SASL. SASL is described in RFC 2222.

### SASL Library Basics

The SASL library is called `libsasl`. `libsasl` is a framework that allows properly written SASL consumer applications to use any SASL plug-ins that are available on the system. The term *plug-in* refers to objects that provide services for SASL. Plug-ins are external to `libsasl`. SASL plug-ins can be used for authentication and security, canonicalization of names, and lookup of auxiliary properties, such as passwords. Cryptographic algorithms are stored in plug-ins rather than in `libsasl`.

`libsasl` provides an application programming interface (API) for consumer applications and libraries. A service provider interface (SPI) is provided for plug-ins to supply services to

`libsasl`. `libsasl` is not aware of the network or the protocol. Accordingly, the application must take responsibility for sending and receiving data between the client and server.

SASL uses two important identifiers for users. The *authentication ID* (`authid`) is the user ID for authenticating the user. The authentication ID grants the user access to a system. The *authorization ID* (`userid`) is used to check whether the user is allowed to use a particular option.

The SASL client application and SASL server application negotiate a common SASL mechanism and security level. Typically, the SASL server application sends its list of acceptable authentication mechanisms to the client. The SASL client application can then decide which authentication mechanism best satisfies its requirements. After this point, the authentication takes place using the agreed-upon authentication mechanism as a series of client-server exchanges of the SASL supplied authentication data. This exchange continues until the authentication successfully completes, fails, or is aborted by the client or the server.

In the process of authentication, the SASL authentication mechanism can negotiate a security layer. If a security layer is selected, that layer must be used for the duration of the SASL session.

## SASL Architecture

The following figure shows the basic SASL architecture.

FIGURE 7-1 SASL Architecture

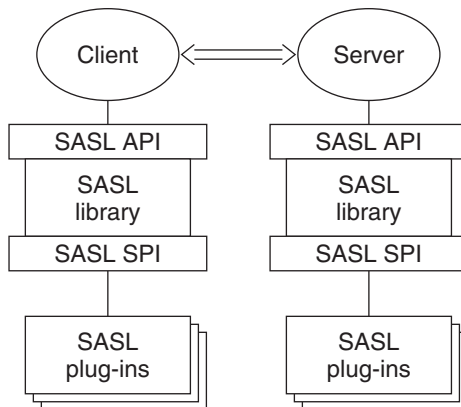

Client and server applications make calls to their local copies of `libsasl` through the SASL API. `libsasl` communicates with the SASL mechanisms through the SASL service provider interface (SPI).

## Security Mechanisms

Security mechanism plug-ins provide security services to `libsasl`. Some typical functions that are provided by security mechanisms follow:

- Authentication on the client side
- Authentication on the server side
- Integrity, that is, checking that transmitted data is intact
- Confidentiality, that is, encrypting and decrypting transmitted data

## SASL Security Strength Factor

*SSF*, the security strength factor, indicates the strength of the SASL protection. If the mechanism supports a security layer, the client and server negotiate the *SSF*. The value of the *SSF* is based on the security properties that were specified before the SASL negotiation. If a non-zero *SSF* is negotiated, both client and server need to use the mechanism's security layer when the authentication has completed.

*SSF* is represented by an integer with one of the following values:

- 0 – No protection.
- 1 – Integrity checking only.
- >1 – Supports authentication, integrity and confidentiality. The number represents the encryption key length.

The confidentiality and integrity operations are performed by the security mechanism. `libsasl` coordinates these requests.

---

**Note** – In the negotiation, the SASL client selects the mechanism with the maximum *SSF*. However, the actual SASL mechanism that is chosen might subsequently negotiate a lower *SSF*.

---

## Communication in SASL

Applications communicate with `libsasl` through the `libsasl` API. `libsasl` can request additional information by means of callbacks that are registered by the application. Applications do not call plug-ins directly, only through `libsasl`. Plug-ins generally call the `libsasl` framework's plug-ins, which then call the application's callbacks. SASL plug-ins can also call the application directly, although the application does not know whether the call came from a plug-in or from `libsasl`.

Callbacks are useful in multiple areas, as follows.

- `libsasl` can use callbacks to get information that is needed to complete authentication.
- `libsasl` consumer applications can use callbacks to change search paths for plug-ins and configuration data, to verify files, and to change various default behaviors.

- Servers can use callbacks to change authorization policies, to supply different password verification methods, and to get password change information.
- Clients and servers can use callbacks to specify the language for error messages.

Applications register two sorts of callbacks: global and session. Additionally, `libsasl` defines a number of callback identifiers that are used to register for different sorts of callbacks. If a given type of callback is not registered, `libsasl` takes default action.

Session callbacks override global callbacks. If a session callback is specified for a given ID, the global callback is not called for that session. Some callbacks must be global, because these callbacks occur outside of sessions.

The following instances require global callbacks:

- Determination of search paths for plug-ins to load
- Verification of plug-ins
- Location of configuration data
- The logging of error messages
- Other global configuration of `libsasl` or its plug-ins

A SASL callback can be registered with a NULL callback function for a given SASL callback ID. The NULL callback function indicates that the client is equipped to supply the needed data. All SASL callback IDs start with the prefix `SASL_CB_`.

SASL provides the following callbacks for use by either a client or a server:

<code>SASL_CB_GETOPT</code>	Gets a SASL option. Options modify the behavior of <code>libsasl(3LIB)</code> and related plug-ins. Can be used by either a client or a server.
<code>SASL_CB_LOG</code>	Sets the logging function for <code>libsasl</code> and its plug-ins. The default behavior is to use <code>syslog</code> .
<code>SASL_CB_GETPATH</code>	Gets the colon-separated list of SASL plug-in search paths.  The default SASL plug-in search paths depend on the architecture as follows: <ul style="list-style-type: none"> <li>▪ 32-bit SPARC architecture: <code>/usr/lib/sasl</code></li> <li>▪ 32-bit x86 architecture: <code>/usr/lib/sasl</code></li> <li>▪ 64-bit SPARC architecture: <code>/usr/lib/sasl/sparcv9</code></li> <li>▪ x64 architecture: <code>/usr/lib/sasl/amd64</code></li> </ul>
<code>SASL_CB_GETCONF</code>	Gets the path to the SASL server's configuration directory. The default is <code>/etc/sasl</code> .
<code>SASL_CB_LANGUAGE</code>	Specifies a comma-separated list of RFC 1766 language codes in order of preference, for client and server error messages and for client prompts. The default is <code>i-default</code> .



`SASL_CB_VERIFYFILE` Verifies the configuration file and plug-in files.

SASL provides the following callbacks for use by clients only:

<code>SASL_CB_USER</code>	Gets the client user name. The user name is the same as the authorization ID. The <code>LOGNAME</code> environment variable is the default.
<code>SASL_CB_AUTHNAME</code>	Gets the client authentication name.
<code>SASL_CB_PASS</code>	Gets a client passphrase-based secret.
<code>SASL_CB_ECHOPROMPT</code>	Gets the result for a given challenge prompt. The input from the client can be echoed.
<code>SASL_CB_NOECHOPROMPT</code>	Gets the result for a given challenge prompt. The input from the client should not be echoed.
<code>SASL_CB_GETREALM</code>	Sets the realm to be used for authentication.

SASL provides the following callbacks for use by servers only:

`SASL_CB_PROXY_POLICY`

Checks that an authenticated user is authorized to act on behalf of the specified user. If this callback is not registered, then the authenticated user and the user to be authorized must be the same. If these IDs are not the same, then the authentication fails. Use the server application to take care of nonstandard authorization policies.

`SASL_CB_SERVER_USERDB_CHECKPASS`

Verifies a plain text password against the caller-supplied user database.

`SASL_CB_SERVER_USERDB_SETPASS`

Stores a plain text password in the user database

`SASL_CB_CANON_USER`

Calls an application-supplied user canonicalization function.

When the SASL library is first initialized, the server and client declare any necessary global callbacks. The global callbacks are available prior to and during the SASL sessions. Prior to initialization, callbacks perform such tasks as loading plug-ins, logging data, and reading configuration files. At the start of a SASL session, additional callbacks can be declared. Such callbacks can override global callbacks if necessary.

## SASL Connection Contexts

`libsasl` uses a SASL connection *context* to maintain the state of each SASL session for both SASL clients and SASL servers. Each context can be used for only one authentication and security session at a time.

The maintained state includes the following information:

- Connection information, such as service, naming and address information, and protocol flags
- Callbacks specific to the connection
- Security properties for negotiating the SASL SSF
- State of the authentication along with security layer information

## Steps in the SASL Cycle

The following diagram shows steps in the SASL life cycle. The client actions are shown on the left of the diagram and the server actions on the right side. The arrows in the middle show interactions between the client and server over an external connection.

FIGURE 7-2 SASL Life Cycle

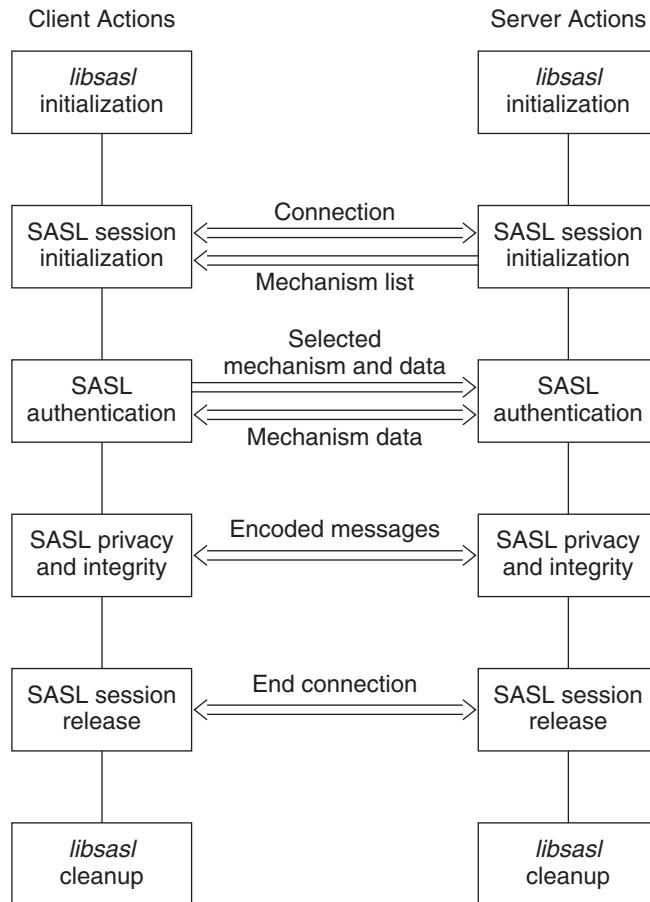

The sections that follow illustrate the steps in the life cycle.

## libsasl Initialization

The client calls `sasl_client_init()` to initialize `libsasl` for the client's use. The server calls `sasl_server_init()` to initialize `libsasl` for server use.

When `sasl_client_init()` is run, the SASL client, the client's mechanisms and the client's canonicalization plug-in are loaded. Similarly, when `sasl_server_init()` is called, the SASL server, the server's mechanisms, the server's canonicalization plug-in, and the server's auxprop plug-in are loaded. After `sasl_client_init()` has been called, additional client plug-ins can be added by using `sasl_client_add_plugin()` and `sasl_canonuser_add_plugin()`. On the

server side, after `sasl_server_init()` has been called, additional server plug-ins can be added through `sasl_server_add_plugin()`, `sasl_canonuser_add_plugin()`, and `sasl_auxprop_add_plugin()`.

SASL mechanisms are provided in the Oracle Solaris software in the following directories according to the architecture:

- 32-bit SPARC architecture: `/usr/lib/sasl`
- 32-bit x86 architecture: `/usr/lib/sasl`
- 64-bit SPARC architecture: `/usr/lib/sasl/sparcv9`
- x64 architecture: `/usr/lib/sasl/amd64`

The `SASL_CB_GETPATH` callback can be used to override the default location.

At this point, any required global callbacks are set. SASL clients and servers might include the following callbacks:

- `SASL_CB_GETOPT`
- `SASL_CB_LOG`
- `SASL_CB_GETPATH`
- `SASL_CB_VERIFYFILE`

A SASL server might additionally include the `SASL_CB_GETCONF` callback.

## SASL Session Initialization

The server and client use establish the connection through the protocol. To use SASL for authentication, the server and client create SASL connection contexts by using `sasl_server_new()` and `sasl_client_new()` respectively. The SASL client and server can use `sasl_setprop()` to set properties that impose security restrictions on mechanisms. This approach enables a SASL consumer application to decide the minimum SSF, the maximum SSF, and the security properties for the specified SASL connection context.

```
#define SASL_SEC_NOPLAINTEXT          0x0001
#define SASL_SEC_NOACTIVE             0x0002
#define SASL_SEC_NODICTIONARY        0x0004
#define SASL_SEC_FORWARD_SECRECY     0x0008
#define SASL_SEC_NOANONYMOUS        0x0010
#define SASL_SEC_PASS_CREDENTIALS    0x0020
#define SASL_SEC_MUTUAL_AUTH         0x0040
```

---

**Note** – Authentication and a security layer can be provided by the client-server protocol or by some other mechanism that is external to `libsasl`. In such a case, `sasl_setprop()` can be used to set the external authentication ID or the external SSF. For example, consider the case in which the protocol uses SSL with client authentication to the server. In this case, the external authentication identity can be the client's subject name. The external SSF can be the key size.

---

For the server, `libsasl` determines the available SASL mechanisms according to the security properties and the external SSF. The client obtains the available SASL mechanisms from the SASL server through the protocol.

For a SASL server to create a SASL connection context, the server should call `sasl_server_new()`. An existing SASL connection context that is no longer in use can be reused. However, the following parameters might need to be reset:

```
#define SASL_DEFUSERREALM 3      /* default realm passed to server_new or set with setprop */
#define SASL_IPLOCALPORT 8      /* iplocalport string passed to server_new */
#define SASL_IPREMOTEPORT 9     /* ipremoteport string passed to server_new */
#define SASL_SERVICE 12        /* service passed to sasl_*_new */
#define SASL_SERVERFQDN 13     /* serverFQDN passed to sasl_*_new */
```

You can modify any of the parameters to `sasl_client_new()` and `sasl_server_new()` except the callbacks and protocol flags.

The server and client can also establish security policy and set connection specific parameters by using `sasl_setprop()` to specify the following properties:

```
#define SASL_SSF_EXTERNAL 100 /* external SSF active (sasl_ssf_t *) */
#define SASL_SEC_PROPS 101 /* sasl_security_properties_t */
#define SASL_AUTH_EXTERNAL 102 /* external authentication ID (const char *)
*/
```

- SASL\_SSF\_EXTERNAL – For setting the strength factor, that is, the number of bits in the key
- SASL\_SEC\_PROPS – For defining security policy
- SASL\_AUTH\_EXTERNAL – The external authentication ID

The server can call `sasl_listmech()` to get a list of the available SASL mechanisms that satisfy the security policy. The client can generally get the list of available mechanisms from the server in a protocol-dependent way.

The initialization of a SASL session is illustrated in the following diagram. In this diagram and subsequent diagrams, data checks after transmission over the protocol have been omitted for the sake of simplicity.

FIGURE 7-3 SASL Session Initialization

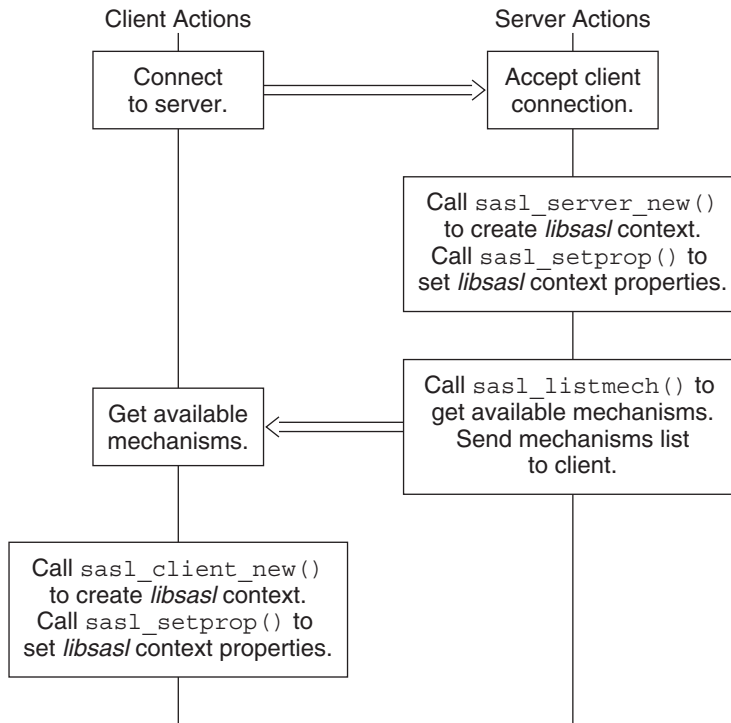

## SASL Authentication

Authentication takes a variable number of client and server steps depending on the security mechanism that is used. The SASL client calls `sasl_client_start()` with a list of security mechanisms to use. This list typically comes from the server. `libsasl` selects the best mechanism to use for this SASL session, according to the available mechanisms and the client's security policy. The client's security policy controls which mechanisms are permitted. The selected mechanism is returned by `sasl_client_start()`. Sometimes the security mechanism for the client sometimes needs additional information for authentication. For registered callbacks, `libsasl` calls the specified callback unless the callback function is `NULL`. If the callback function is `NULL`, `libsasl` returns `SASL_INTERACT` and a request for needed information. If `SASL_INTERACT` is returned, then `sasl_client_start()` should be called with the requested information.

If `sasl_client_start()` returns `SASL_CONTINUE` or `SASL_OK`, the client should send the selected mechanism with any resulting authentication data to the server. If any other value is returned, an error has occurred. For example, no mechanism might be available.

The server receives the mechanism that has been selected by the client, along with any authentication data. The server then calls `sasl_server_start()` to initialize the mechanism

data for this session. `sasl_server_start()` also processes any authentication data. If `sasl_server_start()` returns `SASL_CONTINUE` or `SASL_OK`, the server sends authentication data. If `sasl_server_start()` returns any other value, an error has occurred such as an unacceptable mechanism or an authentication failure. The authentication must be aborted. The SASL context should be either freed or reused.

This part of the authentication process is illustrated in the following diagram.

FIGURE 7-4 SASL Authentication: Sending Client Data

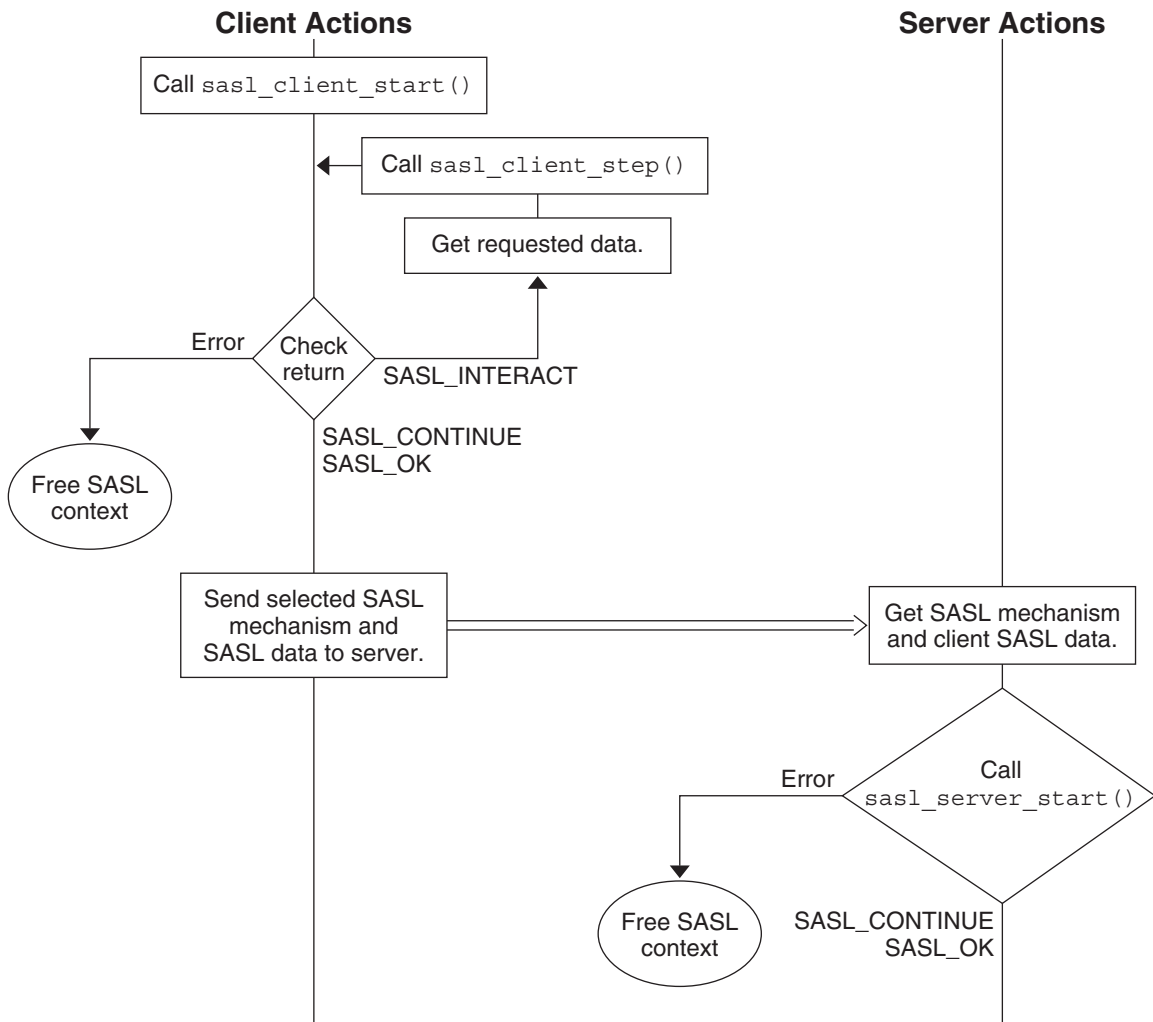

If the server call to `sasl_server_start()` returns `SASL_CONTINUE`, the server continues to communicate with the client to get all the necessary authentication information. The number of subsequent steps depends on the mechanism. If needed, the client calls `sasl_client_step()` to process the authentication data from the server and to generate a reply. Similarly, the server can call `sasl_server_step()` to process the authentication from the client and to generate a reply in turn. This exchange continues until the authentication is complete or until an error has occurred. `SASL_OK` is returned to indicate that the authentication has successfully completed for the client or server. The SASL mechanism might still have additional data to send to the other side so the other side can complete authentication. When authentication has been achieved on both sides, the server and client can inquire about each other's properties.

The following diagram shows the interactions between the server and client to transfer the additional authentication data.



FIGURE 7-5 SASL Authentication: Processing Server Data

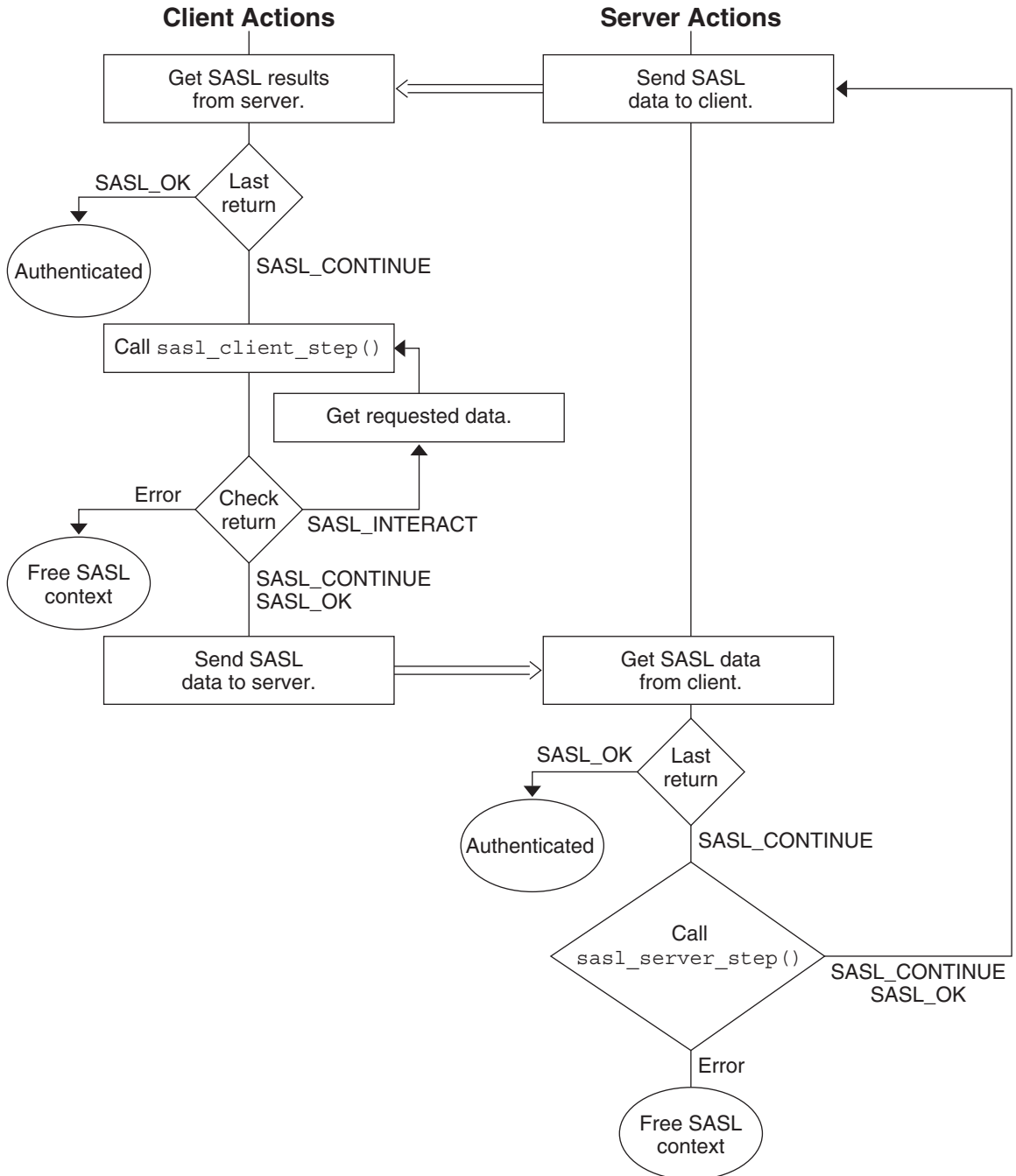

## SASL Confidentiality and Integrity

To check for a security layer, use the `sasl_getprop(3SASL)` function to see if the security strength factor (SSF) has a value that is greater than 0. If a security layer has been negotiated, the client and server must use the resulting SSF after successful authentication. Data is exchanged between the client and server in a similar fashion to authentication. `sasl_encode()` is applied to data before the data is sent by the protocol to the client or server. On the receiving end, data is decoded by `sasl_decode()`. If a security layer has not been negotiated, the SASL connection context is not needed. The context can then be disposed of or reused.

## Releasing SASL Sessions

A SASL connection context should only be freed when the session is not to be reused. `sasl_dispose()` frees the SASL connection context and all associated resources and mechanisms. The SASL connection contexts must be disposed before calling `sasl_done()`. `sasl_done()` is not responsible for releasing context resources for the SASL connection. See “[libsasl Cleanup](#)” on page 138.

When a SASL session is freed, the associated mechanisms are informed that all state can be freed. A SASL session should only be freed when the session is not to be reused. Otherwise, the SASL state can be reused by another session. Both the client and server use `sasl_dispose()` to free the SASL connection context.

## libsasl Cleanup

This step releases all the resources in the SASL library and the plug-ins. The client and server call `sasl_done()` to release `libsasl()` resources and to unload all the SASL plug-ins. `sasl_done()` does not release SASL connection contexts. Note that if an application is both a SASL client and a SASL server, `sasl_done()` releases both the SASL client and SASL server resources. You cannot release the resources for just the client or the server.



**Caution** – Libraries should not call `sasl_done()`. Applications should exercise caution when calling `sasl_done()` to avoid interference with any libraries that might be using `libsasl`.

---

## SASL Example

This section demonstrates a typical SASL session between a client application and server application. The example goes through these steps:

1. The client application initializes `libsasl`.

The client application sets the following global callbacks:

- `SASL_CB_GETREALM`
- `SASL_CB_USER`

- SASL\_CB\_AUTHNAME
  - SASL\_CB\_PASS
  - SASL\_CB\_GETPATH
  - SASL\_CB\_LIST\_END
2. The server application initializes `libsasl`.

The server application sets the following global callbacks:

- SASL\_CB\_LOG
  - SASL\_CB\_LIST\_END
3. The client creates a SASL connection context, sets the security properties, and requests the list of available mechanisms from the server.
  4. The server creates a SASL connection context, sets the security properties, gets a list of suitable SASL mechanisms, and sends the list to client.
  5. The client receives the list of available mechanisms, chooses a mechanism, and sends the mechanism choice to the server together with any authentication data.
  6. The client and server then exchange SASL data until the authentication and security layer negotiation is complete.
  7. With the authentication complete, the client and server determine whether a security layer was negotiated. The client encodes a test message. The message is then sent to the server. The server also determines the user name of the authenticated user and the user's realm.
  8. The server receives, decodes, and prints the encoded message.
  9. The client calls `sasl_dispose()` to release the client's SASL connection context. The client then calls `sasl_done()` to release the `libsasl` resources.
  10. The server calls `sasl_dispose()` to release the client connection context.

The dialogue between the client and the server follows. Each call to `libsasl` is displayed as the call is made. Each transfer of data is indicated by the sender and receiver. The data is displayed in encoded form preceded by the source: C: for the client and S: for server. The source code for both applications is provided in the [Appendix D, “Source Code for SASL Example.”](#)

#### Client

```
% doc-sample-client
*** Calling sasl_client_init() to initialize libsasl for client use ***
*** Calling sasl_client_new() to create client SASL connection context ***
*** Calling sasl_setprop() to set sasl context security properties ***
Waiting for mechanism list from server...
```

#### Server

```
% doc-sample-server digest-md5
*** Calling sasl_server_init() to initialize libsasl for server use ***
*** Calling sasl_server_new() to create server SASL connection context ***
*** Calling sasl_setprop() to set sasl context security properties ***
Forcing use of mechanism digest-md5
```

```
Sending list of 1 mechanism(s)
S: ZGlnZXN0LW1kNQ==
```

## Client

```
S: ZGlnZXN0LW1kNQ==
received 10 byte message
got 'digest-md5'
Choosing best mechanism from: digest-md5
*** Calling sasl_client_start() ***
Using mechanism DIGEST-MD5
Sending initial response...
C: RELHRVNULU1ENQ==
Waiting for server reply...
```

## Server

```
C: RELHRVNULU1ENQ==
got 'DIGEST-MD5'
*** Calling sasl_server_start() ***
Sending response...
S: bm9uY2U9IklicGxhRHJZNE4Z1gyVm5lQzL5MTZOYWxUOVcvanUrcmp5YmRqaHM\
sbT0iam0xMTQxNDIiLHFvcD0iYXV0aCxdXR0LWludCxdXR0LWNvbYiLGNpcGhlcj0ic\
QwLHJjNC01NixyYzQiLG1heGJ1Zj0yMDQ4LGN0YXJzZXQ9dXRmLTgsYXxnb3JpdGhtPW1k\
XNz
Waiting for client reply...
```

## Client

```
S: bm9uY2U9IklicGxhRHJZNE4Z1gyVm5lQzL5MTZOYWxUOVcvanUrcmp5YmRqaHM\
sbT0iam0xMTQxNDIiLHFvcD0iYXV0aCxdXR0LWludCxdXR0LWNvbYiLGNpcGhlcj0ic\
QwLHJjNC01NixyYzQiLG1heGJ1Zj0yMDQ4LGN0YXJzZXQ9dXRmLTgsYXxnb3JpdGhtPW1k\
XNz
received 171 byte message
got 'nonce="IbplaDrY4N4szhgX2VneC9y16NaLT9W/ju+rjybdjhs=",\
realm="jm114142",qop="auth,auth-int,auth-conf",cipher="rc4-40,rc4-56,\
rc4",maxbuf=2048,charset=utf-8,algorithm=md5-sess'
*** Calling sasl_client_step() ***
Please enter your authorization name : zzzz
Please enter your authentication name : zzzz
Please enter your password : zz
*** Calling sasl_client_step() ***
Sending response...
C: dXNlc m5hbWU9Inp6enoilHJlYWxtPSJqbTExnDE0MiIsbm9uY2U9IklicGxhRHJZNE4\
yVm5lQzL5MTZOYWxUOVcvanUrcmp5YmRqaHM9Iixjbm9uY2U9InlqZ2hMvMhjRfJMa0Fob\
tDS0p2WVUxMUM4V1NycjJVWm5IR2VkcLk9IixuYz0wMDAwMDAwMSxxb3A9YXV0aC1jb25m\
Ghlcj0icmM0IixtYXhidwY9MjA0OCxkaWdlc3QtdXJpPSJyY21kLyIs cmVzcG9uc2U90TY\
ODI1MmRmNzY4YTJjYzKxYjJjZDMyYTk0ZW M=
Waiting for server reply...
```

## Server

```
C: dXNlc m5hbWU9Inp6enoilHJlYWxtPSJqbTExnDE0MiIsbm9uY2U9IklicGxhRHJZNE4\
yVm5lQzL5MTZOYWxUOVcvanUrcmp5YmRqaHM9Iixjbm9uY2U9InlqZ2hMvMhjRfJMa0Fob\
tDS0p2WVUxMUM4V1NycjJVWm5IR2VkcLk9IixuYz0wMDAwMDAwMSxxb3A9YXV0aC1jb25m\
Ghlcj0icmM0IixtYXhidwY9MjA0OCxkaWdlc3QtdXJpPSJyY21kLyIs cmVzcG9uc2U90TY\
ODI1MmRmNzY4YTJjYzKxYjJjZDMyYTk0ZW M=
got 'username="zzzz",realm="jm114142",\
nonce="IbplaDrY4N4szhgX2VneC9y16NaLT9W/ju+rjybdjhs=",\
```

```

cnonce="yjghLVhcDRLkAhoirwKCKJvYU11C8WSrr2UZnHGedrY=", \
nc=00000001,qop=auth-conf,cipher="rc4",maxbuf=2048,digest-uri="rcmd/",\
response=966e978252df768a2cc91b2cd32a94ec'
*** Calling sasl_server_step() ***
Sending response...
S: cnNwYXV0aD0yYjEzMzRjYzU4NTE4MTEwOwM3OTdhMjUwYjkwMzk3OQ==
Waiting for client reply...

```

Client

```

S: cnNwYXV0aD0yYjEzMzRjYzU4NTE4MTEwOwM3OTdhMjUwYjkwMzk3OQ==
received 40 byte message
got 'rspauth=2b1334cc585181109c797a250b903979'
*** Calling sasl_client_step() ***
C:
Negotiation complete
*** Calling sasl_getprop() ***
Username: zzzz
SSF: 128
Waiting for encoded message...

```

Server

```

Waiting for client reply...
C: got '' *** Calling sasl_server_step() ***
Negotiation complete
*** Calling sasl_getprop() to get username, realm, ssf ***
Username: zzzz
Realm: 22c38
SSF: 128
*** Calling sasl_encode() *** sending encrypted message 'srv message 1'
S: AAAAHvArjnAvDFuMBqAAxkqdzJB6VD1oajiwABAAAAAA==

```

Client

```

S: AAAAHvArjnAvDFuMBqAAxkqdzJB6VD1oajiwABAAAAAA==
received 34 byte message
got ''
*** Calling sasl_decode() ***
received decoded message 'srv message 1'
*** Calling sasl_encode() ***
sending encrypted message 'client message 1'
C: AAAAIRdkTEMYOn9X4NXkxPc30TFvAZUnLbZANqzn6gABAAAAAA==
*** Calling sasl_dispose() to release client SASL connection context ***
*** Calling sasl_done() to release libsasl resources ***

```

Server

```

Waiting for encrypted message...
C: AAAAIRdkTEMYOn9X4NXkxPc30TFvAZUnLbZANqzn6gABAAAAAA==
got ''
*** Calling sasl_decode() ***
received decoded message 'client message 1'
*** Calling sasl_dispose() to release client SASL connection context ***

```

## SASL for Service Providers

This section describes how to create plug-ins for providing mechanisms and other services to SASL applications.

---

**Note** – Due to export regulations, the Oracle Solaris SASL SPI does not support a security layer for non-Oracle Solaris client/server mechanism plug-ins. As a result, non-Oracle Solaris client/server mechanism plug-ins cannot offer integrity or privacy services. Oracle Solaris client/server mechanism plug-ins do not have this restriction.

---

### SASL Plug-in Overview

The SASL service provider interface (SPI) enables communication between plug-ins and the `libsasl` library. SASL plug-ins are typically implemented as shared libraries. A single shared library can contain one or more SASL plug-ins of different types. Plug-ins that are in shared libraries are opened dynamically by `libsasl` through the `dlopen(3C)` function.

Plug-ins can also be statically bound to an application that calls `libsasl`. These kinds of plug-ins are loaded through either the `sasl_client_add_plugin()` function or the `sasl_server_add_plugin()` function, depending on whether the application is a client or server.

A SASL plug-in in the Oracle Solaris operating system has the following requirements:

- A plug-in in a shared library must be in a valid executable object file, preferably with the `.so` file extension.
- The plug-in must be in a location that can be verified. The `SASL_CB_VERIFYFILE` callback is used to verify plug-ins.
- The plug-in must contain the proper entry points.
- The version of the plug-in for the SASL client must match the version of the corresponding plug-in for the SASL server.
- The plug-in needs to be able to be initialized successfully.
- The binary type of the plug-in must match the binary type for `libsasl`.

SASL plug-ins fall into four categories:

- Client mechanism plug-in
- Server mechanism plug-in
- Canonicalization plug-in
- Auxprop plug-in

The `sasl_client_init()` function causes SASL clients to load any available client plug-ins. The `sasl_server_init()` function causes SASL servers to load the server, canonicalization, and auxprop plug-ins. All plug-ins are unloaded when `sasl_done()` is called.

To locate plug-ins, `libsasl` uses either the `SASL_CB_GETPATH` callback function or the default path. `SASL_CB_GETPATH` returns a colon-separated list of directories to be searched for plug-ins. If the SASL consumer specifies a `SASL_CB_GETPATH` callback, then `libsasl` uses the returned path for searching. Otherwise, the SASL consumer can use the default path that corresponds to the binary type.

The following list shows the default path and binary type correspondence:

- 64-bit SPARC architecture: `/usr/lib/sasl/sparcv9`
- x64 architecture: `/usr/lib/sasl/amd64`
- 32-bit SPARC architecture: `/usr/lib/sasl`
- 32-bit x86 architecture: `/usr/lib/sasl`

As part of the loading process, `libsasl` calls the latest, supported version of the plug-in. The plug-in returns the version and a structure that describes the plug-in. If the version checks out, `libsasl` loads the plug-in. The current version number is `SASL_UTILS_VERSION`.

After a plug-in has been initialized, subsequent communication between the plug-in and `libsasl` takes place through structures that have to be established. Plug-ins use the `sasl_utils_t` structure to call `libsasl`.

The `libsasl` library uses entry points in the following structures to communicate with plug-ins:

- `sasl_out_params_t`
- `sasl_client_params_t`
- `sasl_server_params_t`
- `sasl_client_plug_t`
- `sasl_server_plug_t`
- `sasl_canonuser_plug_t`
- `sasl_auxprop_plug_t`

The source code for these structures can be found in the SASL header files. The structures are described in the following section.

## Important Structures for SASL Plug-ins

Communication between `libsasl` and plug-ins is accomplished through the following structures:

- `sasl_utils_t` – The `sasl_utils_t` structure contains a number of utility functions, along with the three contexts.

This structure contains a number of utility functions that serve as a convenience for plug-in writers. Many of the functions are pointers to public interfaces in `libsasl`. Plug-ins do not need to call `libsasl` directly, unless for some reason the plug-in needs to be a SASL consumer.

`libsasl` creates three contexts for `sasl_utils_t`:

- `sasl_conn_t *conn`
- `sasl_rand_t *rpool`
- `void *getopt_context`

In some cases, such as loading plug-ins, the `conn` variable in `sasl_utils_t` is not actually associated with a connection. In other cases, `conn` is the SASL consumer's SASL connection context. The `rpool` variable is used for random number generation functions. `getopt_context` is the context that should be used with the `getopt()` function.

See [`sasl\_getopt\_t\(3SASL\)`](#), [`sasl\_log\_t\(3SASL\)`](#), and [`sasl\_getcallback\_t\(3SASL\)`](#).

- `sasl_out_params_t` – `libsasl` creates the `sasl_out_params_t` structure and passes the structure to `mech_step()` in the client or server. This structure communicates the following information to `libsasl`: authentication status, the `authid`, the `authzid`, `maxbuf`, the negotiated `ssf`, and information for encoding and decoding data.
- `sasl_client_params_t` – The `sasl_client_params_t` structure is used by `libsasl` to pass the client state to a SASL client mechanism. The client mechanism's `mech_new()`, `mech_step()`, and `mech_idle()` entry points are used to send this state data. The `canon_user_client()` entry point also requires client state to be passed along.
- `sasl_server_params_t` – The `sasl_server_params_t` structure performs a similar function to `sasl_client_params_t` on the server side.

## Client Plug-ins

Client plug-ins are used to manage the client-side of a SASL negotiation. Client plug-ins are usually packaged with the corresponding server plug-ins. A client plug-in contains one or more client-side SASL mechanisms. Each SASL client mechanism supports authentication, and optionally integrity and confidentiality.



Each SASL client mechanism provides information on that mechanism's capabilities:

- Maximum SSF
- Maximum security flags
- Plug-in features
- Callbacks and prompt IDs for using the plug-in

Client plug-ins must export `sasl_client_plug_init()`. `libsasl` calls `sasl_client_plug_init()` to initialize the plug-in for the client. The plug-in returns a `sasl_client_plug_t` structure.

The `sasl_client_plug_t` provides the following entry points for `libsasl` to call the mechanism:

- `mech_new()` – The client starts a connection by calling `sasl_client_start()`, which uses `mech_new()`. `mech_new()` performs initialization that is specific to the mechanism. If necessary, a connection context is allocated.
- `mech_step()` – `mech_step()` can be called by `sasl_client_start()` and `sasl_client_step()`. `mech_step()` performs authentication on the client side after `mech_new()` has been called. `mech_step()` returns `SASL_OK` if authentication is successful. `SASL_CONTINUE` is returned if more data is required. A SASL error code is returned if authentication fails. If an error occurs, then `seterror()` is called. If the authentication is successful, `mech_step()` must return the `sasl_out_params_t` structure with the relevant security layer information and callbacks. The `canon_user()` function is part of this structure. `canon_user()` must be called when the client receives the authentication and authorization IDs.
- `mech_dispose()` – `mech_dispose()` is called when the context can be safely closed. `mech_dispose()` is called by `sasl_dispose()`.
- `mech_free()` – `mech_free()` is called when `libsasl` shuts down. Any remaining global state for the plug-in is freed by `mech_free()`.

## Server Plug-ins

Server plug-ins are used to manage the server-side of a SASL negotiation. Server plug-ins are usually packaged with the corresponding client plug-ins. A server plug-in contains one or more server-side SASL mechanisms. Each SASL server mechanism supports authentication, and optionally integrity and confidentiality.

Each SASL server mechanism provides information on that mechanism's capabilities:

- Maximum SSF
- Maximum security flags
- Plug-in features
- Callbacks and prompt IDs for using the plug-in

Server plug-ins must export `sasl_server_plug_init()`. `libsasl` calls `sasl_server_plug_init()` to initialize the plug-in for the server. The plug-in returns a `sasl_server_plug_t` structure.

The `sasl_server_plug_t` structure provides the following entry points for `libsasl` to call the mechanism:

- `mech_new()` – The server starts a connection by calling `sasl_server_start()`, which uses `mech_new()`. `mech_new()` performs initialization that is specific to the mechanism. If necessary, `mech_new()` allocates a connection context.
- `mech_step()` – `mech_step()` can be called by `sasl_server_start()` and `sasl_server_step()`. `mech_step()` performs authentication on the server-side after `mech_new()` has been called. `mech_step()` returns `SASL_OK` if authentication is successful. `SASL_CONTINUE` is returned if more data is required. A SASL error code is returned if authentication fails. If an error occurs, then `seterror()` is called. If the authentication is successful, `mech_step()` must return the `sasl_out_params_t` structure with the relevant security layer information and callbacks. The `canon_user()` function is part of this structure. `canon_user()` must be called when the server receives the authentication and authorization IDs. Calling the `canon_user()` function causes `propctx` to be filled in. Any required auxiliary property requests should be performed before the authentication is canonicalized. Authorization ID lookups are performed after the authentication is canonicalized.

The `mech_step()` function must fill any related `sasl_out_params_t` fields before `SASL_OK` is returned. These fields perform the following functions:

- `doneflag` – Indicates a complete exchange
- `maxoutbuf` – Indicates maximum output size for a security layer
- `mech_ssf` – Supplied SSF for the security layer
- `encode()` – Called by `sasl_encode()`, `sasl_encodev()`, and `sasl_decode()`
- `decode()` – Called by `sasl_encode()`, `sasl_encodev()`, and `sasl_decode()`
- `encode_context()` – Called by `sasl_encode()`, `sasl_encodev()`, and `sasl_decode()`
- `decode_context()` – Called by `sasl_encode()`, `sasl_encodev()`, and `sasl_decode()`
- `mech_dispose()` – `mech_dispose()` is called when the context can be safely closed. `mech_dispose()` is called by `sasl_dispose()`.
- `mech_free()` – `mech_free()` is called when `libsasl` shuts down. Any remaining global state for the plug-in is freed by `mech_free()`.
- `setpass()` sets a user's password. `setpass()` enables a mechanism to have an internal password.
- `mech_avail()` is called by `sasl_listmech()` to check if a mechanism is available for a given user. `mech_avail()` can create a new context and thus avoid a call to `mech_new()`. Use this method to create a context as long as performance is not affected.

## User Canonicalization Plug-ins

A canonicalization plug-in provides support for alternate canonicalization of authentication and authorization names for both the client and server-side. The `sasl_canonuser_plug_init()` is used to load canonicalization plug-ins.

A canonicalization plug-in has the following requirements:

- The canonicalized name must be copied to the output buffers.
- The same input buffer can be used as an output buffer.
- A canonicalization plug-in must function in cases where only authentication IDs or authorization IDs exist.

User canonicalization plug-ins must export a `sasl_canonuser_init()` function. The `sasl_canonuser_init()` function must return `sasl_canonuser_plug_t` to establish the necessary entry points. User canonicalization plug-ins must implement at least one of the `canon_user_client()` or `canon_user_server()` members of the `sasl_canonuser_plug_t` structure.

## Auxiliary Property (auxprop) Plug-ins

Auxprop plug-ins provide support for the lookup of auxiliary properties for both `authid` and `authzid` for a SASL server. For example, an application might want to look up the user password for an internal authentication. The `sasl_auxprop_plug_init()` function is used to initialize auxprop plug-ins and returns the `sasl_auxprop_plug_t` structure.

To implement an auxprop plug-in successfully, the `auxprop_lookup` member of the `sasl_auxprop_plug_t` structure must be implemented. The `auxprop_lookup()` function is called after canonicalization of the user name, with the canonicalized user name. The plug-in can then do any lookups that are needed for the requested auxiliary properties.

---

**Note** – Sun Microsystems, Inc. does not currently provide auxprop plug-ins.

---

## SASL Plug-in Development Guidelines

This section provides some additional pointers for developing SASL plug-ins.

### Error Reporting in SASL Plug-ins

Good error reporting can help in tracking down authentication problems and in other debugging. Developers of plug-ins are encouraged to use the `sasl_seterror()` callback in the `sasl_utils_t` structure to supply detailed error information for a given connection.

## Memory Allocation in SASL Plug-ins

The general rule for allocating memory in SASL is to free any memory that you have allocated when that memory is no longer needed. Following this rule improves performance and portability, and prevents memory leaks.

## Setting the SASL Negotiation Sequence

A plug-in mechanism can set the order in which a client and server conduct a SASL conversation through the following flags:

- SASL\_FEAT\_WANT\_CLIENT\_FIRST – The client side begins the interchange.
- SASL\_FEAT\_WANT\_SERVER\_LAST – The server sends the final data to the client.

If neither flag is set, the mechanism plug-in sets the order internally. In this case, the mechanism must check both the client and server for data that needs to be sent. Note that the situation where the client sends first is only possible when the protocol permits an initial response.

The case in which the server sends last requires that the plug-in set `*serverout` when the step function returns SASL\_OK. Those mechanisms that never have the server send last must set `*serverout` to NULL. Those mechanisms that always have the server send last need to point `*serverout` to the success data.

# Introduction to the Oracle Solaris Cryptographic Framework

---

The Oracle Solaris cryptographic framework is an architecture that enables applications in the Oracle Solaris operating system to use or provide cryptographic services. All interactions with the framework are based on the RSA Security Inc. PKCS#11 Cryptographic Token Interface (Cryptoki). PKCS#11 is a product by RSA Laboratories, the research arm of RSA Security Inc.

This chapter presents the following topics on the Oracle Solaris cryptographic framework:

- “Overview of the Cryptographic Framework” on page 150
- “Components of the Cryptographic Framework” on page 152
- “What Cryptography Developers Need to Know” on page 153
- “Adding Signatures to Providers” on page 282
- “Avoiding Data Cleanup Collisions in User-Level Providers” on page 155

## Oracle Solaris Cryptography Terminology

An application, library, or kernel module that obtains cryptographic services is called a *consumer*. An application that provides cryptographic services to consumers through the framework is referred to as a *provider* and also as a *plug-in*. The software that implements a cryptographic operation is called a *mechanism*. A mechanism is not just the algorithm but includes the way in which the algorithm is to be applied. For example, the DES algorithm when applied to authentication is considered a separate mechanism. DES when applied to block-by-block encryption would be a different mechanism.

A *token* is the abstraction of a device that can perform cryptography. In addition, tokens can store information for use in cryptographic operations. A single token can support one or more mechanisms. Tokens can represent hardware, as in an accelerator board. Tokens that represent pure software are referred to as *soft tokens*. A token can be *plugged* into a *slot*, which continues the physical metaphor. A slot is the connecting point for applications that use cryptographic services.

In addition to specific slots for providers, the Oracle Solaris implementation provides a special slot called the *metaslot*. The metaslot is a component of the Oracle Solaris cryptographic framework library (`libpkcs11.so`). The metaslot serves as a single virtual slot with the combined capabilities of all tokens and slots that have been installed in the framework. Effectively, the metaslot enables an application to transparently connect with any available cryptographic service through a single slot. When an application requests a cryptographic service, the metaslot points to the most appropriate slot, which simplifies the process of selecting a slot. In some cases, a different slot might be required, in which case the application must perform a separate search explicitly. The metaslot is automatically enabled and can only be disabled through explicit action by the system administrator.

A *session* is a connection between an application that use cryptographic services and a token. The PKCS #11 standard uses two kinds of objects: token objects and session objects. *Session objects* are ephemeral, that is, objects that last only for the duration of a session. Objects that persist beyond the length of a session are referred to as *token objects*.

The default location for token objects is `$HOME/.sunw/pkcs11_softtoken`. Alternatively, token objects can be stored in `$SOFTTOKEN_DIR/pkcs11_softtoken`. Private token objects are protected by personal identification numbers (PIN). To create or change a token object requires that the user be authenticated, unless the user is accessing a private token object.

## Overview of the Cryptographic Framework



The cryptographic framework is the portion of the Oracle Solaris OS that provides cryptographic services from Sun Microsystems, Inc. and from third-party suppliers. The framework provides various services:

- Message encryption and message digest
- Message authentication codes (MACs)
- Digital signing
- Application programmer interfaces (APIs) for accessing cryptographic services
- Service provider interfaces (SPIs) for providing cryptographic services
- An administration command for managing cryptographic resources

The following figure provides an overview of the cryptographic framework. The light gray shading in the figure indicates the user-level portion of the cryptographic framework. The dark gray shading represents the kernel-level portion of the framework. Private software is indicated by a background with diagonal striping.

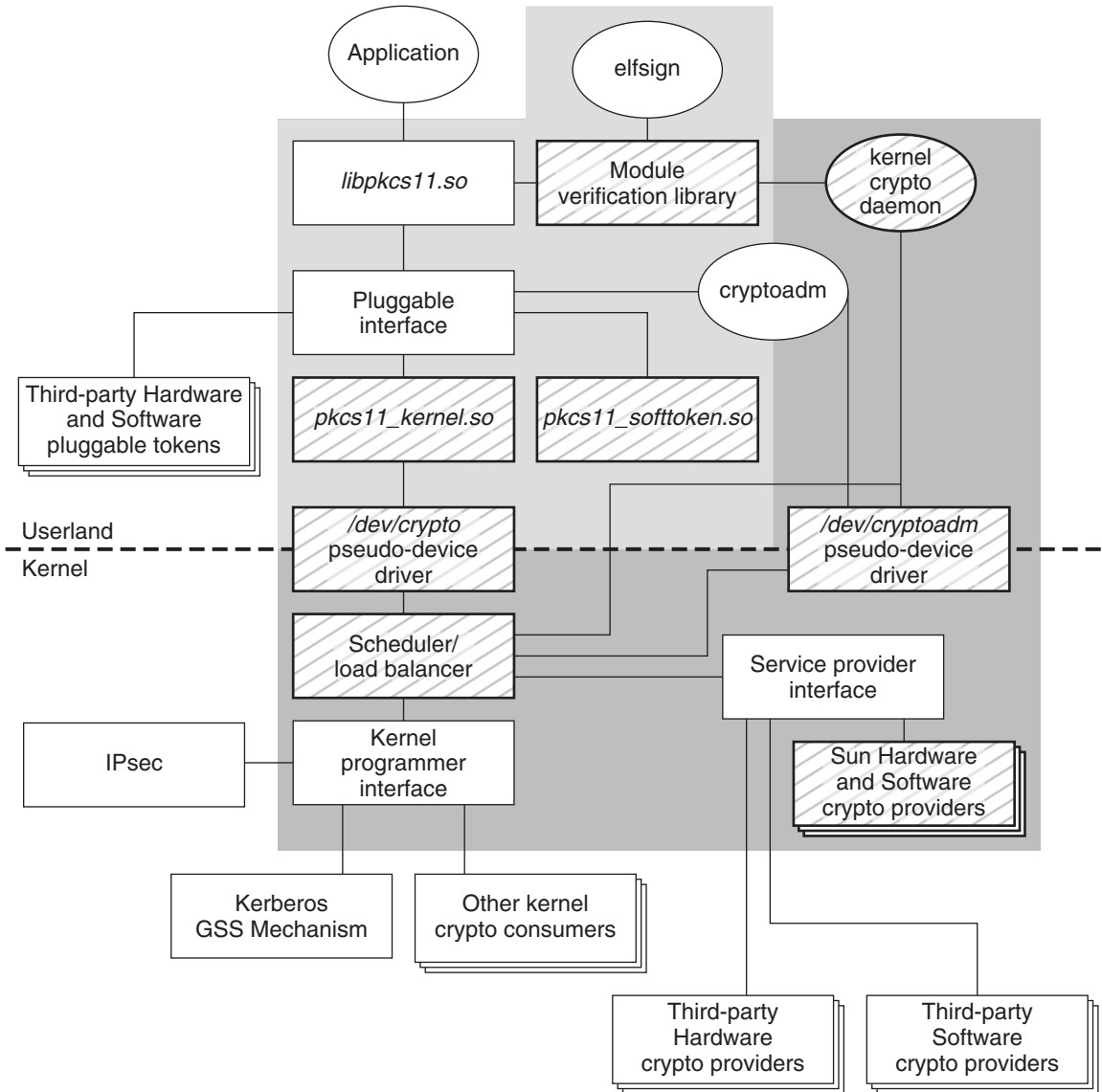
FIGURE 8-1 Overview of the Oracle Solaris Cryptographic Framework



-  Private components
-  User portion of cryptographic framework
-  Kernel portion of cryptographic framework

# Components of the Cryptographic Framework

The components of the cryptographic framework are described as follows.

- `libpkcs11.so` – The framework provides access through the RSA Security Inc. PKCS#11 Cryptographic Token Interface (Cryptoki). Applications need to link to the `libpkcs11.so` library, which implements the RSA PKCS#11 v2.11 of the standard.
- **Pluggable interface** – The pluggable interface is the service provider interface (SPI) for PKCS #11 cryptographic services that are provided by Sun Microsystems, Inc. and third-party developers. Providers are user-level libraries. Providers are implemented through encryption services that are available from either hardware or software.
- `pkcs11_softtoken.so` – A private shared object that contains user-level cryptographic mechanisms that are provided by Sun Microsystems, Inc. The `pkcs11_softtoken(5)` library implements the RSA PKCS#11 v2.11 of the standard.
- `pkcs11_kernel.so` – The private shared object used to access kernel-level cryptographic mechanisms. `pkcs11_kernel(5)` implements the RSA PKCS#11 v2.11 specification. `pkcs11_kernel.so` offers a PKCS#11 user interface for cryptographic services that are plugged into the kernel's service provider interface.
- `/dev/crypto` **pseudo device driver** – The private pseudo device driver for using kernel-level cryptographic mechanisms. This information is provided to avoid inadvertent deletion of the pseudo device driver.
- **Scheduler / load balancer** – The kernel software that is responsible for coordinating use, load balancing, and dispatching of the cryptographic service requests.
- **Kernel programmer interface** – The interface for kernel-level consumers of cryptographic services. The IPsec protocol and the kerberos GSS mechanism are typical cryptographic consumers.

---

**Note** – This interface is only available through a special contract with Sun Microsystems, Inc. Send email to [solaris-crypto-api@sun.com](mailto:solaris-crypto-api@sun.com) for more information.

---

- **Service provider interface** – The SPI for providers of kernel-level cryptographic services. These services can be implemented on either hardware or software. To use the SPI, a provider must import special routines from the Oracle Solaris kernel. These routines enable modules and device drivers to register and remove services. The routines also notify the framework about changes in state. The framework also requires that providers export certain routines. The exported routines enable consumers and other components of the cryptographic framework to send requests to the provider.
- **Sun HW and SW cryptographic providers** – Kernel-level cryptographic services that are provided by Sun Microsystems, Inc. HW refers to hardware cryptographic services such as accelerator boards. SW refers to kernel modules that provide cryptographic services, such as an implementation of a cryptographic algorithm.



- **Kernel cryptographic framework daemon** – The private daemon that is responsible for managing system resources for cryptographic operations. The daemon is also responsible for verifying cryptographic providers.
- **Module verification library** – A private library used to verify the integrity and authenticity of all binaries that the Oracle Solaris cryptographic framework is importing.
- `elfsign` – A utility offered to third-party providers of cryptographic services. `elfsign` is used to request certificates from Sun. `elfsign` also enables providers to actually sign the binaries, that is, elf objects that plug into the Oracle Solaris cryptographic framework.
- `/dev/cryptoadm` **pseudo device driver** – The private pseudo device driver used by `cryptoadm(1M)` for administering kernel-level cryptographic mechanisms. This information is provided to avoid inadvertent deletion of the pseudo device driver.
- `cryptoadm` – A user-level command for administrators to manage cryptographic services. A typical `cryptoadm` task is listing cryptographic providers and their capabilities. Disabling and enabling cryptographic mechanisms according to security policy is also performed with `cryptoadm`.

## What Cryptography Developers Need to Know

This section describes the requirements to develop the four types of applications that can plug into the Oracle Solaris cryptographic framework.

### Requirements for Developers of User-Level Consumers

To develop a user-level consumer, do all of the following:

- Include `<security/cryptoki.h>`.
- Make all calls through the PKCS #11 interfaces only.
- Link with `libpkcs11.so`.
- Libraries should not call the `C_Finalize()` function.

See [Chapter 9, “Writing User-Level Cryptographic Applications and Providers,”](#) for more information.

## Requirements for Developers of User-Level Providers

To develop a user-level provider, do all of the following:

- Design the provider to stand alone. Although the provider shared object need not be a full-fledged library to which applications link, all necessary symbols must exist in the provider. Assume that the provider is to be opened by `dlopen(3C)` in `RTLD_GROUP` and `RTLD_NOW` mode.
- Create a PKCS #11 Cryptoki implementation in a shared object. This shared object should include necessary symbols rather than depend on consumer applications.
- It is highly recommended though not required to provide a `_fini()` routine for data cleanup. This method is required to avoid collisions between `C_Finalize()` calls when an application or shared library loads `libpkcs11` and other provider libraries concurrently. See [“Avoiding Data Cleanup Collisions in User-Level Providers” on page 155](#).
- Apply for a certificate from Sun Microsystems, Inc. See [“To Request a Certificate for Signing a Provider” on page 282](#).
- Use the certificate with `elfsign` to sign the binary. See [“To Sign a Provider” on page 283](#).
- Package the shared object according to Sun conventions. See [Appendix F, “Packaging and Signing Cryptographic Providers.”](#)

## Requirements for Developers of Kernel-Level Consumers

To develop a kernel-level consumer, do all of the following:

- Include `<sys/crypto/common.h>` and `<sys/crypto/api.h>`.
- Make all calls through the kernel programming interface.

## Requirements for Developers of Kernel-Level Providers

To develop a kernel-level provider, do all of the following:

- Include `<sys/crypto/common.h>` and `<sys/crypto/api.h>`.
- Import required routines for registering, unregistering, and providing status.
- Export required routines to provide entry points for kernel cryptographic framework.
- Export data structure with descriptions of supported algorithms.
- Create loadable kernel module.
- Apply for a certificate from Sun Microsystems, Inc. See [“To Request a Certificate for Signing a Provider” on page 282](#).

- Use the certificate with `elfsign` to sign the binary. See “To Sign a Provider” on page 283.
- Package the kernel module according to Sun conventions. See Appendix F, “Packaging and Signing Cryptographic Providers.”

## Avoiding Data Cleanup Collisions in User-Level Providers

User-level libraries that plug into the cryptographic framework should supply a `_fini()` function. The `_fini()` function is called by the loader when the library is unloaded. The `_fini()` function is required to ensure that all cleanup is done correctly at the right time. Libraries that use `libpkcs11` are not supposed to call `C_Finalize()`, because `libpkcs11` is a shared library that could potentially be in use by the application.

To supply a `_fini()` function, you need to create a `.fini` section in the program data section of a relocatable object. The `.fini` section provides a runtime termination code block. See *Linker and Libraries Guide*. The following code sample demonstrates how to design a `.fini` section.

**EXAMPLE 8-1** Supplying `_fini()` to PKCS #11 Libraries

```
#pragma fini(pkcs11_fini)
static void pkcs11_fini();

/* [... (other library code omitted)] */

static void
pkcs11_fini()
{
    (void) pthread_mutex_lock(&pkcs11mutex);

    /* If CRYPTOKI is not initialized, do not clean up */
    if (!initialized) {
        (void) pthread_mutex_unlock(&pkcs11mutex);
        return;
    }

    (void) finalize_routine(NULL_PTR);

    (void) pthread_mutex_unlock(&pkcs11mutex);
}
```



# Writing User–Level Cryptographic Applications and Providers

---

This chapter explains how to develop user–level applications and providers that use the PKCS #11 functions for cryptography.

The following topics are covered:

- “PKCS #11 Function List” on page 158
- “Functions for Using PKCS #11” on page 158
- “Message Digest Example” on page 165
- “Symmetric Encryption Example” on page 168
- “Sign and Verify Example” on page 172
- “Random Byte Generation Example” on page 179

For more information on the cryptographic framework, refer to [Chapter 8, “Introduction to the Oracle Solaris Cryptographic Framework.”](#)

## Overview of the Cryptoki Library

User-level applications in the Oracle Solaris cryptographic framework access PKCS #11 functions through the `cryptoki` library, which is provided in the `libpkcs11.so` module. The `pkcs11_softtoken.so` module is a PKCS #11 Soft Token implementation that is provided by Oracle Corporation to supply cryptographic mechanisms. The soft token plug-in is the default source of mechanisms. Cryptographic mechanisms can also be supplied through third-party plug-ins.

This section lists the PKCS #11 functions and return values that are supported by the soft token. Return codes vary depending on the providers that are plugged into the framework. The section also describes some common functions. For a complete description of all the elements in the `cryptoki` library, refer to [libpkcs11\(3LIB\)](#) or to [PKCS #11: Cryptographic Token Interface Standard](#) on the [RSA Laboratories](#) web site.

Ensure that direct bindings are used for all providers. See `ld(1)` and the [Linker and Libraries Guide](#) for more information.

## PKCS #11 Function List

The following list shows the categories of PKCS #11 functions that are supported by `pkcs11_softtoken.so` in the Oracle Solaris cryptographic framework with the associated functions:

- **General purpose** – `C_Initialize()`, `C_Finalize()`, `C_GetInfo()`, `C_GetFunctionList()`
- **Session management** – `C_OpenSession()`, `C_CloseSession()`, `C_GetSessionInfo()`, `C_CloseAllSessions()`, `C_Login()`, `C_Logout()`
- **Slot and token management** – `C_GetSlotList()`, `C_GetSlotInfo()`, `C_GetMechanismList()`, `C_GetMechanismInfo()`, `C_SetPIN()`
- **Encryption and decryption** – `C_EncryptInit()`, `C_Encrypt()`, `C_EncryptUpdate()`, `C_EncryptFinal()`, `C_DecryptInit()`, `C_Decrypt()`, `C_DecryptUpdate()`, `C_DecryptFinal()`
- **Message digesting** – `C_DigestInit()`, `C_Digest()`, `C_DigestKey()`, `C_DigestUpdate()`, `C_DigestFinal()`
- **Signing and applying MAC** – `C_Sign()`, `C_SignInit()`, `C_SignUpdate()`, `C_SignFinal()`, `C_SignRecoverInit()`, `C_SignRecover()`
- **Signature verification** – `C_Verify()`, `C_VerifyInit()`, `C_VerifyUpdate()`, `C_VerifyFinal()`, `C_VerifyRecoverInit()`, `C_VerifyRecover()`
- **Dual-purpose cryptographic functions** – `C_DigestEncryptUpdate()`, `C_DecryptDigestUpdate()`, `C_SignEncryptUpdate()`, `C_DecryptVerifyUpdate()`
- **Random number generation** – `C_SeedRandom()`, `C_GenerateRandom()`
- **Object management** – `C_CreateObject()`, `C_DestroyObject()`, `C_CopyObject()`, `C_FindObjects()`, `C_FindObjectsInit()`, `C_FindObjectsFinal()`, `C_GetAttributeValue()`, `C_SetAttributeValue()`
- **Key management** – `C_GenerateKey()`, `C_GenerateKeyPair()`, `C_DeriveKey()`

## Functions for Using PKCS #11

This section provides descriptions of the following functions for using PKCS #11:

- “PKCS #11 Functions: `C_Initialize()`” on page 159
- “PKCS #11 Functions: `C_GetInfo()`” on page 159
- “PKCS #11 Functions: `C_GetSlotList()`” on page 160
- “PKCS #11 Functions: `C_GetTokenInfo()`” on page 160
- “PKCS #11 Functions: `C_OpenSession()`” on page 161
- “PKCS #11 Functions: `C_GetMechanismList()`” on page 162

---

**Note** – All the PKCS #11 functions are available from `libpkcs11.so` library. You do not have to use the `C_GetFunctionList()` function to get the list of functions available.

---

## PKCS #11 Functions: `C_Initialize()`

`C_Initialize()` initializes the PKCS #11 library. `C_Initialize()` uses the following syntax:

```
C_Initialize(CK_VOID_PTR pInitArgs);
```

*pInitArgs* is either the null value `NULL_PTR` or else a pointer to a `CK_C_INITIALIZE_ARGS` structure. With `NULL_PTR`, the library uses the Oracle Solaris mutexes as locking primitives to arbitrate the access to internal shared structures between multiple threads. Note that the Oracle Solaris cryptographic framework does not accept mutexes. Because this implementation of the cryptoki library handles multithreading safely and efficiently, using `NULL_PTR` is recommended. An application can also use *pInitArgs* to set flags such as `CKF_LIBRARY_CANT_CREATE_OS_THREADS`. `C_Finalize()` signals that the application is through with the PKCS #11 library.

---

**Note** – `C_Finalize()` should never be called by libraries. By convention, applications are responsible for calling `C_Finalize()` to close out a session.

---

In addition to `CKR_FUNCTION_FAILED`, `CKR_GENERAL_ERROR`, `CKR_HOST_MEMORY`, and `CKR_OK`, `C_Initialize()` uses the following return values:

- `CKR_ARGUMENTS_BAD`
- `CKR_CANT_LOCK`
- `CKR_CRYPTOKI_ALREADY_INITIALIZED` (not fatal)

## PKCS #11 Functions: `C_GetInfo()`

`C_GetInfo()` uses manufacturer and version information about the cryptoki library. `C_GetInfo()` uses the following syntax:

```
C_GetInfo(CK_INFO_PTR pInfo);
```

`C_GetInfo()` returns the following values:

- `cryptokiVersion = 2, 11`
- `manufacturerID = Sun Microsystems, Inc.`

In addition to `CKR_FUNCTION_FAILED`, `CKR_GENERAL_ERROR`, `CKR_HOST_MEMORY`, and `CKR_OK`, `C_GetInfo()` gets the following return values:

- `CKR_ARGUMENTS_BAD`
- `CKR_CRYPTOKI_NOT_INITIALIZED`

## PKCS #11 Functions: C\_GetSlotList()

C\_GetSlotList() uses a list of available slots. If no additional cryptographic providers have been installed other than pkcs11\_softtoken.so, then C\_GetSlotList() returns the default slot only. C\_GetSlotList() uses the following syntax:

```
C_GetSlotList(CK_BBOOL tokenPresent, CK_SLOT_ID_PTR pSlotList,  
CK_ULONG_PTR pulCount);
```

When set to TRUE, *tokenPresent* limits the search to those slots whose tokens are present.

When *pSlotList* is set to NULL\_PTR, C\_GetSlotList() returns the number of slots only. *pulCount* is a pointer to the location to receive the slot count.

When *pSlotList* points to the buffer to receive the slots, *\*pulCount* is set to the maximum expected number of CK\_SLOT\_ID elements. On return, *\*pulCount* is set to the actual number of CK\_SLOT\_ID elements.

Typically, PKCS #11 applications call C\_GetSlotList() twice. The first time, C\_GetSlotList() is called to get the number of slots for memory allocation. The second time, C\_GetSlotList() is called to retrieve the slots.

---

**Note** – The order of the slots is not guaranteed. The order of the slots can vary with each load of the PKCS #11 library.

---

In addition to CKR\_FUNCTION\_FAILED, CKR\_GENERAL\_ERROR, CKR\_HOST\_MEMORY, and CKR\_OK, C\_GetSlotList() gets the following return values:

- CKR\_ARGUMENTS\_BAD
- CKR\_BUFFER\_TOO\_SMALL
- CKR\_CRYPTOKI\_NOT\_INITIALIZED

## PKCS #11 Functions: C\_GetTokenInfo()

C\_GetTokenInfo() gets information about a specific token. C\_GetTokenInfo() uses the following syntax:

```
C_GetTokenInfo(CK_SLOT_ID slotID, CK_TOKEN_INFO_PTR pInfo);
```

*slotID* identifies the slot for the token. *slotID* has to be a valid ID that was returned by C\_GetSlotList(). *pInfo* is a pointer to the location to receive the token information.



If `pkcs11_softtoken` is the only installed provider, then `C_GetTokenInfo()` returns the following fields and values:

- `label` – Sun Software PKCS#11 softtoken.
- `flags` – `CKF_DUAL_CRYPT_OPERATIONS`, `CKF_TOKEN_INITIALIZED`, `CKF_RNG`, `CKF_USER_PIN_INITIALIZED`, and `CKF_LOGIN_REQUIRED`, which are set to 1.
- `ulMaxSessionCount` – Set to `CK_EFFECTIVELY_INFINITE`.
- `ulMaxRwSessionCount` – Set to `CK_EFFECTIVELY_INFINITE`.
- `ulMaxPinLen` – Set to 256.
- `ulMinPinLen` – Set to 1.
- `ulTotalPublicMemory` set to `CK_UNAVAILABLE_INFORMATION`.
- `ulFreePublicMemory` set to `CK_UNAVAILABLE_INFORMATION`.
- `ulTotalPrivateMemory` set to `CK_UNAVAILABLE_INFORMATION`.
- `ulFreePrivateMemory` set to `CK_UNAVAILABLE_INFORMATION`.

In addition to `CKR_FUNCTION_FAILED`, `CKR_GENERAL_ERROR`, `CKR_HOST_MEMORY`, and `CKR_OK`, `C_GetSlotList()` gets the following return values:

- `CKR_ARGUMENTS_BAD`
- `CKR_BUFFER_TOO_SMALL`
- `CKR_CRYPTOKI_NOT_INITIALIZED`
- `CKR_SLOT_ID_INVALID`

The following return values are relevant for plug-ins with hardware tokens:

- `CKR_DEVICE_ERROR`
- `CKR_DEVICE_MEMORY`
- `CKR_DEVICE_REMOVED`
- `CKR_TOKEN_NOT_PRESENT`
- `CKR_TOKEN_NOT_RECOGNIZED`

## PKCS #11 Functions: `C_OpenSession()`

`C_OpenSession()` enables an application to start a cryptographic session with a specific token in a specific slot. `C_OpenSession()` uses the following syntax:

```
C_OpenSession(CK_SLOT_ID slotID, CK_FLAGS flags, CK_VOID_PTR pApplication,
CK_NOTIFY Notify, CK_SESSION_HANDLE_PTR phSession);
```

`slotID` identifies the slot. `flags` indicates whether the session is read-write or read-only. `pApplication` is a pointer that is defined by the application for use in callbacks. `Notify` holds the address of an optional callback function. `phSession` is a pointer to the location of the session handle.

In addition to `CKR_FUNCTION_FAILED`, `CKR_GENERAL_ERROR`, `CKR_HOST_MEMORY`, and `CKR_OK`, `C_OpenSession()` gets the following return values:

- `CKR_ARGUMENTS_BAD`
- `CKR_CRYPTOKI_NOT_INITIALIZED`
- `CKR_SLOT_ID_INVALID`
- `CKR_TOKEN_WRITE_PROTECTED` (occurs with write-protected tokens)

The following return values are relevant for plug-ins with hardware tokens:

- `CKR_DEVICE_ERROR`
- `CKR_DEVICE_MEMORY`
- `CKR_DEVICE_REMOVED`
- `CKR_SESSION_COUNT`
- `CKR_SESSION_PARALLEL_NOT_SUPPORTED`
- `CKR_SESSION_READ_WRITE_SO_EXISTS`
- `CKR_TOKEN_NOT_PRESENT`
- `CKR_TOKEN_NOT_RECOGNIZED`

## **PKCS #11 Functions: `C_GetMechanismList()`**

`C_GetMechanismList()` gets a list of mechanism types that are supported by the specified token. `C_GetMechanismList()` uses the following syntax:

```
C_GetMechanismList(CK_SLOT_ID slotID, CK_MECHANISM_TYPE_PTR pMechanismList,  
CK_ULONG_PTR pulCount);
```

*slotID* identifies the slot for the token. *pulCount* is a pointer to the location to receive the number of mechanisms. When *pMechanismList* is set to `NULL_PTR`, the number of mechanisms is returned in *\*pulCount*. Otherwise, *\*pulCount* must be set to the size of the list and *pMechanismList* points to the buffer to hold the list.

When PKCS #11 Soft Token is plugged in, `C_GetMechanismList()` returns the following list of supported mechanisms:

- `CKM_AES_CBC`
- `CKM_AES_CBC_PAD`
- `CKM_AES_ECB`
- `CKM_AES_KEY_GEN`
- `CKM_DES_CBC`
- `CKM_DES_CBC_PAD`
- `CKM_DES_ECB`
- `CKM_DES_KEY_GEN`
- `CKM_DES_MAC`
- `CKM_DES_MAC_GENERAL`
- `CKM_DES3_CBC`
- `CKM_DES3_CBC_PAD`

- CKM\_DES3\_ECB
- CKM\_DES3\_KEY\_GEN
- CKM\_DH\_PKCS\_DERIVE
- CKM\_DH\_PKCS\_KEY\_PAIR\_GEN
- CKM\_DSA
- CKM\_DSA\_KEY\_PAIR\_GEN
- CKM\_DSA\_SHA\_1
- CKM\_MD5
- CKM\_MD5\_KEY\_DERIVATION
- CKM\_MD5\_RSA\_PKCS
- CKM\_MD5\_HMAC
- CKM\_MD5\_HMAC\_GENERAL
- CKM\_PBE\_SHA1\_RC4\_128
- CKM\_PKCS5\_PBKD2
- CKM\_RC4
- CKM\_RC4\_KEY\_GEN
- CKM\_RSA\_PKCS
- CKM\_RSA\_X\_509
- CKM\_RSA\_PKCS\_KEY\_PAIR\_GEN
- CKM\_SHA\_1
- CKM\_SHA\_1\_HMAC\_GENERAL
- CKM\_SHA\_1\_HMAC
- CKM\_SHA\_1\_KEY\_DERIVATION
- CKM\_SHA\_1\_RSA\_PKCS
- CKM\_SSL3\_KEY\_AND\_MAC\_DERIVE
- CKM\_SSL3\_MASTER\_KEY\_DERIVE
- CKM\_SSL3\_MASTER\_KEY\_DERIVE\_DH
- CKM\_SSL3\_MD5\_MAC
- CKM\_SSL3\_PRE\_MASTER\_KEY\_GEN
- CKM\_SSL3\_SHA1\_MAC
- CKM\_TLS\_KEY\_AND\_MAC\_DERIVE
- CKM\_TLS\_MASTER\_KEY\_DERIVE
- CKM\_TLS\_MASTER\_KEY\_DERIVE\_DH
- CKM\_TLS\_PRE\_MASTER\_KEY\_GEN

In addition to CKR\_FUNCTION\_FAILED, CKR\_GENERAL\_ERROR, CKR\_HOST\_MEMORY, and CKR\_OK, C\_GetSlotList() uses the following return values:

- CKR\_ARGUMENTS\_BAD
- CKR\_BUFFER\_TOO\_SMALL
- CKR\_CRYPTOKI\_NOT\_INITIALIZED
- CKR\_SLOT\_ID\_INVALID

The following return values are relevant for plug-ins with hardware tokens:

- CKR\_DEVICE\_ERROR
- CKR\_DEVICE\_MEMORY
- CKR\_DEVICE\_REMOVED
- CKR\_TOKEN\_NOT\_PRESENT
- CKR\_TOKEN\_NOT\_RECOGNIZED

## Extended PKCS #11 Functions

In addition to the standard PKCS #11 functions, two convenience functions are supplied with the Oracle Solaris cryptographic framework:

- [“Extended PKCS #11 Functions: SUNW\\_C\\_GetMechSession\(\)” on page 164](#)
- [“Extended PKCS #11 Functions: SUNW\\_C\\_KeyToObject” on page 164](#)

### Extended PKCS #11 Functions: SUNW\_C\_GetMechSession()

`SUNW_C_GetMechSession()` is a convenience function that initializes the Oracle Solaris cryptographic framework. The function then starts a session with the specified mechanism. `SUNW_C_GetMechSession()` uses the following syntax:

```
SUNW_C_GetMechSession(CK_MECHANISM_TYPE mech, C\
K_SESSION_HANDLE_PTR hSession)
```

The *mech* parameter is used to specify the mechanism to be used. *hSession* is a pointer to the session location.

Internally, `SUNW_C_GetMechSession()` calls `C_Initialize()` to initialize the cryptoki library. `SUNW_C_GetMechSession()` next calls `C_GetSlotList()` and `C_GetMechanismInfo()` to search through the available slots for a token with the specified mechanism. When the mechanism is found, `SUNW_C_GetMechSession()` calls `C_OpenSession()` to open a session.

The `SUNW_C_GetMechSession()` only needs to be called once. However, calling `SUNW_C_GetMechSession()` multiple times does not cause any problems.

### Extended PKCS #11 Functions: SUNW\_C\_KeyToObject

`SUNW_C_KeyToObject()` creates a secret key object. The calling program must specify the mechanism to be used and raw key data. Internally, `SUNW_C_KeyToObject()` determines the type of key for the specified mechanism. A generic key object is created through `C_CreateObject()`. `SUNW_C_KeyToObject()` next calls `C_GetSessionInfo()` and `C_GetMechanismInfo()` to get the slot and mechanism. `C_SetAttributeValue()` then sets the attribute flag for the key object according to the type of mechanism.

# User-Level Cryptographic Application Examples

This section includes the following examples:

- “Message Digest Example” on page 165
- “Symmetric Encryption Example” on page 168
- “Sign and Verify Example” on page 172
- “Random Byte Generation Example” on page 179

## Message Digest Example

This example uses PKCS #11 functions to create a digest from an input file. The example performs the following steps:

1. Specifies the digest mechanism.

In this example, the CKM\_MD5 digest mechanism is used.

2. Finds a slot that is capable of the specified digest algorithm.

This example uses the Sun convenience function `SUNW_C_GetMechSession()`.

`SUNW_C_GetMechSession()` opens the `cryptoki` library, which holds all the PKCS #11 functions that are used in the Oracle Solaris cryptographic framework.

`SUNW_C_GetMechSession()` then finds the slot with the desired mechanism. The session is then started. Effectively, this convenience function replaces the `C_Initialize()` call, the `C_OpenSession()` call, and any code needed to find a slot that supports the specified mechanism.

3. Obtains `cryptoki` information.

This part is not actually needed to create the message digest, but is included to demonstrate use of the `C_GetInfo()` function. This example gets the manufacturer ID. The other information options retrieve version and library data.

4. Conducts a digest operation with the slot.

The message digest is created in this task through these steps:

- a. Opening the input file.
- b. Initializing the digest operation by calling `C_DigestInit()`.
- c. Processing the data a piece at a time with `C_DigestUpdate()`.
- d. Ending the digest process by using `C_DigestFinal()` to get the complete digest.

5. Ends the session.

The program uses `C_CloseSession()` to close the session and `C_Finalize()` to close the library.

The source code for the message digest example is shown in the following example.

**Note** – The source code for this example is also available through the Sun download center. See <http://www.sun.com/download/products.xml?id=41912db5>.

---

**EXAMPLE 9-1** Creating a Message Digest Using PKCS #11 Functions

```
#include <stdio.h>
#include <fcntl.h>
#include <errno.h>
#include <sys/types.h>
#include <security/cryptoki.h>
#include <security/pkcs11.h>

#define BUFFERSIZ 8192
#define MAXDIGEST 64

/* Calculate the digest of a user supplied file. */
void
main(int argc, char **argv)
{
    CK_BYTE digest[MAXDIGEST];
    CK_INFO info;
    CK_MECHANISM mechanism;
    CK_SESSION_HANDLE hSession;
    CK_SESSION_INFO Info;
    CK_ULONG ulDataLen = BUFFERSIZ;
    CK_ULONG ulDigestLen = MAXDIGEST;
    CK_RV rv;
    CK_SLOT_ID slotID;

    int i, bytes_read = 0;
    char inbuf[BUFFERSIZ];
    FILE *fs;
    int error = 0;

    /* Specify the CKM_MD5 digest mechanism as the target */
    mechanism.mechanism = CKM_MD5;
    mechanism.pParameter = NULL_PTR;
    mechanism.ulParameterLen = 0;

    /* Use SUNW convenience function to initialize the cryptoki
     * library, and open a session with a slot that supports
     * the mechanism we plan on using. */
    rv = SUNW_C_GetMechSession(mechanism.mechanism, &hSession);
    if (rv != CKR_OK) {
        fprintf(stderr, "SUNW_C_GetMechSession: rv = 0x%.8X\n", rv);
        exit(1);
    }

    /* Get cryptoki information, the manufacturer ID */
    rv = C_GetInfo(&info);
    if (rv != CKR_OK) {
        fprintf(stderr, "WARNING: C_GetInfo: rv = 0x%.8X\n", rv);
    }
    fprintf(stdout, "Manufacturer ID = %s\n", info.manufacturerID);

    /* Open the input file */
```

**EXAMPLE 9-1** Creating a Message Digest Using PKCS #11 Functions (Continued)

```

if ((fs = fopen(argv[1], "r")) == NULL) {
    perror("fopen");
    fprintf(stderr, "\n\tusage: %s filename>\n", argv[0]);
    error = 1;
    goto exit_session;
}

/* Initialize the digest session */
if ((rv = C_DigestInit(hSession, &mechanism)) != CKR_OK) {
    fprintf(stderr, "C_DigestInit: rv = 0x%.8X\n", rv);
    error = 1;
    goto exit_digest;
}

/* Read in the data and create digest of this portion */
while (!feof(fs) && (ulDataLen = fread(inbuf, 1, BUFFERSIZ, fs)) > 0) {
    if ((rv = C_DigestUpdate(hSession, (CK_BYTE_PTR)inbuf,
        ulDataLen)) != CKR_OK) {
        fprintf(stderr, "C_DigestUpdate: rv = 0x%.8X\n", rv);
        error = 1;
        goto exit_digest;
    }
    bytes_read += ulDataLen;
}
fprintf(stdout, "%d bytes read and digested!!!\n\n", bytes_read);

/* Get complete digest */
ulDigestLen = sizeof (digest);
if ((rv = C_DigestFinal(hSession, (CK_BYTE_PTR)digest,
    &ulDigestLen)) != CKR_OK) {
    fprintf(stderr, "C_DigestFinal: rv = 0x%.8X\n", rv);
    error = 1;
    goto exit_digest;
}

/* Print the results */
fprintf(stdout, "The value of the digest is: ");
for (i = 0; i < ulDigestLen; i++) {
    fprintf(stdout, "%.2x", digest[i]);
}
fprintf(stdout, "\nDone!!!\n\n");

exit_digest:
    fclose(fs);

exit_session:
    (void) C_CloseSession(hSession);

exit_program:
    (void) C_Finalize(NULL_PTR);

    exit(error);
}

```

## Symmetric Encryption Example

[Example 9–2](#) creates a key object for encryption with the DES algorithm in the CBC mode. This source code performs the following steps:

1. Declares key materials.

Defines DES and initialization vector. The initialization vector is declared statically for demonstration purposes only. Initialization vectors should always be defined dynamically and never reused.

2. Defines a key object.

For this task, you have to set up a template for the key.

3. Finds a slot that is capable of the specified encryption mechanism.

This example uses the Sun convenience function `SUNW_C_GetMechSession()`.

`SUNW_C_GetMechSession()` opens the `cryptoki` library, which holds all the PKCS #11 functions that are used in the Oracle Solaris cryptographic framework.

`SUNW_C_GetMechSession()` then finds the slot with the desired mechanism. The session is then started. Effectively, this convenience function replaces the `C_Initialize()` call, the `C_OpenSession()` call, and any code needed to find a slot that supports the specified mechanism.

4. Conducts an encryption operation in the slot.

The encryption is performed in this task through these steps:

- a. Opening the input file.
- b. Creating an object handle for the key.
- c. Setting the encryption mechanism to `CKM_DES_CBC_PAD` by using the mechanism structure.
- d. Initializing the encryption operation by calling `C_EncryptInit()`.
- e. Processing the data a piece at a time with `C_EncryptUpdate()`.
- f. Ending the encryption process by using `C_EncryptFinal()` to get the last portion of the encrypted data.

5. Conducts a decryption operation in the slot.

The decryption is performed in this task through these steps. The decryption is provided for testing purposes only.

- a. Initializes the decryption operation by calling `C_DecryptInit()`.
- b. Processes the entire string with `C_Decrypt()`.

6. Ends the session.

The program uses `C_CloseSession()` to close the session and `C_Finalize()` to close the library.

The source code for the symmetric encryption example is shown in the following example.



---

**Note** – The source code for this example is also available through the Sun download center. See <http://www.sun.com/download/products.xml?id=41912db5>.

---

**EXAMPLE 9-2** Creating an Encryption Key Object Using PKCS #11 Functions

```
#include <stdio.h>
#include <fcntl.h>
#include <errno.h>
#include <sys/types.h>
#include <security/cryptoki.h>
#include <security/pkcs11.h>

#define BUFFERSIZ 8192

/* Declare values for the key materials. DO NOT declare initialization
 * vectors statically like this in real life!! */
uchar_t des_key[] = { 0x01, 0x23, 0x45, 0x67, 0x89, 0xab, 0xcd, 0xef};
uchar_t des_cbc_iv[] = { 0x12, 0x34, 0x56, 0x78, 0x90, 0xab, 0xcd, 0xef};

/* Key template related definitions. */
static CK_BBOOL truevalue = TRUE;
static CK_BBOOL falsevalue = FALSE;
static CK_OBJECT_CLASS class = CKO_SECRET_KEY;
static CK_KEY_TYPE keyType = CKK_DES;

/* Example encrypts and decrypts a file provided by the user. */
void
main(int argc, char **argv)
{
    CK_RV rv;
    CK_MECHANISM mechanism;
    CK_OBJECT_HANDLE hKey;
    CK_SESSION_HANDLE hSession;
    CK_ULONG ciphertext_len = 64, lastpart_len = 64;
    long ciphertext_space = BUFFERSIZ;
    CK_ULONG decryptttext_len;
    CK_ULONG total_encrypted = 0;
    CK_ULONG ulDataLen = BUFFERSIZ;

    int i, bytes_read = 0;
    int error = 0;
    char inbuf[BUFFERSIZ];
    FILE *fs;
    uchar_t ciphertext[BUFFERSIZ], *pciphertext, decryptttext[BUFFERSIZ];

    /* Set the key object */
    CK_ATTRIBUTE template[] = {
        {CKA_CLASS, &class, sizeof (class) },
        {CKA_KEY_TYPE, &keyType, sizeof (keyType) },
        {CKA_TOKEN, &>falsevalue, sizeof (falsevalue) },
        {CKA_ENCRYPT, &>truevalue, sizeof (truevalue) },
        {CKA_VALUE, &des_key, sizeof (des_key) }
    };

    /* Set the encryption mechanism to CKM_DES_CBC_PAD */
```

## EXAMPLE 9-2 Creating an Encryption Key Object Using PKCS #11 Functions (Continued)

```

mechanism.mechanism = CKM_DES_CBC_PAD;
mechanism.pParameter = des_cbc_iv;
mechanism.ulParameterLen = 8;

/* Use SUNW convenience function to initialize the cryptoki
 * library, and open a session with a slot that supports
 * the mechanism we plan on using. */
rv = SUNW_C_GetMechSession(mechanism.mechanism, &hSession);

if (rv != CKR_OK) {
    fprintf(stderr, "SUNW_C_GetMechSession: rv = 0x%.8X\n", rv);
    exit(1);
}

/* Open the input file */
if ((fs = fopen(argv[1], "r")) == NULL) {
    perror("fopen");
    fprintf(stderr, "\n\tusage: %s filename>\n", argv[0]);
    error = 1;
    goto exit_session;
}

/* Create an object handle for the key */
rv = C_CreateObject(hSession, template,
    sizeof(template) / sizeof(CK_ATTRIBUTE),
    &hKey);

if (rv != CKR_OK) {
    fprintf(stderr, "C_CreateObject: rv = 0x%.8X\n", rv);
    error = 1;
    goto exit_session;
}

/* Initialize the encryption operation in the session */
rv = C_EncryptInit(hSession, &mechanism, hKey);

if (rv != CKR_OK) {
    fprintf(stderr, "C_EncryptInit: rv = 0x%.8X\n", rv);
    error = 1;
    goto exit_session;
}

/* Read in the data and encrypt this portion */
pciphertext = &ciphertext[0];
while (!feof(fs) && (ciphertext_space > 0) &&
    (ulDataLen = fread(inbuf, 1, ciphertext_space, fs)) > 0) {
    ciphertext_len = ciphertext_space;

    /* C_EncryptUpdate is only being sent one byte at a
     * time, so we are not checking for CKR_BUFFER_TOO_SMALL.
     * Also, we are checking to make sure we do not go
     * over the allotted buffer size. A more robust program
     * could incorporate realloc to enlarge the buffer
     * dynamically. */
    rv = C_EncryptUpdate(hSession, (CK_BYTE_PTR)inbuf, ulDataLen,

```

## EXAMPLE 9-2 Creating an Encryption Key Object Using PKCS #11 Functions (Continued)

```

    pciphertext, &ciphertext_len);
    if (rv != CKR_OK) {
        fprintf(stderr, "C_EncryptUpdate: rv = 0x%.8X\n", rv);
        error = 1;
        goto exit_encrypt;
    }
    pciphertext += ciphertext_len;
    total_encrypted += ciphertext_len;
    ciphertext_space -= ciphertext_len;
    bytes_read += ulDataLen;
}

if (!feof(fs) || (ciphertext_space < 0)) {
    fprintf(stderr, "Insufficient space for encrypting the file\n");
    error = 1;
    goto exit_encrypt;
}

/* Get the last portion of the encrypted data */
lastpart_len = ciphertext_space;
rv = C_EncryptFinal(hSession, pciphertext, &lastpart_len);
if (rv != CKR_OK) {
    fprintf(stderr, "C_EncryptFinal: rv = 0x%.8X\n", rv);
    error = 1;
    goto exit_encrypt;
}
total_encrypted += lastpart_len;

fprintf(stdout, "%d bytes read and encrypted. Size of the "
        "ciphertext: %d!\n\n", bytes_read, total_encrypted);

/* Print the encryption results */
fprintf(stdout, "The value of the encryption is:\n");
for (i = 0; i < ciphertext_len; i++) {
    if (ciphertext[i] < 16)
        fprintf(stdout, "0%x", ciphertext[i]);
    else
        fprintf(stdout, "%2x", ciphertext[i]);
}

/* Initialize the decryption operation in the session */
rv = C_DecryptInit(hSession, &mechanism, hKey);

/* Decrypt the entire ciphertext string */
decrypttext_len = sizeof (decrypttext);
rv = C_Decrypt(hSession, (CK_BYTE_PTR)ciphertext, total_encrypted,
        decrypttext, &decrypttext_len);

if (rv != CKR_OK) {
    fprintf(stderr, "C_Decrypt: rv = 0x%.8X\n", rv);
    error = 1;
    goto exit_encrypt;
}

fprintf(stdout, "\n\n%d bytes decrypted!!!\n\n", decrypttext_len);

```

**EXAMPLE 9-2** Creating an Encryption Key Object Using PKCS #11 Functions *(Continued)*

```
    /* Print the decryption results */
    fprintf(stdout, "The value of the decryption is:\n%s", decrypttext);

    fprintf(stdout, "\nDone!!!\n");

exit_encrypt:
    fclose(fs);

exit_session:
    (void) C_CloseSession(hSession);

exit_program:
    (void) C_Finalize(NULL_PTR);
    exit(error);
}
```

## Sign and Verify Example

The example in this section generates an RSA key pair. The key pair is used to sign and verify a simple string. The example goes through the following steps:

1. Defines a key object.
2. Sets the public key template.
3. Sets the private key template.
4. Creates a sample message.
5. Specifies the genmech mechanism, which generates the key pair.
6. Specifies the smech mechanism, which signs the key pair.
7. Initializes the `cryptoki` library.
8. Finds a slot with mechanisms for signing, verifying, and key pair generation.

The task uses a function that is called `getMySlot()`, which performs the following steps:

- a. Calling the function `C_GetSlotList()` to get a list of the available slots.  
`C_GetSlotList()` is called twice, as the PKCS #11 convention suggests. `C_GetSlotList()` is called the first time to get the number of slots for memory allocation. `C_GetSlotList()` is called the second time to retrieve the slots.
  - b. Finding a slot that can supply the desired mechanisms.  
For each slot, the function calls `GetMechanismInfo()` to find mechanisms for signing and for key pair generation. If the mechanisms are not supported by the slot, `GetMechanismInfo()` returns an error. If `GetMechanismInfo()` returns successfully, then the mechanism flags are checked to make sure the mechanisms can perform the needed operations.
9. Opens the session by calling `C_OpenSession()`.

10. Generates the key pair by using `C_GenerateKeyPair()`.
11. Displays the public key with `C_GetAttributeValue()` – For demonstration purposes only.
12. Signing is started with `C_SignInit()` and completed with `C_Sign()`.
13. Verification is started with `C_VerifyInit()` and completed with `C_Verify()`.
14. Closes the session.

The program uses `C_CloseSession()` to close the session and `C_Finalize()` to close the library.

The source code for the sign-and-verify example follows.

---

**Note** – The source code for this example is also available through the Sun download center. See <http://www.sun.com/download/products.xml?id=41912db5>.

---

#### EXAMPLE 9-3 Signing and Verifying Text Using PKCS #11 Functions

```
#include <stdio.h>
#include <fcntl.h>
#include <errno.h>
#include <sys/types.h>
#include <security/cryptoki.h>
#include <security/pkcs11.h>

#define BUFFERSIZ    8192

/* Define key template */
static CK_BBOOL truevalue = TRUE;
static CK_BBOOL falsevalue = FALSE;
static CK_ULONG modulusbits = 1024;
static CK_BYTE public_exponent[] = {3};

boolean_t GetMySlot(CK_MECHANISM_TYPE sv_mech, CK_MECHANISM_TYPE kpgen_mech,
    CK_SLOT_ID_PTR pslot);

/* Example signs and verifies a simple string, using a public/private
 * key pair. */
void
main(int argc, char **argv)
{
    CK_RV    rv;
    CK_MECHANISM genmech, smech;
    CK_SESSION_HANDLE hSession;
    CK_SESSION_INFO sessInfo;
    CK_SLOT_ID slotID;
    int error, i = 0;

    CK_OBJECT_HANDLE privatekey, publickey;

    /* Set public key. */
    CK_ATTRIBUTE publickey_template[] = {
        {CKA_VERIFY, &>truevalue, sizeof (truevalue)},
        {CKA_MODULUS_BITS, &modulusbits, sizeof (modulusbits)},
        {CKA_PUBLIC_EXPONENT, &public_exponent,
```

## EXAMPLE 9-3 Signing and Verifying Text Using PKCS #11 Functions (Continued)

```

        sizeof (public_exponent))
};

/* Set private key. */
CK_ATTRIBUTE privatekey_template[] = {
    {CKA_SIGN, &>truevalue, sizeof (truevalue)},
    {CKA_TOKEN, &>falsevalue, sizeof (falsevalue)},
    {CKA_SENSITIVE, &>truevalue, sizeof (truevalue)},
    {CKA_EXTRACTABLE, &>truevalue, sizeof (truevalue)}
};

/* Create sample message. */
CK_ATTRIBUTE getattributes[] = {
    {CKA_MODULUS_BITS, NULL_PTR, 0},
    {CKA_MODULUS, NULL_PTR, 0},
    {CKA_PUBLIC_EXPONENT, NULL_PTR, 0}
};

CK_ULONG messagelen, slen, template_size;

boolean_t found_slot = B_FALSE;
uchar_t *message = (uchar_t *)"Simple message for signing & verifying.";
uchar_t *modulus, *pub_exponent;
char sign[BUFFERSIZ];
slen = BUFFERSIZ;

messagelen = strlen((char *)message);

/* Set up mechanism for generating key pair */
genmech.mechanism = CKM_RSA_PKCS_KEY_PAIR_GEN;
genmech.pParameter = NULL_PTR;
genmech.ulParameterLen = 0;

/* Set up the signing mechanism */
smech.mechanism = CKM_RSA_PKCS;
smech.pParameter = NULL_PTR;
smech.ulParameterLen = 0;

/* Initialize the CRYPTOKI library */
rv = C_Initialize(NULL_PTR);

if (rv != CKR_OK) {
    fprintf(stderr, "C_Initialize: Error = 0x%.8X\n", rv);
    exit(1);
}

found_slot = GetMySlot(smech.mechanism, genmech.mechanism, &slotID);

if (!found_slot) {
    fprintf(stderr, "No usable slot was found.\n");
    goto exit_program;
}

fprintf(stdout, "selected slot: %d\n", slotID);

/* Open a session on the slot found */

```

## EXAMPLE 9-3 Signing and Verifying Text Using PKCS #11 Functions (Continued)

```

rv = C_OpenSession(slotID, CKF_SERIAL_SESSION, NULL_PTR, NULL_PTR,
    &hSession);

if (rv != CKR_OK) {
    fprintf(stderr, "C_OpenSession: rv = 0x%.8X\n", rv);
    error = 1;
    goto exit_program;
}

fprintf(stdout, "Generating keypair...\n");

/* Generate Key pair for signing/verifying */
rv = C_GenerateKeyPair(hSession, &genmech, publickey_template,
    (sizeof (publickey_template) / sizeof (CK_ATTRIBUTE)),
    privatekey_template,
    (sizeof (privatekey_template) / sizeof (CK_ATTRIBUTE)),
    &publickey, &privatekey);

if (rv != CKR_OK) {
    fprintf(stderr, "C_GenerateKeyPair: rv = 0x%.8X\n", rv);
    error = 1;
    goto exit_session;
}

/* Display the publickey. */
template_size = sizeof (getattributes) / sizeof (CK_ATTRIBUTE);

rv = C_GetAttributeValue(hSession, publickey, getattributes,
    template_size);

if (rv != CKR_OK) {
    /* not fatal, we can still sign/verify if this failed */
    fprintf(stderr, "C_GetAttributeValue: rv = 0x%.8X\n", rv);
    error = 1;
} else {
    /* Allocate memory to hold the data we want */
    for (i = 0; i < template_size; i++) {
        getattributes[i].pValue =
            malloc (getattributes[i].ulValueLen *
                sizeof(CK_VOID_PTR));
        if (getattributes[i].pValue == NULL) {
            int j;
            for (j = 0; j < i; j++)
                free(getattributes[j].pValue);
            goto sign_cont;
        }
    }

    /* Call again to get actual attributes */
    rv = C_GetAttributeValue(hSession, publickey, getattributes,
        template_size);

    if (rv != CKR_OK) {
        /* not fatal, we can still sign/verify if failed */
        fprintf(stderr,
            "C_GetAttributeValue: rv = 0x%.8X\n", rv);
    }
}

```

**EXAMPLE 9-3** Signing and Verifying Text Using PKCS #11 Functions *(Continued)*

```

        error = 1;
    } else {
        /* Display public key values */
        fprintf(stdout, "Public Key data:\n\tModulus bits: "
            "%d\n",
            *((CK_ULONG_PTR)(getattributes[0].pValue)));

        fprintf(stdout, "\tModulus: ");
        modulus = (uchar_t *)getattributes[1].pValue;
        for (i = 0; i < getattributes[1].ulValueLen; i++) {
            fprintf(stdout, "%.2x", modulus[i]);
        }

        fprintf(stdout, "\n\tPublic Exponent: ");
        pub_exponent = (uchar_t *)getattributes[2].pValue;
        for (i = 0; i < getattributes[2].ulValueLen; i++) {
            fprintf(stdout, "%.2x", pub_exponent[i]);
        }
        fprintf(stdout, "\n");
    }
}

sign_cont:
    rv = C_SignInit(hSession, &smech, privatekey);

    if (rv != CKR_OK) {
        fprintf(stderr, "C_SignInit: rv = 0x%.8X\n", rv);
        error = 1;
        goto exit_session;
    }

    rv = C_Sign(hSession, (CK_BYTE_PTR)message, messagelen,
        (CK_BYTE_PTR)sign, &slen);

    if (rv != CKR_OK) {
        fprintf(stderr, "C_Sign: rv = 0x%.8X\n", rv);
        error = 1;
        goto exit_session;
    }

    fprintf(stdout, "Message was successfully signed with private key!\n");

    rv = C_VerifyInit(hSession, &smech, publickey);

    if (rv != CKR_OK) {
        fprintf(stderr, "C_VerifyInit: rv = 0x%.8X\n", rv);
        error = 1;
        goto exit_session;
    }

    rv = C_Verify(hSession, (CK_BYTE_PTR)message, messagelen,
        (CK_BYTE_PTR)sign, slen);

    if (rv != CKR_OK) {
        fprintf(stderr, "C_Verify: rv = 0x%.8X\n", rv);
        error = 1;
    }
}

```



## EXAMPLE 9-3 Signing and Verifying Text Using PKCS #11 Functions (Continued)

```

        goto exit_session;
    }

    fprintf(stdout, "Message was successfully verified with public key!\n");

exit_session:
    (void) C_CloseSession(hSession);

exit_program:
    (void) C_Finalize(NULL_PTR);

    for (i = 0; i < template_size; i++) {
        if (getattributes[i].pValue != NULL)
            free(getattributes[i].pValue);
    }

    exit(error);
}

/* Find a slot capable of:
 * . signing and verifying with sv_mech
 * . generating a key pair with kpgen_mech
 * Returns B_TRUE when successful. */
boolean_t GetMySlot(CK_MECHANISM_TYPE sv_mech, CK_MECHANISM_TYPE kpgen_mech,
    CK_SLOT_ID_PTR pSlotID)
{
    CK_SLOT_ID_PTR pSlotList = NULL_PTR;
    CK_SLOT_ID SlotID;
    CK_ULONG ulSlotCount = 0;
    CK_MECHANISM_INFO mech_info;
    int i;
    boolean_t returnval = B_FALSE;

    CK_RV rv;

    /* Get slot list for memory allocation */
    rv = C_GetSlotList(0, NULL_PTR, &ulSlotCount);

    if ((rv == CKR_OK) && (ulSlotCount > 0)) {
        fprintf(stdout, "slotCount = %d\n", ulSlotCount);
        pSlotList = malloc(ulSlotCount * sizeof (CK_SLOT_ID));

        if (pSlotList == NULL) {
            fprintf(stderr, "System error: unable to allocate "
                "memory\n");
            return (returnval);
        }

        /* Get the slot list for processing */
        rv = C_GetSlotList(0, pSlotList, &ulSlotCount);
        if (rv != CKR_OK) {
            fprintf(stderr, "GetSlotList failed: unable to get "
                "slot count.\n");
            goto cleanup;
        }
    }
}

```

**EXAMPLE 9-3** Signing and Verifying Text Using PKCS #11 Functions *(Continued)*

```
    } else {
        fprintf(stderr, "GetSlotList failed: unable to get slot "
            "list.\n");
        return (returnval);
    }

    /* Find a slot capable of specified mechanism */
    for (i = 0; i < ulSlotCount; i++) {
        SlotID = pSlotList[i];

        /* Check if this slot is capable of signing and
         * verifying with sv_mech. */
        rv = C_GetMechanismInfo(SlotID, sv_mech, &mech_info);

        if (rv != CKR_OK) {
            continue;
        }

        if (!(mech_info.flags & CKF_SIGN &&
            mech_info.flags & CKF_VERIFY)) {
            continue;
        }

        /* Check if the slot is capable of key pair generation
         * with kpgen_mech. */
        rv = C_GetMechanismInfo(SlotID, kpgen_mech, &mech_info);

        if (rv != CKR_OK) {
            continue;
        }

        if (!(mech_info.flags & CKF_GENERATE_KEY_PAIR)) {
            continue;
        }

        /* If we get this far, this slot supports our mechanisms. */
        returnval = B_TRUE;
        *pSlotID = SlotID;
        break;
    }

cleanup:
    if (pSlotList)
        free(pSlotList);

    return (returnval);
}
```

## Random Byte Generation Example

[Example 9–4](#) demonstrates how to find a slot with a mechanism that can generate random bytes. The example performs the following steps:

1. Initializes the cryptoki library.
2. Calls `GetRandSlot()` to find a slot with a mechanism that can generate random bytes.

The task of finding a slot performs the following steps:

- a. Calling the function `C_GetSlotList()` to get a list of the available slots.

`C_GetSlotList()` is called twice, as the PKCS #11 convention suggests.

`C_GetSlotList()` is called the first time to get the number of slots for memory allocation. `C_GetSlotList()` is called the second time to retrieve the slots.

- b. Finding a slot that can generate random bytes.

For each slot, the function obtains the token information by using `GetTokenInfo()` and checks for a match with the `CKF_RNG` flag set. When a slot that has the `CKF_RNG` flag set is found, the `GetRandSlot()` function returns.

3. Opens the session by using `C_OpenSession()`.
4. Generates random bytes by using `C_GenerateRandom()`.
5. Ends the session.

The program uses `C_CloseSession()` to close the session and `C_Finalize()` to close the library.

The source code for the random number generation sample is shown in the following example.

---

**Note** – The source code for this example is also available through the Sun download center. See <http://www.sun.com/download/products.xml?id=41912db5>.

---

### EXAMPLE 9–4 Generating Random Numbers Using PKCS #11 Functions

```
#include <stdio.h>
#include <fcntl.h>
#include <errno.h>
#include <sys/types.h>
#include <security/cryptoki.h>
#include <security/pkcs11.h>

#define RANDSIZE 64

boolean_t GetRandSlot(CK_SLOT_ID_PTR pslot);

/* Example generates random bytes. */
void
main(int argc, char **argv)
{
    CK_RV    rv;
```

## EXAMPLE 9-4 Generating Random Numbers Using PKCS #11 Functions (Continued)

```
CK_MECHANISM mech;
CK_SESSION_HANDLE hSession;
CK_SESSION_INFO sessInfo;
CK_SLOT_ID slotID;
CK_BYTE randBytes[RANDSIZE];

boolean_t found_slot = B_FALSE;
int error;
int i;

/* Initialize the CRYPTOKI library */
rv = C_Initialize(NULL_PTR);

if (rv != CKR_OK) {
    fprintf(stderr, "C_Initialize: Error = 0x%.8X\n", rv);
    exit(1);
}

found_slot = GetRandSlot(&slotID);

if (!found_slot) {
    goto exit_program;
}

/* Open a session on the slot found */
rv = C_OpenSession(slotID, CKF_SERIAL_SESSION, NULL_PTR, NULL_PTR,
    &hSession);

if (rv != CKR_OK) {
    fprintf(stderr, "C_OpenSession: rv = 0x%.8X\n", rv);
    error = 1;
    goto exit_program;
}

/* Generate random bytes */
rv = C_GenerateRandom(hSession, randBytes, RANDSIZE);

if (rv != CKR_OK) {
    fprintf(stderr, "C_GenerateRandom: rv = 0x%.8X\n", rv);
    error = 1;
    goto exit_session;
}

fprintf(stdout, "Random value: ");
for (i = 0; i < RANDSIZE; i++) {
    fprintf(stdout, "%.2x", randBytes[i]);
}

exit_session:
    (void) C_CloseSession(hSession);

exit_program:
    (void) C_Finalize(NULL_PTR);
    exit(error);
}
```

## EXAMPLE 9-4 Generating Random Numbers Using PKCS #11 Functions (Continued)

```

boolean_t
GetRandSlot(CK_SLOT_ID_PTR pslot)
{
    CK_SLOT_ID_PTR pSlotList;
    CK_SLOT_ID SlotID;
    CK_TOKEN_INFO tokenInfo;
    CK_ULONG ulSlotCount;
    CK_MECHANISM_TYPE_PTR pMechTypeList = NULL_PTR;
    CK_ULONG ulMechTypecount;
    boolean_t result = B_FALSE;
    int i = 0;

    CK_RV rv;

    /* Get slot list for memory allocation */
    rv = C_GetSlotList(0, NULL_PTR, &ulSlotCount);

    if ((rv == CKR_OK) && (ulSlotCount > 0)) {
        fprintf(stdout, "slotCount = %d\n", (int)ulSlotCount);
        pSlotList = malloc(ulSlotCount * sizeof(CK_SLOT_ID));

        if (pSlotList == NULL) {
            fprintf(stderr,
                "System error: unable to allocate memory\n");
            return (result);
        }

        /* Get the slot list for processing */
        rv = C_GetSlotList(0, pSlotList, &ulSlotCount);
        if (rv != CKR_OK) {
            fprintf(stderr, "GetSlotList failed: unable to get "
                "slot list.\n");
            free(pSlotList);
            return (result);
        }
    } else {
        fprintf(stderr, "GetSlotList failed: unable to get slot"
            " count.\n");
        return (result);
    }

    /* Find a slot capable of doing random number generation */
    for (i = 0; i < ulSlotCount; i++) {
        SlotID = pSlotList[i];

        rv = C_GetTokenInfo(SlotID, &tokenInfo);

        if (rv != CKR_OK) {
            /* Check the next slot */
            continue;
        }

        if (tokenInfo.flags & CKF_RNG) {
            /* Found a random number generator */
            *pslot = SlotID;
        }
    }
}

```

**EXAMPLE 9-4** Generating Random Numbers Using PKCS #11 Functions *(Continued)*

```
        fprintf(stdout, "Slot # %d supports random number "
                "generation!\n", SlotID);
        result = B_TRUE;
        break;
    }
}

if (pSlotList)
    free(pSlotList);

return (result);
}
```

# Introduction to the Oracle Solaris Key Management Framework

---

The Oracle Solaris Key Management Framework (KMF) provides a unified set of interfaces for managing Public Key Infrastructure (PKI) objects in Oracle Solaris. These interfaces include both programming interfaces and administrative tools.

This chapter discusses the following topics:

- [“Oracle Solaris Key Management Framework Features” on page 183](#)
- [“Oracle Solaris Key Management Framework Components” on page 184](#)
- [“Oracle Solaris Key Management Framework Example Application” on page 187](#)

## Oracle Solaris Key Management Framework Features

Developers and system administrators can choose among several different *keystore* systems when designing systems that employ PKI technologies. A keystore is a storage system for PKI objects. The primary choices for Oracle Solaris users are NSS, OpenSSL, and PKCS#11. Each of these keystore systems presents different programming interfaces and administrative tools. None of these keystore systems includes any PKI policy enforcement system.

KMF provides generic interfaces that manipulate keys and certificates in all of these keystores.

- A generic API layer enables the developer to specify which type of keystore to use. KMF also provides plugin modules for each of these three keystore systems so that you can write new applications to use any of these keystores. Applications written to KMF are not bound to one keystore system.
- A management utility enables the administrator to manage PKI objects in all three of these keystores. You do not need to use a different utility for each keystore.

KMF also provides a system-wide policy database that KMF applications can use, regardless of which type of keystore is being used. The administrator can create policy definitions in a global database. KMF applications can choose which policy to assert, and then all subsequent KMF operations behave according to the limitations of that policy. Policy definitions include rules for

how to perform validations, requirements for key usage and extended key usage, trust anchor definitions, Online Certificate Status Protocol (OCSP) parameters, and Certificate Revocation List (CRL) DB parameters such as location.

Oracle Solaris KMF includes the following features:

- Programming interfaces for developing PKI aware applications. These interfaces are keystore independent: The interface does not bind the application to a particular keystore system such as NSS, OpenSSL, or PKCS#11.
- An administrative utility for managing PKI objects.
- A PKI policy database and enforcement system for PKI aware applications. The enforcement system is keystore independent and can be applied system-wide.
- A plugin interface to extend KMF for legacy and proprietary systems.

KMF consumers include any project that uses certificates, such as authentication services and smart card authentication with X.509 certificates.

## Oracle Solaris Key Management Framework Components

This section describes the following KMF components:

- The `pktool(1)` key management tool
- The KMF policy database
- The `kmfcfg(1)` policy definition and plugin configuration utility
- KMF data types defined in `kmftypes.h` and programming interfaces defined in `kmfapi.h` and `libkmf(3LIB)`

### KMF Key Management Tool

The following `pktool(1)` subcommands specifically support KMF:

<code>delete</code>	Delete objects in the keystore.
<code>download</code>	Download a CRL or certificate file from an external source.
<code>export</code>	Export objects from the keystore to a file.
<code>gencert</code>	Create a self-signed X.509v3 certificate.
<code>gencsr</code>	Create a PKCS#10 Certificate Signing Request (CSR) file.
<code>genkey</code>	Create a symmetric key in the keystore.
<code>help</code>	Displays a help message.
<code>import</code>	Import objects from an external source.



<code>inittoken</code>	Initialize a PKCS#11 token.
<code>list</code>	List a summary of objects in the keystore.
<code>setpin</code>	Change user authentication passphrase for keystore access.
<code>signcsr</code>	Sign a PKCS#10 CSR.
<code>tokens</code>	List all visible PKCS#11 tokens.

## KMF Policy Enforcement Mechanisms

KMF policy is a hierarchical tree of policies. A default policy is defined when the system is installed. The default policy applies unless the application asserts a different policy.

Policy parameters control the use of X.509 certificates by an application. KMF policy applies to all certificates and is not restricted to any particular keystore.

Use the `kmfcfg(1)` utility to manage the KMF policy database and configure plugins. You can use `kmfcfg` to list, create, modify, delete, import, and export policy definitions in the system default database file `/etc/security/kmfpolicy.xml` or in a user-defined database file. Note that you cannot modify the default policy in the system KMF policy database. For plugin configuration, you can use `kmfcfg` to display plugin information, install or uninstall a KMF plugin, and modify the plugin option.

The following list shows some of the KMF policy attributes. See the `kmfcfg(1)` man page for a complete list and descriptions of these policy attributes.

- Policy Name. Applications reference this name.
- Default Keystore. Examples include NSS, files, PKCS11.
- Ignore Date. Ignore the validity periods defined in the certificates when evaluating their validity.
- Ignore Unknown EKU. Ignore any unrecognized EKU values in the Extended Key Usage extension.
- Token Label. This attribute only applies to NSS or PKCS11 keystores.
- Validation Method. Examples include OCSP and CRL.
- Key Usage Values. This attribute is a comma separated list of key usage values that are required by the policy being defined. These bits must be set in order to use the certificate.
- Extended Key Usage Values. This attribute is a comma separated list of Extended Key Usage OIDs that are required by the policy being defined. These OIDs must be present in order to use the certificate.

See the [kmfpolicy.h](#) file for definitions of policy data types.

The following [plugin libraries](#) are provided in Oracle Solaris KMF:

- PKCS#11 keystore plugin: `kmf_pkcs11`
- OpenSSL keystore plugin: `kmf_openssl`
- NSS keystore plugin: `kmf_nss`

## KMF Application Programming Interfaces

The Oracle Solaris KMF provides abstract APIs for PKI operations. Applications written to KMF can access multiple keystores such as files (OpenSSL), NSS, and PKCS11 tokens and multiple validation modules such as OCSP and CRL checking. The KMF API can be extended by third parties for proprietary and legacy implementations.

The KMF APIs are provided in the Key Management Framework Library, [libkmf\(3LIB\)](#). These APIs enable your application to create and manage public key objects such as public/private keypairs, certificates, CSRs, certificate validation, CRLs, and OCSP response processing.

- Keys, certificate, and CSR operations: create and delete, store and retrieve, search, import and export
- Common cryptographic operations: sign and verify, encrypt and decrypt using certificates as keys
- Access complex PKI objects: set and get X.509 attributes and extensions, and extract data in human-readable formats

The KMF APIs are defined in the [kmfapi.h](#) file, and structures and types are defined in the [kmftypes.h](#) file. The `kmfapi.h` file lists the functions in the following groups:

- Setup operations
- Key operations
- Certificate operations
- Cryptographic operations with key or certificate
- CRL operations
- CSR operations
- Get certificate operations
- Set certificate operations
- PK12 operations
- OCSP operations
- Policy operations
- Error handling
- Memory cleanup operations
- APIs for PKCS#11 tokens
- Attribute management operations

# Oracle Solaris Key Management Framework Example Application

The `pktool` application is an excellent example of how to use the KMF APIs.

This section shows a simple application that uses KMF. This section describes the basic steps that an application needs to take in order to perform some KMF operations. This example assumes that you have experience in C programming and a basic understanding of public key technologies and standards. This example goes through the steps of initializing KMF for use and then creates a self-signed X.509v3 certificate and associated RSA key pair. This example also shows how to use the KMF-enhanced `pktool` command to verify that the application was successful.

## KMF Headers and Libraries

To give the program access to the KMF function prototypes and type definitions, include the `kmfapi.h` file.

```
#include <stdio.h>
#include <kmfapi.h>
```

Be sure to include the KMF library in the link step.

```
$ cc -o kmftest kmftest.c -lkmf
```

## KMF Basic Data Types

See the [kmftypes.h](#) file for definitions of structures and types. This example uses variables of the following KMF types.

<code>KMF_HANDLE_T</code>	Session handle for KMF calls
<code>KMF_RETURN</code>	Return code for all KMF calls
<code>KMF_KEY_HANDLE</code>	Handle to a KMF key
<code>KMF_CREDENTIAL</code>	KMF credential
<code>KMF_ATTRIBUTE</code>	Make sure this is big enough
<code>KMF_KEYSTORE_TYPE</code>	Keystore type, such as <code>KMF_KEYSTORE_PK11TOKEN</code>
<code>KMF_KEY_ALG</code>	Key type, such as <code>KMF_RSA</code>
<code>KMF_X509_CERTIFICATE</code>	Data record that gets signed

KMF_X509_NAME	Distinguished name record
KMF_DATA	Final certificate data record
KMF_BIGINT	Variable length integer

## KMF Application Results Verification

The user can verify that the program successfully created the certificate and keypair by using the `pktool(1M)` utility.

```
$ pktool list objtype=both
Enter pin for Sun Software PKCS#11 softtoken :
Found 1 certificates.
1. (X.509 certificate)
   Label: admin@foobar.com
   ID:
09:ac:7f:1a:01:f7:fc:a9:1a:cd:fd:8f:d4:92:4c:25:bf:b1:97:fe
   Subject: C=US, ST=CA, L=Menlo Park, O=Foobar Inc., OU=Foobar
IT Office, CN=admin@foobar.com
   Issuer: C=US, ST=CA, L=Menlo Park, O=Foobar Inc., OU=Foobar IT
Office, CN=admin@foobar.com
   Serial: 0x452BF693
   X509v3 Subject Alternative Name:
   email:admin@foobar.com

Found 1 keys.
Key #1 - RSA private key: admin@foobar.com
```

## Complete KMF Application Source Code

See the [libkmf\(3LIB\)](#) man page for definitions of KMF APIs.

This application performs the following steps:

1. Before any KMF functions can be called, the application must first use `kmf_initialize()` to initialize a handle for a KMF session. This handle is used as the first argument to most KMF function calls. It is an opaque data type and is used to hold internal state and context information for that session.
2. This example application uses the PKCS#11 keystore. Use `kmf_configure_keystore()` to define a token to use for future operations.
3. The first step to create a certificate or a PKCS#10 CSR is to generate a keypair. Use `kmf_create_keypair()` to create both the public and private keys needed and store the private key in the specified keystore. The function returns handles to the application so that the caller can reference the public and private key objects in future operations if necessary.

4. Once a keypair is established, use `kmf_set_cert_pubkey()` and `kmf_set_cert_version()` to populate the template record that is used to generate the final certificate. KMF provides different APIs for setting the various fields of an X.509v3 certificate, including extensions. Use `kmf_hexstr_to_bytes()`, `kmf_set_cert_serial()`, `kmf_set_cert_validity()`, and `kmf_set_cert_sig_alg()` to set the serial number. The serial number is a `KMF_BIGINT` record. Use `kmf_dn_parser()`, `kmf_set_cert_subject()`, and `kmf_set_cert_issuer()` to create a `KMF_X509_NAME` structure.
5. Because this is a self-signed certificate creation exercise, this application signs the certificate template created above with the private key that goes with the public key in the certificate itself. This `kmf_sign_cert()` operation results in a `KMF_DATA` record that contains the ASN.1 encoded X.509v3 certificate data.
6. Now that the certificate is signed and in its final format, it can be stored in any of the keystores. Use `kmf_store_cert()` to store the certificate in the PKCS#11 token defined at the beginning of this application. The certificate could also be stored in NSS or an OpenSSL file at this point.
7. Memory allocated to data structures generated by KMF should be cleaned up when the data structure is no longer needed. KMF provides convenience APIs for properly deallocating memory associated with these objects. The proper cleanup of memory is strongly encouraged in order to conserve resources. Cleanup interfaces include `kmf_free_data()`, `kmf_free_dn()`, and `kmf_finalize()`.

Below is the complete source code for this example application, including all of the data types and helper functions. When you compile, be sure to include the KMF library.

```

/*
 * KMF Example code for generating a self-signed X.509 certificate.
 * This is completely unsupported and is just to be used as an example.
 *
 * Compile:
 * $ cc -o keytest keytest.c -lkmf
 *
 * Run:
 * $ ./keytest
 *
 * Once complete, the results can be verified using the pktool(1) command:
 *
 * $ pktool list
 * This should show an RSA public key labeled "keytest" and a cert labeled "keytest".
 *
 * The objects created by this program can be deleted from the keystore
 * using pktool(1) also:
 *
 * $ pktool delete label=keytest
 */
#include <stdio.h>
#include <strings.h>
#include <fcntl.h>
#include <sys/types.h>

```

```

#include <sys/stat.h>
#include <tzfile.h>

#include <kmfapi.h>

int
main(int argc, char *argv[])
{
    KMF_HANDLE_T      kmfhandle;
    KMF_RETURN        ret;
    char              opt, *str = NULL;
    extern char       *optarg;
    KMF_KEY_HANDLE    prikey, pubkey;
    KMF_CREDENTIAL    cred;
    KMF_ATTRIBUTE      attrlist[16]; /* this needs to be big enough */
    KMF_KEYSTORE_TYPE kstype;
    KMF_KEY_ALG        keytype;
    KMF_KEY_HANDLE    prik, pubk;
    KMF_X509_CERTIFICATE certstruct;
    KMF_X509_NAME      certsubject, certissuer;
    KMF_DATA           rawcert;
    KMF_BIGINT         serno;
    char              *token = "Sun Software PKCS#11 softtoken";
    char              *keylabel = "keytest";
    boolean_t         readonly = B_FALSE;
    uint32_t          keylen = 1024;
    uint32_t          ltime = SECSPERDAY * DAYSPERYEAR; /* seconds in a
        year (see tzfile.h) */
    char              prompt[1024];
    int               numattrs;

    (void) memset(&certstruct, 0, sizeof (certstruct));
    (void) memset(&rawcert, 0, sizeof (rawcert));
    (void) memset(&certissuer, 0, sizeof (certissuer));
    (void) memset(&certsubject, 0, sizeof (certsubject));

    /*
     * Initialize a KMF handle for use in future calls.
     */
    ret = kmf_initialize(&kmfhandle, NULL, NULL);
    if (ret != KMF_OK) {
        printf("kmf_initialize failed: 0x%0x\n", ret);
        exit(1);
    }

    /* We want to use the PKCS11 keystore */
    kstype = KMF_KEYSTORE_PK11TOKEN;
    numattrs = 0;
    kmf_set_attr_at_index(attrlist, numattrs, KMF_KEYSTORE_TYPE_ATTR,
        &kstype, sizeof (kstype));
    numattrs++;

    /* Indicate which PKCS11 token will be used */
    kmf_set_attr_at_index(attrlist, numattrs, KMF_TOKEN_LABEL_ATTR,
        token, strlen(token));
    numattrs++;

    kmf_set_attr_at_index(attrlist, numattrs, KMF_READONLY_ATTR,

```

```

        &readonly, sizeof (readonly));
    numattrs++;

    ret = kmf_configure_keystore(kmfhandle, numattrs, attrlist);
    if (ret != KMF_OK)
        exit (ret);

    /* Reset the attribute count for a new command */
    numattrs = 0;

    /*
     * Get the PIN to access the token.
     */
    (void) snprintf(prompt, sizeof (prompt), "Enter PIN for %s:", token);
    cred.cred = getpassphrase(prompt);
    if (cred.cred != NULL) {
        cred.credlen = strlen(cred.cred);
        kmf_set_attr_at_index(attrlist, numattrs, KMF_CREDENTIAL_ATTR,
            &cred, sizeof (cred));
        numattrs++;
    }

    kmf_set_attr_at_index(attrlist, numattrs, KMF_KEYSTORE_TYPE_ATTR,
        &kstype, sizeof (kstype));
    numattrs++;

    keytype = KMF_RSA;
    keylen = 1024;
    keylabel = "keytest";

    kmf_set_attr_at_index(attrlist, numattrs, KMF_KEYALG_ATTR,
        &keytype, sizeof (keytype));
    numattrs++;

    kmf_set_attr_at_index(attrlist, numattrs, KMF_KEYLENGTH_ATTR,
        &keylen, sizeof (keylen));
    numattrs++;

    kmf_set_attr_at_index(attrlist, numattrs, KMF_KEYLABEL_ATTR,
        keylabel, strlen(keylabel));
    numattrs++;

    kmf_set_attr_at_index(attrlist, numattrs, KMF_CREDENTIAL_ATTR,
        &cred, sizeof (cred));
    numattrs++;

    /*
     * Set the handles so they can be used later.
     */
    kmf_set_attr_at_index(attrlist, numattrs, KMF_PRIVKEY_HANDLE_ATTR,
        &prik, sizeof (prik));
    numattrs++;

    kmf_set_attr_at_index(attrlist, numattrs, KMF_PUBKEY_HANDLE_ATTR,
        &pubk, sizeof (pubk));
    numattrs++;

    ret = kmf_create_keypair(kmfhandle, numattrs, attrlist);

```

```
if (ret != KMF_OK) {
    printf("kmf_create_keypair error: 0x%02x\n", ret);
    goto cleanup;
}

/*
 * Now the keys have been created, generate an X.509 certificate
 * by populating the template and signing it.
 */
if ((ret = kmf_set_cert_pubkey(kmfhandle, &pubk, &certstruct)) {
    printf("kmf_set_cert_pubkey error: 0x%02x\n", ret);
    goto cleanup;
}

/* Version "2" is for an x509.v3 certificate */
if ((ret = kmf_set_cert_version(&certstruct, 2)) {
    printf("kmf_set_cert_version error: 0x%02x\n", ret);
    goto cleanup;
}

/*
 * Set up the serial number, it must be a KMF_BIGINT record.
 */
if ((ret = kmf_hexstr_to_bytes((uchar_t *)"0x010203", &serno.val, \
    &serno.len))) {
    printf("kmf_hexstr_to_bytes error: 0x%02x\n", ret);
    goto cleanup;
}

if ((ret = kmf_set_cert_serial(&certstruct, &serno)) {
    printf("kmf_set_cert_serial error: 0x%02x\n", ret);
    goto cleanup;
}

if ((ret = kmf_set_cert_validity(&certstruct, NULL, ltime)) {
    printf("kmf_set_cert_validity error: 0x%02x\n", ret);
    goto cleanup;
}

if ((ret = kmf_set_cert_sig_alg(&certstruct, KMF_ALGID_SHA1WithRSA)) {
    printf("kmf_set_cert_sig_alg error: 0x%02x\n", ret);
    goto cleanup;
}

/*
 * Create a KMF_X509_NAME struct by parsing a distinguished name.
 */
if ((ret = kmf_dn_parser("cn=testcert", &certsubject)) {
    printf("kmf_dn_parser error: 0x%02x\n", ret);
    goto cleanup;
}

if ((ret = kmf_dn_parser("cn=testcert", &certissuer)) {
    printf("kmf_dn_parser error: 0x%02x\n", ret);
    goto cleanup;
}

if ((ret = kmf_set_cert_subject(&certstruct, &certsubject)) {
```



```

        printf("kmf_set_cert_sig_alg error: 0x%02x\n", ret);
        goto cleanup;
    }

    if ((ret = kmf_set_cert_issuer(&certstruct, &certissuer)) {
        printf("kmf_set_cert_sig_alg error: 0x%02x\n", ret);
        goto cleanup;
    }

    /*
     * Now we have the certstruct setup with the minimal amount needed
     * to generate a self-signed cert. Put together the attributes to
     * call kmf_sign_cert.
     */
    numattrs = 0;
    kmf_set_attr_at_index(attrlist, numattrs, KMF_KEYSTORE_TYPE_ATTR,
        &kstype, sizeof (kstype));
    numattrs++;

    kmf_set_attr_at_index(attrlist, numattrs, KMF_KEY_HANDLE_ATTR,
        &prik, sizeof (KMF_KEY_HANDLE_ATTR));
    numattrs++;

    /* The X509 template structure to be signed goes here. */
    kmf_set_attr_at_index(attrlist, numattrs, KMF_X509_CERTIFICATE_ATTR,
        &certstruct, sizeof (KMF_X509_CERTIFICATE));
    numattrs++;

    /*
     * Set the output buffer for the signed cert.
     * This will be a block of raw ASN.1 data.
     */
    kmf_set_attr_at_index(attrlist, numattrs, KMF_CERT_DATA_ATTR,
        &rawcert, sizeof (KMF_DATA));
    numattrs++;

    if ((ret = kmf_sign_cert(kmfhandle, numattrs, attrlist)) {
        printf("kmf_sign_cert error: 0x%02x\n", ret);
        goto cleanup;
    }

    /*
     * Now we have the certificate and we want to store it in the
     * keystore (which is the PKCS11 token in this example).
     */
    numattrs = 0;
    kmf_set_attr_at_index(attrlist, numattrs, KMF_KEYSTORE_TYPE_ATTR,
        &kstype, sizeof (kstype));
    numattrs++;
    kmf_set_attr_at_index(attrlist, numattrs, KMF_CERT_DATA_ATTR,
        &rawcert, sizeof (KMF_DATA));
    numattrs++;

    /* Use the same label as the public key */
    kmf_set_attr_at_index(attrlist, numattrs, KMF_CERT_LABEL_ATTR,
        keylabel, strlen(keylabel));
    numattrs++;

```

```
    if ((ret = kmf_store_cert(kmfhandle, numattrs, attrlist)) {
        printf("kmf_store_cert error: 0x%02x\n", ret);
        goto cleanup;
    }

cleanup:
    kmf_free_data(&rawcert);
    kmf_free_dn(&certissuer);
    kmf_free_dn(&certsubject);
    kmf_finalize(kmfhandle);

    return (ret);
}
```

## Sample C–Based GSS-API Programs

---

This appendix shows the source code for two sample applications that use GSS-API to make a safe network connection. The first application is a typical client. The second application demonstrates how a server works in GSS-API. The two programs display benchmarks in the course of being run. A user can thus view GSS-API in action. Additionally, certain miscellaneous functions are provided for use by the client and server applications.

This chapter covers the following topics:

- “Client-Side Application” on page 195
- “Server-Side Application” on page 206
- “Miscellaneous GSS-API Sample Functions” on page 215

These programs are examined in detail in the [Chapter 5, “GSS-API Client Example,”](#) and [Chapter 6, “GSS-API Server Example.”](#)

### Client-Side Application

The source code for the client-side program, `gss_client`, is provided in the following example.

---

**Note** – The source code for this example is also available through the Sun download center. See <http://www.sun.com/download/products.xml?id=41912db5>.

---

EXAMPLE A-1 Complete Listing of `gss-client.c` Sample Program

```
/*
 * Copyright 1994 by OpenVision Technologies, Inc.
 *
 * Permission to use, copy, modify, distribute, and sell this software
 * and its documentation for any purpose is hereby granted without fee,
 * provided that the above copyright notice appears in all copies and
 * that both that copyright notice and this permission notice appear in
 * supporting documentation, and that the name of OpenVision not be used
```

## EXAMPLE A-1 Complete Listing of gss-client.c Sample Program (Continued)

```

* in advertising or publicity pertaining to distribution of the software
* without specific, written prior permission. OpenVision makes no
* representations about the suitability of this software for any
* purpose. It is provided "as is" without express or implied warranty.
*
* OPENVISION DISCLAIMS ALL WARRANTIES WITH REGARD TO THIS SOFTWARE,
* INCLUDING ALL IMPLIED WARRANTIES OF MERCHANTABILITY AND FITNESS, IN NO
* EVENT SHALL OPENVISION BE LIABLE FOR ANY SPECIAL, INDIRECT OR
* CONSEQUENTIAL DAMAGES OR ANY DAMAGES WHATSOEVER RESULTING FROM LOSS OF
* USE, DATA OR PROFITS, WHETHER IN AN ACTION OF CONTRACT, NEGLIGENCE OR
* OTHER TORTIOUS ACTION, ARISING OUT OF OR IN CONNECTION WITH THE USE OR
* PERFORMANCE OF THIS SOFTWARE.
*/

#if !defined(lint) && !defined(__CODECENTER__)
static char *rcsid = \
"$Header: /cvs/krbdev/krb5/src/appl/gss-sample/gss-client.c,\
v 1.16 1998/10/30 02:52:03 marc Exp $";
#endif

#include <stdio.h>
#include <unistd.h>
#include <stdlib.h>
#include <string.h>
#include <ctype.h>
#include <sys/types.h>
#include <sys/socket.h>
#include <netinet/in.h>
#include <netdb.h>
#include <errno.h>
#include <sys/stat.h>
#include <fcntl.h>

#include <gssapi/gssapi.h>
#include <gssapi/gssapi_ext.h>
#include <gss-misc.h>

void usage()
{
    fprintf(stderr, "Usage: gss-client [-port port] [-d] host service \
msg\n");
    exit(1);
}

/*
 * Function: connect_to_server
 *
 * Purpose: Opens a TCP connection to the name host and port.
 *
 * Arguments:
 *
 *     host          (r) the target host name
 *     port          (r) the target port, in host byte order
 *
 * Returns: the established socket file descriptor, or -1 on failure
 *
 */

```

## EXAMPLE A-1 Complete Listing of gss-client.c Sample Program (Continued)

```

* Effects:
*
* The host name is resolved with gethostbyname(), and the socket is
* opened and connected. If an error occurs, an error message is
* displayed and -1 is returned.
*/
int connect_to_server(host, port)
    char *host;
    u_short port;
{
    struct sockaddr_in saddr;
    struct hostent *hp;
    int s;

    if ((hp = gethostbyname(host)) == NULL) {
        fprintf(stderr, "Unknown host: %s\n", host);
        return -1;
    }

    saddr.sin_family = hp->h_addrtype;
    memcpy((char *)&saddr.sin_addr, hp->h_addr, sizeof(saddr.sin_addr));
    saddr.sin_port = htons(port);

    if ((s = socket(AF_INET, SOCK_STREAM, 0)) < 0) {
        perror("creating socket");
        return -1;
    }
    if (connect(s, (struct sockaddr *)&saddr, sizeof(saddr)) < 0) {
        perror("connecting to server");
        (void) close(s);
        return -1;
    }
    return s;
}

/*
* Function: client_establish_context
*
* Purpose: establishes a GSS-API context with a specified service and
* returns the context handle
*
* Arguments:
*
*     s                (r) an established TCP connection to the service
*     service_name    (r) the ASCII service name of the service
*     context         (w) the established GSS-API context
*     ret_flags       (w) the returned flags from init_sec_context
*
* Returns: 0 on success, -1 on failure
*
* Effects:
*
* service_name is imported as a GSS-API name and a GSS-API context is
* established with the corresponding service; the service should be
* listening on the TCP connection s. The default GSS-API mechanism
* is used, and mutual authentication and replay detection are

```

## EXAMPLE A-1 Complete Listing of gss-client.c Sample Program (Continued)

```

* requested.
*
* If successful, the context handle is returned in context. If
* unsuccessful, the GSS-API error messages are displayed on stderr
* and -1 is returned.
*/
int client_establish_context(s, service_name, deleg_flag, oid,
                           gss_context, ret_flags)
{
    int s;
    char *service_name;
    gss_OID oid;
    OM_uint32 deleg_flag;
    gss_ctx_id_t *gss_context;
    OM_uint32 *ret_flags;

    gss_buffer_desc send_tok, rcv_tok, *token_ptr;
    gss_name_t target_name;
    OM_uint32 maj_stat, min_stat, init_sec_min_stat;

    /*
     * Import the name into target_name. Use send_tok to save
     * local variable space.
     */
    send_tok.value = service_name;
    send_tok.length = strlen(service_name) + 1;
    maj_stat = gss_import_name(&min_stat, &send_tok,
                              (gss_OID) GSS_C_NT_HOSTBASED_SERVICE, &target_name);
    if (maj_stat != GSS_S_COMPLETE) {
        display_status("parsing name", maj_stat, min_stat);
        return -1;
    }

    /*
     * Perform the context-establishement loop.
     *
     * On each pass through the loop, token_ptr points to the token
     * to send to the server (or GSS_C_NO_BUFFER on the first pass).
     * Every generated token is stored in send_tok which is then
     * transmitted to the server; every received token is stored in
     * rcv_tok, which token_ptr is then set to, to be processed by
     * the next call to gss_init_sec_context.
     *
     * GSS-API guarantees that send_tok's length will be non-zero
     * if and only if the server is expecting another token from us,
     * and that gss_init_sec_context returns GSS_S_CONTINUE_NEEDED if
     * and only if the server has another token to send us.
     */

    token_ptr = GSS_C_NO_BUFFER;
    *gss_context = GSS_C_NO_CONTEXT;

    do {
        maj_stat =
            gss_init_sec_context(&init_sec_min_stat,
                               GSS_C_NO_CREDENTIAL,
                               gss_context,

```

## EXAMPLE A-1 Complete Listing of gss-client.c Sample Program (Continued)

```

        target_name,
        oid,
        GSS_C_MUTUAL_FLAG | GSS_C_REPLAY_FLAG |
                                deleg_flag,
        0,
        NULL, /* no channel bindings */
        token_ptr,
        NULL, /* ignore mech type */
        &send_tok,
        ret_flags,
        NULL); /* ignore time_rec */

    if (token_ptr != GSS_C_NO_BUFFER)
        (void) gss_release_buffer(&min_stat, &recv_tok);

    if (send_tok.length != 0) {
        printf("Sending init_sec_context token (size=%d)...",
            send_tok.length);
        if (send_token(s, &send_tok) < 0) {
            (void) gss_release_buffer(&min_stat, &send_tok);
            (void) gss_release_name(&min_stat, &target_name);
            return -1;
        }
    }
    (void) gss_release_buffer(&min_stat, &send_tok);

    if (maj_stat!=GSS_S_COMPLETE && maj_stat!=GSS_S_CONTINUE_NEEDED) {
        display_status("initializing context", maj_stat,
            init_sec_min_stat);
        (void) gss_release_name(&min_stat, &target_name);
        if (*gss_context == GSS_C_NO_CONTEXT)
            gss_delete_sec_context(&min_stat, gss_context,
                GSS_C_NO_BUFFER);

        return -1;
    }

    if (maj_stat == GSS_S_CONTINUE_NEEDED) {
        printf("continue needed...");
        if (recv_token(s, &recv_tok) < 0) {
            (void) gss_release_name(&min_stat, &target_name);
            return -1;
        }
        token_ptr = &recv_tok;
    }
    printf("\n");
} while (maj_stat == GSS_S_CONTINUE_NEEDED);

(void) gss_release_name(&min_stat, &target_name);
return 0;
}

void read_file(file_name, in_buf)
    char *file_name;
    gss_buffer_t in_buf;
{
    int fd, bytes_in, count;

```

## EXAMPLE A-1 Complete Listing of gss-client.c Sample Program (Continued)

```

    struct stat stat_buf;

    if ((fd = open(file_name, O_RDONLY, 0)) < 0) {
        perror("open");
        fprintf(stderr, "Couldn't open file %s\n", file_name);
        exit(1);
    }
    if (fstat(fd, &stat_buf) < 0) {
        perror("fstat");
        exit(1);
    }
    in_buf->length = stat_buf.st_size;

    if (in_buf->length == 0) {
        in_buf->value = NULL;
        return;
    }

    if ((in_buf->value = malloc(in_buf->length)) == 0) {
        fprintf(stderr, \
            "Couldn't allocate %d byte buffer for reading file\n",
                in_buf->length);
        exit(1);
    }

    /* this code used to check for incomplete reads, but you can't get
       an incomplete read on any file for which fstat() is meaningful */

    count = read(fd, in_buf->value, in_buf->length);
    if (count < 0) {
        perror("read");
        exit(1);
    }
    if (count < in_buf->length)
        fprintf(stderr, "Warning, only read in %d bytes, expected %d\n",
            count, in_buf->length);
}

/*
 * Function: call_server
 *
 * Purpose: Call the "sign" service.
 *
 * Arguments:
 *
 *     host          (r) the host providing the service
 *     port          (r) the port to connect to on host
 *     service_name  (r) the GSS-API service name to authenticate to
 *     msg           (r) the message to have "signed"
 *
 * Returns: 0 on success, -1 on failure
 *
 * Effects:
 *
 * call_server opens a TCP connection to <host:port> and establishes a
 * GSS-API context with service_name over the connection. It then

```



## EXAMPLE A-1 Complete Listing of gss-client.c Sample Program (Continued)

```

* seals msg in a GSS-API token with gss_seal, sends it to the server,
* reads back a GSS-API signature block for msg from the server, and
* verifies it with gss_verify. -1 is returned if any step fails,
* otherwise 0 is returned. */
int call_server(host, port, oid, service_name, deleg_flag, msg, use_file)
    char *host;
    u_short port;
    gss_OID oid;
    char *service_name;
    OM_uint32 deleg_flag;
    char *msg;
    int use_file;
{
    gss_ctx_id_t context;
    gss_buffer_desc in_buf, out_buf;
    int s, state;
    OM_uint32 ret_flags;
    OM_uint32 maj_stat, min_stat;
    gss_name_t      src_name, targ_name;
    gss_buffer_desc  sname, tname;
    OM_uint32      lifetime;
    gss_OID         mechanism, name_type;
    int            is_local;
    OM_uint32      context_flags;
    int            is_open;
    gss_qop_t      qop_state;
    gss_OID_set    mech_names;
    gss_buffer_desc oid_name;
    size_t        i;

    /* Open connection */
    if ((s = connect_to_server(host, port)) < 0)
        return -1;

    /* Establish context */
    if (client_establish_context(s, service_name, deleg_flag, oid,
        &context, &ret_flags) < 0) {
        (void) close(s);
        return -1;
    }

    /* display the flags */
    display_ctx_flags(ret_flags);

    /* Get context information */
    maj_stat = gss_inquire_context(&min_stat, context,
        &src_name, &targ_name, &lifetime,
        &mechanism, &context_flags,
        &is_local,
        &is_open);
    if (maj_stat != GSS_S_COMPLETE) {
        display_status("inquiring context", maj_stat, min_stat);
        return -1;
    }

    maj_stat = gss_display_name(&min_stat, src_name, &sname,

```

## EXAMPLE A-1 Complete Listing of gss-client.c Sample Program (Continued)

```

        &name_type);
if (maj_stat != GSS_S_COMPLETE) {
    display_status("displaying source name", maj_stat, min_stat);
    return -1;
}
maj_stat = gss_display_name(&min_stat, targ_name, &name,
                           (gss_OID *) NULL);
if (maj_stat != GSS_S_COMPLETE) {
    display_status("displaying target name", maj_stat, min_stat);
    return -1;
}
fprintf(stderr, "\\%.*s\\ to \\%.*s\\", lifetime %d, flags %x, %s,
         %s\\n", (int) sname.length, (char *) sname.value,
         (int) tname.length, (char *) tname.value, lifetime,
         context_flags,
         (is_local) ? "locally initiated" : "remotely initiated",
         (is_open) ? "open" : "closed");

(void) gss_release_name(&min_stat, &src_name);
(void) gss_release_name(&min_stat, &targ_name);
(void) gss_release_buffer(&min_stat, &sname);
(void) gss_release_buffer(&min_stat, &tname);

maj_stat = gss_oid_to_str(&min_stat,
                        name_type,
                        &oid_name);
if (maj_stat != GSS_S_COMPLETE) {
    display_status("converting oid->string", maj_stat, min_stat);
    return -1;
}
fprintf(stderr, "Name type of source name is %.*s.\\n",
         (int) oid_name.length, (char *) oid_name.value);
(void) gss_release_buffer(&min_stat, &oid_name);

/* Now get the names supported by the mechanism */
maj_stat = gss_inquire_names_for_mech(&min_stat,
                                     mechanism,
                                     &mech_names);
if (maj_stat != GSS_S_COMPLETE) {
    display_status("inquiring mech names", maj_stat, min_stat);
    return -1;
}

maj_stat = gss_oid_to_str(&min_stat,
                        mechanism,
                        &oid_name);
if (maj_stat != GSS_S_COMPLETE) {
    display_status("converting oid->string", maj_stat, min_stat);
    return -1;
}
fprintf(stderr, "Mechanism %.*s supports %d names\\n",
         (int) oid_name.length, (char *) oid_name.value,
         mech_names->count);
(void) gss_release_buffer(&min_stat, &oid_name);

for (i=0; i<mech_names->count; i++) {

```

## EXAMPLE A-1 Complete Listing of gss-client.c Sample Program (Continued)

```

    maj_stat = gss_oid_to_str(&min_stat,
                            &mech_names->elements[i],
                            &oid_name);
    if (maj_stat != GSS_S_COMPLETE) {
        display_status("converting oid->string", maj_stat, min_stat);
        return -1;
    }
    fprintf(stderr, " %d: %.*s\n", i,
            (int) oid_name.length, (char *) oid_name.value);

    (void) gss_release_buffer(&min_stat, &oid_name);
}
(void) gss_release_oid_set(&min_stat, &mech_names);

if (use_file) {
    read_file(msg, &in_buf);
} else {
    /* Seal the message */
    in_buf.value = msg;
    in_buf.length = strlen(msg);
}

maj_stat = gss_wrap(&min_stat, context, 1, GSS_C_QOP_DEFAULT,
                  &in_buf, &state, &out_buf);
if (maj_stat != GSS_S_COMPLETE) {
    display_status("sealing message", maj_stat, min_stat);
    (void) close(s);
    (void) gss_delete_sec_context(&min_stat, &context,
                                GSS_C_NO_BUFFER);
    return -1;
} else if (!state) {
    fprintf(stderr, "Warning! Message not encrypted.\n");
}

/* Send to server */
if (send_token(s, &out_buf) < 0) {
    (void) close(s);
    (void) gss_delete_sec_context(&min_stat, &context, GSS_C_NO_BUFFER);
    return -1;
}
(void) gss_release_buffer(&min_stat, &out_buf);

/* Read signature block into out_buf */
if (recv_token(s, &out_buf) < 0) {
    (void) close(s);
    (void) gss_delete_sec_context(&min_stat, &context, GSS_C_NO_BUFFER);
    return -1;
}

/* Verify signature block */
maj_stat = gss_verify_mic(&min_stat, context, &in_buf,
                        &out_buf, &qop_state);
if (maj_stat != GSS_S_COMPLETE) {
    display_status("verifying signature", maj_stat, min_stat);
    (void) close(s);
    (void) gss_delete_sec_context(&min_stat, &context, GSS_C_NO_BUFFER);
}

```

## EXAMPLE A-1 Complete Listing of gss-client.c Sample Program (Continued)

```

        return -1;
    }
    (void) gss_release_buffer(&min_stat, &out_buf);

    if (use_file)
        free(in_buf.value);

    printf("Signature verified.\n");

    /* Delete context */
    maj_stat = gss_delete_sec_context(&min_stat, &context, &out_buf);
    if (maj_stat != GSS_S_COMPLETE) {
        display_status("deleting context", maj_stat, min_stat);
        (void) close(s);
        (void) gss_delete_sec_context(&min_stat, &context, GSS_C_NO_BUFFER);
        return -1;
    }

    (void) gss_release_buffer(&min_stat, &out_buf);
    (void) close(s);
    return 0;
}

static void parse_oid(char *mechanism, gss_OID *oid)
{
    char      *mehcstr = 0, *cp;
    gss_buffer_desc tok;
    OM_uint32 maj_stat, min_stat;

    if (isdigit(mechanism[0])) {
        mehcstr = malloc(strlen(mechanism)+5);
        if (!mehcstr) {
            printf("Couldn't allocate mechanism scratch!\n");
            return;
        }
        sprintf(mehcstr, "{ %s }", mechanism);
        for (cp = mehcstr; *cp; cp++)
            if (*cp == '.')
                *cp = ' ';
        tok.value = mehcstr;
    } else
        tok.value = mechanism;
    tok.length = strlen(tok.value);
    maj_stat = gss_str_to_oid(&min_stat, &tok, oid);
    if (maj_stat != GSS_S_COMPLETE) {
        display_status("str_to_oid", maj_stat, min_stat);
        return;
    }
    if (mehcstr)
        free(mehcstr);
}

int main(argc, argv)
    int argc;
    char **argv;
{

```

## EXAMPLE A-1 Complete Listing of gss-client.c Sample Program (Continued)

```

char *service_name, *server_host, *msg;
char *mechanism = 0;
u_short port = 4444;
int use_file = 0;
OM_uint32 deleg_flag = 0, min_stat;
gss_OID oid = GSS_C_NULL_OID;

display_file = stdout;

/* Parse arguments. */
argc--; argv++;
while (argc) {
    if (strcmp(*argv, "-port") == 0) {
        argc--; argv++;
        if (!argc) usage();
        port = atoi(*argv);
    } else if (strcmp(*argv, "-mech") == 0) {
        argc--; argv++;
        if (!argc) usage();
        mechanism = *argv;
    } else if (strcmp(*argv, "-d") == 0) {
        deleg_flag = GSS_C_DELEG_FLAG;
    } else if (strcmp(*argv, "-f") == 0) {
        use_file = 1;
    } else
        break;
    argc--; argv++;
}
if (argc != 3)
    usage();

server_host = *argv++;
service_name = *argv++;
msg = *argv++;

if (mechanism)
    parse_oid(mechanism, &oid);

if (call_server(server_host, port, oid, service_name,
               deleg_flag, msg, use_file) < 0)
    exit(1);

if (oid != GSS_C_NULL_OID)
    (void) gss_release_oid(&min_stat, &oid);

return 0;
}

```

# Server-Side Application

The source code for the server-side program, `gss_server`, is provided in the following example.

---

**Note** – The source code for this example is also available through the Sun download center. See <http://www.sun.com/download/products.xml?id=41912db5>.

---

## EXAMPLE A-2 Complete Code Listing for `gss-server.c` Sample Program

```

/*
 * Copyright 1994 by OpenVision Technologies, Inc.
 *
 * Permission to use, copy, modify, distribute, and sell this software
 * and its documentation for any purpose is hereby granted without fee,
 * provided that the above copyright notice appears in all copies and
 * that both that copyright notice and this permission notice appear in
 * supporting documentation, and that the name of OpenVision not be used
 * in advertising or publicity pertaining to distribution of the software
 * without specific, written prior permission. OpenVision makes no
 * representations about the suitability of this software for any
 * purpose. It is provided "as is" without express or implied warranty.
 *
 * OPENVISION DISCLAIMS ALL WARRANTIES WITH REGARD TO THIS SOFTWARE,
 * INCLUDING ALL IMPLIED WARRANTIES OF MERCHANTABILITY AND FITNESS, IN NO
 * EVENT SHALL OPENVISION BE LIABLE FOR ANY SPECIAL, INDIRECT OR
 * CONSEQUENTIAL DAMAGES OR ANY DAMAGES WHATSOEVER RESULTING FROM LOSS OF
 * USE, DATA OR PROFITS, WHETHER IN AN ACTION OF CONTRACT, NEGLIGENCE OR
 * OTHER TORTIOUS ACTION, ARISING OUT OF OR IN CONNECTION WITH THE USE OR
 * PERFORMANCE OF THIS SOFTWARE.
 */

#if !defined(lint) && !defined(__CODECENTER__)
static char *rcsid = \
"$Header: /cvs/krbdev/krb5/src/appl/gss-sample/gss-server.c, \
v 1.21 1998/12/22 \
04:10:08 tytso Exp $";
#endif

#include <stdio.h>
#include <sys/types.h>
#include <sys/socket.h>
#include <sys/time.h>
#include <netinet/in.h>
#include <unistd.h>
#include <stdlib.h>
#include <ctype.h>

#include <gssapi/gssapi.h>
#include <gssapi/gssapi_ext.h>
#include <gss-misc.h>

#include <string.h>

void usage()
{

```

## EXAMPLE A-2 Complete Code Listing for gss-server.c Sample Program (Continued)

```

        fprintf(stderr, "Usage: gss-server [-port port] [-verbose]\n");
        fprintf(stderr, "          [-inetd] [-logfile file] [service_name]\n");
        exit(1);
    }

    FILE *log;

    int verbose = 0;

    /*
     * Function: server_acquire_creds
     *
     * Purpose: imports a service name and acquires credentials for it
     *
     * Arguments:
     *
     *     service_name    (r) the ASCII service name
     *     server_creds    (w) the GSS-API service credentials
     *
     * Returns: 0 on success, -1 on failure
     *
     * Effects:
     *
     * The service name is imported with gss_import_name, and service
     * credentials are acquired with gss_acquire_cred. If either operation
     * fails, an error message is displayed and -1 is returned; otherwise,
     * 0 is returned.
     */
    int server_acquire_creds(service_name, server_creds)
        char *service_name;
        gss_cred_id_t *server_creds;
    {
        gss_buffer_desc name_buf;
        gss_name_t server_name;
        OM_uint32 maj_stat, min_stat;

        name_buf.value = service_name;
        name_buf.length = strlen(name_buf.value) + 1;
        maj_stat = gss_import_name(&min_stat, &name_buf,
            (gss_OID) GSS_C_NT_HOSTBASED_SERVICE, &server_name);
        if (maj_stat != GSS_S_COMPLETE) {
            display_status("importing name", maj_stat, min_stat);
            return -1;
        }

        maj_stat = gss_acquire_cred(&min_stat, server_name, 0,
            GSS_C_NULL_OID_SET, GSS_C_ACCEPT,
            server_creds, NULL, NULL);
        if (maj_stat != GSS_S_COMPLETE) {
            display_status("acquiring credentials", maj_stat, min_stat);
            return -1;
        }

        (void) gss_release_name(&min_stat, &server_name);

        return 0;
    }

```

## EXAMPLE A-2 Complete Code Listing for gss-server.c Sample Program (Continued)

```

}

/*
 * Function: server_establish_context
 *
 * Purpose: establishes a GSS-API context as a specified service with
 * an incoming client, and returns the context handle and associated
 * client name
 *
 * Arguments:
 *
 *     s           (r) an established TCP connection to the client
 *     service_creds (r) server credentials, from gss_acquire_cred
 *     context      (w) the established GSS-API context
 *     client_name  (w) the client's ASCII name
 *
 * Returns: 0 on success, -1 on failure
 *
 * Effects:
 *
 * Any valid client request is accepted. If a context is established,
 * its handle is returned in context and the client name is returned
 * in client_name and 0 is returned. If unsuccessful, an error
 * message is displayed and -1 is returned.
 */
int server_establish_context(s, server_creds, context, client_name, \
    ret_flags)

    int s;
    gss_cred_id_t server_creds;
    gss_ctx_id_t *context;
    gss_buffer_t client_name;
    OM_uint32 *ret_flags;
{
    gss_buffer_desc send_tok, recv_tok;
    gss_name_t client;
    gss_OID doid;
    OM_uint32 maj_stat, min_stat, acc_sec_min_stat;
    gss_buffer_desc oid_name;

    *context = GSS_C_NO_CONTEXT;

    do {
        if (recv_token(s, &recv_tok) < 0)
            return -1;

        if (verbose && log) {
            fprintf(log, "Received token (size=%d): \n", recv_tok.length);
            print_token(&recv_tok);
        }

        maj_stat =
            gss_accept_sec_context(&acc_sec_min_stat,
                                context,
                                server_creds,
                                &recv_tok,

```



## EXAMPLE A-2 Complete Code Listing for gss-server.c Sample Program (Continued)

```

        GSS_C_NO_CHANNEL_BINDINGS,
        &client,
        &doid,
        &send_tok,
        ret_flags,
        NULL, /* ignore time_rec */
        NULL); /* ignore del_cred_handle */

(void) gss_release_buffer(&min_stat, &recv_tok);

if (send_tok.length != 0) {
    if (verbose && log) {
        fprintf(log,
            "Sending accept_sec_context token (size=%d):\n",
            send_tok.length);
        print_token(&send_tok);
    }
    if (send_token(s, &send_tok) < 0) {
        fprintf(log, "failure sending token\n");
        return -1;
    }

    (void) gss_release_buffer(&min_stat, &send_tok);
}
if (maj_stat!=GSS_S_COMPLETE && maj_stat!=GSS_S_CONTINUE_NEEDED) {
    display_status("accepting context", maj_stat,
        acc_sec_min_stat);
    if (*context == GSS_C_NO_CONTEXT)
        gss_delete_sec_context(&min_stat, context,
            GSS_C_NO_BUFFER);
    return -1;
}

if (verbose && log) {
    if (maj_stat == GSS_S_CONTINUE_NEEDED)
        fprintf(log, "continue needed...\n");
    else
        fprintf(log, "\n");
    fflush(log);
}
} while (maj_stat == GSS_S_CONTINUE_NEEDED);

/* display the flags */
display_ctx_flags(*ret_flags);

if (verbose && log) {
    maj_stat = gss_oid_to_str(&min_stat, doid, &oid_name);
    if (maj_stat != GSS_S_COMPLETE) {
        display_status("converting oid->string", maj_stat, min_stat);
        return -1;
    }
    fprintf(log, "Accepted connection using mechanism OID %.*s.\n",
        (int) oid_name.length, (char *) oid_name.value);
    (void) gss_release_buffer(&min_stat, &oid_name);
}
}

```

## EXAMPLE A-2 Complete Code Listing for gss-server.c Sample Program (Continued)

```

    maj_stat = gss_display_name(&min_stat, client, client_name, &doid);
    if (maj_stat != GSS_S_COMPLETE) {
        display_status("displaying name", maj_stat, min_stat);
        return -1;
    }
    maj_stat = gss_release_name(&min_stat, &client);
    if (maj_stat != GSS_S_COMPLETE) {
        display_status("releasing name", maj_stat, min_stat);
        return -1;
    }
    return 0;
}

/*
 * Function: create_socket
 *
 * Purpose: Opens a listening TCP socket.
 *
 * Arguments:
 *
 *     port          (r) the port number on which to listen
 *
 * Returns: the listening socket file descriptor, or -1 on failure
 *
 * Effects:
 *
 * A listening socket on the specified port is created and returned.
 * On error, an error message is displayed and -1 is returned.
 */
int create_socket(port)
    u_short port;
{
    struct sockaddr_in saddr;
    int s;
    int on = 1;

    saddr.sin_family = AF_INET;
    saddr.sin_port = htons(port);
    saddr.sin_addr.s_addr = INADDR_ANY;

    if ((s = socket(AF_INET, SOCK_STREAM, 0)) < 0) {
        perror("creating socket");
        return -1;
    }
    /* Let the socket be reused right away */
    (void) setsockopt(s, SOL_SOCKET, SO_REUSEADDR, (char *)&on,
        sizeof(on));
    if (bind(s, (struct sockaddr *) &saddr, sizeof(saddr)) < 0) {
        perror("binding socket");
        (void) close(s);
        return -1;
    }
    if (listen(s, 5) < 0) {
        perror("listening on socket");
        (void) close(s);
        return -1;
    }
}

```

## EXAMPLE A-2 Complete Code Listing for gss-server.c Sample Program (Continued)

```

    }
    return s;
}

static float timeval_subtract(tv1, tv2)
    struct timeval *tv1, *tv2;
{
    return ((tv1->tv_sec - tv2->tv_sec) +
            ((float) (tv1->tv_usec - tv2->tv_usec)) / 1000000);
}

/*
 * Yes, yes, this isn't the best place for doing this test.
 * DO NOT REMOVE THIS UNTIL A BETTER TEST HAS BEEN WRITTEN, THOUGH.
 *                                     -TYT
 */
int test_import_export_context(context)
    gss_ctx_id_t *context;
{
    OM_uint32      min_stat, maj_stat;
    gss_buffer_desc context_token, copied_token;
    struct timeval tm1, tm2;

    /*
     * Attempt to save and then restore the context.
     */
    gettimeofday(&tm1, (struct timezone *)0);
    maj_stat = gss_export_sec_context(&min_stat, context, \
        &context_token);
    if (maj_stat != GSS_S_COMPLETE) {
        display_status("exporting context", maj_stat, min_stat);
        return 1;
    }
    gettimeofday(&tm2, (struct timezone *)0);
    if (verbose && log)
        fprintf(log, "Exported context: %d bytes, %7.4f seconds\n",
            context_token.length, timeval_subtract(&tm2, &tm1));
    copied_token.length = context_token.length;
    copied_token.value = malloc(copied_token.length);
    if (copied_token.value == 0) {
        fprintf(log, "Couldn't allocate memory to copy context \
            token.\n");
        return 1;
    }
    memcpy(copied_token.value, context_token.value, \
        copied_token.length);
    maj_stat = gss_import_sec_context(&min_stat, &copied_token, \
        context);
    if (maj_stat != GSS_S_COMPLETE) {
        display_status("importing context", maj_stat, min_stat);
        return 1;
    }
    free(copied_token.value);
    gettimeofday(&tm1, (struct timezone *)0);
    if (verbose && log)
        fprintf(log, "Importing context: %7.4f seconds\n",

```

## EXAMPLE A-2 Complete Code Listing for gss-server.c Sample Program (Continued)

```

        timeval_subtract(&tm1, &tm2));
    (void) gss_release_buffer(&min_stat, &context_token);
    return 0;
}

/*
 * Function: sign_server
 *
 * Purpose: Performs the "sign" service.
 *
 * Arguments:
 *
 *     s                (r) a TCP socket on which a connection has been
 *                     accept(ied
 *     service_name     (r) the ASCII name of the GSS-API service to
 *                     establish a context as
 *
 * Returns: -1 on error
 *
 * Effects:
 *
 * sign_server establishes a context, and performs a single sign request.
 *
 * A sign request is a single GSS-API sealed token. The token is
 * unsealed and a signature block, produced with gss_sign, is returned
 * to the sender. The context is then destroyed and the connection
 * closed.
 *
 * If any error occurs, -1 is returned.
 */
int sign_server(s, server_creds)
    int s;
    gss_cred_id_t server_creds;
{
    gss_buffer_desc client_name, xmit_buf, msg_buf;
    gss_ctx_id_t context;
    OM_uint32 maj_stat, min_stat;
    int i, conf_state, ret_flags;
    char *cp;

    /* Establish a context with the client */
    if (server_establish_context(s, server_creds, &context,
                                &client_name, &ret_flags) < 0)
        return(-1);

    printf("Accepted connection: \"%.*s\"\n",
           (int) client_name.length, (char *) client_name.value);
    (void) gss_release_buffer(&min_stat, &client_name);

    for (i=0; i < 3; i++)
        if (test_import_export_context(&context))
            return -1;

    /* Receive the sealed message token */
    if (recv_token(s, &xmit_buf) < 0)
        return(-1);
}

```

## EXAMPLE A-2 Complete Code Listing for gss-server.c Sample Program (Continued)

```

    if (verbose && log) {
        fprintf(log, "Sealed message token:\n");
        print_token(&xmit_buf);
    }

    maj_stat = gss_unwrap(&min_stat, context, &xmit_buf, &msg_buf,
                        &conf_state, (gss_qop_t *) NULL);
    if (maj_stat != GSS_S_COMPLETE) {
        display_status("unsealing message", maj_stat, min_stat);
        return(-1);
    } else if (! conf_state) {
        fprintf(stderr, "Warning! Message not encrypted.\n");
    }

    (void) gss_release_buffer(&min_stat, &xmit_buf);

    fprintf(log, "Received message: ");
    cp = msg_buf.value;
    if ((isprint(cp[0]) || isspace(cp[0])) &&
        (isprint(cp[1]) || isspace(cp[1]))) {
        fprintf(log, "\"%.*s\"\n", msg_buf.length, msg_buf.value);
    } else {
        printf("\n");
        print_token(&msg_buf);
    }

    /* Produce a signature block for the message */
    maj_stat = gss_get_mic(&min_stat, context, GSS_C_QOP_DEFAULT,
                        &msg_buf, &xmit_buf);
    if (maj_stat != GSS_S_COMPLETE) {
        display_status("signing message", maj_stat, min_stat);
        return(-1);
    }

    (void) gss_release_buffer(&min_stat, &msg_buf);

    /* Send the signature block to the client */
    if (send_token(s, &xmit_buf) < 0)
        return(-1);

    (void) gss_release_buffer(&min_stat, &xmit_buf);

    /* Delete context */
    maj_stat = gss_delete_sec_context(&min_stat, &context, NULL);
    if (maj_stat != GSS_S_COMPLETE) {
        display_status("deleting context", maj_stat, min_stat);
        return(-1);
    }

    fflush(log);

    return(0);
}

int

```

## EXAMPLE A-2 Complete Code Listing for gss-server.c Sample Program (Continued)

```
main(argc, argv)
    int argc;
    char **argv;
{
    char *service_name;
    gss_cred_id_t server_creds;
    OM_uint32 min_stat;
    u_short port = 4444;
    int s;
    int once = 0;
    int do_inetd = 0;

    log = stdout;
    display_file = stdout;
    argc--; argv++;
    while (argc) {
        if (strcmp(*argv, "-port") == 0) {
            argc--; argv++;
            if (!argc) usage();
            port = atoi(*argv);
        } else if (strcmp(*argv, "-verbose") == 0) {
            verbose = 1;
        } else if (strcmp(*argv, "-once") == 0) {
            once = 1;
        } else if (strcmp(*argv, "-inetd") == 0) {
            do_inetd = 1;
        } else if (strcmp(*argv, "-logfile") == 0) {
            argc--; argv++;
            if (!argc) usage();
            log = fopen(*argv, "a");
            display_file = log;
            if (!log) {
                perror(*argv);
                exit(1);
            }
        } else
            break;
        argc--; argv++;
    }
    if (argc != 1)
        usage();

    if ((*argv)[0] == '-')
        usage();

    service_name = *argv;

    if (server_acquire_creds(service_name, &server_creds) < 0)
        return -1;

    if (do_inetd) {
        close(1);
        close(2);

        sign_server(0, server_creds);
        close(0);
    }
}
```

EXAMPLE A-2 Complete Code Listing for `gss-server.c` Sample Program (Continued)

```

    } else {
        int stmp;

        if ((stmp = create_socket(port)) >= 0) {
            do {
                /* Accept a TCP connection */
                if ((s = accept(stmp, NULL, 0)) < 0) {
                    perror("accepting connection");
                    continue;
                }
                /* this return value is not checked, because there's
                 not really anything to do if it fails */
                sign_server(s, server_creds);
                close(s);
            } while (!once);

            close(stmp);
        }
    }

    (void) gss_release_cred(&min_stat, &server_creds);

    /*NOTREACHED*/
    (void) close(s);
    return 0;
}

```

## Miscellaneous GSS-API Sample Functions

To make the client and server programs work as shown, a number of other functions are required. These functions are used to display values. The functions are not otherwise needed. The functions in this category are as follows:

- `send_token()` – Transfers tokens and messages to a recipient
- `recv_token()` – Accepts tokens and messages from a sender
- `display_status()` – Shows the status returned by the last GSS-API function called
- `write_all()` – Writes a buffer to a file
- `read_all()` – Reads a file into a buffer
- `display_ctx_flags()` – Shows in a readable form information about the current context, such as whether confidentiality or mutual authentication is allowed
- `print_token()` – Prints out a token's value

The code for these functions is shown in the following example.

---

**Note** – The source code for this example is also available through the Sun download center. See <http://www.sun.com/download/products.xml?id=41912db5>.

---

**EXAMPLE A-3** Code Listings for Miscellaneous GSS-API Functions

```

/*
 * Copyright 1994 by OpenVision Technologies, Inc.
 *
 * Permission to use, copy, modify, distribute, and sell this software
 * and its documentation for any purpose is hereby granted without fee,
 * provided that the above copyright notice appears in all copies and
 * that both that copyright notice and this permission notice appear in
 * supporting documentation, and that the name of OpenVision not be used
 * in advertising or publicity pertaining to distribution of the software
 * without specific, written prior permission. OpenVision makes no
 * representations about the suitability of this software for any
 * purpose. It is provided "as is" without express or implied warranty.
 *
 * OPENVISION DISCLAIMS ALL WARRANTIES WITH REGARD TO THIS SOFTWARE,
 * INCLUDING ALL IMPLIED WARRANTIES OF MERCHANTABILITY AND FITNESS, IN NO
 * EVENT SHALL OPENVISION BE LIABLE FOR ANY SPECIAL, INDIRECT OR
 * CONSEQUENTIAL DAMAGES OR ANY DAMAGES WHATSOEVER RESULTING FROM LOSS OF
 * USE, DATA OR PROFITS, WHETHER IN AN ACTION OF CONTRACT, NEGLIGENCE OR
 * OTHER TORTIOUS ACTION, ARISING OUT OF OR IN CONNECTION WITH THE USE OR
 * PERFORMANCE OF THIS SOFTWARE.
 */

#if !defined(lint) && !defined(__CODECENTER__)
static char *rcsid = "$Header: /cvs/krbdev/krb5/src/appl/gss-sample/\
gss-misc.c, v 1.15 1996/07/22 20:21:20 marc Exp $";
#endif

#include <stdio.h>
#include <sys/types.h>
#include <netinet/in.h>
#include <errno.h>
#include <unistd.h>
#include <string.h>

#include <gssapi/gssapi.h>
#include <gssapi/gssapi_ext.h>
#include <gss-misc.h>

#include <stdlib.h>

FILE *display_file;

static void display_status_1
    (char *m, OM_uint32 code, int type);

static int write_all(int fildes, char *buf, unsigned int nbyte)
{
    int ret;
    char *ptr;

    for (ptr = buf; nbyte; ptr += ret, nbyte -= ret) {

```



## EXAMPLE A-3 Code Listings for Miscellaneous GSS-API Functions (Continued)

```

        ret = write(fildes, ptr, nbyte);
        if (ret < 0) {
            if (errno == EINTR)
                continue;
            return(ret);
        } else if (ret == 0) {
            return(ptr-buf);
        }
    }

    return(ptr-buf);
}

static int read_all(int fildes, char *buf, unsigned int nbyte)
{
    int ret;
    char *ptr;

    for (ptr = buf; nbyte; ptr += ret, nbyte -= ret) {
        ret = read(fildes, ptr, nbyte);
        if (ret < 0) {
            if (errno == EINTR)
                continue;
            return(ret);
        } else if (ret == 0) {
            return(ptr-buf);
        }
    }

    return(ptr-buf);
}

/*
 * Function: send_token
 *
 * Purpose: Writes a token to a file descriptor.
 *
 * Arguments:
 *
 *     s          (r) an open file descriptor
 *     tok        (r) the token to write
 *
 * Returns: 0 on success, -1 on failure
 *
 * Effects:
 *
 * send_token writes the token length (as a network long) and then the
 * token data to the file descriptor s. It returns 0 on success, and
 * -1 if an error occurs or if it could not write all the data.
 */
int send_token(s, tok)
    int s;
    gss_buffer_t tok;
{
    int len, ret;

```

## EXAMPLE A-3 Code Listings for Miscellaneous GSS-API Functions (Continued)

```

    len = htonl(tok->length);

    ret = write_all(s, (char *) &len, 4);
    if (ret < 0) {
        perror("sending token length");
        return -1;
    } else if (ret != 4) {
        if (display_file)
            fprintf(display_file,
                    "sending token length: %d of %d bytes written\n",
                    ret, 4);
        return -1;
    }

    ret = write_all(s, tok->value, tok->length);
    if (ret < 0) {
        perror("sending token data");
        return -1;
    } else if (ret != tok->length) {
        if (display_file)
            fprintf(display_file,
                    "sending token data: %d of %d bytes written\n",
                    ret, tok->length);
        return -1;
    }

    return 0;
}

/*
 * Function: recv_token
 *
 * Purpose: Reads a token from a file descriptor.
 *
 * Arguments:
 *
 *     s           (r) an open file descriptor
 *     tok         (w) the read token
 *
 * Returns: 0 on success, -1 on failure
 *
 * Effects:
 *
 * recv_token reads the token length (as a network long), allocates
 * memory to hold the data, and then reads the token data from the
 * file descriptor s. It blocks to read the length and data, if
 * necessary. On a successful return, the token should be freed with
 * gss_release_buffer. It returns 0 on success, and -1 if an error
 * occurs or if it could not read all the data.
 */
int recv_token(s, tok)
    int s;
    gss_buffer_t tok;
{
    int ret;

```

## EXAMPLE A-3 Code Listings for Miscellaneous GSS-API Functions (Continued)

```

    ret = read_all(s, (char *) &tok->length, 4);
    if (ret < 0) {
        perror("reading token length");
        return -1;
    } else if (ret != 4) {
        if (display_file)
            fprintf(display_file,
                    "reading token length: %d of %d bytes read\n",
                    ret, 4);
        return -1;
    }

    tok->length = ntohl(tok->length);
    tok->value = (char *) malloc(tok->length);
    if (tok->value == NULL) {
        if (display_file)
            fprintf(display_file,
                    "Out of memory allocating token data\n");
        return -1;
    }

    ret = read_all(s, (char *) tok->value, tok->length);
    if (ret < 0) {
        perror("reading token data");
        free(tok->value);
        return -1;
    } else if (ret != tok->length) {
        fprintf(stderr, "sending token data: %d of %d bytes written\n",
                ret, tok->length);
        free(tok->value);
        return -1;
    }

    return 0;
}

static void display_status_1(m, code, type)
char *m;
OM_uint32 code;
int type;
{
    OM_uint32 maj_stat, min_stat;
    gss_buffer_desc msg;
    OM_uint32 msg_ctx;

    msg_ctx = 0;
    while (1) {
        maj_stat = gss_display_status(&min_stat, code,
                                     type, GSS_C_NULL_OID,
                                     &msg_ctx, &msg);

        if (display_file)
            fprintf(display_file, "GSS-API error %s: %s\n", m,
                    (char *)msg.value);
        (void) gss_release_buffer(&min_stat, &msg);

        if (!msg_ctx)

```

## EXAMPLE A-3 Code Listings for Miscellaneous GSS-API Functions (Continued)

```

        break;
    }
}

/*
 * Function: display_status
 *
 * Purpose: displays GSS-API messages
 *
 * Arguments:
 *
 *     msg           a string to be displayed with the message
 *     maj_stat      the GSS-API major status code
 *     min_stat      the GSS-API minor status code
 *
 * Effects:
 *
 * The GSS-API messages associated with maj_stat and min_stat are
 * displayed on stderr, each preceded by "GSS-API error <msg>: " and
 * followed by a newline.
 */
void display_status(msg, maj_stat, min_stat)
    char *msg;
    OM_uint32 maj_stat;
    OM_uint32 min_stat;
{
    display_status_1(msg, maj_stat, GSS_C_GSS_CODE);
    display_status_1(msg, min_stat, GSS_C_MECH_CODE);
}

/*
 * Function: display_ctx_flags
 *
 * Purpose: displays the flags returned by context initiation in
 *          a human-readable form
 *
 * Arguments:
 *
 *     int           ret_flags
 *
 * Effects:
 *
 * Strings corresponding to the context flags are printed on
 * stdout, preceded by "context flag: " and followed by a newline
 */
void display_ctx_flags(flags)
    OM_uint32 flags;
{
    if (flags & GSS_C_DELEG_FLAG)
        fprintf(display_file, "context flag: GSS_C_DELEG_FLAG\n");
    if (flags & GSS_C_MUTUAL_FLAG)
        fprintf(display_file, "context flag: GSS_C_MUTUAL_FLAG\n");
    if (flags & GSS_C_REPLAY_FLAG)
        fprintf(display_file, "context flag: GSS_C_REPLAY_FLAG\n");
    if (flags & GSS_C_SEQUENCE_FLAG)

```

## EXAMPLE A-3 Code Listings for Miscellaneous GSS-API Functions (Continued)

```
        fprintf(display_file, "context flag: GSS_C_SEQUENCE_FLAG\n");
    if (flags & GSS_C_CONF_FLAG )
        fprintf(display_file, "context flag: GSS_C_CONF_FLAG \n");
    if (flags & GSS_C_INTEG_FLAG )
        fprintf(display_file, "context flag: GSS_C_INTEG_FLAG \n");
}

void print_token(tok)
    gss_buffer_t tok;
{
    int i;
    unsigned char *p = tok->value;

    if (!display_file)
        return;
    for (i=0; i < tok->length; i++, p++) {
        fprintf(display_file, "%02x ", *p);
        if ((i % 16) == 15) {
            fprintf(display_file, "\n");
        }
    }
    fprintf(display_file, "\n");
    fflush(display_file);
}
```



# GSS-API Reference

---

This appendix includes the following sections:

- “[GSS-API Functions](#)” on [page 223](#) provides a table of GSS-API functions.
- “[GSS-API Status Codes](#)” on [page 225](#) discusses status codes returned by GSS-API functions, and provides a list of those status codes.
- “[GSS-API Data Types and Values](#)” on [page 229](#) discusses the various data types used by GSS-API.
- “[Implementation-Specific Features in GSS-API](#)” on [page 232](#) covers features that are unique to the Sun implementation of GSS-API.
- “[Kerberos v5 Status Codes](#)” on [page 235](#) lists the status codes that can be returned by the Kerberos v5 mechanism.

Additional GSS-API definitions can be found in the file `gssapi.h`.

## GSS-API Functions

The Oracle Solaris software implements the GSS-API functions. For more information on each function, see its man page. See also “[Functions From Previous Versions of GSS-API](#)” on [page 225](#).

<code>gss_acquire_cred()</code>	Assume a global identity by obtaining a GSS-API credential handle for preexisting credentials
<code>gss_add_cred()</code>	Construct credentials incrementally
<code>gss_inquire_cred()</code>	Obtain information about a credential
<code>gss_inquire_cred_by_mech()</code>	Obtain per-mechanism information about a credential
<code>gss_release_cred()</code>	Discard a credential handle
<code>gss_init_sec_context()</code>	Initiate a security context with a peer application

<code>gss_accept_sec_context()</code>	Accept a security context initiated by a peer application
<code>gss_delete_sec_context()</code>	Discard a security context
<code>gss_process_context_token()</code>	Process a token on a security context from a peer application
<code>gss_context_time()</code>	Determine how long a context is to remain valid
<code>gss_inquire_context()</code>	Obtain information about a security context
<code>gss_wrap_size_limit()</code>	Determine token-size limit for <code>gss_wrap()</code> on a context
<code>gss_export_sec_context()</code>	Transfer a security context to another process
<code>gss_import_sec_context()</code>	Import a transferred context
<code>gss_get_mic()</code>	Calculate a cryptographic message integrity code (MIC) for a message
<code>gss_verify_mic()</code>	Check a MIC against a message to verify integrity of a received message
<code>gss_wrap()</code>	Attach a MIC to a message, and optionally encrypt the message content
<code>gss_unwrap()</code>	Verify a message with attached MIC. Decrypt message content if necessary
<code>gss_import_name()</code>	Convert a contiguous string name to an internal-form name
<code>gss_display_name()</code>	Convert internal-form name to text
<code>gss_compare_name()</code>	Compare two internal-form names
<code>gss_release_name()</code>	Discard an internal-form name
<code>gss_inquire_names_for_mech()</code>	List the name types supported by the specified mechanism
<code>gss_inquire_mechs_for_name()</code>	List mechanisms that support the specified name type
<code>gss_canonicalize_name()</code>	Convert an internal name to a mechanism name (MN)
<code>gss_export_name()</code>	Convert an MN to export form
<code>gss_duplicate_name()</code>	Create a copy of an internal name
<code>gss_add_oid_set_member()</code>	Add an object identifier to a set
<code>gss_display_status()</code>	Convert a GSS-API status code to text
<code>gss_indicate_mechs()</code>	Determine available underlying authentication mechanisms



<code>gss_release_buffer()</code>	Discard a buffer
<code>gss_release_oid_set()</code>	Discard a set of object identifiers
<code>gss_create_empty_oid_set()</code>	Create a set with no object identifiers
<code>gss_test_oid_set_member()</code>	Determine whether an object identifier is a member of a set

## Functions From Previous Versions of GSS-API

This section explains functions that were included in previous versions of the GSS-API.

### Functions for Manipulating OIDs

The Sun implementation of GSS-API provides the following functions for convenience and for backward compatibility. However, these functions might not be supported by other implementations of GSS-API.

- `gss_delete_oid()`
- `gss_oid_to_str()`
- `gss_str_to_oid()`

Although a mechanism's name can be converted from a string to an OID, programmers should use the default GSS-API mechanism if at all possible.

### Renamed Functions

The following functions have been supplanted by newer functions. In each case, the new function is the functional equivalent of the older function. Although the old functions are supported, developers should replace these functions with the newer functions whenever possible.

- `gss_sign()` has been replaced with `gss_get_mic()`.
- `gss_verify()` has been replaced with `gss_verify_mic()`.
- `gss_seal()` has been replaced with `gss_wrap()`.
- `gss_unseal()` has been replaced with `gss_unwrap()`.

## GSS-API Status Codes

Major status codes are encoded in the `OM_uint32` as shown in the following figure.

FIGURE B-1 Major-Status Encoding

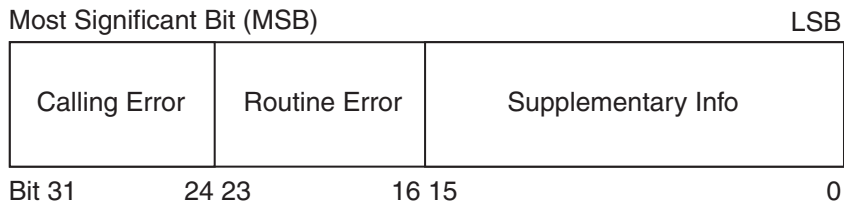
**Major Status Code OM\_uint32**

If a GSS-API routine returns a GSS status code whose upper 16 bits contain a nonzero value, the call has failed. If the calling error field is nonzero, the application's call of the routine was erroneous. The *calling errors* are listed in [Table B-1](#). If the routine error field is nonzero, the routine failed because of a *routine-specific error*, as listed in [Table B-2](#). The bits in the supplementary information field of the status code can be set whether the upper 16 bits indicate a failure or a success. The meaning of individual bits is listed in [Table B-3](#).

## GSS-API Major Status Code Values

The following tables list the calling errors that are returned by GSS-API. These errors are specific to a particular language-binding, which is C in this case.

TABLE B-1 GSS-API Calling Errors

Error	Value in Field	Meaning
GSS_S_CALL_INACCESSIBLE_READ	1	An input parameter that is required could not be read
GSS_S_CALL_INACCESSIBLE_WRITE	2	A required output parameter could not be written
GSS_S_CALL_BAD_STRUCTURE	3	A parameter was malformed

The following table lists the GSS-API routine errors, generic errors that are returned by GSS-API functions.

TABLE B-2 GSS-API Routine Errors

Error	Value in Field	Meaning
GSS_S_BAD_MECH	1	An unsupported mechanism was requested.
GSS_S_BAD_NAME	2	An invalid name was supplied.
GSS_S_BAD_NAME_TYPE	3	A supplied name was of an unsupported type.
GSS_S_BAD_BINDINGS	4	Incorrect channel bindings were supplied.
GSS_S_BAD_STATUS	5	An invalid status code was supplied.
GSS_S_BAD_MIC, GSS_S_BAD_SIG	6	A token had an invalid MIC.
GSS_S_NO_CRED	7	The credentials were unavailable, inaccessible, or not supplied.
GSS_S_NO_CONTEXT	8	No context has been established.
GSS_S_DEFECTIVE_TOKEN	9	A token was invalid.
GSS_S_DEFECTIVE_CREDENTIAL	10	A credential was invalid.
GSS_S_CREDENTIALS_EXPIRED	11	The referenced credentials have expired.
GSS_S_CONTEXT_EXPIRED	12	The context has expired.
GSS_S_FAILURE	13	Miscellaneous failure. The underlying mechanism detected an error for which no specific GSS-API status code is defined. The mechanism-specific status code, that is, the minor-status code, provides more details about the error.
GSS_S_BAD_QOP	14	The quality-of-protection that was requested could not be provided.
GSS_S_UNAUTHORIZED	15	The operation is forbidden by local security policy.
GSS_S_UNAVAILABLE	16	The operation or option is unavailable.
GSS_S_DUPLICATE_ELEMENT	17	The requested credential element already exists.
GSS_S_NAME_NOT_MN	18	The provided name was not a mechanism name (MN).

The name GSS\_S\_COMPLETE, which is a zero value, indicates an absence of any API errors or supplementary information bits.

The following table lists the supplementary information values returned by GSS-API functions.

TABLE B-3 GSS-API Supplementary Information Codes

Code	Bit Number	Meaning
GSS_S_CONTINUE_NEEDED	0 (LSB)	Returned only by <code>gss_init_sec_context()</code> or <code>gss_accept_sec_context()</code> . The routine must be called again to complete its function.
GSS_S_DUPLICATE_TOKEN	1	The token was a duplicate of an earlier token.
GSS_S_OLD_TOKEN	2	The token's validity period has expired.
GSS_S_UNSEQ_TOKEN	3	A later token has already been processed.
GSS_S_GAP_TOKEN	4	An expected per-message token was not received.

For more on status codes, see [“GSS-API Status Codes” on page 71](#).

## Displaying Status Codes

The function `gss_display_status()` translates GSS-API status codes into text format. This format allows the codes to be displayed to a user or put in a text log. `gss_display_status()` only displays one status code at a time, and some functions can return multiple status conditions. Accordingly, `gss_display_status()` should be called as part of a loop. When `gss_display_status()` indicates a non-zero status code, another status code is available for the function to fetch.

### EXAMPLE B-1 Displaying Status Codes with `gss_display_status()`

```
OM_uint32 message_context;
OM_uint32 status_code;
OM_uint32 maj_status;
OM_uint32 min_status;
gss_buffer_desc status_string;

...

message_context = 0;

do {
    maj_status = gss_display_status(
        &min_status,
        status_code,
        GSS_C_GSS_CODE,
        GSS_C_NO_OID,
        &message_context,
        &status_string);

    fprintf(stderr, "%.*s\n", \
        (int)status_string.length, \
```

EXAMPLE B-1 Displaying Status Codes with `gss_display_status()` (Continued)

```

        (char *)status_string.value);

    gss_release_buffer(&min_status, &status_string,);
} while (message_context != 0);

```

## Status Code Macros

The macros, `GSS_CALLING_ERROR()`, `GSS_ROUTINE_ERROR()` and `GSS_SUPPLEMENTARY_INFO()`, take a GSS status code. These macros remove all information except for the relevant field. For example, the `GSS_ROUTINE_ERROR()` can be applied to a status code to remove the calling errors and supplementary information fields. This operation leaves the routine errors field only. The values delivered by these macros can be directly compared with a `GSS_S_xxx` symbol of the appropriate type. The macro `GSS_ERROR()` returns a non-zero value if a status code indicates a calling or routine error, and a zero value otherwise. All macros that are defined by GSS-API evaluate the arguments exactly once.

# GSS-API Data Types and Values

This section describes various types of GSS-API data types and values. Some data types, such as `gss_cred_id_t` or `gss_name_t`, are opaque to the user. These data types do not need to be discussed. This section explains the following topics:

- “Basic GSS-API Data Types” on page 229 – Shows the definitions of the `OM_uint32`, `gss_buffer_desc`, `gss_OID_desc`, `gss_OID_set_desc_struct`, and `gss_channel_bindings_struct` data types.
- “Name Types” on page 230 – Shows the various name formats recognized by the GSS-API for specifying names.
- “Address Types for Channel Bindings” on page 231 – Shows the various values that can be used as the `initiator_addrtype` and `acceptor_addrtype` fields of the `gss_channel_bindings_t` structure.

## Basic GSS-API Data Types

This section describes data types that are used by GSS-API.

### OM\_uint32

The `OM_uint32` is a platform-independent 32-bit unsigned integer.

## **gss\_buffer\_desc**

The definition of the `gss_buffer_desc` with the `gss_buffer_t` pointer takes the following form:

```
typedef struct gss_buffer_desc_struct {
    size_t length;
    void *value;
} gss_buffer_desc, *gss_buffer_t;
```

## **gss\_OID\_desc**

The definition of the `gss_OID_desc` with the `gss_OID` pointer takes the following form:

```
typedef struct gss_OID_desc_struct {
    OM_uint32 length;
    void*elements;
} gss_OID_desc, *gss_OID;
```

## **gss\_OID\_set\_desc**

The definition of the `gss_OID_set_desc` with the `gss_OID_set` pointer takes the following form:

```
typedef struct gss_OID_set_desc_struct {
    size_t count;
    gss_OID elements;
} gss_OID_set_desc, *gss_OID_set;
```

## **gss\_channel\_bindings\_struct**

The definition of the `gss_channel_bindings_struct` structure and the `gss_channel_bindings_t` pointer has the following form:

```
typedef struct gss_channel_bindings_struct {
    OM_uint32 initiator_addrtype;
    gss_buffer_desc initiator_address;
    OM_uint32 acceptor_addrtype;
    gss_buffer_desc acceptor_address;
    gss_buffer_desc application_data;
} *gss_channel_bindings_t;
```

## **Name Types**

A name type indicates the format of the associated name. See [“Names in GSS-API” on page 63](#) and [“GSS-API OIDs” on page 69](#) for more on names and name types. The GSS-API supports the `gss_OID` name types in the following table.

### **GSS\_C\_NO\_NAME**

The symbolic name `GSS_C_NO_NAME` is recommended as a parameter value to indicate that no value is supplied in the transfer of names.

**GSS\_C\_NO\_OID**

This value corresponds to a null input value instead of an actual object identifier. Where specified, the value indicates interpretation of an associated name that is based on a mechanism-specific default printable syntax.

**GSS\_C\_NT\_ANONYMOUS**

A means to identify anonymous names. This value can be compared with to determine in a mechanism-independent fashion whether a name refers to an anonymous principal.

**GSS\_C\_NT\_EXPORT\_NAME**

A name that has been exported with the `gss_export_name()` function.

**GSS\_C\_NT\_HOSTBASED\_SERVICE**

Used to represent services that are associated with host computers. This name form is constructed using two elements, service and hostname, as follows: *service@hostname*.

**GSS\_C\_NT\_MACHINE\_UID\_NAME**

Used to indicate a numeric user identifier corresponding to a user on a local system. The interpretation of this value is OS-specific. The `gss_import_name()` function resolves this UID into a user name, which is then treated as the User Name Form.

**GSS\_C\_NT\_STRING\_STRING\_UID\_NAME**

Used to indicate a string of digits that represents the numeric user identifier of a user on a local system. The interpretation of this value is OS-specific. This name type is similar to the Machine UID Form, except that the buffer contains a string that represents the user ID.

**GSS\_C\_NT\_USER\_NAME**

A named user on a local system. The interpretation of this value is OS-specific. The value takes the form: *username*.

## Address Types for Channel Bindings

The following table shows the possible values for the *initiator\_addrtype* and *acceptor\_addrtype* fields of the `gss_channel_bindings_struct` structure. These fields indicate the format that a name can take, for example, ARPAnet IMP address or AppleTalk address. Channel bindings are discussed in “Using Channel Bindings in GSS-API” on page 82.

**TABLE B-4** Channel Binding Address Types

Field	Value (Decimal)	Address Type
GSS_C_AF_UNSPEC	0	Unspecified address type
GSS_C_AF_LOCAL	1	Host-local
GSS_C_AF_INET	2	Internet address type, for example, IP
GSS_C_AF_IMPLINK	3	ARPAnet IMP

TABLE B-4 Channel Binding Address Types (Continued)

Field	Value (Decimal)	Address Type
GSS_C_AF_PUP	4	pup protocols, for example, BSP
GSS_C_AF_CHAOS	5	MIT CHAOS protocol
GSS_C_AF_NS	6	XEROX NS
GSS_C_AF_NBS	7	nbs
GSS_C_AF_ECMA	8	ECMA
GSS_C_AF_DATAKIT	9	Datakit protocols
GSS_C_AF_CCITT	10	CCITT
GSS_C_AF_SNA	11	IBM SNA
GSS_C_AF_DECnet	12	DECnet
GSS_C_AF_DLI	13	Direct data link interface
GSS_C_AF_LAT	14	LAT
GSS_C_AF_HYLINK	15	NSC Hyperchannel
GSS_C_AF_APPLETALK	16	AppleTalk
GSS_C_AF_BSC	17	BISYNC
GSS_C_AF_DSS	18	Distributed system services
GSS_C_AF_OSI	19	OSI TP4
GSS_C_AF_X25	21	X.25
GSS_C_AF_NULLADDR	255	No address specified

## Implementation-Specific Features in GSS-API

Some aspects of the GSS-API can differ between implementations of the API. In most cases, differences in implementations have only minimal effect on programs. In all cases, developers can maximize portability by not relying on any behavior that is specific to a given implementation, including the Sun implementation.

### Sun-Specific Functions

The Sun implementation does not have customized GSS-API functions.



## Human-Readable Name Syntax

Implementations of GSS-API can differ in the printable syntax that corresponds to names. For portability, applications should not compare names that use human-readable, that is, printable, forms. Instead, such applications should use `gss_compare_name()` to determine whether an internal-format name matches any other name.

The Sun implementation of `gss_display_name()` displays names as follows. If the *input\_name* argument denotes a user principal, the `gss_display_name()` returns `user_principal@realm` as the *output\_name\_buffer* and the `gss_OID` value as the *output\_name\_type*. If Kerberos v5 is the underlying mechanism, `gss_OID` is `1.2.840.11354.1.2.2`.

If `gss_display_name()` receives a name that was created by `gss_import_name()` with the `GSS_C_NO_OID` name type, `gss_display_name()` returns `GSS_C_NO_OID` in the *output\_name\_type* parameter.

### Format of Anonymous Names

The `gss_display_name()` function outputs the string '<anonymous>' to indicate an anonymous GSS-API principal. The name type OID associated with this name is `GSS_C_NT_ANONYMOUS`. No other valid printable names supported by the Sun implementation should be surrounded by angle brackets (<>).

## Implementations of Selected Data Types

The following data types have been implemented as pointers, although some implementations might specify these types as arithmetic types: `gss_cred_t`, `gss_ctx_id_t`, and `gss_name_t`.

## Deletion of Contexts and Stored Data

When context establishment fails, the Sun implementation does not automatically delete partially built contexts. Applications should therefore handle this event by deleting the contexts with `gss_delete_sec_context()`.

The Sun implementation automatically releases stored data, such as internal names, through memory management. However, applications should still call appropriate functions, such as `gss_release_name()`, when data elements are no longer needed.

## Protection of Channel-Binding Information

Support for channel bindings varies by mechanism. Both the Diffie-Hellman mechanism and the Kerberos v5 mechanism support channel bindings.

Developers should assume that channel bindings data do not have confidentiality protection. Although the Kerberos v5 mechanism provides this protection, confidentiality for channel-bindings data is not available with the Diffie-Hellman mechanism.

## Context Exportation and Interprocess Tokens

The Sun implementation detects and rejects attempted multiple imports of the same context.

## Types of Credentials Supported

The Sun implementation of the GSS-API supports the acquisition of `GSS_C_INITIATE`, `GSS_C_ACCEPT`, and `GSS_C_BOTH` credentials through `gss_acquire_cred()`.

## Credential Expiration

The Sun implementation of the GSS-API supports credential expiration. Therefore, programmers can use parameters that relate to credential lifetime in functions such as `gss_acquire_cred()` and `gss_add_cred()`.

## Context Expiration

The Sun implementation of the GSS-API supports context expiration. Therefore, programmers can use parameters that relate to context lifetime in functions such as `gss_init_sec_context()` and `gss_inquire_context()`.

## Wrap Size Limits and QOP Values

The Sun implementation of the GSS-API, as opposed to any underlying mechanism, does not impose a maximum size for messages to be processed by `gss_wrap()`. Applications can determine the maximum message size with `gss_wrap_size_limit()`.

The Sun implementation of the GSS-API detects invalid QOP values when `gss_wrap_size_limit()` is called.

## Use of *minor\_status* Parameter

In the Sun implementation of the GSS-API, functions return only mechanism-specific information in the *minor\_status* parameter. Other implementations might include implementation-specific return values as part of the returned minor-status code.

## Kerberos v5 Status Codes

Each GSS-API function returns two status codes: a *major status code* and a *minor status code*. Major status codes relate to the behavior of GSS-API. For example, if an application attempts to transmit a message after a security context has expired, GSS-API returns a major status code of `GSS_S_CONTEXT_EXPIRED`. Major status codes are listed in [“GSS-API Status Codes” on page 225](#).

Minor status codes are returned by the underlying security mechanisms supported by a given implementation of GSS-API. Every GSS-API function takes as the first argument a *minor\_status* or *minor\_stat* parameter. An application can examine this parameter when the function returns, successfully or not, to see the status that is returned by the underlying mechanism.

The following tables list the status messages that can be returned by Kerberos v5 in the *minor\_status* argument. For more on GSS-API status codes, see [“GSS-API Status Codes” on page 71](#).

### Messages Returned in Kerberos v5 for Status Code 1

The following table lists the minor status messages that are returned in Kerberos v5 for status code 1.

TABLE B-5 Kerberos v5 Status Codes 1

Minor Status	Value	Meaning
<code>KRB5KDC_ERR_NONE</code>	<code>-1765328384L</code>	No error
<code>KRB5KDC_ERR_NAME_EXP</code>	<code>-1765328383L</code>	Client's entry in database has expired
<code>KRB5KDC_ERR_SERVICE_EXP</code>	<code>-1765328382L</code>	Server's entry in database has expired
<code>KRB5KDC_ERR_BAD_PVNO</code>	<code>-1765328381L</code>	Requested protocol version not supported
<code>KRB5KDC_ERR_C_OLD_MAST_KVNO</code>	<code>-1765328380L</code>	Client's key is encrypted in an old master key
<code>KRB5KDC_ERR_S_OLD_MAST_KVNO</code>	<code>-1765328379L</code>	Server's key is encrypted in an old master key
<code>KRB5KDC_ERR_C_PRINCIPAL_UNKNOWN</code>	<code>-1765328378L</code>	Client not found in Kerberos database
<code>KRB5KDC_ERR_S_PRINCIPAL_UNKNOWN</code>	<code>-1765328377L</code>	Server not found in Kerberos database

TABLE B-5 Kerberos v5 Status Codes 1 (Continued)

Minor Status	Value	Meaning
KRB5KDC_ERR_PRINCIPAL_NOT_UNIQUE	-1765328376L	Principal has multiple entries in Kerberos database
KRB5KDC_ERR_NULL_KEY	-1765328375L	Client or server has a null key
KRB5KDC_ERR_CANNOT_POSTDATE	-1765328374L	Ticket is ineligible for postdating
KRB5KDC_ERR_NEVER_VALID	-1765328373L	Requested effective lifetime is negative or too short
KRB5KDC_ERR_POLICY	-1765328372L	KDC policy rejects request
KRB5KDC_ERR_BADOPTION	-1765328371L	KDC can't fulfill requested option
KRB5KDC_ERR_ETYPE_NOSUPP	-1765328370L	KDC has no support for encryption type
KRB5KDC_ERR_SUMTYPE_NOSUPP	-1765328369L	KDC has no support for checksum type
KRB5KDC_ERR_PADATA_TYPE_NOSUPP	-1765328368L	KDC has no support for padata type
KRB5KDC_ERR_TRTYPE_NOSUPP	-1765328367L	KDC has no support for transited type
KRB5KDC_ERR_CLIENT_REVOKED	-1765328366L	Client's credentials have been revoked
KRB5KDC_ERR_SERVICE_REVOKED	-1765328365L	Credentials for server have been revoked

## Messages Returned in Kerberos v5 for Status Code 2

The following table lists the minor status messages that are returned in Kerberos v5 for status code 2.

TABLE B-6 Kerberos v5 Status Codes 2

Minor Status	Value	Meaning
KRB5KDC_ERR_TGT_REVOKED	-1765328364L	TGT has been revoked
KRB5KDC_ERR_CLIENT_NOTYET	-1765328363L	Client not yet valid, try again later

TABLE B-6 Kerberos v5 Status Codes 2 (Continued)

Minor Status	Value	Meaning
KRB5KDC_ERR_SERVICE_NOTYET	-1765328362L	Server not yet valid, try again later
KRB5KDC_ERR_KEY_EXP	-1765328361L	Password has expired
KRB5KDC_ERR_PREAUTH_FAILED	-1765328360L	Preauthentication failed
KRB5KDC_ERR_PREAUTH_REQUIRED	-1765328359L	Additional preauthentication required
KRB5KDC_ERR_SERVER_NOMATCH	-1765328358L	Requested server and ticket don't match
KRB5PLACEHOLD_27 through KRB5PLACEHOLD_30	-1765328357L through -1765328354L	KRB5 error codes 27 through 30 (reserved)
KRB5KRB_AP_ERR_BAD_INTEGRITY	-1765328353L	Decrypt integrity check failed
KRB5KRB_AP_ERR_TKT_EXPIRED	-1765328352L	Ticket expired
KRB5KRB_AP_ERR_TKT_NYV	-1765328351L	Ticket not yet valid
KRB5KRB_AP_ERR_REPEAT	-1765328350L	Request is a replay
KRB5KRB_AP_ERR_NOT_US	-1765328349L	The ticket isn't for us
KRB5KRB_AP_ERR_BADMATCH	-1765328348L	Ticket/authenticator do not match
KRB5KRB_AP_ERR_SKEW	-1765328347L	Clock skew too great
KRB5KRB_AP_ERR_BADADDR	-1765328346L	Incorrect net address
KRB5KRB_AP_ERR_BADVERSION	-1765328345L	Protocol version mismatch
KRB5KRB_AP_ERR_MSG_TYPE	-1765328344L	Invalid message type
KRB5KRB_AP_ERR_MODIFIED	-1765328343L	Message stream modified
KRB5KRB_AP_ERR_BADORDER	-1765328342L	Message out of order
KRB5KRB_AP_ERR_ILL_CR_TKT	-1765328341L	Illegal cross-realm ticket
KRB5KRB_AP_ERR_BADKEYVER	-1765328340L	Key version is not available

## Messages Returned in Kerberos v5 for Status Code 3

The following table lists the minor status messages that are returned in Kerberos v5 for status code 3.

TABLE B-7 Kerberos v5 Status Codes 3

Minor Status	Value	Meaning
KRB5KRB_AP_ERR_NOKEY	-1765328339L	Service key not available
KRB5KRB_AP_ERR_MUT_FAIL	-1765328338L	Mutual authentication failed
KRB5KRB_AP_ERR_BADDIRECTION	-1765328337L	Incorrect message direction
KRB5KRB_AP_ERR_METHOD	-1765328336L	Alternative authentication method required
KRB5KRB_AP_ERR_BADSEQ	-1765328335L	Incorrect sequence number in message
KRB5KRB_AP_ERR_INAPP_CKSUM	-1765328334L	Inappropriate type of checksum in message
KRB5PLACEHOLD_51 through KRB5PLACEHOLD_59	-1765328333L through -1765328325L	KRB5 error codes 51 through 59 (reserved)
KRB5KRB_ERR_GENERIC	-1765328324L	Generic error
KRB5KRB_ERR_FIELD_TOOLONG	-1765328323L	Field is too long for this implementation
KRB5PLACEHOLD_62 through KRB5PLACEHOLD_127	-1765328322L through -1765328257L	KRB5 error codes 62 through 127 (reserved)
<i>value not returned</i>	-1765328256L	<i>For internal use only</i>
KRB5_LIBOS_BADLOCKFLAG	-1765328255L	Invalid flag for file lock mode
KRB5_LIBOS_CANTREADPWD	-1765328254L	Cannot read password
KRB5_LIBOS_BADPWDMATCH	-1765328253L	Password mismatch
KRB5_LIBOS_PWDINTR	-1765328252L	Password read interrupted
KRB5_PARSE_ILLCHAR	-1765328251L	Illegal character in component name
KRB5_PARSE_MALFORMED	-1765328250L	Malformed representation of principal
KRB5_CONFIG_CANTOPEN	-1765328249L	Can't open/find Kerberos /etc/krb5/krb5 configuration file
KRB5_CONFIG_BADFORMAT	-1765328248L	Improper format of Kerberos /etc/krb5/krb5 configuration file

TABLE B-7 Kerberos v5 Status Codes 3 (Continued)

Minor Status	Value	Meaning
KRB5_CONFIG_NOTENUFSPACE	-1765328247L	Insufficient space to return complete information
KRB5_BADMSGTYPE	-1765328246L	Invalid message type has been specified for encoding
KRB5_CC_BADNAME	-1765328245L	Credential cache name malformed

## Messages Returned in Kerberos v5 for Status Code 4

The following table lists the minor status messages that are returned in Kerberos v5 for status code 4.

TABLE B-8 Kerberos v5 Status Codes 4

Minor Status	Value	Meaning
KRB5_CC_UNKNOWN_TYPE	-1765328244L	Unknown credential cache type
KRB5_CC_NOTFOUND	-1765328243L	No matching credential has been found
KRB5_CC_END	-1765328242L	End of credential cache reached
KRB5_NO_TKT_SUPPLIED	-1765328241L	Request did not supply a ticket
KRB5KRB_AP_WRONG_PRINC	-1765328240L	Wrong principal in request
KRB5KRB_AP_ERR_TKT_INVALID	-1765328239L	Ticket has invalid flag set
KRB5_PRINC_NOMATCH	-1765328238L	Requested principal and ticket don't match
KRB5_KDCREP_MODIFIED	-1765328237L	KDC reply did not match expectations
KRB5_KDCREP_SKEW	-1765328236L	Clock skew too great in KDC reply
KRB5_IN_TKT_REALM_MISMATCH	-1765328235L	Client/server realm mismatch in initial ticket request
KRB5_PROG_ETYPE_NOSUPP	-1765328234L	Program lacks support for encryption type

TABLE B-8 Kerberos v5 Status Codes 4 (Continued)

Minor Status	Value	Meaning
KRB5_PROG_KEYTYPE_NOSUPP	-1765328233L	Program lacks support for key type
KRB5_WRONG_ETYPE	-1765328232L	Requested encryption type not used in message
KRB5_PROG_SUMTYPE_NOSUPP	-1765328231L	Program lacks support for checksum type
KRB5_REALM_UNKNOWN	-1765328230L	Cannot find KDC for requested realm
KRB5_SERVICE_UNKNOWN	-1765328229L	Kerberos service unknown
KRB5_KDC_UNREACH	-1765328228L	Cannot contact any KDC for requested realm
KRB5_NO_LOCALNAME	-1765328227L	No local name found for principal name
KRB5_MUTUAL_FAILED	-1765328226L	Mutual authentication failed
KRB5_RC_TYPE_EXISTS	-1765328225L	Replay cache type is already registered
KRB5_RC_MALLOC	-1765328224L	No more memory to allocate in replay cache code
KRB5_RC_TYPE_NOTFOUND	-1765328223L	Replay cache type is unknown

## Messages Returned in Kerberos v5 for Status Code 5

The following table lists the minor status messages that are returned in Kerberos v5 for status code 5

TABLE B-9 Kerberos v5 Status Codes 5

Minor Status	Value	Meaning
KRB5_RC_UNKNOWN	-1765328222L	Generic unknown RC error
KRB5_RC_REPLAY	-1765328221L	Message is a replay
KRB5_RC_IO	-1765328220L	Replay I/O operation failed
KRB5_RC_NOIO	-1765328219L	Replay cache type does not support non-volatile storage



TABLE B-9 Kerberos v5 Status Codes 5 (Continued)

Minor Status	Value	Meaning
KRB5_RC_PARSE	-1765328218L	Replay cache name parse and format error
KRB5_RC_IO_EOF	-1765328217L	End-of-file on replay cache I/O
KRB5_RC_IO_MALLOC	-1765328216L	No more memory to allocate in replay cache I/O code
KRB5_RC_IO_PERM	-1765328215L	Permission denied in replay cache code
KRB5_RC_IO_IO	-1765328214L	I/O error in replay cache i/o code
KRB5_RC_IO_UNKNOWN	-1765328213L	Generic unknown RC/IO error
KRB5_RC_IO_SPACE	-1765328212L	Insufficient system space to store replay information
KRB5_TRANS_CANTOPEN	-1765328211L	Can't open/find realm translation file
KRB5_TRANS_BADFORMAT	-1765328210L	Improper format of realm translation file
KRB5_LNAME_CANTOPEN	-1765328209L	Can't open or find lname translation database
KRB5_LNAME_NOTRANS	-1765328208L	No translation is available for requested principal
KRB5_LNAME_BADFORMAT	-1765328207L	Improper format of translation database entry
KRB5_CRYPTO_INTERNAL	-1765328206L	Cryptosystem internal error
KRB5_KT_BADNAME	-1765328205L	Key table name malformed
KRB5_KT_UNKNOWN_TYPE	-1765328204L	Unknown Key table type
KRB5_KT_NOTFOUND	-1765328203L	Key table entry not found
KRB5_KT_END	-1765328202L	End of key table reached
KRB5_KT_NOWRITE	-1765328201L	Cannot write to specified key table

## Messages Returned in Kerberos v5 for Status Code 6

The following table lists the minor status messages that are returned in Kerberos v5 for status code 6.

TABLE B-10 Kerberos v5 Status Codes 6

Minor Status	Value	Meaning
KRB5_KT_IOERR	-1765328200L	Error writing to key table
KRB5_NO_TKT_IN_RLM	-1765328199L	Cannot find ticket for requested realm
KRB5DES_BAD_KEYPAR	-1765328198L	DES key has bad parity
KRB5DES_WEAK_KEY	-1765328197L	DES key is a weak key
KRB5_BAD_ENCTYPE	-1765328196L	Bad encryption type
KRB5_BAD_KEYSIZE	-1765328195L	Key size is incompatible with encryption type
KRB5_BAD_MSIZ	-1765328194L	Message size is incompatible with encryption type
KRB5_CC_TYPE_EXISTS	-1765328193L	Credentials cache type is already registered
KRB5_KT_TYPE_EXISTS	-1765328192L	Key table type is already registered
KRB5_CC_IO	-1765328191L	Credentials cache I/O operation failed
KRB5_FCC_PERM	-1765328190L	Credentials cache file permissions incorrect
KRB5_FCC_NOFILE	-1765328189L	No credentials cache file found
KRB5_FCC_INTERNAL	-1765328188L	Internal file credentials cache error
KRB5_CC_WRITE	-1765328187L	Error writing to credentials cache file
KRB5_CC_NOMEM	-1765328186L	No more memory to allocate in credentials cache code
KRB5_CC_FORMAT	-1765328185L	Bad format in credentials cache

TABLE B-10 Kerberos v5 Status Codes 6 (Continued)

Minor Status	Value	Meaning
KRB5_INVALID_FLAGS	-1765328184L	Invalid KDC option combination, which is an internal library error
KRB5_NO_2ND_TKT	-1765328183L	Request missing second ticket
KRB5_NOCREDS_SUPPLIED	-1765328182L	No credentials supplied to library routine
KRB5_SENDAUTH_BADAUTHVERS	-1765328181L	Bad sendauth version was sent
KRB5_SENDAUTH_BADAPPLVERS	-1765328180L	Bad application version was sent by sendauth
KRB5_SENDAUTH_BADRESPONSE	-1765328179L	Bad response during sendauth exchange
KRB5_SENDAUTH_REJECTED	-1765328178L	Server rejected authentication during sendauth exchange

## Messages Returned in Kerberos v5 for Status Code 7

The following table lists the minor status messages that are returned in Kerberos v5 for status code 7.

TABLE B-11 Kerberos v5 Status Codes 7

Minor Status	Value	Meaning
KRB5_PREAUTH_BAD_TYPE	-1765328177L	Unsupported preauthentication type
KRB5_PREAUTH_NO_KEY	-1765328176L	Required preauthentication key not supplied
KRB5_PREAUTH_FAILED	-1765328175L	Generic preauthentication failure
KRB5_RCACHE_BADVNO	-1765328174L	Unsupported format version number for replay cache
KRB5_CCACHE_BADVNO	-1765328173L	Unsupported credentials cache format version number

TABLE B-11 Kerberos v5 Status Codes 7 (Continued)

Minor Status	Value	Meaning
KRB5_KEYTAB_BADVNO	-1765328172L	Unsupported version number for key table format
KRB5_PROG_ATYPE_NOSUPP	-1765328171L	Program lacks support for address type
KRB5_RC_REQUIRED	-1765328170L	Message replay detection requires rcache parameter
KRB5_ERR_BAD_HOSTNAME	-1765328169L	Host name cannot be canonicalized
KRB5_ERR_HOST_REALM_UNKNOWN	-1765328168L	Cannot determine realm for host
KRB5_SNAME_UNSUPP_NAMETYPE	-1765328167L	Conversion to service principal is undefined for name type
KRB5KRB_AP_ERR_V4_REPLY	-1765328166L	Initial Ticket response appears to be Version 4 error
KRB5_REALM_CANT_RESOLVE	-1765328165L	Cannot resolve KDC for requested realm
KRB5_TKT_NOT_FORWARDABLE	-1765328164L	The requesting ticket cannot get forwardable tickets
KRB5_FWD_BAD_PRINCIPAL	-1765328163L	Bad principal name while trying to forward credentials
KRB5_GET_IN_TKT_LOOP	-1765328162L	Looping detected inside krb5_get_in_tkt
KRB5_CONFIG_NODEFREALM	-1765328161L	Configuration file /etc/krb5/krb5.conf does not specify default realm
KRB5_SAM_UNSUPPORTED	-1765328160L	Bad SAM flags in obtain_sam_padata
KRB5_KT_NAME_TOOLONG	-1765328159L	Keytab name too long
KRB5_KT_KVNONOTFOUND	-1765328158L	Key version number for principal in key table is incorrect

TABLE B-11 Kerberos v5 Status Codes 7 (Continued)

Minor Status	Value	Meaning
KRB5_CONF_NOT_CONFIGURED	-1765328157L	Kerberos /etc/krb5/krb5.conf configuration file not configured
ERROR_TABLE_BASE_krb5	-1765328384L	default



## Specifying an OID

---

You should use the default QOP and mechanism provided by the GSS-API if at all possible. See “GSS-API OIDs” on page 69. However, you might have your own reasons for specifying OIDs. This appendix describes how to specify OIDs.

The following topics are covered.

- “Files with OID Values” on page 247
- “Constructing Mechanism OIDs” on page 249
- “Specifying a Non-Default Mechanism” on page 251

### Files with OID Values

For convenience, the GSS-API does allow mechanisms and QOPs to be displayed in human-readable form. On Oracle Solaris systems, two files, `/etc/gss/mech` and `/etc/gss/qop`, contain information about available mechanisms and available QOPs. If you do not have access to these files, then you must provide the string literals from some other source. The published Internet standard for that mechanism or QOP should serve that purpose.

#### `/etc/gss/mech` File

The `/etc/gss/mech` file lists the mechanisms that are available. `/etc/gss/mech` contains the names in both the numerical format and the alphabetic form. `/etc/gss/mech` presents the information in this format:

- Mechanism name, in ASCII
- Mechanism's OID
- Shared library for implementing the services that are provided by this mechanism
- Optionally, the kernel module for implementing the service

A sample `/etc/gss/mech` might look like [Example C-1](#).

**EXAMPLE C-1** The /etc/gss/mech File

```
#
# Copyright 2003 Sun Microsystems, Inc. All rights reserved.
# Use is subject to license terms.
#
#ident "@(#)mech 1.12 03/10/20 SMI"
#
# This file contains the GSS-API based security mechanism names,
# the associated object identifiers (OID) and a shared library that
# implements the services for the mechanisms under GSS-API.
#
# Mechanism Name      Object Identifier      Shared Library      Kernel Module
# [Options]
#
kerberos_v5          1.2.840.113554.1.2.2    mech_krb5.so      kmec_h_krb5
spnego               1.3.6.1.5.5.2           mech_spnego.so.1  [msinterop]
diffie_hellman_640_0 1.3.6.4.1.42.2.26.2.4    dh640-0.so.1
diffie_hellman_1024_0 1.3.6.4.1.42.2.26.2.5    dh1024-0.so.1
```

## /etc/gss/qop File

The /etc/gss/qop file stores, for all mechanisms installed, all the QOPs supported by each mechanism, both as an ASCII string and as the corresponding 32-bit integer. A sample /etc/gss/qop might look like the following example.

**EXAMPLE C-2** The /etc/gss/qop File

```
#
# Copyright (c) 2000, by Sun Microsystems, Inc.
# All rights reserved.
#
#ident "@(#)qop 1.3 00/11/09 SMI"
#
# This file contains information about the GSS-API based quality of
# protection (QOP), its string name and its value (32-bit integer).
#
# QOP string                QOP Value      Mechanism Name
#
GSS_KRB5_INTEG_C_QOP_DES_MD5  0                kerberos_v5
GSS_KRB5_CONF_C_QOP_DES      0                kerberos_v5
```

## gss\_str\_to\_oid() Function

For backward compatibility with earlier versions of the GSS-API, this implementation of the GSS-API supports the function `gss_str_to_oid()`. `gss_str_to_oid()` converts a string that represents a mechanism or QOP to an OID. The string can be either as a number or a word.





---

**Caution** – `gss_str_to_oid()`, `gss_oid_to_str()`, and `gss_release_oid()` are not supported by some implementations of the GSS-API to discourage the use of explicit, non-default mechanisms and QOPs.

---

The mechanism string can be hard-coded in the application or come from user input. However, not all implementations of the GSS-API support `gss_str_to_oid()`, so applications should not rely on this function.

The number that represents a mechanism can have two different formats. The first format, { 1 2 3 4 }, is officially mandated by the GSS-API specifications. The second format, 1.2.3.4, is more widely used but is not an official standard format. `gss_str_to_oid()` expects the mechanism number in the first format, so you must convert the string if the string is in the second format before calling `gss_str_to_oid()`. An example of `gss_str_to_oid()` is shown in [Example C-3](#). If the mechanism is not a valid one, `gss_str_to_oid()` returns `GSS_S_BAD_MECH`.

Because `gss_str_to_oid()` allocates GSS-API data space, the `gss_release_oid()` function exists to remove the allocated OID when you are finished. Like `gss_str_to_oid()`, `gss_release_oid()` is not a generally supported function and should not be relied upon in programs that aspire to universal portability.

## Constructing Mechanism OIDs

Because `gss_str_to_oid()` cannot always be used, there are alternative techniques for finding and selecting mechanisms. One way is to construct a mechanism OID manually and then compare that mechanism to a set of available mechanisms. Another way is to get the set of available mechanisms and choose one from the set.

The `gss_OID` type has the following form:

```
typedef struct gss_OID_desc struct {
    OM_uint32 length;
    void *elements;
} gss_OID_desc, *gss_OID;
```

where the *elements* field of this structure points to the first byte of an octet string containing the ASN.1 BER encoding of the value portion of the normal BER TLV encoding of the `gss_OID`. The *length* field contains the number of bytes in this value. For example, the `gss_OID` value that corresponds to the DASS X.509 authentication mechanism has a *length* field of 7 and an *elements* field that points to the following octal values: 53, 14, 2, 207, 163, 7, 5.

One way to construct a mechanism OID is to declare a `gss_OID` and then initialize the elements manually to represent a given mechanism. As above, the input for the *elements* values can be hard-coded, obtained from a table, or entered by a user. This method is somewhat more painstaking than using `gss_str_to_oid()` but achieves the same effect.

This constructed `gss_OID` can then be compared against a set of available mechanisms that have been returned by the functions `gss_indicate_mechs()` or `gss_inquire_mechs_for_name()`. The application can check for the constructed mechanism OID in this set of available mechanisms by using the `gss_test_oid_set_member()` function. If `gss_test_oid_set_member()` does not return an error, then the constructed OID can be used as the mechanism for GSS-API transactions.

As an alternative to constructing a preset OID, the application can use `gss_indicate_mechs()` or `gss_inquire_mechs_for_name()` to get the `gss_OID_set` of available mechanisms. A `gss_OID_set` has the following form:

```
typedef struct gss_OID_set_desc_struct {
    OM_uint32 length;
    void      *elements;
} gss_OID_set_desc, *gss_OID_set;
```

where each of the elements is a `gss_OID` that represents a mechanism. The application can then parse each mechanism and display the numerical representation. A user can use this display to choose the mechanism. The application then sets the mechanism to the appropriate member of the `gss_OID_set`. The application can also compare the desired mechanisms against a list of preferred mechanisms.

## createMechOid() Function

This function is shown for the sake of completeness. Normally, you should use the default mechanism, which is specified by `GSS_C_NULL_OID`.

### EXAMPLE C-3 createMechOid() Function

```
gss_OID createMechOid(const char *mechStr)
{
    gss_buffer_desc mechDesc;
    gss_OID mechOid;
    OM_uint32 minor;

    if (mechStr == NULL)
        return (GSS_C_NULL_OID);

    mechDesc.length = strlen(mechStr);
    mechDesc.value = (void *) mechStr;

    if (gss_str_to_oid(&minor, &mechDesc, &mechOid) !
        = GSS_S_COMPLETE) {
        fprintf(stderr, "Invalid mechanism oid specified <%s>",
            mechStr);
        return (GSS_C_NULL_OID);
    }

    return (mechOid);
}
```

## Specifying a Non-Default Mechanism

`parse_oid()` converts the name of a security mechanism on the command line to a compatible OID.

### EXAMPLEC-4 `parse_oid()` Function

```
static void parse_oid(char *mechanism, gss_OID *oid)
{
    char      *mechstr = 0, *cp;
    gss_buffer_desc tok;
    OM_uint32 maj_stat, min_stat;

    if (isdigit(mechanism[0])) {
        mechstr = malloc(strlen(mechanism)+5);
        if (!mechstr) {
            printf("Couldn't allocate mechanism scratch!\n");
            return;
        }
        sprintf(mechstr, "{ %s }", mechanism);
        for (cp = mechstr; *cp; cp++)
            if (*cp == ',')
                *cp = ' ';
        tok.value = mechstr;
    } else
        tok.value = mechanism;
    tok.length = strlen(tok.value);
    maj_stat = gss_str_to_oid(&min_stat, &tok, oid);
    if (maj_stat != GSS_S_COMPLETE) {
        display_status("str_to_oid", maj_stat, min_stat);
        return;
    }
    if (mechstr)
        free(mechstr);
}
```



## Source Code for SASL Example

---

This appendix contains the source code for the example in “SASL Example” on page 138. The appendix includes the following topics:

- “SASL Client Example” on page 253
- “SASL Server Example” on page 261
- “Common Code” on page 269

### SASL Client Example

The following code listing is for the sample client in “SASL Example” on page 138.

---

**Note** – The source code for this example is also available through the Sun download center. See <http://www.sun.com/download/products.xml?id=41912db5>.

---

```
#pragma ident    "@(#)client.c    1.4    03/04/07 SMI"
/* $Id: client.c,v 1.3 2002/09/03 15:11:59 rjs3 Exp $ */
/*
 * Copyright (c) 2001 Carnegie Mellon University.  All rights reserved.
 *
 * Redistribution and use in source and binary forms, with or without
 * modification, are permitted provided that the following conditions
 * are met:
 *
 * 1. Redistributions of source code must retain the above copyright
 *    notice, this list of conditions and the following disclaimer.
 *
 * 2. Redistributions in binary form must reproduce the above copyright
 *    notice, this list of conditions and the following disclaimer in
 *    the documentation and/or other materials provided with the
 *    distribution.
 *
 * 3. The name "Carnegie Mellon University" must not be used to
 *    endorse or promote products derived from this software without
```

```
*   prior written permission. For permission or any other legal
*   details, please contact
*   Office of Technology Transfer
*   Carnegie Mellon University
*   5000 Forbes Avenue
*   Pittsburgh, PA 15213-3890
*   (412) 268-4387, fax: (412) 268-7395
*   tech-transfer@andrew.cmu.edu
*
* 4. Redistributions of any form whatsoever must retain the following
* acknowledgment:
* "This product includes software developed by Computing Services
* at Carnegie Mellon University (http://www.cmu.edu/computing/)."
*
* CARNEGIE MELLON UNIVERSITY DISCLAIMS ALL WARRANTIES WITH REGARD TO
* THIS SOFTWARE, INCLUDING ALL IMPLIED WARRANTIES OF MERCHANTABILITY
* AND FITNESS, IN NO EVENT SHALL CARNEGIE MELLON UNIVERSITY BE LIABLE
* FOR ANY SPECIAL, INDIRECT OR CONSEQUENTIAL DAMAGES OR ANY DAMAGES
* WHATSOEVER RESULTING FROM LOSS OF USE, DATA OR PROFITS, WHETHER IN
* AN ACTION OF CONTRACT, NEGLIGENCE OR OTHER TORTIOUS ACTION, ARISING
* OUT OF OR IN CONNECTION WITH THE USE OR PERFORMANCE OF THIS SOFTWARE.
*/

#include <config.h>

#include <stdio.h>
#include <stdlib.h>
#include <stdarg.h>
#include <ctype.h>
#include <errno.h>
#include <string.h>

#ifdef HAVE_UNISTD_H
#include <unistd.h>
#endif

#include <sys/socket.h>
#include <netinet/in.h>
#include <arpa/inet.h>
#include <netdb.h>
#ifdef _SUN_SDK
#include <sysexits.h>
#endif /* _SUN_SDK */

#include <assert.h>

#include <sasl.h>

#include "common.h"

/* remove \r\n at end of the line */
static void chop(char *s)
{
    char *p;

    assert(s);
    p = s + strlen(s) - 1;
    if (p[0] == '\n') {
        *p-- = '\0';
    }
}
```

```

    }
    if (p >= s && p[0] == '\r') {
        *p-- = '\0';
    }
}

static int getrealm(void *context __attribute__((unused)),
                  int id,
                  const char **availrealms,
                  const char **result)
{
    static char buf[1024];

    /* Double-check the ID */
    if (id != SASL_CB_GETREALM) return SASL_BADPARAM;
    if (!result) return SASL_BADPARAM;

    printf("please choose a realm (available:");
    while (*availrealms) {
        printf(" %s", *availrealms);
        availrealms++;
    }
    printf("): ");

    fgets(buf, sizeof buf, stdin);
    chop(buf);
    *result = buf;

    return SASL_OK;
}

static int simple(void *context __attribute__((unused)),
                 int id,
                 const char **result,
                 unsigned *len)
{
    static char buf[1024];

    /* Double-check the connection */
    if (!result)
        return SASL_BADPARAM;

    switch (id) {
    case SASL_CB_USER:
        printf("please enter an authorization id: ");
        break;
    case SASL_CB_AUTHNAME:
        printf("please enter an authentication id: ");
        break;
    default:
        return SASL_BADPARAM;
    }

    fgets(buf, sizeof buf, stdin);
    chop(buf);
    *result = buf;
    if (len) *len = strlen(buf);

    return SASL_OK;
}

```

```

}

#ifdef HAVE_GETPASSPHRASE
static char *
getpassphrase(const char *prompt)
{
    return getpass(prompt);
}
#endif /* ! HAVE_GETPASSPHRASE */

static int
getsecret(sasl_conn_t *conn,
          void *context __attribute__((unused)),
          int id,
          sasl_secret_t **psecret)
{
    char *password;
    size_t len;
    static sasl_secret_t *x;

    /* paranoia check */
    if (! conn || ! psecret || id != SASL_CB_PASS)
        return SASL_BADPARAM;

    password = getpassphrase("Password: ");
    if (! password)
        return SASL_FAIL;

    len = strlen(password);

    x = (sasl_secret_t *) realloc(x, sizeof(sasl_secret_t) + len);

    if (!x) {
        memset(password, 0, len);
        return SASL_NOMEM;
    }

    x->len = len;
#ifdef _SUN_SDK_
    strcpy((char *)x->data, password);
#else
    strcpy(x->data, password);
#endif /* _SUN_SDK_ */
    memset(password, 0, len);

    *psecret = x;
    return SASL_OK;
}

static int getpath(void * context __attribute__((unused)),
                  const char **path)
{
    *path = getenv("SASL_PATH");

    if (*path == NULL)
        *path = PLUGINDIR;

    return SASL_OK;
}

```



```

/* callbacks we support */
static sasl_callback_t callbacks[] = {
    {
        SASL_CB_GETREALM, &getrealm, NULL
    }, {
        SASL_CB_USER, &simple, NULL
    }, {
        SASL_CB_AUTHNAME, &simple, NULL
    }, {
        SASL_CB_PASS, &getsecret, NULL
    }, {
        SASL_CB_GETPATH, &getpath, NULL
    }, {
        SASL_CB_LIST_END, NULL, NULL
    }
};

int getconn(const char *host, const char *port)
{
    struct addrinfo hints, *ai, *r;
    int err, sock = -1;

    memset(&hints, 0, sizeof(hints));
    hints.ai_family = PF_UNSPEC;
    hints.ai_socktype = SOCK_STREAM;

    if ((err = getaddrinfo(host, port, &hints, &ai)) != 0) {
        fprintf(stderr, "getaddrinfo: %s\n", gai_strerror(err));
        exit(EX_UNAVAILABLE);
    }

    for (r = ai; r; r = r->ai_next) {
        sock = socket(r->ai_family, r->ai_socktype, r->ai_protocol);
        if (sock < 0)
            continue;
        if (connect(sock, r->ai_addr, r->ai_addrlen) >= 0)
            break;
        close(sock);
        sock = -1;
    }

    freeaddrinfo(ai);
    if (sock < 0) {
        perror("connect");
        exit(EX_UNAVAILABLE);
    }

    return sock;
}

char *mech;

int mysasl_negotiate(FILE *in, FILE *out, sasl_conn_t *conn)
{
    char buf[8192];
    const char *data;
    const char *chosenmech;
#ifdef _SUN_SDK_

```

```
    unsigned len;
#else
    int len;
#endif /* _SUN_SDK_ */
    int r, c;

    /* get the capability list */
    dprintf(0, "receiving capability list... ");
    len = recv_string(in, buf, sizeof buf);
    dprintf(0, "%s\n", buf);

    if (mech) {
        /* make sure that 'mech' appears in 'buf' */
        if (!strstr(buf, mech)) {
            printf("server doesn't offer mandatory mech '%s'\n", mech);
            return -1;
        }
    } else {
        mech = buf;
    }

    r = sasl_client_start(conn, mech, NULL, &data, &len, &chosenmech);
    if (r != SASL_OK && r != SASL_CONTINUE) {
        sasler(r, "starting SASL negotiation");
        printf("\n%s\n", sasl_errdetail(conn));
        return -1;
    }

    dprintf(1, "using mechanism %s\n", chosenmech);

    /* we send up to 3 strings;
       the mechanism chosen, the presence of initial response,
       and optionally the initial response */
    send_string(out, chosenmech, strlen(chosenmech));
    if(data) {
        send_string(out, "Y", 1);
        send_string(out, data, len);
    } else {
        send_string(out, "N", 1);
    }

    for (;;) {
        dprintf(2, "waiting for server reply...\n");

        c = fgetc(in);
        switch (c) {
            case 'O':
                goto done_ok;

            case 'N':
                goto done_no;

            case 'C': /* continue authentication */
                break;

            default:
                printf("bad protocol from server (%c %x)\n", c, c);
                return -1;
        }
    }
}
```

```

    len = recv_string(in, buf, sizeof buf);

    r = sasl_client_step(conn, buf, len, NULL, &data, &len);
    if (r != SASL_OK && r != SASL_CONTINUE) {
        saslerr(r, "performing SASL negotiation");
        printf("\n%s\n", sasl_errdetail(conn));
        return -1;
    }

    if (data) {
        dprintf(2, "sending response length %d...\n", len);
        send_string(out, data, len);
    } else {
        dprintf(2, "sending null response...\n");
        send_string(out, "", 0);
    }
}

done_ok:
    printf("successful authentication\n");
    return 0;

done_no:
    printf("authentication failed\n");
    return -1;
}

#ifdef _SUN_SDK_
void usage(const char *s)
#else
void usage(void)
#endif /* _SUN_SDK_ */
{
#ifdef _SUN_SDK_
    fprintf(stderr, "usage: %s [-p port] [-s service] [-m mech] host\n", s);
#else
    fprintf(stderr, "usage: client [-p port] [-s service] \
        [-m mech] host\n");
#endif /* _SUN_SDK_ */
    exit(EX_USAGE);
}

int main(int argc, char *argv[])
{
    int c;
    char *host = "localhost";
    char *port = "12345";
    char localaddr[NI_MAXHOST + NI_MAXSERV],
        remoteaddr[NI_MAXHOST + NI_MAXSERV];
    char *service = "rcmd";
    char hbuf[NI_MAXHOST], pbuf[NI_MAXSERV];
    int r;
    sasl_conn_t *conn;
    FILE *in, *out;
    int fd;
    int salen;
    struct sockaddr_storage local_ip, remote_ip;

    while ((c = getopt(argc, argv, "p:s:m:")) != EOF) {

```

```

switch(c) {
case 'p':
    port = optarg;
    break;

case 's':
    service = optarg;
    break;

case 'm':
    mech = optarg;
    break;

default:
#ifdef _SUN_SDK_
    usage(argv[0]);
#else
    usage();
#endif /* _SUN_SDK_ */
}

if (optind > argc - 1) {
#ifdef _SUN_SDK_
    usage(argv[0]);
#else
    usage();
#endif /* _SUN_SDK_ */
}
if (optind == argc - 1) {
    host = argv[optind];
}

/* initialize the sasl library */
r = sasl_client_init(callbacks);
if (r != SASL_OK) saslfail(r, "initializing libsasl");

/* connect to remote server */
fd = getconn(host, port);

/* set ip addresses */
salen = sizeof(local_ip);
if (getsockname(fd, (struct sockaddr *)&local_ip, &salen) < 0) {
    perror("getsockname");
}

getnameinfo((struct sockaddr *)&local_ip, salen,
            hbuf, sizeof(hbuf), pbuf, sizeof(pbuf),
#ifdef _SUN_SDK_ /* SOLARIS doesn't support NI_WITHSCOPEID */
            NI_NUMERICHOST | NI_NUMERICSERV);
#else
            NI_NUMERICHOST | NI_WITHSCOPEID | NI_NUMERICSERV);
#endif
    snprintf(localaddr, sizeof(localaddr), "%s;%s", hbuf, pbuf);

    salen = sizeof(remote_ip);
    if (getpeername(fd, (struct sockaddr *)&remote_ip, &salen) < 0) {
        perror("getpeername");
    }
}

```

```

    }

    getnameinfo((struct sockaddr *)&remote_ip, salen,
                hbuf, sizeof(hbuf), pbuf, sizeof(pbuf),
#ifdef _SUN_SDK /* SOLARIS doesn't support NI_WITHSCOPEID */
                NI_NUMERICHOST | NI_NUMERICSERV);
#else
                NI_NUMERICHOST | NI_WITHSCOPEID | NI_NUMERICSERV);
#endif
    snprintf(remoteaddr, sizeof(remoteaddr), "%s;%s", hbuf, pbuf);

    /* client new connection */
    r = sasl_client_new(service, host, localaddr, remoteaddr, NULL,
                       0, &conn);
    if (r != SASL_OK) saslfail(r, "allocating connection state");

    /* set external properties here
       sasl_setprop(conn, SASL_SSF_EXTERNAL, &extprops); */

    /* set required security properties here
       sasl_setprop(conn, SASL_SEC_PROPS, &secprops); */

    in = fdopen(fd, "r");
    out = fdopen(fd, "w");

    r = mysasl_negotiate(in, out, conn);
    if (r == SASL_OK) {
        /* send/receive data */

    }

    printf("closing connection\n");
    fclose(in);
    fclose(out);
    close(fd);
    sasl_dispose(&conn);

    sasl_done();

    return 0;
}

```

## SASL Server Example

The following code listing is for the sample server in “SASL Example” on page 138.

---

**Note** – The source code for this example is also available through the Sun download center. See <http://www.sun.com/download/products.xml?id=41912db5>.

---

```

#pragma ident    "@(#)server.c    1.3    03/04/07 SMI"
/* $Id: server.c,v 1.4 2002/10/07 05:04:05 rjs3 Exp $ */
/*

```

```
* Copyright (c) 2001 Carnegie Mellon University. All rights reserved.
*
* Redistribution and use in source and binary forms, with or without
* modification, are permitted provided that the following conditions
* are met:
*
* 1. Redistributions of source code must retain the above copyright
* notice, this list of conditions and the following disclaimer.
*
* 2. Redistributions in binary form must reproduce the above copyright
* notice, this list of conditions and the following disclaimer in
* the documentation and/or other materials provided with the
* distribution.
*
* 3. The name "Carnegie Mellon University" must not be used to
* endorse or promote products derived from this software without
* prior written permission. For permission or any other legal
* details, please contact
* Office of Technology Transfer
* Carnegie Mellon University
* 5000 Forbes Avenue
* Pittsburgh, PA 15213-3890
* (412) 268-4387, fax: (412) 268-7395
* tech-transfer@andrew.cmu.edu
*
* 4. Redistributions of any form whatsoever must retain the following
* acknowledgment:
* "This product includes software developed by Computing Services
* at Carnegie Mellon University (http://www.cmu.edu/computing/)."
```

CARNEGIE MELLON UNIVERSITY DISCLAIMS ALL WARRANTIES WITH REGARD TO  
THIS SOFTWARE, INCLUDING ALL IMPLIED WARRANTIES OF MERCHANTABILITY  
AND FITNESS, IN NO EVENT SHALL CARNEGIE MELLON UNIVERSITY BE LIABLE  
FOR ANY SPECIAL, INDIRECT OR CONSEQUENTIAL DAMAGES OR ANY DAMAGES  
WHATSOEVER RESULTING FROM LOSS OF USE, DATA OR PROFITS, WHETHER IN  
AN ACTION OF CONTRACT, NEGLIGENCE OR OTHER TORTIOUS ACTION, ARISING  
OUT OF OR IN CONNECTION WITH THE USE OR PERFORMANCE OF THIS SOFTWARE.

```
*/

#include <config.h>

#include <stdio.h>
#include <stdlib.h>
#include <stdarg.h>
#include <ctype.h>
#include <errno.h>
#include <string.h>

#ifdef HAVE_UNISTD_H
#include <unistd.h>
#endif

#include <sys/socket.h>
#include <netinet/in.h>
#include <arpa/inet.h>
#include <netdb.h>
#ifdef _SUN_SDK
#include <syssexits.h>
#endif /* _SUN_SDK */
```

```

#include <sasL.h>

#include "common.h"

#if !defined(IPV6_BINDV6ONLY) && defined(IN6P_IPV6_V6ONLY)
#define IPV6_BINDV6ONLY IN6P_BINDV6ONLY
#endif
#if !defined(IPV6_V6ONLY) && defined(IPV6_BINDV6ONLY)
#define IPV6_V6ONLY IPV6_BINDV6ONLY
#endif
#ifndef IPV6_BINDV6ONLY
#undef IPV6_V6ONLY
#endif

static int getpath(void * context __attribute__((unused)),
                  const char **path)
{
    *path = getenv("SASL_PATH");

    if (*path == NULL)
        *path = PLUGINDIR;

    return SASL_OK;
}

/* callbacks we support */
static sasl_callback_t callbacks[] = {
    {
        SASL_CB_GETPATH, &getpath, NULL
    }, {
        SASL_CB_LIST_END, NULL, NULL
    }
};

/* create a socket listening on port 'port' */
/* if af is PF_UNSPEC more than one socket might be returned */
/* the returned list is dynamically allocated, so caller needs to free it */
int *listensock(const char *port, const int af)
{
    struct addrinfo hints, *ai, *r;
    int err, maxs, *sock, *socks;
    const int on = 1;

    memset(&hints, 0, sizeof(hints));
    hints.ai_flags = AI_PASSIVE;
    hints.ai_family = af;
    hints.ai_socktype = SOCK_STREAM;
    err = getaddrinfo(NULL, port, &hints, &ai);
    if (err) {
        fprintf(stderr, "%s\n", gai_strerror(err));
        exit(EX_USAGE);
    }

    /* Count max number of sockets we can open */
    for (maxs = 0, r = ai; r; r = r->ai_next, maxs++)
        ;
    socks = malloc((maxs + 1) * sizeof(int));
    if (!socks) {

```

```

    fprintf(stderr, "couldn't allocate memory for sockets\n");
    freeaddrinfo(ai);
    exit(EX_OSERR);
}

socks[0] = 0; /* num of sockets counter at start of array */
sock = socks + 1;
for (r = ai; r; r = r->ai_next) {
    fprintf(stderr, "trying %d, %d, %d\n", r->ai_family, r->ai_socktype,
        r->ai_protocol);
    *sock = socket(r->ai_family, r->ai_socktype, r->ai_protocol);
    if (*sock < 0) {
        perror("socket");
        continue;
    }
    if (setsockopt(*sock, SOL_SOCKET, SO_REUSEADDR,
        (void *) &on, sizeof(on)) < 0) {
        perror("setsockopt(SO_REUSEADDR)");
        close(*sock);
        continue;
    }
#ifdef IPV6_V6ONLY && !(defined(__FreeBSD__) && __FreeBSD__ < 3)
    if (r->ai_family == AF_INET6) {
        if (setsockopt(*sock, IPPROTO_IPV6, IPV6_BINDV6ONLY,
            (void *) &on, sizeof(on)) < 0) {
            perror("setsockopt (IPV6_BINDV6ONLY)");
            close(*sock);
            continue;
        }
    }
#endif
    if (bind(*sock, r->ai_addr, r->ai_addrlen) < 0) {
        perror("bind");
        close(*sock);
        continue;
    }

    if (listen(*sock, 5) < 0) {
        perror("listen");
        close(*sock);
        continue;
    }

    socks[0]++;
    sock++;
}

freeaddrinfo(ai);

if (socks[0] == 0) {
    fprintf(stderr, "Couldn't bind to any socket\n");
    free(socks);
    exit(EX_OSERR);
}

return socks;
}

#ifdef _SUN_SDK_

```



```

void usage(const char *s)
#else
void usage(void)
#endif /* _SUN_SDK_ */
{
#ifdef _SUN_SDK_
    fprintf(stderr, "usage: %s [-p port] [-s service] [-m mech]\n", s);
#else
    fprintf(stderr, "usage: server [-p port] [-s service] [-m mech]\n");
#endif /* _SUN_SDK_ */
    exit(EX_USAGE);
}

/* Globals are used here, but local variables are preferred */
char *mech;

/* do the sasl negotiation; return -1 if it fails */
int mysasl_negotiate(FILE *in, FILE *out, sasl_conn_t *conn)
{
    char buf[8192];
    char chosenmech[128];
    const char *data;
#ifdef _SUN_SDK_
    unsigned len;
#else
    int len;
#endif /* _SUN_SDK_ */
    int r = SASL_FAIL;
    const char *userid;

    /* generate the capability list */
    if (mech) {
        dprintf(2, "forcing use of mechanism %s\n", mech);
        data = strdup(mech);
    } else {
        int count;

        dprintf(1, "generating client mechanism list... ");
        r = sasl_listmech(conn, NULL, NULL, " ", NULL,
            &data, &len, &count);
        if (r != SASL_OK) saslfail(r, "generating mechanism list");
        dprintf(1, "%d mechanisms\n", count);
    }

    /* send capability list to client */
    send_string(out, data, len);

    dprintf(1, "waiting for client mechanism...\n");
    len = rcv_string(in, chosenmech, sizeof chosenmech);
    if (len <= 0) {
        printf("client didn't choose mechanism\n");
        fputc('N', out); /* send NO to client */
        fflush(out);
        return -1;
    }

    if (mech && strcasecmp(mech, chosenmech)) {
        printf("client didn't choose mandatory mechanism\n");
        fputc('N', out); /* send NO to client */
    }
}

```

```
fflush(out);
return -1;
}

len = recv_string(in, buf, sizeof(buf));
if(len != 1) {
    saslerr(r, "didn't receive first-send parameter correctly");
    fputc('N', out);
    fflush(out);
    return -1;
}

if(buf[0] == 'Y') {
    /* receive initial response (if any) */
    len = recv_string(in, buf, sizeof(buf));

    /* start libsassl negotiation */
    r = sasl_server_start(conn, chosenmech, buf, len,
        &data, &len);
} else {
    r = sasl_server_start(conn, chosenmech, NULL, 0,
        &data, &len);
}

if (r != SASL_OK && r != SASL_CONTINUE) {
    saslerr(r, "starting SASL negotiation");
    fputc('N', out); /* send NO to client */
    fflush(out);
    return -1;
}

while (r == SASL_CONTINUE) {
    if (data) {
        dprintf(2, "sending response length %d...\n", len);
        fputc('C', out); /* send CONTINUE to client */
        send_string(out, data, len);
    } else {
        dprintf(2, "sending null response...\n");
        fputc('C', out); /* send CONTINUE to client */
        send_string(out, "", 0);
    }
}

dprintf(1, "waiting for client reply...\n");
len = recv_string(in, buf, sizeof buf);
if (len < 0) {
    printf("client disconnected\n");
    return -1;
}

r = sasl_server_step(conn, buf, len, &data, &len);
if (r != SASL_OK && r != SASL_CONTINUE) {
    saslerr(r, "performing SASL negotiation");
    fputc('N', out); /* send NO to client */
    fflush(out);
    return -1;
}
}

if (r != SASL_OK) {
```

```

        saslerr(r, "incorrect authentication");
        fputc('N', out); /* send NO to client */
        fflush(out);
        return -1;
    }

    fputc('O', out); /* send OK to client */
    fflush(out);
    dprintf(1, "negotiation complete\n");

    r = sasl_getprop(conn, SASL_USERNAME, (const void **) &userid);
    printf("successful authentication '%s'\n", userid);

    return 0;
}

int main(int argc, char *argv[])
{
    int c;
    char *port = "12345";
    char *service = "rcmd";
    int *l, maxfd=0;
    int r, i;
    sasl_conn_t *conn;

    while ((c = getopt(argc, argv, "p:s:m:")) != EOF) {
        switch(c) {
            case 'p':
                port = optarg;
                break;

            case 's':
                service = optarg;
                break;

            case 'm':
                mech = optarg;
                break;

            default:
#ifdef _SUN_SDK
                usage(argv[0]);
#else
                usage();
#endif /* _SUN_SDK */
                break;
        }
    }

    /* initialize the sasl library */
    r = sasl_server_init(callbacks, "sample");
    if (r != SASL_OK) saslfail(r, "initializing libsasl");

    /* get a listening socket */
    if ((l = listensock(port, PF_UNSPEC)) == NULL) {
        saslfail(SASL_FAIL, "allocating listensock");
    }

    for (i = 1; i <= l[0]; i++) {

```

```

        if (l[i] > maxfd)
            maxfd = l[i];
    }

    for (;;) {
        char localaddr[NI_MAXHOST | NI_MAXSERV],
            remoteaddr[NI_MAXHOST | NI_MAXSERV];
        char myhostname[1024+1];
        char hbuf[NI_MAXHOST], pbuf[NI_MAXSERV];
        struct sockaddr_storage local_ip, remote_ip;
        int salen;
        int nfds, fd = -1;
        FILE *in, *out;
        fd_set readfds;

        FD_ZERO(&readfds);
        for (i = 1; i <= l[0]; i++)
            FD_SET(l[i], &readfds);

        nfds = select(maxfd + 1, &readfds, 0, 0, 0);
        if (nfds <= 0) {
            if (nfds < 0 && errno != EINTR)
                perror("select");
            continue;
        }

        for (i = 1; i <= l[0]; i++)
            if (FD_ISSET(l[i], &readfds)) {
                fd = accept(l[i], NULL, NULL);
                break;
            }

        if (fd < 0) {
            if (errno != EINTR)
                perror("accept");
            continue;
        }

        printf("accepted new connection\n");

        /* set ip addresses */
        salen = sizeof(local_ip);
        if (getsockname(fd, (struct sockaddr *)&local_ip, &salen) < 0) {
            perror("getsockname");
        }
        getnameinfo((struct sockaddr *)&local_ip, salen,
                    hbuf, sizeof(hbuf), pbuf, sizeof(pbuf),
#ifdef _SUN_SDK /* SOLARIS doesn't support NI_WITHSCOPEID */
                    NI_NUMERICHOST | NI_NUMERICSERV);
#else
                    NI_NUMERICHOST | NI_WITHSCOPEID | NI_NUMERICSERV);
#endif
        snprintf(localaddr, sizeof(localaddr), "%s;%s", hbuf, pbuf);

        salen = sizeof(remote_ip);
        if (getpeername(fd, (struct sockaddr *)&remote_ip, &salen) < 0) {
            perror("getpeername");
        }
    }

```

```

        getnameinfo((struct sockaddr *)&remote_ip, salen,
                    hbuf, sizeof(hbuf), pbuf, sizeof(pbuf),
#ifdef _SUN_SDK /* SOLARIS doesn't support NI_WITHSCOPEID */
                    NI_NUMERICHOST | NI_NUMERICSERV);
#else
                    NI_NUMERICHOST | NI_WITHSCOPEID | NI_NUMERICSERV);
#endif
        snprintf(remoteaddr, sizeof(remoteaddr), "%s;%s", hbuf, pbuf);

        r = gethostname(myhostname, sizeof(myhostname)-1);
        if(r == -1) saslfail(r, "getting hostname");

        r = sasl_server_new(service, myhostname, NULL, localaddr, remoteaddr,
                            NULL, 0, &conn);
        if (r != SASL_OK) saslfail(r, "allocating connection state");

        /* set external properties here
           sasl_setprop(conn, SASL_SSF_EXTERNAL, &extprops); */

        /* set required security properties here
           sasl_setprop(conn, SASL_SEC_PROPS, &secprops); */

        in = fdopen(fd, "r");
        out = fdopen(fd, "w");

        r = mysasl_negotiate(in, out, conn);
        if (r == SASL_OK) {
            /* send/receive data */

        }

        printf("closing connection\n");
        fclose(in);
        fclose(out);
        close(fd);
        sasl_dispose(&conn);
    }

    sasl_done();
}

```

## Common Code

The following code sample includes listings for miscellaneous SASL functions.

---

**Note** – The source code for this example is also available through the Sun download center. See <http://www.sun.com/download/products.xml?id=41912db5>.

---

```

#pragma ident    "@(#)common.c    1.1    03/03/28 SMI"
/* $Id: common.c,v 1.3 2002/09/03 15:11:59 rjs3 Exp $ */
/*
 * Copyright (c) 2001 Carnegie Mellon University. All rights reserved.

```

```
*
* Redistribution and use in source and binary forms, with or without
* modification, are permitted provided that the following conditions
* are met:
*
* 1. Redistributions of source code must retain the above copyright
* notice, this list of conditions and the following disclaimer.
*
* 2. Redistributions in binary form must reproduce the above copyright
* notice, this list of conditions and the following disclaimer in
* the documentation and/or other materials provided with the
* distribution.
*
* 3. The name "Carnegie Mellon University" must not be used to
* endorse or promote products derived from this software without
* prior written permission. For permission or any other legal
* details, please contact
* Office of Technology Transfer
* Carnegie Mellon University
* 5000 Forbes Avenue
* Pittsburgh, PA 15213-3890
* (412) 268-4387, fax: (412) 268-7395
* tech-transfer@andrew.cmu.edu
*
* 4. Redistributions of any form whatsoever must retain the following
* acknowledgment:
* "This product includes software developed by Computing Services
* at Carnegie Mellon University (http://www.cmu.edu/computing/)."
*
* CARNEGIE MELLON UNIVERSITY DISCLAIMS ALL WARRANTIES WITH REGARD TO
* THIS SOFTWARE, INCLUDING ALL IMPLIED WARRANTIES OF MERCHANTABILITY
* AND FITNESS, IN NO EVENT SHALL CARNEGIE MELLON UNIVERSITY BE LIABLE
* FOR ANY SPECIAL, INDIRECT OR CONSEQUENTIAL DAMAGES OR ANY DAMAGES
* WHATSOEVER RESULTING FROM LOSS OF USE, DATA OR PROFITS, WHETHER IN
* AN ACTION OF CONTRACT, NEGLIGENCE OR OTHER TORTIOUS ACTION, ARISING
* OUT OF OR IN CONNECTION WITH THE USE OR PERFORMANCE OF THIS SOFTWARE.
*/

#include <config.h>

#include <stdio.h>
#include <ctype.h>
#include <stdarg.h>
#ifdef _SUN_SDK_
#include <syssexits.h>
#endif /* _SUN_SDK_ */

#include <sasl.h>

/* send/recv library for IMAP4 style literals.

   really not important; just one way of doing length coded strings */

int send_string(FILE *f, const char *s, int l)
{
    int al;

    al = fprintf(f, "{%d}\r\n", l);
    fwrite(s, 1, l, f);
}
```

```

    fflush(f);

    printf("send: {%d}\n", l);
    while (l--) {
        if (isprint((unsigned char) *s)) {
            printf("%c", *s);
        } else {
            printf("[%X]", (unsigned char) *s);
        }
        s++;
    }
    printf("\n");

    return al;
}

int recv_string(FILE *f, char *buf, int buflen)
{
    int c;
    int len, l;
    char *s;

    c = fgetc(f);
    if (c != '{') return -1;

    /* read length */
    len = 0;
    c = fgetc(f);
    while (isdigit(c)) {
        len = len * 10 + (c - '0');
        c = fgetc(f);
    }
    if (c != '}') return -1;
    c = fgetc(f);
    if (c != '\r') return -1;
    c = fgetc(f);
    if (c != '\n') return -1;

    /* read string */
    if (buflen <= len) {
        fread(buf, buflen - 1, 1, f);
        buf[buflen - 1] = '\0';
        /* discard oversized string */
        len -= buflen - 1;
        while (len--) (void)fgetc(f);

        len = buflen - 1;
    } else {
        fread(buf, len, 1, f);
        buf[len] = '\0';
    }

    l = len;
    s = buf;
    printf("recv: {%d}\n", len);
    while (l--) {
        if (isprint((unsigned char) *s)) {
            printf("%c", *s);
        } else {

```

```
        printf("[%X]", (unsigned char) *s);
    }
    s++;
}
printf("\n");

return len;
}

int debuglevel = 0;

int dprintf(int lvl, const char *fmt, ...)
{
    va_list ap;
    int ret = 0;

    if (debuglevel >= lvl) {
        va_start(ap, fmt);
        ret = vfprintf(stdout, fmt, ap);
        va_end(ap);
    }

    return ret;
}

void saslerr(int why, const char *what)
{
    fprintf(stderr, "%s: %s", what, sasl_errstring(why, NULL, NULL));
}

void saslfail(int why, const char *what)
{
    saslerr(why, what);
    exit(EX_TEMPFAIL);
}
```



# SASL Reference Tables

---

This appendix provides reference information for SASL, which is an acronym for simple authentication and security layer.

## SASL Interface Summaries

The following tables provide brief descriptions of some SASL interfaces.

**TABLE E-1** SASL Functions Common to Clients and Servers

Function	Description
<code>sasl_version</code>	Get version information for the SASL library.
<code>sasl_done</code>	Release all SASL global state.
<code>sasl_dispose</code>	Dispose of <code>sasl_conn_t</code> when connection is done.
<code>sasl_getprop</code>	Get property, for example, user name, security layer info.
<code>sasl_setprop</code>	Set a SASL property.
<code>sasl_errdetail</code>	Generate string from last error on connection.
<code>sasl_errstring</code>	Translate SASL error code to a string.
<code>sasl_encode</code>	Encode data to send using security layer.
<code>sasl_encodev</code>	Encode a block of data for transmission through the security layer. Uses <code>iovec *</code> as the input parameter.
<code>sasl_listmech</code>	Create list of available mechanisms.
<code>sasl_global_listmech</code>	Return an array of all possible mechanisms. Note that this interface is obsolete.
<code>sasl_seterror</code>	Set the error string to be returned by <code>sasl_errdetail()</code> .

TABLE E-1 SASL Functions Common to Clients and Servers (Continued)

Function	Description
<code>sasl_idle</code>	Configure <code>sasl</code> lib to perform calculations during an idle period or during a network round trip.
<code>sasl_decode</code>	Decode data received using security layer.

TABLE E-2 Basic SASL Client-only Functions

Function	Description
<code>sasl_client_init</code>	Called once initially to load and initialize client plug-ins.
<code>sasl_client_new</code>	Initialize client connection. Sets up the <code>sasl_conn_t</code> context.
<code>sasl_client_start</code>	Select mechanism for connection.
<code>sasl_client_step</code>	Perform one authentication step.

TABLE E-3 Basic SASL Server Functions (Clients Optional)

Function	Description
<code>sasl_server_init</code>	Called once initially to load and initialize server plug-ins.
<code>sasl_server_new</code>	Initialize server connection. Sets up the <code>sasl_conn_t</code> context.
<code>sasl_server_start</code>	Begin an authentication exchange.
<code>sasl_server_step</code>	Perform one authentication exchange step.
<code>sasl_checkpass</code>	Check a plain text passphrase.
<code>sasl_checkapop</code>	Check an APOP challenge/response. Uses a pseudo APOP mechanism, which is similar to a CRAM-MD5 mechanism. Optional. Note that this interface is obsolete.
<code>sasl_user_exists</code>	Check whether user exists.
<code>sasl_setpass</code>	Change a password. Optionally, add a user entry.
<code>sasl_auxprop_request</code>	Request auxiliary properties.
<code>sasl_auxprop_getctx</code>	Get auxiliary property context for connection.

TABLE E-4 SASL Functions for Configuring Basic Services

Function	Description
<code>sasl_set_alloc</code>	Assign memory allocation functions. Note that this interface is obsolete.
<code>sasl_set_mutex</code>	Assign mutex functions. Note that this interface is obsolete.

TABLE E-4 SASL Functions for Configuring Basic Services (Continued)

Function	Description
<code>sasl_client_add_plugin</code>	Add a client plug-in.
<code>sasl_server_add_plugin</code>	Add a server plug-in.
<code>sasl_canonuser_add_plugin</code>	Add a user canonicalization plug-in.
<code>sasl_auxprop_add_plugin</code>	Add an auxiliary property plug-in.

TABLE E-5 SASL Utility Functions

Function	Description
<code>sasl_decode64</code>	Use base64 to decode.
<code>sasl_encode64</code>	Use base64 to encode.
<code>sasl_utf8verify</code>	Verify that a string is valid UTF-8.
<code>sasl_erasebuffer</code>	Erase a security-sensitive buffer or password. Implementation might use recovery-resistant erase logic.

TABLE E-6 SASL Property Functions

Function	Description
<code>prop_clear()</code>	Clear values and optionally requests from property context
<code>prop_dispose()</code>	Dispose of a property context
<code>prop_dup()</code>	Create new <code>propctx</code> which duplicates the contents of an existing <code>propctx</code>
<code>prop_erase()</code>	Erase the value of a property
<code>prop_format()</code>	Format the requested property names into a string
<code>prop_get()</code>	Return array of the <code>propval</code> structure from the context
<code>prop_getnames()</code>	Fill in an array of <code>struct propval</code> , given a list of property names
<code>prop_new()</code>	Create a property context
<code>prop_request()</code>	Add property names to a request
<code>prop_set()</code>	Add a property value to the context
<code>prop_setvals()</code>	Set the values for a property
<code>sasl_auxprop_getctx()</code>	Get auxiliary property context for connection
<code>sasl_auxprop_request()</code>	Request auxiliary properties

**TABLE E-7** Callback Data Types

Callback	Description
<code>sasl_getopt_t</code>	Get an option value. Used by both clients and servers.
<code>sasl_log_t</code>	Log message handler. Used by both clients and servers.
<code>sasl_getpath_t</code>	Get path to search for mechanisms. Used by both clients and servers.
<code>sasl_verifyfile_t</code>	Verify files for use by SASL. Used by both clients and servers.
<code>sasl_canon_user_t</code>	User name canonicalization function. Used by both clients and servers.
<code>sasl_getsimple_t</code>	Get user and language list. Used by clients only.
<code>sasl_getsecret_t</code>	Get authentication secret. Used by clients only.
<code>sasl_chalprompt_t</code>	Display challenge and prompt for response. Used by clients only.
<code>sasl_getrealm_t</code>	Get the authentication realm. Used by clients only.
<code>sasl_authorize_t</code>	Authorize policy callback. Used by servers only.
<code>sasl_server_userdb_checkpass_t</code>	Verify plain text password. Used by servers only.
<code>sasl_server_userdb_setpass_t</code>	Set plain text password. Used by servers only.

**TABLE E-8** SASL Include Files

Include File	Comments
<code>sasl/saslplug.h</code>	
<code>sasl/sasl.h</code>	Needed for developing plug-ins
<code>sasl/saslutil.h</code>	
<code>sasl/prop.h</code>	

**TABLE E-9** SASL Return Codes: General

Return Code	Description
<code>SASL_BADMAC</code>	Integrity check failed
<code>SASL_BADVERS</code>	Mismatch between versions of a mechanism
<code>SASL_BADPARAM</code>	Invalid parameter supplied
<code>SASL_BADPROT</code>	Bad protocol, cancel operation
<code>SASL_BUFOVER</code>	Overflowed buffer
<code>SASL_CONTINUE</code>	Another step is needed in authentication

TABLE E-9 SASL Return Codes: General (Continued)

Return Code	Description
SASL_FAIL	Generic failure
SASL_NOMECH	Mechanism not supported
SASL_NOMEM	Insufficient memory to complete operation
SASL_NOTDONE	Cannot request information until later in exchange
SASL_NOTINIT	SASL library not initialized
SASL_OK	Successful result
SASL_TRYAGAIN	Transient failure, for example, a weak key

TABLE E-10 SASL Return Codes: Client-Only

Function	Description
SASL_BADSERV	Server failed mutual authentication step
SASL_INTERACT	Needs user interaction
SASL_WRONGMECH	Mechanism does not support requested feature

TABLE E-11 SASL Return Codes: Server-Only

Function	Description
SASL_BADAUTH	Authentication failure
SASL_BADVERS	Version mismatch with plug-in
SASL_DISABLED	Account disabled
SASL_ENCRYPT	Encryption needed to use mechanism
SASL_EXPIRED	Passphrase expired and needs to be reset
SASL_NOAUTHZ	Authorization failure
SASL_NOUSER	User not found
SASL_NOVERIFY	User exists, but without verifier
SASL_TOOWEAK	Mechanism too weak for this user
SASL_TRANS	One-time use of a plain text password enables requested mechanism for user
SASL_UNAVAIL	Remote authentication server unavailable

**TABLE E-12** SASL Return Codes – Password Operations

<b>Function</b>	<b>Description</b>
SASL_NOCHANGE	Requested change not needed
SASL_NOUSERPASS	User-supplied passwords not permitted
SASL_PWLOCK	Passphrase locked
SASL_WEAKPASS	Passphrase too weak for security policy

## Packaging and Signing Cryptographic Providers

---

This appendix describes how to package Oracle Solaris cryptographic provider applications and modules. The following topics are covered:

- “Packaging Cryptographic Provider Applications and Modules” on page 279
- “Adding Signatures to Providers” on page 282

### Packaging Cryptographic Provider Applications and Modules

In the Oracle Solaris operating system, application software is delivered in units that are called *packages*. A package is a collection of files that are required for the distribution and installation of a software product. Packages are usually designed and built by the application developer after the development of the application code is complete. For general information on packaging software applications, see *Application Packaging Developer's Guide*.

Packaging a cryptographic provider has two additional requirements:

- The developer must supply input files that add the application to the configuration files that manage the cryptographic framework.
- The developer must supply an X.509 certificate to indicate compliance with the United States government's export laws. For testing purposes, the certificate can be generated prior to obtaining U.S. government approval. A package must have approval and a signed provider to be shipped.

### Complying with U.S. Government Export Laws

The United States government restricts the export of open cryptographic interfaces, which are also referred to as *crypto-with-a-hole*. Due to this restriction, all vendors of providers must obtain export approval from the U.S. government. The vendor needs to request a certificate from Oracle Corporation to indicate compliance with export laws. The vendor then signs the provider electronically and ships the software with the certificate.

In the export approval process, the strength of your encryption determines the countries in which the software can be used.

The U.S. government defines two export categories for encryption products that are manufactured in the U.S.A.:

- **Retail encryption products** – Retail encryption products are permitted to be shipped to all countries except for designated nations that are considered to be security threats.
- **Non-retail encryption products** – Non-retail encryption products are permitted for domestic use only and to countries that have been exempted by the U.S. government.

If your provider has non-retail approval, you can make the provider eligible for retail approval. Retail approval can be obtained by disabling the use of your provider by certain callers such as IPsec. Oracle provides two different certificates in this case, for restricted and unrestricted use. You indicate this situation in the certificate request process, “[To Request a Certificate for Signing a Provider](#)” on page 282. In addition, a special activation file must be generated, signed, and shipped with the provider. See “[To Generate an Activation File for Retail Export](#)” on page 284.

## Packaging User-Level Provider Applications

A third-party developer of a user-level cryptographic provider application completes the following process:

1. Acquire a certificate from Oracle Corporation. Then, sign the library. See “[Adding Signatures to Providers](#)” on page 282.
2. Ship the certificate with the package. The certificate must be placed in the `/etc/crypto/certs` directory.
3. Add the `pkcs11conf` class into the `CLASSES` string of the `pkginfo` file. The following line should be added:

```
CLASS=none pkcs11conf
```

4. Create an input file `pkcs11.conf` in the `etc/crypto` directory.

The input file for user-level providers is named `pkcs11.conf`. This file specifies the path to the provider. The `pkcs11.conf` uses the following syntax for the entry:

*filename*

The entry is an absolute path to a file such as `/opt/lib/$ISA/myProviderApp.so`. This file is added to the configuration file when `pkgadd` is run. Note the `$ISA` expression in the path name. `$ISA` points to either a 32-bit version or a 64-bit version of the application, as needed.

5. Add the following line to the package's prototype file:

```
e pkcs11conf etc/crypto/pkcs11conf 0644 root sys
```



## Packaging Kernel-Level Provider Modules

A third-party developer of a kernel-level cryptographic provider module completes the following process. For Solaris builds earlier than build 103, complete all steps. For Solaris build 103 or later, complete only the first two steps.

1. Acquire a certificate from Oracle Corporation. Then, sign the kernel software module or device driver. See [“Adding Signatures to Providers” on page 282](#).
2. Ship the certificate with the package. The certificate should be placed in the `/etc/crypto/certs` directory.
- 3.

---

**Note** – The following steps are required only if you are using a Solaris build earlier than build 103. If you are using build 103 or later, the following steps are no longer required and are ignored.

---

Add the `kcfconf` class into the `CLASSES` string of the `pkginfo` file. The following line should be added:

```
CLASS=none kcfconf
```

4. Create an input file `kcf.conf` in the `etc/crypto` directory. This file is used to add software and hardware plug-ins to the kernel configuration file.
  - If the provider is a kernel software module with cryptographic mechanisms, use the following syntax for the entry:

```
provider-name:supportedlist=mech1,mech2,...
```

*provider-name*      Base name for the kernel software module

*mech\**                Name of the cryptographic mechanism in the list

The following entry is an example of a kernel software module:

```
des:supportedlist=CKM_DES_CBC,CKM_DES_ECB,CKM_DES_CFB
```

- If the provider is a device driver for cryptographic mechanisms, such as an accelerator card, then use the following syntax for the entry:

```
driver_names=devicedriver1,devicedriver2,...
```

*devicedriver\**      Name of a device driver for a cryptographic device.

The following entry is an example of a device driver:

```
driver_names=dca
```

# Adding Signatures to Providers

This section describes how to add a digital signature to a provider so that the provider can work within the framework. The section also describes how to verify that a provider has been properly signed. Providers can be one of the following objects: a PKCS #11 library, a loadable kernel module that implements an algorithm, or a device driver for a hardware accelerator.

## ▼ To Request a Certificate for Signing a Provider

Typically, the developer of a provider requests the certificate. However, the system administrator might be called on to handle the request as part of a site's security policy.

### 1 Request a certificate from Oracle by using the `elfsign request` command.

The command generates a private key along with the certificate request.

```
% elfsign request -k private-keyfile -r certificate-request
```

*private-keyfile* Path to the location of the private key. This key is needed later when the system administrator signs providers for the cryptographic framework. The directory should be secure. Use a different directory from the directory that holds the Oracle certificate.

*certificate-request* Path to the certificate request.

The following example shows how a typical request is submitted to Oracle:

```
% elfsign request \  
-k /securecrypt/private/MyCompany.private.key \  
-r /reqcrypt/MyCompany.certrequest
```

Enter Company Name / Stock Symbol or some other globally unique identifier.  
This will be the prefix of the Certificate DN:MYCORP

The government of the United States of America restricts the export of "open cryptographic interfaces", also known as "crypto-with-a-hole". Due to this restriction, all providers for the cryptographic framework must be signed, regardless of the country of origin.

The terms "retail" and "non-retail" refer to export classifications for products manufactured in the USA. These terms define the portion of the world where the product may be shipped. Roughly speaking, "retail" is worldwide (minus certain excluded nations) and "non-retail" is domestic only (plus some highly favored nations). If your provider is subject to USA export control, then you must obtain an export approval (classification) from the government of the USA before exporting your provider. It is critical that you specify the obtained (or expected, when used during development) classification to the following questions so that your provider will be appropriately signed.

Do you have retail export approval for use without restrictions based on the caller (for example, IPsec)? [Yes/No] **N**

If you have non-retail export approval for unrestricted use of your provider by callers, are you also planning to receive retail approval restricting which export sensitive callers (for example, IPsec) may use your provider? [Y/N] **Y**

The private key is placed in the file name that you specify, for example, `/etc/crypto/private/MyCompany.private.key` file. The certificate request is also placed in a file name that you specify, for example, `/reqcrypt/MyCompany.certrequest` file.

## 2 Submit the certificate request to Oracle.

Send the certificate request to the following email address: `solaris-crypto-req@sun.com`

Oracle generates a certificate from your certificate request file. A copy of the certificate is sent back to you.

## 3 Store the certificate that you receive from Oracle in the `/etc/crypto/certs` directory.

For security, the private key and the certificate request should be stored in other directories.

## ▼ To Sign a Provider

Typically, the developer of the provider signs the provider. However, the system administrator might be called on to sign the developer's binary as part of your site security policy.

### ● Sign the provider. Use the `elfsign sign` command, the certificate from Oracle, and the private key for requesting certificates from Oracle.

```
% elfsign sign -k private-keyfile -c Oracle-certificate -e provider-object
```

- k File that contains that private key that was used to generate the certificate request that was sent to Oracle.
- c Path to the certificate from Oracle that was issued from the certificate request.
- e Path to the provider, or binary, to be signed for use within the cryptographic framework.

The following example shows how to sign a provider.

```
% elfsign sign \  
-k /securecrypt/private/MyCompany.private.key \  
-c /etc/crypto/certs/MyCompany  
-e /path/to/provider.object
```

Note that using `elfsign sign` changes the object in the location that was specified. If an unsigned version of the object is needed, then the object should be copied to a different location before `elfsign sign` is applied.

## ▼ To Verify That a Provider Is Signed

- 1 Collect the certificate that Oracle issued and the path to the signed provider.
- 2 Verify that the provider is correctly signed by using the `elfsign verify` command.

The following example demonstrates verification with the assumption that the certificate is in the default directory, `/etc/crypto/certs/MyCompany`.

```
% elfsign verify \  
-e /path/to/MyProvider.so.1  
elfsign: verification of /path/to/MyProvider.so.1 passed
```

The following example demonstrates storage of the certificate in a non-default directory.

```
% elfsign verify \  
-c /path/to/MyCerts \  
-e /path/to/MyProvider.so.1  
elfsign: verification of /path/to/MyProvider.so.1 passed
```

The following example demonstrates verification of a provider that has been signed with a restricted certificate.

```
% elfsign verify \  
-e /path/to/MyRestrictedProvider.so.1  
elfsign: verification of /path/to/MyRestrictedProvider.so.1 passed, \  
but restricted.
```

## ▼ To Generate an Activation File for Retail Export

This procedure is useful for when the same provider is to be shipped for both domestic use and restricted international use. You sign the provider with a key for a usage-restricted certificate for all customers. For those customers who use providers without caller-based restrictions, you generate and include a special activation file that permits use with IPsec. The activation file should reside in the same directory as the provider. The convention for naming the activation file is to combine the name of the driver with the extension `.esa`, for example, `/kernel/drv/vca.esa`.

- Sign the provider. Use the `elfsign sign` command, the certificate from Oracle, and the private key for requesting certificates from Oracle.

```
% elfsign sign -a -k private-keyfile -c Oracle-certificate -e provider-object
```

`-a` Generate a signed ELF Sign Activation (`.esa`) file. This option is used when a cryptographic provider needs both non-retail export approval and retail approval. The retail approval is accomplished by restricting export-sensitive callers such as IPsec. This option assumes that the provider binary has previously been signed with a restricted certificate.

- k File that contains that private key that was used to generate the certificate request that was sent to Oracle Corporation.
- c Path to the certificate from Oracle that was issued from the certificate request.
- e Path to the provider, or binary, to be signed for use within the cryptographic framework.

The following example shows how to sign a provider.

```
% elfsign sign \  
-a \  
-k /securecrypt/private/MyCompany.private.key \  
-c /etc/crypto/certs/MyCompany  
-e /path/to/provider.object
```



# Glossary

---

<b>Access Control List (ACL)</b>	A file containing a list of principals with certain access permissions. Typically, a server consults an access control list to verify that a client has permission to use its services. Note that a principal authenticated by GSS-API can still be denied services if an ACL does not permit them.
<b>authentication</b>	A security service that verifies the claimed identity of a principal.
<b>authorization</b>	The process of determining whether a principal can use a service, which objects the principal is allowed to access, and the type of access allowed for each.
<b>client</b>	Narrowly, a process that makes use of a network service on behalf of a user, for example, an application that uses <code>rlogin</code> . In some cases, a server can itself be a client of some other server or service. Informally, a principal that makes use of a service.
<b>confidentiality</b>	A security service that encrypts data. Confidentiality also includes integrity and authentication services. See also <a href="#">authentication</a> , <a href="#">integrity</a> , <a href="#">service</a> .
<b>consumer</b>	An application, library, or kernel module that uses system services.
<b>context</b>	A state of trust between two applications. When a context has successfully been established between two peers, the context acceptor is aware that the context initiator is who it claims to be, and can verify and decrypt messages sent to it. If the context includes mutual authentication, then the initiator knows the acceptor's identity is valid and can also verify and decrypt messages from the acceptor.
<b>context-level token</b>	See <a href="#">token</a> .
<b>credential</b>	An information package that identifies a principal and a principal's identification. A credential specifies who the principal is and, often, what privileges the principal has. Credentials are produced by security mechanisms.
<b>credential cache</b>	A storage space (usually a file) containing credentials stored by a given mechanism.
<b>CRL</b>	Certificate Revocation List
<b>CSR</b>	Certificate Signing Request
<b>data replay</b>	When a single message in a message stream is received more than once. Many security mechanisms support data replay detection. Replay detection, if available, must be requested at context-establishment time.
<b>data type</b>	The form that a given piece of data takes, for example, an <code>int</code> , a <code>string</code> , a <code>gss_name_t</code> structure, or a <code>gss_OID_set</code> structure.

<b>delegation</b>	If permitted by the underlying security mechanism, a principal (generally the context initiator) can designate a peer principal (usually the context acceptor) as a proxy by <i>delegating</i> its credentials to it. The delegated credentials can be used by the recipient to make requests on behalf of the original principal, as might be the case when a principal uses <code>rlogin</code> from machine to machine to machine.
<b>exported name</b>	A mechanism name that has been converted from the GSS-API internal-name format to the GSS-API Exported Name format by <code>gss_export_name()</code> . An exported name can be compared with names that are in non-GSS-API string format with <code>memcmp()</code> . See also <a href="#">mechanism name (MN)</a> , <a href="#">name</a> .
<b>flavor</b>	Historically, <i>security flavor</i> and <i>authentication flavor</i> were equivalent terms, as a flavor indicated a type of authentication, such as <code>AUTH_UNIX</code> , <code>AUTH_DES</code> , <code>AUTH_KERB</code> . <code>RPCSEC_GSS</code> is also a security flavor, even though it provides integrity and confidentiality services in addition to authentication.
<b>GSS-API</b>	The Generic Security Service Application Programming Interface. A network layer providing support for various modular security services. GSS-API provides for security authentication, integrity, and confidentiality services, and allows maximum portability of applications with regard to security. See also <a href="#">authentication</a> , <a href="#">confidentiality</a> , <a href="#">integrity</a> .
<b>host</b>	A machine accessible over a network.
<b>integrity</b>	A security service that, in addition to user authentication, provides proof of the validity of transmitted data through cryptographic tagging. See also <a href="#">authentication</a> , <a href="#">confidentiality</a> , <a href="#">message integrity code (MIC)</a> .
<b>keystore</b>	A storage system for PKI objects. The following examples are popular keystores: <ul style="list-style-type: none"><li>▪ OpenSSL stores keys and certificates on disk in files (PEM, DER, or PKCS#12 format).</li><li>▪ NSS is a private database that stores objects. NSS also supports PKCS#11 tokens.</li><li>▪ PKCS#11 storage depends on the token selected: Local files use Oracle Solaris <code>softtoken</code>. Smart cards, for example, use hardware tokens.</li></ul>
<b>KMF</b>	Oracle Solaris Key Management Framework
<b>mechanism</b>	A software package that specifies cryptographic techniques to achieve data authentication or confidentiality. Examples include Kerberos v5 and Diffie-Hellman public key.
<b>mechanism name (MN)</b>	A special instance of a GSS-API internal-format name. A normal internal-format GSS-API name can contain several instances of a name, each in the format of an underlying mechanism. A mechanism name, however, is unique to a particular mechanism. Mechanism names are generated by <code>gss_canonicalize_name()</code> .
<b>message</b>	Data in the form of a <code>gss_buffer_t</code> object that is sent from one GSS-API-based application to a peer. An example of a message is “ls” sent to a remote <code>ftp</code> server.  A message can contain more than just the user-provided data. For example, <code>gss_wrap()</code> takes an unwrapped message and produces a wrapped one to be sent. The wrapped message includes both the original message and an accompanying MIC. GSS-API-generated information that does not include a message is a <i>token</i> . See <a href="#">token</a> .



---

<b>message integrity code (MIC)</b>	A cryptographic tag that is attached to transmitted data to ensure the data's validity. The recipient of the data generates another MIC and compares this MIC to the one that was sent. If the MICs are equal, the message is valid. Some MICs, such as those generated by <code>gss_get_mic()</code> , are visible to the application, while others, such as those generated by <code>gss_wrap()</code> or <code>gss_init_sec_context()</code> , are not.
<b>message-level token</b>	See <a href="#">token</a> .
<b>MIC</b>	See <a href="#">message integrity code (MIC)</a> .
<b>MN</b>	See <a href="#">mechanism name (MN)</a> .
<b>mutual authentication</b>	When a context is established, a context initiator must authenticate itself to the context acceptor. In some cases the initiator might request that the acceptor authenticate itself back. If the acceptor does so, the two are said to be <i>mutually authenticated</i> .
<b>name</b>	The name of a principal, such as <code>user@machine</code> . Names in the GSS-API are handled through the <code>gss_name_t</code> structure, which is opaque to applications. See also <a href="#">exported name</a> , <a href="#">mechanism name (MN)</a> , <a href="#">name type</a> , <a href="#">principal</a> .
<b>name type</b>	The particular form in which a name is given. Name types are stored as <code>gss_OID</code> types and are used to indicate the format used for a name. For example, the name <code>user@machine</code> would have a name type of <code>GSS_C_NT_HOSTBASED_SERVICE</code> . See also <a href="#">exported name</a> , <a href="#">mechanism name (MN)</a> , <a href="#">name</a> .
<b>OCSP</b>	Online Certificate Status Protocol
<b>opaque</b>	Applies to a piece of data whose value or format is not normally visible to functions that use it. For example, the <code>input_token</code> parameter to <code>gss_init_sec_context()</code> is opaque to the application, but significant to the GSS-API. Similarly, the <code>input_message</code> parameter to <code>gss_wrap()</code> is opaque to the GSS-API but important to the application doing the wrapping.
<b>out-of-sequence detection</b>	Many security mechanisms can detect whether messages in a message stream are received out of their proper order. Message detection, if available, must be requested at context-establishment time.
<b>per-message token</b>	See <a href="#">token</a> .
<b>PKCS</b>	Public Key Cryptography Standards
<b>PKI</b>	Public Key Infrastructure
<b>principal</b>	A uniquely named client/user or server/service instance that participates in a network communication; GSS-API-based transactions involve interactions between principals. Examples of principal names include: <ul style="list-style-type: none"> <li>▪ <code>user</code></li> <li>▪ <code>user@machine</code></li> <li>▪ <code>nfs@machine</code></li> <li>▪ <code>123.45.678.9</code></li> <li>▪ <code>ftp://ftp.company.com</code></li> </ul> See also <a href="#">name</a> , <a href="#">name type</a> .
<b>privacy</b>	See <a href="#">confidentiality</a> .

<b>provider</b>	An application, library, or kernel module that provides services to consumers.
<b>Quality of Protection (QOP)</b>	A parameter used to select the cryptographic algorithms to be used in conjunction with the integrity or confidentiality service. With integrity, the QOP specifies the algorithm for producing a message integrity code (MIC). With confidentiality, the QOP specifies the algorithm for both the MIC and message encryption.
<b>replay detection</b>	Many security mechanisms can detect whether a message in a message stream has been incorrectly repeated. Message replay detection, if available, must be requested at context-establishment time.
<b>security flavor</b>	See <a href="#">flavor</a> .
<b>security mechanism</b>	See <a href="#">mechanism</a> .
<b>security service</b>	See <a href="#">service</a> .
<b>server</b>	A principal that provides a resource to network clients. For example, if you use <code>rlogin</code> to log in to the machine <code>boston.eng.acme.com</code> , then that machine is the server providing the <code>rlogin</code> service.
<b>service</b>	<ol style="list-style-type: none"><li>1. (Also, <i>network service</i>) A resource provided to network clients; often provided by more than one server. For example, if you use <code>rlogin</code> to log in to the machine <code>boston.eng.acme.com</code>, then that machine is the server providing the <code>rlogin</code> service.</li><li>2. A <i>security service</i> can be either integrity or confidentiality, providing a level of protection beyond authentication. See also <a href="#">authentication</a>, <a href="#">integrity</a>, and <a href="#">confidentiality</a>.</li></ol>
<b>SSL</b>	Secure Sockets Layer
<b>token</b>	<p>A data packet in the form of a GSS-API <code>gss_buffer_t</code> structure. Tokens are produced by GSS-API functions for transfer to peer applications.</p> <p>Tokens come in two types. <i>Context-level tokens</i> contain information used to establish or manage a security context. For example, <code>gss_init_sec_context()</code> bundles a context initiator's credential handle, the target machine's name, flags for various requested services, and possibly other items into a token to be sent to the context acceptor.</p> <p><i>Message tokens</i> (also known as <i>per-message tokens</i> or <i>message-level tokens</i>) contain information generated by a GSS-API function from messages to be sent to a peer application. For example, <code>gss_get_mic()</code> produces an identifying cryptographic tag for a given message and stores it in a token to be sent to a peer with the message. Technically, a token is considered to be separate from a message, which is why <code>gss_wrap()</code> is said to produce an <i>output_message</i> and not an <i>output_token</i>.</p> <p>See also <a href="#">message</a>.</p>

# Index

---

## A

access control lists, use in GSS-API, 65  
account management, PAM service module, 40  
ACL, *See* access control list  
acquiring context information, 85  
anonymous authentication, 81–82  
authentication  
    flavor, 288  
    GSS-API, 59  
        anonymous, 81–82  
        mutual, 81  
    PAM process for, 41  
    PAM service module, 40  
    SASL, 134  
authid  
    auxprop plug-ins, 147  
    SASL, 126  
authorizations  
    code example, 37  
    defined, 25  
    use in application development, 36  
authzid, auxprop plug-ins, 147  
auxiliary properties, *See* auxprop plug-ins  
auxprop plug-ins, 147

## C

C\_CloseSession() function  
    digest message example, 165  
    message signing example, 173  
    random byte generation example, 179

C\_Decrypt() function, 168  
C\_DecryptInit() function, 168  
C\_EncryptFinal() function, 168  
C\_EncryptInit() function, 168  
C\_EncryptUpdate() function, 168  
C\_Finalize() function  
    digest message example, 165  
    message signing example, 173  
C\_GenerateKeyPair() function, 173  
C\_GenerateRandom() function, 179  
C\_GetAttributeValue() function, 173  
C\_GetInfo() function, 159, 165  
C\_GetMechanismList() function, 162  
C\_GetSlotList() function, 160  
    message signing example, 172  
    random byte generation example, 179  
C\_Initialize() function, 159  
C\_OpenSession() function, 161  
    random byte generation example, 179  
C\_SignInit() function, 173  
C\_Verify() function, 173  
C\_VerifyInit() function, 173  
callbacks  
    SASL, 127  
        SASL\_CB\_AUTHNAME, 129  
        SASL\_CB\_CANON\_USER, 129  
        SASL\_CB\_ECHOPROMPT, 129  
        SASL\_CB\_GETCONF, 128  
        SASL\_CB\_GETOPT, 128  
        SASL\_CB\_GETPATH, 128  
        SASL\_CB\_GETREALM, 129  
        SASL\_CB\_LANGUAGE, 128

callbacks, SASL (*Continued*)

- SASL\_CB\_LOG, 128
- SASL\_CB\_NOECHOPROMPT, 129
- SASL\_CB\_PASS, 129
- SASL\_CB\_PROXY\_POLICY, 129
- SASL\_CB\_SERVER\_USERDB\_CHECKPASS, 129
- SASL\_CB\_SERVER\_USERDB\_SETPASS, 129
- SASL\_CB\_USER, 129
- SASL\_CB\_VERIFYFILE, 129

## canonicalization, SASL, 147

## Certificate Revocation List (CRL), 183

## Certificate Signing Request (CSR), 184–185

## certificates

- cryptographic applications, 279
- requesting from Oracle, 282

## channel bindings

- GSS-API, 82–83, 231

## client\_establish\_context() function, GSS-API

- client example, 99

## client plug-ins

- SASL, 144, 147

## confidentiality

- GSS-API, 59, 86

## connect\_to\_server() function

- GSS-API client example, 98, 102

## connection contexts, SASL, 129–130

## consumers

- defined, 22

- Oracle Solaris cryptographic framework, 149

## context-level tokens, GSS-API, 72

## contexts

## GSS-API

- acceptance, 79–80
- acceptance example, 117–121
- deletion, 94
- establishing, 76–86
- establishing example, 100
- exporting, 84
- getting acquisition information, 85
- gss-client example, 108
- import and export, 83–84, 122–123
- introduction, 58
- other context services, 80
- releasing, 124

contexts (*Continued*)

- initiation in GSS-API, 76–78

## createMechOid() function, 250

## credentials

- cache, 287
- delegation, 81
- GSS-API, 75–76, 234
  - acquisition, 112
  - GSS-API default, 75

## CRL (Certificate Revocation List), 183

## crypto pseudo device driver, 152

## cryptoadm pseudo device driver, 153

## cryptoadm utility, 153

## cryptographic checksum (MIC), 87–88

cryptographic framework, *See* Oracle Solaris

- cryptographic framework

## cryptographic providers, Oracle Solaris cryptographic framework, 152

## cryptoki library, overview, 157

## CSR (Certificate Signing Request), 184–185

**D**

## data encryption, GSS-API, 88

## data protection, GSS-API, 86

## data replay, 287

## data types

- GSS-API, 62–71, 229–232
  - integers, 62
  - names, 63–64
  - strings, 62–63
  - privileges, 29–30

## default credentials, GSS-API, 75

## delegation, credentials, 81

## design requirements

- Oracle Solaris cryptographic framework
  - kernel-level consumers, 154
  - kernel-level providers, 154–155
  - user-level consumers, 153
  - user-level providers, 154

## digesting messages, Oracle Solaris cryptographic framework, 165–167

**E**

effective privilege set, defined, 27

elfsign command

- Oracle Solaris cryptographic framework, 153
- request subcommand, 282
- sign subcommand, 283, 284
- verify subcommand, 284

encryption

- GSS-API, 86
- wrapping messages with `gss_wrap()`, 88

encryption products, export laws, 279

error codes, GSS-API, 226

examples

- checking for authorizations, 37
- GSS-API client application
  - description, 95
  - source code, 195
- GSS-API miscellaneous functions
  - source code, 215–221
- GSS-API server application
  - description, 109
  - source code, 206
- miscellaneous SASL functions, 269
- Oracle Solaris cryptographic framework
  - message digest, 165–167
  - random byte generation, 179–182
  - signing and verifying messages, 172–178
  - symmetric encryption, 168–172
- PAM consumer application, 42
- PAM conversation function, 47
- PAM service provider, 52
- privilege bracketing, 32
- SASL client application, 253
- SASL server application, 261

export laws, encryption products, 279

exporting GSS-API contexts, 83–84

**F**

`_fini()` function, Oracle Solaris cryptographic framework, 155

flavor, *See* security flavor

functions

- See* specific function name

functions (*Continued*)

- GSS-API, 223–225

**G**

General Security Standard Application Programming Interface, *See* GSS-API

`GetMechanismInfo()` function, 172

`GetRandSlot()` function, 179

`GetTokenInfo()` function, 179

`gss_accept_sec_context()` function, 79, 224

- GSS-API server example, 121

`gss_acquire_cred()` function, 75, 223

- GSS-API server example, 112

`gss_add_cred()` function, 76, 223

`gss_add_oid_set_member()` function, 224

GSS-API

- acquiring credentials, 112
- anonymous authentication, 81–82
- anonymous name format, 233
- channel bindings, 82–83, 231
- communication layers, 57
- comparing names in, 65–69
- confidentiality, 86
- constructing OIDs, 249–250
- context establishment example, 100
- contexts
  - acceptance example, 117–121
  - deallocation, 94
  - expiration, 234
- `createMechOid()` function, 250
- credentials, 75–76
  - expiration, 234
- data types, 62–71, 229–232
- detecting out-of-sequence problems, 90
- developing applications, 74–94
- displaying status codes, 228–229
- encryption, 86, 88
- exporting contexts, 84, 234
- files containing OID values, 247–248
- functions, 223–225
- generalized steps, 74–75
- `gss-client` example
  - context deletion, 108

GSS-API, *gss-client* example (*Continued*)

- contexts, 104
- sending messages, 105–107
- signature blocks, 107

*gss-server* example

- signing messages, 122
- unwrapping messages, 121

`gss_str_to_oid()` function, 248–249

include files, 75

integrity, 86

interprocess tokens, 234

introduction, 57–61

Kerberos v5 status codes, 235

language bindings, 61

limitations, 61

`mech` file, 247–248

message transmission, 92

MICs, 86

minor-status codes, 234

miscellaneous sample functions

- source code, 215–221

mutual authentication, 81

name types, 70–71, 230–231

OIDs, 69–71

other context services, 80

outside references, 61

portability, 59

protecting channel-binding information, 233–234

QOP, 59, 248

readable name syntax, 233

releasing contexts, 124

releasing stored data, 233

remote procedure calls, 60

replaced functions, 225

role in Oracle Solaris OS, 22

sample client application

- description, 95
- source code, 195

sample server application

- description, 109
- source code, 206

specifying non-default mechanisms, 251

specifying OIDs, 247

status code macros, 229

GSS-API (*Continued*)

- status codes, 71–72, 225–229
- supported credentials, 234
- tokens, 72–74
  - context-level, 72
  - interprocess, 73–74
  - per-message, 72
- translation into GSS-API format, 100
- wrap-size limits, 234

`gss_buffer_desc` structure, 62

`gss_buffer_desc` structure, 230

`gss_buffer_t` pointer, 62

GSS\_C\_ACCEPT credential, 75

GSS\_C\_BOTH credential, 75

GSS\_C\_INITIATE credential, 75

GSS\_CALLING\_ERROR macro, 71, 229

`gss_canonicalize_name()` function, 64, 224

`gss_channel_bindings_structure` structure, 230

`gss_channel_bindings_t` data type, 82

*gss-client* example

- context deletion, 108
- obtaining context status, 104
- restoring contexts, 104
- saving contexts, 104
- sending messages, 105–107
- signature blocks, 107

*gss-client* sample application, 95

`gss_compare_name()` function, 66, 68, 224

`gss_context_time()` function, 224

`gss_create_empty_oid_set()` function, 225

`gss_delete_oid()` function, 225

`gss_delete_sec_context()` function, 94, 224

- releasing contexts, 233

`gss_display_name()` function, 64, 224

`gss_display_status()` function, 224, 228–229

`gss_duplicate_name()` function, 224

`gss_export_context()` function, 73

`gss_export_name()` function, 224

`gss_export_sec_context()` function, 83, 224

`gss_get_mic()` function, 86, 87–88, 224

- comparison with `gss_wrap()` function, 86
- GSS-API server example, 122

`gss_import_name()` function, 63, 224

- GSS-API client example, 100

`gss_import_name()` function (*Continued*)  
     GSS-API server example, 113  
`gss_import_sec_context()` function, 83, 224  
`gss_indicate_mechs()` function, 224  
`gss_init_sec_context()` function, 77, 80, 223  
     GSS-API client example, 100  
     use in anonymous authentication, 81–82  
     use in mutual authentication, 81  
`gss_inquire_context()` function, 224  
`gss_inquire_context` function, 85  
`gss_inquire_cred_by_mech()` function, 223  
`gss_inquire_cred()` function, 223  
`gss_inquire_mechs_for_name()` function, 224  
`gss_inquire_names_for_mech()` function, 224  
`gss_OID_desc` structure, 230  
`gss_OID` pointer, 70  
`gss_OID_set_desc` structure, 70  
`gss_OID_set_desc` structure, 230  
`gss_OID_set` pointer, 70  
`gss_oid_to_str()` function, 225  
`gss_process_context_token()` function, 224  
`gss_release_buffer()` function, 94, 225  
`gss_release_cred()` function, 94, 223  
     GSS-API server example, 124  
`gss_release_name()` function, 94, 224  
     releasing stored data, 233  
`gss_release_oid()` function  
     GSS-API client example, 97  
     GSS-API server example, 113  
`gss_release_oid_set()` function, 94, 225  
`GSS_ROUTINE_ERROR` macro, 71, 229  
`gss_seal()` function, 225  
`gss-server` example  
     signing messages, 122  
     unwrapping messages, 121  
`gss-server` sample application, 109  
`gss_sign()` function, 225  
`gss_str_to_oid()` function, 225, 248–249  
`GSS_SUPPLEMENTARY_INFO` macro, 71, 229  
`gss_test_oid_set_member()` function, 225  
`gss_unseal()` function, 225  
`gss_unwrap()` function, 224  
     GSS-API server example, 121  
`gss_verify()` function, 225

`gss_verify_mic()` function, 224  
`gss_wrap()` function, 86, 88, 224  
     comparison with `gss_get_mic()` function, 86  
     wrapping messages, 88  
`gss_wrap_size_limit()` function, 88, 224  
`gssapi.h` file, 75  
 guidelines for privileged applications, 35

## H

header files, GSS-API, 75

## I

importing GSS-API contexts, 83–84  
`inetd`, checking for in `gss-client()` example, 115  
 inheritable privilege set, defined, 27  
 integers, GSS-API, 62  
 integrity  
     GSS-API, 59, 86  
 interprocess tokens, GSS-API, 73–74  
 IPC privileges, 28

## J

Java API, 23

## K

Kerberos v5, GSS-API, 60  
 Key Management Framework (KMF), 183–194  
 keypair, 186  
 keystore, 183–184  
 KMF (Key Management Framework), 183–194  
`kmfcfg(1)` configuration utility, 185–186

## L

language bindings, GSS-API, 61  
`libpam`, 41

libpkcs11.so library, Oracle Solaris cryptographic framework, 152  
libsasl  
  initialization, 131  
  use of API, 127  
libsasl library, 125  
limit privilege set, defined, 27

## M

macros  
  GSS-API  
    GSS\_CALLING\_ERROR, 71  
    GSS\_ROUTINE\_ERROR, 71  
    GSS\_SUPPLEMENTARY\_INFO, 71  
major status codes  
  GSS-API, 71  
  descriptions, 226  
major-status codes  
  GSS-API  
    encoding, 225  
mech file, 247–248  
Mechanism Name (MN), 64  
mechanisms  
  defined, 22  
  GSS-API, 60  
  Oracle Solaris cryptographic framework, 149  
  printable formats, 249  
  SASL, 127  
  specifying GSS-API, 70  
memcmp function, 68  
message digesting, Oracle Solaris cryptographic framework, 165–167  
Message Integrity Code, *See* MICs  
messages  
  *See also* data  
  encrypting with `gss_wrap()`, 88  
  GSS-API, 72  
    out-of-sequence problems, 90  
    sending, 105–107  
    signing, 122  
    transmission confirmation, 92  
    unwrapping, 121  
  tagging with MICs, 87–88

messages (*Continued*)  
  wrapping in GSS-API, 88  
  metaslot, Oracle Solaris cryptographic framework, 150  
MICs  
  defined, 86  
  GSS-API  
    tagging messages, 87–88  
    message transmission confirmation, 92  
  minor status codes, GSS-API, 71  
MN, *See* Mechanism Name  
mutual authentication, GSS-API, 81

## N

name types, GSS-API, 230–231  
names  
  comparing in GSS-API, 65–69  
  GSS-API, 63–64  
  types in GSS-API, 70–71  
network security, overview, 22  
non-retail encryption products, export laws, 280

## O

Object Identifiers, *See* OIDs  
OCSP (Online Certificate Status Protocol), 183  
OIDs  
  constructing, 249–250  
  deallocation of, 70  
  GSS-API, 69–71  
  sets, 70  
  specifying, 70, 247  
  types of data stored as, 70  
Online Certificate Status Protocol (OCSP), 183  
Oracle Solaris cryptographic framework  
  architecture, 150  
  crypto pseudo device driver, 152  
  cryptoadm pseudo device driver, 153  
  cryptoadm utility, 153  
  cryptographic providers, 152  
  cryptoki library, 157  
  design requirements  
    kernel-level consumers, 154



Oracle Solaris cryptographic framework, design requirements (*Continued*)

- kernel-level providers, 154–155
- special treatment of `_fini()` function, 155
- user-level consumers, 153
- user-level providers, 154

elfsign utility, 153

examples

- message digest, 165–167
- random byte generation, 179–182
- signing and verifying messages, 172–178
- symmetric encryption, 168–172

introduction, 149

kernel programmer interface, 152

libpkcs11.so, 152

modules verification library, 153

packaging applications, 279

pkcs11\_kernel.so, 152

pkcs11\_softtoken.so, 152

pluggable interface, 152

role in Oracle Solaris OS, 23

scheduler / load balancer, 152, 153

SPI

- kernel level, 152

Oracle Solaris Enterprise Authentication Mechanism,  
See SEAM

out-of-sequence problems, GSS-API, 90

## P

packaging cryptographic applications, 279

PAM, 39

- authentication process, 41
- configuration file
  - introduction, 42
- consumer application example, 42
- framework, 39
- items, 42
- library, 41
- requirements for PAM consumers, 42
- role in Oracle Solaris OS, 22
- service modules, 40
- service provider example, 52
- service provider requirements, 51

PAM (*Continued*)

- writing conversation functions, 47
- pam.conf file, *See* PAM configuration file
- pam\_end() function, 42
- pam\_getenvlist() function, 46
- pam\_open\_session() function, 46
- pam\_set\_item() function, 42
- pam\_setcred() function, 44
- pam\_start() function, 42
- parse\_oid() function, 251
  - GSS-API client example, 97
- per-message tokens, GSS-API, 72
- permitted privilege set, defined, 26
- PKCS#11
  - C\_GetInfo() function, 159
  - C\_GetMechanismList() function, 162
  - C\_GetSlotList() function, 160
  - C\_GetTokenInfo() function, 160
  - C\_Initialize() function, 159
  - C\_OpenSession() function, 161
  - function list, 158
  - pkcs11\_softtoken.so module, 157
  - SUNW\_C\_GetMechSession() function, 164
- pkcs11\_kernel.so library, Oracle Solaris cryptographic framework, 152
- pkcs11\_softtoken.so library, Oracle Solaris cryptographic framework, 152
- PKI (Public Key Infrastructure), 183–194
- pktool(1) key management tool, 184–185
- plug-ins
  - Oracle Solaris cryptographic framework, 149
  - SASL, 142
- pluggable authentication module, *See* PAM
- pluggable interface, Oracle Solaris cryptographic framework, 152
- principals, GSS-API, 63
- PRIV\_FILE\_LINK\_ANY, 28
- PRIV\_OFF flag, 29
- PRIV\_ON flag, 29
- PRIV\_PROC\_EXEC, 28
- PRIV\_PROC\_FORK, 28
- PRIV\_PROC\_INFO, 28
- PRIV\_PROC\_SESSION, 28
- PRIV\_SET flag, 30

`priv_set_t` structure, 29  
`priv_str_to_set()` function, synopsis, 31  
`priv_t` type, 29  
privilege sets, defined, 26  
privileged applications, defined, 25  
privileges  
    assignment, 26  
    bracketing in the least privilege model, 32  
    bracketing in the superuser model, 32  
    categories, 28  
        IPC, 28  
        process, 28  
        system, 28  
        System V IPC, 28  
    code example, 32  
    compatibility with superuser, 28  
    data types, 29–30  
    defined, 25  
    interfaces, 30  
    introduction, 21  
    operation flags, 29  
    overview, 26  
    `priv_str_to_set()` function, 31  
    privilege ID data type, 29  
    required header file, 29  
    `setppriv()` function, 31  
    use in application development, 35  
process privileges, 28  
    See privileges  
protecting data, GSS-API, 86  
providers  
    defined, 22  
    Oracle Solaris cryptographic framework, 149, 152  
    packaging kernel-level applications, 281  
    packaging user-level applications, 280  
Public Key Infrastructure (PKI), 183–194

## Q

qop file, 248  
QOPs, 59  
    role in wrap size, 88  
    specifying, 70, 247–248  
    storage in OIDs, 69

Quality of Protection, *See* QOP

## R

random byte generation  
    Oracle Solaris cryptographic framework  
        example, 179–182  
remote procedure calls, GSS-API, 60  
retail encryption products, export laws, 280  
return codes, GSS-API, 71–72  
RPCSEC\_GSS, 60

## S

SASL  
    architecture, 126  
    authentication, 134  
    authid, 126  
    auxprop plug-ins, 147  
    callbacks  
        SASL\_CB\_AUTHNAME, 129  
        SASL\_CB\_CANON\_USER, 129  
        SASL\_CB\_ECHOPROMPT, 129  
        SASL\_CB\_GETCONF, 128  
        SASL\_CB\_GETOPT, 128  
        SASL\_CB\_GETPATH, 128  
        SASL\_CB\_GETREALM, 129  
        SASL\_CB\_LANGUAGE, 128  
        SASL\_CB\_LOG, 128  
        SASL\_CB\_NOECHOPROMPT, 129  
        SASL\_CB\_PASS, 129  
        SASL\_CB\_PROXY\_POLICY, 129  
        SASL\_CB\_SERVER\_USERDB\_CHECKPASS, 129  
        SASL\_CB\_SERVER\_USERDB\_SETPASS, 129  
        SASL\_CB\_USER, 129  
        SASL\_CB\_VERIFYFILE, 129  
    canonicalization, 147  
    client sample application, 253  
    confidentiality, 138  
    connection contexts, 129–130  
    functions, 273  
    integrity, 138  
    library, 125

SASL (*Continued*)

- libsasl API, 127
- libsasl initialization, 131
- life cycle, 130
- mechanisms, 127
- overview, 125
- plug-in design, 147
  - client plug-ins, 144
  - overview, 142
  - server plug-ins, 145
  - structures, 144
- reference tables, 273
- releasing resources, 138
- releasing sessions, 138
- role in Oracle Solaris OS, 23
- sample functions, 269
- sample output, 138–141
- server sample application, 261
- session initialization, 132
- setting SSF, 132
- SPI, 142
- SSF, 127
- userid, 126
- sasl\_canonuser\_plug\_nit() function, 147
- SASL\_CB\_AUTHNAME callback, 129
- SASL\_CB\_CANON\_USER callback, 129
- SASL\_CB\_ECHOPROMPT callback, 129
- SASL\_CB\_GETCONF callback, 128
- SASL\_CB\_GETOPT callback, 128
- SASL\_CB\_GETPATH callback, 128
- SASL\_CB\_GETREALM callback, 129
- SASL\_CB\_LANGUAGE callback, 128
- SASL\_CB\_LOG callback, 128
- SASL\_CB\_NOECHOPROMPT callback, 129
- SASL\_CB\_PASS callback, 129
- SASL\_CB\_PROXY\_POLICY callback, 129
- SASL\_CB\_SERVER\_USERDB\_CHECKPASS callback, 129
- SASL\_CB\_SERVER\_USERDB\_SETPASS callback, 129
- SASL\_CB\_USER callback, 129
- SASL\_CB\_VERIFYFILE callback, 129
- sasl\_client\_add\_plugin() function, 142
- sasl\_client\_init() function, 131, 143
- sasl\_client\_new() function, SASL life cycle, 132
- sasl\_client\_start() function, SASL life cycle, 134
- SASL\_CONTINUE flag, 134
- sasl\_decode() function, 138
- sasl\_dispose() function, 138
- sasl\_done() function, 138
- sasl\_encode() function, 138
- sasl\_getprop() function, checking SSF, 138
- SASL\_INTERACT flag, 134
- SASL\_OK flag, 134
- sasl\_server\_add\_plugin() function, 142
- sasl\_server\_init() function, 131, 143
- sasl\_server\_new() function, SASL life cycle, 132
- sasl\_server\_start() function, SASL life cycle, 134
- SEAM, GSS-API, 60
- security context, *See* contexts
- security flavor, 288
- security mechanisms, *See* GSS-API
- security policy, privileged application guidelines, 35
- security strength factor, *See* SSF
- send\_token() function, GSS-API client example, 102
- sequence problems, GSS-API, 90
- server\_acquire\_creds() function, GSS-API server example, 112
- server\_establish\_context() function, GSS-API server example, 117
- server plug-ins, SASL, 145
- service provider interface, *See* SPI
- session management, PAM service module, 40
- session objects, Oracle Solaris cryptographic framework, 150
- setppriv() function, synopsis, 31
- shell escapes, and privileges, 36
- sign\_server() function
  - GSS-API client example, 110–112
  - GSS-API server example, 116
- signature blocks
  - GSS-API
    - gss-client example, 107
- signing messages, GSS-API, 122
- signing messages example, Oracle Solaris cryptographic framework, 172–178
- signing packages, 282
- Simple Authentication and Security Layer, *See* SASL
- slots, Oracle Solaris cryptographic framework, 149

- soft tokens, Oracle Solaris cryptographic framework, 149
- specifying a QOP, 247–248
- specifying mechanisms in GSS-API, 247–248
- specifying OIDs, 247
- SPI
  - Oracle Solaris cryptographic framework
    - kernel level, 152
    - user level, 152
- SSF
  - defined, 127
  - setting, 132, 134
- status codes
  - GSS-API, 71–72, 225–229
  - major, 71
  - minor, 71
- strings, GSS-API, 62–63
- SUNW\_C\_GetMechSession() function, 164
  - digest message example, 165
  - symmetric encryption example, 168
- symmetric encryption
  - Oracle Solaris cryptographic framework example, 168–172
- system privileges, 28
- System V IPC privileges, 28

## T

- test\_import\_export\_context() function, GSS-API
  - server example, 122–123
- token objects, Oracle Solaris cryptographic framework, 150
- tokens
  - distinguishing GSS-API types, 73
  - GSS-API, 72–74
    - context-level, 72
    - interprocess, 73–74
    - per-message, 72
  - Oracle Solaris cryptographic framework, 149

## U

- userid, SASL, 126

## V

- verifying messages example
  - Oracle Solaris cryptographic framework example, 172–178

## W

- wrapping messages, GSS-API, 88

## X

- X.509 certificates, 279