

System Administration Guide: Devices and File Systems

Copyright © 2004, 2012, Oracle and/or its affiliates. All rights reserved.

This software and related documentation are provided under a license agreement containing restrictions on use and disclosure and are protected by intellectual property laws. Except as expressly permitted in your license agreement or allowed by law, you may not use, copy, reproduce, translate, broadcast, modify, license, transmit, distribute, exhibit, perform, publish or display any part, in any form, or by any means. Reverse engineering, disassembly, or decompilation of this software, unless required by law for interoperability, is prohibited.

The information contained herein is subject to change without notice and is not warranted to be error-free. If you find any errors, please report them to us in writing.

If this is software or related documentation that is delivered to the U.S. Government or anyone licensing it on behalf of the U.S. Government, the following notice is applicable:

U.S. GOVERNMENT RIGHTS. Programs, software, databases, and related documentation and technical data delivered to U.S. Government customers are "commercial computer software" or "commercial technical data" pursuant to the applicable Federal Acquisition Regulation and agency-specific supplemental regulations. As such, the use, duplication, disclosure, modification, and adaptation shall be subject to the restrictions and license terms set forth in the applicable Government contract, and, to the extent applicable by the terms of the Government contract, the additional rights set forth in FAR 52.227-19, Commercial Computer Software License (December 2007). Oracle America, Inc., 500 Oracle Parkway, Redwood City, CA 94065.

This software or hardware is developed for general use in a variety of information management applications. It is not developed or intended for use in any inherently dangerous applications, including applications that may create a risk of personal injury. If you use this software or hardware in dangerous applications, then you shall be responsible to take all appropriate fail-safe, backup, redundancy, and other measures to ensure its safe use. Oracle Corporation and its affiliates disclaim any liability for any damages caused by use of this software or hardware in dangerous applications.

Oracle and Java are registered trademarks of Oracle and/or its affiliates. Other names may be trademarks of their respective owners.

Intel and Intel Xeon are trademarks or registered trademarks of Intel Corporation. All SPARC trademarks are used under license and are trademarks or registered trademarks of SPARC International, Inc. AMD, Opteron, the AMD logo, and the AMD Opteron logo are trademarks or registered trademarks of Advanced Micro Devices. UNIX is a registered trademark of The Open Group.

This software or hardware and documentation may provide access to or information on content, products, and services from third parties. Oracle Corporation and its affiliates are not responsible for and expressly disclaim all warranties of any kind with respect to third-party content, products, and services. Oracle Corporation and its affiliates will not be responsible for any loss, costs, or damages incurred due to your access to or use of third-party content, products, or services.

Ce logiciel et la documentation qui l'accompagne sont protégés par les lois sur la propriété intellectuelle. Ils sont concédés sous licence et soumis à des restrictions d'utilisation et de divulgation. Sauf disposition de votre contrat de licence ou de la loi, vous ne pouvez pas copier, reproduire, traduire, diffuser, modifier, breveter, transmettre, distribuer, exposer, exécuter, publier ou afficher le logiciel, même partiellement, sous quelque forme et par quelque procédé que ce soit. Par ailleurs, il est interdit de procéder à toute ingénierie inverse du logiciel, de le désassembler ou de le décompiler, excepté à des fins d'interopérabilité avec des logiciels tiers ou tel que prescrit par la loi.

Les informations fournies dans ce document sont susceptibles de modification sans préavis. Par ailleurs, Oracle Corporation ne garantit pas qu'elles soient exemptes d'erreurs et vous invite, le cas échéant, à lui en faire part par écrit.

Si ce logiciel, ou la documentation qui l'accompagne, est concédé sous licence au Gouvernement des Etats-Unis, ou à toute entité qui délivre la licence de ce logiciel ou l'utilise pour le compte du Gouvernement des Etats-Unis, la notice suivante s'applique:

U.S. GOVERNMENT RIGHTS. Programs, software, databases, and related documentation and technical data delivered to U.S. Government customers are "commercial computer software" or "commercial technical data" pursuant to the applicable Federal Acquisition Regulation and agency-specific supplemental regulations. As such, the use, duplication, disclosure, modification, and adaptation shall be subject to the restrictions and license terms set forth in the applicable Government contract, and, to the extent applicable by the terms of the Government contract, the additional rights set forth in FAR 52.227-19, Commercial Computer Software License (December 2007). Oracle America, Inc., 500 Oracle Parkway, Redwood City, CA 94065.

Ce logiciel ou matériel a été développé pour un usage général dans le cadre d'applications de gestion des informations. Ce logiciel ou matériel n'est pas conçu ni n'est destiné à être utilisé dans des applications à risque, notamment dans des applications pouvant causer des dommages corporels. Si vous utilisez ce logiciel ou matériel dans le cadre d'applications dangereuses, il est de votre responsabilité de prendre toutes les mesures de secours, de sauvegarde, de redondance et autres mesures nécessaires à son utilisation dans des conditions optimales de sécurité. Oracle Corporation et ses affiliés déclinent toute responsabilité quant aux dommages causés par l'utilisation de ce logiciel ou matériel pour ce type d'applications.

Oracle et Java sont des marques déposées d'Oracle Corporation et/ou de ses affiliés. Tout autre nom mentionné peut correspondre à des marques appartenant à d'autres propriétaires qu'Oracle.

Intel et Intel Xeon sont des marques ou des marques déposées d'Intel Corporation. Toutes les marques SPARC sont utilisées sous licence et sont des marques ou des marques déposées de SPARC International, Inc. AMD, Opteron, le logo AMD et le logo AMD Opteron sont des marques ou des marques déposées d'Advanced Micro Devices. UNIX est une marque déposée d'The Open Group.

Ce logiciel ou matériel et la documentation qui l'accompagne peuvent fournir des informations ou des liens donnant accès à des contenus, des produits et des services émanant de tiers. Oracle Corporation et ses affiliés déclinent toute responsabilité ou garantie expresse quant aux contenus, produits ou services émanant de tiers. En aucun cas, Oracle Corporation et ses affiliés ne sauraient être tenus pour responsables des pertes subies, des coûts occasionnés ou des dommages causés par l'accès à des contenus, produits ou services tiers, ou à leur utilisation.

Contents

Preface	21
1 Managing Removable Media (Overview)	25
What's New in Removable Media?	25
voId is Managed by the Service Management Facility (SMF)	25
Improvements to Volume Management (voId)	26
Where to Find Managing Removable Media Tasks	27
Removable Media Features and Benefits	27
Comparison of Manual and Automatic Mounting	28
Overview of Accessing Removable Media	28
2 Managing Removable Media (Tasks)	31
Managing Removable Media (Task Map)	31
Formatting Diskettes	32
Removable Media Hardware Considerations	32
▼ How to Load Removable Media	33
▼ How to Format a Diskette (rmformat)	34
▼ How to Create a File System on Removable Media	35
▼ How to Create a File System on a DVD-RAM	37
▼ How to Check a File System on Removable Media	38
▼ How to Repair Bad Blocks on Removable Media	38
Applying Read or Write Protection and Password Protection to Removable Media	39
▼ How to Enable or Disable Write Protection on Removable Media	39
▼ How to Enable or Disable Read or Write Protection and Set a Password on Removable Media	39

3	Accessing Removable Media (Tasks)	41
	Accessing Removable Media (Task Map)	41
	Accessing Removable Media	42
	Using Removable Media Names	42
	Guidelines for Accessing Removable Media Data	43
	▼ How to Add a New Removable Media Drive	43
	▼ How to Disable or Enable Removable Media Services	43
	▼ How to Access Information on Removable Media	44
	▼ How to Copy Information From Removable Media	45
	▼ How to Determine If Removable Media Is Still in Use	45
	▼ How to Eject Removable Media	46
	Accessing Removable Media on a Remote System (Task Map)	46
	▼ How to Make Local Media Available to Other Systems	47
	▼ How to Access Removable Media on Remote Systems	48
4	Writing CDs and DVDs (Tasks)	51
	Working With Audio CDs and Data CDs and DVDs	51
	CD/DVD Media Commonly Used Terms	52
	Writing CD and DVD Data and Audio CDs	53
	Restricting User Access to Removable Media With RBAC	54
	▼ How to Restrict User Access to Removable Media With RBAC	54
	▼ How to Identify a CD or DVD Writer	55
	▼ How to Check the CD or DVD Media	55
	Creating a Data CD or DVD	56
	▼ How to Create an ISO 9660 File System for a Data CD or DVD	56
	▼ How to Create a Multi-Session Data CD	57
	Creating an Audio CD	59
	▼ How to Create an Audio CD	59
	▼ How to Extract an Audio Track on a CD	60
	▼ How to Copy a CD	61
	▼ How to Erase CD-RW Media	62
5	Managing Devices (Overview/Tasks)	63
	What's New in Device Management?	63
	New Hot Plugging Features	64

x86: Device Detection Tool	64
Support for PCI Express (PCIe)	64
USB and 1394 (FireWire) Support Enhancements	65
Improved Device In Use Error Checking	65
Where to Find Device Management Tasks	66
Managing Devices in the Oracle Solaris OS	67
Power Management of Devices	67
About Device Drivers	68
Automatic Configuration of Devices	68
Displaying Device Configuration Information	70
Adding a Peripheral Device to a System	73
▼ How to Add a Peripheral Device	74
▼ How to Add a Device Driver	75
Accessing Devices	76
How Device Information Is Created	76
How Devices Are Managed	76
Device Naming Conventions	77
Logical Disk Device Names	77
Logical Tape Device Names	80
Logical Removable Media Device Names	80
6 Dynamically Configuring Devices (Tasks)	81
Dynamic Reconfiguration and Hot-Plugging	81
Attachment Points	83
Detaching PCI or PCIe Adapter Cards	84
Attaching PCI or PCIe Adapter Cards	85
PCIe Hot-Plugging With the (hotplug) Command	85
SCSI Hot-Plugging With the cfgadm Command (Task Map)	86
SCSI Hot-Plugging With the cfgadm Command	87
▼ How to Display Information About SCSI Devices	87
▼ How to Unconfigure a SCSI Controller	88
▼ How to Configure a SCSI Controller	88
▼ How to Configure a SCSI Device	89
▼ How to Disconnect a SCSI Controller	90
▼ SPARC: How to Connect a SCSI Controller	91

▼ SPARC: How to Add a SCSI Device to a SCSI Bus	91
▼ SPARC: How to Replace an Identical Device on a SCSI Controller	92
▼ SPARC: How to Remove a SCSI Device	93
Troubleshooting SCSI Configuration Problems	94
▼ How to Resolve a Failed SCSI Unconfigure Operation	96
PCI or PCIe Hot-Plugging With the <code>cfgadm</code> Command (Task Map)	96
PCI or PCIe Hot-Plugging With the <code>cfgadm</code> Command	97
PCIe Led Indicator Behavior	97
▼ How to Display PCI Slot Configuration Information	97
▼ How to Remove a PCI Adapter Card	99
▼ How to Add a PCI Adapter Card	100
Troubleshooting PCI Configuration Problems	102
Reconfiguration Coordination Manager (RCM) Script Overview	102
What Is an RCM Script?	103
What Can an RCM Script Do?	103
How Does the RCM Script Process Work?	103
RCM Script Tasks	104
Application Developer RCM Script (Task Map)	104
System Administrator RCM Script (Task Map)	105
Naming an RCM Script	106
Installing or Removing an RCM Script	106
▼ How to Install an RCM Script	106
▼ How to Remove an RCM Script	107
▼ How to Test an RCM Script	107
Tape Backup RCM Script Example	108
7 Using USB Devices (Overview)	113
What's New in USB Devices?	113
EHCI Isochronous Transfer Support	114
Support for CDC ACM Devices	114
Changed USB Device Hotpluggable Behavior	114
Oracle Solaris ZFS Support on USB Devices	114
Support for Prolific and Keyspan Serial Adapters	115
USB Power Budgeting	115
x86: Support for USB CDs and DVDs in GRUB-Based Booting	115

USB Virtual Keyboard and Mouse Support	115
vo1d Provides Awareness of Hot-Plugged USB Devices	116
Oracle Solaris Support for USB Devices	116
Overview of USB Devices	117
Commonly Used USB Acronyms	117
USB Bus Description	118
About USB in the Oracle Solaris OS	123
USB 2.0 Features	123
USB Keyboards and Mouse Devices	125
USB Host Controller and Hubs	126
Guidelines for USB Cables	127
8 Using USB Devices (Tasks)	129
Managing USB Devices in the Oracle Solaris OS (Roadmap)	129
Using USB Mass Storage Devices (Task Map)	130
Using USB Mass Storage Devices	131
Using USB Diskette Devices	132
Using Non-Compliant USB Mass Storage Devices	133
Hot-Plugging USB Mass Storage Devices	134
Preparing to Use a USB Mass Storage Device With vo1d Running	137
▼ How to Display USB Device Information	138
▼ How to Create a File System on a USB Mass Storage Device	138
▼ How to Create a File System on a USB Mass Storage Device Without vo1d Running	140
▼ How to Modify Partitions and Create a PCFS File System on a USB Mass Storage Device Without vo1d Running	142
▼ How to Create a Solaris Partition and Modify the Slices on a USB Mass Storage Device Without vo1d Running	146
▼ How to Mount or Unmount a USB Mass Storage Device Without vo1d Running	147
Troubleshooting Tips for USB Mass Storage Devices	149
Disabling Specific USB Drivers	149
▼ How to Disable Specific USB Drivers	150
▼ How to Remove Unused USB Device Links	150
Using USB Audio Devices (Task Map)	150
Using USB Audio Devices	151
Hot-Plugging Multiple USB Audio Devices	152
▼ How to Add USB Audio Devices	152

- ▼ How to Identify Your System's Primary Audio Device 153
- ▼ How to Change the Primary USB Audio Device 153
- Troubleshooting USB Audio Device Problems 154
- Hot-Plugging USB Devices With the `cfgadm` Command (Task Map) 154
- Hot-Plugging USB Devices With the `cfgadm` Command 155
- ▼ How to Display USB Bus Information (`cfgadm`) 156
- ▼ How to Unconfigure a USB Device 157
- ▼ How to Configure a USB Device 157
- ▼ How to Logically Disconnect a USB Device 158
- ▼ How to Logically Connect a USB Device 158
- ▼ How to Logically Disconnect a USB Device Subtree 159
- ▼ How to Reset a USB Device 159
- ▼ How to Change the Default Configuration of a Multi-Configuration USB Device 159

- 9 Using InfiniBand Devices (Overview/Tasks) 161**
- Overview of InfiniBand Devices 161
- Dynamically Reconfiguring IB Devices (Task Map) 162
- Dynamically Reconfiguring IB Devices (`cfgadm`) 164
- ▼ How to Display IB Device Information 165
- ▼ How to Unconfigure an IOC Device 166
- ▼ How to Configure an IOC Device 167
- ▼ How to Unconfigure an IB Port, HCA_SVC, or a VPPA Device 167
- ▼ How to Configure a IB Port, HCA_SVC, or a VPPA Device 168
- ▼ How to Unconfigure an IB Pseudo Device 168
- ▼ How to Configure an IB Pseudo Device 169
- ▼ How to Display Kernel IB Clients of an HCA 169
- ▼ How to Unconfigure IB Devices Connected to an HCA 169
- Configuring an IB HCA 170
- ▼ How to Update the IB `p_key` Tables 170
- ▼ How to Display IB Communication Services 171
- ▼ How to Add a VPPA Communication Service 171
- ▼ How to Remove an Existing IB Port, HCA_SVC, or a VPPA Communication Service 172
- ▼ How to Update an IOC Configuration 172
- Using the uDAPL Application Interface With InfiniBand Devices 173
- ▼ How to Enable uDAPL 174

	Updating the DAT Static Registry	174
10	Managing Disks (Overview)	177
	What's New in Disk Management?	177
	The <code>diskinfo</code> Command	178
	Multiple Disk Sector Size Support	179
	Two-Terabyte Disk Support for Installing and Booting the Oracle Solaris OS	179
	iSNS Support in the Solaris iSCSI Target and Initiator	180
	Solaris iSCSI Target Support	180
	x86: Disk Management in the GRUB Boot Environment	180
	Support for SCSI Disks That are Larger Than 2 Terabytes	181
	Where to Find Disk Management Tasks	181
	Overview of Disk Management	182
	Disk Terminology	182
	About Disk Labels	182
	EFI Disk Label	183
	About Disk Slices	187
	format Utility	191
	Partitioning a Disk	195
	Partition Table Terminology	195
	Displaying Partition Table Information	196
	Using the Free Hog Slice	197
11	Administering Disks (Tasks)	199
	Administering Disks (Task Map)	199
	Identifying Disks on a System	200
	▼ How to Identify the Disks on a System	200
	Formatting a Disk	202
	▼ How to Determine if a Disk Is Formatted	202
	▼ How to Format a Disk	203
	Displaying Disk Slices	204
	▼ How to Display Disk Slice Information	204
	Creating and Examining a Disk Label	206
	▼ How to Label a Disk	206
	▼ How to Examine a Disk Label	210

Recovering a Corrupted Disk Label	212
▼ How to Recover a Corrupted Disk Label	212
Adding a Third-Party Disk	214
12 SPARC: Setting Up Disks (Tasks)	215
SPARC: Setting Up Disks for UFS File Systems (Task Map)	215
SPARC: Setting Up Disks for UFS File Systems	216
▼ SPARC: How to Set Up a Disk for a UFS Root File System	216
▼ SPARC: How to Set Up a Disk for a UFS File System	217
▼ SPARC: How to Create Disk Slices for a UFS File System	218
▼ SPARC: How to Create a UFS File System	222
▼ SPARC: How to Install Boot Blocks for a UFS Root File System	223
SPARC: Setting up Disks for ZFS File Systems (Task Map)	223
SPARC: Setting Up Disks for ZFS File Systems	224
▼ SPARC: How to Set Up a Disk for a ZFS Root File System	225
SPARC: Creating a Disk Slice for a ZFS Root File System	225
▼ SPARC: How to Create a Disk Slice for a ZFS Root File System	226
▼ SPARC: How to Install Boot Blocks for a ZFS Root File System	229
▼ SPARC: How to Set Up a Disk for a ZFS File System	230
13 x86: Setting Up Disks (Tasks)	233
x86: Setting Up Disks for UFS File Systems (Task Map)	233
x86: Setting Up Disks for UFS File Systems	234
x86: Setting Up Disks for ZFS File Systems (Task Map)	238
x86: Setting Up Disks for ZFS File Systems	239
Creating and Changing Solaris <code>fdisk</code> Partitions	246
x86: Guidelines for Creating an <code>fdisk</code> Partition	246
▼ x86: How to Create a Solaris <code>fdisk</code> Partition	247
Changing the <code>fdisk</code> Partition Identifier	249
▼ How to Change the Solaris <code>fdisk</code> Identifier	249
14 Configuring Oracle Solaris iSCSI Targets and Initiators (Tasks)	251
iSCSI Technology (Overview)	251
Solaris iSCSI Software and Hardware Requirements	252

Setting Up Solaris iSCSI Targets and Initiators (Task Map)	253
Configuring Solaris iSCSI Targets and Initiators	254
▼ How to Prepare for a Solaris iSCSI Configuration	256
Setting Up Your Solaris iSCSI Target Devices	256
Configuring Authentication in Your iSCSI-Based Storage Network	258
Using a Third-Party RADIUS Server to Simplify CHAP Management in Your iSCSI Configuration	261
▼ How to Configure iSCSI Target Discovery	262
▼ How to Remove Discovered iSCSI Targets	263
Accessing iSCSI Disks	264
▼ How to Access iSCSI Disks Upon Reboot	265
▼ Monitoring Your iSCSI Configuration	265
Modifying iSCSI Initiator and Target Parameters	267
Setting Up Solaris iSCSI Multipathed Devices	270
▼ How to Enable Multiple iSCSI Sessions for a Target	271
Troubleshooting iSCSI Configuration Problems	274
No Connections to the iSCSI Target From the Local System	274
iSCSI Device or Disk Is Not Available on the Local System	275
Use LUN Masking When Using the iSNS Discovery Method	275
General iSCSI Error Messages	276
15 The format Utility (Reference)	281
Recommendations and Requirements for Using the format Utility	281
format Menu and Command Descriptions	282
partition Menu	284
x86: fdisk Menu	284
analyze Menu	285
defect Menu	287
format .dat File	288
Contents of the format .dat File	288
Syntax of the format .dat File	289
Keywords in the format .dat File	289
Partition Tables (format .dat)	291
Specifying an Alternate Data File for the format Utility	292
Rules for Input to format Commands	292

Specifying Numbers to format Commands	292
Specifying Block Numbers to format Commands	293
Specifying format Command Names	293
Specifying Disk Names to format Commands	294
Getting Help on the format Utility	294
16 Managing File Systems (Overview)	295
What's New in Oracle Solaris File Systems?	295
File System Monitoring Tool (fsstat)	295
Oracle Solaris ZFS File System	296
Enhancements to UFS File System Utilities (fsck, mkfs, and newfs)	296
Where to Find File System Management Tasks	303
Overview of File Systems	303
Types of Oracle Solaris File Systems	304
Commands for UFS File System Administration	310
How File System Commands Determine the File System Type	310
Manual Pages for Generic and Specific File System Commands	311
Default Oracle Solaris File Systems	311
UFS File System	313
UFS File System Features	313
Planning UFS File Systems	314
Support of Multiterabyte UFS File Systems	314
UFS Logging	316
UFS Snapshots	318
UFS Direct Input/Output (I/O)	318
Overview of Mounting and Unmounting File Systems	319
The Mounted File System Table	320
The Virtual File System Table	321
The NFS Environment	322
Automounting (autofs)	323
Determining a File System's Type	324
How to Determine a File System's Type	324
17 Creating and Mounting File Systems (Tasks)	327
Creating Oracle Solaris File Systems	327

Creating ZFS File Systems	327
Creating UFS File Systems	328
Creating a Temporary File System	329
Creating a LOFS File System	329
Mounting and Unmounting Oracle Solaris File Systems	329
Field Descriptions for the <code>/etc/vfstab</code> File	331
Prerequisites for Unmounting Oracle Solaris File Systems	333
Creating and Mounting Oracle Solaris File Systems	333
▼ How to Create an ZFS File System	333
▼ How to Create and Mount a UFS File System	334
▼ How to Create a Multiterabyte UFS File System	335
▼ How to Expand a Multiterabyte UFS File System	336
▼ How to Expand a UFS File System to a Multiterabyte UFS File System	337
Troubleshooting Multiterabyte UFS File System Problems	338
▼ How to Create and Mount a TMPFS File System	339
▼ How to Create and Mount an LOFS File System	340
▼ How to Add an Entry to the <code>/etc/vfstab</code> File	341
▼ How to Mount a File System (<code>/etc/vfstab</code> File)	342
▼ How to Mount a UFS File System (<code>mount</code> Command)	343
▼ How to Mount a UFS File System Without Large Files (<code>mount</code> Command)	344
▼ How to Mount an NFS File System (<code>mount</code> Command)	345
▼ x86: How to Mount a PCFS (DOS) File System From a Hard Disk (<code>mount</code> Command) ...	345
▼ How to Stop All Processes Accessing a File System	346
▼ How to Unmount a File System	347
18 Using The CacheFS File System (Tasks)	349
High-Level View of Using the CacheFS File System (Task Map)	349
Overview of the CacheFS File System	350
How a CacheFS File System Works	350
CacheFS File System Structure and Behavior	351
Creating and Mounting a CacheFS File System (Task Map)	352
▼ How to Create the Cache	353
Mounting a File System in the Cache	353
▼ How to Mount a CacheFS File System (<code>mount</code>)	354
▼ How to Mount a CacheFS File System (<code>/etc/vfstab</code>)	356

▼ How to Mount a CacheFS File System (autofs)	356
Maintaining a CacheFS File System (Task Map)	357
Maintaining a CacheFS File System	358
Modifying a CacheFS File System	358
▼ How to Display Information About a CacheFS File System	359
Consistency Checking of a CacheFS File System	359
▼ How to Specify Cache Consistency Checking on Demand	360
▼ How to Delete a CacheFS File System	360
▼ How to Check the Integrity of a CacheFS File System	361
Packing a Cached File System (Task Map)	362
Packing a CacheFS File System	363
▼ How to Pack Files in the Cache	363
▼ How to Display Packed Files Information	364
Using Packing Lists	365
▼ How to Create a Packing List	366
▼ How to Pack Files in the Cache With a Packing List	366
Unpacking Files or Packing Lists From the Cache	367
▼ How to Unpack Files or Packing Lists From the Cache	367
Troubleshooting cachefspack Errors	368
Collecting CacheFS Statistics (Task Map)	371
Collecting CacheFS Statistics	372
▼ How to Set Up CacheFS Logging	373
▼ How to Locate the CacheFS Log File	373
How to Stop CacheFS Logging	374
▼ How to View the Working Set (Cache) Size	374
Viewing CacheFS Statistics	375
▼ How to View CacheFS Statistics	376
19 Configuring Additional Swap Space (Tasks)	377
About Swap Space	377
Swap Space and Virtual Memory	378
Swap Space and the TMPFS File System	378
Swap Space as a Dump Device	379
Swap Space and Dynamic Reconfiguration	379
Configuring Swap Space in a SAN Environment	380

How Do I Know If I Need More Swap Space?	380
Swap-Related Error Messages	380
TMPFS-Related Error Messages	381
How Swap Space Is Allocated	381
Swap Areas and the <code>/etc/vfstab</code> File	381
Planning for Swap Space	382
Allocating Swap Space for UFS-Based Systems	383
Allocating Swap Space for ZFS-Based Systems	383
Monitoring Swap Resources	384
Adding More Swap Space	385
Creating a Swap File in a UFS Root Environment	385
▼ How to Create a Swap File and Make It Available in UFS Root Environment	386
Adding or Changing Swap Space in an Oracle Solaris ZFS Root Environment	387
▼ How to Add Swap Space in an Oracle Solaris ZFS Root Environment	388
Removing a Swap File From Use	388
▼ How to Remove Unneeded Swap Space in UFS Root Environment	389
▼ How to Remove a Swap Volume in a ZFS Root Environment	389
20 Checking UFS File System Consistency (Tasks)	391
UFS File System Consistency	392
How the UFS File System State Is Recorded	392
What the <code>fsck</code> Command Checks and Tries to Repair	393
Why UFS File System Inconsistencies Might Occur	393
UFS Components That Are Checked for Consistency	394
<code>fsck</code> Summary Message	399
Interactively Checking and Repairing a UFS File System	399
▼ How to Check the UFS root (<code>/</code>), <code>/usr</code> , or <code>/var</code> File Systems From an Alternate Boot Device	400
▼ How to Check Other UFS File Systems (Not root (<code>/</code>), <code>/usr</code> , or <code>/var</code>)	402
Preening UFS File Systems	404
▼ How to Preen a UFS File System	404
Fixing a UFS File System That the <code>fsck</code> Command Cannot Repair	405
Restoring a Bad UFS Superblock	406
▼ How to Restore a Bad UFS Superblock (Solaris 10 6/06 Release)	406
▼ How to Restore a Bad Superblock (Solaris 8, 9, and 10 Releases)	409

Syntax and Options for the <code>fsck</code> Command	411
21 UFS File System (Reference)	413
Structure of Cylinder Groups for UFS File Systems	413
Boot Block	414
Superblock	414
Inodes	414
Data Blocks	415
Free Blocks	416
Customizing UFS File System Parameters	416
Logical Block Size	417
Fragment Size	417
Minimum Free Space	418
Rotational Delay	418
Optimization Type	418
Number of Inodes (Files)	419
Maximum UFS File and File System Size	419
Maximum Number of UFS Subdirectories	419
22 Backing Up and Restoring UFS File Systems (Overview)	421
Where to Find UFS Backup and Restore Tasks	421
Introduction to Backing Up and Restoring UFS File Systems	422
Why You Should Back Up File Systems	422
Planning Which UFS File Systems to Back Up	423
Choosing the Type of Backup	424
Choosing a Tape Device	425
High-Level View of Backing Up and Restoring UFS File Systems (Task Map)	426
Considerations for Scheduling Backups	427
Guidelines for Scheduling Backups	428
Using Dump Levels to Create Incremental Backups	429
Sample Backup Schedules	430
23 Backing Up UFS Files and File Systems (Tasks)	437
Backing Up UFS Files and File System (Task Map)	437

Preparing for File System Backups	438
▼ How to Find UFS File System Names	438
▼ How to Determine the Number of Tapes Needed for a Full Backup	439
Backing Up a UFS File System	439
▼ How to Back Up a UFS File System to Tape	440
24 Using UFS Snapshots (Tasks)	447
Using UFS Snapshots (Task Map)	447
UFS Snapshots Overview	448
Why Use UFS Snapshots?	448
UFS Snapshots Performance Issues	449
Creating and Deleting UFS Snapshots	449
Creating a Multiterabyte UFS Snapshot	450
▼ How to Create a UFS Snapshot	451
▼ How to Display UFS Snapshot Information	452
Deleting a UFS Snapshot	453
▼ How to Delete a UFS Snapshot	453
Backing Up a UFS Snapshot	454
▼ How to Create a Full Backup of a UFS Snapshot (ufsdump)	454
▼ How to Create an Incremental Backup of a UFS Snapshot (ufsdump)	455
▼ How to Back Up a UFS Snapshot (tar)	456
Restoring Data From a UFS Snapshot Backup	456
25 Restoring UFS Files and File Systems (Tasks)	457
Restoring UFS Files and File System Backups (Task Map)	457
Preparing to Restore UFS Files and File Systems	458
Determining the UFS File System Name	458
Determining the Type of Tape Device You Need	458
Determining the Tape Device Name	459
Restoring UFS Files and File Systems	459
▼ How to Determine Which Tapes to Use	459
▼ How to Restore UFS Files Interactively	460
▼ How to Restore Specific UFS Files Noninteractively	463
▼ How to Restore a Complete UFS File System	464
▼ How to Restore a UFS root (/) and /usr File System	468

26	UFS Backup and Restore Commands (Reference)	471
	How the <code>ufsdump</code> Command Works	471
	Determining Device Characteristics	471
	Detecting the End of Media	472
	Copying Data With the <code>ufsdump</code> Command	472
	Purpose of the <code>/etc/dumpdates</code> File	472
	Backup Device (<i>dump-file</i>) Argument	473
	Specifying Files to Back Up	474
	Specifying Tape Characteristics	475
	Limitations of the <code>ufsdump</code> Command	475
	Specifying <code>ufsdump</code> Command Options and Arguments	475
	Default <code>ufsdump</code> Options	476
	The <code>ufsdump</code> Command and Security Issues	476
	Specifying <code>ufsrestore</code> Options and Arguments	476
27	Copying Files and File Systems (Tasks)	477
	Commands for Copying File Systems	477
	Copying File Systems Between Disks	480
	Making a Literal File System Copy	480
	▼ How to Copy a Disk (<code>dd</code>)	480
	Copying Directories Between File Systems (<code>cpio</code> Command)	483
	▼ How to Copy Directories Between File Systems (<code>cpio</code>)	484
	Copying Files and File Systems to Tape	485
	Copying Files to Tape (<code>tar</code> Command)	485
	▼ How to Copy Files to a Tape (<code>tar</code>)	485
	▼ How to List the Files on a Tape (<code>tar</code>)	486
	▼ How to Retrieve Files From a Tape (<code>tar</code>)	487
	Copying Files to a Tape With the <code>pax</code> Command	488
	▼ How to Copy Files to a Tape (<code>pax</code>)	488
	Copying Files to Tape With the <code>cpio</code> Command	489
	▼ How to Copy All Files in a Directory to a Tape (<code>cpio</code>)	489
	▼ How to List the Files on a Tape (<code>cpio</code>)	490
	▼ How to Retrieve All Files From a Tape (<code>cpio</code>)	490
	▼ How to Retrieve Specific Files From a Tape (<code>cpio</code>)	491
	Copying Files to a Remote Tape Device	492

- ▼ How to Copy Files to a Remote Tape Device (tar and dd) 492
 - ▼ How to Extract Files From a Remote Tape Device 494
- Copying Files and File Systems to Diskette 494
 - What You Should Know When Copying Files to Diskettes 495
 - ▼ How to Copy Files to a Single Formatted Diskette (tar) 495
 - ▼ How to List the Files on a Diskette (tar) 496
 - ▼ How to Retrieve Files From a Diskette (tar) 496
 - Archiving Files to Multiple Diskettes 497
- 28 Managing Tape Drives (Tasks) 499**
 - Choosing Which Media to Use 499
 - Backup Device Names 500
 - Specifying the Rewind Option for a Tape Drive 501
 - Specifying Different Densities for a Tape Drive 502
 - Displaying Tape Drive Status 502
 - ▼ How to Display Tape Drive Status 502
 - Handling Magnetic Tape Cartridges 503
 - Retensioning a Magnetic Tape Cartridge 503
 - Rewinding a Magnetic Tape Cartridge 504
 - Guidelines for Drive Maintenance and Media Handling 504
- Index 505**

Preface

System Administration Guide: Devices and File Systems is part of a set that includes a significant part of the Oracle Solaris system administration information. This guide contains information for both SPARC based and x86 based systems.

This book assumes you have completed the following tasks:

- Installed the SunOS 5.10 Operating System
- Set up all the networking software that you plan to use

For the Oracle Solaris 10 releases, new features of interest to system administrators are covered in sections called *What's New in ... ?* in the appropriate chapters.

Note – This Oracle Solaris release supports systems that use the SPARC and x86 families of processor architectures. The supported systems appear in the *Oracle Solaris Hardware Compatibility List* at <http://www.oracle.com/webfolder/technetwork/hcl/index.html>. This document cites any implementation differences between the platform types.

In this document these x86 terms mean the following:

- “x86” refers to the larger family of 64-bit and 32-bit x86 compatible products.
- “x64” relates specifically to 64-bit compatible CPUs.
- “32-bit x86” points out specific 32-bit information about x86 based systems.

Note – Oracle is not responsible for the availability of third-party web sites mentioned in this document. Oracle does not endorse and is not responsible or liable for any content, advertising, products, or other materials that are available on or through such sites or resources. Oracle will not be responsible or liable for any actual or alleged damage or loss caused by or in connection with the use of or reliance on any such content, goods, or services that are available on or through such sites or resources.

Who Should Use This Book

This book is intended for anyone responsible for administering one or more systems running the Oracle Solaris 10 release. To use this book, you should have 1–2 years of UNIX system administration experience. Attending UNIX system administration training courses might be helpful.

How the System Administration Guides Are Organized

Here is a list of the topics that are covered by the System Administration Guides.

Book Title	Topics
<i>System Administration Guide: Basic Administration</i>	User accounts and groups, server and client support, shutting down and booting a system, and managing services
<i>System Administration Guide: Advanced Administration</i>	Terminals and modems, system resources (disk quotas, accounting, and crontabs), system processes, and troubleshooting Oracle Solaris software problems
<i>System Administration Guide: Devices and File Systems</i>	Removable media, disks and devices, file systems, and backing up and restoring data
<i>System Administration Guide: IP Services</i>	TCP/IP network administration, IPv4 and IPv6 address administration, DHCP, IPsec, IKE, IP filter, Mobile IP, IP network multipathing (IPMP), and IPQoS
<i>System Administration Guide: Naming and Directory Services (DNS, NIS, and LDAP)</i>	DNS, NIS, and LDAP naming and directory services, including transitioning from NIS to LDAP and transitioning from NIS+ to LDAP
<i>System Administration Guide: Naming and Directory Services (NIS+)</i>	NIS+ naming and directory services
<i>System Administration Guide: Network Services</i>	Web cache servers, time-related services, network file systems (NFS and autofs), mail, SLP, and PPP
<i>System Administration Guide: Printing</i>	Printing topics and tasks, using services, tools, protocols, and technologies to set up and administer printing services and printers
<i>System Administration Guide: Security Services</i>	Auditing, device management, file security, BART, Kerberos services, PAM, Oracle Solaris Cryptographic Framework, privileges, RBAC, SASL, and Oracle Solaris Secure Shell

Book Title	Topics
<i>System Administration Guide: Oracle Solaris Containers-Resource Management and Oracle Solaris Zones</i>	Resource management topics projects and tasks, extended accounting, resource controls, fair share scheduler (FSS), physical memory control using the resource capping daemon (rcapd), and resource pools; virtualization using Solaris Zones software partitioning technology and lx branded zones
<i>Oracle Solaris ZFS Administration Guide</i>	ZFS storage pool and file system creation and management, snapshots, clones, backups, using access control lists (ACLs) to protect ZFS files, using ZFS on a Solaris system with zones installed, emulated volumes, and troubleshooting and data recovery
<i>Trusted Extensions Administrator's Procedures</i>	
<i>Trusted Extensions Configuration Guide</i>	Starting with the Solaris 10 5/08 release, describes how to plan for, enable, and initially configure the Oracle Solaris' Trusted Extensions feature

Access to Oracle Support

Oracle customers have access to electronic support through My Oracle Support. For information, visit <http://www.oracle.com/pls/topic/lookup?ctx=acc&id=info> or visit <http://www.oracle.com/pls/topic/lookup?ctx=acc&id=trs> if you are hearing impaired.

What Typographic Conventions Mean

The following table describes the typographic conventions used in this book.

TABLE P-1 Typographic Conventions

Typeface or Symbol	Meaning	Example
AaBbCc123	The names of commands, files, and directories; on screen computer output	Edit your <code>.login</code> file. Use <code>ls -a</code> to list all files. <code>machine_name% you have mail.</code>
AaBbCc123	What you type, contrasted with on screen computer output	<code>machine_name% su</code> Password:
<i>AaBbCc123</i>	Command-line placeholder: replace with a real name or value	To delete a file, type <code>rm filename.</code>

TABLE P-1 Typographic Conventions (Continued)

Typeface or Symbol	Meaning	Example
<i>AaBbCc123</i>	Book titles, new words or terms, or words to be emphasized	Read Chapter 6 in <i>User's Guide</i> . These are called <i>class</i> options. Do <i>not</i> save changes yet.

Shell Prompts in Command Examples

The following table shows the default system prompt and superuser prompt for the C shell, Bourne shell, and Korn shell.

TABLE P-2 Shell Prompts

Shell	Prompt
C shell prompt	machine_name%
C shell superuser prompt	machine_name#
Bourne shell and Korn shell prompt	\$
Bourne shell and Korn shell superuser prompt	#

Managing Removable Media (Overview)

This chapter provides general guidelines for managing removable media in the Oracle Solaris OS.

This is a list of the overview information in this chapter.

- “What's New in Removable Media?” on page 25
- “Where to Find Managing Removable Media Tasks” on page 27
- “Removable Media Features and Benefits” on page 27
- “Comparison of Manual and Automatic Mounting” on page 28
- “Overview of Accessing Removable Media” on page 28

What's New in Removable Media?

The following section describes new removable media features in the Oracle Solaris release.

- “`vol` is Managed by the Service Management Facility (SMF)” on page 25
- “Improvements to Volume Management (`vol`)” on page 26

For a complete listing of new Oracle Solaris features and a description of Oracle Solaris releases, see *Oracle Solaris 10 8/11 What's New*.

`vol` is Managed by the Service Management Facility (SMF)

Solaris 10 1/06: The volume management daemon, `vol`, is now managed by the Service Management Facility (SMF). This means you can use the `svcadm disable` command to disable the following new `volfs` service, if appropriate:

```
# svcadm disable volfs
```

You can identify the status of the `volfs` service by using this command:

```
$ svcs volfs
STATE          STIME      FMRI
online         Sep_29     svc:/system/filesystem/volfs:default
```

For more information, see [smf\(5\)](#).

You can use the `svccfg` command to display and to set additional `vold` properties. For example, you could temporarily enable `vold` logging to help troubleshooting a problem. For example:

```
# svccfg
svc:> select system/filesystem/volfs
svc:/system/filesystem/volfs> setprop vold/log_debuglevel=3
svc:/system/filesystem/volfs> exit
# svcadm disable volfs
# svcadm enable volfs
```

You can also use the `svccfg` command to display a listing of settable `vold` properties.

```
# svccfg
svc:> select volfs
svc:/system/filesystem/volfs> listprop vold/*
vold/config_file          astring
vold/log_debuglevel       count      3
vold/log_file             astring
vold/log_nfs_trace        boolean    false
vold/log_verbose          boolean    false
vold/root_dir             astring
vold/never_writeback_label boolean    false
svc:/system/filesystem/volfs> exit
```

For a description of these properties, see the [vold\(1M\)](#).

Improvements to Volume Management (`vold`)

Solaris 10 1/06: Removable media management is improved. Previously, `vold` did not create device links for removable devices that contain no media. Now, device links are properly created for devices that contain no media, similar to the following:

```
lrwxrwxrwx  1 root    root      28 Jun 13 13:09 /vol/dev/aliases/cdrom0 ->
/vol/dev/rdisk/c2t2d0/nomedia
```

Now, you can use the `cdwr` and `rmformat` commands to list devices that have no media when `vold` is running.

You can revert back to the previous `vold` behavior by changing the following support `nomedia` entry in the `/etc/vold.conf` file as follows:

```
support media
```

Then, restart `vol`. For more information, see `vol.d.conf(4)`.

In addition, `vol` is now hot-plug aware. This improvement means that if you insert removable media, the media is automatically detected and mounted by `vol`. There should be no need to restart `vol` manually to recognize and mount a file system from any removable media device.

If you are using a legacy or non-USB diskette device, then you might need to issue the `vol check` command before `vol` can recognize the media.

If the media is detected, but for some reason, is unmounted, then you'll need to run the following commands:

```
# volrmmount -i rmdisk0
```

Before you hot-remove a removable media device, eject the media first. For example:

```
# eject rmdisk0
```

Where to Find Managing Removable Media Tasks

Use these references to find step-by-step instructions for managing removable media.

Removable Media Management Task	For More Information
Access removable media	Chapter 3, “Accessing Removable Media (Tasks)”
Format removable media	Chapter 2, “Managing Removable Media (Tasks)”
Write data CDs and DVDs and music CDs	Chapter 4, “Writing CDs and DVDs (Tasks)”

Removable Media Features and Benefits

The Oracle Solaris release gives users and software developers a standard interface for dealing with removable media. Removable media services provide the following benefits:

- Automatically mounts removable media. For a comparison of manual and automatic mounting, see the following section.
- Enables you to access removable media without having to become superuser.
- Allows you to give other systems on the network automatic access to any removable media on your local system. For more information, see [Chapter 3, “Accessing Removable Media \(Tasks\)”](#).

Comparison of Manual and Automatic Mounting

The following table compares the steps involved in manual mounting (without removable media services) and automatic mounting (with removable media management) of removable media.

TABLE 1-1 Comparison of Manual and Automatic Mounting of Removable Media

Steps	Manual Mounting	Automatic Mounting
1	Insert media.	Insert media.
2	Become superuser.	For diskettes, use the <code>volcheck</code> command.
3	Determine the location of the media device.	Removable media services automatically perform many of the tasks that are required to manually mount and work with removable media.
4	Create a mount point.	
5	Make sure you are not in the mount point directory.	
6	Mount the device and use the proper mount options.	
7	Exit the superuser account.	
8	Work with files on media.	Work with files on media.
9	Become superuser.	
10	Unmount the media device.	
11	Eject media.	Eject media.
12	Exit the superuser account.	

Overview of Accessing Removable Media

Essentially, removable media services enable you to access removable media just as manual mounting does, but more easily and without the need for superuser access.

If your system has more than one type of removable device, see the following table for their access points.

TABLE 1-2 How to Access Data on Removable Media

Access	Insert	Find the Files Here
Files on the first diskette	The diskette and type <code>volcheck</code> on the command line	<code>/floppy</code>
Files on the removable hard disk	The removable hard disk and type <code>volcheck</code> on the command line	<code>/rmdisk/rmdisk0</code> or <code>/rmdisk/rmdisk1</code>
Files on the first CD	The CD and wait for a few seconds	<code>/cdrom/volume-name</code>
Files on the first DVD	The DVD and wait for a few seconds	<code>/cdrom/volume-name</code>

TABLE 1-3 Where to Access Removable Media

Access File Systems With This Path	Access Raw Data With This Path
<code>/floppy/floppy0</code>	<code>/vol/dev/aliases/floppy0</code>
<code>/floppy/floppy1</code>	<code>/vol/dev/aliases/floppy1</code>
<code>/cdrom/cdrom0</code>	<code>/vol/dev/aliases/cdrom0</code>
<code>/cdrom/cdrom1</code>	<code>/vol/dev/aliases/cdrom1</code>
<code>/rmdisk/rmdisk0</code> or	<code>/vol/dev/aliases/rmdisk0</code> or
<code>/rmdisk/rmdisk1</code>	<code>/vol/dev/aliases/rmdisk1</code>
<code>/pcmem/pcmem0</code>	<code>/vol/dev/aliases/pcmem0</code>

Managing Removable Media (Tasks)

This chapter describes how to manage removable media from the command line in the Oracle Solaris OS.

For information on the procedures associated with managing removable media, see [“Managing Removable Media \(Task Map\)” on page 31](#). For background information on removable media, see [Chapter 1, “Managing Removable Media \(Overview\)”](#).

Managing Removable Media (Task Map)

The following task map describes the tasks for managing removable media.

Task	Description	For Instructions
1. Load media.	Insert the diskette into the drive and type the <code>volcheck</code> command.	“How to Load Removable Media” on page 33
2. (Optional) Format the diskette.	Format diskette.	“How to Format a Diskette (<code>rmformat</code>)” on page 34
3. (Optional) Add a UFS or PCFS file system.	Add a UFS or PCFS file system to use the media for transferring files.	“How to Create a File System on Removable Media” on page 35
	Add a UFS or UDFS file system to a DVD-RAM device.	“How to Create a File System on a DVD-RAM” on page 37
4. (Optional) Check the media.	Verify the integrity of the file system on the media.	“How to Check a File System on Removable Media” on page 38
5. (Optional) Repair bad blocks on the media.	Repair any bad blocks on the media, if necessary.	“How to Repair Bad Blocks on Removable Media” on page 38

Task	Description	For Instructions
6. (Optional) Apply read or write and password protection.	Apply read or write protection or password protection on the media, if necessary.	“How to Enable or Disable Write Protection on Removable Media” on page 39

Formatting Diskettes

You can use the `rmformat` command to format and protect rewritable diskettes. This utility does not require superuser privilege unless `vold` is not running. File systems are mounted automatically. So, you might have to unmount media before you can format it, if the media contains an existing file system.

The `rmformat` command has three formatting options:

- `quick` – This option formats diskettes without certification or with limited certification of certain tracks on the media.
- `long` – This option completely formats diskettes. For some devices, the use of this option might include the certification of the whole media by the drive.
- `force` – This option formats completely without user confirmation. For diskettes with a password-protection mechanism, this option clears the password before formatting. This feature is useful when a password is forgotten. On diskettes without password protection, this option forces a long format.

Removable Media Hardware Considerations

Keep the following restrictions in mind when working with diskettes:

- SPARC and x86 UFS formats are different. SPARC uses little-endian bit coding, x86 uses big-endian. Media formatted for UFS is restricted to the hardware platform on which they were formatted. So, a diskette formatted for UFS on a SPARC based platform cannot be used for UFS on an x86 platform. Likewise, a diskette formatted for UFS on an x86 platform cannot be used on a SPARC platform.
- A complete format for SunOS file systems consists of the basic “bit” formatting in addition the structure to support a SunOS file system. A complete format for a DOS file system consists of the basic “bit” formatting in addition the structure to support either an MS-DOS or an NEC-DOS file system. The procedures required to prepare a media for each type of file system are different. Therefore, before you format a diskette, consider which procedure to follow. For more information, see [“Managing Removable Media \(Task Map\)” on page 31](#).

Diskette Hardware Considerations

Keep the following in mind when formatting diskettes:

- For information on diskette names, see [Table 3–1](#).

- Diskettes that are not named (that is, they have no “label”) are assigned the default name of `unnamed_floppy`.
- Diskettes that are not named (that is, they have no “label”) are assigned the default name of `floppy`.

An Oracle Solaris system can format the following diskette types:

- UFS
- MS-DOS or NEC-DOS (PCFS)
- UDFS

On an Oracle Solaris system (either SPARC or x86), you can format diskettes with the following densities.

Diskette Size	Diskette Density	Capacity
3.5”	High density (HD)	1.44 MB
3.5”	Double density (DD)	720 KB

By default, the diskette drive formats a diskette to a like density. This default means that a 1.44 MB drive attempts to format a diskette for 1.44 MB, regardless of whether the diskette is, in fact, a 1.44 MB diskette, unless you instruct it otherwise. In other words, a diskette can be formatted to its capacity or lower, and a drive can format to its capacity or lower.

▼ How to Load Removable Media

For information about removable media hardware considerations, see [“Removable Media Hardware Considerations” on page 32](#).

1 Insert the media.

2 Ensure that the media is formatted.

If you aren't sure, insert the media and check the status messages in the system console window, as described in [Step 3](#). If you need to format the media, go to [“How to Format a Diskette \(rmformat\)” on page 34](#).

3 (Optional) Notify volume management if you are using a legacy, non-USB diskette device.

```
$ volcheck -v
```

Two status messages are possible:

```
media was found
```

Volume management detected the media and will attempt to mount it in the directory described in [Table 3–1](#).

If the media is formatted properly, no error messages appear in the console.

If the media is not formatted, the “media was found” message is still displayed. However, error messages similar to the following appear in the system console window:

```
fd0: unformatted diskette or no diskette in the drive
```

```
fd0: read failed (40 1 0)
```

```
fd0: bad format
```

You must format the media before volume management can mount it. For more information, see [Chapter 2, “Managing Removable Media \(Tasks\).”](#)

no media was found Volume management did not detect the media. Ensure that the media is inserted properly, and run `volcheck` again. If unsuccessful, check the media, which could be damaged. You can also try to mount the media manually.

4 Verify that the media was mounted by listing its contents.

For example, do the following for a diskette:

```
$ ls /floppy
floppy0 myfiles
```

Tip – `floppy0` is a symbolic link to the actual name of the diskette. In this case, `myfiles`. If the diskette has no name but is formatted correctly, the system refers to it as `unnamed_floppy`.

If nothing appears under the `/floppy` directory, the diskette was either not mounted or is not formatted properly. To find out, run the mount command and look for the line that begins with `/floppy` (usually at the end of the listing):

```
/floppy/name on /vol/dev/diskette0/name
```

If this line does not appear, the diskette was not mounted. Check the system console window for error messages.

▼ How to Format a Diskette (`rmformat`)

You can use the `rmformat` command to format a diskette. By default, this command creates two partitions on the media: partition 0 and partition 2 (the whole media).

- 1 **Verify that removable media service is running. If so, you can use the shorter nickname for the device name.**

```
$ svcs volfs
STATE          STIME      FMRI
online         10:39:12  svc:/system/filesystem/volfs:default
```

For information on restarting removable media services, see [“How to Disable or Enable Removable Media Services”](#) on page 43. For information on identifying media device names, see [“Using Removable Media Names”](#) on page 42.

- 2 **Format the diskette.**

```
$ rmformat -F [ quick | long | force ] device-name
```

See [“Formatting Diskettes”](#) on page 32 for more information on `rmformat` formatting options.

If the `rmformat` output indicates bad blocks, see [“How to Repair Bad Blocks on Removable Media”](#) on page 38.

- 3 **(Optional) Label the diskette with an 8-character label.**

```
$ rmformat -b label device-name
```

For information on creating a DOS label, see `mkfs_pcfs(1M)`.

Example 2-1 Formatting a Diskette

This example shows how to format a diskette.

```
$ rmformat -F quick /dev/rdiskette
Formatting will erase all the data on disk.
Do you want to continue? (y/n) y
.....
```

▼ How to Create a File System on Removable Media

- 1 **(Optional) Format the diskette.**

```
$ rmformat -F quick device-name
```

- 2 **(Optional) Create an alternate Solaris partition table.**

```
$ rmformat -s slice-file device-name
```

A sample slice file appears similar to the following:

```
slices: 0 = 0, 30MB, "wm", "home" :
         1 = 30MB, 51MB :
         2 = 0, 94MB, "wm", "backup" :
         6 = 81MB, 13MB
```

- 3 Become superuser.
- 4 Determine the appropriate file system type and select one of the following:
 - Create a UFS file system. For example:

```
# newfs /vol/dev/aliases/floppy0
```
 - Create a PCFS file system. For example:

```
# mkfs -F pcfs /dev/rdisk/c0t4d0s2:c
```
 - Create a UDFS file system. For example:

```
# mkfs -F udfs /dev/rdisk/c0t1d0s1
```

Example 2-2 Formatting a Diskette for a UFS File System

The following example shows how to format a diskette and create a UFS file system on the diskette.

```
$ rmformat -F quick /vol/dev/aliases/floppy0
Formatting will erase all the data on disk.
Do you want to continue? (y/n) y
$ su
# /usr/sbin/newfs /vol/dev/aliases/floppy0
newfs: construct a new file system /dev/rdiskette: (y/n)? y
/dev/rdiskette: 2880 sectors in 80 cylinders of 2 tracks, 18 sectors
      1.4MB in 5 cyl groups (16 c/g, 0.28MB/g, 128 i/g)
super-block backups (for fsck -F ufs -o b=#) at:
 32, 640, 1184, 1792, 2336,
#

$ rmformat -F quick /dev/rdiskette
Formatting will erase all the data on disk.
Do you want to continue? (y/n)y
$ su
# /usr/sbin/newfs /dev/rdiskette
newfs: construct a new file system /dev/rdiskette: (y/n)? y
/dev/rdiskette: 2880 sectors in 80 cylinders of 2 tracks, 18 sectors
      1.4MB in 5 cyl groups (16 c/g, 0.28MB/g, 128 i/g)
super-block backups (for fsck -F ufs -o b=#) at:
 32, 640, 1184, 1792, 2336,
```

Example 2-3 Formatting a Diskette for a PCFS File System

This example shows how to create a PCFS file system with an alternate fdisk partition. In these examples, vold is not running.

```
$ rmformat -F quick /dev/rdisk/c0t4d0s2:c
Formatting will erase all the data on disk.
Do you want to continue? (y/n) y
$ su
# fdisk /dev/rdisk/c0t4d0s2:c
```

```
# mkfs -F pcfs /dev/rdisk/c0t4d0s2:c
Construct a new FAT file system on /dev/rdisk/c0t4d0s2:c: (y/n)? y
#
```

This example shows how to create a PCFS file system without an fdisk partition.

```
$ rmformat -F quick /dev/rdiskette
Formatting will erase all the data on disk.
Do you want to continue? (y/n) y
$ su
# mkfs -F pcfs -o nofdisk,size=2 /dev/rdiskette
Construct a new FAT file system on /dev/rdiskette: (y/n)? y
#
```

▼ How to Create a File System on a DVD-RAM

Currently, `vol` doesn't support DVD-RAM devices. So, if you disable `vol` to use a DVD-RAM device, you cannot use CD-R, CD-RW, DVD-R, DVD-RW, DVD+R, DVD+RW devices because `vol` is not available during the time that it is disabled.

1 Become superuser.

2 Stop `vol`.

```
# svcadm disable volfs
```

3 Create a file system on the DVD-RAM device.

- Create a UFS file system. For example:

```
# newfs /dev/rdisk/c0t0d0s2
```
- Create a UDFS file system. For example:

```
# mkfs -F udfs /dev/rdisk/c0t0d0s2
```

4 Mount the file system.

- Mount a UFS file system. For example:

```
# mount -F ufs /dev/dsk/c0t0d0s2 /mnt
```
- Mount a UDFS file system. For example:

```
# mount -F udfs /dev/dsk/c0t0d0s2 /mnt
```

5 Verify that you can read or write to the file system.

6 When finished, eject the DVD-RAM.

7 Restart vold.

```
# svcadm enable volfs
```

▼ How to Check a File System on Removable Media

1 Become superuser.**2 Identify the file system type and select one of the following:**

- Check a UFS file system.

```
# fsck -F ufs device-name
```

- Check a UDFS file system.

```
# fsck -F udfs device-name
```

- Check a PCFS file system.

```
# fsck -F pcfs device-name
```

Example 2-4 Checking a PCFS File System on Removable Media

The following example shows how check the consistency of a PCFS file system on media. In this example, vold is not running.

```
# fsck -F pcfs /dev/rdisk/c0t4d0s2
** /dev/rdisk/c0t4d0s2
** Scanning file system meta-data
** Correcting any meta-data discrepancies
1457664 bytes.
0 bytes in bad sectors.
0 bytes in 0 directories.
0 bytes in 0 files.
1457664 bytes free.
512 bytes per allocation unit.
2847 total allocation units.
2847 available allocation units.
#
```

▼ How to Repair Bad Blocks on Removable Media

You can only use the `rmformat` command to verify, analyze, and repair bad sectors that are found during verification if the drive supports bad block management. Most diskettes and USB memory sticks do not support bad block management.

If the drive supports bad block management, a best effort is made to rectify the bad block. If the bad block cannot be rectified despite the best effort mechanism, a message indicates the failure to repair the media.

1 Repair bad blocks on removable media.

```
$ rmformat -c block-numbers device-name
```

Supply the block number in decimal, octal, or hexadecimal format from a previous `rmformat` session.

2 Verify the media.

```
$ rmformat -V read device-name
```

Applying Read or Write Protection and Password Protection to Removable Media

You can apply read protection or write protection, and set a password, on removable media that support this feature.

▼ How to Enable or Disable Write Protection on Removable Media

1 Determine whether you want to enable or disable write protection and select one of the following:

- Enable write protection.

```
$ rmformat -w enable device-name
```

- Disable write protection.

```
$ rmformat -w disable device-name
```

2 Verify whether the media's write protection is enabled or disabled.

```
$ rmformat -p device-name
```

▼ How to Enable or Disable Read or Write Protection and Set a Password on Removable Media

You can apply a password with a maximum of 32 characters for removable media that support this feature.

You will receive a warning message if you attempt to apply a password on media that does not support this feature.

1 Determine whether you want to enable or disable read protection or write protection and set a password. Select one of the following:

- Enable read protection or write protection.

```
$ rmformat -W enable device-name  
Please enter password (32 chars maximum): xxx  
Please reenter password:
```

```
$ rmformat -R enable device-name  
Please enter password (32 chars maximum): xxx  
Please reenter password:
```

- Disable read protection or write protection and remove the password.

```
$ rmformat -W disable device-name  
Please enter password (32 chars maximum): xxx
```

```
$ rmformat -R disable device-name  
Please enter password (32 chars maximum): xxx
```

2 Verify whether the media's read protection or write protection is enabled or disabled.

```
$ rmformat -p device-name
```

Example 2-5 Enabling or Disabling Read or Write Protection and Password Protection

This example shows how to enable write protection and set a password on a diskette.

```
$ rmformat -W enable /vol/dev/aliases/floppy0  
Please enter password (32 chars maximum): xxx  
Please reenter password: xxx
```

This example shows to disable read protection and remove the password on a diskette.

```
$ rmformat -R disable /vol/dev/aliases/floppy0  
Please enter password (32 chars maximum): xxx
```

Accessing Removable Media (Tasks)

This chapter describes how to access removable media from the command line in the Oracle Solaris OS.

For information on the procedures associated with accessing removable media, see the following:

- [“Accessing Removable Media \(Task Map\)” on page 41](#)
- [“Accessing Removable Media on a Remote System \(Task Map\)” on page 46](#)

For background information on removable media, see [Chapter 1, “Managing Removable Media \(Overview\).”](#)

Accessing Removable Media (Task Map)

The following task map describes the tasks for accessing removable media.

Task	Description	For Instructions
1. (Optional) Add the removable media drive.	Add the removable media drive to your system, if necessary.	“How to Add a New Removable Media Drive” on page 43
2. (Optional) Decide whether you want to use removable media with or without volume management (<code>vol</code>).	Volume management (<code>vol</code>) runs by default. Decide whether you want to use removable media with or without volume management.	“How to Disable or Enable Removable Media Services” on page 43
3. Access removable media.	Access different kinds of removable media with or without volume management running.	“How to Access Information on Removable Media” on page 44
4. (Optional) Copy files or directories.	Copy files or directories from the media as you would from any other location in the file system.	“How to Copy Information From Removable Media” on page 45

Task	Description	For Instructions
5. Find out if the media is still in use.	Before ejecting the media, find out if it is still in use.	“How to Determine If Removable Media Is Still in Use” on page 45
6. Eject the media.	When you finish, eject the media from the drive.	“How to Eject Removable Media” on page 46

Accessing Removable Media

You can access information on removable media with or without using volume management. For information on accessing information on removable media with GNOME's File Manager, see the GNOME desktop documentation.

Volume management (`vol`) actively manages all removable media devices. So, any attempt to access removable media with device names such as `/dev/rdisk/cntndnsn` or `/dev/dsk/cntndnsn` will be unsuccessful.

Using Removable Media Names

You can access all removable media with different names. The following table describes the different media names that can be accessed with or without volume management.

TABLE 3-1 Removable Media Names

Media	Volume Management Device Name	Volume Management Device Alias Name	Device Name
First diskette drive	<code>/floppy</code>	<code>/vol/dev/aliases/floppy0</code>	<code>/dev/rdiskette</code> <code>/vol/dev/rdiskette0/</code> <i>volume-name</i>
First, second, third CD-ROM or DVD-ROM drives	<code>/cdrom0</code> <code>/cdrom1</code> <code>/cdrom2</code>	<code>/vol/dev/aliases/cdrom0</code> <code>/vol/dev/aliases/cdrom1</code> <code>/vol/dev/aliases/cdrom2</code>	<code>/vol/dev/rdisk/cntn[dn]/</code> <i>volume-name</i>
USB memory stick	<code>/rmdisk/noname</code>	<code>/vol/dev/aliases/rmdisk0</code>	<code>/vol/dev/dsk/cntndn/volume-name:c</code>

Guidelines for Accessing Removable Media Data

Most CDs and DVDs are formatted to the ISO 9660 standard, which is portable. So, most CDs and DVDs can be mounted by volume management. However, CDs or DVDs with UFS file systems are not portable between architectures. So, they must be used on the architecture for which they were designed.

For example, a CD or DVD with a UFS file system for a SPARC platform cannot be recognized by an x86 platform. Likewise, an x86 UFS CD cannot be mounted by volume management on a SPARC platform. The same limitation generally applies to diskettes. However, some architectures share the same bit structure, so occasionally a UFS format specific to one architecture will be recognized by another architecture. Still, the UFS file system structure was not designed to guarantee this compatibility.

To accommodate the different formats, the CD or DVD is split into slices. Slices are similar in effect to partitions on hard disks. The 9660 portion is portable, but the UFS portion is architecture-specific. If you are having trouble mounting a CD or DVD, particularly if it is an installation CD or DVD, make sure that its UFS file system is appropriate for your system's architecture. For example, you can check the label on the CD or DVD.

▼ How to Add a New Removable Media Drive

Generally, most modern bus types support hot-plugging. This means you can insert a disk in an empty slot and the system recognizes it.

For more information about hot-plugging devices, see [Chapter 6, “Dynamically Configuring Devices \(Tasks\).”](#)

- 1 **Become superuser.**
- 2 **Connect the new media drive.**
See your hardware handbook for specific instructions.
- 3 **Confirm that the system sees the new media drive.**

```
# rmformat
Looking for devices...
```

▼ How to Disable or Enable Removable Media Services

Occasionally, you might want to manage media without using removable media services. This section describes how to disable and enable removable media services.

Disabling these services means that you would have to mount all media manually by using the mount command.

1 Ensure that the media is not being used.

If you are not sure whether you have found all users of the media, use the `fuser` command, see “[How to Determine If Removable Media Is Still in Use](#)” on page 45.

2 Become superuser.**3 Select one of the following:**

- Disable removable media services.

```
# svcadm disable volfs
```

- Enable removable media services.

```
# svcadm enable volfs
volume management starting.
```

▼ How to Access Information on Removable Media

1 Insert the media.

The media is mounted after a few seconds.

2 List the contents of the media.

```
% ls /media
```

Use the appropriate device name to access information by using the command-line interface. See [Table 3–1](#) for an explanation of device names.

Example 3–1 Accessing Information on Removable Media

This example shows how to access information on a diskette.

```
$ ls /floppy
myfile
```

This example shows how to access information on a USB memory stick.

```
$ ls /rmdisk
rmdisk0/      rmdisk1/
```

This example shows how to access information on a DVD.

```
$ ls /cdrom
cdrom0          sol_10_910_sparc
```

▼ How to Copy Information From Removable Media

You can access files and directories on removable media as with any other file system. The only significant restrictions are related to ownership and permissions.

For instance, if you copy a file from a DVD into your file system, you are the owner. However, you won't have write permissions because the file on the DVD never had them. You must change the permissions yourself.

1 Ensure that the media is mounted.

```
$ ls /media
```

The `ls` command displays the contents of a mounted media. If no contents are displayed, see [“How to Access Information on Removable Media” on page 44](#).

2 (Optional) Copy the files or directories.

For example, for a DVD, you would do the following:

```
$ cp /cdrom/sol_10_910_sparc/Solaris_10/Tools/add_install_client .
$ ls -l
-rwxr-xr-x  1 pmorph      gelfs   64065 Jul 12  2010 add_install_client
```

▼ How to Determine If Removable Media Is Still in Use

1 Become superuser.

2 Identify the processes that are accessing the media.

```
# fuser -u /media
```

The `-u` displays the user of the media.

For more information, see [fuser\(1M\)](#).

3 (Optional) Kill the process accessing the media.

```
# fuser -u -k /media
```

The `-k` kills the processes accessing the media.



Caution – Killing the processes that are accessing the media should only be used in emergency situations.

4 Verify that the process is gone.

```
# pgrep process-ID
```

Example 3-2 Determining If the Media Is Still in Use

The following example shows that the user `pmorph`, is accessing the `/cdrom/sol_10_910_sparc/Solaris_10/Tools` directory.

```
# fuser -u /cdrom/sol_10_910_sparc/Solaris_10/Tools
/cdrom/sol_10_910_sparc/Solaris_10/Tools: 902c(pmorph) 339c(pmorph)
```

▼ How to Eject Removable Media**1 Ensure that the media is not being used.**

Remember, media is “being used” if a shell or an application is accessing any of its files or directories. If you are not sure whether you have found all users of a DVD (for example, a shell hidden behind a desktop tool might be accessing it), use the `fuser` command. See [“How to Determine If Removable Media Is Still in Use” on page 45](#).

2 Eject the media.

```
# eject media
```

For example, for a DVD, you would do the following:

```
# eject cdrom
```

For example, for a USB memory stick, you would do the following:

```
# eject rmdisk0
```

Tip – You can view the removable device name with the `eject -l` command.

Accessing Removable Media on a Remote System (Task Map)

The following task map describes the tasks need to access removable media on a remote system.

Task	Description	For Instructions
1. Make local media available to remote systems.	configure your system to share its media drives to make any media in those drives available to other systems.	“How to Make Local Media Available to Other Systems” on page 47
2. Access removable media on remote systems.	Access the remote media on the local system.	“How to Access Information on Removable Media” on page 44

▼ How to Make Local Media Available to Other Systems

You can configure your system to share its media drives to make any media in those drives available to other systems. One exception is musical CDs. Once your media drives are shared, other systems can access the media they contain simply by mounting them. For instructions, see [“How to Access Removable Media on Remote Systems”](#) on page 48.

1 Become superuser.

2 Confirm that the media is loaded.

3 Add the following entry to the `/etc/dfs/dfstab` file.

For example:

```
share -F nfs -o ro /cdrom/sol_10_910_sparc
```

4 Determine whether the NFS server service is running.

```
# svcs *nfs*
```

The following output is returned from the `svcs` command if NFS server service is running:

```
online          14:28:43 svc:/network/nfs/server:default
```

5 Identify the NFS server status, and select one of the following:

- If the NFS server service is running, go to [Step 7](#).
- If the NFS server service is *not* running, go to the next step.

6 Start the NFS server service.

```
# svcadm enable network/nfs/server
```

Verify that the NFS daemons are running.

For example:

```
# svcs -p svc:/network/nfs/server:default
STATE      STIME      FMRI
online     Aug_30     svc:/network/nfs/server:default
           Aug_30     319 mountd
           Aug_30     323 nfsd
```

7 Verify that the media is indeed available to other systems.

If the media is available, its share configuration is displayed.

```
# share
-          /cdrom/sol_10_910_sparc  ro  ""
```

Example 3-3 Making Local DVDs or CDs Available to Other Systems

The following example shows how to make any local DVD available to other systems on the network.

```
# vi /etc/dfs/dfstab
(Add the following line:)
# share -F nfs -o ro /media
# svcs *nfs*
# svcadm enable network/nfs/server
# svcs -p svc:/network/nfs/server:default
# share
-          /cdrom/sol_10_910_sparc  ro  ""
```

Example 3-4 Making Local Diskettes Available to Other Systems

The following example shows how to make any local diskette available to other systems on the network.

```
# vi /etc/dfs/dfstab
(Add the following line, for example)
share -F nfs -o ro /floppy/myfiles
# svcs *nfs*
# svcadm enable network/nfs/server
# svcs -p svc:/network/nfs/server:default
# volcheck -v
media was found
# share
-          /floppy/myfiles  rw  ""
```

▼ How to Access Removable Media on Remote Systems

You can access media on a remote system by manually mounting the media into your file system. Also, the remote system must have shared its media according to the instructions in [“How to Make Local Media Available to Other Systems”](#) on page 47.

1 Select an existing directory to serve as the mount point. Or create a mount point.

```
$ mkdir /directory
```

where */directory* is the name of the directory that you create to serve as a mount point for the remote system's DVD.

2 Find the name of the media you want to mount.

```
$ showmount -e system-name
```

3 As superuser, mount the media.

```
# mount -F nfs -o ro system-name:/media/media-name local-mount-point
```

system-name: Is the name of the system whose media you will mount.

media-name Is the name of the media you want to mount.
local-mount-point Is the local directory onto which you will mount the remote media.

- 4 Log out as superuser.
- 5 Verify that the media has been mounted.

```
$ ls /media
```

Example 3-5 Accessing DVDs or CDs on Remote Systems

The following example shows how to automatically access the remote DVD named `sol_10_910_sparc` from the remote system `starbug` using `autofs`.

```
% showmount -e starbug
export list for starbug:
/cdrom/sol_10_910_sparc (everyone)
$ /net/starbug/cdrom/sol_10_910_sparc
```

Example 3-6 Accessing Diskettes on Other Systems

The following example shows how to automatically access `myfiles` from the remote system `mars` using `autofs`.

```
$ showmount -e mars
$ cd /net/mars
$ ls /floppy
floppy0    myfiles
```

Writing CDs and DVDs (Tasks)

This chapter provides step-by-step instructions for writing and copying data CDs and DVDs and audio CDs with the `cdwr` command.

- “How to Restrict User Access to Removable Media With RBAC” on page 54
- “How to Identify a CD or DVD Writer” on page 55
- “How to Check the CD or DVD Media” on page 55
- “How to Create an ISO 9660 File System for a Data CD or DVD” on page 56
- “How to Create a Multi-Session Data CD” on page 57
- “How to Create an Audio CD” on page 59
- “How to Extract an Audio Track on a CD” on page 60
- “How to Copy a CD” on page 61
- “How to Erase CD-RW Media” on page 62

Working With Audio CDs and Data CDs and DVDs

You can use the `cdwr` command to write file systems for CDs and DVDs in ISO 9660 format with Rock Ridge or Joliet extensions on CD-R, CD-RW, DVD-RW, or DVD+RW media devices.

You can use the `cdwr` command to perform the following tasks:

- Create data CDs and DVDs.
- Create audio CDs.
- Extract audio data from an audio CD.
- Copy CDs and DVDs.
- Erase CD-RW media.

For information on recommended CD-R or CD-RW devices, go to:

<http://www.oracle.com/us/sun/index.html>

CD/DVD Media Commonly Used Terms

This section defines commonly used terms related to CD/DVD media.

Term	Description
CD-R	CD read media that can be written once and after that, can only be read from.
CD-RW	CD rewritable media that can be written to and erased. CD-RW media can only be read by CD-RW devices.
DVD-R	Digital video disk (recordable) that can be written once and after that, can only be read from. These devices have much larger capacity than CD-R media.
DVD+R	Digital video disk (recordable) that can be written once and after that, can only be read from. DVD+R devices have more complete error management system than DVD-R, which allows for more accurate burning to media, independent of the quality of the media.
DVD-RW	Digital video disk (rewritable) with storage capacity equal to a DVD-R. This media can be re-recorded by first erasing the entire disk.
DVD+RW	Digital video disk (random-access rewritable) with storage capacity equal to a DVD+R. This medium allows overwriting of individual blocks without erasing the entire disk.
DVD-RAM	Digital video disk (random access memory, rewritable) with circular rather than spiral tracks and hard sectoring.
ISO 9660	ISO, an acronym for Industry Standards Organization, is an organization that sets standards for computer storage formats. An ISO 9660 file system is a standard CD or DVD file system that enables you to read the same CD or DVD on any major computer platform. The standard, issued in 1988, was written by an industry group named High Sierra, named after the High Sierra Hotel in Nevada. Almost all computers with CD or DVD drives can read files from an ISO 9660 file system.
Joliet extensions	Adds Windows file system information.
Rock Ridge extensions	Adds UNIX file system information. (Rock Ridge is named after the town in the movie Blazing Saddles.) Note – These extensions are not exclusive. You can specify both <code>mkisofs -R</code> and <code>-j</code> options for compatibility with both systems. (See <code>mkisofs(1M)</code> for details.)

Term	Description
MMC-compliant recorder	Acronym for Multi Media Command, which means these recorders comply with a common command set. Programs that can write to one MMC-compliant recorder should be able to write to all other recorders.
Red Book CDDA	Acronym for Compact Disc Digital Audio, which is an industry standard method for storing digital audio on compact discs. Also known by the term “Red Book” format. The official industry specification calls for one or more audio files sampled in 16-bit stereo sound at a sampling rate of 44.1 kilohertz (kHz).

Commonly used terms when writing to CD media are:

Term	Description
blanking	The process of erasing data from the CD-RW media.
mkisofs	The command to create ISO file system on a CD.
session	A complete track with lead-in and lead-out information.
track	A complete data or audio unit.

Writing CD and DVD Data and Audio CDs

The process of writing to a CD or DVD cannot be interrupted and needs a constant stream of data. Consider using the `cdrw -S` option to simulate writing to the media to verify that the system can provide data at a sufficient rate for writing to the CD or DVD.

Write errors can be caused by one of the following problems:

- The media cannot handle the drive speed. For example, some media are only certified for 2x or 4x speeds.
- The system is running too many heavy processes that are starving the writing process.
- Network congestion is causing delays in reading the image, and the image is on a remote system.
- The source drive is slower than the destination drive.

If any of these problems occur, you can lower the writing speed of the device by using the `cdrw -p` option.

For example, the following command shows how to simulate writing at 4x speed:

```
$ cdrw -iS -p 4 image.iso
```

Note – CD-R, CD-RW (not MRW formatted), DVD-R, and DVD-RW media support simulation mode (-S), but DVD-RAM, DVD+R, DVD+RW, and any MRW-formatted media and some others do not support simulation mode. The following message is displayed if simulation mode is not supported:

```
Media does not support simulated writing
```

For more information about media types, see [“CD/DVD Media Commonly Used Terms”](#) on [page 52](#).

You can also use the `cd rw -C` option to use the stated media capacity for copying an 80-minute CD. Otherwise, the `cd rw` command uses a default value of 74 minutes for copying an audio CD.

For more information, see [`cd rw\(1\)`](#).

Restricting User Access to Removable Media With RBAC

By default, all users can access removable media starting in the Solaris 9 release. However, you can restrict user access to removable media by setting up a role through role-based access control (RBAC). Access to removable media is restricted by assigning the role to a limited set of users.

For a discussion of using roles, see [“Role-Based Access Control \(Overview\)”](#) in *System Administration Guide: Security Services*.

▼ How to Restrict User Access to Removable Media With RBAC

1 Become superuser or assume an equivalent role.

2 Start the Solaris Management Console.

```
$ /usr/sadm/bin/smc &
```

For more information on starting the console, see [“Starting the Solaris Management Console”](#) in *System Administration Guide: Basic Administration*.

3 Set up a role that includes the Device Management rights.

For more information, see [Chapter 9, “Using Role-Based Access Control \(Tasks\)”](#), in *System Administration Guide: Security Services*.

```
# roleadd -m -d /export/home/muser -c "mediauser role" -A solaris.device.cdrw -P All muser
```

4 Add users who need to use the `cdwr` command to the newly created role.

```
# usermod -R muser joe
```

5 Comment the following line in the `/etc/security/policy.conf` file:

```
AUTHS_GRANTED=solaris.device.cdwr
```

If you do not do this step, all users still have access to the `cdwr` command, not just the members of the device management role.

After this file is modified, the device management role members are the only users who can use the `cdwr` command. Everyone else is denied access with the following message:

```
Authorization failed, Cannot access disks.
```

▼ How to Identify a CD or DVD Writer**1 Identify the CD or DVD writers on the system.**

For example:

```
$ cdwr -l
Looking for CD devices...
      Node | Connected Device | Device type
-----+-----+-----
cdrom0 | YAMAHA CRW8824S | 1.0d | CD Reader/Writer
```

2 Identify a specific CD or DVD writer.

For example:

```
$ cdwr -a filename.wav -d cdrom2
```

3 Identify whether the media is blank or whether a table of contents exists on the media.

For example:

```
$ cdwr -M

Device : YAMAHA CRW8824S
Firmware : Rev. 1.00 (26/04/00)
Media is blank
%
```

▼ How to Check the CD or DVD Media

The `cdwr` command works with or without removable media services running. For more information about disabling or enabling removable media services, see [“How to Disable or Enable Removable Media Services”](#) on page 43.

1 Insert a CD or DVD into the drive.

The CD or DVD can be any CD or DVD that the drive can read.

2 Check that the drive is connected properly by listing the drive.

```
$ cdwr -l
Looking for CD devices...
  Node                               Connected Device                               Device type
-----+-----+-----+-----+-----+-----+-----+-----+-----+
cdrom1                               | YAMAHA    CRW8824S                               1.0d | CD Reader/Writer
```

3 (Optional) If you do not see the drive in the list, select one of the following so that the system recognizes the drive.

- Perform a reconfiguration boot.

```
# touch /reconfigure
# init 6
```

- Add the drive without rebooting the system

```
# drvconfig
# disks
```

Then restart removable media services.

```
# svcadm disable volfs
# svcadm enable volfs
```

Creating a Data CD or DVD

Prepare the data first by using the `mkisofs` command to convert the file and file information into the High Sierra format used on CDs or DVDs.

▼ How to Create an ISO 9660 File System for a Data CD or DVD

1 Insert a blank CD or DVD into the drive.

2 Create the ISO 9660 file system on the new CD or DVD.

```
$ mkisofs -r /pathname > cd-file-system
```

`-r` Creates Rock Ridge information and resets file ownerships to zero.

`/pathname` Identifies the path name used to create the ISO 9660 file system.

`> cd-file-system` Identifies the name of the file system to be put on the CD or DVD.

3 Copy the file system onto the CD or DVD.

```
$ cdwr -i cd-file-system
```

The `-i cd-file-system` specifies the image file for creating a data CD or DVD.

Example 4-1 Creating an ISO 9660 File System for a Data CD or DVD

The following example shows how to create an ISO 9660 file system for a data CD or DVD.

```
$ mkisofs -r /home/dubs/ufs_dir > ufs_cd
Total extents actually written = 56
Total translation table size: 0
Total rockridge attributes bytes: 329
Total directory bytes: 0
Path table size(bytes): 10
Max brk space used 8000
56 extents written (0 Mb)
```

Then, copy the file system onto the CD or DVD.

```
$ cdrw -i ufs_cd
Initializing device...done.
Writing track 1...done.
Finalizing (Can take several minutes)...done.
```

▼ How to Create a Multi-Session Data CD

This procedure describes how to put more than one session on a CD. This procedure includes an example of copying the `infoA` and `infoB` directories onto the CD.

1 Create the file system for the first CD session.

```
$ mkisofs -o infoA -r -V my_infoA /data/infoA
Total translation table size: 0
Total rockridge attributes bytes: 24507
Total directory bytes: 34816
Path table size(bytes): 98
Max brk space used 2e000
8929 extents written (17 Mb)
```

- o `infoA` Identifies the name of the ISO file system.
- r Creates Rock Ridge information and resets file ownerships to zero.
- V `my_infoA` Identifies a volume label to be used as the mount point by removable media services.
- `/data/infoA` Identifies the ISO image directory to create.

2 Copy the ISO file system for the first session onto the CD.

```
$ cdrw -i0 infoA
Initializing device...done.
Writing track 1...done.
done.
Finalizing (Can take several minutes)...done.
-i infoA      Identifies the name of the image file to write to the CD.
```

-O Keeps the CD open for writing.

3 Re-insert the CD after it is ejected.

4 Identify the path name of the CD media to include in the next write session.

```
$ eject -n
.
.
.
cdrom0 -> /vol/dev/rdisk/c2t4d0/my_infoA
```

Note the /vol/dev/. . . path name.

5 Identify the next writeable address on the CD to write the next session.

```
% cdrw -M /cdrom
Device : YAMAHA    CRW8424S
Firmware : Rev. 1.0d (06/10/99)

Track No. |Type    |Start address
-----+-----+-----
1        |Audio   |0
2        |Audio   |33057
3        |Data    |60887
4        |Data    |68087
5        |Data    |75287
Leadout  |Data    |84218
```

```
Last session start address: 75287
Next writable address: 91118
```

Note the address in the Next writable address output so that you can provide this address when you write the next session.

6 Create the next ISO file system for the next CD session, and write it onto the CD.

```
$ mkisofs -o infoB -r -C 0,91118 -M /vol/dev/rdisk/c2t4d0/my_infoA
/data/infoB
Total translation table size: 0
Total rockridge attributes bytes: 16602
Total directory bytes: 22528
Path table size(bytes): 86
Max brk space used 20000
97196 extents written (189 Mb)
```

-o <i>infoB</i>	Identifies the name of the ISO file system.
-r	Creates Rock Ridge information and resets file ownerships to zero.
-C <i>0,91118</i>	Identifies the starting address of the first session and the next writable address.
-M /vol/dev/rdisk/c2t4d0/my_infoA	Specifies the path of the existing ISO image to be merged.

/data/infoB

Identifies the ISO image directory to create.

Creating an Audio CD

You can use the `cdwr` command to create audio CDs from individual audio tracks or from `.au` and `.wav` files.

The supported audio formats are describes in the following table:

Format	Description
<code>sun</code>	Oracle <code>.au</code> file with data in Red Book CDDA format
<code>wav</code>	RIFF (<code>.wav</code>) file with data in Red Book CDDA format
<code>cda</code>	<code>.cda</code> file with raw CD audio data, which is 16-bit PCM stereo at 44.1 kHz sample rate in little-endian byte order
<code>aur</code>	<code>.aur</code> files with raw CD data in big-endian byte order

If no audio format is specified, the `cdwr` command tries to determine the audio file format based on the file extension. The case of the characters in the extension is ignored.

▼ How to Create an Audio CD

This procedure describes how to copy audio files onto a CD.

- 1 **Insert a blank CD into the CD-RW drive.**
- 2 **Change to the directory that contains the audio files.**

```
$ cd /myaudiodir
```

- 3 **Copy the audio files onto the CD.**

```
$ cdwr -a track1.wav track2.wav track3.wav
```

The `-a` option creates an audio CD.

Example 4–2 Creating an Audio CD

The following example shows how to create an audio CD.

```
$ cdwr -a bark.wav chirp.au meow.wav
Initializing device...done.
Writing track 1...done.
```

```
done.  
Writing track 2...done.  
Writing track 3...done.  
done.  
Finalizing (Can take several minutes)...done.
```

The following example shows how to create a multisession audio CD. The CD is ejected after the first session is written. You would need to re-insert the CD before the next writing session.

```
$ cdwr -a0 groucho.wav chico.au harpo.wav  
Initializing device...done.  
Writing track 1...done.  
done.  
Writing track 2...done.  
Writing track 3...done.  
done.  
Finalizing (Can take several minutes)...done.  
<Re-insert CD>  
$ cdwr -a zeppo.au  
Initializing device...done.  
Writing track 1...done.  
done.  
Finalizing (Can take several minutes)...done.
```

▼ How to Extract an Audio Track on a CD

Use the following procedure to extract an audio track from a CD and copy the audio track to a new CD.

If you don't use the `cdwr -T` option to specify the audio file type, the `cdwr` command uses the filename extension to determine the audio file type. For example, the `cdwr` command detects that this file is a `.wav` file.

```
$ cdwr -x 1 testme.wav
```

1 Insert an audio CD into the CD-RW drive.

2 Extract an audio track.

```
$ cdwr -x -T audio-type 1 audio-file
```

`-x` Extracts audio data from an audio CD.

`T audio-type` Identifies the type of audio file to be extracted. Supported audio types are `sun`, `wav`, `cda`, or `aur`.

`audio-file` Identifies the audio track to be extracted.

3 Copy the track to a new CD.

```
$ cdwr -a audio-file
```

Example 4-3 Extracting and Creating Audio CDs

The following example shows how to extract the first track from an audio CD and name the file `song1.wav`.

```
$ cdrw -x -T wav 1 song1.wav
Extracting audio from track 1...done.
```

This example shows how to copy a track to an audio CD.

```
$ cdrw -a song1.wav
Initializing device...done.
Writing track 1...done.
Finalizing (Can take several minutes)...done.
```

▼ How to Copy a CD

This procedure describes how to extract all the tracks from an audio CD into a directory and then copy all of them onto a blank CD.

Note – By default, the `cdrw` command copies the CD into the `/tmp` directory. The copying might require up to 700 MB of free space. If there is insufficient space in the `/tmp` directory for copying the CD, use the `-m` option to specify an alternate directory.

- 1 Insert an audio CD into a CD-RW drive.**

- 2 Create a directory for the audio files.**

```
$ mkdir /music_dir
```

- 3 Extract the tracks from the audio CD.**

```
$ cdrw -c -m music_dir
```

An `Extracting audio ...` message is display for each track.

The CD is ejected when all the tracks are extracted.

- 4 Insert a blank CD and press Return.**

After the tracks are extracted, the audio CD is ejected. You are prompted to insert a blank CD.

Example 4-4 Copying a CD

This example shows how to copy one CD to another CD. You must have two CD-RW devices to do this task.

```
$ cdrw -c -s cdrom0 -d cdrom1
```

▼ How to Erase CD-RW Media

You have to erase existing CD-RW data before the CD can be rewritten.

- **Erase the entire media or just the last session on the CD by selecting one of the following:**

- Erase the last session only.

```
$ cdrw -d cdrom0 -b session
```

Erasing just the last session with the `-b session` option is faster than erasing the entire media with the `-b all` option. You can use the `-b session` option even if you used the `cdrw` command to create a data or audio CD in just one session.

- Erase the entire media.

```
$ cdrw -d cdrom0 -b all
```

Managing Devices (Overview/Tasks)

This chapter provides overview information and step-by-step instructions for managing peripheral devices, such as disks, DVD drives, and tape devices, in the Oracle Solaris release.

This is a list of the overview information in this chapter.

- “What's New in Device Management?” on page 63
- “Where to Find Device Management Tasks” on page 66
- “About Device Drivers” on page 68
- “Automatic Configuration of Devices” on page 68
- “Displaying Device Configuration Information” on page 70
- “Accessing Devices” on page 76

This is a list of the step-by-step instructions in this chapter.

- “How to Display System Configuration Information” on page 71
- “How to Add a Device Driver” on page 75
- “How to Add a Peripheral Device” on page 74

Device management in the Oracle Solaris release usually involves adding and removing peripheral devices from systems, possibly adding a third-party device driver to support a device, and displaying system configuration information.

What's New in Device Management?

This section provides information about new device management features in the Oracle Solaris release.

- “New Hot Plugging Features” on page 64
- “x86: Device Detection Tool” on page 64
- “Support for PCI Express (PCIe)” on page 64
- “USB and 1394 (FireWire) Support Enhancements” on page 65
- “Improved Device In Use Error Checking” on page 65

New Hot Plugging Features

Oracle Solaris 10 9/10: In this Oracle Solaris release, the `hotplug` command is available to manage hot pluggible connections on PCI Express (PCIe) and PCI SHPC (Standard Hot Plug Controller) devices. This feature is not supported on other bus types, such as USB and SCSI.

You would still use the `cfgadm` to manage hot pluggible USB and SCSI devices as in previous Solaris releases. The benefit of using the `hotplug` features in this release is that in addition to enable and disable operations, the `hotplug` command provides offline and online capabilities for your supported PCI devices.

For more information, see “[PCIe Hot-Plugging With the \(`hotplug`\) Command](#)” on page 85.

x86: Device Detection Tool

Solaris 10 5/08: You can use the device detection tool to identify whether your x86 hardware is supported in this Oracle Solaris release. For more information, go to the following site:

http://www.oracle.com/webfolder/technetwork/hcl/hcts/device_detect.jsp

Support for PCI Express (PCIe)

Solaris 10 11/06: This Oracle Solaris release provides support for the PCI Express (PCIe) interconnect, which is designed to connect peripheral devices to desktop, enterprise, mobile, communication, and embedded applications, on both SPARC and x86 systems.

The PCIe interconnect is an industry-standard, high-performance, serial I/O bus. For details on PCIe technology, go to the following site:

<http://www.pcisig.com/home>

The PCIe software provides the following features in this Oracle Solaris release:

- Support for extended PCIe configuration space
- Support for PCIe baseline error handling and MSI interrupts
- Modified IEEE-1275 properties for PCIe devices
- PCIe hotplug support (both native and ACPI-based) by enhancing the `cfgadm_pci` component of the `cfgadm` command
- ATTN Button usage based PCIe peripheral autoconfiguration

The administrative model for hotplugging PCIe peripherals is the same as for PCI peripherals, which uses the `cfgadm` command.

Check your hardware platform guide to ensure that PCIe and PCIe hotplug support is provided on your system. In addition, carefully review the instructions for physically inserting or removing adapters on your system and the semantics of device auto-configuration, if applicable.

For information about using the `cfgadm` command with PCIe peripherals, see [“PCI or PCIe Hot-Plugging With the `cfgadm` Command \(Task Map\)”](#) on page 96.

USB and 1394 (FireWire) Support Enhancements

Solaris 10 6/06: In this Oracle Solaris release, both non-removable USB storage devices and 1394 mass storage devices are identified as hotpluggable devices at the driver level. This new behavior means that these devices can be connected or disconnected without rebooting the system and configured or unconfigured automatically without intervention. These changes are made at the kernel level and do not impact the use of these devices. For example, the responsibility of mounting and unmounting these devices is controlled by the removable media management services.

In addition, non-removable USB devices and 1394 mass storage devices can be accessed and labeled by using the `format` utility. However, you can override the new hotpluggable behavior of these devices by setting the `remvalue` to `true` in the `/kernel/drv/scsa2usb.conf` file. Setting this parameter to `true` means that the device is treated as a removable media device at the driver level, if that behavior is preferred.

For more information on using these devices, see [`scsa1394\(7D\)`](#) and [“Using USB Mass Storage Devices \(Task Map\)”](#) on page 130.

Improved Device In Use Error Checking

Solaris 10 6/06: This feature was undocumented previously.

The following utilities have been enhanced to detect when a specified device is in use:

- `dumpadm`
- `format`
- `mkfs` and `newfs`
- `swap`

These enhancements mean that the above utilities might detect some of the following usage scenarios:

- Device is part of a ZFS storage pool
- Device is a dump or swap device
- Mounted file system or an entry for the device exists in the `/etc/vfstab` file

- Device is part of live upgrade configuration
- Device is part of a Solaris Volume Manager configuration or Veritas Volume Manager configuration

For example, if you attempt to use the `format` utility to access an active device, you will see a message similar to the following:

```
# format
.
.
.
Specify disk (enter its number): 1
selecting c0t1d0
[disk formatted]
Warning: Current Disk has mounted partitions.
/dev/dsk/c0t1d0s0 is currently mounted on /. Please see umount(1M).
/dev/dsk/c0t1d0s1 is currently used by swap. Please see swap(1M).
```

However, these utilities do not detect all scenarios in the same way. For example, you can use the `newfs` command to create a new file system on a device in a live upgrade configuration. You cannot use the `newfs` command to create a new file system on a device that is part of a live upgrade configuration if it also has a mounted file system.

Where to Find Device Management Tasks

The following table describes where to find step-by-step instructions for hot-plugging devices and adding serial devices, such as printers and modems, and peripheral devices, such as a disk, DVD drive, or tape device.

TABLE 5-1 Where to Find Instructions for Adding a Device

Device Management Task	For More Information
Add a disk that is not hot-pluggable.	Chapter 12, “SPARC: Setting Up Disks (Tasks),” or Chapter 13, “x86: Setting Up Disks (Tasks)”
Hot-plug a SCSI or PCI device.	“SCSI Hot-Plugging With the <code>cfgadm</code> Command” on page 87 or “PCI or PCIe Hot-Plugging With the <code>cfgadm</code> Command” on page 97
Hot-plug a USB device.	“Using USB Mass Storage Devices (Task Map)” on page 130
Add a DVD drive or tape device.	“How to Add a Peripheral Device” on page 74
Add a modem.	Chapter 1, “Managing Terminals and Modems (Overview),” in <i>System Administration Guide: Advanced Administration</i>
Add a printer.	<i>System Administration Guide: Printing</i>

TABLE 5-1 Where to Find Instructions for Adding a Device (Continued)

Device Management Task	For More Information
Secure a device.	Chapter 4, “Controlling Access to Devices (Tasks),” in <i>System Administration Guide: Security Services</i>

Managing Devices in the Oracle Solaris OS

The following sections provide overview information about features that manage devices in the Oracle Solaris OS. For information about accessing devices, see “[Accessing Devices](#)” on [page 76](#).

Power Management of Devices

The United States Environmental Protection Agency created the Energy Star guidelines for computer products to encourage the use of energy-efficient computer systems and to reduce air pollution associated with energy generation. To meet these guidelines, Oracle hardware is designed to use power efficiently. In addition, power management software is provided to configure the power management settings.

For more information about power managing your system, see your specific hardware documentation or [power.conf\(4\)](#).

Power Management of Fibre Channel Devices

Power management of Oracle systems has been provided in many previous Oracle Solaris releases. For example, the internal drives on the following systems are power managed by default:

- SunBlade 1000 or 2000
- SunBlade 100 or 150
- SunBlade 2500 or 1500

The default settings in the `/etc/power.conf` file ensure Energy Star compliance and fully support power management of these systems.

The following adapters connect external Fibre Channel storage devices:

- Oracle's Sun StorEdge PCI Dual Fibre Channel Host Adapter
- Oracle's Sun StorEdge PCI Single Fibre Channel Network Adapter

If a combination of the above adapters and Oracle systems are used to attach external Fibre Channel storage devices, the external storage devices will also be power managed by default.

Under the following conditions, power management should be disabled:

- If the system has Fibre Channel attached disks that are connected to a storage area network (SAN)
- If the system has Fibre Channel attached disks that are used in a multi-initiator configuration, such as with the SunCluster software
- If the system is using IP over a Fibre Channel interface (see [fcip\(7D\)](#))

Power management should not be enabled when more than one Oracle Solaris system might share the same devices, as in the above conditions.

You can disable power management for the system by changing the `autopm` keyword in the `/etc/power.conf` file as follows:

```
autopm          disable
```

Then, reconfigure power management by running the `pmconfig` command or by rebooting the system.

For more information, see [power.conf\(4\)](#) and [pmconfig\(1M\)](#).

About Device Drivers

A computer typically uses a wide range of peripheral devices and mass-storage devices. Your system, for example, probably has a disk drive, a keyboard and a mouse, and some kind of magnetic backup medium. Other commonly used devices include the following:

- DVD drives
- Printers and plotters
- Light pens
- Touch-sensitive screens
- Digitizers
- Tablet-and-stylus pairs

The Oracle Solaris software does not directly communicate with all these devices. Each type of device requires different data formats, protocols, and transmission rates.

A *device driver* is a low-level program that allows the operating system to communicate with a specific piece of hardware. The driver serves as the operating system's “interpreter” for that piece of hardware.

Automatic Configuration of Devices

The kernel consists of a small generic core with a platform-specific component and a set of modules. The kernel is configured automatically in the Oracle Solaris release.

A *kernel module* is a hardware or software component that is used to perform a specific task on the system. An example of a *loadable* kernel module is a device driver that is loaded when the device is accessed.

The platform-independent kernel is `/kernel/genunix`. The platform-specific component is `/platform/'uname -m'/kernel/unix`.

The kernel modules are described in the following table.

TABLE 5-2 Description of Solaris Kernel Modules

Location	Directory Contents
<code>/platform/'uname -m'/kernel</code>	Platform-specific kernel components
<code>/kernel</code>	Kernel components common to all platforms that are needed for booting the system
<code>/usr/kernel</code>	Kernel components common to all platforms within a particular instruction set

The system determines what devices are attached to it at boot time. Then, the kernel configures itself dynamically, loading needed modules into memory. At this time, device drivers are loaded when devices, such as disk devices and tape devices, are accessed. This process is called *autoconfiguration* because all kernel modules are loaded automatically when they are needed.

You can customize the way in which kernel modules are loaded by modifying the `/etc/system` file. For instructions on modifying this file, see [system\(4\)](#).

Features and Benefits of Autoconfiguration

The benefits of autoconfiguration are as follows:

- Main memory is used more efficiently because modules are loaded when needed.
- There is no need to reconfigure the kernel when new devices are added to the system.
- Drivers can be loaded and tested without having to rebuild the kernel and reboot the system.

Autoconfiguration is used when you add a new device (and driver) to the system. At this time, you might need to perform reconfiguration boot so that the system recognizes the new device unless the device is hot-pluggable. For information about hot-plugging devices, see [Chapter 6](#), “[Dynamically Configuring Devices \(Tasks\)](#).”

What You Need for Unsupported Devices

Device drivers needed to support a wide range of standard devices are included in the Oracle Solaris release. These drivers can be found in the `/kernel/drv` and `/platform/'uname -m'/kernel/drv` directories.

However, if you have purchased an unsupported device, the manufacturer should provide the software that is needed for the device to be properly installed, maintained, and administered.

At a minimum, this software includes a device driver and its associated configuration (.conf) file. The .conf files reside in the drv directories. This software might also include custom maintenance and administrative utilities because the device might be incompatible with Oracle Solaris utilities.

For more information about what you need for unsupported devices, contact your device manufacturer.

Displaying Device Configuration Information

Three commands are used to display system and device configuration information.

Command	Description	Man Page
prtconf	Displays system configuration information, including the total amount of memory and the device configuration as described by the system's device hierarchy. The output displayed by this command depends upon the type of system.	prtconf(1M)
sysdef	Displays device configuration information, including system hardware, pseudo devices, loadable modules, and selected kernel parameters.	sysdef(1M)
dmesg	Displays system diagnostic messages as well as a list of devices attached to the system since the last reboot.	dmesg(1M)

For information on the device names that are used to identify devices on the system, see “[Device Naming Conventions](#)” on page 77.

driver not attached Message

The following driver-related message might be displayed by the prtconf and sysdef commands:

```
device, instance #number (driver not attached)
```

This message does not always mean that a driver is unavailable for this device. This message means that no driver is *currently* attached to the device instance because no device exists at this node or the device is not in use. Drivers are loaded automatically when the device is accessed. They are unloaded when the device is not in use.

▼ How to Display System Configuration Information

Use the output of the `prtconf` and `sysdef` commands to identify which disk, tape, and DVD devices are connected to the system. The output of these commands displays the `driver not attached` messages next to the device instances. Because these devices are always being monitored by some system process, the `driver not attached` message is usually a good indication that no device exists at that device instance.

Use the `sysdef` command to display system configuration information that include pseudo devices, loadable modules, and selected kernel parameters.

● Display system and device configuration information.

- Display all the devices connected to a system.

For example, the following `prtconf -v` output on a SunBlade 1000 identifies the disk devices connected to the system. The detailed disk information is described in the Device Minor Nodes section within the `ssd/fp` driver section.

```
$ /usr/sbin/prtconf -v | more
.
.
.
          Device Minor Nodes:
            dev=(118,8)
              dev_path=/pci@8,600000/SUNW,qlc@4/fp@0,0/ssd@w210000
2037bde864,0:a
              spectype=blk type=minor
              dev_link=/dev/dsk/c0t1d0s0
              dev_path=/pci@8,600000/SUNW,qlc@4/fp@0,0/ssd@w210000
2037bde864,0:a,raw
              spectype=chr type=minor
              dev_link=/dev/rdisk/c0t1d0s0
            dev=(118,9)
              dev_path=/pci@8,600000/SUNW,qlc@4/fp@0,0/ssd@w210000
2037bde864,0:b
              spectype=blk type=minor
              dev_link=/dev/dsk/c0t1d0s1
              dev_path=/pci@8,600000/SUNW,qlc@4/fp@0,0/ssd@w210000
2037bde864,0:b,raw
.
.
.
```

- Display information about one specific device connected to the system.

For example, the following `prtconf` output on a SunBlade 1000 displays the `ssd` instance number for `/dev/dsk/c0t1d0s0`.

```
# prtconf -v /dev/dsk/c0t1d0s0
ssd, instance #1
```

- Display only the devices that are attached to the system.

```
# prtconf | grep -v not
```

- Display device usage information.

For example, the following `fuser` command displays which processes are accessing the `/dev/console` device.

```
# fuser -d /dev/console
/dev/console:      346o      323o
```

Example 5-1 Displaying System Configuration Information

The following `prtconf` output is displayed on a SPARC based system.

```
# prtconf
System Configuration: Oracle Corporation i86pc
Memory size: 8192 Megabytes
System Peripherals (Software Nodes):

i86pc
  scsi_vhci, instance #0
  pci, instance #0
    pci108e,4843, instance #0
    pci8086,25e2, instance #0
      pci8086,3500, instance #7
        pci8086,3510, instance #9
        pci8086,3518, instance #10
          pci108e,4843, instance #0
          pci108e,4843, instance #1
        pci8086,350c, instance #8
      pci8086,25e3 (driver not attached)
    pci8086,25f8, instance #2
      pci108e,286, instance #0
        disk, instance #0
        disk, instance #2
        disk, instance #3
        disk, instance #1
      pci8086,25e5 (driver not attached)
      pci8086,25f9 (driver not attached)
      pci8086,25e7 (driver not attached)
      pci108e,4843, instance #0 (driver not attached)
      pci108e,4843, instance #1
      pci108e,4843, instance #2 (driver not attached)
      pci108e,4843 (driver not attached)
      pci108e,4843 (driver not attached)
      pci108e,4843 (driver not attached)
      pci108e,4843 (driver not attached)
      pci8086,2690, instance #6
        pci108e,125e, instance #2
        pci108e,125e, instance #3
      pci108e,4843, instance #0
      pci108e,4843, instance #1
        device, instance #0
          keyboard, instance #0
          mouse, instance #1
      pci108e,4843, instance #2
      pci108e,4843, instance #3
      pci108e,4843, instance #0
        storage, instance #0
          disk, instance #4
```

.
.

The following sysdef output is displayed from an x86 based system.

```
# sysdef
* Hostid
*
  29f10b4d
*
* i86pc Configuration
*
*
* Devices
*
+boot (driver not attached)
memory (driver not attached)
aliases (driver not attached)
chosen (driver not attached)
i86pc-memory (driver not attached)
i86pc-mmio (driver not attached)
openprom (driver not attached)
options, instance #0
packages (driver not attached)
delayed-writes (driver not attached)
itu-props (driver not attached)
isa, instance #0
  motherboard (driver not attached)
  pnpADP,1542, instance #0
  asy, instance #0
  asy, instance #1
  lp, instance #0 (driver not attached)
  fdc, instance #0
    fd, instance #0
    fd, instance #1 (driver not attached)
  kd (driver not attached)
  kdmouse (driver not attached)
.
.
.
```

Adding a Peripheral Device to a System

Adding a new peripheral device that is not-pluggable usually involves the following:

- Shutting down the system
- Connecting the device to the system
- Rebooting the system

Use “[How to Add a Peripheral Device](#)” on page 74 to add the following devices that are not hot-pluggable to a system:

- DVD drive
- Secondary disk drive

- Tape drive
- SBUS card

In some cases, you might have to add a third-party device driver to support the new device.

For information on hot-plugging devices, see [Chapter 6, “Dynamically Configuring Devices \(Tasks\)”](#)

▼ How to Add a Peripheral Device

1 Become superuser.

2 (Optional) If you need to add a device driver to support the device, complete the procedure “How to Add a Device Driver” on page 75.

3 Create the `/reconfigure` file.

```
# touch /reconfigure
```

The `/reconfigure` file causes the Solaris software to check for the presence of any newly installed devices the next time you turn on or boot your system.

4 Shut down the system.

```
# shutdown -i0 -g30 -y
```

`-i0` Brings the system to the 0 init state, which is the appropriate state for turning the system power off for adding and removing devices.

`-g30` Shuts the system down in 30 seconds. The default is 60 seconds.

`-y` Continues the system shutdown without user intervention. Otherwise, you are prompted to continue the shutdown process.

5 Select one of the following to turn off power to the system after it is shut down:

- For SPARC platforms, it is safe to turn off power if the `ok` prompt is displayed.
- For x86 platforms, it is safe to turn off power if the `type any key to continue` prompt is displayed.

6 Turn off power to all peripheral devices.

For the location of power switches on any peripheral devices, refer to the hardware installation guides that accompany your peripheral devices.

7 Install the peripheral device, making sure that the device you are adding has a different target number than the other devices on the system.

Often, a small switch is located at the back of the disk for selecting the target number.

Refer to the hardware installation guide that accompanies the peripheral device for information on installing and connecting the device.

8 Turn on the power to the system.

The system boots to multiuser mode, and the login prompt is displayed.

9 Verify that the peripheral device has been added by attempting to access the device.

For information on accessing the device, see [“Accessing Devices” on page 76](#).

▼ How to Add a Device Driver

This procedure assumes that the device has already been added to the system. If not, see [“What You Need for Unsupported Devices” on page 69](#).

1 Become superuser.

2 Place the tape, diskette, or DVD into the drive.

3 Install the driver.

```
# pkgadd [-d] device package-name
```

4 Verify that the package has been added correctly.

```
# pkgchk package-name
#
```

The system prompt returns with no response if the package is installed correctly.

Example 5-2 Adding a Device Driver

The following example shows how to install and verify a package called XYZdrv.

```
# pkgadd XYZdrv
(licensing messages displayed)
.
.
.
Installing XYZ Company driver as <XYZdrv>
.
.
.
Installation of <XYZdrv> was successful.
# pkgchk XYZdrv
#
```

Accessing Devices

You need to know how to specify device names when using commands to manage disks, file systems, and other devices. In most cases, you can use logical device names to represent devices that are connected to the system. Both logical and physical device names are represented on the system by logical and physical device files.

How Device Information Is Created

When a system is booted for the first time, a device hierarchy is created to represent all the devices connected to the system. The kernel uses the device hierarchy information to associate drivers with their appropriate devices. The kernel also provides a set of pointers to the drivers that perform specific operations.

How Devices Are Managed

The `devfs` file system manages the `/devices` directory, which is the name space of all devices on the system. This directory represents the *physical* devices that consists of actual bus and device addresses.

The `dev` file system manages the `/dev` directory, which is the name space of *logical* device names.

By default, the `devfsadm` command attempts to load every driver in the system and attach to all possible device instances. Then, `devfsadm` creates the device files in the `/devices` directory and the logical links in the `/dev` directory. The `devfsadm` command also maintains the `path_to_inst` instance database.

Updates to the `/dev` and `/devices` directories in response to dynamic reconfiguration events or file system accesses are handled by `devfsd`, the daemon version of the `devfsadm` command. This daemon is started by the service management facility when a system is booted.

Because the `devfsd` daemon automatically detects device configuration changes generated by any reconfiguration event, there is no need to run this command interactively.

For more information, see the following references:

- [devfsadm\(1M\)](#)
- [dev\(7FS\)](#)
- [devfs\(7FS\)](#)
- [path_to_inst\(4\)](#)

Device Naming Conventions

Devices are referenced in three ways in the Oracle Solaris OS.

- **Physical device name** – Represents the full device path name in the device information hierarchy. The physical device name is created by when the device is first added to the system. Physical device files are found in the `/devices` directory.
- **Instance name** – Represents the kernel's abbreviation name for every possible device on the system. For example, `sd0` and `sd1` represent the instance names of two disk devices. Instance names are mapped in the `/etc/path_to_inst` file.
- **Logical device name** – The logical device name is created by when the device is first added to the system. Logical device names are used with most file system commands to refer to devices. For a list of file commands that use logical device names, see [Table 5–3](#). Logical device files in the `/dev` directory are symbolically linked to physical device files in the `/devices` directory.

The preceding device name information is displayed with the following commands:

- `dmesg`
- `format`
- `sysdef`
- `prtconf`

Logical Disk Device Names

Logical device names are used to access disk devices when you perform the following tasks:

- Add a new disk to the system.
- Move a disk from one system to another system.
- Access or mount a file system residing on a local disk.
- Back up a local file system.

Many administration commands take arguments that refer to a disk slice or file system.

Refer to a disk device by specifying the subdirectory to which it is symbolically linked, either `/dev/dsk` or `/dev/rdsk`, followed by a string identifying the particular controller, disk, and slice.

FIGURE 5-1 Description of Logical Device Names

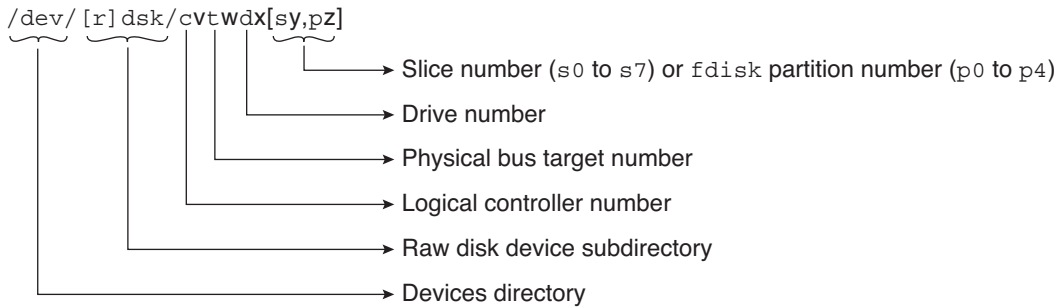

Specifying the Disk Subdirectory

Disk and file administration commands require the use of either a *raw* (or *character*) device interface, or a *block* device interface. The distinction is made by how data is read from the device.

Raw device interfaces transfer only small amounts of data at a time. Block device interfaces include a buffer from which large blocks of data are read at once.

Different commands require different interfaces:

- When a command requires the raw device interface, specify the `/dev/rdisk` subdirectory. (The “r” in `rdisk` stands for “raw.”)
- When a command requires the block device interface, specify the `/dev/dsk` subdirectory.
- When you are not sure whether a command requires use of `/dev/dsk` or `/dev/rdisk`, check the man page for that command.

The following table shows which interface is required for some commonly used disk and file system commands.

TABLE 5-3 Device Interface Type Required by Some Frequently Used Commands

Command Reference	Interface Type	Example of Use
df(1M)	Block	<code>df /dev/dsk/c0t3d0s6</code>
fsck(1M)	Raw	<code>fsck -p /dev/rdisk/c0t0d0s0</code>
mount(1M)	Block	<code>mount /dev/dsk/c1t0d0s7 /export/home</code>
newfs(1M)	Raw	<code>newfs /dev/rdisk/c0t0d1s1</code>
prtvtoc(1M)	Raw	<code>prtvtoc /dev/rdisk/c0t0d0s2</code>

Direct and Bus-Oriented Controllers

You might access disk partitions or slices differently depending upon whether the disk device is connected to a direct or bus-oriented controller. Generally, direct controllers do not include a *target* identifier in the logical device name.

The conventions for both types of controllers are explained in the following subsections.

Note – Controller numbers are assigned automatically during system initialization. The numbers are strictly logical and imply no direct mapping to physical controllers.

x86: Disks With Direct Controllers

To specify a slice on a disk with an IDE controller on an x86 based system, follow the naming convention shown in the following figure.

FIGURE 5-2 x86: Disks With Direct Controllers

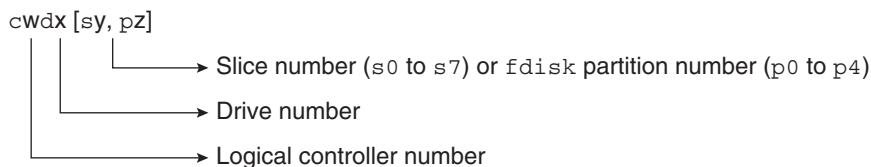

To indicate the entire Solaris `fdisk` partition, specify slice 2 (s2).

If you have only one controller on your system, *w* is usually 0.

Disks With Bus-Oriented Controllers

To specify a slice on a disk with a bus-oriented controller, SCSI for instance, follow the naming convention shown in the following figure.

FIGURE 5-3 Disks With Bus-Oriented Controllers

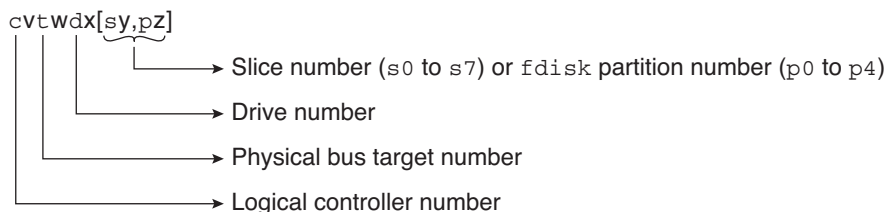

On a SPARC based system with directly connected disks such as the IDE disks on an UltraSPARC system, the naming convention is the same as that for systems with bus-oriented controllers.

If you have only one controller on your system, *w* is usually 0.

For SCSI controllers, *x* is the target address set by the switch on the back of the unit, and *y* is the logical unit number (LUN) of the drive attached to the target. If the disk has an embedded controller, *y* is usually 0.

To indicate the whole disk, specify slice 2 (*s2*).

Logical Tape Device Names

Logical tape device files are found in the `/dev/rmt/*` directory as symbolic links from the `/devices` directory.

FIGURE 5-4 Logical Tape Device Names

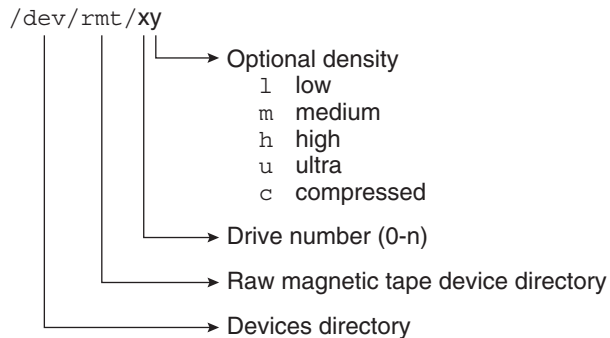

The first tape device connected to the system is 0 (`/dev/rmt/0`). Tape density values (`l`, `m`, `h`, `c`, and `u`) are described in [Chapter 28, “Managing Tape Drives \(Tasks\)”](#).

Logical Removable Media Device Names

Since removable media is managed by removable media management services, the logical device name is usually not used unless you want to mount the media manually.

The logical device name that represents the removable media devices on a system are described in [Chapter 3, “Accessing Removable Media \(Tasks\)”](#).

Dynamically Configuring Devices (Tasks)

This chapter provides instructions for dynamically configuring devices in the Oracle Solaris OS. You can add, remove, or replace devices in the Oracle Solaris OS while the system is still running, if the system components support hot-plugging. If the system components do not support hot-plugging, you can reboot the system to reconfigure the devices.

For information on the procedures associated with dynamically configuring devices, see the following:

- “SCSI Hot-Plugging With the `cfgadm` Command (Task Map)” on page 86
- “PCI or PCIe Hot-Plugging With the `cfgadm` Command (Task Map)” on page 96
- “Application Developer RCM Script (Task Map)” on page 104
- “System Administrator RCM Script (Task Map)” on page 105

For information on hot-plugging USB devices with the `cfgadm` command, see “Hot-Plugging USB Devices With the `cfgadm` Command” on page 155.

For information on hot-plugging InfiniBand devices with `cfgadm` command, see [Chapter 9](#), “Using InfiniBand Devices (Overview/Tasks).”

For information about accessing devices, see “Accessing Devices” on page 76.

Dynamic Reconfiguration and Hot-Plugging

Hot-plugging is the ability to physically add, remove, or replace system components while the system is running. *Dynamic reconfiguration* refers to the ability to hot-plug system components. This term also refers to the general ability to move system resources (both hardware and software) around in the system or to disable them in some way without physically removing them from the system.

Generally, you can hot-plug the following bus types:

- USB

- Fibre Channel
- 1394
- ATA
- SCSI
- Infiniband

In addition, you can hot-plug the following devices with the `cfgadm` command:

- USB devices on SPARC and x86 platforms
- SCSI devices on SPARC and x86 platforms
- PCI devices on SPARC and x86 platforms
- PCIe devices on SPARC or x86 platforms
- InfiniBand devices on SPARC and x86 devices

Features of the `cfgadm` command include the following:

- Displaying system component status
- Testing system components
- Changing component configurations
- Displaying configuration help messages

The benefit of using the `cfgadm` command to reconfigure systems components is that you can add, remove, or replace components while the system is running. An added benefit is that the `cfgadm` command guides you through the steps needed to add, remove, or replace system components.

For step-by-step instructions on hot-plugging components, see the following:

- [“SCSI Hot-Plugging With the `cfgadm` Command” on page 87](#)
- [“PCI or PCIe Hot-Plugging With the `cfgadm` Command” on page 97](#)
- [`cfgadm\(1M\)`](#)

Note – Not all SCSI and PCI controllers support hot-plugging with the `cfgadm` command.

As part of Oracle's high availability strategy, dynamic reconfiguration is expected to be used in conjunction with additional layered products, such as alternate pathing or fail over software. Both products provide fault tolerance in the event of a device failure.

Without any high availability software, you can replace a failed device by manually stopping the appropriate applications, unmounting noncritical file systems, and then proceeding with the add or remove operations.

Note – Some systems have slots that hot-pluggable and slots that are not hot-pluggable. For information about hot-plugging devices on your specific hardware configuration, such as on enterprise-level systems, refer to your hardware configuration documentation.

Attachment Points

The `cfgadm` command displays information about *attachment points*, which are locations in the system where dynamic reconfiguration operations can occur.

An attachment point consists of the following:

- An *occupant*, which represents a hardware component that can be configured into the system
- A *receptacle*, which is the location that accepts the occupant

Attachment points are represented by logical and physical attachment point IDs (`Ap_Ids`). The physical `Ap_Id` is the physical path name of the attachment point. The logical `Ap_Id` is a user-friendly alternative for the physical `Ap_Id`. For more information on `Ap_Ids`, refer to [`cfgadm\(1M\)`](#).

The logical `Ap_Id` for a SCSI Host Bus Adapter (HBA), or SCSI controller, is usually represented by the controller number, such as `c0`.

In cases where no controller number has been assigned to a SCSI HBA, then an internally generated unique identifier is provided. An example of a unique identifier for a SCSI controller is the following:

```
fas1:scsi
```

The logical `Ap_Id` for a SCSI device usually has this format:

```
HBA-logical-apid::device-identifier
```

In the following example, `c0` is the logical `Ap_Id` for the SCSI HBA:

```
c0::dsk/c0t3d0
```

The device identifier is typically derived from the logical device name for the device in the `/dev` directory. For example, a tape device with logical device name, `/dev/rmt/1`, has the following logical `Ap_Id`:

```
c0::rmt/1
```

If a logical `Ap_Id` of a SCSI device cannot be derived from the logical name in the `/dev` directory, then an internally generated unique identifier is provided. An example of an identifier for the `/dev/rmt/1` tape device is the following:

`c0::st4`

For more information on SCSI Ap_Ids, refer to [cfgadm_scsi\(1M\)](#).

The `cfgadm` command represents all resources and dynamic reconfiguration operations in terms of a common set of states (such as configured and unconfigured) and operations (such as connect, configure, unconfigure, and so on). For more information on these common states and operations, see [cfgadm\(1M\)](#).

The following table shows the receptacle and occupant states for the SCSI HBA attachment points.

Receptacle State	Description	Occupant State	Description
empty	N/A for SCSI HBA	configured	One or more devices is configured on the bus
disconnected	Bus quiesced	unconfigured	No devices are configured
connected	Bus active		

The following table shows the receptacle and occupant states for SCSI device attachment points.

Receptacle State	Description	Occupant State	Description
empty	N/A for SCSI devices	configured	Device is configured
disconnected	Bus quiesced	unconfigured	Device is not configured
connected	Bus active		

The state of SCSI attachment points is unknown unless special hardware indicates otherwise. For instructions on displaying SCSI component information, see [“How to Display Information About SCSI Devices” on page 87](#).

Detaching PCI or PCIe Adapter Cards

A PCI adapter card that is hosting nonvital system resources can be removed if the device driver supports hot-plugging. A PCI adapter card is not detachable if it is a vital system resource. For a PCI adapter card to be detachable, the following conditions must be met:

- The device driver must support hot-plugging.
- Critical resources must be accessible through an alternate pathway.

For example, if a system has only one Ethernet card installed in it, the Ethernet card cannot be detached without losing the network connection. This detachment requires additional layered software support to keep the network connection active.

Attaching PCI or PCIe Adapter Cards

A PCI adapter card can be added to the system as long as the following conditions are met:

- There are slots available.
- The device driver supports hot-plugging for this adapter card.

For step-by-step instructions on adding or removing a PCI adapter card, see [“PCI or PCIe Hot-Plugging With the `cfgadm` Command” on page 97](#).

PCIe Hot-Plugging With the (`hotplug`) Command

You can use the `hotplug` command to manage hot pluggible connections, where a connection can be a connector or port, on PCI Express (PCIe) and PCI SHPC devices only. A *hotplug connector* is a physical representation in the system where a component is inserted or removed. A *hotplug port* is a logical representation in the system device tree where the connection of a device to the system is managed.

You can use the `hotplug` features to online or offline a device, even an on-board device, without physically adding or removing the device from the system.

You must enable the `hotplug` service to manage devices with the `hotplug` command.

```
# svcadm enable svc:/system/hotplug:default
```

The following examples describe how to use the `hotplug` command.

Display all the PCI/PCIe hot pluggible connectors/ports (virtual and physical) in the system as follows:

```
# hotplug list -lv
```

Configure an Ethernet card in a PCIe slot. For example:

```
# hotplug enable /pci0,0 pcie0
```

Unconfigure an Ethernet card in a PCIe slot. For example:

```
# hotplug disable /pci0,0 pcie0
```

Offline a PCI device node, which means detach the device driver for that node. For example:

```
# hotplug offline /pci0,0/pci1 pci.0,2
```

Online a PCI device node, which means attach the driver for that node. For example:

```
# hotplug online /pci0,0/pci1 pci.0,2
```

Troubleshooting PCI Hot Plug Operations (`hotplug`)

The following service must be running to use the `hotplug` command.

```
svc:/system/hotplug:default
```

Otherwise, you will see the following message:

```
ERROR: hotplug service is not available.
```

The following error message is displayed on systems that do not have any supported I/O buses:

```
ERROR: there are no connections to display.
      (See hotplug(1m) for more information.)
```

The above message could mean that the system might have other hot-pluggible I/O devices, but you need to use the `cfgadm` command rather than the `hotplug` command to manage these devices.

SCSI Hot-Plugging With the `cfgadm` Command (Task Map)

Task	Description	For Instructions
Display information about SCSI devices.	Display information about SCSI controllers and devices.	“How to Display Information About SCSI Devices” on page 87
Unconfigure a SCSI controller.	Unconfigure a SCSI controller.	“How to Unconfigure a SCSI Controller” on page 88
Configure a SCSI controller.	Configure a SCSI controller that was previously unconfigured.	“How to Configure a SCSI Controller” on page 88
Configure a SCSI device.	Configure a specific SCSI device.	“How to Configure a SCSI Device” on page 89
Disconnect a SCSI controller.	Disconnect a specific SCSI controller.	“How to Disconnect a SCSI Controller” on page 90
Connect a SCSI controller.	Connect a specific SCSI controller that was previously disconnected.	“SPARC: How to Connect a SCSI Controller” on page 91
Add a SCSI device to a SCSI bus.	Add a specific SCSI device to a SCSI bus.	“SPARC: How to Add a SCSI Device to a SCSI Bus” on page 91
Replace an identical device on a SCSI controller.	Replace a device on the SCSI bus with another device of the same type.	“SPARC: How to Replace an Identical Device on a SCSI Controller” on page 92
Remove a SCSI device.	Remove a SCSI device from the system.	“SPARC: How to Remove a SCSI Device” on page 93

Task	Description	For Instructions
Troubleshoot SCSI configuration problems.	Resolve a failed SCSI unconfigure operation.	“How to Resolve a Failed SCSI Unconfigure Operation” on page 96

SCSI Hot-Plugging With the `cfgadm` Command

This section describes various SCSI hot-plugging procedures that you can perform with the `cfgadm` command.

Note – The SCSI framework generally supports hot-plugging of SCSI devices. However, you should consult your hardware documentation to confirm whether hot-plugging is supported for your SCSI devices.

These procedures use specific devices as examples to illustrate how to use the `cfgadm` command to hot-plug SCSI components. The device information that you supply, and that the `cfgadm` command displays, depends on your system configuration.

▼ How to Display Information About SCSI Devices

The following procedure uses SCSI controllers `c0` and `c1` and the devices that are attached to them in the examples of the type of device configuration information that you can display with the `cfgadm` command.

Note – If the SCSI device is not supported by the `cfgadm` command, the device does not display in the `cfgadm` command output.

- 1 Become superuser.
- 2 Display information about attachment points on the system.

```
# cfgadm -l
Ap_Id          Type          Receptacle  Occupant    Condition
c0             scsi-bus     connected   configured  unknown
c1             scsi-bus     connected   configured  unknown
```

In this example, `c0` and `c1` represent two SCSI controllers.

- 3 Display information about a system's SCSI controllers and their attached devices.

```
# cfgadm -al
Ap_Id          Type          Receptacle  Occupant    Condition
c0             scsi-bus     connected   configured  unknown
```

```

c0::dsk/c0t0d0      disk          connected    configured   unknown
c0::rmt/0           tape          connected    configured   unknown
c1                  scsi-bus     connected    configured   unknown
c1::dsk/c1t3d0     disk          connected    configured   unknown
c1::dsk/c1t4d0     unavailable  connected    unconfigured unknown

```

Note – The `cfgadm -l` command displays information about SCSI HBAs but not SCSI devices. Use the `cfgadm -al` command to display information about SCSI devices such as disk and tapes.

▼ How to Unconfigure a SCSI Controller

The following procedure uses SCSI controller `c1` in the example of unconfiguring a SCSI controller.

- 1 **Become superuser.**
- 2 **Unconfigure a SCSI controller.**
- 3 **Verify that the SCSI controller is unconfigured.**

```
# cfgadm -c unconfigure c1
```

```
# cfgadm -al
```

Ap_Id	Type	Receptacle	Occupant	Condition
<code>c0</code>	scsi-bus	connected	configured	unknown
<code>c0::dsk/c0t0d0</code>	disk	connected	configured	unknown
<code>c0::rmt/0</code>	tape	connected	configured	unknown
<code>c1</code>	scsi-bus	connected	unconfigured	unknown

Notice that the `Occupant` column for `c1` specifies `unconfigured`, indicating that the SCSI bus has no configured occupants.

If the unconfigure operation fails, see [“How to Resolve a Failed SCSI Unconfigure Operation” on page 96](#).

▼ How to Configure a SCSI Controller

The following procedure uses SCSI controller `c1` in the example of configuring a SCSI controller.

- 1 **Become superuser.**
- 2 **Configure a SCSI controller.**

```
# cfgadm -c configure c1
```

3 Verify that the SCSI controller is configured.

```
# cfgadm -al
Ap_Id          Type          Receptacle  Occupant    Condition
c0             scsi-bus     connected   configured  unknown
c0::dsk/c0t0d0 disk          connected   configured  unknown
c0::rmt/0      tape         connected   configured  unknown
c1             scsi-bus     connected   configured  unknown
c1::dsk/c1t3d0 disk          connected   configured  unknown
c1::dsk/c1t4d0 unavailable   connected   unconfigured unknown
```

The previous unconfigure procedure removed all devices on the SCSI bus. Now all the devices are configured back into the system.

▼ How to Configure a SCSI Device

The following procedure uses SCSI disk `c1t4d0` in the example of configuring a SCSI device.

1 Become superuser.

2 Identify the device to be configured.

```
# cfgadm -al
Ap_Id          Type          Receptacle  Occupant    Condition
c0             scsi-bus     connected   configured  unknown
c0::dsk/c0t0d0 disk          connected   configured  unknown
c0::rmt/0      tape         connected   configured  unknown
c1             scsi-bus     connected   configured  unknown
c1::dsk/c1t3d0 disk          connected   configured  unknown
c1::dsk/c1t4d0 unavailable   connected   unconfigured unknown
```

3 Configure the SCSI device.

```
# cfgadm -c configure c1::dsk/c1t4d0
```

4 Verify that the SCSI device is configured.

```
# cfgadm -al
Ap_Id          Type          Receptacle  Occupant    Condition
c0             scsi-bus     connected   configured  unknown
c0::dsk/c0t0d0 disk          connected   configured  unknown
c0::rmt/0      tape         connected   configured  unknown
c1             scsi-bus     connected   configured  unknown
c1::dsk/c1t3d0 disk          connected   configured  unknown
c1::dsk/c1t4d0 disk          connected   configured  unknown
```

▼ How to Disconnect a SCSI Controller



Caution – Disconnecting a SCSI device must be done with caution, particularly when you are dealing with controllers for disks that contain critical file systems such as `root (/)`, `usr`, `var`, and the swap partition. The dynamic reconfiguration software cannot detect all cases where a system hang might result. Use this procedure with caution.

The following procedure uses SCSI controller `c1` in the example of disconnecting a SCSI device.

- 1 **Become superuser.**
- 2 **Verify that the device is connected before you disconnect it.**

```
# cfgadm -al
Ap_Id                Type           Receptacle  Occupant    Condition
c0                   scsi-bus      connected   configured  unknown
c0::dsk/c0t0d0       disk          connected   configured  unknown
c0::rmt/0            tape          connected   configured  unknown
c1                   scsi-bus      connected   configured  unknown
c1::dsk/c1t3d0       disk          connected   configured  unknown
c1::dsk/c1t4d0       disk          connected   configured  unknown
```

- 3 **Disconnect the SCSI controller.**

```
# cfgadm -c disconnect c1
WARNING: Disconnecting critical partitions may cause system hang.
Continue (yes/no)? y
```



Caution – This command suspends all I/O activity on the SCSI bus until the `cfgadm -c connect` command is used. The `cfgadm` command does some basic checking to prevent critical partitions from being disconnected, but it cannot detect all cases. Inappropriate use of this command can result in a system hang and could require a system reboot.

- 4 **Verify that the SCSI bus is disconnected.**

```
# cfgadm -al
Ap_Id                Type           Receptacle  Occupant    Condition
c0                   scsi-bus      connected   configured  unknown
c0::dsk/c0t0d0       disk          connected   configured  unknown
c0::rmt/0            tape          connected   configured  unknown
c1                   unavailable   disconnected  configured  unknown
c1::dsk/c1t3d0       unavailable   disconnected  configured  unknown
c1::dsk/c1t4d0       unavailable   disconnected  configured  unknown
```

The controller and all the devices that are attached to it are disconnected from the system.

▼ SPARC: How to Connect a SCSI Controller

The following procedure uses SCSI controller c1 in the example of connecting a SCSI controller.

- 1 Become superuser.
- 2 Verify that the device is disconnected before you connect it.

```
# c f g a d m - a l
Ap_Id          Type          Receptacle  Occupant    Condition
c0             scsi-bus     connected   configured  unknown
c0::dsk/c0t0d0 disk         connected   configured  unknown
c0::rmt/0      tape         connected   configured  unknown
c1             unavailable  disconnected  configured  unknown
c1::dsk/c1t3d0 unavailable  disconnected  configured  unknown
c1::dsk/c1t4d0 unavailable  disconnected  configured  unknown
```

- 3 Connect the SCSI controller.

```
# c f g a d m - c connect c1
```

- 4 Verify that the SCSI controller is connected.

```
# c f g a d m - a l
Ap_Id          Type          Receptacle  Occupant    Condition
c0             scsi-bus     connected   configured  unknown
c0::dsk/c0t0d0 disk         connected   configured  unknown
c0::rmt/0      tape         connected   configured  unknown
c1             scsi-bus     connected   configured  unknown
c1::dsk/c1t3d0 disk         connected   configured  unknown
c1::dsk/c1t4d0 disk         connected   configured  unknown
```

▼ SPARC: How to Add a SCSI Device to a SCSI Bus

SCSI controller c1 is used in the example of how to add a SCSI device to a SCSI bus.

Note – When you add devices, you specify the Ap_Id of the SCSI HBA (controller) to which the device is attached, not the Ap_Id of the device itself.

- 1 Become superuser.
- 2 Identify the current SCSI configuration.

```
# c f g a d m - a l
Ap_Id          Type          Receptacle  Occupant    Condition
c0             scsi-bus     connected   configured  unknown
c0::dsk/c0t0d0 disk         connected   configured  unknown
c0::rmt/0      tape         connected   configured  unknown
c1             scsi-bus     connected   configured  unknown
c1::dsk/c1t3d0 disk         connected   configured  unknown
```

3 Add the SCSI device to the SCSI bus.**a. Type the following `cfgadm` command.**

For example:

```
# cfgadm -x insert_device c1
Adding device to SCSI HBA: /devices/sbus@1f,0/SUNW,fas@1,8800000
This operation will suspend activity on SCSI bus: c1
```

b. Type `y` at the Continue (yes/no)? prompt to proceed.

```
Continue (yes/no)? y
SCSI bus quiesced successfully.
It is now safe to proceed with hotplug operation.
```

I/O activity on the SCSI bus is suspended while the hot-plug operation is in progress.

c. Connect the device and then power it on.**d. Type `y` at the Enter y if operation is complete or n to abort (yes/no)? prompt.**

```
Enter y if operation is complete or n to abort (yes/no)? y
```

4 Verify that the device has been added.

```
# cfgadm -al
Ap_Id           Type           Receptacle    Occupant      Condition
c0              scsi-bus      connected     configured    unknown
c0::dsk/c0t0d0  disk          connected     configured    unknown
c0::rmt/0       tape          connected     configured    unknown
c1              scsi-bus      connected     configured    unknown
c1::dsk/c1t3d0  disk          connected     configured    unknown
c1::dsk/c1t4d0  disk          connected     configured    unknown
```

A new disk has been added to controller c1.

▼ SPARC: How to Replace an Identical Device on a SCSI Controller

The following procedure uses SCSI disk c1t4d0 in the example of replacing an identical device on a SCSI controller.

1 Become superuser.**2 Identify the current SCSI configuration.**

```
# cfgadm -al
Ap_Id           Type           Receptacle    Occupant      Condition
c0              scsi-bus      connected     configured    unknown
c0::dsk/c0t0d0  disk          connected     configured    unknown
c0::rmt/0       tape          connected     configured    unknown
c1              scsi-bus      connected     configured    unknown
```

```
c1::dsk/c1t3d0      disk          connected    configured   unknown
c1::dsk/c1t4d0      disk          connected    configured   unknown
```

3 Replace a device on the SCSI bus with another device of the same type.

a. Type the following `cfgadm` command.

For example:

```
# cfgadm -x replace_device c1::dsk/c1t4d0
Replacing SCSI device: /devices/sbus@1f,0/SUNW,fas@1,8800000/sd@4,0
This operation will suspend activity on SCSI bus: c1
```

b. Type `y` at the Continue (yes/no)? prompt to proceed.

I/O activity on the SCSI bus is suspended while the hot-plug operation is in progress.

```
Continue (yes/no)? y
SCSI bus quiesced successfully.
It is now safe to proceed with hotplug operation.
```

c. Power off the device to be removed and remove it.

d. Add the replacement device. Then, power it on.

The replacement device should be of the same type and at the same address (target and lun) as the device to be removed.

e. Type `y` at the Enter `y` if operation is complete or `n` to abort (yes/no)? prompt.

```
Enter y if operation is complete or n to abort (yes/no)? y
```

4 Verify that the device has been replaced.

```
# cfgadm -al
Ap_Id          Type          Receptacle  Occupant    Condition
c0             scsi-bus      connected   configured   unknown
c0::dsk/c0t0d0 disk          connected   configured   unknown
c0::rmt/0      tape          connected   configured   unknown
c1             scsi-bus      connected   configured   unknown
c1::dsk/c1t3d0 disk          connected   configured   unknown
c1::dsk/c1t4d0 disk          connected   configured   unknown
```

▼ SPARC: How to Remove a SCSI Device

The following procedure uses SCSI disk `c1t4d0` in the example of removing a device on a SCSI controller.

1 Become superuser.

2 Identify the current SCSI configuration.

```
# cfgadm -al
Ap_Id          Type          Receptacle  Occupant    Condition
```

<code>c0</code>	<code>scsi-bus</code>	<code>connected</code>	<code>configured</code>	<code>unknown</code>
<code>c0::dsk/c0t0d0</code>	<code>disk</code>	<code>connected</code>	<code>configured</code>	<code>unknown</code>
<code>c0::rmt/0</code>	<code>tape</code>	<code>connected</code>	<code>configured</code>	<code>unknown</code>
<code>c1</code>	<code>scsi-bus</code>	<code>connected</code>	<code>configured</code>	<code>unknown</code>
<code>c1::dsk/c1t3d0</code>	<code>disk</code>	<code>connected</code>	<code>configured</code>	<code>unknown</code>
<code>c1::dsk/c1t4d0</code>	<code>disk</code>	<code>connected</code>	<code>configured</code>	<code>unknown</code>

3 Remove the SCSI device from the system.

a. Type the following `cfgadm` command.

For example:

```
# cfgadm -x remove_device c1::dsk/c1t4d0
Removing SCSI device: /devices/sbus@1f,0/SUNW,fas@1,8800000/sd@4,0
This operation will suspend activity on SCSI bus: c1
```

b. Type `y` at the `Continue (yes/no)?` prompt to proceed.

```
Continue (yes/no)? y
SCSI bus quiesced successfully.
It is now safe to proceed with hotplug operation.
```

I/O activity on the SCSI bus is suspended while the hot-plug operation is in progress.

c. Power off the device to be removed and remove it.

d. Type `y` at the `Enter y if operation is complete or n to abort (yes/no)?` prompt.

```
Enter y if operation is complete or n to abort (yes/no)? y
```

Note – This step must be performed if you are removing a SCSI RAID device from a SCSI RAID array.

4 Verify that the device has been removed from the system.

```
# cfgadm -al
Ap_Id          Type          Receptacle  Occupant    Condition
c0             scsi-bus     connected   configured  unknown
c0::dsk/c0t0d0 disk         connected   configured  unknown
c0::rmt/0      tape        connected   configured  unknown
c1            scsi-bus     connected   configured  unknown
c1::dsk/c1t3d0 disk         connected   configured  unknown
```

Troubleshooting SCSI Configuration Problems

This section provides error messages and possible solutions for troubleshooting SCSI configuration problems. For more information on troubleshooting SCSI configuration problems, see [`cfgadm\(1M\)`](#).

Error Message

```

cfgadm: Component system is busy, try again: failed to offline:
  device-path
  Resource           Information
  -----
/dev/dsk/clt0d0s0  mounted filesystem "/file-system"
    
```

Cause

You attempted to remove or replace a device with a mounted file system.

Solution

Unmount the file system that is listed in the error message and retry the `cfgadm` operation.

Error Message

```

cfgadm: Component system is busy, try again: failed to offline:
  device-path
  Resource           Information
  -----
/dev/dsk/device-name  swap area
    
```

Cause

If you use the `cfgadm` command to remove a system resource, such as a swap device or a dedicated dump device, a similar error message is displayed if the system resource is still active.

Solution

Unconfigure the swap areas on the device that is specified and retry the `cfgadm` operation.

Error Message

```

cfgadm: Component system is busy, try again: failed to offline:
  device-path
  Resource           Information
  -----
/dev/dsk/device-name  dump device (swap)
    
```

Cause

You attempted to remove or replace a dump device that is configured on a swap area.

Solution

Unconfigure the dump device that is configured on the swap area and retry the `cfgadm` operation.

Error Message

```

cfgadm: Component system is busy, try again: failed to offline:
  device-path
  Resource           Information
  -----
/dev/dsk/device-name  dump device (dedicated)
    
```

Cause

You attempted to remove or replace a dedicated dump device.

Solution

Unconfigure the dedicate dump device and retry the `cfgadm` operation.

▼ How to Resolve a Failed SCSI Unconfigure Operation

Use this procedure if one or more target devices are busy and the SCSI unconfigure operation fails. Otherwise, future dynamic reconfiguration operations on this controller and target devices will fail with a `dr in progress` message.

1 Become superuser.

2 Reconfigure the controller.

```
# cfgadm -c configure device-name
```

PCI or PCIe Hot-Plugging With the `cfgadm` Command (Task Map)

The following task map describes the tasks for managing PCI or PCIe devices on your system.

Task	Description	For Instructions
Display PCI slot configuration information.	Display the status of PCI hot-pluggable devices and slots on the system.	“How to Display PCI Slot Configuration Information” on page 97
Remove a PCI adapter card.	Unconfigure the card, disconnect power from the slot, and remove the card from the system.	“How to Remove a PCI Adapter Card” on page 99
Add a PCI adapter card.	Insert the adapter card into a hot-pluggable slot, connect power to the slot, and configure the card.	“How to Add a PCI Adapter Card” on page 100
Troubleshoot PCI configuration problems.	Identify error message and possible solutions to resolve PCI configuration problems.	“Troubleshooting PCI Configuration Problems” on page 102

PCI or PCIe Hot-Plugging With the `cfgadm` Command

This section provides step-by-step instructions for hot-plugging PCI or PCIe adapter cards on SPARC and x86 systems.

In addition to the `cfgadm` command, the `prtconf` command is helpful during hot-plug operations. The `prtconf` command displays additional configuration information that pertains to the hardware.

After adding hardware, you can use the `prtconf` command to verify that the hardware is configured correctly. For example, after a configure operation, use the `prtconf -D` command to verify that the driver is attached to the newly installed hardware device. If the device driver has not been added to the system prior to hardware configuration, it may be manually added by using the `add_drv` command.

For more information, see [prtconf\(1M\)](#) and [add_drv\(1M\)](#).

In the examples, only PCI attachment points are listed, for brevity. The attachment points that are displayed on your system depend on your system configuration.

PCIe Led Indicator Behavior

You might observe the LED indicators on the system to get a visual indication about the status of the slot's hot-plug operation. The LED behavior, in case of PCI Express, matches that defined in the PCI Express specification or the behavior might otherwise be platform dependent.

Please refer to your platform guide for specific details. In case of PCI Express, when the Attention Button is pressed, the power indicator blinks, which indicates the beginning of a state transition. The blinking ends when the state transition has ended.

▼ How to Display PCI Slot Configuration Information

This procedure has been updated to include PCIe configuration information.

The `cfgadm` command displays the status of PCI hot-pluggable devices and slots on a system. For more information, see [cfgadm\(1M\)](#).

- 1 **Become superuser.**
- 2 **Display PCI configuration information.**
 - Display PCI slot configuration information.
For example:

```
# cfgadm
Ap_Id                Type                Receptacle  Occupant  Condition
pci1:hpc0_slot0     unknown            empty       unconfigured unknown
pci1:hpc0_slot1     unknown            empty       unconfigured unknown
pci1:hpc0_slot2     unknown            empty       unconfigured unknown
pci1:hpc0_slot3     ethernet/hp        connected   configured ok
pci1:hpc0_slot4     unknown            empty       unconfigured unknown
```

- Display specific PCI device information.

For example:

```
# cfgadm -s "cols=ap_id:type:info" pci
Ap_Id                Type                Information
pci1:hpc0_slot0     unknown            Slot 7
pci1:hpc0_slot1     unknown            Slot 8
pci1:hpc0_slot2     unknown            Slot 9
pci1:hpc0_slot3     ethernet/hp        Slot 10
pci1:hpc0_slot4     unknown            Slot 11
```

The logical Ap_Id, `pci1:hpc0_slot0`, is the logical Ap_Id for hot-pluggable slot, Slot 7. The component `hpc0` indicates the hot-pluggable adapter card for this slot, and `pci1` indicates the PCI bus instance. The Type field indicates the type of PCI adapter card that is present in the slot.

- Display PCIe slot configuration information.

For example:

```
# cfgadm pci
Ap_Id                Type                Receptacle  Occupant  Condition
pcie1                unknown            empty       unconfigured unknown
pcie2                unknown            empty       unconfigured unknown
pcie3                unknown            empty       unconfigured unknown
pcie4                etherne/hp        connected   configured ok
pcie5                pci-pci/hp        connected   configured ok
pcie6                unknown            disconnected unconfigured unknown
```

- Display specific PCIe device information.

For example:

```
# cfgadm -s "cols=ap_id:busy:o_state" pci
Ap_Id                Busy  Occupant
pcie1                n     unconfigured
pcie2                n     unconfigured
pcie3                n     unconfigured
pcie4                n     configured
pcie5                n     configured
pcie6                n     configured
```

Note – The logical Ap_Id in most cases should match the slot label that is silk-screened on the system chassis. Refer to your platform guide for the `cfgadm` output of the hot-pluggable slots. The Busy field can be displayed to ensure that the Ap_Id is not transitioning to another state before a hot-plug operation is attempted.

▼ How to Remove a PCI Adapter Card

The following procedure has been updated for removing a PCIe adapter card. However, the procedure to remove an adapter card is the same whether you are using PCI or PCIe.

- 1 **Become superuser.**
- 2 **Determine which slot the PCI adapter card is in.**

For example:

```
# c f g a d m p c i
Ap_Id      Type      Receptacle  Occupant    Condition
pcie1     unknown   empty       unconfigured unknown
pcie2     unknown   empty       unconfigured unknown
pcie3     unknown   empty       unconfigured unknown
pcie4     etherne/hp connected   configured  ok
pcie5     pci-pci/hp connected   configured  ok
pcie6     unknown   disconnected unconfigured unknown
```

- 3 **Stop the application that has the device open.**

For example, if the device is an Ethernet card, use the `ifconfig` command to bring down the interface and unplumb the interface.

- 4 **Unconfigure the device manually by using the `c f g a d m` command as shown below. Or, if you have a PCIe adapter card, use the auto-configuration method, such as pressing the slot's Attention Button as defined by your platform guide.**

```
# c f g a d m - c u n c o n f i g u r e p c i e 4
```

- 5 **Confirm that the device has been unconfigured.**

For example:

```
# c f g a d m p c i
Ap_Id      Type      Receptacle  Occupant    Condition
pcie1     unknown   empty       unconfigured unknown
pcie2     unknown   empty       unconfigured unknown
pcie3     unknown   empty       unconfigured unknown
pcie4     unknown   connected   unconfigured unknown
pcie5     pci-pci/hp connected   configured  ok
pcie6     unknown   disconnected unconfigured unknown
```

Note – The Type and Condition also become unknown when the device is unconfigured.

- 6 **Disconnect the power to the slot manually. If the auto-configuration method is used, this step is not necessary. Refer to your platform guide for more information.**

```
# c f g a d m - c d i s c o n n e c t p c i e 4
```

7 Confirm that the device has been disconnected.

For example:

```
# cfgadm pci
Ap_Id          Type          Receptacle  Occupant    Condition
pcie1         unknown      empty       unconfigured unknown
pcie2         unknown      empty       unconfigured unknown
pcie3         unknown      empty       unconfigured unknown
pcie4         unknown      disconnected unconfigured unknown
pcie5         pci-pci/hp   connected   configured  ok
pcie6         unknown      disconnected unconfigured unknown
```

8 Follow appropriate instructions in your platform guide to remove the PCI adapter card. After the card is removed, the Receptacle state is empty.

For example:

```
# cfgadm pci
Ap_Id          Type          Receptacle  Occupant    Condition
pcie1         unknown      empty       unconfigured unknown
pcie2         unknown      empty       unconfigured unknown
pcie3         unknown      empty       unconfigured unknown
pcie4         unknown      empty       unconfigured unknown
pcie5         pci-pci/hp   connected   configured  ok
pcie6         unknown      disconnected unconfigured unknown
```

Note – The auto-configuration method can be enabled or disabled at boot, depending on the platform implementation. Set the auto-configuration method as appropriate for your environment.

▼ How to Add a PCI Adapter Card

The following procedure has been updated for adding a PCIe adapter card. However, the procedure to add an adapter card is the same whether you are using PCI or PCIe.

- 1 Become superuser.**
- 2 Identify the hot-pluggable slot and open latches.**

For example, `pcie3`.

```
# cfgadm pci
Ap_Id          Type          Receptacle  Occupant    Condition
pcie1         unknown      empty       unconfigured unknown
pcie2         unknown      empty       unconfigured unknown
pcie3         unknown      empty       unconfigured unknown
pcie4         unknown      empty       unconfigured unknown
pcie5         pci-pci/hp   connected   configured  ok
pcie6         unknown      disconnected unconfigured unknown
```

- 3 Follow the appropriate instructions in your platform guide to insert a PCI adapter card into the slot.**

4 Determine which slot the PCI adapter card is in after it is inserted.

For example:

```
# cfgadm pci
Ap_Id          Type          Receptacle  Occupant    Condition
pcie1         unknown      empty       unconfigured unknown
pcie2         unknown      empty       unconfigured unknown
pcie3         unknown      disconnected unconfigured unknown
pcie4         unknown      empty       unconfigured unknown
pcie5         pci-pci/hp   connected   configured  ok
pcie6         unknown      disconnected unconfigured unknown
```

5 Connect the power to the slot manually using the `cfgadm` command. Or, if you have a PCIe adapter card, use the auto-configuration method, such as pressing the slot's Attention Button as defined by your platform guide.

For example:

```
# cfgadm -c connect pcie3
```

6 Confirm that the attachment point is connected.

For example:

```
# cfgadm pci
Ap_Id          Type          Receptacle  Occupant    Condition
pcie1         unknown      empty       unconfigured unknown
pcie2         unknown      empty       unconfigured unknown
pcie3         unknown      connected   unconfigured unknown
pcie4         unknown      empty       unconfigured unknown
pcie5         pci-pci/hp   connected   configured  ok
pcie6         unknown      disconnected unconfigured unknown
```

7 Configure the PCI adapter card manually by using the `cfgadm` command as shown below. If using the auto-configuration method, this step should not be necessary. Refer to your platform guide for more information.

For example:

```
# cfgadm -c configure pcie3
```

8 Verify the configuration of the PCI adapter card in the slot.

For example:

```
# cfgadm pci
Ap_Id          Type          Receptacle  Occupant    Condition
pcie1         unknown      empty       unconfigured unknown
pcie2         unknown      empty       unconfigured unknown
pcie3         etherne/hp   connected   configured  unknown
pcie5         pci-pci/hp   connected   configured  ok
pcie6         unknown      disconnected unconfigured unknown
```

9 Configure any supporting software if this device is a new device.

For example, if this device is an Ethernet card, use the `ifconfig` command to set up the interface.

Note – The auto-configuration method can be enabled or disabled at boot, depending on the platform implementation. Set the auto-configuration method as appropriate for your environment.

Troubleshooting PCI Configuration Problems

Error Message

```
cfgadm: Configuration operation invalid: invalid transition
```

Cause

An invalid transition was attempted.

Solution

Check whether the `cfgadm -c` command was issued appropriately. Use the `cfgadm` command to check the current receptacle and occupant state and to make sure that the `Ap_Id` is correct.

Error Message

```
cfgadm: Attachment point not found
```

Cause

The specified attachment point was not found.

Solution

Check whether the attachment point is correct. Use the `cfgadm` command to display a list of available attachment points. Also check the physical path to see if the attachment point is still there.

Reconfiguration Coordination Manager (RCM) Script Overview

The Reconfiguration Coordination Manager (RCM) is the framework that manages the dynamic removal of system components. By using RCM, you can register and release system resources in an orderly manner.

You can use the new RCM script feature to write your own scripts to shut down your applications, or to cleanly release the devices from your applications during dynamic reconfiguration. The RCM framework launches a script automatically in response to a reconfiguration request, if the request impacts the resources that are registered by the script.

You can also release resources from applications manually before you dynamically remove the resource. Or, you can use the `cfgadm` command with the `-f` option to force a reconfiguration

operation. However, this option might leave your applications in an unknown state. Also, the manual release of resources from applications commonly causes errors.

The RCM script feature simplifies and better controls the dynamic reconfiguration process. By creating an RCM script, you can do the following:

- Automatically release a device when you dynamically remove a device. This process also closes the device if the device is opened by an application.
- Run site-specific tasks when you dynamically remove a device from the system.

What Is an RCM Script?

- An executable shell script (Perl, sh, csh, or ksh) or binary program that the RCM daemon runs. Perl is the recommended language.
- A script that runs in its own address space by using the user ID of the script file owner.
- A script that is run by the RCM daemon when you use the `cfgadm` command to dynamically reconfigure a system resource.

What Can an RCM Script Do?

You can use an RCM script to release a device from an application when you dynamically remove a device. If the device is currently open, the RCM script also closes the device.

For example, an RCM script for a tape backup application can inform the tape backup application to close the tape drive or shut down the tape backup application.

How Does the RCM Script Process Work?

You can invoke an RCM script as follows:

```
$ script-name command [args ...]
```

An RCM script performs the following basic steps:

1. Takes the RCM command from command-line arguments.
2. Executes the command.
3. Writes the results to `stdout` as name-value pairs.
4. Exits with the appropriate exit status.

The RCM daemon runs one instance of a script at a time. For example, if a script is running, the RCM daemon does not run the same script until the first script exits.

RCM Script Commands

You must include the following RCM commands in an RCM script:

- `scriptinfo` – Gathers script information
- `register` – Registers interest in resources
- `resourceinfo` – Gathers resource information

You might include some or all of the following RCM commands:

- `queryremove` – Queries whether the resource can be released
- `preremove` – Releases the resource
- `postremove` – Provides post-resource removal notification
- `undoremove` – Undoes the actions done in `preremove`

For a complete description of these RCM commands, see [rcmscript\(4\)](#).

RCM Script Processing Environment

When you dynamically remove a device, the RCM daemon runs the following:

- The script's `register` command to gather the list of resources (device names) that are identified in the script.
- The script's `queryremove` and `preremove` commands prior to removing the resource if the script's registered resources are affected by the dynamic remove operation.
- The script's `postremove` command if the remove operation succeeds. However, if the remove operation fails, the RCM daemon runs the script's `undoremove` command.

RCM Script Tasks

The following sections describe the RCM script tasks for application developers and system administrators.

Application Developer RCM Script (Task Map)

The following task map describes the tasks for an application developer who is creating an RCM script.

Task	Description	For Instructions
1. Identify the resources your application uses.	Identify the resources (device names) your application uses that you could potentially dynamically remove.	cfgadm(1M)

Task	Description	For Instructions
2. Identify the commands to release the resource.	Identify the commands for notifying the application to cleanly release the resource from the application.	Application documentation
3. Identify the commands for post-removal of the resource.	Include the commands for notifying the application of the resource removal.	rcmscript(4)
4. Identify the commands if the resource removal fails.	Include the commands for notifying the application of the available resource.	rcmscript(4)
5. Write the RCM script.	Write the RCM script based on the information identified in tasks 1-4.	“Tape Backup RCM Script Example” on page 108
6. Install the RCM script.	Add the script to the appropriate script directory.	“How to Install an RCM Script” on page 106
7. Test the RCM script	Test the script by running the script commands manually and by initiating a dynamic reconfiguration operation.	“How to Test an RCM Script” on page 107

System Administrator RCM Script (Task Map)

The following task map describes the tasks for a system administrator who is creating an RCM script to do site customization.

Task	Description	For Instructions
1. Identify the resources to be dynamically removed.	Identify the resources (device names) to be potentially removed by using the <code>cfgadm -l</code> command.	cfgadm(1M)
2. Identify the applications to be stopped.	Identify the commands for stopping the applications cleanly.	Application documentation
3. Identify the commands for pre-removal and post-removal of the resource.	Identify the actions to be taken before and after the resource is removed.	rcmscript(4)
4. Write the RCM script.	Write the RCM script based on the information identified in tasks 1-3.	“Tape Backup RCM Script Example” on page 108
5. Install the RCM script.	Add the script to the appropriate script directory.	“How to Install an RCM Script” on page 106

Task	Description	For Instructions
6. Test the RCM script.	Test the script by running the script commands manually and by initiating a dynamic reconfiguration operation.	“How to Test an RCM Script” on page 107

Naming an RCM Script

A script must be named as *vendor,service* where the following applies:

vendor Is the stock symbol of the vendor that provides the script, or any distinct name that identifies the vendor.

service Is the name of the service that the script represents.

Installing or Removing an RCM Script

You must be superuser (root) to install or remove an RCM script. Use this table to determine where you should install your RCM script.

TABLE 6-1 RCM Script Directories

Directory Location	Script Type
/etc/rcm/scripts	Scripts for specific systems
/usr/platform/'uname -i'/lib/rcm/scripts	Scripts for a specific hardware implementation
/usr/platform/'uname -m'/lib/rcm/scripts	Scripts for a specific hardware class
/usr/lib/rcm/scripts	Scripts for any hardware

▼ How to Install an RCM Script

- 1 **Become superuser.**
- 2 **Copy the script to the appropriate directory.**
See [Table 6-1](#).
For example:

```
# cp SUNW,sample.pl /usr/lib/rcm/scripts
```
- 3 **Change the user ID and the group ID of the script to the desired values.**

```
# chown user:group /usr/lib/rcm/scripts/SUNW,sample.pl
```

- 4 Send SIGHUP to the RCM daemon.

```
# pkill -HUP -x -u root rcm_daemon
```

▼ How to Remove an RCM Script

- 1 Become superuser.
- 2 Remove the script from the RCM script directory.

For example:

```
# rm /usr/lib/rcm/scripts/SUNW/sample.pl
```

- 3 Send SIGHUP to the RCM daemon.

```
# pkill -HUP -x -u root rcm_daemon
```

▼ How to Test an RCM Script

- 1 Set environment variables, such as RCM_ENV_FORCE, in the command-line shell before running your script.

For example, in the Korn shell, use the following:

```
$ export RCM_ENV_FORCE=TRUE
```

- 2 Test the script by running the script commands manually from the command line.

For example:

```
$ script-name scriptinfo
$ script-name register
$ script-name preremove resource-name
$ script-name postremove resource-name
```

- 3 Make sure that each RCM script command in your script prints appropriate output to stdout.

- 4 Install the script in the appropriate script directory.

For more information, see [“How to Install an RCM Script”](#) on page 106.

- 5 Test the script by initiating a dynamic remove operation.

For example, assume your script registers the device, /dev/dsk/c1t0d0s0. Try these commands.

```
$ cfgadm -c unconfigure c1::dsk/c1t0d0
$ cfgadm -f -c unconfigure c1::dsk/c1t0d0
$ cfgadm -c configure c1::dsk/c1t0d0
```



Caution – Make sure that you are familiar with these commands because they can alter the state of the system and cause system failures.

Tape Backup RCM Script Example

This example illustrates how to use an RCM script for tape backups.

What the Tape Backup RCM Script Does

The tape backup RCM script performs the following steps:

1. Sets up a dispatch table of RCM commands.
2. Calls the dispatch routine that corresponds to the specified RCM command and exits with status 2 for unimplemented RCM commands.
3. Sets up the `scriptinfo` section.

```
rcm_script_func_info=Tape backup appl script for DR
```

4. Registers all tape drives in the system by printing all tape drive device names to `stdout`.

```
rcm_resource_name=/dev/rmt/$f
```

If an error occurs, the script prints the error information to `stdout`.

```
rcm_failure_reason=$errmsg
```

5. Sets up the resource information for the tape device.

```
rcm_resource_usage_info=Backup Tape Unit Number $unit
```

6. Sets up the `preremove` information by checking if the backup application is using the device. If the backup application is not using the device, the dynamic reconfiguration operation continues. If the backup application is using the device, the script checks `RCM_ENV_FORCE`. If `RCM_ENV_FORCE` is set to `FALSE`, the script denies the dynamic reconfiguration operation and prints the following message:

```
rcm_failure_reason=tape backup in progress pid=...
```

If `RCM_ENV_FORCE` is set to `TRUE`, the backup application is stopped, and the reconfiguration operation proceeds.

Outcomes of the Tape Backup Reconfiguration Scenarios

Here are the various outcomes if you use the `cfgadm` command to remove a tape device without the RCM script.

- If you use the `cfgadm` command and the backup application is not using the tape device, the operation succeeds.
- If you use the `cfgadm` command and the backup application is using the tape device, the operation fails.

Here are the various outcomes if you use the `cfgadm` command to remove a tape device with the RCM script.

- If you use the `cfgadm` command and the backup application is not using the tape device, the operation succeeds.
- If you use the `cfgadm` command without the `-f` option and the backup application is using the tape device, the operation fails with an error message similar to the following:

```
tape backup in progress pid=...
```
- If you use the `cfgadm -f` command and the backup application is using the tape device, the script stops the backup application and the `cfgadm` operation succeeds.

Example—Tape Backup RCM Script

```
#!/usr/bin/perl -w
#
# A sample site customization RCM script.
#
# When RCM_ENV_FORCE is FALSE this script indicates to RCM that it cannot
# release the tape drive when the tape drive is being used for backup.
#
# When RCM_ENV_FORCE is TRUE this script allows DR removing a tape drive
# when the tape drive is being used for backup by killing the tape
# backup application.
#

use strict;

my ($cmd, %dispatch);
$cmd = shift(@ARGV);
# dispatch table for RCM commands
%dispatch = (
    "scriptinfo" => \&do_scriptinfo,
    "register" => \&do_register,
    "resourceinfo" => \&do_resourceinfo,
    "queryremove" => \&do_preremove,
    "preremove" => \&do_preremove
);

if (defined($dispatch{$cmd})) {
    &{$dispatch{$cmd}};
} else {
    exit (2);
}

sub do_scriptinfo
{
    print "rcm_script_version=1\n";
    print "rcm_script_func_info=Tape backup appl script for DR\n";
    exit (0);
}

sub do_register
{
```

```

    my ($dir, $f, $errmsg);

    $dir = opendir(RMT, "/dev/rmt");
    if (!$dir) {
        $errmsg = "Unable to open /dev/rmt directory: $!";
        print "rcm_failure_reason=$errmsg\n";
        exit (1);
    }

    while ($f = readdir(RMT)) {
        # ignore hidden files and multiple names for the same device
        if (($f !~ /^\.\/) && ($f =~ /^[0-9]+$/)) {
            print "rcm_resource_name=/dev/rmt/$f\n";
        }
    }

    closedir(RMT);
    exit (0);
}
sub do_resourceinfo
{
    my ($rsrc, $unit);

    $rsrc = shift(@ARGV);
    if ($rsrc =~ /^\/dev\/rmt\/([0-9]+)$/) {
        $unit = $1;
        print "rcm_resource_usage_info=Backup Tape Unit Number $unit\n";
        exit (0);
    } else {
        print "rcm_failure_reason=Unknown tape device!\n";
        exit (1);
    }
}

sub do_preremove
{
    my ($rsrc);

    $rsrc = shift(@ARGV);

    # check if backup application is using this resource
    #if (the backup application is not running on $rsrc) {
        # allow the DR to continue
    #
    #}
    #
    # If RCM_ENV_FORCE is FALSE deny the operation.
    # If RCM_ENV_FORCE is TRUE kill the backup application in order
    # to allow the DR operation to proceed
    #
    if ($ENV{RCM_ENV_FORCE} eq 'TRUE') {
        if ($cmd eq 'preremove') {
            # kill the tape backup application
        }
        exit (0);
    } else {
        #
        # indicate that the tape drive can not be released
    }
}

```

```
        # since the device is being used for backup by the
        # tape backup application
        #
        print "rcm_failure_reason=tape backup in progress pid=...\n"
;
    }
    exit (3);
}
```

Using USB Devices (Overview)

This chapter provides an overview of Universal Serial Bus (USB) devices in the Oracle Solaris OS.

This is a list of the overview information in this chapter.

- “What's New in USB Devices?” on page 113
- “Overview of USB Devices” on page 117
- “About USB in the Oracle Solaris OS” on page 123

For recent information about USB devices, go to the following site:

<http://www.oracle.com/us/sun/index.html>

For general information about USB devices, go to the following site:

<http://developers.sun.com/solaris/developer/support/driver/usb.html>

For step-by-step instructions on using USB devices in the Oracle Solaris OS, see [Chapter 8](#), “Using USB Devices (Tasks).”

For general information about dynamic reconfiguration and hot-plugging, see [Chapter 6](#), “Dynamically Configuring Devices (Tasks).”

For information on configuring USB printers, see *System Administration Guide: Printing*.

What's New in USB Devices?

The following section describes new USB features in the Oracle Solaris release.

- “EHCI Isochronous Transfer Support” on page 114
- “Support for CDC ACM Devices” on page 114
- “Changed USB Device Hotpluggable Behavior” on page 114
- “USB Power Budgeting” on page 115

- “Oracle Solaris ZFS Support on USB Devices” on page 114
- “Support for Prolific and Keyspan Serial Adapters” on page 115
- “x86: Support for USB CDs and DVDs in GRUB-Based Booting” on page 115
- “USB Virtual Keyboard and Mouse Support” on page 115
- “`voId` Provides Awareness of Hot-Plugged USB Devices” on page 116

For a complete listing of new Oracle Solaris features and a description of Oracle Solaris releases, see [Oracle Solaris 10 8/11 What's New](#).

EHCI Isochronous Transfer Support

Solaris 10 8/07 USB EHCI host controller driver provides isochronous transfer support for USB 2.0 or high-speed isochronous devices. For more information, see [usb_isoc_request\(9S\)](#).

Support for CDC ACM Devices

Solaris 10 8/07 Support for CDC ACM devices is provided in this release. For more information, see “[USB Driver Enhancements](#)” on page 120.

Changed USB Device Hotpluggable Behavior

Solaris 10 6/06: This Solaris release introduces a new device attribute, *hotpluggable*, to identify those devices that can be connected or disconnected without rebooting the system and configured or unconfigured automatically without user intervention. All USB and 1394 devices are identified as hotpluggable devices to gain those benefits described in “[Using USB Mass Storage Devices](#)” on page 131. In addition, non-removable media USB and 1394 devices are no longer identified as removable-media devices and no longer have a *removable-media* attribute.

The changes are primarily made at the kernel level to improve support for non-removable media USB and 1394 devices, and improve the performance for those devices. However, these changes do not impact the use of these devices. For example, the responsibility of mounting and unmounting these devices is controlled by `voId`. From a user's perspective, the only visible changes are the *hotpluggable* and *removable-media* attributes of a device.

For more information, see “[USB and 1394 \(FireWire\) Support Enhancements](#)” on page 65.

Oracle Solaris ZFS Support on USB Devices

Solaris 10 6/06: You can create and mount ZFS file systems on USB mass storage devices. For information about using USB mass storage devices, see “[Using USB Mass Storage Devices](#)” on page 131.

For information about creating and mounting ZFS file systems, see [zfs\(1M\)](#) and [zpool\(1M\)](#).

Support for Prolific and Keyspan Serial Adapters

Solaris 10 6/06: Support for Prolific and Keyspan serial adapters is provided in this release. For more information, see “[USB Driver Enhancements](#)” on page 120.

USB Power Budgeting

Solaris 10 6/06: This Solaris release includes power budgeting of USB devices to better manage the power that is distributed to USB devices. Power budget control helps prevent over-current conditions from occurring and generally makes using USB devices safer. For more information about Solaris USB power budgeting limitations, see “[Bus-Powered Devices](#)” on page 125.

x86: Support for USB CDs and DVDs in GRUB-Based Booting

Solaris 10 1/06: You can use the following USB features in the GRUB-based booting environment:

- Installing from USB CD or DVD drives
- Booting from USB storage devices. You must install the Solaris release on the USB drive before you can boot from it.

For more information about GRUB-based booting, see [Chapter 9, “Shutting Down and Booting a System \(Overview\)”](#) in *System Administration Guide: Basic Administration*.

USB Virtual Keyboard and Mouse Support

Solaris 10 1/06: USB virtual keyboard and mouse support enables you to hook up multiple keyboards and multiple mice, where the set of keyboards or mice behave as one virtual keyboard or mouse. This means that the input of each physical device is coalesced into a single input stream. For example, if you type SHIFT on one keyboard and A on another, the character echoed is an uppercase A.

Also supported is the ability to add a USB keyboard or mouse to a laptop and have these devices work as one device with the laptop's PS/2 keyboard and pad.

In addition, support for barcode readers is provided by the virtual keyboard and mouse feature.

For more information, refer to [virtualkm\(7D\)](#).

vo1d Provides Awareness of Hot-Plugged USB Devices

Solaris 10 1/06: The removable media manager (vo1d) is now hotplug aware. There is no need to restart this daemon to mount a USB mass storage device that has been hot-inserted. However, for some devices, it might still be necessary to manually mount the devices as vo1d is not always successful. In the case where vo1d fails to automatically mount a USB device, stop vo1d, like this:

```
# /etc/init.d/volmgt stop
```

For information about manually mounting a USB mass storage device, see [“How to Mount or Unmount a USB Mass Storage Device Without vo1d Running”](#) on page 147.

Oracle Solaris Support for USB Devices

Use the following table to identify Solaris support information for specific USB 1.1 and USB 2.0 devices.

USB Device	Solaris 8 HW 5/03 and Later Releases	Solaris 9 Releases	Solaris 10 Releases
General USB 1.1 device support	SPARC and x86	SPARC and x86	SPARC and x86
General USB 2.0 device support	SPARC only	SPARC and x86 (Solaris 9 4/04)	SPARC and x86
Specific USB 1.1 and USB 2.0 device support			
audio devices (See notes below.)	USB 1.1 only: Not supported on a USB 2.0 hub	USB 1.1 only: Not supported on a USB 2.0 hub	USB 1.1 only: Supported on a USB 2.0 hub
generic USB driver (ugen(7D))	SPARC only	SPARC and x86	SPARC and x86
hid devices (keyboard and mouse devices, hid(7D))	SPARC and x86	SPARC and x86	SPARC and x86
hubs (hubd(7D))	SPARC and x86	SPARC and x86	SPARC and x86
printers	SPARC and x86	SPARC and x86	SPARC and x86
serial devices (Edgeport (usbser_edge(7D)), Prolific (usbprl(7D)), Keyspan (usbksp(7D))	SPARC and x86	SPARC and x86	SPARC and x86
storage devices (scsa2usb(7D))	SPARC and x86	SPARC and x86	SPARC and x86

USB Device	Solaris 8 HW 5/03 and Later Releases	Solaris 9 Releases	Solaris 10 Releases
user-space USB device management library (<code>libusb(3LIB)</code>)	Not supported	Not supported	SPARC and x86

Notes:

- Only USB 1.x audio devices are supported. No USB 2.0 audio devices are supported.
- A USB 1.x audio device that is connected to a USB 2.0 hub, which is connected to a USB 2.0 port, can be used. For more information, see [usb_ac\(7D\)](#) and [usb_as\(7D\)](#).
- Devices that are not supported by a USB driver might have `libusb` applications such as `gphoto2`, `gtkam`, and `pilotlink`. For more information, refer to `/usr/sfw/share/doc/libusb/libusb.txt`.
- **Solaris 8 and Solaris 9 releases** – For USB dual framework issues, refer to the following site: <http://www.oracle.com/us/sun/index.html>

For task information associated with mass storage devices, see [Chapter 8, “Using USB Devices \(Tasks\)”](#).

For more information about `ugen`, see [“USB Driver Enhancements”](#) on page 120.

Overview of USB Devices

Universal Serial Bus (USB) was developed by the PC industry to provide a low-cost solution for attaching peripheral devices, such as keyboards, mouse devices, and printers, to a system.

USB connectors are designed to fit only one type of cable, in one way. The primary design motivation for USB was to alleviate the need for multiple connector types for different devices. This design reduces the clutter on the back panel of a system.

Devices connect to USB ports on external USB hubs, or on a root hub that is located on the computer itself. Since hubs have several ports, several branches of a device tree can stem from a hub.

For more information, see [usba\(7D\)](#) or go to the following site:

<http://www.usb.org/home>

Commonly Used USB Acronyms

The following table describes the USB acronyms that are used in the Oracle Solaris OS. For a complete description of USB components and acronyms, go to:

<http://www.usb.org/home>

Acronym	Definition	For More Information
UGEN	USB generic driver	ugen(7D)
USB	Universal Serial Bus	usb(7D)
USBA	Universal Serial Bus Architecture (Solaris)	usba(7D)
USBAI	USBA Client Driver Interface (Solaris)	N/A
HCD	USB host controller driver	N/A
EHCI	Enhanced Host Controller Interface	ehci(7D)
OHCI	Open Host Controller Interface	ohci(7D)
UHCI	Universal Host Controller Interface	uhci(7D)

USB Bus Description

The USB specification is openly available and free of royalties. The specification defines the electrical and mechanical interfaces of the bus and the connectors.

USB employs a topology in which hubs provide attachment points for USB devices. The host controller contains the root hub, which is the origin of all USB ports in the system. For more information about hubs, see “[USB Host Controller and Hubs](#)” on page 126.

FIGURE 7-1 USB Physical Device Hierarchy

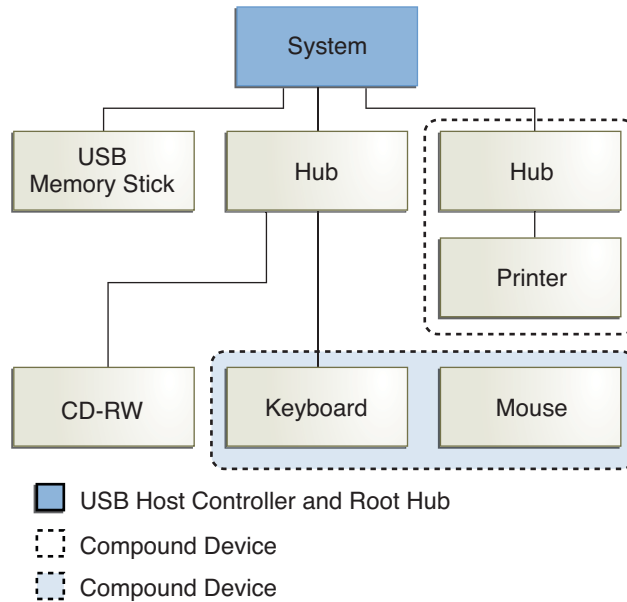

Figure 7-1 shows a system with three active USB ports. The first USB port connects a USB memory stick. The second USB port connects an external hub, which in turn, connects a cdrw device and a composite keyboard/mouse device. As a *composite device*, this keyboard contains a USB controller, which operates both the keyboard and an attached mouse. The keyboard and the mouse share a common USB bus address because they are directed by the same USB controller.

Figure 7-1 also shows an example of a hub and a printer as a *compound device*. The hub is an external hub that is enclosed in the same casing as the printer. The printer is permanently connected to the hub. The hub and printer have separate USB bus addresses.

The device tree path name for some of the devices that are displayed in Figure 7-1 are listed here.

Memory stick	/pci@1f,4000/usb@5/storage@1
Keyboard	/pci@1f,4000/usb@5/hub@2/device@1/keyboard@0
Mouse	/pci@1f,4000/usb@5/hub@2/device@1/mouse@1
cdrw device	/pci@1f,4000/usb@5/hub@2/storage@3
Printer	/pci@1f,4000/usb@5/hub@3/printer@1

USB Devices and Drivers

USB devices with similar attributes and services are grouped into device classes. Each device class has a corresponding driver. Devices within a class are managed by the same device driver pair. However, the USB specification also allows for vendor-specific devices that are not part of a specific class.

The Human Interface Device (HID) class contains devices that are user-controlled such as the following devices:

- Keyboards
- Mouse devices
- Joysticks

The Communication Device class includes the following devices:

- Modems
- Ethernet adapters

Other device classes include the following classes:

- Audio
- Monitor
- Printer
- Storage Device

Each USB device contains descriptors that reflect the class of the device. A device class specifies how its members should behave in configuration and data transfer. You can obtain additional class information from:

<http://www.usb.org/home>

For more information about USB devices supported in the Oracle Solaris release, see [usb\(7D\)](#).

USB Driver Enhancements

The following USB driver enhancements are included.

- **USB CDC ACM device support** – The acm driver can work with devices that are compliant with the USB Communication Class Device specification's Abstract Control Model and some PCMCIA cards that have modem capabilities.

The pppd daemon can access these devices through the `/dev/term/[0~9]*` entries. For more information, see [pppd\(1M\)](#).

For more information, see [usbsacm\(7D\)](#).

- **Generic USB driver** – USB devices can now be accessed and manipulated by applications using standard UNIX `read(2)` and `write(2)` system calls, and without writing a special kernel driver. Additional features include:

- Applications have access to raw device data and device status.
- The driver supports control, bulk, and interrupt (in and out) transfers.

The `ugen` driver no longer needs to bind explicitly to a device. By default, `usb_mid` binds to devices that lack a class driver and exports a `ugen` interface that works with `libusb`. For example, you can plug in a USB camera that is not a mass-storage device and use a `libusb` application to access it. In addition, both `scsa2usb` and `usbprn` drivers export `ugen` interfaces and `libusb` applications can be used on these classes of devices directly.

For more information, refer to [ugen\(7D\)](#).

▪ **USB serial driver support**

- Digi Edgeport USB support – The Edgeport USB driver only works with Edgeport devices and not with other USB serial devices.
 - New devices are accessed as `/dev/term/[0-9]*` and `/dev/cua/[0-9]*`.
 - USB serial ports are usable as any other serial port would be, except that they cannot serve as a local serial console. The fact that their data is run through a USB port is transparent to the user.

For more information, see [usbser_edge\(7D\)](#), or go to the following sites:

- <http://www.digi.com>
- <http://www.oracle.com/us/sun/index.html>
- Keyspan – The Keyspan USB serial driver only works with Keyspan devices, which currently supports the USA-19HS and USA-49WLC models.

For more information, see [usbksp\(7D\)](#).

- Prolific – The Prolific USB serial driver only works with devices based on the PL2303 chipset.

For more information, see [usbprl\(7D\)](#).

For more information about the USB to serial devices support, go to the following site:

<http://www.oracle.com/us/sun/index.html>

- **Documentation and binary support for user-written kernel and userland drivers** – For up-to-date information on USB driver development, go to:
 - <http://www.oracle.com/us/sun/index.html>
 - <http://developers.sun.com/solaris/developer/support/driver/usb.html>
 - Chapter 20, “USB Drivers,” in *Writing Device Drivers*
 - Appendix C, “Making a Device Driver 64-Bit Ready,” in *Writing Device Drivers*
 - *Device Driver Tutorial*
 - [Intro\(7\)](#), [Intro\(9F\)](#), and [Intro\(9S\)](#)

- http://developers.sun.com/solaris/driverdev/reference/codesamples/usb_security/index.html

The EHCI, OHCI, and UHCI Drivers

Features of the EHCI driver include:

- Complies with enhanced host controller interface that supports USB 2.0.
- Supports high-speed control, bulk, interrupt, and isochronous transfers.
- The USB 2.0 chip has one EHCI controller and one or more OHCI or UHCI controllers.
- A USB 1.1 device is dynamically assigned to the OHCI or UHCI controller when it is plugged in. A USB 2.0 device is dynamically assigned to the EHCI controller when it is plugged in.

Use the `prtconf` command output to identify whether your system supports USB 1.1 or USB 2.0 devices. For example:

```
# prtconf -D | egrep "ehci|ohci|uhci"
```

If your `prtconf` output identifies an EHCI controller, your system supports USB 2.0 devices.

If your `prtconf` output identifies an OHCI or UHCI controller, your system supports USB 1.1 devices.

Oracle Solaris USB Architecture (USBA)

USB devices can be represented as two levels of device tree nodes. A device node represents the entire USB *device*. One or more child *interface* nodes represent the individual USB interfaces on the device.

Driver binding is achieved by using the compatible name properties. For more information, refer to 3.2.2.1 of the IEEE 1275 USB binding and *Writing Device Drivers*. A driver can either bind to the entire device and control all the interfaces, or can bind to just one interface. If no vendor or class driver claims the entire device, a generic USB multi-interface driver is bound to the device-level node. This driver attempts to bind drivers to each interface by using compatible names properties, as defined in section 3.3.2.1 of the IEEE 1275 binding specification.

The Oracle Solaris USB Architecture (USBA) adheres to the USB 1.1 and USB 2.0 specifications and is part of the Oracle Solaris Device Driver Interface (DDI). The USBA model is similar to Sun Common SCSI Architecture (SCSA). As the following figure shows, the USBA is a thin layer that provides a generic USB transport-layer abstraction to client drivers, providing them with services that implement core generic USB functionality.

FIGURE 7-2 Oracle Solaris USB Architecture (USBA)

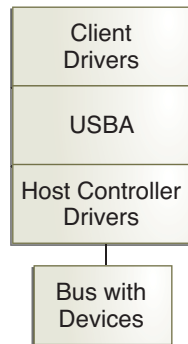

About USB in the Oracle Solaris OS

This section describes information you should know about USB in the Oracle Solaris OS.

USB 2.0 Features

The following USB 2.0 features are included:

- **Better performance** – Increased data throughput for devices connected to USB 2.0 controllers, up to 40 times faster than USB 1.1 devices.
You can take advantage of the high-speed USB protocol when accessing high-speed USB devices, such as DVDs and hard disks.
- **Backward Compatibility** – Compatibility with 1.0 and 1.1 devices and drivers so that you can use the same cables, connectors, and software interfaces.

For a description of USB devices and terminology, see “[Overview of USB Devices](#)” on page 117.

USB 2.0 Device Features and Compatibility Issues

USB 2.0 devices are defined as high-speed devices that follow the USB 2.0 specification. You can refer to the USB 2.0 specification at <http://www.usb.org/home>.

To identify the speed of your USB device, check the `/var/adm/messages` file for messages similar to the following:

```
Dec 13 17:05:57 mysystem usba: [ID 912658 kern.info] USB 2.0 device
(usb50d,249) operating at hi speed (USB 2.x) on USB 2.0 external hub:
storage@4, scsa2usb0 at bus address 4
```

Here are some of the USB devices that are supported in this Oracle Solaris release:

- Mass storage devices, such as CD-RWs, hard disks, DVDs, digital cameras, diskettes, tape drives, memory sticks, and multi-format card readers
- Keyboards and mouse devices
- Audio devices, such as speakers and microphones

For a full listing of USB devices that have been verified on the Oracle Solaris release, go to:

<http://www.oracle.com/us/sun/index.html>

Additional storage devices might work by modifying the `scsa2usb.conf` file. For more information, see [scsa2usb\(7D\)](#).

Oracle Solaris USB 2.0 device support includes the following features:

- Increased USB bus speed from 12 MB/sec to 480 MB/sec. This increase means devices that support the USB 2.0 specification can run significantly faster than their USB 1.1 counterparts, when they are connected to a USB 2.0 port.

A USB 2.0 port might be one of the following possibilities:

- A port on a USB 2.0 PCI card
- A port on a USB 2.0 hub that is connected to USB 2.0 port
- A port on a SPARC or x86 computer motherboard

A USB 2.0 PCI card might be needed for older SPARC platforms.

- For a list of USB 2.0 PCI cards that have been verified for the Oracle Solaris release, go to: <http://www.oracle.com/us/sun/index.html>
- USB 1.1 devices work as they have in the past, even if you have both USB 1.1 and USB 2.0 devices on the same system.
- While USB 2.0 devices operate on a USB 1.x port, their performance is significantly better when they are connected to a USB 2.0 port.
- A USB 2.0 host controller has one high-speed Enhanced Host Controller Interface (EHCI) and one or more OpenHCI Host Controller Interface (OHCI) or Universal Host Controller Interface (UHCI) embedded controllers. Devices connected to a USB 2.0 port are dynamically assigned to either an EHCI or OHCI controller, depending on whether they support USB 2.0.

Note – USB 2.0 storage devices that are connected to a port on a USB 2.0 PCI card, and that were used with a prior Solaris release in the same hardware configuration, can change device names after upgrading to this release. This change occurs because these devices are now seen as USB 2.0 devices and are taken over by the EHCI controller. The controller number, *w* in `/dev/[r]dsk/cwt.xdysz`, is changed for these devices.

Also note that the speed of a USB device is limited to what the parent port can support. For example, if a USB 2.0 external hub is followed by a USB 1.x hub and a USB 2.0 device downstream, devices that are connected to the USB 2.0 external hub run at full speed and not high speed.

For more information on USB 2.0 device support, see [ehci\(7D\)](#) and [usba\(7D\)](#).

Bus-Powered Devices

Bus-powered hubs use power from the USB bus to which they are connected, to power devices connected to them. Special care must be taken to not overload these hubs, because the power these hubs offer to their downstream devices is limited.

Starting in the Solaris 10 6/06 release, power budgeting is implemented for USB devices. This feature has the following limitations:

- Cascading two bus-powered hubs is prohibited.
- Each bus-powered hub is allowed a maximum of 100 mA only for each port.
- Only self-powered or low bus-powered devices are allowed to connect to a bus-powered hub. High bus-powered devices are denied the connection. Some hubs or devices can report a false power source, such that the connection might be unpredictable.

USB Keyboards and Mouse Devices

Keep the following issues in mind when using USB keyboards and mouse devices:

- Do not move the keyboard and mouse *during* a reboot or at the `ok` prompt on a SPARC system. You can move the keyboard and mouse to another hub at any time *after* a system reboot. After you plug in a keyboard and mouse, they are fully functional again.
- The keys just to the left of the keypad might not function on some third-party USB keyboards.
- **SPARC** – Keep the following issues in mind when using USB keyboards and mouse devices on SPARC systems:

- The power key on a USB keyboard behaves differently than the power key on the Sun type 5 keyboard. On a USB keyboard, you can suspend or shut down the system by using the SUSPEND/SHUTDOWN key. However, you cannot use that key to power up the system.
- Before the boot process finishes, the OpenBoot PROM (OBP) limits keyboard and mouse devices to the motherboard root hub ports only.
- USB keyboard and mouse devices cannot be used simultaneously with Sun Type 3, 4, or 5 keyboards on legacy SPARC systems, such as the Ultra 80.
- For information about multiple keyboard and mouse device support, see [virtualkm\(7D\)](#).

USB Wheel Mouse Support

The following wheel mouse features are supported:

- Support for more than 3 buttons is available on USB or PS/2 mouse devices.
- Wheel mouse scrolling is available on a USB or PS/2 mouse device. This support means that rolling the wheel on a USB or a PS/2 mouse results in a scroll in the application or window under mouse focus. StarOffice, Firefox, and GNOME applications support wheel mouse scrolling. However, other applications might not support wheel mouse scrolling.

USB Host Controller and Hubs

A USB hub is responsible for the following:

- Monitoring the insertion or removal of a device on its ports
- Power managing individual devices on its ports
- Controlling power to its ports

The USB host controller has an embedded hub called the *root hub*. The ports that are visible at the system's back panel are the ports of the root hub. The USB host controller is responsible for the following:

- Directing the USB bus. Individual devices cannot arbitrate for the bus.
- Polling the devices by using a polling interval that is determined by the device. The device is assumed to have sufficient buffering to account for the time between the polls.
- Sending data between the USB host controller and its attached devices. Peer-to-peer communication is not supported.

USB Hub Devices

- Do not cascade hubs beyond four levels on either SPARC based systems or x86 based systems. On SPARC systems, the OpenBoot PROM cannot reliably probe beyond four levels of devices.
- Do not plug a bus-powered hub into another bus-powered hub in a cascading style. A bus-powered hub does not have its own power supply.
- Do not connect a device that requires a large amount of power to a bus-powered hub. These devices might be denied connection to bus-powered hubs or might drain the hub of power for other devices. An example of such a device is a USB diskette device.

SPARC: USB Power Management

Suspending and resuming USB devices is fully supported on SPARC systems. However, do not suspend a device that is busy and never remove a device when the system is powered off under a suspend shutdown.

The USB framework makes a best effort to power manage all devices on SPARC based systems with power management enabled. Power managing a USB device means that the hub driver suspends the port to which the device is connected. Devices that support *remote wake up* can notify the system to wake up everything in the device's path so that the device can be used. The host system could also wake up the device if an application sends an I/O to the device.

All HID devices (keyboard, mouse, hub, and storage devices), hub devices, and storage devices are power managed by default if they support remote wake-up capability. A USB printer is power managed only between two print jobs. Devices that are managed by the generic USB driver (UGEN) are power managed only when they are closed.

When power management is running to reduce power consumption, USB leaf devices are powered down first. After all devices that are connected to a hub's ports are powered down, the hub is powered down after some delay. To achieve the most efficient power management, do not cascade many hubs.

For information about using the SUSPEND/SHUTDOWN key on SPARC systems, see [“USB Keyboards and Mouse Devices” on page 125](#).

Guidelines for USB Cables

Keep the following guidelines in mind when connecting USB cables:

- Always use USB 2.0 compliant, fully rated (480 Mbit/sec) 20/28 AWG cables for connecting USB 2.0 devices.
- The maximum cable length that is supported is 5 meters.

- Do not use cable extenders. For best results, use a self-powered hub to extend cable length.

For more information, go to:

<http://www.usb.org/about/faq/ans5>

Using USB Devices (Tasks)

This chapter provides step-by-step instructions for using USB devices in the Oracle Solaris OS.

For information on the procedures associated with using USB devices, see the following:

- “Managing USB Devices in the Oracle Solaris OS (Roadmap)” on page 129
- “Using USB Mass Storage Devices (Task Map)” on page 130
- “Using USB Audio Devices (Task Map)” on page 150
- “Hot-Plugging USB Devices With the `cfgadm` Command (Task Map)” on page 154

For recent information about USB devices, go to the following site:

<http://www.oracle.com/us/sun/index.html>

For overview information about using USB devices, see [Chapter 7, “Using USB Devices \(Overview\)”](#).

Managing USB Devices in the Oracle Solaris OS (Roadmap)

Use this road map to identify all the tasks for managing USB devices in the Oracle Solaris OS. Each task points to a series of additional tasks such as using USB devices, hot-plugging USB devices, and adding USB audio devices.

For information about using USB components in the Oracle Solaris OS, see [“About USB in the Oracle Solaris OS” on page 123](#).

Task	Description	For Instructions
Use USB mass storage devices.	A USB mass storage device must contain a file system before you can add data to it. In addition, a USB diskette must be formatted before file systems can be created and mounted on them. This section also describes how to physically add or remove USB devices from your system.	“Using USB Mass Storage Devices (Task Map)” on page 130
Add USB audio devices.	Use this task map to identify tasks associated with adding USB audio devices.	“Using USB Audio Devices (Task Map)” on page 150
Add or remove USB devices to and from your system with the <code>cfgadm</code> command.	You can logically add or remove USB devices to and from your system with the <code>cfgadm</code> command.	“Hot-Plugging USB Devices With the <code>cfgadm</code> Command (Task Map)” on page 154

Using USB Mass Storage Devices (Task Map)

Task	Description	For Instructions
Add or remove a USB mass storage device.	Select one of the following to add a USB mass storage device: Add a USB mass storage device. Add a USB camera to access digital images. Remove a USB mass storage device without <code>vo1d</code> running.	“How to Add a USB Mass Storage Device Without <code>vo1d</code> Running” on page 135 “How to Add a USB Camera” on page 135 “How to Remove a USB Mass Storage Device Without <code>vo1d</code> Running” on page 137
Add a non-compliant USB mass storage device.	Add a non-compliant USB mass storage device by adding an entry to <code>scsa2usb.conf</code> .	“How to Use a Non-Compliant USB Mass Storage Device” on page 133
Prepare to use a USB mass storage device.	Prepare to use a USB mass storage device with <code>vo1d</code> running.	“Preparing to Use a USB Mass Storage Device With <code>vo1d</code> Running” on page 137
Display USB device information.	Display information about USB devices.	“How to Display USB Device Information” on page 138

Task	Description	For Instructions
Create a file system on a USB mass storage device.	You must create a file system on a device before you can put data on it.	<p>“How to Create a File System on a USB Mass Storage Device” on page 138</p> <p>“How to Create a File System on a USB Mass Storage Device Without vol Running” on page 140</p>
Modify partitions and create a file system on a USB mass storage device.	You might need to modify existing partitions before creating file systems on a USB mass storage device.	“How to Modify Partitions and Create a PCFS File System on a USB Mass Storage Device Without vol Running” on page 142
Create a Solaris partition and modify the slices on a USB mass storage device.	You will need to create a file with slice information before using the <code>rmformat</code> to modify the slice information.	“How to Create a Solaris Partition and Modify the Slices on a USB Mass Storage Device Without vol Running” on page 146
Mount a USB mass storage device without vol running.	Mount a USB mass storage device without vol running.	“How to Mount or Unmount a USB Mass Storage Device Without vol Running” on page 147
(Optional) Disable a USB device driver.	Disable a USB device driver if you do not want USB support on your system.	“How to Disable Specific USB Drivers” on page 150
(Optional) Remove unused USB device links.	Remove USB device links with the <code>devfsadm</code> command.	“How to Remove Unused USB Device Links” on page 150

Using USB Mass Storage Devices

The following USB removable mass storage devices are supported:

- CD-RWs
- Hard disks
- DVDs
- Digital cameras
- Diskette devices
- SmartMedia and CompactFlash devices

For information about using USB mass storage devices with the Oracle Solaris ZFS file system, see “What’s New in USB Devices?” on page 113

For a complete list of USB devices that are supported in the Oracle Solaris OS, see:

<http://www.oracle.com/us/sun/index.html>

In previous Solaris releases, all USB storage devices were identified as removable media devices, which provides many of the following advantages, including automatic mounting. In the Solaris 10 6/06 release, USB mass storage devices are identified as hotpluggable devices but also enjoy the advantages of USB removable devices that are listed below. For more information about the hotpluggable behavior, see [“USB and 1394 \(FireWire\) Support Enhancements”](#) on page 65.

- A hot-pluggable device is automatically mounted. For more information, see [“vold Provides Awareness of Hot-Plugged USB Devices”](#) on page 116.
- USB storage devices with standard MS-DOS or Windows (FAT) file systems are supported.
- You can use the user-friendly `rmformat` command to create slices. You can also use the `fdisk` command to partition a USB device, but never use the `format` utility or the `rmformat -F` command to physically format a USB drive.
- Use the `rmformat` command to display all USB devices with media inserted. For example, see [“How to Display USB Device Information”](#) on page 138.
- Non-root users can now access USB storage devices, since the `mount` command is no longer needed. The device is automatically mounted and is available under the `/rmdisk` directory. If a new device is connected while the system is down, do a reconfiguration boot with the `boot -r` command so that the device is recognized.
- These devices can be managed with or without removable media services.
- Disks with FAT file systems can be mounted and accessed. For example:

```
mount -F pcfs /dev/dsk/c2t0d0s0:c /mnt
```
- All USB storage devices are now power managed, except for those that support LOG SENSE pages. Devices with LOG SENSE pages are usually SCSI drives connected through a USB-to-SCSI bridge device.
- Applications might work differently with USB mass storage devices. Keep the following issues in mind when using applications with USB storage devices:
 - Applications might make incorrect assumptions about the size of the media since only smaller devices like diskettes were removable previously.
 - Requests by applications to eject media on devices where this would be inapplicable, such as a hard drive, will succeed and do nothing.
 - If you prefer the behavior in previous Solaris releases where all USB mass storage were treated as removable media devices, then you can force the old behavior by updating the `/kernel/drv/scsa2usb.conf` file.

For more information on using USB mass storage devices, see [scsa2usb\(7D\)](#).

Using USB Diskette Devices

USB diskette devices appear as removable media devices. USB diskette devices are not managed by the `fd` (floppy) driver. Applications that issue `ioctl(2)` calls intended for the `fd` (native

floppy) driver will fail. Applications that issue only `read(2)` and `write(2)` calls will succeed. Other applications, such as `SunPCI` and `rmformat`, also succeed.

The USB diskette device is identified as a SCSI removable media device. The device is available for access under the `/rmdisk` directory.

For more information on how to use USB diskette devices, see [Chapter 1, “Managing Removable Media \(Overview\)”](#).

Using Non-Compliant USB Mass Storage Devices

Some devices might be supported by the USB mass storage driver even though they do not identify themselves as compliant with the USB mass storage class or identify themselves incorrectly. The `scsa2usb.conf` file contains an attribute-override list that lists the vendor ID, product ID, and revision for matching mass storage devices, as well as fields for overriding the default device attributes. The entries in this list are commented out by default. These entries can be copied and uncommented to enable support of particular devices.

If you connect a USB mass storage device to a system running this Solaris release and the system is unable to use it, you can check the `/kernel/drv/scsa2usb.conf` file to see if there is a matching, commented entry for this device. Follow the information given in the `scsa2usb.conf` file to see if a particular device can be supported by using the override information.

For a listing of recommended USB mass storage devices, go to:

<http://www.oracle.com/us/sun/index.html>

For more information, see [scsa2usb\(7D\)](#).

▼ How to Use a Non-Complaint USB Mass Storage Device

- 1 **Become superuser.**
- 2 **Add an entry to the `/kernel/drv/scsa2usb.conf` file.**
The following entry is appropriate for a USB memory stick.
`attribute-override-list = "vid=* reduced-cmd-support=true";`
- 3 **Either reboot the system or do the following:**
 - a. **Remove the device.**
 - b. **Manually update the driver.**
`# update_drv -f scsa2usb`

c. **Add the device.**

Hot-Plugging USB Mass Storage Devices

Hot-plugging a device means the device is added or removed without shutting down the operating system or powering off the system. All USB devices are hot-pluggable.

The removable media manager is now aware of hot-plugged devices. You can just plug in the device, which is mounted in a few seconds. If nothing happens, check to see if it is mounted.

Make sure that removable media services are running.

```
# svcs volfs
STATE          STIME      FMRI
online         10:39:12  svc:/system/filesystem/volfs:default

# svcs hal dbus rmvolmgr
STATE          STIME      FMRI
online         May_03     svc:/system/dbus:default
online         May_03     svc:/system/hal:default
online         May_03     svc:/system/filesystem/rmvolmgr:default
```

The file system can be mounted from the device if it is valid and it is recognized.

If it fails to mount, stop `vold`.

```
# svcadm disable volfs
```

If the file system on the device is not automatically mounted, try a manual mount.

Before hot-removing the device, find the name of the device in the `eject -l` command's alias name. Then `eject` the device's media. If you don't do this, the device is released and the port is usable again, but the file system on the device might have been damaged.

When you hot-plug a USB device, the device is immediately seen in the system's device hierarchy, as displayed in the `prtconf` command output. When you remove a USB device, the device is removed from the system's device hierarchy, unless you are using the device.

If you are using a device when it is unplugged, the device node remains, but the driver controlling this device stops all activity on the device. Any new I/O activity issued to this device returns an error.

In this situation, the system prompts you to plug in the original device. If the device is no longer available, stop the applications. After a few seconds, the port becomes available again.

Note – Data integrity might be impaired if you remove an active or open device. Always close the device before removing, except the attached keyboard and mouse, which can be moved while active.

▼ How to Add a USB Mass Storage Device Without `vol` Running

- 1 For information on disabling removable media management, see [“How to Disable or Enable Removable Media Services” on page 43](#).

- 2 Verify that `vol` is not running.

```
# svcs volfs
STATE          STIME      FMRI
disabled      10:39:12  svc:/system/filesystem/volfs:default
```

- 3 Connect the USB mass storage device.

- 4 Verify that the USB device has been added.

Locate the USB disk device links, which might be among device links of non-USB storage devices, as follows:

```
$ rmformat
Looking for devices...
1. Logical Node: /dev/rdisk/c3t0d0p0
   Physical Node: /pci@0,0/pci108e,4131@2,1/storage@4/disk@0,0
   Connected Device: USB2.0 Flash Disk 2.00
   Device Type: Removable
```

▼ How to Add a USB Camera

If the camera's media uses a PCFS file system, it will be automatically mounted. If the device does not bind to the `scsa2usb` driver, use `libusb` applications for transferring the pictures. For more information, refer to `/usr/sfw/share/doc/libusb/libusb.txt`.

- 1 Become superuser.

- 2 Plug in and turn on the USB camera.

The system creates a logical device for the camera. After the camera is plugged in, output is written to the `/var/adm/messages` file to acknowledge the device's connection. The system treats the camera as a storage device.

- 3 Examine the output that is written to the `/var/adm/messages` file.

```
# more /var/adm/messages
```

Examining this output enables you to determine which logical device was created so that you can then use that device to access your images. The output looks similar to the following:

```
Jul 15 09:53:35 buffy usba: [ID 349649 kern.info] OLYMPUS, C-3040ZOOM,
000153719068
Jul 15 09:53:35 buffy genunix: [ID 936769 kern.info] scsa2usb1 is
/pci@0,0/pci925,1234@7,2/storage@2
Jul 15 09:53:36 buffy scsi: [ID 193665 kern.info] sd3 at scsa2usb1:
target 0 lun 0
```

Match the device with a mountable `/dev/dsk` link entry, by doing the following:

```
# ls -l /dev/dsk/c*0 | grep /pci@0,0/pci925,1234@7,2/storage@2
lrwxrwxrwx 1 root root 58 Jun 14 2010 c3t0d0p0 ->
../.. /devices/pci@0,0/pci925,1234@7,2/storage@2/disk@0,0:a
```

4 Mount the USB camera file system.

The camera's file system is most likely a PCFS file system. If file system is PCFS, then it should be automatically mounted.

To manually mount the file system on an x86 system, you would use syntax similar to the following:

```
# mount -F pcfs /dev/dsk/c3t0d0p0:c /mnt
```

To manually mount the file system on a SPARC system, you would use syntax similar to the following:

```
# mount -F pcfs /dev/dsk/c3t0d0s0:c /mnt
```

For information on mounting file systems, see [“Mounting and Unmounting Oracle Solaris File Systems” on page 329](#).

For information on mounting different PCFS file systems, see [mount_pcfs\(1M\)](#).

5 Verify that the image files are available.

For example:

```
# ls /mnt/DCIM/100OLYMP/
P7220001.JPG* P7220003.JPG* P7220005.JPG*
P7220002.JPG* P7220004.JPG* P7220006.JPG*
```

6 View and manipulate the image files created by the USB camera.

For example:

```
# /usr/dt/bin/sdtimage P7220001.JPG &
```

7 Unmount the file system before disconnecting the camera.

For example:

```
# umount /mnt
```

8 (Optional) Turn off and disconnect the camera.

▼ How to Remove a USB Mass Storage Device Without `voLd` Running

This procedure is performed with removable media services disabled.

- 1 Become superuser.
- 2 For information on disabling removable media services, see [“How to Disable or Enable Removable Media Services” on page 43](#).
- 3 Verify that removable media services are not running.

```
# svcs volfs
STATE          STIME      FMRI
disabled       Sep_29     svc:/system/filesystem/volfs:default
```
- 4 Stop any active applications that are using the device.
- 5 Unmount the device.
- 6 Remove the device.

Preparing to Use a USB Mass Storage Device With `voLd` Running

You can access information on removable media with or without using removable media services. For information on accessing information on removable media with GNOME's File Manager, see the GNOME desktop documentation.

After the USB device is formatted, it is usually mounted under the `/rmdisk/label` directory.

The device nodes are created under the `/vol/dev` directory. For more information on configuring removable storage devices, see `rmmount.conf(4)` or `voLd.conf(4)`.

The following procedures describe how to manage USB mass storage devices without `voLd` running. The device nodes are created under the `/dev/rdisk` directory for character devices and under the `/dev/dsk` directory for block devices. Device links are created when the devices are hot-plugged. For more information, see [`sca2usb\(7D\)`](#).

If the device cannot be identified by removable media services, then try to manually mount the device. First, use the `rmformat` command to identify the device path and then use the `mount` command to manually mount the device as superuser.

If the device is manually mounted, then you would unmount it using the `umount` command as superuser.

For more information about mounting and unmounting USB devices, see [“How to Mount or Unmount a USB Mass Storage Device Without `voLd` Running” on page 147](#).

▼ How to Display USB Device Information

● Display information about USB devices.

For example, use the `prtconf` command to display USB device information. The `prtconf` output in this example has been truncated to only display USB device information.

```
$ prtconf
usb, instance #0
  hub, instance #2
    device, instance #8
      interface (driver not attached)
    printer (driver not attached)
  mouse, instance #14
    device, instance #9
      keyboard, instance #15
      mouse, instance #16
  storage, instance #7
    disk (driver not attached)
  communications, instance #10
    modem (driver not attached)
    data (driver not attached)
  storage, instance #0
    disk (driver not attached)
  storage, instance #1
    disk (driver not attached)
```

For example, use the `rmformat` command to display USB device information.

```
$ rmformat
Looking for devices...
  1. Volmgt Node: /vol/dev/aliases/cdrom0
     Logical Node: /dev/rdisk/c0t2d0s2
     Physical Node: /pci@1f,0/pci@1,1/ide@3/sd@2,0
     Connected Device: LG CD-ROM CRD-8322B 1.03
     Device Type: CD Reader
```

▼ How to Create a File System on a USB Mass Storage Device

A USB diskette must be formatted before you can add a file system to it. All other USB mass storage devices just need a PCFS or UFS file system before they can be used. Keep the following key points in mind when formatting a USB device:

- Do not use the `rmformat -F` except on a USB diskette.
- If the default slices are not acceptable, use the `rmformat -s` command to create slices. Use the `fdisk` utility to partition a USB device, if needed. For step-by-step instructions, see:
 - [“How to Modify Partitions and Create a PCFS File System on a USB Mass Storage Device Without `vol` Running”](#) on page 142
 - [“How to Create a Solaris Partition and Modify the Slices on a USB Mass Storage Device Without `vol` Running”](#) on page 146

- If the USB device is automatically mounted, you will have to unmount it before you can create a file system on the USB device.

Note – Perform steps 4-5 only if you need to format a USB diskette.

1 Become superuser.

2 Add the USB device to your system. For information on hot-plugging USB devices, see:

- [“Hot-Plugging USB Mass Storage Devices”](#) on page 134
- [“Hot-Plugging USB Devices With the `cfgadm` Command \(Task Map\)”](#) on page 154

3 (Optional) Identify the USB device.

For example:

```
# cd /dev/rdisk
# ls -l c*0 | grep usb
lrwxrwxrwx 1 root root 55 Mar 5 10:35 c2t0d0s0 ->
../../../../devices/pci@1f,0/usb@c,3/storage@3/disk@0,0:a,raw
```

In this example, the diskette device is `c2t0d0s0`.

4 Insert a diskette into the diskette drive, if necessary.

5 Format the diskette, if necessary.

```
% rmformat -F long raw-device
```

For example, on a SPARC system:

```
% rmformat -F long /dev/rdsk/c2t0d0s2
```

For example, on an x86 system:

```
% rmformat -F long /dev/rdsk/c3t0d0p0
```

6 Determine the file system type and make sure the device is unmounted. Then, select one of the following:

For more information about unmounting a USB device, see [“How to Mount or Unmount a USB Mass Storage Device Without `vol` Running”](#) on page 147.

- Create a PCFS file system.

```
# mkfs -F pcfs -o nofdisk,size=size raw-device
```

Specify the `-size` option in 512-byte blocks.

The following example shows how to create a PCFS file system on a 1.4-MB diskette on a SPARC system:

```
# mkfs -F pcfs /dev/rdisk/c2t0d0p0  
Construct a new FAT file system on /dev/rdisk/c2t0d0p0: (y/n)? y
```

The following example shows how to create a PCFS file system on a 1.4-MB diskette on an x86 system:

```
# mkfs -F pcfs /dev/rdisk/c2t0d0s2  
Construct a new FAT file system on /dev/rdisk/c2t0d0s2: (y/n)? y
```

The following example shows how to create a PCFS file system on a 100-MB USB memory stick on a SPARC system:

```
# mkfs -F pcfs /dev/rdisk/c5t0d0s2:c
```

The following example shows how to create a PCFS file system on a 100-MB USB memory stick on an x86 system:

```
# mkfs -F pcfs /dev/rdisk/c5t0d0p0:c
```

This command can take several minutes to complete.

- Create a UFS file system.

```
# newfs raw-device
```

For example:

```
# newfs /dev/rdisk/c4t0d0s7
```

Consider using the `newfs -f 4096` option or `newfs -T` option for large USB hard disks.

Note – UFS file system overhead consumes a significant portion of space on a diskette, due to a diskette's limited storage capacity.

See the next two procedures for a detailed example of creating a PCFS file system and modifying slices on a USB mass storage device.

▼ How to Create a File System on a USB Mass Storage Device Without `vol0` Running

Use this procedure to add a file system to a USB mass storage device with removable media services disabled.

A USB diskette must be formatted before you can add a file system to it. All other USB mass storage devices just need a PCFS or UFS file system before they can be used. Keep the following key points in mind when formatting a USB diskette:

- Do not use the `rmformat -F` except on a USB diskette.
- If the default slices are not acceptable, use the `rmformat -s` command to create slices. Use the `fdisk` utility to partition a USB device, if needed. For step-by-step instructions, see:

- “How to Modify Partitions and Create a PCFS File System on a USB Mass Storage Device Without `vo!d` Running” on page 142
- “How to Create a Solaris Partition and Modify the Slices on a USB Mass Storage Device Without `vo!d` Running” on page 146

Note – Perform steps 7–8 only if you need to format a USB diskette.

1 Become superuser.

2 For information on disabling removable media services, see “How to Disable or Enable Removable Media Services” on page 43.

3 Verify that removable media services are not running.

```
# svcs volfs
STATE          STIME      FMRI
disable        10:39:12  svc:/system/filesystem/volfs:default
```

4 Add the USB device to your system.

For information on hot-plugging USB devices, see:

- “Hot-Plugging USB Mass Storage Devices” on page 134
- “Hot-Plugging USB Devices With the `cfgadm` Command (Task Map)” on page 154

5 (Optional) Identify the USB device.

The following example identifies a USB diskette device.

```
# cd /dev/rdisk
# ls -l c*0 | grep usb
lrwxrwxrwx  1 root  root   55 Mar  5 10:35 c2t0d0s0 ->
../../../../devices/pci@1f,0/usb@c,3/storage@3/disk@0,0:a,raw
```

In this example, the diskette device is `c2t0d0s0`.

6 Insert a diskette into the diskette drive, if necessary.

7 Format the diskette, if necessary.

```
% rmformat -F long raw-device
```

For example, on a SPARC system:

```
% rmformat -F long /dev/rdisk/c2t0d0s2
```

For example, on an x86 system:

```
% rmformat -F long /dev/rdisk/c3t0d0p0
```

8 Determine the file system type and select one of the following:

- Create a PCFS file system.

```
# mkfs -F pcfs -o nofdisk,size=size raw-device
```

Specify the `-size` option in 512-byte blocks.

The following example shows how to create a PCFS file system on a 1.4-MB diskette on a SPARC system:

```
# mkfs -F pcfs -o nofdisk,size=2880 /dev/rdisk/c4t0d0s2
```

The following example shows how to create a PCFS file system on a 1.4-MB diskette on an x86 system:

```
# mkfs -F pcfs -o nofdisk,size=2880 /dev/rdisk/c4t0d0p0
```

The following example shows how to create a PCFS file system on a 100-MB USB memory stick on a SPARC system:

```
# mkfs -F pcfs /dev/rdisk/c5t0d0s2:c
```

The following example shows how to create a PCFS file system on a 100-MB USB memory stick on an x86 system:

```
# mkfs -F pcfs /dev/rdisk/c5t0d0p0:c
```

This command can take several minutes to complete.

- Create a UFS file system.

```
# newfs raw-device
```

For example:

```
# newfs /dev/rdisk/c4t0d0s7
```

Consider using the `newfs -f 4096` option or `newfs -T` option for large USB hard disks.

Note – UFS file system overhead consumes a significant portion of space on a diskette, due to a diskette's limited storage capacity.

See the next two procedures for a detailed example of creating a PCFS file system and modifying slices on a USB mass storage device.

▼ How to Modify Partitions and Create a PCFS File System on a USB Mass Storage Device Without `vol0` Running

The following steps describe how to delete an existing partition, create a new partition, and then create a PCFS file system on the USB device with removable media services disabled. Make sure you back up any data before you perform this task.

- 1 Become superuser.
- 2 For information about disabling removable media services, see [“How to Disable or Enable Removable Media Services”](#) on page 43.

- 3 Start the `fdisk` utility.

For example:

```
# fdisk /dev/rdisk/c3t0d0p0
```

- 4 Delete the partition by selecting option 3.

For example:

```
Total disk size is 29 cylinders
      Cylinder size is 2048 (512 byte) blocks
```

Partition	Status	Type	Cylinders		Length	%
			Start	End		
1	Active	Solaris2	1	28	28	97

SELECT ONE OF THE FOLLOWING:

1. Create a partition
2. Specify the active partition
3. Delete a partition
4. Change between Solaris and Solaris2 Partition IDs
5. Exit (update disk configuration and exit)
6. Cancel (exit without updating disk configuration)

Enter Selection: **3**

- 5 Choose the partition number to delete.

For example:

```
Total disk size is 29 cylinders
      Cylinder size is 2048 (512 byte) blocks
```

Partition	Status	Type	Cylinders		Length	%
			Start	End		
1	Active	Solaris2	1	28	28	97

SELECT ONE OF THE FOLLOWING:

1. Create a partition
2. Specify the active partition
3. Delete a partition
4. Change between Solaris and Solaris2 Partition IDs
5. Exit (update disk configuration and exit)
6. Cancel (exit without updating disk configuration)

Specify the partition number to delete (or enter 0 to exit): **1**

Partition deleted.

6 Create a partition.

For example:

Total disk size is 29 cylinders
Cylinder size is 2048 (512 byte) blocks

Partition	Status	Type	Start	End	Length	%
=====	=====	=====	=====	===	=====	===

WARNING: no partitions are defined!

SELECT ONE OF THE FOLLOWING:

1. Create a partition
2. Specify the active partition
3. Delete a partition
4. Change between Solaris and Solaris2 Partition IDs
5. Exit (update disk configuration and exit)
6. Cancel (exit without updating disk configuration)

Enter Selection: 1

7 Select the FAT32 partition type.

Total disk size is 29 cylinders
Cylinder size is 2048 (512 byte) blocks

Partition	Status	Type	Start	End	Length	%
=====	=====	=====	=====	===	=====	===

WARNING: no partitions are defined!

SELECT ONE OF THE FOLLOWING:

1. Create a partition
2. Specify the active partition
3. Delete a partition
4. Change between Solaris and Solaris2 Partition IDs
5. Exit (update disk configuration and exit)
6. Cancel (exit without updating disk configuration)

Select the partition type to create:

1=SOLARIS2	2=UNIX	3=PCIXOS	4=Other
5=DOS12	6=DOS16	7=DOSEXT	8=DOSBIG
9=DOS16LBA	A=x86 Boot	B=Diagnostic	C=FAT32
D=FAT32LBA	E=DOSEXTLBA	F=EFI	0=Exit? c

8 Specify the percentage of disk to use for this partition.

Total disk size is 29 cylinders
Cylinder size is 2048 (512 byte) blocks

Partition	Status	Type	Start	End	Length	%
=====	=====	=====	=====	===	=====	===

WARNING: no partitions are defined!

SELECT ONE OF THE FOLLOWING:

1. Create a partition

```

2. Specify the active partition
3. Delete a partition
4. Change between Solaris and Solaris2 Partition IDs
5. Exit (update disk configuration and exit)
6. Cancel (exit without updating disk configuration)
Select the partition type to create:
Specify the percentage of disk to use for this partition (or type "c" to
specify the size in cylinders). 100

```

9 Select whether the new partition should be the active partition or an inactive partition.

```

Total disk size is 29 cylinders
Cylinder size is 2048 (512 byte) blocks

```

Partition	Status	Type	Cylinders		Length	%
			Start	End		
=====	=====	=====	=====	===	=====	===

WARNING: no partitions are defined!

SELECT ONE OF THE FOLLOWING:

1. Create a partition
2. Specify the active partition
3. Delete a partition
4. Change between Solaris and Solaris2 Partition IDs
5. Exit (update disk configuration and exit)
6. Cancel (exit without updating disk configuration)

Select the partition type to create:

Should this become the active partition? If yes, it will be activated each time the computer is reset or turned on.

Please type "y" or "n". n

10 Update the disk configuration and exit.

```

Total disk size is 29 cylinders
Cylinder size is 2048 (512 byte) blocks

```

Partition	Status	Type	Cylinders		Length	%
			Start	End		
=====	=====	=====	=====	===	=====	===
1		Win95 FAT32	1	28	28	97

SELECT ONE OF THE FOLLOWING:

1. Create a partition
2. Specify the active partition
3. Delete a partition
4. Change between Solaris and Solaris2 Partition IDs
5. Exit (update disk configuration and exit)
6. Cancel (exit without updating disk configuration)

Enter Selection: 5

11 Create the PCFS file system on this partition.

For example:

```
# mkfs -F pcfs -o fat=32 /dev/rdisk/c3t0d0p0:c
```

Construct a new FAT file system on /dev/rdisk/c3t0d0p0:c: (y/n)? y

▼ How to Create a Solaris Partition and Modify the Slices on a USB Mass Storage Device Without `volD` Running

The following steps illustrate how to create a Solaris partition and modify the slices with removable media services disabled.

Make sure you back up any data before you perform this task.

- 1 **Become superuser.**
- 2 **For information on disabling removable media services, see [“How to Disable or Enable Removable Media Services”](#) on page 43.**
- 3 **Start the `fdisk` utility.**

For example:

```
# fdisk /dev/rdisk/c5t0d0s2
No fdisk table exists. The default partition for the disk is:
```

```
  a 100% "SOLARIS System" partition
```

Type "y" to accept the default partition, otherwise type "n" to edit the partition table.

```
y
```

- 4 **Display the current slices.**

For example:

```
# prtvtoc /dev/rdisk/c5t0d0s2
* /dev/rdisk/c5t0d0s2 partition map
*
* Dimensions:
*   512 bytes/sector
*   63 sectors/track
*   255 tracks/cylinder
*  16065 sectors/cylinder
*   5836 cylinders
*   5836 accessible cylinders
*
* Flags:
*  1: unmountable
* 10: read-only
*
* Partition  Tag  Flags      First Sector    Sector    Last Sector  Mount Directory
*          0    0    00          0  93755340  93755339
*          2    0    00          0  93755340  93755339
```

- 5 **Create a text file with the slice information.**

For example:

```
slices: 0 = 0, 5GB, "wm", "home" :
        1 = 8225280000, 6GB :
```

```
2 = 0, 44GB, "wm", "backup" :
6 = 16450560000, 15GB
```

Make sure each slice starts on a cylinder boundary. For example, slice 1 starts at 822280000 bytes, which is the cylinder size in bytes multiplied by 1000.

For more information, see the `-s` option description in `rmformat(1)`.

6 Create the slices by including the slice file created above.

For example:

```
# rmformat -s slice_file /dev/rdisk/c5t0d0s2
```

7 View the new slice information.

For example:

```
# prtvtoc /dev/rdisk/c5t0d0s2
* /dev/rdisk/c5t0d0s2 partition map
*
* Dimensions:
*   512 bytes/sector
*   63 sectors/track
*   255 tracks/cylinder
* 16065 sectors/cylinder
*   5836 cylinders
*   5836 accessible cylinders
*
* Flags:
*   1: unmountable
*  10: read-only
*
* Unallocated space:
*   First Sector   Last
*   Sector   Count   Sector
* 10485760  5579240 16064999
* 28647912  3482088 32129999
* 63587280  30168060 93755339
*
* Partition Tag  Flags   First Sector   Sector Count   Last Sector   Mount Directory
*      0      8    00      0 10485760 10485759
*      1      3    01 16065000 12582912 28647911
*      2      5    00      0 92274688 92274687
*      6      4    00 32130000 31457280 63587279
```

▼ How to Mount or Unmount a USB Mass Storage Device Without `vol`d Running

The following steps illustrate how to mount and unmount a USB mass storage device with removable media services disabled.

1 Become superuser.

- 2 For information on disabling removable media services, see [“How to Disable or Enable Removable Media Services” on page 43.](#)

- 3 Verify that removable media services are not running.

```
# svcs volfs
STATE          STIME      FMRI
disabled       10:39:12  svc:/system/filesystem/volfs:default
```

- 4 (Optional) Identify the device.

For example:

```
# cd /dev/rdisk
# ls -l c*0 | grep usb
lrwxrwxrwx  1 root  root   55 Mar  5 10:35 c2t0d0s0 ->
../../../../devices/pci@1f,0/usb@c,3/storage@3/disk@0,0:a,raw
```

In this example, the diskette device is c2t0d0s0.

- 5 Select one of the following to mount or unmount a USB mass storage device:

- Mount a USB mass storage device.

```
# mount [ -F fstype ] block-device mount-point
```

This example shows how to mount a device with a UFS file system:

```
# mount /dev/dsk/c1t0d0s2 /mnt
```

This example shows how to mount a device with a PCFS file system on a SPARC system:

```
# mount -F pcfs /dev/dsk/c3t0d0s2:c /mnt
```

This example shows how to mount a device with a PCFS file system on an x86 system:

```
# mount -F pcfs /dev/dsk/c3t0d0p0:c /mnt
```

This example shows how to mount a CD with a read-only HSFS file system:

```
# mount -F hsfs -o ro /dev/dsk/c1t0d0s2 /mnt
```

- Unmount a USB mass storage device.

First, be sure no one is using the file system on the device.

For example:

```
# fuser -c -u /mnt
# umount /mnt
```

- 6 Eject the device, which is optional for CD or diskette devices.

```
# eject /dev/[r]dsk/cntndnsn
```

For example:

```
# eject /dev/rdsk/c1t0d0s2
```

Troubleshooting Tips for USB Mass Storage Devices

Keep the following tips in mind if you have problems adding or removing a USB mass storage device.

Check the `/var/adm/messages` file for failures to enumerate the device. For enumeration failures, possibly, insert the USB hub or remove a hub and connect it directly to a root USB hub.

- If USB devices are added or removed when the system is down, you must perform a reconfiguration boot.

```
ok boot -r
```

If you have problems accessing a device that was connected while the system is running, try the following command:

```
# devfsadm
```

- Do not move devices around if the system has been powered down by a suspend operation. For more information, see [“SPARC: USB Power Management” on page 127](#).
- If a device has been hot removed while in use by applications and is no longer available, then stop the applications. Use the `prtconf` command to see whether the device node has been removed.

Disabling Specific USB Drivers

You can disable specific types of USB devices by disabling their client driver. For example, USB printers can be disabled by disabling the `usbprn` driver that directs them. Disabling `usbprn` does not affect other kinds of devices, such as USB storage devices.

The following table identifies some USB device types and their corresponding drivers.

Device Type	Driver to Disable
Audio	<code>usb_ac</code> and <code>usb_as</code>
HID (usually keyboard and mouse)	<code>hid</code>
Storage	<code>scsa2usb</code>
Printer	<code>usbprn</code>
Serial	<code>usbser_edge</code>

If you disable a driver for a USB device that is still connected to the system, you see a console message similar to the following:

```
usb10: WARNING: usba: no driver found for device name
```

▼ How to Disable Specific USB Drivers

1 Become superuser.

2 Exclude the driver alias entry from the `/etc/system` file.

For example, include the following exclude statement to exclude the `usbprn` driver.

```
exclude: usbprn
```

3 Reboot the system.

```
# init 6
```

▼ How to Remove Unused USB Device Links

Use this procedure if a USB device is removed while the system is powered off. Removing the USB device while the system is powered off can leave device links for devices that do not exist.

1 Become superuser.

2 Close all applications that might be accessing the device.

3 Remove the unused links for a specific USB class.

For example:

```
# devfsadm -C -c audio
```

Or, just remove the dangling links:

```
# devfsadm -C
```

Using USB Audio Devices (Task Map)

Task	Description	For Instructions
Add USB audio devices.	Add a USB microphone and speakers.	“How to Add USB Audio Devices” on page 152
Identify your system's primary audio device.	Identify which audio device is your primary audio device.	“How to Identify Your System's Primary Audio Device” on page 153
Change the primary USB audio device.	You might want to make one audio device the primary audio device if you remove or change your USB audio devices.	“How to Change the Primary USB Audio Device” on page 153

Task	Description	For Instructions
Remove unused USB device links.	If you remove a USB audio device while the system is powered off, the <code>/dev/audio</code> device might be pointing to a <code>/dev/sound/*</code> device that doesn't exist.	“How to Remove Unused USB Device Links” on page 150
Solve USB audio problems.	Use this section if no sound comes from the USB speakers.	“Troubleshooting USB Audio Device Problems” on page 154

Using USB Audio Devices

For information about USB audio support in specific Oracle Solaris releases, see [“Oracle Solaris Support for USB Devices” on page 116](#).

This Oracle Solaris release provides USB audio support that is implemented by a pair of cooperating drivers, `usb_ac` and `usb_as`. The audio control driver, `usb_ac`, is a Solaris USB Architecture compliant client driver that provides the controlling interface to user applications. The audio streaming driver, `usb_as`, processes audio data messages during play and record. It sets sample frequency and precision, and encodes requests from the `usb_ac` driver. Both drivers comply with the USB audio class 1.0 specification.

Some audio devices can set volume under software control. A STREAMS module, `usb_ah`, is pushed on top of the HID driver for managing this function.

Oracle Solaris supports USB audio devices that are play-only, record-only, or record and play. Hot-plugging of USB audio devices is supported.

- USB audio devices are supported on SPARC Ultra and x86 platforms that have USB connectors.
- For fully supported audio data format information, see [usb_ac\(7D\)](#).

The primary audio device is `/dev/audio`. You can verify that `/dev/audio` is pointing to USB audio by using the following command:

```
% mixerctl
Device /dev/audioctl:
  Name    = USB Audio
  Version = 1.0
  Config  = external
```

Audio mixer for `/dev/audioctl` is enabled

After you connect your USB audio devices, you access them with the `audioplay` and `audiorecord` command through the `/dev/sound/N` device links.

Note that the `/dev/audio` and `/dev/sound/N` devices can refer to speakers, microphones, or combination devices. If you refer to the incorrect device type, the command fails. For example, the `audioplay` command fails if you try to use it with a microphone.

You can select a specific default audio device for most Oracle audio applications, such as `audioplay` and `audiorecord`, by setting the `AUDIODEV` shell variable or by specifying the `-d` option for these commands. However, setting `AUDIODEV` does not work for third-party applications that have `/dev/audio` hardcoded as the audio file.

When you plug in a USB audio device, it automatically becomes the primary audio device, `/dev/audio`, unless `/dev/audio` is in use. For instructions on changing `/dev/audio` from on-board audio to USB audio and vice versa, refer to [“How to Change the Primary USB Audio Device” on page 153](#), and [usb_ac\(7D\)](#).

Hot-Plugging Multiple USB Audio Devices

If a USB audio device is plugged into a system, it becomes the primary audio device, `/dev/audio`. It remains the primary audio device even after the system is rebooted. If additional USB audio devices are plugged in, the last one becomes the primary audio device.

For additional information on troubleshooting USB audio device problems, see [usb_ac\(7D\)](#).

▼ How to Add USB Audio Devices

1 Plug in the USB speaker.

The primary audio device, `/dev/audio`, points to the USB speaker.

```
% ls -l /dev/audio
lrwxrwxrwx  1 root    root    10 Feb 13 08:46 /dev/audio -> usb/audio0
```

2 (Optional) Remove the speaker. Then, plug it back in.

If you remove the speaker, the `/dev/audio` device reverts back to on-board audio.

```
% ls -l /dev/audio
lrwxrwxrwx  1 root    root    7 Feb 13 08:47 /dev/audio -> sound/0
```

3 Add a USB microphone.

```
% ls -l /dev/audio
lrwxrwxrwx  1 root    root    10 Feb 13 08:54 /dev/audio -> usb/audio1
```

▼ How to Identify Your System's Primary Audio Device

This procedure assumes that you have already connected the USB audio devices.

● Examine your system's new audio links.

- Display your system's new audio links with the `ls` command.

For example:

```
% ls -lt /dev/audio*
lrwxrwxrwx  1 root  root    7 Jul 23 15:46 /dev/audio -> usb/audio0
lrwxrwxrwx  1 root  root   10 Jul 23 15:46 /dev/audiocctl ->
usb/audiocctl0/
% ls -lt /dev/sound/*
lrwxrwxrwx  1 root  root    74 Jul 23 15:46 /dev/sound/1 ->
../..devices/pci@1f,4000/usb@5/hub@1/device@3/sound-control@0:...
lrwxrwxrwx  1 root  root    77 Jul 23 15:46 /dev/sound/1ctl ->
../..devices/pci@1f,4000/usb@5/hub@1/device@3/sound-control@0:...
lrwxrwxrwx  1 root  other  66 Jul 23 14:21 /dev/sound/0 ->
../..devices/pci@1f,4000/ebus@1/SUNW,CS4231@14,200000:sound,audio
lrwxrwxrwx  1 root  other  69 Jul 23 14:21 /dev/sound/0ctl ->
../..devices/pci@1f,4000/ebus@1/SUNW,CS4231@14,200000:sound,audiocctl
%
```

Notice that the primary audio device, `/dev/audio`, is pointing to the newly plugged in USB audio device, `/dev/usb/audio0`.

- You can also examine your system's USB audio devices with the `prtconf` command and look for the USB device information.

```
% prtconf
.
.
.
usb, instance #0
  hub, instance #0
    mouse, instance #0
    keyboard, instance #1
    device, instance #0
      sound-control, instance #0
      sound, instance #0
      input, instance #0
.
.
.
```

▼ How to Change the Primary USB Audio Device

- Select one of the following to change the primary USB audio device.

- If you want the on-board audio device to become the primary audio device, remove the USB audio devices. The `/dev/audio` link then points to the `/dev/sound/0` entry. If the `/dev/sound/0` entry is not the primary audio device, then either shut down the system and use the `boot -r` command, or run the `devfsadm -i` command as root.
- If you want the USB audio device to become primary audio device, just plug it in and check the device links.

Troubleshooting USB Audio Device Problems

Sometimes, USB speakers do not produce any sound, even though the driver is attached and the volume is set to high. Hot-plugging the device might not change this behavior.

The workaround is to power cycle the USB speakers.

Key Points of Audio Device Ownership

Keep the following key points of audio device ownership in mind when working with audio devices:

- When you plug in a USB audio device and you are logged in on the console, the console is the owner of the `/dev/*` entries. This situation means you can use the audio device as long as you are logged in to the console.
- If you are not logged in to the console when you plug in a USB audio device, root becomes the owner of the device. However, if you log in to the console and attempt to access the USB audio device, device ownership changes to the console. For more information, see [logindevperm\(4\)](#).
- When you remotely log in with the `rlogin` command and attempt to access the USB audio device, the ownership does not change. This means that, for example, unauthorized users cannot listen to conversations over a microphone owned by someone else.

Hot-Plugging USB Devices With the `cfgadm` Command (Task Map)

Task	Description	For Instructions
Display USB bus information.	Display information about USB devices and buses.	“How to Display USB Bus Information (cfgadm)” on page 156
Unconfigure a USB device.	Logically unconfigure a USB device that is still physically connected to the system.	“How to Unconfigure a USB Device” on page 157

Task	Description	For Instructions
Configure a USB device.	Configure a USB device that was previously unconfigured.	“How to Configure a USB Device” on page 157
Logically disconnect a USB device.	You can logically disconnect a USB device if you are not physically near the system.	“How to Logically Disconnect a USB Device” on page 158
Logically connect a USB device.	Logically connect a USB device that was previously logically disconnected or unconfigured.	“How to Logically Connect a USB Device” on page 158
Disconnect a USB device subtree.	Disconnect a USB device subtree, which is the hierarchy (or tree) of devices below a hub.	“How to Logically Disconnect a USB Device Subtree” on page 159
Reset a USB device.	Reset a USB device to logically remove and re-create the device.	“How to Reset a USB Device” on page 159
Change the default configuration of a multi-configuration USB device.	Change the default configuration of a multi-configuration USB device.	“How to Change the Default Configuration of a Multi-Configuration USB Device” on page 159

Hot-Plugging USB Devices With the `cfgadm` Command

You can add and remove a USB device from a running system without using the `cfgadm` command. However, a USB device can also be *logically* hot-plugged without physically removing the device. This scenario is convenient when you are working remotely and you need to disable or reset a non functioning USB device. The `cfgadm` command also provides a way to display the USB device tree, including manufacturer and product information.

The `cfgadm` command displays information about *attachment points*, which are locations in the system where dynamic reconfiguration operations can occur. An attachment point consists of the following:

- An occupant, which represents a hardware resource, such as a USB device, that might be configured into the system
- A receptacle, which is the location that accepts the occupant, such as a USB port

Attachment points are represented by logical and physical attachment point IDs (`Ap_Ids`). The physical `Ap_Id` is the physical path name of the attachment point. The logical `Ap_Id` is a user-friendly alternative for the physical `Ap_Id`. For more information on `Ap_Ids`, see [`cfgadm_usb\(1M\)`](#).

The `cfgadm` command provides the following USB device status information.

Receptacle State	Description
empty/unconfigured	The device is not physically connected.
disconnected/unconfigured	The device is logically disconnected and unavailable, even though the device could still be physically connected.
connected/unconfigured	The device is logically connected, but unavailable. The device is visible in <code>prtconf</code> output.
connected/configured	The device is connected and available.

The following sections describe how to hot-plug a USB device through the software with the `cfgadm` command. All of the sample USB device information in these sections has been truncated to focus on relevant information.

▼ How to Display USB Bus Information (`cfgadm`)

For examples of using the `prtconf` command to display USB configuration information, see [“How to Display USB Device Information” on page 138](#).

1 Display USB bus information.

For example:

```
% cfgadm
Ap_Id                Type      Receptacle  Occupant  Condition
usb0/4.5             usb-hub   connected   configured ok
usb0/4.5.1          usb-device connected   configured ok
usb0/4.5.2          usb-printer connected   configured ok
usb0/4.5.3          usb-mouse  connected   configured ok
usb0/4.5.4          usb-device connected   configured ok
usb0/4.5.5          usb-storage connected   configured ok
usb0/4.5.6          usb-communi connected   configured ok
usb0/4.5.7          unknown   empty       unconfigured ok
```

In the preceding example, `usb0/4.5.1` identifies a device connected to port 1 of the second-level external hub, which is connected to port 5 of first-level external hub, which is connected to the first USB controller's root hub, port 4.

2 Display specific USB device information.

For example:

```
% cfgadm -l -s "cols=ap_id:info"
Ap_Id      Information
usb0/4.5.1 Mfg: Inside Out Networks Product: Edgeport/421 NConfigs: 1
Config: 0 : ...
usb0/4.5.2 Mfg: <undef> Product: <undef> NConfigs: 1 Config: 0 ...
usb0/4.5.3 Mfg: Mitsumi Product: Apple USB Mouse NConfigs: 1
Config: 0 ...
usb0/4.5.4 Mfg: NMB Product: NMB USB KB/PS2 M NConfigs: 1 Config: 0
```

```
usb0/4.5.5 Mfg: Hagiwara Sys-Com Product: SmartMedia R/W NConfigs: 1
Config: 0 : ...
usb0/4.5.6 Mfg: 3Com Inc. Product: U.S.Robotics 56000 Voice USB Modem
NConfigs: 2 ...
usb0/4.5.7
```

▼ How to Unconfigure a USB Device

You can unconfigure a USB device that is still physically connected to the system. However, a driver will never attach to the device. Note that a USB device remains in the `prtconf` output even after that device is unconfigured.

- 1 **Become superuser.**
- 2 **Unconfigure the USB device.**

For example:

```
# cfgadm -c unconfigure usb0/4.7
Unconfigure the device: /devices/pci@8,700000/usb@5,3/hub@4:4.7
This operation will suspend activity on the USB device
Continue (yes/no)? y
```

- 3 **Verify that the device is unconfigured.**

For example:

```
# cfgadm
```

Ap_Id	Type	Receptacle	Occupant	Condition
usb0/4.5	usb-hub	connected	configured	ok
usb0/4.5.1	usb-device	connected	configured	ok
usb0/4.5.2	usb-printer	connected	configured	ok
usb0/4.5.3	usb-mouse	connected	configured	ok
usb0/4.5.4	usb-device	connected	configured	ok
usb0/4.5.5	usb-storage	connected	configured	ok
usb0/4.5.6	usb-communi	connected	configured	ok
usb0/4.5.7	unknown	empty	unconfigured	ok
usb0/4.6	usb-storage	connected	configured	ok
usb0/4.7	usb-storage	connected	unconfigured	ok

▼ How to Configure a USB Device

- 1 **Become superuser.**
- 2 **Configure a USB device.**

For example:

```
# cfgadm -c configure usb0/4.7
```

3 Verify that the USB device is configured.

For example:

```
# cfgadm usb0/4.7
Ap_Id          Type          Receptacle  Occupant    Condition
usb0/4.7      usb-storage   connected   configured  ok
```

▼ How to Logically Disconnect a USB Device

If you want to remove a USB device from the system and the `prtconf` output, but you are not physically near the system, just logically disconnect the USB device. The device is still physically connected. However, the device is logically disconnected, unusable, and not visible to the system.

1 Become superuser.**2 Disconnect a USB device.**

For example:

```
# cfgadm -c disconnect -y usb0/4.7
```

3 Verify that the device is disconnected.

For example:

```
# cfgadm usb0/4.7
Ap_Id          Type          Receptacle  Occupant    Condition
usb0/4.7      unknown      disconnected  unconfigured ok
```

▼ How to Logically Connect a USB Device

Use this procedure to logically connect a USB device that was previously logically disconnected or unconfigured.

1 Become superuser.**2 Connect a USB device.**

For example:

```
# cfgadm -c configure usb0/4.7
```

3 Verify that the device is connected.

For example:

```
# cfgadm usb0/4.7
Ap_Id          Type          Receptacle  Occupant    Condition
usb0/4.7      usb-storage   connected   configured  ok
```

The device is now available and visible to the system.

▼ How to Logically Disconnect a USB Device Subtree

Use this procedure to disconnect a USB device subtree, which is the hierarchy (or tree) of devices below a hub.

1 **Become superuser.**

2 **Remove a USB device subtree.**

For example:

```
# cfgadm -c disconnect -y usb0/4
```

3 **Verify that the USB device subtree is disconnected.**

For example:

```
# cfgadm usb0/4
Ap_Id          Type      Receptacle  Occupant    Condition
usb0/4        unknown  disconnected  unconfigured ok
```

▼ How to Reset a USB Device

If a USB device behaves erratically, use the `cfgadm` command to reset the device, which logically removes and re-creates the device.

1 **Become superuser.**

2 **Make sure that the device is not in use.**

3 **Reset the device.**

For example:

```
# cfgadm -x usb_reset -y usb0/4.7
```

4 **Verify that the device is connected.**

For example:

```
# cfgadm usb0/4.7
Ap_Id          Type      Receptacle  Occupant    Condition
usb0/4.7      usb-storage  connected  configured  ok
```

▼ How to Change the Default Configuration of a Multi-Configuration USB Device

Keep the following in mind when working with multi-configuration USB devices:

- A USB device configuration defines how a device presents itself to the operating system. This method is different from system device configurations discussed in other `cfgadm` sections.
- Some USB devices support multiple configurations, but only one configuration can be active at a time.
- Multi-configuration devices can be identified by examining the `cfgadm -lv` output. `Nconfigs` will be greater than 1.
- The default USB configuration is configuration 1. The current configuration is reflected in `cfgadm -lv` output as `Config`.
- Changes to the default configuration persist across reboots, hot-removes, and the reconfiguration of the device, as long as the device is reconnected to the same port.

1 Make sure that the device is not in use.

2 Change the default USB configuration.

For example:

```
# cfgadm -x usb_config -o config=2 usb0/4
Setting the device: /devices/pci@1f,0/usb@c,3:4
to USB configuration 2
This operation will suspend activity on the USB device
Continue (yes/no)? yes
```

3 Verify that the device changed.

For example:

```
# cfgadm -lv usb0/4
Ap_Id  Receptacle  Occupant    Condition  Information  When  Type
      Busy      Phys_Id
usb0/4 connected  unconfigured ok          Mfg: Sun 2000
Product: USB-B0B0 aka Robotech
With 6 EPPS High Clk Mode  NConfigs: 7  Config: 2  : EVAL Board Setup
unavailable
usb-device  n          /devices/pci@1f,0/usb@c,3:4
```

Note that `Config`: now shows 2.

Using InfiniBand Devices (Overview/Tasks)

InfiniBand (IB) is a I/O technology based on switch fabrics. It provides high bandwidth, low latency interconnect for attaching I/O devices to hosts and for host-to-host communication.

This is a list of the overview information in this chapter.

- “Overview of InfiniBand Devices” on page 161
- “Dynamically Reconfiguring IB Devices (c f gadm)” on page 164

For information on the procedures associated with using IB devices, see the following:

- “Dynamically Reconfiguring IB Devices (Task Map)” on page 162
- “Using the uDAPL Application Interface With InfiniBand Devices” on page 173

For general information about dynamic reconfiguration and hot-plugging, see [Chapter 6](#), “Dynamically Configuring Devices (Tasks).”

Overview of InfiniBand Devices

IB devices are managed by the Solaris IB nexus driver. This driver supports 5 types of devices:

- IB Port devices
- IB virtual physical point of attachment (VPPA) devices
- IB HCA service (HCA_SVC) devices
- Pseudo devices
- I/O controller (IOC) devices

The IB nexus driver queries the Solaris IB Device Manager (IBDM) for services, referred in this guide as *communication services*, to enumerate the IB Port, HCA_SVC, and IB VPPA devices.

The Port devices bind a communication service to a given port# of a Host Channel Adapter (HCA). The VPPA devices bind a communication service to a port#, p_key# combination instead. The HCA_SVC devices bind a communication service to a given HCA. Note that the

Port devices and the HCA_SVC devices always use a `p_key` (partition key) whose value is zero. The Port, HCA_SVC, and VPPA devices are children of the HCA and are enumerated through the `ib.conf` file. For more information, see [ib\(7D\)](#).

The IOC devices are children of the IB nexus driver and are part of an I/O unit. The pseudo devices are also children of the IB nexus driver and refer to all other devices that provide their own configuration files to enumerate. For more information, see [ib\(4\)](#).

The possible IB device tree path name(s) are listed in the following table.

IOC device	<code>/ib/ioc@1730000007F510C,1730000007F50</code>
IB pseudo device	<code>/ib/<driver>@<unit-address></code>
IB VPPA device	<code>/pci@1f,2000/pci@1/pci15b3,5a44@0/ibport@<port#>,<p_key>,<service></code>
IB HCA_SVC device	<code>/pci@1f,2000/pci@1/pci15bc,5a44@0/ibport@0,0,<service></code>
IB Port device	<code>/pci@1f,2000/pci@1/pci15b3,5a44@0/ibport@<port#>,0,<service></code>
HCA	<code>/pci@1f,2000/pci@1/pci15b3,5a44@0</code>

Note that the IB HCA_SVC devices have zero as the `port#` and the `p_key`.

The IB components in the preceding table are described as follows:

<code><services></code>	Is a communication service. For example, <code>ipib</code> is the communication service used by the <code>ibd</code> kernel client driver.
<code><p_key></code>	Is the partition key value being used.
<code><port></code>	Is the port number.
<code><unit-address></code>	Refers to IB kernel client driver's property by this name specified in its <code>driver.conf</code> file. For more information, see driver.conf(4) .

Dynamically Reconfiguring IB Devices (Task Map)

Task	Description	For Instructions
Display IB device information.	Display information about the IB devices on your system.	“How to Display IB Device Information” on page 165
Configure or unconfigure an IOC device.	Select one of the following:	

Task	Description	For Instructions
	<p>Unconfigure an IOC device.</p> <p>Configure an IOC device.</p>	<p>“How to Unconfigure an IOC Device” on page 166</p> <p>“How to Configure an IOC Device” on page 167</p>
Configure or unconfigure a port or VPPA device.	<p>Select one of the following:</p> <p>Unconfigure a port or a VPPA device.</p> <p>Configure a port or a VPPA device.</p>	<p>“How to Unconfigure an IB Port, HCA_SVC, or a VPPA Device” on page 167</p> <p>“How to Configure a IB Port, HCA_SVC, or a VPPA Device” on page 168</p>
Configure or unconfigure an IB pseudo device.	<p>Select one of the following:</p> <p>Unconfigure an IB pseudo device.</p> <p>Configure an IB pseudo device.</p>	<p>“How to Unconfigure an IB Pseudo Device” on page 168</p> <p>“How to Configure an IB Pseudo Device” on page 169</p>
Display kernel IB clients of an HCA.	You might need to display information about kernel IP clients of an HCA, particularly if you're going to unconfigure an HCA.	“How to Display Kernel IB Clients of an HCA” on page 169
Configure or unconfigure an IB HCA.	<p>Select one of the following:</p> <p>Unconfigure IB devices that are connected to an HCA.</p> <p>Configure IB devices that are connected to an HCA.</p>	<p>“How to Unconfigure IB Devices Connected to an HCA” on page 169</p> <p>“Configuring an IB HCA” on page 170</p>
Update the IB p_key tables.	If the p_key table information of a HCA port changes, IBTF and IBDM need to be notified so that their internal p_key databases are updated.	“How to Update the IB p_key Tables” on page 170
Display IB communication services	Display the IB communication services that are currently in use by the IBTF.	“How to Display IB Communication Services” on page 171

Task	Description	For Instructions
Add or remove a VPPA communication service.	Select one of the following: Add a VPPA communication service. Remove a VPPA communication service.	“How to Add a VPPA Communication Service” on page 171 “How to Remove an Existing IB Port, HCA_SVC, or a VPPA Communication Service” on page 172
Update an IOC configuration.	You can update the properties of all the IOC device nodes or update a particular IOC Ap_Id.	“How to Update an IOC Configuration” on page 172

Dynamically Reconfiguring IB Devices (c f g a d m)

One can configure or unconfigure an IB device from a running system by using the `c f g a d m` CLI only. This command also provides a way to display the IB fabric, manage communication services, and update `p_` key table databases. For more information, see `c f g a d m_ib(1M)`.

The `c f g a d m` CLI manages dynamic reconfiguration, referred to in this guide as DR, of the entire IB fabric as seen by a host. The `c f g a d m` operations are supported on all the IB devices, such as Port, VPPA, HCA_SVC, IOC, and pseudo devices.

The `c f g a d m` command displays information about attachment points (`Ap_Ids`), which are locations in the system where DR operations can occur. For details on the `Ap_Ids` that `c f g a d m` supports, see `c f g a d m_ib.1M`. Note that all IB `Ap_Ids` are shown as connected.

The `c f g a d m` command provides the following IB device status information.

Receptacle State	Description
connected/configured/ok	The device is connected and available. The <code>devinfo</code> node is present.
connected/unconfigured/unknown	The device is unavailable and no <code>devinfo</code> node or device driver exists for this device. Or, the device was never configured for use by <code>ib_nexus</code> driver. The device might be known to the IB Device Manager.

The following sections describe how to dynamically reconfigure (DR) IB devices with the `c f g a d m` command. All of the sample IB device information in these sections has been truncated to focus on relevant information.

▼ How to Display IB Device Information

You can use the `prtconf` command to display general information about IB devices. For example:

```
$ prtconf
pci, instance #0
  pci15b3,5a44, instance #0
    ibport, instance #253
    ibport, instance #254
    ibport, instance #255
  .
  .
  .
ib, instance #0
  ioc, instance #243
  ioc, instance #244
  ioc, instance #245
  ioc, instance #246
  ioc, instance #247
  ioc, instance #248
  ibgen, instance #249
```

In the preceding example, `pci15b3,5a44` refers to an IB HCA.

Use the following steps to display specific IB device information.

- 1 **Become superuser.**
- 2 **Display IB fabric information.**

For example:

```
# c f gadm -a
Ap_Id                               Type           Receptacle Occupant  Condition
ib                                   IB-Fabric     connected  configured ok
hca:1730000008070                   IB-HCA        connected  configured ok
ib::1730000007F5198                 IB-IOC        connected  configured ok
ib::1730000007F5199                 IB-IOC        connected  configured ok
ib::1730000008070,0,hnfs             IB-HCA_SVC    connected  configured ok
ib::1730000008071,0,sdp              IB-PORT       connected  configured ok
ib::1730000008072,0,sdp              IB-PORT       connected  configured ok
ib::1730000008071,8001,ipib          IB-VPPA       connected  configured ok
ib::1730000008072,8001,ipib          IB-VPPA       connected  configured ok
ib::ibgen,0                           IB-PSEUDO     connected  configured ok
#
```

In the preceding example output, the components are described as follows:

Ap_Id	ib::1730000008072,0,sdp	Identifies an IB Port device that is connected to port 2 and is bound to the <code>sdp</code> service.
Ap_Id	ib::1730000008072,8001,ipib	Identifies an IB VPPA device that is connected to port 2, using a <code>p_key</code> value of <code>0x8001</code> , and is bound to the <code>ibd</code> service.

Ap_Id ib:: 1730000008070,0,hnfs	Identifies an IB HCA_SVC device bound to the hnfs service.
Ap_Id ib::1730000007F5198	Identifies an IOC device.
Ap_Id ib::ibgen,0	Identifies a pseudo device.

3 Display specific IB device information.

For example, for an IB VPPA device:

```
# cfgadm -al -s "cols=ap_id:info" ib::1730000008072,8001,ipib
Ap_Id                               Information
ib::1730000008072,8001,ipib        ipib
#
```

For example, for an IB HCA device:

```
# cfgadm -al -s "cols=ap_id:info" hca::1730000008070
Ap_Id                               Information
hca::1730000008070                  VID: 0x15b3, PID: 0x5a44, #ports: 0x2,
port1 GUID: 0x1730000008071, port2 GUID: 0x1730000008072
#
```

The preceding output displays the number of ports and their GUIDs.

▼ How to Unconfigure an IOC Device

You can unconfigure an IB device that is still physically connected to the system, but a driver will never attach to it.

1 Become superuser.

2 Unconfigure the IB device.

For example:

```
# cfgadm -c unconfigure ib::1730000007F5198
Unconfigure the device: /devices/ib:fabric::1730000007F5198
This operation will suspend activity on the IB device
Continue (yes/no)? y
#
```

3 Verify that the device is unconfigured.

For example:

```
# cfgadm -a ib::1730000007F5198
ib::1730000007F5198          IB-IOC          connected  unconfigured  unknown
#
```

▼ How to Configure an IOC Device

1 Become superuser.

2 Configure a IB device.

For example:

```
# cfgadm -yc configure ib::1730000007F5198
```

3 Verify that the IB device is configured.

For example:

```
# cfgadm -al ib::1730000007F5198
Ap_Id          Type      Receptacle  Occupant   Condition
ib::1730000007F5198  IB-IOC   connected   configured ok
```

▼ How to Unconfigure an IB Port, HCA_SVC, or a VPPA Device

Use the following steps if you want to remove an IB Port, HCA_SVC, or a VPPA device from the system.

The example below illustrates how to unconfigure a VPPA device, but the same procedure applies to Port and HCA_SVC devices as well.

1 Become superuser.

2 Unconfigure the IB VPPA device.

For example:

```
# cfgadm -c unconfigure ib::1730000007F51,8001,ipib
Unconfigure the device: /devices/ib:fabric::1730000007F51,8001,ipib
This operation will suspend activity on the IB device
Continue (yes/no)? Y
#
```

3 Verify that the device is disconnected.

For example:

```
# cfgadm -a ib::1730000007F51,8001,ipib
Ap_Id          Type      Receptacle  Occupant   Condition
ib::1730000007F51,8001,ipib  IB-VPPA   connected   unconfigured unknown
#
```

▼ How to Configure a IB Port, HCA_SVC, or a VPPA Device

Use the following steps if you want to configure an IB Port, HCA_SVC, or a VPPA device on the system.

The example below illustrates how to configure a VPPA device, but similar steps can be used to configure Port and HCA_SVC devices as well.

1 Become superuser.

2 Configure the IB VPPA device.

For example:

```
# cfgadm -c configure ib::1730000007F51,8001,ipib
```

3 Verify that the device is connected.

For example:

```
# cfgadm -a ib::1730000007F51,8001,ipib
Ap_Id                Type      Receptacle Occupant  Condition
ib::1730000007F51,8001,ipib IB-VPPA   connected  configured ok
```

Note – A `cfgadm` based configure or unconfigure operation of IB Port and HCA_SVC devices is similar to the preceding examples for an IB VPPA device.

▼ How to Unconfigure an IB Pseudo Device

Use the following steps if you want to remove an IB pseudo device from the system.

1 Become superuser.

2 Unconfigure the IB pseudo device.

For example:

```
# cfgadm -c unconfigure ib::ibgen,0
Unconfigure the device: /devices/ib:fabric::ibgen,0
This operation will suspend activity on the IB device
Continue (yes/no)? Y
#
```

3 Verify that the device is disconnected.

```
# cfgadm -a ib::ibgen,0
Ap_Id                Type      Receptacle Occupant  Condition
ib::ibgen,0         IB-PSEUDO connected  unconfigured unknown
```

▼ How to Configure an IB Pseudo Device

Use the following steps to configure an IB pseudo device.

- 1 **Become superuser.**
- 2 **Configure the IB pseudo device.**

For example:

```
# c f g a d m -y c o n f i g u r e i b : : i b g e n , 0
```

- 3 **Verify that the device is connected.**

For example:

```
# c f g a d m -a i b : : i b g e n , 0
Ap_Id      Type      Receptacle Occupant  Condition
ib::ibgen,0  IB-PSEUDO  connected  configured ok
```

▼ How to Display Kernel IB Clients of an HCA

The following IB c f g a d m plugin command can be invoked to list kernel IB clients using this HCA. Note that the last column would show a “yes” if a kernel IB client uses another HCA. IB Managers and kernel clients that do not use the HCA are shown with an Ap_Id of “-”.

- **Display kernel IB clients of an HCA.**

For example:

```
$ c f g a d m -x l i s t _ c l i e n t s h c a : 1 7 3 0 0 0 0 0 7 F 5 0
Ap_Id      IB Client      Alternate HCA
ib::1730000007F51D0  ibgen          no
ib::1730000007F51D1  ibgen          no
ib::1730000007F51,8001,ipib  ibd            no
ib::ibgen,0        ibgen          no
-            ibdm           no
-            ibmf           no
-            nfs/ib        no
$
```

▼ How to Unconfigure IB Devices Connected to an HCA

An actual DR of an HCA is beyond the scope of the IB c f g a d m plugin. Although DR of an HCA can be achieved by using the plugin of the underlying bus. For example, a PCI based HCA can use the c f g a d m _ p c i command. For more information, see [c f g a d m _ p c i \(1 M \)](#).

However, the IB c f g a d m plugin assists in the HCA DR by listing its kernel IB clients as illustrated in steps below.

- 1 Become superuser.
- 2 List the kernel IB clients of the HCA.

For example:

```
# c f g a d m -x list_clients hca:173000007F50
Ap_Id                IB Client            Alternate HCA
ib::1730000007F51D0  ibgen                no
ib::1730000007F51D1  ibgen                no
ib::1730000007F51,8001,ipib  ibd                  no
ib::ibgen,0          ibgen                no
-                    ibdm                 no
-                    ibmf                 no
-                    nfs/ib               no
```

- 3 Unconfigure kernel IB clients, such as Port, VPPA, HCA_SVC, or IOC devices, that do not have alternate HCAs present.

For example:

```
# c f g a d m -x unconfig_clients hca:1730000008070
Unconfigure Clients of HCA /devices/ib:1730000008070
This operation will unconfigure IB clients of this HCA
Continue (yes/no)? y
```

- 4 Verify that the kernel IB clients of the HCA are unconfigured.

```
# c f g a d m -x list_clients hca:173000007F50
Ap_Id                IB Client            Alternate HCA
-                    ibdm                 no
-                    ibmf                 no
-                    nfs/ib               no
#
```

Configuring an IB HCA

Invoke the bus-specific `c f g a d m` plugin to configure the HCA. The exact details are beyond the scope of this chapter.

▼ How to Update the IB `p_key` Tables

If the `p_key` table information of an HCA ports changes, for example, additional `p_key`s are enabled or disabled, InfiniBand Transport Framework (IBTF) and IBDM need to be notified so that their internal `p_key` databases are updated. The `c f g a d m` command helps update the `p_key` databases of IBTF and IBDM. For more information, see [ibtl\(7D\)](#) and [ibdm\(7D\)](#).

- 1 Become superuser.

2 Update the p_key tables.

For example:

```
# cfgadm -x update_pkey_tbls -y ib
```

▼ How to Display IB Communication Services

Use the following steps to display the communication services that are currently in use by the IBTF.

1 Become superuser.

2 Display IB communication services.

For example:

```
# cfgadm -x list_services ib
Port communication services:
    srp
VPPA communication services:
    ibd
HCA_SVC communication services:
    hnfs
```

▼ How to Add a VPPA Communication Service

Use the following steps to add a new VPPA communication service.

Similar steps can be used to add a new HCA_SVC or a port communication service.

1 Become superuser.

2 Add a new VPPA communication service.

For example:

```
# cfgadm -o comm=vppa,service=new -x add_service ib
```

3 Verify that the new service has been added.

For example:

```
# cfgadm -x list_services ib
Port communication services:
    srp
VPPA communication services:
    ibd
    new
HCA_SVC communication services:
    nfs_service
#
```

▼ How to Remove an Existing IB Port, HCA_SVC, or a VPPA Communication Service

Use the following steps to delete an existing IB Port, HCA_SVC, or a VPPA communication service.

1 Become superuser.

2 Remove a VPPA communication service.

For example:

```
# c f g a d m -o comm=vppa,service=new -x delete_service ib
```

3 Verify that the communication service has been removed.

For example:

```
# c f g a d m -x list_services ib
Port communication services:
    srp
VPPA communication services:
    ibd
HCA_SVC communication services:
    hnfs
#
```

▼ How to Update an IOC Configuration

Use the following steps to update properties of all the IOC device nodes or for a particular IOC Ap_Id. The properties that can get updated are as follows:

- port-list
- port-entries
- service-id
- service-name

For more information on these properties, see [ib\(7D\)](#).

Note that these properties may not get updated if there is no configuration change. The following example describes how to update a particular IOC's configuration. If you need to update the configuration of all the IOCs, then specify the static `ib Ap_Id` instead of the particular IOC `Ap_Id`.

1 Become superuser.

2 Update the configuration of an IOC.

For example:

```
# cfgadm -x update_ioc_conf ib::1730000007F5198
This operation can update properties of IOC devices.
Continue (yes/no)? y
#
```

3 Verify that the properties have been updated by running `prtconf -v`.

Using the uDAPL Application Interface With InfiniBand Devices

User Direct Access Programming Library (uDAPL) is a standard API that promotes data center application data messaging performance, scalability, and reliability over Remote Direct Memory Access (RDMA) capable interconnects such as InfiniBand. The uDAPL interface is defined by the DAT collaborative. For more information about the DAT collaborative, go to the following site:

<http://www.datcollaborative.org>

The Solaris release provides the following uDAPL features:

- A standard DAT registry library, `libdat`. For more information, see [libdat\(3LIB\)](#).
- A standard service provider registration file, `dat.conf`. For more information, see [dat.conf\(4\)](#).
- Support for multiple service providers so that each provider specifies their own uDAPL library path, version number, and so on, in their own `service_provider.conf` file. For more information, see, [service_provider.conf\(4\)](#).
- An administrative tool, the `datadm` command, to configure `dat.conf`. For more information, see [datadm\(1M\)](#).
- A new resource control property, `project.max-device-locked-memory`, to regulate the amount of locked down physical memory.
- A naming scheme that uses either IPv4 or IPv6 addresses that leverage the IP infrastructure, such as ARP in IPv4 and neighbor discovery in IPv6, for address resolution. The Solaris uDAPL Interface Adapter directly maps to an IPoIB device instance.
- Support for the standard Address Translation Scheme that is used by the DAT collaborative community.
- A uDAPL service provider library to support the Mellanox Tavor Host Channel Adapter with automatic registration to the `dat.conf` registration file.
- Supports both SPARC platform and x86 platforms.

▼ How to Enable uDAPL

- 1 Become superuser.
- 2 Confirm that the following packages are installed. Or, install them, if needed.
 - SUNWib – Sun InfiniBand Framework
 - SUNWtavor – Sun Tavor HCA Driver
 - SUNWipoib – Sun IP over InfiniBand
 - SUNWudapl_r – Direct Access Transport (DAT) registry package (root)
 - SUNWudapl_u – Direct Access Transport (DAT) registry packages (usr)
 - SUNWudapl_r – Service Provider for Tavor packages (root)
 - SUNWudapl_tu – Service Provider for Tavor packages (usr)
- 3 Select one of the following to plumb the IPoIB interfaces.
 - Manually plumb the interfaces with the `ifconfig` and `datadm` commands.
For example:

```
# ifconfig ibd1 plumb
# ifconfig ibd1 192.168.0.1/24 up
# datadm -a /usr/share/dat/SUNWudapl_t.conf
```
 - Automatically plumb the interfaces by doing the following:
 - Create the following file with the appropriate IP address.
`/etc/hostname.ibd1`
 - Reboot the system.

Updating the DAT Static Registry

You can use the `datadm` command to maintain the DAT static registry, the `dat.conf` file. For more information about this file, see [dat.conf\(4\)](#).

The `datadm` command can also be used to register or unregister a service provider to the `dat.conf` file. For more information, see [datadm\(1M\)](#).

When IPoIB interface adapters are added or removed, run the `datadm` command to update the `dat.conf` file to reflect the current state of the system. A new set of interface adapters for all the service providers that are currently installed will be regenerated.

▼ How to Update the DAT Static Registry

- 1 Become superuser.
- 2 Update the DAT static registry after you add or remove IPoIP interface adapters from the system.
`# datadm -u`
- 3 Display the updated DAT static registry.
`# datadm`

▼ How to Register a Service Provider in the DAT Static Registry

- 1 Become superuser.
- 2 Update the DAT static registry after you add Sun's service provider for the Mellanox Tavor Host Channel Adapter.
`# datadm -a /usr/share/dat/SUNWudapl1t.conf`
- 3 Display the updated DAT static registry.
`# datadm -v`

▼ How to Unregister a Service Provider from the DAT Static Registry

- 1 Become superuser.
- 2 Update the DAT static registry after you remove Sun's service provider for the Mellanox Tavor Host Channel Adapter from the system.
`# datadm -r /usr/share/dat/SUNWudapl1t.conf`
- 3 Display the updated DAT static registry.
`# datadm -v`

Managing Disks (Overview)

This chapter provides overview information about Oracle Solaris disk slices and introduces the `format` utility.

This is a list of overview information in this chapter.

- “What's New in Disk Management?” on page 177
- “Where to Find Disk Management Tasks” on page 181
- “Overview of Disk Management” on page 182
- “Disk Terminology” on page 182
- “About Disk Labels” on page 182
- “About Disk Slices” on page 187
- “`format` Utility” on page 191
- “Partitioning a Disk” on page 195

For instructions on how to add a disk to your system, see [Chapter 12, “SPARC: Setting Up Disks \(Tasks\)”](#), or [Chapter 13, “x86: Setting Up Disks \(Tasks\)”](#).

What's New in Disk Management?

This section describes new disk management features in the Oracle Solaris release.

- “The `diskinfo` Command” on page 178
- “Two-Terabyte Disk Support for Installing and Booting the Oracle Solaris OS” on page 179
- “iSNS Support in the Solaris iSCSI Target and Initiator” on page 180
- “Solaris iSCSI Target Support” on page 180
- “x86: Disk Management in the GRUB Boot Environment” on page 180
- “Support for SCSI Disks That are Larger Than 2 Terabytes” on page 181

For a complete listing of new Oracle Solaris features and a description of Oracle Solaris releases, see *Oracle Solaris 10 8/11 What's New*.

The `diskinfo` Command

Oracle Solaris 10 8/11: This Oracle Solaris release provides the `diskinfo` command that you can use to display the relationship between disk paths and disk slots (or bays) for devices that are found on the system. Devices that can be identified by the `diskinfo` command are generally JBODs and direct-attached devices in blade systems.

You can use the `diskinfo -a` command to display information about all the disks on the system. For example:

```
# diskinfo -a
```

```
Enclosure path:      0631AM1028
Chassis Serial Number: 0631AM1028
Chassis Model:      Sun-Fire-X4200-Server
```

Label	Disk name	Vendor	Product	Vers
HD0	c1t0d0	FUJITSU	MAY2073RCSUN72G	0401
HD1	c1t1d0	FUJITSU	MAY2073RCSUN72G	0401

After you identify the disks on the system, you can display disk path information for a specific device. For example:

```
# diskinfo -d c1t1d0 -p
```

```
Enclosure path:      0631AM1028
Chassis Serial Number: 0631AM1028
Chassis Model:      Sun-Fire-X4200-Server
```

Label	Disk name	Vendor	Product	Vers
HD1	c1t1d0	FUJITSU	MAY2073RCSUN72G	0401
	Physical path			
	0: /pci@0,0/pci1022,7450@2/pci1000,3060@3/sd@1,0			

With multiple enclosures on a system, display all the disks within a specific enclosure. For example:

```
# diskinfo -e 0631AM1028
```

```
Enclosure path:      0631AM1028
Chassis Serial Number: 0631AM1028
Chassis Model:      Sun-Fire-X4200-Server
```

Label	Disk name	Vendor	Product	Vers
HD0	c1t0d0	FUJITSU	MAY2073RCSUN72G	0401
HD1	c1t1d0	FUJITSU	MAY2073RCSUN72G	0401

For more information, see [diskinfo\(1M\)](#).

Multiple Disk Sector Size Support

Solaris 10 9/10: Previous Solaris releases supported a disk sector size of 512 bytes. In this Oracle Solaris release, disks with sector sizes of 512 bytes, 1024 bytes, 2048 bytes, or 4096 bytes are supported. Large sector disks provide greater disk capacity, higher reliability, and greater efficiency for data transfer and faster drive maintenance.

The ability to boot and install from a large sector disk is not currently supported.

Two-Terabyte Disk Support for Installing and Booting the Oracle Solaris OS

Oracle Solaris 10 10/09: In previous Solaris releases, you could not install and boot the Solaris OS from a disk that was greater than 1 TB in size. In this Solaris release, you can install and boot the Solaris OS from a disk that is up to 2 TB in size. In previous releases, you also had to use an EFI label for a disk that is larger than 1 TB. In this release, you can use the VTOC label on any size disk, but the addressable space by the VTOC is limited to 2 TB.

The Oracle Solaris disk drivers and disk utilities have been updated to provide the following support:

- Installing and booting the Oracle Solaris OS on a two-terabyte disk must be connected to a system that runs a 64-bit kernel, with a minimum of 1.5 GB of memory.
- You can use the `format -e` utility to label a disk of any size with a VTOC label, but the addressable space is limited to 2 TB.
- The default label that is used by the `format` utility and the installation software for a disk that is less than 2 TB in size is a VTOC label.
- You can use the `fdisk` utility on a disk that is greater than 1 TB on x86 systems. Support is added for up to 2-TB partitions in the MBR for non-EFI partition types. This support means that Solaris partitions can go up to 2 TB. Other non-EFI partitions may be subject to a limit depending on partition type.

When the `fdisk` utility is run on a disk that is greater than 2 TB in size, a warning message is displayed to indicate that you cannot create a non-EFI partition that is greater than 2 TB.

- The Solaris Volume Manager software has been modified to create metadevices that support physical disks with VTOC labels up to 2 TB in size.

Keep in mind that you cannot move a disk over 1 TB with a legacy MBR or a legacy VTOC to a previous Solaris release. EFI labeled disks continue to work as in previous Solaris releases.

For more information about the EFI label changes in this release, see [“EFI Disk Label” on page 183](#).

iSNS Support in the Solaris iSCSI Target and Initiator

Solaris 10 8/07: This Solaris release provides support for the Internet Storage Name Service (iSNS) protocol in the Solaris iSCSI target and initiator software. The iSNS protocol allows for the automated discovery, management, and configuration of iSCSI devices on a TCP/IP network.

In this Solaris release, you can use the `iscsitadm` command to add access to an existing third-party iSNS server or you can use the Solaris iSNS server to automatically discover the iSCSI devices in your network. The iSNS server can be specified by hostname or IP address. After you add the iSNS server information, you will need to enable access to the server.

For information about configuring the Oracle Solaris iSCSI target to use a third-party iSNS server, see [Chapter 14, “Configuring Oracle Solaris iSCSI Targets and Initiators \(Tasks\)”](#) and `iscsitadm(1M)`.

Solaris iSCSI Target Support

Solaris 10 8/07: This Solaris release provides support for iSCSI target devices, which can be disk or tape devices. Previous Solaris releases provide support for iSCSI initiators. The advantage of setting up Solaris iSCSI targets is you might have existing Fibre-Channel devices that can be connected to clients without the cost of Fibre-Channel HBAs. In addition, systems with dedicated arrays can now export replicated storage with ZFS or UFS file systems.

You can use the `iscsitadm` command to set up and manage your iSCSI target devices. For the disk device that you select as your iSCSI target, you'll need to provide an equivalently sized ZFS or UFS file system as the backing store for the iSCSI daemon.

After the target device is set up, use the `iscsiadm` command to identify your iSCSI targets, which will discover and use the iSCSI target device.

For more information, see [Chapter 14, “Configuring Oracle Solaris iSCSI Targets and Initiators \(Tasks\)”](#), `iscsiadm(1M)`, and `iscsitadm(1M)`.

x86: Disk Management in the GRUB Boot Environment

Solaris 10 1/06: The GRUB boot menu has replaced the previous method for booting an x86 system. In the area of disk management, you use the GRUB interface when booting from an alternative device to replace a system disk or when installing the bootblocks.

The GRUB boot environment provides the following features:

- **Solaris failsafe boot** – A Solaris failsafe boot option that boots into the miniroot so you can recover from a problem that is preventing the system from booting without having to boot from an alternative device. Use the arrow keys to select the following option from the GRUB boot menu and then press return:

Solaris failsafe

You'll need to reboot the system after using the Solaris failsafe boot option.

- **Network boot** – Boot from the network by pressing the F12 key during the BIOS configuration phase.
- **Single-user boot** – Boot to single-user mode by selecting this option from the Solaris failsafe boot menu:

```
kernel /platform/i86pc/multiboot
```

Then, use the e (edit) option to add the -s single-user option. For example:

```
kernel /platform/i86pc/multiboot -s
```

Press return and then press the b key to boot the system. Press control-D to boot the system back to multiuser mode.

In the GRUB environment, you cannot use the `fmt hard` command to install the boot blocks automatically when run on an x86 system. You must install the boot blocks separately.

For detailed feature information and instructions on using the new GRUB based booting on x86 systems, see “[Booting an x86 Based System by Using GRUB \(Task Map\)](#)” in *System Administration Guide: Basic Administration*.

This feature is not available on SPARC systems.

Support for SCSI Disks That are Larger Than 2 Terabytes

Solaris 10 1/06: The SCSI driver, `ssd` or `sd`, supports 2 terabytes and greater. The SCSI driver, `ssd` or `sd`, is limited to 2 TB in previous Solaris releases.

The `format` utility can be used to label, configure, and partition these larger disks. For information about using the EFI disk label on large disks and restrictions with the `fdisk` utility, see “[Restrictions of the EFI Disk Label](#)” on page 184.

Where to Find Disk Management Tasks

Use these references to find step-by-step instructions for managing disks.

Disk Management Task	For More Information
Format a disk and examine a disk label.	Chapter 11, “Administering Disks (Tasks)”
Add a new disk to a SPARC system.	Chapter 12, “SPARC: Setting Up Disks (Tasks)”

Disk Management Task	For More Information
Add a new disk to an x86 system.	Chapter 13, “x86: Setting Up Disks (Tasks)”
Hot-plug a SCSI or PCI disk.	Chapter 6, “Dynamically Configuring Devices (Tasks)”

Overview of Disk Management

Managing disks in the Oracle Solaris OS usually involves setting up the system and running the Oracle Solaris installation program to create the appropriate disk slices and file systems and to install the Oracle Solaris OS. Occasionally, you might need to use the `format` utility to add a new disk drive or replace a defective disk drive.

Disk Terminology

Before you can effectively use the information in this section, you should be familiar with basic disk architecture. In particular, you should be familiar with the following terms:

Disk Term	Description
Track	A concentric ring on a disk that passes under a single stationary disk head as the disk rotates.
Cylinder	The set of tracks with the same nominal distance from the axis about which the disk rotates.
Sector	Section of each disk platter. A sector holds 512 bytes.
Block	A data storage area on a disk. A disk block is 512 bytes.
Disk controller	A chip and its associated circuitry that controls the disk drive.
Disk label	The first sector of a disk that contains disk geometry and partition information.
Device driver	A kernel module that controls a hardware or virtual device.

For additional information, see the product information from your disk's manufacturer.

About Disk Labels

A special area of every disk is set aside for storing information about the disk's controller, geometry, and slices. This information is called the disk's *label*. Another term that is used to

described the disk label is the *VTOC (Volume Table of Contents)* on a disk with a VTOC label. To *label* a disk means to write slice information onto the disk. You usually label a disk after you change its slices.

The Oracle Solaris release supports the following two disk labels:

- SMI – The traditional VTOC label for disks that are less than 2 TB in size.
- EFI – Provides support for disks that are larger than 2 TB on systems that run a 64-bit Solaris kernel. The Extensible Firmware Interface GUID Partition Table (EFI GPT) disk label is also available for disks less than 2 TB that are connected to a system that runs a 32-bit Solaris kernel.

If you fail to label a disk after you create slices, the slices will be unavailable because the OS has no way of “knowing” about the slices.

EFI Disk Label

The EFI label provides support for physical disks and virtual disk volumes that are greater than 2 TB in size. This release also includes updated disk utilities for managing disks greater than 2 TB in size. The UFS file system is compatible with the EFI disk label, and you can create a UFS file system greater than 2 TB. For information on creating a multiterabyte UFS file system, see “[Support of Multiterabyte UFS File Systems](#)” on page 314.

The following file system products support file systems greater than 1 TB in size:

- The Oracle Solaris ZFS file system supports file systems greater than 1 TB in size.
- The Sun StorEdge QFS file system is also available to create file systems greater than 1 TB in size. For information on the Oracle QFS file system, see <http://download.oracle.com/docs/cd/E19526-01/819-1550-10/819-1550-10.pdf>.
- The Solaris Volume Manager software can also be used to manage disks greater than 1 TB in this Solaris release. For information on using Solaris Volume Manager, see [Solaris Volume Manager Administration Guide](#).

The VTOC label is still available for disks less than 2 terabytes in size. If you are only using disks smaller than 2 TB on your systems, managing disks will be the same as in previous Solaris releases. In addition, you can use the `format -e` command to label a disk 2 TB in size or less with an EFI label. For more information, see [Example 11-5](#).

You can use the `format -e` command to apply an EFI label to a disk if the system is running the appropriate Oracle Solaris release. However, you should review the important information in “[Restrictions of the EFI Disk Label](#)” on page 184 before attempting to apply an EFI label.

You can also use the `format -e` command to reapply a VTOC label if the EFI label is no longer needed. For example:

```
# format -e
Specify disk (enter its number): 2
selecting c0t5d0
[disk formatted]
.
.
format> label
[0] SMI Label
[1] EFI Label
Specify Label type[1]: 0
Warning: This disk has an EFI label. Changing to SMI label will erase all
current partitions.
Continue? yes
Auto configuration via format.dat[no]?
Auto configuration via generic SCSI-2[no]?
format> quit
```



Caution – Keep in mind that changing disk labels will destroy any data on the disk.

Comparison of the EFI Label and the VTOC Label

The EFI disk label differs from the VTOC disk label in the following ways:

- Provides support for disks greater than 2 terabytes in size.
- Provides usable slices 0-6, where slice 2 is just another slice.
- Partitions (or slices) cannot overlap with the primary or backup label, nor with any other partitions. The size of the EFI label is usually 34 sectors, so partitions usually start at sector 34. This feature means that no partition can start at sector zero (0).
- No cylinder, head, or sector information is stored in the EFI label. Sizes are reported in blocks.
- Information that was stored in the alternate cylinders area, the last two cylinders of the disk, is now stored in slice 8.
- If you use the `format` utility to change partition sizes, the unassigned partition tag is assigned to partitions with sizes equal to zero. By default, the `format` utility assigns the `usr` partition tag to any partition with a size greater than zero. You can use the partition change menu to reassign partition tags after the partitions are changed. However, you cannot change a partition with a non-zero size to the unassigned partition tag.

Restrictions of the EFI Disk Label

Keep the following restrictions in mind when determining whether using disks greater than 1 terabyte is appropriate for your environment:

- Layered software products intended for systems with VTOC-labeled disks might be incapable of accessing a disk with an EFI disk label.
- A disk with an EFI label is not recognized on systems running previous Solaris releases.

- You cannot boot from a disk with an EFI disk label.
- On x86 based systems, you can use the `fdisk` command on a disk with an EFI label that is greater than 2 TB in size.
- You cannot use the Solaris Management Console's Disk Manager tool to manage disks with EFI labels. Use the `format` utility to partition disks with EFI labels. Then, you can use the Solaris Management Console's Enhanced Storage Tool to manage volumes and disk sets with EFI-labeled disks.
- The EFI specification prohibits overlapping slices. The entire disk is represented by `cxydz`.
- The EFI disk label provides information about disk or partition sizes in sectors and blocks, but not in cylinders and heads.
- The following `format` options are either not supported or are not applicable on disks with EFI labels:
 - The `save` option is not supported because disks with EFI labels do not need an entry in the `format.dat` file.
 - The `backup` option is not applicable because the disk driver finds the primary label and writes it back to the disk.

Support for EFI-Labeled Disks on x86 Systems

Oracle Solaris support for the EFI disk label is available on x86 systems. Use the following command to add an EFI label on an x86 system:

```
# format -e
> [0] SMI Label
> [1] EFI Label
> Specify Label type[0]: 1
> WARNING: converting this device to EFI labels will erase all current
> fdisk partition information. Continue? yes
```

Previous label information is not converted to the EFI disk label.

You will have to recreate the label's partition information manually with the `format` command. You cannot use the `fdisk` command on a disk with an EFI label that is 2 terabytes in size. If the `fdisk` command is run on disk that is greater than 2 TB in size to create a Solaris partition, the Solaris partition is limited to 2 TB. For more information about EFI disk labels, see the preceding section.

Installing a System With an EFI-Labeled Disk

The Oracle Solaris installation utilities automatically recognize disks with EFI labels. However, you cannot use the Oracle Solaris installation program to repartition these disks. You must use the `format` utility to repartition an EFI-labeled disk before or after installation.

After the Oracle Solaris release is installed on a system with an EFI-labeled disk, the partition table appears similar to the following:

Current partition table (original):
 Total disk sectors available: 2576924638 + 16384 (reserved sectors)

Part	Tag	Flag	First Sector	Size	Last Sector
0	root	wm	34	1.20TB	2576924636
1	unassigned	wm	0	0	0
2	unassigned	wm	0	0	0
3	unassigned	wm	0	0	0
4	unassigned	wm	0	0	0
5	unassigned	wm	0	0	0
6	unassigned	wm	0	0	0
8	reserved	wm	2576924638	8.00MB	2576941021

Managing Disks With EFI Disks Labels

Use the following table to locate information on managing disks with EFI disk labels.

Task	For More Information
If the system is already installed, connect the disk to the system.	<p>“SPARC: Setting Up Disks for UFS File Systems (Task Map)” on page 215 or “x86: Setting Up Disks for UFS File Systems (Task Map)” on page 233</p> <p>“SPARC: Setting up Disks for ZFS File Systems (Task Map)” on page 223 or “x86: Setting Up Disks for ZFS File Systems (Task Map)” on page 238</p>
Repartition the disk by using the <code>format</code> utility, if necessary.	“SPARC: How to Create Disk Slices for a UFS File System” on page 218 or “x86: How to Create Disk Slices for UFS File Systems” on page 235
Create disk volumes, and if needed, create soft partitions by using Solaris Volume Manager. Or, set up a ZFS storage pool.	Chapter 2, “Storage Management Concepts,” in <i>Solaris Volume Manager Administration Guide</i> or “Creating a ZFS Storage Pool” in <i>Oracle Solaris ZFS Administration Guide</i>
Create UFS file systems for the new disk by using the <code>newfs</code> command.	“SPARC: How to Create a UFS File System” on page 222 or “x86: How to Create a UFS File System” on page 237
Create a ZFS file system.	“SPARC: Setting Up Disks for ZFS File Systems” on page 224 or “x86: Setting Up Disks for ZFS File Systems” on page 239
Clone a disk with an EFI label	Example 27-2

Troubleshooting Problems With EFI Disk Labels

Use the following error messages and solutions to troubleshoot problems with EFI-labeled disks.

Error Message

```
Dec 3 09:26:48 holoship scsi: WARNING: /sbus@a,0/SUNW,socal@d,10000/
sf@1,0/ssd@w50020f23000002a4,0 (ssd1):
Dec 3 09:26:48 holoship disk has 2576941056 blocks, which is too large
for a 32-bit kernel
```

Cause

You attempted to boot a system running a 32-bit SPARC or x86 kernel with a disk greater than 1 terabyte.

Solution

Boot a system running a 64-bit SPARC or x86 kernel with a disk greater than 1 terabyte.

Error Message

```
Dec 3 09:12:17 holoship scsi: WARNING: /sbus@a,0/SUNW,socal@d,10000/
sf@1,0/ssd@w50020f23000002a4,0 (ssd1):
Dec 3 09:12:17 holoship corrupt label - wrong magic number
```

Cause

You attempted to add a disk to a system running an older Solaris release.

Solution

Add the disk to a system running the Solaris release that supports the EFI disk label.

About Disk Slices

Files stored on a disk are contained in file systems. Each file system on a disk is assigned to a *slice*, which is a group of sectors set aside for use by that file system. Each disk slice appears to the Oracle Solaris OS (and to the system administrator) as though it were a separate disk drive.

For information about file systems, see [Chapter 16, “Managing File Systems \(Overview\)”](#).

Note – Slices are sometimes referred to as *partitions*. Certain interfaces, such as the format utility, refer to slices as partitions.

When setting up slices, remember these rules:

- Each disk slice holds only one file system.
- No file system can span multiple slices.

Slices are set up slightly differently on SPARC and x86 platforms. The following table summarizes the differences.

TABLE 10-1 Slice Differences on SPARC and x86 Platforms

SPARC Platform	x86 Platform
The entire disk is devoted to Oracle Solaris OS.	Disk is divided into <code>fdisk</code> partitions, one <code>fdisk</code> partition per operating system.
VTOC – The disk is divided into 8 slices, numbered 0-7.	VTOC – The Solaris <code>fdisk</code> partition is divided into 10 slices, numbered 0-9.
EFI – The disk is divided into 7 slices, numbered 0-6.	EFI – The disk is divided into 7 slices, numbered 0-6

Solaris Volume Manager, previously the Solstice DiskSuite, has a partitioning feature, *soft partitions*. Soft partitions enable more than eight partitions per disk.

For general information about Solaris Volume Manager, see [Chapter 2, “Storage Management Concepts,”](#) in *Solaris Volume Manager Administration Guide*. For information on soft partitions, see [Chapter 12, “Soft Partitions \(Overview\),”](#) in *Solaris Volume Manager Administration Guide*.

Disk Slices

The following table describes the slices for UFS file systems that might be found on a system that runs the Oracle Solaris OS.

On x86 systems:

- Disks are divided into `fdisk` partitions. An `fdisk` partition is a section of the disk that is reserved for a particular operating system, such as the Oracle Solaris OS.
- The Oracle Solaris OS places ten slices, numbered 0-9, on a Solaris `fdisk` partition. In general, the ZFS root pool is contained in slice 0. The ZFS root pool must exist on a slice or mirrored slices because of a long-standing boot limitation. For non-root storage pools, you can use whole disks. ZFS file systems do not correspond to specific disk slices. Managing whole disks is easier than managing disks with slices.

TABLE 10-2 UFS Customary Disk Slices

Slice	File System	Usually Found on Client or Server Systems?	Comments
0	root (/)	Both	Holds files and directories that make up the OS. EFI – You cannot boot from a disk with an EFI label.
1	swap	Both	Provides virtual memory, or <i>swap space</i> .

TABLE 10-2 UFS Customary Disk Slices (Continued)

Slice	File System	Usually Found on Client or Server Systems?	Comments
2	—	Both	<p>VTOC – Refers to the entire disk, by convention. The size of this slice should not be changed.</p> <p>EFI – Optional slice to be defined based on your site's needs.</p>
3	/export, for example	Both	<p>Optional slice that can be defined based on your site's needs.</p> <p>Can be used on a server to hold alternative versions of operating systems that are required by client systems.</p>
4		Both	Optional slice to be defined based on your site's needs.
5	/opt, for example	Both	<p>Optional slice to be defined based on your site's needs.</p> <p>Can be used to hold application software added to a system. If a slice is not allocated for the /opt file system during installation, the /opt directory is put in slice 0.</p>
6	/usr	Both	Holds OS commands (also known as <i>executables</i>). This slice also holds documentation, system programs (<i>init</i> and <i>syslogd</i> , for example), and library routines.
7	/home or /export/home	Both	Holds files that are created by users.
8	N/A	N/A	<p>VTOC – Contains GRUB boot information.</p> <p>EFI – A reserved slice created by default. This area is similar to the VTOC's alternate cylinders. Do not modify or delete this slice.</p>
9 (x86 only)	—	Both	<p>EFI – Not applicable.</p> <p>VTOC – Provides an area that is reserved for alternate disk blocks. Slice 9 is known as the alternate sector slice.</p>

Note – On a disk with a VTOC label, do not modify slice or use slice 2 to store a file system. Products, such as Solaris Volume Manager, Solaris Live Upgrade, and `installgrub`, do not work correctly if slice 2 is modified in any way.

Using Raw Data Slices

The disk label is stored in block 0 of each disk. So, third-party database applications that create raw data slices must not start at block 0. Otherwise, the disk label will be overwritten, and the data on the disk will be inaccessible.

Do not use the following areas of the disk for raw data slices, which are sometimes created by third-party database applications:

- Block 0 where the disk label is stored
- Slice 2, which represents the entire disk with a VTOC label

Slice Arrangements on Multiple Disks

Although a single large disk can hold all slices and their corresponding UFS file systems, two or more disks are often used to hold a system's slices and file systems.

Note – A slice cannot be split between two or more disks. However, multiple swap slices on separate disks are allowed.

For instance, a single disk might hold the UFS root (`/`) file system, a swap area, and the `/usr` file system, while another disk holds the `/export/home` file system and other file systems that contain user data.

When you arrange a system's file systems on multiple disks, you can modify non-root UFS file systems and slices on the disks without having to shut down the system or reload the OS.

ZFS file systems do not correspond to specific disk slices, except for the ZFS root pool, which needs to contain a disk slice. This is a long-standing boot limitation. In addition, the Solaris OS components of a ZFS root file system include the following restrictions:

- All subdirectories of the root file system that are part of the OS image, with the exception of `/var`, must be in the same dataset as the root file system.
- All Solaris OS components must reside in the root pool, with the exception of the swap and dump devices.
- Another restriction is that the `/var` directory or dataset must be a single dataset. For example, you cannot create a descendent `/var` file system, such as `/var/tmp`, if you want to also use Oracle Solaris Live Upgrade to migrate or patch a ZFS BE or create a ZFS flash archive of this pool.

When you have more than one disk, you also increase input-output (I/O) volume. By distributing disk load across multiple disks, you can avoid I/O bottlenecks.

Determining Which Slices to Use for UFS File Systems

When you set up a disk's UFS file systems, you choose not only the size of each slice, but also which slices to use. Your decisions about these matters depend on the configuration of the system to which the disk is attached and the software you want to install on the disk.

System configurations that need disk space are as follows:

- Servers
- Stand-alone systems

Each system configuration can use slices in a different way. The following table lists some examples.

TABLE 10-3 System Configurations and Slices for UFS File Systems

Slice	Servers	Stand-alone Systems
0	root	root
1	swap	swap
2	—	—
3	/export	—
6	/usr	/usr
7	/export/home	/home

For more information about UFS system configurations, see [“Overview of System Types” in *System Administration Guide: Basic Administration*](#).

Note – The Solaris installation utility provides default slice sizes based on the software you select for installation.

format Utility

Read the following overview of the `format` utility and its uses before proceeding to the “how-to” or reference sections.

The `format` utility is a system administration tool that is used to prepare hard disk drives for use on your Oracle Solaris system.

The following table shows the features and associated benefits that the `format` utility provides.

TABLE 10–4 Features and Benefits of the format Utility

Feature	Benefit
Searches your system for all attached disk drives	Reports on the following: <ul style="list-style-type: none"> ▪ Target location ▪ Disk geometry ▪ Whether the disk is formatted ▪ If the disk has mounted partitions
Retrieves disk labels	Convenient for repair operations
Repairs defective sectors	Allows administrators to repair disk drives with recoverable errors instead of sending the drive back to the manufacturer
Formats and analyzes a disk	Creates sectors on the disk and verifies each sector
Partitions a disk	Divides a disk into slices so that individual UFS file systems can be created on separate slices. ZFS file systems do not correspond to disk slices except for the ZFS root pool.
Labels a disk	Writes disk name and configuration information to the disk for future retrieval (usually for repair operations)

The format utility options are described in [Chapter 15, “The format Utility \(Reference\).”](#)

When to Use the format Utility

Disk drives are partitioned and labeled by the Oracle Solaris installation utility when you install the Oracle Solaris release. You can use the format utility to do the following:

- Display slice information
- Partition a disk
- Add a disk drive to an existing system
- Format a disk drive
- Label a disk
- Repair a disk drive
- Analyze a disk for errors

The main reason a system administrator uses the format utility is to partition a disk. These steps are covered in [Chapter 12, “SPARC: Setting Up Disks \(Tasks\),”](#) and [Chapter 13, “x86: Setting Up Disks \(Tasks\).”](#)

See the following section for guidelines on using the format utility.

Guidelines for Using the format Utility

TABLE 10-5 format Utility Guidelines

Task	Guidelines	For More Information
Format a disk.	<ul style="list-style-type: none"> ■ Any existing data is destroyed when you reformat a disk. ■ The need for formatting a disk drive has decreased as more and more manufacturers ship their disk drives formatted and partitioned. You might not need to use the format utility when you add or replace a disk drive to an existing system. ■ If a disk has been relocated and is displaying many disk errors, you can attempt to relabel it. 	<p>“How to Format a Disk” on page 203 or “How to Label a Disk” on page 206</p>
Set up a disk that contains a UFS root file system.	UFS root file system data from the damaged disk must be restored from a backup medium. Otherwise, the system will have to be reinstalled by using the installation utility.	<p>“SPARC: How to Set Up a Disk for a UFS Root File System” on page 216, “x86: How to Set Up a Disk for a UFS Root File System” on page 234, or, if the system must be reinstalled, <i>Oracle Solaris 10 8/11 Installation Guide: Basic Installations</i></p>
Set up a disk that contains a ZFS root file system.	In a non-redundant configuration, a ZFS root file system data from the damaged disk must be restored from a backup medium. Otherwise, the system will have to be reinstalled by using the installation utility.	<p>“SPARC: How to Set Up a Disk for a ZFS Root File System” on page 225 or “x86: How to Set Up a Disk for a ZFS Root File System” on page 240, or, if the system must be reinstalled, <i>Oracle Solaris 10 8/11 Installation Guide: Basic Installations</i></p>
Create a disk slice for a root pool.	<ul style="list-style-type: none"> ■ The best way to use a ZFS storage pool is by creating a pool with whole disks. ■ If a disk is intended to be used for a root pool, you must create a disk slice. This is long-standing boot limitation. 	<p>“SPARC: How to Create a Disk Slice for a ZFS Root File System” on page 226 or “x86: How to Create a Disk Slice for a ZFS Root File System” on page 241</p>

TABLE 10-5 format Utility Guidelines (Continued)

Task	Guidelines	For More Information
Set up a disk that contains a UFS file system.	A disk that is used for a non-root UFS file system usually contains space for user or data files. Any existing data must be restored from backup media if the disk is changed or repartitioned.	“SPARC: How to Set Up a Disk for a UFS File System” on page 217 or “x86: How to Connect a Disk for a UFS File System” on page 235
Set up a disk that contains a ZFS file system.	A disk that is used for a non-root ZFS file system usually contains space for user or data files. You can attach or add another disk to a root pool or a non-root pool for more disk space.	“SPARC: How to Set Up a Disk for a ZFS File System” on page 230 or “x86: How to Set Up a Disk for a ZFS File System” on page 245

Formatting a Disk

In most cases, disks are formatted by the manufacturer or reseller. So, they do not need to be reformatted when you install the drive. To determine if a disk is formatted, use the `format` utility. For more information, see [“How to Determine if a Disk Is Formatted” on page 202](#).

If you determine that a disk is not formatted, use the `format` utility to format the disk.

When you format a disk, you accomplish two steps:

- The disk media is prepared for use.
- A list of disk defects based on a surface analysis is compiled.



Caution – Formatting a disk is a destructive process because it overwrites data on the disk. For this reason, disks are usually formatted only by the manufacturer or reseller. If you think disk defects are the cause of recurring problems, you can use the `format` utility to do a surface analysis. However, be careful to use only the commands that do not destroy data. For details, see [“How to Format a Disk” on page 203](#).

A small percentage of total disk space that is available for data is used to store defect and formatting information. This percentage varies according to disk geometry, and decreases as the disk ages and develops more defects.

Formatting a disk might take anywhere from a few minutes to several hours, depending on the type and size of the disk.

Partitioning a Disk

The `format` utility is most often used by system administrators to partitioning a disk. The steps are as follows:

- Determining which slices are needed
- Determining the size of each slice or partition
- Using the `format` utility to partition the disk
- Labeling the disk with new partition information
- Creating the file system for each partition

The easiest way to partition a disk is to use the `modify` command from the partition menu of the `format` utility. The `modify` command allows you to create partitions by specifying the size of each partition without having to keep track of the starting cylinder boundaries. The `modify` command also keeps tracks of any disk space that remains in the “free hog” slice.

Partition Table Terminology

An important part of the disk label is the *partition table*. The partition table identifies a disk's slices, the slice boundaries (in cylinders), and the total size of the slices. You can display a disk's partition table by using the `format` utility. The following describes partition table terminology.

TABLE 10-6 Partition Table Terminology

Partition Term	Value	Description
Number	0–7	VTOC – Partitions or slices, numbered 0–7. EFI – Partitions or slices, numbered 0–6.
Tag	0=UNASSIGNED 1=BOOT 2=ROOT 3=SWAP 4=USR 5=BACKUP 7=VAR 8=HOME 11=RESERVED	A numeric value that usually describes the file system mounted on this partition.
Flags	wm wu rm rm	The partition is writable and mountable. The partition is writable and unmountable. This state is the default for partitions that are dedicated for swap areas. (However, the <code>mount</code> command does not check the “not mountable” flag.) The partition is read only and mountable.

Partition flags and tags are assigned by convention and require no maintenance.

For more information on displaying the partition table, see the following references:

- [“Displaying Partition Table Information” on page 196](#)

- “How to Display Disk Slice Information” on page 204
- “How to Examine a Disk Label” on page 210

Displaying Partition Table Information

The following format utility output shows an example of a partition table from a 74-GB disk with a VTOC label displayed:

Total disk cylinders available: 38756 + 2 (reserved cylinders)

Part	Tag	Flag	Cylinders	Size	Blocks
0	root	wm	3 - 2083	4.00GB	(2081/0/0) 8390592
1	swap	wu	2084 - 3124	2.00GB	(1041/0/0) 4197312
2	backup	wm	0 - 38755	74.51GB	(38756/0/0) 156264192
3	unassigned	wm	0	0	(0/0/0) 0
4	unassigned	wm	0	0	(0/0/0) 0
5	unassigned	wm	0	0	(0/0/0) 0
6	unassigned	wm	0	0	(0/0/0) 0
7	home	wm	3125 - 38755	68.50GB	(35631/0/0) 143664192
8	boot	wu	0 - 0	1.97MB	(1/0/0) 4032
9	alternates	wu	1 - 2	3.94MB	(2/0/0) 8064

partition>

The partition table displayed by the format utility contains the following information.

Column Name	Description
Part	Partition or slice number. See Table 10–6 for a description of this column.
Tag	Partition tag. See Table 10–6 for a description of this column.
Flag	Partition flag. See Table 10–6 for a description of this column.
Cylinders	The starting and ending cylinder number for the slice. Not displayed on EFI-labeled disks.
Size	The slice size in MB.
Blocks	The total number of cylinders and the total number of sectors per slice. Not displayed on EFI-labeled disks.
First Sector	EFI – The starting block number. Not displayed on VTOC-labeled disks.
Last Sector	EFI – The ending block number. Not displayed on VTOC-labeled disks.

The following is an example of an EFI disk label displayed by using the `prtvtoc` command.

```
# prtvtoc /dev/rdisk/c4t1d0s0
* /dev/rdisk/c4t1d0s0 partition map
*
```

```

* Dimensions:
*   512 bytes/sector
* 2576941056 sectors
* 2576940989 accessible sectors
*
* Flags:
*  1: unmountable
* 10: read-only
*
*
* Partition  Tag  Flags      First      Sector      Last
* Partition  Tag  Flags      Sector     Count       Sector  Mount Directory
*      0      2    00          34    629145600  629145633
*      1      4    00    629145634    629145600  1258291233
*      6      4    00    1258291234    1318633404  2576924637
*      8     11    00    2576924638         16384  2576941021

```

The output of the `prtvtoc` command provides information in the following three sections:

- Dimensions
- Flags
- Partition Table

prtvtoc Column Name	Description
Partition	Partition or slice number. For a description of this column, see Table 10–6 .
Tag	Partition tag. For a description of this column, see Table 10–6 .
Flags	Partition flag. For a description of this column, see Table 10–6 .
First Sector	The first sector of the slice.
Sector Count	The total number of sectors in the slice.
Last Sector	The last sector of the slice.
Mount Directory	The last mount point directory for the file system.

Using the Free Hog Slice

When you use the `format` utility to change the size of one or more disk slices, you designate a temporary slice that will expand and shrink to accommodate the resizing operations.

This temporary slice donates, or “frees,” space when you expand a slice, and receives, or “hogs,” the discarded space when you shrink a slice. For this reason, the donor slice is sometimes called the *free hog*.

The free hog slice exists only during installation or when you run the `format` utility. There is no permanent free hog slice during day-to-day operations.

For information on using the free hog slice, see the following sections:

- “[SPARC: How to Create Disk Slices for a UFS File System](#)” on page 218

- “x86: How to Create Disk Slices for UFS File Systems” on page 235
- “SPARC: How to Create a Disk Slice for a ZFS Root File System” on page 226
- “x86: How to Create a Disk Slice for a ZFS Root File System” on page 241

Administering Disks (Tasks)

This chapter contains disk administration procedures. Many procedures described in this chapter are optional if you are already familiar with how disks are managed on systems running the Oracle Solaris OS.

For information on the procedures associated with administering disks, see [“Administering Disks \(Task Map\)” on page 199](#).

For overview information about disk management, see [Chapter 10, “Managing Disks \(Overview\)”](#).

Administering Disks (Task Map)

Task	Description	For Instructions
Identify the disks on a system.	If you are not sure of the types of disks on a system, use the <code>format</code> utility to identify the disk types.	“How to Identify the Disks on a System” on page 200
Format the disk.	Determine whether a disk is already formatted by using the <code>format</code> utility. In most cases, disks are already formatted. Use the <code>format</code> utility if you need to format a disk.	“How to Determine if a Disk Is Formatted” on page 202 “How to Format a Disk” on page 203
Display slice information.	Display slice information by using the <code>format</code> utility.	“How to Display Disk Slice Information” on page 204
Label the disk.	Create the disk label by using the <code>format</code> utility.	“How to Label a Disk” on page 206

Task	Description	For Instructions
Examine the disk label.	Examine the disk label by using the <code>prtvtoc</code> command.	“How to Examine a Disk Label” on page 210
Recover a corrupted disk label.	You can attempt to recover a disk label that was damaged due to a system or power failure.	“How to Recover a Corrupted Disk Label” on page 212

Identifying Disks on a System

Use the `format` utility to discover the types of disks that are connected to a system. You can also use the `format` utility to verify that a disk is known to the system. For detailed information on using the `format` utility, see [Chapter 15, “The `format` Utility \(Reference\).”](#)

▼ How to Identify the Disks on a System

1 Become superuser or assume an equivalent role.

Roles contain authorizations and privileged commands. For more information about roles, see [“Configuring RBAC \(Task Map\)” in *System Administration Guide: Security Services*](#).

2 Identify the disks that are recognized on the system by using the `format` utility.

```
# format
```

The `format` utility displays a list of disks that it recognizes under AVAILABLE DISK SELECTIONS.

Example 11-1 Identifying the Disks on a System

The following example shows `format` command output.

```
# format
AVAILABLE DISK SELECTIONS:
  0. c2t0d0 <SUN72G cyl 14087 alt 2 hd 24 sec 424>
    /pci@1c,600000/scsi@2/sd@0,0
  1. c2t1d0 <SUN72G cyl 14087 alt 2 hd 24 sec 424>
    /pci@1c,600000/scsi@2/sd@1,0
  2. c2t2d0 <SUN146G cyl 14087 alt 2 hd 24 sec 848>
    /pci@1c,600000/scsi@2/sd@2,0
  3. c2t3d0 <SUN146G cyl 14087 alt 2 hd 24 sec 848>
    /pci@1c,600000/scsi@2/sd@3,0
Specify disk (enter its number):
```

The output associates a disk's physical and logical device name to the disk's marketing name, which appears in angle brackets `<>`. See the example below. This method is an easy way to identify which logical device names represent the disks that are connected to your system. For a description of logical and physical device names, see [“Device Naming Conventions” on page 77](#).

The following example uses a wildcard to display the four disks that are connected to a controller 0.

```
# format /dev/rdisk/c0t6*
AVAILABLE DISK SELECTIONS:
  0. /dev/rdisk/c0t600A0B800022024E000054AC4970A629d0p0 <...>
    /scsi_vhci/disk@g600a0b800022024e000054ac4970a629
  1. /dev/rdisk/c0t600A0B800022024E000054AE4970A711d0p0 <...>
    /scsi_vhci/disk@g600a0b800022024e000054ae4970a711
  2. /dev/rdisk/c0t600A0B800022028A000050444970A834d0p0 <....>
    /scsi_vhci/disk@g600a0b800022028a000050444970a834
  3. /dev/rdisk/c0t600A0B800022028A000050454970A8EAd0p0 <...>
    /scsi_vhci/disk@g600a0b800022028a000050454970a8ea
Specify disk (enter its number):
```

The following example shows how to identify the disk information.

```
# format
0. c2t0d0 <SUN36G cyl 24620 alt 2 hd 27 sec 107>
   /pci@1c,600000/scsi@2/sd@0,0
```

The output identifies that disk 0 (target 0) is connected to the second SCSI host adapter (`scsi@2`), which is connected to the second PCI interface (`/pci@1c,600000/...`). The output also associates both the physical and logical device name to the disk's marketing name, SUN36G.

Some disks do not have a marketing name. If the `format` output does not identify disks by their marketing names, then you can use the `format` utility's `type` and `label` features as described in the following steps to include the disk's marketing name.

The following steps must be done while the disk or system is inactive, which means booting from an installation DVD or the network. unless the disk is currently unused and it will not contain the Oracle Solaris release. In addition, the final step is to relabel the disk, which can remove any existing partition information or data.

```
# format
Searching for disks...done

AVAILABLE DISK SELECTIONS:
  0. c2t0d0 <SUN36G cyl 24620 alt 2 hd 27 sec 107>
    /pci@1c,600000/scsi@2/sd@0,0
  1. c2t1d0 <SEAGATE-ST336607LSUN36G-0307-33.92GB>
    /pci@1c,600000/scsi@2/sd@1,0
  2. c2t2d0 <SEAGATE-ST336607LSUN36G-0507-33.92GB>
    /pci@1c,600000/scsi@2/sd@2,0
  3. c2t3d0 <drive type unknown>
    /pci@1c,600000/scsi@2/sd@3,0
Specify disk (enter its number): 3
selecting c2t3d0
[disk formatted]
format> type
AVAILABLE DRIVE TYPES:
  0. Auto configure
  1. other
```

```
Specify disk type (enter its number): 0
c2t3d0: configured with capacity of 33.92GB
<SEAGATE-ST336607LSUN36G-0507-33.92GB>
[disk formatted]
format> label
Ready to label disk, continue? yes
format> quit
```

More Information If the format Utility Does Not Recognize a Disk ...

- Go to [Chapter 12, “SPARC: Setting Up Disks \(Tasks\)”](#) or [Chapter 13, “x86: Setting Up Disks \(Tasks\)”](#).
- Go to [“How to Label a Disk” on page 206](#).
- Connect the disk to the system by using your disk hardware documentation.

Formatting a Disk

Disks are typically formatted by the manufacturer or reseller. They usually do not need to be reformatted when you install the drive.

A disk must be formatted before you can do the following:

- Write data to the disk. However, most disks are already formatted.
- Use the Oracle Solaris installation utility to install the system.



Caution – Formatting a disk is a destructive process because it overwrites data on the disk. For this reason, disks are usually formatted only by the manufacturer or reseller. If you think disk defects are the cause of recurring problems, you can use the `format` utility to do a surface analysis. However, be careful to use only the commands that do not destroy data.

▼ How to Determine if a Disk Is Formatted

- 1 **Become superuser or assume an equivalent role.**
- 2 **Invoke the `format` utility.**

```
# format
```

A numbered list of disks is displayed.
- 3 **Type the number of the disk that you want to check.**

```
Specify disk (enter its number): 0
```
- 4 **Verify that the disk you chose is formatted by noting the following message:**

```
[disk formatted]
```

Example 11–2 Determining if a Disk Is Formatted

The following example shows that disk `c2t3d0` is formatted.

```
# format
AVAILABLE DISK SELECTIONS:
  0. c2t0d0 <SUN72G cyl 14087 alt 2 hd 24 sec 424>
     /pci@1c,600000/scsi@2/sd@0,0
  1. c2t1d0 <SUN72G cyl 14087 alt 2 hd 24 sec 424>
     /pci@1c,600000/scsi@2/sd@1,0
  2. c2t2d0 <SUN146G cyl 14087 alt 2 hd 24 sec 848>
     /pci@1c,600000/scsi@2/sd@2,0
  3. c2t3d0 <SUN146G cyl 14087 alt 2 hd 24 sec 848>
     /pci@1c,600000/scsi@2/sd@3,0
Specify disk (enter its number): 3
selecting c2t3d0
[disk formatted]
```

▼ How to Format a Disk

Disks are formatted by the manufacturer. Reformatting a disk should occur rarely. The process is time-consuming and removes all data from the disk.

1 Become superuser or assume an equivalent role.

2 Invoke the `format` utility.

```
# format
```

A numbered list of disks is displayed.

3 Type the number of the disk that you want to format.

```
Specify disk (enter its number): 3
```



Caution – Do not select the disk that contains the root file system. If you format a root pool disk, you delete the OS and any data on this disk.

4 To begin formatting the disk, type `format` at the `format>` prompt. Confirm the command by typing `y`.

```
format> format
```

```
The protection information is not enabled
The disk will be formatted with protection type 0
```

```
Ready to format. Formatting cannot be interrupted
and takes 169 minutes (estimated). Continue? yes
```

5 Verify that the disk format was successful by noting the following messages:

```
Beginning format. The current time is Fri Apr 1 ...
```

```
Formatting...
```

```
done

Verifying media...
    pass 0 - pattern = 0xc6dec6de
14086/23/734

    pass 1 - pattern = 0x6db6db6d
14086/23/734

Total of 0 defective blocks repaired.
```

6 Exit the format utility.

```
format> quit
```

Displaying Disk Slices

The best way to create ZFS storage pools is to use whole disks instead of disk slices because whole disks are easier to manage. The only time you need to use a disk slice is when the disk is intended for the ZFS root pool. This is a long-standing boot limitation. For non-root pools, use whole disks. When you create a pool with whole disks, an EFI label is applied. See the EFI disk label example below.

If you need to prepare a disk for use a root pool disk, create slice 0 that contains the entire disk capacity, as shown in the VTOC disk label example below.

For information about setting up disks for use with ZFS storage pools, see [Chapter 12, “SPARC: Setting Up Disks \(Tasks\)”](#), or [Chapter 13, “x86: Setting Up Disks \(Tasks\)”](#).

Note – The format utility uses the term *partition* instead of *slice*.

▼ How to Display Disk Slice Information

You might need to display disk slice information if the disk is intended to be used for the ZFS root pool. It must also include a SMI label.

1 Become superuser or assume an equivalent role.

2 Invoke the format utility.

```
# format
```

A numbered list of disks is displayed.

3 Type the number of the disk for which you want to display slice information.

```
Specify disk (enter its number):1
```

4 Select the partition menu.

```
format> partition
```

5 Display the slice information for the selected disk.

```
partition> print
```

6 Exit the format utility.

```
partition> q
format> q
#
```

7 Verify the displayed slice information by identifying specific slice tags and slices.

If the screen output shows that no slice sizes are assigned, the disk probably does not have slices.

Example 11-3 Displaying Disk Slice Information

The following example displays slice information for a disk with a VTOC label.

```
# format
Searching for disks...done
Specify disk (enter its number):3
Selecting c2t3d0
format> partition
partition> print
Current partition table (c2t3d0):
Total disk cylinders available: 14087 + 2 (reserved cylinders)

Part    Tag    Flag    Cylinders    Size    Blocks
  0     root   wm      0 - 14086    136.71GB (14087/0/0) 286698624
  1     swap   wu      0            0 (0/0/0) 0
  2  backup wu      0 - 14086    136.71GB (14087/0/0) 286698624
  3 unassigned wm      0            0 (0/0/0) 0
  4 unassigned wm      0            0 (0/0/0) 0
  5 unassigned wm      0            0 (0/0/0) 0
  6     usr   wm      0            0 (0/0/0) 0
  7 unassigned wm      0            0 (0/0/0) 0
partition> q
format> q
```

For a detailed description of the slice information in these examples, see [Chapter 10, “Managing Disks \(Overview\)”](#).

The following example shows the slice information for a disk with an EFI label.

```
# format
Searching for disks...done
Specify disk (enter its number): 3
selecting c2t3d0
[disk formatted]
format> partition
partition> print
Current partition table (default):
```

Total disk sectors available: 286722878 + 16384 (reserved sectors)

Part	Tag	Flag	First Sector	Size	Last Sector
0	usr	wm	34	136.72GB	286722911
1	unassigned	wm	0	0	0
2	unassigned	wm	0	0	0
3	unassigned	wm	0	0	0
4	unassigned	wm	0	0	0
5	unassigned	wm	0	0	0
6	unassigned	wm	0	0	0
7	unassigned	wm	0	0	0
8	reserved	wm	286722912	8.00MB	286739295

```
partition> q
format> q
```

Creating and Examining a Disk Label

The labeling of a disk is usually done during system installation or when you are using new disks. You might need to relabel a disk if the disk label becomes corrupted. For example, from a power failure.

The `format` utility attempts to automatically configure any unlabeled SCSI disk. If the `format` utility is able to automatically configure an unlabeled disk, it displays a message similar to the following:

```
c2t3d0: configured with capacity of 136.73GB
```

Tip – For information on labeling multiple disks with the same disk label, see [Example 11–7](#).

▼ How to Label a Disk

You can use the following procedure to do the following:

- Label a disk with a VTOC or an EFI label for a disk 2 terabytes in size.
- Label a disk that is greater than 2 terabytes in size with an EFI label.

If you want to put an EFI label on disk smaller than 2 terabytes, see [Example 11–5](#).

1 Become superuser or assume an equivalent role.

2 Invoke the `format` utility.

```
# format
```

A numbered list of disks is displayed.

3 Type the number of the disk that you want to label.

```
Specify disk (enter its number):1
```

If the format utility recognizes the disk type, the next step is to search for a backup label to label the disk. Labeling the disk with the backup label labels the disk with the correct partitioning information, the disk type, and disk geometry.

4 Select one of the following to label the disk:

- If the disk is unlabeled and was successfully configured, go to Step 5 to label the disk. The format utility will ask if you want to label the disk.
- If the disk is labeled but you want to change the disk type, or if the format utility was not able to automatically configure the disk, proceed to Step 6 to set the disk type and label the disk.

5 Label the disk by typing y at the Label it now? prompt.

Disk not labeled. Label it now? **y**

The disk is now labeled. Go to step 10 to exit the format utility.

6 Enter type at the format> prompt.

format> **type**

The Available Drive Types menu is displayed.

7 Select a disk type from the list of possible disk types.

Specify disk type (enter its number)[12]: **12**

Or, select 0 to automatically configure a SCSI-2 disk.

8 Label the disk. If the disk is not labeled, the following message is displayed.

Disk not labeled. Label it now? **y**

Otherwise, you are prompted with this message:

Ready to label disk, continue? **y**

9 Verify the disk label.

format> **verify**

10 Exit the format utility.

format> **q**
#

Example 11-4 Labeling a Disk

The following example shows how to automatically configure and label a 36-GB disk.

```
# format
AVAILABLE DISK SELECTIONS:
```

```

0. c0t0d0 <SUN36G cyl 24620 alt 2 hd 27 sec 107>
  /pci@lc,600000/scsi@2/sd@0,0
1. c0t1d0 <SEAGATE-ST336607LSUN36G-0307-33.92GB>
  /pci@lc,600000/scsi@2/sd@1,0
2. c0t2d0 <SEAGATE-ST336607LSUN36G-0507-33.92GB>
  /pci@lc,600000/scsi@2/sd@2,0
3. c0t3d0 <SEAGATE-ST336607LSUN36G-0507-33.92GB>
  /pci@lc,600000/scsi@2/sd@3,0
Specify disk (enter its number): 3
c0t3d0: configured with capacity of 33.92GB
Disk not labeled. Label it now? yes
format> verify
format> q
#

```

Example 11-5 Labeling a Disk With an EFI Label

The following example shows how to use the `format -e` command to label a disk with an EFI label. Remember to verify that your layered software products will continue to work on systems with EFI-labeled disks. For general information on EFI label restrictions, see [“Restrictions of the EFI Disk Label”](#) on page 184.

```

# format -e
Searching for disks...done
AVAILABLE DISK SELECTIONS:
0. c2t0d0 <SUN72G cyl 14087 alt 2 hd 24 sec 424>
  /pci@lc,600000/scsi@2/sd@0,0
1. c2t1d0 <SUN72G cyl 14087 alt 2 hd 24 sec 424>
  /pci@lc,600000/scsi@2/sd@1,0
2. c2t2d0 <FUJITSU-MAP3147N SUN146G-0501-136.73GB>
  /pci@lc,600000/scsi@2/sd@2,0
3. c2t3d0 <FUJITSU-MAP3147N SUN146G-0501-136.73GB>
  /pci@lc,600000/scsi@2/sd@3,0
Specify disk (enter its number): 3
selecting c2t3d0
[disk formatted]
format> Label
[0] SMI Label
[1] EFI Label
Specify Label type[0]: 1
Ready to label disk, continue? yes
format> quit

```

Example 11-6 Change a EFI-Labeled Disk to an SMI-Labeled Disk

The following example shows how to use the `format -e` command to change an EFI labeled disk to an SMI-labeled disk that can be used for a ZFS root pool.

```

# format -e
Searching for disks...done
AVAILABLE DISK SELECTIONS:
0. c2t0d0 <SUN72G cyl 14087 alt 2 hd 24 sec 424>
  /pci@lc,600000/scsi@2/sd@0,0
1. c2t1d0 <SUN72G cyl 14087 alt 2 hd 24 sec 424>

```



```

        /pci@1c,600000/scsi@2/sd@1,0
    2. c2t2d0 <FUJITSU-MAP3147N SUN146G-0501-136.73GB>
        /pci@1c,600000/scsi@2/sd@2,0
    3. c2t3d0 <FUJITSU-MAP3147N SUN146G-0501-136.73GB>
        /pci@1c,600000/scsi@2/sd@3,0
Specify disk (enter its number): 3
selecting c2t0d0
[disk formatted]
format> label
[0] SMI Label
[1] EFI Label
Specify Label type[1]: 0
Ready to label disk, continue? yes

```

You should also check the default partition table to ensure that it is optimal for a root pool slice, which means that the bulk of the disk space is in slice 0. See the steps below to increase the size of slice 0.

```

format> partition
partition> print
Current partition table (default):
Total disk cylinders available: 14085 + 2 (reserved cylinders)

```

Part	Tag	Flag	Cylinders	Size	Blocks
0	root	wm	1 - 13	129.19MB	(13/0/0) 264576
1	swap	wu	14 - 26	129.19MB	(13/0/0) 264576
2	backup	wu	0 - 14086	136.71GB	(14087/0/0) 286698624
3	unassigned	wm	0	0	(0/0/0) 0
4	unassigned	wm	0	0	(0/0/0) 0
5	unassigned	wm	0	0	(0/0/0) 0
6	usr	wm	27 - 14084	136.43GB	(14058/0/0) 286108416
7	unassigned	wm	0	0	(0/0/0) 0
8	boot	wu	0 - 0	9.94MB	(1/0/0) 20352
9	alternates	wm	0	0	(0/0/0) 0

```

partition> modify
Select partitioning base:
    0. Current partition table (default)
    1. All Free Hog
Choose base (enter number) [0]? 1

```

Part	Tag	Flag	Cylinders	Size	Blocks
0	root	wm	0	0	(0/0/0) 0
1	swap	wu	0	0	(0/0/0) 0
2	backup	wu	0 - 14084	136.69GB	(14085/0/0) 286657920
3	unassigned	wm	0	0	(0/0/0) 0
4	unassigned	wm	0	0	(0/0/0) 0
5	unassigned	wm	0	0	(0/0/0) 0
6	usr	wm	0	0	(0/0/0) 0
7	unassigned	wm	0	0	(0/0/0) 0
8	boot	wu	0 - 0	9.94MB	(1/0/0) 20352
9	alternates	wm	0	0	(0/0/0) 0

```

Do you wish to continue creating a new partition
table based on above table[yes]? yes
Free Hog partition[6]? 0
Enter size of partition '1' [0b, 0c, 0.00mb, 0.00gb]:

```

```

Enter size of partition '3' [0b, 0c, 0.00mb, 0.00gb]:
Enter size of partition '4' [0b, 0c, 0.00mb, 0.00gb]:
Enter size of partition '5' [0b, 0c, 0.00mb, 0.00gb]:
Enter size of partition '6' [0b, 0c, 0.00mb, 0.00gb]:
Enter size of partition '7' [0b, 0c, 0.00mb, 0.00gb]:

```

Part	Tag	Flag	Cylinders	Size	Blocks
0	root	wm	1 - 14084	136.68GB	(14084/0/0) 286637568
1	swap	wu	0	0	(0/0/0) 0
2	backup	wu	0 - 14084	136.69GB	(14085/0/0) 286657920
3	unassigned	wm	0	0	(0/0/0) 0
4	unassigned	wm	0	0	(0/0/0) 0
5	unassigned	wm	0	0	(0/0/0) 0
6	usr	wm	0	0	(0/0/0) 0
7	unassigned	wm	0	0	(0/0/0) 0
8	boot	wu	0 - 0	9.94MB	(1/0/0) 20352
9	alternates	wm	0	0	(0/0/0) 0

```

Okay to make this the current partition table[yes]? yes
Enter table name (remember quotes): "c2t0d0"
Ready to label disk, continue? yes
partition> quit
format> quit

```

Example 11-7 Labeling Multiple Disks

You can use the `prtvtoc` and `fmthard` commands to label multiple disks with the same disk geometry.

Use the following for loop in a script to copy a disk label from one disk and replicate it on multiple disks.

```

# for i in xyz
> do
> prtvtoc /dev/rdisk/cwtxdysz | fmthard -s - /dev/rdisk/cwt${i}d0s2
> done

```

In this example, the disk label from `c2t0d0s0` is copied to four other disks.

```

# for i in 1 2 3 5
> do
> prtvtoc /dev/rdisk/c2t0d0s0 | fmthard -s - /dev/rdisk/c2t${i}d0s2
> done
fmthard: New volume table of contents now in place.
fmthard: New volume table of contents now in place.
fmthard: New volume table of contents now in place.
fmthard: New volume table of contents now in place.

```

▼ How to Examine a Disk Label

Examine disk label information by using the `prtvtoc` command. For a detailed description of the disk label and the information that is displayed by the `prtvtoc` command, see [Chapter 10, “Managing Disks \(Overview\).”](#)

- 1 Become superuser or assume an equivalent role.
- 2 Display the disk label information.

```
# prtvtoc /dev/rdisk/device-name
```

where *device-name* is the raw disk device you want to examine.

Example 11-8 Examining a Disk Label

The following example shows disk label information for a disk with a VTOC label.

```
# prtvtoc /dev/rdisk/c2t3d0s0
* /dev/rdisk/c2t3d0s0 partition map
*
* Dimensions:
*   512 bytes/sector
*   848 sectors/track
*   24 tracks/cylinder
* 20352 sectors/cylinder
* 14089 cylinders
* 14087 accessible cylinders
*
* Flags:
* 1: unmountable
* 10: read-only
*
*
* Partition  Tag  Flags      First      Sector      Last
*           0    2    00        Sector    Count    Sector  Mount Directory
*           2    5    01          0 286698624 286698623
*           2    5    01          0 286698624 286698623
```

The following example shows disk label information for a disk with an EFI label.

```
# prtvtoc /dev/rdisk/c2t3d0s0
* /dev/rdisk/c2t3d0s0 partition map
*
* Dimensions:
*   512 bytes/sector
*   848 sectors/track
*   24 tracks/cylinder
* 20352 sectors/cylinder
* 14089 cylinders
* 14087 accessible cylinders
*
* Flags:
* 1: unmountable
* 10: read-only
*
*
* Partition  Tag  Flags      First      Sector      Last
*           0    2    00        Sector    Count    Sector  Mount Directory
*           2    5    01          0 286698624 286698623
*           2    5    01          0 286698624 286698623
```

Recovering a Corrupted Disk Label

Sometimes, a power or system failure causes a disk's label to become unrecognizable. A corrupted disk label doesn't always mean that the slice information or the disk's data must be re-created or restored.

The first step to recovering a corrupted disk label is to label the disk with the correct geometry and disk type information. You can complete this step through the normal disk labeling method, by using either automatic configuration or manual disk type specification.

If the `format` utility recognizes the disk type, the next step is to search for a backup label to label the disk. Labeling the disk with the backup label labels the disk with the correct partitioning information, the disk type, and disk geometry.

▼ How to Recover a Corrupted Disk Label

1 Boot the system to single-user mode.

If necessary, boot the system from a local Oracle Solaris DVD or the network in single-user mode to access the disk.

See Chapter 12, “Booting an Oracle Solaris System (Tasks),” in *System Administration Guide: Basic Administration* or “Booting an x86 Based System by Using GRUB (Task Map)” in *System Administration Guide: Basic Administration* for information on booting the system.

2 Relabel the disk.

```
# format
```

The `format` utility attempts to automatically configure any unlabeled SCSI disk. If the `format` utility is able to configure the unlabeled and corrupted disk, it will display this message:

```
cwtxdy: configured with capacity of abcMB
```

The `format` utility then displays a numbered list of disks on the system.

3 Type the number of the disk that you need to recover.

```
Specify disk (enter its number): 1
```

4 Select one of the following to determine how to label the disk.

- If the disk was configured successfully, follow Steps 5 and 6. Then go to step 12.
- If the disk was not configured successfully, follow Steps 7–11. Then go to step 12.

5 Search for the backup label.

```
format> verify
```

```
Warning: Could not read primary label.
```

```
Warning: Check the current partitioning and 'label' the disk or
```

use the 'backup' command.

Backup label contents:

```
Volume name = <          >
ascii name  = <FUJITSU-MAP3147N SUN146G-0501>
pcyl        = 14089
ncyl        = 14087
acyl        = 2
nhead       = 24
nsect       = 848
```

Part	Tag	Flag	Cylinders	Size	Blocks
0	root	wm	0 - 14086	136.71GB	(14087/0/0) 286698624
1	swap	wu	0	0	(0/0/0) 0
2	backup	wu	0 - 14086	136.71GB	(14087/0/0) 286698624
3	unassigned	wm	0	0	(0/0/0) 0
4	unassigned	wm	0	0	(0/0/0) 0
5	unassigned	wm	0	0	(0/0/0) 0
6	usr	wm	0	0	(0/0/0) 0
7	unassigned	wm	0	0	(0/0/0) 0

- 6 If the format utility was able to find a backup label and the backup label contents appear satisfactory, use the backup command to label the disk with the backup label.**

```
format> backup
Disk has a primary label, still continue? y
```

```
Searching for backup labels...found.
Restoring primary label
```

The disk label has been recovered. Go to Step 12.

- 7 If the format utility was not able to automatically configure the disk, specify the disk type by using the type command.**

```
format> type
```

The Available Drives Type menu is displayed.

- 8 Select 0 to automatically configure the disk. Or, select a disk type from the list of possible disk types.**

```
Specify disk type (enter its number)[12]: 12
```

- 9 If the disk was successfully configured, reply with no when the format utility asks if you want to label the disk.**

```
Disk not labeled. Label it now? no
```

- 10 Use the verify command to search for backup labels.**

```
format> verify
Warning: Could not read primary label.
Warning: Check the current partitioning and 'label' the disk
or use the 'backup' command.
```

```
.
.
.
```

- 11 If the format utility was able to find a backup label and the backup label contents appear satisfactory, use the backup command to label the disk with the backup label.**

```
format> backup
Disk has a primary label, still continue? y
Searching for backup labels...found.
Restoring primary label
```

The disk label has been recovered.

- 12 Exit the format utility.**

```
format> q
```

- 13 Verify the file systems on the recovered disk by using the fsck command.**

For information on using the fsck command, see [Chapter 20, “Checking UFS File System Consistency \(Tasks\)”](#).

Adding a Third-Party Disk

The Oracle Solaris OS supports many third-party disks. However, for the disk to be recognized, you might need to supply a device driver. Other options for adding disks are as follows:

- If you are adding a SCSI disk, you might try the format utility's automatic configuration feature.
- You might try hot-plugging a PCI, SCSI, or USB disk. For more information, see [Chapter 5, “Managing Devices \(Overview/Tasks\)”](#).

Note – Oracle cannot guarantee that its format utility will work properly with all third-party disk drivers. If the disk driver is not compatible with the Solaris format utility, the disk drive vendor should supply you with a custom disk formatting program.

Typically, you discover that software support is missing when you invoke the format utility and find that the disk type is not recognized.

Refer to the appropriate configuration procedure for adding system disks or secondary disks in [Chapter 12, “SPARC: Setting Up Disks \(Tasks\)”](#), or [Chapter 13, “x86: Setting Up Disks \(Tasks\)”](#).

SPARC: Setting Up Disks (Tasks)

This chapter describes how to set up disks on a SPARC system.

For information on the procedures associated with setting up disks on a SPARC system, see the following sections:

- “SPARC: Setting Up Disks for UFS File Systems (Task Map)” on page 215
- “SPARC: Setting up Disks for ZFS File Systems (Task Map)” on page 223

For overview information about disk management, see [Chapter 10, “Managing Disks \(Overview\)”](#). For step-by-step instructions on setting up disks on an x86 based system, see [Chapter 13, “x86: Setting Up Disks \(Tasks\)”](#).

SPARC: Setting Up Disks for UFS File Systems (Task Map)

The following task map identifies the procedures for setting up a disk for a UFS root file system or a disk for a UFS file system on a SPARC based system.

Task	Description	For Instructions
1. Connect the disk.	<p><i>Disk for a UFS root file system</i></p> <p>Connect the new disk and boot from a local or remote Oracle Solaris DVD.</p> <p><i>Disk for a UFS file system</i></p> <p>Connect the disk.</p>	<p>“SPARC: How to Set Up a Disk for a UFS Root File System” on page 216</p> <p>“SPARC: How to Set Up a Disk for a UFS File System” on page 217</p>
2. Create slices and label the disk for UFS file systems.	Create disk slices and label the disk.	“SPARC: How to Create Disk Slices for a UFS File System” on page 218

Task	Description	For Instructions
3. Create UFS file systems.	Create UFS file systems on the disk slices by using the <code>newfs</code> command. You must re-create the root (<code>/</code>) or <code>/usr</code> file system, or both.	“SPARC: How to Create a UFS File System” on page 222
4. Restore UFS file systems.	Restore the UFS root (<code>/</code>) or <code>/usr</code> file system, or both. If necessary, restore file systems on other disks.	Chapter 25, “Restoring UFS Files and File Systems (Tasks)”
5. Install boot blocks for a UFS root file system.	Install the boot blocks on the root (<code>/</code>) file system so that the system can boot.	“SPARC: How to Install Boot Blocks for a UFS Root File System” on page 223

SPARC: Setting Up Disks for UFS File Systems

A disk can contain the UFS root (`/`) and `/usr` file systems, user or data file systems, or a combination of file systems. If the disk contains the UFS root (`/`) or `/usr` file systems, you have two ways to recover:

- You can reinstall the entire Oracle Solaris OS.
- Or, you can replace the disk and restore your Oracle Solaris OS file systems from a backup medium.

A disk that contains user or data file systems can be replaced and the file systems restored, if necessary, without having to reinstall or reboot the system.

▼ SPARC: How to Set Up a Disk for a UFS Root File System

You can use this procedure to replace a disk that contained the UFS root or `/usr` file system. Refer to your hardware installation guide for information on replacing a disk.

- 1 **Disconnect the damaged system disk from the system, if necessary.**
- 2 **Connect the replacement disk to the system and check the disk's physical connections.**
- 3 **Follow the instructions in the following table, depending on whether you are booting from a local Oracle Solaris DVD or a remote Oracle Solaris DVD from the network.**

Boot Type	Action
From an Oracle Solaris DVD in a local drive	1. Make sure the Oracle Solaris DVD is in the drive. 2. Boot from the media to single-user mode: ok boot cdrom -s
From the network	Boot from the network to single-user mode: ok boot net -s

After a few minutes, the root prompt (#) is displayed.

More Information After You Set Up a Disk for a UFS Root File System ...

Create slices for the UFS root and /usr file systems and a disk label on the disk. Go to [“SPARC: How to Create Disk Slices for a UFS File System” on page 218](#).

▼ SPARC: How to Set Up a Disk for a UFS File System

If you are adding a disk with an EFI disk label, see [“EFI Disk Label” on page 183](#) for more information.

Generally, most modern bus types support hot-plugging. This means you can insert a disk in an empty slot and the system recognizes it. For more information about hot-plugging devices, see [Chapter 6, “Dynamically Configuring Devices \(Tasks\)”](#).

- 1 Become superuser or assume an equivalent role.**
- 2 (Optional) If the disk type is unsupported by the Solaris software, add the device driver for the disk by following the instructions included with the hardware.**
- 3 Connect the disk to the system and check the disk's physical connections.**
Refer to the disk's hardware installation guide for details.
- 4 Use the format utility to confirm that the new disk is recognized.**

More Information After You Connect a Disk for a UFS File System ...

After the disk is connected, create slices and a disk label on the disk. Go to [“SPARC: How to Create Disk Slices for a UFS File System” on page 218](#).

▼ SPARC: How to Create Disk Slices for a UFS File System

1 Become superuser or assume an equivalent role.

2 Invoke the format utility.

```
# format
```

A numbered list of available disks is displayed.

3 Select the number of the disk that you want to repartition.

```
Specify disk (enter its number): disk-number
```

disk-number is the number of the disk that you want to repartition.

4 Select the partition menu.

```
format> partition
```

5 Display the current partition (slice) table.

```
partition> print
```

6 Start the modification process.

```
partition> modify
```

7 Set the disk to all free hog.

```
Choose base (enter number) [0]?1
```

For more information about the free hog slice, see [“Using the Free Hog Slice” on page 197](#).

8 Create a new partition table by answering y when prompted to continue.

```
Do you wish to continue creating a new partition table based on  
above table[yes]? y
```

9 Identify the free hog partition (slice) and the sizes of the slices when prompted.

When adding a system disk, you must set up slices for:

- root (slice 0) and swap (slice 1)
- /usr (slice 6)

After you identify the slices, the new partition table is displayed.

For an example of creating disk slices, see [Example 12-1](#).

10 Make the displayed partition table the current partition table by answering y when prompted.

```
Okay to make this the current partition table[yes]? y
```

If you do not want the current partition table and you want to change it, answer no and go to [Step 6](#).

11 Name the partition table.

Enter table name (remember quotes): "*partition-name*"

where *partition-name* is the name for the new partition table.

12 Label the disk with the new partition table after you have finished allocating slices on the new disk.

Ready to label disk, continue? **yes**

13 Quit the partition menu.

partition> **q**

14 Verify the disk label.

format> **verify**

15 Exit the format utility.

format> **q**

Example 12-1 SPARC: Creating Disk Slices for a UFS Root File System

The following example shows the `format` utility being used to divide a 18-GB disk into three slices: one slice for the root (`/`) file system, one slice for the swap area, and one slice for the `/usr` file system.

```
# format
AVAILABLE DISK SELECTIONS:
  0. /dev/rdisk/clt0d0s0 <SUN18G cyl 7506 alt 2 hd 19 sec 248>
    /sbus@2,0/QLGC,isp@2,10000/sd@0,0
  1. /dev/rdisk/clt1d0s0 <SUN18G cyl 7506 alt 2 hd 19 sec 248>
    /sbus@2,0/QLGC,isp@2,10000/sd@1,0
  2. /dev/rdisk/clt8d0s0 <SUN18G cyl 7506 alt 2 hd 19 sec 248>
    /sbus@2,0/QLGC,isp@2,10000/sd@8,0
  3. /dev/rdisk/clt9d0s0 <SUN18G cyl 7506 alt 2 hd 19 sec 248>
    /sbus@2,0/QLGC,isp@2,10000/sd@9,0
Specify disk (enter its number): 0
selecting clt0d0
[disk formatted]
format> partition
partition> print
partition> modify
Select partitioning base:
  0. Current partition table (original)
  1. All Free Hog
Part   Tag   Flag   Cylinders      Size          Blocks
  0     root   wm      0                0          (0/0/0)      0
  1     swap   wu      0                0          (0/0/0)      0
  2     backup  wu      0 - 7505        16.86GB      (7506/0/0) 35368272
  3 unassigned  wm      0                0          (0/0/0)      0
  4 unassigned  wm      0                0          (0/0/0)      0
  5 unassigned  wm      0                0          (0/0/0)      0
  6     usr    wm      0                0          (0/0/0)      0
```

```

7 unassigned   wm      0          0          (0/0/0)      0

Choose base (enter number) [0]? 1
table based on above table[yes]? yes
Free Hog partition[6]? 6
Enter size of partition '0' [0b, 0c, 0.00mb, 0.00gb]: 4gb
Enter size of partition '1' [0b, 0c, 0.00mb, 0.00gb]: 4gb
Enter size of partition '3' [0b, 0c, 0.00mb, 0.00gb]:
Enter size of partition '4' [0b, 0c, 0.00mb, 0.00gb]:
Enter size of partition '5' [0b, 0c, 0.00mb, 0.00gb]:
Enter size of partition '7' [0b, 0c, 0.00mb, 0.00gb]:
Part      Tag      Flag      Cylinders      Size      Blocks
0         root     wm        0 - 1780       4.00GB    (1781/0/0) 8392072
1         swap     wu        1781 - 3561    4.00GB    (1781/0/0) 8392072
2         backup   wu        0 - 7505       16.86GB   (7506/0/0) 35368272
3 unassigned wm        0              0          (0/0/0)      0
4 unassigned wm        0              0          (0/0/0)      0
5 unassigned wm        0              0          (0/0/0)      0
6         usr      wm        3562 - 7505    8.86GB    (3944/0/0) 18584128
7 unassigned wm        0              0          (0/0/0)      0

Okay to make this the current partition table[yes]? yes
Enter table name (remember quotes): "disk0"
Ready to label disk, continue? yes
partition> quit
format> verify
format> quit

```

Example 12-2 SPARC: Creating Disk Slices for a UFS File System

The following example shows the `format` utility being used to divide a 18-GB disk into one slice for the `/export/home` file system.

```

# format /dev/rdisk/c1*
AVAILABLE DISK SELECTIONS:
  0. /dev/rdisk/clt0d0s0 <SUN18G cyl 7506 alt 2 hd 19 sec 248>
     /sbus@2,0/QLGC,isp@2,10000/sd@0,0
  1. /dev/rdisk/clt1d0s0 <SUN18G cyl 7506 alt 2 hd 19 sec 248>
     /sbus@2,0/QLGC,isp@2,10000/sd@1,0
  2. /dev/rdisk/clt8d0s0 <SUN18G cyl 7506 alt 2 hd 19 sec 248>
     /sbus@2,0/QLGC,isp@2,10000/sd@8,0
  3. /dev/rdisk/clt9d0s0 <SUN18G cyl 7506 alt 2 hd 19 sec 248>
     /sbus@2,0/QLGC,isp@2,10000/sd@9,0

Specify disk (enter its number): 1
selecting clt1d0
[disk formatted]
format> partition
partition> print
partition> modify
Select partitioning base:
  0. Current partition table (original)
  1. All Free Hog
Choose base (enter number) [0]? 1
Part      Tag      Flag      Cylinders      Size      Blocks
0         root     wm        0              0          (0/0/0)      0
1         swap     wu        0              0          (0/0/0)      0
2         backup   wu        0 - 7505       16.86GB   (7506/0/0) 35368272

```

```

3 unassigned   wm      0          0          (0/0/0)      0
4 unassigned   wm      0          0          (0/0/0)      0
5 unassigned   wm      0          0          (0/0/0)      0
6      usr     wm      0          0          (0/0/0)      0
7 unassigned   wm      0          0          (0/0/0)      0

```

Do you wish to continue creating a new partition table based on above table[yes]? **y**

Free Hog partition[6]? **7**

Enter size of partition '0' [0b, 0c, 0.00mb, 0.00gb]:

Enter size of partition '1' [0b, 0c, 0.00mb, 0.00gb]:

Enter size of partition '3' [0b, 0c, 0.00mb, 0.00gb]:

Enter size of partition '4' [0b, 0c, 0.00mb, 0.00gb]:

Enter size of partition '5' [0b, 0c, 0.00mb, 0.00gb]:

Enter size of partition '6' [0b, 0c, 0.00mb, 0.00gb]:

Part	Tag	Flag	Cylinders	Size	Blocks
0	root	wm	0	0	(0/0/0) 0
1	swap	wu	0	0	(0/0/0) 0
2	backup	wu	0 - 7505	16.86GB	(7506/0/0) 35368272
3	unassigned	wm	0	0	(0/0/0) 0
4	unassigned	wm	0	0	(0/0/0) 0
5	unassigned	wm	0	0	(0/0/0) 0
6	usr	wm	0	0	(0/0/0) 0
7	unassigned	wm	0 - 7505	16.86GB	(7506/0/0) 35368272

Okay to make this the current partition table[yes]? **yes**

Enter table name (remember quotes): **"home"**

Ready to label disk, continue? **y**

partition> **q**

format> **verify**

format> **q**

#

The following example shows how to use the format utility to divide a 1.15 terabyte disk with an EFI label into three slices.

```
# format
```

```
.
```

```
.
```

```
.
```

```
partition> modify
```

Select partitioning base:

0. Current partition table (original)

1. All Free Hog

Choose base (enter number) [0]? **1**

Part	Tag	Flag	First Sector	Size	Last Sector
0	root	wm	0	0	0
1	usr	wm	0	0	0
2	unassigned	wm	0	0	0
3	unassigned	wm	0	0	0
4	unassigned	wm	0	0	0
5	unassigned	wm	0	0	0
6	usr	wm	0	0	0
8	reserved	wm	2576924638	8.00MB	2576941021

Do you wish to continue creating a new partition

table based on above table[yes]? **y**

Free Hog partition[6]? **4**

Enter size of partition 0 [0b, 34e, 0mb, 0gb, 0tb]:

Enter size of partition 1 [0b, 34e, 0mb, 0gb, 0tb]:

```

Enter size of partition 2 [0b, 34e, 0mb, 0gb, 0tb]: 400gb
Enter size of partition 3 [0b, 838860834e, 0mb, 0gb, 0tb]: 400gb
Enter size of partition 5 [0b, 1677721634e, 0mb, 0gb, 0tb]:
Enter size of partition 6 [0b, 1677721634e, 0mb, 0gb, 0tb]:
Part      Tag      Flag      First Sector      Size      Last Sector
  0 unassigned  wm          0                0          0
  1 unassigned  wm          0                0          0
  2          usr      wm          34             400.00GB   838860833
  3          usr      wm      838860834       400.00GB   1677721633
  4          usr      wm     1677721634     428.77GB   2576924637
  5 unassigned  wm          0                0          0
  6 unassigned  wm          0                0          0
  8 reserved   wm     2576924638       8.00MB     2576941021
Ready to label disk, continue? yes

partition> q

```

More Information After You Create Disk Slices and Label a Disk for UFS File Systems ...

After you create disk slices and label the disk, you can create file systems on the disk. Go to [“SPARC: How to Create a UFS File System”](#) on page 222.

▼ SPARC: How to Create a UFS File System

1 Become superuser or assume an equivalent role.

2 Create a file system for each slice.

```
# newfs /dev/rdisk/cwtxdysz
```

where `/dev/rdisk/cwtxdysz` is the raw device for the file system to be created.

For more information about the `newfs` command, see [Chapter 17, “Creating and Mounting File Systems \(Tasks\)”](#), or [newfs\(1M\)](#).

3 Verify the new file system by mounting it.

```
# mount /dev/dsk/cwtxdysz /mnt
# ls
lost+found
```

More Information After Creating a UFS File System ...

- **Disk for a UFS root file system** – You need to restore the root (`/`) and `/usr` file systems on the disk.
 - Go to [Chapter 25, “Restoring UFS Files and File Systems \(Tasks\)”](#)
 - After the root (`/`) and `/usr` file systems are restored, install the boot block. Go to [“SPARC: How to Install Boot Blocks for a UFS Root File System”](#) on page 223.

- **Disk for a UFS file system** – You might need to restore file systems on the new disk. Go to [Chapter 25, “Restoring UFS Files and File Systems \(Tasks\)”](#). If you are not restoring file systems on the new disk, you are finished adding a secondary disk.
- For information on making the UFS file systems available to users, see [“Mounting and Unmounting Oracle Solaris File Systems”](#) on page 329.

▼ SPARC: How to Install Boot Blocks for a UFS Root File System

1 Become superuser or assume an equivalent role.

2 Install a boot block for a UFS root file system.

```
# installboot /usr/platform/'uname -i'/lib/fs/ufs/bootblk
/dev/rdisk/cwtxdys0
```

For more information, see [installboot\(1M\)](#).

3 Verify that the boot blocks are installed by rebooting the system to run level 3.

```
# init 6
```

Example 12–3 SPARC: Installing a Boot Block for a UFS Root File System

The following example shows how to install the boot block on a UFS root file system.

```
# installboot /usr/platform/sun4u/lib/fs/ufs/bootblk
/dev/rdisk/c0t0d0s0
```

SPARC: Setting up Disks for ZFS File Systems (Task Map)

The following task map identifies the procedures for setting up a ZFS root pool disk for a ZFS root file system or a non-root ZFS pool disk on a SPARC based system.

Task	Description	For Instructions
1. Set up the disk for a ZFS root file system.	<i>Disk for a ZFS Root File System</i> Connect the new disk or replace the existing root pool disk and boot from a local or remote Oracle Solaris DVD.	“SPARC: How to Set Up a Disk for a ZFS Root File System” on page 225
2. Create a disk slice for a ZFS root file system	Create a disk slice for a disk that is intended for a ZFS root pool. This is a long-standing boot limitation.	“SPARC: How to Create a Disk Slice for a ZFS Root File System” on page 226

Task	Description	For Instructions
3. Install the boot blocks for a ZFS root file system, if necessary.	If you replace a disk that is intended for the root pool by using the <code>zpool replace</code> command, then you must install the boot blocks manually so that the system can boot from the replacement disk.	“SPARC: How to Install Boot Blocks for a ZFS Root File System” on page 229
4. Set up a disk for ZFS file system.	<i>Disk for a ZFS File System</i> Set up a disk for a ZFS file system.	“SPARC: How to Set Up a Disk for a ZFS File System” on page 230

SPARC: Setting Up Disks for ZFS File Systems

Although the procedures that describe how to set up a disk can be used with a ZFS file system, a ZFS file system is not directly mapped to a disk or a disk slice. You must create a ZFS storage pool before creating a ZFS file system. For more information, see [Oracle Solaris ZFS Administration Guide](#)

The root pool contains the root file system that is used to boot the Oracle Solaris OS. If a root pool disk becomes damaged and the root pool is not mirrored, the system might not boot. If a root pool disk becomes damaged, you have two ways to recover:

- You can reinstall the entire Oracle Solaris OS.
- Or, you can replace the root pool disk and restore your file systems from snapshots or from a backup medium. You can reduce system down time due to hardware failures by creating a redundant root pool. The only supported redundant root pool configuration is a mirrored root pool.

A disk that is used in a non-root pool usually contains space for user or data files. You can attach or add another disk to a root pool or a non-root pool for more disk space. Or, you can replace a damaged disk in a pool in the following ways.

- A disk can be replaced in a non-redundant pool if all the devices are currently ONLINE.
- A disk can be replaced in a redundant pool if enough redundancy exists among the other devices.
- In a mirrored root pool, you can replace a disk or attach a disk and then detach the failed disk or a smaller disk to increase a pool's size.

In general, setting up a disk on the system depends on the hardware so review your hardware documentation when adding or replacing a disk on your system. If you need to add a disk to an existing controller, then it might just be a matter of inserting the disk in an empty slot, if the system supports hot-plugging. If you need to configure a new controller, see [“Dynamic Reconfiguration and Hot-Plugging” on page 81](#).

▼ SPARC: How to Set Up a Disk for a ZFS Root File System

Refer to your hardware installation guide for information on replacing a disk.

- 1 **Disconnect the damaged disk from the system, if necessary.**
- 2 **Connect the replacement disk to the system and check the disk's physical connections, if necessary.**
- 3 **Follow the instructions in the following table, depending on whether you are booting from a local Oracle Solaris DVD or a remote Oracle Solaris DVD from the network.**

Boot Type	Action
From an Oracle Solaris DVD in a local drive	1. Make sure the Oracle Solaris DVD is in the drive. 2. Boot from the media to single-user mode: ok boot cdrom -s
From the network	Boot from the network to single-user mode: ok boot net -s

After a few minutes, the root prompt (#) is displayed.

More Information After You Set Up a Disk for a ZFS Root File System ...

After the disk is connected or replaced, you can create a slice and update the disk label. Go to [“SPARC: How to Create a Disk Slice for a ZFS Root File System” on page 226](#).

SPARC: Creating a Disk Slice for a ZFS Root File System

You must create a disk slice for a disk that is intended for a ZFS root pool. This is a long-standing boot limitation. Review the following root pool disk requirements:

- Must contain a disk slice and an SMI (VTOC) label.
- An EFI label is not supported for a root pool disk.
- Must be a single disk or be part of mirrored configuration. A non-redundant configuration nor a RAIDZ configuration is supported for the root pool.
- All subdirectories of the root file system that are part of the OS image, with the exception of `/var`, must be in the same dataset as the root file system.
- All Solaris OS components must reside in the root pool, with the exception of the swap and dump devices.

- Another restriction is that the `/var` directory or dataset must be a single dataset. For example, you cannot create a descendent `/var` file system, such as `/var/tmp`, if you want to also use Oracle Solaris Live Upgrade to migrate or patch a ZFS BE or create a ZFS flash archive of this pool.

In general, you should create a disk slice with the bulk of disk space in slice 0. Attempting to use different slices on a disk and share that disk among different operating systems or with a different ZFS storage pool or storage pool components is not recommended.

▼ SPARC: How to Create a Disk Slice for a ZFS Root File System

In general, the root pool disk is installed automatically when the system is installed. If you need to replace a root pool disk or attach a new disk as a mirrored root pool disk, see the steps below.

1 Become superuser or assume an equivalent role.

2 Offline and unconfigure the failed disk, if necessary.

Some hardware requires that you offline and unconfigure a disk before attempting the `zpool` replace operation to replace a failed disk. For example:

```
# zpool offline rpool c2t1d0s0
# cfgadm -c unconfigure c2::disk/c2t1d0
```

3 Physically connect the new or replacement disk to the system, if necessary.

a. Physically remove the failed disk.

b. Physically insert the replacement disk.

c. Configure the replacement disk, if necessary. For example:

```
# cfgadm -c configure c2::disk/c2t1d0
```

On some hardware, you do not have to reconfigure the replacement disk after it is inserted.

4 Confirm that the disk is accessible by reviewing the format output.

For example, the `format` command sees 4 disks connected to this system.

```
# format -e
AVAILABLE DISK SELECTIONS:
  0. c2t0d0 <SUN36G cyl 24620 alt 2 hd 27 sec 107>
    /pci@1c,600000/scsi@2/sd@0,0
  1. c2t1d0 <SEAGATE-ST336607LSUN36G-0307-33.92GB>
    /pci@1c,600000/scsi@2/sd@1,0
  2. c2t2d0 <SEAGATE-ST336607LSUN36G-0507-33.92GB>
    /pci@1c,600000/scsi@2/sd@2,0
  3. c2t3d0 <SEAGATE-ST336607LSUN36G-0507-33.92GB>
    /pci@1c,600000/scsi@2/sd@3,0
```

5 Select the disk to be used for the ZFS root pool.**6 Confirm that the disk has an SMI label by printing the partition (slice) information.**

For example, the partition (slice) output for `c2t1d0` shows that this disk has an EFI label because it identifies first and last sectors.

```
Specify disk (enter its number): 1
selecting c2t1d0
[disk formatted]
format> p
PARTITION MENU:
    0 - change '0' partition
    1 - change '1' partition
    2 - change '2' partition
    3 - change '3' partition
    4 - change '4' partition
    5 - change '5' partition
    6 - change '6' partition
expand - expand label to use whole disk
select - select a predefined table
modify - modify a predefined partition table
name - name the current table
print - display the current table
label - write partition map and label to the disk
!<cmd> - execute <cmd>, then return
quit
partition> p
Current partition table (original):
Total disk sectors available: 71116508 + 16384 (reserved sectors)
```

Part	Tag	Flag	First Sector	Size	Last Sector
0	usr	wm	256	33.91GB	71116541
1	unassigned	wm	0	0	0
2	unassigned	wm	0	0	0
3	unassigned	wm	0	0	0
4	unassigned	wm	0	0	0
5	unassigned	wm	0	0	0
6	unassigned	wm	0	0	0
8	reserved	wm	71116542	8.00MB	71132925

```
partition>
```

7 If the disk contains an EFI label, relabel the disk with an SMI label.

For example, the `c2t1d0` disk is relabeled with an SMI label, but a default partition table is provided that does not provide an optimal slice configuration.

```
partition> label
[0] SMI Label
[1] EFI Label
Specify Label type[1]: 0
Auto configuration via format.dat[no]?
Auto configuration via generic SCSI-2[no]?
partition> p
Current partition table (default):
Total disk cylinders available: 24620 + 2 (reserved cylinders)
```

Part	Tag	Flag	Cylinders	Size	Blocks
0	root	wm	0 - 90	128.37MB	(91/0/0) 262899
1	swap	wu	91 - 181	128.37MB	(91/0/0) 262899
2	backup	wu	0 - 24619	33.92GB	(24620/0/0) 71127180
3	unassigned	wm	0	0	(0/0/0) 0
4	unassigned	wm	0	0	(0/0/0) 0
5	unassigned	wm	0	0	(0/0/0) 0
6	usr	wm	182 - 24619	33.67GB	(24438/0/0) 70601382
7	unassigned	wm	0	0	(0/0/0) 0

partition>

8 Create an optimal slice configuration for a ZFS root pool disk.

Set the free hog partition so that all the unallocated disk space is collected in slice 0. Then, press return through the slice size fields to create one large slice 0.

```
partition> modify
Select partitioning base:
  0. Current partition table (default)
  1. All Free Hog
Choose base (enter number) [0]? 1
```

Part	Tag	Flag	Cylinders	Size	Blocks
0	root	wm	0	0	(0/0/0) 0
1	swap	wu	0	0	(0/0/0) 0
2	backup	wu	0 - 24619	33.92GB	(24620/0/0) 71127180
3	unassigned	wm	0	0	(0/0/0) 0
4	unassigned	wm	0	0	(0/0/0) 0
5	unassigned	wm	0	0	(0/0/0) 0
6	usr	wm	0	0	(0/0/0) 0
7	unassigned	wm	0	0	(0/0/0) 0

Do you wish to continue creating a new partition table based on above table[yes]?

Free Hog partition[6]? 0

Enter size of partition '1' [0b, 0c, 0.00mb, 0.00gb]:

Enter size of partition '3' [0b, 0c, 0.00mb, 0.00gb]:

Enter size of partition '4' [0b, 0c, 0.00mb, 0.00gb]:

Enter size of partition '5' [0b, 0c, 0.00mb, 0.00gb]:

Enter size of partition '6' [0b, 0c, 0.00mb, 0.00gb]:

Enter size of partition '7' [0b, 0c, 0.00mb, 0.00gb]:

Part	Tag	Flag	Cylinders	Size	Blocks
0	root	wm	0 - 24619	33.92GB	(24620/0/0) 71127180
1	swap	wu	0	0	(0/0/0) 0
2	backup	wu	0 - 24619	33.92GB	(24620/0/0) 71127180
3	unassigned	wm	0	0	(0/0/0) 0
4	unassigned	wm	0	0	(0/0/0) 0
5	unassigned	wm	0	0	(0/0/0) 0
6	usr	wm	0	0	(0/0/0) 0
7	unassigned	wm	0	0	(0/0/0) 0

Okay to make this the current partition table[yes]?

Enter table name (remember quotes): "c2t1d0"

Ready to label disk, continue? yes

partition> quit

format> quit

9 Let ZFS know that the failed disk is replaced.

```
# zpool replace rpool c2t1d0s0
# zpool online rpool c2t1d0s0
```

On some hardware, you do not have to online the replacement disk after it is inserted.

If you are attaching a new disk to create a mirrored root pool or attaching a larger disk to replace a smaller disk, use syntax similar to the following:

```
# zpool attach rpool c0t0d0s0 c1t0d0s0
```

10 If a root pool disk is replaced with a new disk, apply the boot blocks after the new or replacement disk is resilvered.

For example:

```
# zpool status rpool
installboot -F zfs /usr/platform/'uname -i'/lib/fs/zfs/bootblk /dev/rdisk/c2t1d0s0
```

11 Verify that you can boot from the new disk.**12 If the system boots from the new disk, detach the old disk.**

This step is only necessary if you attach a new disk to replace a failed disk or a smaller disk.

```
# zpool detach rpool c0t0d0s0
```

13 Set up the system to boot automatically from the new disk, either by using the eeprom command or the setenv command from the SPARC boot PROM.**More Information** After You Have Created a Disk Slice for a ZFS Root File System ...

After you have created a disk slice for the ZFS root file system and you need to restore root pool snapshots to recover your root pool, see [“Recovering the ZFS Root Pool or Root Pool Snapshots”](#) in *Oracle Solaris ZFS Administration Guide*.

▼ SPARC: How to Install Boot Blocks for a ZFS Root File System**1 Become superuser or assume an equivalent role.****2 Install a boot block for a ZFS root file system.**

```
# installboot -F zfs /usr/platform/'uname -i'/lib/fs/zfs/bootblk
/dev/rdisk/cwtxdys0
```

For more information, see [installboot\(1M\)](#).

3 Verify that the boot blocks are installed by rebooting the system to run level 3.

```
# init 6
```

Example 12-4 SPARC: Installing Boot Blocks for a ZFS Root File System

If you physically replace the disk that is intended for the root pool and the Oracle Solaris OS is then reinstalled, or you attach a new disk for the root pool, the boot blocks are installed automatically. If you replace a disk that is intended for the root pool by using the `zpool replace` command, then you must install the boot blocks manually so that the system can boot from the replacement disk.

The following example shows how to install boot blocks for a ZFS root file system.

```
# installboot -F zfs /usr/platform/'uname -i'/lib/fs/zfs/bootblk /dev/rdisk/c0t1d0s0
```

▼ SPARC: How to Set Up a Disk for a ZFS File System

If you are setting up a disk to be used with a non-root ZFS file system, the disk is relabeled automatically when the pool is created or when the disk is added to the pool. If a pool is created with whole disks or when a whole disk is added to a ZFS storage pool, an EFI label is applied. For more information about EFI disk labels, see [“EFI Disk Label” on page 183](#).

Generally, most modern bus types support hot-plugging. This means you can insert a disk in an empty slot and the system recognizes it. For more information about hot-plugging devices, see [Chapter 6, “Dynamically Configuring Devices \(Tasks\)”](#).

- 1 Become superuser or assume an equivalent role.**
- 2 Connect the disk to the system and check the disk's physical connections.**
Refer to the disk's hardware installation guide for details.
- 3 Offline and unconfigure the failed disk, if necessary.**

Some hardware requires that you offline and unconfigure a disk before attempting the `zpool replace` operation to replace a failed disk. For example:

```
# zpool offline tank c1t1d0
# cfmadm -c unconfigure c1::disk/c1t1d0
<Physically remove failed disk c1t1d0>
<Physically insert replacement disk c1t1d0>
# cfmadm -c configure c1::disk/c1t1d0
```

On some hardware, you do not to reconfigure the replacement disk after it is inserted.

4 Confirm that the new disk is recognized.

Review the output of the `format` utility to see if the disk is listed under AVAILABLE DISK SELECTIONS. Then, quit the `format` utility.

```
# format
```

5 Let ZFS know that the failed disk is replaced, if necessary.

```
# zpool replace tank c1t1d0  
# zpool online tank c1t1d0
```

Confirm that the new disk is resilvering.

```
# zpool status tank
```

6 Attach a new disk to an existing ZFS storage pool, if necessary.

For example:

```
# zpool attach tank mirror c1t0d0 c2t0d0
```

Confirm that the new disk is resilvering.

```
# zpool status tank
```

For more information, see [Chapter 4, “Managing Oracle Solaris ZFS Storage Pools,”](#) in *Oracle Solaris ZFS Administration Guide*.

x86: Setting Up Disks (Tasks)

This chapter describes how to set up disks on an x86 based system.

For information on the procedures associated with setting up disks on an x86 based system, see the following sections:

- “x86: Setting Up Disks for UFS File Systems (Task Map)” on page 233
- “x86: Setting Up Disks for ZFS File Systems (Task Map)” on page 238
- “Creating and Changing Solaris fdisk Partitions” on page 246

For overview information about disk management, see [Chapter 10, “Managing Disks \(Overview\)”](#). For step-by-step instructions on setting up disks on a SPARC based system, see [Chapter 12, “SPARC: Setting Up Disks \(Tasks\)”](#).

x86: Setting Up Disks for UFS File Systems (Task Map)

The following task map identifies the procedures for setting up a disk for a UFS root file system or a disk for a UFS file system on an x86 based system.

Task	Description	For Instructions
1. Connect the disk.	<p><i>Disk for a UFS root file system</i></p> <p>Connect the new disk and boot from a local or remote Oracle Solaris DVD.</p> <p><i>Disk for a UFS file system</i></p> <p>Connect the disk.</p>	<p>“x86: How to Set Up a Disk for a UFS Root File System” on page 234</p> <p>“x86: How to Connect a Disk for a UFS File System” on page 235</p>
2. Create or change the fdisk partition	The disk for an x86 based system must contain an fdisk partition.	

Task	Description	For Instructions
3. Create slices and label the disk.	Create disk slices and label the disk if the disk manufacturer has not already done so.	“x86: How to Create a Solaris fdisk Partition” on page 247 and “x86: How to Create Disk Slices for UFS File Systems” on page 235
4. Create UFS file systems.	Create UFS file systems on the disk slices with the <code>newfs</code> command. You must re-create the root (<code>/</code>) or <code>/usr</code> file system (or both).	“x86: How to Create a UFS File System” on page 237
5. Restore UFS file systems.	Restore the UFS root (<code>/</code>) or <code>/usr</code> file system (or both) on the system disk. If necessary, restore file systems on other disks	Chapter 25, “ Restoring UFS Files and File Systems (Tasks) ”
6. Install boot blocks for a UFS root file system.	Install the boot blocks on the root (<code>/</code>) file system so that the system can boot.	“x86: How to Install Boot Blocks for a UFS Root File System” on page 238

x86: Setting Up Disks for UFS File Systems

A disk can contain the UFS root (`/`) and `/usr` file systems, user or data file systems, or a combination of file systems. If the disk contains the UFS root (`/`) or `/usr` file systems, you have two ways to recover:

- You can reinstall the entire Oracle Solaris OS.
- Or, you can replace the disk and restore your Oracle Solaris OS file systems from a backup medium.

A disk that contains user or data file systems can be replaced and the file systems restored, if necessary, without having to reinstall or reboot the system.

▼ x86: How to Set Up a Disk for a UFS Root File System

You can use this procedure to replace a disk that contained the UFS root or `/usr` file system. Refer to your hardware installation guide for information on replacing a disk.

- 1 **Disconnect the damaged system disk from the system, if necessary.**
- 2 **Connect the replacement disk to the system, and check the disk's physical connections.**
- 3 **Follow the instructions in the following table, depending on whether you are booting from a local Oracle Solaris DVD or a remote Oracle Solaris DVD from the network.**

Boot Type	Action
From an Oracle Solaris DVD in a local drive	<ol style="list-style-type: none"> 1. Make sure the Oracle Solaris DVD is in the drive. 2. Select the option to boot from the media.
From the network	<ol style="list-style-type: none"> 3. Select the option to boot from the network.

More Information After You Set Up a Disk for a UFS Root File System ...

Create an `fdisk` partition, if necessary. Go to [“x86: How to Create a Solaris `fdisk` Partition” on page 247](#).

▼ x86: How to Connect a Disk for a UFS File System

If you are adding a disk with an EFI disk label, see [“EFI Disk Label” on page 183](#) for more information.

Generally, most modern bus types support hot-plugging. This means you can insert a disk in an empty slot and the system recognizes it. For more information about hot-plugging devices, see [Chapter 6, “Dynamically Configuring Devices \(Tasks\)”](#).

- 1 **Become superuser or assume an equivalent role.**
- 2 **(Optional) If the disk is unsupported by the Oracle Solaris software, add the device driver for the disk by following the instructions included with the hardware.**
- 3 **Connect the disk to the system and check the disk's physical connections.**
Refer to the disk's hardware installation guide for details.
- 4 **Use the format utility to confirm that the new disk is recognized.**

More Information After You Connect a Disk for a UFS File System ...

After the disk is connected, create an `fdisk` partition. Go to [“x86: How to Create a Solaris `fdisk` Partition” on page 247](#).

▼ x86: How to Create Disk Slices for UFS File Systems

- 1 **Become superuser or assume an equivalent role.**
- 2 **Confirm that the disk has a valid Solaris `fdisk` partition.**
For information about creating or changing a Solaris `fdisk` partition, see [“Creating and Changing Solaris `fdisk` Partitions” on page 246](#).

3 Invoke the format utility.

```
# format
```

A numbered list of disks is displayed.

4 Type the number of the disk that you want to repartition.

```
Specify disk (enter its number): disk-number
```

where *disk-number* is the number of the disk that you want to repartition.

5 Select the partition menu.

```
format> partition
```

6 Display the current partition (slice) table.

```
partition> print
```

7 Start the modification process.

```
partition> modify
```

8 Set the disk to all free hog.

```
Choose base (enter number) [0]? 1
```

For more information about the free hog slice, see [“Using the Free Hog Slice”](#) on page 197.

9 Create a new partition table by answering yes when prompted to continue.

```
Do you wish to continue creating a new partition  
table based on above table[yes]? yes
```

10 Identify the free hog partition (slice) and the sizes of the slices when prompted.

When adding a system disk, you must set up slices for the following:

- root (slice 0) and swap (slice 1) and/or
- /usr (slice 6)

After you identify the slices, the new partition table is displayed.

11 Make the displayed partition table the current partition table by answering yes when prompted.

```
Okay to make this the current partition table[yes]? yes
```

If you don't want the current partition table and you want to change it, answer no and go to [Step 7](#).

12 Name the partition table.

```
Enter table name (remember quotes): "partition-name"
```

where *partition-name* is the name for the new partition table.

- 13 Label the disk with the new partition table after you have finished allocating slices on the new disk.**

```
Ready to label disk, continue? yes
```

- 14 Quit the partition menu.**

```
partition> quit
```

- 15 Verify the new disk label.**

```
format> verify
```

- 16 Exit the format utility.**

```
format> quit
```

More Information [After You Create Disk Slices and Label a Disk ...](#)

After you create disk slices and label the disk, you can create file systems on the disk. Go to [“x86: How to Create a UFS File System” on page 237](#).

▼ **x86: How to Create a UFS File System**

- 1 Become superuser or assume an equivalent role.**

- 2 Create a file system for each slice.**

```
# newfs /dev/rdisk/cwtxdysz
```

where /dev/rdisk/cwtxdysz is the raw device for the file system to be created.

For more information about the newfs command, see [Chapter 17, “Creating and Mounting File Systems \(Tasks\)”](#) or [newfs\(1M\)](#).

- 3 Verify the new file system by mounting it.**

```
# mount /dev/dsk/cwtxdysz /mnt
# ls /mnt
lost+found
```

More Information [After You Create a UFS File System ...](#)

- **Disk for a UFS root file system** – You need to restore the root (/) and /usr file systems on the disk.
 - Go to [Chapter 25, “Restoring UFS Files and File Systems \(Tasks\)”](#)
 - After the root (/) and /usr file systems are restored, install the boot block. Go to [“x86: How to Install Boot Blocks for a UFS Root File System” on page 238](#).
- **Disk for a UFS file system** – You might need to restore file systems on the new disk. Go to [Chapter 25, “Restoring UFS Files and File Systems \(Tasks\)”](#). If you are not restoring file systems on the new disk, you are finished adding a secondary disk.

- For information on making the file systems available to users, see [“Mounting and Unmounting Oracle Solaris File Systems”](#) on page 329.

▼ x86: How to Install Boot Blocks for a UFS Root File System

1 Become superuser or assume an equivalent role.

2 Install the boot blocks for a UFS root file system.

```
# /sbin/installgrub /boot/grub/stage1 /boot/grub/stage2 /dev/rdisk/cwtxdysz
```

For more information, see [installgrub\(1M\)](#).

3 Verify that the boot blocks are installed by rebooting the system to run level 3.

```
# init 6
```

Example 13–1 x86: Installing Boot Blocks for a UFS Root File System

The following example shows how to install the boot blocks for a UFS root file system on an x86 system.

```
# /sbin/installgrub /boot/grub/stage1 /boot/grub/stage2 /dev/rdisk/c1d0s0
stage1 written to partition 0 sector 0 (abs 2016)
stage2 written to to partition 0, 227 sectors starting 50 (abs 2066)
```

x86: Setting Up Disks for ZFS File Systems (Task Map)

The following task map identifies the procedures for setting up a ZFS root pool disk for a ZFS root file system on an x86 based system.

Task	Description	For Instructions
1. Set up the disk for a ZFS root file system.	<i>Disk for a ZFS Root File System</i> Connect the new disk or replace the existing root pool disk and boot from a local or remote Oracle Solaris DVD.	“x86: How to Set Up a Disk for a ZFS Root File System” on page 240
2. Create or change an fdisk partition, if necessary.	The disk must contain a valid Solaris fdisk partition.	“Creating and Changing Solaris fdisk Partitions” on page 246
3. Create a disk slice for the ZFS root file system.	Create a disk slice for a disk that is intended for a ZFS root pool. This is a long-standing boot limitation.	“x86: How to Create a Solaris fdisk Partition” on page 247 and “x86: How to Create a Disk Slice for a ZFS Root File System” on page 241

Task	Description	For Instructions
4. Install the boot blocks for a ZFS root file system.	If you replace a disk that is intended for the root pool by using the <code>zpool replace</code> command, then you must install the boot blocks manually so that the system can boot from the replacement disk.	“x86: How to Install Boot Blocks for a ZFS Root File System” on page 244
5. Set up a disk for a ZFS file system.	<i>Disk for a ZFS File System</i> Connect the disk.	“x86: How to Set Up a Disk for a ZFS File System” on page 245

x86: Setting Up Disks for ZFS File Systems

Although the procedures that describe how to set up a disk and create an fdisk partition can be used with a ZFS file systems, a ZFS file system is not directly mapped to a disk or a disk slice. You must create a ZFS storage pool before creating a ZFS file system. For more information, see [Oracle Solaris ZFS Administration Guide](#).

The root pool contains the root file system that is used to boot the Oracle Solaris OS. If a root pool disk becomes damaged and the root pool is not mirrored, the system might not boot. If a root pool disk becomes damaged, you have two ways to recover:

- You can reinstall the entire Oracle Solaris OS.
- Or, you can replace the root pool disk and restore your file systems from snapshots or from a backup medium. You can reduce system down time due to hardware failures by creating a redundant root pool. The only supported redundant root pool configuration is a mirrored root pool.

A disk that is used in a non-root pool usually contains space for user or data files. You can attach or add another disk to a root pool or a non-root pool for more disk space. Or, you can replace a damaged disk in a pool in the following ways:

- A disk can be replaced in a non-redundant pool if all the devices are currently ONLINE.
- A disk can be replaced in a redundant pool if enough redundancy exists among the other devices.
- In a mirrored root pool, you can replace a disk or attach a disk and then detach the failed disk or a smaller disk to increase a pool's size.

In general, setting up a disk to the system depends on the hardware so review your hardware documentation when adding or replacing a disk on your system. If you need to add a disk to an existing controller, then it might just be a matter of inserting the disk in an empty slot, if the system supports hot-plugging. If you need to configure a new controller, see [“Dynamic Reconfiguration and Hot-Plugging” on page 81](#).

▼ **x86: How to Set Up a Disk for a ZFS Root File System**

Refer to your hardware installation guide for information on replacing a disk.

- 1 **Disconnect the damaged disk from the system, if necessary.**
- 2 **Connect the replacement disk to the system, and check the disk's physical connections.**
- 3 **Follow the instructions in the following table, depending on whether you are booting from a local Oracle Solaris DVD or a remote Oracle Solaris DVD from the network.**

Boot Type	Action
From an Oracle Solaris DVD in a local drive	<ol style="list-style-type: none"> 1. Make sure the Oracle Solaris DVD is in the drive. 2. Select the option to boot from the media.
From the network	<ol style="list-style-type: none"> 3. Select the option to boot from the network.

More Information After You Set Up a Disk for a ZFS Root File System ...

After the disk is connected or replaced, create an `fdisk` partition.. Go to [“x86: How to Create a Solaris `fdisk` Partition” on page 247.](#)

x86: Creating a Disk Slice for a ZFS Root File System

You must create a disk slice for a disk that is intended for a ZFS root pool. This is a long-standing boot limitation. Review the following root pool disk requirements:

- Must contain a disk slice and an SMI (VTOC) label.
- An EFI label is not supported for a root pool disk.
- A root pool disk on an x86 system must contain an `fdisk` partition.
- Must be a single disk or be part of mirrored configuration. A non-redundant configuration nor a RAIDZ configuration is supported for the root pool.
- All subdirectories of the root file system that are part of the OS image, with the exception of `/var`, must be in the same dataset as the root file system.
- All Solaris OS components must reside in the root pool, with the exception of the swap and dump devices.
- Another restriction is that the `/var` directory or dataset must be a single dataset. For example, you cannot create a descendent `/var` file system, such as `/var/tmp`, if you want to also use Oracle Solaris Live Upgrade to migrate or patch a ZFS BE or create a ZFS flash archive of this pool.

On an x86 based system, you must first create an `fdisk` partition. Then, create a disk slice with the bulk of disk space in slice 0.

Attempting to use different slices on a disk and share that disk among different operating systems or with a different ZFS storage pool or storage pool components is not recommended.

▼ **x86: How to Create a Disk Slice for a ZFS Root File System**

In general, the root pool disk is installed automatically when the system is installed. If you need to replace a root pool disk or attach a new disk as a mirrored root pool disk, see the steps below.

For a full description of `fdisk` partitions, see “[x86: Guidelines for Creating an `fdisk` Partition](#)” on page 246.

1 **Become superuser or assume an equivalent role.**

2 **Offline and unconfigure the failed disk, if necessary.**

Some hardware requires that you offline and unconfigure a disk before attempting the `zpool` replace operation to replace a failed disk. For example:

```
# zpool offline rpool c2t1d0s0
# cfgadm -c unconfigure c2::disk/c2t1d0
```

3 **Physically connect the new or replacement disk to the system, if necessary.**

a. Physically remove the failed disk.

b. Physically insert the replacement disk.

c. Configure the replacement disk, if necessary. For example:

```
# cfgadm -c configure c2::disk/c2t1d0
```

On some hardware, you do not have to reconfigure the replacement disk after it is inserted.

4 **Confirm that the disk is accessible by reviewing the format output.**

For example, the `format` command sees 4 disks connected to this system.

```
# format -e
AVAILABLE DISK SELECTIONS:
  1. c8t0d0 <Sun-STK RAID INT-V1.0 cyl 17830 alt 2 hd 255 sec 63>
     /pci@0,0/pci10de,375ef/pci108e,286@0/disk@0,0
  2. c8t1d0 <Sun-STK RAID INT-V1.0-136.61GB>
     /pci@0,0/pci10de,375ef/pci108e,286@0/disk@1,0
  3. c8t2d0 <Sun-STK RAID INT-V1.0-136.61GB>
     /pci@0,0/pci10de,375ef/pci108e,286@0/disk@2,0
  4. c8t3d0 <Sun-STK RAID INT-V1.0-136.61GB>
     /pci@0,0/pci10de,375ef/pci108e,286@0/disk@3,0
```

5 **Select the disk to be used for the ZFS root pool.**

```
Specify disk (enter its number): 1
selecting c8t0d0
[disk formatted]
.
```

```
.
.
format>
```

6 Review the status of the fdisk partition.

- If the disk has no fdisk partition, you will see a message similar to the following:

```
format> fdisk
No Solaris fdisk partition found.
```

If so, go to step 4 to create an fdisk partition.

- If the disk has an EFI fdisk or some other partition type, go to step 5 to create a Solaris fdisk partition.
- If the disk has a Solaris fdisk partition, go to step 6 to create a disk slice for the root pool.

7 If necessary, create a Solaris fdisk partition by selecting the fdisk option.

```
format> fdisk
No fdisk table exists. The default partition for the disk is:
```

```
  a 100% "SOLARIS System" partition
```

Type "y" to accept the default partition, otherwise type "n" to edit the partition table. **y**

Then, go to step 6 to create a disk slice for the root pool.

8 If the disk has an EFI fdisk partition, then you will need to create a Solaris fdisk partition.

If you print the disk's partition table with the format utility, and you see the partition table refers to the first sector and the size, then this is an EFI partition. You will need to create a Solaris fdisk partition as follows:

- Select fdisk from the format options.

```
# format -e c8t0d0
selecting c8t0d0
[disk formatted]
format> fdisk
```

- Delete the existing EFI partition by selecting option 3, Delete a partition.

```
Enter Selection: 3
Specify the partition number to delete (or enter 0 to exit): 1
Are you sure you want to delete partition 1? This will make all files and
programs in this partition inaccessible (type "y" or "n"). y
```

Partition 1 has been deleted.

- Create a new Solaris partition by selecting option 1, Create a partition.

```
Enter Selection: 1
Select the partition type to create: 1
Specify the percentage of disk to use for this partition
(or type "c" to specify the size in cylinders). 100
```

Should this become the active partition? If yes, it will be activated each time the computer is reset or turned on.
Please type "y" or "n". **y**
Partition 1 is now the active partition.

- Update the disk configuration and exit.

```
Enter Selection: 6
format>
```

- Display the SMI partition table. If the default partition table is applied, then slice 0 might be 0 in size or it might be too small. See the next step.

```
format> partition
partition> print
```

9 Confirm that the disk has an SMI label by printing the partition (slice) information and review the slice 0 size information.

Set the free hog partition so that all the unallocated disk space is collected in slice 0. Then, press return through the slice size fields to create one large slice 0.

```
partition> modify
Select partitioning base:
    0. Current partition table (default)
    1. All Free Hog
Choose base (enter number) [0]? 1
Part   Tag   Flag   Cylinders      Size          Blocks
0      root   wm      0                0          (0/0/0)      0
1      swap   wu      0                0          (0/0/0)      0
2      backup wu     0 - 17829      136.58GB    (17830/0/0) 286438950
3  unassigned  wm      0                0          (0/0/0)      0
4  unassigned  wm      0                0          (0/0/0)      0
5  unassigned  wm      0                0          (0/0/0)      0
6      usr   wm      0                0          (0/0/0)      0
7  unassigned  wm      0                0          (0/0/0)      0
8      boot  wu      0 - 0           7.84MB     (1/0/0)      16065
9  alternates  wm      0                0          (0/0/0)      0
```

Do you wish to continue creating a new partition table based on above table[yes]?

```
Free Hog partition[6]? 0
Enter size of partition '1' [0b, 0c, 0.00mb, 0.00gb]:
Enter size of partition '3' [0b, 0c, 0.00mb, 0.00gb]:
Enter size of partition '4' [0b, 0c, 0.00mb, 0.00gb]:
Enter size of partition '5' [0b, 0c, 0.00mb, 0.00gb]:
Enter size of partition '6' [0b, 0c, 0.00mb, 0.00gb]:
Enter size of partition '7' [0b, 0c, 0.00mb, 0.00gb]:
```

```
Part   Tag   Flag   Cylinders      Size          Blocks
0      root   wm     1 - 17829      136.58GB    (17829/0/0) 286422885
1      swap   wu      0                0          (0/0/0)      0
2      backup wu     0 - 17829      136.58GB    (17830/0/0) 286438950
3  unassigned  wm      0                0          (0/0/0)      0
4  unassigned  wm      0                0          (0/0/0)      0
5  unassigned  wm      0                0          (0/0/0)      0
6      usr   wm      0                0          (0/0/0)      0
7  unassigned  wm      0                0          (0/0/0)      0
8      boot  wu      0 - 0           7.84MB     (1/0/0)      16065
```

```

    9 alternates      wm      0      0      (0/0/0)      0
Do you wish to continue creating a new partition
table based on above table[yes]? yes
Enter table name (remember quotes): "c8t0d0"

Ready to label disk, continue? yes

```

10 Let ZFS know that the failed disk is replaced.

```

# zpool replace rpool c2t1d0s0
# zpool online rpool c2t1d0s0

```

On some hardware, you do not have to online the replacement disk after it is inserted.

If you are attaching a new disk to create a mirrored root pool or attaching a larger disk to replace a smaller disk, use syntax similar to the following:

```

# zpool attach rpool c0t0d0s0 c1t0d0s0

```

11 If a root pool disk is replaced with a new disk, apply the boot blocks.

For example:

```

# installgrub /boot/grub/stage1 /boot/grub/stage2 /dev/rdisk/c8t0d0s0

```

12 Verify that you can boot from the new disk.

13 If the system boots from the new disk, detach the old disk.

This step is only necessary if you attach a new disk to replace a failed disk or a smaller disk.

```

# zpool detach rpool c0t0d0s0

```

14 Set up the system to boot automatically from the new disk by reconfiguring the system's BIOS.

More Information After You Have Created a Disk Slice for the ZFS Root File System ...

After you have created a disk slice for the ZFS root file system and you need to restore root pool snapshots to recover your root pool, see [“Recovering the ZFS Root Pool or Root Pool Snapshots”](#) in *Oracle Solaris ZFS Administration Guide*.

▼ x86: How to Install Boot Blocks for a ZFS Root File System

1 Become superuser or assume an equivalent role .

2 Install the boot blocks on the system disk.

```

# installgrub /boot/grub/stage1 /boot/grub/stage2 /dev/rdsk/cwtxdysz

```

For more information, see [installgrub\(1M\)](#).

3 Verify that the boot blocks are installed by rebooting the system to run level 3.

```

# init 6

```

Example 13-2 x86: Installing Boot Blocks for a ZFS Root File System

If you physically replace the disk that is intended for the root pool and the Oracle Solaris OS is then reinstalled, or you attach a new disk for the root pool, the boot blocks are installed automatically. If you replace a disk that is intended for the root pool by using the `zpool replace` command, then you must install the boot blocks manually so that the system can boot from the replacement disk.

The following example shows how to install the boot blocks for a ZFS root file system.

```
# installgrub /boot/grub/stage1 /boot/grub/stage2 /dev/rdisk/c1d0s0
stage2 written to partition 0, 277 sectors starting at 50 (abs 16115)
stage1 written to partition 0 sector 0 (abs 16065)
```

▼ x86: How to Set Up a Disk for a ZFS File System

If you are setting up a disk to be used with a non-root ZFS file system, the disk is relabeled automatically when the pool is created or when the disk is added to the pool. If a pool is created with whole disks or when a whole disk is added to a ZFS storage pool, an EFI label is applied. For more information about EFI disk labels, see [“EFI Disk Label” on page 183](#).

Generally, most modern bus types support hot-plugging. This means you can insert a disk in an empty slot and the system recognizes it. For more information about hot-plugging devices, see [Chapter 6, “Dynamically Configuring Devices \(Tasks\)”](#).

- 1 Become superuser or assume an equivalent role.**
- 2 Connect the disk to the system and check the disk's physical connections.**

Refer to the disk's hardware installation guide for details.

- 3 Offline and unconfigure the failed disk, if necessary.**

Some hardware requires that you offline and unconfigure a disk before attempting the `zpool replace` operation to replace a failed disk. For example:

```
# zpool offline tank c1t1d0
# cfmadm -c unconfigure c1::disk/c1t1d0
<Physically remove failed disk c1t1d0>
<Physically insert replacement disk c1t1d0>
# cfmadm -c configure c1::disk/c1t1d0
```

On some hardware, you do not to reconfigure the replacement disk after it is inserted.

- 4 Confirm that the new disk is recognized.**

Review the output of the `format` utility to see if the disk is listed under AVAILABLE DISK SELECTIONS. Then, quit the `format` utility.

```
# format
```

5 Let ZFS know that the failed disk is replaced, if necessary.

```
# zpool replace tank c1t1d0  
# zpool online tank c1t1d0
```

Confirm that the new disk is resilvering.

```
# zpool status tank
```

6 Attach a new disk to an existing ZFS storage pool, if necessary.

For example:

```
# zpool attach tank mirror c1t0d0 c2t0d0
```

Confirm that the new disk is resilvering.

```
# zpool status tank
```

For more information, see [Chapter 4, “Managing Oracle Solaris ZFS Storage Pools,”](#) in *Oracle Solaris ZFS Administration Guide*.

Creating and Changing Solaris fdisk Partitions

Review the following sections for guidelines and examples of creating or changing Solaris fdisk partitions.

x86: Guidelines for Creating an fdisk Partition

Follow these guidelines when you set up one or more fdisk partitions.

- The disk can be divided into a maximum of four fdisk partitions. One of partitions must be a Solaris partition.
- The Solaris partition must be made the active partition on the disk. The active partition is partition whose operating system will be booted by default at system startup.
- Solaris fdisk partitions must begin on cylinder boundaries.
- Solaris fdisk partitions must begin at cylinder 1, not cylinder 0, on the first disk because additional boot information, including the master boot record, is written in sector 0.
- The Solaris fdisk partition can be the entire disk. Or, you might want to make it smaller to allow room for a DOS partition. You can also make a new fdisk partition on a disk without disturbing existing partitions (if sufficient space is available) to create a new partition.

x86 only – Solaris slices are also called partitions. Certain interfaces might refer to a *slice* as a *partition*.

fdisk partitions are supported only on x86 based systems. To avoid confusion, Oracle Solaris documentation tries to distinguish between fdisk partitions and the entities within the Solaris fdisk partition. These entities might be called slices or partitions.

▼ x86: How to Create a Solaris fdisk Partition

Before You Begin If you need information about fdisk partitions, see “[x86: Guidelines for Creating an fdisk Partition](#)” on page 246.

- 1 **Become superuser or assume an equivalent role.**
- 2 **Invoke the format utility.**

```
# format
```

A numbered list of disks is displayed.

For more information, see [format\(1M\)](#).
- 3 **Type the number of the disk on which to create a Solaris fdisk partition.**

Specify disk (enter its number): *disk-number*

where *disk-number* is the number of the disk on which you want to create a Solaris fdisk partition.
- 4 **Select the fdisk menu.**

```
format> fdisk
```

The fdisk menu that is displayed depends upon whether the disk has existing fdisk partitions.
- 5 **Create and activate a Solaris fdisk partition that spans the entire disk by specifying y at the prompt. Then, go to step 13.**

No fdisk table exists. The default partition for the disk is:

```
a 100% "SOLARIS System" partition
```

Type "y" to accept the default partition, otherwise type "n" to edit the partition table.

```
y
```
- 6 **Specify n at the prompt if you do not want the Solaris fdisk partition to span the entire disk.**

Type "y" to accept the default partition, otherwise type "n" to edit the partition table.

```
n
```

Total disk size is 17848 cylinders
 Cylinder size is 16065 (512 byte) blocks

Partition	Status	Type	Cylinders		Length	%
			Start	End		
=====	=====	=====	=====	=====	=====	=====

SELECT ONE OF THE FOLLOWING:

1. Create a partition
2. Specify the active partition
3. Delete a partition
4. Change between Solaris and Solaris2 Partition IDs
5. Edit/View extended partitions
6. Exit (update disk configuration and exit)
7. Cancel (exit without updating disk configuration)

Enter Selection:

7 Select option 1, Create a partition, to create an fdisk partition.

Enter Selection: 1

8 Create a Solaris fdisk partition by selecting 1(=Solaris2).

Select the partition type to create:

- | | | | |
|------------|-------------|--------------|-----------|
| 1=SOLARIS2 | 2=UNIX | 3=PCIXOS | 4=Other |
| 5=DOS12 | 6=DOS16 | 7=DOSEXT | 8=DOSBIG |
| 9=DOS16LBA | A=x86 Boot | B=Diagnostic | C=FAT32 |
| D=FAT32LBA | E=DOSEXTLBA | F=EFI | 0=Exit? 1 |

9 Identify the percentage of the disk to be reserved for the Solaris fdisk partition. Keep in mind the size of any existing fdisk partitions when you calculate this percentage.

Specify the percentage of disk to use for this partition
 (or type "c" to specify the size in cylinders). *nn*

10 Activate the Solaris fdisk partition by typing y at the prompt.

Should this become the active partition? If yes, it will be activated each time the computer is reset or turned on. Please type "y" or "n". *y*

The Enter Selection prompt is displayed after the fdisk partition is activated.

11 Select option 1, Create a partition, to create another fdisk partition.

See steps 8–10 for instructions on creating an fdisk partition.

12 Update the disk configuration, and exit the fdisk menu from the selection menu.

Selection: 6

13 Relabel the disk by using the label command.

```
format> label
Ready to label disk, continue? yes
format>
```

14 Quit the format utility.

```
format> quit
```

Example 13-3 x86: Creating a Solaris fdisk Partition That Spans the Entire Drive

The following example uses the format utility's fdisk option to create a Solaris fdisk partition that spans the entire drive.

```
# format
Searching for disks...done
AVAILABLE DISK SELECTIONS:
  0. c0d0 <DEFAULT cyl 2466 alt 2 hd 16 sec 63>
    /pci@0,0/pci-ide@7,1/ide@0/cmdk@0,0
  1. c0d1 <DEFAULT cyl 522 alt 2 hd 32 sec 63>
    /pci@0,0/pci-ide@7,1/ide@0/cmdk@1,0
  2. c1d0 <DEFAULT cyl 13102 alt 2 hd 16 sec 63>
    /pci@0,0/pci-ide@7,1/ide@1/cmdk@0,0
Specify disk (enter its number): 0
selecting c0d0
Controller working list found
[disk formatted]
format> fdisk
No fdisk table exists. The default partitioning for your disk is:

    a 100% "SOLARIS System" partition.

Type "y" to accept the default partition, otherwise type "n" to edit the
partition table. y

format> label
Ready to label disk, continue? yes
format> quit
```

More Information After You Create a Solaris fdisk Partition ...

After you create a Solaris fdisk partition on the disk, you can use for a root pool disk or non-root pool disk. For more information, see [“SPARC: Setting Up Disks for UFS File Systems” on page 216](#).

Changing the fdisk Partition Identifier

The Solaris fdisk partition identifier on x86 systems has been changed from 130 (0x82) to 191 (0xbf). All Oracle Solaris commands, utilities, and drivers have been updated to work with either fdisk identifier. There is no change in fdisk functionality.

▼ How to Change the Solaris fdisk Identifier

A new fdisk menu option enables you to switch back and forth between the new and old identifier. The fdisk identifier can be changed even when the file system that is contained in the partition is mounted.

Two type values in the fdisk menu reflect the old and new identifiers as follows:

- Solaris identifies 0x82
- Solaris2 identifies 0xbf

1 Become superuser.

2 Display the current fdisk identifier.

For example:

```

Total disk size is 39890 cylinders
Cylinder size is 4032 (512 byte) blocks

      Cylinders
Partition  Status  Type          Start  End  Length  %
=====  =====  =====
          1  Active  x86 Boot      1     6     6     0
          2          Solaris2    7  39889  39883   100
    
```

3 Select option 4 from the fdisk menu to change the fdisk partition identifier back to 0x82.

SELECT ONE OF THE FOLLOWING:

1. Create a partition
2. Specify the active partition
3. Delete a partition
4. Change between Solaris and Solaris2 Partition IDs
5. Exit (update disk configuration and exit)
6. Cancel (exit without updating disk configuration)

Enter Selection: 4

4 Select option 5 to update your disk configuration and exit.

5 If necessary, select option 4 from the fdisk menu to change the fdisk partition identifier back to 0xbf.

For example:

```

Total disk size is 39890 cylinders
Cylinder size is 4032 (512 byte) blocks
    
```

```

      Cylinders
Partition  Status  Type          Start  End  Length  %
=====  =====  =====
          1  Active  x86 Boot      1     6     6     0
          2          Solaris     7  39889  39883   100
    
```

SELECT ONE OF THE FOLLOWING:

1. Create a partition
2. Specify the active partition
3. Delete a partition
4. Change between Solaris and Solaris2 Partition IDs
5. Exit (update disk configuration and exit)
6. Cancel (exit without updating disk configuration)

Enter Selection: 4

6 Select option 5 to update your disk configuration and exit.

Configuring Oracle Solaris iSCSI Targets and Initiators (Tasks)

This chapter describes how to configure Solaris iSCSI targets and initiators, available in the Oracle Solaris release. For information about the procedures associated with configuring iSCSI targets and initiators, see “[Setting Up Solaris iSCSI Targets and Initiators \(Task Map\)](#)” on page 253.

For information about the latest Oracle Solaris iSCSI initiator features, see “[What's New in Disk Management?](#)” on page 177

For troubleshooting Solaris iSCSI configuration problems, see “[Troubleshooting iSCSI Configuration Problems](#)” on page 274.

iSCSI Technology (Overview)

iSCSI is an acronym for Internet SCSI (Small Computer System Interface), an Internet Protocol (IP)-based storage networking standard for linking data storage subsystems. This networking standard was developed by the Internet Engineering Task Force (IETF). For more information about the iSCSI technology, see RFC 3720:

<http://www.ietf.org/rfc/rfc3720.txt>

By carrying SCSI commands over IP networks, the iSCSI protocol enables you to access block devices from across the network as if they were connected to the local system.

If you want to use storage devices in your existing TCP/IP network, the following solutions are available:

- iSCSI block devices or tape – Translates SCSI commands and data from the block level into IP packets. Using iSCSI in your network is advantageous when you need to have block-level access between one system and the target device, such as a tape device or a database. Access to a block-level device is not locked so that you could have multiple users or systems accessing a block-level device such as an iSCSI target device.

- NFS – Transfers file data over IP. The advantage of using NFS in your network is that you can share file data across many systems. Access to file data is locked appropriately when many users are accessing data that is available in an NFS environment.

Here are the benefits of using Solaris iSCSI targets and initiators:

- The iSCSI protocol runs across existing Ethernet networks.
 - You can use any supported network interface card (NIC), Ethernet hub, or Ethernet switch.
 - One IP port can handle multiple iSCSI target devices.
 - You can use existing infrastructure and management tools for IP networks.
- You might have existing Fibre-Channel devices that can be connected to clients without the cost of Fibre-Channel HBAs. In addition, systems with dedicated arrays can now export replicated storage with ZFS or UFS file systems.
- There is no upper limit on the maximum number of configured iSCSI target devices.
- The protocol can be used to connect to Fibre Channel or iSCSI Storage Area Network (SAN) environments with the appropriate hardware.

Here are the current limitations or restrictions of using the Solaris iSCSI initiator software:

- Support for iSCSI devices that use SLP is not currently available.
- Boot support for iSCSI devices is not currently available.
- iSCSI targets cannot be configured as dump devices.
- iSCSI supports multiple connections per session, but the current Solaris implementation only supports a single connection per session.

For more information, see RFC 3720.

- Transferring large amounts of data over your existing network can have an impact on performance.

Solaris iSCSI Software and Hardware Requirements

- Solaris iSCSI software and devices
- Solaris 10 release (at least the 1/06 release) for Solaris iSCSI initiator software
- Solaris 10 release (at least the 8/07 release) for Solaris iSCSI target software
- The following Solaris 10 software packages:
 - SUNwiscsir – Sun iSCSI Device Driver (root)
 - SUNwiscsiu – Sun iSCSI Management Utilities (usr)
 - SUNwiscsitgtr – Sun iSCSI Target Device Driver (root)
 - SUNwiscsitgtu – Sun iSCSI Target Management Utilities (usr)
- Any supported NIC

Setting Up Solaris iSCSI Targets and Initiators (Task Map)

Task	Description	For Instructions
1. Identify the iSCSI software and hardware requirements.	Identify the software and hardware requirements for setting up an iSCSI-based storage network.	“Solaris iSCSI Software and Hardware Requirements” on page 252
2. Set up your iSCSI target devices.	<p>Connect and set up your Solaris iSCSI target devices.</p> <p>In addition, you can set up third-party target devices. See your vendor's documentation for setup instructions.</p> <p>Set up iSNS discovery on your Solaris iSCSI target, if an iSNS server is available.</p>	<p>“Setting Up Your Solaris iSCSI Target Devices” on page 256</p> <p>“How to Configure iSNS Discovery for the Solaris iSCSI Target” on page 257</p>
3. Prepare for your Solaris iSCSI configuration.	Make sure you have the correct software versions and hardware installed.	“How to Prepare for a Solaris iSCSI Configuration” on page 256
4. (Optional) Set up authentication in your Solaris iSCSI configuration.	<p>Decide whether you want to use authentication in your Solaris iSCSI configuration:</p> <p>Consider using unidirectional CHAP or bidirectional CHAP.</p> <p>Consider using a third-party RADIUS server to simplify CHAP management.</p>	<p>“How to Configure CHAP Authentication for Your iSCSI Initiator” on page 259</p> <p>“How to Configure CHAP Authentication for Your iSCSI Target” on page 260</p> <p>“How to Configure RADIUS for Your iSCSI Configuration” on page 261</p>
5. Configure the iSCSI target discovery method.	Select the iSCSI target discovery method best suited for your environment.	“How to Configure iSCSI Target Discovery” on page 262
6. (Optional) Remove discovered iSCSI targets.	You might need to remove a discovered iSCSI target.	“How to Remove Discovered iSCSI Targets” on page 263

Task	Description	For Instructions
7. Access iSCSI disks.	You can access your iSCSI disks with the <code>format</code> utility. You can also enable the iSCSI disks to be available automatically after the system is rebooted.	“Accessing iSCSI Disks” on page 264
8. Monitor your iSCSI configuration.	Monitor your iSCSI configuration by using the <code>iscsiadm</code> command.	“Monitoring Your iSCSI Configuration” on page 265
9. (Optional) Modify your iSCSI configuration.	You might want to modify your iSCSI target settings such as the header and data digest parameters.	“How to Modify iSCSI Initiator and Target Parameters” on page 268
10. (Optional) Set up Solaris iSCSI multipathed devices.	Determine whether you want to set up Solaris iSCSI multipathed devices. Use this procedure to create multiple iSCSI sessions that connect to a single target.	“Setting Up Solaris iSCSI Multipathed Devices” on page 270 “How to Enable Multiple iSCSI Sessions for a Target” on page 271

Configuring Solaris iSCSI Targets and Initiators

Configuring your Solaris iSCSI targets and initiators involves the following steps:

- Identifying the hardware and software requirements
- Configuring your IP network
- Connecting and setting up your iSCSI target device
- (Optional) Configuring iSCSI authentication between the iSCSI initiator and the iSCSI target, if necessary
- Configuring the iSCSI target discovery method
- Creating file systems on your iSCSI disks
- Monitoring your iSCSI configuration

The iSCSI configuration information is stored in the `/etc/iscsi` directory. This information requires no administration.

iSCSI Terminology

Review the following terminology before configuring iSCSI targets and initiators.

Term	Description
Initiator	The driver that initiates SCSI requests to the iSCSI target.

Term	Description
Target device	The iSCSI storage component.
Discovery	The process that presents the initiator with a list of available targets.
Discovery method	The way in which the iSCSI targets can be found. Three methods are currently available: <ul style="list-style-type: none"> ▪ Internet Storage Name Service (iSNS) – Potential targets are discovered by interacting with one or more iSNS servers. ▪ SendTargets – Potential targets are discovered by using a <i>discovery-address</i>. ▪ Static – Static target addressing is configured.

Configuring Dynamic or Static Target Discovery

Determine whether you want to configure one of the dynamic device discovery methods or use static iSCSI initiator targets to perform device discovery.

- **Dynamic device discovery** – If an iSCSI node exposes many targets, such as an iSCSI to Fibre-Channel bridge, you can supply the iSCSI node IP address/port combination and allow the iSCSI initiator to use the SendTargets features to perform device discovery.

Two dynamic device discovery methods are available:

- SendTargets - If an iSCSI node exposes a large number of targets, such as an iSCSI to Fibre-Channel bridge, you can supply the iSCSI node IP address/port combination and allow the iSCSI initiator to use the SendTargets features to perform the device discovery.
- iSNS - iSNS (Internet Storage Name Service) allows the iSCSI initiator to discover the targets to which it has access using as little configuration information as possible. It also provides state change notification to notify the iSCSI initiator when changes in the operational state of storage nodes occur. To use the iSNS discovery method, you can supply the iSNS server address/port combination and allow the iSCSI initiator to query the iSNS servers that you specified to perform the device discovery. The default port for the iSNS server is 3205. For more information about iSNS, see RFC 4171:

<http://www.ietf.org/rfc/rfc4171.txt>

The iSNS discovery service provides an administrative model to discover all targets in a network.

- **Static device discovery** – If an iSCSI node has few targets or if you want to restrict the targets that the initiator attempts to access, you can statically configure the *target-name* by using the following static target address naming convention:

target,target-address[:port-number]

You can determine the static target address from the array's management tool.

Note – Do not configure an iSCSI target to be discovered by both static and dynamic device discovery methods. The consequence of using redundant discovery methods might be slow performance when the initiator is communicating with the iSCSI target device.

▼ How to Prepare for a Solaris iSCSI Configuration

This procedure assumes that you are logged in to the local system where you want to access a configured iSCSI target device.

- 1 **Become superuser.**
- 2 **Verify that the iSCSI software packages are installed.**
- 3 **Verify that you are running at least the Solaris 10 1/06 release.**
- 4 **Confirm that your TCP/IP network is setup.**
- 5 **Connect your iSCSI target devices and confirm that they are configured.**

```
initiator# pkginfo SUNWiscsiu SUNWiscsir
system      SUNWiscsiu Sun iSCSI Device Driver (root)
system      SUNWiscsir Sun iSCSI Management Utilities (usr)
```

For example, determine if the iSCSI target device is reachable by using the `telnet` command to connect to the iSCSI target device using port 3260. If the connection is refused, see [“Troubleshooting iSCSI Configuration Problems” on page 274](#).

For information about connecting your third-party iSCSI target devices, see your vendor documentation.

Setting Up Your Solaris iSCSI Target Devices

You can use the `iscsitadm` command to set up and manage your Solaris iSCSI target devices, which can be disk or tape devices. For the device that you select as your iSCSI target, you must provide an equivalently sized ZFS or UFS file system as the backing store for the iSCSI daemon.

For information about setting up a Solaris iSCSI target device with ZFS, see [“ZFS and Solaris iSCSI Improvements” in *Oracle Solaris ZFS Administration Guide*](#).

After the target device is set up, use the `iscsiadm` command to identify your iSCSI targets, which will discover and use the iSCSI target device.

For more information, see `iscsitadm(1M)` and `iscsiadm(1M)`.

The basic process is as follows:

- Identify the backing store directory – For each target and logical unit that is created, the iSCSI daemon needs to store some information. By default, the backing store for this device is also located in the base directory. So, if the host system has a large ZFS pool to use, it might be easiest to allow the daemon to store everything in that location. If the backing store needs to be spread out, it's possible to specify the backing store location during the creation of each logical unit.
- Create the iSCSI target – By default, the CLI assumes that the requested device type is an LBA of logical unit 0. If a pass through mode is desired for character devices, the `-raw` option must be used. After the creation of the first LUN, other LUNs might be created for the same iSCSI target by specifying `-lun number`.

The daemon starts a background task that initializes the LUN to zeros. If, during that initialization, the underlying file system becomes 100 percent full, the daemon removes the target. During this initialization, the LUN is marked as being offline and cannot be used by an initiator. During this time, however, it is possible to have an initiator discover this LUN. The Solaris initiator waits until it receives an Inventory Change notification and then automatically brings the device online.

▼ How to Create an iSCSI Target

This procedure assumes that you are logged in to the local system that contains the iSCSI targets.

1 Become superuser.

2 Identify the backing store directory.

For example:

```
target# iscsitadm modify admin -d /export/sandbox
```

3 Create an iSCSI target.

For example:

```
target# iscsitadm create target --size 2g sandbox
```

4 Display information about the iSCSI target.

For example:

```
target# iscsitadm list target -v sandbox
```

5 Set up your iSCSI initiator to discover and use this target.

For more information, see [“How to Configure iSCSI Target Discovery” on page 262](#).

▼ How to Configure iSNS Discovery for the Solaris iSCSI Target

If your network includes a third-party iSNS server or a Sun iSNS server, you can set up iSNS target discovery on your Solaris iSCSI targets.

This procedure assumes that you are logged in to the local system where you want to access a configured iSCSI target device.

- 1 **Become superuser.**
- 2 **Add the iSNS server information.**

For example:

```
initiator# iscsitadm modify admin --isns-server ip-address or hostname[:port]
```

Identify the *ip-address* of the iSNS server in your network.

This step adds the iSNS server information to all of the Solaris iSCSI targets.

- 3 **Enable iSNS server discovery.**

For example:

```
initiator# iscsitadm modify admin --isns-access enable
```

This step enables iSNS discovery for all of the Solaris iSCSI targets.

Configuring Authentication in Your iSCSI-Based Storage Network

Setting up authentication for your iSCSI devices is optional.

In a secure environment, authentication is not required because only trusted initiators can access the targets.

In a less secure environment, the target cannot determine if a connection request is truly from a given host. In that case, the target can authenticate an initiator by using the Challenge-Handshake Authentication Protocol (CHAP).

CHAP authentication uses the notion of a challenge and response, which means that the target challenges the initiator to prove its identity. For the challenge/response method to work, the target must know the initiator's secret key, and the initiator must be set up to respond to a challenge. Refer to the array vendor's documentation for instructions on setting up the secret key on the array.

iSCSI supports unidirectional and bidirectional authentication:

- *Unidirectional authentication* enables the target to authenticate the identity of the initiator.
- *Bidirectional authentication* adds a second level of security by enabling the initiator to authenticate the identity of the target.

▼ How to Configure CHAP Authentication for Your iSCSI Initiator

This procedure assumes that you are logged in to the local system where you want to securely access the configured iSCSI target device.

1 Become superuser.

2 Determine whether you want to configure unidirectional or bidirectional CHAP.

- Unidirectional authentication, the default method, enables the target to validate the initiator. Complete steps 3–5 only.
- Bidirectional authentication adds a second level of security by enabling the initiator to authenticate the target. Complete steps 3–9.

3 Unidirectional CHAP – Set the secret key on the initiator.

For example, the following command initiates a dialogue to define the CHAP secret key.

```
initiator# iscsiadm modify initiator-node --CHAP-secret
```

Note – The CHAP secret length must be a minimum of 12 characters and a maximum of 16 characters.

4 (Optional) Unidirectional CHAP – Set the CHAP name on the initiator.

By default, the initiator's CHAP name is set to the initiator node name.

You can use the following command to change the initiator's CHAP name.

```
initiator# iscsiadm modify initiator-node --CHAP-name new-CHAP-name
```

In the Solaris environment, the CHAP name is always set to the initiator node name by default. The CHAP name can be set to any length text that is less than 512 bytes. The 512-byte length limit is a Solaris limitation. However, if you do not set the CHAP name, it is set to the initiator node name upon initialization.

5 Unidirectional CHAP – Enable CHAP authentication on the initiator after the secret has been set.

```
initiator# iscsiadm modify initiator-node --authentication CHAP
```

CHAP requires that the initiator node have both a user name and a password. The user name is typically used by the target to look up the secret for the given username.

6 Select one of the following to enable or disable Bidirectional CHAP.

- Bidirectional CHAP – Enable bidirectional authentication parameters on the target.

For example:

```
initiator# iscsiadm modify target-param -B enable eui.5000ABCD78945E2B
```

- Disable bidirectional CHAP. For example:

```
initiator# iscsiadm modify target-param -B disable eui.5000ABCD78945E2B
```

7 Bidirectional CHAP – Set the authentication method to CHAP on the target.

For example:

```
initiator# iscsiadm modify target-param --authentication CHAP eui.5000ABCD78945E2B
```

8 Bidirectional CHAP – Set the target device secret key on the target.

For example, the following command initiates a dialogue to define the CHAP secret key:

```
initiator# iscsiadm modify target-param --CHAP-secret eui.5000ABCD78945E2B
```

9 Bidirectional CHAP - Set the CHAP name on the target.

By default, the target's CHAP name is set to the target name.

You can use the following command to change the target's CHAP name:

```
initiator# iscsiadm modify target-param --CHAP-name target-CHAP-name
```

▼ How to Configure CHAP Authentication for Your iSCSI Target

This procedure assumes that you are logged in to the local system that contains the iSCSI targets.

1 Become superuser.

2 Set the CHAP secret name for the target.

A convention is to use the host name for the secret name. For example:

```
target# iscsitadm modify admin -H stormpike
```

3 Specify the CHAP secret.

The CHAP secret must be between 12 and 16 characters. For example:

```
target# iscsitadm modify admin -C
Enter secret: xxxxxx
Re-enter secret: xxxxxx
```

4 Create an initiator object that will be associated with one or more targets.

This step is done so that you can associate a friendly name (normally the host name, in this case `monster620`) with the IQN value, instead of typing it in every time. For example:

```
# iscsitadm create initiator -n iqn.1986-03.com.sun:01:00e081553307.4399f40e monster620
```

5 Provide the same CHAP name that was used on the initiator.

This name can be different from the friendly name that was used for the initiator object. For example:

```
target# iscsitadm modify initiator -H monster620 monster620
```

6 Use the same CHAP secret that was used on the initiator.

For example:

```
target# iscsitadm modify initiator -C monster620
Enter secret: xxxxxx
Re-enter secret: xxxxxx
```

7 Associate the initiator object with one or more targets.

For example:

```
target# iscsitadm modify target -l monster620 sandbox
```

Using a Third-Party RADIUS Server to Simplify CHAP Management in Your iSCSI Configuration

You can use a third-party RADIUS server to simplify CHAP secret management. A RADIUS server is a centralized authentication service. While you must still specify the initiator's CHAP secret, you are no longer required to specify each target's CHAP secret on each initiator when using bidirectional authentication with a RADIUS server.

For more information, see:

- CHAP – <http://www.ietf.org/rfc/rfc1994.txt>
- RADIUS – <http://www.ietf.org/rfc/rfc2865.txt>

▼ How to Configure RADIUS for Your iSCSI Configuration

This procedure assumes that you are logged in to the local system where you want to securely access the configured iSCSI target device.

1 Become superuser.**2 Configure the initiator node with the IP address and port (the default port is 1812) of the RADIUS server.**

For example:

```
initiator# iscsiadm modify initiator-node --radius-server 10.0.0.72:1812
```

3 Configure the initiator node with the shared secret of the RADIUS server.

```
initiator# iscsiadm modify initiator-node --radius-shared-secret
```

Note – The Solaris iSCSI implementation requires that the RADIUS server is configured with a shared secret before the Solaris iSCSI software can interact with the RADIUS server.

4 Enable the RADIUS server.

```
initiator# iscsiadm modify initiator-node --radius-access enable
```

Solaris iSCSI and RADIUS Server Error Messages

This section describes the error messages that are related to a Solaris iSCSI and RADIUS server configuration, along with potential solutions for recovery.

empty RADIUS shared secret

Cause: The RADIUS server is enabled on the initiator, but the RADIUS shared secret is not set.

Solution: Configure the initiator with the RADIUS shared secret. For more information, see [“How to Configure RADIUS for Your iSCSI Configuration” on page 261.](#)

WARNING: RADIUS packet authentication failed

Cause: The initiator failed to authenticate the RADIUS data packet. This error can occur if the shared secret configured on the initiator node is different from the shared secret on the RADIUS server.

Reconfigure the initiator with the correct RADIUS shared secret. For more information, see [“How to Configure RADIUS for Your iSCSI Configuration” on page 261.](#)

▼ How to Configure iSCSI Target Discovery

This procedure assumes that you are logged in to the local system where you want to configure access to an iSCSI target device.

- 1 **Become superuser.**
- 2 **Configure the target device to be discovered dynamically or statically using one of the following methods:**

- Configure the device to be dynamically discovered (SendTargets).

For example:

```
initiator# iscsiadm add discovery-address 10.0.0.1:3260
```

- Configure the device to be dynamically discovered (iSNS).

For example:

```
initiator# iscsiadm add iSNS-server 10.0.0.1:3205
```

- Configure the device to be statically discovered.

For example:

```
initiator# iscsiadm add static-config eui.5000ABCD78945E2B,10.0.0.1
```

The iSCSI connection is not initiated until the discovery method is enabled. See the next step.

- 3 **Enable the iSCSI target discovery method using one of the following:**

- If you have configured a dynamically discovered (SendTargets) device, enable the SendTargets discovery method.

```
initiator# iscsiadm modify discovery --sendtargets enable
```

- If you have configured a dynamically discovered (iSNS) device, enable the iSNS discovery method.

```
initiator# iscsiadm modify discovery --iSNS enable
```

- If you have configured static targets, enable the static target discovery method.

```
initiator# iscsiadm modify discovery --static enable
```

4 Create the iSCSI device links for the local system.

```
initiator# devfsadm -i iscsi
```

▼ How to Remove Discovered iSCSI Targets

After removing a discovery address, iSNS server, or static configuration, or after disabling a discovery method, the associated targets are logged out. If these associated targets are still in use, for example, they have mounted file systems, the logout of these devices will fail, and they will remain on the active target list.

This optional procedure assumes that you are logged in to the local system where access to an iSCSI target device has already been configured.

1 Become superuser.

2 (Optional) Disable an iSCSI target discovery method using one of the following:

- If you need to disable the SendTargets discovery method, use the following command:

```
initiator# iscsiadm modify discovery --sendtargets disable
```

- If you need to disable the iSNS discovery method, use the following command:

```
initiator# iscsiadm modify discovery --iSNS disable
```

- If you need to disable the static target discovery method, use the following command:

```
initiator# iscsiadm modify discovery --static disable
```

3 Remove an iSCSI device discovery entry using one of the following:

- Remove an iSCSI SendTargets discovery entry.

For example:

```
initiator# iscsiadm remove discovery-address 10.0.0.1:3260
```

- Remove an iSCSI iSNS discovery entry.

For example:

```
# iscsiadm remove isns-server 10.0.0.1:3205
```

- Remove a static iSCSI discovery entry.

For example:

```
initiator# iscsiadm remove static-config eui.5000ABCD78945E2B,10.0.0.1
```

Note – If you attempt to disable or remove a discovery entry that has an associated logical unit in use, the disable or remove operation fails with the following message:

```
logical unit in use
```

If this errors occurs, stop all associated I/O on the logical unit, unmount the file systems, and so on. Then, repeat the disable or remove operation.

4 Remove the iSCSI target device.

Remove a target by specifying the logical unit number (LUN). If you did not specify a LUN when the target was created, a value of 0 was used. LUN 0 must be the last LUN removed if multiple LUNs are associated with a target.

For example:

```
initiator# iscsitadm delete target --lun 0 sandbox
```

Accessing iSCSI Disks

If you want to access the iSCSI disks upon reboot, create the file system on the disk, and add an `/etc/vfstab` entry as you would with a UFS file system on a SCSI device. Then, create a new SMF service for mounting iSCSI disks that depends on the iSCSI initiator service. For more information, see [“How to Access iSCSI Disks Upon Reboot”](#) on page 265.

After the devices have been discovered by the Solaris iSCSI initiator, the login negotiation occurs automatically. The Solaris iSCSI driver determines the number of available LUNs and creates the device nodes. Then, the iSCSI devices can be treated as any other SCSI device.

You can view the iSCSI disks on the local system by using the `format` utility.

In the following `format` output, disks 2 and 3 are iSCSI LUNs that are not under MPxIO control. Disks 21 and 22 are iSCSI LUNs under MPxIO control.

```
initiator# format
AVAILABLE DISK SELECTIONS:
  0. c0t1d0 <SUN72G cyl 14087 alt 2 hd 24 sec 424>
    /pci@8,600000/SUNW,q1c@4/fp@0,0/ssd@w500000e010685cf1,0
  1. c0t2d0 <SUN72G cyl 14087 alt 2 hd 24 sec 424>
    /pci@8,600000/SUNW,q1c@4/fp@0,0/ssd@w500000e0106e3ba1,0
  2. c3t0d0 <ABCSTORAGE-100E-00-2.2 cyl 20813 alt 2 hd 16 sec 63>
    /iscsi/disk@0000iqn.2001-05.com.abcstorage%3A6-8a0900-477d70401-
```



```

b0fff044352423a2-hostname-020000,0
3. c3t1d0 <ABCSTORAGE-100E-00-2.2 cyl 20813 alt 2 hd 16 sec 63>
   /iscsi/disk@0000iqn.2001-05.com.abcstorage%3A6-8a0900-3fcd70401
   -085ff04434f423a2-hostname-010000,0
.
.
.
21. c4t60A98000686F694B2F59775733426B77d0 <ABCSTORAGE-LUN-0.2 cyl
    4606 alt 2 hd 16 sec 256>
    /scsi_vhci/ssd@g60a98000686f694b2f59775733426b77
22. c4t60A98000686F694B2F59775733434C41d0 <ABCSTORAGE-LUN-0.2 cyl
    4606 alt 2 hd 16 sec 256>
    /scsi_vhci/ssd@g60a98000686f694b2f59775733434c41

```

▼ How to Access iSCSI Disks Upon Reboot

Follow the steps below to access iSCSI disks after the system is rebooted.

- 1 **Become superuser or assume an equivalent role.**
- 2 **Add entries for the iSCSI LUN(s) to the `/etc/vfstab` file. Set the mount at boot option to `iscsi`.**

```

initiator# vi /etc/vfstab
#device      device      mount      FS      fsck      mount      mount
#to mount    to fsck     point      type    pass     at boot    options
#
/dev/dsk/c3t600144F04B555F370000093D00495B00d0s0 -      /mnt      ufs     -         no        -

```

▼ Monitoring Your iSCSI Configuration

You can display information about the iSCSI initiator and target devices by using the `iscsiadm list` command.

- 1 **Become superuser.**
- 2 **Display information about the iSCSI initiator.**

For example:

```

# iscsiadm list initiator-node
Initiator node name: iqn.1986-03.com.sun:01:0003ba4d233b.425c293c
Initiator node alias: zzrl200
  Login Parameters (Default/Configured):
    Header Digest: NONE/-
    Data Digest: NONE/-
  Authentication Type: NONE
  RADIUS Server: NONE
  RADIUS access: unknown
  Configured Sessions: 1

```

3 Display information about which discovery methods are in use.

For example:

```
# iscsiadm list discovery
Discovery:
  Static: enabled
  Send Targets: enabled
  iSNS: enabled
```

Example 14-1 Displaying iSCSI Target Information

The following example shows how to display the parameter settings for a specific iSCSI target.

```
# iscsiadm list target-param iqn.1992-08.com.abcstorage:sn.33592219
Target: iqn.1992-08.com.abcstorage:sn.33592219
```

The `iscsiadm list target-param -v` command displays the following information:

- The authentication settings for the target
- The default settings for the target login parameters
- The configured value for each login parameter

The `iscsiadm list target-param -v` command displays the *default* parameter value before the / designator and the *configured* parameter value after the / designator. If you have not configured any parameters, the configured parameter value displays as a hyphen (-). For more information, see the following examples.

```
# iscsiadm list target-param -v eui.50060e8004275511 Target: eui.50060e8004275511
Alias: -
Bi-directional Authentication: disabled
Authentication Type: NONE
Login Parameters (Default/Configured):
  Data Sequence In Order: yes/-
  Data PDU In Order: yes/-
  Default Time To Retain: 20/-
  Default Time To Wait: 2/-
  Error Recovery Level: 0/-
  First Burst Length: 65536/-
  Immediate Data: yes/-
  Initial Ready To Transfer (R2T): yes/-
  Max Burst Length: 262144/-
  Max Outstanding R2T: 1/-
  Max Receive Data Segment Length: 65536/-
  Max Connections: 1/-
  Header Digest: NONE/-
  Data Digest: NONE/-
Configured Sessions: 1
```

The following example output displays the parameters that were negotiated between the target and the initiator.

```
# iscsiadm list target -v eui.50060e8004275511
Target: eui.50060e8004275511
TPGT: 1
```

```

ISID: 4000002a0000
Connections: 1
CID: 0
IP address (Local): 172.90.101.71:32813
IP address (Peer): 172.90.101.40:3260
Discovery Method: Static
Login Parameters (Negotiated):
  Data Sequence In Order: yes
  Data PDU In Order: yes
  Default Time To Retain: 0
  Default Time To Wait: 3
  Error Recovery Level: 0
  First Burst Length: 65536
  Immediate Data: yes
  Initial Ready To Transfer (R2T): yes
  Max Burst Length: 262144
  Max Outstanding R2T: 1
  Max Receive Data Segment Length: 65536
  Max Connections: 1
  Header Digest: NONE
  Data Digest: NONE

```

Modifying iSCSI Initiator and Target Parameters

You can modify parameters on both the iSCSI initiator and the iSCSI target device. However, the only parameters that can be modified on the iSCSI initiator are the following:

- iSCSI initiator node name – You can change the initiator node name to a different name. If you change the initiator node name, the targets that were discovered by iSNS might be removed from the initiator's target list, depending on the discovery domain configuration on the iSNS server at the time when the name was changed. For more information, see [“How to Modify iSCSI Initiator and Target Parameters” on page 268](#).
- Header digest – NONE, the default value or CRC32.
- Data digest – NONE, the default value or CRC32.
- Authentication and CHAP secret – For more information about setting up authentication, see [“How to Configure CHAP Authentication for Your iSCSI Initiator” on page 259](#).
- Configured sessions – For more information about configuring multiple sessions, see [“How to Enable Multiple iSCSI Sessions for a Target” on page 271](#).

The iSCSI driver provides default values for the iSCSI initiator and iSCSI target device parameters. If you modify the parameters of the iSCSI initiator, the modified parameters are inherited by the iSCSI target device, unless the iSCSI target device already has different values.



Caution – Ensure that the target software supports the parameter to be modified. Otherwise, you might be unable to log in to the iSCSI target device. See your array documentation for a list of supported parameters.

Modifying iSCSI parameters should be done when I/O between the initiator and the target is complete. The iSCSI driver reconnects the session after the changes are made by using the `iscsiadm modify` command.

▼ How to Modify iSCSI Initiator and Target Parameters

The first part of this procedure illustrates how modified parameters of the iSCSI initiator are inherited by the iSCSI target device. The second part of this procedure shows how to actually modify parameters on the iSCSI target device.

This optional procedure assumes that you are logged in to the local system where access to an iSCSI target device has already been configured.

- 1 **Become superuser.**
- 2 **List the current parameters of the iSCSI initiator and target device.**
 - a. **List the current parameters of the iSCSI initiator. For example:**

```
initiator# iscsiadm list initiator-node
Initiator node name: iqn.1986-03.com.sun:01:0003ba4d233b.425c293c
Initiator node alias: z zr1200
      Login Parameters (Default/Configured):
            Header Digest: NONE/-
            Data Digest: NONE/-
      Authentication Type: NONE
      RADIUS Server: NONE
      RADIUS access: unknown
      Configured Sessions: 1
```

- b. **List the current parameters of the iSCSI target device. For example:**

```
initiator# iscsiadm list target-param -v iqn.1992-08.com.abcstorage:sn.84186266
Target: iqn.1992-08.com.abcstorage:sn.84186266
Alias: -
Bi-directional Authentication: disabled
Authentication Type: NONE
      Login Parameters (Default/Configured):
            Data Sequence In Order: yes/-
            Data PDU In Order: yes/-
            Default Time To Retain: 20/-
            Default Time To Wait: 2/-
            Error Recovery Level: 0/-
            First Burst Length: 65536/-
            Immediate Data: yes/-
            Initial Ready To Transfer (R2T): yes/-
            Max Burst Length: 262144/-
            Max Outstanding R2T: 1/-
            Max Receive Data Segment Length: 65536/-
            Max Connections: 1/-
            Header Digest: NONE/-
            Data Digest: NONE/-
      Configured Sessions: 1
```

Note that both header digest and data digest parameters are currently set to NONE for both the iSCSI initiator and the iSCSI target device.

To review the default parameters of the iSCSI target device, see the `iscsiadm list target-param` output in [Example 14-1](#).

3 Modify the parameter of the iSCSI initiator.

For example, set the header digest to CRC32.

```
initiator# iscsiadm modify initiator-node -h CRC32
```

If you change the initiator node name, the targets that were discovered by iSNS might be logged out and removed from the initiator's target list, if the new name does not belong to the same discovery domain as that of the targets. However, if the targets are in use, they are not removed. For example, if a file is open or a file system is mounted on these targets, the targets will not be removed.

You might also see new targets after the name change if these targets and the new initiator node name belong to the same discovery domain.

4 Verify that the parameter was modified.

a. Display the updated parameter information for the iSCSI initiator. For example:

```
initiator# iscsiadm list initiator-node
Initiator node name: iqn.1986-03.com.sun:01:0003ba4d233b.425c293c
Initiator node alias: z zr1200
  Login Parameters (Default/Configured):
    Header Digest: NONE/CRC32
    Data Digest: NONE/-
  Authentication Type: NONE
  RADIUS Server: NONE
  RADIUS access: unknown
  Configured Sessions: 1
```

Note that the header digest is now set to CRC32.

b. Display the updated parameter information for the iSCSI target device. For example:

```
initiator# iscsiadm list target-param -v iqn.1992-08.com.abcstorage:sn.84186266
Target: iqn.1992-08.com.abcstorage:sn.84186266
Alias: -
Bi-directional Authentication: disabled
Authentication Type: NONE
  Login Parameters (Default/Configured):
    Data Sequence In Order: yes/-
    Data PDU In Order: yes/-
    Default Time To Retain: 20/-
    Default Time To Wait: 2/-
    Error Recovery Level: 0/-
    First Burst Length: 65536/-
    Immediate Data: yes/-
    Initial Ready To Transfer (R2T): yes/-
    Max Burst Length: 262144/-
    Max Outstanding R2T: 1/-
```

```

Max Receive Data Segment Length: 65536/-
Max Connections: 1/-
Header Digest: CRC32/-
Data Digest: NONE/-
Configured Sessions: 1

```

Note that the header digest is now set to CRC32.

5 Verify that the iSCSI initiator has reconnected to the iSCSI target. For example:

```

initiator# iscsiadm list target -v iqn.1992-08.com.abcstorage:sn.84186266
Target: iqn.1992-08.com.abcstorage:sn.84186266
TPGT: 2
ISID: 4000002a0000
Connections: 1
  CID: 0
  IP address (Local): nnn.nn.nn.nnn:64369
  IP address (Peer): nnn.nn.nn.nnn:3260
  Discovery Method: SendTargets
  Login Parameters (Negotiated):
  .
  .
  .
  Header Digest: CRC32
  Data Digest: NONE

```

6 (Optional) Unset an iSCSI initiator parameter or an iSCSI target device parameter.

You can unset a parameter by setting it back to its default setting by using the `iscsiadm modify` command. Or, you can use the `iscsiadm remove` command to reset all target properties to the default settings.

The `iscsiadm modify target-param` command changes only the parameters that are specified on the command line.

The following example shows how to reset the header digest to NONE:

```
initiator# iscsiadm modify target-param -h none iqn.1992-08.com.abcstorage:sn...
```

For information about the `iscsiadm remove target-param` command, see [iscsiadm\(1M\)](#).

Setting Up Solaris iSCSI Multipathed Devices

Consider the following guidelines for using Solaris iSCSI multipathed (MPxIO) devices:

- **Solaris iSCSI and MPxIO** – MPxIO supports target port aggregation and availability in Solaris iSCSI configurations that configure multiple sessions per target (MS/T) on the iSCSI initiator.
 - Use IPMP for aggregation and failover of two or more NICs.
 - A basic configuration for an iSCSI host is a server with two NICs that are dedicated to iSCSI traffic. The NICs are configured by using IPMP. Additional NICs are provided for non-iSCSI traffic to optimize performance.

- Active multipathing can only be achieved by using the Solaris iSCSI MS/T feature, and the failover and redundancy of an IPMP configuration.
 - If one NIC fails in an IPMP configuration, IPMP handles the failover. The MPxIO driver does not notice the failure. In a non-IPMP configuration, the MPxIO driver fails and offlines the path.
 - If one target port fails in an IPMP configuration, the MPxIO driver notices the failure and provides the failover. In a non-IPMP configuration, the MPxIO driver notices the failure and provides the failover.

For more information about using the Solaris iSCSI MS/T feature with IPMP and multipathing, see SunSolve Infodoc 207607, *Understanding an iSCSI MS/T multi-path configuration*.

- For information about configuring multiple sessions per target, see [“How to Enable Multiple iSCSI Sessions for a Target” on page 271](#). For information about configuring IPMP, see [Part VI, “IPMP” in *System Administration Guide: IP Services*](#).
- **Solaris iSCSI, Fibre-Channel (FC), and MPxIO** – The MPxIO driver provides the following behavior in more complex iSCSI/FC configurations:
 - If you have dual iSCSI to FC bridges in an FC SAN, iSCSI presents target paths to MPxIO. MPxIO matches the unique SCSI per LUN identifier, and if they are identical, presents one path to the iSCSI driver.
 - If you have a configuration that connects a target by using both iSCSI and FC, the MPxIO driver can provide different transports to the same device. In this configuration, MPxIO utilizes both paths.
 - If you are using iSCSI and FC in combination with MPxIO, make sure that the MPxIO settings in the `/kernel/drv/fp.conf` file and the `/kernel/drv/iscsi.conf` files match the MPxIO configuration that you want supported. For example, in `fp.conf`, you can determine whether MPxIO is enabled globally on the HBA or on a per-port basis.
- **Third-party hardware considerations**– Find out if your third-party HBA is qualified to work with Solaris iSCSI and MPxIO.

If you are using a third-party HBA, you might need to ask your third-party HBA vendor for the `symmetric-option` information for the `/kernel/drv/scsi_vhci.conf` file.

▼ How to Enable Multiple iSCSI Sessions for a Target

This procedure can be used to create multiple iSCSI sessions that connect to a single target. This scenario is useful with iSCSI target devices that support login redirection or have multiple target portals in the same target portal group. Use iSCSI multiple sessions per target with Solaris SCSI Multipathing (MPxIO). You can also achieve higher bandwidth if you utilize multiple NICs on the host side to connect to multiple portals on the same target.

The MS/T feature creates two or more sessions on the target by varying the initiator's session ID (ISID). Enabling this feature creates two SCSI layer paths on the network so that multiple targets are exposed through the iSCSI layer to the Solaris I/O layer. The MPxIO driver handles the reservations across these paths.

For more information about how iSCSI interacts with MPxIO paths, see [“Setting Up Solaris iSCSI Multipathed Devices” on page 270](#).

Review the following items before configuring multiple sessions for an iSCSI target:

- A typical MS/T configuration has two or more configured-sessions.
However, if your storage supports multiple TPGTs and if you are using SendTarget discovery on your host system, then the number of configured sessions can be set to 1. SendTarget discovery automatically detects the existence of multiple paths and multiple target sessions are created.

- Confirm that the `mpxio` configuration parameter is enabled in the `/kernel/drv/iscsi.conf` file.

```
# cd /kernel/drv
# grep mpxio iscsi.conf
iscsi.conf:mpxio-disable="no";
```

- Confirm that the multiple network connections are configured by using IPMP.
- Confirm that the multiple network connections are available.

```
# ifconfig -a
```

1 Become superuser.

2 List the current parameters for the iSCSI initiator and target.

a. List the current parameters for the iSCSI initiator. For example:

```
initiator# iscsiadm list initiator-node
Initiator node name: iqn.1986-03.com.sun:01:0003ba4d233b.425c293c
Initiator node alias: z2r1200
.
.
.
Configured Sessions: 1
```

b. List the current parameters of the iSCSI target device. For example:

```
initiator# iscsiadm list target-param -v iqn.1992-08.com.abcstorage:sn.84186266
Target: iqn.1992-08.com.abcstorage:sn.84186266
Alias: -
.
.
.
Configured Sessions: 1
```

The configured sessions value is the number of configured iSCSI sessions that will be created for each target name in a target portal group.

3 Select one of the following to modify the number of configured sessions either at the initiator node to apply to all targets or at a target level to apply to a specific target.

The number of sessions for a target must be between 1 and 4.

- Apply the parameter to the iSCSI initiator node.

For example:

```
initiator# iscsiadm modify initiator-node -c 2
```

- Apply the parameter to the iSCSI target.

For example:

```
initiator# iscsiadm modify target-param -c 2 iqn.1992-08.com.abcstorage:sn.84186266
```

- Bind configured sessions to one or more local IP addresses.

Configured sessions can also be bound to a specific local IP address. Using this method, one or more local IP addresses are supplied in a comma-separated list. Each IP address represents an iSCSI session. This method can also be done at the `initiator-node` or `target-param` level. For example:

```
initiator# iscsiadm modify initiator-node -c 10.0.0.1,10.0.0.2
```

Note – If the specified IP address is not routable, the address is ignored and the default Solaris route and IP address is used for this session.

4 Verify that the parameter was modified.

a. Display the updated information for the initiator node. For example:

```
initiator# iscsiadm list initiator-node
Initiator node name: iqn.1986-03.com.sun:01:0003ba4d233b.425c293c
Initiator node alias: zzr1200
.
.
.
Configured Sessions: 2
```

b. Display the updated information for the target node. For example:

```
initiator# iscsiadm list target-param -v iqn.1992-08.com.abcstorage:sn.84186266
Target: iqn.1992-08.com.abcstorage:sn.84186266
Alias: -
.
.
.
Configured Sessions: 2
```

5 List the multiple paths by using the `mpathadm list lu` command to confirm that the OS device name matches the `iscsiadm list` output, and that the path count is 2 or more.

Troubleshooting iSCSI Configuration Problems

The following tools are available to troubleshoot general iSCSI configuration problems:

- snoop – This tool has been updated to support iSCSI packets.
- wireshark – This product is available from <http://www.wireshark.org/>.

Both tools can filter iSCSI packets on port 3260.

The following sections describe various iSCSI troubleshooting and error message resolution scenarios.

No Connections to the iSCSI Target From the Local System

▼ How to Troubleshoot iSCSI Connection Problems

- 1 Become superuser.
- 2 List your iSCSI target information.

For example:

```
initiator# iscsiadm list target
Target: iqn.2001-05.com.abcstorage:6-8a0900-37ad70401-bcfff02df8a421df-zzr1200-01
TPGT: default
ISID: 4000002a0000
Connections: 0
```

- 3 If no connections are listed in the `iscsiadm list target` output, check the `/var/adm/messages` file for possible reasons why the connection failed.

You can also verify whether the connection is accessible by using the `ping` command or by connecting to the storage device's iSCSI port by using the `telnet` command to ensure that the iSCSI service is available. The default port is 3260.

In addition, check the storage device's log file for errors.

- 4 If your target is not listed in the `iscsiadm list target` output, check the `/var/adm/messages` file for possible causes.

If you are using `SendTargets` as the discovery method, try listing the *discovery-address* using the `-v` option to ensure that the expected targets are visible to the host. For example:

```
initiator# iscsiadm list discovery-address -v 10.0.0.1
Discovery Address: 10.0.0.1:3260
  Target name: eui.210000203787dfc0
    Target address: 10.0.0.1:11824
  Target name: eui.210000203787e07b
    Target address: 10.0.0.1:11824
```

If you are using iSNS as the discovery method, try enabling the iSNS discovery method and listing the *isns-server* using the `-v` option to ensure that the expected targets are visible to the host. For example:

```
initiator# iscsiadm list isns-server -v
iSNS Server IP Address: 10.20.56.56:3205
  Target name: iqn.1992-08.com.xyz:sn.1234566
    Target address: 10.20.57.161:3260, 1
  Target name: iqn.2003-10.com.abc:group-0:154:abc-65-01
    Target address: 10.20.56.206:3260, 1
  Target name: iqn.2003-10.com.abc:group-0:154:abc-65-02
    Target address: 10.20.56.206:3260, 1
.
.
.
```

iSCSI Device or Disk Is Not Available on the Local System

▼ How to Troubleshoot iSCSI Device or Disk Unavailability

- 1 Become superuser.
- 2 Identify the LUNs that were discovered on this target during enumeration.

For example:

```
# iscsiadm list target -S
Target: iqn.2001-05.com.abcstorage:6-8a0900-37ad70401-bcfff02df8a421df-zzr1200-01
  TPGT: default
  ISID: 4000002a0000
  Connections: 1
  LUN: 0
    Vendor: ABCSTOR
    Product: 0010
    OS Device Name: /dev/rdisk/c3t34d0s2
```

The `-S` option shows which LUNs were discovered on this target during enumeration. If you think a LUN should be listed but it is not, review the `/var/adm/messages` file to see if an error was reported. Check the storage device's log files for errors. Also, ensure that any storage device LUN masking is properly configured.

Use LUN Masking When Using the iSNS Discovery Method

Avoid using the iSNS discovery domain as the means to control storage authorization to specific initiators. Use *LUN masking* instead if you want to make sure that only authorized initiators can access a LUN.

If you remove a target from a discovery domain while the target is in use, the iSCSI initiator does not log out from this target. If you do not want this initiator to access this target (and the associated LUNs), you must use LUN masking. Removing the target from the discovery domain is not sufficient.

General iSCSI Error Messages

This section describes the iSCSI messages that might be found in the `/var/adm/messages` file and potential solutions for recovery.

The message format is as follows:

`iscsi TYPE (OID) STRING (STATUS-CLASS#/STATUS-DETAIL#)`

TYPE Is either connection or session.

OID Is the object ID of the connection or session. This ID is unique for an OS instance.

STRING Is a description of the condition.

STATUS-CLASS#/STATUS-DETAIL# These values are returned in an iSCSI login response as defined by RFC 3720.

`iscsi connection(OID) login failed - Miscellaneous iSCSI initiator errors.`

Cause: The device login failed due to some form of initiator error.

`iscsi connection(OID) login failed - Initiator could not be successfully authenticated.`

Cause: The device could not successfully authenticate the initiator.

Solution: If applicable, verify that the settings for CHAP names, CHAP passwords, or the RADIUS server are correct.

`iscsi connection(OID) login failed - Initiator is not allowed access to the given target.`

Cause: The device cannot allow the initiator access to the iSCSI target device.

Solution: Verify your initiator name and confirm that it is properly masked or provisioned by the storage device.

`iscsi connection(OID) login failed - Requested ITN does not exist at this address.`

Cause: The device does not provide access to the iSCSI target name (ITN) that you are requesting.

Solution: Verify that the initiator discovery information is specified properly and that the storage device is configured properly.

`iscsi connection(OID) login failed - Requested ITN has been removed and no forwarding address is provided.`

Cause: The device can no longer provide access to the iSCSI target name (ITN) that you are requesting.

Solution: Verify that the initiator discovery information has been specified properly and that the storage device has been configured properly.

`iscsi connection(OID) login failed - Requested iSCSI version range is not supported by the target.`

Cause: The initiator's iSCSI version is not supported by the storage device.

`iscsi connection(OID) login failed - No more connections can be accepted on this Session ID (SSID).`

Cause: The storage device cannot accept another connection for this initiator node to the iSCSI target device.

`iscsi connection(OID) login failed - Missing parameters (e.g., iSCSI initiator and/or target name).`

Cause: The storage device is reporting that the initiator or target name has not been properly specified.

Solution: Properly specify the iSCSI initiator or target name.

`iscsi connection(OID) login failed - Target hardware or software error.`

Cause: The storage device encountered a hardware or software error.

Solution: Consult the storage documentation, or contact the storage vendor for further assistance.

`iscsi connection(OID) login failed - iSCSI service or target is not currently operational.`

Cause: The storage device is currently not operational.

Solution: Consult the storage documentation, or contact the storage vendor for further assistance.

`iscsi connection(OID) login failed - Target has insufficient session, connection or other resources.`

Cause: The storage device has insufficient resources.

Solution: Consult the storage documentation, or contact the storage vendor for further assistance.

iscsi connection(*OID*) login failed - unable to initialize authentication

iscsi connection(*OID*) login failed - unable to set authentication

iscsi connection(*OID*) login failed - unable to set username

iscsi connection(*OID*) login failed - unable to set password

iscsi connection(*OID*) login failed - unable to set ipsec

iscsi connection(*OID*) login failed - unable to set remote authentication

Cause: The initiator was unable to initialize or set authentication properly.

Solution: Verify that your initiator settings for authentication are properly configured.

iscsi connection(*OID*) login failed - unable to make login pdu

Cause: The initiator was unable to make a login payload data unit (PDU) based on the initiator or storage device settings.

Solution: Try resetting any target login parameters or other nondefault settings.

iscsi connection(*OID*) login failed - failed to transfer login

iscsi connection(*OID*) login failed - failed to receive login response

Cause: The initiator failed to transfer or receive a login payload data unit (PDU) across the network connection.

Solution: Verify that the network connection is reachable.

iscsi connection(*OID*) login failed - received invalid login response (*OP CODE*)

Cause: The storage device has responded to a login with an unexpected response.

iscsi connection(*OID*) login failed - login failed to authenticate with target

Cause: The initiator was unable to authenticate the storage device.

Solution: Verify that your initiator settings for authentication are properly configured.

iscsi connection(*OID*) login failed - initiator name is required

Cause: An initiator name must be configured to perform all actions.

Solution: Verify that the initiator name is configured.

iscsi connection(*OID*) login failed - authentication receive failed

iscsi connection(*OID*) login failed - authentication transmit failed

Cause: The initiator was unable to transmit or receive authentication information.

Solution: Verify network connectivity with the storage device or the RADIUS server, as applicable.

`iscsi connection(OID) login failed - login redirection invalid`

Cause: The storage device attempted to redirect the initiator to an invalid destination.

Solution: Consult the storage documentation, or contact the storage vendor for further assistance.

`iscsi connection(OID) login failed - target protocol group tag mismatch, expected <TPGT>, received <TPGT>`

Cause: The initiator and target had a TPGT (target portal group tag) mismatch.

Solution: Verify your TPGT discovery settings on the initiator or the storage device.

`iscsi connection(OID) login failed - can't accept PARAMETER in security stage`

Cause: The device responded with an unsupported login parameter during the security phase of login.

Solution: The parameter name is noted for reference. Consult the storage documentation, or contact the storage vendor for further assistance.

`iscsi connection(OID) login failed - HeaderDigest=CRC32 is required, can't accept VALUE`

`iscsi connection(OID) login failed - DataDigest=CRC32 is required, can't accept VALUE`

Cause: The initiator is only configured to accept a HeaderDigest or DataDigest that is set to CRC32 for this target. The device returned the value of *VALUE*.

Solution: Verify that the initiator and device digest settings are compatible.

`iscsi connection(OID) login failed - HeaderDigest=None is required, can't accept VALUE`

`iscsi connection(OID) login failed - DataDigest=None is required, can't accept VALUE`

Cause: The initiator is only configured to accept a HeaderDigest or DataDigest that is set to NONE for this target. The device returned the value of *VALUE*.

Solution: Verify that the initiator and device digest settings are compatible.

`iscsi connection(OID) login failed - can't accept PARAMETER`

Cause: The initiator does not support this parameter.

iscsi connection(*OID*) login failed - can't accept MaxOutstandingR2T *VALUE*

Cause: The initiator does not accept MaxOutstandingR2T of the noted *VALUE*.

iscsi connection(*OID*) login failed - can't accept MaxConnections *VALUE*

Cause: The initiator does not accept the maximum connections of the noted *VALUE*.

iscsi connection(*OID*) login failed - can't accept ErrorRecoveryLevel *VALUE*

Cause: The initiator does not accept an error recovery level of the noted *VALUE*.

iscsi session(*OID*) *NAME* offline

Cause: All connections for this target *NAME* have been removed or have failed.

iscsi connection(*OID*) failure - unable to schedule enumeration

Cause: The initiator was unable to enumerate the LUNs on this target.

Solution: You can force LUN enumeration by running the `devfsadm -i iscsi` command. For more information, see [devfsadm\(1M\)](#).

iscsi connection(*OID*) unable to connect to target *NAME* (errno:*ERRNO*)

Cause: The initiator failed to establish a network connection.

Solution: For information about the specific *ERRNO* on the connection failure, see the `/usr/include/sys/errno.h` file.

The format Utility (Reference)

This chapter describes the `format` utility's menus and commands.

This is a list of the reference information in this chapter.

- “Recommendations and Requirements for Using the `format` Utility” on page 281
- “`format` Menu and Command Descriptions” on page 282
- “`format.dat` File” on page 288
- “Rules for Input to `format` Commands” on page 292
- “Getting Help on the `format` Utility” on page 294

For an overview of when to use the `format` utility, see “`format` Utility” on page 191.

Recommendations and Requirements for Using the `format` Utility

You must be superuser or have assumed an equivalent role to use the `format` utility. Otherwise, the following error message is displayed when you try to use the `format` utility:

```
$ format  
Searching for disks...done  
No permission (or no disks found)!
```

Keep the following guidelines in mind when you use the `format` utility and want to preserve the existing data:

- Back up all files on the disk drive.
- Save all your defect lists in files by using the `format` utility's `dump` command. The file name should include the drive type, model number, and serial number.
- Save the paper copies of the manufacturer's defect list that was shipped with your drive.

format Menu and Command Descriptions

The format main menu appears similar to the following:

```

FORMAT MENU:
  disk      - select a disk
  type      - select (define) a disk type
  partition - select (define) a partition table
  current   - describe the current disk
  format    - format and analyze the disk
  fdisk     - run the fdisk program (x86 only)
  repair    - repair a defective sector
  label     - write label to the disk
  analyze   - surface analysis
  defect    - defect list management
  backup    - search for backup labels
  verify    - read and display labels
  save      - save new disk/partition definitions
  inquiry   - show vendor, product and revision
  volname   - set 8-character volume name
  !<cmd>    - execute <cmd>, then return
  quit
format>

```

The following table describes the main menu items for the format utility.

TABLE 15-1 The Main Menu Item Descriptions for the format Utility

Menu Item	Command or Menu?	Description
disk	Command	Lists all of the system's drives. Also lets you choose the disk you want to use in subsequent operations. This disk is referred to as the current disk.
type	Command	Identifies the manufacturer and model of the current disk. Also displays a list of known drive types. Choose the Auto configure option for all SCSI-2 disk drives.
partition	Menu	Creates and modifies slices. For more information, see “partition Menu” on page 284 .
current	Command	Displays the following information about the current disk: <ul style="list-style-type: none"> ■ Device name and device type ■ Number of cylinders, alternate cylinders, heads and sectors ■ Physical device name

TABLE 15-1 The Main Menu Item Descriptions for the format Utility (Continued)

Menu Item	Command or Menu?	Description
format	Command	<p>Formats the current disk by using one of these sources of information in this order:</p> <ol style="list-style-type: none"> 1. Information that is found in the <code>format.dat</code> file 2. Information from the automatic configuration process 3. Information that you type at the prompt if no <code>format.dat</code> entry exists <p>This command does not apply to IDE disks. IDE disks are preformatted by the manufacturer.</p>
fdisk	Menu	<p>x86 platform only: Runs the <code>fdisk</code> program to create a Solaris <code>fdisk</code> partition.</p> <p>The <code>fdisk</code> command cannot be used on disks with an EFI label that are greater than 1 terabyte in size.</p>
repair	Command	Repairs a specific block on the current disk.
label	Command	Writes a new label to the current disk.
analyze	Menu	Runs read, write, and compare tests. For more information, see “ analyze Menu ” on page 285.
defect	Menu	Retrieves and displays defect lists. For more information, see “ defect Menu ” on page 287. This feature does not apply to IDE disks. IDE disks manage defects automatically.
backup	Command	<p>VTOC – Searches for backup labels.</p> <p>EFI – Not supported.</p>
verify	Command	<p>Displays the following information about the current disk:</p> <ul style="list-style-type: none"> ■ Device name and device type ■ Number of cylinders, alternate cylinders, heads and sectors ■ Partition table
save	Command	<p>VTOC – Saves new disk and partition information.</p> <p>EFI – Not applicable.</p>
inquiry	Command	SCSI disks only – Displays the vendor, product name, and revision level of the current drive.
volname	Command	Labels the disk with a new eight-character volume name that you specify.
quit	Command	Exits the format menu.

partition Menu

The partition menu appears similar to the following:

```
format> partition
PARTITION MENU:
  0      - change '0' partition
  1      - change '1' partition
  2      - change '2' partition
  3      - change '3' partition
  4      - change '4' partition
  5      - change '5' partition
  6      - change '6' partition
  7      - change '7' partition
select  - select a predefined table
modify  - modify a predefined partition table
name    - name the current table
print   - display the current table
label   - write partition map and label to the disk
quit
```

partition>

The following table describes the partition menu items.

TABLE 15-2 Descriptions for partition Menu Items

Subcommand	Description
change 'n' partition	Enables you to specify the following information for the new partition: <ul style="list-style-type: none"> ■ Identification tag ■ Permission flags ■ Starting cylinder ■ Size
select	Enables you to choose a predefined partition table.
modify	Enables you to change all the slices in the partition table. This command is preferred over the individual change 'x' partition commands.
name	Enables you to specify a name for the current partition table.
print	Displays the current partition table.
label	Writes the partition map and the label to the current disk.
quit	Exits the partition menu.

x86: fdisk Menu

The fdisk menu appears on x86 based systems only and appears similar to the following.

```
format> fdisk
```

```
Total disk size is 14169 cylinders
Cylinder size is 2510 (512 byte) blocks
```

Partition	Status	Type	Cylinders		Length	%
			Start	End		
1	Active	x86 Boot	1	9	9	0
2		Solaris2	10	14168	14159	100

SELECT ONE OF THE FOLLOWING:

1. Create a partition
 2. Specify the active partition
 3. Delete a partition
 4. Change between Solaris and Solaris2 Partition IDs
 5. Exit (update disk configuration and exit)
 6. Cancel (exit without updating disk configuration)
- Enter Selection:

The following table describes the fdisk menu items.

TABLE 15-3 x86: Descriptions for fdisk Menu Items

Menu Item	Description
Create a partition	Creates an fdisk partition. You must create a separate partition for each OS such as Oracle Solaris or DOS. There is a maximum of four partitions per disk. You are prompted for the size of the fdisk partition as a percentage of the disk.
Specify the active partition	Enables you to specify the partition to be used for booting. This menu item identifies where the first stage boot program looks for the second stage boot program.
Delete a partition	Deletes a previously created partition. This command destroys all the data in the partition.
Change between Solaris and Solaris2 Partition IDs	Changes partition IDs from 130 (0x82) to 191 (0xbf) and back again.
Exit (update disk configuration and exit)	Writes a new version of the partition table and exits the fdisk menu.
Cancel (exit without updating disk configuration)	Exits the fdisk menu without modifying the partition table.

analyze Menu

The analyze menu appears similar to the following.

```
format> analyze
```

```
ANALYZE MENU:
```

```
read      - read only test   (doesn't harm SunOS)
refresh  - read then write   (doesn't harm data)
test     - pattern testing  (doesn't harm data)
write    - write then read   (corrupts data)
compare  - write, read, compare (corrupts data)
purge    - write, read, write (corrupts data)
verify   - write entire disk, then verify (corrupts data)
print    - display data buffer
setup    - set analysis parameters
config   - show analysis parameters
quit
analyze>
```

The following table describes the analyze menu items.

TABLE 15-4 Descriptions for analyze Menu Items

Subcommand	Description
read	Reads each sector on the current disk. Repairs defective blocks as a default.
refresh	Reads then writes data on the current disk without harming the data. Repairs defective blocks as a default.
test	Writes a set of patterns to the disk without harming the data. Repairs defective blocks as a default.
write	Writes a set of patterns to the disk then reads back the data on the disk. Destroys existing data on the disk. Repairs defective blocks as a default.
compare	Writes a set of patterns to the disk, reads back the data, and then compares it to the data in the write buffer. Destroys existing data on the disk. Repairs defective blocks as a default.
purge	Removes all data from the disk so that the data cannot be retrieved by any means. Data is removed by writing three distinct patterns over the entire disk (or a section of the disk). If the verification passes, a hex-bit pattern is written over the entire disk (or a section of the disk). Repairs defective blocks as a default.
verify	In the first pass, writes unique data to each block on the entire disk. In the next pass, reads and verifies the data. Destroys existing data on the disk. Repairs defective blocks as a default.
print	Displays the data in the read/write buffer.

TABLE 15-4 Descriptions for analyze Menu Items (Continued)

Subcommand	Description
setup	Enables you to specify the following analysis parameters: Analyze entire disk? yes Starting block number: <i>depends on drive</i> Ending block number: <i>depends on drive</i> Loop continuously? no Number of passes: 2 Repair defective blocks? yes Stop after first error? no Use random bit patterns? no Number of blocks per transfer: 126 (0/n/nn) Verify media after formatting? yes Enable extended messages? no Restore defect list? yes Restore disk label? yes
config	Displays the current analysis parameters.
quit	Exits the analyze menu.

defect Menu

The defect menu appears similar to the following:

```
format> defect
DEFECT MENU:
  primary - extract manufacturer's defect list
  grown   - extract manufacturer's and repaired defects lists
  both    - extract both primary and grown defects lists
  print   - display working list
  dump    - dump working list to file
  quit
defect>
```

The following table describes the defect menu items.

TABLE 15-5 The defect Menu Item Descriptions

Subcommand	Description
primary	Reads the manufacturer's defect list from the disk drive and updates the in-memory defect list.
grown	Reads the grown defect list and then updates the in-memory defect list. Grown defects are defects that have been detected during analysis.
both	Reads both the manufacturer's defect list and the grown defect list. Then, updates the in-memory defect list.

TABLE 15-5 The defect Menu Item Descriptions *(Continued)*

Subcommand	Description
print	Displays the in-memory defect list.
dump	Saves the in-memory defect list to a file.
quit	Exits the defect menu.

format.dat File

The `format.dat` file that is shipped with the Oracle Solaris OS supports many standard disks. If your disk drive is not listed in the `format.dat` file, you can do the following:

- Add an entry to the `format.dat` file for the disk.
- Add entries with the `format` utility by selecting the `type` command and choosing the other option.

Adding an entry to the `format.dat` file can save time if the disk drive will be used throughout your site. To use the `format.dat` file on other systems, copy the file to each system that will use the specific disk drive that you added to the `format.dat` file.

You might need to modify the `/etc/format.dat` file for your system if you have one of the following:

- A disk that is not supported by the Oracle Solaris OS
- A disk with a partition table that is different from the Oracle Solaris OS's default configuration

Note – Do not alter default entries in the `/etc/format.dat` file. If you want to alter the default entries, copy the entry, give the entry a different name, and make the appropriate changes to avoid confusion.

The `/etc/format.dat` is not applicable for disks with EFI labels.

Contents of the format.dat File

The `format.dat` contains disk drive information that is used by the `format` utility. Three items are defined in the `format.dat` file:

- Search paths
- Disk types
- Slice tables

Syntax of the format.dat File

The following syntax rules apply to the `/etc/format.dat` file:

- The pound sign (`#`) is the comment character. Any text on a line after a pound sign is not interpreted by the `format` utility.
- Each definition in the `format.dat` file appears on a single logical line. If the definition is longer than one line long, all lines but the last line of the definition must end with a backslash (`\`).
- A definition consists of a series of assignments that have an identifier on the left side and one or more values on the right side. The assignment operator is the equal sign (`=`). The assignments within a definition must be separated by a colon (`:`).
- White space is ignored by the `format` utility. If you want an assigned value to contain white space, enclose the entire value in double quotation marks (`"`). This syntax causes the white space within the quotes to be preserved as part of the assignment value.
- Some assignments can have multiple values on the right side. Separate values by a comma.

Keywords in the format.dat File

The `format.dat` file contains disk definitions that are read by the `format` utility when it is started. Each definition starts with one of the following keywords: `disk_type` or `partition`. These keywords are described in the following table.

TABLE 15-6 Keyword Descriptions for the `format.dat` File

Keyword	Description
<code>disk_type</code>	<p>Defines the controller and disk model. Each <code>disk_type</code> definition contains information that concerns the physical geometry of the disk. The default data file contains definitions for the controllers and disks that the Oracle Solaris OS supports.</p> <p>You need to add a new <code>disk_type</code> definition only if you have an unsupported disk. You can add as many <code>disk_type</code> definitions to the data file as you want.</p>
<code>partition</code>	<p>Defines a partition table for a specific disk type. The partition table contains the partition information, plus a name that lets you refer to it in the <code>format</code> utility. The default <code>format.dat</code> file contains default partition definitions for several kinds of disk drives. Add a partition definition if you recreated partitions on any of the disks on your system. Add as many partition definitions to the data file as you need.</p>

Disk Type (format.dat)

The `disk_type` keyword in the `format.dat` file defines the controller and disk model. Each `disk_type` definition contains information about the physical geometry of the disk. The default `format.dat` file contains definitions for the controllers and disks that the Oracle Solaris OS supports. You need to add a new `disk_type` only if you have an unsupported disk. You can add as many `disk_type` definitions to the data file as you want.

The keyword itself is assigned the name of the disk type. This name appears in the disk's label, and is used to identify the disk type whenever the `format` utility is run. Enclose the name in double quotation marks to preserve any white space in the name. The following table describes the identifiers that must also be assigned values in all `disk_type` definitions.

TABLE 15-7 Required `disk_type` Identifiers (`format.dat`)

Identifier	Description
<code>ctlr</code>	Identifies the controller type for the disk type. Currently, the supported values are SCSI and ATA.
<code>ncyl</code>	Specifies the number of data cylinders in the disk type. This determines how many logical disk cylinders the system will be allowed to access.
<code>acyl</code>	Specifies the number of alternate cylinders in the disk type. These cylinders are used by the <code>format</code> utility to store information such as the defect list for the drive. You should always reserve at least two cylinders for alternates.
<code>pcyl</code>	Specifies the number of physical cylinders in the disk type. This number is used to calculate the boundaries of the disk media. This number is usually equal to <code>ncyl</code> plus <code>acyl</code> .
<code>nhead</code>	Specifies the number of heads in the disk type. This number is used to calculate the boundaries of the disk media.
<code>nsect</code>	Specifies the number of data sectors per track in the disk type. This number is used to calculate the boundaries of the disk media. Note that this number includes only the data sectors. Any spares are not reflected in the number of data sections per track.
<code>rpm</code>	Specifies the rotations per minute of the disk type. This information is put in the label and later used by the file system to calculate the optimal placement of file data.

Other identifiers might be necessary, depending on the controller. The following table describes the identifiers that are required for SCSI controllers.

TABLE 15-8 Required `disk_type` Identifiers for SCSI Controllers `format.dat`

Identifier	Description
<code>fmt_time</code>	Specifies a number that indicates how long it takes to format a given drive. See the controller manual for more information.

TABLE 15-8 Required `disk_type` Identifiers for SCSI Controllers `format.dat` (Continued)

Identifier	Description
<code>cache</code>	Specifies a number that controls the operation of the on-board cache while the <code>format</code> utility is operating. See the controller manual for more information.
<code>trks_zone</code>	Specifies a number that identifies how many tracks that exist per defect zone, to be used in alternate sector mapping. See the controller manual for more information.
<code>asect</code>	Specifies a number that identifies how many sectors are available for alternate mapping within a given defect zone. See the controller manual for more information.

EXAMPLE 15-1 Required `disk_type` Identifiers for SCSI Controllers (`format.dat`)

The following are examples of `disk_type` definitions:

```
disk_type = "SUN1.3G" \
: ctlr = SCSI : fmt_time = 4 \
: trks_zone = 17 : asect = 6 : atrks = 17 \
: ncyl = 1965 : acyl = 2 : pcyl = 3500 : nhead = 17 : nsect = 80 \
: rpm = 5400 : bpt = 44823

disk_type = "SUN2.1G" \
: ctlr = SCSI : fmt_time = 4 \
: ncyl = 2733 : acyl = 2 : pcyl = 3500 : nhead = 19 : nsect = 80 \
: rpm = 5400 : bpt = 44823

disk_type = "SUN2.9G" \
: ctlr = SCSI : fmt_time = 4 \
: ncyl = 2734 : acyl = 2 : pcyl = 3500 : nhead = 21 : nsect = 99 \
: rpm = 5400
```

Partition Tables (`format.dat`)

A partition table in the `format.dat` file defines a slice table for a specific disk type.

The `partition` keyword in the `format.dat` file is assigned the name of the partition table. Enclose the name in double quotation marks to preserve any white space in the name. The following table describes the identifiers that must be assigned values in all partition tables.

TABLE 15-9 Required Identifiers for Partition Tables (`format.dat`)

Identifier	Description
<code>disk</code>	The name of the <code>disk_type</code> that this partition table is defined for. This name must appear exactly as it does in the <code>disk_type</code> definition.
<code>ctlr</code>	The disk controller type that this partition table can be attached to. Currently, the supported values are ATA for ATA controllers and SCSI for SCSI controllers. The controller type that is specified here must also be defined for the <code>disk_type</code> that you specified in the <code>disk_type</code> definition.

The other identifiers in a slice definition describe the actual partition information. The identifiers are the numbers 0 through 7. These identifiers are optional. Any partition that is not explicitly assigned is set to 0 length. The value of each of these identifiers is a pair of numbers separated by a comma. The first number is the starting cylinder for the partition. The second is the number of sectors in the slice.

EXAMPLE 15-2 Required Identifiers for Partition Tables (`format.dat`)

The following are some examples of slice definitions:

```
partition = "SUN1.3G" \
    : disk = "SUN1.3G" : ctlr = SCSI \
    : 0 = 0, 34000 : 1 = 25, 133280 : 2 = 0, 2672400 : 6 = 123, 2505120

partition = "SUN2.1G" \
    : disk = "SUN2.1G" : ctlr = SCSI \
    : 0 = 0, 62320 : 1 = 41, 197600 : 2 = 0, 4154160 : 6 = 171, 3894240

partition = "SUN2.9G" \
    : disk = "SUN2.9G" : ctlr = SCSI \
    : 0 = 0, 195426 : 1 = 94, 390852 : 2 = 0, 5683986 : 6 = 282, 5097708
```

Specifying an Alternate Data File for the `format` Utility

The `format` utility determines the location of an alternate file by the following methods in this order:

1. If a file name is given with the `format -x` option, that file is always used as the data file.
2. If the `-x` option is not specified, then the `format` utility searches the current directory for a file named `format.dat`. If the file exists, it is used as the data file.
3. If neither of these methods yields a data file, the `format` utility uses the `/etc/format.dat` file as the data file. This file is shipped with the Oracle Solaris OS and should always be present.

Rules for Input to `format` Commands

When you use the `format` utility, you need to provide various kinds of information. This section describes the rules for this information. For information on using `format`'s help facility when you specify data, see [“Getting Help on the `format` Utility” on page 294](#).

Specifying Numbers to `format` Commands

Several places in the `format` utility require number as input. You must either specify the appropriate data or select a number from a list of choices. In either case, the help facility causes `format` to display the upper and lower limits of the number expected. Simply enter the

appropriate number. The number is assumed to be in decimal format unless a base is explicitly specified as part of the number (for example, 0x for hexadecimal).

The following are examples of integer input:

```
Enter number of passes [2]: 34
Enter number of passes [34] 0xf
```

Specifying Block Numbers to format Commands

Whenever you are required to specify a disk block number, there are two ways to do so:

- Specify the block number as an integer
- Specify the block number in the cylinder/head/sector format

You can specify the information as an integer that represents the logical block number. You can specify the number in any base, but the default is decimal. The maximum operator (a dollar sign, \$) can also be used here so that `format` utility can select the appropriate value. Logical block format is used by the SunOS disk drivers in error messages.

The other way to specify a block number is by using cylinder/head/sector format. In this method, you must specify explicitly the three logical components of the block number: the cylinder, head, and sector values. These values are still logical. However, they allow you to define regions of the disk that are related to the layout of the media.

If any of the cylinder/head/sector numbers are not specified, the value is assumed to be zero. You can also use the maximum operator in place of any of the numbers. Then, the `format` utility will select the appropriate value. The following are some examples of cylinder, head, and sector values:

```
Enter defective block number: 34/2/3
Enter defective block number: 23/1/
Enter defective block number: 457//
Enter defective block number: 12345
Enter defective block number: 0xabcd
Enter defective block number: 334/$/2
Enter defective block number: 892//$
```

The `format` utility always displays block numbers in both formats. Also, the help facility shows you the upper and lower limits of the block number expected, in both formats.

Specifying format Command Names

Command names are needed as input whenever the `format` utility displays a menu prompt. You can abbreviate the command names, as long as what you type is sufficient to uniquely identify the command desired.

For example, use `p` to access the partition menu from the format menu. Then, type `p` to display the current slice table.

```
format> p
PARTITION MENU:
  0 - change '0' partition
  1 - change '1' partition
  2 - change '2' partition
  3 - change '3' partition
  4 - change '4' partition
  5 - change '5' partition
  6 - change '6' partition
  7 - change '7' partition
select - select a predefined table
modify - modify a predefined partition table
name - name the current table
print - display the current table
label - write partition map and label to the disk
quit
partition> p
```

Specifying Disk Names to format Commands

At certain points in the format utility, you must name something. In these cases, you are free to specify any string you want for the name. If the name has white space in it, the entire name must be enclosed in double quotation marks (""). Otherwise, only the first word of the name is used.

For example, if you want to identify a specific partition table for a disk, you can use the name subcommand that is available from the partition menu:

```
partition> name
Enter table name (remember quotes): "new disk3"
```

Getting Help on the format Utility

The format utility provides a help facility that you can use whenever the format utility is expecting input. You can request help about what input is expected by typing a question mark (?). The format utility displays a brief description of what type of input is needed.

If you type a ? at a menu prompt, a list of available commands is displayed.

The man pages associated with the format utility include the following:

- `format(1M)` – Describes the basic format utility capabilities and provides descriptions of all command-line variables.
- `format.dat(4)` – Describes disk drive configuration information for the format utility.

Managing File Systems (Overview)

Managing file systems is one of your most important system administration tasks.

This is a list of the overview information in this chapter.

- “What's New in Oracle Solaris File Systems?” on page 295
- “Where to Find File System Management Tasks” on page 303
- “Overview of File Systems” on page 303
- “Types of Oracle Solaris File Systems” on page 304
- “Commands for UFS File System Administration” on page 310
- “Default Oracle Solaris File Systems” on page 311
- “Swap Space” on page 309
- “UFS File System” on page 313
- “Overview of Mounting and Unmounting File Systems” on page 319
- “Determining a File System's Type” on page 324

What's New in Oracle Solaris File Systems?

This section describes new file system features in the Oracle Solaris release.

- “File System Monitoring Tool (`fsstat`)” on page 295
- “Oracle Solaris ZFS File System” on page 296
- “Enhancements to UFS File System Utilities (`fsck`, `mkfs`, and `newfs`)” on page 296

For a complete listing of new Oracle Solaris features and a description of Oracle Solaris releases, see *Oracle Solaris 10 8/11 What's New*.

File System Monitoring Tool (`fsstat`)

Solaris 10 6/06: A new file system monitoring tool, `fsstat`, is available to report file system operations. You can use several options to report activity, such as by mount point or by file system type.

For example, the following `fsstat` command displays all ZFS file system operations since the ZFS module was loaded:

```
$ fsstat zfs
new name name attr attr lookup rddir read read write write
file remov chng get set ops ops ops bytes ops bytes
268K 145K 93.6K 28.0M 71.1K 186M 2.74M 12.9M 56.2G 1.61M 9.46G zfs
```

For example, the following `fsstat` command displays all file system operations since the `/export/ws` file system mounted.

```
$ fsstat /export/ws
new name name attr attr lookup rddir read read write write
file remov chng get set ops ops ops bytes ops bytes
0 0 0 18.1K 0 12.6M 52 0 0 0 0 /export/ws
```

The default form is to report statistical information in easy to understand values, such as GB, KB, and MB.

For more information, see [fsstat\(1M\)](#).

Oracle Solaris ZFS File System

Solaris 10 6/06: Oracle Solaris ZFS, a revolutionary new file system, provides simple administration, transactional semantics, end-to-end data integrity, and immense scalability. In addition, ZFS provides the following administration features:

- Device management support
- GUI administration tool
- Persistent snapshots and cloning features
- Quotas that can be set for file systems
- ACL-based access control
- Storage pool space reservations for file systems
- Support for Oracle Solaris systems that have zones installed

For more information about using ZFS, see [Oracle Solaris ZFS Administration Guide](#).

Enhancements to UFS File System Utilities (`fsck`, `mkfs`, and `newfs`)

Solaris 10 6/06: The file system check utility, `fsck`, has been enhanced to include features from the FreeBSD 4.9 version of the `fsck` program, as well as other enhancements.

The `fsck` utility in this Oracle Solaris release includes the following improvements:

- Checks and repairs file systems more thoroughly and provides improved error messages. For example, in some scenarios, `fsck` determines what structures are missing and replaces them appropriately.
- Automatically searches for backup superblocks.
- Reports when `fsck` needs to be rerun.
- When clearing directories, `fsck` now attempts to recover directory contents immediately and therefore, reduces the time spent rerunning this utility.
- If `fsck` finds duplicate blocks, and not all files that reference the duplicate blocks were cleared, `fsck` reports the inode numbers at the end of the `fsck` run. Then, you can use the `find` command to review the inodes that are damaged.
- Improved error messages regarding the status of extended attributes and other special files, such as device files and ACL entries, are included.
- Includes a `-v` option to enable more verbose messages.

In addition, the `newfs` and `mkfs` commands have been updated to include new options for displaying a file system's superblock information in text or dumping the superblock information in binary format.

```
newfs [ -S or -B ] /dev/rdisk/...
```

```
-S    Displays the file system's superblock in text
```

```
-B    Dumps the file system's superblock in binary
```

```
mkfs [ -o calcsb or -o calcbinsb ] /dev/rdisk/... size
```

```
-o calcsb    Displays the file system's superblock in text
```

```
-o calcbinsb Dumps the file system's superblock in binary
```

The `fsck` utility uses this superblock information to search for backup superblocks.

The following sections describe specific `fsck` enhancements and their corresponding error messages. For step-by-step instructions on using the `fsck` utility to repair a damaged superblock, see [“How to Restore a Bad UFS Superblock \(Solaris 10 6/06 Release\)”](#) on page 406.

Automatic Search for Backup Superblocks

The following `fsck` error message examples illustrate the automatic backup superblock discovery feature.



Caution – If a file system has a damaged superblock and it was created with `newfs` or `mkfs` customized parameters, such as `nt rack` or `nsect`, using `fsck`'s automatically discovered superblock for the repair process could damage your file system.

In the case of a file system that was created with customized parameters and it has a bad superblock, `fsck` provides the prompt to cancel the `fsck` session:

CANCEL FILESYSTEM CHECK?

- If the file system was created with the `newfs` command and `fsck` responds that just the primary superblocks are corrupted, then consider letting `fsck` restore the superblock.

```
# fsck /dev/dsk/c1t2d0s0
** /dev/rdisk/c1t2d0s0
BAD SUPERBLOCK AT BLOCK 16: BLOCK SIZE LARGER THAN MAXIMUM SUPPORTED

LOOK FOR ALTERNATE SUPERBLOCKS WITH MKFS? no

LOOK FOR ALTERNATE SUPERBLOCKS WITH NEWFS? yes

FOUND ALTERNATE SUPERBLOCK 32 WITH NEWFS

USE ALTERNATE SUPERBLOCK? yes

FOUND ALTERNATE SUPERBLOCK AT 32 USING NEWFS
If filesystem was created with manually-specified geometry, using
auto-discovered superblock may result in irrecoverable damage to
filesystem and user data.

CANCEL FILESYSTEM CHECK? no

** Last Mounted on
** Phase 1 - Check Blocks and Sizes
** Phase 2 - Check Pathnames
** Phase 3a - Check Connectivity
** Phase 3b - Verify Shadows/ACLs
** Phase 4 - Check Reference Counts
** Phase 5 - Check Cylinder Groups
CORRECT GLOBAL SUMMARY
SALVAGE? y

UPDATE STANDARD SUPERBLOCK? y

81 files, 3609 used, 244678 free (6 frags, 30584 blocks, 0.0%
fragmentation)

***** FILE SYSTEM WAS MODIFIED *****
```

- If the file system was created with the `mkfs` command and `fsck` responds that just the primary superblocks are corrupted, then consider letting `fsck` restore the superblock.

```

# fsck /dev/dsk/c1t2d0s0
** /dev/rdisk/c1t2d0s0
BAD SUPERBLOCK AT BLOCK 16: BLOCK SIZE LARGER THAN MAXIMUM SUPPORTED

LOOK FOR ALTERNATE SUPERBLOCKS WITH MKFS? yes

FOUND ALTERNATE SUPERBLOCK 32 WITH MKFS

USE ALTERNATE SUPERBLOCK? yes

FOUND ALTERNATE SUPERBLOCK AT 32 USING MKFS
If filesystem was created with manually-specified geometry, using
auto-discovered superblock may result in irrecoverable damage to
filesystem and user data.

CANCEL FILESYSTEM CHECK? no

** Last Mounted on
** Phase 1 - Check Blocks and Sizes
** Phase 2 - Check Pathnames
** Phase 3a - Check Connectivity
** Phase 3b - Verify Shadows/ACLs
** Phase 4 - Check Reference Counts
** Phase 5 - Check Cylinder Groups
CORRECT GLOBAL SUMMARY
SALVAGE? y

UPDATE STANDARD SUPERBLOCK? y

81 files, 3609 used, 243605 free (117 frags, 30436 blocks, 0.0%
fragmentation)

***** FILE SYSTEM WAS MODIFIED *****

```

The following example illustrates what would happen if you specified `fsck's -y` option in a damaged superblock scenario. You are automatically dropped out of the `fsck` session. A message is displayed to rerun it with the alternate superblock.

```

# fsck -y /dev/dsk/c1t2d0s0
#
** /dev/rdisk/c1t2d0s0
BAD SUPERBLOCK AT BLOCK 16: BLOCK SIZE LARGER THAN MAXIMUM SUPPORTED

LOOK FOR ALTERNATE SUPERBLOCKS WITH MKFS? yes

LOOK FOR ALTERNATE SUPERBLOCKS WITH NEWFS? yes

SEARCH FOR ALTERNATE SUPERBLOCKS FAILED.

USE GENERIC SUPERBLOCK FROM MKFS? yes

CALCULATED GENERIC SUPERBLOCK WITH MKFS
If filesystem was created with manually-specified geometry, using
auto-discovered superblock may result in irrecoverable damage to
filesystem and user data.

```

CANCEL FILESYSTEM CHECK? **yes**

Please verify that the indicated block contains a proper superblock for the filesystem (see fsdb(1M)).

FSCK was running in YES mode. If you wish to run in that mode using the alternate superblock, run 'fsck -y -o b=453920 /dev/rdisk/c1t2d0s0'.

The following fsck error message scenario illustrates the new prompts for the backup superblock, but the fsck run is not canceled, in this example. Canceling the fsck session would be an appropriate response if this file system was created with customized parameters or if there is some other concern about running fsck on this file system.

The various superblock error conditions are provided in *italics* as follows:

fsck /dev/rdisk/c0t1d0s0

** /dev/rdisk/c0t1d0s0

*BAD SUPERBLOCK AT BLOCK 16: BLOCK SIZE LARGER THAN MAXIMUM SUPPORTED
 BAD SUPERBLOCK AT BLOCK 16: NUMBER OF DATA BLOCKS OUT OF RANGE
 BAD SUPERBLOCK AT BLOCK 16: INODES PER GROUP OUT OF RANGE
 BAD SUPERBLOCK AT BLOCK 16: MAGIC NUMBER WRONG
 BAD SUPERBLOCK AT BLOCK 16: BAD VALUES IN SUPER BLOCK
 BAD SUPERBLOCK AT BLOCK 16: NCG OUT OF RANGE
 BAD SUPERBLOCK AT BLOCK 16: CPG OUT OF RANGE
 BAD SUPERBLOCK AT BLOCK 16: NCYL IS INCONSISTENT WITH NCG*CPG
 BAD SUPERBLOCK AT BLOCK 16: SIZE OUT OF RANGE
 BAD SUPERBLOCK AT BLOCK 16: NUMBER OF DIRECTORIES OUT OF RANGE
 BAD SUPERBLOCK AT BLOCK 16: ROTATIONAL POSITION TABLE SIZE OUT OF RANGE
 BAD SUPERBLOCK AT BLOCK 16: SIZE OF CYLINDER GROUP SUMMARY AREA WRONG
 BAD SUPERBLOCK AT BLOCK 16: INOPB NONSENSICAL RELATIVE TO BSIZE*

LOOK FOR ALTERNATE SUPERBLOCKS WITH MKFS? **yes**

FOUND ALTERNATE SUPERBLOCK 32 WITH MKFS

USE ALTERNATE SUPERBLOCK? **yes**

FOUND ALTERNATE SUPERBLOCK AT 32 USING MKFS

If filesystem was created with manually-specified geometry, using auto-discovered superblock may result in irrecoverable damage to filesystem and user data.

CANCEL FILESYSTEM CHECK? **no**

** Last Mounted on
 ** Phase 1 - Check Blocks and Sizes
 ** Phase 2a - Check Duplicated Names
 ** Phase 2b - Check Pathnames
 ** Phase 3a - Check Connectivity
 ** Phase 3b - Verify Shadows/ACLs
 ** Phase 4 - Check Reference Counts
 ** Phase 5 - Check Cylinder Groups

SALVAGE? **yes**

UPDATE STANDARD SUPERBLOCK? **yes**

82 files, 3649 used, 244894 free (6 frags, 30611 blocks, 0.0% fragmentation)

***** FILE SYSTEM WAS MODIFIED *****

fsck Reports When it Needs to be Rerun

Better reporting by `fsck` about when it needs to be rerun should alleviate the time and necessity of running it multiple times, which can be particularly time consuming on large file systems.

The following new messages prompt you to rerun the `fsck` utility at the end of an error scenario:

***** PLEASE RERUN FSCK *****

Or:

Please rerun `fsck(1M)` to correct this.

These new prompts resolve the previous difficulty in determining whether `fsck` should be rerun or not.

Unless you are prompted to rerun `fsck` as in the above messages, there is no need to run `fsck`, even after you see the following message:

***** FILE SYSTEM WAS MODIFIED *****

However, it doesn't harm the file system to rerun `fsck` after this message. This message is just informational about `fsck`'s corrective actions.

New fsck Messages Regarding Extended Attributes

New `fsck` messages are included that report on and repair files with extended attributes. For example:

BAD ATTRIBUTE REFERENCE TO I=1 FROM I=96

Attribute directory I=97 not attached to file I=96
 I=96 OWNER=root MODE=40755
 SIZE=512 MTIME=Jul 12 10:55:10 2010
 DIR= <xattr>

FIX? **yes**

```
ZERO LENGTH ATTR DIR I=12 OWNER=root MODE=160755
SIZE=0 MTIME=Jul 12 10:56:10 2010
CLEAR? yes
```

```
File should BE marked as extended attribute
I=22 OWNER=root MODE=100644
SIZE=0 MTIME=Jul 12 10:57:10 2010
FILE= <xattr>
```

```
FIX? yes
```

```
UNREF ATTR DIR I=106 OWNER=root MODE=160755
SIZE=512 MTIME=Jul 12 10:58:10 2010
RECONNECT? yes
```

```
File I=107 should NOT be marked as extended attribute
I=107 OWNER=root MODE=100644
SIZE=0 MTIME=Jul 12 10:59:10 2010
FILE=?/attfsdir-7-att
```

```
FIX? yes
DIR I=106 CONNECTED.
```

Better Handling of Duplicate Blocks or Fragments

The fsck error messages now reports information about blocks, fragments, or a LFNs, which are the logical fragment numbers from the start of the file. For example, you might see output similar to the following:

```
** Phase 1 - Check Blocks and Sizes
FRAGMENT 784 DUP I=38 LFN 0
FRAGMENT 785 DUP I=38 LFN 1
FRAGMENT 786 DUP I=38 LFN 2
.
.
.
```

fsck processes objects as fragments, but in previous Solaris releases, only reported object information as blocks. It now correctly reports as fragments.

If fsck finds error conditions that involve duplicate blocks or fragments, fsck offers to display the uncleared files at end of the fsck output. For example, you might see output similar to the following:

```
LIST REMAINING DUPS? yes
```

```
Some blocks that were found to be in multiple files are still
assigned to file(s).
```

```
Fragments sorted by inode and logical offsets:
```

```
Inode 38:
```

Logical Offset	0x00000000	Physical Fragment	784
Logical Offset	0x00000800	Physical Fragment	786
Logical Offset	0x00001000	Physical Fragment	788

Logical Offset 0x00001800

Physical Fragment 790

Then, you can use the `find -i inode-number` command to identify the name of inode 38, in this example.

Where to Find File System Management Tasks

Use these references to find step-by-step instructions for managing file systems.

File System Management Task	For More Information
Create new file systems.	Chapter 17, “Creating and Mounting File Systems (Tasks),” and Chapter 18, “Using The CacheFS File System (Tasks)”
Make local and remote files available to users.	“Overview of Mounting and Unmounting File Systems” on page 319
Connect and configure new disk devices.	Chapter 10, “Managing Disks (Overview)”
Design and implement a backup schedule and restore files and file systems, as needed.	Chapter 22, “Backing Up and Restoring UFS File Systems (Overview)”
Check for and correct file system inconsistencies.	Chapter 20, “Checking UFS File System Consistency (Tasks)”

Overview of File Systems

A file system is a structure of directories that is used to organize and store files. The term *file system* is used to describe the following:

- A particular type of file system: disk-based, network-based, or virtual
- The entire file tree, beginning with the root (`/`) directory
- The data structure of a disk slice or other media storage device
- A portion of a file tree structure that is attached to a mount point on the main file tree so that the files are accessible

Usually, you know from the context which meaning is intended.

The Oracle Solaris OS uses the *virtual file system* (VFS) architecture, which provides a standard interface for different file system types. The VFS architecture enables the kernel to handle basic operations, such as reading, writing, and listing files. The VFS architecture also makes it easier to add new file systems.

Types of Oracle Solaris File Systems

The Oracle Solaris OS supports three types of file systems:

- Disk-based
- Network-based
- Virtual

To identify the file system type, see “[Determining a File System's Type](#)” on page 324.

Oracle Solaris Disk-Based File Systems

Disk-based file systems are stored on physical media such as hard disks, DVDs, and diskettes. Disk-based file systems can be written in different formats. The available formats are described in the following table.

Disk-Based File System	Format Description
UFS	<p>UNIX file system (based on the BSD Fat Fast File system that was provided in the 4.3 Tahoe release). UFS is the default disk-based file system for the Oracle Solaris OS.</p> <p>Before you can create a UFS file system on a disk, you must format the disk and divide it into slices. For information on formatting disks and dividing disks into slices, see Chapter 10, “Managing Disks (Overview)”.</p>
ZFS	The ZFS file system is available in the Solaris 10 6/06 release. For more information, see the Oracle Solaris ZFS Administration Guide .
HSFS	High Sierra, Rock Ridge, and ISO 9660 file system. High Sierra is the first CD-ROM file system. ISO 9660 is the official standard version of the High Sierra file system. The HSFS file system is used on CD-ROMs, and is a read-only file system. Oracle Solaris HSFS supports Rock Ridge extensions to ISO 9660. When present on a CD-ROM, these extensions provide all UFS file system features and file types, except for writability and hard links.
PCFS	PC file system, which allows read- and write- access to data and programs on DOS-formatted disks that are written for DOS-based personal computers.
UDFS	The Universal Disk Format (UDFS) file system, the industry-standard format for storing information on the optical media technology called DVD (Digital Versatile Disc or Digital Video Disc).

Each type of disk-based file system is customarily associated with a particular media device, as follows:

- UFS with hard disk
- HSFS with CD-ROM
- PCFS with diskette

- UDF with DVD

However, these associations are not restrictive. For example, CD-ROMs and diskettes can have UFS file systems created on them.

The Universal Disk Format (UDFS) File System

For information about creating a UDFS file system on removable media, see [“How to Create a File System on Removable Media” on page 35](#).

The UDF file system is the industry-standard format for storing information on *DVD* (Digital Versatile Disc or Digital Video Disc) optical media.

The UDF file system is provided as dynamically loadable 32-bit and 64-bit modules, with system administration utilities for creating, mounting, and checking the file system on both SPARC and x86 platforms. The Oracle Solaris UDF file system works with supported ATAPI and SCSI DVD drives, CD-ROM devices, and disk and diskette drives. In addition, the Oracle Solaris UDF file system is fully compliant with the UDF 1.50 specification.

The UDF file system provides the following features:

- Ability to access the industry-standard CD-ROM and DVD-ROM media when they contain a UDF file system
- Flexibility in exchanging information across platforms and operating systems
- A mechanism for implementing new applications rich in broadcast-quality video, high-quality sound, and interactivity using the DVD video specification based on UDF format

The following features are not included in the UDF file system:

- Support for write-once media, (CD-RW), with either the sequential disk-at-once recording and incremental recording
- UFS components such as quotas, ACLs, transaction logging, file system locking, and file system threads, which are not part of the UDF 1.50 specification

The UDF file system requires the following:

- Supported SPARC or x86 platform
- Supported CD-ROM or DVD-ROM device

The Oracle Solaris UDF file system implementation provides the following:

- Support for industry-standard read/write UDF version 1.50
- Fully internationalized file system utilities

Network-Based File Systems

Network-based file systems can be accessed from the network. Typically, network-based file systems reside on one system, typically a server, and are accessed by other systems across the network.

With NFS, you can administer distributed *resources* (files or directories) by exporting them from a server and mounting them on individual clients. For more information, see [“The NFS Environment” on page 322](#).

Virtual File Systems

Virtual file systems are memory-based file systems that provide access to special kernel information and facilities. Most virtual file systems do not use file system disk space. However, the CacheFS file system uses a file system on the disk to contain the cache. Also, some virtual file systems, such as the temporary file system (TMPFS), use the swap space on a disk.

CacheFS File System

The CacheFS file system can be used to improve the performance of remote file systems or slow devices such as CD-ROM drives. When a file system is cached, the data that is read from the remote file system or CD-ROM is stored in a cache on the local system.

If you want to improve the performance and scalability of an NFS or CD-ROM file system, you should use the CacheFS file system. The CacheFS software is a general purpose caching mechanism for file systems that improves NFS server performance and scalability by reducing server and network load.

Designed as a layered file system, the CacheFS software provides the ability to cache one file system on another. In an NFS environment, CacheFS software increases the client per server ratio, reduces server and network loads, and improves performance for clients on slow links, such as Point-to-Point Protocol (PPP). You can also combine a CacheFS file system with the `autofs` service to help boost performance and scalability.

For detailed information about the CacheFS file system, see [Chapter 18, “Using The CacheFS File System \(Tasks\)”](#).

NFS Version 4 and CacheFS Compatibility Issues

If both the CacheFS client and the CacheFS server are running NFS version 4, files are no longer cached in a front file system. All file access is provided by the back file system. Also, since no files are being cached in the front file system, CacheFS-specific mount options, which are meant to affect the front file system, are ignored. CacheFS-specific mount options do not apply to the back file system.

Note – The first time you configure your system for NFS version 4, a warning appears on the console to indicate that caching is no longer performed.

If you want to implement your CacheFS mounts as in previous Oracle Solaris releases, then specify NFS version 3 in your CacheFS mount commands. For example:

```
mount -F cachefs -o backfstype=nfs,cachedir=/local/mycache,vers=3
starbug:/docs /docs
```

Temporary File System

The temporary file system (TMPFS) uses local memory for file system reads and writes. Typically, using memory for file system reads and writes is much faster than using a UFS file system. Using TMPFS can improve system performance by saving the cost of reading and writing temporary files to a local disk or across the network. For example, temporary files are created when you compile a program. The OS generates a much disk activity or network activity while manipulating these files. Using TMPFS to hold these temporary files can significantly speed up their creation, manipulation, and deletion.

Files in TMPFS file systems are not permanent. These files are deleted when the file system is unmounted and when the system is shut down or rebooted.

TMPFS is the default file system type for the `/tmp` directory in the Oracle Solaris OS. You can copy or move files into or out of the `/tmp` directory, just as you would in a UFS file system.

The TMPFS file system uses swap space as a temporary backing store. If a system with a TMPFS file system does not have adequate swap space, two problems can occur:

- The TMPFS file system can run out of space, just as regular file systems do.
- Because TMPFS allocates swap space to save file data (if necessary), some programs might not execute because of insufficient swap space.

For information about creating TMPFS file systems, see [Chapter 17, “Creating and Mounting File Systems \(Tasks\)”](#). For information about increasing swap space, see [Chapter 19, “Configuring Additional Swap Space \(Tasks\)”](#).

The Loopback File System

The loopback file system (LOFS) lets you create a new virtual file system so that you can access files by using an alternative path name. For example, you can create a loopback mount of the root (`/`) directory on `/tmp/newroot`. This loopback mounts make the entire file system hierarchy appear as if it is duplicated under `/tmp/newroot`, including any file systems mounted from NFS servers. All files will be accessible either with a path name starting from root (`/`), or with a path name that starts from `/tmp/newroot`.

For information on how to create LOFS file systems, see [Chapter 17, “Creating and Mounting File Systems \(Tasks\)”](#).

Process File System

The process file system (PROCFS) resides in memory and contains a list of active processes, by process number, in the `/proc` directory. Information in the `/proc` directory is used by commands such as `ps`. Debuggers and other development tools can also access the address space of the processes by using file system calls.



Caution – Do not delete files in the `/proc` directory. The deletion of processes from the `/proc` directory does not kill them. `/proc` files do not use disk space, so there is no reason to delete files from this directory.

The `/proc` directory does not require administration.

Additional Virtual File Systems

These additional types of virtual file systems are listed for your information. They do not require administration.

Virtual File System	Description
CTFS	CTFS (the contract file system) is the interface for creating, controlling, and observing contracts. A contract enhances the relationship between a process and the system resources it depends on by providing richer error reporting and (optionally) a means of delaying the removal of a resource. The service management facility (SMF) uses process contracts (a type of contract) to track the processes which compose a service, so that a failure in a part of a multi-process service can be identified as a failure of that service.
FIFOFS (first-in first-out)	Named pipe files that give processes common access to data
FDFS (file descriptors)	Provides explicit names for opening files by using file descriptors
MNTFS	Provides read-only access to the table of mounted file systems for the local system
NAMEFS	Used mostly by STREAMS for dynamic mounts of file descriptors on top of files
OBJFS	The OBJFS (object) file system describes the state of all modules currently loaded by the kernel. This file system is used by debuggers to access information about kernel symbols without having to access the kernel directly.

Virtual File System	Description
SHAREFS	Provides read-only access to the table of shared file systems for the local system
SPECFS (special)	Provides access to character special devices and block devices
SWAPFS	Used by the kernel for swapping

Platform-Specific Libraries

The mount output might include a loopback mount of a hardware-optimized, platform-specific library. This loopback mount requires no administration and consumes no disk space.

Extended File Attributes

The UFS, NFS, and TMPFS file systems have been enhanced to include extended file attributes. Extended file attributes enable application developers to associate specific attributes to a file. For example, a developer of an application used to manage a windowing system might choose to associate a display icon with a file. Extended file attributes are logically represented as files within a hidden directory that is associated with the target file.

You can use the `runat` command to add attributes and execute shell commands in the extended attribute namespace. This namespace is a hidden attribute directory that is associated with the specified file.

To use the `runat` command to add attributes to a file, you first have to create the attributes file.

```
$ runat filea cp /tmp/attrdata attr.1
```

Then, use the `runat` command to list the attributes of the file.

```
$ runat filea ls -l
```

For more information, see the [runat\(1\)](#) man page.

Many Oracle Solaris file system commands have been modified to support file system attributes by providing an attribute-aware option. Use this option to query, copy, or find file attributes. For more information, see the specific man page for each file system command.

Swap Space

The Oracle Solaris OS uses some disk slices for temporary storage rather than for file systems. These slices are called *swap* slices, or *swap space*. Swap space is used for virtual memory storage areas when the system does not have enough physical memory to handle current processes.

Since many applications rely on swap space, you should know how to plan for, monitor, and add more swap space, when needed. For an overview about swap space and instructions for adding swap space, see [Chapter 19, “Configuring Additional Swap Space \(Tasks\)”](#).

Commands for UFS File System Administration

Most commands for file system administration have both a generic component and a file system–specific component. Whenever possible, you should use the generic commands, which call the file system–specific component. The following table lists the generic commands for file system administration. These commands are located in the `/usr/sbin` directory.

TABLE 16–1 Generic Commands for File System Administration

Command	Description	Man Page
<code>clri</code>	Clears inodes	clri(1M)
<code>df</code>	Reports the number of free disk blocks and files	df(1M)
<code>ff</code>	Lists file names and statistics for a file system	ff(1M)
<code>fsck</code>	Checks the integrity of a file system and repairs any damage found	fsck(1M)
<code>fsdb</code>	Debugs the file system	fsdb(1M)
<code>fstyp</code>	Determines the file system type	fstyp(1M)
<code>labelit</code>	Lists or provides labels for file systems when they are copied to tape (for use only by the <code>volcopy</code> command)	labelit(1M)
<code>mkfs</code>	Creates a new file system	mkfs(1M)
<code>mount</code>	Mounts local and remote file systems	mount(1M)
<code>mountall</code>	Mounts all file systems that are specified in the virtual file system table (<code>/etc/vfstab</code>)	mountall(1M)
<code>ncheck</code>	Generates a list of path names with their inode numbers	ncheck(1M)
<code>umount</code>	Unmounts local and remote file systems	mount(1M)
<code>umountall</code>	Unmounts all file systems that are specified in the virtual file system table (<code>/etc/vfstab</code>)	mountall(1M)
<code>volcopy</code>	Creates an image copy of a file system	volcopy(1M)

How File System Commands Determine the File System Type

The generic file system commands determine the file system type by following this sequence:

1. From the `-F` option, if supplied.

2. By matching a special device with an entry in the `/etc/vfstab` file (if the *special* device is supplied). For example, `fsck` first looks for a match against the `fsck` device field. If no match is found, the command then checks the *special* device field.
3. By using the default specified in the `/etc/default/fs` file for local file systems and in the `/etc/dfs/fstypes` file for remote file systems.

Manual Pages for Generic and Specific File System Commands

Both the generic commands and specific commands have manual pages in the *man pages section 1M: System Administration Commands*. The manual pages for the generic file system commands provide information about generic command options only. The manual page for a specific file system command has information about options for that file system. To look at a manual page for a specific file system, append an underscore and the abbreviation for the file system type to the generic command name.

For example, to see the specific manual page for mounting a UFS file system, type the following:

```
$ man mount_ufs
```

For example, to see the specific manual page for mounting a ZFS file system, type the following:

```
$ man zfs
```

Default Oracle Solaris File Systems

The ZFS or UFS file system is hierarchical, starting with the root directory (`/`) and continuing downwards through a number of directories. The Oracle Solaris installation process enables you to install a default set of directories and uses a set of conventions to group similar types of files together.

For a brief overview of Oracle Solaris file systems and directories, see [filesystem\(5\)](#).

The following table provides a summary of the default Oracle Solaris file systems.

TABLE 16-2 The Default Oracle Solaris File Systems

File System or Directory	File System Type	Description
root (<code>/</code>)	UFS or ZFS	The top of the hierarchical file tree. The root (<code>/</code>) directory contains the directories and files that are critical for system operation, such as the kernel, the device drivers, and the programs used to boot the system. The root (<code>/</code>) directory also contains the mount point directories where local and remote file systems can be attached to the file tree.

TABLE 16–2 The Default Oracle Solaris File Systems (Continued)

File System or Directory	File System Type	Description
/usr	UFS or ZFS	System files and directories that can be shared with other users. Files that run only on certain types of systems are in the /usr file system or directory (for example, SPARC executables). Files that can be used on all types of systems, such as the man pages, might be placed in the /usr/share directory.
/export/home or /home	NFS, UFS, or ZFS	The mount point for user home directories, which store user work files. By default, the /home directory is an automounted file system. On stand-alone systems, the /home directory might be a UFS file system or a ZFS file system.
/var	UFS or ZFS	System files and directories that are likely to change or grow over the life of the local system. These include system logs, such as vi and ex backup files.
/opt	NFS, UFS or ZFS	Optional mount point for third-party software. On some systems, the /opt directory might be a UFS file system or ZFS file system.
/tmp	TMPFS	Temporary files, which are removed each time the system is booted or the /tmp file system is unmounted.
/proc	PROCFS	A list of active processes, by process number.
/etc/mnttab	MNTFS	A virtual file system that provides read-only access to the table of mounted file systems for the local system.
/var/run	TMPFS	A memory-based file system for storing temporary files that are not needed after the system is booted.
/system/contract	CTFS	A virtual file system that maintains contract information.
/system/object	OBJFS	A virtual file system that is used by debuggers to access information about kernel symbols without having to access the kernel directly.

The root (/) and /usr file systems are required to run a system. Some of the most basic commands in the /usr file system (like mount) are also included in the root (/) file system. As such, they are available when the system boots or is in single-user mode, and /usr is not mounted.

UFS File System

See the following sections for details about the UFS file system.

- “UFS File System Features” on page 313
- “Planning UFS File Systems” on page 314
- “Support of Multiterabyte UFS File Systems” on page 314
- “UFS Logging” on page 316
- “UFS Snapshots” on page 318
- “UFS Direct Input/Output (I/O)” on page 318

UFS File System Features

UFS is the default disk-based file system in Oracle Solaris OS. Most often, when you administer a disk-based file system, you are administering UFS file systems. UFS provides the following features.

UFS Feature	Description
Extended fundamental types (EFT)	Provides 32-bit user ID (UID), group ID (GID), and device numbers.
Large file systems	Allows files of about 1 terabyte in size in a file system that can be up to 16 terabytes in size. You can create a multiterabyte UFS file system on a disk with an EFI disk label.
Logging	UFS logging bundles the multiple metadata changes that comprise a complete UFS operation into a transaction. Sets of transactions are recorded in an on-disk log and are applied to the actual UFS file system's metadata.
Multiterabyte file systems	A multiterabyte file system enables creation of a UFS file system up to approximately 16 terabytes of usable space, minus approximately one percent overhead.
State flags	Shows the state of the file system: clean, stable, active, logging, or unknown. These flags eliminate unnecessary file system checks. If the file system is “clean,” “stable,” or “logging,” file system checks are not run.

For detailed information about the UFS file system structure, see [Chapter 21, “UFS File System \(Reference\).”](#)

Planning UFS File Systems

When laying out file systems, you need to consider possible conflicting demands. Here are some suggestions:

- Distribute the workload as evenly as possible among different I/O systems and disk drives. Distribute the `/export/home` file system and swap space evenly across disks.
- Keep pieces of projects or members of groups within the same file system.
- Use as few file systems per disk as possible. On the system (or boot) disk, you should have three file systems: root (`/`), `/usr`, and swap space. On other disks, create one or at most two file systems, with one file system preferably being additional swap space. Fewer, roomier file systems cause less file fragmentation than many small, over crowded file systems. Higher-capacity tape drives and the ability of the `ufsdump` command to handle multiple volumes make it easier to back up larger file systems.
- If you have some users who consistently create very small files, consider creating a separate file system with more inodes. However, most sites do not need to keep similar types of user files in the same file system.

For information on default file system parameters as well as procedures for creating new UFS file systems, see [Chapter 17, “Creating and Mounting File Systems \(Tasks\).”](#)

Support of Multiterabyte UFS File Systems

This Solaris release provides support for multiterabyte UFS file systems.

Previously, UFS file systems were limited to approximately 1 terabyte. All UFS file system commands and utilities have been updated to support multiterabyte UFS file systems.

For example, the `ufsdump` command has been updated with a larger block size for dumping large UFS file systems:

```
# ufsdump 0f /dev/md/rdisk/d97 /dev/md/rdisk/d98
DUMP: Date of this level 0 dump: Mon Jul 12 10:51:10 2010
DUMP: Date of last level 0 dump: the epoch
DUMP: Dumping /dev/md/rdisk/d97 to /dev/md/rdisk/d98
DUMP: Mapping (Pass I) [regular files]
DUMP: Mapping (Pass II) [directories]
DUMP: Writing 32 Kilobyte records
DUMP: Estimated 17439410 blocks (8515.34MB).
DUMP: Dumping (Pass III) [directories]
DUMP: Dumping (Pass IV) [regular files]
```

Administering UFS file systems that are less than 1 terabyte remains the same. No administration differences exist between UFS file systems that are less than one terabyte and file systems that are greater than 1 terabyte.

You can initially create a UFS file system that is less than 1 terabyte and specify that it can eventually be expanded into a multiterabyte file system by using the `newfs -T` option. This option sets the inode and fragment density to scale appropriately for a multiterabyte file system.

Using the `newfs -T` option when you create a UFS file system less than 1 terabyte enables you to eventually expand this file system by using the `growfs` command when you boot this system. For more information, see [newfs\(1M\)](#).

You can use the `fstyp -v` command to identify whether a UFS file system has multiterabyte support by checking the following value in the magic column:

```
# /usr/sbin/fstyp -v /dev/md/rdisk/d3 | head -5
ufs
magic  decade  format  dynamic time    Mon Jul 12 11:12:36 2010
```

A UFS file system with no multiterabyte support has the following `fstyp` output:

```
# /usr/sbin/fstyp -v /dev/md/rdisk/d0 | head -5
ufs
magic  11954  format  dynamic time    Mon Jul 12 12:41:29 2010
```

You can use the `growfs` command to expand a UFS file system to the size of the slice or the volume without loss of service or data. For more information, see [growfs\(1M\)](#).

Two new related features are multiterabyte volume support with the EFI disk label and multiterabyte volume support with Solaris Volume Manager. For more information, see “[EFI Disk Label](#)” on page 183 and the *Solaris Volume Manager Administration Guide*.

Features of Multiterabyte UFS File Systems

Multiterabyte UFS file systems include the following features:

- Provides the ability to create a UFS file system up to 16 terabytes in size.
- Provides the ability to create a file system less than 16 terabytes that can later be increased in size up to 16 terabytes.
- Multiterabyte file systems can be created on physical disks, Solaris Volume Manager's logical volumes, and Veritas' VxVM logical volumes.
- Multiterabyte file systems benefit from the performance improvements of having UFS logging enabled. Multiterabyte file systems also benefit from the availability of logging because the `fsck` command might not have to be run when logging is enabled.
- When you create a partition for your multiterabyte UFS file system, the disk will be labeled automatically with an EFI disk label. For more information on EFI disk labels, see “[EFI Disk Label](#)” on page 183.
- Provides the ability to snapshot a multiterabyte file system by creating multiple backing store files when a file system is over 512 GB.

Limitations of Multiterabyte UFS File Systems

Limitations of multiterabyte UFS file systems are as follows:

- This feature is not supported on 32-bit systems.
- You cannot mount a file system greater than 1 terabyte on a system that is running a 32-bit Solaris kernel.
- There is no support for individual files greater than 1 terabyte.
- The maximum number of files is 1 million files per terabyte of a UFS file system. For example, a 4-terabyte file system can contain 4 million files.
This limit is intended to reduce the time it takes to check the file system with the `fsck` command.
- The maximum quota that you can set on a multiterabyte UFS file system is 2 terabytes of 1024-byte blocks.

Where to Find Multiterabyte UFS Tasks

Use these references to find step-by-step instructions for working with multiterabyte UFS file systems.

Multiterabyte UFS Task	For More Information
Create multiterabyte UFS file systems	“How to Create a Multiterabyte UFS File System” on page 335 “How to Expand a Multiterabyte UFS File System” on page 336 “How to Expand a UFS File System to a Multiterabyte UFS File System” on page 337
Create a multiterabyte UFS snapshot	Example 24-2
Troubleshoot multiterabyte UFS problems	“Troubleshooting Multiterabyte UFS File System Problems” on page 338

UFS Logging

UFS logging bundles the multiple metadata changes that comprise a complete UFS operation into a transaction. Sets of transactions are recorded in an on-disk log. Then, they are applied to the actual UFS file system's metadata.

At reboot, the system discards incomplete transactions, but applies the transactions for completed operations. The file system remains consistent because only completed transactions are ever applied. This consistency remains even when a system crashes. A system crash might interrupt system calls and introduces inconsistencies into a UFS file system.

UFS logging provides two advantages:

- If the file system is already consistent due to the transaction log, you might not have to run the `fsck` command after a system crash or an unclean shutdown. For more information on unclean shutdowns, see [“What the fsck Command Checks and Tries to Repair” on page 393](#).
- The performance of UFS logging improves or exceeds the level of performance of non logging file systems. This improvement can occur because a file system with logging enabled converts multiple updates to the same data into single updates. Thus, reducing the number of overhead disk operations required.

Logging is enabled by default for all UFS file systems, except under the following conditions:

- When logging is explicitly disabled.
- If there is insufficient file system space for the log.

In previous Solaris releases, you had to manually enable UFS logging.

Keep the following issues in mind when using UFS logging:

- Ensure that you have enough disk space for your general system needs, such as for users and applications, and for UFS logging.
- If you don't have enough disk space for logging data, a message similar to the following is displayed:

```
# mount /dev/dsk/c0t4d0s0 /mnt
/mnt: No space left on device
Could not enable logging for /mnt on /dev/dsk/c0t4d0s0.
#
```

However, the file system is still mounted. For example:

```
# df -h /mnt
Filesystem              size  used  avail capacity  Mounted on
/dev/dsk/c0t4d0s0      142M  142M    0K    100%    /mnt
#
```

- A UFS file system with logging enabled that is generally empty will have some disk space consumed for the log.
- If you upgrade to this Solaris release from a previous Solaris release, your UFS file systems will have logging enabled, even if the logging option was not specified in the `/etc/vfstab` file. To disable logging, add the `no logging` option to the UFS file system entries in the `/etc/vfstab` file.

The UFS transaction log has the following characteristics:

- Is allocated from free blocks on the file system
- Sized at approximately 1 MB per 1 GB of file system space, up to 256 MB. The log size might be larger, up to a maximum of 512 MB, if the file system has a large number of cylinder groups.

- Continually flushed as it fills up
- Also flushed when the file system is unmounted or as a result of any `lockfs` command.

If you need to enable UFS logging, specify the `-o logging` option with the `mount` command in the `/etc/vfstab` file or when you manually mount the file system. Logging can be enabled on any UFS file system, including the root (`/`) file system. Also, the `fsdb` command has new debugging commands to support UFS logging.

In some operating systems, a file system with logging enabled is known as a *journaling* file system.

UFS Snapshots

You can use the `fsnap` command to create a read-only snapshot of a file system. A *snapshot* is a file system's temporary image that is intended for backup operations.

See [Chapter 24, “Using UFS Snapshots \(Tasks\)”](#) for more information.

UFS Direct Input/Output (I/O)

Direct I/O is intended to boost bulk I/O operations. Bulk I/O operations use large buffer sizes to transfer large files (larger than 256 KB).

Using UFS direct I/O might benefit applications, such as database engines, that do their own internal buffering. UFS direct I/O allows the same kind of I/O concurrency that occurs when raw devices are accessed. Now you can get the benefit of file system naming and flexibility with very little performance penalty. Check with your database vendor to see if it can enable UFS direct I/O in its product configuration options.

Direct I/O can also be enabled on a file system by using the `forcedirectio` option to the `mount` command. Enabling direct I/O is a performance benefit only when a file system is transferring large amounts of sequential data.

When a file system is mounted with this option, data is transferred directly between a user's address space and the disk. When forced direct I/O is not enabled for a file system, data transferred between a user's address space and the disk is first buffered in the kernel address space.

The default behavior is no forced direct I/O on a UFS file system. For more information, see [`mount_ufs\(1M\)`](#).

Overview of Mounting and Unmounting File Systems

Before you can access the files on a file system, you need to mount the file system. When you mount a file system, you attach that file system to a directory (*mount point*) and make it available to the system. The root (/) file system is always mounted. Any other file system can be connected or disconnected from the root (/) file system.

Most file systems are automatically mounted by SMF services at system boot time. Generally, you do not need to mount or unmount file systems manually. For more information about mounting different file system types, see “Mounting and Unmounting Oracle Solaris File Systems” on page 329.

When you mount a file system, any files or directories in the underlying mount point directory are unavailable as long as the file system is mounted. These files are not permanently affected by the mounting process. They become available again when the file system is unmounted. However, mount directories are typically empty because you usually do not want to obscure existing files.

For example, the following figure shows a local file system, starting with a root (/) file system and the `sbin`, `etc`, and `opt` subdirectories.

FIGURE 16-1 Sample UFS root (/) File System

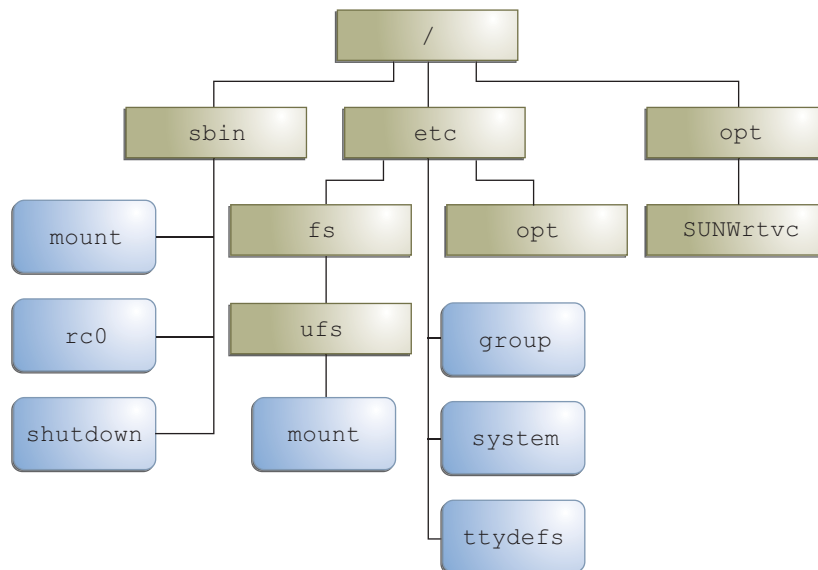

To access a local file system from the `/opt` file system that contains a set of unbundled products, you must do the following:

- First, you must create a directory to use as a mount point for the file system you want to mount, for example, `/opt/unbundled`.
- Once the mount point is created, you can mount the file system by using the `mount` command. This command makes all of the files and directories in `/opt/unbundled` available, as shown in the following figure.

FIGURE 16-2 Mounting a UFS File System

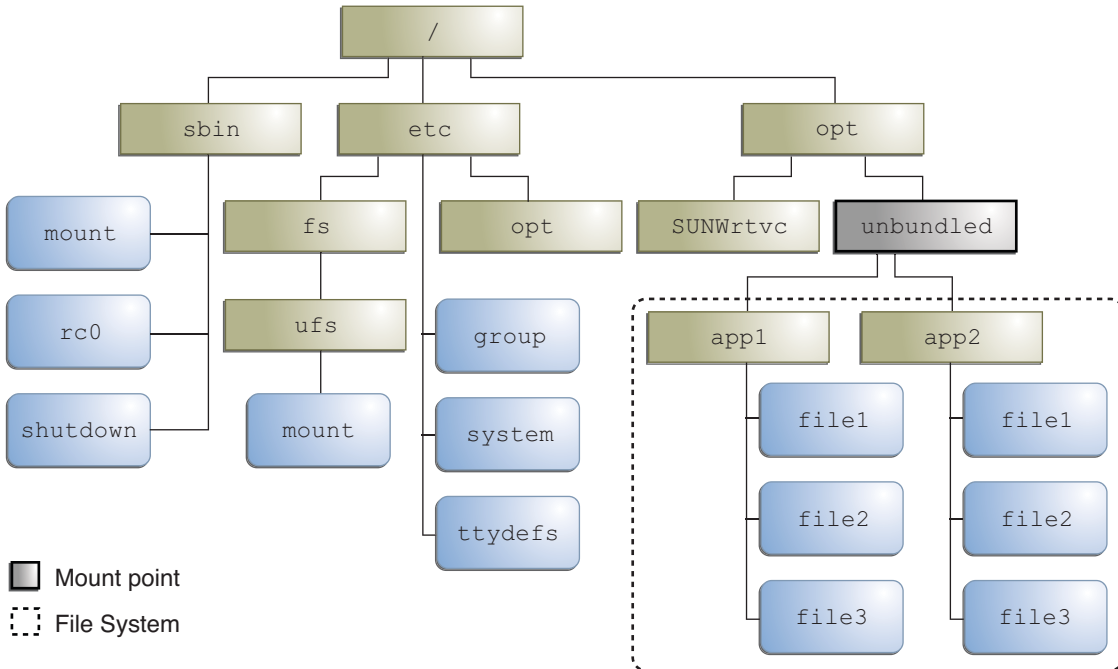

For step-by-step instructions on how to mount file systems, see “Mounting and Unmounting Oracle Solaris File Systems” on page 329.

The Mounted File System Table

Whenever you mount or unmount a file system, the `/etc/mnttab` (mount table) file is modified with the list of currently mounted file systems. You can display the contents of this file by using the `cat` or `more` commands. However, you cannot edit this file. Here is an example of an `/etc/mnttab` file:

```
$ more /etc/mnttab
rpool/ROOT/s10zfsBE / zfs dev=4010002 0
/devices /devices devfs dev=53c0000 1307136647
```



```

ctfs    /system/contract      ctfs    dev=5440001    1307136648
proc    /proc proc dev=5400000    1307136648
mnttab  /etc/mnttab             mntfs   dev=5480001    1307136648
swap    /etc/svc/volatile       tmpfs   xattr,dev=54c0001    1307136648
objfs   /system/object          objfs   dev=5500001    1307136648
sharefs /etc/dfs/sharetab      sharefs dev=5540001    1307136648
/platform/sun4u-us3/lib/libc_psr/libc_psr_hwcap1.so.1 ...
/platform/sun4u-us3/lib/sparcv9/libc_psr/libc_psr_hwcap1.so.1 ...
fd      /dev/fd fd rw,dev=56c0001 1307136677
swap    /tmp tmpfs xattr,dev=54c0002 1307136678
swap    /var/run tmpfs xattr,dev=54c0003 1307136678
rpool/export /export zfs rw,devices,setuid,nonbmand,exec ...
rpool/export/home /export/home zfs rw,devices, ...
rpool /rpool zfs rw,devices,setuid,nonbmand,exec,

```

The Virtual File System Table

Most file systems are mounted automatically by an SMF service at system boot time.

Manually mounting file systems every time you wanted to access them would be a very time-consuming and error-prone. To avoid these problems, the virtual file system table (the `/etc/vfstab` file) provides a list of file systems and information on how to mount them.

The `/etc/vfstab` file provides two important features:

- You can specify file systems to automatically mount when the system boots. ZFS file systems are automatically mounted at boot time by an SMF service without entries in the `vfstab` file.
- You can mount file systems by using only the mount point name. The `/etc/vfstab` file contains the mapping between the mount point and the actual device slice name.

A default `/etc/vfstab` file is created when you install a system, depending on the selections during installation. To add an entry, the information you need to specify is as follows:

- The device where the file system resides
- The file system mount point
- File system type
- Whether you want the file system to mount automatically when the system boots (by using the `mountall` command)
- Any mount options

The following is an example of an `/etc/vfstab` file for a system that runs a UFS root file system. Comment lines begin with `#`. This example shows an `/etc/vfstab` file for a system with two disks (`c0t0d0` and `c0t3d0`).

```

$ more /etc/vfstab
#device          device          mount          FS          fsck          mount  mount
#to mount        to fsck         point          type         pass         at boot options
#

```

fd	-	/dev/fd	fd	-	no	-
/proc	-	/proc	proc	-	no	-
/dev/dsk/c0t0d0s1	-	-	swap	-	no	-
/dev/dsk/c0t0d0s0	/dev/rdisk/c0t0d0s0	/	ufs	1	no	-
/dev/dsk/c0t0d0s6	/dev/rdisk/c0t0d0s6	/usr	ufs	1	no	-
/dev/dsk/c0t0d0s7	/dev/rdisk/c0t0d0s7	/export/home	ufs	2	yes	-
/dev/dsk/c0t0d0s5	/dev/rdisk/c0t0d0s5	/opt	ufs	2	yes	-
/devices	-	/devices	devfs	-	no	-
sharefs	-	/etc/dfs/sharetabsharefs	-	-	no	-
ctfs	-	/system/contract	ctfs	-	no	-
objfs	-	/system/object	objfs	-	no	-
swap	-	/tmp	tmpfs	-	yes	-

In this example, root (/) and /usr, the mount at boot field value is specified as no. These file systems are mounted by the kernel as part of the boot sequence before the mountall command is run.

The following vfstab example is from a system that runs a ZFS root file system.

```
# cat /etc/vfstab
#device      device      mount      FS      fsck      mount      mount
#to mount    to fsck     point      type     pass     at boot   options
#
fd           -           /dev/fd    fd       -         no        -
/proc       -           /proc      proc    -         no        -
/dev/zvol/dsk/rpool/swap -           -          swap    -         no        -
/devices    -           /devices   devfs   -         no        -
sharefs     -           /etc/dfs/sharetabsharefs -         no        -
ctfs        -           /system/contract ctfs    -         no        -
objfs       -           /system/object objfs   -         no        -
swap        -           /tmp       tmpfs   -         yes       -
```

ZFS file systems are mounted automatically by the SMF service at boot time. You can mount ZFS file systems from the vfstab by using the legacy mount feature. For more information, see [Oracle Solaris ZFS Administration Guide](#).

For descriptions of each /etc/vfstab field and information on how to edit and use the file, see [vfstab\(4\)](#).

The NFS Environment

NFS is a distributed file system service that can be used to share *resources* (files or directories) from one system, typically a server, with other systems on the network. For example, you might want to share third-party applications or source files with users on other systems.

NFS makes the actual physical location of the resource irrelevant to the user. Instead of placing copies of commonly used files on every system, NFS allows you to place one copy on one system's disk and let all other systems access it from the network. Under NFS, remote files are virtually indistinguishable from local files.

For more information, see [Chapter 4, “Managing Network File Systems \(Overview\),”](#) in *System Administration Guide: Network Services*.

A system becomes an NFS server if it has resources to share on the network. A server keeps a list of currently shared resources and their access restrictions (such as read/write or read-only access).

When you share a resource, you make it available for mounting by remote systems.

You can share a resource in these ways:

- Create a ZFS share by using the ZFS `sharenf s` property.
- By using the `share` or `shareall` command
- By adding an entry to the `/etc/dfs/dfstab` (distributed file system table) file and rebooting the system

For a complete description of NFS, see [Chapter 4, “Managing Network File Systems \(Overview\)”](#) in *System Administration Guide: Network Services*.

NFS Version 4

Oracle's implementation of the NFS version 4 distributed file access protocol is included in the Oracle Solaris release.

NFS version 4 integrates file access, file locking, and mount protocols into a single, unified protocol to ease traversal through a firewall and improve security. The Oracle Solaris implementation of NFS version 4 is fully integrated with Kerberos V5, also known as SEAM, thus providing authentication, integrity, and privacy. NFS version 4 also enables the negotiation of security flavors to be used between the client and the server. With NFS version 4, a server can offer different security flavors for different file systems.

For more information about NFS Version 4 features, see [“What's New With the NFS Service”](#) in *System Administration Guide: Network Services*.

Automounting (autofs)

You can mount NFS file system resources by using a client-side service called *automounting* (or *autofs*). The *autofs* service enables a system to automatically mount and unmount NFS resources whenever you access them. The resource remains mounted as long as you remain in the directory and are using a file within that directory. If the resource is not accessed for a certain period of time, it is automatically unmounted.

The *autofs* service provides the following features:

- NFS resources don't need to be mounted when the system boots, which saves booting time.
- Users don't need to know the root password to mount and unmount NFS resources.
- Network traffic might be reduced because NFS resources are mounted only when they are in use.

The autofs service is initialized by the automount utility, which runs automatically when a system is booted. The automountd daemon runs continuously and is responsible for the mounting and unmounting of NFS file systems on an as-needed basis. By default, the /home file system is mounted by the automount daemon.

With autofs, you can specify multiple servers to provide the same file system. This way, if one of these servers is down, autofs can try to mount the file system from another machine.

For complete information on how to set up and administer autofs, see [Chapter 5, “Network File System Administration \(Tasks\)”](#) in *System Administration Guide: Network Services*.

Determining a File System's Type

You can determine a file system's type by using one of the following:

- The FS type field in the virtual file system table (the /etc/vfstab file)
- The /etc/default/fs file for local file systems
- The /etc/dfs/fstypes file for NFS file systems

How to Determine a File System's Type

This procedure works whether or not the file system is mounted.

Determine a file system's type by using the grep command.

```
$ grep mount-point fs-table
```

mount-point Specifies the mount point name of the file system for which you want to know the file system type. For example, the /var directory.

fs-table Specifies the absolute path to the file system table in which to search for the file system's type. If the file system is mounted, *fs-table* should be /etc/mnttab. If the file system isn't mounted, *fs-table* should be /etc/vfstab.

Information for the mount point is displayed.

Note – If you have the raw device name of a disk slice, you can use the fstyp command to determine a file system's type (if the disk slice contains a file system). For more information, see [fstyp\(1M\)](#).

EXAMPLE 16-1 Determining a File System's Type

The following example uses the fstyp command to determine the file system type.

```
# fstyp /dev/rdisk/c0t0d0s0  
zfs
```

EXAMPLE 16-1 Determining a File System's Type *(Continued)*

The following example uses the `/etc/vfstab` file to determine the file system type for the `/legacy` file system.

```
$ grep /legacy /etc/vfstab  
/dev/dsk/c0t3d0s6 /dev/rdisk/c0t3d0s6 /legacy ufs 2 yes -
```

Creating and Mounting File Systems (Tasks)

This chapter describes how to create and mount ZFS, UFS, temporary (TMPFS), and loopback (LOFS) file systems. Because TMPFS and LOFS are virtual file systems, you actually “access” them by mounting them.

This is a list of the step-by-step instructions in this chapter.

- “How to Create an ZFS File System” on page 333
- “How to Create and Mount a UFS File System” on page 334
- “How to Create a Multiterabyte UFS File System” on page 335
- “How to Expand a Multiterabyte UFS File System” on page 336
- “How to Expand a UFS File System to a Multiterabyte UFS File System” on page 337
- “How to Create and Mount a TMPFS File System” on page 339
- “How to Create and Mount an LOFS File System” on page 340

Note – For instructions on how to create UFS and DOS file systems on removable media, see Chapter 1, “Managing Removable Media (Overview).”

Creating Oracle Solaris File Systems

This section provides an overview of creating Oracle Solaris file systems.

Creating ZFS File Systems

A ZFS file system is not directly tied to a specific disk partition. A ZFS file system is contained within a ZFS storage pool that can contain many devices. Either whole disks or disk slices can be added to a ZFS storage pool. Within a pool, you will probably want to create additional file systems. File systems provide points of administration that allow you to manage different sets of data within the same pool.

A ZFS file system is created by using the `zfs create` command. A ZFS file system is automatically mounted when it is created. For more information, see [“How to Create an ZFS File System” on page 333](#).

For more information about creating ZFS storage pools and file systems, see [Oracle Solaris ZFS Administration Guide](#).

Creating UFS File Systems

Before you can create a UFS file system on a disk, the disk must be formatted and divided into slices. A *disk slice* is a physical subset of a disk that is composed of a single range of contiguous blocks. A slice can be used either as a raw device that provides, for example, swap space, or to hold a disk-based file system. See [Chapter 10, “Managing Disks \(Overview\)”](#), for complete information on formatting disks and dividing disks into slices.

A UFS file system is created by using the `newfs` or `mkfs` command. You must mount a UFS file system after it is created.

For more information, see [“How to Create and Mount a UFS File System” on page 334](#).

Disk and storage management products, such as Solaris Volume Manager, create more sophisticated *volumes*. Volumes expand beyond single-slice or single-disk boundaries. For more information about using volumes, see [Solaris Volume Manager Administration Guide](#).

Note – Oracle Solaris device names use the term *slice* (and the letter *s* in the device name) to refer to the slice number. Slices are also called *partitions*.

You need to create UFS file systems only occasionally, because the Oracle Solaris OS automatically creates them as part of the installation process. You need to create (or re-create) a UFS file system when you want to do the following:

- Add or replace disks
- Change the existing partitioning structure of a disk
- Fully restore of a file system

The `newfs` command is the standard way to create UFS file systems. The `newfs` command is a convenient front end to the `mkfs` command, which actually creates the new file system. The `newfs` command reads parameter defaults, such as tracks per cylinder and sectors per track, from the label for the disk that will contain the new file system. The options you choose are passed to the `mkfs` command to build the file system.

For information about the default parameters that are used by the `newfs` command, see [`newfs\(1M\)`](#).

Creating a Temporary File System

A *temporary file system (TMPFS)* uses local memory for file system reads and writes, which is typically much faster than reads and writes in a UFS file system. TMPFS file systems can improve system performance by saving the cost of reading and writing temporary files to a local disk or across the network. Files in TMPFS file systems do not survive across reboots or unmounts.

If you create multiple TMPFS file systems, be aware that they all use the same system resources. Files created under one TMPFS file system use up space available for any other TMPFS file system, unless you limit TMPFS sizes by using the `-o size` option of the `mount` command.

For more information about creating and mounting a TMPFS file system, see [“How to Create and Mount a TMPFS File System”](#) on page 339.

For general information, see the [tmpfs\(7FS\)](#).

Creating a LOFS File System

An *LOFS file system* is a virtual file system that provides an alternate path to an existing file system. When other file systems are mounted onto an LOFS file system, the original file system does not change.

For more information about creating and mounting a LOFS file system, see [“How to Create and Mount an LOFS File System”](#) on page 340.

For general information, see the [lofs\(7FS\)](#).

Note – Be careful when creating LOFS file systems. Because LOFS file systems are virtual file systems, the potential for confusing both users and applications is enormous.

Mounting and Unmounting Oracle Solaris File Systems

ZFS file systems are mounted and unmounted automatically. You can make a legacy UFS file system available by mounting it, which attaches the file system to the system directory tree at the specified mount point. The root (`/`) file system is always mounted.

The following table provides guidelines on mounting file systems based on how you use them.

Mount Type Needed	Suggested Mount Method
Local or remote file systems that need to be mounted infrequently.	The <code>mount</code> command that you type manually from the command line.

Mount Type Needed	Suggested Mount Method
Local UFS file systems that need to be mounted frequently. Local ZFS file systems are automatically mounted by an SMF service.	The <code>/etc/vfstab</code> file, which mounts the file system automatically when the system is booted in multi user state.
Remote UFS file systems, such as home directories, that need to be mounted frequently.	<ul style="list-style-type: none"> ■ The <code>/etc/vfstab</code> file, which automatically mounts the file system when the system is booted in multiuser state. ■ <code>autofs</code>, which automatically mounts the file system when you access it or unmounts the file system when you change to another directory.

You can mount removable media that contains a file system by inserting the media into the drive and running the `volcheck` command, if necessary. For more information on mounting removable media, see [Chapter 1, “Managing Removable Media \(Overview\)”](#).

You can determine which file systems are already mounted by using the `mount` command.

```
$ mount [ -v ]
```

The `-v` displays the list of mounted file systems in verbose mode.

EXAMPLE 17-1 Determining Which File Systems Are Mounted

This example shows how to use the `mount` command to display information about the file systems that are currently mounted.

```
$ mount
/ on rpool/ROOT/zfsBE read/write/setuid/devices/rstchown/dev=40d0002 on Wed ...
/devices on /devices read/write/setuid/devices/rstchown/dev=9500000 on Wed ...
/dev on /dev read/write/setuid/devices/rstchown/dev=9580000 on Wed Jun ...
/system/contract on ctfs read/write/setuid/devices/rstchown/dev=95c0001 ...
/proc on proc read/write/setuid/devices/rstchown/dev=9540000 on Wed Jun ...
/etc/mnttab on mnttab read/write/setuid/devices/rstchown/dev=9600001 on Wed ...
/system/volatile on swap read/write/setuid/devices/rstchown/xattr/dev=9640001 ...
/system/object on objfs read/write/setuid/devices/rstchown/dev=9680001 on Wed ...
/etc/dfs/sharetab on sharefs read/write/setuid/devices/rstchown/dev=96c0001 on ...
/dev/fd on fd read/write/setuid/devices/rstchown/dev=97c0001 on Wed Jun 8 ...
/tmp on swap read/write/setuid/devices/rstchown/xattr/dev=9640002 on Wed Jun ...
/export on rpool/export read/write/setuid/devices/rstchown/nonbmand/exec/xattr/
/export/home on rpool/export/home read/write/setuid/devices/rstchown
/rpool on rpool read/write/setuid/devices/rstchown/nonbmand/exec/
/home/rimmer on pluto:/export/home/rimmer remote/read/write/setuid/xattr/...
```

This example shows how to use the `zfs mount` command to display information about ZFS file systems that are currently mounted.

```
$ zfs mount
rpool/ROOT/zfsBE          /
rpool/export              /export
```

EXAMPLE 17-1 Determining Which File Systems Are Mounted (Continued)

```
rpool/export/home      /export/home
rpool                  /rpool
```

The unmounting of a UFS file system removes it from the file system mount point, and deletes the entry from the `/etc/mnttab` file. Some file system administration tasks cannot be performed on mounted file systems. You should unmount a UFS file system when the following occurs:

- The file system is no longer needed or has been replaced by a file system that contains more current software.
- You need to check and repair the file system by using the `fsck` command. For more information about the `fsck` command, see [Chapter 20, “Checking UFS File System Consistency \(Tasks\)”](#).

Note – File systems are automatically unmounted as part of the system shutdown procedure.

In an emergency situation, you can use the `umount -f` option to forcibly unmount a busy file system. This practice is not recommended under normal circumstances because the unmounting of a file system with open files could cause a loss of data. This option is only available for UFS and NFS file systems.

Field Descriptions for the `/etc/vfstab` File

An entry in the `/etc/vfstab` file has seven fields, which are described in the following table.

TABLE 17-1 Field Descriptions for the `/etc/vfstab` File

Field Name	Description
device to mount	This field identifies one of the following: <ul style="list-style-type: none"> ■ The block device name for a local UFS file system (for example, <code>/dev/dsk/c0t0d0s0</code>). ■ The resource name for a remote file system (for example, <code>myserver:/export/home</code>). For more information about NFS, see System Administration Guide: IP Services. ■ The block device name of the slice on which to swap (for example, <code>/dev/dsk/c0t3d0s1</code>). ■ A directory for a virtual file system.

TABLE 17-1 Field Descriptions for the `/etc/vfstab` File (Continued)

Field Name	Description
device to fsck	The raw (character) device name that corresponds to the UFS file system identified by the <code>device to mount</code> field (for example, <code>/dev/rdsk/c0t0d0s0</code>). This field determines the raw interface that is used by the <code>fsck</code> command. Use a dash (-) when there is no applicable device, such as for a read-only file system or a remote file system.
mount point	Identifies where to mount the file system (for example, <code>/usr</code>).
FS type	Identifies the type of file system.
fsck pass	<p>The pass number used by the <code>fsck</code> command to decide whether to check a UFS file system. When the field contains a dash (-), the file system is not checked. Currently, the <code>fsck pass</code> value in the <code>/etc/vfstab</code> file is ignored during the boot process.</p> <p>When the field contains a zero, UFS file systems are not checked. When the field contains a value greater than zero, the UFS file system is always checked.</p> <p>All UFS file systems with a value of 1 in this field are checked one at a time in the order they appear in the <code>vfstab</code> file. When the <code>fsck</code> command is run on multiple UFS file systems that have <code>fsck pass</code> values greater than 1 and the <code>preen</code> option (-o p) is used, the <code>fsck</code> command automatically checks the file systems on different disks in parallel to maximize efficiency. Otherwise, the value of the pass number does not have any effect.</p>
mount at boot	Set to yes or no for whether the file system should be automatically mounted by the <code>mountall</code> command when the system is booted. Note that this field has nothing to do with <code>autofs</code> . The root (/), <code>/usr</code> and <code>/var</code> file systems are not mounted from the <code>vfstab</code> file initially. This field should always be set to no for these file systems and for virtual file systems such as <code>/proc</code> and <code>/dev/fd</code> .
mount options	A list of comma-separated options (with no spaces) that are used for mounting the file system. Use a dash (-) to indicate no options. For more information, see vfstab(4) .

Note – You must have an entry in each field in the `/etc/vfstab` file. If there is no value for a field, be sure to specify a dash (-). Otherwise, the system might not boot successfully. Similarly, white space should not be used as a field value.

Prerequisites for Unmounting Oracle Solaris File Systems

The prerequisites for unmounting file systems include the following:

- You must be superuser or assume an equivalent role.
- You cannot unmount a file system that is busy. A file system is considered busy if a user is accessing a directory in the file system, if a program has a file open in that file system, or if the file system is being shared. You can make a file system available for unmounting by doing the following:
 - Changing to a directory in a different file system.
 - Logging out of the system.
 - Using the `fuser` command to list all processes that are accessing the file system and to stop them, if necessary. For more details, see [“How to Stop All Processes Accessing a File System” on page 346](#).
Notify users if you need to unmount a file system that they are using.
 - Unsharing the file system. For information about unsharing a file system, see [`unshare\(1M\)`](#).

To verify that you unmounted a file system or a number of file systems, examine the output from the `mount` command.

```
$ mount | grep unmounted-file-system
```

Creating and Mounting Oracle Solaris File Systems

This section provides examples of creating and mounting Oracle Solaris file systems.

▼ How to Create an ZFS File System

- 1 Become superuser or assume an equivalent role.

- 2 Create a ZFS storage pool.

The following example illustrates how to create a simple mirrored storage pool named `tank` and a ZFS file system named `tank` in one command. Assume that the whole disks `/dev/dsk/c1t0d0` and `/dev/dsk/c2t0d0` are available for use.

```
# zpool create tank mirror c1t0d0 c2t0d0
```

- 3 Create a ZFS file system.

```
# zfs create tank/fs
```

The new ZFS file system, `tank/fs`, can use as much of the disk space as needed, and is automatically mounted at `/tank/fs`.

4 Confirm that the file system is created.

```
# zfs list -r tank
NAME      USED  AVAIL  REFER  MOUNTPOINT
tank      117K  268G   21K    /tank
tank/fs   21K   268G   21K    /tank/fs
```

▼ How to Create and Mount a UFS File System

Before You Begin Ensure that you have met the following prerequisites:

- The disk must be formatted and divided into slices.
- If you are re-creating an existing UFS file system, unmount it.
- You need to know the device name of the slice that will contain the file system.

For information on finding disks and disk slice numbers, see [Chapter 11, “Administering Disks \(Tasks\)”](#).

For information on formatting disks and dividing disks into slices, see [Chapter 10, “Managing Disks \(Overview\)”](#).

1 Become superuser or assume an equivalent role.

2 Create the UFS file system.

```
# newfs [-N] [-b size] [-i bytes] /dev/rdisk/device-name
```

The system asks for confirmation.



Caution – Be sure you have specified the correct device name for the slice before performing this step. If you specify the wrong slice, you will erase its contents when the new file system is created. This error might cause the system to panic.

3 To verify the creation of the UFS file system, check the new file system.

```
# fsck /dev/rdisk/device-name
```

where *device-name* argument specifies the name of the disk device that contains the new file system.

The `fsck` command checks the consistency of the new file system, reports any problems, and prompts you before it repairs the problems. For more information on the `fsck` command, see [Chapter 20, “Checking UFS File System Consistency \(Tasks\)”](#) or `fsck(1M)`.

Example 17-2 Creating and Mounting a UFS File System

The following example shows how to create and mount a UFS file system `/dev/rdisk/c0t1d0s0` on `/legacy`.

```
# newfs /dev/rdisk/c0t1d0s0
newfs: construct a new file system /dev/rdisk/c0t1d0s0: (y/n)? y
/dev/rdisk/c0t1d0s0: 286722656 sectors in 46668 cylinders of 48 tracks, 128 sectors
140001.3MB in 2917 cyl groups (16 c/g, 48.00MB/g, 5824 i/g)
super-block backups (for fsck -F ufs -o b=#) at:
 32, 98464, 196896, 295328, 393760, 492192, 590624, 689056, 787488, 885920,
Initializing cylinder groups:
.....
super-block backups for last 10 cylinder groups at:
 285773216, 285871648, 285970080, 286068512, 286166944, 286265376, 286363808,
 286462240, 286560672, 286659104
# fsck /dev/rdisk/c0t1d0s0
# mkdir /legacy
# mount /dev/dsk/c0t1d0s0 /legacy
```

More Information After You Create a UFS File System ...

To mount the legacy UFS file system automatically at boot time, go to [“How to Add an Entry to the `/etc/vfstab` File” on page 341](#).

▼ How to Create a Multiterabyte UFS File System

Support for a multiterabyte UFS file system assumes the availability of multiterabyte LUNs, provided as Solaris Volume Manager or VxVM volumes, or as physical disks greater than 1 terabyte.

Before you can create a multiterabyte UFS file system, verify that you have done either of the following:

- Created a multiterabyte disk partition by using the `format` utility or the Solaris installation utilities
- Set up a multiterabyte volume with Solaris Volume Manager

For more information about multiterabyte UFS file systems, see [“Support of Multiterabyte UFS File Systems” on page 314](#).

- 1 **Become superuser or assume an equivalent role.**
- 2 **Create a multiterabyte UFS file system on a logical volume.**

For example, this command creates a UFS file system for a 1.8 terabyte volume:

```
# newfs /dev/md/rdisk/d99
newfs: construct a new file system /dev/md/rdisk/d99: (y/n)? y
/dev/md/rdisk/d99: 3859402752 sectors in 628158 cylinders of 48 tracks,
```

```

128 sectors
    1884474.0MB in 4393 cyl groups (143 c/g, 429.00MB/g, 448 i/g)
super-block backups (for fsck -F ufs -o b=#) at:
32, 878752, 1757472, 2636192, 3514912, 4393632, 5272352, 6151072, 702...
Initializing cylinder groups:
.....
super-block backups for last 10 cylinder groups at:
 3850872736, 3851751456, 3852630176, 3853508896, 3854387616, 3855266336,
 3856145056, 3857023776, 3857902496, 3858781216
    
```

3 Verify the integrity of the newly created file system.

For example:

```

# fsck /dev/md/rdisk/d99
** /dev/md/rdisk/d99
** Last Mounted on
** Phase 1 - Check Blocks and Sizes
** Phase 2 - Check Pathnames
** Phase 3 - Check Connectivity
** Phase 4 - Check Reference Counts
** Phase 5 - Check Cyl groups
2 files, 2 used, 241173122 free (0 frags, 241173122 blocks, 0.0%
fragmentation)
    
```

4 Mount and verify the newly created file system.

For example:

```

# mount /dev/md/dsk/d99 /bigdir
# df -h /bigdir
Filesystem          size  used  avail capacity  Mounted on
/dev/md/dsk/d99    1.8T   64M   1.8T     1%   /bigdir
    
```

▼ How to Expand a Multiterabyte UFS File System

After a multiterabyte UFS file system is created, you can use the `growfs` command to expand the file system. For example, using the file system that was created for the volume in the preceding procedure, you can add another disk to this volume. Then, expand the file system.

1 Become superuser.

2 Add another disk to the volume.

For example:

```

# metattach d99 c4t5d0s4
d99: component is attached
# metastat
d99: Concat/Stripe
    Size: 5145882624 blocks (2.4 TB)
    Stripe 0:
        Device      Start Block  Dbase  Reloc
        c0t1d0s4      36864       Yes   Yes
    Stripe 1:
        Device      Start Block  Dbase  Reloc
    
```



```

        c3t7d0s4          0      No      Yes
Stripe 2:
Device      Start Block  Dbase  Reloc
c1t1d0s4    0          No     Yes
Stripe 3:
Device      Start Block  Dbase  Reloc
c4t5d0s4    0          No     Yes

```

3 Expand the file system.

For example:

```

# growfs -v /dev/md/rdisk/d99
/usr/lib/fs/ufs/mkfs -G /dev/md/rdisk/d99 5145882624
/dev/md/rdisk/d99: 5145882624 sectors in 837546 cylinders of 48 tracks,
128 sectors
2512638.0MB in 5857 cyl groups (143 c/g, 429.00MB/g, 448 i/g)
super-block backups (for fsck -F ufs -o b=#) at:
 32, 878752, 1757472, 2636192, 3514912, 4393632, 5272352, 6151072, 702...
Initializing cylinder groups:
.....
super-block backups for last 10 cylinder groups at:
 5137130400, 5138009120, 5138887840, 5139766560, 5140645280, 5141524000,
 5142402720, 5143281440, 5144160160, 5145038880,
#

```

4 Mount and verify the expanded file system.

For example:

```

# mount /dev/md/dsk/d99 /bigdir
# df -h /bigdir
Filesystem      size  used  avail capacity  Mounted on
/dev/md/dsk/d99 2.4T   64M   2.4T     1%    /bigdir

```

▼ How to Expand a UFS File System to a Multiterabyte UFS File System

Use the following procedure to expand a UFS file system to greater than 1 terabyte in size. This procedure assumes that the `newfs -T` option was used initially to create the UFS file system.

- 1 Become superuser.
- 2 Identify the size of the current disk or volume.

For example, the following volume is 800 gigabytes:

```

# metastat d98
d98: Concat/Stripe
Size: 1677754368 blocks (800 GB)
Stripe 0:
Device      Start Block  Dbase  Reloc
c0t1d0s4    0          No     Yes
Stripe 1:
Device      Start Block  Dbase  Reloc
c3t7d0s4    0          No     Yes

```

3 Increase the volume to greater than 1 terabyte.

For example:

```
# metattach d98 c1t1d0s4
d98: component is attached
# metastat d98
d98: Concat/Stripe
    Size: 2516631552 blocks (1.2 TB)
    Stripe 0:
        Device      Start Block  Dbase  Reloc
        c0t1d0s4      0          No     Yes
    Stripe 1:
        Device      Start Block  Dbase  Reloc
        c3t7d0s4      0          No     Yes
    Stripe 2:
        Device      Start Block  Dbase  Reloc
        c1t1d0s4      0          No     Yes
```

4 Expand the UFS file system for the disk or volume to greater than 1 terabyte.

For example:

```
growfs -v /dev/md/rdisk/d98
/usr/lib/fs/ufs/mkfs -G /dev/md/rdisk/d98 2516631552
/dev/md/rdisk/d98: 2516631552 sectors in 68268 cylinders of 144 tracks,
256 sectors
    1228824.0MB in 2731 cyl groups (25 c/g, 450.00MB/g, 448 i/g)
super-block backups (for fsck -F ufs -o b=#) at:
    32, 921888, 1843744, 2765600, 3687456, 4609312, 5531168, 6453024, 737...
    8296736,
Initializing cylinder groups:
.....
super-block backups for last 10 cylinder groups at:
    2507714848, 2508636704, 2509558560, 2510480416, 2511402272, 2512324128,
    2513245984, 2514167840, 2515089696, 2516011552,
```

5 Mount and verify the expanded file system.

For example:

```
# mount /dev/md/dsk/d98 /datadir
# df -h /datadir
Filesystem      size  used  avail capacity  Mounted on
/dev/md/dsk/d98  1.2T   64M   1.2T     1%    /datadir
```

Troubleshooting Multiterabyte UFS File System Problems

Use the following error messages and solutions to troubleshoot problems with multiterabyte UFS file systems.

Error Message (similar to the following):

```
mount: /dev/rdisk/c0t0d0s0 is not this fstype.
```

Cause

You attempted to mount a UFS file system that is greater than 1 terabyte on a system running a Solaris release that does not support this feature.

Solution

Mount a UFS file system that is greater than 1 terabyte on a system running a current Solaris release.

Error Message

```
"File system was not set up with the multi-terabyte format." "Its size
cannot be increased to a terabyte or more."
```

Cause

You attempted to expand a file system that was not created by using the `newfs -T` command.

Solution

1. Back up the data for the file system that you want to expand to greater than 1 terabyte.
2. Re-create the file system by using the `newfs` command to create a multiterabyte file system.
3. Restore the backup data into the newly created file system.

▼ How to Create and Mount a TMPFS File System

- 1 **Become superuser or assume an equivalent role.**
- 2 **Create the directory that you want to mount as the TMPFS file system, if necessary.**

```
# mkdir /mount-point
```

where *mount-point* is the directory on which the TMPFS file system is mounted.

- 3 **Mount the TMPFS file system.**

```
# mount -F tmpfs [-o size=number] swap mount-point
```

`-o size=number` Specifies the size limit of the TMPFS file system in MB.

mount-point Specifies the directory on which the TMPFS file system is mounted.

To set up the system to automatically mount a TMPFS file system at boot time, see [Example 17-4](#).

- 4 **Verify that the TMPFS file system has been created.**

```
# mount -v
```

Example 17-3 Creating and Mounting a TMPFS File System

The following example shows how to create, mount, and limit the size of the TMPFS file system, `/export/reports`, to 50 MB.

```
# mkdir /export/reports
# chmod 777 /export/reports
# mount -F tmpfs -o size=50m swap /export/reports
# mount -v
```

Example 17-4 Mounting a TMPFS File System at Boot Time

You can set up the system to automatically mount a TMPFS file system at boot time by adding an `/etc/vfstab` entry. The following example shows an entry in the `/etc/vfstab` file that mounts `/export/test` as a TMPFS file system at boot time. Because the `size=number` option is not specified, the size of the TMPFS file system on `/export/test` is limited only by the available system resources.

```
swap - /export/test tmpfs - yes -
```

For more information on the `/etc/vfstab` file, see [“Field Descriptions for the `/etc/vfstab` File” on page 331](#).

▼ How to Create and Mount an LOFS File System

- 1 **Become superuser or assume an equivalent role.**
- 2 **Create the directory you want to mount as an LOFS file system, if necessary.**

```
# mkdir loopback-directory
```
- 3 **Grant the appropriate permissions and ownership on the newly created directory.**
- 4 **Create the mount point where you want to mount the LOFS file system, if necessary.**

```
# mkdir /mount-point
```
- 5 **Mount the LOFS file system.**

```
# mount -F lofs loopback-directory /mount-point
```

`loopback-directory` Specifies the file system to be mounted on the loopback mount point.

`/mount-point` Specifies the directory on which to mount the LOFS file system.
- 6 **Verify that the LOFS file system has been mounted.**

```
# mount -v
```

Example 17-5 Creating and Mounting an LOFS File System

The following example shows how to create, mount, and test new software in the `/new/dist` directory as a loopback file system without actually having to install it.

```
# mkdir /tmp/newroot
# mount -F lofs /new/dist /tmp/newroot
# chroot /tmp/newroot newcommand
```

Example 17-6 Mounting an LOFS File System at Boot Time

You can set up the system to automatically mount an LOFS file system at boot time by adding an entry to the end of the `/etc/vfstab` file. The following example shows an entry in the `/etc/vfstab` file that mounts an LOFS file system for the root (`/`) file system on `/tmp/newroot`.

```
/ - /tmp/newroot lofs - yes -
```

Ensure that the loopback entries are the last entries in the `/etc/vfstab` file. Otherwise, if the `/etc/vfstab` entry for a loopback file system precedes the file systems to be included in it, the loopback file system cannot be mounted.

See Also For more information on the `/etc/vfstab` file, see [“Field Descriptions for the `/etc/vfstab` File” on page 331](#).

▼ How to Add an Entry to the `/etc/vfstab` File

Use this procedure to mount non-ZFS file systems at boot time unless legacy mount behavior is needed for some ZFS file systems. For more information about mounting ZFS file systems, see [Oracle Solaris ZFS Administration Guide](#).

- 1 **Become an administrator or assume an equivalent role.**
- 2 **Create a mount point for the file system to be mounted, if necessary.**

```
# mkdir /mount-point
```

There must be a mount point on the local system to mount a file system. A *mount point* is a directory to which the mounted file system is attached.

- 3 **Edit the `/etc/vfstab` file and add an entry. Ensure that you do the following:**
 - a. **Separate each field with white space (a space or a tab).**
 - b. **Specify a dash (-) if a field has no contents.**

c. Save the changes.

For detailed information about the `/etc/vfstab` field entries, see [Table 17-1](#).

Note – Because the root (`/`) file system is mounted read-only by the kernel during the boot process, only the `remount` option (and options that can be used in conjunction with `remount`) affect the root (`/`) entry in the `/etc/vfstab` file.

Example 17-7 Adding an Entry to the `/etc/vfstab` File

The following example shows how to mount the disk slice `/dev/dsk/c0t3d0s7` as a UFS file system to the mount point `/files1`. The raw character device `/dev/rdisk/c0t3d0s7` is specified as the device to `fsck`. The `fsck` pass value of 2 means that the file system will be checked, but not sequentially.

```
#device      device      mount  FS      fsck  mount  mount
#to mount    to fsck     point  type    pass  at boot options
#
/dev/dsk/c0t3d0s7 /dev/rdisk/c0t3d0s7 /files1 ufs     2     yes    -
```

The following example shows how to mount the `/export/man` directory from the system `pluto` as an NFS file system on mount point `/usr/man`. Neither a device to `fsck` nor a `fsck` pass is specified because it's an NFS file system. In this example, mount options are `ro` (read-only) and `soft`.

```
#device      device      mount  FS      fsck  mount  mount
#to mount    to fsck     point  type    pass  at boot options
pluto:/export/man -        /usr/man nfs     -     yes    ro,soft
```

The following example shows how to mount the root (`/`) file system on a loopback mount point, `/tmp/newroot`. LOFS file systems must always be mounted after the file systems that are in the LOFS file system.

```
#device      device      mount  FS      fsck  mount  mount
#to mount    to fsck     point  type    pass  at boot options
#
/              -          /tmp/newroot lofs   -     yes    -
```

▼ How to Mount a File System (`/etc/vfstab` File)

- 1 Become superuser or assume an equivalent role.
- 2 Mount a file system listed in the `/etc/vfstab` file.

```
# mount /mount-point
```

where */mount-point* specifies an entry in the mount point or device to mount field in the */etc/vfstab* file. It is usually easier to specify the mount point.

Example 17-8 Mounting a File System (*/etc/vfstab* File)

The following example shows how to mount the */legacy* file system that is listed in the */etc/vfstab* file.

```
# mount /legacy
```

Example 17-9 Mounting All File Systems (*/etc/vfstab* File)

The following example shows the messages that are displayed when you use the `mountall` command and the file systems are already mounted.

```
# mountall
mount: /tmp is already mounted or swap is busy
```

The following example shows how to mount all the local systems that are listed in the */etc/vfstab* file.

```
# mountall -l
```

The following example shows how to mount all available ZFS file systems.

```
# zfs mount -a
```

The following example shows how to mount all the remote file systems that are listed in the */etc/vfstab* file.

```
# mountall -r
```

▼ How to Mount a UFS File System (mount Command)

- 1 Become superuser or assume an equivalent role.
- 2 Create a mount point for the UFS file system to be mounted, if necessary.

```
# mkdir /mount-point
```

There must be a mount point on the local system to mount a file system. A *mount point* is a directory to which the mounted file system is attached.

- 3 Mount the UFS file system.

```
# mount [-o mount-options] /dev/dsk/device-name /mount-point
```

Example 17–10 Mounting a UFS File System (mount Command)

The following example shows how to mount `/dev/dsk/c0t3d0s7` on the `/files1` directory.

```
# mount /dev/dsk/c0t3d0s7 /files1
```

▼ How to Mount a UFS File System Without Large Files (mount Command)

When you mount a file system, the `largefiles` option is selected by default. This option enables you to create files larger than 2 GB. If a file system contains large files, you cannot remount the file system with the `noLargefiles` option or mount it on a system that is running older Solaris versions, until you remove any large files and run the `fsck` command to reset the state to `noLargefiles`.

This procedure assumes that the file system is in the `/etc/vfstab` file.

- 1 **Become superuser or assume an equivalent role.**
- 2 **Create a mount point for the UFS file system to be mounted, if necessary.**

```
# mkdir /mount-point
```

There must be a mount point on the local system to mount a file system. A *mount point* is a directory to which the mounted file system is attached.

- 3 **Ensure that no large files exist in the UFS file system.**

```
# cd /mount-point
# find . -xdev -size +20000000 -exec ls -l {} \;
```

where `/mount-point` identifies the mount point of the file system you want to check for large files.

- 4 **Remove or move any large files in this UFS file system to another file system, if necessary.**
- 5 **Unmount the file system.**

```
# umount /mount-point
```
- 6 **Reset the file system state.**

```
# fsck /mount-point
```
- 7 **Remount the file system with the `noLargefiles` option.**

```
# mount -o noLargefiles /mount-point
```

Example 17–11 Mounting a UFS File System Without Large Files (mount Command)

The following example shows how to check the /datab file system and remount it with the nolargefiles option.

```
# cd /datab
# find . -xdev -size +20000000 -exec ls -l {} \;
# umount /datab
# fsck /datab
# mount -o nolargefiles /datab
```

▼ How to Mount an NFS File System (mount Command)

- 1 Become superuser or assume an equivalent role.
- 2 Create a mount point for the file system to be mounted, if necessary.

```
# mkdir /mount-point
```

There must be a mount point on the local system to mount a file system. A mount point is a directory to which the mounted file system is attached.

- 3 Ensure that the resource (file or directory) is available from a server.

To mount an NFS file system, the resource must be made available on the server by using the share command. For information on how to share resources, see [“About the NFS Service” in System Administration Guide: Network Services](#).

- 4 Mount the NFS file system.

```
# mount -F nfs [-o mount-options] server:/directory /mount-point
```

Example 17–12 Mounting an NFS File System (mount Command)

The following example shows how to mount the /export/packages directory on /mnt from the server pluto.

```
# mount -F nfs pluto:/export/packages /mnt
```

▼ x86: How to Mount a PCFS (DOS) File System From a Hard Disk (mount Command)

Use the following procedure to mount a PCFS (DOS) file system from a hard disk.

- 1 Become superuser or assume an equivalent role.

2 Create a mount point for the file system to be mounted, if necessary.

```
# mkdir /mount-point
```

There must be a mount point on the local system to mount a file system. A *mount point* is a directory to which the mounted file system is attached.

3 Mount the PCFS file system.

```
# mount -F pcfs [-o rw | ro] /dev/dsk/device-name:logical-drive /mount-point
```

`-o rw | ro` Specifies that you can mount a PCFS file system read/write (*rw*) or read-only (*ro*). If you do not specify this option, the default is *rw*.

`/dev/dsk/device-name` Specifies the device name of the whole disk (for example, `/dev/dsk/c0t0d0p0`).

`logical-drive` Specifies either the DOS logical drive letter (c through z) or a drive number (1 through 24). Drive c is equivalent to drive 1 and represents the primary DOS slice on the drive. All other letters or numbers represent DOS logical drives within the extended DOS slice.

`/mount-point` Specifies the directory on which to mount the file system.

Note that the *device-name* and *logical-drive* must be separated by a colon.

Example 17-13 x86: Mounting a PCFS (DOS) File System From a Hard Disk (mount Command)

The following example shows how to mount the logical drive in the primary DOS slice on the `/pcfs/c` directory.

```
# mount -F pcfs /dev/dsk/c0t0d0p0:c /pcfs/c
```

The following example shows how to mount read-only the first logical drive in the extended DOS slice on the `/mnt` directory.

```
# mount -F pcfs -o ro /dev/dsk/c0t0d0p0:2 /mnt
```

▼ How to Stop All Processes Accessing a File System**1 Become superuser or assume an equivalent role.****2 List all the processes that are accessing the file system so that you know which processes you are going to stop.**

```
# fuser -c [ -u ] /mount-point
```

- c Reports on files that are mount points for file systems and any files within those mounted file systems.
- u Displays the user login name for each process ID.
- /mount-point* Specifies the name of the file system for which you want to stop processes.

3 Stop all processes that are accessing the file system.

```
# fuser -c -k /mount-point
```

A SIGKILL is sent to each process that is using the file system.

Note – You should not stop a user's processes without first warning the user.

4 Verify that no processes are accessing the file system.

```
# fuser -c /mount-point
```

Example 17–14 Stopping All Processes Accessing a File System

The following example shows how to stop process 4006c that is using the `/export/home` file system.

```
# fuser -c /export/home
/export/home: 4006c
# fuser -c -k /export/home
/export/home: 4006c
# fuser -c /export/home
/export/home:
```

▼ How to Unmount a File System

Use the following procedure to unmount a UFS file system, except for the root (`/`), `/usr`, or `/var` file systems.

Note – The root (`/`), `/usr`, and `/var` file systems can be unmounted only during a shutdown. The system needs these file systems to function.

1 Ensure that you have met the prerequisites listed in “Prerequisites for Unmounting Oracle Solaris File Systems” on page 333.

2 Unmount the file system.

```
# umount /mount-point
```

where */mount-point* is the name of the file system that you want to unmount. This can be one of the following:

- The directory name where the file system is mounted
- The device name path of the file system
- The resource for an NFS file system
- The loopback directory for an LOFS file system

Example 17–15 Unmounting a File System

The following example shows how to unmount a legacy UFS file system.

```
# umount /legacy
```

The following example shows how to unmount the UFS file system on slice 7.

```
# umount /dev/dsk/c0t0d0s7
```

The following example shows how to forcibly unmount the UFS */legacy* file system.

```
# umount -f /legacy  
#
```

The following example shows how to unmount all UFS file systems in the */etc/vfstab* file, except for the root (*/*), */proc*, */var*, and */usr* file systems.

```
# umountall
```

The following example shows to unmount all ZFS file systems.

```
# zfs umount -a
```

All file systems are unmounted, except for those file systems that are busy.

Using The CacheFS File System (Tasks)

This chapter describes how to set up and maintain CacheFS file systems.

This is a list of task maps in this chapter.

- “High-Level View of Using the CacheFS File System (Task Map)” on page 349
- “Creating and Mounting a CacheFS File System (Task Map)” on page 352
- “Maintaining a CacheFS File System (Task Map)” on page 357
- “Packing a Cached File System (Task Map)” on page 362
- “Collecting CacheFS Statistics (Task Map)” on page 371

For information on troubleshooting CacheFS errors, see “[Troubleshooting cachefspack Errors](#)” on page 368.

Note – For important information about NFS version 4 and the CacheFS software, see “[NFS Version 4 and CacheFS Compatibility Issues](#)” on page 306.

High-Level View of Using the CacheFS File System (Task Map)

Use this task map to identify all the tasks for using CacheFS file systems. Each task points to a series of additional tasks such as creating and mounting CacheFS file systems, and packing and maintaining the cache.

Task	Description	For Instructions
1. Create and mount a CacheFS file system.	Create the cache and mount the file system in the cache.	“ Creating and Mounting a CacheFS File System (Task Map) ” on page 352

Task	Description	For Instructions
2. Maintain a CacheFS file system.	Display and modify a CacheFS file system by unmounting, removing, or re-creating the cache.	“Maintaining a CacheFS File System (Task Map)” on page 357
3. (Optional) Pack and unpack a CacheFS file system.	Determine whether you want to pack the cache and use packing lists. Packing the cache ensures that certain files and directories are always updated in the cache.	“Packing a Cached File System (Task Map)” on page 362
4. Collect CacheFS statistics.	Determine cache performance and appropriate cache size.	“Collecting CacheFS Statistics (Task Map)” on page 371

Overview of the CacheFS File System

The CacheFS file system is a general purpose caching mechanism that improves NFS server performance and scalability by reducing server and network load. Designed as a layered file system, the CacheFS file system provides the ability to cache one file system on another file system. In an NFS environment, the CacheFS file system increases the client per server ratio, reduces server and network loads, and improves performance for clients on slow links, such as Point-to-Point Protocol (PPP).

How a CacheFS File System Works

You create a CacheFS file system on a client system so that file systems you cache can be accessed by the client locally instead of across the network. The following figure shows the relationship of the components that are involved in using CacheFS file systems.

FIGURE 18-1 How a CacheFS File System Works

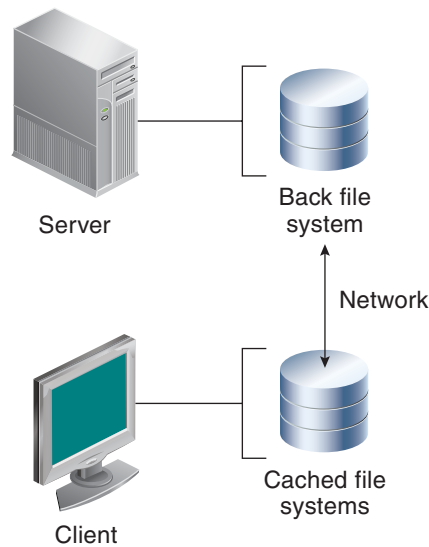

The *back* file system is the file system that you specify to be mounted in the cache. A back file system can be either NFS or HSPFS (High Sierra File System). When the user attempts to access files that are part of the back file system, those files are placed in the cache. The *front* file system is the file system that is mounted in the cache and is accessed from the local mount point. The front file system type must be UFS.

To the user, the initial request to access a file in a CacheFS file system might seem slow. However, subsequent uses of the same file are faster.

CacheFS File System Structure and Behavior

Each cache has a set of parameters that determines the cache structure and how it behaves. The parameters are set to the default values listed in the following table. The default values specify that the entire front file system is used for caching, which is the recommended method of caching file systems.

TABLE 18-1 CacheFS File System Parameters and Their Default Values

CacheFS File System Parameter	Default Value	Definition
maxblocks	90 %	Sets the maximum number of blocks that a CacheFS file system is allowed to claim within the front file system.
minblocks	0 %	Sets the minimum number of blocks that a CacheFS file system is allowed to claim within the front file system.

TABLE 18-1 CacheFS File System Parameters and Their Default Values *(Continued)*

CacheFS File System Parameter	Default Value	Definition
<code>threshblocks</code>	85 %	Sets the number of blocks that must be available in the front file system before a CacheFS file system can claim more than the blocks specified by <code>minblocks</code> .
<code>maxfiles</code>	90 %	Sets the maximum number of available inodes (number of files) that a CacheFS file system is allowed to claim within the front file system.
<code>minfiles</code>	0 %	Sets the minimum number of available inodes that a CacheFS file system is allowed to claim within the front file system.
<code>threshfiles</code>	85 %	Sets the number of inodes that must be available in the front file system before a CacheFS file system can claim more files than is specified in <code>minfiles</code> .

Typically, you should not change any of these parameter values. They are set to default values to achieve optimal cache behavior. However, you might want to modify the `maxblocks` and `maxfiles` values if you have some room in the front file system that is not used by the cache, and you want to use it for some other file system. You do so by using the `cfsadmin` command. For example:

```
$ cfsadmin -o maxblocks=60
```

Creating and Mounting a CacheFS File System (Task Map)

Use the procedures in this task map to create and mount a CacheFS file system.

Task	Description	For Instructions
1. Share the file system to be cached.	Verify that the file system you want to cache is shared.	share(1M)
2. Create the cache.	Use the <code>cfsadmin</code> command to create the cache.	“How to Create the Cache” on page 353
3. Mount a file system in the cache.	Mount a file system in a cache by using one of the following methods:	
	Mount a CacheFS file system by using the <code>mount</code> command.	“How to Mount a CacheFS File System (mount)” on page 354

Task	Description	For Instructions
	Mount a CacheFS file system by editing the <code>/etc/vfstab</code> file.	“How to Mount a CacheFS File System (/etc/vfstab)” on page 356
	Mount a cached file system by using the <code>autofs</code> service.	“How to Mount a CacheFS File System (autofs)” on page 356

▼ How to Create the Cache

- 1 Become superuser on the client system.
- 2 Create the cache.

```
# cfsadmin -c /cache-directory
```

where *cache-directory* indicates the name of the directory where the cache resides.

For more information, see [cfsadmin\(1M\)](#).

Note – After you have created the cache, do not perform any operations within the cache directory itself. Doing so could cause conflicts within the CacheFS software.

Example 18–1 Creating the Cache

The following example shows how to create a cache in the `/local/mycache` directory by using the default cache parameter values.

```
# mkdir /local
# cfsadmin -c /local/mycache
```

Mounting a File System in the Cache

You specify a file system to be mounted in the cache so that users can locally access files in that file system. The files do not actually get placed in the cache until the user accesses the files.

The following table describes three ways to mount a CacheFS file system.

Mount Type for CacheFS File System	Frequency of CacheFS Mount Type
Using the mount command	Every time the system reboots in order to access the same file system.
Editing the <code>/etc/vfstab</code> file	Only once. The <code>/etc/vfstab</code> file remains unchanged after the system reboots.

Mount Type for CacheFS File System	Frequency of CacheFS Mount Type
Using autofs	Only once. The autofs maps remain unchanged after the system reboots.

Choose the method of mounting file systems that best suits your environment.

You can mount only file systems that are shared. For information on sharing file systems, see [share\(1M\)](#).

Note – The caching of the root (/) and /usr file systems is not supported in a CacheFS file system.

▼ How to Mount a CacheFS File System (mount)

1 Become superuser on the client system.

2 Create the mount point, if necessary.

```
# mkdir /mount-point
```

You can create the mount point from anywhere, but it must be a UFS file system. The CacheFS options used with the mount command, as shown in the next step, determine that the mount point you create is cached in the cache directory you specify.

3 Mount a file system in the cache.

```
# mount -F cachefs -o backfstype=fstype,cachedir=/cache-directory[,options]
/back-filesystem /mount-point
```

<i>fstype</i>	Indicates the file system type of the back file system, which can be either NFS or HSFS.
<i>/cache-directory</i>	Indicates the name of the UFS directory where the cache resides. This name is the same name you specified when you created the cache in “How to Create the Cache” on page 353.
<i>options</i>	Specifies other mount options that you can include when you mount a file system in a cache. For a list of CacheFS mount options, see mount_cachefs(1M) .
<i>/back-filesystem</i>	Specifies the mount point of the back file system to cache. If the back file system is an NFS file system, you must specify the host name of the server from which you are mounting the file system and the name of the file system to cache, separated by a colon. For example, <i>merlin:/data/abc</i> .
<i>/mount-point</i>	Indicates the directory where the file system is mounted.

4 Verify that the cache you created was actually mounted.

```
# cachefsstat /mount-point
```

The */mount-point* is the CacheFS file system that you created.

For example:

```
# cachefsstat /docs
/docs
      cache hit rate: 100% (0 hits, 0 misses)
      consistency checks: 1 (1 pass, 0 fail)
      modifies: 0
      garbage collection: 0
```

If the file system was not mounted in the cache, an error message similar to the following is displayed:

```
# cachefsstat /mount-point
cachefsstat: /mount-point: not a cachefs mountpoint
```

For more information about the `cachefsstat` command, see [“Collecting CacheFS Statistics” on page 372](#).

Example 18–2 Mounting a CacheFS File System (mount)

The following example shows how to mount the NFS file system `merlin:/docs` as a CacheFS file system named `/docs` in the cache named `/local/mycache`.

```
# mkdir /docs
# mount -F cachefs -o backfstype=nfs,cachedir=/local/mycache merlin:/docs /docs
```

The following example shows how to make a Solaris 10 DVD available as a CacheFS file system named `/cfssrc`. Because you cannot write to the DVD, the `ro` argument is specified to make the CacheFS file system read-only. This example assumes that the removable media services are not running.

```
# mount -F hsfs -o ro /dev/dsk/c0t6d0s0 /sol10
# mount -F cachefs -o backfstype=hsfs,cachedir=/cfs/cache,ro,noconst,
backpath=/sol10 /dev/dsk/c0t6d0s0 /cfssrc
# ls /cfssrc
Copyright Solaris_10
```

The following example shows how to mount a Solaris 10 DVD as a CacheFS file system with `vol`d running.

```
# mount -F cachefs -o backfstype=hsfs,cachedir=/cfs/cache,ro,noconst,
backpath=/cdrom/sol_10_sparc/s0 /vol/dev/dsk/c0t2d0/sol_10_sparc/s0 /cfssrc
```

The following example shows how to mount a DVD as a CacheFS file system with `vol`d running.

```
# mount -F cachefs -o backfstype=hsfs,cachedir=/cfs/cache,ro,noconst,
backpath=/cdrom/epson /vol/dev/dsk/c0t2d0/epson /drvrs
```

The following example uses the `demandconst` option to specify consistency checking on demand for the NFS CacheFS file system `/docs`, whose back file system is `merlin:/docs`. For more information, see [“Consistency Checking of a CacheFS File System” on page 359](#).

```
# mount -F cachefs -o backfstype=nfs,cachedir=/local/mycache,demandconst merlin:/docs /docs
```

▼ How to Mount a CacheFS File System (/etc/vfstab)

- 1 Become superuser on the client system.
- 2 Using an editor, specify the file systems to be mounted in the `/etc/vfstab` file.

See the example that follows.

For more information on the `/etc/vfstab` file, see [“Field Descriptions for the /etc/vfstab File” on page 331](#).

- 3 Mount the CacheFS file system.

```
# mount /mount-point
```

Or, reboot the system.

Example 18–3 Mounting a CacheFS File System (/etc/vfstab)

The following example shows the `/etc/vfstab` entry for the `/data/abc` directory from the remote system `starbug` that is mounted in the cached directory, `/opt/cache`.

```
#device          device          mount   FS   fsck  mount  mount
#to mount        to fsck        point   type  pass  at boot options
#
starbug:/data/abc /local/abc     /opt/cache cachefs 7    yes    local-access,bg,
nosuid,demandconst,backfstype=nfs,cachedir=/opt/cache
```

▼ How to Mount a CacheFS File System (autofs)

You can mount a file system in a cache with `autofs` by specifying the `-fstype=cachefs` mount option in your automount map. Note that the CacheFS mount options, for example, `backfstype` and `cachedir`, are also specified in the automount map.

For details on automount maps, see [“Task Overview for Autofs Administration” in *System Administration Guide: Network Services*](#) or `automount(1M)`.

- 1 **Become superuser on the client system.**
- 2 **Using an editor, add the following line to the `auto_direct` map:**

```
/mount-point -fstype=cachefs, cachedir=/directory, backfstype=nfs
server:/file-system
```
- 3 **Using an editor, add the following line to the `auto_master` map:**

```
/-
```

The `/-` entry is a pointer to check the `auto_direct` map.
- 4 **Reboot the system.**
- 5 **Verify that the entry was made correctly by changing to the file system you mounted in the cache, and then list the contents.**

```
# cd /filesystem
# ls
```

Example 18–4 Mounting a CacheFS File System (autofs)

The following `auto_direct` entry automatically mounts the CacheFS file system in the `/docs` directory.

```
/docs -fstype=cachefs, cachedir=/local/mycache, backfstype=nfs merlin:/docs
```

Maintaining a CacheFS File System (Task Map)

After a CacheFS file system is set up, it requires little maintenance. Use the optional procedures in this task map if you need to perform maintenance tasks on your CacheFS file systems.

Task	Description	For Instructions
Modify a CacheFS file system.	Modify CacheFS file system behavior by unmounting, deleting, or re-creating the cache.	“Modifying a CacheFS File System” on page 358
Display CacheFS file system information.	Display information about CacheFS file systems by using the <code>cfsadmin</code> command.	“How to Display Information About a CacheFS File System” on page 359
Perform consistency checking.	Perform consistency checking on demand by using the <code>cfsadmin</code> command.	“How to Specify Cache Consistency Checking on Demand” on page 360

Task	Description	For Instructions
Delete a CacheFS file system.	Delete a CacheFS file system by using the <code>umount</code> command and the <code>cfsadmin</code> command.	“How to Delete a CacheFS File System” on page 360
Check the integrity of a CacheFS file system.	Check the integrity of a CacheFS file system by using the <code>fsck_cacheofs</code> command.	“How to Check the Integrity of a CacheFS File System” on page 361

Maintaining a CacheFS File System

This section describes how to maintain a CacheFS file system.

If you are using the `/etc/vfstab` file to mount file systems, you modify the cache by editing the file system options in the `/etc/vfstab` file. If you are using `autofs`, you modify the cache by editing the file system options in the `autofs` maps.

Modifying a CacheFS File System

When you modify a file system in the cache, you need to delete the cache and then re-create it. You might also need to reboot your machine in single-user mode, depending on how your file systems are shared and accessed.

In the following example, the cache is deleted, re-created, and then mounted again by using `demandconst` option specified for the `/docs` file system.

```
# shutdown -g30 -y
.
.
.
Root password for system maintenance (control-d to bypass):
single-user privilege assigned to /dev/console.

.
.
.
Here is where you might be prompted to run fsck on the
file system where the cache is located.

# fsck /local
# mount /local
# cfsadmin -d all /local/mycache
# cfsadmin -c /local/mycache
# init 6
.
.
.
console login:
```

```
password:
# mount -F cachefs -o backfstype=nfs,cachedir=/local/cache1,demandconst
merlin:/docs /docs
#
```

▼ How to Display Information About a CacheFS File System

- 1 Become superuser on the client system.
- 2 Display information about all file systems cached under a specified cache.

```
# cfsadmin -l /cache-directory
```

where */cache-directory* is the name of the directory where the cache resides.

Example 18-5 Displaying Information About CacheFS File Systems

The following example shows information about the */local/mycache* cache directory. In this example, the */docs* file system is cached in */local/mycache*. The last line displays the name of the CacheFS file system.

```
# cfsadmin -l /local/mycache
cfsadmin: list cache FS information
  maxblocks      90%
  minblocks      0%
  threshblocks   85%
  maxfiles       90%
  minfiles       0%
  threshfiles    85%
  maxfilesize    3MB
merlin:_docs:_docs
#
```

Consistency Checking of a CacheFS File System

To ensure that the cached directories and files remain current, the CacheFS software periodically checks the consistency of files stored in the cache. To check consistency, the CacheFS software compares the current modification time to the previous modification time. If the modification times are different, all data and attributes for the directory or file are purged from the cache. Then, new data and attributes are retrieved from the back file system.

Consistency Checking on Demand

Consistency checks can be performed only when you explicitly request checks for file systems that are mounted by using the *-o demandconst* option. If you mount a file system in a cache with this option, then use the *cfsadmin* command with the *-s* option to request a consistency

check. By default, consistency checking is performed file by file as the files are accessed. If no files are accessed, no checks are performed. Using the `-o demandconst` option avoids the situation where the network is flooded with consistency checks.

For more information, see [mount_cacheefs\(1M\)](#).

▼ How to Specify Cache Consistency Checking on Demand

- 1 Become superuser on the client system.
- 2 Mount the file system in the cache and specify cache consistency checking.

```
# mount -F cachefs -o backfstype=nfs, cachedir=/directory, demandconst
server:/file-system /mount-point
```

- 3 Initiate consistency checking on a specific CacheFS file system.

```
# cfsadmin -s /mount-point
```

▼ How to Delete a CacheFS File System

- 1 Become superuser on the client system.
- 2 Unmount the CacheFS file system.

```
# umount /mount-point
```

where `/mount-point` specifies the CacheFS file system that you want to delete.

- 3 Determine the name of the CacheFS file system (cache ID).

```
# cfsadmin -l /cache-directory
cfsadmin: list cache FS information
maxblocks      90%
minblocks      0%
threshblocks   85%
maxfiles       90%
minfiles       0%
threshfiles    85%
maxfilesize    3MB
```

cache-ID

```
#
```

- 4 Delete the CacheFS file system from the specified cache.

```
# cfsadmin -d cache-ID /cache-directory
```

cache-ID

Indicates the name of the CacheFS file system, which is the last line of the `cfsadmin -l` output. For more information, see [“How to Display](#)

[Information About a CacheFS File System](#)” on page 359. You can delete all the CacheFS file systems in a particular cache by specifying `all` for *cache-ID*.

/cache-directory Specifies the directory where the cache resides.

5 Verify that the CacheFS file system has been deleted.

The cache ID of the file system you just deleted should be missing from the `cfsadmin -l` output.

```
# cfsadmin -l /cache-directory
cfsadmin: list cache FS information
maxblocks      90%
minblocks      0%
threshblocks   85%
maxfiles       90%
minfiles       0%
threshfiles    85%
maxfilesize    3MB
#
```

For more information about the fields that are specified in the command output, refer to [cfsadmin\(1M\)](#).

6 Update the resource counts for the cache.

```
# fsck -F cachefs /cache-directory
```

For more information, see [“How to Check the Integrity of a CacheFS File System”](#) on page 361.

Example 18–6 Deleting a CacheFS File System

The following example shows how to delete the file systems from the cache.

```
# umount /cfssrc
# cfsadmin -l /cfssrc
# cfsadmin -d _dev_dsk_c0t6d0s0:_cfssrc
# cfsadmin -l
# fsck -F cachefs /cache-directory
```

▼ How to Check the Integrity of a CacheFS File System

Use the `fsck` command to check the integrity of CacheFS file systems. The CacheFS version of the `fsck` command automatically corrects problems without requiring user interaction. You should not need to run the `fsck` command manually for CacheFS file systems because the `fsck` command is run automatically at boot time or when the file system is mounted. If you want to manually check the integrity, you can use the following procedure.

For more information, see [fsck_cachefs\(1M\)](#).

1 Become superuser on the client system.**2 Check the file systems in the specified cache.**

```
# fsck -F cacheefs [-m -o noclean] /cache-directory
```

`-m` Causes the `fsck` command to check a CacheFS file system without making any repairs.

`-o noclean` Forces a check on the CacheFS file systems only. Does not make any repairs.

`/cache-directory` Indicates the name of the directory where the cache resides.

Example 18-7 Checking the Integrity of CacheFS File Systems

The following example shows how to check the file systems cached in the `/local/mycache` cache.

```
# fsck -F cacheefs /local/mycache
#
```

Packing a Cached File System (Task Map)

The following task map describes the procedures that are associated with packing a CacheFS file system. All of these procedures are optional.

Task	Description	For Instructions
Pack files in the cache.	Identify files and directories to be loaded in the cache and pack them. Packing ensures that current copies of these files are available in the cache.	“How to Pack Files in the Cache” on page 363
Create a packing list.	Create a packing list if you do not want to specify each individual file that you want packed in the cache.	“How to Create a Packing List” on page 366
Pack files in the cache with a packing list.	Specify the name of the packing list of the files to be packed in the cache.	“How to Pack Files in the Cache With a Packing List” on page 366

Task	Description	For Instructions
Unpack files or packing lists from the cache.	Remove a file from the cache that is no longer needed.	“How to Unpack Files or Packing Lists From the Cache” on page 367 “How to Unpack Files or Packing Lists From the Cache” on page 367
Display packed files information.	View information about the files that you've packed, including their packing status.	“How to Display Packed Files Information” on page 364

Packing a CacheFS File System

For general use, the CacheFS software operates automatically after it is set up, without requiring any action from the user. Files are cached on a most recently used basis. With the *packing* feature, you can take a more active role in managing your cache by ensuring that certain files or directories are always updated in the cache.

You can specify files and directories to be loaded in the cache by using the `cachefspack` command. This command ensures that current copies of these files are available in the cache.

The *packing list* contains the names of specific files and directories. The packing list can also contain other packing lists. This feature saves you from having to specify individual files and directories when you have many items to pack in your cache.

You can print out a brief help summary of all the `cachefspack` options by using the `-h` option as follows:

```
$ cachefspack -h
Must select 1 and only 1 of the following 5 options
-d Display selected filenames
-i Display selected filenames packing status
-p Pack selected filenames
-u Unpack selected filenames
-U Unpack all files in directory 'dir'
-f Specify input file containing rules
-h Print usage information
-r Interpret strings in LIST rules as regular expressions
-s Strip './' from the beginning of a pattern name
-v Verbose option
files - a list of filenames to be packed/unpacked
```

▼ How to Pack Files in the Cache

- Pack files in the cache.

```
$ cachefspack -p filename
```

- `-p` Specifies that you want the file or files to be packed. This option is also the default.
- `filename` Specifies the name of the file or directory you want packed in the cache. When you specify a directory, all of its subdirectories are also packed. For more information, see [cachefspack\(1M\)](#).

Example 18–8 Examples—Packing Files in the Cache

The following example shows the `projects` file being packed in the cache.

```
$ cachefspack -p projects
```

The following example shows three files being packed in the cache.

```
$ cachefspack -p projects updates master_plan
```

The following example shows a directory being packed in the cache.

```
$ cachefspack -p /data/abc/bin
```

▼ How to Display Packed Files Information

● Display packed files information.

```
$ cachefspack -i[v] cached-filename-or-directory
```

- `-i` Specifies that you want to view information about your packed files.

- `-v` Is the verbose option.

- `cached-filename-or-directory` Specifies the name of the file or directory for which to display information.

Example 18–9 Displaying Packed Files Information

The following example shows that the `doc_file` file has been successfully packed.

```
$ cachefspack -i doc_file
cachefspack: file doc_file marked packed YES, packed YES
```

In the following example, the `/data/abc` directory contains the `bin` subdirectory. The `bin` subdirectory has three files: `big`, `medium`, and `small`. Although the `big` and `small` files are specified to be packed, they are not. The `medium` file is successfully packed.

```
$ cd /data/abc
$ cachefspack -i bin
```

```

.
.
.
cachefspack: file /bin/big marked packed YES, packed NO
cachefspack: file /bin/medium marked packed YES,
packed YES
cachefspack: file /bin/small marked packed YES,
packed NO
.
.
.

```

If you use the `-iv` options together, you get additional information as to whether the file or directory specified has been flushed from the cache. For example:

```

$ cd /data/bin
FSCACHEPACK-4$ cachefspack -iv bin
.
.
.
cachefspack: file /bin/big marked packed YES, packed NO,
nocache YES
cachefspack: file /bin/medium marked packed YES,
packed YES, nocache NO
cachefspack: file /bin/small marked packed YES,
packed NO
nocache NO
.
.
.

```

The last line of this example shows that the directory contents have not been flushed from the cache.

Using Packing Lists

One feature of the `cachefspack` command is the ability to create packing lists.

A *packing list* contains files or directories to be packed in the cache. If a directory is in the packing list, all of its subdirectories and files will also be packed.

This feature saves the time of having to specify each individual file that you want packed in the cache.

▼ How to Create a Packing List

● Create a packing list file by using vi.

The packing list file format uses the same format as the `filesync` command. For more information, see [filesync\(1\)](#).

Two packing list features are the following:

- You can identify files in the packing list as regular expressions rather than literal file names so that you don't have to specify each individual file name.
- You can pack files from a shared directory by ensuring that you pack only those files that you own.

For more information on using these features, see [cachefspack\(1M\)](#).

Example 18–10 Creating a Packing List

The following example shows the contents of a packing list file.

```
BASE /home/ignatz
LIST plans
LIST docs
IGNORE *.ps
```

- The path identified with the `BASE` statement is the directory where you have items you want to pack.
- The two `LIST` statements identify specific files within that directory to pack.
- The `IGNORE` statement identifies the file type of `.ps`, which you do not want to pack.

▼ How to Pack Files in the Cache With a Packing List

● Pack files in the packing list.

```
$ cachefspack -f packing-list
```

`-f` Specifies that you want to use a packing list.

`packing-list` Specifies the name of the packing list.

Example 18–11 Packing Files in the Cache With a Packing List

This example uses the `list.pkg` file as the packing list for the `cachefspack` command.

```
$ cachefspack -f list.pkg
```

Unpacking Files or Packing Lists From the Cache

You might need to remove, or *unpack*, a file from the cache. Perhaps you have some files or directories that have a higher priority than others, so you need to unpack the less critical files. For example, you finished up a project and have archived the files that are associated with that project. You are now working on a new project, and therefore, a new set of files.

▼ How to Unpack Files or Packing Lists From the Cache

- **Unpack files or packing lists from the cache.**

```
$ cachefspack -u filename | -U cache-directory
```

-u Specifies that you want the file or files unpacked. You must specify a file name with this option.

filename Specifies the name of the file or packing list that you want unpacked in the cache.

-U Specifies that you want to unpack all files in the cache.

For more information, see [cachefspack\(1M\)](#).

Example 18–12 Unpacking Files or Packing Lists From the Cache

The following example shows the file `/data/abc/bin/big` being unpacked from the cache.

```
$ cachefspack -u /data/abc/bin/big
```

The following example shows three files being unpacked from the cache.

```
$ cd /data/abc/bin/big
$ cachefspack -u big small medium
```

The following example shows how to unpack a packing list. A packing list is a file that contains the path to a directory of files:

```
$ cachefspack -uf list.pkg
```

The following example uses the `-U` option to specify that all files in a cache directory being unpacked.

```
$ cachefspack -U /local/mycache
```

You cannot unpack a cache that does not have at least one file system mounted. With the `-U` option, if you specify a cache that does not contain mounted file systems, output similar to the following is displayed:

```
$ cachefspack -U /local/mycache
cachefspack: Could not unpack cache /local/mycache, no mounted
filesystems in the cache.
```

Troubleshooting cachefspack Errors

You might see the following error messages when you use the `cachefspack` command.

```
cachefspack: pathname - can't open directory: permission denied
```

Cause

You might not have the correct permissions to access the file or directory.

Action

Set the correct permissions.

```
cachefspack: pathname - can't open directory: no such file or
directory
```

Cause

You might not have specified the correct file or directory.

Action

Check for a possible typo.

```
cachefspack: pathname - can't open directory: stale NFS file handle
```

Cause

The file or directory might have been moved or deleted from the server at the time you attempted to access it.

Action

Verify that the file or directory on the server is still accessible.

```
cachefspack: pathname - can't open directory: interrupted system
call
```

Cause

You might have inadvertently pressed Control-C while issuing the command.

Action

Reissue the command.

```
cachefspack: pathname - can't open directory: I/O error
```

Cause

You might have a hardware problem.

Action

Check your hardware connections.

cachefspack: error opening dir

Cause

You might not have specified the correct file or directory. The path identified after the BASE command in the file format could be a file and not a directory. The path specified must be a directory.

Action

Check for a possible typo. Check the path identified after the BASE command in your file format. Ensure that the path identifies a directory, not a file.

cachefspack: unable to get shared objects

Cause

The executable might be corrupt or in a format that is not recognizable.

Action

Replace the executable.

cachefspack: *filename* - can't pack file: permission denied

Cause

You might not have the correct permissions to access the file or directory.

Action

Set the correct permissions.

cachefspack: *filename* - can't pack file: no such file or directory

Cause

You might not have specified the correct file or directory.

Action

Check for a possible typo.

cachefspack: *filename*- can't pack file: stale NFS file handle

Cause

The file or directory might have been moved or deleted from the server at the time you attempted to access it.

Action

Verify that the file or directory on the server is still accessible.

cachefspack: *filename*- can't pack file: interrupted system call

Cause

You might have inadvertently pressed Control-C while issuing the command.

Action

Reissue the command.

cachefspack: *filename*- can't pack file: I/O error

Cause

You might have a hardware problem.

Action

Check your hardware connections.

cachefspack: *filename*- can't pack file: no space left on device.

Cause

The cache is out of disk space.

Action

You need to increase the size of the cache by increasing disk space.

cachefspack: *filename* - can't unpack file: permission denied

Cause

You might not have the correct permissions to access the file or directory.

Action

Set the correct permissions.

cachefspack: *filename* - can't unpack file: no such file or directory

Cause

You might not have specified the correct file or directory.

Action

Check for a possible typo.

cachefspack: *filename*- can't unpack file: stale NFS file handle

Cause

The file or directory might have been moved or deleted from the server at the time you attempted to access it.

Action

Verify that the file or directory on the server is still accessible.

cachefspack: *filename*- can't unpack file: interrupted system call

Cause

You might have inadvertently pressed Control-C while issuing the command.

Action

Reissue the command.

cachefspack: *filename*- can't unpack file I/O error

Cause

You might have a hardware problem.

Action

Check your hardware connections.

cachefspack: only one 'd', 'i', 'p', or 'u' option allowed

Cause

You specified more than one of these options in a command session.

Action

Select one option for the command session.

cachefspack: can't find environment variable.

Cause

You forgot to set a corresponding environment variable to match the \$ in your configuration file.

Action

Define the environment variable in the proper location.

cachefspack: skipping LIST command - no active base

Cause

A LIST command is present in your configuration file but has no corresponding BASE command.

Action

Define the BASE command.

Collecting CacheFS Statistics (Task Map)

The following task map shows the steps involved in collecting CacheFS statistics. All these procedures are optional.

Task	Description	For Instructions
Set up logging.	Set up logging on a CacheFS file system by using the <code>cachefs log</code> command.	“How to Set Up CacheFS Logging” on page 373
Locate the log file.	Locate the log file by using the <code>cachefs log</code> command.	“How to Locate the CacheFS Log File” on page 373
Stop logging.	Stop logging by using the <code>cachefs log</code> command.	“How to Stop CacheFS Logging” on page 374
View the cache size.	View the cache size by using the <code>cachefswssize</code> command.	“How to View the Working Set (Cache) Size” on page 374

Task	Description	For Instructions
View the cache statistics.	View the statistics by using the <code>cachefsstat</code> command.	“How to View CacheFS Statistics” on page 376

Collecting CacheFS Statistics

Collecting CacheFS statistics enables you to do the following:

- Determine an appropriate cache size.
- Observe the performance of the cache.

These statistics help you determine the trade-off between your cache size and the desired performance of the cache.

The following table describes the CacheFS statistics commands.

Command	Description	Man Page
<code>cachefslog</code>	Specifies the location of the log file. This command also displays where the statistics are currently being logged, and enables you to stop logging.	cachefslog(1M)
<code>cachefswssize</code>	Interprets the log file to give a recommended cache size.	cachefswssize(1M)
<code>cachefsstat</code>	Displays statistical information about a specific CacheFS file system or all CacheFS file systems. The information provided in the command output is taken directly from the cache.	cachefsstat(1M)

Note – You can use the CacheFS statistics commands from any directory. You must be superuser to use the `cachefswssize` command.

The CacheFS statistics begin accumulating when you create the log file. When the work session is over, stop the logging by using the `cachefslog -h` command, as described in [“How to Stop CacheFS Logging” on page 374](#).

Before using the CacheFS statistics commands, you must do the following:

- Set up your cache by using the `cfsadmin` command.

- Decide on an appropriate length of time to allow statistical information to collect in the log file you create. The length of time should equal a typical work session. For example, a day, a week, or a month.
- Select a location or path for the log file. Ensure that sufficient space to allows for the growth of the log file. The longer you intend to allow statistical information to collect in the log file, the more space you need.

Note – The following procedures are presented in a recommended order. This order is not required.

▼ How to Set Up CacheFS Logging

1 Set up logging.

```
$ cachefslog -f log-file-path /mount-point
```

-f Sets up logging.

log-file-path Specifies the location of the log file. The log file is a standard file you create with an editor, such as vi.

/mount-point Designates the mount point (CacheFS file system) for which statistics are being collected.

2 Verify that you correctly set up the log file.

```
$ cachefslog /mount-point
```

Example 18–13 Setting Up CacheFS Logging

The following example shows how to set up the `/var/tmp/samlog` log file to collect statistics about the `/home/sam` directory.

```
$ cachefslog -f /var/tmp/samlog /home/sam
/var/tmp/samlog: /home/sam
```

▼ How to Locate the CacheFS Log File

● Display where CacheFS statistics are being logged.

```
$ cachefslog /mount-point
```

where */mount-point* specifies the CacheFS file system for which you want to view the statistics.

You can also use the `cachefslog` command with no options to locate a log file for a particular mount point.

Example 18–14 Locating the CacheFS Log File

The following example shows what you would see if a log file has been set up. The location of the log file is `/var/tmp/stufflog`.

```
$ cachefslog /home/stuff
/var/tmp/stufflog: /home/stuff
```

The following example shows that no log file has been set up for the specified file system.

```
$ cachefslog /home/zap
not logged: /home/zap
```

How to Stop CacheFS Logging

Use the `cachefslog -h` option to stop logging.

```
$ cachefslog -h /mount-point
```

The following example shows how to stop logging on `/home/stuff`.

```
$ cachefslog -h /home/stuff
not logged: /home/stuff
```

If you get a system response other than the response specified here, you did not successfully stop logging. Determine if you are using the correct log file name and mount point.

▼ How to View the Working Set (Cache) Size

You might want to check if you need to increase the size of the cache. Or, you might want to determine the ideal cache size based on your activity since you last used the `cachefslog` command for a particular mount point.

- 1 **Become superuser on the client system.**
- 2 **View the current cache size and highest logged cache size.**

```
# cachefswsize log-file-path
```

For more information, see `cachefswsize(1M)`.

Example 18–15 Viewing the Working Set (Cache) Size

In the following example, the end size is the size of the cache at the time you issued the `cachefswsize` command. The high water size is the largest size of the cache during the timeframe in which logging occurred.

```
# cachefswsize /var/tmp/samlog

/home/sam
    end size: 10688k
    high water size: 10704k

/
    end size: 1736k
    high water size: 1736k

/opt
    end size: 128k
    high water size: 128k

/nfs/saturn.dist
    end size: 1472k
    high water size: 1472k

/data/abc
    end size: 7168k
    high water size: 7168k

/nfs/venus.svr4
    end size: 4688k
    high water size: 5000k

/data
    end size: 4992k
    high water size: 4992k

total for cache
    initial size: 110960k
    end size: 30872k
    high water size: 30872k
```

Viewing CacheFS Statistics

The following table explains the terminology that is displayed in the statistics output for CacheFS file systems.

TABLE 18–2 CacheFS Statistics Terminology

Output Term	Description
cache hit rate	The rate of cache hits compared to cache misses, followed by the actual number of hits and misses. A <i>cache hit</i> occurs when the user wants to perform an operation on a file or files, and the file or files are actually in the cache. A <i>cache miss</i> occurs when the file is not in the cache. The load on the server is the sum of cache misses, consistency checks, and modifications (modifies).
consistency checks	The number of consistency checks performed, followed by the number that passed, and the number that failed.
modifies	The number of modify operations. For example, writes or creates.

▼ How to View CacheFS Statistics

View the statistics with the `cachefsstat` command. You can view the statistics at any time. For example, you do not have to set up logging in order to view the statistics.

- **View CacheFS statistics.**

```
$ cachefsstat /mount-point
```

where */mount-point* specifies the CacheFS file system for which you want to view the statistics.

If you do not specify the mount point, statistics for all mounted CacheFS file systems will be displayed.

Example 18–16 Viewing CacheFS Statistics

This example shows how to view statistics on the cached file system, `/home/sam`.

```
$ cachefsstat /home/sam
  cache hit rate: 73% (1234 hits, 450 misses)
  consistency checks: 700 (650 pass, 50 fail)
  modifies: 321
garbage collection: 0
```

Configuring Additional Swap Space (Tasks)

This chapter provides guidelines and step-by-step instructions for configuring additional swap space for both UFS root file system and ZFS root file system environments after the Oracle Solaris OS is installed.

This is a list of the step-by-step instructions in this chapter.

- [“How to Create a Swap File and Make It Available in UFS Root Environment” on page 386](#)
- [“How to Add Swap Space in an Oracle Solaris ZFS Root Environment” on page 388](#)
- [“How to Remove Unneeded Swap Space in UFS Root Environment” on page 389](#)
- [“How to Remove a Swap Volume in a ZFS Root Environment” on page 389](#)

This is a list of the overview information in this chapter.

- [“About Swap Space” on page 377](#)
- [“How Do I Know If I Need More Swap Space?” on page 380](#)
- [“How Swap Space Is Allocated” on page 381](#)
- [“Planning for Swap Space” on page 382](#)
- [“Monitoring Swap Resources” on page 384](#)
- [“Adding More Swap Space” on page 385](#)

About Swap Space

You should understand the features of the SunOS swap mechanism to determine the following:

- Swap space requirements
- The relationship between swap space and the TMPFS file system
- How to recover from error messages related to swap space

Swap Space and Virtual Memory

Oracle Solaris OS software and application software can use some disk space for temporary storage rather than for file systems. The reserved area of the disk is called *swap* space. Swap space is used as virtual memory storage areas when the system does not have enough physical memory to handle current processes. In a UFS root file system, the disk space reserved for swap is a disk slice. In a ZFS root file system, the disk space reserved for swap is a ZFS volume.

The virtual memory system maps physical copies of files on disk to virtual addresses in memory. Physical memory pages that contain the data for these mappings can be backed by regular files in the file system, or by swap space. If the memory is backed by swap space it is referred to as *anonymous memory* because no identity is assigned to the disk space that is backing the memory.

The Oracle Solaris OS uses the concept of *virtual swap space*, a layer between anonymous memory pages and the physical storage (or disk-backed swap space) that actually back these pages. A system's virtual swap space is equal to the sum of all its physical (disk-backed) swap space plus a portion of the currently available physical memory.

Virtual swap space has these advantages:

- The need for large amounts of physical swap space is reduced because virtual swap space does not necessarily correspond to physical (disk) storage.
- A pseudo file system called SWAPFS provides addresses for anonymous memory pages. Because SWAPFS controls the allocation of memory pages, it has greater flexibility in deciding what happens to a page. For example, SWAPFS might change the page's requirements for disk-backed swap storage.

Swap Space and the TMPFS File System

The TMPFS file system is activated automatically in the Oracle Solaris environment by an entry in the `/etc/vfstab` file. The TMPFS file system stores files and their associated information in memory (in the `/tmp` directory) rather than on disk, which speeds access to those files. This feature results in a major performance enhancement for applications such as compilers and DBMS products that use `/tmp` heavily.

The TMPFS file system allocates space in the `/tmp` directory from the system's swap resources. This feature means that as you use up space in the `/tmp` directory, you are also using up swap space. So, if your applications use the `/tmp` directory heavily and you do not monitor swap space usage, your system could run out of swap space.

Do use the following if you want to use TMPFS, but your swap resources are limited:

- Mount the TMPFS file system with the `size` option (`-o size`) to control how much swap resources TMPFS can use.

- Use your compiler's TMPDIR environment variable to point to another larger directory.
Using your compiler's TMPDIR variable only controls whether the compiler is using the /tmp directory. This variable has no effect on other programs' use of the /tmp directory.

Swap Space as a Dump Device

A *dump device* is usually disk space that is reserved to store system crash dump information. By default, a system's dump device is configured to be a swap slice in a UFS root environment. If possible, you should configure an alternate disk partition as a *dedicated dump device* instead to provide increased reliability for crash dumps and faster reboot time after a system failure. You can configure a dedicated dump device by using the `dumpadm` command. For more information, see [Chapter 17, “Managing System Crash Information \(Tasks\),” in *System Administration Guide: Advanced Administration*](#).

In a ZFS root environment, swap and dump are configured as separate ZFS volumes. The advantages to this model are as follows:

- You don't have to partition a disk to include swap and dump areas.
- Swap and dump devices benefit from the underlying ZFS I/O pipeline architecture.
- You can set characteristics, such as compression, on swap and dump devices.
- You can reset swap and dump device sizes. For example:

```
# zfs set volsize=2G rpool/dump
# zfs get volsize rpool/dump
NAME          PROPERTY  VALUE      SOURCE
rpool/dump    volsize   2G         -
```

Keep in mind that reallocating a large dump device is a time-consuming process.

- On an active system, you might consider adding a second swap volume to increase overall swap size.

For more information about using ZFS swap and dump devices, see “[ZFS Support for Swap and Dump Devices](#)” in [Oracle Solaris ZFS Administration Guide](#).

If you are using a volume manager to manage your disks in a UFS environment, such as Solaris Volume Manager, do not configure your dedicated dump device to be under its control. You can keep your swap areas under Solaris Volume Manager's control, which is a recommended practice. However, for accessibility and performance reasons, configure another disk as a dedicated dump device outside of Solaris Volume Manager's control.

Swap Space and Dynamic Reconfiguration

A good practice is to allocate enough swap space to support a failing CPU or system board during dynamic reconfiguration. Otherwise, a CPU or system board failure might result in your host or domain rebooting with less memory.

Without having this additional swap space available, one or more of your applications might fail to start due to insufficient memory. This problem would require manual intervention either to add additional swap space or to reconfigure the memory usage of these applications.

If you have allocated additional swap space to handle a potential loss of memory on reboot, all of your intensive applications might start as usual. This means the system will be available to the users, perhaps possibly slower due to some additional swapping.

For more information, see your hardware dynamic reconfiguration guide.

Configuring Swap Space in a SAN Environment

Review the following points to determine whether you might configure swap space on a network-connected disk, such as in a SAN environment:

- Diagnosing swap space issues on a locally-attached disk is easier than diagnosing swap space issues on a network-connected disk.
- The performance of swap space over a SAN should be comparable to swap space configured on a locally-attached disk.
- Adding more memory to a system with performance issues, after analyzing performance data, might resolve a swap over SAN performance problem better than moving the swap to a locally-attached disk.

How Do I Know If I Need More Swap Space?

Use the `swap -l` command to determine if your system needs more swap space.

For example, the following `swap -l` output shows that this system's swap space is almost entirely consumed or at 100% allocation.

```
% swap -l
swapfile      dev      swaplo blocks   free
/dev/dsk/c0t0d0s1  136,1      16 1638608    88
```

When a system's swap space is at 100% allocation, an application's memory pages become temporarily locked. Application errors might not occur, but system performance will likely suffer.

For information on adding more swap space to your system, see [“How to Create a Swap File and Make It Available in UFS Root Environment”](#) on page 386.

Swap-Related Error Messages

These messages indicate that an application was trying to get more anonymous memory. However, no swap space was left to back it.

application is out of memory

malloc error 0

```
messages.1:Sep 21 20:52:11 mars genunix: [ID 470503 kern.warning]
WARNING: Sorry, no swap space to grow stack for pid 100295 (myprog)
```

TMPFS-Related Error Messages

The following message is displayed if a page could not be allocated when a file was being written. This problem can occur when TMPFS tries to write more than it is allowed or if currently executed programs are using a lot of memory.

directory: File system full, swap space limit exceeded

The following message means that TMPFS ran out of physical memory while attempting to create a new file or directory:

directory: File system full, memory allocation failed

For information on recovering from the TMPFS-related error messages, see [tmpfs\(7FS\)](#).

How Swap Space Is Allocated

Initially, swap space is allocated as part of the Oracle Solaris installation process. If you use the installation program's automatic layout of disk space for swap and do not manually change the size of the swap slice, the Oracle Solaris installation program allocates a default swap area.

For general guidelines on allocating swap space, see [“Planning for Swap Space” on page 382](#).

You can allocate additional swap space to the system by creating a swap file in a UFS root environment. Swap files are not supported in a ZFS root environment. For information about creating a swap file, see [“Adding More Swap Space” on page 385](#).

Swap Areas and the /etc/vfstab File

After the system is installed, swap areas and swap files are listed in the `/etc/vfstab` file. They are activated by the `/sbin/swapadd` script when the system is booted.

An entry for a swap device in the `/etc/vfstab` file contains the following:

- The full path name of the swap slice or swap file on system with a UFS root file system or a swap volume path name on a system with a ZFS root file system
- File system type of the swap slice or swap file

The file system that contains a swap file must be mounted before the swap file is activated. So, in the `/etc/vfstab` file, ensure that the entry that mounts the file system comes before the entry that activates the swap file.

Planning for Swap Space

The most important factors in determining swap space size are the requirements of the system's software applications. For example, large applications such as computer-aided design simulators, database management products, transaction monitors, and geologic analysis systems can consume as much as 200–1000 MB of swap space.

Consult your application vendors for swap space requirements for their applications.

If you are unable to determine swap space requirements from your application vendors, use the following general guidelines based on your system type to allocate swap space.

Note – Crash dump content is compressed so the dump device does not have to be the same size as physical memory. By default, the dump content value is set to kernel pages. However, if the dump content value is set to dump all memory pages, then consider increasing the dump size to half the size of physical memory or more.

TABLE 19-1 Swap and Dump Volume Sizes for ZFS File Systems

System Type	Swap Volume Size	Dump Volume Size
System with about 4 GB of physical memory	1 GB	2 GB
Mid-range server with about 8 GB of physical memory	2 GB	4 GB
High-end server with about 16 to 128 GB of physical memory	4 GB	8-64 GB
High-end server with more than 128 GB of physical memory	1/4 of physical memory size	1/2 of physical memory size

Note – A busy system with many active ZFS file systems might use 1/2 to 3/4 the size of physical memory for the size of the dump device.

On a system with a ZFS root file system, if you attempt to designate a dump device that is too small to hold a system crash system with the `dumpadm -d` command, you will see a message similar to the following:

```
dumpadm: dump device /dev/zvol/dsk/rpool/dump is too small to hold a
system dump dump size 43467329536 bytes, device size 42949672960 bytes
```

TABLE 19–2 Swap and Dump Device Sizes for UFS File Systems

System Type	Swap Device Size	Dedicated Dump Device Size
System with about 4 GB of physical memory	1 GB	1 GB
Mid-range server with about 8 GB of physical memory	2 GB	2 GB
High-end server with about 16 to 128 GB of physical memory	4 GB	4 GB
High-end server with more than 128 GB of physical memory	1/4 of physical memory size	1/4 of physical memory size

Allocating Swap Space for UFS-Based Systems

In addition to preceding general guidelines, consider allocating swap space or disk space for a UFS-based system for the following:

- A dedicated dump device.
- The `/var/crash` directory. The default system crash dump content is kernel memory pages only and the dump is compressed before it is written. Consider sizing this directory to the size of the dump device unless you attend to keep several system crash dumps.
- Determine whether large applications (such as compilers) will be using the `/tmp` directory. Then, allocate additional swap space to be used by TMPFS. For information about TMPFS, see [“Swap Space and the TMPFS File System” on page 378](#).

Allocating Swap Space for ZFS-Based Systems

During an initial installation of a ZFS root file system or an Oracle Solaris Live Upgrade migration of a UFS file system to a ZFS root file system, a swap area is automatically created on a ZFS volume in the ZFS root pool. In the case of a UFS to ZFS migration by using Oracle Solaris Live Upgrade, a swap volume is created based on the sizes of existing swap areas.

In a ZFS root pool, swap devices are not pre-allocated to fixed-size slices, so it is fairly easy to modify the swap size later.

After you assess the swap requirements of your applications, you can use the default swap size or adjust the swap volume size during an initial installation or after the installation, if necessary.

During an initial installation, the default dump volume size is calculated by the kernel based on `dumpadm` information and the size of physical memory.

In a ZFS environment, file systems consume space from the pool so the `/var/crash` directory consumes what it needs depending on how many crash dumps are saved.

Monitoring Swap Resources

The `/usr/sbin/swap` command is used to manage swap areas. Two options, `-l` and `-s`, display information about swap resources.

Use the `swap -l` command to identify a system's swap areas. Activated swap devices or files are listed under the `swapfile` column. For example:

```
# swap -l
swapfile          dev swaplo blocks  free
/dev/dsk/c0t0d0s1 136,1      16 1638608 1600528
```

On a system with a ZFS root file system, the `swap -l` command identifies similar output except that it identifies the ZFS volume path name. For example:

```
# swap -l
swapfile          dev swaplo blocks  free
/dev/zvol/dsk/rpool/swap 256,1      16 1058800 1058800
```

Use the `swap -s` command to monitor swap resources.

```
# swap -s
total: 57416k bytes allocated + 10480k reserved = 67896k used,
833128k available
```

The `used` value plus the `available` value equals the total swap space on the system, which includes a portion of physical memory and swap devices (or files).

You can use the amount of available and used swap space (in the `swap -s` output) as a way to monitor swap space usage over time. If a system's performance is good, use `swap -s` to determine how much swap space is available. When the performance of a system slows down, check the amount of available swap space to determine if it has decreased. Then you can identify what changes to the system might have caused swap space usage to increase.

When using this command, keep in mind that the amount of physical memory available for swap usage changes dynamically as the kernel and user processes lock down and release physical memory.

Note – The `swap -l` command displays swap space in 512-byte blocks. The `swap -s` command displays swap space in 1024-byte blocks. If you add up the blocks from `swap -l` and convert them to KB, the result is less than `used + available` (in the `swap -s` output). The reason is that `swap -l` does not include physical memory in its calculation of swap space.

The output from the `swap -s` command is summarized in the following table.

TABLE 19-3 Output of the `swap -s` Command

Keyword	Description
bytes allocated	The total amount of swap space in 1024-byte blocks that is currently allocated as backing store (disk-backed swap space).
reserved	The total amount of swap space in 1024-byte blocks that is not currently allocated, but claimed by memory for possible future use.
used	The total amount of swap space in 1024-byte blocks that is either allocated or reserved.
available	The total amount of swap space in 1024-byte blocks that is currently available for future reservation and allocation.

Adding More Swap Space

As system configurations change and new software packages are installed, you might need to add more swap space. The easiest way to add more swap space is to use the `mkfile` and `swap` commands to designate a part of an existing UFS or NFS file system as a supplementary swap area. These commands, described in the following sections, enable you to add more swap space without repartitioning a disk.

Alternative ways to add more swap space are to repartition an existing disk or to add another disk. For information on how to repartition a disk, see [Chapter 10, “Managing Disks \(Overview\)”](#).

Creating a Swap File in a UFS Root Environment

You can create a swap file to be used in a UFS root file system. Swap files are currently not supported in a ZFS root environment. The following general steps are involved in creating a swap file:

- Creating a swap file by using the `mkfile` command.
- Activating the swap file by using the `swap` command.

- Adding an entry for the swap file in the `/etc/vfstab` file so that the swap file is activated automatically when the system is booted.

mkfile Command

The `mkfile` command creates a file that is suitable for use as either an NFS-mounted swap area or a local swap area. The sticky bit is set, and the file is filled with zeros. You can specify the size of the swap file in bytes (the default) or in KB, blocks, or MB by using the `k`, `b`, or `m` suffixes, respectively.

The following table shows the `mkfile` command options.

TABLE 19-4 Options to the `mkfile` Command

Option	Description
<code>-n</code>	Creates an empty file. The size is noted. However, the disk blocks are not allocated until data is written to them.
<code>-v</code>	Reports the names and sizes of created files.

Note – Use the `-n` option only when you create an NFS swap file.

▼ How to Create a Swap File and Make It Available in UFS Root Environment

1 Become superuser or assume an equivalent role.

You can create a swap file without root permissions. However, to avoid accidental overwriting, root should be the owner of the swap file.

2 Create a directory for the swap file, if needed.

3 Create the swap file.

```
# mkfile nnn[k|b|m] filename
```

The swap file of the size *nnn* (in KB, bytes, or MB) with the *filename* you specify is created.

4 Activate the swap file.

```
# /usr/sbin/swap -a /path/filename
```

You must use the absolute path name to specify the swap file. The swap file is added and available until the file system is unmounted, the system is rebooted, or the swap file is removed. Keep in mind that you cannot unmount a file system while some process or program is swapping to the swap file.

- 5 **Add an entry for the swap file to the `/etc/vfstab` file that specifies the full path name of the file, and designates swap as the file system type.**

```
/path/filename - - swap - no -
```

- 6 **Verify that the swap file is added.**

```
$ /usr/sbin/swap -l
```

Note – If a swap file does not get activated, make sure that the following service is running:

```
# svcs nfs/client
STATE          STIME      FMRI
enabled        14:14:34  svc:/network/nfs/client:default
```

Example 19–1 Creating a Swap File and Making It Available in a UFS Root Environment

The following examples shows how to create a 100-MB swap file called `/files/swapfile`.

```
# mkdir /files
# mkfile 100m /files/swapfile
# swap -a /files/swapfile
# vi /etc/vfstab
(An entry is added for the swap file):
/files/swapfile - - swap - no -
# swap -l
swapfile          dev  swaplo  blocks  free
/dev/dsk/c0t0d0s1 136,1    16 1638608 1600528
/files/swapfile   -        16 204784  204784
```

Adding or Changing Swap Space in an Oracle Solaris ZFS Root Environment

The following section describes how to add or change swap space in a ZFS root environment. See the previous sections to determine if your system or applications need additional swap space.

▼ How to Add Swap Space in an Oracle Solaris ZFS Root Environment

1 Become superuser or assume an equivalent role.

2 Identify the current swap volume.

A swap volume cannot be removed if it is in use. You can tell if the current swap volume is in use by comparing the blocks identified in the blocks column and blocks identified in the free column. If the blocks in the two columns are equal, the swap area is not busy. For example:

```
# swap -l
swapfile                dev swaplo  blocks  free
/dev/zvol/dsk/rpool/swap 256,1      16 1058800 1058800
```

3 Select one of the following to resize the swap volume.

a. If the current swap area is not in use, you can resize the size of the current swap volume.

For example:

```
# zfs get volsize rpool/swap
NAME      PROPERTY  VALUE  SOURCE
rpool/swap volsize   517M   -
# zfs set volsize=2g rpool/swap
# zfs get volsize rpool/swap
NAME      PROPERTY  VALUE  SOURCE
rpool/swap volsize   2G     -
```

b. If the current swap area is in use, you can add another swap volume.

For example:

```
# zfs create -V 2G rpool/swap2
```

c. Activate the second swap volume.

For example:

```
# swap -a /dev/zvol/dsk/rpool/swap2
# swap -l
swapfile                dev swaplo  blocks  free
/dev/zvol/dsk/rpool/swap 256,1      16 1058800 1058800
/dev/zvol/dsk/rpool/swap2 256,3      16 4194288 4194288
```

Removing a Swap File From Use

If you have unneeded swap space, you can remove it.

▼ How to Remove Unneeded Swap Space in UFS Root Environment

- 1 Become superuser.
- 2 Remove the swap space in a UFS root environment.

```
# /usr/sbin/swap -d /path/filename
```

The swap file name is removed so that it is no longer available for swapping. The file itself is not deleted.

- 3 Edit the `/etc/vfstab` file and delete the entry for the swap file.
- 4 Recover the disk space so that you can use it for something else.

```
# rm /path/filename
```

If the swap space is a file, remove it. Or, if the swap space is on a separate slice and you are sure you will not need it again, make a new file system and mount the file system.

For information on mounting a file system, see [“Mounting and Unmounting Oracle Solaris File Systems” on page 329](#).

- 5 Verify that the swap file is no longer available.

```
# swap -l
```

Example 19-2 Removing Unneeded Swap Space

The following examples shows how to delete the `/files/swapfile` swap file.

```
# swap -d /files/swapfile
# (Remove the swap entry from the /etc/vfstab file)
# rm /files/swapfile
# swap -l
swapfile          dev swaplo  blocks  free
/dev/dsk/c0t0d0s1 136,1      16 1638608 1600528
```

▼ How to Remove a Swap Volume in a ZFS Root Environment

Most systems require some amount of swap space configured. If your system's swap space requirements change, then you might need to remove a swap volume before you can increase or decrease space allocated for swap. On a busy system, it might be easier to create a second swap volume if you need to increase swap space rather than trying to remove a swap volume that is busy just to increase its size.

1 Become superuser.

2 If the swap volume is in use, then you might not be able to delete it. Check to see if the swap area is in use.

```
# swap -l
swapfile          dev      swaplo  blocks    free
/dev/zvol/dsk/rpool/swap 102,2      16 16646128 16646128
```

In the above output, blocks == free, so the swap device is not actually being used.

3 If the swap area is not in use, remove the swap area.

```
# swap -d /dev/zvol/dsk/rpool/swap
```

4 Edit the /etc/vfstab file and delete the entry for the swap volume.

5 Verify that the swap volume is no longer available.

```
# swap -l
```

Checking UFS File System Consistency (Tasks)

This chapter provides overview information and step-by-step instructions about checking UFS file system consistency.

This is a list of step-by-step instructions in this chapter.

- “How to Check the UFS root (/), /usr, or /var File Systems From an Alternate Boot Device” on page 400
- “How to Check Other UFS File Systems (Not root (/), /usr, or /var)” on page 402
- “How to Preen a UFS File System” on page 404
- “How to Restore a Bad Superblock (Solaris 8, 9, and 10 Releases)” on page 409
- “How to Restore a Bad UFS Superblock (Solaris 10 6/06 Release)” on page 406

This is a list of the overview information in this chapter.

- “UFS File System Consistency” on page 392
- “How the UFS File System State Is Recorded” on page 392
- “What the fsck Command Checks and Tries to Repair” on page 393
- “Interactively Checking and Repairing a UFS File System” on page 399
- “Restoring a Bad UFS Superblock” on page 406
- “Syntax and Options for the fsck Command” on page 411

For new information about fsck in the Solaris 10 6/06 release, see “Enhancements to UFS File System Utilities (fsck, mkfs, and newfs)” on page 296.

For information about fsck error messages, see Chapter 20, “Resolving UFS File System Inconsistencies (Tasks),” in *System Administration Guide: Advanced Administration*.

For background information on the UFS file system structures referred to in this chapter, see Chapter 21, “UFS File System (Reference).”

UFS File System Consistency

The UFS file system relies on an internal set of tables to keep track of inodes used and available blocks. When these internal tables are not properly synchronized with data on a disk, inconsistencies result and file systems need to be repaired.

File systems can be inconsistent because of abrupt termination of the operating system from the following:

- Power failure
- Accidental unplugging of the system
- Turning off the system without proper shutdown procedure
- A software error in the kernel

File system inconsistencies, while serious, are not common. When a system is booted, a check for file system consistency is automatically performed (with the `fsck` command). Often, this file system check repairs problems it encounters.

The `fsck` command places files and directories that are allocated but unreferenced in the `lost+found` directory. An inode number is assigned as the name of unreferenced file and directory. If the `lost+found` directory does not exist, the `fsck` command creates it. If there is not enough space in the `lost+found` directory, the `fsck` command increases its size.

For a description of inodes, see [“Inodes” on page 414](#).

How the UFS File System State Is Recorded

The `fsck` command uses a state flag, which is stored in the superblock, to record the condition of the file system. This flag is used by the `fsck` command to determine whether a file system needs to be checked for consistency. The flag is used by the `/sbin/rcS` script during booting and by the `fsck -m` command. If you ignore the result from the `fsck -m` command, all file systems can be checked regardless of the setting of the state flag.

For a description of the superblock, see [“Superblock” on page 414](#).

The possible state flag values are described in the following table.

TABLE 20-1 Values of UFS File System State Flags

State Flag Value	Description
FSACTIVE	Indicates a mounted file system that has modified data in memory. A mounted file system with this state flag indicates that user data or metadata would be lost if power to the system is interrupted.
FSBAD	Indicates that the file system contains inconsistent file system data.

TABLE 20-1 Values of UFS File System State Flags (Continued)

State Flag Value	Description
FSCLEAN	Indicates an undamaged, cleanly unmounted file system.
FSLOG	Indicates that the file system has logging enabled. A file system with this flag set is either mounted or unmounted. If a file system has logging enabled, the only flags that it can have are FSLOG or FSBAD. A file system that has logging disable can have FACTIVE, FSSTABLE, or FSCLEAN.
FSSTABLE	Indicates an idle mounted file system. A mounted file system with this state flag indicates that neither user data nor metadata would be lost if power to the system is interrupted.

What the `fsck` Command Checks and Tries to Repair

This section describes what happens in the normal operation of a file system, what can go wrong, what problems the `fsck` command (the checking and repair utility) looks for, and how this command corrects the inconsistencies it finds.

Why UFS File System Inconsistencies Might Occur

Every working day, hundreds of files might be created, modified, and removed. Each time a file is modified, the operating system performs a series of file system updates. These updates, when written to the disk reliably, yield a consistent file system.

When a user program does an operation to change the file system, such as a write, the data to be written is first copied into an in-core buffer in the kernel. Normally, the disk update is handled asynchronously. The user process is allowed to proceed even though the data write might not happen until long after the write system call has returned. Thus, at any given time, the file system, as it resides on the disk, lags behind the state of the file system that is represented by the in-core information.

The disk information is updated to reflect the in-core information when the buffer is required for another use or when the kernel automatically runs the `fsflush` daemon (at 30-second intervals). If the system is halted without writing out the in-core information, the file system on the disk might be in an inconsistent state.

A file system can develop inconsistencies in several ways. The most common causes are operator error and hardware failures.

Problems might result from an *unclean shutdown*, if a system is shut down improperly, or when a mounted file system is taken offline improperly. To prevent unclean shutdowns, the current state of the file systems must be written to disk (that is, “synchronized”) before you shut down the system, physically take a disk pack out of a drive, or take a disk offline.

Inconsistencies can also result from defective hardware or problems with the disk or controller firmware. Blocks can become damaged on a disk drive at any time. Or, a disk controller can stop functioning correctly.

UFS Components That Are Checked for Consistency

This section describes the kinds of consistency checks that the fsck command applies to these UFS file system components: superblock, cylinder group blocks, inodes, indirect blocks, and data blocks.

For information about UFS file system structures, see [“Structure of Cylinder Groups for UFS File Systems” on page 413](#).

Superblock Checks

The *superblock* stores summary information, which is the most commonly corrupted component in a UFS file system. Each change to file system inodes or data blocks also modifies the superblock. If the CPU is halted and the last command is not a sync command, the superblock almost certainly becomes corrupted.

The superblock is checked for inconsistencies in the following:

- File system size
- Number of inodes
- Free block count
- Free inode count

File System Size and Inode List Size Checks

The file system size must be larger than the number of blocks used by the superblock and the list of inodes. The number of inodes must be less than the maximum number allowed for the file system. An *inode* represents all the information about a file. The file system size and layout information are the most critical pieces of information for the fsck command. There is no way to actually check these sizes because they are statically determined when the file system is created. However, the fsck command can check that the sizes are within reasonable bounds. All other file system checks require that these sizes be correct. If the fsck command detects corruption in the static parameters of the primary superblock, it requests the operator to specify the location of an alternate superblock.

For more information about the structure of the UFS file system, see [“Structure of Cylinder Groups for UFS File Systems” on page 413](#).

Free Block Checks

Free blocks are stored in the cylinder group block maps. The `fsck` command checks that all the blocks marked as free are not claimed by any files. When all the blocks have been accounted for, the `fsck` command checks if the number of free blocks plus the number of blocks that are claimed by the inodes equal the total number of blocks in the file system. If anything is wrong with the block maps, the `fsck` command rebuilds them, leaving out blocks already allocated.

The summary information in the superblock includes a count of the total number of free blocks within the file system. The `fsck` command compares this count to the number of free blocks it finds within the file system. If the counts do not agree, the `fsck` command replaces the count in the superblock with the actual free block count.

Free Inode Checks

Summary information in the superblock contains a count of the free inodes within the file system. The `fsck` command compares this count to the number of free inodes it finds within the file system. If the counts do not agree, `fsck` replaces the count in the superblock with the actual free inode count.

Inodes

The list of inodes is checked sequentially starting with inode 2. (Inode 0 and inode 1 are reserved). Each inode is checked for inconsistencies in the following:

- Format and type
- Link count
- Duplicate block
- Bad block numbers
- Inode size

Format and Type of Inodes

Each inode contains a *mode word*, which describes the type and state of the inode. Inodes might be one of nine types:

- Regular
- Directory
- Block special
- Character special
- FIFO (named pipe)
- Symbolic link
- Shadow (used for ACLs)
- Attribute directory
- Socket

Inodes might be in one of three states:

- Allocated
- Unallocated
- Partially allocated

When the file system is created, a fixed number of inodes are set aside. However, these inodes are not allocated until they are needed. An *allocated inode* is one that points to a file. An *unallocated inode* does not point to a file and, therefore, should be empty. The *partially allocated* state means that the inode is incorrectly formatted. An inode can get into this state if, for example, bad data is written into the inode list because of a hardware failure. The only corrective action the fsck command can take is to clear the inode.

Link Count Checks

Each inode contains a count of the number of directory entries linked to it. The fsck command verifies the link count of each inode by examining the entire directory structure, starting from the root (/) directory, and calculating an actual link count for each inode.

Discrepancies between the link count stored in the inode and the actual link count as determined by the fsck command might be one of three types:

- The stored count is *not* 0, and the actual count is 0.
This condition can occur if no directory entry exists for the inode. In this case, the fsck command puts the disconnected file in the `lost+found` directory.
- The stored count is *not* 0 and the actual count is *not* 0. However, the counts are *unequal*.
This condition can occur if a directory entry has been added or removed, but the inode has not been updated. In this case, the fsck command replaces the stored link count with the actual link count.
- The stored count is 0, and the actual count is not 0.
In this case, the fsck command changes the link count of the inode to the actual count.

Duplicate Block Checks

Each inode contains a list, or pointers to lists (indirect blocks), of all the blocks claimed by the inode. Because indirect blocks are owned by an inode, inconsistencies in indirect blocks directly affect the inode that owns the indirect block.

The fsck command compares each block number claimed by an inode to a list of allocated blocks. If another inode already claims a block number, the block number is put on a list of duplicate blocks. Otherwise, the list of allocated blocks is updated to include the block number.

If duplicate blocks are found, the fsck command makes a second pass of the inode list to find the other inode that claims each duplicate block. The fsck command cannot determine with certainty which inode is in error. So, the fsck command prompts you to choose which inode should be kept and which inode should be cleared. Note that a large number of duplicate blocks in an inode might be caused by an indirect block not being written to the file system.

Bad Block Number Checks

The `fsck` command checks each block number claimed by an inode to determine whether its value is higher than the value of the first data block and lower than that of the last data block in the file system. If the block number is outside this range, it is considered a bad block number.

Bad block numbers in an inode might be caused by an indirect block not being written to the file system. The `fsck` command prompts you to clear the inode.

Inode Size Checks

Each inode contains a count of the number of data blocks that it references. The number of actual data blocks is the sum of the allocated data blocks and the indirect blocks. The `fsck` command computes the number of data blocks and compares that block count against the number of blocks that the inode claims. If an inode contains an incorrect count, the `fsck` command prompts you to fix it.

Each inode contains a 64-bit size field. This field shows the number of characters (data bytes) in the file associated with the inode. A rough check of the consistency of the size field of an inode uses the number of characters shown in the size field to calculate how many blocks should be associated with the inode, and then compares that number to the actual number of blocks claimed by the inode.

Indirect Blocks

Indirect blocks are owned by an inode. Therefore, inconsistencies in an indirect block affect the inode that owns it. Inconsistencies that can be checked are the following:

- Blocks already claimed by another inode
- Block numbers outside the range of the file system

These consistency checks listed are also performed for direct blocks.

Data Blocks

An inode can directly or indirectly reference three kinds of data blocks. All referenced blocks must be of the same kind. The three types of data blocks are the following:

- Plain data blocks
- Symbolic-link data blocks
- Directory data blocks

Plain data blocks contain the information stored in a file. *Symbolic-link data blocks* contain the path name stored in a symbolic link. *Directory data blocks* contain directory entries. The `fsck` command can check only the validity of directory data blocks.

Directories are distinguished from regular files by an entry in the mode field of the inode. Data blocks associated with a directory contain the directory entries. Directory data blocks are checked for inconsistencies involving the following:

- Directory inode numbers that point to unallocated inodes
- Directory inode numbers that are greater than the number of inodes in the file system
- Incorrect directory inode numbers for “.” and “..” directories
- Directories that are disconnected from the file system

Directory Unallocated Checks

If the inode number in a directory data block points to an unallocated inode, the `fsck` command removes the directory entry. This condition can occur if the data blocks that contain a new directory entry are modified and written out, but the inode does not get written out. This condition can occur if the CPU is shut down abruptly.

Bad Inode Number Checks

If a directory entry inode number points beyond the end of the inode list, the `fsck` command removes the directory entry. This condition can occur when bad data is written into a directory data block.

Incorrect “.” and “..” Entry Checks

The directory inode number entry for “.” must be the first entry in the directory data block. The directory inode number must reference itself. That is, its value must be equal to the inode number for the directory data block.

The directory inode number entry for “..” must be the second entry in the directory data block. The directory inode number value must be equal to the inode number of the parent directory or the inode number of itself if the directory is the root (`/`) directory).

If the directory inode numbers for “.” and “..” are incorrect, the `fsck` command replaces them with the correct values. If there are multiple hard links to a directory, the first hard link found is considered the real parent to which “..” should point. In this case, the `fsck` command recommends that you have it delete the other names.

Disconnected Directories

The `fsck` command checks the general connectivity of the file system. If a directory that is not linked to the file system is found, the `fsck` command links the directory to the `lost+found` directory of the file system. This condition can occur when inodes are written to the file system. However, the corresponding directory data blocks are not.

Regular Data Blocks

Data blocks associated with a regular file hold the contents of the file. The `fsck` command does not attempt to check the validity of the contents of a regular file's data blocks.

fsck Summary Message

When you run the `fsck` command interactively and it completes successfully, a message similar to the following is displayed:

```
# fsck /dev/rdisk/c0t0d0s7
** /dev/rdisk/c0t0d0s7
** Last Mounted on /export/home
** Phase 1 - Check Blocks and Sizes
** Phase 2 - Check Pathnames
** Phase 3a - Check Connectivity
** Phase 3b - Verify Shadows/ACLs
** Phase 4 - Check Reference Counts
** Phase 5 - Check Cylinder Groups
2 files, 9 used, 2833540 free (20 frags, 354190 blocks, 0.0% fragmentation)
#
```

The last line of `fsck` output describes the following information about the file system:

# files	Number of inodes in use
# used	Number of fragments in use
# free	Number of unused fragments
# frags	Number of unused non-block fragments
# blocks	Number of unused full blocks
% fragmentation	Percentage of fragmentation, where: free fragments x 100 / total fragments in the file system

For information about fragments, see [“Fragment Size” on page 417](#).

Interactively Checking and Repairing a UFS File System

You might need to interactively check file systems in the following instances:

- When they cannot be mounted
- When they develop inconsistencies while in use

When an in-use file system develops inconsistencies, error messages might be displayed in the console window or the system messages file. Or, the system might crash. For example, the system messages file, `/var/adm/messages`, might include messages similar to the following:

```
Sep  5 13:42:40 hostname ufs: [ID 879645 kern.notice] NOTICE: /: unexpected
free inode 630916, run fsck(1M)
```

hostname is the system reporting the error.

Before using the `fsck` command, you might want to refer to these references for information on resolving `fsck` error messages:

- [“Syntax and Options for the `fsck` Command” on page 411](#)
- [Chapter 20, “Resolving UFS File System Inconsistencies \(Tasks\),” in *System Administration Guide: Advanced Administration*](#)

Keep the following points in mind when running the `fsck` command to check UFS file systems:

- A file system *should* be inactive when you use `fsck` to check a file system. File system changes waiting to be flushed to disk or file system changes that occur during the `fsck` checking process can be interpreted as file system corruption. These issues may not be a reliable indication of a problem.
- A file system *must* be inactive when you use `fsck` to repair that file system. File system changes waiting to be flushed to disk or file system changes that occur during the `fsck` repairing process might cause the file system to become corrupted. Or, they might cause the system to crash.
- Unmount a file system before you use `fsck` on that file system. Doing so ensures that the file system data structures are consistent as possible. The only exceptions are for the active root (`/`), `/usr`, and `/var` file systems because they must be mounted to run `fsck`.
- If you need to repair the root (`/`), `/usr`, and `/var` file systems, boot the system from an alternate device, if possible, so that these file systems are unmounted and inactive.

For step-by-step instructions on running `fsck` on the root (`/`), `/usr`, or `/var` file systems, see [“How to Check the UFS root \(`/`\), `/usr`, or `/var` File Systems From an Alternate Boot Device” on page 400](#).

▼ How to Check the UFS root (`/`), `/usr`, or `/var` File Systems From an Alternate Boot Device

For new information about `fsck` in the Solaris 10 6/06 release, see [“Enhancements to UFS File System Utilities \(`fsck`, `mkfs`, and `newfs`\)” on page 296](#). There is no need to rerun `fsck` if you see the following message:

```
***** FILE SYSTEM WAS MODIFIED *****
```

However, it doesn't harm the file system to rerun `fsck` after this message. This message is just informational about `fsck`'s corrective actions.

This procedure assumes that a local Solaris DVD or network boot server is available so that you can boot the system from an alternate device.

For information on restoring a bad superblock, see “How to Restore a Bad UFS Superblock (Solaris 10 6/06 Release)” on page 406 or “How to Restore a Bad Superblock (Solaris 8, 9, and 10 Releases)” on page 409.

- 1 **Become superuser or assume an equivalent role.**
- 2 **For systems with mirrored root (/) file systems only: Detach the root (/) mirror before booting from the alternate device, or you risk corrupting the file system.**

For information on detaching the root (/) mirror, see “Working With Submirrors” in *Solaris Volume Manager Administration Guide*.

- 3 **Identify the device, such as /dev/dsk/c0t0d0s0, of the root (/), /usr, or /var file system that needs to be checked.**

You'll need to supply this device name when booted from an alternate device. Identifying this device when you are already booted from the alternate device is more difficult.

- 4 **Boot the system with the root (/), /usr, or /var file system that needs to be checked from an alternate device, such as a local Solaris DVD or the network, in single-user mode.**

Doing so ensures that there is no activity on these file systems.

For example:

```
# init 0
ok boot net -s
.
.
.
#
```

- 5 **Check the device that contains the root (/), /usr, or /var file system as identified in Step 3.**

If the hardware for the file system to be checked or repaired has changed, the device names might have changed. Check that the `fsck -n` message Last Mounted on . . . indicates the expected device for the file system.

In this example, the root (/) file system to be checked is /dev/dsk/c0t0d0s0.

```
# fsck -n /dev/rdisk/c0t0d0s0
** /dev/rdisk/c0t0d0s0 (NO WRITE)
** Last Mounted on /
.
.
.
fsck /dev/rdisk/c0t0d0s0
** /dev/rdisk/c0t0d0s0
** Last Mounted on /
** Phase 1 - Check Blocks and Sizes
** Phase 2 - Check Pathnames
.
.
.
```

6 Correct any reported fsck errors.

For information on how to respond to the error message prompts while you interactively check one or more UFS file systems, see [Chapter 20, “Resolving UFS File System Inconsistencies \(Tasks\)”](#), in *System Administration Guide: Advanced Administration*.

7 If fsck cannot repair all of the problems after running it, see “Fixing a UFS File System That the fsck Command Cannot Repair” on page 405.**8 Mount the repaired file system to determine if any files exist in the lost+found directory.**

Individual files put in the `lost+found` directory by the `fsck` command are renamed with their inode numbers. If possible, rename the files and move them where they belong. Try to use the `grep` command to match phrases within individual files and the `file` command to identify file types.

Eventually, remove unidentifiable files or directories left in the `lost+found` directory so that it doesn't fill up unnecessarily.

9 Bring the system back to multiuser mode.

```
# init 6
```

10 For systems with mirrored root (/) file systems only: Reattach the root (/) mirror.**▼ How to Check Other UFS File Systems (Not root (/), /usr, or /var)**

For new information about `fsck` in the Solaris 10 6/06 release, see [“Enhancements to UFS File System Utilities \(fsck, mkfs, and newfs\)”](#) on page 296. There is no need to rerun `fsck` if you see the following message:

```
***** FILE SYSTEM WAS MODIFIED *****
```

However, it doesn't harm the file system to rerun `fsck` after this message. This message is just informational about `fsck`'s corrective actions.

This procedure assumes that the file system to be checked is unmounted.

For information on restoring a bad superblock, see [“How to Restore a Bad UFS Superblock \(Solaris 10 6/06 Release\)”](#) on page 406 or [“How to Restore a Bad Superblock \(Solaris 8, 9, and 10 Releases\)”](#) on page 409.

1 Become superuser or assume an equivalent role.

2 Unmount the local file system to ensure that there is no activity on the file system.

Specify the mount point directory or `/dev/dsk/device-name` as arguments to the `fsck` command. Any inconsistency messages are displayed.

For example:

```
# umount /export/home
# fsck /dev/rdisk/c0t0d0s7
** /dev/dsk/c0t0d0s7
** Last Mounted on /export/home
.
.
.
```

3 Correct any reported fsck errors.

For information on how to respond to the error message prompts while you interactively check one or more UFS file systems, see [Chapter 20, “Resolving UFS File System Inconsistencies \(Tasks\)”](#) in *System Administration Guide: Advanced Administration*.

4 If fsck cannot repair all of the problems after running it, see “Fixing a UFS File System That the fsck Command Cannot Repair” on page 405.**5 Mount the repaired file system to determine if there are any files in the lost+found directory.**

Individual files put in the `lost+found` directory by the `fsck` command are renamed with their inode numbers.

6 Rename and move any files put in the lost+found directory.

If possible, rename the files and move them where they belong. Try to use the `grep` command to match phrases within individual files and the `file` command to identify file types.

Eventually, remove unidentifiable files or directories left in the `lost+found` directory so that it doesn't fill up unnecessarily.

Example 20–1 Interactively Checking UFS Non-root (/) or Non-/usr File Systems

The following example shows how to check the `/dev/rdisk/c0t0d0s6` file system and correct the incorrect block count. This example assumes that the file system is unmounted.

```
# fsck /dev/rdisk/c0t0d0s6
** Phase 1 - Check Block and Sizes
INCORRECT BLOCK COUNT I=2529 (6 should be 2)
CORRECT? y

** Phase 2 - Check Pathnames
** Phase 3 - Check Connectivity
** Phase 4 - Check Reference Counts
** Phase 5 - Cylinder Groups
929 files, 8928 used, 2851 free (75 frags, 347 blocks, 0.6%
```

```
fragmentation)
***** FILE SYSTEM WAS MODIFIED *****
#
```

Preening UFS File Systems

The `fsck -o p` command (p is for preen) checks UFS file systems and automatically fixes the problems that normally result from an unexpected system shutdown. This command exits immediately if it encounters a problem that requires operator intervention. This command also permits parallel checking of file systems.

You can run the `fsck -o p` command to preen the file systems after an unclean shutdown. In this mode, the `fsck` command does not look at the clean flag and does a full check. These actions are a subset of the actions that the `fsck` command takes when it runs interactively.

▼ How to Preen a UFS File System

This procedure assumes that the file system is unmounted or inactive.

- 1 **Become superuser or assume an equivalent role.**
- 2 **Unmount the UFS file system.**
- 3 **Check the UFS file system with the preen option.**

```
# umount /mount-point
```

```
# fsck -o p /dev/rdisk/device-name
```

You can preen individual file systems by using `/mount-point` or `/dev/rdisk/device-name` as arguments to the `fsck` command.

Example 20–2 Preening a UFS File System

The following example shows how to preen the `/export/home` file system.

```
# fsck -o p /export/home
```

Fixing a UFS File System That the `fsck` Command Cannot Repair

The `fsck` command operates in several passes, and a problem corrected in a later pass can expose other problems that are only detected by earlier passes. Therefore, it is sometimes necessary to run `fsck` until it no longer reports any problems. Doing so ensures that all errors have been found and repaired.

Pay attention to the information displayed by the `fsck` command. This information might help you fix the problem. For example, the messages might point to a damaged directory. If you delete the directory, you might find that the `fsck` command runs cleanly.

If the `fsck` command still cannot repair the file system, try to use the `ff`, `clri`, and `ncheck` commands to figure out and fix what is wrong. For information about how to use these commands, see the following references:

- [fsdb\(1M\)](#)
- [ff\(1M\)](#)
- [clri\(1M\)](#)
- [ncheck\(1M\)](#)

Ultimately, you might need to re-create the file system and restore its contents from backup media.

For information about restoring complete file systems, see [Chapter 25, “Restoring UFS Files and File Systems \(Tasks\)”](#).

If you cannot fully repair a file system but you can mount it read-only, try using the `cp`, `tar`, or `cpio` commands to retrieve all or part of the data from the file system.

If hardware disk errors are causing the problem, you might need to reformat and repartition the disk again before re-creating and restoring file systems. Check that the device cables and connectors are functional before replacing the disk device. Hardware errors usually display the same error again and again across different commands. The `format` command tries to work around bad blocks on the disk. However, if the disk is too severely damaged, the problems might persist, even after reformatting. For information about using the `format` command, see [format\(1M\)](#). For information about installing a new disk, see [Chapter 12, “SPARC: Setting Up Disks \(Tasks\)”](#) or [Chapter 13, “x86: Setting Up Disks \(Tasks\)”](#).

Restoring a Bad UFS Superblock

When the superblock of a file system becomes damaged, you must restore it. The `fsck` command tells you when a superblock is bad. Fortunately, copies of the superblock are stored within a file system.

You can use the `fsck -o b` command to replace the superblock with one of these copies or use `fsck`'s automatic search for backup superblocks feature, which is new in the Solaris 10 6/06 release. For more information about this feature, see [“Automatic Search for Backup Superblocks” on page 297](#).

For more information about the superblock, see [“Superblock” on page 414](#).

If the superblock in the root (`/`) file system becomes damaged and you cannot restore it, you have two choices:

- Reinstall the system.
- Boot from the network or local Solaris DVD, and attempt the following steps. If these steps fail, recreate the root (`/`) file system by using the `newfs` command and restore it from a backup copy.

▼ How to Restore a Bad UFS Superblock (Solaris 10 6/06 Release)

If your file system has a bad UFS superblock, `fsck` automatically calculates an alternative superblock as seen in the following messages:

```
BAD SUPERBLOCK AT ...  
  
LOOK FOR ALTERNATE SUPERBLOCKS WITH MKFS?  
LOOK FOR ALTERNATE SUPERBLOCKS WITH NEWFS?
```



Caution – If a file system with a damaged superblock was created with `newfs` or `mkfs` customized parameters, such as `nt rack` or `nsect`, using `fsck`'s automatically calculated superblock for the repair process could irreparably damage your file system.

In the case of a file system that was created with customized parameters and it has a bad superblock, `fsck` provides the following prompt to cancel the `fsck` session:

```
CANCEL FILESYSTEM CHECK?
```

Canceling the `fsck` session would be an appropriate response if this file system was created with customized parameters or if there is some other concern about running `fsck` on this file system.

- 1 Become superuser or assume an equivalent role.
- 2 Check the file system with the suspected bad superblock.

```
# fsck /dev/rdisk/c0t1d0s0
```

```
** /dev/rdisk/c0t1d0s0
```

BAD SUPERBLOCK at ...
- 3 Determine how the file system was created and select one of the following:

- The file system was created with the newfs command.
 - fsck responds that all superblocks are corrupt and it must use a generic superblock. Answer the fsck prompts as described in the example below.



Caution – Do not use this option if the file system was created with customized parameters. This option should only be used as a last resort. Be prepared to restore the file system from a backup copy.

```
# fsck /dev/dsk/c1t2d0s0
```

```
** /dev/rdisk/c1t2d0s0
```

BAD SUPERBLOCK AT BLOCK 16: BLOCK SIZE LARGER THAN MAXIMUM SUPPORTED

LOOK FOR ALTERNATE SUPERBLOCKS WITH MKFS? **no**

LOOK FOR ALTERNATE SUPERBLOCKS WITH NEWFS? **yes**

SEARCH FOR ALTERNATE SUPERBLOCKS FAILED.

USE GENERIC SUPERBLOCK FROM MKFS? **no**

USE GENERIC SUPERBLOCK FROM NEWFS? **yes**

CALCULATED GENERIC SUPERBLOCK WITH NEWFS

If filesystem was created with manually-specified geometry, using auto-discovered superblock may result in irrecoverable damage to filesystem and user data.

CANCEL FILESYSTEM CHECK? **no**

```
** Last Mounted on
```

```
** Phase 1 - Check Blocks and Sizes
```

```
** Phase 2 - Check Pathnames
```

```
** Phase 3a - Check Connectivity
```

```
** Phase 3b - Verify Shadows/ACLs
```

```
** Phase 4 - Check Reference Counts
```

```
** Phase 5 - Check Cylinder Groups
```

CORRECT GLOBAL SUMMARY

SALVAGE? **y**

```
UPDATE STANDARD SUPERBLOCK? y
```

```
81 files, 3609 used, 244678 free (6 frags, 30584 blocks, 0.0% fragmentation)
```

```
***** FILE SYSTEM WAS MODIFIED *****
```

- fsck responds that it found an alternate superblock with a message similar to the following:

```
FOUND ALTERNATE SUPERBLOCK 32 WITH NEWFS
```

With this fsck scenario, follow the prompts as shown in [“Automatic Search for Backup Superblocks” on page 297](#).

- **The file system was created with the mkfs command.**
- fsck responds that all superblocks are corrupt and must use a generic superblock. Answer the fsck prompts as described in the example below.



Caution – Do not use this option if the file system was created with customized parameters. This option should only be used as a last resort. Be prepared to restore the file system from a backup copy.

```
# fsck /dev/dsk/c1t2d0s0
** /dev/rdisk/c1t2d0s0
BAD SUPERBLOCK AT BLOCK 16: BLOCK SIZE LARGER THAN MAXIMUM SUPPORTED

LOOK FOR ALTERNATE SUPERBLOCKS WITH MKFS? yes

LOOK FOR ALTERNATE SUPERBLOCKS WITH NEWFS? no

SEARCH FOR ALTERNATE SUPERBLOCKS FAILED.

USE GENERIC SUPERBLOCK FROM MKFS? yes

CALCULATED GENERIC SUPERBLOCK WITH MKFS
If filesystem was created with manually-specified geometry, using
auto-discovered superblock may result in irrecoverable damage to
filesystem and user data.

CANCEL FILESYSTEM CHECK? no

** Last Mounted on
** Phase 1 - Check Blocks and Sizes
** Phase 2 - Check Pathnames
** Phase 3a - Check Connectivity
** Phase 3b - Verify Shadows/ACLs
** Phase 4 - Check Reference Counts
** Phase 5 - Check Cylinder Groups
CORRECT GLOBAL SUMMARY
SALVAGE? y

UPDATE STANDARD SUPERBLOCK? y
```

81 files, 3609 used, 243605 free (117 frags, 30436 blocks, 0.0% fragmentation)

- `fsck` responds that it found an alternate superblock with a message similar to the following:

```
FOUND ALTERNATE SUPERBLOCK 32 WITH MKFS
```

With this `fsck` scenario, follow the prompts as shown in [“Automatic Search for Backup Superblocks”](#) on page 297.

4 Answer the prompts to salvage and restore the superblock.

There is no need to rerun `fsck` when you see the following message:

```
***** FILE SYSTEM WAS MODIFIED *****
```

However, it doesn't harm the file system to rerun `fsck` after this message. This message is just informational about `fsck`'s corrective actions.

▼ How to Restore a Bad Superblock (Solaris 8, 9, and 10 Releases)

- 1 Become superuser or assume an equivalent role.
- 2 Determine whether the bad superblock is in the root (`/`), `/usr`, or `/var` file system and select one of the following:

- If the bad superblock is in either the root (`/`), `/usr`, or `/var` file system, then boot from the network or a locally connected Solaris DVD.

From a locally-connected DVD, use the following command:

```
ok boot cdrom -s
```

From the network where a boot or install server is already setup, use the following command:

```
ok boot net -s
```

If you need help stopping the system, see [Chapter 12, “Booting an Oracle Solaris System \(Tasks\)”](#) in *System Administration Guide: Basic Administration* or [“Booting an x86 Based System by Using GRUB \(Task Map\)”](#) in *System Administration Guide: Basic Administration*.

- If the bad superblock is not in either the root (`/`), `/usr`, `/var` file system, change to a directory outside the damaged file system and unmount the file system.

```
# umount /mount-point
```



Caution – Be sure to use the `newfs -N` in the next step. If you omit the `-N` option, you will destroy all of the data in the file system and replace it with an empty file system.

3 Display the superblock values by using the `newfs -N` command.

```
# newfs -N /dev/rdisk/device-name
```

The command output displays the block numbers that were used for the superblock copies when the `newfs` command created the file system, unless the file system was created with special parameters. For information on creating a customized file system, see “[Customizing UFS File System Parameters](#)” on page 416.

4 Provide an alternate superblock by using the `fsck` command.

```
# fsck -F ufs -o b=block-number /dev/rdisk/device-name
```

The `fsck` command uses the alternate superblock you specify to restore the primary superblock. You can always try 32 as an alternate block. Or, use any of the alternate blocks shown by the `newfs -N` command.

Example 20–3 Restoring a Bad Superblock (Solaris 8, 9, and 10 Releases)

The following example shows how to restore the superblock copy 5264.

```
# newfs -N /dev/rdisk/c0t3d0s7
/dev/rdisk/c0t3d0s7: 163944 sectors in 506 cylinders of 9 tracks, 36 sectors
83.9MB in 32 cyl groups (16 c/g, 2.65MB/g, 1216 i/g)
super-block backups (for fsck -b #) at:
 32, 5264, 10496, 15728, 20960, 26192, 31424, 36656, 41888,
47120, 52352, 57584, 62816, 68048, 73280, 78512, 82976, 88208,
93440, 98672, 103904, 109136, 114368, 119600, 124832, 130064, 135296,
140528, 145760, 150992, 156224, 161456,
# fsck -F ufs -o b=5264 /dev/rdisk/c0t3d0s7
Alternate superblock location: 5264.
** /dev/rdisk/c0t3d0s7
** Last Mounted on
** Phase 1 - Check Blocks and Sizes
** Phase 2 - Check Pathnames
** Phase 3 - Check Connectivity
** Phase 4 - Check Reference Counts
** Phase 5 - Check Cyl groups
36 files, 867 used, 75712 free (16 frags, 9462 blocks, 0.0% fragmentation)

***** FILE SYSTEM WAS MODIFIED *****
#
```

Syntax and Options for the `fsck` Command

The `fsck` command checks and repairs inconsistencies in file systems. If you run the `fsck` command without any options, it interactively asks for confirmation before making repairs. This command has four options.

Command and Option	Description
<code>fsck -m</code>	Checks whether a file system can be mounted
<code>fsck -y</code>	Assumes a yes response for all repairs
<code>fsck -n</code>	Assumes a no response for all repairs
<code>fsck -o p</code>	Noninteractively preens the file system, fixing all expected (innocuous) inconsistencies, but exits when a serious problem is encountered

UFS File System (Reference)

This is a list of the reference information in this chapter.

- “Structure of Cylinder Groups for UFS File Systems” on page 413
- “Customizing UFS File System Parameters” on page 416

Structure of Cylinder Groups for UFS File Systems

When you create a UFS file system, the disk slice is divided into cylinder groups. A *cylinder group* is comprised of one or more consecutive disk cylinders. Cylinder groups are then further divided into addressable blocks to control and organize the structure of the files within the cylinder group. Each type of block has a specific function in the file system. A UFS file system has these four types of blocks.

Block Type	Type of Information Stored
Boot block	Information used when the system is booted
Superblock	Detailed information about the file system
Inode	All information about a file
Storage or data block	Data for each file

The following sections provide additional information about the organization and function of these blocks.

Boot Block

The *boot block* stores objects that are used in booting the system. If a file system is not to be used for booting, the boot block is left blank. The boot block appears only in the first cylinder group (cylinder group 0) and is the first 8 KB in a slice.

Superblock

The *superblock* stores much of the information about the file system, which includes the following:

- Size and status of the file system
- Label, which includes the file system name and volume name
- Size of the file system logical block
- Date and time of the last update
- Cylinder group size
- Number of data blocks in a cylinder group
- Summary data block
- File system state
- Path name of the last mount point

Because the superblock contains critical data, multiple superblocks are made when the file system is created.

A summary information block is kept within the superblock. The summary information block is not replicated, but is grouped with the primary superblock, usually in cylinder group 0. The summary block records changes that take place as the file system is used. In addition, the summary block lists the number of inodes, directories, fragments, and storage blocks within the file system.

Inodes

An *inode* contains all the information about a file except its name, which is kept in a directory. An inode is 128 bytes. The inode information is kept in the cylinder information block, and contains the following:

- The type of the file:
 - Regular
 - Directory
 - Block special
 - Character special
 - FIFO, also known as named pipe
 - Symbolic link

- Socket
- Other inodes – Attribute directory and shadow (used for ACLs)
- The mode of the file (the set of read-write-execute permissions)
- The number of hard links to the file
- The user ID of the owner of the file
- The group ID to which the file belongs
- The number of bytes in the file
- An array of 15 disk-block addresses
- The date and time the file was last accessed
- The date and time the file was last modified
- The date and time the inode was changed

The array of 15 disk-block addresses (0 to 14) points to the data blocks that store the contents of the file. The first 12 are direct addresses. That is, they point directly to the first 12 logical storage blocks of the file contents. If the file is larger than 12 logical blocks, the 13th address points to an indirect block, which contains direct-block addresses instead of file contents. The 14th address points to a double indirect block, which contains addresses of indirect blocks. The 15th address is for triple indirect addresses. The following figure shows this chaining of address blocks starting from the inode.

FIGURE 21-1 Address Chain for a UFS File System

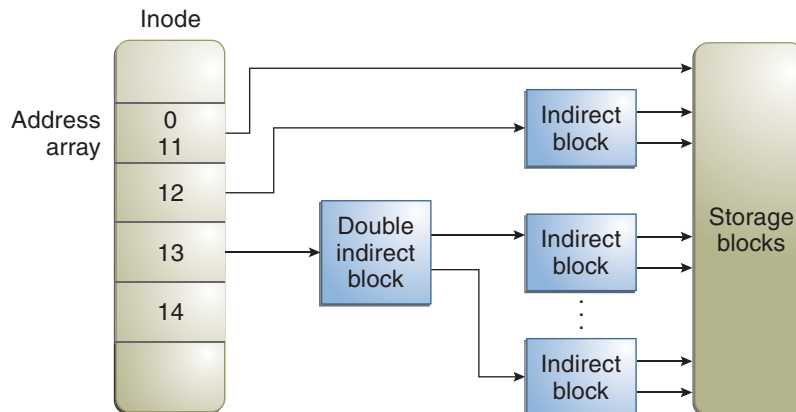

Data Blocks

Data blocks, also called *storage blocks*, contain the rest of the space that is allocated to the file system. The size of these data blocks is determined when a file system is created. By default, data blocks are allocated in two sizes: an 8-KB logical block size, and a 1-KB fragment size.

For a regular file, the data blocks contain the contents of the file. For a directory, the data blocks contain entries that give the inode number and the file name of the files in the directory.

Free Blocks

Blocks that are not currently being used as inodes, as indirect address blocks, or as storage blocks are marked as free in the cylinder group map. This map also keeps track of fragments to prevent fragmentation from degrading disk performance.

To give you an idea of the structure of a typical UFS file system, the following figure shows a series of cylinder groups in a generic UFS file system.

FIGURE 21-2 A Typical UFS File System

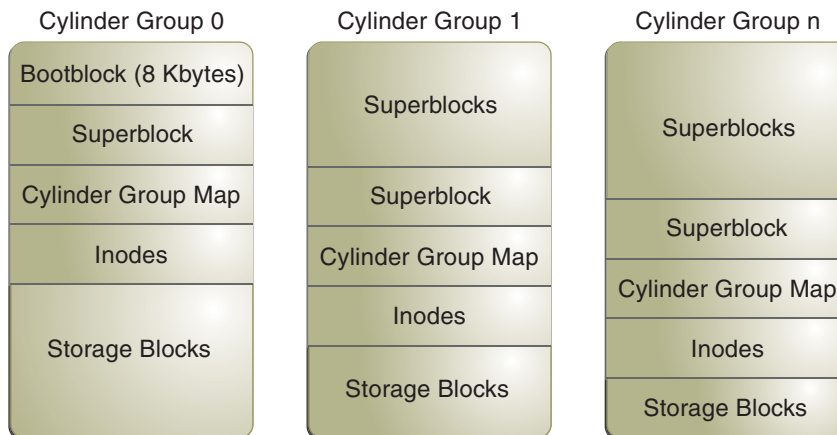

Customizing UFS File System Parameters

Before you alter the default file system parameters that are assigned by the `newfs` command, you need to understand them. This section describes these parameters:

- “Logical Block Size” on page 417
- “Fragment Size” on page 417
- “Minimum Free Space” on page 418
- “Rotational Delay” on page 418 (Obsolete)
- “Optimization Type” on page 418
- “Number of Inodes (Files)” on page 419

For a description of the command options that customize these parameters, see `newfs(1M)` and `mkfs_ufs(1M)`.

Logical Block Size

The *logical block size* is the size of the blocks that the UNIX kernel uses to read or write files. The logical block size is usually different from the physical block size. The physical block size is usually 512 bytes, which is the size of the smallest block that the disk controller can read or write.

Logical block size is set to the page size of the system by default. The default logical block size is 8192 bytes (8 KB) for UFS file systems. The UFS file system supports block sizes of 4096 or 8192 bytes (4 or 8 KB). The recommended logical block size is 8 KB.

SPARC only – You can specify only the 8192-byte block size on the sun-4u platform.

To choose the best logical block size for your system, consider both the performance you want and the available space. For most UFS systems, an 8-KB file system provides the best performance, offering a good balance between disk performance and the use of space in primary memory and on disk.

As a general rule, to increase efficiency, use a larger logical block size for file systems when most of the files are very large. Use a smaller logical block size for file systems when most of the files are very small. You can use the `quot -c filesystem` command on a file system to display a complete report on the distribution of files by block size.

However, the page size set when the file system is created is probably the best size in most cases.

Fragment Size

As files are created or expanded, they are allocated disk space in either full logical blocks or portions of logical blocks called *fragments*. When disk space is needed for a file, full blocks are allocated first, and then one or more fragments of a block are allocated for the remainder. For small files, allocation begins with fragments.

The ability to allocate fragments of blocks to files, rather than just whole blocks, saves space by reducing *fragmentation* of disk space that results from unused holes in blocks.

You define the *fragment size* when you create a UFS file system. The default fragment size is 1 KB. Each block can be divided into 1, 2, 4, or 8 fragments, which results in fragment sizes from 8192 bytes to 512 bytes (for 4-KB file systems only). The lower bound is actually tied to the disk sector size, typically 512 bytes.

For multiterabyte file systems, the fragment size must be equal to the file system block size.

Note – The upper bound for the fragment is the logical block size, in which case the fragment is not a fragment at all. This configuration might be optimal for file systems with very large files when you are more concerned with speed than with space.

When choosing a fragment size, consider the trade-off between time and space: A small fragment size saves space, but requires more time to allocate. As a general rule, to increase storage efficiency, use a larger fragment size for file systems when most of the files are large. Use a smaller fragment size for file systems when most of the files are small.

Minimum Free Space

The *minimum free space* is the percentage of the total disk space that is held in reserve when you create the file system. The default reserve is $((64 \text{ MB/partition size}) * 100)$, rounded down to the nearest integer and limited between 1 percent and 10 percent, inclusively.

Free space is important because file access becomes less and less efficient as a file system gets full. As long as an adequate amount of free space exists, UFS file systems operate efficiently. When a file system becomes full, using up the available user space, only root can access the reserved free space.

Commands such as `df` report the percentage of space that is available to users, excluding the percentage allocated as the minimum free space. When the command reports that more than 100 percent of the disk space in the file system is in use, some of the reserve has been used by root.

If you impose quotas on users, the amount of space available to them does not include the reserved free space. You can change the value of the minimum free space for an existing file system by using the `tunefs` command.

Rotational Delay

This parameter is obsolete. The value is always set to 0, regardless of the value you specify.

Optimization Type

The *optimization type* parameter is set to either *space* or *time*.

- **Space** – When you select space optimization, disk blocks are allocated to minimize fragmentation and disk use is optimized.
- **Time** – When you select time optimization, disk blocks are allocated as quickly as possible, with less emphasis on their placement. When sufficient free space exists, allocating disk blocks is relatively easy, without resulting in too much fragmentation. The default is *time*.

You can change the value of the optimization type parameter for an existing file system by using the `tunefs` command.

For more information, see [tunefs\(1M\)](#).

Number of Inodes (Files)

The number of bytes per inode specifies the density of inodes in the file system. The number is divided into the total size of the file system to determine the number of inodes to create. Once the inodes are allocated, you cannot change the number without re-creating the file system.

The default number of bytes per inode is 2048 bytes (2 KB) if the file system is less than 1 GB. If the file system is larger than 1 GB, the following formula is used:

File System Size	Number of Bytes Per Inode
Less than or equal to 1 GB	2048
Less than 2 GB	4096
Less than 3 GB	6144
3 GB up to 1 TB	8192
Greater than 1 TB or created with <code>-T</code> option	1048576

If you have a file system with many symbolic links, they can lower the average file size. If your file system is going to have many small files, you can give this parameter a lower value. Note, however, that having too many inodes is much better than running out of inodes. If you have too few inodes, you could reach the maximum number of files on a disk slice that is practically empty.

Maximum UFS File and File System Size

The maximum size of a UFS file system is about 16 TB of usable space, minus about one percent overhead. A *sparse* file can have a logical size of one terabyte. However, the actual amount of data that can be stored in a file is approximately one percent less than 1 TB because of the file system overhead.

Maximum Number of UFS Subdirectories

The maximum number of subdirectories per directory in a UFS file system is 32,767. This limit is predefined and cannot be changed.

Backing Up and Restoring UFS File Systems (Overview)

This chapter provides guidelines and planning information for backing up and restoring UFS file systems by using the `ufsdump` and `ufsrestore` commands.

This is a list of the overview information in this chapter.

- “Where to Find UFS Backup and Restore Tasks” on page 421
- “Introduction to Backing Up and Restoring UFS File Systems” on page 422
- “Why You Should Back Up File Systems” on page 422
- “Planning Which UFS File Systems to Back Up” on page 423
- “Choosing the Type of Backup” on page 424
- “Choosing a Tape Device” on page 425
- “High-Level View of Backing Up and Restoring UFS File Systems (Task Map)” on page 426
- “Considerations for Scheduling Backups” on page 427
- “Sample Backup Schedules” on page 430

Where to Find UFS Backup and Restore Tasks

Backup or Restore Task	For More Information
Back up file systems by using the <code>ufsdump</code> command.	Chapter 23, “Backing Up UFS Files and File Systems (Tasks)”
Create UFS snapshots by using the <code>fsnap</code> command.	Chapter 24, “Using UFS Snapshots (Tasks)”
Restore file systems by using the <code>ufsrestore</code> command.	Chapter 25, “Restoring UFS Files and File Systems (Tasks)”
Copy files and directories by using the <code>cpio</code> , <code>dd</code> , <code>pax</code> , and <code>cpio</code> commands.	Chapter 27, “Copying Files and File Systems (Tasks)”

Introduction to Backing Up and Restoring UFS File Systems

Backing up file systems means copying file systems to removable media, such as tape, to safeguard against loss, damage, or corruption. *Restoring* file systems means copying reasonably current backup files from removable media to a working directory.

This chapter describes the `ufsdump` and `ufsrestore` commands for backing up and restoring UFS file systems. Other commands are available for copying files and file systems for the purpose of sharing or transporting files. The following table provides pointers to all commands that copy individual files and file systems to other media.

TABLE 22-1 Commands for Backing Up and Restoring Files and File Systems

Task	Command	For More Information
Back up one or more file systems to a local tape device or a remote tape device.	<code>ufsdump</code>	Chapter 23, “Backing Up UFS Files and File Systems (Tasks),” or Chapter 26, “UFS Backup and Restore Commands (Reference)”
Create read-only copies of file systems.	<code>fsnap</code>	Chapter 24, “Using UFS Snapshots (Tasks)”
Back up all file systems for systems on a network from a backup server.	Solstice Backup software	<i>Solstice Backup 6.1 Administration Guide</i>
Back up and restore an NIS+ master server.	<code>nisbackup</code> and <code>nisrestore</code>	<i>System Administration Guide: Naming and Directory Services (NIS+)</i>
Copy, list, and retrieve files on a tape or diskette.	<code>tar</code> , <code>cpio</code> , or <code>pax</code>	Chapter 27, “Copying Files and File Systems (Tasks)”
Copy the master disk to a clone disk.	<code>dd</code>	Chapter 27, “Copying Files and File Systems (Tasks)”
Restore complete file systems or individual files from removable media to a working directory.	<code>ufsrestore</code>	Chapter 25, “Restoring UFS Files and File Systems (Tasks)”

Why You Should Back Up File Systems

Backing up files is one of the most crucial system administration functions. You should perform regularly scheduled backups to prevent loss of data due to the following types of problems:

- System crashes
- Accidental deletion of files
- Hardware failures

- Natural disasters such as fire, hurricanes, or earthquakes
- Problems when you reinstall or upgrade a system

Planning Which UFS File Systems to Back Up

You should back up all file systems that are critical to users, including file systems that change frequently. The following tables provide general guidelines on the file systems to back up for stand-alone systems and servers.

TABLE 22-2 File Systems to Back Up for Stand-alone Systems

File System to Back Up	Description	Back Up Interval
root (/) – slice 0	This file system contains the kernel and possibly the /var directory. The /var directory contains temporary files, logging files, or status files, and possibly contains frequently updated system accounting and mail files.	At regular intervals such as weekly or daily
/usr – slice 6, /opt	The /usr and /opt file systems contain software and executables. The /opt directory is either part of root (/) or is its own file system.	Occasionally
/export/home – slice 7	This file system can contain the directories and subdirectories of all users on the stand-alone system.	More often than root (/) or /usr, perhaps as often as once a day, depending on your site's needs
/export, /var, or other file systems	The /export file system can contain the kernel and executables for diskless clients. The /var directory contains temporary files, logging files, or status files.	As your site requires

TABLE 22-3 UFS File Systems to Back Up for Servers

File System to Back Up	Description	Back Up Interval
root (/) – slice 0	This file system contains the kernel and executables.	Once a day to once a month depending on your site's needs. If you frequently add and remove users and systems on the network, you have to change configuration files in this file system. In this case, you should do a full backup of the root (/) file system at intervals between once a week and once a month. If your site keeps user mail in the /var/mail directory on a mail server, which client systems then mount, you might want to back up root (/) daily. Or, backup the /var directory, if it is a separate file system.
/export – slice 3	This file system can contain the kernel and executables for diskless clients.	Once a day to once a month, depending on your site's needs. Because the information in this file system is similar to the server's root directory in slice 0, the file system does not change frequently. You need to back up this file system only occasionally, unless your site delivers mail to client systems. Then, you should back up /export more frequently.
/usr – slice 6, /opt	The /usr and /opt file systems contain software and executables. The /opt directory is either part of root (/) or is its own file system.	Once a day to once a month, depending on your site's needs. These file systems are fairly static unless software is added or removed frequently.
/export/home – slice 7	This file system can contain the home directories of all the users on the system. The files in this file system are volatile.	Once a day to once a week.

Choosing the Type of Backup

You can perform full or incremental backups by using the `ufsdump` command. You can create a temporary image of a file system by using the `fsnap` command. The following table lists the differences between these types of backup procedures.

TABLE 22-4 Differences Between Types of Backups

Backup Type	Result	Advantages	Disadvantages
Full	Copies a complete file system or directory	All data is in one place	Requires large numbers of backup tapes that take a long time to write. Takes longer to retrieve individual files because the drive has to move sequentially to the point on the tape where the file is located. You might have to search multiple tapes.
Snapshot	Creates a temporary image of a file system	System can be in multiuser mode	System performance might degrade while the snapshot is created.
Incremental	Copies only those files in the specified file system that have changed since a previous backup	Easier to retrieve small changes in file systems	Finding which incremental tape contains a file can take time. You might have to go back to the last full backup.

Choosing a Tape Device

The following table shows typical tape devices that are used for storing file systems during the backup process. The storage capacity depends on the type of drive and the data being written to the tape. For more information on tape devices, see [Chapter 28, “Managing Tape Drives \(Tasks\)”](#)

TABLE 22-5 Typical Media for Backing Up File Systems

Backup Media	Storage Capacity
1/2-inch reel tape	140 MB (6250 bpi)
2.5-GB 1/4-inch cartridge (QIC) tape	2.5 GB
DDS3 4-mm cartridge tape (DAT)	12–24 GB
14-GB 8-mm cartridge tape	14 GB
DLT 7000 1/2-inch cartridge tape	35–70 GB

High-Level View of Backing Up and Restoring UFS File Systems (Task Map)

Use this task map to identify all the tasks for backing up and restoring file systems. Each task points to a series of additional tasks, such as determining the type of backup to perform.

Task	Description	For Instructions
1. Identify the file systems to back up.	Identify which file systems need to be backed up on a daily, weekly, or monthly basis.	“Planning Which UFS File Systems to Back Up” on page 423
2. Determine the type of backup.	Determine the type of backup you need for the file systems at your site.	“Choosing the Type of Backup” on page 424
3. Create the backup.	Use one of the following methods:	
	<p>If you want to have full and incremental backups of your file systems, use the <code>ufsdump</code> command.</p> <p>If you want to create a snapshot of a file system while it is active and mounted, consider using the <code>fsnap</code> command.</p> <p>If you just want to have full backups of your personal home directory or smaller, less-important file systems, use the <code>tar</code>, <code>cpio</code>, or <code>pax</code> commands.</p>	<p>Chapter 23, “Backing Up UFS Files and File Systems (Tasks)”</p> <p>Chapter 24, “Using UFS Snapshots (Tasks)”</p> <p>Chapter 27, “Copying Files and File Systems (Tasks)”</p>
4. (Optional) Restore a file system.	<p>Select the restoration method that is based on the command used to back up the files or file system:</p> <p>Restore a file system backup that was created with the <code>ufsdump</code> command.</p> <p>Restore a file system that was created with the <code>tar</code>, <code>cpio</code>, or <code>pax</code> command.</p>	<p>Chapter 25, “Restoring UFS Files and File Systems (Tasks)”</p> <p>Chapter 27, “Copying Files and File Systems (Tasks)”</p>
5. (Optional) Restore the root (/) or /usr file system.	Restoring the root (/) or /usr file system is more complicated than restoring a noncritical file system. You need to boot from a local Solaris DVD or from the network while these file systems are being restored.	“How to Restore a UFS root (/) and /usr File System” on page 468

Considerations for Scheduling Backups

A *backup schedule* is the schedule that you establish to run the `ufsdump` command. This section identifies considerations to think about when you create a backup schedule. This section also includes sample backup schedules.

The backup schedule that you create depends on the following:

- Your need to minimize the number of tapes that are used for backups
- The time available for doing backups
- The time available for doing a full restore of a damaged file system
- The time available for retrieving individual files that are accidentally deleted

How Often Should You Do Backups?

If you do not need to minimize time requirements and the number of media that is used for backups, you can do full backups every day. However, this backup method is not realistic for most sites, so incremental backups are used most often. In this case, you should back up your site enough to so that you can restore files from the last four weeks. This schedule requires at least four sets of tapes, one set for each week. You would then reuse the tapes each month. In addition, you should archive the monthly backups for at least a year. Then, keep yearly backups for a number of years.

Backup Interval Terms and Definitions

The following table describes backup interval terms and definitions.

Term	Definition
Snapshot	Creates a temporary image of a file system.
Full backup	Copies a complete file system or directory.

Term	Definition
Incremental backup	<p>Copies only those files in the specified file system that have changed since a previous backup. Incremental backup types include the following:</p> <ul style="list-style-type: none"> ■ Daily, cumulative – Copies a day's worth of file changes on Monday. Then, overwrites Monday's backup with file changes from Tuesday, Wednesday, and so on. ■ Daily, incremental – Copies a day's worth of file changes so that you have distinct tapes of Monday's changes, Tuesday's changes, and so on. ■ Weekly cumulative – Copies the files that have changed during the week and includes the previous week's file changes. ■ Weekly incremental – Copies the files that have changed during the week since the previous weekly backup.

Guidelines for Scheduling Backups

The following table provides guidelines for scheduling backups. For additional backup schedule considerations, see [“Considerations for Scheduling Backups” on page 427](#).

TABLE 22-6 Guidelines for Backup Schedules

File Restoration Need	Backup Interval	Comments
To restore different versions of files (for example, file systems that are used for word processing)	<p>Do daily incremental backups every working day.</p> <p>Do <i>not</i> reuse the same tape for daily incremental backups.</p>	<p>This schedule saves all files modified that day, as well as those files still on disk that were modified since the last backup of a lower level. However, with this schedule, you should use a different tape each day because you might otherwise be unable to restore the needed version of the file.</p> <p>For example, a file that changed on Tuesday, and again on Thursday, goes onto Friday's lower-level backup appearing as it did Thursday night, not Tuesday night. If a user needs the Tuesday version, you cannot restore it unless you have a Tuesday backup tape (or a Wednesday backup tape). Similarly, a file that is present on Tuesday and Wednesday, but removed on Thursday, does not appear on the Friday lower-level backup.</p>

TABLE 22-6 Guidelines for Backup Schedules (Continued)

File Restoration Need	Backup Interval	Comments
To quickly restore a complete file system	Do lower-level backups more frequently.	—
To back up a number of file systems on the same server	Consider staggering the schedule for different file systems.	This way you're not doing all level 0 backups on the same day.
To minimize the number of tapes used	Increase the level of incremental backups that are done across the week.	Only changes from day to day are saved on each daily tape.
	Increase the level of backups that are done at the end of the week. Put each day's and week's incremental backups onto the same tape.	Only changes from week to week (rather than the entire month) are saved on the weekly tapes.
	Put each day's and week's incremental backups onto the same tape.	To do so, use the no rewind option of the <code>ufsdump</code> command, such as specifying <code>/dev/rmt/0n</code> .

Using Dump Levels to Create Incremental Backups

The dump level you specify in the `ufsdump` command (0–9) determines which files are backed up. Dump level 0 creates a full backup. Levels 1–9 are used to schedule incremental backups, but have *no defined meanings*. Levels 1–9 are just a range of numbers that are used to schedule cumulative or discrete backups. The only meaning levels 1–9 have is in relationship to each other, as a higher or lower number. A lower dump number always restarts a full or a cumulative backup. The following examples show the flexibility of the incremental dump procedure using levels 1–9.

Example—Dump Levels for Daily, Cumulative Backups

Doing daily, cumulative incremental backups is the most commonly used backup schedule and is recommended for most situations. The following example shows a schedule that uses a level 9 dump Monday through Thursday, and a level 5 dump on Friday restarts process.

FIGURE 22-1 Incremental Backup: Daily Cumulative

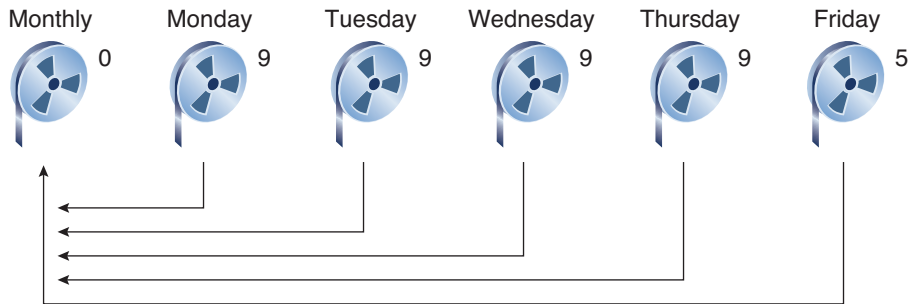

In the preceding example, you could have used other numbers in the 1–9 range to produce the same results. The key is using the same number Monday through Thursday, with any *lower* number on Friday. For example, you could have specified levels 4, 4, 4, 4, 2 or 7, 7, 7, 7, 5.

Example—Dump Levels for Daily, Incremental Backups

The following example shows a schedule where you capture only a day's work on different tapes. This type of backup is referred to as a daily, incremental backup. In this case, sequential dump level numbers are used during the week (3, 4, 5, 6) with a lower number (2) on Friday. The lower number on Friday restarts the processing.

FIGURE 22-2 Incremental Backup: Daily Incremental

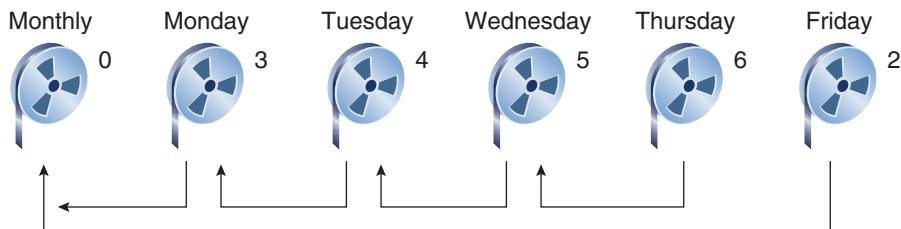

In the preceding example, you could have used the sequence 6, 7, 8, 9 followed by 2, or 5, 6, 7, 8 followed by 3. Remember, the numbers themselves have no defined meaning. You attribute meaning by ordering them in a specified sequence, as described in the examples.

Sample Backup Schedules

This section provides sample backup schedules. All schedules assume that you begin with a full backup (dump level 0), and that you use the `-u` option to record each backup in the `/etc/dumpdates` file.

Example—Daily Cumulative, Weekly Cumulative Backup Schedule

Table 22–7 shows the most commonly used incremental backup schedule. This schedule is recommended for most situations. With this schedule, the following occurs:

- Each day, all files that have changed since the lower-level backup at the end of the previous week are saved.
- For each weekday level 9 backup, the previous level 0 or level 5 backup is the closest backup at a lower level. Therefore, each weekday tape contains all the files that changed since the end of the previous week or the initial level 0 backup for the first week.
- For each Friday level 5 backup, the closest lower-level backup is the level 0 backup done at the beginning of the month. Therefore, each Friday's tape contains all the files changed during the month up to that point.

TABLE 22–7 Daily Cumulative/Weekly Cumulative Backup Schedule

	Floating	Mon	Tues	Wed	Thurs	Fri
1st of Month	0					
Week 1		9	9	9	9	5
Week 2		9	9	9	9	5
Week 3		9	9	9	9	5
Week 4		9	9	9	9	5

The following table shows how the contents of the tapes can change across two weeks with the daily cumulative, weekly cumulative schedule. Each letter represents a different file.

TABLE 22–8 Contents of Tapes for Daily Cumulative/Weekly Cumulative Backup Schedule

	Mon	Tues	Wed	Thurs	Fri
Week 1	a b	a b c	a b c d	a b c d e	a b c d e f
Week 2	g	g h	g h i	g h i j	a b c d e f g h i j k

Tape Requirements for the Daily Cumulative, Weekly Cumulative Schedule

With this schedule, you need six tapes if you want to reuse daily tapes. However, you need nine tapes if you want to use four different daily tapes:

- One tape for the level 0 backup
- Four tapes for Fridays
- One or four daily tapes

If you need to restore a complete file system, you need the following tapes:

- The level 0 tape
- The most recent Friday tape
- The most recent daily tape since the last Friday tape, if any

Example—Daily Cumulative, Weekly Incremental Backup Schedule

The following table shows a schedule where each weekday tape accumulates all files that changed since the beginning of the week, or the initial level 0 backup for the first week. In addition, each Friday's tape contains all the files that changed that week.

TABLE 22-9 Daily Cumulative, Weekly Incremental Backup Schedule

	Floating	Mon	Tues	Wed	Thurs	Fri
1st of Month	0					
Week 1		9	9	9	9	3
Week 2		9	9	9	9	4
Week 3		9	9	9	9	5
Week 4		9	9	9	9	6

The following table shows how the contents of the tapes can change across two weeks with the daily cumulative, weekly incremental backup schedule. Each letter represents a different file.

TABLE 22-10 Contents of Tapes for Daily Cumulative, Weekly Incremental Backup Schedule

	Mon	Tues	Wed	Thurs	Fri
Week 1	a b	a b c	a b c d	a b c d e	a b c d e f
Week 2	g	g h	g h i	g h i j	g h i j k

Tape Requirements for the Daily Cumulative, Weekly Incremental Backup Schedule

With this schedule, you need six tapes if you want to reuse daily tapes. However, you need nine tapes if you want to use four different daily tapes:

- One tape for the level 0 backup
- Four tapes for Fridays
- One or four daily tapes

If you need to restore a complete file system, you need the following tapes:

- The level 0 tape
- All the Friday tapes

- The most recent daily tape since the last Friday tape, if any

Example—Daily Incremental, Weekly Cumulative Backup Schedule

The following table shows a schedule where each weekday tape contains only the files that changed since the previous day. In addition, each Friday's tape contains all files changed since the initial level 0 backup at the beginning of the month.

TABLE 22-11 Daily Incremental, Weekly Cumulative Backup Schedule

	Floating	Mon	Tues	Wed	Thurs	Fri
1st of Month	0					
Week 1		3	4	5	6	2
Week 2		3	4	5	6	2
Week 3		3	4	5	6	2
Week 4		3	4	5	6	2

The following table shows how the contents of the tapes can change across two weeks with the daily incremental, weekly cumulative schedule. Each letter represents a different file.

TABLE 22-12 Contents of Tapes for Daily Incremental, Weekly Cumulative Backup Schedule

	Mon	Tues	Wed	Thurs	Fri
Week 1	a b	c d	e f g	h i	a b c d e f g h i
Week 2	j k l	m	n o	p q	a b c d e f g h i j k l m n o p q r s

Tape Requirements for Daily Incremental, Weekly Cumulative Schedule

With this schedule, you need at least 9 tapes if you want to reuse daily tapes, which is not recommended. Preferably, you need 21 tapes if you save weekly tapes for a month: one tape for the level 0, 4 tapes for the Friday backups, and 4 or 16 daily tapes.

- 1 tape for the level 0 backup
- 4 tapes for all the Friday backups
- 4 or 16 daily tapes

If you need to restore the complete file system, you need the following tapes:

- The level 0 tape
- The most recent Friday tape
- All the daily tapes since the last Friday tape, if any

Example—Monthly Backup Schedule for a Server

The following table shows an example backup strategy for a heavily used file server on a small network where users are doing file-intensive work, such as program development or document production. This example assumes that the backup period begins on a Sunday and consists of four seven-day weeks.

TABLE 22-13 Example of Monthly Backup Schedule for a Server

Directory	Date	Dump Level	Tape Name
root (/)	1st Sunday	0	<i>n</i> tapes
/usr	1st Sunday	0	<i>n</i> tapes
/export	1st Sunday	0	<i>n</i> tapes
/export/home	1st Sunday	0	<i>n</i> tapes
	1st Monday	9	A
	1st Tuesday	9	B
	1st Wednesday	5	C
	1st Thursday	9	D
	1st Friday	9	E
	1st Saturday	5	F
root (/)	2nd Sunday	0	<i>n</i> tapes
/usr	2nd Sunday	0	<i>n</i> tapes
/export	2nd Sunday	0	<i>n</i> tapes
/export/home	2nd Sunday	0	<i>n</i> tapes
	2nd Monday	9	G
	2nd Tuesday	9	H
	2nd Wednesday	5	I
	2nd Thursday	9	J
	2nd Friday	9	K
	2nd Saturday	5	L
root (/)	3rd Sunday	0	<i>n</i> tapes
/usr	3rd Sunday	0	<i>n</i> tapes
/export	3rd Sunday	0	<i>n</i> tapes

TABLE 22-13 Example of Monthly Backup Schedule for a Server (Continued)

Directory	Date	Dump Level	Tape Name
/export/home	3rd Sunday	0	<i>n</i> tapes
	3rd Monday	9	M
	3rd Tuesday	9	N
	3rd Wednesday	5	O
	3rd Thursday	9	P
	3rd Friday	9	Q
	3rd Saturday	5	R
root (/)	4th Sunday	0	<i>n</i> tapes
/usr	4th Sunday	0	<i>n</i> tapes
/export	4th Sunday	0	<i>n</i> tapes
/export/home	4th Sunday	0	<i>n</i> tapes
	4th Monday	9	S
	4th Tuesday	9	T
	4th Wednesday	5	U
	4th Thursday	9	V
	4th Friday	9	W
	4th Saturday	5	X

With this schedule, you use $4n$ tapes, the number of tapes needed for 4 full backups of the root (/), /usr, /export, and /export/home file systems. Also, you need 24 additional tapes for the incremental backups of the /export/home file systems. This schedule assumes that each incremental backup uses one tape and that you save the tapes for a month.

Here's how this schedule works:

1. On each Sunday, do a full backup (level 0) of the root (/), /usr, /export, and /export/home file systems. Save the level 0 tapes for at least three months.
2. On the first Monday of the month, use tape A to do a level 9 backup of the /export/home file system. The `ufsdump` command copies all files changed since the previous lower-level backup. In this case, the previous lower-level backup is the level 0 backup that you did on Sunday.
3. On the first Tuesday of the month, use tape B to do a level 9 backup of the /export/home file system. Again, the `ufsdump` command copies all files changed since the last lower-level backup, which is Sunday's level 0 backup.

4. On the first Wednesday of the month, use tape C to do a level 5 backup of the `/export/home` file system. The `ufsdump` command copies all files that changed since Sunday.
5. Do the Thursday and Friday level 9 backups of the `/export/home` file system on tapes D and E. The `ufsdump` command copies all files that changed since the last lower-level backup, which is Wednesday's level 5 backup.
6. On the first Saturday of the month, use tape F to do a level 5 backup of `/export/home`. The `ufsdump` command copies all files changed since the previous lower-level backup (in this case, the level 0 backup you did on Sunday). Store tapes A–F until the first Monday of the next four-week period, when you use them again.
7. Repeat steps 1–6 for the next three weeks, using tapes G–L and $4n$ tapes for the level 0 backup on Sunday, and so on.
8. For each four-week period, repeat steps 1–7, using a new set of tapes for the level 0 backups and reusing tapes A–X for the incremental backups. The level 0 tapes could be reused after three months.

This schedule lets you save files in their various states for a month. This plan requires many tapes, but ensures that you have a library of tapes to draw upon. To reduce the number of tapes, you could reuse Tapes A–F each week.

Backing Up UFS Files and File Systems (Tasks)

This chapter describes the procedures for backing up file systems by using the `ufsdump` command.

For information on these procedures, see [“Backing Up UFS Files and File System \(Task Map\)” on page 437](#).

For overview information about performing backups, see [Chapter 22, “Backing Up and Restoring UFS File Systems \(Overview\)”](#).

For information about backing up individual files to diskettes, see [Chapter 27, “Copying Files and File Systems \(Tasks\)”](#).

For additional information on the `ufsdump` command, see [Chapter 26, “UFS Backup and Restore Commands \(Reference\)”](#).

Backing Up UFS Files and File System (Task Map)

Task	Description	For Instructions
1. Prepare for file system backups.	Identify the file systems, the type of backup, and the tape device to be used for the backups.	“Preparing for File System Backups” on page 438
2. Determine the number of tapes needed to back up a file system.	Determine the number of tapes that are needed for a full backup of a file system.	“How to Determine the Number of Tapes Needed for a Full Backup” on page 439

Task	Description	For Instructions
3. Back up file systems.	<p>Perform a full backup of file systems to get baseline copies of all files.</p> <p>Perform an incremental backup of file systems based on whether keeping copies of files that have changed on a daily basis is important at your site.</p>	“How to Back Up a UFS File System to Tape” on page 440

Preparing for File System Backups

The preparation for backing up file systems begins with planning, which is described in [Chapter 22, “Backing Up and Restoring UFS File Systems \(Overview\),”](#) and includes choosing the following:

- The file systems to back up
- The type of backup (full or incremental) to perform
- A backup schedule
- A tape drive

For more information, see [Chapter 22, “Backing Up and Restoring UFS File Systems \(Overview\).”](#)

This section describes two other tasks you might need to perform before you back up file systems:

- Finding the names of file systems to back up
- Determining the number of tapes that are needed for a full backup

▼ How to Find UFS File System Names

- 1 **Display the contents of the `/etc/vfstab` file.**
`$ more /etc/vfstab`
- 2 **Look in the `mount point` column for the name of the file system.**
- 3 **Use the directory name listed in the `mount point` column when you back up the file system.**

Example 23-1 Finding File System Names

In this example, the file systems to be backed up are root (`/`), `/usr`, and `/export/home`.

```
# more /etc/vfstab
#device      device      mount      FS      fsck      mount      mount
#to mount    to fsck     point      type     pass     at boot   options
```

```
#
fd - /dev/fd fd - no -
/proc - /proc proc - no
/dev/dsk/c0t0d0s1 - - swap - no -
/dev/dsk/c0t0d0s0 /dev/rdisk/c0t0d0s0 / ufs 1 no -
/dev/dsk/c0t0d0s6 /dev/rdisk/c0t0d0s6 /usr ufs 1 no -
/dev/dsk/c0t0d0s7 /dev/rdisk/c0t0d0s7 /export/home ufs 2 yes -
/devices - /devices devfs - no -
sharefs - /etc/dfs/sharetab sharefs - no -
ctfs - /system/contract ctfs - no -
objfs - /system/object objfs - no -
swap - /tmp tmpfs - yes -
```

▼ How to Determine the Number of Tapes Needed for a Full Backup

- 1 Become superuser or assume an equivalent role.
- 2 Estimate the size of the backup in bytes.

```
# ufsdump [0]S file-system
```

Use the `S` option to display the estimated number of bytes that are needed to do the backup if this is the first backup of the file system.

Use the `0S` option to display the estimated number of bytes that are needed to do the backup if this is not the first backup of the file system.

- 3 Divide the estimated size by the capacity of the tape to determine how many tapes you need.

For a list of tape capacities, see [Table 22-5](#).

Example 23-2 Determining the Number of Tapes

In this example, the file system easily fits on a 150-MB tape.

```
# ufsdump S /export/home
178176
```

Backing Up a UFS File System

The following are general guidelines for performing backups:

- Use single-user mode or unmount the file system, unless you are creating a snapshot of a file system. For information about UFS snapshots, see [Chapter 24, “Using UFS Snapshots \(Tasks\).”](#)

- Be aware that backing up file systems when directory-level operations (such as creating, removing, and renaming files) and file-level activity are occurring simultaneously means that some data will not be included in the backup.
- You can run the `ufsdump` command from a single system and remotely back up groups of systems across the network through remote shell or remote login. In addition, you can direct the output to the system on which the tape device is located. Typically, the tape device is located on the system from which you run the `ufsdump` command, but it does not have to be. Another way to back up files to a remote device is to pipe the output from the `ufsdump` command to the `dd` command. For information about using the `dd` command, see [Chapter 27, “Copying Files and File Systems \(Tasks\)”](#).
- If you are doing remote backups across the network, the system with the tape device must have entries in its `/.rhosts` file for each client that will be using the device. Also, the system that initiates the backup must be included in the `/.rhosts` file on each system that it will back up.

▼ How to Back Up a UFS File System to Tape

The following are general steps for backing up file systems by using the `ufsdump` command. The examples show specific uses of options and arguments.

1 Become superuser or assume an equivalent role.

2 Bring the system to run level S (single-user mode).

For example:

```
# shutdown -g30 -y
```

3 (Optional) Check the file system for consistency.

For example:

```
# fsck -m /dev/rdisk/c0t0d0s7
```

The `fsck -m` command checks for the consistency of file systems. For example, power failures can leave files in an inconsistent state. For more information on the `fsck` command, see [Chapter 20, “Checking UFS File System Consistency \(Tasks\)”](#).

4 If you need to back up file systems to a remote tape drive, follow these steps:

a. On the system to which the tape drive is attached (the tape server), add the following entry to its `/.rhosts` file:

```
host root
```

The `host` entry specifies the name of the system on which you will run the `ufsdump` command to perform the backup.

- b. On the tape server, verify that the host added to the `/etc/hosts` file is accessible through the name service.
- 5 Identify the device name of the tape drive.
The default tape drive is the `/dev/rmt/0` device.
- 6 Insert a tape that is write-enabled into the tape drive.
- 7 Back up file systems.
`# ufsdump options arguments filenames`
You can back up file systems or directories, or files within file systems. For information on backing up individual files, see [tar\(1\)](#) or [cpio\(1\)](#).
The following examples show how to use the most common `ufsdump` options and arguments:
 - [Example 23-3](#)
 - [Example 23-4](#)
 - [Example 23-5](#)
 - [Example 23-6](#)
 For other `ufsdump` options and arguments, see [Chapter 26, “UFS Backup and Restore Commands \(Reference\)”](#).
- 8 If prompted, remove the tape and insert the next tape volume.
- 9 Label each tape with the volume number, dump level, date, system name, disk slice, and file system.
- 10 Bring the system back to run level 3 by pressing Control-D.
- 11 Verify that the backup was successful.
`# ufsrestore tf device-name`

Example 23-3 Performing a Full Backup of a UFS root (/) File system

The following example shows how to do a full backup of the root (/) file system. The system in this example is brought to single-user mode before the backup. The following `ufsdump` options are included:

- `0` specifies a `0` level dump (or a full backup).
- `u` specifies that the `/etc/dumpdates` file is updated with the date of this backup.
- `c` identifies a cartridge tape device.
- `f /dev/rmt/0` identifies the tape device.
- `/` is the file system being backed up.

For example:

```
# init 0
ok boot -s
.
.
.
# ufsdump 0ucf /dev/rmt/0 /
DUMP: Date of this level 0 dump: Mon Jul 12 10:00:50 2010
DUMP: Date of last level 0 dump: the epoch
DUMP: Dumping /dev/rdisk/c0t0d0s0 (starbug:/) to /dev/rmt/0.
DUMP: Mapping (Pass I) [regular files]
DUMP: Mapping (Pass II) [directories]
DUMP: Writing 63 Kilobyte records
DUMP: Estimated 1843276 blocks (900.04MB).
DUMP: Dumping (Pass III) [directories]
DUMP: Dumping (Pass IV) [regular files]
DUMP: 1843252 blocks (900.03MB) on 1 volume at 6602 KB/sec
DUMP: DUMP IS DONE
DUMP: Level 0 dump on Mon Jul 12 10:22:50 MDT 2010
# ufsrestore tf /dev/rmt/0
2      .
3      ./lost+found
4      ./usr
5      ./var
6      ./export
7      ./bin
8      ./dev
.
.
.
# (Press Control-D to bring system to run level 3)
```

Example 23-4 Performing an Incremental Backup of a UFS root (/) File System

The following example shows how to do an incremental backup of the root (/) file system in single-user mode. The following `ufsdump` options are included:

- `9` specifies a 9 level dump (or an incremental backup).
- `u` specifies that the `/etc/dumpdates` file is updated with the date of this backup.
- `c` identifies a cartridge tape device.
- `f /dev/rmt/0` identifies the tape device.
- `/` is the file system being backed up.

```
# init 0
ok boot -s
# ufsdump 9ucf /dev/rmt/0 /
DUMP: Date of this level 9 dump: Mon Jul 12 10:52:50 2010
DUMP: Date of last level 0 dump: Mon Jul 12 10:50:50 2010
DUMP: Dumping /dev/rdisk/c0t0d0s0 (starbug:/) to /dev/rmt/0.
DUMP: Mapping (Pass I) [regular files]
DUMP: Mapping (Pass II) [directories]
DUMP: Mapping (Pass II) [directories]
```

```

DUMP: Mapping (Pass II) [directories]
DUMP: Writing 63 Kilobyte records
DUMP: Estimated 422 blocks (211KB).
DUMP: Dumping (Pass III) [directories]
DUMP: Dumping (Pass IV) [regular files]
DUMP: 376 blocks (188KB) on 1 volume at 1843 KB/sec
DUMP: DUMP IS DONE
DUMP: Level 9 dump on Mon Jul 12 10:55:50 2010
# ufsrestore tf /dev/rmt/0
    2      .
    9      ./etc
   304    ./etc/dumpdates
  1117   ./devices
  1118   ./devices/pseudo
  3381   ./devices/pseudo/pts@0:1
.
.
.

# init 0
ok boot -s
# ufsdump 9ucf /dev/rmt/0 /
DUMP: Date of this level 9 dump: Mon Jul 12 10:33:14 2010
DUMP: Date of last level 0 dump: the epoch
DUMP: Dumping /dev/rdisk/c2t1d0s0 (v880-brm-03:/root) to /dev/rmt/0.
DUMP: Mapping (Pass I) [regular files]
DUMP: Mapping (Pass II) [directories]
DUMP: Writing 63 Kilobyte records
DUMP: Estimated 120694 blocks (58.93MB).
DUMP: Dumping (Pass III) [directories]
DUMP: Dumping (Pass IV) [regular files]
DUMP: 120580 blocks (58.88MB) on 1 volume at 9026 KB/sec
DUMP: DUMP IS DONE
DUMP: Level 9 dump on Mon Jul 12 10:33:14 2010
# ufsrestore tf /dev/rmt/0
    2      .
    9      ./etc
   304    ./etc/dumpdates
  1117   ./devices
  1118   ./devices/pseudo
  3381   ./devices/pseudo/pts@0:1
.
.
.

```

Example 23-5 Performing a Full Backup of a UFS Home Directory

The following example shows how to do a full backup of the `/export/home/kryten` home directory. The following `ufsdump` options are included:

- `0` specifies that this is a `0` level dump (or a full backup).
- `u` specifies that the `/etc/dumpdates` file is updated with the date of this backup.
- `c` identifies a cartridge tape device.
- `f /dev/rmt/0` identifies the tape device.
- `/export/home/kryten` is the directory being backed up.

```

# ufsdump 0ucf /dev/rmt/0 /export/home/kryten
DUMP: Date of this level 0 dump: Wed Jul 10:35:18 2010
DUMP: Date of last level 0 dump: the epoch
DUMP: Dumping /dev/rdisk/c0t0d0s7 (starbug:/export/home) to /dev/rmt/0.
DUMP: Mapping (Pass I) [regular files]
DUMP: Mapping (Pass II) [directories]
DUMP: Writing 63 Kilobyte records
DUMP: Estimated 105158 blocks (51.35MB).
DUMP: Dumping (Pass III) [directories]
DUMP: Dumping (Pass IV) [regular files]
DUMP: 105082 blocks (51.31MB) on 1 volume at 5025 KB/sec
DUMP: DUMP IS DONE
DUMP: Level 9 dump on Mon Jul 12 10:38:14 2010
# ufsrestore tf /dev/rmt/0
232      ./kryten
233      ./kryten/filea
234      ./kryten/fileb
235      ./kryten/filec
236      ./kryten/letters
237      ./kryten/letters/letter1
238      ./kryten/letters/letter2
239      ./kryten/letters/letter3
240      ./kryten/reports
241      ./kryten/reports/reportA
242      ./kryten/reports/reportB
243      ./kryten/reports/reportC

```

Example 23–6 Performing a Full Backup to a Remote System (Solaris 10 Data to Solaris 10 System)

The following example shows how to do a full backup of a local `/export/home` file system on a Solaris 10 system (`mars`) to a tape device on a remote Solaris 10 system (`earth`) in single-user mode. The systems must be set up so that remote access is enabled. The following `ufsdump` options are included:

- `0` specifies a `0` level dump (or a full backup).
- `u` specifies that the `/etc/dumpdates` file is updated with the date of this backup.
- `c` identifies a cartridge tape device.
- `f earth:/dev/rmt/0` identifies the remote system name and tape device.
- `/export/home` is the file system being backed up.

```

# ufsdump 0ucf earth:/dev/rmt/0 /export/home
DUMP: Date of this level 0 dump: Mon Jul 12 10:36:30 MDT 2010
DUMP: Date of last level 0 dump: the epoch
DUMP: Dumping /dev/rdisk/c0t0d0s7 (mars:/export/home) to earth:/dev/rmt/0.
DUMP: Mapping (Pass I) [regular files]
DUMP: Mapping (Pass II) [directories]
DUMP: Writing 63 Kilobyte records
DUMP: Estimated 105172 blocks (51.35MB).
DUMP: Dumping (Pass III) [directories]
DUMP: Dumping (Pass IV) [regular files]
DUMP: 105082 blocks (51.31MB) on 1 volume at 4425 KB/sec
DUMP: DUMP IS DONE
DUMP: Level 0 dump on Mon Jul 12 10:39:30 MDT 2010

```

```
# ufsrestore tf earth:/dev/rmt/0
2      .
3      ./lost+found
4      ./kryten
5      ./kryten/filea
6      ./kryten/fileb
7      ./kryten/filec
8      ./kryten/letters
9      ./kryten/letters/letter1
10     ./kryten/letters/letter2
11     ./kryten/letters/letter3
12     ./kryten/reports
.
.
.
```

Using UFS Snapshots (Tasks)

This chapter describes how to create and back up UFS snapshots.

For information on the procedures associated with creating UFS snapshots, see “Using UFS Snapshots (Task Map)” on page 447.

For overview information about performing backups, see Chapter 22, “Backing Up and Restoring UFS File Systems (Overview).”

Using UFS Snapshots (Task Map)

Task	Description	For Instructions
1. Create a UFS snapshot.	Create a read-only copy of a file system by using the <code>fsnap</code> command.	“How to Create a UFS Snapshot” on page 451
2. Display UFS snapshot information.	Identify UFS snapshot information such as the raw snapshot device.	“How to Display UFS Snapshot Information” on page 452
3. (Optional) Delete a UFS snapshot.	Delete a snapshot that is already backed up or no longer needed.	“How to Delete a UFS Snapshot” on page 453
4. (Optional) Back up a UFS snapshot.	Choose one of the following backup methods:	
	Create a full backup of a UFS snapshot by using the <code>ufsdump</code> command.	“How to Create a Full Backup of a UFS Snapshot (<code>ufsdump</code>)” on page 454
	Create an incremental backup of a UFS snapshot by using the <code>ufsdump</code> command.	“How to Create an Incremental Backup of a UFS Snapshot (<code>ufsdump</code>)” on page 455

Task	Description	For Instructions
	Back up a UFS snapshot by using the <code>tar</code> command.	“How to Back Up a UFS Snapshot (tar)” on page 456
5. (Optional) Restore data from a UFS snapshot.	Restore the UFS snapshot the same way as you would restore data by using the <code>ufsrestore</code> command.	“How to Restore a Complete UFS File System” on page 464

UFS Snapshots Overview

You can use the `fsnap` command to back up file systems while the file system is mounted. This command creates a read-only snapshot of a file system. A *snapshot* is a file system's temporary image that is intended for backup operations.

When the `fsnap` command is run, it creates a virtual device and a backing-store file. You can back up the *virtual device*, which looks and acts like a real device, with any of the existing Solaris backup commands. The *backing-store file* is a bitmap file that contains copies of pre snapshot data that has been modified since the snapshot was taken.

Keep the following key points in mind when specifying backing-store files:

- The destination path of the backing store files must have enough free space to hold the file system data. The size of the backing store files vary with the amount of activity on the file system.
- The backing store file location must be different from the file system that is being captured in a snapshot.
- The backing-store files can reside on any type of file system, including another UFS file system or an NFS file system.
- Multiple backing-store files are created when you create a snapshot of a UFS file system that is larger than 512 GB.
- Backing-store files are sparse files. The logical size of a sparse file, as reported by the `ls` command, is not the same as the amount of space that has been allocated to the sparse file, as reported by the `du` command.

For more information about creating snapshots for a UFS file system larger than 512 GB, see [“Creating a Multiterabyte UFS Snapshot” on page 450](#).

Why Use UFS Snapshots?

The UFS snapshots feature provides additional availability and convenience for backing up a file system because the file system remains mounted and the system remains in multiuser mode during backups. Then, you can use the `tar` or `cpio` commands to back up a UFS snapshot to

tape for more permanent storage. If you use the `ufsdump` command to perform backups, the system should be in single-user mode to keep the file system inactive when you perform backups.

The `fsnap` command gives administrators of non enterprise-level systems the power of enterprise-level tools, such as Sun StorEdge Instant Image, without the large storage demands.

The UFS snapshots feature is similar to the Instant Image product. Although UFS snapshots can make copies of large file systems, Instant Image is better suited for enterprise-level systems. UFS snapshots is better suited for smaller systems. Instant Image allocates space equal to the size of the entire file system that is being captured. However, the backing-store file that is created by UFS snapshots occupies only as much disk space as needed.

This table describes specific differences between UFS snapshots and Instant Image.

UFS Snapshots	Sun StorEdge Instant Image
Size of the backing-store file depends on how much data has changed since the snapshot was taken	Size of the backing-store file equals the size of the entire file system being copied
Does not persist across system reboots	Persists across system reboots
Works on UFS file systems	Cannot be used with root (/) or /usr file systems
Available in the Oracle Solaris release	Part of Sun StorEdge products

UFS Snapshots Performance Issues

When the UFS snapshot is first created, users of the file system might notice a slight pause. The length of the pause increases with the size of the file system to be captured. While the snapshot is active, users of the file system might notice a slight performance impact when the file system is written to. However, they see no impact when the file system is read.

Creating and Deleting UFS Snapshots

When you use the `fsnap` command to create a UFS snapshot, observe how much disk space the backing-store file consumes. The backing-store file initially uses no space, and then it grows quickly, especially on heavily used systems. Make sure that the backing-store file has enough space to expand. Or, limit its size with the `-o maxsize=n [k, m, g]` option, where $n [k, m, g]$ is the maximum size of the backing-store file.



Caution – If the backing-store file runs out of space, the snapshot might delete itself, which causes the backup to fail. Check the `/var/adm/messages` file for possible snapshot errors.

You can also specify a directory for the backing-store path, which means a backing store file is created in the directory specified. For example, if `/var/tmp` is specified for the backing-store path, the following backing-store file is created.

```
/var/tmp/snapshot0
```

If you created one large root (`/`) file system instead of creating separate file systems for `/export/home`, `/usr`, and so on, you will be unable to create a snapshot of those separate file systems. For example, this system does not have a separate file system for `/usr` as indicated under the Mounted on column:

```
# df -k /usr
Filesystem          kbytes  used  avail capacity  Mounted on
/dev/dsk/c0t0d0s0  3618177 2190002 1391994    62%      /
```

If you attempt to create a snapshot for the `/usr` file system, you will see a message similar to the following:

```
# fssnap -F ufs -o bs=/snaps/usr.back.file /usr
snapshot error: Invalid backing file path
```

This message indicates that you cannot have the backing store file on the same file system as the file system being snapped, which is the case for the `/usr` file system, in this example.

For more information, see the [fssnap_ufs\(1M\)](#) man page.

Creating a Multiterabyte UFS Snapshot

Creating a multiterabyte UFS snapshot is identical to creating a snapshot for a smaller UFS file system. The only difference is that multiple backing store files are created for each 512 GB of file system space.

Keep the following key points in mind when creating a snapshot for a file system that is larger than 512 GB:

- Multiple backing store files are created.
 - If you specify a backing store file name when the snapshot is created, then the subsequent backing store file names will be iterated based on the file name that you specify. The subsequent backing-store files will have the same name, but with the suffixes `.2`, `.3`, and so on.

- If you only specify a backing store file destination (or directory) and not a backing store file name, then multiple backing store file names will be created and iterated with the suffixes .2, .3, and so on.
- The `fssnap -i` command only reports the first backing store file name even if multiple backing store files have been created. However, the reported backing-store length is the combined sizes of all the backing store files for the snapshot.

Note – Backing-store files are sparse files. The logical size of a sparse file, as reported by the `ls` command, is not the same as the amount of space that has been allocated to the sparse file, as reported by the `du` command.

- After you have backed up the snapshot or you would just like to remove the snapshot, you will have to remove the backing store files manually if you did not use the `unlink` option when the snapshot was created.

For an example of creating a snapshot for a file system that is larger than 512 GB, see [Example 24–2](#).

For more information, see [fssnap_ufs\(1M\)](#).

▼ How to Create a UFS Snapshot

- 1 **Become superuser or assume an equivalent role.**
- 2 **Make sure that the file system has enough disk space for the backing-store file.**
`df -k`
- 3 **Make sure that a backing-store file of the same name and location does not already exist.**
`ls /backing-store-file`
- 4 **Create the UFS snapshot.**
`fssnap -F ufs -o bs=/backing-store-file /file-system`

Note – The backing-store file must reside on a different file system than the file system that is being captured using UFS snapshots.

- 5 **Verify that the snapshot has been created.**
`/usr/lib/fs/ufs/fssnap -i /file-system`

Example 24-1 Creating a UFS Snapshot

The following example shows how to create a snapshot of the `/usr` file system. The backing-store file is `/scratch/usr.back.file`. The virtual device is `/dev/fssnap/1`.

```
# fssnap -F ufs -o bs=/scratch/usr.back.file /usr
/dev/fssnap/1
```

The following example shows how to limit the backing-store file to 500 MB.

```
# fssnap -F ufs -o maxsize=500m,bs=/scratch/usr.back.file /usr
/dev/fssnap/1
```

Example 24-2 Creating a Multiterabyte UFS Snapshot

The following example shows how to create a snapshot of a 1.6 TB UFS file system.

```
# fssnap -F ufs -o bs=/var/tmp /datab
/dev/fssnap/2
# /usr/lib/fs/ufs/fssnap -i /datab
Snapshot number      : 2
Block Device         : /dev/fssnap/2
Raw Device           : /dev/rfssnap/2
Mount point          : /datab
Device state         : idle
Backing store path   : /var/tmp/snapshot3
Backing store size    : 0 KB
Maximum backing store size : Unlimited
Snapshot create time : Mon Jul 12 10:37:50 2010
Copy-on-write granularity : 32 KB
```

▼ How to Display UFS Snapshot Information

You can display the current snapshots on the system by using the `fssnap -i` option. If you specify a file system, you see detailed information about that file system snapshot. If you don't specify a file system, you see information about all of the current UFS snapshots and their corresponding virtual devices.

Note – Use the UFS file system-specific `fssnap` command to view the extended snapshot information as shown in the following examples.

- 1 **Become superuser or assume an equivalent role.**
- 2 **List all current snapshots.**

For example:

```
# /usr/lib/fs/ufs/fssnap -i
Snapshot number      : 0
Block Device         : /dev/fssnap/0
```

```

Raw Device           : /dev/rfssnap/0
Mount point          : /export/home
Device state         : idle
Backing store path   : /var/tmp/snapshot0
Backing store size   : 0 KB
Maximum backing store size : Unlimited
Snapshot create time : Mon Jul 12 10:37:50 2010
Copy-on-write granularity : 32 KB

```

3 Display detailed information about a specific snapshot.

For example:

```

# /usr/lib/fs/ufs/fssnap -i /export
Snapshot number      : 1
Block Device         : /dev/fssnap/1
Raw Device           : /dev/rfssnap/1
Mount point          : /export
Device state         : idle
Backing store path   : /var/tmp/snapshot1
Backing store size   : 0 KB
Maximum backing store size : Unlimited
Snapshot create time : Mon Jul 12 10:37:50 2010
Copy-on-write granularity : 32 KB

```

Deleting a UFS Snapshot

When you create a UFS snapshot, you can specify that the backing-store file is unlinked. An unlinked backing-store file is removed after the snapshot is deleted. If you don't specify the `-o unLink` option when you create a UFS snapshot, you must manually delete the backing-store file.

The backing-store file occupies disk space until the snapshot is deleted, whether you use the `-o unLink` option to remove the backing-store file or you manually delete the file.

▼ How to Delete a UFS Snapshot

You can delete a snapshot either by rebooting the system or by using the `fssnap -d` command. When you use this command, you must specify the path of the file system that contains the UFS snapshot.

1 Become superuser or assume an equivalent role.

2 Identify the snapshot to be deleted.

```
# /usr/lib/fs/ufs/fssnap -i
```

3 Delete the snapshot.

```
# fssnap -d /file-system
Deleted snapshot 1.
```

- 4 If you did not use the `-o unLink` option when you created the snapshot, manually delete the backing-store file.

```
# rm /file-system/backing-store-file
```

Example 24-3 Deleting a UFS Snapshot

The following example shows how to delete a snapshot and assumes that the `-o unLink` option was not used.

```
# fssnap -i
  0    /export/home
  1    /export
# fssnap -d /export
Deleted snapshot 1.
# rm /var/tmp/snapshot1
```

Backing Up a UFS Snapshot

You can create a full backup or an incremental backup of a UFS snapshot. You can use the standard Solaris backup commands to back up a UFS snapshot.

The virtual device that contains the UFS snapshot acts as a standard read-only device. So, you can back up the virtual device as if you were backing up a file system device.

If you are using the `ufsdump` command to back up a UFS snapshot, you can specify the snapshot name during the backup. See the following procedure for more information.

▼ How to Create a Full Backup of a UFS Snapshot (ufsdump)

- 1 Become superuser or assume an equivalent role.
- 2 Identify the UFS snapshot to be backed up.

```
# /usr/lib/fs/ufs/fssnap -i /file-system
```

For example:

```
# /usr/lib/fs/ufs/fssnap -i /usr
Snapshot number      : 1
Block Device         : /dev/fssnap/1
Raw Device           : /dev/rfssnap/1
Mount point          : /usr
Device state         : idle
Backing store path   : /var/tmp/snapshot2
```

```
Backing store size           : 544 KB
Maximum backing store size  : Unlimited
Snapshot create time        : Mon Jul 12 10:37:50 2010
Copy-on-write granularity   : 32 KB
```

3 Back up the UFS snapshot.

```
# ufsdump 0ucf /dev/rmt/0 /snapshot-name
```

For example:

```
# ufsdump 0ucf /dev/rmt/0 /dev/rfssnap/1
```

4 Verify that the snapshot has been backed up.

For example:

```
# ufsrestore tf /dev/rmt/0
```

▼ How to Create an Incremental Backup of a UFS Snapshot (ufsdump)

Backing up a UFS snapshot incrementally means that only the files that have been modified since the last snapshot are backed up. Use the `ufsdump` command with the `N` option. This option specifies the file system device name to be inserted into the `/etc/dumpdates` file for tracking incremental dumps.

The following `ufsdump` command specifies an embedded `fssnap` command to create an incremental backup of a file system.

1 Become superuser or assume an equivalent role.

2 Create an incremental backup of a UFS snapshot.

For example:

```
# ufsdump 1ufN /dev/rmt/0 /dev/rdisk/c0t1d0s0 'fssnap -F ufs -o raw,bs=
/export/scratch,unlink /dev/rdisk/c0t1d0s0'
```

In this example, the `-o raw` option is used to display the name of the raw device instead of the block device. By using this option, you make it easier to embed the `fssnap` command in commands (such as the `ufsdump` command) that require the raw device instead.

3 Verify that the snapshot has been backed up.

```
# ufsrestore ta /dev/rmt/0
```

▼ How to Back Up a UFS Snapshot (tar)

If you are using the `tar` command to back up the snapshot, mount the snapshot before backing it up.

1 Become superuser or assume an equivalent role.

2 Create a mount point for the snapshot.

For example:

```
# mkdir /backups/home.bkup
```

3 Mount the snapshot.

```
# mount -F ufs -o ro /dev/fssnap/1 /backups/home.bkup
```

4 Change to the mounted snapshot directory.

```
# cd /backups/home.bkup
```

5 Back up the snapshot with the tar command.

```
# tar cvf /dev/rmt/0 .
```

Restoring Data From a UFS Snapshot Backup

The backup created from the virtual device is essentially just a backup of what the original file system looked like when the snapshot was taken. When you restore a file system from the backup, restore as if you had taken the backup directly from the original file system. Such a restore uses the `ufs restore` command. For information on using the `ufs restore` command to restore a file or file system, see [Chapter 25, “Restoring UFS Files and File Systems \(Tasks\)”](#).

Restoring UFS Files and File Systems (Tasks)

This chapter describes how to use the `ufs restore` command to restore files and file systems that were backed up by using the `ufsdump` command.

For information on the procedures associated with restoring files and file systems, see [“Restoring UFS Files and File System Backups \(Task Map\)”](#) on page 457.

For information about other commands you can use to archive, restore, copy, or move files and file systems, see [Chapter 27, “Copying Files and File Systems \(Tasks\)”](#).

For information about backing up and restoring file systems, see [Chapter 22, “Backing Up and Restoring UFS File Systems \(Overview\)”](#).

Restoring UFS Files and File System Backups (Task Map)

The following task map describes the procedures associated with restoring files and file systems.

Task	Description	For Instructions
Prepare to restore files and file systems.	Identify the file systems or files to be restored, the tape device, and how you will restore them.	“Preparing to Restore UFS Files and File Systems” on page 458
Determine which tapes to use.	Refer to your backup tapes to find the date of the last backup that contains the file or file system that you need to restore.	“How to Determine Which Tapes to Use” on page 459
Restore files.	Choose one of the following restore methods:	

Task	Description	For Instructions
	<p>Restore files interactively – Use this method when you are unsure of the file names because you can browse the media contents and select individual files and directories.</p> <p>Restore files noninteractively – Use this method when you already know the few file names to be restored.</p> <p>Restore a file system – Use this method when you get a new disk drive or as part of a recovery procedure.</p>	<p>“How to Restore UFS Files Interactively” on page 460</p> <p>“How to Restore Specific UFS Files Noninteractively” on page 463</p> <p>“How to Restore a Complete UFS File System” on page 464</p>
Restore the root (/) or /usr file systems.	Restoring the root (/) or /usr file systems involves booting the system from a local Solaris DVD or the network.	“How to Restore a UFS root (/) and /usr File System” on page 468

Preparing to Restore UFS Files and File Systems

The `ufs restore` command copies files to disk, relative to the current working directory, from backups that were created by using the `ufsdump` command. You can use the `ufs restore` command to reload an entire file system hierarchy from a level 0 dump and incremental dumps that follow it. You can also use this command to restore one or more single files from any backup tape. If you run the `ufs restore` command as superuser, files are restored with their original owner, last modification time, and mode (permissions).

Before you start to restore files or file systems, you need to know the following:

- The tapes (or diskettes) you need to restore from
- The raw device name on which you want to restore the file system
- The type of tape device you will use
- The device name (local or remote) for the tape device

Determining the UFS File System Name

If you have properly labeled your backup tapes, you should be able to use the file system name (`/dev/rdisk/device-name`) from the tape label. For more information, see [“How to Find UFS File System Names” on page 438](#).

Determining the Type of Tape Device You Need

You must use a tape device that is compatible with the backup media to restore the files. The format of the backup media determines which drive you must use to restore files. For example, if your backup media is 8-mm tape, you must use an 8-mm tape device to restore the files.

Determining the Tape Device Name

You might have specified the tape device name (`/dev/rmt/n`) as part of the backup tape label information. If you are using the same drive to restore a backup tape, you can use the device name from the label. For more information on media devices and device names, see [Chapter 28](#), “Managing Tape Drives (Tasks).”

Restoring UFS Files and File Systems

When you back up files and directories, you save them relative to the file system in which they belong. When you restore files and directories, the `ufs restore` command re-creates the file hierarchy in the current working directory.

For example, files backed up from the `/export/doc/books` directory (where `/export` is the file system) are saved relative to `/export`. In other words, the `book1` file in the `books` directory is saved as `./doc/books/book1` on the tape. Later on, if you restored the `./doc/books/book1` file to the `/var/tmp` directory, the file would be restored to `/var/tmp/doc/books/book1`.

When you restore individual files and directories, you should restore them to a temporary location, such as the `/var/tmp` directory. After you verify the files, you can move them to their proper locations. However, you can restore individual files and directories to their original locations. If you do so, be sure you are not overwriting newer files with older versions from the backup tape.

To avoid conflicts with other users, you might want to create and change to a subdirectory, such as `/var/tmp/restore` file, in which to restore the files.

If you are restoring a hierarchy, you should restore the files to a temporary directory on the same file system where the files will reside. Then, you can use the `mv` command to move the entire hierarchy where it belongs after it is restored.

Note – Do not restore files in the `/tmp` directory even temporarily. The `/tmp` directory is usually mounted as a TMPFS file system. TMPFS does not support UFS file system attributes such as ACLs.

▼ How to Determine Which Tapes to Use

- 1 Ask the user for the approximate date the files to be restored were last modified.
- 2 Refer to your backup plan to find the date of the last backup that contains the file or file system.

To retrieve the most recent version of a file, work backward through the incremental backups from highest to lowest dump level and from most recent to least recent date, unless the user requests otherwise.

3 If you have online archive files, identify the correct media.

```
# ufsrestore ta archive-name ./path/filename ./path/filename
```

t Lists each file on the tape.

a Reads the table of contents from the online archive file instead of from the tape.

archive-name Identifies the online archive file name.

./path/filename Identifies the file name or file names you are looking for on the online archive. If successful, the `ufsrestore` command prints out the inode number and file name. If unsuccessful, `ufsrestore` prints an error message.

For more information, see the [ufsrestore\(1M\)](#) man page.

4 Insert the media that contains the files to be restored in the drive and verify the correct media.

```
# ufsrestore tf /dev/rmt/n ./path/filename ./path/filename
```

Be sure to use the complete path for each *filename*. If a file is in the backup, its name and inode number are listed. Otherwise, a message states that the file is not on the volume.

5 If you have multiple backup files on the same tape, position the tape at the backup file you want to use.

```
# ufsrestore xfs /dev/rmt/n tape-number
```

Example 25-1 Determining Which Tapes to Use

The following example shows how to check if the `/etc/passwd` file is in the online archive.

```
# ufsrestore ta /var/tmp/root.archive ./etc/passwd
```

The following example shows how to verify that the `/etc/passwd` file is on the backup tape.

```
# ufsrestore tf /dev/rmt/0 ./etc/passwd
```

▼ How to Restore UFS Files Interactively

- 1 Become superuser or assume an equivalent role.
- 2 (Optional) Write-protect the tapes for safety.
- 3 Insert the volume 1 tape into the tape drive.

4 Change to a directory that will be used to restore the files to temporarily.

```
# cd /var/tmp
```

5 Start the interactive restoration.

```
# ufsrestore if /dev/rmt/n
```

Some informational messages and the `ufs restore>` prompt are displayed.

6 Create a list of files to be restored.**a. List the contents of a directory.**

```
ufsrestore> ls [directory-name]
```

b. Change to a directory.

```
ufsrestore> cd directory-name
```

c. Create a list of files and directories that you want to restore.

```
ufsrestore> add filenames
```

d. (Optional) Remove any directory or file from the list of files to be restored, if necessary.

```
ufsrestore> delete filename
```

7 (Optional) Display the file names as they are being restored.

```
ufsrestore> verbose
```

8 Restore the files.

```
ufsrestore> extract
```

The `ufsrestore` command asks you which volume number to use.

9 Type the volume number and press Return. If you have only one volume, type 1 and press Return.

```
Specify next volume #: 1
```

The files and directories in the list are extracted and restored to the current working directory.

10 To maintain the mode of the current directory, enter n at the set owner/mode prompt.

```
set owner/mode for './?' [yn] n
```

You must wait while the `ufs restore` command performs its final cleanup.

11 Quit the `ufsrestore` program.

```
ufsrestore> quit
```

You then see the shell prompt.

12 Verify the restored files.**a. List the restored files and directories.**

```
# ls -l
```

A list of files and directories is displayed.

b. Check the list to be sure that all the files and directories you specified in the list have been restored.**13 Move the files to the proper directories.****Example 25-2 Restoring UFS Files Interactively**

The following example shows how to extract the `/etc/passwd` and `/etc/shadow` files from the backup tape.

```
# cd /var/tmp
# ufsrestore if /dev/rmt/0
ufsrestore> ls
.:
.:
.sunw/      export/    net/       sbin/      usr/
Sources/    etools/   opt/       scde/      var/
b/          home/     ptools/    set/       vol/
bin         kernel/   pkg/       share/
dev/        lib/      platform/  shared/
devices/    lost+found/ proc/      src/
etc/        mnt/     rtools/    tmp/
ufsrestore> cd etc
ufsrestore> add passwd shadow
ufsrestore> verbose
verbose mode on
ufsrestore> extract
Extract requested files
You have not read any volumes yet.
Unless you know which volume your file(s) are on you should start
with the last volume and work towards the first.
Specify next volume #: 1
extract file ./etc/shadow
extract file ./etc/passwd
Add links
Set directory mode, owner, and times.
set owner/mode for './?' [yn] n
ufsrestore> quit
# cd etc
# mv passwd /etc
# mv shadow /etc
# ls -l /etc
```

▼ How to Restore Specific UFS Files Noninteractively

- 1 Become superuser or assume an equivalent role.
- 2 (Optional) Write-protect the tape for safety.
- 3 Insert the volume 1 tape into the tape drive.
- 4 Change to a directory that will be used to restore files to temporarily.

```
# cd /var/tmp
```
- 5 Restore the file or files.

```
# ufsrestore xvf /dev/rmt/n filename
```

 - x Tells `ufsrestore` to copy specific files or directories in the *filename* argument.
 - v Displays the file names as they are restored.
 - f /dev/rmt/n Identifies the tape device name.
 - filename* Specifies one or more file names or directory names, separated by spaces. For example: `./export/home/user1/mail ./export/home/user2/mail`.
- 6 Type the volume number where files are located. Press Return.

```
Specify next volume #: 1
```

The file or files are restored to the current working directory.
- 7 To maintain the mode of the current directory, type `n` and press Return at the `set owner/mode` prompt.

```
set owner/mode for '.'? [yn] n
```
- 8 Verify the restored files.
 - a. List the restored files and directories.

```
# ls -l
```

A list of files and directories is displayed.
 - b. Check the list to be sure that all the files and directories you specified in the list have been restored.
- 9 Move the files to the proper directories.

Example 25-3 Restoring Specific Files Noninteractively

The following example shows how to noninteractively restore the `passwd` and `shadow` files to the `/var/tmp` directory.

```
# cd /var/tmp
# ufsrestore xvf /dev/rmt/0 ./etc/passwd ./etc/shadow
Verify volume and initialize maps
Media block size is 126
Dump date: Wed Jul 14 13:36:17 2010
Dumped from: the epoch
Level 0 dump of / on starbug:/dev/dsk/c0t0d0s0
Label: none
Extract directories from tape
Initialize symbol table.
Extract requested files
You have not read any volumes yet.
Unless you know which volume your file(s) are on you should start
with the last volume and work towards the first.
Specify next volume #: 1
extract file ./etc/passwd
extract file ./etc/shadow
Add links
Set directory mode, owner, and times.
Specify next volume #:1
extract file ./etc/passwd
extract file ./etc/shadow
Add links
Set directory mode, owner, and times.
set owner/mode for './?' [yn] n
# cd etc
# mv passwd /etc
# mv shadow /etc
# ls -l /etc
```

Example 25-4 Restoring Files From a Remote Tape Device

You can restore files from a remote tape drive by adding *remote-host:* to the front of the tape device name, when using the `ufsrestore` command.

The following example shows how to restore files by using a remote tape drive `/dev/rmt/0` on the system `venus`.

```
# ufsrestore xf venus:/dev/rmt/0 ./etc/hosts
```

▼ How to Restore a Complete UFS File System

Occasionally, a file system becomes so damaged that you must completely restore it. Typically, you need to restore a complete file system after a disk failure. You might need to replace the hardware before you can restore the software. For information on how to replace a disk, see

“SPARC: Setting Up Disks for UFS File Systems (Task Map)” on page 215 or “x86: Setting Up Disks for UFS File Systems (Task Map)” on page 233.

Full restoration of a file system such as `/export/home` can take a lot of time. If you have consistently backed up file systems, you can restore them to their state from the time of the last incremental backup.

Note – You cannot use this procedure to restore the root (`/`) or `/usr` file systems. For instructions on restoring these file systems, see “How to Restore a UFS root (`/`) and `/usr` File System” on page 468.

1 Become superuser or assume an equivalent role.

2 If necessary, unmount the file system.

```
# umount /dev/rdisk/device-name
```

Or:

```
# umount /file-system
```

3 Create the new file system.

```
# newfs /dev/rdisk/device-name
```

You are asked if you want to construct a new file system on the raw device. Verify that the *device-name* is correct so that you don't destroy the wrong file system.

For more information, see the `newfs(1M)` man page.

4 Confirm that the new file system should be created.

```
newfs: construct a new file system /dev/rdisk/cwtxdysz:(y/n)? y
```

The new file system is created.

5 Mount the new file system on a temporary mount point.

```
# mount /dev/dsk/device-name /mnt
```

6 Change to the mount point directory.

```
# cd /mnt
```

7 (Optional) Write-protect the tapes for safety.

8 Insert the first volume of the level 0 tape into the tape drive.

9 Restore the files.

```
# ufsrestore rvf /dev/rmt/n
```

The dump level 0 backup is restored. If the backup required multiple tapes, you are prompted to load each tape in numeric order.

10 Remove the tape and load the next level tape in the drive.

Always restore tapes starting with dump level 0 and continuing until you reach the highest dump level.

11 Repeat [Step 8](#) through [Step 10](#) for each dump level, from the lowest to the highest level.

12 Verify that the file system has been restored.

```
# ls
```

13 Remove the `restoresymtable` file.

```
# rm restoresymtable
```

The `restoresymtable` file that is created and used by the `ufsrestore` command to check-point the restore is removed.

14 Change to another directory.

```
# cd /
```

15 Unmount the newly restored file system.

```
# umount /mnt
```

16 Remove the last tape and insert a new tape that is not write-protected in the tape drive.

17 Make a level 0 backup of the newly restored file system.

```
# ufsdump 0ucf /dev/rmt/n /dev/rdisk/device-name
```

A level 0 backup is performed. Always immediately do a full backup of a newly created file system because the `ufsrestore` command repositions the files and changes the inode allocation.

18 Mount the restored file system.

```
# mount /dev/dsk/device-name mount-point
```

The restored file system is mounted and available for use.

19 Verify that the restored and mounted file system is available.

```
# ls mount-point
```

Example 25-5 Restoring a Complete UFS File System

The following example shows how to restore the `/export/home` file system.

```

# newfs /dev/rdisk/c0t0d0s7
newfs: /dev/rdisk/c0t0d0s7 last mounted as /export/home
newfs: construct a new file system /dev/rdisk/c0t0d0s7: (y/n)? y
/dev/rdisk/c0t0d0s7: 143358064 sectors in 23334 cylinders of 48 tracks, 128 sectors
69999.1MB in 1459 cyl groups (16 c/g, 48.00MB/g, 5824 i/g)
super-block backups (for fsck -F ufs -o b=#) at:
 32, 98464, 196896, 295328, 393760, 492192, 590624, 689056, 787488, 885920,
Initializing cylinder groups:
.....
super-block backups for last 10 cylinder groups at:
 142447776, 142546208, 142644640, 142743072, 142841504, 142939936, 143038368,
 143136800, 143235232, 143333664
# mount /dev/dsk/c0t0d0s7 /mnt
# cd /mnt
# ufsrestore rvf /dev/rmt/0
Verify volume and initialize maps
Media block size is 126
Dump date: Wed Jul 14 12:45:33 2010
Dumped from: the epoch
Level 0 dump of /export/home on starbug:/dev/dsk/c0t0d0s7
Label: none
Begin level 0 restore
Initialize symbol table.
Extract directories from tape
Calculate extraction list.
Warning: ./lost+found: File exists
Make node ./rimmer
Make node ./rimmer/wdir
Make node ./lister
Make node ./pmorph
Make node ./inquisitor
Make node ./kryten
Make node ./kryten/letters
Make node ./kryten/reports
Extract new leaves.
Check pointing the restore
extract file ./rimmer/words
extract file ./rimmer/words1
extract file ./rimmer/words2
extract file ./rimmer/words3
extract file ./rimmer/wdir/words
extract file ./rimmer/wdir/words1
extract file ./rimmer/wdir/words2
extract file ./rimmer/wdir/words3
.
.
.
Add links
Set directory mode, owner, and times.
Check the symbol table.
Check pointing the restore
# rm restoresymtable
# cd /
# umount /mnt
# ufsdump 0ucf /dev/rmt/0 /export/home
.
.
.

```

```
# mount /dev/dsk/c0t0d0s7 /export/home
# ls /export/home
```

▼ How to Restore a UFS root (/) and /usr File System

- 1 **Become superuser or assume an equivalent role.**
- 2 **Add a new system disk to the system where the root (/) and /usr file systems will be restored.**
For a detailed description about adding a system disk, refer to “[SPARC: How to Set Up a Disk for a UFS Root File System](#)” on page 216 or “[x86: How to Set Up a Disk for a UFS Root File System](#)” on page 234.
- 3 **Mount the new file system on a temporary mount point.**

```
# mount /dev/dsk/device-name /mnt
```
- 4 **Change to the /mnt directory.**

```
# cd /mnt
```
- 5 **(Optional) Write-protect the tapes for safety.**
- 6 **Create the links for the tape device.**

```
# tapes
```
- 7 **Restore the root (/) file system.**

```
# ufsrestore rvf /dev/rmt/n
```

The dump level 0 tape is restored.
- 8 **Remove the tape and load the next level tape in the drive.**
Always restore tapes starting with dump level 0 and continuing from the lowest to highest dump level.
- 9 **Continue restoring as needed.**

```
# ufsrestore rvf /dev/rmt/n
```

The next level tape is restored.
- 10 **Repeat [Step 8](#) and [Step 9](#) for each additional tape.**
- 11 **Verify that the file system has been restored.**

```
# ls
```

12 Remove the `restoresymtable` file.

```
# rm restoresymtable
```

The `restoresymtable` file that is created and used by the `ufs restore` command to check-point the restore is removed.

13 Change to the root (`/`) directory.

```
# cd /
```

14 Unmount the newly created file system.

```
# umount /mnt
```

15 Check the new file system.

```
# fsck /dev/rdisk/device-name
```

The restored file system is checked for consistency.

16 Create the boot blocks on the root partition.

On a SPARC system:

```
# installboot /usr/platform/'uname-i'/lib/fs/ufs/bootblk
/dev/rdisk/device-name
```

For more information, see the [installboot\(1M\)](#) man page.

For an example of using the `installboot` command on a SPARC based system, see [Example 25-6](#).

On an x86 system:

```
# /sbin/installgrub /boot/grub/stage1 /boot/grub/stage2 /dev/rdisk/cwtxdysz
```

For more information, see [installgrub\(1M\)](#).

For an example of using the `installgrub` command on an x86 based system, see [Example 25-7](#).

17 Insert a new tape in the tape drive.**18 Back up the new file system.**

```
# ufsdump 0uf /dev/rmt/n /dev/rdisk/device-name
```

A dump level 0 backup is performed. Always immediately do a full backup of a newly created file system because the `ufs restore` command repositions the files and changes the inode allocation.

19 Repeat steps 5 through 16 for the `/usr` file system, if necessary.**20 Reboot the system.**

```
# init 6
```

The system is rebooted.

Example 25-6 SPARC: Restoring a UFS root (/) File System

This example shows how to restore the root (/) file system on a SPARC system. This example assumes that the system is booted from a local Solaris DVD or from the network.

```
# mount /dev/dsk/c0t3d0s0 /mnt
# cd /mnt
# tapes
# ufsrestore rvf /dev/rmt/0
# ls
# rm restoresymtable
# cd /
# umount /mnt
# fsck /dev/rdisk/c0t3d0s0
# installboot /usr/platform/sun4u/lib/fs/ufs/bootblk
/dev/rdisk/c0t3d0s0
# ufsdump 0uf /dev/rmt/0 /dev/rdisk/c0t3d0s0
# init 6
```

Example 25-7 x86: Restoring a UFS root (/) File System

This example shows how to restore the root (/) file system on an x86 system. This example assumes that the system is booted from a GRUB failsafe boot session, local Solaris DVD, or from the network.

```
# mount /dev/dsk/c0t3d0s0 /mnt
# cd /mnt
# tapes
# ufsrestore rvf /dev/rmt/0
# ls
# rm restoresymtable
# cd /
# umount /mnt
# fsck /dev/rdisk/c0t3d0s0
# /sbin/installgrub /boot/grub/stage1 /boot/grub/stage2 /dev/rdisk/c0t3d0s0
stage1 written to partition 0 sector 0 (abs 2016)
stage2 written to to partition 0, 227 sectors starting 50 (abs 2066)
# ufsdump 0uf /dev/rmt/0 /dev/rdisk/c0t3d0s0
# init 6
```

UFS Backup and Restore Commands (Reference)

This chapter contains reference information on the `ufsdump` and `ufsrestore` commands.

This is a list of the information in this chapter.

- “How the `ufsdump` Command Works” on page 471
- “Specifying `ufsdump` Command Options and Arguments” on page 475
- “The `ufsdump` Command and Security Issues” on page 476
- “Specifying `ufsrestore` Options and Arguments” on page 476

For overview information about performing backups, see [Chapter 22, “Backing Up and Restoring UFS File Systems \(Overview\)”](#).

For information about backup tasks, see [Chapter 23, “Backing Up UFS Files and File Systems \(Tasks\)”](#).

How the `ufsdump` Command Works

The `ufsdump` command makes two passes when it backs up a file system. On the first pass, this command scans the raw device file for the file system and builds a table of directories and files in memory. Then, this command writes the table to the backup media. In the second pass, the `ufsdump` command goes through the inodes in numerical order, reading the file contents and writing the data to the backup media.

Determining Device Characteristics

The `ufsdump` command needs to know only an appropriate tape block size and how to detect the end of media.

Detecting the End of Media

The `ufsdump` command writes a sequence of fixed-size records. When the `ufsdump` command receives notification that a record was only partially written, it assumes that it has reached the physical end of the media. This method works for most devices. If a device is not able to notify the `ufsdump` command that only a partial record has been written, a media error occurs as the `ufsdump` command tries to write another record.

Note – DAT devices and 8-mm tape devices detect end-of-media. Cartridge tape devices and 1/2-inch tape devices do not detect end-of-media.

The `ufsdump` command automatically detects the end-of-media for most devices. Therefore, you do not usually need to use the `-c`, `-d`, `-s`, and `-t` options to perform multivolume backups.

You need to use the end-of-media options when the `ufsdump` command does not understand the way the device detects the end-of-media.

To ensure compatibility with the `restore` command, the `size` option can still force the `ufsdump` command to go to the next tape or diskette before reaching the end of the current tape or diskette.

Copying Data With the `ufsdump` Command

The `ufsdump` command copies data only from the raw disk slice. If the file system is still active, any data in memory buffers is probably not copied. The backup done by the `ufsdump` command does not copy free blocks, nor does it make an image of the disk slice. If symbolic links point to files on other slices, the link itself is copied.

Purpose of the `/etc/dumpdates` File

The `ufsdump` command, when used with the `-u` option, maintains and updates the `/etc/dumpdates` file. Each line in the `/etc/dumpdates` file shows the following information:

- The file system backed up
- The dump level of the last backup
- The day, date, and time of the backup

For example:

```
# cat /etc/dumpdates
/dev/rdisk/c0t0d0s0      0 Wed Jul 7 13:36:17 2010
/dev/rdisk/c0t0d0s7      0 Thu Jul 8 12:53:12 2010
/dev/rdisk/c0t0d0s7      9 Thu Jul 8 13:41:48 2010
```

When you do an incremental backup, the `ufsdump` command checks the `/etc/dumpdates` file to find the date of the most recent backup of the next lower dump level. Then, this command copies to the media all files that were modified since the date of that lower-level backup. After the backup is complete, a new information line, which describes the backup you just completed, replaces the information line for the previous backup at that level.

Use the `/etc/dumpdates` file to verify that backups are being done. This verification is particularly important if you are having equipment problems. If a backup cannot be completed because of equipment failure, the backup is not recorded in the `/etc/dumpdates` file.

If you need to restore an entire disk, check the `/etc/dumpdates` file for a list of the most recent dates and levels of backups so that you can determine which tapes you need to restore the entire file system.

Note – The `/etc/dumpdates` file is a text file that can be edited. However, edit it only at your own risk. If you make changes to the file that do not match your archive tapes, you might be unable to find the tapes (or files) you need.

Backup Device (*dump-file*) Argument

The *dump-file* argument (to the `-f` option) specifies the destination of the backup. The destination can be one of the following:

- Local tape drive
- Local diskette drive
- Remote tape drive
- Remote diskette drive
- Standard output

Use this argument when the destination is not the default local tape drive `/dev/rmt/0`. If you use the `-f` option, then you must specify a value for the *dump-file* argument.

Note – The *dump-file* argument can also point to a file on a local disk or on a remote disk. If done by mistake, this usage can fill up a file system.

Local Tape or Diskette Drive

Typically, the *dump-file* argument specifies a raw device file for a tape device or diskette. When the `ufsdump` command writes to an output device, it creates a single backup file that might span multiple tapes or diskettes.

You specify a tape device or a diskette on your system by using a device abbreviation. The first device is always 0. For example, if you have a SCSI tape controller and one QIC-24 tape drive that uses medium-density formatting, use this device name:

```
/dev/rmt/0m
```

When you specify a tape device name, you can also type the letter “n” at the end of the name to indicate that the tape drive should not rewind after the backup is completed. For example:

```
/dev/rmt/0mn
```

Use the “no-rewind” option if you want to put more than one file onto the tape. If you run out of space during a backup, the tape does not rewind before the `ufsdump` command asks for a new tape. For a complete description of device-naming conventions, see [“Backup Device Names” on page 500](#).

Remote Tape or Diskette Drive

You specify a remote tape device or a remote diskette by using the syntax `host:device`. The `ufsdump` command writes to the remote device when superuser on the local system has access to the remote system. If you usually run the `ufsdump` command as superuser, the name of the local system must be included in the `/.rhosts` file on the remote system. If you specify the device as `user@host:device`, the `ufsdump` command tries to access the device on the remote system as the specified user. In this case, the specified user must be included in the `/.rhosts` file on the remote system.

Using Standard Output With the `ufsdump` Command

When you specify a dash (-) as the `dump-file` argument, the `ufsdump` command writes to standard output.

Note – The `-v` option (verify) does not work when the `dump-file` argument is standard output.

You can use the `ufsdump` and `ufsrestore` commands in a pipeline to copy a file system by writing to standard output with the `ufsdump` command and reading from standard input with the `ufsrestore` command. For example:

```
# ufsdump 0f - /dev/rdisk/c0t0d0s7 | (cd /home; ufsrestore xf -)
```

Specifying Files to Back Up

You must always include `filenames` as the last argument on the command line. This argument specifies the source or contents of the backup.

For a file system, specify the raw device file as follows:

```
/dev/rdisk/c0t0d0s7
```

You can specify the file system by its mount point directory (for example, `/export/home`), as long as an entry for it exists in the `/etc/vfstab` file.

For a complete description of device-naming conventions, see “[Backup Device Names](#)” on page 500.

For individual files or directories, type one or more names separated by spaces.

Note – When you use the `ufsdump` command to back up one or more directories or files (rather than a complete file system), a level 0 backup is done. Incremental backups do not apply.

Specifying Tape Characteristics

If you do not specify any tape characteristics, the `ufsdump` command uses a set of defaults. You can specify the tape cartridge (`c`), density (`d`), size (`s`), and number of tracks (`t`). Note that you can specify the options in any order, as long as the arguments that follow match the order of the options.

Limitations of the `ufsdump` Command

The `ufsdump` command cannot do the following:

- Automatically calculate the number of tapes or diskettes that are needed for backing up file systems. You can use the dry run mode (`S` option) to determine how much space is needed before actually backing up file systems.
- Provide built-in error checking to minimize problems when it backs up an active file system.
- Back up files that are remotely mounted from a server. Files on the server must be backed up on the server itself. Users are denied permission to run the `ufsdump` command on files they own that are located on a server.

Specifying `ufsdump` Command Options and Arguments

This section describes how to specify options and arguments for the `ufsdump` command. The syntax for the `ufsdump` command is as follows:

```
/usr/sbin/ufsdump options arguments filenames
```

options Is a single string of one-letter option names.

arguments Identifies option arguments and might consist of multiple strings. The option letters and their associated arguments must be in the same order.

filenames Identifies the files to back up. These arguments must always come last, each separated by a space.

Default `ufsdump` Options

If you run the `ufsdump` command without any options, use this syntax:

```
# ufsdump filenames
```

The `ufsdump` command uses these options and arguments, by default:

```
ufsdump 9uf /dev/rmt/0 filenames
```

These options do a level 9 incremental backup to the default tape drive at its preferred density.

For a description of the `ufsdump` options, see [ufsdump\(1M\)](#).

The `ufsdump` Command and Security Issues

If you are concerned about security, you should do the following:

- Require superuser access for the `ufsdump` command.
- Ensure superuser access entries are removed from `/.rhosts` files on clients and servers if you are doing centralized backups.

For general information on security, see [System Administration Guide: Security Services](#).

Specifying `ufsrestore` Options and Arguments

The syntax of the `ufsrestore` command is as follows:

```
/usr/sbin/ufsrestore options arguments filenames
```

options Is a single string of one-letter option names. You must choose one and only one of these options: `i`, `r`, `R`, `t`, or `x`. For a description of the `ufsrestore` options, see [ufsrestore\(1M\)](#).

arguments Follows the option string with the arguments that match the options. The option letters and their associated arguments must be in the same order.

filenames Specifies the file or files to be restored as arguments to the `x` or `t` options. These arguments must always come last, separated by spaces.

Copying Files and File Systems (Tasks)

This chapter describes how to copy files and file systems to disk, tape, and diskettes by using various backup commands.

This is a list of the step-by-step instructions in this chapter.

- “How to Copy a Disk (`dd`)” on page 480
- “How to Copy Directories Between File Systems (`cpio`)” on page 484
- “How to Copy Files to a Tape (`tar`)” on page 485
- “How to List the Files on a Tape (`tar`)” on page 486
- “How to Retrieve Files From a Tape (`tar`)” on page 487
- “Copying Files to a Tape With the `pax` Command” on page 488
- “How to Copy All Files in a Directory to a Tape (`cpio`)” on page 489
- “How to List the Files on a Tape (`cpio`)” on page 490
- “How to Retrieve All Files From a Tape (`cpio`)” on page 490
- “How to Retrieve Specific Files From a Tape (`cpio`)” on page 491
- “How to Copy Files to a Remote Tape Device (`tar` and `dd`)” on page 492
- “How to Extract Files From a Remote Tape Device” on page 494
- “How to Copy Files to a Single Formatted Diskette (`tar`)” on page 495
- “How to List the Files on a Diskette (`tar`)” on page 496
- “How to Retrieve Files From a Diskette (`tar`)” on page 496

Commands for Copying File Systems

When you need to back up and restore complete UFS file systems, use the `ufsdump` and `ufsrestore` commands described in [Chapter 26, “UFS Backup and Restore Commands \(Reference\)”](#). When you want to copy or move individual files, portions of file systems, or complete file systems, you can use the procedures described in this chapter instead of the `ufsdump` and `ufsrestore` commands.

The following table describes when to use the various backup commands.

TABLE 27-1 When to Use Various Backup Commands

Task	Command	For More Information
Back up UFS file systems to tape.	<code>ufsdump</code>	“How to Back Up a UFS File System to Tape” on page 440
Create a file system snapshot.	<code>fssnap</code>	Chapter 24, “Using UFS Snapshots (Tasks)”
Restore UFS file systems from tape.	<code>ufsrestore</code>	“How to Restore a Complete UFS File System” on page 464
Transport files to other systems.	<code>pax</code> , <code>tar</code> , or <code>cpio</code>	“Copying Files and File Systems to Tape” on page 485
Copy files or file systems between disks.	<code>dd</code>	“How to Copy a Disk (<code>dd</code>)” on page 480
Copy files to diskette.	<code>tar</code>	“How to Copy Files to a Single Formatted Diskette (<code>tar</code>)” on page 495

The following table describes various backup and restore commands.

TABLE 27-2 Summary of Various Backup Commands

Command Name	Aware of File System Boundaries?	Supports Multiple Volume Backups?	Physical or Logical Copy?
<code>volcopy</code>	Yes	Yes	Physical
<code>tar</code>	No	No	Logical
<code>cpio</code>	No	Yes	Logical
<code>pax</code>	Yes	Yes	Logical
<code>dd</code>	Yes	No	Physical
<code>ufsdump/ufsrestore</code>	Yes	Yes	Logical
<code>fssnap</code>	N/A	N/A	Logical

The following table describes the advantages and disadvantages of some of these commands.

TABLE 27-3 Advantages and Disadvantages of tar, pax, and cpio Commands

Command	Function	Advantages	Disadvantages
tar	Use to copy files and directory subtrees to a single tape.	<ul style="list-style-type: none"> ■ Available on most UNIX operating systems ■ Public domain versions are readily available 	<ul style="list-style-type: none"> ■ Is not aware of file system boundaries ■ Length of full path name cannot exceed 255 characters ■ Cannot be used to create multiple tape volumes
pax	Use to copy files, special files, or file systems that require multiple tape volumes. Or, use when you want to copy files to and from POSIX-compliant systems.	<ul style="list-style-type: none"> ■ Better portability than the tar or cpio commands for POSIX-compliant systems ■ Multiple vendor support 	Same disadvantages as the tar command, except that the pax command can create multiple tape volumes.
cpio	Use to copy files, special files, or file systems that require multiple tape volumes. Or, use when you want to copy files from systems running current Oracle Solaris releases systems to systems running older Solaris releases.	<ul style="list-style-type: none"> ■ Packs data onto tape more efficiently than the tar command ■ Skips over any bad spots in a tape when restoring ■ Provides options for writing files with different header formats, such as (tar, ustar, crc, odc, bar), for portability between different system types ■ Creates multiple tape volumes 	The command syntax is more difficult than the tar or pax commands.

The following sections describes step-by-step instructions and examples of how to use these commands.

Copying File Systems Between Disks

Two commands are used to copy file systems between disks:

- `volcopy`
- `dd`

For more information about `volcopy`, see [volcopy\(1M\)](#).

The next section describes how to use the `dd` command to copy file systems between disks.

Making a Literal File System Copy

The `dd` command makes a literal (block-level) copy of a complete UFS file system to another file system or to a tape. By default, the `dd` command copies standard input to standard output.

Note – Do not use the `dd` command with variable-length tape drives without first specifying an appropriate block size.

You can specify a device name in place of standard input or standard output, or both. In this example, the contents of the diskette are copied to a file in the `/tmp` directory:

```
$ dd < /floppy/floppy0 > /tmp/output.file
2400+0 records in
2400+0 records out
```

The `dd` command reports on the number of blocks it reads and writes. The number after the `+` is a count of the partial blocks that were copied. The default block size is 512 bytes.

The `dd` command syntax is different from most other commands. Options are specified as *keyword=value* pairs, where *keyword* is the option you want to set and *value* is the argument for that option. For example, you can replace standard input and standard output with this syntax:

```
$ dd if=input-file of=output-file
```

To use the *keyword=value* pairs instead of the redirect symbols, you would type the following:

```
$ dd if=/floppy/floppy0 of=/tmp/output.file
```

▼ How to Copy a Disk (dd)

Keep the following key points in mind when you consider copying a disk:

- Do not use this procedure to copy a disk that is under the control of a volume manager.

- The primary methods for copying UFS file system data from one disk or system to another disk or system is by using the `ufsdump` and `ufsrestore` commands. For more information on using these commands, see [Chapter 22, “Backing Up and Restoring UFS File Systems \(Overview\)”](#).
- You can clone systems by creating a flash archive and copying it to destination systems. For more information about creating a flash archive, see [Oracle Solaris 10 8/11 Installation Guide: Solaris Flash Archives \(Creation and Installation\)](#).
- If you are copying a disk with an EFI disk label, see [Example 27–2](#).

If you are still considering copying a disk with the `dd` command keep the following cautions in mind:

- Make sure that the source disk and destination disk have the same disk geometry.
- Check the UFS file systems on the disk to be copied with the `fsck` utility.
- Make sure the system is in single-user mode when copying a disk with the `dd` command.

- 1 **Become superuser or assume an equivalent role.**
- 2 **(Optional) Create the `/reconfigure` file so that the system will recognize the destination disk to be added when it reboots, if necessary.**

```
# touch /reconfigure
```

- 3 **Shut down the system.**

```
# init 0
```

- 4 **Attach the destination disk to the system.**

- 5 **Boot the system.**

```
ok boot -s
```

- 6 **Copy the source disk to the destination disk.**

```
# dd if=/dev/rdisk/device-name of=/dev/rdisk/device-name bs=block-size
```

`if=/dev/rdisk/device-name` Represents the overlap slice of the master disk device, usually slice 2.

`of=/dev/rdisk/device-name` Represents the overlap slice of the destination disk device, usually slice 2.

`bs=blocksize` Identifies the block size, such as 128 KB or 256 KB. A large block size decreases the time it takes to copy the disk.

For more information, see [dd\(1M\)](#).

7 Check the new file system.

```
# fsck /dev/rdisk/device-name
```

8 Mount the destination disk's root (/) file system.

```
# mount /dev/dsk/device-name /mnt
```

9 Change to the directory where the /etc/vfstab file is located.

```
# cd /mnt/etc
```

10 Using a text editor, edit the destination disk's /etc/vfstab file to reference the correct device names.

For example, change all instances of c0t3d0 to c0t1d0.

11 Change to the destination disk's root (/) directory.

```
# cd /
```

12 Unmount the destination disk's root (/) file system.

```
# umount /mnt
```

13 Shut down the system.

```
# init 0
```

14 Boot from the destination disk to single-user mode.

```
# boot diskn -s
```

Note – The `installboot` command is not needed for the destination disk because the boot blocks are copied as part of the overlap slice.

15 Unconfigure the destination disk.

```
# sys-unconfig
```

The system is shut down after it is unconfigured.

16 Boot from the destination disk again and provide its system information, such as host name, time zone, and so forth.

```
# boot diskn
```

17 After the system is booted, log in as superuser to verify the system information.

```
hostname console login:
```

Example 27-1 Copying a Disk With a VTOC Label (dd)

This example shows how to copy the master disk (with a VTOC label) `/dev/rdisk/c0t0d0s2` to the destination disk `/dev/rdisk/c0t2d0s2`.

```
# touch /reconfigure
# init 0
ok boot
# dd if=/dev/rdisk/c0t0d0s2 of=/dev/rdisk/c0t2d0s2 bs=128k
# fsck /dev/rdisk/c0t2d0s2
# mount /dev/dsk/c0t2d0s2 /mnt
# cd /mnt/etc
# vi vfstab
(Modify entries for the new disk)
# cd /
# umount /mnt
# init 0
# boot disk2 -s
# sys-unconfig
# boot disk2
```

Example 27-2 Copying a Disk with an EFI Label (dd)

In previous Solaris releases, slice 2 (s2) was used to represent the entire disk. On a disk with an EFI label, you must use a slightly different procedure to clone or copy disks larger than 1 terabyte so that the UUID of cloned disks is unique. If you do not create a new label for the cloned disk, other software products might corrupt data on EFI-labeled disks if they encounter duplicate UUIDs.

For example:

1. Clone the disk with an EFI label. For example:

```
# dd if=/dev/rdisk/c0t0d0 of=/dev/rdisk/c0t2d0 bs=128k
```

2. Pipe the `prtvtoc` output of the disk to be copied to the `fmthard` command to create a new label for the cloned disk. For example:

```
# prtvtoc /dev/rdisk/c0t0d0 | fmthard -s - /dev/rdisk/c0t2d0
```

For more information about EFI disk labels, see [“EFI Disk Label”](#) on page 183.

Copying Directories Between File Systems (cpio Command)

You can use the `cpio` (copy in and out) command to copy individual files, groups of files, or complete file systems. This section describes how to use the `cpio` command to copy complete file systems.

The `cpio` command is an archiving program that copies a list of files into a single, large output file. This command inserts headers between the individual files to facilitate recovery. You can use the `cpio` command to copy complete file systems to another slice, another system, or to a media device, such as a tape or diskette.

Because the `cpio` command recognizes end-of-media and prompts you to insert another volume, it is the most effective command, other than `ufsdump`, to use to create archives that require multiple tapes or diskettes.

With the `cpio` command, you frequently use the `ls` and `find` commands to list and select the files you want to copy, and then to pipe the output to the `cpio` command.

▼ How to Copy Directories Between File Systems (cpio)

1 Become superuser or assume an equivalent role.

2 Change to the appropriate directory.

```
# cd filesystem1
```

3 Copy the directory tree from *filesystem1* to *filesystem2* by using a combination of the `find` and `cpio` commands.

```
# find . -print -depth | cpio -pdm filesystem2
```

`.` Starts in the current working directory.

`-print` Prints the file names.

`-depth` Descends the directory hierarchy and prints file names from the bottom up.

`-p` Creates a list of files.

`-d` Creates directories as needed.

`-m` Sets the correct modification times on directories.

For more information, see [cpio\(1\)](#).

The files from the directory name you specify are copied. The symbolic links are preserved.

You might also specify the `-u` option. This option forces an unconditional copy. Otherwise, older files do not replace newer files. This option might be useful if you want an exact copy of a directory, and some of the files being copied might already exist in the target directory.

4 Verify that the copy was successful by displaying the contents of the destination directory.

```
# cd filesystem2
# ls
```

5 If appropriate, remove the source directory.

```
# rm -rf filesystem1
```

Example 27-3 Copying Directories Between File Systems (cpio)

```
# cd /data1
# find . -print -depth | cpio -pdm /data2
19013 blocks
# cd /data2
# ls
# rm -rf /data1
```

Copying Files and File Systems to Tape

You can use the `tar`, `pax`, and `cpio` commands to copy files and file systems to tape. The command that you choose depends on how much flexibility and precision you require for the copy. Because all three commands use the raw device, you do not need to format or make a file system on tapes before you use them.

The tape drive and device name that you use depend on the hardware configuration for each system. For more information about tape device names, see [“Choosing Which Media to Use” on page 499](#).

Copying Files to Tape (tar Command)

Here is information that you should know before you copy files to tape with the `tar` command:

- Copying files to a tape with the `-c` option to the `tar` command destroys any files already on the tape at or beyond the current tape position.
- You can use file name substitution wildcards (`?` and `*`) as part of the file names that you specify when copying files. For example, to copy all documents with a `.doc` suffix, type `*.doc` as the file name argument.
- You cannot use file name substitution wildcards when you extract files from a `tar` archive.

▼ How to Copy Files to a Tape (tar)

- 1 Change to the directory that contains the files you want to copy.
- 2 Insert a write-enabled tape into the tape drive.

3 Copy the files to tape.

```
$ tar cvf /dev/rmt/n filenames
```

c Indicates that you want to create an archive.

v Displays the name of each file as it is archived.

f /dev/rmt/n Indicates that the archive should be written to the specified device or file.

filenames Indicates the files and directories that you want to copy. Separate multiple files with spaces.

The file names that you specify are copied to the tape, overwriting any existing files on the tape.

4 Remove the tape from the drive. Write the names of the files on the tape label.**5 Verify that the files you copied are on the tape.**

```
$ tar tvf /dev/rmt/n
```

For more information on listing files on a tar tape, see [“How to List the Files on a Tape \(tar\)” on page 486](#).

Example 27–4 Copying Files to a Tape (tar)

The following example shows how to copy three files to the tape in tape drive 0.

```
$ cd /export/home/kryten
$ ls reports
reportA reportB reportC
$ tar cvf /dev/rmt/0 reports
a reports/ 0 tape blocks
a reports/reportA 59 tape blocks
a reports/reportB 61 tape blocks
a reports/reportC 63 tape blocks
$ tar tvf /dev/rmt/0
```

▼ How to List the Files on a Tape (tar)**1 Insert a tape into the tape drive.****2 Display the tape contents.**

```
$ tar tvf /dev/rmt/n
```

t Lists the table of contents for the files on the tape.

v Used with the t option, and provides detailed information about the files on the tape.

f /dev/rmt/n Indicates the tape device.

Example 27-5 Listing the Files on a Tape (tar)

The following example shows a listing of files on the tape in drive 0.

```
$ tar tvf /dev/rmt/0
drwxr-xr-x  0/0      0 Jul 14 13:50 2010 reports/
-r--r--r--  0/0    206663 Jul 14 13:50 2010 reports/reportC
-r--r--r--  0/0    206663 Jul 14 13:50 2010 reports/reportB
-r--r--r--  0/0    206663 Jul 14 13:50 2010 reports/reportA
```

▼ How to Retrieve Files From a Tape (tar)

- 1 Change to the directory where you want to put the files.
- 2 Insert the tape into the tape drive.
- 3 Retrieve the files from the tape.

```
$ tar xvf /dev/rmt/n [filenames]
```

x Indicates that the files should be extracted from the specified archive file. All files on the tape in the specified drive are copied to the current directory.

v Displays the name of each file as it is retrieved.

f /dev/rmt/n Indicates the tape device that contains the archive.

filenames Specifies a file to retrieve. Separate multiple files with spaces.

For more information, see the [tar\(1\)](#) man page.

- 4 Verify that the files have been copied.

```
$ ls -l
```

Example 27-6 Retrieving Files on a Tape (tar)

The following example shows how to retrieve all the files from the tape in drive 0.

```
$ cd /var/tmp
$ tar xvf /dev/rmt/0
x reports/, 0 bytes, 0 tape blocks
x reports/reportA, 0 bytes, 0 tape blocks
x reports/reportB, 0 bytes, 0 tape blocks
x reports/reportC, 0 bytes, 0 tape blocks
x reports/reportD, 0 bytes, 0 tape blocks
$ ls -l
```

Troubleshooting The names of the files extracted from the tape must exactly match the names of the files that are stored on the archive. If you have any doubts about the names or paths of the files, first list the files on the tape. For instructions on listing the files on the tape, see [“How to List the Files on a Tape \(tar\)” on page 486](#).

Copying Files to a Tape With the pax Command

▼ How to Copy Files to a Tape (pax)

1 Change to the directory that contains the files you want to copy.

2 Insert a write-enabled tape into the tape drive.

3 Copy the files to tape.

```
$ pax -w -f /dev/rmt/n filenames
```

-w Enables the write mode.

-f /dev/rmt/n Identifies the tape drive.

filenames Indicates the files and directories that you want to copy. Separate multiple files with spaces.

For more information, see the [pax\(1\)](#) man page.

4 Verify that the files have been copied to tape.

```
$ pax -f /dev/rmt/n
```

5 Remove the tape from the drive. Write the names of the files on the tape label.

Example 27-7 Copying Files to a Tape (pax)

The following example shows how to use the pax command to copy all the files in the current directory.

```
$ pax -w -f /dev/rmt/0 .  
$ pax -f /dev/rmt/0  
filea fileb filec
```

Copying Files to Tape With the `cpio` Command

▼ How to Copy All Files in a Directory to a Tape (`cpio`)

- 1 Change to the directory that contains the files you want to copy.
- 2 Insert a write-enabled tape into the tape drive.
- 3 Copy the files to tape.

```
$ ls | cpio -oc > /dev/rmt/n
```

`ls` Provides the `cpio` command with a list of file names.

`cpio -oc` Specifies that the `cpio` command should operate in copy-out mode (`-o`) and write header information in ASCII character format (`-c`). These options ensure portability to other vendors' systems.

`> /dev/rmt/n` Specifies the output file.

All files in the directory are copied to the tape in the drive you specify, overwriting any existing files on the tape. The total number of blocks that are copied is shown.

- 4 Verify that the files have been copied to tape.

```
$ cpio -civt < /dev/rmt/n
```

`-c` Specifies that the `cpio` command should read files in ASCII character format.

`-i` Specifies that the `cpio` command should operate in copy-in mode, even though the command is only listing files at this point.

`-v` Displays the output in a format that is similar to the output from the `ls -l` command.

`-t` Lists the table of contents for the files on the tape in the tape drive that you specify.

`< /dev/rmt/n` Specifies the input file of an existing `cpio` archive.

- 5 Remove the tape from the drive. Write the names of the files on the tape label.

Example 27-8 Copying All Files in a Directory to a Tape (`cpio`)

The following example shows how to copy all of the files in the `/export/home/kryten` directory to the tape in tape drive 0.

```

$ cd /export/home/kryten
$ ls | cpio -oc > /dev/rmt/0
1280 blocks
$ cpio -civt < /dev/rmt/0
-r--r--r-- 1 kryten  staff    206663 Jul 14 13:52 2010, filea
-r--r--r-- 1 kryten  staff    206663 Jul 14 13:52 2010, fileb
-r--r--r-- 1 kryten  staff    206663 Jul 14 13:52 2010, filec
drwxr-xr-x 2 kryten  staff      0 Jul 14 13:52 2010, letters
drwxr-xr-x 2 kryten  staff      0 Jul 14 13:52 2010, reports
1280 blocks

```

▼ How to List the Files on a Tape (`cpio`)

Note – Listing the table of contents on a tape takes a long time because the `cpio` command must process the entire archive.

- 1 Insert an archive tape into the tape drive.
- 2 List the files on the tape.

```
$ cpio -civt < /dev/rmt/n
```

Example 27-9 Listing the Files on a Tape (`cpio`)

The following example shows how to list the files on the tape in drive 0.

```

$ cpio -civt < /dev/rmt/0
-r--r--r-- 1 kryten  staff    206663 Jul 14 13:52 2010, filea
-r--r--r-- 1 kryten  staff    206663 Jul 14 13:52 2010, fileb
-r--r--r-- 1 kryten  staff    206663 Jul 14 13:52 2010, filec
drwxr-xr-x 2 kryten  staff      0 Jul 14 13:52 2010, letters
drwxr-xr-x 2 kryten  staff      0 Jul 14 13:52 2010, reports
1280 blocks

```

▼ How to Retrieve All Files From a Tape (`cpio`)

If the archive was created using relative path names, the input files are built as a directory within the current directory when you retrieve the files. If, however, the archive was created with absolute path names, the same absolute paths are used to re-create the file on your system.



Caution – The use of absolute path names can be dangerous because you might overwrite existing files on your system.

- 1 Change to the directory where you want to put the files.

2 Insert the tape into the tape drive.**3 Extract all files from the tape.**

```
$ cpio -icvd < /dev/rmt/n
```

-i Extracts files from standard input.

-c Specifies that the `cpio` command should read files in ASCII character format.

-v Displays the files as they are retrieved in a format that is similar to the output from the `ls` command.

-d Creates directories as needed.

< /dev/rmt/n Specifies the output file.

4 Verify that the files were copied.

```
$ ls -l
```

Example 27–10 Retrieving All Files From a Tape (`cpio`)

The following example shows how to retrieve all files from the tape in drive 0.

```
$ cd /var/tmp
cpio -icvd < /dev/rmt/0
answers
sc.directives
tests
8 blocks
$ ls -l
```

▼ How to Retrieve Specific Files From a Tape (`cpio`)**1 Change to the directory where you want to put the files.****2 Insert the tape into the tape drive.****3 Retrieve a subset of files from the tape.**

```
$ cpio -icv "*file" < /dev/rmt/n
```

-i Extracts files from standard input.

-c Specifies that the `cpio` command should read headers in ASCII character format.

- v Displays the files as they are retrieved in a format that is similar to the output from the `ls` command.
- "*file" Specifies that all files that match the pattern are copied to the current directory. You can specify multiple patterns, but each pattern must be enclosed in double quotation marks.
- < /dev/rmt/n Specifies the input file.

For more information, see the [cpio\(1\)](#) man page.

4 Verify that the files were copied.

```
$ ls -l
```

Example 27-11 Retrieving Specific Files From a Tape (cpio)

The following example shows how to retrieve all files with the `chapter` suffix from the tape in drive 0.

```
$ cd /home/smith/Book
$ cpio -icv "**chapter" < /dev/rmt/0
Boot.chapter
Directory.chapter
Install.chapter
Intro.chapter
31 blocks
$ ls -l
```

Copying Files to a Remote Tape Device

▼ How to Copy Files to a Remote Tape Device (tar and dd)

1 The following prerequisites must be met to use a remote tape drive:

- a. The local host name and optionally, the user name of the user doing the copy, must appear in the remote system's `/etc/hosts.equiv` file. Or, the user doing the copy must have his or her home directory accessible on the remote machine, and have the local machine name in `$HOME/.rhosts`.

For more information, see the [hosts.equiv\(4\)](#) man page.

- b. An entry for the remote system must be in the local system's `/etc/inet/hosts` file or in the name service `hosts` file.

- 2 **To test whether you have the appropriate permission to execute a remote command, try the following:**

```
$ rsh remotehost echo test
```

If test is echoed back to you, you have permission to execute remote commands. If Permission denied is echoed back to you, check your setup as described in Step 1.
- 3 **Change to the directory where you want to put the files.**
- 4 **Insert the tape into the tape drive.**
- 5 **Copy the files to a remote tape drive.**

```
$ tar cvf - filenames | rsh remote-host dd of=/dev/rmt/n obs=block-size
```

<code>tar cf</code>	Creates a tape archive, lists the files as they are archived, and specifies the tape device.
<code>v</code>	Provides additional information about the tar file entries.
<code>-</code> (Hyphen)	Represents a placeholder for the tape device.
<code>filenames</code>	Identifies the files to be copied. Separate multiple files with spaces.
<code>rsh remote-host</code>	Pipes the tar command's output to a remote shell.
<code>dd of= /dev/rmt/n</code>	Represents the output device.
<code>obs=block-size</code>	Represents the blocking factor.
- 6 **Remove the tape from the drive. Write the names of the files on the tape label.**

Example 27–12 Copying Files to a Remote Tape Drive (tar and dd)

```
# tar cvf - * | rsh mercury dd of=/dev/rmt/0 obs=126b
a answers/ 0 tape blocks
a answers/test129 1 tape blocks
a sc.directives/ 0 tape blocks
a sc.directives/sc.190089 1 tape blocks
a tests/ 0 tape blocks
a tests/test131 1 tape blocks
6+9 records in
0+1 records out
```

▼ How to Extract Files From a Remote Tape Device

1 Insert the tape into the tape drive.

2 Change to a temporary directory.

```
$ cd /var/tmp
```

3 Extract the files from a remote tape device.

```
$ rsh remote-host dd if=/dev/rmt/n | tar xvBpf -
```

`rsh remote-host` Indicates a remote shell that is started to extract the files from the tape device by using the `dd` command.

`dd if=/dev/rmt/n` Indicates the input device.

`| tar xvBpf -` Pipes the output of the `dd` command to the `tar` command, which is used to restore the files.

4 Verify that the files have been extracted.

```
$ ls -l
```

Example 27-13 Extracting Files From a Remote Tape Drive

```
$ cd /var/tmp
$ rsh mercury dd if=/dev/rmt/0 | tar xvBpf -
x answers/, 0 bytes, 0 tape blocks
x answers/test129, 48 bytes, 1 tape blocks
20+0 records in
20+0 records out
x sc.directives/, 0 bytes, 0 tape blocks
x sc.directives/sc.190089, 77 bytes, 1 tape blocks
x tests/, 0 bytes, 0 tape blocks
x tests/test131, 84 bytes, 1 tape blocks
$ ls -l
```

Copying Files and File Systems to Diskette

Before you can copy files or file systems to diskette, you must format the diskette. For information on how to format a diskette, see [Chapter 2, “Managing Removable Media \(Tasks\)”](#).

Use the `tar` command to copy UFS files to a single formatted diskette.

Use the `cpio` command if you need to copy UFS files to multiple formatted diskettes. The `cpio` command recognizes end-of-media and prompts you to insert the next diskette.

What You Should Know When Copying Files to Diskettes

- Copying files to a formatted diskette by using the `tar -c` command destroys any files that are already on the diskette.
- A diskette that contains a tar image is not mountable.
- If you need a multiple-volume interchange utility, use the `cpio` command. The `tar` command is only a single-volume utility.

For more information, see [tar\(1\)](#).

▼ How to Copy Files to a Single Formatted Diskette (tar)

1 Change to the directory that contains the files you want to copy.

2 Insert a formatted diskette that is not write-protected into the drive.

3 Make the diskette available.

```
$ volcheck
```

4 Reformat the diskette, if necessary.

```
$ rmformat -U /dev/rdiskette
Formatting will erase all the data on disk.
Do you want to continue? (y/n)y
```

5 Copy the files to diskette.

```
$ tar cvf /vol/dev/aliases/floppy0 filenames
```

The file names that you specify are copied to the diskette, overwriting any existing files on the diskette.

6 Verify that the files were copied.

```
$ tar tvf /vol/dev/aliases/floppy0
```

For more information on listing files, see [“How to List the Files on a Diskette \(tar\)”](#) on page 496.

7 Remove the diskette from the drive.

8 Write the names of the files on the diskette label.

Example 27-14 Copying Files to a Single Formatted Diskette (tar)

The following example shows how to copy files named `evaluation*` to a diskette.

```
$ cd /home/smith
$ volcheck
$ ls evaluation*
evaluation.doc  evaluation.doc.backup
$ tar cvf /vol/dev/aliases/floppy0 evaluation*
a evaluation.doc 86 blocks
a evaluation.doc.backup 84 blocks
$ tar tvf /vol/dev/aliases/floppy0
```

▼ How to List the Files on a Diskette (tar)

1 Insert a diskette into the drive.

2 Make the diskette available.

```
$ volcheck
```

3 List the files on a diskette.

```
$ tar tvf /vol/dev/aliases/floppy0
```

Example 27-15 Listing the Files on a Diskette (tar)

The following example shows how to list the files on a diskette.

```
$ volcheck
$ tar tvf /vol/dev/aliases/floppy0
rw-rw-rw-6693/10 44032 Jun 9 15:45 evaluation.doc
rw-rw-rw-6693/10 43008 Jun 9 15:55 evaluation.doc.backup
$
```

▼ How to Retrieve Files From a Diskette (tar)

1 Change to the directory where you want to put the files.

2 Insert the diskette into the drive.

3 Make the diskette available.

```
$ volcheck
```

4 Retrieve files from the diskette.

```
$ tar xvf /vol/dev/aliases/floppy0
```

All files on the diskette are copied to the current directory.

5 Verify that the files have been retrieved.

```
$ ls -l
```

6 Remove the diskette from the drive.

Example 27-16 Retrieving Files From a Diskette (tar)

The following example shows how to retrieve all the files from a diskette.

```
$ cd /home/smith/Evaluations
$ volcheck
$ tar xvf /vol/dev/aliases/floppy0
x evaluation.doc, 44032 bytes, 86 tape blocks
x evaluation.doc.backup, 43008 bytes, 84 tape blocks
$ ls -l
```

The following example shows how to retrieve an individual file from a diskette. The file is extracted from the diskette and placed in the current working directory.

```
$ volcheck
$ tar xvf /vol/dev/aliases/floppy0 evaluation.doc
x evaluation.doc, 44032 bytes, 86 tape blocks
$ ls -l
```

Archiving Files to Multiple Diskettes

If you are copying large files onto diskettes, you want to be prompted to replace a full diskette with another formatted diskette. The `cpio` command provides this capability. The `cpio` commands you use are the same that you would use to copy files to tape, except you would specify `/vol/dev/aliases/floppy0` as the device instead of the tape device name.

For information on how to use the `cpio` command, see [“How to Copy All Files in a Directory to a Tape \(cpio\)”](#) on page 489.

Managing Tape Drives (Tasks)

This chapter describes how to manage tape drives in the Oracle Solaris OS.

This is a list of the step-by-step instructions in this chapter.

- “How to Display Tape Drive Status” on page 502
- “Retensioning a Magnetic Tape Cartridge” on page 503
- “Rewinding a Magnetic Tape Cartridge” on page 504

This is a list of overview information in this chapter.

- “Choosing Which Media to Use” on page 499
- “Backup Device Names” on page 500
- “Displaying Tape Drive Status” on page 502
- “Guidelines for Drive Maintenance and Media Handling” on page 504

Choosing Which Media to Use

You typically back up Oracle Solaris systems by using the following tape media:

- 1/2-inch reel tape
- 1/4-inch streaming cartridge tape
- 8-mm cartridge tape
- 4-mm cartridge tape (DAT)

You can perform backups with diskettes, but doing so is time-consuming and cumbersome.

The media that you choose depends on the availability of the equipment that supports it and of the media (usually tape) that you use to store the files. Although you must do the backup from a local system, you can write the files to a remote device.

The following table shows typical tape devices that are used for backing up file systems. The storage capacity for each device depends on the type of drive and the data being written to the tape.

TABLE 28-1 Media Storage Capacities

Backup Media	Storage Capacity
1/2-inch reel tape	140 MB (6250 bpi)
2.5-GB 1/4-inch cartridge (QIC) tape	2.5 GB
DDS3 4-mm cartridge tape (DAT)	12–24 GB
14-GB 8-mm cartridge tape	14 GB
DLT 7000 1/2-inch cartridge tape	35–70 GB

Backup Device Names

You specify a tape or diskette to use for backup by supplying a logical device name. This name points to the subdirectory that contains the “raw” device file and includes the logical unit number of the drive. Tape drive naming conventions use a logical, not a physical, device name. The following table shows this naming convention.

TABLE 28-2 Basic Device Names for Backup Devices

Device Type	Name
Tape	<code>/dev/rmt/<i>n</i></code>
Diskette	<code>/vol/dev/rdiskette0/unlabeled</code>

In general, you specify a tape device as shown in the following figure.

FIGURE 28-1 Tape Drive Device Names

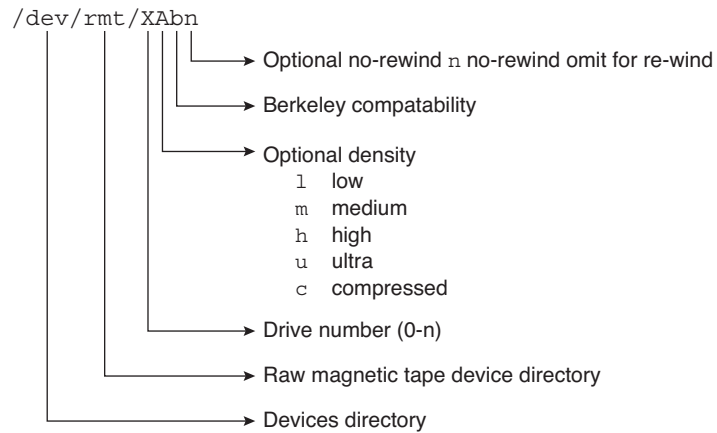

If you don't specify the density, a tape drive typically writes at its “preferred” density. The preferred density usually means the highest density the tape drive supports. Most SCSI drives can automatically detect the density or format on the tape and read it accordingly. To determine the different densities that are supported for a drive, look at the `/dev/rmt` subdirectory. This subdirectory includes the set of tape device files that support different output densities for each tape.

Also, a SCSI controller can have a maximum of seven SCSI tape drives.

Specifying the Rewind Option for a Tape Drive

Normally, you specify a tape drive by its logical unit number, which can run from 0 to *n*. The following table describes how to specify tape device names with a rewind or a no-rewind option.

TABLE 28-3 Specifying Rewind or No-Rewind for a Tape Drive

Drive and Rewind Value	Use This Option
First drive, rewind	<code>/dev/rmt/0</code>
First drive, no rewind	<code>/dev/rmt/0n</code>
Second drive, rewind	<code>/dev/rmt/1</code>
Second drive, no rewind	<code>/dev/rmt/1n</code>

Specifying Different Densities for a Tape Drive

By default, the drive writes at its “preferred” density, which is usually the highest density the tape drive supports. If you do not specify a tape device, the command writes to drive number 0 at the default density the device supports.

To transport a tape to a system whose tape drive supports only a certain density, specify a device name that writes at the desired density. The following table describes how to specify different densities for a tape drive.

TABLE 28-4 Specifying Different Densities for a Tape Drive

Drive, Density, and Rewind Value	Use This Option
First drive, low density, rewind	<code>/dev/rmt/0l</code>
First drive, low density, no rewind	<code>/dev/rmt/0ln</code>
Second drive, medium density, rewind	<code>/dev/rmt/1m</code>
Second drive, medium density, no rewind	<code>/dev/rmt/1mn</code>

The additional density values are shown in [“Backup Device Names” on page 500](#).

Displaying Tape Drive Status

You can use the `status` option with the `mt` command to get status information about tape drives. The `mt` command reports information about any tape drives that are described in the `/kernel/drv/st.conf` file.

▼ How to Display Tape Drive Status

- 1 Load a tape into the drive you want information about.
- 2 Display the tape drive status.

```
# mt -f /dev/rmt/n status
```
- 3 Repeat steps 1–2, substituting tape drive numbers 0, 1, 2, 3, and so on to display information about all available tape drives.

Example 28-1 Displaying Tape Drive Status

The following example shows the status for a QIC-150 tape drive (`/dev/rmt/0`):

```
$ mt -f /dev/rmt/0 status
Archive QIC-150 tape drive:
  sense key(0x0)= No Additional Sense   residual= 0   retries= 0
  file no= 0   block no= 0
```

The following example shows the status for an Exabyte tape drive (/dev/rmt/1):

```
$ mt -f /dev/rmt/1 status
Exabyte EXB-8200 8mm tape drive:
sense key(0x0)= NO Additional Sense residual= 0   retries= 0
file no= 0   block no= 0
```

The following example shows a quick way to poll a system and locate all of its tape drives:

```
$ for drive in 0 1 2 3 4 5 6 7
> do
> mt -f /dev/rmt/$drive status
> done
Archive QIC-150 tape drive:
  sense key(0x0)= No Additional Sense   residual= 0   retries= 0
  file no= 0   block no= 0
/dev/rmt/1: No such file or directory
/dev/rmt/2: No such file or directory
/dev/rmt/3: No such file or directory
/dev/rmt/4: No such file or directory
/dev/rmt/5: No such file or directory
/dev/rmt/6: No such file or directory
/dev/rmt/7: No such file or directory
$
```

Handling Magnetic Tape Cartridges

If errors occur when a tape is being read, you can retension the tape, clean the tape drive, and then try again.

Retensioning a Magnetic Tape Cartridge

Retension a magnetic tape cartridge with the `mt` command.

For example:

```
$ mt -f /dev/rmt/1 retension
$
```

Note – Do not retension non-QIC tape drives.

Rewinding a Magnetic Tape Cartridge

To rewind a magnetic tape cartridge, use the `mt` command.

For example:

```
$ mt -f /dev/rmt/1 rewind
$
```

Guidelines for Drive Maintenance and Media Handling

A backup tape that cannot be read is useless. So, periodically clean and check your tape drives to ensure correct operation. See your hardware manuals for instructions on procedures for cleaning a tape drive. You can check your tape hardware by doing either of the following:

- Copying some files to the tape, reading the files back, and then comparing the original files with the copied files.
- Using the `-v` option of the `ufsdump` command to verify the contents of the media with the source file system. The file system must be unmounted or completely idle for the `-v` option to be effective.

Be aware that hardware can fail in ways that the system does not report.

Always label your tapes after a backup. If you are using a backup strategy similar to the strategies suggested in [Chapter 22, “Backing Up and Restoring UFS File Systems \(Overview\)”](#), you should indicate on the label “Tape A,” “Tape B,” and so forth. This label should never change. Every time you do a backup, make another tape label that contains the following information:

- The backup date
- The name of the machine and file system that is backed up
- The backup level
- The tape number (1 of *n*, if the backup spans multiple volumes)
- Any information specific to your site

Store your tapes in a dust-free safe location, away from magnetic equipment. Some sites store archived tapes in fireproof cabinets at remote locations.

You should create and maintain a log that tracks which media (tape volume) stores each job (backup) and the location of each backed-up file.

Index

Numbers and Symbols

/export/home directory, 312
1394 (FireWire) support, description, 65
4.3 Tahoe file system, 304
9660 CD format, 43

A

accessing
 disk devices, 77
 iSCSI disks (how to), 264
 removable media (how to), 44
 tape devices, 80
adding
 a SCSI device to a SCSI bus (how to), 91
 a USB camera (how to), 135
 a USB mass storage device without `vold` running
 (how to), 135
 adding a new removable media drive (how to), 43
 entry to `/etc/vfstab` file (how to), 341
 PCI adapter card (how to), 100
 swap to `vfstab`, 381
 USB audio devices (how to), 152
 VPPA communication service (how to), 171
allocated inodes, 395
archiving, files to multiple diskettes with `cpio`
 command (how to), 497
autoconfiguration process, 69
autofs, 323–324
automounting, and `/home`, 324

B

backing up
 and restoring file systems
 commands for, 422
 definition, 422
 choosing file systems to, 423
 full and incremental, definition, 424
 preparing for (overview), 438–439
 reasons for, 422
 types of, 424
backup
 device names, 500–502
 record of incremental, 473
backup schedules
 daily cumulative, weekly cumulative backups, 431
 daily cumulative, weekly incremental backups, 432
 daily incremental, weekly cumulative backups, 433
 examples, 430, 436
 for a server, 434–436
 guidelines, 428
 guidelines for, 427
 using dump levels for, 429
bad block numbers, 397
bad inode number, 398
bad superblock, 406
block disk device interface
 definition, 78
 when to use, 78
blocks
 bad, 397
 boot, 414
 data, 415–416

blocks (*Continued*)

- directory data, 397
 - duplicate, 396
 - free, 416
 - indirect, 397
 - logical size, 417
 - regular data, 398
 - special inodes, 395
- boot block, 414
- BSD Fat Fast File system, 304
- bus-oriented disk controllers, 79
- bytes (number per inode), 419

C

CacheFS file systems

- (overview), 351
- checking with `fsck` command (example of), 362
- collecting CacheFS statistics (overview), 372
- creating (how to), 353
- creating a packing list (how to), 366
- deleting (how to), 360
- displaying information about (how to), 359
- displaying packed files (example of), 364
- displaying packed files (how to), 364
- locating CacheFS log file, 373
- mounting (how to), 354
- packing with `cachefspack` command (how to), 363
- packing with `cachefspack` command (overview), 363
- parameters, 351
- setting up CacheFS logging (how to), 373
- stopping CacheFS logging, 374
- troubleshooting `cachefspack` errors, 368
- viewing CacheFS statistics, 376

`cachefspack` command

- how to use, 363
- overview, 363

causes of file system damage, 392

`cd rw` command

- description, 51
- restricting access to (how to), 54
- writing data CDs and DVDs and audio CDs (overview), 53

CDs

- ISO 9660 format, 43
- names, 42
- UFS CDs
 - SPARC vs. x86 format, 43

`cfgadm`

- PCI hot-plugging (overview), 82
- SCSI hot-plugging (overview), 82

`cfscadmin` command, 353, 360

changing, primary USB audio device (how to), 154

character special inodes, 395

checking

- a file system on removable media (how to), 38
- and repairing file systems, 399
- CacheFS file systems (example of), 362
- file system size, 394
- format and type of inodes, 395
- free blocks, 395
- free inodes, 395
- inode list for consistency, 394

`clri` command, 310

collecting, CacheFS statistics (overview), 372

configuring

- a SCSI controller (how to), 88
- a SCSI device (how to), 89
- a USB device (how to), 157
- IB Port, HCA_SVC, or a VPPA device (how to), 168
- IB pseudo device (how to), 169
- IOC device (how to), 167
- iSCSI target discovery (how to), 262
- unidirectional or bidirectional CHAP authentication for iSCSI (how to), 259

connecting

- a SCSI controller (how to), 91
- a USB device, logically (how to), 158

copying

- complete file systems (`dd`), 480
- directories between file systems with `cpio` command (overview), 483
- files to diskette (overview), 494
- groups of files with `cpio` command (overview), 483
- individual files with `cpio` command (overview), 483

`cpio` command

- (overview), 483

- cpio command (*Continued*)
 - copying directories between file systems (how to), 484
 - extract all files from tape (how to), 491
 - listing files on tape (how to), 490
- creating
 - a data CD or DVD file system (how to), 56
 - a disk slice for a ZFS root file system
 - SPARC, 226
 - a file system on a DVD-RAM (how to), 37
 - a file system on a USB mass storage device (how to), 139
 - a file system on removable media (how to), 35
 - a full backup of UFS snapshot information (how to), 454
 - a packing list (how to), 366
 - a UFS snapshot
 - (example of), 452
 - a UFS snapshot (how to), 451
 - disk slice for a ZFS root file system (how to)
 - x86, 241
 - file systems (overview), 328
 - loopback file system (overview), 329
 - swap file, 385
- CTFS file system, 308
- custom parameters for file systems, 416–419
- cylinder group, 413–416

- D**
- daily discrete backups, 430
- damage to file systems, 392
- data block, 398, 415–416
- data directory blocks, 397
- datadm command, 175
- dd command
 - (overview), 480
 - cloning disks (how to), 481
- default
 - file system for /tmp (TMPFS), 307
 - SunOS file system, 311
- deleting
 - CacheFS file systems (how to), 360
 - deleting (*Continued*)
 - UFS snapshot information
 - (example of), 454
 - detecting end of media
 - cpio command, 484
 - ufsdump command, 472
 - determining
 - file system types, 324
 - mounted file systems, 330
 - tape device name, 459
 - type of tape drive, 458
 - /dev/dsk directory, 77
 - /dev/rdisk directory, 77
 - devfsadm command, 76
 - device driver
 - adding, 75
 - definition, 68
 - device names
 - backup, 500–502
 - finding a file system name, 458
 - finding tape, 459
 - devices, accessing, 76
 - df command, 78, 310
 - dfstab file, configuring for shared local removable media (how to), 47
 - direct I/O, 318
 - directories
 - copying between file systems with cpio command
 - (overview), 483
 - inodes, 395
 - /proc, 308
 - /tmp, 307
 - unallocated blocks, 398
 - disabling
 - removable media services, 25
 - removable media services (how to), 43
 - write protection on removable media (how to), 39
 - disconnect, a USB device, logically (how to), 158
 - disconnecting
 - a SCSI controller (how to), 90
 - a USB device subtree, logically (how to), 159
 - disk
 - formatting a (overview), 194

disk (*Continued*)

- setting up for UFS file systems (overview)
 - x86, 234
- setting up for ZFS file systems (overview)
 - x86, 239–246
- when to format (overview), 202
- disk-based file systems, 304
- disk controllers, 79
- disk for a ZFS file system
 - setting up (how to)
 - SPARC, 230
- disk for UFS file systems
 - setting up (how to)
 - SPARC, 217
- disk label
 - creating (overview), 206
 - description, 182
- disk setup for a ZFS root file system
 - connecting (how to)
 - SPARC, 225
 - x86, 240
- disk slice
 - creating for a ZFS root file system
 - SPARC, 226
 - for a ZFS root file system (how to)
 - x86, 241
- disk slices
 - definition, 187
 - determining which slices to use, 191
 - displaying information about (overview), 204
 - requirements for system configurations, 191
- diskettes
 - archiving files to multiple with `cpio` command (how to), 497
 - creating a file system on (how to), 35
 - formatting with `rmformat` (how to), 34
 - loading with volume management (how to), 33
- disks
 - creating disk slices and labeling a disk (how to)
 - SPARC, 218
 - creating disk slices for a UFS root file system (example of)
 - SPARC, 219
 - determining if formatted (how to), 202

disks (*Continued*)

- recovering a corrupted disk label (how to), 212
- recovering a corrupted disk label (overview), 212
- setting up for a UFS file system (example of)
 - SPARC, 220
- setting up for UFS file systems (overview)
 - SPARC, 216
- setting up for ZFS file systems (overview)
 - SPARC, 224
- displaying
 - disk slice information (overview), 204
 - IB communication services (how to), 171
 - InfiniBand device information (how to), 165
 - information about SCSI devices, 87
 - kernel IB clients of an HCA (how to), 169
 - packed files (example of), 364
 - packed files (how to), 364
 - PCI slot configuration information (how to), 97
 - removable media user (how to), 45
 - swap space, 384–385
 - system configuration information, 70, 73
 - USB bus information (how to), 156
 - USB device information (how to), 138
- DOS, file system, 304
- driver not attached message, 70
- dump levels
 - daily, incremental backups, 430
 - definition, 429
- duplicate blocks, 396
- DVD-RAM, creating a file system on (how to), 37
- DVD-ROM, 305
- dynamic reconfiguration, InfiniBand devices, 164
- dynamic reconfiguration (overview), 82

E

- EFI label
 - (overview), 183
 - comparison with VTOC label, 184
 - installing a system with, 185
 - restrictions of, 184
 - troubleshooting problems, 186
- eject command, removable media (how to), 46
- ejecting, removable media (how to), 46

- enabling
 - removable media services (how to), 43
 - uDAPL, 174
 - write protection on removable media (how to), 39
- end-of-media detection
 - cpio command, 484
 - ufsdump command, 472
- error messages, iSCSI, 276
- /etc/dfs/dfsstab file, configuring for shared
 - removable media (how to), 47
- /etc/dumpdates file, 472–473
- extended fundamental types (UFS file system), 313

F

- FDFS file system, 308
- ff command, 310
- FIFO inodes, 395
- FIFOFS file system, 308
- file system name, 458
- file system table, virtual, 321
- file systems
 - 4.3 Tahoe, 304
 - BSD Fat Fast, 304
 - cached (overview), 351
 - checking and repairing, 399
 - checking size, 394
 - copying complete (dd), 480
 - creating (overview)
 - loopback (LOFS), 329
 - CTFS, 308
 - custom parameters, 416–419
 - cylinder group structure, 413–416
 - damage to, 392
 - default SunOS, 311
 - description of administration commands, 310
 - disk-based, 304
 - DOS, 304
 - /export/home, 312
 - FDFS, 308
 - FIFOFS, 308
 - finding types, 324
 - fixing, 405
 - High Sierra, 304

file systems (*Continued*)

- ISO 9660, 304
- making available (overview), 329
- manual pages for, 311
- MNTFS, 312
- mount table, 320
- NAMEFS, 308
- network-based, 306
- OBJFS, 308
- /opt, 312
- PCFS, 304
- preening, 404
- /proc, 312
- process, (overview), 308
- PROCFS, (overview), 308
- pseudo, (overview), 306
- reasons for inconsistencies, 393
- SHAREFS, 309
- sharing, 322–323
- SPECFS, 309
- stopping all processes accessing (how to), 346
- SWAPFS, 309
- TMPFS, 307
- types of, 304
- UFS, 304
- UNIX, 304
- /usr, 312
- /var, 312
- which to back up, 423
- why you back up, 422

files

- archiving to multiple diskettes with cpio command
 - (how to), 497
- commands for copying to media (overview), 477
- /etc/default/fs, 324
- /etc/dfs/fstypes, 324
- in the /proc directory, 308
- retrieving from tape with tar command (how to), 487
- sharing, 322–323

finding

- file system name, 458
- tape device name, 459
- type of file system, 324

- fixing inconsistent file systems, 405
 - format.dat file
 - keywords, 289, 292
 - syntax rules, 289
 - format of inodes, 395
 - format utility
 - (overview), 191
 - analyze menu, 285
 - creating a Solaris fdisk partition (how to), 247
 - creating disk slices (how to)
 - SPARC, 218
 - creating disk slices for a UFS file systems (how to)
 - x86, 236
 - defect menu, 287–288
 - determining if a disk is formatted (how to), 202
 - displaying disk slice information (example of), 205
 - entering command names (how to), 293
 - fdisk menu, 284
 - features and benefits, 191
 - guidelines for using, 193–194
 - identifying disks on a system (examples of), 201
 - identifying disks on a system (how to), 200
 - input to, 292, 294
 - labeling a disk
 - example of, 207
 - main menu, 282
 - partition menu, 284
 - recovering corrupted disk label (how to), 212
 - specifying block numbers (how to), 293
 - using help facility, 294
 - when to use, 192
 - formatting
 - a USB mass storage device without vold running (how to), 141
 - diskettes with rmformat (how to), 34
 - formatting a disk, (overview), 194
 - fragment size, 417–418
 - free blocks, 395, 416
 - free hog slice, *See* donor slice
 - free inodes, 395
 - free space (minimum), 418
 - fsck command, 78, 310
 - checking
 - free blocks, 395
 - fsck command, checking (*Continued*)
 - free inodes, 395
 - inode list size, 394
 - superblock, 394
 - conditions to repair, 393
 - FSACTIVE state flag, 392
 - FSBAD state flag, 392
 - FSCLEAN state flag, 392
 - FSSTABLE state flag, 392
 - preening, 404
 - state flags, 392
 - syntax and options, 411
 - using interactively, 399
 - fsdb command, 310
 - fsnap command, creating a UFS snapshot (how to), 451
 - fsstat command, description, 295
 - fsstat command (examples of), 295
 - fstyp command, 310
 - fstypes file, 324
 - full backup
 - (example of), 441, 443
 - definition, 425
 - fuser command
 - finding if removable media is in use (how to), 45
 - killing processes accessing removable media (how to), 45
- ## G
- grep command, 324
 - GRUB
 - managing disks with GRUB
 - x86, 180
 - Solaris failsafe boot
 - x86, 180
- ## H
- High Sierra file system, 304
 - /home (automounted), 324
 - hot-plugging
 - (overview), 82

hot-plugging (Continued)

- adding a SCSI device to a SCSI bus (how to), 91
 - adding PCI adapter card (how to), 100
 - configuring a SCSI controller (how to), 88
 - configuring a SCSI device (how to), 89
 - configuring a USB device (how to), 157
 - connecting a SCSI controller (how to), 91
 - disconnecting a SCSI controller with `cfgadm` command (how to), 90
 - logically connecting a USB device (how to), 158
 - logically disconnecting a USB device (how to), 158
 - logically disconnecting a USB device subtree (how to), 159
 - PCI devices (overview), 97
 - removing a SCSI device (how to), 93
 - removing PCI adapter card (how to), 99
 - replacing an identical SCSI device on a SCSI controller (how to), 92
 - unconfiguring a SCSI device (how to), 88
 - unconfiguring a USB device (how to), 157
- HSFS, *See* High Sierra file system

I

- I/O, direct, 318
- identifying
 - devices, 71
 - disks on a system (how to), 200
 - primary USB audio device (how to), 153
- inconsistencies in file systems, 393
- incorrect `.` and `..` entries, 398
- incremental backup, 425, 473
 - (example of), 442
- indirect blocks, 397
- InfiniBand devices
 - adding a VPPA communication service (how to), 171
 - configuring an IB Port, HCA_SVC, or a VPPA device (how to), 168
 - configuring an IB pseudo device (how to), 169
 - configuring an IOC device (how to), 167
 - displaying (how to), 165
 - displaying IB communication services (how to), 171

InfiniBand devices (Continued)

- displaying kernel IB clients of an HCA (how to), 169
- dynamic reconfiguration (overview), 164
- overview, 161
- removing an existing IB port, HCA_SVC, or a VPPA communication service (how to), 172
- unconfiguring an IB Port, HCA_SVC, or a VPPA (how to), 167
- unconfiguring an IB pseudo device (how to), 168
- unconfiguring an IOC device (how to), 166
- unconfiguring IB devices connected an HCA (how to), 170
- updating an IOC configuration (how to), 173
- updating the IP `p_key` tables (how to), 171
- inode list size, 394
- inode states, 395
- inodes, 414–415
 - bad number, 398
 - block special, 395
 - character special, 395
 - checking format and type, 395
 - directory, 395
 - FIFO, 395
 - link count, 396
 - number of bytes per, 419
 - regular, 395
 - size, 397
 - symbolic link, 395
- `installboot` command, SPARC, 223
- `installboot` command for a ZFS root file system, 229
- `installgrub` command, x86, 238
- `installgrub` command for a ZFS root file system, 244
- installing boot blocks for a UFS root file system (how to), SPARC, 223
- installing boot blocks for a ZFS root file system (how to), SPARC, 229
- iSCSI
 - (overview), 251
 - accessing iSCSI disks (how to), 264
 - configuring iSCSI target discovery (how to), 262
 - configuring unidirectional or bidirectional CHAP authentication for (how to), 259
 - general iSCSI error messages, 276

iSCSI (*Continued*)

- modifying iSCSI initiator and target parameters (how to), 268
 - monitoring your iSCSI configuration (how to), 265
 - preparing for a Solaris iSCSI configuration (how to), 256
 - removing discovered iSCSI targets (how to), 263
 - software and hardware requirements, 252
 - static and dynamic target discovery, 255
 - troubleshooting iSCSI configuration problems (how to), 274
- iscsiadm** add command, adding static or dynamic targets (example of), 262
- iscsiadm** list, displaying iSCSI configuration information (example of), 266
- iscsiadm** modify command
- enabling CHAP (example of), 259
 - enabling or disabling static or dynamic targets (example of), 263
- iscsiadm** remove command, removing static or dynamic targets (example of), 264
- ISO 9660 file system, 304
- ISO standards, 9660 CD format, 43

K

- /kernel/drv directory, 69
- killing
 - all processes accessing a file system (how to), 346
 - processes accessing removable media (how to), 45

L

- labelit command, 310
- level 0 backup, 429
- link count of inodes, 396
- loading, diskettes (how to), 33
- locating, CacheFS log file, 373
- log (record of dumps), 472–473
- logical block size, 417
- logical device name
 - definition, 77
 - disk, 77

logical device name (*Continued*)

- tape, 80
- logical device names, removable media, 80
- loopback file system (LOFS)
 - creating (overview), 329
 - mounting, 342
- lost+found directory, 392

M

- maintaining tape drives, 504
- managing
 - disks with GRUB
 - x86, 180
- manual pages, for file systems, 311
- media was found message, 33
- memory storage (virtual), definition, 378
- minimum free space, 418
- mkfile command, 385, 386
- mkfs command, 310, 328
- mkisofs command, create a data CD or DVD file system (how to), 56
- MNTFS file system, 312
- mnttab file, 320
- modifying, iSCSI initiator and target parameters (how to), 268
- monitoring, your iSCSI configuration (how to), 265
- mount command, 78
- mount point, definition, 319
- mount table, 320
- mountall command, 310
- mounting
 - a file system with /etc/vfstab, 343
 - a USB mass storage device without vold running (how to), 148
 - all files in vfstab file, 342
 - file systems automatically, 323–324
 - loopback file systems (LOFS), 342
 - NFS file systems, 342
 - remote removable media manually (example of), 49
 - removable media
 - automatic mounting compared to, 28
 - UFS file systems, 342

mounting (*Continued*)

UFS file systems (how to)
without large files, 344

mt command, 503

N

NAMEFS file system, 308

ncheck command, 310

network-based file systems, 306

newfs command, 78, 328

NFS

description, 322

server description, 323

vfstab entry for, 342

nfsd daemon

starting, 47

verifying if running, 47

no media was found message, 34

O

OBJFS file system, 308

/opt directory, 312

options, for ufsdump command, 475

P

parameters (file system), 416–419

partition (swap), definition, 378

passwd file, restoring from tape (example of), 464

PCFS file system, 304

PCI devices

adding PCI adapter card (how to), 100

displaying PCI slot configuration information (how to), 97

removing PCI adapter card (how to), 99

troubleshooting PCI configuration problems, 102

PCI Express (PCIe) support, description, 64

physical device name

definition, 77

power management of devices, description, 67

preening file systems, 404

preparing

for backing up (overview), 438–439

to restore files (overview), 458–459

preparing for, Solaris iSCSI configuration (how to), 256

/proc directory, 308, 312

process file system (PROCFS), 308

PROCFS file system, (overview), 308

prtvto command, 78

(example of), 211

pseudo file systems, (overview), 306

R

raw disk device interface, 78

RCM script

commands for, 104

overview, 103

record of

dumps, 472–473

incremental backup, 473

registering, service provider in the DAT static registry (how to), 175

regular inodes, 395

removable media

accessing (examples of), 44

accessing (how to), 44

accessing media on other systems (example of), 49

adding a new removable media drive (how to), 43

checking a file system on (how to), 38

creating a file system on (how to), 35

creating a file system on a DVD-RAM (how to), 37

disabling or enabling removable media services (how to), 43

ejecting (how to), 46

enabling write protection on (how to), 39

finding out if media is in use (how to), 45

formatting diskettes with rmformat (how to), 34

killing processes accessing (how to), 45

loading diskettes (how to), 33

management, benefits, 27

mounting

manual compared to automatic, 28

removable media (*Continued*)

- mounting remote media (example of), 49
- names, 42
- repairing bad blocks on removable media (how to), 38
- services, disabling, 25
- removing
 - a SCSI device (how to), 93
 - a swap file from use, 388
 - a USB mass storage device without `vol` running (how to), 137
 - discovered iSCSI targets (how to), 263
 - existing IB port, HCA_SVC, or a VPPA communication service (how to), 172
 - PCI adapter card (how to), 99
- repairing, bad blocks on removable media (how to), 38
- replacing, an identical SCSI device on a SCSI controller (how to), 92
- resetting, a USB device (how to), 159
- resolving, a failed SCSI unconfigure operation (how to), 96
- restoring bad superblock, 406
- restoring file systems
 - complete (example of), 466
 - complete (how to), 465
 - determining which tapes to use (how to), 459
 - preparing to (overview), 458–459
 - root and `/usr` (SPARC) (example of), 470
 - root or `/usr` (x86) (example of), 470
 - type of tape drive, 458
- restoring files
 - interactive restore (example of), 462
 - non-interactive restore (example of), 464
- restricting, removable media access (how to), 54
- retrieving, files from tape with `tar` command (how to), 487
- Rock Ridge extension (HSFS file system), 304
- root (`/`) file system or directory, 311

S

- scheduling backups, 427
- SCSI devices
 - adding a SCSI device to a SCSI bus (how to), 91

SCSI devices (*Continued*)

- configuring a SCSI controller (how to), 88
- configuring a SCSI device (how to), 89
- connecting a SCSI controller (how to), 91
- disconnecting with `cfgadm` command (how to), 90
- displaying information about (how to), 87
- removing a SCSI device (how to), 93
- replacing an identical SCSI device on a SCSI controller (how to), 92
- resolving a failed SCSI unconfigure operation (how to), 96
- troubleshooting SCSI configuration problem, 94
- unconfiguring a SCSI controller (how to), 88
- SCSI tape drives, 501
- setting up
 - a disk for ZFS file systems (overview)
 - x86, 239–246
 - CacheFS logging, 373
 - disks for ZFS file systems (overview)
 - SPARC, 224
 - setting up for UFS file systems
 - a disk (overview)
 - SPARC, 216
 - x86, 234
- share command, 323
 - making removable media available to other systems (how to), 47
- shareall command, 323
- SHAREFS file system, 309
- sharing, files, 322–323
- size
 - checking file system, 394
 - fragment, 417–418
 - inode, 397
- slice (definition), 187
- Solaris failsafe boot, x86, 180
- Solaris `fdisk` partition, guidelines, 246–247
- space optimization type, 418–419
- SPARC based systems, UFS format, 43
- SPECFS file system, 309
- specifying a disk slice, 79
- starting, `nfsd` daemon, 47
- state flag
 - `fsck`, 392

state flag (*Continued*)

- UFS file systems, 313

stopping

- all processes for a file system (how to), 346
- CacheFS logging, 374
- killing processes accessing removable media (how to), 45

storage (virtual memory), definition, 378

storage capacities (media), 425, 499

structure of cylinder groups, 413–416

SunOS default file system, 311

superblock, 394, 406, 414

svcadm disable, (example of), 25

swap command, 385

swap file

- adding to `vfstab`, 381
- creating, 385
- displaying, 384–385
- removing from use, 388

swap partition, definition, 378

swapadd command, 381

SWAPFS file system, 309

symbolic links, 395

syntax, `fsck` command, 411

`sysdef` command, 71

T

tape

- capacity, 475
- characteristics, 475
- retrieving files from with `tar` command (how to), 487
- sizes, 425, 499
- storage capacities, 425, 499

tape devices (naming), 80

tape drive

- determining type for restore, 458
- maintaining, 504
- maximum SCSI, 501
- rewind, 501–502

tar command

- (overview), 485

tar command (*Continued*)

- copying files to remote tape with `dd` command (how to), 493
- listing files on diskette (how to), 496
- listing files on tape (how to), 486
- retrieving files from diskette (how to), 496
- retrieving files from remote tape with `dd` command (how to), 494
- retrieving files from tape (how to), 487

temporary file system (TMPFS), overview, 307

time (optimization type), 418–419

`/tmp` directory, 307, 312

TMPFS file system, overview, 307

troubleshooting

- a failed SCSI unconfigure operation, 96
- cache/spack errors, 368
- EFI disk labels, 186
- iSCSI configuration problems (how to), 274
- PCI configuration problems, 102
- SCSI configuration problems, 94
- USB audio device problems, 154
- USB mass storage devices, 149

type of file systems, 304

type of inodes, 395

U

uDAPL

- (overview), 173
- enabling (how to), 174
- registering a service provider in the DAT static registry (how to), 175
- unregistering a service provider in the DAT static registry (how to), 175
- updating the DAT static registry (how to), 175

UDF file system, 305

UFS CDs, SPARC compared to x86 formats, 43

UFS file system, 304, 313

- extended fundamental types, 313

- large file systems, 313

- logging, 313

- mounting, 342

- mounting with `/etc/vfstab`, 343

- mounting without large files (how to), 344

- UFS file system (*Continued*)
 - multiterabyte file systems, 313
 - state flags, 313
- UFS file systems, /, 311
- UFS logging, overview, 316
- UFS snapshot
 - creating (how to), 451
 - creating a full backup of (how to), 454
 - description, 449
- ufsdump command
 - end-of-media detection, 472
 - full backup (example of), 441, 443
 - how data is copied with, 472
 - how it works, 471–475
 - incremental backup (example of), 442
 - limitations, 475
 - options and arguments, 475
- ufsdump command (overview), 440
- ufsrestore command, 476
 - determining which tapes to use (how to), 459
 - preparing to use (overview), 458
- umount command, 310
- umountall command, 310
- unallocated directory blocks, 398
- unallocated inodes, 395
- unconfiguring
 - a SCSI controller (how to), 88
 - a USB device (how to), 157
 - IB devices connected an HCA (how to), 170
 - IB Port, HCA_SVC, or a VPPA Device (how to), 167
 - IB pseudo device (how to), 168
 - IOC device (how to), 166
- UNIX file system, 304
- unmounting, a USB mass storage device without `voId` running (how to), 148
- unregistering, service provider in the DAT static registry (how to), 175
- unsupported devices, 69
- updating
 - DAT static registry (how to), 175
 - IOC configuration (how to), 173
 - IP `p_key` tables (how to), 171
- USB devices
 - (overview), 117
 - acronyms, 117
 - adding a mass storage device without `voId` running (how to), 135
 - adding a USB camera (how to), 135
 - adding audio devices (how to), 152
 - audio
 - (overview), 151
 - changing the primary device (how to), 154
 - device ownership, 154
 - bus description, 118
 - bus-powered devices, 125
 - cables for, 127
 - CDC ACM device support, 114
 - composite device, 119
 - compound device, 119
 - configuring a USB device (how to), 157
 - connect a USB device (how to), 158
 - creating a file system on a mass storage device (how to), 139
 - device classes, 120
 - device nodes, 122
 - diskette devices (overview), 133
 - displaying bus information (how to), 156
 - displaying USB device information (how to), 138
 - drivers, 120
 - EHCI, OHCI, and UHCI support, 122
 - formatting a mass storage device without `voId` running (how to), 141
 - host controller and root hub, 126
 - hot-plugging (overview), 134
 - hotpluggable attribute, 114
 - identifying primary audio device (how to), 153
 - keyboards and mouse devices, 125
 - logically disconnecting a USB device (how to), 158
 - logically disconnecting a USB device subtree (how to), 159
 - mounting mass storage without `voId` running (how to), 148
 - names of, 119
 - Oracle Solaris USB Architecture (USBA), 122
 - overview of 2.0 devices, 123
 - physical device hierarchy, 118

USB devices (*Continued*)

- power budgeting support, 115
 - power management, 127
 - Prolific and Keyspan serial adapter support, 121
 - removable mass storage (overview), 131
 - removing a mass storage device without `voId`
 - running (how to), 137
 - resetting a USB device (how to), 159
 - support for ZFS file systems, 114
 - troubleshooting audio device problems, 154
 - troubleshooting tips for mass storage devices, 149
 - unconfiguring a device (how to), 157
 - unmounting mass storage without `voId` running
 - (how to), 148
 - USB 2.0 support, 123
 - using non-compliant mass storage devices
 - (overview), 133
 - virtual keyboard and mouse support, 115
 - wheel mouse support, 126
- `/usr` file system, 312

V

- `/var` directory, 312
- verifying, `nfsd` daemon is running, 47
- `vfstab` file, 324, 381
 - adding entries to (how to), 341
 - adding swap to, 381
 - default, 321
 - entry for LOFS, 341
 - mounting all files, 342
- viewing, CacheFS statistics, 376
- virtual file system table, 321
- virtual memory storage, definition, 378
- `voLcopy` command, 310

W

- writing, data CDs and DVDs and audio CDs
 - (overview), 53

X

- x86 based systems, UFS format, 43

Z

- ZFS file system
 - setting up a disk (how to)
 - x86, 245

