

**Oracle® Retail Central Office**

Operations Guide

Release 12.0.11

April 2010

Copyright © 2010, Oracle Corporation and/or its affiliates. All rights reserved.

Primary Author: Graham Fredrickson

This software and related documentation are provided under a license agreement containing restrictions on use and disclosure and are protected by intellectual property laws. Except as expressly permitted in your license agreement or allowed by law, you may not use, copy, reproduce, translate, broadcast, modify, license, transmit, distribute, exhibit, perform, publish, or display any part, in any form, or by any means. Reverse engineering, disassembly, or decompilation of this software, unless required by law for interoperability, is prohibited.

The information contained herein is subject to change without notice and is not warranted to be error-free. If you find any errors, please report them to us in writing.

If this software or related documentation is delivered to the U.S. Government or anyone licensing it on behalf of the U.S. Government, the following notice is applicable:

U.S. GOVERNMENT RIGHTS Programs, software, databases, and related documentation and technical data delivered to U.S. Government customers are "commercial computer software" or "commercial technical data" pursuant to the applicable Federal Acquisition Regulation and agency-specific supplemental regulations. As such, the use, duplication, disclosure, modification, and adaptation shall be subject to the restrictions and license terms set forth in the applicable Government contract, and, to the extent applicable by the terms of the Government contract, the additional rights set forth in FAR 52.227-19, Commercial Computer Software License (December 2007). Oracle USA, Inc., 500 Oracle Parkway, Redwood City, CA 94065.

This software is developed for general use in a variety of information management applications. It is not developed or intended for use in any inherently dangerous applications, including applications which may create a risk of personal injury. If you use this software in dangerous applications, then you shall be responsible to take all appropriate fail-safe, backup, redundancy, and other measures to ensure the safe use of this software. Oracle Corporation and its affiliates disclaim any liability for any damages caused by use of this software in dangerous applications.

Oracle is a registered trademark of Oracle Corporation and/or its affiliates. Other names may be trademarks of their respective owners.

This software and documentation may provide access to or information on content, products, and services from third parties. Oracle Corporation and its affiliates are not responsible for and expressly disclaim all warranties of any kind with respect to third-party content, products, and services. Oracle Corporation and its affiliates will not be responsible for any loss, costs, or damages incurred due to your access to or use of third-party content, products, or services.

## Value-Added Reseller (VAR) Language

### Oracle Retail VAR Applications

The following restrictions and provisions only apply to the programs referred to in this section and licensed to you. You acknowledge that the programs may contain third party software (VAR applications) licensed to Oracle. Depending upon your product and its version number, the VAR applications may include:

- (i) the software component known as **ACUMATE** developed and licensed by Lucent Technologies Inc. of Murray Hill, New Jersey, to Oracle and imbedded in the Oracle Retail Predictive Application Server - Enterprise Engine, Oracle Retail Category Management, Oracle Retail Item Planning, Oracle Retail Merchandise Financial Planning, Oracle Retail Advanced Inventory Planning, Oracle Retail Demand Forecasting, Oracle Retail Regular Price Optimization, Oracle Retail Size Profile Optimization, Oracle Retail Replenishment Optimization applications.
- (ii) the **MicroStrategy** Components developed and licensed by MicroStrategy Services Corporation (MicroStrategy) of McLean, Virginia to Oracle and imbedded in the MicroStrategy for Oracle Retail Data Warehouse and MicroStrategy for Oracle Retail Planning & Optimization applications.
- (iii) the **SeeBeyond** component developed and licensed by Sun Microsystems, Inc. (Sun) of Santa Clara, California, to Oracle and imbedded in the Oracle Retail Integration Bus application.
- (iv) the **Wavelink** component developed and licensed by Wavelink Corporation (Wavelink) of Kirkland, Washington, to Oracle and imbedded in Oracle Retail Mobile Store Inventory Management.
- (v) the software component known as **Crystal Enterprise Professional and/or Crystal Reports Professional** licensed by SAP and imbedded in Oracle Retail Store Inventory Management.
- (vi) the software component known as **Access Via™** licensed by Access Via of Seattle, Washington, and imbedded in Oracle Retail Signs and Oracle Retail Labels and Tags.
- (vii) the software component known as **Adobe Flex™** licensed by Adobe Systems Incorporated of San Jose, California, and imbedded in Oracle Retail Promotion Planning & Optimization application.
- (viii) the software component known as **Style Report™** developed and licensed by InetSoft Technology Corp. of Piscataway, New Jersey, to Oracle and imbedded in the Oracle Retail Value Chain Collaboration application.
- (ix) the software component known as **DataBeacon™** developed and licensed by Cognos Incorporated of Ottawa, Ontario, Canada, to Oracle and imbedded in the Oracle Retail Value Chain Collaboration application.

You acknowledge and confirm that Oracle grants you use of only the object code of the VAR Applications. Oracle will not deliver source code to the VAR Applications to you. Notwithstanding any other term or condition of the agreement and this ordering document, you shall not cause or permit alteration of any VAR Applications. For purposes of this section, "alteration" refers to all alterations, translations, upgrades, enhancements, customizations or modifications of all or any portion of the VAR Applications including all reconfigurations, reassembly or reverse assembly, re-engineering or reverse engineering and recompilations or reverse compilations of the VAR Applications or any derivatives of the VAR Applications. You acknowledge that it shall be a breach of the agreement to utilize the relationship, and/or confidential information of the VAR Applications for purposes of competitive discovery.

The VAR Applications contain trade secrets of Oracle and Oracle's licensors and Customer shall not attempt, cause, or permit the alteration, decompilation, reverse engineering, disassembly or other reduction of the VAR Applications to a human perceivable form. Oracle reserves the right to replace, with functional equivalent software, any of the VAR Applications in future releases of the applicable program.



---

---

# Contents

<b>Send Us Your Comments</b> .....	xv
<b>Preface</b> .....	xvii
Audience.....	xvii
Related Documents .....	xvii
Customer Support.....	xvii
Review Patch Documentation .....	xviii
Oracle Retail Documentation on the Oracle Technology Network .....	xviii
Conventions .....	xviii
<b>1 Backend System Administration and Configuration</b>	
<b>Security Configuration</b> .....	1-1
Security Implementation -- Warnings and Advice .....	1-1
<b>Password Policy</b> .....	1-2
Password Reset.....	1-3
Password Change.....	1-3
Adding User.....	1-4
<b>Running Central Office</b> .....	1-4
Browser Configuration for Mozilla and Firefox Browsers.....	1-4
<b>Data Management</b> .....	1-5
<b>Parameters</b> .....	1-5
Importing Initial Parameters .....	1-5
<b>Establishing a Store Hierarchy</b> .....	1-6
Creating the XML File .....	1-6
The Store Hierarchy Schema File.....	1-6
Constructing the XML Store Hierarchy File .....	1-9
Importing the XML File.....	1-10
Adding Store Information to the Database .....	1-11
<b>Modifying Help Files</b> .....	1-12
<b>2 Technical Architecture</b>	
<b>Tier Organization</b> .....	2-1
<b>Client Tier</b> .....	2-2
<b>Middle Tier</b> .....	2-2

Model .....	2-2
View .....	2-3
Controller .....	2-4
Struts Configuration .....	2-4
Application Services .....	2-5
<b>Data Tier</b> .....	2-5
<b>Dependencies in Application and Commerce Services</b> .....	2-6
<b>Example of Operation</b> .....	2-7

### 3 Extracting Source Code

### 4 Development Environment

Using the Apache Ant Build Tool .....	4-1
Prerequisites for the Development Environment .....	4-2
Install and Configure Oracle Application Server .....	4-2
Build the Central Office Application .....	4-3
Create and pre-load the Central Office database .....	4-4
Deploy Central Office in Oracle App Server .....	4-4
Load Application Parameters .....	4-5

### 5 General Development Standards

<b>Basics</b> .....	5-1
Java Dos and Don'ts .....	5-1
Avoiding Common Java Bugs .....	5-2
Formatting .....	5-2
Javadoc .....	5-3
Naming Conventions .....	5-4
SQL Guidelines .....	5-5
DB2 .....	5-5
Oracle .....	5-6
PostgreSQL .....	5-6
Sybase .....	5-7
Unit Testing .....	5-7
<b>Architecture and Design Guidelines</b> .....	5-8
AntiPatterns .....	5-8
Designing for Extension .....	5-9
<b>Common Frameworks</b> .....	5-10
Internationalization .....	5-10
Logging .....	5-11
Guarding Code .....	5-11
When to Log .....	5-12
Writing Log Messages .....	5-12
Exception Messages .....	5-12
Heartbeat or Life cycle Messages .....	5-13
Debug Messages .....	5-13
Exception Handling .....	5-14

Types of Exceptions .....	5-14
Avoid java.lang.Exception.....	5-14
Avoid Custom Exceptions .....	5-14
Catching Exceptions .....	5-15
Keep the Try Block Short.....	5-15
Avoid Throwing New Exceptions.....	5-16
Catching Specific Exceptions .....	5-17
Favor a Switch over Code Duplication.....	5-17

## 6 Coding Your First Feature

<b>Related Materials</b> .....	6-1
<b>Before You Begin</b> .....	6-1
<b>Extending Transaction Search</b> .....	6-1
Item Quantity Example .....	6-1
Web UI Framework.....	6-2
Create a New JSP file.....	6-2
Add Strings to Properties Files .....	6-3
Configure the sideNav Tile .....	6-3
Configure Action Mapping.....	6-4
Add Code to Handle New Fields to Search Transaction Form.....	6-5
Create a Struts Action Class .....	6-6
Add Method to Base Class.....	6-7
Verify Application Manager Implementation .....	6-8
Add Business Logic to Commerce Service .....	6-8
Create a Class to Create the Criteria Object .....	6-8
Add New Criteria to the Service.....	6-10
Handle SQL Code Changes in the Service Bean .....	6-11

## 7 Extension Guidelines

<b>Audience</b> .....	7-1
Application Layers.....	7-2
UI.....	7-2
Application Manager.....	7-2
Commerce Service.....	7-2
Algorithm .....	7-2
Entity.....	7-3
Database .....	7-3
<b>Extension and Customization Scenarios</b> .....	7-3
Style and Appearance Changes .....	7-3
Additional Information Presented to User.....	7-3
Changes to Application Flow .....	7-4
Access Data from a Different Database .....	7-4
Access Data from External System .....	7-6
Change an Algorithm used by a Service.....	7-6
<b>Extension Strategies</b> .....	7-7
Extension with Inheritance .....	7-7

Replacement of Implementation.....	7-10
Service Extension with Composition .....	7-12
Data Extension Through Composition .....	7-14

## 8 Application Services

<b>Application Service Architecture</b> .....	8-3
<b>Application Manager Mapping</b> .....	8-3
<b>Extending an Application Manager</b> .....	8-4
<b>Creating a New Application Manager</b> .....	8-4
<b>Application Manager Reference</b> .....	8-5
Admin Manager .....	8-5
Dashboard Manager .....	8-5
Data Manager .....	8-5
EJournal Manager .....	8-5
Report Manager.....	8-6
Store Manager.....	8-6
Task Manager .....	8-6

## 9 Commerce Services

<b>Commerce Services in Operation</b> .....	9-2
Creating a New Commerce Service.....	9-3
<b>Calendar Service</b> .....	9-3
Database Tables Used .....	9-3
Interfaces .....	9-3
Extending This Service .....	9-3
Dependencies.....	9-4
Tier Relationships.....	9-4
<b>Code List Service</b> .....	9-4
Database Tables Used .....	9-4
Interfaces .....	9-4
Extending This Service .....	9-6
Dependencies.....	9-6
Tier Relationships.....	9-6
<b>Currency Service</b> .....	9-6
Database Tables Used .....	9-6
Interfaces .....	9-6
Extending This Service .....	9-7
Dependencies.....	9-7
Tier Relationships.....	9-7
<b>Customer Service</b> .....	9-7
Database Tables Used .....	9-7
Interfaces .....	9-7
Extending This Service .....	9-7
Dependencies.....	9-8
Tier Relationships.....	9-8
<b>Employee/User Service</b> .....	9-8
Database Tables Used .....	9-8

Interfaces .....	9-8
Extending This Service .....	9-8
Dependencies.....	9-9
Tier Relationships.....	9-9
<b>File Transfer Service</b> .....	9-9
Database Tables Used .....	9-9
Interfaces .....	9-9
Extending This Service .....	9-9
Dependencies.....	9-9
Tier Relationships.....	9-10
<b>Financial Totals</b> .....	9-10
Database Tables Used .....	9-10
Interfaces .....	9-10
Extending This Service .....	9-10
Dependencies.....	9-10
Tier Relationships.....	9-11
<b>Item Service</b> .....	9-11
Database Tables Used .....	9-11
Interfaces .....	9-11
Extending This Service .....	9-13
Dependencies.....	9-13
Tier Relationships.....	9-13
<b>Parameter Service</b> .....	9-13
Database Tables Used .....	9-14
Interfaces .....	9-14
Extending This Service .....	9-14
Dependencies.....	9-14
Tier Relationships.....	9-15
<b>Party Service</b> .....	9-15
Database Tables Used .....	9-15
Interfaces .....	9-15
Extending This Service .....	9-15
Dependencies.....	9-15
Tier Relationships.....	9-15
<b>POSlog Import Service</b> .....	9-15
Database Tables Used .....	9-15
Interfaces .....	9-17
Extending This Service .....	9-17
Dependencies.....	9-17
Tier Relationships.....	9-17
<b>Pricing Service</b> .....	9-17
Database Tables Used .....	9-18
Interfaces .....	9-18
Extending This Service .....	9-19
Dependencies.....	9-19
Tier Relationships.....	9-19
<b>Reporting Service</b> .....	9-19

Database Tables Used .....	9-20
Interfaces .....	9-20
Extending This Service .....	9-20
Dependencies.....	9-20
Tier Relationships.....	9-20
<b>Store Directory Service.....</b>	<b>9-20</b>
Database Tables Used .....	9-20
Interfaces .....	9-21
Extending This Service .....	9-21
Dependencies.....	9-21
Tier Relationships.....	9-22
<b>Store Service .....</b>	<b>9-22</b>
Database Tables Used .....	9-22
Interfaces .....	9-22
Extending This Service .....	9-22
Dependencies.....	9-22
Tier Relationships.....	9-23
<b>Transaction Service .....</b>	<b>9-23</b>
Database Tables Used .....	9-23
Interfaces .....	9-23
Extending This Service .....	9-24
Dependencies.....	9-24
Tier Relationships.....	9-24
<b>Workflow/Scheduling Service .....</b>	<b>9-25</b>
Database Tables Used .....	9-25
Interfaces .....	9-25
Extending This Service .....	9-25
Dependencies.....	9-25
Tier Relationships.....	9-25

## **10 Enterprise Database**

Related Documentation .....	10-1
Database/System Interface .....	10-1
ARTS Compliance .....	10-3
Bean-managed Persistence in the Database .....	10-3

### **A Appendix: Central Office Data Purge**

Invoking Stored Procedures.....	A-2
Calls to invoke stored procedures .....	A-2

### **B Appendix: Changing Currency**

## List of Figures

2-1	High-Level Architecture .....	2-2
2-2	Tiles in an Oracle Retail Application .....	2-4
2-3	Application Manager as Facade for Commerce Services .....	2-5
2-4	Dependencies in Central Office .....	2-6
2-5	Operation of Central Office .....	2-7
6-1	Item Quantity Criteria JSP Page Mock-up .....	6-2
7-1	Application Layers.....	7-2
7-2	Managing Additional Information.....	7-4
7-3	Accessing Data from a Different Database.....	7-5
7-4	Accessing Data from an External System .....	7-6
7-5	Application Layers.....	7-6
7-6	Sample Classes for Extension.....	7-7
7-7	Extension with Inheritance .....	7-8
7-8	Extension with Inheritance Class Diagram .....	7-9
7-9	Replacement of Implementation.....	7-11
7-10	Extension with Composition: Class Diagram .....	7-12
7-11	Extension with Composition.....	7-13
7-12	Data Extension through Composition .....	7-15
7-13	Data Extension through Composition: Class Diagram .....	7-16
8-1	Application Manager in Operation .....	8-2
8-2	Example Application Service Interactions .....	8-3
9-1	Commerce Services in Operation .....	9-2
10-1	Commerce Services, Entity Beans, and Database Tables .....	10-2

## List of Tables

1-1	Tags Defined in store_hierarchy.xsd.....	1-9
1-2	Database Tables Requiring Population by Store Data.....	1-11
5-1	Common Java Bugs.....	5-2
5-2	Naming Conventions .....	5-4
5-3	DB2 SQL Code Problems .....	5-5
5-4	Oracle SQL Code Problems .....	5-6
5-5	Common AntiPatterns .....	5-8
8-1	Application Manager Mapping .....	8-3
10-1	Related Documentation.....	10-1
A-1	Stored Procedure Calls.....	A-2

## List of Examples

5-1	Header Sample .....	5-2
5-2	SQL Code Before PostgresqlDataFilter Conversion .....	5-7
5-3	SQL Code After PostgresqlDataFilter Conversion.....	5-7
5-4	Wrapping Code in a Code Guard.....	5-11
5-5	Switching Graphics Contexts via a Logging Level Test.....	5-11
5-6	JUnit .....	5-13
5-7	Network Test .....	5-15
5-8	Network Test with Shortened Try Block .....	5-16
5-9	Wrapped Exception .....	5-16
5-10	Declaring an Exception .....	5-17
5-11	Clean Up First, then Rethrow Exception.....	5-17
5-12	Using a Switch to Execute Code Specific to an Exception .....	5-18
5-13	Using Multiple Catch Blocks Causes Duplicate Code.....	5-18
6-1	transaction_tracker.xml: SideNav Option List and Roles .....	6-3
6-2	Example Definition Tags for tiles-transaction_tracker.xml .....	6-4
6-3	Struts Action Configuration for Item Quantity .....	6-4
6-4	New Instance Fields.....	6-5
6-5	Getter and Setter Methods for New Instance Fields.....	6-5
6-6	Code to Add to Validate Method .....	6-6
6-7	New Validation Method .....	6-6
6-8	Call a New Method to Get Item Quantity Criteria .....	6-7
6-9	getItemQuantityCriteria Method Implementation .....	6-7
6-10	LineItemQuantityCriteria.java .....	6-8
6-11	SearchCriteria.java .....	6-10
6-12	addToFromClause() Method.....	6-12
6-13	addToWhereClause() Method.....	6-12
6-14	setBindVariables() method .....	6-13
9-1	CalendarServiceIfc.java: Methods .....	9-3
9-2	CodeListServiceIfc.java: Methods .....	9-4
9-3	CurrencyIfc.java: Some Methods.....	9-6
9-4	CustomerServiceIfc.java: Methods .....	9-7
9-5	EmployeeServiceIfc.java: Some Methods .....	9-8
9-6	FileTransferServiceIfc.java: Methods .....	9-9
9-7	FinancialTotalsServiceIfc.java .....	9-10
9-8	ItemServiceIfc.java: Some Methods.....	9-11
9-9	ParameterServiceIfc.java: Sample Methods .....	9-14
9-10	PricingServiceIfc.java: Some Methods .....	9-18
9-11	ReportingServiceIfc.java: Methods.....	9-20
9-12	StoreDirectoryIfc.java: Some Methods.....	9-21
9-13	StoreServiceIfc.java .....	9-22
9-14	TransactionServiceIfc.java: Some Sample Methods.....	9-24
10-1	ItemPriceDerivationBean.java:.ejbStore Method.....	10-3
A-1	Invoking The Stored Procedures -- SQL Plus Method 1 .....	A-2
A-2	Invoking The Stored Procedures -- SQL Plus Method 2 .....	A-2



---

---

# Send Us Your Comments

Oracle Retail Central Office Operations Guide, Release 12.0.11

Oracle welcomes customers' comments and suggestions on the quality and usefulness of this document.

Your feedback is important, and helps us to best meet your needs as a user of our products. For example:

- Are the implementation steps correct and complete?
- Did you understand the context of the procedures?
- Did you find any errors in the information?
- Does the structure of the information help you with your tasks?
- Do you need different information or graphics? If so, where, and in what format?
- Are the examples correct? Do you need more examples?

If you find any errors or have any other suggestions for improvement, then please tell us your name, the name of the company who has licensed our products, the title and part number of the documentation and the chapter, section, and page number (if available).

---

---

**Note:** Before sending us your comments, you might like to check that you have the latest version of the document and if any concerns are already addressed. To do this, access the new Applications Release Online Documentation CD available on My Oracle Support and [www.oracle.com](http://www.oracle.com). It contains the most current Documentation Library plus all documents revised or released recently.

---

---

Send your comments to us using the electronic mail address: [retail-doc\\_us@oracle.com](mailto:retail-doc_us@oracle.com)

Please give your name, address, electronic mail address, and telephone number (optional).

If you need assistance with Oracle software, then please contact your support representative or Oracle Support Services.

If you require training or instruction in using Oracle software, then please contact your Oracle local office and inquire about our Oracle University offerings. A list of Oracle offices is available on our Web site at [www.oracle.com](http://www.oracle.com).



---

---

# Preface

Oracle Retail Operations Guides contain the requirements and procedures that are necessary for the retailer to configure Central Office, and extend code for a Central Office implementation.

## Audience

This document is intended for Oracle Retail Central Office developers who develop code for a Central Office implementation.

## Related Documents

For more information, see the following documents in the Oracle Retail Central Office Release 12.0.11 documentation set:

- *Oracle Retail Central Office Release Notes*
- *Oracle Retail Central Office Installation Guide*
- *Oracle Retail Strategic Store Solutions Licensing Information*

## Customer Support

To contact Oracle Customer Support, access My Oracle Support at the following URL:

<https://support.oracle.com>

When contacting Customer Support, please provide the following:

- Product version and program/module name
- Functional and technical description of the problem (include business impact)
- Detailed step-by-step instructions to re-create
- Exact error message received
- Screen shots of each step you take

## Review Patch Documentation

When you install the application for the first time, you install either a base release (for example, 13.2) or a later patch release (for example, 13.2.2). If you are installing the base release, additional patch, and bundled hot fix releases, read the documentation for all releases that have occurred since the base release before you begin installation.

Documentation for patch and bundled hot fix releases can contain critical information related to the base release, as well as information about code changes since the base release.

## Oracle Retail Documentation on the Oracle Technology Network

Documentation is packaged with each Oracle Retail product release. Oracle Retail product documentation is also available on the following Web site:

[http://www.oracle.com/technology/documentation/oracle\\_retail.html](http://www.oracle.com/technology/documentation/oracle_retail.html)

(Data Model documents are not available through Oracle Technology Network. These documents are packaged with released code, or you can obtain them through My Oracle Support.)

Documentation should be available on this Web site within a month after a product release.

## Conventions

The following text conventions are used in this document:

<b>Convention</b>	<b>Meaning</b>
<b>boldface</b>	Boldface type indicates graphical user interface elements associated with an action, or terms defined in text or the glossary.
<i>italic</i>	Italic type indicates book titles, emphasis, or placeholder variables for which you supply particular values.
monospace	Monospace type indicates commands within a paragraph, URLs, code in examples, text that appears on the screen, or text that you enter.

---

# Backend System Administration and Configuration

This chapter covers required and optional configuration steps that must be performed after Oracle Retail Central Office is deployed, as well as how to run the application when it has been configured. It includes the following topics:

- [Security Configuration](#)
- [Password Policy](#)
- [Running Central Office](#)
- [Data Management](#)
- [Parameters](#)
- [Establishing a Store Hierarchy](#)

## Security Configuration

You can use your own security system, for example, an LDAP server, or you can use the security provided with the Central Office database. The Central Office database needs certain security information, whether that information comes from another database or is manually set. You may work with Oracle Retail to map your security roles to the roles Central Office expects.

Central Office offers more than sixty security access points which you can map to control access to various functions. You can also control workflow through approval permissions, allowing some employees to schedule tasks which others must approve.

Security roles are listed in the  
`\applications\centraloffice\deploy\centraloffice.ear\application.xml` file.

If your browser does not already have an SVG viewer plug-in, and you are using SVG-format signature captures (the default), you must install an SVG plug-in for each browser that accesses Oracle Retail Central Office.

## Security Implementation -- Warnings and Advice

Oracle Retail is committed to providing our customers software, that when combined with overall system security, is capable of meeting or exceeding industry standards for securing sensitive data. By maintaining solutions based on standards, Oracle Retail provides the flexibility for retailers to choose the level and implementation of security without being tied to any specific solution.

Each retailer should carefully review the standards that apply to them with special emphasis on the Payment Card Industry (PCI) best practices. The Oracle Retail applications represent one portion of the entire system that must be secured; therefore, it is important to evaluate the entire system including operating system, network, and physical access.

The following recommendations are required by Visa:

1. Don't use database or operating systems administrative accounts for application accounts. Administrative accounts and any account that has access to sensitive data should require complex passwords as described below. Always disable default accounts before use in production.
2. Assign a unique account to each user. Never allow users to share accounts. Users that have access to more than one customer record should use complex passwords.
3. Complex passwords should have a minimum length of 7 characters, contain both numeric and alphabetic characters, be changed at least every 90 days, and not repeat for at least 4 cycles.
4. Unused accounts should be disabled. Accounts should be temporarily disabled for at least 15 minutes after six invalid authentication attempts.
5. If sensitive data is transmitted over a wireless network, the network must be adequately secure, usually through use of WPA, 802.11i, or VPN.
6. Never store sensitive data on machines connected to the internet. Always limit access using a DMZ and/or firewall.
7. For remote support, be sure to use secure access methods such as two-factor authentication, SSH, SFTP, and so forth. Use the security settings provided by third-party remote access products.
8. When transmitting sensitive data, always use network encryption such as SSL.

Following these recommendations does not necessarily ensure a secure implementation of the Oracle Retail products. Oracle recommends a periodic security audit by a third-party. Please review the PCI standards for additional information.

## Password Policy

One of the most efficient ways to manage user access to a system is through the use of a password policy. The policy can be defined in the database. One policy is defined and applied to all users for Oracle Retail Central Office. The Password Policy consists of the following set of out-of-the-box criteria. For this release, customizing the password policy criteria is permitted through enabling status code system settings and updating password policy system settings to the desired setting.

In order to be PCI (Payment Card Industry) compliant, the Password Policy needs to be set to the following:

- Force user to change password after 90 days.
- Warn user of password expiration 5 days before password expires.
- Lockout user 3 days after password expires or password is reset.
- Lockout user after 6 consecutive invalid login attempts.
- Password must be at least 7 characters in length.
- Password must not exceed 22 characters in length.
- Password must not match any of the 4 previous passwords.

- Password must include at least 1 alphabetic character(s).
- Password must include at least 1 numeric character(s).

Once the desired password policy has been defined, it is applied to all authorized users of the Oracle Retail Point-of-Service, Oracle Retail Mobile Point-of-Service, Oracle Retail Back Office, Oracle Retail Labels and Tags, and Oracle Retail Central Office applications. The password policy must be defined once per database.

## Password Reset

Users locked out of the system must request the assistance of an administrator to have their password reset. The administrator resets the password by selecting the reset password option in Central Office, Back Office or Point-of-Service, when applicable. When a user password is reset the system generates a temporary random password. The reset password status is immediately set to "expired", prompting the user to change the temporary password at the next successful login.

Each time a password is changed, the previous password is stored subject to the 'Passwords must not match any of the N previous passwords' criteria set for the policy associated with the assigned user role. Temporary passwords may not comply with the password policy and are not stored in the password list.

Do the following to change the password of another user:

1. Log in.
2. Click **Admin**.
3. Click **Users**.
4. Search for the user whose password you are resetting. You can search by user ID or name. Click **Search**.
5. Click on the user ID in the User Search Results screen. This opens the User Details screen.
6. Make sure User Info and Role Assignments information is accurate.
7. Click **Reset Password**.  
You will see a message asking if you are sure you want to reset the password. Click **Yes**.
8. A screen with the user's new temporary password is shown.

---

---

**Note:** This temporary password is provided on this screen only. Record this temporary password. The password is not recorded or logged, and is not provided by email. Administrators must provide this temporary password to the user.

---

---

9. Click **Enter**.

## Password Change

Do the following to change your password:

1. Log in.
2. Click **Change Password** in the left navigation bar.
3. Enter your current password.

4. Enter a new password.
5. Enter the new password again.
6. Click **Update**.
7. You will see a screen with the following message:  

Your password has been changed.  
Use this password the next time you log in.
8. Click **Enter**.

## Adding User

Do the following to add a user:

1. Log in.
2. Click **Admin**.
3. Click **Users** on the left navigation bar.
4. Click **Add**.
5. Enter the following:
  - First name
  - Last name
  - User ID
6. Select a status, for example, *Active*.
7. Provide a Role Assignment, for example, *Administrator*.
8. Click **Save**.
9. A screen with the new user's temporary password is shown.

---

---

**Note:** This temporary password is provided on this screen only. Record this temporary password. The password is not recorded or logged, and is not provided by email. Administrators must provide this temporary password to the user.

---

---

## Running Central Office

You must run the Central Office user interface to perform some final configuration tasks, like importing parameters. First verify that the application is running in the application server environment. Then, access the following URL from a browser, specifying the application server hostname and port number where indicated:

`http://<app-server-hostname>:<HTTP-port#>/centraloffice/`

<HTTP-port#> is typically 9080 for WebSphere Application Server.

## Browser Configuration for Mozilla and Firefox Browsers

When Central Office is viewed from a Mozilla or Firefox browser, displayed graphs might not be updated correctly when you change users. To avoid this problem, turn off image caching.

To turn off image caching:

1. In the browser's address bar, type `about:config`.
2. Scroll to the entry `browser.cache.memory.enable` and double-click it. A dialog box appears.
3. Change the value in the dialog box to **false**.
4. Click **OK**.
5. Restart the browser.

## Data Management

Within Central Office, select the **Data Management** tab to display a list of data import and export options. You can import data immediately or schedule an import for later. The following types of data can be imported or exported:

- POSlog
- Store parameters and Central Office application parameters (see [Parameters](#))

## Parameters

---

---

**Note:** An initial set of parameters must be imported before you can use Oracle Retail Central Office.

---

---

This section provides an overview of the procedures for importing an initial set of parameters. The procedure for importing parameters through the application user interface are described in more detail in the Oracle Retail Central Office User Guide.

For information on specific parameters, see the Oracle Retail Strategic Store Solutions Configuration Guide.

## Importing Initial Parameters

To import the initial parameters through the user interface:

1. Click the **Data Management** tab. The Available Imports screen is displayed.
2. To import the master parameter set, click the **File** link in the Import Parameters for Distribution row. Click **Browse** to import `parameterset.xml` from the `<Central Office install directory>/centraloffice/db` folder.
3. To import the initial set of Oracle Retail Central Office application parameters, click the **File** link in the Import Application Parameters row.
4. Click **Browse** to import `centraloffice.xml` from the `<Central Office install directory>/centraloffice/db` folder.

To import parameters using an ant target:

1. Change to the `<Central Office install directory>/centraloffice/db` directory.
2. Edit the `db.properties` file. Ensure that the properties that affect parameter loading are properly set.

3. Execute the following command:

```
ant load_parameters
```

---

---

**Note:** Make sure that the Apache Ant utility is in your PATH. You can find it in `thirdparty/apache-ant-1.6.2/bin`.

---

---

## Establishing a Store Hierarchy

The stores that comprise a corporate retail chain are generally organized into a hierarchy. A hierarchy can be constructed in many different ways: stores can be grouped into cities and cities into regions, or stores can be grouped into divisions or regions. Whatever your hierarchy, it can be reproduced in Central Office. You can include stores at any level of the hierarchy and you can assign any name to the levels.

Creating a store hierarchy in Central Office involves the following steps:

- Create an XML file that describes the store hierarchy. See [Creating the XML File](#).
- Import the XML file. See [Importing the XML File](#).

---

---

**Note:** This import has two files to be imported:

-Preload

-Postload

Preload has all the store Hierarchy information and Postload contains store information.

Instead of using the queries to generate store data, you can import the postload .xml file.

---

---

- Add store information to the necessary database tables. It is useful to perform this step before importing the XML file. See [Adding Store Information to the Database](#).

## Creating the XML File

### The Store Hierarchy Schema File

The tags in `storeHierarchy.xml` are defined by the schema file, `store_hierarchy.xsd`, that follows.

```
<?xml version="1.0" encoding="UTF-8"?>
<xs:schema xmlns:xs="http://www.w3.org/2001/XMLSchema"
  elementFormDefault="qualified">
  <xs:element name="hierarchy">
    <xs:complexType>
      <xs:sequence>
        <xs:element ref="level-list"/>
        <xs:element ref="node-list"/>
      </xs:sequence>
      <xs:attribute name="function" type="xs:byte" use="required"/>
      <xs:attribute name="name" type="xs:string" use="required"/>
    </xs:complexType>
  </xs:element>
  <xs:element name="hierarchy-list">
    <xs:complexType>
      <xs:sequence>
```

```

        <xs:element ref="hierarchy"/>
    </xs:sequence>
</xs:complexType>
</xs:element>
<xs:element name="level">
    <xs:complexType>
        <xs:sequence>
            <xs:element ref="level" minOccurs="0"/>
        </xs:sequence>
        <xs:attribute name="id" use="required">
<!--
=====
RESTRICTION 1:
The following restriction may be imposed if we want to limit the number of level
IDs in the store hierarchy. The enumeration will contain the level IDs starting
from zero, and will correspond with the number of levels within the store
hierarchy.
=====
        <xs:simpleType>
            <xs:restriction base="xs:NMTOKEN">
                <xs:enumeration value="0"/>
                <xs:enumeration value="1"/>
                <xs:enumeration value="2"/>
                <xs:enumeration value="3"/>
            </xs:restriction>
        </xs:simpleType>
-->
    </xs:attribute>
    <xs:attribute name="name" use="required">
<!--
=====
RESTRICTION 2:
The following restriction may be imposed if we want to limit the number of levels
in the store hierarchy. The enumeration will contain the store hierarchy level
names, which should have a corresponding level ID in the attribute, above.
=====
        <xs:simpleType>
            <xs:restriction base="xs:NMTOKEN">
                <xs:enumeration value="Level1"/>
                <xs:enumeration value="Level2"/>
                <xs:enumeration value="Level3"/>
                <xs:enumeration value="root"/>
            </xs:restriction>
        </xs:simpleType>
-->
    </xs:attribute>
    <xs:attribute name="parent" use="required">
<!--
=====
RESTRICTION 3:
The following restriction may be imposed to tie a specific parent level to the
current node within the store hierarchy. Ensure that the IDs defined in
RESTRICTION 1 will correspond to the IDs defined in the enumeration of this
restriction.
=====
        <xs:simpleType>
            <xs:restriction base="xs:NMTOKEN">
                <xs:enumeration value="0"/>
                <xs:enumeration value="1"/>
                <xs:enumeration value="2"/>

```

```

        </xs:restriction>
    </xs:simpleType>
-->
    </xs:attribute>
</xs:complexType>
</xs:element>
<xs:element name="level-list">
    <xs:complexType>
        <xs:sequence>
            <xs:element ref="level"/>
        </xs:sequence>
    </xs:complexType>
</xs:element>
<xs:element name="node">
    <xs:complexType>
        <xs:sequence>
            <xs:element ref="node" minOccurs="0" maxOccurs="unbounded"/>
            <xs:element ref="store" minOccurs="0"
                maxOccurs="unbounded"/>
            <xs:element ref="node" minOccurs="0" maxOccurs="unbounded"/>
        </xs:sequence>
        <xs:attribute name="level" use="required">
<!--
=====
RESTRICTION 4:
The following restriction may be imposed if we want to limit the number of levels
within the store hierarchy. The number of levels should correspond with the
number of level IDs imposed by RESTRICTION 1.
=====
=====
    <xs:simpleType>
        <xs:restriction base="xs:NMTOKEN">
            <xs:enumeration value="0"/>
            <xs:enumeration value="1"/>
            <xs:enumeration value="2"/>
            <xs:enumeration value="3"/>
        </xs:restriction>
    </xs:simpleType>
-->
    </xs:attribute>
    <xs:attribute name="name" type="xs:string" use="required"/>
</xs:complexType>
</xs:element>
<xs:element name="node-list">
    <xs:complexType>
        <xs:sequence>
            <xs:element ref="node"/>
        </xs:sequence>
    </xs:complexType>
</xs:element>
<xs:element name="store">
    <xs:complexType>
        <xs:attribute name="id" use="required">
<!--
=====
RESTRICTION 5:
The following restriction may be imposed if we want to limit the store IDs within
the store hierarchy to specific values. Can only be 5 characters!!!!
=====
    <xs:simpleType>

```

```

        <xs:restriction base="xs:NMTOKEN">
            <xs:enumeration value="store111"/>
            <xs:enumeration value="store222"/>
            <xs:enumeration value="store333"/>
        </xs:restriction>
    </xs:simpleType>
-->
    </xs:attribute>
</xs:complexType>
</xs:element>
<xs:element name="storehierarchy">
    <xs:complexType>
        <xs:sequence>
            <xs:element ref="hierarchy-list"/>
        </xs:sequence>
    </xs:complexType>
</xs:element>
</xs:schema>

```

Table 1–1 lists the tags defined in `store_hierarchy.xsd`.

**Table 1–1 Tags Defined in `store_hierarchy.xsd`**

Tag	Description
<code>storehierarchy</code>	Wraps the entire hierarchy data structure.
<code>hierarchy</code>	Wraps a particular hierarchy. Includes function and name parameters.
<code>hierarchy-list</code>	Wraps the collection of hierarchies. You can have more than one hierarchy, but this functionality is not currently used.
<code>level</code>	Defines a level in the hierarchy. It requires ID, name, and parent parameters. The level with parent 0 is at the root or top of the directory. Levels can and should be nested to show their arrangement in the hierarchy.
<code>level-list</code>	Wraps the list of hierarchy levels.
<code>node</code>	Defines a particular point in the hierarchy. Any node can contain stores or other nodes. You create your hierarchy of regions by listing nodes. The nesting of nodes should replicate the desired hierarchy.
<code>node-list</code>	Wraps the list of nodes.
<code>store</code>	A particular store. It requires on parameter, ID, which identifies the store by serving as a key to the store record in the appropriate table in the database. The store must have a corresponding database record. A store tag can be empty.

### Constructing the XML Store Hierarchy File

The easiest way to construct a hierarchy is to obtain an existing `storeHierarchy.xml` file and edit it. You can, however, create a new `storeHierarchy.xml` file using the tags defined in `store_hierarchy.xsd`.

To set up a hierarchy:

1. Establish the levels in your hierarchy by creating level tags and giving them appropriate names.
2. Add nodes that replicate all the nodes in your hierarchy.

### 3. Add stores to appropriate nodes.

---

**Note:** Ad hoc groups are a separate hierarchy at the root level. They are accessed by selecting **Admin**, then **Store Directory**, and then **Store Groups** in Central Office. Any number of groups can exist, but they cannot be nested; all the groups remain at the top level. Do not edit XML to define ad hoc groups.

---

The following sample `storeHierarchy.xml` file illustrates the use of hierarchy tags. It defines a root level, three additional levels and five node levels (0 through 4) with store IDs contained by the fifth node level.

```
<?xml version="1.0" ?>
<storehierarchy>
<hierarchy-list>
<hierarchy function="1" name="My Hierarchy">
level-list>
level id="0" name="root" parent="0">
<level id="1" name="Level1" parent="0">
<level id="2" name="Level2" parent="1">
<level id="3" name="Level3" parent="3"/>
</level>
</level>
</level>
</level-list>
<node-list>
<node level="0" name="Enterprise">
<node level="1" name="RetailHierarchy">
<node level="2" name="South">
<node level="3" name="Texas">
<node level="4" name="Austin">
<store id="01445" />
<store id="01502" />
<store id="04241" />
</node>
</node>
</node>
</node>
</node>
</node-list>
</hierarchy>
</hierarchy-list>
</storehierarchy>
```

## Importing the XML File

To import store hierarchy information, use the Data Import module.

For more information, see the *Oracle Retail Strategic Store Solutions Implementation Guide*.

## Adding Store Information to the Database

If you review the descriptions of the tags used in the XML file, you notice that stores and other levels of the hierarchy are identified only by an ID and in some cases by a name for the level. This is sufficient to establish a hierarchy, but not sufficient to maintain necessary information about each store (for example, address or contact information) or about other levels in the hierarchy. In order to do that, certain tables in the database must be populated.

[Table 1–2](#) lists the tables requiring population by store data.

**Table 1–2 Database Tables Requiring Population by Store Data**

Physical Table Name	Logical Table Name
PA_PRTY	Party
LO_ADS	Address
LO_STR_RGN	StoreRegion
LO_STR_DSTRCT	StoreDistricts
PA_STR_RTL	RetailStore

The tables in your database can be populated using SQL. Oracle Retail provides SQL files that populate the database with test data. These files illustrate the kind of data required and the correct format for that data.

The easiest way to populate the necessary hierarchy tables is to open an appropriate SQL file and use the entries in that file as a model for the entry you need to make for each store or level.

Run the updated SQL file to populate your tables with actual data. It is a better practice to perform this process before importing the `storeHierarchy.xml` file.

The following examples illustrate the entries for the three stores in the XML file in [Creating the XML File](#).

All three stores are in the same region, so only one entry is necessary for the LO\_STR\_RGN table:

```
INSERT INTO LO_STR_RGN
(ID_STR_RGN, NM_STR_RGN, TS_CRT_RCRD, TS_MDF_RCRD)
VALUES('00001', 'Texas', NOW(*), NOW(*));
```

The three stores are in different districts, so they require three entries in the region table:

```
INSERT INTO LO_STR_DSTRCT
(ID_STR_RGN, ID_STR_DSTRCT, NM_STR_DSTRCT, TS_CRT_RCRD, TS_MDF_RCRD)
VALUES('00001', '00001', 'Round Rock', NOW(*), NOW(*));
INSERT INTO LO_STR_DSTRCT
(ID_STR_RGN, ID_STR_DSTRCT, NM_STR_DSTRCT, TS_CRT_RCRD, TS_MDF_RCRD)
VALUES('00001', '00002', 'Austin', NOW(*), NOW(*));
INSERT INTO LO_STR_DSTRCT
(ID_STR_RGN, ID_STR_DSTRCT, NM_STR_DSTRCT, TS_CRT_RCRD, TS_MDF_RCRD)
VALUES('00001', '00003', 'Cedar Park', NOW(*), NOW(*));
```

The entries for the PA\_PRTY table identify the party by ID and type, in this case, store:

```
INSERT INTO PA_PRTY
(ID_PRTY, TY_PRTY)
VALUES(12, 'STORE');
INSERT INTO PA_PRTY
(ID_PRTY, TY_PRTY)
VALUES(13, 'STORE');
INSERT INTO PA_PRTY
(ID_PRTY, TY_PRTY)
VALUES(14, 'STORE');
```

The entries for the PA\_STR\_RTL table include the store ID as the key to the record and include the party ID, the district ID, and the region ID:

```
INSERT INTO PA_STR_RTL
(ID_STR_RT, ID_PRTY, ID_CD_GEO, NM_LOC, ID_STR_DSTRCT, ID_STR_RGN, ID_STRGRP, TS_
CRT_RCRD, TS_MDF_RCRD)
VALUES('04241', 12, '78729', 'Lakeline Mall', '00003', '00001', 303, NOW(*),
NOW(*));
```

```
INSERT INTO PA_STR_RTL
(ID_STR_RT, ID_PRTY, ID_CD_GEO, NM_LOC, ID_STR_DSTRCT, ID_STR_RGN, ID_STRGRP, TS_
CRT_RCRD, TS_MDF_RCRD)
VALUES('01445', 16, '79761-0302', 'Gaines Square Mall', '00002', '00001', 302,
NOW(*), NOW(*));
```

```
INSERT INTO PA_STR_RTL
(ID_STR_RT, ID_PRTY, ID_CD_GEO, NM_LOC, ID_STR_DSTRCT, ID_STR_RGN, ID_STRGRP, TS_
CRT_RCRD, TS_MDF_RCRD)
VALUES('01291', 14, '79759-0002', 'Cactus Shopping Emporium', '00001', '00001',
301, NOW(*), NOW(*));
```

The entries for the LO\_ADS table link to the PA\_PRTY table with the party ID:

```
INSERT INTO LO_ADS
(ID_ADS, ID_PRTY, TY_ADS, A1_CNCT, A2_CNCT, CI_CNCT, ST_CNCT, PC_CNCT, CO_CNCT)
VALUES (0,12,'0','8876 Piney Point','Suite 220A','Austin','TX','78729','US');
INSERT INTO LO_ADS
(ID_ADS, ID_PRTY, TY_ADS, A1_CNCT, A2_CNCT, CI_CNCT, ST_CNCT, PC_CNCT, CO_CNCT)
VALUES (0,13,'0','2901 S. Capitol of Texas Hwy','Suite
60','Austin','TX','78746-8100','US');
INSERT INTO LO_ADS
(ID_ADS, ID_PRTY, TY_ADS, A1_CNCT, A2_CNCT, CI_CNCT, ST_CNCT, PC_CNCT, CO_CNCT,
TA_CNCT, TL_CNCT)
VALUES (0,14,'0','1201 Second Avenue','Suite
201','Notrees','TX','79759-0002','US','915','2701200');
```

## Modifying Help Files

Central Office online help is created using Oracle Online Help for the Web. Information on this technology is available at <http://www.oracle.com/technology/docs/tech/java/help/index.html>.

The online help is generated from the Central Office User Guide. Each chapter in the user guide is divided into sections. You can look at the Table of Contents for the user guide to see how each chapter is structured. When the user guide is converted into online help, each section is converted into an html help file.

Some help files contain specific information for a screen. Other help files have the background or topic information that is contained in the user guide. For screen help, the name of the file includes the name of the screen. For background help, the name of the file is based on the section in the user guide. For example, the help file for the User Details screen is named `userdetailshelp.htm`. The information in the Working with Transactions section is in the `workwithtransactionshelp.htm` file.

The `centraloffice.ear` file contains the `centraloffice-help.war`. The war file contains the following:

```
helpsets folder
  co_olh folder
    dcommon folder (definitions for styles, gif files for buttons)
    img folder (any images included in the online help from the user guide)
    help files
```

To update a help file:

1. Locate the help file to be changed.
2. Edit the help file.
3. Replace the updated file in the helpset and in `centraloffice.ear`.
4. Redeploy `centraloffice.ear`.



---

---

## Technical Architecture

This chapter describes the main layers of the application, and goes into some detail about the middle tier's use of a model-view-controller (MVC) pattern. The remainder of this overview covers the top-level tier organization of the application and how the application relates to other Oracle Retail applications in an enterprise environment. This guide assumes a basic familiarity with the J2EE specification and industry standard software design patterns.

The architecture of Central Office reflects its overriding design goals

- Well-defined and decoupled layers
- Use appropriate J2EE standards
- Leverage other open standards where possible

### Tier Organization

The architecture of Central Office uses client, middle, and data tiers. The client tier is a Web browser; the middle tier is deployed on an application server; and the data tier is a database deployed by the retailer.

The middle tier is organized in an MVC design pattern, also called a Model 2 pattern. This chapter focuses on the middle tier and the model, view, and controller layers that it is divided into.

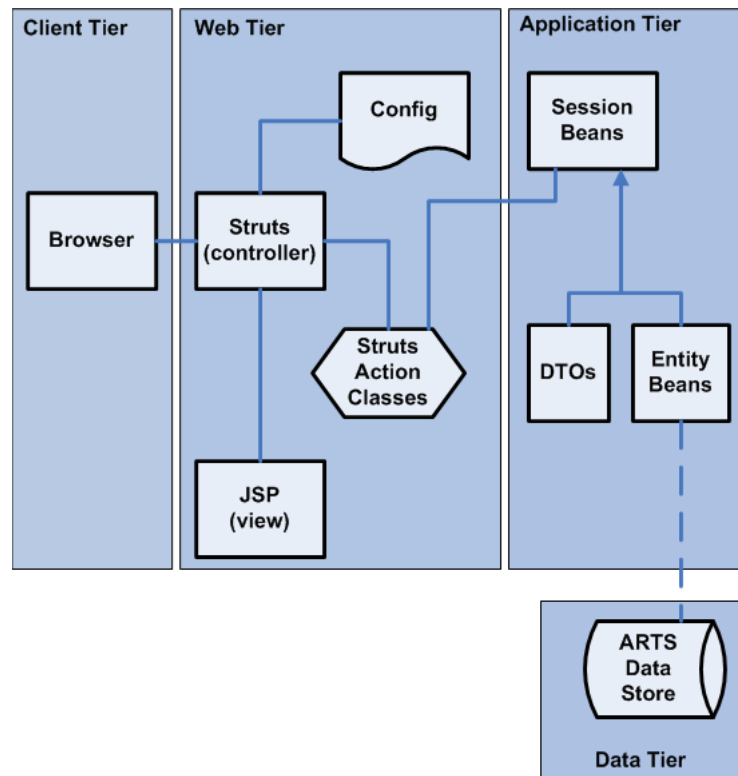
**Figure 2–1 High-Level Architecture**

## Client Tier

The client system uses a Web browser to display data and a GUI generated by the application. Any browser which supports JavaScript, DHTML, CSS, and cookies can be used. In practice, only a few popular browsers are tested.

## Middle Tier

The middle tier of the application resides in a J2EE application server framework on a server machine. The middle tier implements the MVC pattern to separate data structure, data display, and user input.

## Model

The model in an MVC pattern is responsible for storing the state of data and responding to requests to change that state which come from the controller. In Central Office this is handled by a set of Commerce Services, which encapsulates all of the business logic of the application. The Commerce Services talk to the database through a persistence layer of entity EJBs, using bean-managed persistence.

Commerce Services are components that have as their primary interface one or more session beans, possibly exposed as Web services, which contain the shared retail business logic. Commerce Services aggregate database tables into objects, combining sets of data into logical groupings. Commerce Services are organized by business logic categories rather than application functionality. These are services like Transaction, Store Hierarchy, or Parameter that would be usable in any retail-centric application.

These services in turn make use of a persistence layer made up of entity beans. Each Commerce Service talks to one or more entity beans, which map the ARTS standard database schema. Using the bean-managed persistence (BMP) pattern, each entity bean maps to a specific table in the schema, and knows how to read from and write to that table. The Commerce Services thus insulate the rest of the application from changes to the database tables. Database changes can be handled through changes to a few entity beans.

The Commerce Services architecture is designed to facilitate changes without changing the product code. For example:

- You can replace a specific component's implementation. For example, the current Store Hierarchy service persists store hierarchy information to the ARTS database. If a customer site has that information in an LDAP server, the Store Hierarchy could be replaced with one that connected to the LDAP. The interface to the service need not change.
- You can create a new service that wraps an existing service (keeping the interface and source code unchanged), but adds new fields. You might create My Customer Service, which uses the existing Customer Service for most of its information, but adds some specific data. All that you change is the links between the Application Manager and the Customer Service. For more information, see [Chapter 9, "Commerce Services"](#).

## View

The view portion of the MVC pattern displays information to the user. In Central Office this is performed by a Web user interface organized using the Struts/Tiles framework from the open-source Apache Foundation. Using Tiles for page layout allows for greater reuse of the user interface components to enhance the extensibility and customization of the user interface.

To make the view aware of its place in the application, the Struts Actions call into the Application Manager layer for all data updates, business logic, and data requests. Any code in the Struts Actions should be limited to formatting data for the Java server pages (JSPs) and organizing data for calls into the Application Manager layer.

Java Server Pages deliver dynamic HTML content by combining HTML with Java language constructs defined through special tags. Central Office's pages are divided into Tiles which provide navigation and page layout consistency.

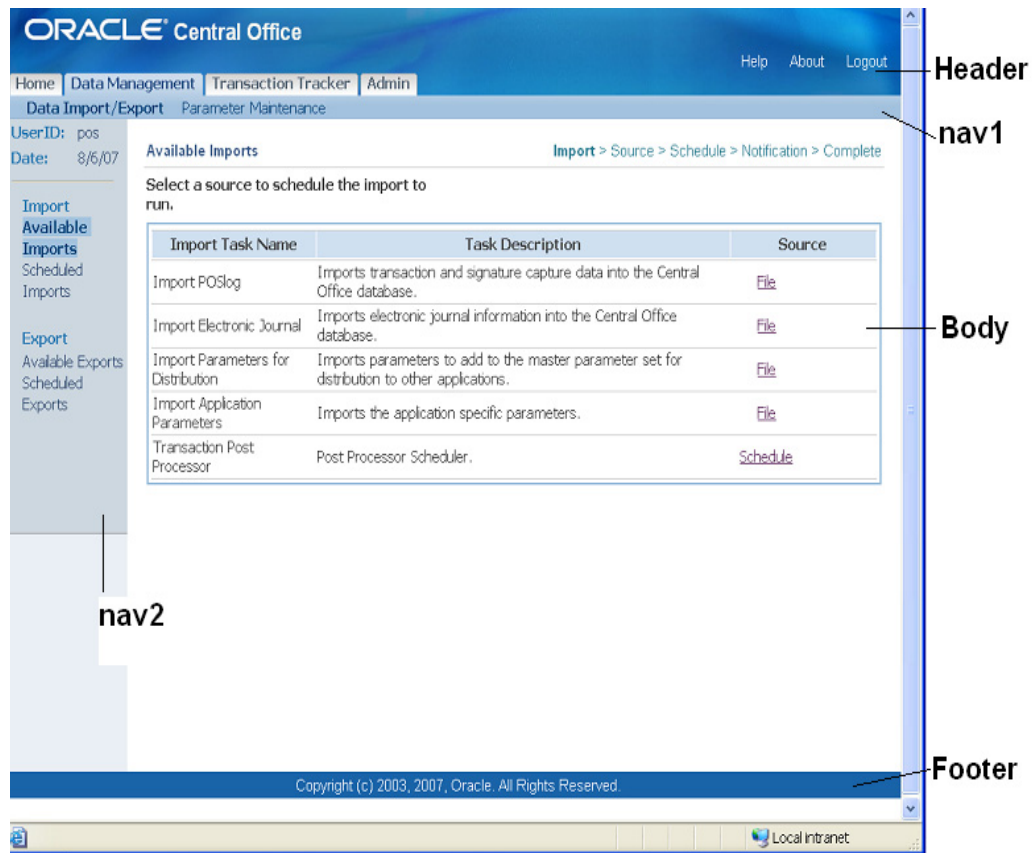
**Figure 2–2 Tiles in an Oracle Retail Application**

## Controller

The controller layer accepts user input and translates that input into calls to change data in the model layer, or change the display in the view layer. Controller functions are handled by Struts configuration files and Application Services.

### Struts Configuration

The application determines which modules to call, on an action request, based on the struts-config.xml file. There are several advantages to this approach:

- The entire logical flow of the application is in a hierarchical text (xml) file. This makes it easier to view and understand, especially with large applications.
- The page designer does not need to read Java code to understand the flow of the application.
- The Java developer does not need to recompile code when making flow changes.

Struts reads the struts-config.xml once, at startup, and creates a mapping database (a listing of the relationships between objects) that is stored in memory to speed up performance.

## Application Services

The application services layer contains logical groupings of related functionality specific to the Central Office application components, such as Store Operations. Each grouping is called an application manager. These managers contain primarily application logic. Retail domain logic should be kept out of these managers and instead shared from the Commerce Services tier.

The application services use the Session Facades pattern; each Manager is a facade for one or more Commerce Services. A typical method in the Application Services layer aggregates several method calls from the Commerce Services layer, allowing the individual Commerce Services to remain decoupled from each other. This also strengthens the Web user interface tier and keeps the transaction and network overhead to a minimum.

For example, the logic for assembling and rendering a retail transaction into various output formats are handled by separate Commerce Services functions. However, the task of creating a PDF file is modeled in the EJournal Manager, which aggregates those separate Commerce Service functions into a single user transaction, thus decreasing network traffic and lowering maintenance costs.

For more information, see [Chapter 8, "Application Services"](#).

**Figure 2–3 Application Manager as Facade for Commerce Services**

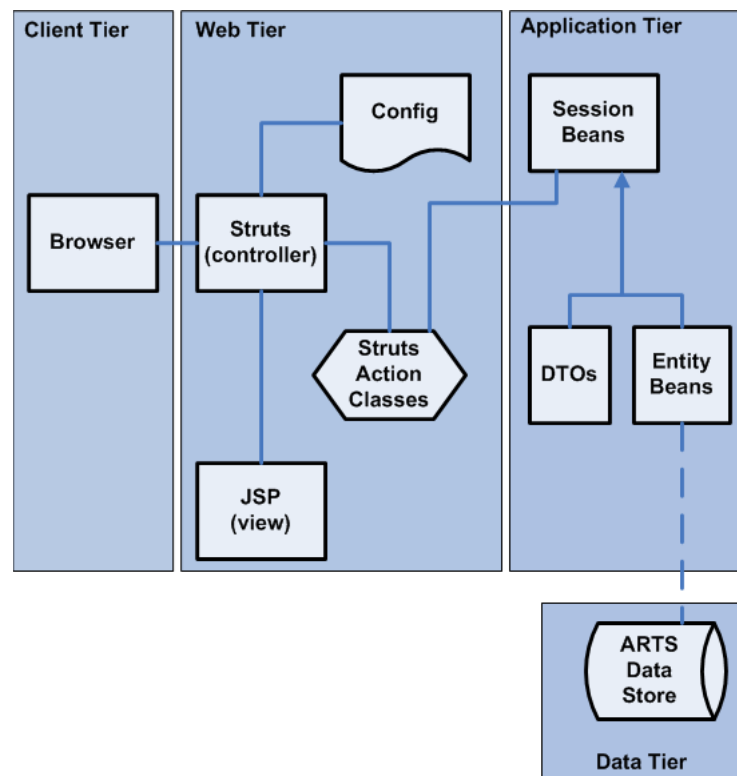

## Data Tier

The Data Tier is represented by a database organized using the ARTS standard schema. Customer requirements determine the specific database selected for a deployment. For more information, see [Chapter 10, "Enterprise Database"](#)

## Dependencies in Application and Commerce Services

The following diagram shows representative components Application Services and Commerce Services. Arrows show the dependencies among various components.

**Figure 2-4** *Dependencies in Central Office*

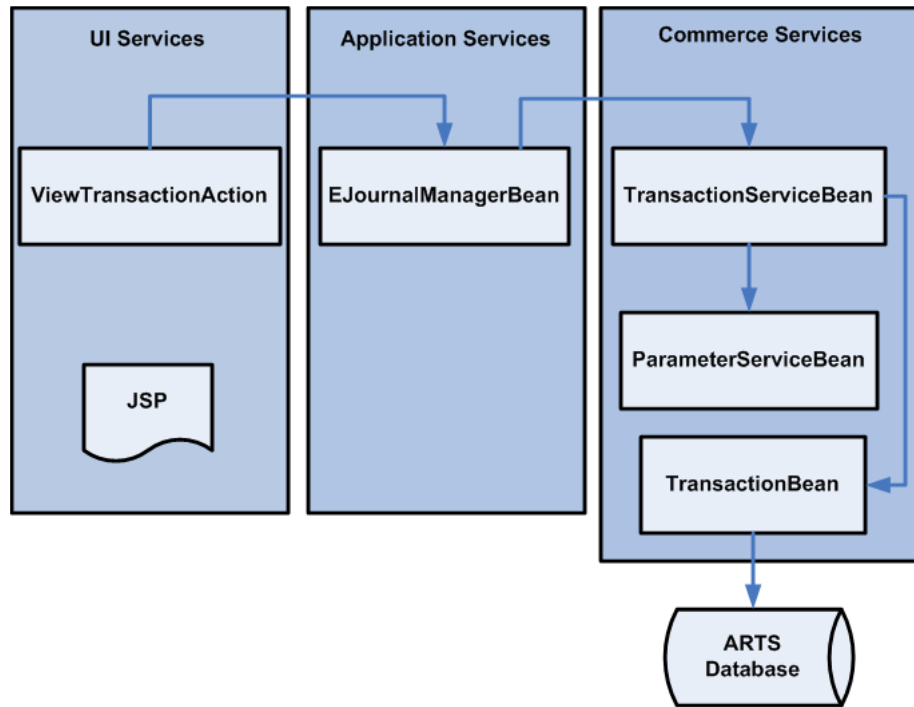

## Example of Operation

The following diagram describes a trip through the Central Office architecture, starting from a user's request for specific information and following through until the system's response is returned to the user's browser.

Figure 2-5 Operation of Central Office

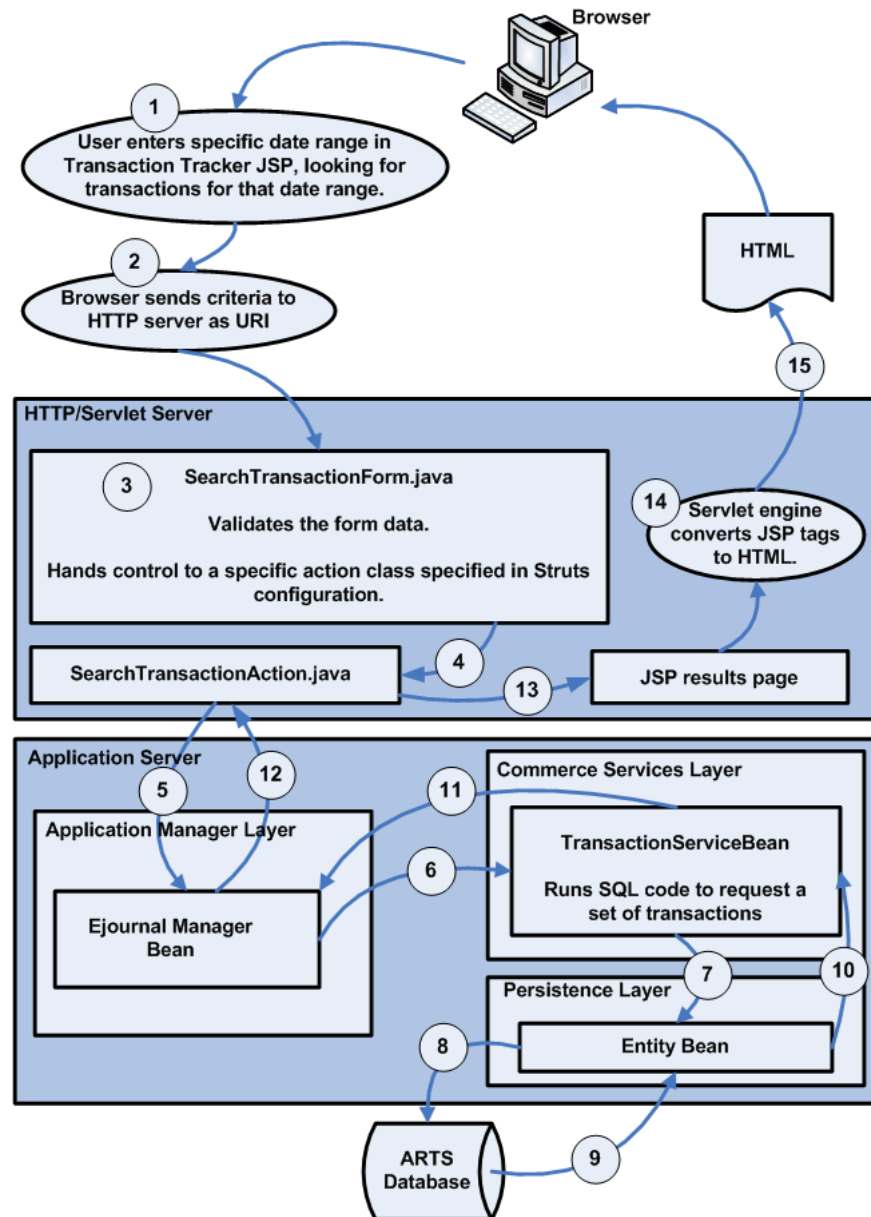



---



---

## Extracting Source Code

Much of this guide deals with the structure and function of Oracle Retail Central Office code, and how you can modify and extend it to serve the needs of your organization. Retailers who wish to make changes to the product, which require the source code, should contact their Oracle representative. All source code distribution requests must be approved, following Oracle's standard Source Code distribution policy.

The source code is downloadable in a single .zip file.

This .zip file contains the following:

File Name	Comments
cmnotes.txt	Configuration Management notes. Describe how to set up and build the source.
ORCO-<release_number>_source.zip	The Central Office source
ORSSS-<release_number>_data_model.zip	Data Model (database schema) documentation
README.html	

Using pkzip, WinZip or similar utilities, you can extract ORCO-<release\_number> onto your local hard disk. Choose the option to preserve the directory structure when you extract. Then all the source files will be placed under some directory like the following:

```
<Path to disk root>/ORCO-<release_number>_source
```

From this point on, this directory is referred to as:

```
<CO_SRC_ROOT>
```

The following is the first-level directory structure under <CO\_SRC\_ROOT>:

Directory	Comments
applications	This has one sub-directory centraloffice, which contains Central Office-specific code. Other directories contain code that might be common to Oracle Retail Stores applications like Back Office, or Point-Of-Service.
build	Files used to compile, assemble and run functional tests
clientinterfaces	Interface definitions, between different code modules
commerceservices	Commerce Services code – see <a href="#">Chapter 9, "Commerce Services"</a> for more details

---

<b>Directory</b>	<b>Comments</b>
modules	A collection of various code modules some of which are the foundation for Commerce Services. The utility module contains SQL files used for database creation and pre-loading.
thirdparty	Executables (mostly .jar files) from third-party providers.
webapp	Web-based user interface code. Also contains the Application Managers.

In subsequent chapters, all pathnames of a code file are made relative to one of these directories. You must prepend <CO\_SRC\_ROOT> to the file path, to get its actual location on disk.

---

---

## Development Environment

This chapter describes how to set up a single-user development environment for Oracle Retail Central Office. The setup enumerates the files, tools, and resources necessary to build and run the Central Office application.

When you complete the steps in this chapter, you will have a local development workspace with the ability to build the application, and an application server installation to which you can deploy the Central Office application.

This chapter assumes that you are using Oracle Application Server and the Oracle database; together, they form the officially supported platform for the current release of Central Office.

Your development environment may use different tools, and you may develop variations on this procedure. Specific property file settings, in particular, may need to be modified in your environment.

For more information about product versions, see the Oracle Retail Central Office Installation Guide.

### Using the Apache Ant Build Tool

Oracle Retail uses the Apache Ant build tool to compile and build executable products from source. Ant uses build information defined in various build.xml files, which in turn read from properties files. Each top-level directory in the product's source contains a build.xml file that specifies a variety of targets, or build tasks, for use by Ant.

Since each code module depends on other modules, the top-level build directory has a build.xml file which contains targets designed to build the entire system. You can build modules individually if you built them in the correct dependency order.

Properties files (such as build.properties) contain values that are used by Ant when it processes tasks. Individual properties can exist in multiple files. The first setting processed by Ant is the one that is used; properties are like constants which cannot be changed once set.

If your system does not already have Ant, you can use the version shipped with Central Office located at:

```
thirdparty\apache-ant-1.6.2
```

---

---

**Note:** Make sure that the Ant bin directory is included in your workstation's PATH.

---

---

## Prerequisites for the Development Environment

The following software resources must be installed and configured before you set up the Central Office development environment as described in the next section. Where a software version is specified, use only the specified version.

- The Central Office source code, on a local (or network) hard disk. See [Chapter 3, "Extracting Source Code"](#) for details on how to extract the code.
- A database server and database. You should have access to the database server; you need its connection URL, user name and password. Depending on your organization's preferences, you may need to install the database server yourself, get a qualified database administrator to install it for you, or you may access a database server installed on another machine. The instructions in this chapter work for a local or remote database.
- JDK 1.4.2. Downloads and instructions are available at <http://sun.com>.

The JAVA\_HOME environment variable needs to be set in your Operating System and the %JAVA\_HOME%\bin directory needs to be added to the path.

## Install and Configure Oracle Application Server

1. Install Oracle Application Server (OAS) under any directory you choose. Follow the instructions that come with the Application Server product. This chapter refers to this directory as <OAS\_ROOT>.
2. Copy the following jars and properties files from the Central Office source to the <OAS\_ROOT>/j2ee/home/applib directory.

```
thirdparty/apache/log4j-1.2.8.jar
applications/centraloffice/appservers/oracle/j2ee/home/applib/log4j.properties
applications/centraloffice/appservers/oracle/j2ee/home/applib/quartz.properties
```

3. Open Oracle Enterprise Manager.

To configure the OAS server instance, use Oracle Enterprise Manager located (by default) at [http://<OAS\\_hostname>:80/em](http://<OAS_hostname>:80/em).

The default administrator login is oc4jadmin with password specified during OAS installation.

Click on the OC4J home of your server instance.

Click on the Administration tab.

4. Configure data sources.

In the Administration Tasks tree, navigate to Administration Tasks > Services > JDBC Resources to create new data sources.

Create a connection pool for the data sources. Name it something like COPool1.

Create a managed data source with JNDI name jdbc/DataSource. Specify COPool1 as its connection pool. Specify the JDBC URL to connect to your Central Office database. It might look like:

```
jdbc:oracle:thin@//<Oracle DB server hostname>:1521/<Database name>
```

Create a second managed data source with JNDI name jdbc/Other. Use the same Connection pool and JDB URL.

**5. Configure Transaction Manager.**

In the Administration Tasks tree, navigate to:

Administration Tasks > Services > Transaction Manager (JTA).

The default transaction timeout is 30 seconds. Increase the timeout to 120 seconds.

**6. Configure JMS queues.**

The queues and connection factories are pre-defined in the jms.xml file contained in the Central Office source.

Stop the Oracle App Server instance. Then copy this file to your OAS installation as follows:

```
cp applications/centraloffice/appservers/oracle/j2ee/home/config/jms.xml
   <OAS_ROOT>/j2ee/home/config/jms.xml
```

**7. Configure mail session.**

Paste the following XML fragment into application.xml under <OAS\_ROOT>/j2ee/home/config. It should be nested directly within the <orion-application> tag.

```
<mail-session location="mail/Mail" smtp-host="360cmail.360commerce.com">
  <property name="mail.transport.protocol" value="smtp"/>
  <property name="mail.smtp.from" value="no_reply@360commerce.com"/>
  <property name="mail.from" value="no_reply@360commerce.com"/>
</mail-session>
```

**8. Enable application security.**

A custom login module security-360-ora.jar must be used within OAS to authenticate and authorize a user. You can build this jar as follows:

```
cd modules/security/oracle
ant clean build
```

Then copy built jar to:

```
<OAS_ROOT>/j2ee/home/applib
```

**9. Configure OC4J start-parameters**

- a. Edit opmn.xml under <OAS\_ROOT>/opmn/conf.
- b. Locate OC4J section nested within the tag <ias-component id="OC4J">.
- c. For each OC4J instance, add the following java options to its start-parameters:

```
-XX:PermSize=128m -XX:MaxPermSize=256m
```

- d. For each OC4J instance, add the following oc4j-option (2nd clause) for userThreads after the java-options:

```
<data id="java-options" value=" ..... " />
<data id="oc4j-options" value="-userThreads"/>
```

## Build the Central Office Application

1. CD to the Central Office build directory.
2. Edit setenv.sh (or setenv.bat on Windows). Make sure that ANT\_HOME is set correctly for your system.

3. Execute `setenv.sh` (or `setenv.bat`).

4. Run the following:

```
ant -Denv=centraloffice clean.build.assemble
```

This command will take several minutes to execute. If successful, it puts the J2EE-compatible `.ear` file in `applications/centraloffice/assemble/assemble.working.dir/centraloffice.ear`.

## Create and pre-load the Central Office database

1. Edit `build/build.xml`.
2. Look for the definition of the "init" target. Change the line:

```
<property name="env" value="backoffice"/>
to
<property name="env" value="centraloffice"/>
```

3. Edit `applications/centraloffice/dist/db/db.properties`.
4. Uncomment the properties that pertain to the database type you are using. Also, set the database user name, password and JDBC URL to point to the pre-existing database you wish to use. Then run:

```
ant load_sql
```

This process takes several minutes to execute. This process builds a Central Office database and pre-loads the database with data required to initially load-up the application.

## Deploy Central Office in Oracle App Server

1. Re-start OAS. You can manually deploy Central Office using Oracle Enterprise Manager GUI. Or you can do this from the command line:

```
<OAS_ROOT>/jdk/bin/java.exe
  -jar <OAS_ROOT>/j2ee/home/admin_client.jar
  deployer:cluster:opmn://localhost/home oc4jadmin oc4jadmin
  -deploy
  -file
  applications/centraloffice/assemble/assemble.working.dir/centraloffice.ear
  -deploymentName CentralOffice
  -bindAllWebApps
```

The above assumes that the default OAS instance called "home" is used.

2. After deploying successfully, the application can be accessed at:

```
http://<OAS_hostname>:80/centraloffice
```

3. Log in to the application with the default login (username `pos`, password `pos`) to verify that it works.

## Load Application Parameters

1. Enable J2SE clients to access OAS EJB container.
2. Inspect and edit the `applications/centraloffice/appservers/oracle/ChPerm.sh` or `ChPerm.cmd` (Windows) script to update the `oc4j` permissions. Make sure that the path information is correct for your installation. If you have changed the credentials (username or password) for your OAS instance away from the default, that will have to be updated, too.
3. Once again inspect and edit the `applications/centraloffice/dist/db/db.properties` file.

This time look at the bottom half of the file that deals with parameter loading. Ensure that everything referring to other application servers (besides OAS) is commented out. Ensure the values of `ora.home.dir` and `parameters.apphost` properties are correct. Then execute:

```
ant load_parameters
```

4. Once the application parameters are loaded, Central Office is ready to use.



---

---

## General Development Standards

The standards in this chapter have been adopted by Oracle Retail product and service development teams. These standards are intended to reduce bugs and increase the quality of the code. The chapter covers basic standards, architectural issues, and common frameworks. These guidelines apply to all Oracle Retail applications.

### Basics

The guidelines in this section cover common coding issues and standards.

### Java Dos and Don'ts

The following dos and don'ts are guidelines for what to avoid when writing Java code.

- DO use polymorphism.
- DO have only one return statement per function or method; make it the last statement.
- DO use constants instead of literal values when possible.
- DO import only the classes necessary instead of using wildcards.
- DO define constants at the top of the class instead of inside a method.
- DO keep methods small, so that they can be viewed on a single screen without scrolling.
- DON'T have an empty catch block. This destroys an exception from further down the line that might include information necessary for debugging.
- DON'T concatenate strings. Oracle Retail products tend to be string-intensive and string concatenation is an expensive operation. Use `StringBuffer` instead.
- DON'T use function calls inside looping conditionals (for example, `while (i <= name.length())`). This calls the function with each iteration of the loop and can affect performance.
- DON'T use a static array of strings.
- DON'T use public attributes.
- DON'T use a switch to make a call based on the object type.



```

// Import only what is used and organize from lowest layer to highest.
import com.ibm.math.BigDecimal;
import com._360commerce.common.utility.Util;

//-----
/**
    This class is a sample class. Its purpose is to illustrate proper
    formatting.
    @version $Revision$
**/
//-----
public class Sample extends AbstractSample
implements SampleIfc
{
    // revision number supplied by configuration management tool
    public static String revisionNumber = "$Revision$";
    // This is a sample data member.
    // Use protected access since someone may need to extend your code.
    // Initializing the data is encouraged.
    protected String sampleData = "";

    //-----
    /**
        Constructs Sample object.
        Include the name of the parameter and its type in the javadoc.
        @param initialData String used to initialize the Sample.
    **/
    //-----
    public Sample(String initialData)
    {
        sampleData = initialData;
        // Declare variables outside the loop
        int length = sampleData.length();
        BigDecimal[] numberList = new BigDecimal[length];

        // Precede code blocks with blank line and pertinent comment
        for (int i = 0; i < length; i++)
        {
            // Sample wrapping line.
            numberList[i] = someInheritedMethodWithALongName(Util.I_BIG_DECIMAL_
ONE,
    sampleData,
    length - i);
        }
    }
}

```

## Javadoc

- Make code comments conform to Javadoc standards.
- Include a comment for every code block.
- Document parameters and return codes for every method, and include a brief statement as to the method's purpose.

## Naming Conventions

Names should not use abbreviations except when they are widely accepted within the domain (such as the customer abbreviation, which is used extensively to distinguish customized code from product code).

Table 5–2 lists additional naming conventions.

**Table 5–2 Naming Conventions**

Element	Description	Example
Package Names	Package names are entirely lower case and should conform to the documented packaging standards.	com.extendyourstore.packagename com.mbs.packagename
Class Names	Mixed case, starting with a capital letter.  Exception classes end in Exception; interface classes end in Ifc; unit tests append Test to the name of the tested class.	DatabaseException DatabaseExceptionTest FoundationScreenIfc
File Names	File names are the same as the name of the class.	DatabaseException.java
Method Names	Method names are mixed case, starting with a lowercase letter. Method names are an action verb, where possible. Boolean-valued methods should read like a question, with the verb first. Accessor functions use the prefixes get or set.	isEmpty() hasChildren() getAttempt() setName()
Attribute Names	Attribute names are mixed case, starting with a lowercase letter.	lineItemCount
Constants	Constants (static final variables) are named using all uppercase letters and underscores.	final static int NORMAL_SIZE = 400
EJBs — entity	Use these conventions for entity beans, where <i>Transaction</i> is a name that describes the entity.	TransactionBean TransactionIfc TransactionLocal TransactionLocalHome TransactionRemote TransactionHome
EJBs — session	Use these conventions for session beans, where <i>Transaction</i> is a name that describes the session.	TransactionService TransactionAdapter TransactionManager

## SQL Guidelines

The following general guidelines apply when creating SQL code:

- Keep SQL code out of client/UI modules. Such components should not interact with the database directly.
- Table and column names must be no more than 18 characters.
- Comply with ARTS specifications for new tables and columns. If you are creating something not currently specified by ARTS, strive to follow the ARTS naming conventions and guidelines.
- Document and describe every object, providing both descriptions and default values so that we can maintain an up-to-date data model.
- Consult your data architect when designing new tables and columns.
- Whenever possible, avoid vendor-specific extensions and strive for SQL-92 compliance with your SQL.
- While Sybase-specific extensions are common in the code base, do not introduce currently unused extensions, because they must be ported to the DataFilters and JdbcHelpers for other databases.
- All SQL commands should be uppercase because the DataFilters currently only handle uppercase.
- If database-specific code is used in the source, move it into the JdbcHelpers.
- All JDBC operations classes must be thread-safe.

Do the following to avoid errors:

- Pay close attention when cutting and pasting SQL.
- Always place a carriage return at the end of the file.
- Test your SQL before committing.

The subsections that follow describe guidelines for specific database environments.

### DB2

[Table 5–3](#) shows examples of potential problems in DB2 SQL code.

**Table 5–3 DB2 SQL Code Problems**

Problem	Problem Code	Corrected Code
Don't use quoted integers or unquoted char and varchar values; these cause DB2 to produce errors.	<pre>CREATE TABLE BLAH (   FIELD1 INTEGER,   FIELD2 CHAR(4) ); INSERT INTO BLAH (FIELD1, FIELD2) VALUES ('5', 1020);</pre>	<pre>CREATE TABLE BLAH (   FIELD1 INTEGER,   FIELD2 CHAR(4) ); INSERT INTO BLAH (FIELD1, FIELD2) VALUES (5, '1020');</pre>
Don't try to declare a field default as NULL.	<pre>CREATE TABLE BLAH (   FIELD1 INTEGER NULL,   FIELD2 CHAR(4) NOT NULL );</pre>	<pre>CREATE TABLE BLAH (   FIELD1 INTEGER,   FIELD2 CHAR(4) NOT NULL );</pre>

## Oracle

Table 5-4 provides some examples of common syntax problems which cause Oracle to produce errors.

**Table 5-4 Oracle SQL Code Problems**

Problem	Problem Code	Corrected Code
Blank line in code block causes error.	<pre>CREATE TABLE BLAH (   FIELD1 INTEGER,   FIELD2 VARCHAR(20) );</pre>	<pre>CREATE TABLE BLAH (   FIELD1 INTEGER,   FIELD2 VARCHAR(20) );</pre>
When using NOT NULL with a default value, NOT NULL must follow the DEFAULT statement.	<pre>CREATE TABLE BLAH (   FIELD1 INTEGER NOT NULL DEFAULT   0,   FIELD2 VARCHAR(20) );</pre>	<pre>CREATE TABLE BLAH (   FIELD1 INTEGER DEFAULT 0 NOT NULL,   FIELD2 VARCHAR(20) );</pre>
In a CREATE or INSERT, do not place a comma after the last item.	<pre>CREATE TABLE BLAH (   FIELD1 INTEGER,   FIELD2 VARCHAR(20), );</pre>	<pre>CREATE TABLE BLAH (   FIELD1 INTEGER,   FIELD2 VARCHAR(20) );</pre>

## PostgreSQL

PostgreSQL does not currently support the command `ALTER TABLE BLAH ADD PRIMARY KEY`. However, it does support the standard `CREATE TABLE` command with a `PRIMARY KEY` specified. For this reason, the `PostgresqlDataFilter` converts SQL of the form shown in the first code sample (Example 5-2) into the standard form shown in the second code example (Example 5-3).

**Example 5–2 SQL Code Before PostgresqlDataFilter Conversion**

```

CREATE TABLE BLAH
(
  COL1 INTEGER NOT NULL,
  COL2 INTEGER NOT NULL,
  COL3 INTEGER,
);

ALTER TABLE ADD PRIMARY KEY (COL1, COL2)ALTER TABLE ADD PRIMARY KEY (COL1,
COL2)ALTER TABLE ADD PRIMARY KEY (COL1, COL2)CREATE TABLE BLAH
(
  COL1 INTEGER NOT NULL,
  COL2 INTEGER NOT NULL,
  COL3 INTEGER,
);

ALTER TABLE ADD PRIMARY KEY (COL1, COL2)CREATE TABLE BLAH
(
  COL1 INTEGER NOT NULL,
  COL2 INTEGER NOT NULL,
  COL3 INTEGER,
);

ALTER TABLE ADD PRIMARY KEY (COL1, COL2)

```

**Example 5–3 SQL Code After PostgresqlDataFilter Conversion**

```

CREATE TABLE BLAH( COL1 INTEGER NOT NULL,
  COL2 INTEGER NOT NULL,
  COL3 INTEGER,
  PRIMARY KEY (COL1, COL2));SQL Code After PostgresqlDataFilter Conversion
CREATE TABLE BLAH( COL1 INTEGER NOT NULL,
  COL2 INTEGER NOT NULL,
  COL3 INTEGER,
  PRIMARY KEY (COL1, COL2));

```

---

**Note:** There must be a new line and an open paren -- (-- after the CREATE TABLE command for the PostgresqlDataFilter's conversion to work, properly formatting the SQL.

---

**Sybase**

Sybase does not throw errors if a table element is too large; it truncates the value. If using a VARCHAR(40), use less than 40 characters.

**Unit Testing**

For details on how to implement unit testing, see separate guidelines on the topic. Some general notes apply:

- Break large methods into smaller, testable units.
- Although unit testing might be difficult for tour scripts, apply it for Java components within the Point-of-Service code.
- If you add a new item to the codebase, make sure your unit tests prove that the new item can be extended.

- In unit tests, directly create the data or preconditions necessary for the test (in a `setUp()` method) and remove them afterwards (in a `tearDown()` method). JUnit expects to use these standard methods in running tests.

## Architecture and Design Guidelines

This section provides guidelines for making design decisions which are intended to promote a robust architecture.

### AntiPatterns

An AntiPattern is a common solution to a problem which results in negative consequences. The name contrasts with the concept of a pattern, a successful solution to a common problem.

[Table 5–5](#) lists AntiPatterns that introduce bugs and reduce the quality of code.

**Table 5–5 Common AntiPatterns**

Pattern	Description	Solution
Reinvent the Wheel	Sometimes code is developed in an unnecessarily unique way that leads to errors, prolonged debugging time and more difficult maintenance.	The analysis process for new features provides awareness of existing solutions for similar functionality so that you can determine the best solution.  There must be a compelling reason to choose a new design when a proven design exists. During development, a similar pattern should be followed in which existing, proven solutions are implemented before new solutions.
Copy-and-paste Programming, classes	When code needs to be reused, it is sometimes copied and pasted instead of using a better method. For example, when a whole class is copied to a new class when the new class could have extended the original class. Another example is when a method is being overridden and the code from the super class is copied and pasted instead of calling the method in the super class.	Use object-oriented techniques when available instead of copying code.

**Table 5–5 Common AntiPatterns**

Pattern	Description	Solution
Copy-and-paste Programming, XML	A new element (such as a Site class or an Overlay XML tag) can be started by copying and pasting a similar existing element. Bugs are created when one or more pieces are not updated for the new element. For example, a new screen might have the screen name or prompt text for the old screen.	If you copy an existing element to create a new element, manually verify each piece of the element to ensure that it is correct for the new element.
Project Mismanagement/ Common Understanding	A lack of common understanding between managers, Business Analysts, Quality Assurance and developers can lead to missed functionality, incorrect functionality and a larger-than-necessary number of defects.	Before you consider code for the requirement finished, all issues must be resolved and the code must match the requirements.
Stovepipe	Multiple systems within an enterprise are designed independently. The lack of commonality prevents reuse and inhibits interoperability between systems. For example, a change to till reconcile in Back Office might not consider the impact on Point-of-Service. Another example is making a change to a field in the Oracle Retail database for a Back Office feature without handling the Point-of-Service effects.	Coordinate technologies across applications at several levels. Define basic standards in infrastructures for the suite of products. Only mission-specific functions should be created independently of the other applications within the suite.

## Designing for Extension

This section defines how to code product features so that they can be easily extended. It is important that developers on customer projects whose code might be rolled back into the base product follow these standards as well as the guidelines in [Chapter 7, "Extension Guidelines"](#).

- Separate external constants such as database table and column names, JMS queue names, port numbers from the rest of the code. Store them in (in order of preference):
  - Configuration files
  - Deployment descriptors
  - Constant classes and interfaces
- Make sure the SQL code included in a component does not touch tables not directly owned by that component.
- Make sure there is some separation from DTO and ViewBean type classes so we have abstraction between the service and the presentation.

- Consider designing so that any fine-grained operation within the larger context of a coarse grain operation can be factored out in a separate algorithm class, so that the fine-grained operation can be replaced without reworking the entire activity flow of the larger operation.

## Common Frameworks

This section provides guidelines which are common to the Oracle Retail applications.

### Internationalization

---

---

**Note:** The only language currently supported is United States English.

Oracle Retail does not provide support for any customer extensions made to the base Central Office product.

---

---

The following are some general guidelines for maintaining an internationalized code base which can be localized when needed. Refer to other documents for detailed instructions on these issues.

- All displayable text must be referenced from the appropriate resource bundle and properties file, so that the text can be changed when needed.
- Numbers must be displayed using Java internationalization conventions, so that appropriate symbols and number dividers can be used for the current locale.
- Currency, and amounts must be displayed by calling the CurrencyService framework (and CurrencyRenderingTag for Back Office/Central Office) so that the appropriate formatting will be used for the selected locale.
- Formats and conventions related to dates, times and calendars are locale sensitive. All the calendar related operations must use Calendar classes, instead of the Date class. Remove hardcoded dates (mm/dd/yyyy, and so forth).
- All date and times must be displayed by calling the DateTimeService framework (and LocalizedDateTag for Back Office/Central Office). Use the formats available as part of the DateTimeService framework.
- Properties in the application.properties file specify default and supported locales:
  - default\_locale=en\_US
  - supported\_locales=en\_US
- Help files for new screens must be created in the appropriate locale directory, and pos\config\ui\help\helpscreens.properties must be updated.
- Display database driven locale sensitive data according to the current locale.

## Logging

Oracle Retail Strategic Store Solutions systems use Log4J for logging. When writing log commands, use the following guidelines:

- Use calls to Log4J rather than System.out from the beginning of your development. Unlike System.out, Log4J calls are naturally written to a file, and can be suppressed when desired.
- Log exceptions where you catch them, unless you are going to rethrow them. This preserves the context of the exceptions and helps reduce duplicate exception reporting.
- Logging uses few CPU cycles, so use debugging statements freely.
- Use the correct logging level:
  - FATAL—crashing exceptions
  - ERROR—nonfatal, unhandled exceptions (there should be few of these)
  - INFO—life cycle/heartbeat information
  - DEBUG—information for debugging purposes

The following sections provide additional information on guarding code, when to log, and how to write log messages.

### Guarding Code

Testing shows that logging takes up very little of a system's CPU resources. However, if a single call to your formatter is abnormally expensive (stack traces, database access, network IO, large data manipulations, and so forth), you can use Boolean methods provided in the Logger class for each level to determine whether you have that level (or better) currently enabled; Jakarta calls this a code guard:

#### **Example 5-4 Wrapping Code in a Code Guard**

```

    if (log.isDebugEnabled()) {
        log.debug(MassiveSlowStringGenerator().message());    if
(log.isDebugEnabled()) {
        log.debug(MassiveSlowStringGenerator().message());
    }

```

An interesting use of code guards, however, is to enable debug-only code, instead of using a DEBUG flag. Using Log4J to maintain this functionality lets you adjust it at runtime by manipulating Log4J configurations.

For instance, you can use code guards to simply switch graphics contexts in your custom swing component:

#### **Example 5-5 Switching Graphics Contexts via a Logging Level Test**

```

protected void paintComponent(Graphics g) {

    if (log.isDebugEnabled()) {
        g = new DebugGraphics(g, this);
    }

    g.drawString("foo", 0, 0);
}

```

## When to Log

There are three main cases for logging:

- Exceptions—Should be logged at an error or fatal level.
- Heartbeat/Life cycle—For monitoring the application; helps to make unseen events clear. Use the info level for these events.
- Debug—Code is usually littered with these when you are first trying to get a class to run. If you use `System.out`, you have to go back later and remove them to keep. With Log4J, you can simply raise the log level. Furthermore, if problems pop up in the field, you can lower the logging level and access them.

## Writing Log Messages

When Log4J is being used, any log message might be seen by a user, so the messages should be written with users in mind. Cute, cryptic, or rude messages are inappropriate. The following sections provide additional guidelines for specific types of log messages.

### Exception Messages

A log message should have enough information to give the user an understanding of the problem and enable the user to fix the problem. Poor logging messages say something opaque like “load failed.”

Consider this piece of code:

```
try {
    File file = new File(fileName);
    Document doc = builder.parse(file);

    NodeList nl = doc.getElementsByTagName("molecule");
    for (int i = 0; i < nl.getLength(); i++) {
        Node node = nl.item(i);
        // something here
    }
} catch {
    // see below
}
```

and these two ways of logging exceptions:

```
} catch (Exception e){
    log.debug("Could not load XML");
}

} catch (IOException e){
    log.error("Problem reading file " + fileName, e);
} catch (DOMException e){
    log.error("Error parsing XML in file " + fileName, e);
} catch (SAXException e){
    log.error("Error parsing XML in file " + fileName, e);
}
```

In the first case, you'll get an error that just tells you something went wrong. In the second case, you're given slightly more context around the error, in that you know if you can't find it, load it, or parse it, and you're given that key piece of data: the file name.

The log lets you augment the message in the exception itself. Ideally, with the messages, the stack trace, and type of exception, you'll have enough information to be able to reproduce the problem at debug time. Given that, the message can be reasonably verbose.

For instance, the `fail()` method in JUnit really just throws an exception, and whatever message you pass to it is in effect logging. It's useful to construct messages that contain a great deal of information about what you are looking for:

### **Example 5-6 JUnit**

```
if (! list.contains(testObj)) {

    StringBuffer buf = new StringBuffer();
    buf.append("Could not find object " + testObj + " in list.\n");
    buf.append("List contains: ");
    for (int i = 0; i < list.size(); i++) {
        if (i > 0) {
            buf.append(", ");
        }
        buf.append(list.get(i));
    }
    fail(buf.toString());
}
```

### **Heartbeat or Life cycle Messages**

The log message should succinctly display what portion of the life cycle is occurring (login, request, loading, and so forth) and what apparatus is doing it (is it a particular EJB, are there multiple servers running, and so forth)

These message should be fairly terse, since you expect them to be running all the time.

### **Debug Messages**

Debug statements are going to be your first insight into a problem with the running code, so having enough, of the right kind, is important.

These statements are usually either of an intra-method-life cycle variety:

```
log.debug("Loading file");

File file = new File(fileName);
log.debug("loaded. Parsing...");
Document doc = builder.parse(file);
log.debug("Creating objects");
for (int i ...
```

or of the variable-inspection variety:

```
log.debug("File name is " + fileName);

log.debug("root is null: " + (root == null));
log.debug("object is at index " + list.indexOf(obj));
```

## Exception Handling

The following are the key guidelines for exception handling:

- Handle the exceptions that you can (File Not Found, and so forth).
- Fail fast if you can't handle an exception.
- Log every exception with Log4J, even when first writing the class, unless you are rethrowing the exception.
- Include enough information in the log message to give the user or developer a chance to know what went wrong.
- Nest the original exception if you rethrow one.

### Types of Exceptions

The EJB specification divides exceptions into the following categories:

#### JVM Exceptions

You cannot recover from these; when one is thrown, it's because the JVM has entered a kernel panic state that the application cannot be expected to recover from. A common example is an Out of Memory error.

#### System Exceptions

Similar to JVM exceptions, these are generally, though not always, non-recoverable exceptions. In the commons-logging parlance, these are *unexpected* exceptions. The canonical example here is `NullPointerException`. The idea is that if a value is null, often you don't know what you should do. If you can simply report back to your calling method that you got a null value, do that. If you cannot gracefully recover, say from an `IndexOutOfBoundsException`, treat as a system exception and fail fast.

#### Application Exceptions

These are the expected exceptions, usually defined by specific application domains. It is useful to think of these in terms of recoverability. A `FileNotFoundException` is sometimes easy to rectify by simply asking the user for another file name. But something that's application specific, like `JDOMException`, still might not be recoverable. The application can recognize that the XML it is receiving is malformed, but it still might not be able to do anything about it.

#### Avoid `java.lang.Exception`

Avoid throwing the generic `Exception`; choose a more specific (but standard) exception.

#### Avoid Custom Exceptions

Custom exceptions are rarely needed. The specific type of exception thrown is rarely important; don't create a custom exception if there is a problem with the formatting of a string (`ApplicationFormattingException`) instead of reusing `IllegalArgumentException`.

The best case for writing a custom exception is if you can provide additional information to the caller which is useful for recovering from the exception or fixing the problem. For example, the `JPOSExceptions` can report problems with the physical device. An XML exception could have line number information embedded in it, allowing the user to easily detect where the problem is. Or, you could subclass `NullPointerException` with a little debugging magic to tell the user what method or variable is null.

## Catching Exceptions

The following sections provide guidelines on catching exceptions.

**Keep the Try Block Short** The following example, from a networking testing application, shows a loop that was expected to require approximately 30 seconds to execute (since it calls `sleep(3000)` ten times):

### *Example 5-7 Network Test*

```
for (int i = 0; i < 10; i++) {
    try {
        System.out.println("Thread " + Thread.currentThread().getName() + "
requesting number " + i);
        URLConnection con = myUrl.openConnection();
        con.getContent();
        Thread.sleep(3000);
    } catch (Exception e) {
        log.error("Error getting connection or content", e);
    }
}
for (int i = 0; i < 10; i++) {
    try {
        System.out.println("Thread " + Thread.currentThread().getName() + "
requesting number " + i);
        URLConnection con = myUrl.openConnection();
        con.getContent();
        Thread.sleep(3000);
    } catch (Exception e) {
        log.error("Error getting connection or content", e);
    }
}
```

The initial expectation was for this loop to take approximately 30 seconds, since the `sleep(3000)` would be called ten times. Suppose, however, that `con.getContent()` throws an `IOException`. The loop then skips the `sleep()` call entirely, finishing in 6 seconds. A better way to write this is to move the `sleep()` call outside of the try block, ensuring that it is executed:

**Example 5–8 Network Test with Shortened Try Block**

```

for (int i = 0; i < 10; i++) {

    try {
        System.out.println("Thread " + Thread.currentThread().getName() + "
requesting number " + i);
        URLConnection con = myUrl.openConnection();
        con.getContent();
    } catch (Exception e) {
        log.error("Error getting connection or content", e);
    }
    Thread.sleep(3000);
}

for (int i = 0; i < 10; i++) {

    try {
        System.out.println("Thread " + Thread.currentThread().getName() + "
requesting number " + i);
        URLConnection con = myUrl.openConnection();
        con.getContent();
    } catch (Exception e) {
        log.error("Error getting connection or content", e);
    }
    Thread.sleep(3000);
}

```

**Avoid Throwing New Exceptions** When you catch an exception, then throw a new exception in its place, you replace the context of where it was thrown with the context of where it was caught.

A slightly better way is to throw a wrapped exception:

**Example 5–9 Wrapped Exception**

```

1:  try {
2:      Class k1 = Class.forName(firstClass);
3:      Class k2 = Class.forName(secondClass);
4:      Object o1 = k1.newInstance();
5:      Object o2 = k2.newInstance();
6:
7:  } catch (Exception e) {
8:      throw new MyApplicationException(e);
9:  }

```

However, the onus is still on the user to call `getCause()` to see what the real cause was. This makes most sense in an RMI-type environment, where you need to tunnel an exception back to the calling methods.

A better way than throwing a wrapped exception is to simply declare that your method throws the exception, and let the caller figure it out:

**Example 5-10 Declaring an Exception**

```

public void buildClasses(String firstName, String secondName)
    throws InstantiationException, ... {

    Class k1 = Class.forName(firstClass);
    Class k2 = Class.forName(secondClass);
    Object o1 = k1.newInstance();
    Object o2 = k2.newInstance();
}public void buildClasses(String firstName, String secondName)
    throws InstantiationException, ... {

    Class k1 = Class.forName(firstClass);
    Class k2 = Class.forName(secondClass);
    Object o1 = k1.newInstance();
    Object o2 = k2.newInstance();
}

```

However, there might be times when you want to deal with some cleanup code and then rethrow an exception:

**Example 5-11 Clean Up First, then Rethrow Exception**

```

try {
    someOperation();
} catch (Exception e) {
    someCleanUp();
    throw e;
}try {
    someOperation();
} catch (Exception e) {
    someCleanUp();
    throw e;
}try {
    someOperation();
} catch (Exception e) {
    someCleanUp();
    throw e;
}

```

**Catching Specific Exceptions** There are various exceptions for a reason: so you can precisely identify what happened by the type of exception thrown. If you just catch `Exception` (rather than, say, `ClassCastException`), you hide information from the user. On the other hand, methods should not generally try to catch every type of exception. The rule of thumb is related to the fail-fast/recover rule: catch as many different exceptions as you are going to handle.

**Favor a Switch over Code Duplication** The syntax of try-and-catch makes code reuse difficult, especially if you try to catch at a granular level. If you want to execute some code specific to a certain exception, and some code in common, you're left with either duplicating the code in two catch blocks, or using a switch-like procedure. The switch-like procedure, shown in the following example, is preferred because it avoids code duplication:

**Example 5–12 Using a Switch to Execute Code Specific to an Exception**

```
try{
    // some code here that throws Exceptions...
} catch (Exception e) {
    if (e instanceof LegalException) {
        callPolice((LegalException) e);
    } else if (e instanceof ReactorException) {
        shutdownReactor();
    }
    logException(e);
    mailException(e);
    haltPlant(e);
}
```

The following example is preferred, in these relatively rare cases, to using multiple catch blocks:

**Example 5–13 Using Multiple Catch Blocks Causes Duplicate Code**

```
try{
    // some code here that throws Exceptions...
} catch (LegalException e) {
    callPolice(e);
    logException(e);
    mailException(e);
    haltPlant(e);
} catch (ReactorException e) {
    shutdownReactor();
    logException(e);
    mailException(e);
    haltPlant(e);
}
```

Exceptions tend to be the backwater of the code; requiring a maintenance developer, even yourself, to remember to update the duplicate sections of separate catch blocks is a recipe for future errors.

---

---

## Coding Your First Feature

This chapter describes how to add a feature to Central Office using a specific example based on extending a search page within the application's Web-based UI. The example is a simple extension of an existing search criteria page to allow it to search on additional criteria.

### Related Materials

See "Example of Operation" in Chapter 2 for a diagram that shows a search query's trip through the Central Office architecture and the Transaction Tracker to return transaction data.

### Before You Begin

Before you attempt to develop new Central Office code, set up your development environment as described in [Chapter 5, "General Development Standards"](#). Verify that you can successfully build and deploy an .ear file.

### Extending Transaction Search

This section explores the extension of transaction search features through the creation of a new criteria page. The changes required to implement this functionality interact with the user interface and the internals of the Central Office system. This example takes you through the process of implementing a new search criteria page, under the assumption that you have been asked to develop a page that enables a user to screen transactions according to new criteria.

---

---

**Note:** Paths in this chapter are assumed to start from your local source code tree, checked out from the source code control system.

---

---

### Item Quantity Example

As an example of how to extend Central Office, this chapter refers to a new search criteria page called Item Quantity. This new page is an addition to the Transaction Tracker tab. The existing interface offers a side navigation bar with options to search by Item, Transaction, Sales Associate, Customer, and others. Item Quantity is a new option on this side navigation bar; it looks much like the Item page but enables the user to set a quantity value and search for transactions whose quantity of any item compares appropriately to a chosen quantity (for example, greater than, greater than or equal to, less than, and so forth).

This example shows how:

- A new user interface can be created.
- Search criteria is collected from the end user.
- Data is handed off from one layer of the interface to another.
- SQL queries are handled and modified.

The following procedures offer general steps followed by specific examples.

## Web UI Framework

To add a new search criteria page, you must create a new JSP file for the page, edit workflow and Struts/Tiles configuration files to register the page, and add appropriate classes to handle the page.

### Create a New JSP file

Create a new JSP file and edit the file content. You can start with a copy of an existing criteria page and add input fields for the new data you intend to factor into your search. Plan your string usage to reference property files for internationalization purposes.

To create `ItemQuantityCriteria.jsp`, make a copy of `webapp/transaction-webapp/web/centralizedElectronicJournal/ItemCriteria.jsp`. Establish input fields to collect store numbers, item numbers, item quantity, and the item quantity limit operator (the operator that determines how to compare a transaction's item quantities with the item quantity criteria).

**Figure 6–1** *Item Quantity Criteria JSP Page Mock-up*

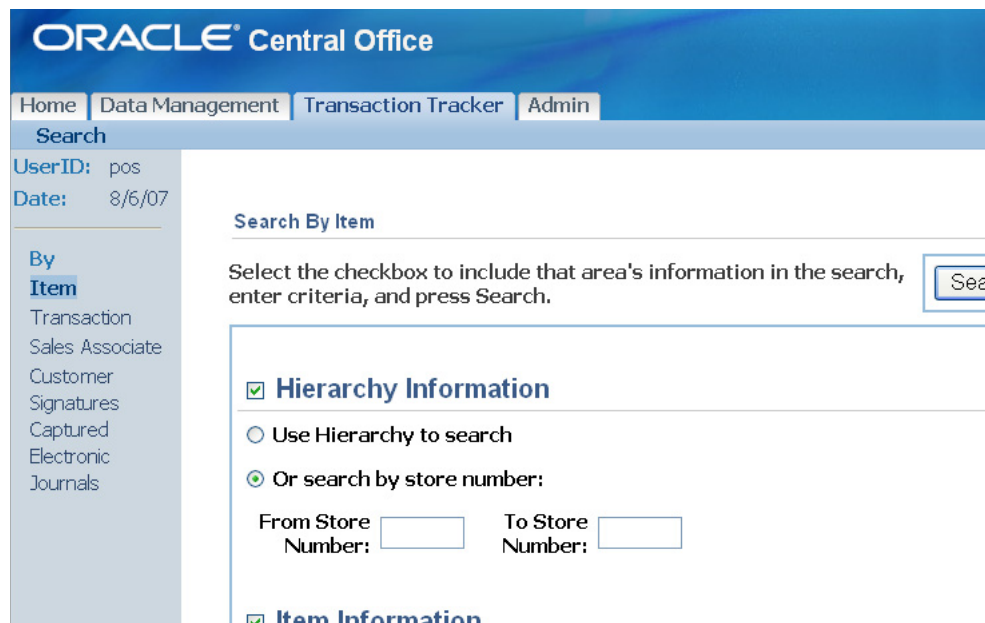

## Add Strings to Properties Files

Add references to any new strings to appropriate properties files.

For example, to add “Item Quantity Information” and “Item Quantity” column labels, edit the `/webapp/i18n-webapp/src/ui/com/_360commerce/webmodules/i18n/transaction.properties` file to add the following entries:

- `transaction.centej.itemquantitycrit.header=Item Quantity Information`
- `transaction.centej.itemquantitycrit.label.itemquantity=Item Quantity`

## Configure the sideNav Tile

To add the new JSP page to the side navigation bar in the Transaction Tracker tab, you configure the sideNav tile. Using Struts/Tiles conventions, edit the `/webapp/transaction-webapp/WEB-INF/360/tiles-transaction_tracker.xml` file, making the following edits:

- Add an entry to the `<putList name="sideNav">` tag to add your new page name to the list of options on the side navigation bar.
- Set the security role for this new option by adding an element tag in the appropriate location in the `<putList name="sideNavRoles">` tag. You can use the element `<add value="BLANK"/>` if no role has yet been defined.
- Add a destination URL to be activated when your new page name is clicked.

The following code sample shows where to add tags:

### Example 6–1 *transaction\_tracker.xml: SideNav Option List and Roles*

```
<putList name="sideNav">
  <add value="By"/>
  <add value="Item"/>    ...add your new tag here...
<add value="Transaction"/>
  <add value="Sales Associate"/>
  <add value="Customer"/>
</putList>
<putList name="sideNavRoles">
  <add value="BLANK"/>
  <add value="search_by_item"/>    ...add your new tag here...
<add value="search_by_trans"/>
  <add value="search_by_assoc"/>
  <add value="search_by_cust"/>
</putList>
<putList name="sideNavURLs">
  <add value="BLANK"/>
  <add value="centralizedElectronicJournal/ejItemSearch.do"/>    ...add your new
tag here...    <add value="centralizedElectronicJournal/ejTransactionSearch.do"/>
  <add value="centralizedElectronicJournal/ejSalesAssociateSearch.do"/>
  <add value="centralizedElectronicJournal/ejCustomerSearch.do"/>
</putList>
```

Finally, add a set of definition tags to define your JSP page's title, help URL, and body layout. The following code sample offers an example:

**Example 6–2 Example Definition Tags for `tiles-transaction_tracker.xml`**

```
<definition name="centralizedElectronicJournal.ejItemQuantitySearch"
extends="ejournal">
    <put name="sideNavIndex" value="Item Quantity"/>
    <put name="title" value="Search By Item Quantity"/>
    <put name="helpURL"
value="centralizedElectronicJournal/help.do#searchbyitem"/>
    <put name="body"
value="centralizedElectronicJournal.ejItemQuantitySearch.layout"/>
</definition>

<!-- the following definition defines the layout for the JSP's body, as called out
above --!>

<definition name="centralizedElectronicJournal.ejItemQuantitySearch.layout"
extends="ejournal.search.layout">
    <put name="resetSearchURL"
value="/centralizedElectronicJournal/ejItemQuantitySearch.do"/>
    <put name="searchTitle" value="Search By Item Quantity"/>
    <put name="searchAction"
value="/centralizedElectronicJournal/searchTransactionByItemQuantity.do"/>
    <put name="expandSections" value="itemQuantityCriteria"/>
    <put name="searchCriteria1"
value="/centralizedElectronicJournal/ItemQuantityCriteria.jsp"/>
    <put name="searchCriteria2"
value="/centralizedElectronicJournal/transactionCriteria.jsp"/>
    <put name="searchCriteria3"
value="/centralizedElectronicJournal/resultsCriteria.jsp"/>
</definition>
```

## Configure Action Mapping

Configure action mapping in one of the struts configuration files so that Struts knows how to handle your new JSP page.

The following example shows how the Item Quantity page could be configured. The file is `/webapp/transaction-webapp/WEB-INF/360/struts-transaction_tracker_actions.xml`. The code sets up the system to request an item quantity search and forwards results to standard result routines, automatically displaying the transaction details (through `showDetails.do`) if only one result is returned, and otherwise displaying a standard transaction list.

**Example 6–3 Struts Action Configuration for Item Quantity**

```
<action path="/centralizedElectronicJournal/ejItemQuantitySearch"
type="com._360commerce.webmodules.transaction.ui.StartSearchAction">
<forward name="success" path="centralizedElectronicJournal.ejItemQuantitySearch"/>
</action>

<action path="/centralizedElectronicJournal/searchTransactionByItemQuantity"
type="com._
360commerce.webmodules.transaction.ui.SearchTransactionByItemQuantityAction"
name="searchTransactionForm"
scope="request"
input="/centralizedElectronicJournal/ejItemQuantitySearch.do">
    <forward name="oneResult"
```

```

path="/centralizedElectronicJournal/showDetails.do"/>
  <forward name="multipleResults"
path="centralizedElectronicJournal.ejTransactionSearchResults"/>
</action>

```

### Add Code to Handle New Fields to Search Transaction Form

Since you have added new search fields for the Item Quantity and Item Quantity Operator, you must add code for handling these fields and their validation to the `webapp/transaction-webapp/src/ui/com/360commerce/webmodules/transaction/ui/SearchTransactionForm.java` file.

1. Add the instance fields for any fields you have added to the criteria page, and use the same names as the input field names you defined in your JSP page, so that the fields can be automatically populated via retrospection. Note an additional static constant for the search based on line item quantity.

#### Example 6-4 New Instance Fields

```

private String itemQuantityLimitOperator;
private int itemQuantityLimit;

public static final String ITEM_QUANTITY_LIMIT_OPERATOR =
    "itemQuantityLimitOperator";

public static final String ITEM_QUANTITY_LIMIT =
    "itemQuantityLimit";
public static final String SEARCH_BY_ITEM_QUANTITY_CRITERIA =
    "searchByItemQuantityCriteria";
private Boolean searchByItemQuantityCriteria;

```

2. Define corresponding getter and setter methods for the instance fields.

#### Example 6-5 Getter and Setter Methods for New Instance Fields

```

public Boolean getSearchByItemQuantityCriteria()
{
    return searchByItemQuantityCriteria;
}

public void setSearchByItemQuantityCriteria(Boolean
    searchByItemQuantityCriteria)
{
    this.searchByItemQuantityCriteria =
        searchByItemQuantityCriteria;
}

public String getItemQuantityLimitOperator()
{
    return itemQuantityLimitOperator;
}

public void setItemQuantityLimitOperator(String
    itemQuantityLimitOperator)
{
    this.itemQuantityLimitOperator = itemQuantityLimitOperator;
}

public int getItemQuantityLimit()

```

```

    {
        return itemQuantityLimit;
    }

    public void setItemQuantityLimit(int itemQuantityLimit)
    {
        this.itemQuantityLimit = itemQuantityLimit;
    }

```

3. Add the validation for the item quantity limit value to check that the input was a valid number and was greater than zero. To do this add the following code in the validate method and then provide the method implementation. The method implementation uses an error message key to look up the actual error message description.

**Example 6-6 Code to Add to Validate Method**

```

    if (getSearchByItemQuantityCriteria().booleanValue())
    {
        validateSearchByItemQuantityCriteria(errors);
    }

```

**Example 6-7 New Validation Method**

```

private void validateSearchByItemQuantityCriteria(ActionErrors
                                                errors)
{
    if (getItemQuantityLimit() <= 0)
    {
        errors.add("searchItemQuantityLimit",
            new ActionError("error.ejournal.search.itemquantity.
                itemquantitylimitvalue"));
    }
}

```

4. Store any error messages for validation in the `webapp/i18n-webapp/src/ui/com/_360commerce/webmodules/i18n/transaction.properties` file.

In the item quantity example, you might store an error message description as follows:

```

error.ejournal.search.itemquantity.itemquantitylimitvalue=Item quantity limit
value must be a valid number and greater than zero.

```

**Create a Struts Action Class**

Create a Struts action class to act as a controller for the JSP you created.

For Item Quantity, create an action class using the filename `SearchTransactionByItemQuantityAction.java`, in the directory `webapp/transaction-webapp/src/ui/com/_360commerce/webmodules/transaction/ui/`.

You can start by copying and modifying `SearchTransactionByItemAction.java`.

## Add Method to Base Class

Add code to the base search class, `SearchTransactionAction.java`, to establish a get method for the new criteria:

1. Add a line to call a new method.

### Example 6–8 Call a New Method to Get Item Quantity Criteria

```
searchCriteria = new SearchCriteria(getTransactionCriteria(searchTransactionForm,
request.getParameterValues(
"transactionType")),
getTenderCriteria(searchTransactionForm),
getSalesAssociateCriteria(searchTransactionForm),
getLineItemCriteria(searchTransactionForm),getLineItemQuantityCriteria(searchTrans
actionForm),getCustomerCriteria(searchTransactionForm),
getSignatureCaptureCriteria(searchTransactionForm));
```

2. Add the method implementation.

### Example 6–9 getLineItemQuantityCriteria Method Implementation

```
/**
 * Returns a LineItemQuantityCriteria object based on values
 * from a SearchTransactionForm.
 */
protected LineItemQuantityCriteria
getLineItemQuantityCriteria(SearchTransactionForm form)
{
    if ( form.getSearchByItemQuantityCriteria().booleanValue() )
    {
        criteria = new LineItemQuantityCriteria();

        if ( StringUtils.isNotEmpty(form.getItemNumber() )
        {
            criteria.setItemNumber(form.getItemNumber());
        }

        if ( StringUtils.isNotEmpty(form.getItemQuantityLimitOperator() )
        {
            criteria.setItemQuantityLimitOperator(form.getItemQuantityLimitOperator());
        }

        if (form.getItemQuantityLimit() > 0)
        {
            criteria.setItemQuantityLimit(form.getItemQuantityLimit());
        }
    }

    return criteria;
}
```

## Verify Application Manager Implementation

Verify that the application manager appropriately calls for information from Commerce Services. In the Item Quantity search criteria example, the `webapp/transaction-webapp/src/app/com/_360commerce/webmodules/transaction/app/ejb/EJournalManagerBean.java` class is used. This class already contains the necessary method implementation for a `getTransactions()` method.

## Add Business Logic to Commerce Service

### Create a Class to Create the Criteria Object

You must create a new class in the Commerce Services layer to handle the creation of the new `ItemQuantityCriteria` object type, adding instance fields for the fields you added. The class should provide the following:

- Variables for required criteria fields
- Boolean flags to indicate (to the data layer) whether a given attribute should be included in a query
- Getter and setter methods for the new fields
- `Use()` and `reset()` methods

The example below, established in `\commerceservices\transaction\src\com\_360commerce\commerceservices\transaction\LineItemQuantityCriteria.java`, handles these requirements.

#### Example 6–10 *LineItemQuantityCriteria.java*

```
private String    itemNumber;
private String    ItemQuantityLimitOperator;
private int       ItemQuantityLimit;
private boolean   searchByItemNumber;
private boolean   searchByItemQuantity;

/**
 * Returns the itemNumber to include in the
 * search criteria.
 *
 * @return String
 */
public String getItemNumber()
{
    return itemNumber;
}

/**
 * Sets the itemNumber.
 * @param itemNumber The itemNumber to set
 */
public void setItemNumber(String itemNumber)
{
    this.itemNumber = itemNumber;
    searchByItemNumber = true;
}

/**
 * Returns the itemQuantityLimit to include in the
```

```
        * search criteria.
        *
        * @return String
        */
    public int getItemQuantityLimit()
    {
        return ItemQuantityLimit;
    }

    /**
     * Sets the itemNumber.
     * @param itemNumber The itemQuantityLimit to set
     */
    public void setItemQuantityLimit(int ItemQuantityLimit)
    {
        this.ItemQuantityLimit = ItemQuantityLimit;
        searchByItemQuantity = true;
    }

    /**
     * Returns the itemQuantityLimitOperator to include in the
     * search criteria.
     *
     * @return String
     */
    public String getItemQuantityLimitOperator()
    {
        return ItemQuantityLimitOperator;
    }

    /**
     * Sets the ItemQuantityLimit.
     * @param ItemQuantityLimit The ItemQuantityLimitOperator to
     * set
     */
    public void setItemQuantityLimitOperator(String
                                           ItemQuantityLimitOperator)
    {
        this.ItemQuantityLimitOperator =
            ItemQuantityLimitOperator;
    }

    /**
     * Returns the searchByItemNumber.
     * @return boolean
     */
    public boolean isSearchByItemNumber()
    {
        return searchByItemNumber;
    }

    /**
     * Returns the searchByItemQuantity.
     * @return boolean
     */
    public boolean isSearchByItemQuantity()
    {
        return searchByItemQuantity;
    }
}
```

```

    }
    /**
     *
     * Indicates whether line item count criteria should be
     * included in a database query.
     *
     * @return boolean
     *
     */
    public boolean use()
    {
        return (isSearchByItemQuantity());
    }
    /**
     *
     * Resets criteria values to defaults and isSearchBy flags to
     * false.
     *
     */
    public void reset()
    {
        itemNumber          = null;
        ItemQuantityLimitOperator = null;
        ItemQuantityLimit     = 0;
        searchByItemNumber    = false;
        searchByItemQuantity  = false;
    }

```

### Add New Criteria to the Service

The new criteria you have added must be included in the class that processes search criteria. For transactions, this class is `\commerceservices\transaction\src\com\_360commerce\commerceservices\transaction\SearchCriteria.java`.

To make `LineItemQuantityCriteria` work, add it to the variable declarations and the constructors and add new getter and setter methods, as shown in the highlighted portions of the following code sample:

#### **Example 6–11** *SearchCriteria.java*

```

public class SearchCriteria implements Serializable
{
    private TransactionCriteria transactionCriteria;
    private TenderCriteria tenderCriteria;
    private SalesAssociateCriteria salesAssociateCriteria;
    private LineItemCriteria lineItemCriteria;
    private LineItemQuantityCriteria lineItemQuantityCriteria;    private
CustomerCriteria customerCriteria;
    private SignatureCaptureCriteria signatureCaptureCriteria;

    public SearchCriteria()
    {
        this(null, null, null, null, null,null);
    }

    public SearchCriteria(TransactionCriteria transactionCriteria,
                           TenderCriteria tenderCriteria,
                           SalesAssociateCriteria
                           salesAssociateCriteria,
                           LineItemCriteria lineItemCriteria,
                           LineItemQuantityCriteria lineItemQuantityCriteria,

```

```

        CustomerCriteria customerCriteria)

    {
        this(transactionCriteria,
            tenderCriteria,
            salesAssociateCriteria,
            lineItemCriteria,
            lineItemQuantityCriteria,
            customerCriteria,
            null);
    }

public SearchCriteria(TransactionCriteria transactionCriteria,
    TenderCriteria tenderCriteria,
    SalesAssociateCriteria
    salesAssociateCriteria,
    LineItemCriteria lineItemCriteria,
    LineItemQuantityCriteria
    lineItemQuantityCriteria,
    CustomerCriteria customerCriteria,
    SignatureCaptureCriteria
    signatureCaptureCriteria)

    {
        setTransactionCriteria(transactionCriteria);
        setTenderCriteria(tenderCriteria);
        setSalesAssociateCriteria(salesAssociateCriteria);
        setLineItemCriteria(lineItemCriteria);
        setLineItemQuantityCriteria(lineItemQuantityCriteria);
        setCustomerCriteria(customerCriteria);
        setSignatureCaptureCriteria(signatureCaptureCriteria);
    }

...

public LineItemQuantityCriteria getLineItemQuantityCriteria()
    {
        return lineItemQuantityCriteria;
    }

public void
    setLineItemQuantityCriteria(LineItemQuantityCriteria
        lineItemQuantityCriteria)
    {
        this.lineItemQuantityCriteria = lineItemQuantityCriteria;
    }

```

### Handle SQL Code Changes in the Service Bean

The service bean creates the SQL code that pulls data from the database. Add code to the appropriate ServiceBean.java file to append new criteria to the From clause and the Where clause.

To make the Line Item Quantity Criteria work, edit the  
 \commerceservices\transaction\src\com\  
**360commerce**\commerceservices\transaction\ejb\TransactionServiceBean.java file as follows:

1. Add a method call to append to the From clause.

```
query.append(addToFromClause(searchCriteria.getLineItemQuantityCriteria()));
```

2. Add the method implementation for the addToFromClause() method.

**Example 6–12 addToFromClause() Method**

```
/** LineItemQuantityCriteria Criteria
 *
 */
private String addToFromClause(LineItemQuantityCriteria
                               criteria)
{
    StringBuffer buffer = new StringBuffer();
    if (criteria != null && criteria.use())
    {
        buffer.append(" JOIN TR_LTM_RTL_TRN ON TR_LTM_RTL_TRN.ID_STR_RT = TR_
TRN.ID_STR_RT AND TR_LTM_RTL_TRN.ID_WS = TR_TRN.ID_WS AND TR_LTM_RTL_TRN.DC_DY_BSN
= TR_TRN.DC_DY_BSN AND TR_LTM_RTL_TRN.AI_TRN = TR_TRN.AI_TRN ");
        buffer.append(" JOIN TR_LTM_SLS_RTN ON TR_TRN.ID_STR_RT = TR_LTM_SLS_
RTN.ID_STR_RT AND TR_TRN.ID_WS = TR_LTM_SLS_RTN.ID_WS AND TR_TRN.DC_DY_BSN = TR_
LTM_SLS_RTN.DC_DY_BSN AND TR_TRN.AI_TRN = TR_LTM_SLS_RTN.AI_TRN ");
        buffer.append(" JOIN AS_ITM ON TR_LTM_SLS_RTN.ID_ITM = AS_ITM.ID_ITM
");
        buffer.append(" JOIN AS_ITM_STK ON AS_ITM.ID_ITM = AS_ITM_STK.ID_ITM
");
        buffer.append(" JOIN ID_IDN_PS ON AS_ITM.ID_ITM = ID_IDN_PS.ID_ITM ");
    }
    return buffer.toString();
}
```

3. Add a method call to append to the Where clause.

```
query.append(addToWhereClause(searchCriteria.getLineItemQuantityCriteria()));
```

4. Add the method implementation for the addToWhereClause() method.

**Example 6–13 addToWhereClause() Method**

addToWhereClause(searchCriteria.getLineItemQuantityCriteria())  
 as below.

```
/**
 *
 */
private String addToWhereClause(LineItemQuantityCriteria
                               criteria)
{
    StringBuffer query = new StringBuffer("");
    if (criteria != null && criteria.use())
    {
        if ((criteria.getItemNumber() != null &&
criteria.getItemNumber().length() > 0))
```

```

        {
            query.append(" AND TR_LTM_SLS_RTN.ID_ITM_
POS="+criteria.getItemNumber());
        }

        if (criteria.isSearchByItemQuantity())
        {
            query.append(" AND TR_LTM_SLS_RTN.QU_ITM_LM_RTN_
SLS"+criteria.getItemQuantityLimitOperator()+"?");
        }
    }
    return query.toString();
}

```

**5.** Add a call to a method to bind the variables in the SQL query.

```
n = setBindVariables(ps, n, searchCriteria.getLineItemQuantityCriteria());
```

**6.** Add the method implementation for the `setBindVariables()` method.

**Example 6-14** *setBindVariables()* method

`setBindVariables(ps, n, searchCriteria.getLineItemQuantityCriteria())` as below.

```

/**
 *
 */
private int setBindVariables(PreparedStatement statement,
                            int index,
                            LineItemQuantityCriteria criteria)
    throws SQLException
{
    if (criteria != null && criteria.use())
    {
        if (criteria.isSearchByItemQuantity())
        {
            if (getLogger().isDebugEnabled())
                bindVariables.add(criteria.getItemQuantityLimit()+"");
            statement.setInt(index++,
                criteria.getItemQuantityLimit());
        }
    }
    return index;
}

```



---

---

## Extension Guidelines

This document describes the various extension mechanisms available in the Commerce Services framework. There are multiple forces driving each extension that determine the correct strategy in each case.

The product has four distinct layers of logic:

### **UI layer**

Struts/Tiles implementation utilizing Actions for processing UI requests and JSP pages with Tiles providing layout.

### **Application Manager**

Session facade for the UI (or external system) that models application business methods. May or may not be reusable between applications. Remote accessibility.

### **Commerce Service**

Session facade for the service that models coarse-grained business logic that should be reusable between applications.

### **Persistence**

Entity beans that are fine-grained and consumed by the service. The entities are local to the service that controls them.

## Audience

This chapter provides guidelines for extending the Oracle Retail Enterprise applications. The guidelines are designed for three audiences:

- Members of customer architecture and design groups can use this document as the basis for their analysis of the overall extension of the systems.
- Members of Oracle Retail's Technology and Architecture Group can use this document as the basis for analyzing the viability of the overall extension strategy for enterprise applications.
- Developers on the project teams can use this document as a reference for code-level design and extension of the product for the solution that is released.

## Application Layers

The following diagram describes the general composition of the enterprise applications. The sections following describe the purpose and responsibility of each layer.

**Figure 7-1 Application Layers**

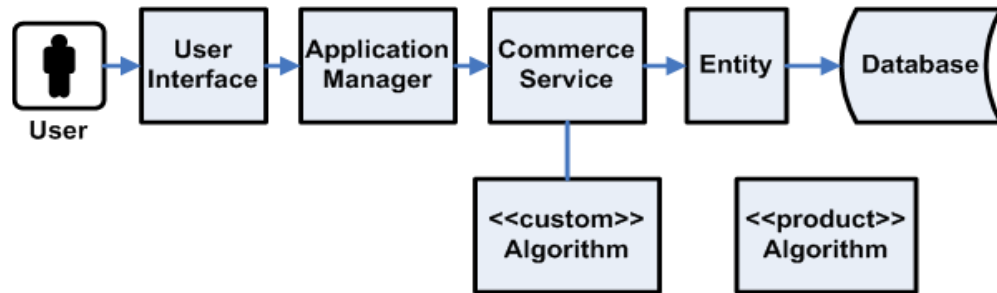

## UI

The user interface (UI) framework consists of Struts Actions, Forms, and Tiles, along with Java server pages (JSPs).

- Struts configuration
- Tiles definition
- Style sheets (CSS)
- JSP pages
- Resource bundles for i18N

## Application Manager

The Application Manager components are coarse-grained business objects that define the behavior of related Commerce Services based on the application context.

- Session Beans
- View Beans for the UI

## Commerce Service

A commerce service is a fine grained component of reusable business logic.

- Session Beans
- Data Transfer Objects (DTOs)

## Algorithm

An SPI-like interface defined to allow more fine grained pieces of business functionality to be replaced without impacting overall application logic. For reference, review the various POJO “calculator” classes that are contained in the Financial Totals Commerce Service.

## Entity

Fine-grained entity beans owned by the commerce service. The current strategy for creating entity beans in the commerce service layer is BMP.

## Database

The Oracle Retail enterprise applications support the ARTS standard database schema. The same tables referenced by Central Office and Back Office are a superset of the tables that support Point-of-Service.

# Extension and Customization Scenarios

## Style and Appearance Changes

This should only present minor changes to the UI layer of the application. These type of changes, while extremely common, should represent minimal impact to the operation of the product. Typical changes could be altering the style of the application (fonts/colors/formatting) or the types of messages that are displayed.

Application impact:

- Struts configuration (flow)
- Tile definition
- Style Sheet
- Minor JSP changes, such as moving fields
- Changing static text through resource bundles

## Additional Information Presented to User

This is one of the more common extensions to the base product: allowing for the full life cycle management of information required by a particular customer that is not represented in the base product.

If the information is simply presented and persisted then we can choose a strategy that simply updates the UI and Persistent layer and passes the additional information through the service layer.

However, if the application must use the additional information to alter the business logic of a service, then each layer of the application must be modified accordingly.

This scenario generally causes the most pervasive changes to the system; it should be handled in a manner that can preserve an upgrade path.

**Figure 7-2 Managing Additional Information**

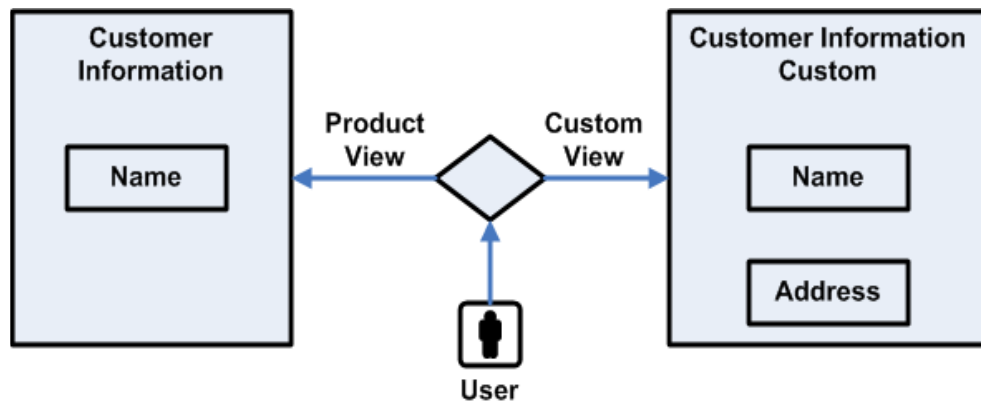

Application impact:

- JSP pages
- View Beans
- Struts configuration
- UI Actions
- UI Forms
- Application Manager
- Commerce Service
- Entity
- Database Schema

### Changes to Application Flow

Sometimes a multi-step application flow can be rearranged or customized without altering the layers of the application outside of the UI. These changes can be accomplished by changing the flow of screens with the struts configuration.

Application impact:

- Struts configuration

### Access Data from a Different Database

This customization describes accessing the same business data from a different database schema. No new fields are added or joined unless for deriving existing interface values. This scenario would most likely not be found isolated from the other scenarios.

Figure 7-3 Accessing Data from a Different Database

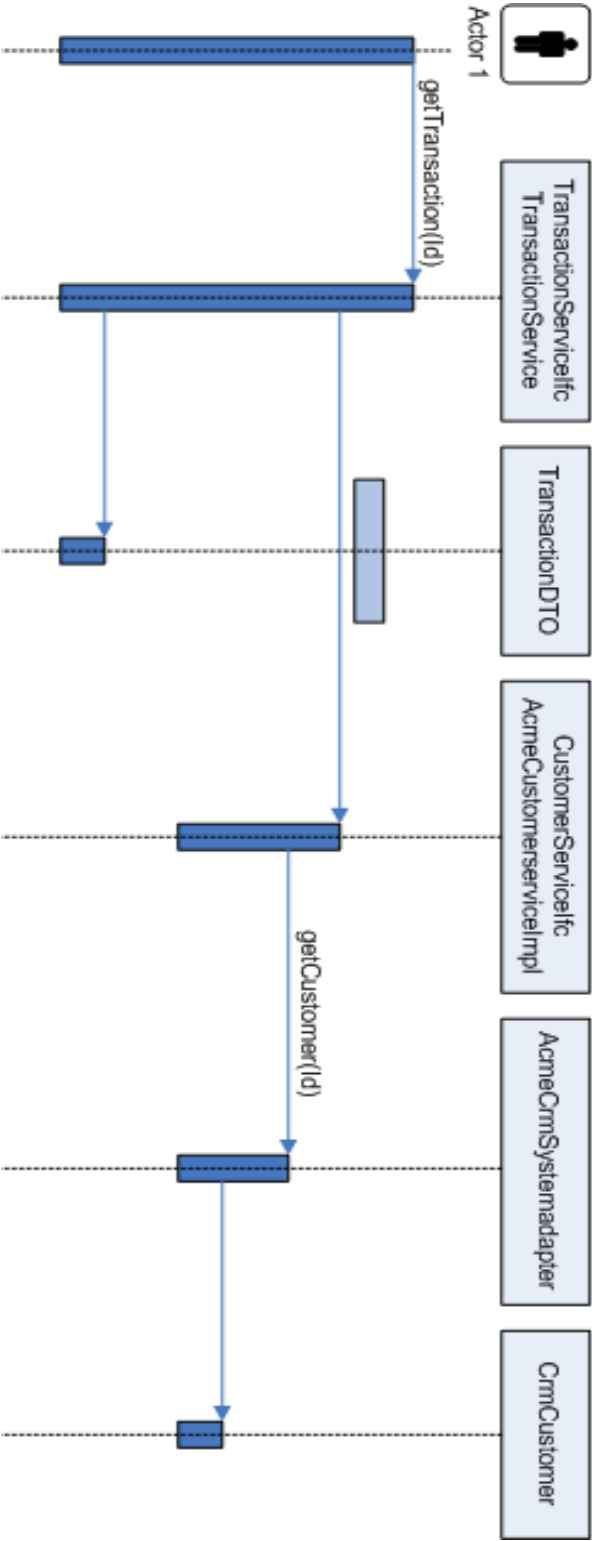

Application impact:

- Entity Beans
- Database Schema

### Access Data from External System

This customization involves replacing an entire Commerce Service with a completely new implementation that accesses an external system.

**Figure 7-4 Accessing Data from an External System**

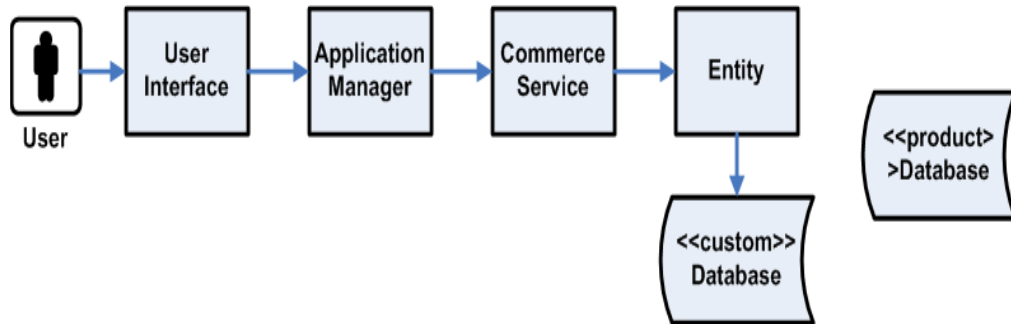

Application impact:

- Deployment Configuration – replacing Commerce Service implementation with custom implementation.

### Change an Algorithm used by a Service

Assuming the UI is held constant, but values such as net totals or other attributes are derived with different calculations, it is advantageous to replace simply the algorithm in question, as the logic flow through the current service does not change.

**Figure 7-5 Application Layers**

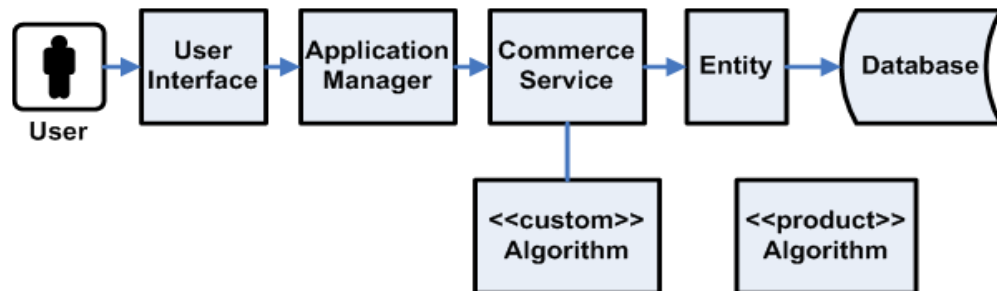

Application impact:

- Algorithm
- Application Configuration

## Extension Strategies

Refer to the following diagram as a subset of classes for comparison purposes.

Figure 7-6 Sample Classes for Extension

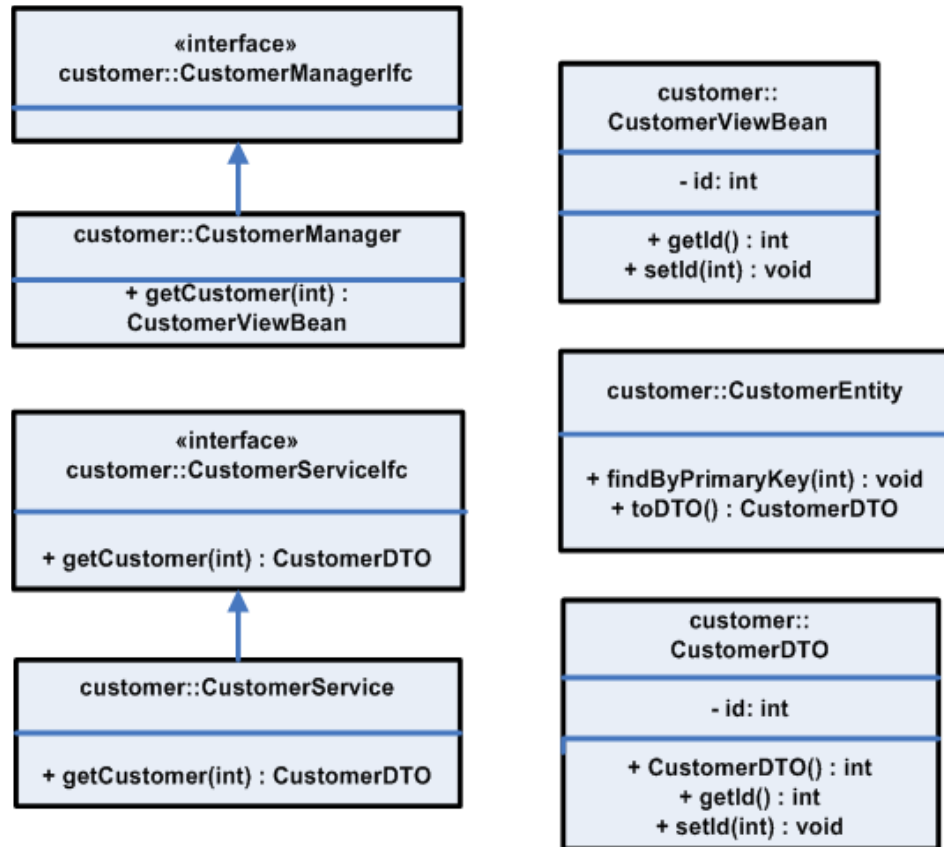

### Extension with Inheritance

This strategy involves changing the interfaces of the service itself, perhaps to include a new finder strategy or data items unique to a particular implementation. For instance, if the customer information contained in base product does not contain data relevant to the implementation, call it CustomField1.

Figure 7-7 Extension with Inheritance

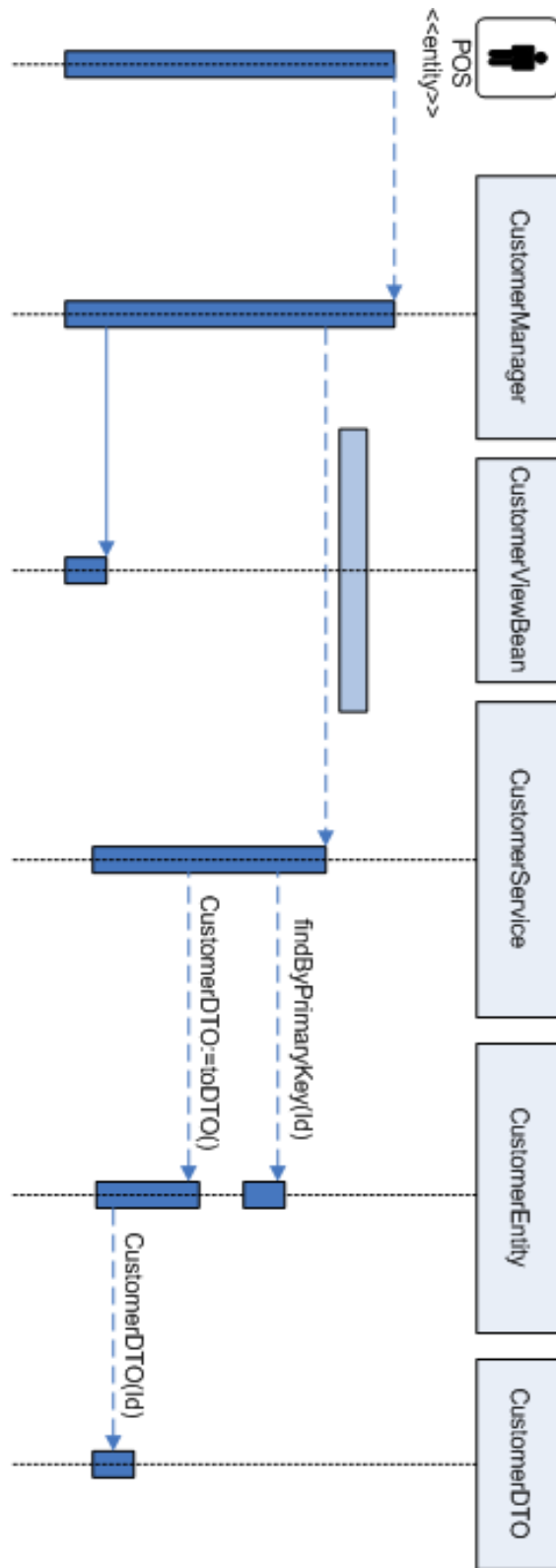

All of the product code would be extended (the service interface, the implementation, the DTO and view beans utilized by the service, the UI layers and the application manager interface and implementation) to handle access to the new field.

**Figure 7–8 Extension with Inheritance Class Diagram**

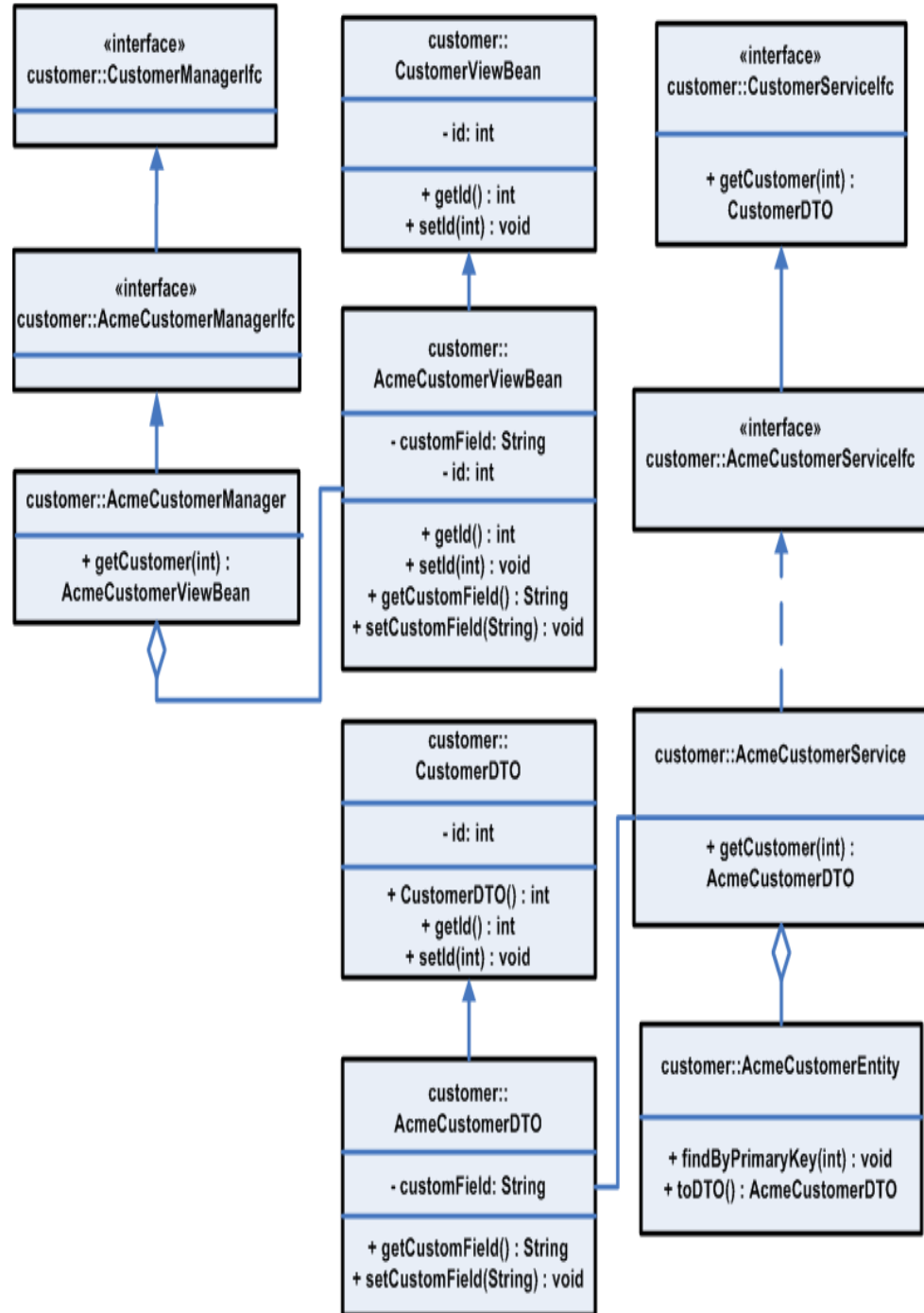

## Replacement of Implementation

This strategy involves keeping the existing product interfaces to the service intact, but utilizing a new implementation. This strategy is suggested for when the entire persistence layer for a particular service is changed or delegated to an existing system.

The following diagram demonstrates the replacement of the product Customer Service implementation with an adapter that delegates to an existing CRM solution for that is the system of record for customer information for the retailer.

This provides access to the data from the existing services that depend on the service interface.

Figure 7-9 Replacement of Implementation

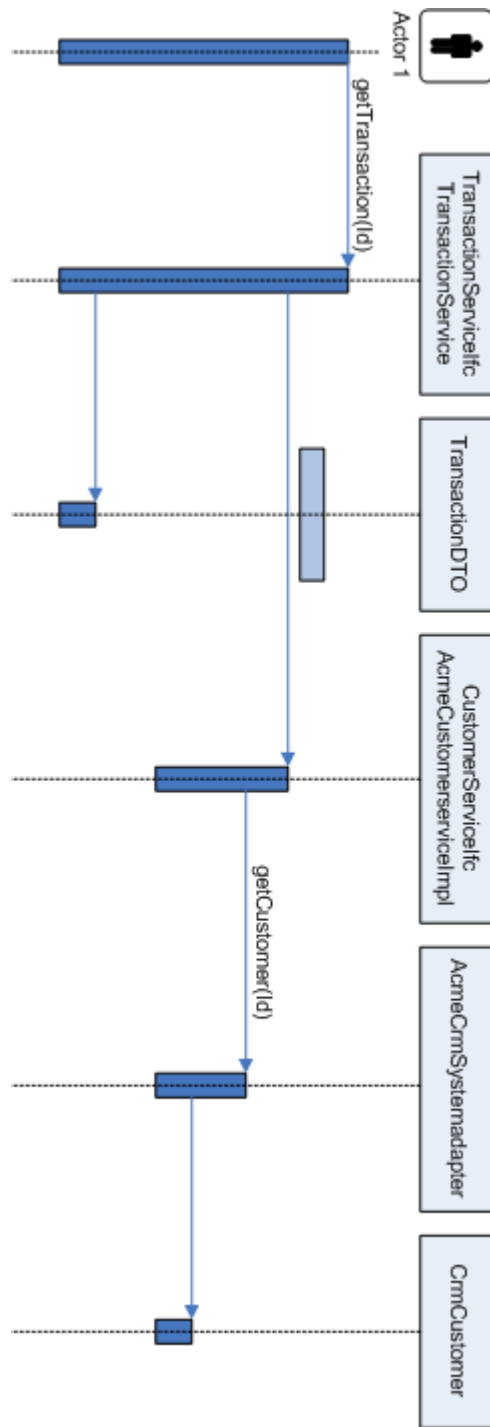

## Service Extension with Composition

This method is preferred adding features and data to the base product configuration. This is done with Composition, instead of inheritance.

For specific instances when you need more information from a service that the base product provides, and you wish to control application behavior in the service layer, it is suggested to use this extension strategy. The composition approach to code reuse provides stronger encapsulation than inheritance. Using it keeps explicit reference to the extended data/operations in the code that needs this information. Also, the new service contains rather than extends the base product. This allows for less coupling of the custom extension to the implementation of the base product.

**Figure 7–10 Extension with Composition: Class Diagram**

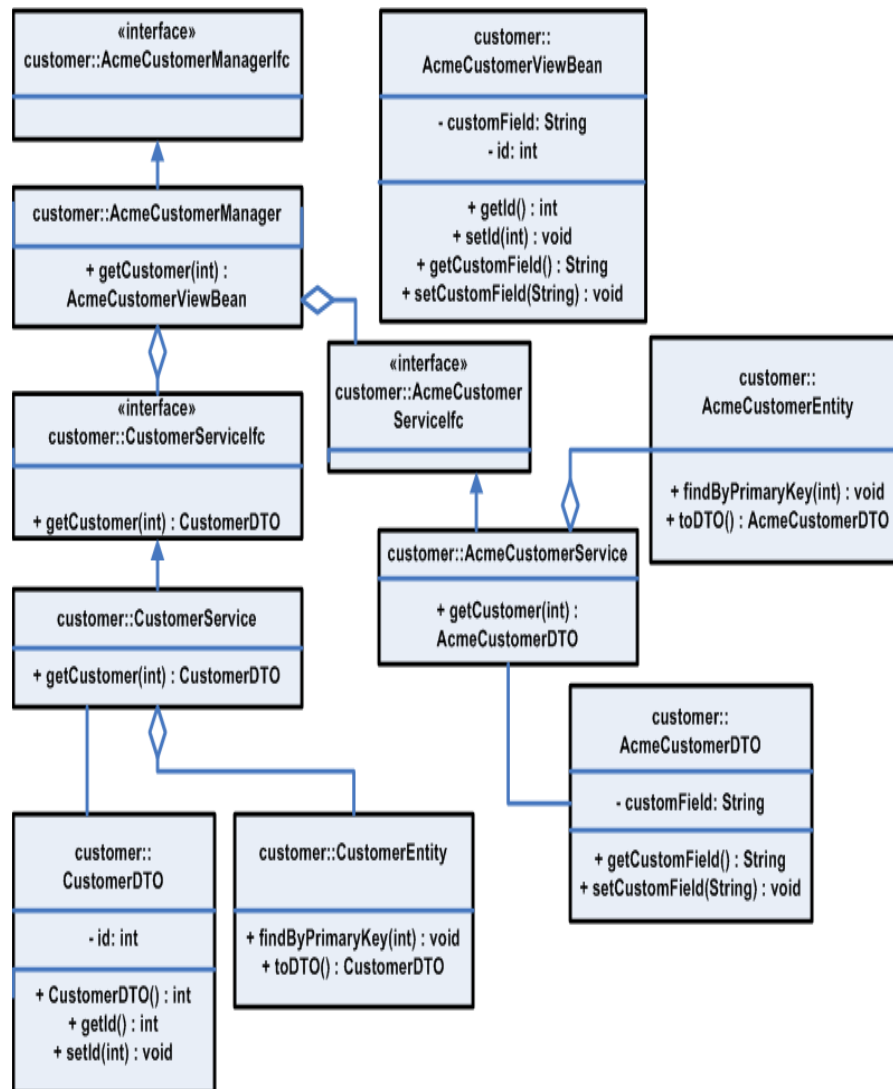
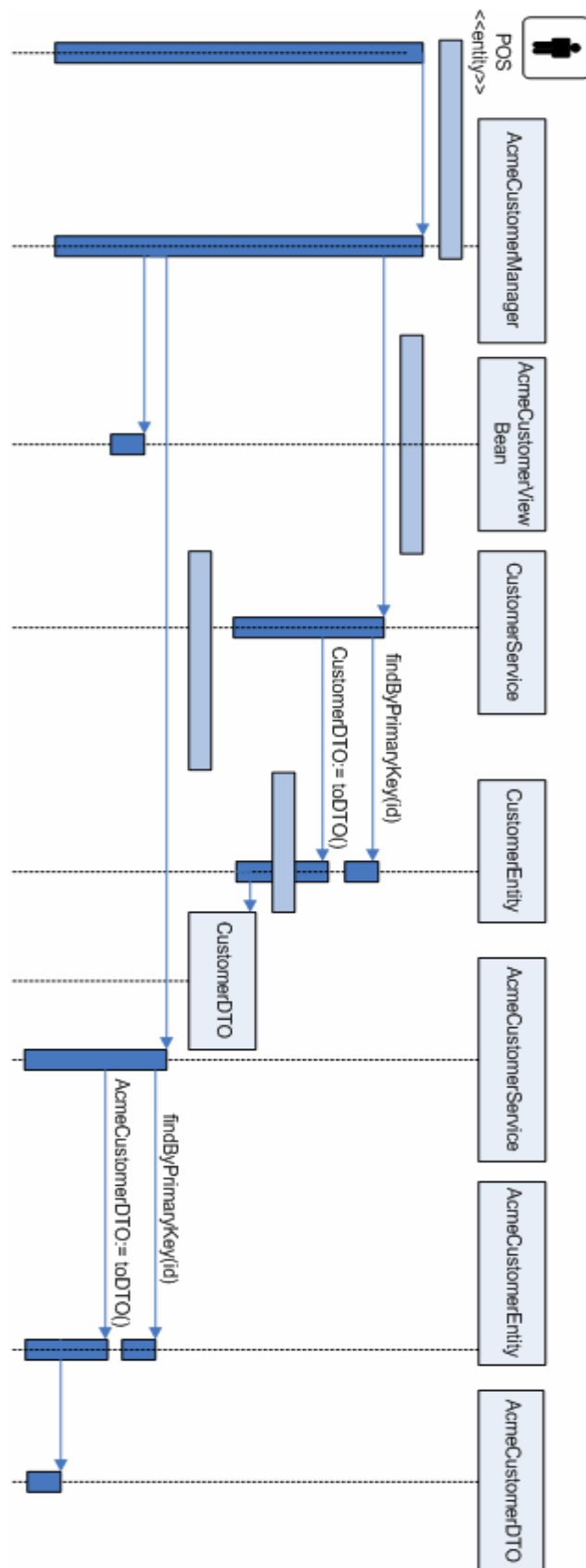

Figure 7-11 Extension with Composition



## Data Extension Through Composition

This strategy describes having the entity layer take responsibility for mapping extra fields to the database by aggregating the custom information and passing it through the service layer. This approach assumes that the extra data is presented to the user of the system and persisted to the database, but is not involved in any service layer business logic.

This scenario alters the UI layer (JSP/Action/ViewBean) and add a new ApplicationManager method to call assemble the ViewBean from the extensible DTO provided by the replaced Entity bean. Slight modifications to the Service session bean may be necessary to support the toDTO() and fromDTO (ExtensibleDTOIfc dto) methods on the Entity bean, depending on base product support of extensions on the particular entity bean.

- Create the new ApplicationManager session facade.
- Create the new ViewBeans required of the UI.
- Create new Entity bean that references the original data to construct a base product DTO that additionally contains the custom data using the extensible DTO pattern.
- Create new DTO based on the extensible DTO pattern.
- Create new JSP pages to reference the additional data.
- Change the deployment descriptors that describe which implementation to use for a particular Entity bean.
- Change the new Struts configuration and Action classes that reference the customized Application Manager Session facade.
- If necessary change the Commerce Service Session facade to give control of the toDTO and fromDTO methods to the Entity bean and not assemble/disassemble the DTO in this layer as it does not give a good plug point for the Extensible DTOs.

The following diagram describes the lifecycle of the data throughout the request.

Figure 7-12 Data Extension through Composition

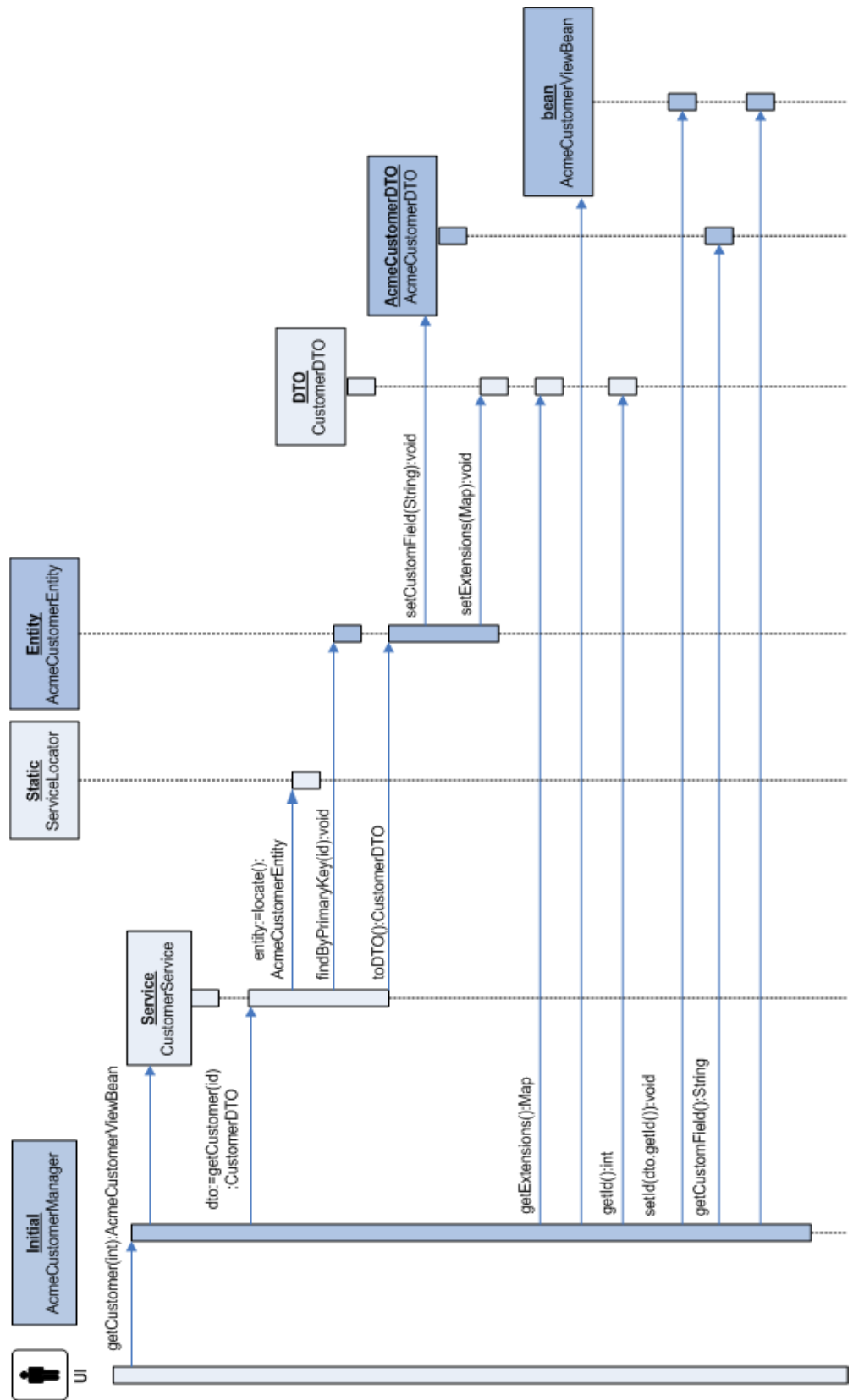

The following class diagram describes the various classes created.

**Figure 7–13 Data Extension through Composition: Class Diagram**

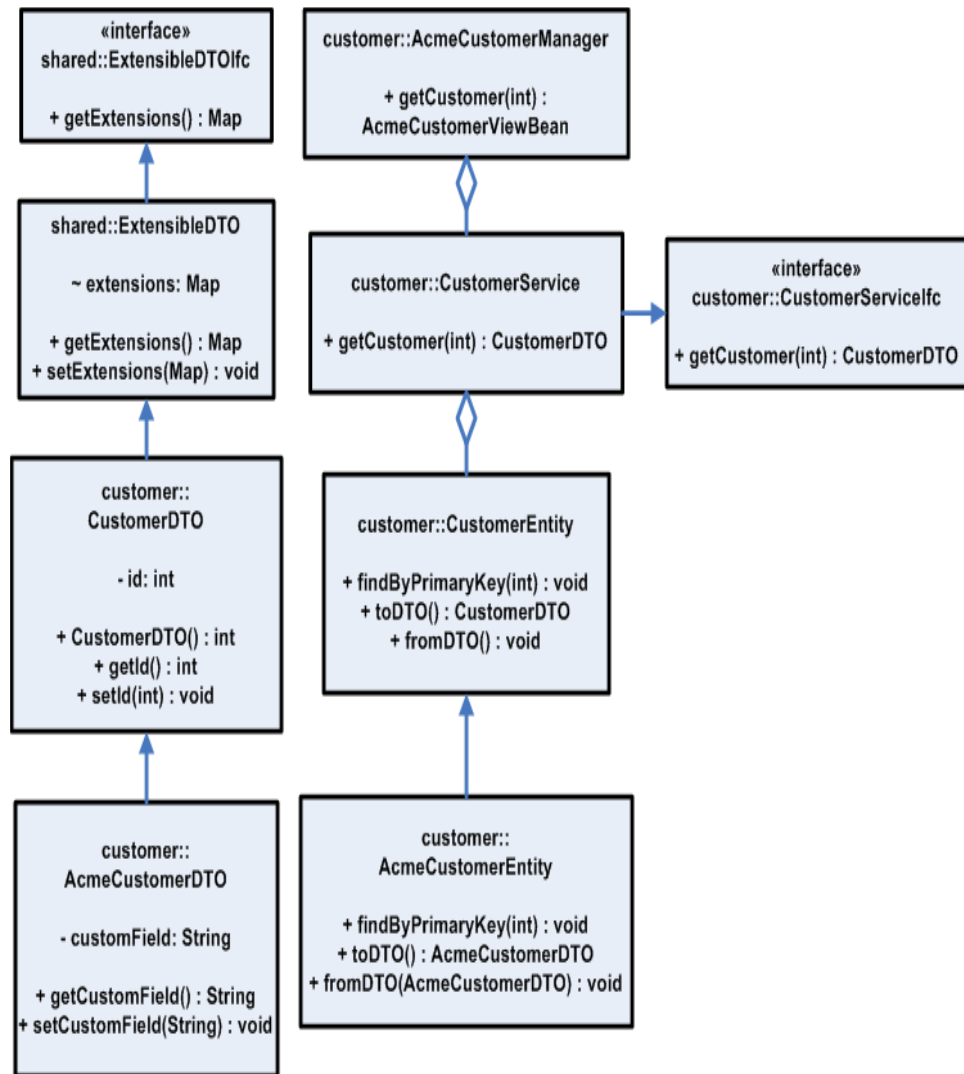

---

---

## Application Services

Application Services requests information from Commerce Services and returns that information to the Web UI in a format that can be displayed by the Web UI.

Oracle Retail implements application services in the form of application managers. Application managers aggregate services from multiple Commerce Services into a smaller number of interfaces, and correspond generally to a specific portion of the application user interface.

The presence of the Application Services layer offers opportunities for customization that can make your implementation of Central Office more stable across upgrades. This pattern optimizes network traffic, as requests for multiple Commerce Services tend to be funneled through a smaller number of application managers.

These services contain primarily application logic. Business logic should be kept out of these services and instead shared from the Commerce Services tier. In many cases the only function of an Application Service method is to call one or more Commerce Services. Each manager is a facade for one or more Commerce Services. A typical method in the Application Services layer aggregates several method calls from the Commerce Services layer, allowing the real retail business components to remain decoupled from each other.

Application managers are called by Struts Action classes to execute functionality that ultimately derives from Commerce Services. Struts Action classes should not call Commerce Services directly.

The following diagram shows how an Application Manager functions within the application.

**Figure 8–1 Application Manager in Operation**

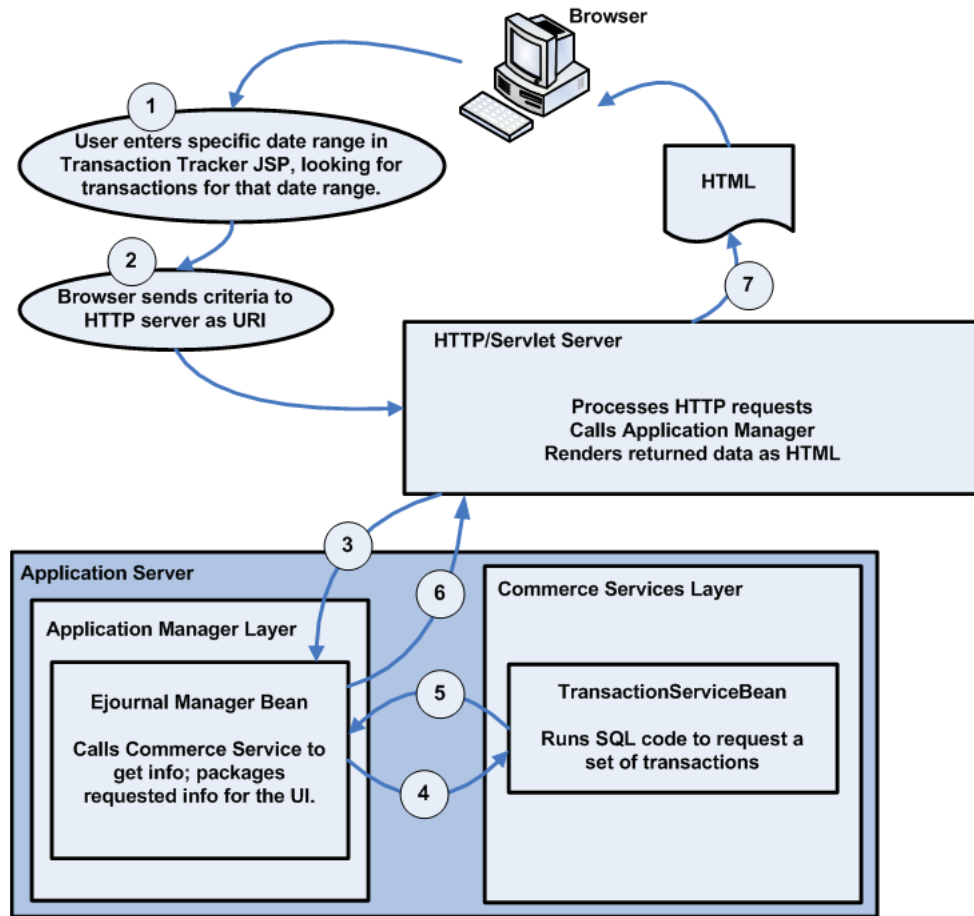

## Application Service Architecture

The following diagram shows the relationship between the user interface, the application services, and the Commerce Services.

**Figure 8–2 Example Application Service Interactions**

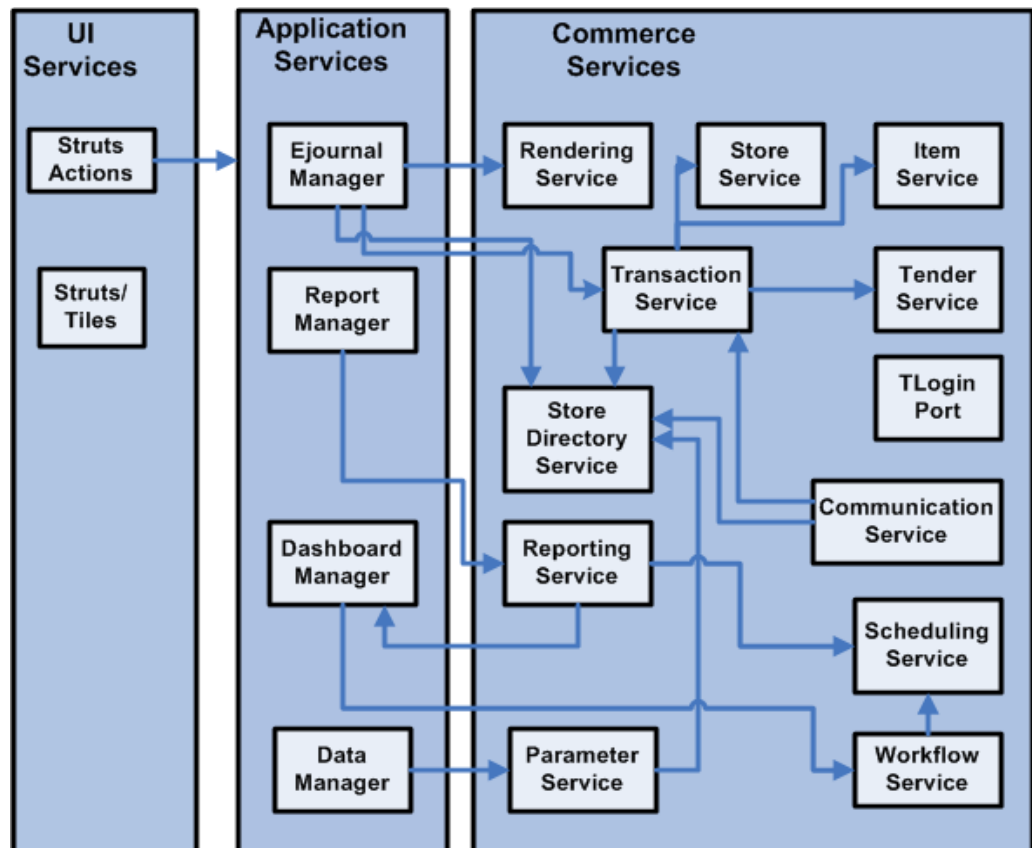

## Application Manager Mapping

Table 8–1 shows how individual Application Managers map to various parts of the application.

**Table 8–1 Application Manager Mapping**

Tab	Manager	API	Functions
Home	Dashboard Manager	DashboardManagerIfc.java	
Transaction Tracker	EJournal Manager	EJournalManagerIfc.java	Searching for transactions

**Table 8–1 Application Manager Mapping**

Tab	Manager	API	Functions
Data Management	Data Manager	DataManagerIfc.java	Import POSlog, E-journal, parameter; edit parameter lists
	Task Manager	TaskManagerIfc.java	Scheduling tasks
Admin	Task Manager	TaskManagerIfc.java	Scheduling tasks Manipulating the employee task list
	Employee Manager	EmployeeManagerIfc.java	Managing security groups, users, and employees

## Extending an Application Manager

The application manager layer provides an opportunity for customizing application behavior without changing the underlying Commerce Services. Some examples of reasons to extend or modify an application manager include:

To change content that comes from Commerce Services. You can remove data or change how it is handled, formatted, or displayed by changing the logic in the application manager.

You can provide additional data to your JSPs via the application managers, either by supplying data that comes from existing Commerce Services functions but is not displayed by the default user interface, or by calling new, custom Commerce Services.

When you add input fields to the user interface, you must make sure that the appropriate application manager knows about those fields and knows how to handle them. If you are extending search criteria, for example, the application manager has to be able to pass those criteria on to the Commerce Service layer.

## Creating a New Application Manager

The following steps outline the requirements for making a new application manager:

1. Make new EJB.jar for the application manager.
  - New directory `\webapp\<<new_app_manager_name>`
  - `build.xml` file to control building with ant
  - sub-directory that contains `\classes`, `\inst`, `\javadoc`, `\WEB-INF`, `\META-INF`, `\dist`, `\src`, `\web` and `\test` directories
  - `WEB-INF` directory that contains Struts/Tiles config files
  - web directory that contains `.jsp` files
2. Edit application configuration files.
  - Add your new module to the list in `build\centraloffice.com`.
  - `application.xml`: add a tag for your EJB to the list of EJBs, as `manager_name-admin-ejb.jar`
  - Add the module in the `centraloffice.env` to build this newly added module under build directory.
3. Edit UI files.

Create UI references in Struts configuration files, as described in [Chapter 2, "Technical Architecture"](#).

## Application Manager Reference

All of the managers are stateless session facades which provide functionality in a UI-centric form to be called by Struts Action classes associated with various JSPs. The topics in this section describe the individual application managers.

### Admin Manager

Provides functions for managing store groups, security groups, scheduled jobs, and users. It is represented in the application user interface by the Administration tab. The following are dependencies:

- Workflow/Scheduling Service
- Store Directory
- Employee/User Service

### Dashboard Manager

Provides functions for displaying the Dashboard, displayed when users click the Home tab in the user interface.

The following are dependencies:

- Workflow/Scheduling Service
- Reporting Service
- Employee/User Service

### Data Manager

The Data Manager provides the ability to import POSlog, E-journal, parameter, as well as the code to support the creation and editing of parameter lists. In Central Office, the Data Manager handles tasks associated with the Data Management tab.

### EJournal Manager

EJournal Manager handles functionality related to the Transaction Tracker tab in the user interface. It allows searches for transactions based on a variety of criteria and combinations of criteria.

The following are dependencies:

- Parameter Service
- Tender Service
- Transaction Service
- Customer Service
- Store Directory
- Reporting Service

## Report Manager

Provides functions for displaying, executing, and scheduling the reports, as well as managing lists of user favorite reports.

The following are dependencies:

- Workflow/Scheduling Service
- Store Directory
- Reporting Service
- ReportGroupTaskExecutionMDB

## Store Manager

Provides the ability to read and write information about a store to and from the database. This includes store address and store hierarchy information.

The following are dependencies:

- Workflow/Scheduling Service
- Store Directory
- Employee/User Service

## Task Manager

Handles workflow and displays job information.

The following are dependencies:

- Workflow Service
- File Transfer Service

---

---

## Commerce Services

The topics in this chapter describe each of the available Commerce Services. The Commerce Services in Central Office provide the model component of the MVC pattern; they store the state of data and respond to requests to change that state which come from the controller. The Commerce Services are intended to encapsulate all of the business logic of the application. They are built as session beans, sometimes exposed as Web services, which contain the shared retail business logic. Commerce Services aggregate database tables into objects, combining sets of data into logical groupings. They are organized by business logic categories rather than application functionality. These are services like Transaction, Store Hierarchy, or Parameter, which could be used with any retail-centric application. The Commerce Services talk to the database through a persistence layer of entity beans, described in [Chapter 10, "Enterprise Database"](#).

For each service, this chapter includes a description, a listing of the database tables used by the service, plus notes on extending the service and a list of dependencies on other services. The database tables listed are those which are updated by the service directly, excluding any services merely accessed by the service, or which are updated through other services.

---

---

**Note:** For complete and updated database tables for the services listed in this chapter, refer to the *Oracle Retail Strategic Store Solutions Data Model: Relational Integrity Diagrams*.

---

---

This chapter covers the following services:

- Calendar Service
- Code List Service
- Currency Service
- Customer Service
- Employee/User Service
- File Transfer Service
- Financial Totals
- Item Service
- Parameter Service
- Party Service
- POSlog Import Service

- Pricing Service
- Reporting Service
- Store Directory Service
- Store Service
- Transaction Service
- Workflow /Scheduling Service

## Commerce Services in Operation

The following figure shows how the Commerce Services function within the application.

*Figure 9–1 Commerce Services in Operation*

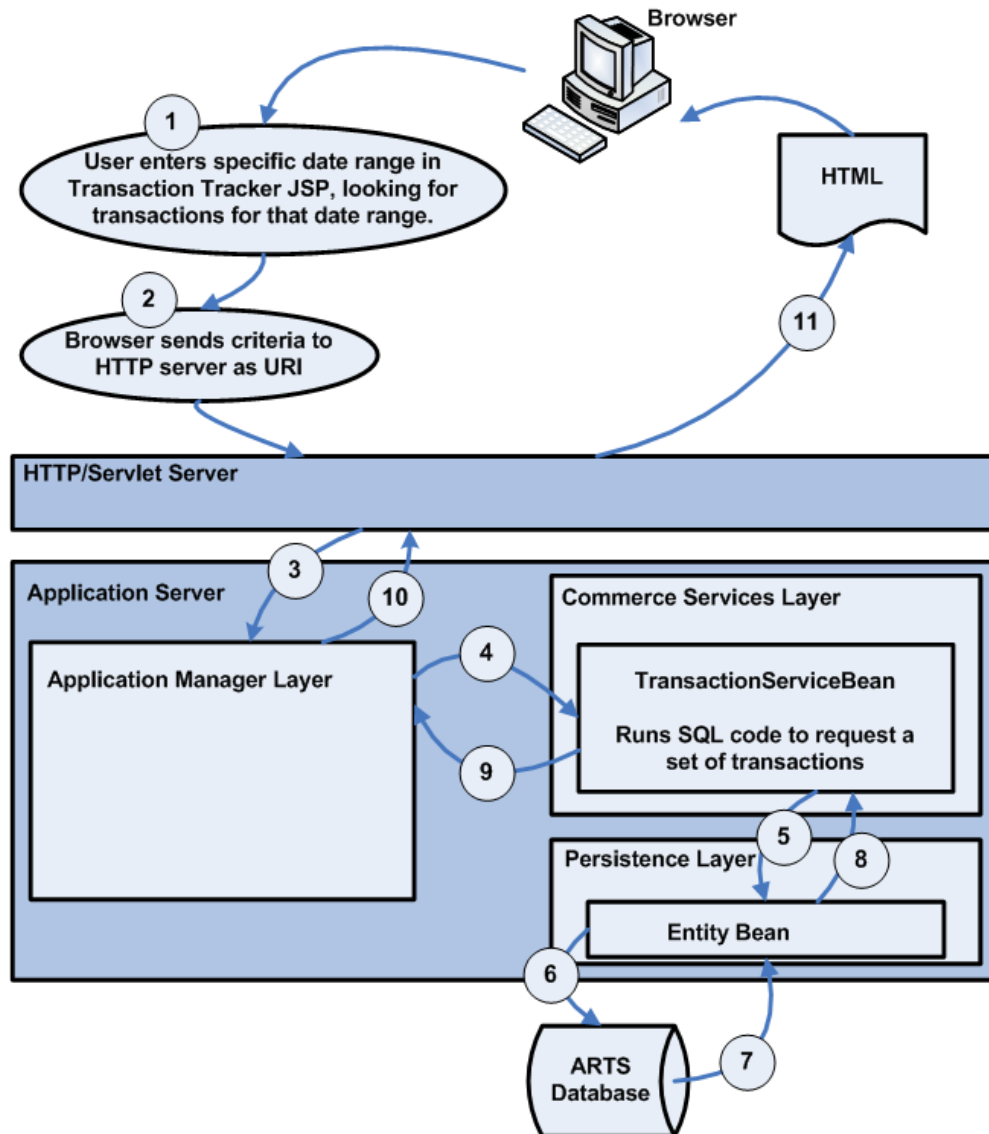

## Creating a New Commerce Service

To create a new Commerce Service, use the following basic steps:

1. Make a new EJB.jar with the following components:
  - New directory \commerceservices\<<new\_service\_name>
  - A build.xml file for ant configurations
  - \classes, \dist, \inst, \javadoc,\META-INF, \src and \test directories
2. Edit application configuration files:
  - Edit the build.xml file for \centraloffice to add the module to the suite.modules property list
  - application.xml: add a tag for the EJB to the list of EJBs
  - Add the module in the centraloffice.env to build this newly added module under build directory.
3. Edit Application Service and UI files:
  - Update Application Service to call methods in the Commerce Service.
  - Create UI references in Struts configuration files.

## Calendar Service

Package of business-calendar-related functionality for reporting.

### Database Tables Used

- CA\_CLD (Calendar)
- CA\_CLD\_LV (Calendar Level)
- CA\_CLD\_PRD (Calendar Period)
- CA\_PRD\_RP\_V4 (Calendar Reporting Period V4)

### Interfaces

Access the service through CalendarServiceIfc.java:

#### **Example 9–1 CalendarServiceIfc.java: Methods**

```
CalendarReportRangeDTO getReportingPeriods(int calendarId, CalendarLevel level,
Date startDate, Date endDate) throws RemoteException, FinderException;
Collection getReportingPeriodsAllLevels(int calendarId, Date transactionTime)
throws RemoteException, FinderException, CreateException;
void createCalendar(int id, String name) throws RemoteException, CreateException;
void removeCalendar(int id) throws RemoteException, RemoveException;
```

### Extending This Service

You could extend this service to change how dates are handled. For example, the default service provides year, month, week, and day as units for reporting. You might want to add quarters to this list. Doing so would require adding code to the service to handle resolving data to the new unit. If, on the other hand, you merely wanted to remove one of these units, for example to remove reporting by week, you could do so by changing the database alone.

## Dependencies

None.

## Tier Relationships

The functionality of this service is the same whether it is used within Central Office or Back Office.

## Code List Service

The Code List Service allows Web applications to retrieve code lists from various sources:

- Inventory codes
- Advanced Pricing codes
- POS Department codes
- Suspended Transactions codes

## Database Tables Used

ID\_LU\_CD (CodeList)

## Interfaces

Access this interface through `CodeListServiceIfc.java`. The following code sample shows the available methods:

### **Example 9–2** *CodeListServiceIfc.java: Methods*

```
public interface CodeListServiceIfc
{
    /**
     * Retrieve the inventory Reason Codes
     */
    public Collection getInventoryCodeList() throws RemoteException,
FinderException;

    /**
     * Retrieve reason codes by store and description
     * @param storeId
     * @param description
     * @return
     * @throws RemoteException
     * @throws FinderException
     */
    public Collection getReasonCodeByStoreAndDescription(String storeId, String
description) throws RemoteException, FinderException;

    /**
     * Retrieve reason codes by store and description and group
     * @param storeId
     * @param description
     * @param group
     * @return
     * @throws RemoteException
     */
}
```

```
        * @throws FinderException
        */
        public Collection getReasonCodeByStoreAndDescriptionAndGroup(String storeId,
String description, String group) throws RemoteException, FinderException;

        /**
        * Retrieve reason code value for a given entry name
        * @param storeId
        * @param description
        * @param group
        * @param entryName
        * @return
        * @throws RemoteException
        * @throws FinderException
        */
        public ReasonCodeDTO getReasonCodeByName(String storeId, String description,
String group, String entryName) throws RemoteException, FinderException;

        /**
        * Retrieve reason code for a given entry value
        * @param storeId
        * @param description
        * @param group
        * @param entryValue
        * @return
        * @throws RemoteException
        * @throws FinderException
        */
        public ReasonCodeDTO getReasonCodeByValue(String storeId, String description,
String group, String entryValue) throws RemoteException, FinderException;

        /**
        * Retrieve default reason code in a group
        * @param storeId
        * @param description
        * @param group
        * @return
        * @throws RemoteException
        * @throws FinderException
        */
        public ReasonCodeDTO getDefaultReasonCode(String storeId, String description,
String group) throws RemoteException, FinderException;

        /**
        * Returns a collection of PosDepartmentDTOs.
        * @return Collection of PosDepartmentDTO
        * @throws RemoteException
        * @throws FinderException
        */
        public Collection getPosDepartments() throws RemoteException, FinderException;

        DBUtilsIfc getDBUtils() throws RemoteException;
    }
}
```

## Extending This Service

You can add additional codes to the system without extending this service, as it simply retrieves the set of codes that exist.

## Dependencies

None.

## Tier Relationships

The functionality of this service is the same whether it is used in Central Office or Back Office.

## Currency Service

The Currency Service allows you to query for the base local currency setting (from the database). It also handles addition of currency, including currency in multiple denominations.

## Database Tables Used

- CO\_CNY (Currency List)
- CO\_RT\_EXC (Exchange Rates)
- CO\_CNY\_DNM (denominations for each currency type defined in CO\_CNY)

## Interfaces

Access this interface through `CurrencyIfc.java`. The following code sample shows a few of the available methods:

### **Example 9-3** *CurrencyIfc.java: Some Methods*

```
/**
    Adds this object to another CurrencyIfc object. <P>
    @param addCurrency object
    @return new value as object
*/
//-----
public CurrencyIfc add(CurrencyIfc addCurrency);

//-----
/**
    Subtracts CurrencyIfc object from this object. <P>
    @param subCurrency object
    @return new value as object
*/
//-----
public CurrencyIfc subtract(CurrencyIfc subCurrency);

//-----
/**
    Multiplies this object times another CurrencyIfc object. <P>
    @param multCurrency object
    @return new value as object
*/
//-----
```

```

public CurrencyIfc multiply(CurrencyIfc multCurrency);

//-----
/**
 * Multiplies this object times another CurrencyIfc object. <P>
 * @param multCurrency object
 * @return new value as object
 */
//-----
public CurrencyIfc multiply(BigDecimal multCurrency);

```

## Extending This Service

The default service supports U.S. dollars, Canadian dollars, Mexican pesos, Japanese yen, and British pounds (pound sterling); it could be extended to handle additional currencies, and to allow the addition of multiple currencies to each other, with appropriate handling of exchange rates.

The service could also be extended to connect to a ASP to get exchange rates or other currency information.

## Dependencies

None.

## Tier Relationships

The functionality of this service is the same whether it is used within Central Office or Back Office; however, it is currently only used by Back Office.

## Customer Service

The Customer Service is used to locate customers' information. Typically this information is displayed as additional details to a transaction.

## Database Tables Used

PA\_CT (Customer)

## Interfaces

Access the service through CustomerServiceIfc.java:

### **Example 9–4 CustomerServiceIfc.java: Methods**

```

public CustomerDTO getCustomer(String customerID) throws RemoteException,
SearchException;

```

## Extending This Service

In a deployment, you could extend this service by connecting it to a Customer Relationship Management (CRM) application. The service encapsulates the Oracle Retail customer data function so that other portions of the application do not have to change should such a connection be implemented.

## Dependencies

Party Service.

## Tier Relationships

The functionality of this service is the same whether it is used within Central Office or Back Office.

## Employee/User Service

Searches for employees and updates their details, including security permissions.

## Database Tables Used

- CO\_ACS\_GP\_RS (GroupResourceAccess)
- CO\_GP\_WRK (WorkGroup)
- PA\_EM (Employee)

## Interfaces

Access the service through `EmployeeServiceIc.java`, which offers methods for finding, adding, and updating employee records. The following code sample provides some examples:

### **Example 9–5** *EmployeeServiceIc.java: Some Methods*

```
/**
 * Finds the employee with the specified employee ID.
 *
 * @param employeeId the ID of the employee to find.
 * @return A DTO containing the employee data.
 * @throws RemoteException
 */
EmployeeDTO getEmployee(String employeeId) throws EmployeeNotFoundException,
RemoteException;

/**
 * Finds the employees whose first and last names begin with the specified
strings.
 *
 * @param firstName the beginning characters of the employee's first name.
 * @param lastName the beginning characters of the employee's last name.
 * @return an array of DTO's containing data about employees that match the
search criteria.
 * @throws RemoteException
 */
EmployeeDTO[] searchEmployees(String firstName, String lastName) throws
RemoteException;
```

## Extending This Service

You could extend this service by replacing it with a connection to a personnel database or application, such as an LDAP system.

## Dependencies

Party Service.

## Tier Relationships

The functionality of this service is the same whether it is used within Central Office or Back Office.

## File Transfer Service

The File Transfer Service passes arbitrary files from one component of the system to another. It stores the files in the database.

## Database Tables Used

- Database Tables Used
- FILE\_SET (File Set)
- FILE\_SET\_ITEM (File Set Item)

## Interfaces

Access the service through FileTransferIfc.java:

### **Example 9–6 FileTransferServiceIfc.java: Methods**

```
public interface FileTransferServiceIfc
{
    FileSetDTO createFileSet(String name, String description) throws
    RemoteException;

    FileSetDTO getFileSet(int id) throws RemoteException;

    FileSetDTO addItemToFileSet(int id, FileSetItemDTO fileSetItemDTO) throws
    RemoteException;

    FileSetDTO removeItemFromFileSet(int id, String fileName) throws
    RemoteException;

    DistributionPayload getDistributionPayload(String source) throws
    RemoteException;
}
```

## Extending This Service

If your project has a particularly optimized solution for storing files on a server, you might want to replace this service with your own solution.

## Dependencies

Store Directory.

## Tier Relationships

The functionality of this service is the same whether it is used within Central Office or Back Office.

## Financial Totals

This service provides functions for getting financial totals for transactions and till history. Each type of transaction and history has an associated Financial Total calculator to derive the various values in the Financial Totals classes from the particular transaction type.

## Database Tables Used

This service does not have persistent storage of its own; it relies on data from other services.

## Interfaces

Access the service through `FinancialTotalsServiceIfc.java`. The following code sample shows the available methods:

### **Example 9–7 `FinancialTotalsServiceIfc.java`**

```
FinancialTotalsIfc getFinancialTotals(Collection transactions) throws
FinancialTotalCalculationException, RemoteException;

    TransactionFinancialTotalsDTO getFinancialTotals(TransactionDTO dto) throws
FinancialTotalCalculationException, RemoteException;

    TillHistoryFinancialTotalsDTO getFinancialTotals(TillHistoryDTO tillHistory,
TillTenderHistoryDTO[] tillTenderHistory) throws
FinancialTotalCalculationException, RemoteException;

    UpdatedTillHistoryFinancialTotalsDTO
getFinancialTotalsAtReconcile(WorkstationDTO workstation, TillHistoryDTO
tillHistory, TillTenderHistoryDTO[] tillTenderHistory, TenderAmountDTO endFloat,
TenderAmountDTO[] tillCounts) throws FinancialTotalCalculationException,
RemoteException;

    FinancialUtilIfc getFinancialUtil() throws RemoteException;
```

## Extending This Service

You could extend this service to perform additional financial aggregations. You could add calculators for additional transaction types or alter the existing calculators.

## Dependencies

- Item Service
- Currency Service
- Transaction Service

## Tier Relationships

The functionality of this service is the same whether it is used in Central Office or Back Office.

## Item Service

The Item Service provides item creation, item search, and item record maintenance. Includes the ability to import item information: a flat file or XML file of item information is imported and can then be processed immediately or scheduled for later upload. The Item Service can take one of three actions on each item listed in an import:

- Add
- Update
- Delete

## Database Tables Used

AS\_ITM (Item)  
 AS\_ITM\_RTL\_STR (Retail Store Item)  
 AS\_ITM\_STK (Stock Item)  
 CO\_CLN\_ITM (Item Collection)  
 CO\_CLR (Item Color)  
 CO\_STYL (Item Style)  
 CO\_SZ (Item Size)  
 CO\_UOM (Item Unit Of Measure)  
 ID\_IDN\_PS (POS Identity)

## Interfaces

Use `ItemServiceIfc.java`, which offers methods to get, update, and import items, search for items, and to get specific information about items, such as units of measure, available colors, and available locations.

### **Example 9–8** *ItemServiceIfc.java: Some Methods*

```
/**
 * @param itemID
 */
ItemDTO getItem(String itemID) throws RemoteException, FinderException;

/**
 * updates the passed in dto, including possibly changing default data
 *
 * @param dto
 */
void updateItem(ItemInfoDTO dto) throws RemoteException;

/**
 * Imports items to the database.
 *
 * @param content - Content containing items to be processed.
```

```
    */
    void importItem(String content) throws RemoteException;

    /**retrieves an item by its full key, if the item isn't found it returns
    default item data
    *
    * @param storeID
    * @param posItemID
    */
    ItemInfoDTO getAllItemInfo(String storeID, String posItemID, String itemID)
    throws RemoteException;

    /** retrieves item data, the collection may contain 0-n iteminfodtos
    *
    * @param storeID
    * @param posItemID
    */
    Collection searchForItems(Collection storeIDs, ItemSearchCriteria criteria)
    throws RemoteException;

    /**
    * @param storeID
    * @param description
    */
    Collection findByDescription(String storeID, String description) throws
    RemoteException, FinderException;

    /**
    * @param storeID
    * @param itemID
    */
    Collection findByPOSItemID(String storeID, String posItemID) throws
    RemoteException, FinderException;

    /**
    * Returns a collection of ColorDTOs representing all the available colors
    for items.
    *
    */
    Collection getAvailableColorsForItems() throws RemoteException,
    FinderException;

    /**
    * Returns a collection of UnitOfMeasureDTOs representing all the available
    sizes for items.
    *
    */
    Collection getAvailableUnitOfMeasuresForItems() throws RemoteException,
    FinderException;

    /**
    * Returns a collection of SizesDTOs representing all the available sizes for
    items.
    *
    */
    Collection getAvailableSizesForItems() throws RemoteException,
    FinderException;

    /**
    * Returns a collection of StylesDTOs representing all the available styles
```

```

for items.
    *
    */
    Collection getAvailableStylesForItems() throws RemoteException,
FinderException;

/**
 * Returns a collection of LocationDTOs representing all the available
locations for items at a given store.
 *
 */
    Collection getAvailableLocationsForItems(String storeID) throws
RemoteException, FinderException;

/**
 * Finds a collection of MerchandiseClassificationDTOs that an item can belong
to.
 * @return
 * @throws RemoteException
 * @throws FinderException
 */
    Collection getMerchandiseClassifications() throws RemoteException,
FinderException;

/**
 * Keys used for importing items.
 *
 * currently maps to the ItemFileTableDef fields
 */
String ITEM_ADD      = "ADD";
String ITEM_DELETE  = "DEL";
String ITEM_UPDATE   = "CHG";
}

```

## Extending This Service

You could extend this service to add item information not carried by the default service. You could change it to delegate to a merchandising system for item classification or item information, or both. Either of these changes could be made by replacing the default service with a new one which adds the new material and references the default service for the rest of its data.

## Dependencies

Party Service.

## Tier Relationships

The functionality of this service is the same whether it is used within Central Office or Back Office. Central Office does not make use of as many of the available functions as Back Office does; currently, only Back Office can update and add items. However, Central Office can import items.

## Parameter Service

Stores application configuration data and provides methods for creating and distributing that data to store systems.

## Database Tables Used

- PARAMETER (Parameter)
- PARAMETER\_SET (Parameter Set)
- PARM\_EDITOR (Parameter Editor)
- PARM\_GROUP (Parameter Group)
- PARM\_SET\_PARM (Parameter Set Member)
- PARM\_SET\_TYPE (Parameter Set Type)
- PARM\_TYPE (Parameter Type)
- PARM\_VAL\_PROP (Parameter Possible Values)
- PARM\_VALIDATOR (Parameter Validator)
- PARM\_VALUE (Parameter Value)
- VAL\_PROP\_NAME (Validator Property Name)
- VAL\_TYPE (Validator Type)

## Interfaces

Methods for the service can be found in `ParameterServiceIfc.java`:

### **Example 9–9** *ParameterServiceIfc.java: Sample Methods*

```
ParameterSetDTO getMasterSet() throws RemoteException;

    ParameterSetDTO getMasterSet(String group) throws RemoteException;

    Set getDistributionSets() throws RemoteException;

    ParameterSetDTO getParameterSet(int id) throws RemoteException;

    ParameterSetDTO getParameterSet(int id, boolean retrieveParameters) throws
RemoteException;

    void deleteParameterSet(int id) throws RemoteException;

    ParameterIfc getApplicationParameter(String param, String defaultValue) throws
RemoteException;

    ParameterIfc getApplicationParameter(String param, List defaultValues) throws
RemoteException;
```

## Extending This Service

Parameters can be added or removed without changing the Parameter Service, by importing a new master set of parameters.

## Dependencies

None.

## Tier Relationships

When used in Back Office, this service distributes parameters to Back Office itself and to Point-of-Service. When used in Central Office, the service distributes parameters to Central Office, Back Office, and Point-of-Service.

## Party Service

The Party Service collects shared party data like addresses, phone number and other contact information. Parties are any person or entity that is a party to a transaction, such as an employee, store, or vendor.

## Database Tables Used

- LO\_ADS (Address)
- PA\_CNCT (Contact)

## Interfaces

The Party Service has no explicit interface file; it is a collection of entities, such as Address and Contact.

## Extending This Service

This service could be extended to connect to a third-party contact database to collect its data.

## Dependencies

None.

## Tier Relationships

The functionality of this service is the same whether it is used within Central Office or Back Office.

## POSlog Import Service

Imports POSlog-formatted XML into the database.

## Database Tables Used

- AS\_DRW\_WS (Workstation Drawer)
- AS\_ITM\_UNK (Unknown Item)
- AS\_LY (Layaway)
- AS\_TL (Till)
- AS\_WS (Workstation)
- CA\_DY\_BSN (Business Day)
- CA\_PRD\_RP (Reporting Period)
- CO\_MDFR\_CMN (Commission Modifier)
- CO\_MDFR\_RTL\_PRC (Retail Price Modifier)

- CO\_MDFR\_SLS\_RTN\_TX (Sale Return Tax Modifier)
- CO\_MDFR\_TX\_EXM (Tax Exemption Modifier)
- DO\_CNT\_PHY (Physical Count Document)
- DO\_CR\_STR (Store Credit)
- DO\_CRD\_GF (Gift Card)
- LE\_HST\_STR (Store History)
- LE\_HST\_STR\_SF\_TND (Store Safe Tender History)
- LE\_HST\_STR\_TND (Store Safe Tender)
- LE\_HST\_TL (Till History)
- LE\_HST\_TL\_TND (Till Tender History)
- LE\_HST\_WS (Workstation History)
- LE\_HST\_WS\_TND (Workstation Tender History)
- LE\_LTM\_MD\_TND (Tender Media Line Item)
- LO\_ADS (Address)
- LO\_EML\_ADS (Email Address)
- OR\_LTM (Order Line Item)
- OR\_LTM\_MDFR\_RPRC (Order Line Item Retail Price Modifier)
- OR\_ORD (Order)
- ORGN\_CT (Business Customer)
- PA\_CNCT (Contact)
- PA\_CT (Customer)
- PA\_ID\_PRTY\_GEN (Party ID Generation)
- PA\_PHN (Phone Number)
- PA\_PRTY (Party)
- TR\_ADS\_SLS\_RTN (Sale Return Line Item Address)
- TR\_CNT\_INV (Inventory Count Transaction)
- TR\_CTL (Control Transaction)
- TR\_FN\_ACNT (Financial Accounting Transaction)
- TR\_ITM\_CPN\_T(NCDo upon Tender Line Item)
- TR\_LON\_TND (Tender Lone Transaction)
- TR\_LTM\_ALTR (Alteration Line Item)
- TR\_LTM\_CHK\_T(NCD heck Tender Line Item)
- TR\_LTM\_CR\_STR\_TND (Store Credit Line Item)
- TR\_LTM\_CRDB\_CRD\_TN (Credit Debit Tender Line Item)
- TR\_LTM\_DSC (Discount Line Item)
- TR\_LTM\_GF\_CF\_TND (Gift Certification Tender Line Item)
- TR\_LTM\_GF\_CRD\_TND (Gift Card Tender Line Item)

- TR\_LTM\_PHY\_CNT (Physical Count Line Item)
- TR\_LTM\_PRCH\_ORD\_TND (Purchase Order Tender Line Item)
- TR\_LTM\_PYAN (Payment On Account Line Item)
- TR\_LTM\_RTL\_TRN (Retail Transaction Line Item)
- TR\_LTM\_SLS\_RTN (Sale Return Line Item)
- TR\_LTM\_SLS\_RTN\_TX (Sale Return Tax Line Item)
- TR\_LTM\_SND\_CHK\_TND (Send Check Tender Line Item)
- TR\_LTM\_TND (Tender Line Item)
- TR\_LTM\_TND\_CHN (Tender Change Line Item)
- TR\_LTM\_TRV\_CHK\_TND (Travelers Check Tender Line Item)
- TR\_LTM\_TX (Tax Line Item)
- TR\_PKP\_TND (Tender Pickup Transaction)
- TR\_RCV\_FND (Funds Receipt Transaction)
- TR\_RTL (Retail Transaction)
- TR\_SLS\_PS\_NO (POS No Sale Transaction)
- TR\_STR\_OPN\_CL (Store Open Close Transaction)
- TR\_TL\_OPN\_CL (Till Open Close Transaction)
- TR\_TRN (Transaction)
- TR\_VD\_PST (Post Void Transaction)
- TR\_WS\_OPN\_CL (Workstation Open Close Transaction)

## Interfaces

The functions of the POSlog Import Service are encapsulated within the Transaction Service; if you need to call for a POSlog Import, do it through the Transaction Service.

## Extending This Service

You could extend this service to capture additional custom POSlog elements which are not part of the base ARTS IXRetail XML standard.

## Dependencies

None.

## Tier Relationships

The functionality of this service is the same whether it is used within Central Office or Back Office.

## Pricing Service

The Pricing service offers functions for requesting pricing rules, modifying them, and creating new ones.

## Database Tables Used

- MA\_PRC\_ITM (ItemPriceMaintenance)
- MA\_ITM\_PRN\_PRC\_ITM (PermanentPriceChangeItem)
- TR\_CHN\_PRN\_PRC (PermanentPriceChange)
- MA\_ITM\_TMP\_PRC\_CHN (TemporaryPriceChangeItem)
- TR\_CHN\_TMP\_PRC (TemporaryPriceChange)
- CO\_EL\_PRDV\_DPT (DepartmentPriceDerivationRuleEligibility)
- CO\_EL\_PRDV\_ITM (ItemPriceDerivationRuleEligibility)
- CO\_PRDV\_ITM (ItemPriceDerivation)
- CO\_EL\_MRST\_PRDV (MerchandiseStructurePriceDerivationRuleEligibility)
- TR\_ITM\_MXMH\_PRDV (MixAndMatchPriceDerivationItem)
- RU\_PRDV (PriceDerivationRule)
- RU\_TY\_PRDV (PriceDerivationRuleType)
- CO\_EV (Event)
- CO\_MNT\_ITM (ItemMaintenanceEvent)
- CO\_EV\_MNT (MaintenanceEvent)
- AS\_ITM\_RTL\_STR (Retail Store Item)

## Interfaces

Access this interface through PricingServiceIfc.java. The following code sample shows a few of the available methods:

### **Example 9–10 PricingServiceIfc.java: Some Methods**

```
{
    void importPricing(String content) throws RemoteException;

    AdvancedPricingRuleDTO createAdvancedPricingRule(String storeID,
        int priceDerivationRuleTypeId, String name,
        Date effectiveDate, Date expirationDate,
        ComparisonBasis sourceBasis, ComparisonBasis targetBasis) throws RemoteException,
        AdvancedPricingRuleException;

    AdvancedPricingRuleDTO getAdvancedPricingRule(String store, int id) throws
        RemoteException, AdvancedPricingRuleException;

    void removeAdvancedPricingRule(String store, int id) throws RemoteException,
        AdvancedPricingRuleException;

    Collection getAllPricingRuleTypesForStore(String storeID) throws
        RemoteException;

    Collection findAdvancedPricingRules(AdvancedPricingRuleSearchCriteria
        criteria) throws RemoteException, AdvancedPricingRuleSearchException;

    void endAdvancedPricingRule(String storeId, int id) throws RemoteException,
        AdvancedPricingRuleException;

    Collection findPricingPromotions(PricingPromotionSearchCriteria
```

```

pricingPromotionSearchCriteria) throws RemoteException,
PricingPromotionNotFoundException;
    PricingChangeDTO updateTemporaryPriceChange(PricingChangeDTO pricingChangeDTO)
throws RemoteException, PricingChangeException;
    java.util.HashMap findPricingPromotion(String promotionId, String storeId)
throws RemoteException, PricingPromotionNotFoundException;

    PricingPromotionSearchCriteria getItemDetails(String eventId, String itemId,
String storeId) throws RemoteException, ItemNotFoundException,
ItemIneligibleException;

    Collection findPricingChanges(PricingChangeSearchCriteria
pricingChangeSearchCriteria) throws RemoteException, PricingChangeSearchException,
PricingChangeException;

    void addSourceToAdvancedPricingRule(int pricingRuleID, String storeID, String
sourceId, BigDecimal comparisonValue) throws RemoteException,
AdvancedPricingRuleException;

    void addTargetToAdvancedPricingRule(int pricingRuleID, String storeID, String
targetId, BigDecimal reduction, int limitCount) throws RemoteException,
AdvancedPricingRuleException;

    void removeSourceTargetFromAdvancedPricingRule(int pricingRuleID, String
storeID, String[] sourceIds, String[] targetIds) throws RemoteException,
AdvancedPricingRuleException;

    void removeTargetFromAdvancedPricingRule(int pricingRuleID, String storeID,
String targetId) throws RemoteException, AdvancedPricingRuleException;

    void removeSourceFromAdvancedPricingRule(int pricingRuleID, String storeID,
String sourceId) throws RemoteException, AdvancedPricingRuleException;

```

## Extending This Service

You could extend this service to add additional pricing functions or to draw data from a different source, such as a marketing database that tracks upcoming price promotions.

## Dependencies

- Item Service
- Workflow Service

## Tier Relationships

When used in Back Office, all of the Pricing functionality is available. When used in Central Office, Import pricing is not available.

## Reporting Service

The Reporting Service is a framework for creating and exporting reports, managing users' favorite reports, and maintaining collections for scheduling. The service supports XMLP reports.

Export formats include HTML, CSV, PDF and TXT.

## Database Tables Used

- EXECUTED\_REPORT (Executed Report)
- FAVORITE\_REPORT (Favorite Report)
- REPORT\_CONFIG (Report Configuration)
- REPORT\_CONFIG\_PARAMETER (Report Configuration Parameters)
- REPORT\_CRITERIA (Report Criteria)
- REPORT\_GROUP (Report Group)
- REPORT\_RECIPIENT (Report Recipient)

## Interfaces

The Reporting Service includes methods for report creation and report type. It is contained within `ReportingServiceI.fc.java`:

### **Example 9–11 ReportingServiceI.fc.java: Methods**

```
String createReport(Handle handle, ReportCriteriaI.fc reportCriteria);
String getType();
```

## Extending This Service

The Reporting Service can be easily extended to support new XSL Reports. Report definitions are database driven. The report definitions contain a name, report implementation, report parameters, and report types.

## Dependencies

- Workflow/Scheduling Service
- Store Service
- Store Ops Service
- Calendar Service

## Tier Relationships

The functionality of this service is the same whether it is used within Central Office or Back Office.

## Store Directory Service

This service provides access to the directory of stores in the enterprise.

## Database Tables Used

- CO\_STRGP\_FNC (RetailStoreGroupFunction)
- ST\_ASCTN\_STRGP\_STR (AssociatedRetailStoreStoreGroup)
- CO\_STRGP\_LV (RetailStoreGroupLevel)
- CO\_STRGP (RetailStoreGroup)
- ST\_ASCTN\_STRGP (AssociatedRetailStoreGroup)

## Interfaces

Use `StoreDirectoryIfc.java`, which offers more than 20 methods. These include methods for getting paths to stores, the current store's node in the hierarchy, or a set of stores based on some set of search criteria.

### Example 9–12 `StoreDirectoryIfc.java`: Some Methods

```

/**
 * Get all of the store hierarchies on the system. This is just the store
 hierarchy alone, no
 * individual store(s) underneath of group node.
 * @return HierarchyNodeIfc if any exists, else null
 * @throws RemoteException
 */
HierarchyNodeIfc getStoreHierarchies() throws RemoteException;

/**
 * Return the hierarchy node that the store belongs to. This hierarchy node
 will also have a list of
 * ancestors of the store represented by storeId.
 * @param storeId
 * @return HierarchyNodeIfc or null if the store does not belong to any store
 hierarchy
 * @throws RemoteException
 * @throws FinderException
 */
HierarchyNodeIfc getStoreItsStoreHierarchy(String storeId) throws
RemoteException, FinderException;

StoreDTO getStore(String storeID) throws RemoteException, FinderException;

/**
 * gets all the stores for a given selection criteria
 *
 * @return a ArrayList of string store ids
 */
Collection getStores(StoreSelectionCriteria criteria) throws RemoteException;

Collection getStores(StoreSelectionCriteria criteria, boolean returnEmpty)
throws RemoteException;

String getGroupName(HierarchyNodeKey key) throws RemoteException;

/**
 *

```

## Extending This Service

You could replace this service with a connection to an existing database of stores, if your enterprise already maintains this information in another form.

## Dependencies

Parameter Service.

## Tier Relationships

The functionality of this service is the same whether it is used within Central Office or Back Office.

## Store Service

Look up and maintain store attributes, store hierarchy information and store history.

### Database Tables Used

- CA\_DY\_BSN (Business Day)
- CA\_PRD\_RP (Reporting Period)
- CO\_STRGP (Store Group)
- CO\_STRGP\_FNC (Store Group Function)
- CO\_STRGP\_LV (Store Group Level)
- EMPLOYEE\_HIERARCHY\_ASSN (Employee Hierarchy Association)
- LE\_HST\_STR (Store History)
- LE\_HST\_STR\_SF\_TND (Store Safe Tender History)
- LE\_TND\_STR\_SF (Store Safe Tender)
- PA\_STR\_RT (Retail Store)
- ST\_ASCTN\_STRGP (Associated Retail Store Group)
- ST\_ASCTN\_STRGP\_STR (Associated Retail Store Group Store)

## Interfaces

Use `StoreServiceIfc.java`, which provides one method:

### **Example 9–13** *StoreServiceIfc.java*

```
public interface StoreServiceIfc
{
    /**
     * Returns list of WorkstationDTOs
     * @param storeId
     * @return
     * @throws RemoteException
     */
    List getAllWorkstations(String storeId) throws RemoteException;
}
```

## Extending This Service

If your enterprise needs additional store information not carried by the default service, you could extend this service to include the new data.

## Dependencies

Parameter Service.

## Tier Relationships

The functionality of this service is the same whether it is used within Central Office or Back Office.

## Transaction Service

Searches for transactions and E-journals based on transaction, customer or item information.

## Database Tables Used

- AS\_ITM (Item)
- AS\_ITM\_STK (Stock Item)
- CO\_MDFR\_CMN (Commission Modifier)
- CO\_MDFR\_RTL\_PRC (Retail Price Modifier)
- ID\_IDN\_PS (POS Identity)
- JL\_ENR (Journal Entry)
- LE\_LTM\_MD\_TND (Tender Media Line Item)
- LO\_ADS (Address)
- PA\_CNCT (Contact)
- PA\_CT (Customer)
- TR\_CTL (Control Transaction)
- TR\_LON\_TND (Tender Lone Transaction)
- TR\_LTM\_CHK\_TND (Check Tender Line Item)
- TR\_LTM\_CRDB\_CRD\_TN (Credit Debit Tender Line Item)
- TR\_LTM\_RTL\_TRN (Retail Transaction Line Item)
- TR\_LTM\_SLS\_RTN (Sale Return Line Item)
- TR\_LTM\_TND (Tender Line Item)
- TR\_PKP\_TND (Tender Pickup Transaction)
- TR\_RTL (Retail Transaction)
- TR\_SLS\_PS\_NO (POS No Sale Transaction)
- TR\_STR\_OPN\_CL (Store Open Close Transaction)
- TR\_TL\_OPN\_CL (Till Open Close Transaction)
- TR\_TRN (Transaction)
- TR\_VD\_PST (Post Void Transaction)
- TR\_WS\_OPN\_CL (Workstation Open Close Transaction)

## Interfaces

The file TransactionServiceIcfc.java contains a number of methods for accessing the service. These include transaction creation, search result, and others.

**Example 9–14 TransactionServiceIcfc.java: Some Sample Methods**

```
/** Retrieves a transaction's type.
 *
 * @param transactionKey
 * @return TransactionType
 */
TransactionType getType(TransactionKey transactionKey)
    throws RemoteException, InvalidTypeException,
    ObjectNotFoundException;

/** Retrieves a transaction data transfer object given a TransactionKey as
input.
 *
 * @param transactionKey
 * @return RetailTransactionDTO
 */
TransactionDTO retrieveTransaction(TransactionKey transactionKey)
    throws RemoteException, ObjectNotFoundException,
    InvalidTypeException;

/** Retrieves a set of ejournal information given ejournal search criteria as
input.
 *
 * @param storeSelectionCriteria
 * @param ejournalCriteria
 * @param startIndex
 * @return returnLimit
 */
EJournalSearchResultDTO getEJournals(
    StoreSelectionCriteria storeSelectionCriteria,
    EJournalCriteria ejournalCriteria, int startIndex, int returnLimit)
    throws RemoteException, SearchResultSizeExceededException;
```

## Extending This Service

You would need to extend this service if you wanted to add new transaction types or new ways of searching for transactions.

## Dependencies

- Parameter Service
- Customer Service
- Item Service
- Store Service

## Tier Relationships

The functionality of this service is the same whether it is used within Central Office or Back Office. Although full functionality is available to both applications, Central Office tends to import transactions while Back Office tends to export them, due to the intended use of the applications.

## Workflow/Scheduling Service

Create and edit tasks, schedule tasks, track task approval. Even for tasks which should be scheduled immediately, the Workflow/Scheduling Service provides task tracking features.

### Database Tables Used

- CO\_EVT\_MSG (Job Event Messages)
- FILE\_SET (File Set)
- FILE\_SET\_ITEM (File Set Item)
- SCHEDULE (Schedule)
- TASK (Task)
- TASK\_DESTINATION\_STATUS (Task Destination Status)
- TASK\_HISTORY (Task History)
- TASK\_NOTIFICATION\_RECIPIENT (Task Notification Recipient)
- TASK\_REVIEW (Task Review)
- WORKFLOW\_CONFIGURATION (Workflow Configuration)

### Interfaces

The Workflow Service's methods are defined in `WorkflowServiceIfc.java`. They include methods for task creation, notification, task destination, and more.

### Extending This Service

Extend this service by adding new task types. You would need to add the new task type to the workflow configuration table, add a map to execute the task, and add a user interface to allow the task type to be created.

### Dependencies

- Parameter Service
- Store Service

### Tier Relationships

This service is the same whether it is used within Central Office or Back Office; either application calls the service to schedule tasks.



---

---

## Enterprise Database

Oracle Retail Central Office uses an ARTS-compliant database. Data is stored and retrieved by entity beans in a bean-managed persistence pattern, so the system makes database calls from the entity bean code.

A single entity bean exists for each database table, and handles reads and writes for that table. Each entity bean contains the necessary methods to create, load, store, and remove its object type.

The Central Office application writes data to the enterprise database, which serves as a repository for information about transactions across the whole enterprise.

### Related Documentation

[Table 10-1](#) lists related sources that provide specific information about the database for your use when developing code.

**Table 10-1** *Related Documentation*

Source	Description
ARTS Database Standard	See <a href="http://www.nrf-arts.org/">http://www.nrf-arts.org/</a> for a description of the ARTS database standard.
Data Dictionary	Contains table and column definitions for the database used to store Central Office data. See the docs zip file provided with your Central Office documentation.
Database Diagrams	See the <code>_resources</code> directory for diagrams which show the relationships between various tables in the database schema.

### Database/System Interface

As described in [Chapter 2, "Technical Architecture"](#) a persistence layer of entity beans represents the database tables to the rest of the system. One bean represents each table.

The following figure illustrates these relationships.

**Figure 10–1 Commerce Services, Entity Beans, and Database Tables**

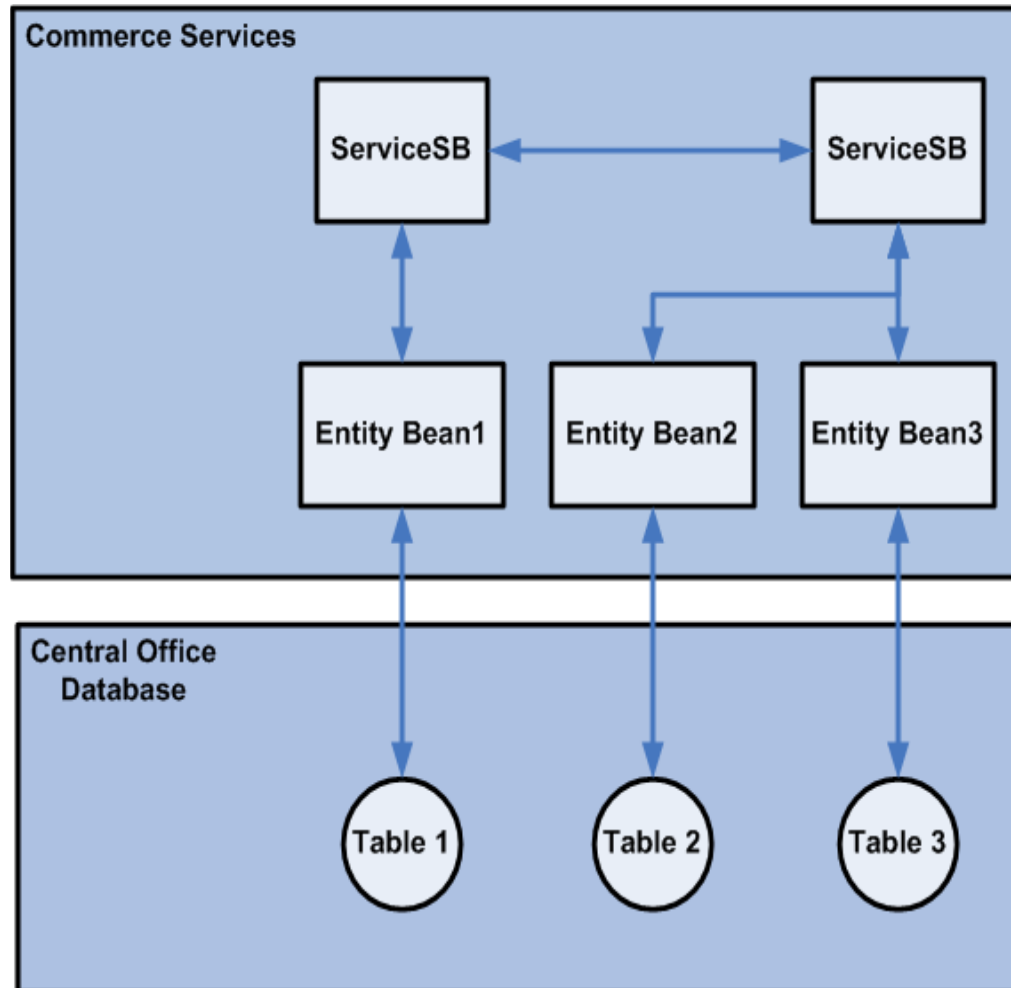

Each commerce service communicates with one or more entity beans, and each entity bean communicates with one database table. Although there are exceptions, in general only one commerce service communicates with an entity bean; other services request the information from the relevant service rather than talking directly to the entity bean. For example, if the Customer Service needs information provided by the Item Bean, it makes a request to the Item Service.

## ARTS Compliance

When new code is added or features are added, modified, or extended, database plans should be evaluated to ensure that new data items fit the ARTS schema. Complying with the standards increases the likelihood that extensions can migrate into the product codebase and improves code reuse and interoperability with other applications.

---



---

**Note:** Because the ARTS standard continues to evolve, older code may contain deviations from the standard or may be compliant only with an earlier version of the standard. Oracle Retail continues to evaluate ARTS compliance with each release of its software.

---



---

## Bean-managed Persistence in the Database

In general, the system uses standard J2EE bean-managed persistence techniques to persist data to the Oracle Retail database. Each of the entity beans that stores data requires JDBC code in standard `ejbLoad`, `ejbStore`, `ejbCreate`, and `ejbRemove` classes. However, there are some differences worth noting:

- All SQL references are handled as constant fields in an interface.
- Session and entity beans extend an `EnterpriseBeanAdapter` class. Special extensions for session and entity beans exist. These contain common code for logging and a reference to the Oracle Retail `DBUtils` class (which provides facilities for opening and closing data source connections, among other resources).

### **Example 10–1** *ItemPriceDerivationBean.java: ejbStore Method*

```
public void ejbStore() throws EJBException
{
    ItemPriceDerivationPK key = (ItemPriceDerivationPK)
getEntityContext().getPrimaryKey();
    getLogger().debug("store");
    PreparedStatement ps = null;
    Connection conn = null;
    if (isModified())
    {
        getLogger().debug("isModified");
        try
        {
            conn = getDBUtils().getConnection();
            ps = conn.prepareStatement(ItemPriceDerivationsQLIfc.STORE_SQL);
            int n = 1;
            ps.setBigDecimal(n++, getReductionAmount().toBigDecimal());
            ps.setBigDecimal(n++, getDiscountPricePoint().toBigDecimal());
            getDBUtils().preparedStatementSetDate(ps, n++,
getRecordCreationTimestamp());
            ps.setBigDecimal(n++, getReductionPercent().toBigDecimal());
            getDBUtils().preparedStatementSetDate(ps, n++,
getRecordLastModifiedTimestamp());
            ps.setInt(n++, key.getPriceDerivationRuleID());
            ps.setString(n++, key.getStoreID());
            if (ps.executeUpdate() != 1)
            {
                throw new EJBException("Error storing (" +
getEntityContext().getPrimaryKey() + ")");
            }
        }
    }
}
```

```
        setModified(false);
    }
    catch (SQLException ex)
    {
        getLogger().error(ex);
        throw new EJBException(ex);
    }
    catch (Exception ex)
    {
        getLogger().error(ex);
        throw new EJBException(ex);
    }
    finally
    {
        getDBUtils().close(conn, ps, null);
    }
}
}
```

---

---

## Appendix: Central Office Data Purge

Data purging is based upon logical sets of data. Logical sets of data can be contained in multiple tables. An example of a logical set of data is all the records associated to a particular Retail Transaction.

A purge of a logical set is not considered complete until all relevant rows of data are deleted.

Data purging is based upon a data-retention schedule whereupon all data existing prior to the computed date are purged. The data within this timeframe must meet constraints as required. For example, if a customer wants to retain the last 180 days worth of retail transaction data, then the integer 180 should be passed into the purge retail transaction routine and the system will purge COMPLETED transactions more than 180 days old.

The stored procedures reads the absolute value of a negative integer. For example, a value of **-30** passed into the stored procedures will be read as **30**, and the data will be retained for 30 days.

If no value is passed into the stored procedures, then the default value is used. The default value is 30.

The number of data retention days is passed into the stored procedures. The constraints are built into the stored procedures and are therefore not parameterized.

A logical set purge will succeed even if data is not found in an expected table.

The Financial History and Financial Summary data purge scripts do not address the issue of the weekly sum of daily totals that will no longer match weekly totals. For example, if the purge occurs on a Wednesday, the sum of the daily totals from Wednesday through Saturday will not match the weekly total that was based upon a Sunday through Saturday timeframe.

---

---

**Caution:** Passing in a **zero (0)** as a parameter to the purge transaction routines will result in the deletion of all completed transactional data. Oracle is not responsible for loss or damage of any sort that might incur from passing in zero as a parameter.

The customer is fully responsible for the database configuration. Oracle assumes the purge routines will operate within the confines of the database configuration, such as the size of the rollback segments and other such parameters that might affect the functioning of the purge routines.

---

---

## Invoking Stored Procedures

The following are examples how to invoke stored procedures.

---



---

**Note:** It is assumed that the user calling the stored procedures has the necessary privileges to invoke these procedures.

---



---

### **Example A–1 Invoking The Stored Procedures -- SQL Plus Method 1**

```
SQL> execute <procedure name (parameters)>;
```

Example:

```
execute Purge_Fn_Smy(90);
```

### **Example A–2 Invoking The Stored Procedures -- SQL Plus Method 2**

```
SQL> BEGIN
SQL> <procedure name (parameters)>;
SQL> END;
```

Example:

```
SQL> BEGIN
SQL> Purge_Fn_Smy(90);
SQL> END;
```

You can choose to create a script file that contains these commands and have a scheduler execute the script on a nightly basis. To do this, you must be logged into the database.

The scheduler must be able to log in to the database to be able to run the scripts, or the log in must be the first line in the script.

## Calls to invoke stored procedures

[Table A–1](#) contains the calls to use to invoke stored procedures.

**Table A–1 Stored Procedure Calls**

Subject Area	Procedure Call
Retail Transactions	Purge_trl_trn (<number of retention days>)
Control Transactions	Purge_ctl_trn (<number of retention days>)
Financial Accounting Transactions	Purge_fn_trn (<number of retention days>)
Orders	Purge_ord (<number of retention days>)
Layaways	Purge_ly (<number of retention days>)
Financial Histories	Purge_Fn_Hst (<number of retention days>)
Financial Summaries	Purge_Fn_Smy (<number of retention days>)
Advanced Pricing	Purge_prdv (<number of retention days>)
Maintenance Events	Purge_ev (<number of retention days>)
eJournal	Purge_ejrl (<number of retention days>)

---

---

## Appendix: Changing Currency

In order to switch to another base and alternate currency you'll have to perform the following steps:

1. Set the base currency flag in the primary currency of the currency table. For example, if EUR is the base currency:

```
update co_cny set FL_CNY_BASE='1' where DE_CNY='EUR'
```

2. Remove the base currency flag from any other currencies in that table. For example:

```
update co_cny set FL_CNY_BASE='0' where DE_CNY='USD'
```

3. Enforce ordering so that the primary currency is first and the alternate currency is second for the AI\_CNY\_PRI column in the currency table. Other rows should be ordered, but the specific order isn't important. For example if EUR is base currency and GBP is the alternate:

```
update co_cny set AI_CNY_PRI=0 where DE_CNY='EUR'  
update co_cny set AI_CNY_PRI=1 where DE_CNY='GBP'  
update co_cny set AI_CNY_PRI=2 where DE_CNY='USD'  
update co_cny set AI_CNY_PRI=3 where DE_CNY='CAD'  
update co_cny set AI_CNY_PRI=4 where DE_CNY='MXN'  
update co_cny set AI_CNY_PRI=5 where DE_CNY='JPY'
```

4. Update the country code for the money order record to reflect the country of base currency. For example if EUR is base currency:

```
update le_tnd_str_sf set LU_CNY_ISSG_CY='EU' where ty_tnd='MNYO'
```

There are some application parameters that must be changed as well:

- **Tender Group:**
  - **CashAccepted:** For example, if EUR is base and GBP is alternate, make sure that the **CashAccepted** parameter is changed so that EUR and GBP are selected.
  - **TravelersChecksAccepted:** For EUR as base and GBP as alternate, the values for the **TravelersChecksAccepted** parameter should be EURCHK and GBPCHK.
  - **ChecksAccepted:** For EUR as base and GBP as alternate, the values for the **ChecksAccepted** parameter should be EURCHK and GBPCHK.

- 
- Reconciliation Group:
    - TendersToCountAtTillReconcile: For EUR as base and GBP as alternate, the values for the TendersToCountAtTillReconcile parameter should be:
      - \* Cash
      - \* Check
      - \* ECheck
      - \* Credit
      - \* Debit
      - \* TravelCheck
      - \* GiftCert
      - \* Coupon
      - \* GiftCard
      - \* StoreCredit
      - \* MallCert
      - \* PurchaseOrder
      - \* MoneyOrder
      - \* GBPCash
      - \* GBPTravelCheck
      - \* GBPCheck
      - \* GBPGiftCert
      - \* GBPStoreCredit