

JD Edwards EnterpriseOne Applications

Procurement Management Implementation Guide

Release 9.1.x

E15131-18

January 2015

Copyright © 2015, Oracle and/or its affiliates. All rights reserved.

This software and related documentation are provided under a license agreement containing restrictions on use and disclosure and are protected by intellectual property laws. Except as expressly permitted in your license agreement or allowed by law, you may not use, copy, reproduce, translate, broadcast, modify, license, transmit, distribute, exhibit, perform, publish, or display any part, in any form, or by any means. Reverse engineering, disassembly, or decompilation of this software, unless required by law for interoperability, is prohibited.

The information contained herein is subject to change without notice and is not warranted to be error-free. If you find any errors, please report them to us in writing.

If this is software or related documentation that is delivered to the U.S. Government or anyone licensing it on behalf of the U.S. Government, then the following notice is applicable:

U.S. GOVERNMENT END USERS: Oracle programs, including any operating system, integrated software, any programs installed on the hardware, and/or documentation, delivered to U.S. Government end users are "commercial computer software" pursuant to the applicable Federal Acquisition Regulation and agency-specific supplemental regulations. As such, use, duplication, disclosure, modification, and adaptation of the programs, including any operating system, integrated software, any programs installed on the hardware, and/or documentation, shall be subject to license terms and license restrictions applicable to the programs. No other rights are granted to the U.S. Government.

This software or hardware is developed for general use in a variety of information management applications. It is not developed or intended for use in any inherently dangerous applications, including applications that may create a risk of personal injury. If you use this software or hardware in dangerous applications, then you shall be responsible to take all appropriate fail-safe, backup, redundancy, and other measures to ensure its safe use. Oracle Corporation and its affiliates disclaim any liability for any damages caused by use of this software or hardware in dangerous applications.

Oracle and Java are registered trademarks of Oracle and/or its affiliates. Other names may be trademarks of their respective owners.

Intel and Intel Xeon are trademarks or registered trademarks of Intel Corporation. All SPARC trademarks are used under license and are trademarks or registered trademarks of SPARC International, Inc. AMD, Opteron, the AMD logo, and the AMD Opteron logo are trademarks or registered trademarks of Advanced Micro Devices. UNIX is a registered trademark of The Open Group.

This software or hardware and documentation may provide access to or information about content, products, and services from third parties. Oracle Corporation and its affiliates are not responsible for and expressly disclaim all warranties of any kind with respect to third-party content, products, and services unless otherwise set forth in an applicable agreement between you and Oracle. Oracle Corporation and its affiliates will not be responsible for any loss, costs, or damages incurred due to your access to or use of third-party content, products, or services, except as set forth in an applicable agreement between you and Oracle.

Contents

Preface	xxvii
Audience	xxvii
JD Edwards EnterpriseOne Products	xxvii
JD Edwards EnterpriseOne Application Fundamentals	xxviii
Documentation Accessibility	xxviii
Related Documents	xxviii
Conventions	xxviii
1 Introduction to JD Edwards EnterpriseOne Procurement Management	
1.1 JD Edwards EnterpriseOne Procurement Management Overview	1-1
1.2 JD Edwards EnterpriseOne Procurement Management Integrations	1-1
1.2.1 JD Edwards EnterpriseOne General Ledger and JD Edwards EnterpriseOne Accounts Payable	1-1
1.2.2 JD Edwards EnterpriseOne Address Book	1-2
1.2.3 JD Edwards EnterpriseOne Manufacturing and Supply Chain Management	1-2
1.2.4 Logistics	1-2
1.2.5 JD Edwards EnterpriseOne Job Costing	1-2
1.2.6 JD Edwards EnterpriseOne Electronic Data Interchange	1-3
1.3 JD Edwards EnterpriseOne Procurement Management Implementation	1-3
1.3.1 Global Implementation Steps	1-4
1.3.2 Procurement Implementation Steps	1-5
1.4 Business Interface Integration Objects	1-6
2 Understanding Procurement	
2.1 Industry Overview	2-1
2.1.1 Procurement Description	2-1
2.1.2 Industry Environment and Concepts for Procurement	2-1
2.1.2.1 Order Generation	2-2
2.1.2.2 Purchasing Methods	2-2
2.1.2.3 Receipt Processing	2-2
2.1.2.4 Special Order Processing	2-2
2.1.2.5 Approval Processing	2-3
2.1.2.6 Receipt Routing	2-3
2.1.2.7 Supplier Management	2-3
2.2 Procurement System Overview	2-4

2.2.1	Procurement System Description.....	2-4
2.2.2	Features, Terms, and Concepts.....	2-4
2.2.2.1	Purchasing for Inventory.....	2-5
2.2.2.2	Purchasing for Non-Inventory	2-5
2.2.2.3	Subcontracting	2-6
2.2.2.4	Procurement Environments	2-6
2.2.3	Order Processing Cycle.....	2-6
2.2.3.1	Optional Procurement Activities.....	2-8

3 Understanding Vertex Sales Tax Q Series

3.1	Compatibility of the Vertex Sales Tax Q Series System	3-1
-----	---	-----

4 Understanding Pricing in Procurement

4.1	Pricing in Procurement	4-1
4.1.1	Matrix Item	4-2
4.1.1.1	Matrix Item Receipts and Tolerance	4-2
4.1.2	Price Matrix.....	4-2
4.1.3	Minimum or Maximum Price Adjustment	4-2
4.1.4	Pricing on Quality Attributes.....	4-3
4.1.5	Manual Purchase Price Override.....	4-3
4.1.6	Pricing at Receipts	4-4
4.1.7	Repricing for Procurement	4-4

5 Understanding Customer and Supplier Self-Service Setup

5.1	Customer and Supplier Self-Service.....	5-1
5.1.1	Prerequisites	5-2
5.2	Self-Service Setup.....	5-2
5.2.1	Self-Service Setup Overview	5-2
5.2.2	Security Issues	5-2
5.2.3	Activation of Processing Options.....	5-3

6 Setting Up the Procurement System

6.1	Understanding System Setup.....	6-1
6.2	Understanding the Setup of Procurement Next Numbers	6-3
6.3	Defining Order Line Types.....	6-3
6.3.1	Understanding Order Line Types	6-3
6.3.2	Form Used to Define Order Line Types	6-4
6.3.3	Defining Order Line Types.....	6-4
6.4	Setting Up Order Activity Rules.....	6-8
6.4.1	Understanding Order Activity Rules.....	6-8
6.4.2	Prerequisites	6-9
6.4.3	Form Used to Set Up Order Activity Rules	6-9
6.4.4	Setting Up Order Activity Rules.....	6-9
6.5	Setting Up Procurement Constants	6-11
6.5.1	Understanding Procurement Constants.....	6-11
6.5.2	Prerequisites	6-11

6.5.3	Forms Used to Set Up Procurement Constants	6-11
6.5.4	Defining Branch/Plant Constants	6-12
6.5.5	Defining Pricing Constants	6-14
6.5.6	Defining Item Availability.....	6-15
6.5.7	Defining System Constants	6-16
6.5.8	Defining Application Control Constants	6-18
6.6	Setting Up UDCs.....	6-19
6.6.1	Document Type (00/DT).....	6-19
6.6.2	Schedule Name (40/AS)	6-19
6.6.3	Average Cost Calculation (40/AV).....	6-19
6.6.4	Landed Cost Components (40/CA).....	6-19
6.6.5	Commitment Document Types (40/CT).....	6-19
6.6.6	Item Change Files - (P40821X) (40/IC).....	6-20
6.6.7	Order Templates (40/OT).....	6-20
6.6.8	Customer Price Groups (40/PC)	6-20
6.6.9	Item Price Groups (40/PI).....	6-20
6.6.10	Print Messages (40/PM)	6-20
6.6.11	G/L Posting Category (41/9).....	6-20
6.6.12	Cross Reference Type Code (41/DT).....	6-20
6.6.13	Commodity Class Codes (41/P1).....	6-21
6.6.14	Commodity Sub Class Codes (41/P2)	6-21
6.6.15	Supplier Rebate Codes (41/P3).....	6-21
6.6.16	Master Planning Family (41/P4)	6-21
6.6.17	Landed Cost Rule (41/P5).....	6-21
6.6.18	Price Category Type (42/CT).....	6-21
6.6.19	Freight Handling Code (42/FR)	6-21
6.6.20	Hold Codes (42/HC).....	6-21
6.6.21	Certification Status (43/CR).....	6-21
6.6.22	Movement Code (43/MC).....	6-21
6.6.23	Model Log Types (43/ML).....	6-22
6.6.24	Operation Codes (43/OC).....	6-22
6.6.25	Outstanding Log Types (43/OL).....	6-22
6.6.26	Procurement Rebate Order Type (43/RB)	6-22
6.6.27	Route Codes (43/RC)	6-22
6.6.28	Rebate Status (43/RS).....	6-22
6.6.29	Rebate Type (43/RT).....	6-22
6.6.30	View Progress Payments (43B/VW).....	6-22
6.6.31	Transaction Set Purpose Code (47/PU).....	6-22
6.7	Setting Up AAIs	6-22
6.7.1	Understanding AAI Tables for the JD Edwards EnterpriseOne Procurement System.....	6-23
6.7.1.1	AAIs for Purchase Order Entry	6-23
6.7.1.2	AAIs for Receipts and Voucher Match.....	6-23
6.7.1.3	AAIs for Variances	6-24
6.7.1.4	AAIs for Tax Liabilities.....	6-24
6.7.1.5	AAIs for Receipt Routing	6-25
6.7.1.6	AAIs for Landed Costs	6-25

6.7.1.7	AAIs for Zero Balance Adjustments	6-25
6.7.2	Understanding AAI Tables for the Financial System.....	6-25
6.7.2.1	AAIs for Freight Distribution (PCFRTD).....	6-26
6.7.2.2	AAIs for Non-Billable Retainage (PCNBRT).....	6-26
6.7.3	Form Used to Set Up AAIs.....	6-26
6.7.4	Setting Processing Options for Distribution AAIs (P40950).....	6-26
6.7.4.1	Defaults	6-26
6.7.5	Setting Up Distribution AAIs.....	6-27
6.8	Creating Tolerance Rules.....	6-27
6.8.1	Understanding Tolerance Rules	6-27
6.8.1.1	Tolerance Rules in the VMA Process (Release 9.1 Update).....	6-27
6.8.2	Form Used to Create Tolerance Rules	6-28
6.8.3	Creating a Tolerance Rule	6-28
6.9	Setting Up Rounding Tolerance Rules For Voucher Match Automation (Release 9.1 Update) 6-29	
6.9.1	Understanding Rounding Tolerance Rules for Voucher Match Automation.....	6-29
6.9.2	Forms Used to Set Up Rounding Tolerance for Voucher Match Automation.....	6-30
6.9.3	Setting Up Rounding Tolerance Rules for Voucher Match Automation.....	6-30
6.10	Setting Up Order Hold Information.....	6-31
6.10.1	Understanding Order Hold Information	6-31
6.10.2	Prerequisite	6-31
6.10.3	Forms Used to Set Up Order Hold Information	6-31
6.10.4	Entering Order Hold Information.....	6-32
6.11	Setting Up Landed Costs	6-33
6.11.1	Understanding Landed Costs	6-33
6.11.2	Prerequisites	6-33
6.11.3	Forms Used to Set Up Landed Costs	6-34
6.11.4	Setting Up Landed Costs	6-34
6.12	Setting Up Nonstock Items.....	6-35
6.12.1	Understanding Nonstock Items.....	6-35
6.12.2	Form Used to Set Up Nonstock Items	6-36
6.12.3	Setting Processing Options for Non Stock Item Master (P4101N)	6-36
6.12.3.1	Defaults	6-36
6.12.3.2	Process.....	6-36
6.12.3.3	Versions.....	6-36
6.12.4	Setting Up Nonstock Items.....	6-37
6.13	Defining Print Messages	6-38
6.13.1	Understanding Print Messages.....	6-38
6.13.2	Forms Used to Define Print Messages	6-38
6.14	Setting Up Templates for Purchase Orders.....	6-39
6.14.1	Understanding Purchase Order Templates	6-39
6.14.2	Prerequisites	6-40
6.14.3	Forms Used to Set Up Templates for Purchase Orders.....	6-40
6.14.4	Setting Processing Options for Order Template Revisions (P4015)	6-40
6.14.4.1	Display	6-40
6.14.4.2	Versions.....	6-41
6.14.5	Creating a Purchase Order Supplier Template	6-41
6.14.6	Creating a Purchase Order User Template	6-42

6.14.7	Revising a Template in Batch Mode	6-42
6.14.8	Setting Processing Options for Supplier History Template Rebuild (R43815)	6-42
6.14.8.1	Default	6-42
6.14.8.2	Process	6-42
6.15	Creating Model Logs	6-43
6.15.1	Understanding Model Logs	6-43
6.15.2	Prerequisite	6-43
6.15.3	Form Used to Create Model Logs	6-44
6.15.4	Creating a Model Log	6-44
6.16	Setting Up Hierarchical Logs	6-45
6.16.1	Understanding Hierarchical Logs	6-45
6.16.2	Forms Used to Set Up Hierarchical Logs	6-46
6.16.3	Setting Up Log Hierarchy Levels	6-46
6.16.4	Activating Log Functionality	6-46
6.16.5	Setting Up Log View Options	6-46

7 Setting Up Supplier Information

7.1	Setting Up Supplier and Item Information	7-1
7.1.1	Understanding Supplier and Item Information Setup	7-1
7.1.1.1	Supplier Purchasing Instructions	7-2
7.1.1.2	Voucher Match Automation Setup for Suppliers (Release 9.1 Update)	7-2
7.1.1.3	Managing Supplier/Item Relationships	7-4
7.1.1.4	Monitoring Supplier Delivery Performance	7-5
7.1.1.5	Monitoring Supplier Quality	7-5
7.1.1.6	Defining a Summary of Supplier Performance Information	7-5
7.1.2	Prerequisites	7-6
7.1.3	Forms Used to Set Up Supplier and Item Information	7-6
7.1.4	Setting Processing Options for Supplier Master (P04012)	7-8
7.1.4.1	Entry	7-8
7.1.4.2	Defaults	7-8
7.1.4.3	Versions	7-8
7.1.5	Defining Supplier Purchasing Instructions	7-8
7.1.5.1	Purchasing 1	7-8
7.1.5.2	Purchasing 2	7-9
7.1.6	Setting Processing Options for Supplier/Item Relationships (P43090)	7-12
7.1.6.1	Process	7-12
7.1.6.2	Versions	7-12
7.1.7	Creating Supplier and Item Relationships	7-12
7.1.8	Setting Up Guidelines for Delivery Performance	7-13
7.1.9	Setting Processing Options for Supplier Analysis Summary (P43230)	7-14
7.1.9.1	Display	7-14
7.1.10	Setting Up Guidelines for Acceptable Items	7-15
7.1.11	Defining a Summary of Supplier Performance Information	7-15
7.1.12	Defining a Supplier Hyperlink (Release 9.1 Update)	7-16
7.2	Defining Supplier Prices and Discount Rules	7-17
7.2.1	Understanding Supplier Prices and Discount Rules	7-17
7.2.1.1	Defining Supplier Prices and Catalogs	7-17

7.2.1.2	Price Rules and Discounts	7-18
7.2.1.3	Attaching Price Discount Rules to Items and Suppliers	7-19
7.2.2	Prerequisites	7-19
7.2.3	Forms Used to Define Supplier Prices and Discount Rules	7-20
7.2.4	Setting Processing Options for Supplier Catalog Maintenance (P41061)	7-20
7.2.4.1	Defaults	7-20
7.2.5	Entering Supplier Prices	7-21
7.2.6	Creating Price Discount Rules for Purchasing	7-21
7.2.7	Attaching Price Discount Rules to Items and Suppliers	7-23

8 Setting Up Rebates

8.1	Understanding Setup for Rebates	8-1
8.2	Entering Basic Rebate Agreement Information	8-2
8.2.1	Understanding Basic Rebate Agreement Information	8-2
8.2.2	Prerequisite	8-2
8.2.3	Form Used to Enter Basic Rebate Agreement Information	8-3
8.2.4	Entering Basic Rebate Agreement Information	8-3
8.3	Defining Conditions for Obtaining a Rebate	8-3
8.3.1	Understanding Rebate Conditions	8-4
8.3.2	Prerequisite	8-4
8.3.3	Form Used to Define Conditions for Obtaining a Rebate	8-5
8.4	Defining Purchase Limits for Rebate Amounts	8-5
8.4.1	Understanding Purchase Limits	8-5
8.4.2	Form Used to Define Purchase Limits for Rebate Amounts	8-6
8.4.3	Setting Processing Options for Purchase Agreements Maintenance (P4340)	8-6
8.4.3.1	Display	8-6
8.4.4	Defining Purchase Limits for Rebate Amounts	8-6

9 Setting Up Purchase Order Commitments

9.1	Setting Up Commitment Tracking	9-1
9.1.1	Understanding Commitment Tracking	9-1
9.1.2	Forms Used to Set Up Commitment Tracking	9-2
9.1.3	Setting Up Commitments	9-3
9.1.4	Setting Up Commitment Relief	9-3

10 Entering Purchase Orders

10.1	Understanding Purchase Order Entry	10-1
10.1.1	Supplier Classification Codes	10-2
10.1.2	Additional Properties and Category Codes	10-2
10.1.3	Purchase Order Clauses	10-3
10.1.4	Retention	10-3
10.2	Setting Processing Options for Purchase Orders (P4310)	10-4
10.2.1	Defaults	10-4
10.2.2	Display	10-6
10.2.3	Interfaces	10-9
10.2.4	Processing	10-11

10.2.5	Duplication	10-12
10.2.6	Cross Ref	10-13
10.2.7	Order Inquiry	10-14
10.2.8	Versions.....	10-14
10.2.9	Currency.....	10-16
10.2.10	Approvals	10-16
10.2.11	Budgeting.....	10-17
10.2.12	Interop	10-19
10.2.13	Order Revision	10-19
10.2.14	Self-Service.....	10-20
10.2.15	Product Variants	10-20
10.2.16	Workflow	10-20
10.2.17	Transfer Order.....	10-22
10.2.18	Style.....	10-22
10.3	Entering Order Header Information.....	10-23
10.3.1	Understanding Order Header Information Entry	10-23
10.3.1.1	Header Information for International Orders	10-24
10.3.1.2	Supplier Information.....	10-24
10.3.1.3	Information for a Specific Branch/Plant.....	10-25
10.3.1.4	Delivery and Shipping Instructions.....	10-25
10.3.1.5	Taxes on Orders	10-25
10.3.1.6	Alternate Tax Rate/ Area Assignment Functionality for Purchase Order Headers (Release 9.1 Update) 10-26	
10.3.1.7	Approval Processing.....	10-26
10.3.1.8	Advanced Pricing Information.....	10-26
10.3.1.9	Additional Order Header Information.....	10-27
10.3.2	Prerequisite	10-27
10.3.3	Forms Used to Enter Order Header Information.....	10-27
10.3.4	Using Real-Time Summarization in the Purchase Orders Program (P4310)	10-28
10.3.5	Entering Order Header Information.....	10-29
10.3.5.1	Order Header	10-29
10.3.5.2	Additional Properties.....	10-31
10.3.5.3	Category Codes.....	10-31
10.3.6	Entering Additional Order Header Information.....	10-32
10.3.6.1	Additional Information	10-32
10.3.6.2	Supplier Classification Codes	10-33
10.4	Entering Order Detail Information.....	10-34
10.4.1	Understanding Order Detail Information Entry	10-34
10.4.1.1	Detail Lines by Account Number.....	10-36
10.4.1.2	Multiple Account Distribution	10-36
10.4.1.3	Shipment Information.....	10-37
10.4.1.4	Tax Information for a Detail Line.....	10-37
10.4.1.5	Alternate Tax Rate/ Area Assignment Functionality in Purchase Order Detail Lines (Release 9.1 Update) 10-38	
10.4.1.6	Discount Terms for a Detail Line	10-38
10.4.1.7	Reporting Codes for a Detail Line.....	10-39
10.4.1.8	Change Orders	10-39

10.4.1.9	Substitute or Replacement Items.....	10-39
10.4.1.10	Kit Orders	10-39
10.4.1.11	Service Units for A/P Matching.....	10-40
10.4.2	Prerequisites	10-41
10.4.3	Forms Used to Enter Order Detail Information	10-41
10.4.4	Entering Detail Lines by Item Number	10-42
10.4.5	Entering Detail Lines by Account Number	10-45
10.4.5.1	Line Defaults	10-45
10.4.6	Entering Multiple Account Distributions	10-46
10.4.7	Entering Tax Information for a Detail Line.....	10-47
10.4.8	Entering Discount Terms for a Detail Line	10-47
10.4.9	Entering Reporting Codes for a Detail Line.....	10-48
10.4.10	Entering Change Orders	10-48
10.4.11	Entering Substitute or Replacement Items.....	10-48
10.4.12	Entering Kit Orders	10-48
10.4.13	Copying Change Orders.....	10-48

11 Working with Purchase Orders

11.1	Working with Special Order-Entry Features	11-1
11.1.1	Understanding Special Order-Entry Features	11-1
11.1.1.1	Order Duplication	11-1
11.1.1.2	Orders for Multiple Suppliers	11-2
11.1.1.3	Choice of Suppliers.....	11-2
11.1.1.4	Supplier Catalogs.....	11-3
11.1.1.5	Order Templates	11-3
11.1.1.6	Creation of Orders from Existing Detail Lines.....	11-3
11.1.1.7	Supplier Classification Codes	11-4
11.1.1.8	Additional Properties and Category Codes	11-4
11.1.1.9	Service Units for A/P Matching.....	11-4
11.1.1.10	Alternate Tax Rate/Area Assignment Functionality in the Purchase Order Workbench Program (Release 9.1 Update) 11-5	
11.1.2	Forms Used to Work with Special Order-Entry Features.....	11-5
11.1.3	Duplicating an Order	11-6
11.1.4	Setting Processing Options for Purchase Order Workbench (P43101)	11-7
11.1.4.1	Defaults	11-7
11.1.4.2	Display	11-9
11.1.4.3	Interfaces	11-12
11.1.4.4	Processing	11-13
11.1.4.5	Duplication	11-15
11.1.4.6	Cross Ref	11-16
11.1.4.7	Order Inquiry	11-16
11.1.4.8	Versions.....	11-17
11.1.4.9	Currency	11-18
11.1.4.10	Approvals	11-19
11.1.4.11	Budgeting.....	11-19
11.1.4.12	Interop	11-21
11.1.4.13	Order Revision	11-22

11.1.4.14	Self-Service.....	11-22
11.1.4.15	Matrix	11-23
11.1.4.16	Workflow	11-23
11.1.4.17	Transfer Order.....	11-24
11.1.5	Entering Orders for Multiple Suppliers	11-24
11.1.6	Selecting a Supplier for an Item.....	11-24
11.1.7	Entering Items Using Supplier Catalogs	11-24
11.1.8	Entering Items Using Order Templates.....	11-25
11.1.9	Creating Orders from Existing Detail Lines	11-25
11.2	Working with Budgets	11-25
11.2.1	Understanding Budget Checking.....	11-25
11.2.1.1	Search Scenarios for Level of Detail.....	11-26
11.2.1.2	Budget Amount Accumulation (Release 9.1 Update)	11-26
11.2.1.3	Example: Calculating the Budget Checking Account (Release 9.1 Update)...	11-26
11.2.1.4	Actual and Committed Amount Accumulation (Release 9.1 Update)	11-27
11.2.1.5	Budget Totaling	11-28
11.2.1.6	Budget Review	11-29
11.2.2	Prerequisite	11-29
11.2.3	Form Used to Work with Budgets.....	11-29
11.2.4	Reviewing a Budget.....	11-30
11.3	Working with Orders on Hold.....	11-30
11.3.1	Understanding Orders on Hold	11-31
11.3.2	Prerequisite	11-31
11.3.3	Form Used to Work with Orders on Hold	11-31
11.3.4	Entering Order Holds	11-31
11.3.5	Setting Processing Options for Held Order Release (P43070).....	11-32
11.3.5.1	Defaults	11-32
11.3.5.2	Display	11-32
11.3.5.3	Versions.....	11-32
11.3.5.4	Process.....	11-33
11.3.5.5	Warehouse	11-33
11.3.5.6	Prepayment	11-34
11.3.6	Releasing Order Holds.....	11-34
11.4	Working with Log Information	11-34
11.4.1	Understanding Log Information	11-34
11.4.2	Prerequisites	11-35
11.4.3	Forms Used to Work with Log Information	11-36
11.4.4	Setting Processing Options for Logs Entry (P4305).....	11-36
11.4.4.1	Default.....	11-36
11.4.4.2	Versions.....	11-37
11.4.5	Entering Log Information.....	11-37
11.4.6	Running the Log Report/Update.....	11-37
11.4.7	Setting Processing Options for Log Report/Update (R43300).....	11-38
11.4.7.1	Print Options	11-38
11.4.8	Copying Information from a Model Log.....	11-38
11.5	Printing Orders by Batch	11-38
11.5.1	Understanding Batch Printing	11-38

11.5.1.1	Supplier Classification Codes	11-39
11.5.1.2	Additional Properties and Category Codes	11-40
11.5.1.3	Purchase Order Clauses.....	11-40
11.5.1.4	Record Reservation (Release 9.1 Update)	11-40
11.5.2	Printing by Batch	11-40
11.5.3	Setting Processing Options for Purchase Order Print (R43500).....	11-41
11.5.3.1	Status Codes	11-41
11.5.3.2	Tax Information	11-41
11.5.3.3	Report Display	11-42
11.5.3.4	Item Number Display	11-43
11.5.3.5	Order Revision	11-43
11.5.3.6	Currency	11-44
11.5.3.7	EDI	11-44
11.5.3.8	Versions.....	11-45
11.5.3.9	Project and Gov Contracting.....	11-46
11.5.4	Setting Processing Options for Purchase Order Print Output (R43501).....	11-46
11.5.4.1	Report Display	11-46
11.6	Printing Orders Individually	11-47
11.6.1	Understanding Individual Order Printing.....	11-47
11.6.2	Forms Used to Print Orders Individually	11-48
11.6.3	Printing on Demand Interactively.....	11-48
11.7	Working with Order Information.....	11-49
11.7.1	Understanding Order-Related Tasks.....	11-49
11.7.1.1	Open-Order Review	11-49
11.7.1.2	As-If Currency Review	11-49
11.7.1.3	Change Order Review.....	11-50
11.7.1.4	Summary and Detail Information Review.....	11-50
11.7.1.5	Financial Status Review	11-50
11.7.2	Forms Used to Work with Order Information	11-50
11.7.3	Reviewing Financial Status Information	11-51
11.7.4	Printing Order Detail Information	11-53
11.7.5	Setting Processing Options for Order Detail Print (R4401P).....	11-53
11.7.5.1	Display	11-53

12 Using Receipt Processing

12.1	Understanding the Receiving Process	12-1
12.1.1	Informal Receiving Process	12-1
12.1.2	Formal Receiving Process.....	12-2
12.2	Printing Purchase Receivers	12-2
12.2.1	Understanding Purchase Receivers	12-2
12.2.2	Setting Processing Options for Purchase Receiver Print (R43510)	12-3
12.2.2.1	Edits	12-3
12.2.2.2	Print (Release 9.1 Update)	12-3
12.2.2.3	Currency	12-4
12.2.3	Printing Receivers in Batch Mode	12-4
12.2.4	Printing Receivers for Individual Orders.....	12-4
12.3	Entering Receipts	12-4

12.3.1	Understanding Receipt Information.....	12-4
12.3.1.1	Entering Receipt Information	12-5
12.3.1.2	Reviewing Foreign and Domestic Currency	12-6
12.3.1.3	Adjusting Purchase Order Detail Lines	12-7
12.3.1.4	Receiving Matrix Items	12-7
12.3.1.5	Pricing and Repricing at Receipts	12-7
12.3.1.6	Service Units for A/P Matching.....	12-7
12.3.1.7	Record Reservation (Release 9.1 Update)	12-8
12.3.2	Prerequisite	12-8
12.3.3	Forms Used to Enter Receipts	12-9
12.3.4	Setting Processing Options for PO Receipts (P4312)	12-9
12.3.4.1	Defaults	12-9
12.3.4.2	Status Default	12-10
12.3.4.3	Display	12-10
12.3.4.4	Process.....	12-11
12.3.4.5	Tolerance.....	12-15
12.3.4.6	Warehousing	12-16
12.3.4.7	Currency	12-17
12.3.4.8	Versions.....	12-17
12.3.4.9	Flex Acct.....	12-18
12.3.4.10	Bulk.....	12-18
12.3.4.11	Interop	12-19
12.3.4.12	Workflow	12-19
12.3.4.13	Cross Docking.....	12-20
12.3.4.14	Cascade Receipt	12-20
12.3.4.15	WIM.....	12-21
12.3.4.16	Matrix	12-21
12.3.4.17	Configurator	12-22
12.3.5	Entering Receipt Information.....	12-23
12.4	Entering Cascading Receipts.....	12-23
12.4.1	Understanding Cascading Receipts	12-23
12.4.1.1	Entering Cascading Receipt Information.....	12-23
12.4.1.2	Assigning Items to Multiple Locations and Lots	12-24
12.4.1.3	Assigning Serial Numbers.....	12-24
12.4.1.4	Reversing a Receipt	12-24
12.4.1.5	Service Units for A/P Matching.....	12-24
12.4.1.6	Record Reservation (Release 9.1 Update)	12-25
12.4.1.7	Transaction Processing (Release 9.1 Update).....	12-25
12.4.2	Prerequisites	12-25
12.4.3	Forms Used to Enter Cascading Receipts.....	12-26
12.4.4	Entering Cascading Receipt Information	12-26
12.4.5	Assigning Items to Multiple Locations and Lots	12-26
12.4.6	Assigning Serial Numbers.....	12-27
12.4.7	Setting Processing Options for Purchase Receipts Inquiry (P43214)	12-27
12.4.7.1	Defaults	12-27
12.4.7.2	Display	12-27
12.4.7.3	Versions.....	12-27

12.4.7.4	Process.....	12-28
12.4.7.5	Landed Cost	12-29
12.4.7.6	Self-Service.....	12-29
12.4.8	Reversing a Receipt	12-30
12.5	Reviewing Journal Entries for Receipt Transactions	12-30
12.5.1	Understanding Journal Entry Review for Receipt Transactions.....	12-30
12.5.2	Reviewing Journal Entries for Receipt Transactions	12-31
12.5.3	Posting Receipts	12-31
12.6	Printing Receipt Information.....	12-31
12.6.1	Understanding Receipt Information Printouts.....	12-31
12.6.2	Printing Open Orders.....	12-32
12.6.3	Printing the Status of Open Orders.....	12-32
12.6.4	Setting Processing Options for Open Purchase Order Status (R43525).....	12-32
12.6.4.1	Print	12-32
12.6.5	Printing Receipt Information by Supplier	12-32

13 Creating Vouchers

13.1	Understanding Voucher Creation	13-1
13.1.1	Prerequisite.....	13-1
13.1.2	Voucher Creation.....	13-1
13.2	Reviewing Open Receipts.....	13-2
13.2.1	Understanding Open-Receipts Review	13-2
13.2.2	Form Used to Review Open Receipts	13-3
13.2.3	Reviewing Open Receipts.....	13-3
13.3	Entering Landed Costs.....	13-3
13.3.1	Understanding Landed Cost Entry During the Receipt Process	13-3
13.3.1.1	Record Reservation (Release 9.1 Update)	13-4
13.3.2	Understanding Landed Cost Entry as a Stand-Alone Process.....	13-4
13.3.3	Prerequisites	13-5
13.3.4	Form Used to Enter Landed Costs	13-5
13.3.5	Setting Processing Options for Landed Cost Selection (P43291)	13-5
13.3.5.1	Flex Account.....	13-5
13.3.5.2	Process.....	13-5
13.3.6	Entering Landed Costs.....	13-6
13.4	Creating Vouchers	13-6
13.4.1	Understanding Voucher Creation	13-6
13.4.1.1	Alternate Tax Rate/ Area Assignment Functionality in the Voucher Match Program (Release 9.1 Update) 13-10	
13.4.1.2	Supplier Classification Codes	13-10
13.4.1.3	Retention	13-11
13.4.1.4	Expense at Voucher Match.....	13-11
13.4.1.5	Service Units for A/P Matching.....	13-12
13.4.1.6	Freight Vouchering.....	13-12
13.4.2	Understanding Management of Invoices Received in an Alternate Currency.....	13-14
13.4.3	Prerequisites	13-14
13.4.4	Forms Used to Create Vouchers	13-14
13.4.5	Setting Processing Options for A/P Standard Voucher Entry (P0411)	13-15

13.4.5.1	Display	13-15
13.4.5.2	Currency	13-16
13.4.5.3	Manual Payments	13-17
13.4.5.4	Purchasing	13-17
13.4.5.5	Voucher Match.....	13-17
13.4.5.6	Multi Company.....	13-18
13.4.5.7	Multi Vouchers	13-18
13.4.5.8	Logging	13-19
13.4.5.9	Prepayments.....	13-20
13.4.5.10	Versions.....	13-21
13.4.5.11	Process.....	13-22
13.4.5.12	Edits	13-22
13.4.5.13	Pay When Paid.....	13-23
13.4.6	Setting Processing Options for Voucher Match (P4314)	13-23
13.4.6.1	Defaults	13-23
13.4.6.2	Display	13-24
13.4.6.3	Process.....	13-25
13.4.6.4	Summarization.....	13-27
13.4.6.5	New Order Line	13-27
13.4.6.6	Retainage.....	13-28
13.4.6.7	Logs.....	13-29
13.4.6.8	Currency	13-29
13.4.6.9	Flex Accounts	13-29
13.4.6.10	Versions.....	13-30
13.4.6.11	Workflow	13-30
13.4.6.12	Progress Payment.....	13-31
13.4.6.13	Redistribution.....	13-32
13.4.6.14	Freight Distribution.....	13-32
13.4.7	Setting Processing Options for Freight Distribution (P43147)	13-32
13.4.7.1	Display	13-32
13.4.7.2	Process.....	13-33
13.4.8	Selecting Receipt Records to Match to a Voucher.....	13-33
13.4.9	Selecting Order Detail Lines to Match to a Voucher	13-33
13.4.10	Selecting Order Detail Lines for Freight Charges	13-34
13.4.11	Selecting Order Detail Lines for Freight Vouchering.....	13-34
13.4.12	Recording Cost Changes to an Invoice.....	13-35
13.5	Working with Retainage	13-36
13.5.1	Understanding Retainage.....	13-36
13.5.1.1	Retention	13-37
13.5.2	Prerequisites	13-41
13.5.3	Forms Used to Work with Retainage.....	13-41
13.5.4	Entering a Voucher with Retainage	13-41
13.5.5	Entering a Voucher to Release Retainage.....	13-42
13.6	Creating Multiple Vouchers from Receipt Records.....	13-42
13.6.1	Understanding Creation of Multiple Vouchers from Receipt Records	13-42
13.6.1.1	Journal Entries for Voucher Transactions	13-43
13.6.1.2	Variance Accounts.....	13-43

13.6.2	Creating Multiple Vouchers from Receipt Records.....	13-44
13.6.3	Setting Processing Options for Evaluated Receipt Settlement (R43800)	13-44
13.6.3.1	Versions.....	13-44
13.6.3.2	Processing	13-44
13.6.4	Reviewing and Posting Journal Entries for Voucher Transactions	13-45
13.6.5	Verifying the Voucher Amounts Balance.....	13-45
13.6.6	Setting Processing Options for Voucher Journal Report (R04305)	13-45
13.6.6.1	Print Options	13-46
13.7	Logging Invoices Before Receiving Goods.....	13-46
13.7.1	Understanding Invoice Logging.....	13-46
13.7.2	Forms Used to Log Invoices Before Receiving Goods.....	13-47
13.7.3	Logging Invoices to Create Preliminary Vouchers.....	13-47
13.7.4	Creating a Permanent Voucher from a Preliminary Voucher.....	13-47
13.7.5	Printing Logged Invoice Information	13-47
13.7.6	Setting Processing Options for Logged Voucher Detail (R43428)	13-48
13.7.6.1	Display	13-48
13.8	Printing Voucher Information.....	13-48
13.8.1	Printing Voucher Information by Detail Line	13-48
13.8.2	Setting Processing Options for Received/Vouchered Status Report (R43412)	13-48
13.8.2.1	Display	13-49
13.8.3	Printing Open Voucher Information by Receipt	13-49
13.8.4	Printing Voucher Amounts for Suppliers	13-49
13.8.5	Setting Processing Options for Supplier Analysis Report (R04602).....	13-49
13.8.5.1	Currency	13-50

14 Understanding the Voucher Match Automation Process (Release 9.1 Update)

14.1	Common Terms.....	14-1
14.2	Understanding the Voucher Match Automation Process	14-4
14.2.1	Voucher Match Automation EnterpriseOne Page (Release 9.1 Update)	14-5
14.2.2	Business Process Flows	14-5
14.2.3	Voucher Match Automation Process Flow	14-8
14.2.4	Populate the Voucher Transaction - Batch Upload Table (F0411Z1)	14-10
14.2.5	Populate the Voucher Transaction Batch Upload - Voucher Match Automation Table (F0411Z1T)	14-12
14.2.6	Automation Rules.....	14-13
14.2.6.1	Exact Match of Invoice Line to Purchase Order Line to Receipt Line (Automation Rule 01)	14-15
14.2.6.2	Match of Invoice Line to Receipt Line, Standard Tolerance Applied (Automation Rule 02)	14-15
14.2.6.3	Match of Invoice Line to Purchase Order Line to Multiple Receipt Lines, Standard Tolerance Applied (Automation Rule 03)	14-16
14.2.6.4	Exact Match of Invoice Line to Receipt Line (Automation Rule 04)	14-18
14.2.6.5	Match of Invoice Line to Purchase Order Line to Multiple Receipt Lines, Rounding Tolerance Applied (Automation Rule 05)	14-19
14.2.6.6	Exact Match of Invoice to Multiple Receipt Lines across Multiple Purchase Orders (Automation Rule 06)	14-21
14.2.7	Suggestion Processing (Release 9.1 Update).....	14-21
14.2.8	Partial Receipts for VMA Process (Release 9.1 Update).....	14-22

14.2.9	Single Voucher Per Invoice for VMA Process (Release 9.1 Update)	14-23
14.2.10	Create and Match Standard Vouchers.....	14-24
14.2.11	Create and Match Logged Vouchers.....	14-28
14.2.12	Setup for Voucher Match Automation (Release 9.1 Update)	14-31
14.2.13	Troubleshooting the Voucher Match Automation Process	14-34
14.3	Understanding Validations and Requirements for Matching	14-35
14.3.1	Validation of Records in the Voucher Transactions - Batch Upload Table (F0411Z1)	14-36
14.3.2	Record Selection from the F0411Z1 Table	14-37
14.3.3	Validation of Records in the Purchase Order Receiver File (F43121)	14-37
14.3.4	Validation of Records in the Purchase Order Detail Table (P4311) (Release 9.1 Update)	14-37
14.4	Understanding Batch Voucher Processing for the Voucher Match Automation Process	14-38
14.4.1	Adding and Modifying Records for the Voucher Match Automation Process (Release 9.1 Update)	14-38

15 Using the Voucher Match Automation Process (Release 9.1 Update)

15.1	Understanding Proof, Final and Suggest Modes	15-1
15.1.1	Effect of Processing Options on Process Output.....	15-2
15.2	Setting Processing Options for the Voucher Match Automation Process	15-8
15.2.1	Understanding Processing Options for the Voucher Match Automation Process	15-9
15.2.1.1	Setting Processing Options for Voucher Match (P4314)	15-10
15.2.1.2	Setting Processing Options for Batch Voucher Processor Report (R04110ZA)	15-12
15.2.2	Setting Processing Options for Voucher Match Automation Driver (R4304010)..	15-13
15.2.2.1	Versions.....	15-13
15.2.2.2	Logged Voucher.....	15-13
15.2.2.3	Process (Release 9.1 Update).....	15-13
15.2.3	Setting Processing Options for Voucher Match Automation UBE for Automation Rule 01 (R4304016) and Voucher Match Automation UBE for Automation Rule 06 (R4304021)	15-14
15.2.3.1	Defaults	15-14
15.2.3.2	Process.....	15-15
15.2.3.3	Line Types.....	15-16
15.2.3.4	Versions.....	15-16
15.2.3.5	Print	15-16
15.2.4	Setting Processing Options for Voucher Match Automation UBE for Automation Rule 02, 03, 04, 05 (R4304020)	15-17
15.2.4.1	Defaults	15-17
15.2.4.2	Process (Release 9.1 Update).....	15-19
15.2.4.3	Line Types.....	15-20
15.2.4.4	Versions.....	15-20
15.2.4.5	Print	15-20
15.3	Running the Voucher Match Automation Process	15-20
15.4	Using the Voucher Match Process Workbench	15-21
15.4.1	Understanding the Voucher Match Process Workbench.....	15-21
15.4.1.1	Create Single Voucher for an Invoice (Release 9.1 Update).....	15-22

15.4.1.2	Create Suggestions and Matches.....	15-23
15.4.1.3	Invoice Match Status	15-23
15.4.1.4	Search Function.....	15-24
15.4.1.5	Selected Invoices Subform.....	15-25
15.4.1.6	Invoice Details Subform (Release 9.1 Update)	15-28
15.4.1.7	Suggestion/Receipt Details Subform	15-28
15.4.1.8	Select Receipts Subform.....	15-32
15.4.1.9	Vouchers Details Subform.....	15-33
15.4.1.10	GL Distribution Subform.....	15-33
15.4.2	Forms Used to Manage Suggested Matches	15-33
15.4.3	Setting Processing Options for Voucher Match Process Workbench (P4314WB) .	15-33
15.4.3.1	Defaults	15-33
15.4.3.2	Line Types.....	15-34
15.4.3.3	Versions.....	15-34
15.4.4	Reviewing, Approving, and Processing a Suggestion	15-34
15.4.5	Clearing Suggestions and Creating New Suggestions.....	15-37
15.4.6	Matching an Unprocessed Record to Receipts	15-39
15.4.7	Replacing a Suggested Receipt Line with a Different Receipt Line	15-43
15.4.8	Returning an Invoice Line to Unprocessed Status	15-44
15.4.8.1	Method 1: No Review	15-44
15.4.8.2	Method 2: Review before Returning to Unprocessed	15-45
15.5	Purging Matched VMA Records From the F0411Z1 and F0411Z1T Tables.....	15-47
15.5.1	Understanding Methods to Purge Matched VMA Records from the F0411Z1 and F0411Z1T Tables	15-47
15.5.2	Purging Matched Records from the F0411Z1 and F0411Z1T Tables	15-48

16 Processing Special Orders

16.1	Understanding Special Order Processing	16-1
16.1.1	Supplier Classification Codes	16-2
16.1.2	Additional Properties and Category Codes.....	16-2
16.2	Working with Requisitions.....	16-3
16.2.1	Understanding Requisitions	16-3
16.2.2	Understanding Requisition Detail Lines	16-4
16.2.3	Prerequisites	16-4
16.2.4	Forms Used to Work with Requisitions	16-5
16.2.5	Setting Processing Options for Generate POs from Requisitions/Blanket Order Release (P43060)	16-5
16.2.5.1	Defaults	16-5
16.2.5.2	Display	16-6
16.2.5.3	Process.....	16-6
16.2.5.4	Versions.....	16-7
16.3	Working with Blanket Orders.....	16-8
16.3.1	Understanding Blanket Orders.....	16-8
16.3.1.1	Alternate Tax Rate/Area Assignment Functionality for Blanket Order Releases (Release 9.1 Update)	16-9
16.3.2	Forms Used to Work with Blanket Orders.....	16-9
16.4	Working with Quote Orders	16-10

16.4.1	Understanding Quote Orders	16-10
16.4.1.1	Item Entry	16-10
16.4.1.2	Supplier Entry	16-10
16.4.1.3	Quote Order Creation from Requisitions.....	16-11
16.4.1.4	Print Requests for Quote Orders	16-11
16.4.1.5	Supplier Price Quotes Entry.....	16-12
16.4.2	Forms Used to Work with Quote Orders	16-12
16.4.3	Printing Requests for Quote Orders	16-13
16.4.4	Setting Processing Options for Request For Quote Report (R43530)	16-13
16.4.4.1	Report Display	16-13
16.4.4.2	Item Number	16-13
16.4.5	Setting Processing Options for Quote Response Entry (P4334)	16-13
16.4.5.1	Default.....	16-14
16.4.5.2	Self-Service.....	16-14
16.5	Creating Orders from Price Quotes.....	16-14
16.5.1	Understanding Creation of Orders from Price Quotes	16-14
16.5.2	Forms Used to Create Orders from Price Quotes	16-15
16.5.3	Setting Processing Options for Quote Order Release (P43360).....	16-15
16.5.3.1	Defaults	16-15
16.5.3.2	Display	16-16
16.5.3.3	Process.....	16-16
16.5.3.4	Versions.....	16-16
16.5.4	Creating an Order from a Price Quote	16-17
16.6	Working with Order Revisions	16-17
16.6.1	Understanding Order Revisions.....	16-18
16.6.2	Forms Used to Work with Order Revisions.....	16-19
16.6.3	Creating Order Revisions	16-19
16.6.4	Setting Processing Options for PO/Change Order Summary (P4319)	16-19
16.6.4.1	Defaults	16-19
16.6.4.2	Versions.....	16-20
16.6.5	Reviewing Order Revision Information	16-20
16.6.6	Printing Order Revision Information	16-21
16.6.7	Setting Processing Options for Order Revisions History Report (R43535)	16-21
16.6.7.1	Display	16-21
16.7	Generating Purchase Orders	16-22
16.7.1	Understanding Purchase Order Generation.....	16-22
16.7.1.1	Calculations for Order Quantities.....	16-22
16.7.2	Prerequisites	16-23
16.7.3	Forms Used to Generate Purchase Orders.....	16-23
16.7.4	Setting Processing Options for PO Generator (P43011)	16-24
16.7.4.1	Display	16-24
16.7.4.2	Process.....	16-25
16.7.4.3	Cross Ref	16-27
16.7.4.4	Sales Select	16-27
16.7.4.5	Versions.....	16-28
16.7.5	Generating Purchase Orders	16-28
16.8	Working with the Stocked Item Reorder Point Batch Purchase Order Generator	16-29

16.8.1	Understanding the Stocked Item Reorder Point Batch Purchase Order Generator Program (R437002) 16-29	
16.8.2	Understanding the Suggested Reorder Stock Items Program (P4371)	16-30
16.8.3	Forms Used to Work with the Stocked Item Reorder Point Batch Purchase Order Generator 16-30	
16.8.4	Running Stocked Item Reorder Point Batch Purchase Order Generator.....	16-30
16.8.5	Setting Processing Options for Stocked Item Reorder Point Batch Purchase Order Generator (R437002) 16-31	
16.8.5.1	Display	16-31
16.8.5.2	Process.....	16-31
16.8.5.3	Blankets.....	16-32
16.8.5.4	Versions.....	16-33
16.8.6	Setting Processing Options for Suggested Reorder Stock Items (P4371).....	16-33
16.8.6.1	Default.....	16-33
16.8.6.2	Versions.....	16-33
16.8.7	Working with Suggestions for Reordering Items	16-34

17 Processing Approvals

17.1	Understanding Approval Processing.....	17-1
17.1.1	Mobile Applications for Approving Purchase Orders (Release 9.1 Update).....	17-2
17.2	Working with Approval Routes	17-2
17.2.1	Understanding Approval Routes	17-2
17.2.1.1	Approval Route Creation	17-2
17.2.1.2	Approval Route Assignment	17-3
17.2.1.3	Transfer of Authority	17-4
17.2.2	Prerequisites	17-4
17.2.3	Forms Used to Work with Approval Routes	17-4
17.2.4	Setting Processing Options for Approval Level Revisions (P43008).....	17-5
17.2.4.1	Defaults	17-5
17.2.5	Creating an Approval Route	17-5
17.2.6	Transferring Approval Authority	17-5
17.3	Working with Orders Awaiting Approval.....	17-6
17.3.1	Understanding Approval Messages and Orders Awaiting Approval	17-6
17.3.1.1	Approval Messages for Orders.....	17-6
17.3.1.2	Orders Awaiting Approval.....	17-7
17.3.2	Forms Used to Work with Orders Awaiting Approval	17-7
17.3.3	Reviewing Approval Messages for Orders.....	17-8
17.3.4	Setting Processing Options for Purchase Order Approvals (P43081).....	17-8
17.3.4.1	Process.....	17-8
17.3.4.2	Defaults	17-8
17.3.4.3	Versions.....	17-9
17.3.5	Reviewing Orders Awaiting Approval	17-9
17.4	Approving or Rejecting Orders	17-10
17.4.1	Understanding Order Approval and Rejection.....	17-10
17.4.2	Prerequisite.....	17-11
17.4.3	Forms Used to Approve or Reject Orders	17-11
17.5	Setting Up Field Constants for Approval Processing.....	17-11

17.5.1	Understanding Field Constants for Approval Processing.....	17-11
17.5.2	Prerequisite	17-12
17.5.3	Form Used to Set Up Field Constants for Approval Processing	17-12
17.5.4	Setting Up Field Constants for Approval Processing.....	17-12

18 Routing Receipts

18.1	Understanding Receipt Routing	18-1
18.2	Creating Receipt Routes.....	18-2
18.2.1	Understanding Definition of Operations	18-2
18.2.2	Understanding Journal Entry Creation for Items in Receipt Routes	18-3
18.2.3	Prerequisites	18-4
18.2.4	Forms Used to Create Receipt Routes.....	18-5
18.2.5	Creating a Receipt Route	18-5
18.3	Defining Payment Eligibility for Item Removal.....	18-6
18.3.1	Understanding Item Removal.....	18-6
18.3.2	Forms Used to Define Payment Eligibility for Item Removal.....	18-6
18.4	Activating Receipt Routing	18-7
18.4.1	Understanding Receipt Routing Activation	18-7
18.4.2	Prerequisite	18-7
18.4.3	Forms Used to Activate Receipt Routing	18-8
18.4.4	Assigning Receipt Routes to Items.....	18-8
18.5	Defining Sample Requirements and Item Specifications	18-8
18.5.1	Understanding Sample Requirements and Item Specifications	18-8
18.5.2	Prerequisite	18-9
18.5.3	Forms Used to Define Sample Requirements and Item Specifications.....	18-9
18.5.4	Defining Sample Requirements and Item Specifications.....	18-9
18.6	Working with Items in a Receipt Route.....	18-9
18.6.1	Understanding Item-Related Tasks	18-10
18.6.1.1	Transferring Items to Operations.....	18-10
18.6.2	Forms Used to Work with Items in a Receipt Route	18-10
18.6.3	Setting Processing Options for Receipt Routing Movement and Disposition (P43250)....	18-11
18.6.3.1	Defaults	18-11
18.6.3.2	Display	18-11
18.6.3.3	Process.....	18-12
18.6.3.4	Versions.....	18-14
18.6.3.5	Workflow	18-15
18.6.3.6	Interop	18-16
18.6.3.7	Transportation.....	18-16
18.6.3.8	Rentals (Release 9.1 Update).....	18-16
18.6.4	Reviewing the Current Operation for Items.....	18-16
18.6.5	Transferring Items to Operations	18-16
18.7	Removing Items from a Receipt Route	18-17
18.7.1	Understanding Removal and Reversal of Items	18-17
18.7.1.1	Removal of Items	18-17
18.7.1.2	Item Reversals	18-17
18.7.1.3	Service Units for A/P Matching.....	18-18

18.7.2	Forms Used to Remove Items from a Receipt Route	18-18
18.7.3	Removing an Item from a Receipt Route	18-18
18.8	Reviewing the History of Items in a Receipt Route	18-19
18.8.1	Understanding Item History	18-19
18.8.1.1	Record Reservation (Release 9.1 Update)	18-19
18.8.2	Form Used to Review the History of Items in a Receipt Route	18-20
18.8.3	Setting Processing Options for Routing Ledger Inquiry (P43252)	18-20
18.8.3.1	Display	18-20
18.8.3.2	Process.....	18-20
18.8.4	Reviewing the History of Items in a Receipt Route.....	18-20

19 Managing Suppliers

19.1	Understanding Conversion of Supplier Limit Amounts	19-1
19.1.1	Example: Rounding Converted Limit Amounts	19-1
19.2	Generating Supplier Prices in an Alternate Currency.....	19-2
19.2.1	Understanding the Generation of Supplier Prices in an Alternate Currency	19-2
19.2.1.1	Example: Generating New Supplier Prices	19-3
19.2.1.2	Before Generating New Supplier Prices.....	19-3
19.2.1.3	After Generating New Supplier Prices.....	19-4
19.2.1.4	Data Selection for Supplier/Catalog Purchase Price Generation by Currency	19-4
19.2.2	Generating Supplier Prices in an Alternate Currency.....	19-4
19.2.3	Setting Processing Options for Supplier/Catalog Purchase Price Generation by Currency (R4106101) 19-5	
19.2.3.1	Process.....	19-5
19.2.3.2	Currency	19-5
19.3	Managing Supplier Performance Information	19-5
19.3.1	Understanding Supplier Performance Information	19-6
19.3.1.1	Reviewing Supplier Delivery Performance	19-6
19.3.1.2	Reviewing Supplier Quality Performance.....	19-6
19.3.1.3	Reviewing Supplier Cost Performance	19-7
19.3.1.4	Reviewing a Summary of Supplier Performance Information	19-7
19.3.2	Prerequisites	19-7
19.3.3	Forms Used to Manage Supplier Performance Information	19-8
19.3.4	Reviewing Supplier Delivery Performance	19-8
19.3.5	Reviewing Supplier Quality Performance	19-9
19.3.6	Reviewing Supplier Cost Performance.....	19-9
19.4	Updating Supplier and Item Analysis Records.....	19-9
19.4.1	Understanding Updates to Supplier and Item Analysis Records	19-9
19.4.2	Updating Supplier and Item Analysis Records.....	19-10
19.4.3	Setting Processing Options for Supplier/Item Relationships Rebuild (R43900)...	19-10
19.4.3.1	Route.....	19-10

20 Processing Rebates

20.1	Understanding Rebates.....	20-1
20.2	Reviewing Summary Information for Rebate Agreements	20-1
20.2.1	Understanding Rebate Status Information	20-1
20.2.2	Forms Used to Review Summary Information for Rebate Agreements.....	20-2

20.3	Reviewing Purchasing Transactions for a Rebate	20-2
20.3.1	Forms Used to Review Purchasing Transactions for a Rebate.....	20-3
20.4	Changing the Quantity or Amount Applied to a Rebate.....	20-3
20.4.1	Understanding the Purchase Quantity or Amount	20-3
20.4.2	Forms Used to Change the Quantity or Amount Applied to a Rebate.....	20-3
20.4.3	Changing the Quantity or Amount Applied to a Rebate.....	20-3
20.5	Updating Rebate Information	20-4
20.5.1	Understanding How to Update Rebate Information.....	20-4
20.5.2	Running the Rebate Report	20-4
20.5.3	Setting Processing Options for Rebate Report (R43400)	20-4
20.5.3.1	Message.....	20-4
20.5.3.2	Details.....	20-5

21 Updating Orders

21.1	Understanding Order Updates	21-1
21.2	Updating Status Codes.....	21-1
21.2.1	Understanding Status Code Updates	21-1
21.2.2	Form Used to Update Status Codes	21-2
21.2.3	Setting Processing Options for PO Speed Status Update (P43025)	21-2
21.2.3.1	Default Values.....	21-2
21.2.3.2	Versions.....	21-2
21.2.4	Updating Status Codes	21-3
21.3	Revising Purchase Dates	21-3
21.3.1	Understanding Purchase Date Revisions	21-3
21.3.2	Form Used to Revise Purchase Dates	21-3
21.3.3	Setting Processing Options for Purchasing Date Revisions (P43100)	21-3
21.3.3.1	Defaults	21-3
21.3.3.2	Self-Service.....	21-3

22 Processing Purchase Order Commitments

22.1	Understanding Commitment Processing	22-1
22.1.1	Creation of an Encumbrance or Commitment	22-2
22.1.2	Relief of an Encumbrance or Commitment.....	22-2
22.1.3	Files Used for Commitments and Encumbrances.....	22-3
22.1.4	F43199 Table	22-3
22.1.5	F0902 Table	22-3
22.2	Understanding How to Review Commitment Information for Orders.....	22-4
22.3	Understanding the Commitment Integrity Verification Process	22-5
22.4	Working with Commitments and Encumbrances.....	22-5
22.4.1	Prerequisites	22-5
22.4.2	Form Used to Work with Commitments and Encumbrances	22-6
22.4.3	Setting Processing Options for Commitment Inquiry (P40230A).....	22-6
22.4.3.1	Default.....	22-6
22.4.3.2	Display	22-6
22.4.3.3	Versions.....	22-6
22.4.4	Reviewing Commitment Information for Orders.....	22-7

22.5	Running the Commitment Integrity Report	22-7
22.5.1	Understanding the Commitment Integrity Report.....	22-7
22.5.2	Running the Commitment Integrity Report	22-8
22.5.3	Setting Processing Options for Commitment Integrity Report (R40910)	22-8
22.5.3.1	Default.....	22-8
22.5.3.2	Process.....	22-9
22.6	Purging PA Ledger Detail Records	22-9
22.6.1	Understanding PA Ledger Detail Records Purge.....	22-9
22.6.2	Purging PA Ledger Detail Records.....	22-9
22.6.3	Setting Processing Options for Ledger (F43199) Purge (R43199P)	22-10
22.6.3.1	Process.....	22-10
22.7	Rebuilding a Commitment Audit Trail	22-10
22.7.1	Understanding a Commitment Audit Trail.....	22-10
22.7.2	Prerequisites	22-11
22.7.3	Rebuilding a Commitment Audit Trail	22-11
22.8	Posting Committed Costs to Jobs	22-12
22.8.1	Understanding Posting Committed Costs to Jobs	22-12
22.8.2	Posting Committed Costs to Jobs	22-12
22.8.3	Setting Processing Options for Repost Committed Costs (R00932)	22-13
22.8.3.1	Process.....	22-13
22.9	Performing Encumbrance Rollover.....	22-13
22.9.1	Understanding Encumbrance Rollover.....	22-13
22.9.1.1	Encumbrance Rollover Timing.....	22-14
22.9.2	Performing Encumbrance Rollover.....	22-14
22.9.3	Setting Processing Options for Encumbrance Rollover (R4317).....	22-14
22.9.3.1	Defaults	22-14
22.9.3.2	Process.....	22-15
22.9.3.3	MFG Edits.....	22-16

23 Using Customer and Supplier Self-Service

23.1	Reviewing Receipts on the Web	23-1
23.1.1	Prerequisite.....	23-1
23.1.2	Form Used to Review Receipts on the Web.....	23-1
23.2	Reviewing Orders on the Web.....	23-1
23.2.1	Understanding Order Review	23-1
23.2.2	Reviewing Orders.....	23-2
23.3	Responding to Requests for Quotes	23-2
23.3.1	Understanding Self-Service Response to Requests for Quotes.....	23-2
23.3.2	Prerequisite.....	23-2
23.3.3	Form Used to Respond to Requests for Quotes	23-2
23.3.4	Setting Processing Options for Quote Response Entry (P4334).....	23-2
23.3.4.1	Default.....	23-2
23.3.4.2	Self-Service.....	23-3

24 Purging Data

24.1	Understanding Data Purge Programs	24-1
24.1.1	Considerations	24-2

24.1.2	Prerequisites	24-2
24.2	Purging Data.....	24-2
24.2.1	Forms Used to Purge Data	24-2
24.2.2	Purging Data.....	24-2
24.2.3	Running the F43001 Purge Transaction Records Program (R43001P)	24-3
24.2.4	Running the Purge Purchase Order Dispatch Program (R4333WFP).....	24-3

A Tables Used by JD Edwards EnterpriseOne Procurement Management

A.1	Tables Used by JD Edwards EnterpriseOne Procurement Management	A-1
-----	--	-----

B Delivered Workflow for JD Edwards EnterpriseOne Procurement Management

B.1	Delivered Workflow for JD Edwards EnterpriseOne Procurement Management.....	B-1
B.1.1	Purchase Order Acknowledgement Approval.....	B-1
B.1.1.1	Description	B-1
B.1.1.2	Workflow Objects	B-2
B.1.2	Promised Date Change	B-2
B.1.2.1	Description	B-2
B.1.2.2	Workflow Objects	B-2

C JD Edwards EnterpriseOne Procurement Management Reports

C.1	JD Edwards EnterpriseOne Procurement Management Reports: A to Z	C-1
C.2	JD Edwards EnterpriseOne Procurement Management Selected Reports.....	C-1
C.2.1	R43415 – Purchase Order Summary by Supplier	C-2
C.2.2	R43420 – Purchase Ledger Report.....	C-2
C.2.3	R43640 – Open Purchase Order by Request Date	C-2
C.2.4	Processing Options for Open Purchase Order by Request Date (R43640)	C-2
C.2.4.1	Periods.....	C-2
C.2.4.2	Print	C-3

Index

Preface

Welcome to the JD Edwards EnterpriseOne Applications Procurement Management Implementation Guide.

Audience

This guide is intended for implementers and end users of the JD Edwards EnterpriseOne Procurement Management system.

JD Edwards EnterpriseOne Products

This implementation guide refers to these JD Edwards EnterpriseOne products from Oracle:

- JD Edwards EnterpriseOne Accounts Payable.
- JD Edwards EnterpriseOne Address Book.
- JD Edwards EnterpriseOne Advanced Pricing.
- JD Edwards EnterpriseOne Bulk Stock Inventory.
- JD Edwards EnterpriseOne Data Interface for Electronic Data Interchange.
- JD Edwards EnterpriseOne General Ledger.
- JD Edwards EnterpriseOne Inventory Management.
- JD Edwards EnterpriseOne Project Costing.
- JD Edwards EnterpriseOne Procurement and Subcontract Management.
- JD Edwards EnterpriseOne Manufacturing - PDM.
- JD Edwards EnterpriseOne Quality Management.
- JD Edwards EnterpriseOne Requirements Planning.
- JD Edwards EnterpriseOne Requisition Self Service.
- JD Edwards EnterpriseOne Transportation Management.
- JD Edwards EnterpriseOne Warehouse Management.
- JD Edwards EnterpriseOne Project and Government Contract Accounting.

JD Edwards EnterpriseOne Application Fundamentals

Additional, essential information describing the setup and design of your system appears in a companion volume of documentation called *JD Edwards EnterpriseOne Financial Management Application Fundamentals 9.0 Implementation Guide*.

Customers must conform to the supported platforms for the release as detailed in the JD Edwards EnterpriseOne minimum technical requirements. In addition, JD Edwards EnterpriseOne may integrate, interface, or work in conjunction with other Oracle products. Refer to the cross-reference material in the Program Documentation at <http://oracle.com/contracts/index.html> for Program prerequisites and version cross-reference documents to assure compatibility of various Oracle products.

See *JD Edwards EnterpriseOne Applications Financial Management Fundamentals Implementation Guide*.

Documentation Accessibility

For information about Oracle's commitment to accessibility, visit the Oracle Accessibility Program website at <http://www.oracle.com/pls/topic/lookup?ctx=acc&id=docacc>.

Access to Oracle Support

Oracle customers that have purchased support have access to electronic support through My Oracle Support. For information, visit <http://www.oracle.com/pls/topic/lookup?ctx=acc&id=info> or visit <http://www.oracle.com/pls/topic/lookup?ctx=acc&id=trs> if you are hearing impaired.

Related Documents

You can access related documents from the JD Edwards EnterpriseOne Release Documentation Overview pages on My Oracle Support. Access the main documentation overview page by searching for the document ID, which is 1308615.1, or by using this link:

<https://support.oracle.com/CSP/main/article?cmd=show&type=NOT&id=1308615.1>

To navigate to this page from the My Oracle Support home page, click the Knowledge tab, and then click the Tools and Training menu, JD Edwards EnterpriseOne, Welcome Center, Release Information Overview.

Conventions

The following text conventions are used in this document:

Convention	Meaning
Bold	Indicates field values.
<i>Italics</i>	Indicates emphasis and JD Edwards EnterpriseOne or other book-length publication titles.
Monospace	Indicates a JD Edwards EnterpriseOne program, other code example, or URL.

Introduction to JD Edwards EnterpriseOne Procurement Management

This chapter contains the following topics:

- [Section 1.1, "JD Edwards EnterpriseOne Procurement Management Overview"](#)
- [Section 1.2, "JD Edwards EnterpriseOne Procurement Management Integrations"](#)
- [Section 1.3, "JD Edwards EnterpriseOne Procurement Management Implementation"](#)
- [Section 1.4, "Business Interface Integration Objects"](#)

1.1 JD Edwards EnterpriseOne Procurement Management Overview

Procurement is the process of obtaining products and services from suppliers. It includes decisions about how much and when to purchase goods and services, the actual purchasing of goods and services, and the process of receiving the requested goods or services. The purchasing cycle ensures that the appropriate quantity and quality of equipment, material, supplies, or services are acquired at the best price and from the most appropriate source. Procurement involves and affects more departments than just the purchasing department. An integrated procurement system provides the purchasing professional with links to information across all of an organization's functions and departments. Some of the links include activities and information, including receiving transactions, order revision data, supplier profiles, accounts payable status, special order processing, and the tracking of incoming purchases through receipt routing.

1.2 JD Edwards EnterpriseOne Procurement Management Integrations

The JD Edwards EnterpriseOne Procurement system from Oracle works with other JD Edwards EnterpriseOne systems to ensure that all information is fully integrated. We discuss integration considerations in the implementation chapters in this implementation guide. Supplemental information about third-party application integrations is located on the My Oracle Support website.

1.2.1 JD Edwards EnterpriseOne General Ledger and JD Edwards EnterpriseOne Accounts Payable

The JD Edwards EnterpriseOne Procurement system integrates with the JD Edwards EnterpriseOne General Ledger system from Oracle and the JD Edwards EnterpriseOne Accounts Payable system from Oracle. With the use of automatic accounting

instructions (AAIs) and user-input account numbers, the system relays pertinent transaction information to the accounting systems.

The JD Edwards EnterpriseOne Procurement system retrieves supplier payment information, tax information, and so forth from the JD Edwards EnterpriseOne Accounts Payable system.

1.2.2 JD Edwards EnterpriseOne Address Book

The JD Edwards EnterpriseOne Procurement system coordinates with the JD Edwards EnterpriseOne Address Book system from Oracle to retrieve:

- Supplier address information.
- Ship-to address information.
- Warehouse address information.
- User identification information.

1.2.3 JD Edwards EnterpriseOne Manufacturing and Supply Chain Management

The JD Edwards EnterpriseOne Procurement system can interact with several JD Edwards EnterpriseOne manufacturing systems from Oracle to help process parts availability, work orders, forecasting and planning, product costing, and so forth.

1.2.4 Logistics

The company might integrate the JD Edwards EnterpriseOne Procurement system with the JD Edwards EnterpriseOne Inventory Management system. This integration involves the validation and exchange of information that pertains to inventory items. The JD Edwards EnterpriseOne Procurement system integrates with other JD Edwards EnterpriseOne logistics systems from Oracle:

- JD Edwards EnterpriseOne Warehouse Management.
- JD Edwards EnterpriseOne Sales Order Management.
- JD Edwards EnterpriseOne Requisition Self Service.

Requisitions and purchase orders can be sent from Oracle's JD Edwards EnterpriseOne Requisition Self Service to JD Edwards EnterpriseOne Procurement.

- JD Edwards EnterpriseOne Forecasting.
- JD Edwards EnterpriseOne Requirements Planning.
- JD Edwards EnterpriseOne Advanced Pricing.

1.2.5 JD Edwards EnterpriseOne Job Costing

The JD Edwards EnterpriseOne Procurement system can also interact with the JD Edwards EnterpriseOne Job Costing system from Oracle to view subcontract commitments. Using job status inquiry, you can view the job and project commitment details on an account-by-account basis.

1.2.6 JD Edwards EnterpriseOne Electronic Data Interchange

Electronic data interchange (EDI) is the computer-to-computer exchange of business transactions, such as purchase orders, invoices, and shipping notices, in a standard format.

The JD Edwards EnterpriseOne EDI system from Oracle consists of system 47, which is the application interface containing interface files, tables, and programs. System 47 works with third-party translation software that translates EDI standard data into a flat file format so that the JD Edwards EnterpriseOne application software can manage the data. When you receive documents, the third-party translation software:

- Retrieves the data via network communications.
- Translates the data from EDI standard format to JD Edwards EnterpriseOne application table format.
- Moves the translated data into the JD Edwards EnterpriseOne EDI flat files.

The inbound conversion program moves the translated data into the JD Edwards EnterpriseOne EDI interface tables. The JD Edwards EnterpriseOne EDI system then moves the data into the appropriate application tables. When you send documents, the system performs the procedures in reverse order.

This table lists the EDI documents currently supported for the JD Edwards EnterpriseOne Procurement system. This table includes corresponding codes for ANSI and EDIFACT, which are EDI standard cross-industry terms:

TRANSACTION	ANSI	EDIFACT	Inbound To	Outbound From
Purchase Order	850	ORDERS	Sales	Procurement
Purchase Order Acknowledgement	855	ORDRSP	Procurement	Sales
Invoice	810	INVOIC	Accounts Payable, Procurement	Sales
Receiving Advice	861	RECADV	Procurement, Sales	Procurement
Purchase Order Change	860	ORDCHG	Sales	Procurement
Purchase Order Response Message	865	ORDRSP	Procurement	Sales

1.3 JD Edwards EnterpriseOne Procurement Management Implementation

This section provides an overview of the steps that are required to implement the JD Edwards EnterpriseOne Procurement system.

In the planning phase of the implementation, take advantage of all JD Edwards EnterpriseOne sources of information, including the installation guides and troubleshooting information.

When determining which electronic software updates (ESUs) to install for JD Edwards EnterpriseOne Procurement, use the EnterpriseOne and World Change Assistant. EnterpriseOne and World Change Assistant, a Java-based tool, reduces the time

required to search and download ESUs by 75 percent or more and enables you to install multiple ESUs at one time.

See *JD Edwards EnterpriseOne Tools Software Updates Guide*.

For information about the Oracle Business Accelerator solution for implementation of JD Edwards EnterpriseOne Procurement, review the documentation available.

See http://docs.oracle.com/cd/E24705_01/index.htm

1.3.1 Global Implementation Steps

The suggested global implementation steps for the JD Edwards EnterpriseOne Procurement system:

1. Set up global user-defined codes (UDCs).
See "Working with User Defined Codes" in the *JD Edwards EnterpriseOne Tools System Administration Guide*.
2. Set up companies, fiscal date patterns, and business units.
See "Setting Up Organizations" in the *JD Edwards EnterpriseOne Applications Financial Management Fundamentals Implementation Guide*.
3. Set up next numbers.
See "Setting Up Next Numbers" in the *JD Edwards EnterpriseOne Applications Financial Management Fundamentals Implementation Guide*.
4. Set up accounts and the chart of accounts.
See "Creating the Chart of Accounts" in the *JD Edwards EnterpriseOne Applications Financial Management Fundamentals Implementation Guide*.
5. Set up General Accounting constants.
See "Setting Up Constants for General Accounting" in the *JD Edwards EnterpriseOne Applications General Accounting Implementation Guide*.
6. Set up multicurrency processing, including currency codes and exchange rates.
See "Setting Up General Accounting for Multicurrency Processing" in the *JD Edwards EnterpriseOne Applications Multicurrency Processing Implementation Guide*.
See "Setting Up Exchange Rates" in the *JD Edwards EnterpriseOne Applications Multicurrency Processing Implementation Guide*.
7. Set up ledger type rules.
See "Setting Up Ledger Type Rules for General Accounting" in the *JD Edwards EnterpriseOne Applications General Accounting Implementation Guide*.
8. Enter address book records.
See "Entering Address Book Records" in the *JD Edwards EnterpriseOne Applications Address Book Implementation Guide*.
9. Set up inventory information, such as branch/plant constants, default locations and printers, manufacturing and distribution AAIs, and document types.
See "Setting Up the Inventory Management System" in the *JD Edwards EnterpriseOne Applications Inventory Management Implementation Guide*.
10. Set up shop floor calendars.

See "Setting Up Shop Floor Management" in the *JD Edwards EnterpriseOne Applications Shop Floor Management Implementation Guide*.

11. Set up manufacturing constants.

See "Setting Up Manufacturing Constants" in the *JD Edwards EnterpriseOne Applications Product Data Management Implementation Guide*.

1.3.2 Procurement Implementation Steps

The suggested application-specific implementation steps for the JD Edwards EnterpriseOne Procurement system:

1. Define order line types.

See [Defining Order Line Types](#).

2. Set up order activity rules.

See [Setting Up Order Activity Rules](#).

3. Set up procurement constants.

See [Setting Up Procurement Constants](#).

4. Define procurement next numbers.

See [Understanding the Setup of Procurement Next Numbers](#).

5. Set up user-defined codes.

See [Setting Up Distribution AAIs](#).

6. Set up AAIs.

See [Setting Up UDCs](#).

7. Create tolerance rules.

See [Creating a Tolerance Rule](#).

8. Set up order hold information.

See [Entering Order Hold Information](#).

9. Set up landed costs.

See [Setting Up Landed Costs](#).

10. Set up nonstock items.

See [Setting Up Nonstock Items](#).

11. Define print messages.

See [Defining Print Messages](#).

12. Set up templates for purchase orders.

See [Understanding Purchase Order Templates](#).

13. Create model logs.

See [Creating a Model Log](#).

14. Set up hierarchical logs.

See [Setting Up Hierarchical Logs](#).

1.4 Business Interface Integration Objects

A business interface is a set of components that implementation teams can use to create an integration between JD Edwards EnterpriseOne and an external system. Business interfaces can include one or more of these business interface components:

- Business Services
- Real-Time Events
- Batch Import and Export Programs

For additional information about business interfaces, and the business objects available for this product area, see these topics in the *JD Edwards EnterpriseOne Applications Business Interface Reference Guide*:

- Business Interfaces Overview
- Procurement - Purchase Orders
- Procurement - Purchase Order Receipts
- Procurement Voucher

Understanding Procurement

The purchasing department is an integral part of processing purchase orders, credit orders, and returns. Procurement involves order entry through actual payment of the goods and services that you receive.

This chapter contains the following topics:

- [Section 2.1, "Industry Overview"](#)
- [Section 2.2, "Procurement System Overview"](#)

2.1 Industry Overview

This section discusses:

- Procurement description.
- Industry environment and concepts for procurement.

2.1.1 Procurement Description

Procurement is the process of obtaining products and services from suppliers. It includes decisions about how much and when to purchase goods and services, the actual purchasing of goods and services, and the process of receiving the requested goods or services. The purchasing cycle ensures that the appropriate quantity and quality of equipment, material, supplies, or services are acquired at the best price and from the most appropriate source. Procurement involves and affects more departments than just the purchasing department. An integrated procurement system provides the purchasing professional with links to information across all of an organization's functions and departments. Some of the links include activities and information, including receiving transactions, order revision data, supplier profiles, accounts payable status, special order processing, and the tracking of incoming purchases through receipt routing.

2.1.2 Industry Environment and Concepts for Procurement

Ideally, the procurement process in any organization has processes and procedures that increase internal customer response and reduce non value-added activities. The JD Edwards EnterpriseOne Procurement system is an effective system that integrates all aspects of the organization, provides the buyer with up-to-date information, which reduces the administrative time spent finding information. This time can then be spent developing new sources of supply, building relationships with current suppliers, and researching new ways to improve the procurement process.

2.1.2.1 Order Generation

The procurement process begins when the need arises for items or services. This need is typically presented to the purchasing department in the form of a requisition. A requisition is a document that identifies to the buyer what is needed, when it is needed, and the approximate or actual cost associated with the item or service requested. The requisition can then be used to generate a quote for suppliers to bid on or to generate a purchase order. The purchase order that is created from the requisition is the written contract between the buyer and the seller for the purchase of items or services at an agreed price and delivery date.

2.1.2.2 Purchasing Methods

Most purchasing organizations use these methods:

- Inventory
- Non-inventory
- Subcontracting

Purchasing for inventory includes items intended for resale, raw materials, and manufactured items. These items require full integration between the JD Edwards EnterpriseOne Procurement system and the JD Edwards EnterpriseOne Inventory Management system. This kind of system integration validates that the item exists in inventory. Information included about the inventory item might include cost, description, supplier, and units of measure. An example of an inventory item for a manufacturer of computer hardware would be printed circuit boards.

Purchasing for non-inventory includes goods, materials, and services that are used internally or are subsequently charged to outside parties. Typically, these items and services are recorded in general ledger accounts. Examples of non-inventory items include office supplies, maintenance, repair, and operating supplies (MRO), and building services.

Subcontract purchasing is associated with outside operations performed by suppliers, or internal projects requiring a number of suppliers to charge their services to a common job number. One example would be a plating operation performed by an outside supplier on a steel part that was produced by the organization.

2.1.2.3 Receipt Processing

Once a supplier ships items to the warehouse based on the specifications outlined on a purchase order, the receiving department needs to receive those items. Items are received and services are performed daily in the organization. When a shipment is received, you typically route it to several operations that ensure that the shipment is:

- Unloaded and checked.
- Verified for the quantity due against the quantity received.
- Entered in the system with the quantity against the corresponding purchase order.

To ensure a high level of customer satisfaction within the organization, the receiving department should notify the person who requisitioned the order or the buyer or both that the goods requested have been received.

2.1.2.4 Special Order Processing

During the day-to-day activities within a purchasing department, special needs exist that require different types of documents. The different types of documents include:

- Blanket purchase orders

- Quote orders
- Change orders

You use blanket orders when the organization repeatedly purchases an item or service. You create a blanket order based on a specified amount or quantity that has been projected to be used over a period of time, typically one year. As required, quantities are released from the blanket order and the system creates a purchase order. You use a blanket order to reduce the administrative costs associated with processing purchase orders and to streamline the procurement process. An example of a blanket order is 1,200 cases of shop towels used by the maintenance department throughout the year. The buyer then releases quantities of approximately 100 cases per month.

You use quote orders when you want to solicit a competitive bid for an item from a number of suppliers. The Request for Quote (RFQ) includes the quantity, specifications, delivery date, and response date needed. After suppliers return the RFQ, the buyer evaluates the information and awards the purchase order to the supplier that best meets the specifications of cost, delivery, and quality outlined in the RFQ. Quote orders can be directly generated from requisitions and, in turn, purchase orders can be generated directly from quote orders.

Change orders enable a buyer to change the original purchase order or contract. Change orders are important because they provide an audit trail about changes to the original purchase order or contract.

2.1.2.5 Approval Processing

Approval processing refers to the steps that a requisition or purchase order goes through to gain the appropriate authorization to purchase the goods or services specified. The process of requiring approvals at the requisition level or purchase order level is becoming more common. Depending on the amount of the requisition or purchase order, different people in the organization need to approve the order at different levels.

2.1.2.6 Receipt Routing

Receipt routing enables you to track the location of purchased items after they leave the supplier's warehouse. Receipt routing enables you to know where products are located: whether they are on the way to the warehouse, in the receiving process, or in the warehouse. Receipt routing provides improved customer service levels to the purchasing department's internal customers. Receipt routing can also be used to record the disposition of items out of the receiving process if they do not meet the specifications outlined on the purchase order. An example of the steps that an item might move through in a given receipt route include:

- In transit
- In customs
- In inspection
- Received into stock

2.1.2.7 Supplier Management

A key step in building a strong supply chain for the organization is developing ongoing partnerships with the suppliers. Some of the tools available to develop these relationships include:

- Performance analysis.
- Supplier price comparison information.

- Certified supplier status.
- Agreed-upon terms.
- Item catalog costing.

To monitor the suppliers' performance, you should consider these key areas:

- Cost
- Delivery
- Quality

You determine cost based on the supplier with the best value and not on the supplier with the lowest cost. Delivery analysis is based on the number of days late as well as the number of days early that are agreed upon. Quality analysis evaluates whether the supplier has met the specifications for the items included on the purchase order after they have been received.

2.2 Procurement System Overview

This section discusses:

- Procurement system description.
- Features, terms, and concepts.
- Order processing cycle.

2.2.1 Procurement System Description

The JD Edwards EnterpriseOne Procurement system accommodates a diverse range of purchasing activities for:

- Replenishing inventory.
- Acquiring materials used to complete projects.
- Charging purchased goods and services to specific departments, jobs, or cost centers.

Procurement involves order entry through actual payment for the goods and services that you receive. You must carefully plan the cycle through which you intend to process the orders and set up the JD Edwards EnterpriseOne Procurement system accordingly. Setup issues include order types, line types, and order activity rules.

You can perform activities that are specific to the procurement operation, such as special order processing, approval processing, and supplier management. A variety of features are available to help you process orders quickly and effectively. Extensive review and reporting capabilities can help you make decisions about current and future purchasing strategies.

2.2.2 Features, Terms, and Concepts

This section discusses:

- Purchasing for inventory.
- Purchasing for non-inventory.
- Subcontracting.
- Procurement environments.

2.2.2.1 Purchasing for Inventory

The company might manage an inventory or stock-based operation, which includes:

- Retail items for sale to customers.
- Items for internal consumption.
- Manufactured items.
- Repair and maintenance items.

You must use the purchasing for inventory method to purchase goods for a stock-based environment. This method enables full integration between the JD Edwards EnterpriseOne Procurement system and the JD Edwards EnterpriseOne Inventory Management system. You purchase items based on the item numbers that exist in the JD Edwards EnterpriseOne Inventory Management system. The JD Edwards EnterpriseOne Procurement system:

- Validates that items exist in the JD Edwards EnterpriseOne Inventory Management system.
- Retrieves item information such as item descriptions, units costs, and units of measure from the JD Edwards EnterpriseOne Inventory Management system.
- Updates item information such as on-hand balances, and unit costs in the JD Edwards EnterpriseOne Inventory Management system.

In a stock-based environment, item costs are classified as inventory on the balance sheet until you issue the items out of inventory. If you sell the items, they become cost of goods sold. If you use the items internally, you determine the expense account to which to charge the items at the time of issuance.

2.2.2.2 Purchasing for Non-Inventory

The company might purchase goods, materials, or services that are used internally or are subsequently charged to outside parties. Purchases might apply to:

- Jobs.
- Projects.
- Internal consumption.
- Repair and maintenance.
- Parts chargeable on a work order.

You use the purchasing for non-inventory method to charge purchases against general ledger account numbers. Each account number can represent a job or project. This method accommodates nonstock, and services and expenditures based environments.

You can also use the purchasing for non-inventory method to purchase items that exist in the JD Edwards EnterpriseOne Inventory Management system. The JD Edwards EnterpriseOne Procurement system validates item numbers and retrieves item descriptions and costs from the JD Edwards EnterpriseOne Inventory Management system, but does not update item balance information.

Tracking commitments or encumbrances is a common practice in nonstock and services and expenditures based environments. A commitment or encumbrance is the recognition of a future obligation. If you purchase against general ledger account numbers, you can have the system track commitment or encumbrance amounts when you enter purchase orders.

2.2.2.3 Subcontracting

You use the subcontracting method to manage the daily and long term details of contracts, payments, and commitments that are associated with the jobs. In addition, you can:

- Create and maintain contracts for the subcontractors on the jobs.
- Establish payment guidelines and make payments against the contracts.
- Track the costs you have paid against a job and the costs you are committed to in the future.
- Make inquiries on contract information.
- Input change orders for the contract commitments.
- Generate status reports for the contracts and commitments.

When you create a new contract, you enter subcontractor information, the work to be done, contract commitments, dates, log items, and so on. For existing contracts, you can enter commitment change orders and track the completion of submittals and transmittals.

You can also enter and release progress payments or hold progress payments. Progress payments are payments that you make to the subcontractors as their jobs progress.

2.2.2.4 Procurement Environments

The JD Edwards EnterpriseOne Procurement system provides four different environments in which you can perform the purchasing activities:

- Stock based.
- Nonstock based.
- Services and expenditures based.
- Subcontract based.

The stock-based environment is designed to accommodate those who purchase for inventory. The nonstock and the services and expenditures based environments accommodate those who purchase against general ledger account numbers. The subcontract-based environment accommodates those who procure goods and services through subcontracts.

You select the environment that is most conducive to the operation. For example, the stock-based environment enables you to perform activities common to inventory operations, such as supplier management and rebate processing. The nonstock and the services and expenditures based environments enable you to track commitments and encumbrances. The subcontract-based environment enables you to enter subcontracts and changes to the subcontract.

Many activities are common to all four environments. However, the menus and forms for each are set up differently to accommodate processes and procedures specific to each environment.

The environments you use depend entirely on the organization. Some organizations may choose to use all environments, while other organizations may choose to use only one environment.

2.2.3 Order Processing Cycle

The purchase order processing cycle consists of three primary steps:

- Creating an order.
- Receiving the goods or services.
- Creating a voucher to pay for the goods or services.

After you enter an order, you can enter receipt information in the system (formal receiving process) to receive the goods or services. If you follow informal receipt processing, you must compare invoice information to the original purchase order to create a voucher. If you purchase for inventory, you must use the formal receiving process. If you purchase against general ledger account numbers, you can use either the formal or informal receiving process.

The method you use to create vouchers depends on the receiving process. If you use the formal receiving process, you can create vouchers:

- Individually by verifying that invoice information matches receipt information.
- In batch mode using existing receipt records.

Each time you enter an order, you must provide details about the items and services that you want to order. For each item or service, you must enter a line of detail that describes the item or service, including the quantity and cost.

You must specify a line type for each detail line. The line type indicates how the system manages information on the detail line. For example, you might have a line type of S (for stock items) to indicate that the system is to replenish the quantity of the item in the JD Edwards EnterpriseOne Inventory Management system and reflect the cost in the general ledger and the JD Edwards EnterpriseOne Accounts Payable system.

You must set up order processing cycles to indicate how the system is to process the detail lines for each order type (purchase orders, requisitions, blanket orders, and so forth). For example, you can set up the processing cycle for inventory purchase orders as follows:

- Enter purchase order.
- Print purchase order.
- Print purchase receiver.
- Receive goods or services.
- Create voucher.

You use order activity rules to define the operations the system performs for a processing cycle and to indicate the progression of the steps.

You must set up order activity rules for every combination of order type and line type. You use user-defined status codes to set up the order activity rules. Each status code represents a step in the processing cycle, for example printing the order.

Each detail line of an order contains a pair of status codes. These codes identify the last status and the next status to which the system advances the line. The last status code represents the last operation performed on the order. The next status code represents the next step in the processing cycle.

This diagram illustrates a typical status code progression:

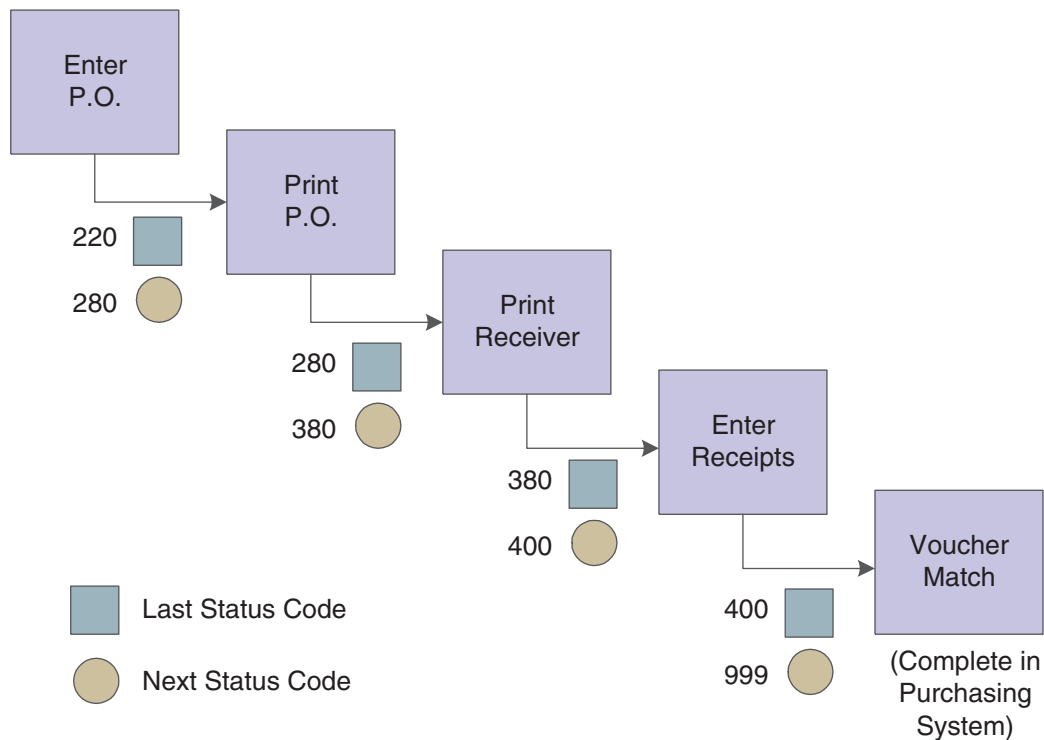
Figure 2–1 Status Code Progression

For each processing cycle you set up, you must specify the order type and line type to which it applies. For example, the processing cycle illustrated might only apply to purchase order detail lines to which you assign a line type of S.

2.2.3.1 Optional Procurement Activities

Optional procurement activities you can perform include:

- Creating multiple orders simultaneously.
- Ensuring that orders are approved before processing.
- Creating special orders such as requisitions and blanket orders.
- Obtaining and comparing price quotes for items and services.
- Tracking revisions to orders.
- Creating change orders.
- Monitoring items from the moment they leave a supplier's warehouse.
- Managing relationships between suppliers and items.
- Checking budgets.
- Processing approvals.

Understanding Vertex Sales Tax Q Series

If the company wants to apply sales taxes automatically, you can use the Vertex Sales Tax Q Series system.

This chapter contains the following topics:

- [Section 3.1, "Compatibility of the Vertex Sales Tax Q Series System"](#)

3.1 Compatibility of the Vertex Sales Tax Q Series System

The Vertex Sales Tax Q Series system integrates with these JD Edwards EnterpriseOne systems from Oracle:

- JD Edwards EnterpriseOne General Ledger.
- JD Edwards EnterpriseOne Accounts Receivable.
- JD Edwards EnterpriseOne Accounts Payable.
- JD Edwards EnterpriseOne Sales Order Management.
- JD Edwards EnterpriseOne Procurement and Subcontract Management.
- JD Edwards EnterpriseOne Service Management.
- JD Edwards EnterpriseOne Contract and Service Billing.

Important: If you are using the JD Edwards EnterpriseOne U.S. Payroll system from Oracle, you are required to use the Quantum for Payroll Tax System.

See "Setting Up Tax Information" in the *JD Edwards EnterpriseOne Applications Payroll Implementation Guide*.

See Also:

- "Setting Up the Interface to Vertex Sales Tax Q Series" in the *JD Edwards EnterpriseOne Applications Tax Processing Implementation Guide*.

Understanding Pricing in Procurement

This chapter contains the following topics:

- [Section 4.1, "Pricing in Procurement"](#)

4.1 Pricing in Procurement

This section discusses:

- Matrix item.
- Price matrix.
- Minimum or maximum price adjustment.
- Pricing on quality attributes.
- Manual purchase price override.
- Pricing at receipts.
- Repricing for procurement.

Because pricing is probably one of the most complex aspects of the business, planning, setting up, and maintaining pricing information might take a considerable amount of time. When you enter a purchase order, the system retrieves the unit cost for the item based on characteristics, such as the branch/plant, the supplier, and the quantity. Before the system processes any type of advanced price adjustment to the purchase order, it must first retrieve the unit cost. Depending on the purchase price level for the item, the system retrieves the unit cost from either the Supplier Price/Catalog File table (F41061) or the Item Cost File table (F4105). After the system retrieves the unit cost, it verifies that Oracle's JD Edwards EnterpriseOne Advanced Pricing is active. If Advanced Pricing for Procurement is active, the system bypasses standard price adjustments and searches for applicable schedules and adjustments in JD Edwards EnterpriseOne Advanced Pricing.

See "Using Base Pricing, Understanding Pricing in JD Edwards EnterpriseOne Procurement" in the *JD Edwards EnterpriseOne Applications Advanced Pricing Implementation Guide*.

JD Edwards EnterpriseOne Advanced Pricing provides flexibility when defining pricing. Setting up advanced pricing for procurement enables you to price items by using an advanced pricing structure and to streamline pricing setup and maintenance. You can easily adjust prices for each purchase order; and then combine the adjustments into a pricing structure or schedule.

See "Understanding Advanced Pricing" in the *JD Edwards EnterpriseOne Applications Advanced Pricing Implementation Guide*.

4.1.1 Matrix Item

Products often have a number of variations, though they share the same basic properties. Thus, products such as bottled water and T-shirts can be matrix items, which consist of a parent item and child items. You must enter a parent item in the Item Master program (P4101) to create all of the variations (child items) of the parent item. You enter a parent item just as you would any other item in the inventory, except that you specify a template and indicate that the item is matrix-controlled or not matrix-controlled. The system uses this information to display forms that enable you to add all variations of the parent item.

The Matrix Order Entry program (P41902) enables you to create purchase orders for matrix items. You also can access existing purchase orders to order quantities of a matrix item. When you enter a purchase order, you can access the Matrix Order Entry program.

See "Working with Matrix and Parent Items" in the *JD Edwards EnterpriseOne Applications Inventory Management Implementation Guide*.

4.1.1.1 Matrix Item Receipts and Tolerance

When a matrix receipt is done, the matrix child items generate new purchase order detail lines at the same time the purchase order receipt is generated so that no difference can ever exist between amounts on the purchase order detail line and the receipt. To process the tolerance correctly, the total of the child lines needs to be accumulated and compared to the purchase order detail line of the matrix parent item.

Important: When the quantity of all matrix child items selected is different from the Control Quantity (quantity of matrix parent items) on Matrix Order Entry, the system issues a warning.

See [Using Receipt Processing](#).

4.1.2 Price Matrix

In JD Edwards EnterpriseOne Advanced Pricing, you can use the Price Matrix program (P4590) to add and edit a multitude of adjustment detail records in the Price Adjustment Detail table (F4072). Using this program enables you to access a view to suit business needs and quickly enter and maintain pricing information. You can use the price matrix with Advanced Pricing for Procurement.

See "Working with the Price Matrix" in the *JD Edwards EnterpriseOne Applications Advanced Pricing Implementation Guide*.

See "Working with Schedules and Adjustments" in the *JD Edwards EnterpriseOne Applications Advanced Pricing Implementation Guide*.

4.1.3 Minimum or Maximum Price Adjustment

In JD Edwards EnterpriseOne Advanced Pricing, you add an adjustment to indicate the minimum or maximum price to pay for an item. The minimum or maximum price adjustment enables you to adjust the unit price of a particular item, customer, item group, customer group, or combinations of these. The sequence of the minimum or maximum price adjustment on the adjustment schedule determines what the price will be at that point in the schedule.

See "Understanding Schedules and Adjustments" in the *JD Edwards EnterpriseOne Applications Advanced Pricing Implementation Guide*.

See "Working with Adjustment Definitions" in the *JD Edwards EnterpriseOne Applications Advanced Pricing Implementation Guide*.

4.1.4 Pricing on Quality Attributes

In JD Edwards EnterpriseOne Advanced Pricing, price setup is based on the quantity, weight, or amount of an item that is entered on an order. Pricing can also be based on quality attributes of the product that is purchased. Quality attribute pricing is a quality level-break adjustment. Therefore, for quality level-break type adjustments, the system will not process adjustments that use quantity, weight, or amount entered for the order.

As you receive shipments of items, you perform the quality tests and enter the test results on the receipt. For the quality level-break adjustment, the system searches for test results and uses the adjustment definition to determine the price.

Note: The quality attributes functionality is supported for JD Edwards EnterpriseOne Procurement receipts only.

Before you define quality attribute price adjustments:

- Ensure that Oracle's JD Edwards EnterpriseOne Quality Management system is activated.
- Set up quality tests on the Quality Management Setup menu (G3741).
- Set up a UDC conversion from an alpha to a numeric value for alpha type test results.

See "Setting Up Advanced Pricing Constants" in the *JD Edwards EnterpriseOne Applications Advanced Pricing Implementation Guide*.

See "Understanding Schedules and Adjustments" in the *JD Edwards EnterpriseOne Applications Advanced Pricing Implementation Guide*.

See "Setting Up Adjustment Definitions" in the *JD Edwards EnterpriseOne Applications Advanced Pricing Implementation Guide*.

4.1.5 Manual Purchase Price Override

In JD Edwards EnterpriseOne Procurement, you can provide a manual purchase price override for detail lines on an order. When you are manually overriding a price, the JD Edwards EnterpriseOne Advanced Pricing system applies any designated adjustments over the price.

Before you can override prices and apply adjustments:

- Activate the Advanced Procurement Pricing constant.
- Set the Apply on override price option for each adjustment that should be applied to the overridden price.

If you manually override a price and the system constant is activated, the system reprices the item. The overridden price is the starting price. The system then searches for applicable adjustments and applies those adjustments to the manually entered price.

See "Understanding Advanced Pricing Constants" in the *JD Edwards EnterpriseOne Applications Advanced Pricing Implementation Guide*.

See "Working with Adjustment Definitions" in the *JD Edwards EnterpriseOne Applications Advanced Pricing Implementation Guide*.

4.1.6 Pricing at Receipts

JD Edwards EnterpriseOne Procurement Management integrates with JD Edwards EnterpriseOne Advanced Pricing to reprice at receipts by retrieving the purchase price and applying adjustments according to the adjustment schedule that is attached to the purchase order or contract. Repricing at receipts uses the standard PO Receipt program (P4312).

To price at receipts:

1. Activate the Advanced Procurement Pricing constant.
2. Set the Price at Receipt processing option on the Process tab of the PO Receipts program (P4312) to reprice purchase prices at receipt entry.
3. Define procurement type adjustments or receipt type adjustments to apply when the purchase order is received.

See "Understanding Advanced Pricing Constants" in the *JD Edwards EnterpriseOne Applications Advanced Pricing Implementation Guide*.

See [Setting Processing Options for PO Receipts \(P4312\)](#).

See "Understanding Schedules and Adjustments" in the *JD Edwards EnterpriseOne Applications Advanced Pricing Implementation Guide*.

See "Working with Adjustment Definitions" in the *JD Edwards EnterpriseOne Applications Advanced Pricing Implementation Guide*.

See "Defining Order Detail Groups" in the *JD Edwards EnterpriseOne Applications Advanced Pricing Implementation Guide*.

4.1.7 Repricing for Procurement

After pricing has occurred on a purchase order or receipt, you can change the price adjustment detail or purchase price and then include the most recent changes on a batch of purchase order or receipt records. You set a processing option on the Reprice Procurement / Receipts program (R45620) to indicate whether the system should process purchase order records from the Purchase Order Detail File table (F4311), receipt records from the Purchase Order Receiver File table (F43121), or both.

See "Repricing Purchase Orders and Receipts" in the *JD Edwards EnterpriseOne Applications Advanced Pricing Implementation Guide*.

Understanding Customer and Supplier Self-Service Setup

This chapter contains the following topics:

- [Section 5.1, "Customer and Supplier Self-Service"](#)
- [Section 5.2, "Self-Service Setup"](#)

5.1 Customer and Supplier Self-Service

Internet Commerce, the exchange of goods and services on the internet, specifically the World Wide Web (WWW), enables businesses to conduct business with other businesses and with consumers. Internet transactions are inexpensive, increasingly secure, platform-independent, and built on standards that make communicating with suppliers, partners, or customers a simple task. Businesses can easily use the internet for time-critical transactions, such as purchasing, invoicing, electronic funds transfer, cargo tracking, and sales force automation.

You can create an internet site from which the customers and suppliers can access the most updated information at any time.

The advantages of internet commerce include:

- Global market expansion.
- Wider product distribution.
- Worldwide, 24-hour access to customers.
- Cost reduction, including reduction of the physical inventory, fewer distribution intermediaries, and reduction of costs on catalog production and distribution.
- Increased revenue.

With JD Edwards EnterpriseOne software, the customers can enter their own orders, inquire on the status of orders, and review service and billing information whenever they want, without security risks or additional costs. Likewise, the suppliers can view real-time information about orders, receipts, and payment information and respond to requests for quotes.

Using the system's tools applications for web-based transactions, you can configure the self-service interface for the environment and business needs.

Note: This documentation is based on JD Edwards EnterpriseOne forms and data that are provided for self-service in a Microsoft Windows environment. The navigations, forms, steps, and data that are illustrated in this documentation might not correspond to the configured self-service internet site.

5.1.1 Prerequisites

Before you set up and use customer and supplier self-service:

- Verify that you have set up address book master and supplier master records for the suppliers.
- Verify that you have set up supplier and item information.
- Assign a branch/plant and default location to each supplier.

When the suppliers inquire on orders, receipts, quotes, and so on, the system retrieves the information based on the branch/plant that you assign to the supplier's user ID.

5.2 Self-Service Setup

This section discusses:

- Self-service setup overview.
- Security issues.
- Activation of processing options.

5.2.1 Self-Service Setup Overview

Before the customers and suppliers can use self-service to access information, you must provide a method for them to perform one or more of these tasks:

- Access item information.
- Review account information.
- Review existing orders and shipments.
- Access product and warranty information.
- Review information about existing calls.
- Review service orders.

When you set up user profiles for the customers and suppliers, you can limit their access to only the self-service menus, based on their user IDs. Customers and suppliers cannot use self-service to add or modify address book, customer master, or supplier master information.

5.2.2 Security Issues

After you set up address book and master records for customers and suppliers, you must set up user profiles to limit the customers' and suppliers' access to the system. Customers and suppliers must have profiles before they can sign in to any self-service applications.

In the user profile, you specify this information for a customer or supplier:

- User ID.
- Password.
- Preferences, such as language and localization information.

You must also specify the menu that you want the supplier or customer to be able to access. Suppliers and customers can access only the programs that are on the menu that you specify in the user profiles. Specify one of these menus, depending on the type of user:

- Daily Self-Service Processing (G1715) for customers who need access to self-service programs in the JD Edwards EnterpriseOne Service Management system from Oracle.
- Supplier Self-Service (G43S11), for suppliers who need access to self-service programs in the JD Edwards EnterpriseOne Procurement system.

When a customer or supplier enters information using self-service programs, the system stores product selections and other information in a memory cache file. The customer or supplier can move between programs, and the cache file retains the current contents of the order or quote.

5.2.3 Activation of Processing Options

To enable the suppliers to use the self-service website to enter quotes and review information such as orders, receipts, and inventory levels, you must first activate the supplier self-service processing options for these programs:

- Address Book (P01012).
- Purchase Orders (P4310).
- Purchase Receipts Inquiry (P43214).
- Quote Response Entry (P4334).
- Supplier Self-Service Inventory (P41201).
- Work with Shipments (P4915).
- Supplier Schedule Revisions (P34301).
- A/P Standard Voucher Entry (P0411).
- Work With Loads (P4960).
- Purchasing Date Revisions (P43100).

When you activate the processing options for supplier self-service, the system displays only those fields that are useful to the suppliers and hides those fields that are not useful or are confidential.

Setting Up the Procurement System

This chapter contains the following topics:

- [Section 6.1, "Understanding System Setup"](#)
- [Section 6.2, "Understanding the Setup of Procurement Next Numbers"](#)
- [Section 6.3, "Defining Order Line Types"](#)
- [Section 6.4, "Setting Up Order Activity Rules"](#)
- [Section 6.5, "Setting Up Procurement Constants"](#)
- [Section 6.6, "Setting Up UDCs"](#)
- [Section 6.7, "Setting Up AAIs"](#)
- [Section 6.8, "Creating Tolerance Rules"](#)
- [Section 6.9, "Setting Up Rounding Tolerance Rules For Voucher Match Automation \(Release 9.1 Update\)"](#)
- [Section 6.10, "Setting Up Order Hold Information"](#)
- [Section 6.11, "Setting Up Landed Costs"](#)
- [Section 6.12, "Setting Up Nonstock Items"](#)
- [Section 6.13, "Defining Print Messages"](#)
- [Section 6.14, "Setting Up Templates for Purchase Orders"](#)
- [Section 6.15, "Creating Model Logs"](#)
- [Section 6.16, "Setting Up Hierarchical Logs"](#)

6.1 Understanding System Setup

Before you use the JD Edwards EnterpriseOne Procurement system, you must define setup information. This information directs the system to accommodate the specific business needs. For example, you must define the purchasing cycle through which the system processes each order type that you use, such as requisitions, blanket orders, and purchase orders.

You set up this information for JD Edwards EnterpriseOne Procurement:

Type of Information	Setup Tasks
Order line types	Define codes that determine how the system processes a detail line on an order.

Type of Information	Setup Tasks
Order activity rules	Establish the sequence of steps in the purchasing cycle through which the system processes each order.
Constants	Define constants for these types of default information: <ul style="list-style-type: none"> ■ Branch/plant constants control daily transactions within a branch/plant. ■ Item availability constants define how the system calculates the quantity of items that are available at a branch/plant. ■ System constants provide default information that applies throughout the system. ■ Batch control constants determine whether an application requires management approval and batch control.
Next numbers	Define next numbers by using the next numbers facility to automatically assign the next available number to document types and address book numbers.
Automatic accounting instructions (AAIs)	Set up AAIs to determine the general ledger accounts for which the system creates journal entries for purchasing transactions.
User-defined codes (UDCs)	Set up UDCs that are used by the JD Edwards EnterpriseOne Procurement system to process orders.
Tolerance rules	Create tolerance rules to specify the number or percentage by which the quantity, unit cost, and extended amount can change on a detail line.
Order hold information	Set up information that the system uses to place orders on hold.
Landed costs	Set up landed costs to specify costs that exceed the purchase price of an item, such as delivery charges, broker fees, and so forth.
Nonstock items	Set up information for items that you do not account for as part of the inventory.
Print messages	Define print messages that consist of predefined text that can be attached to item records, Supplier Master records, purchase order headers, or purchase order detail lines.
Purchase order templates	Set up templates for use during purchase order entry. Templates contain items that you frequently order from a supplier.
Model logs	Create model logs for use during log creation. Model logs contain items that you frequently use in a log.

You set up this information in other systems, including JD Edwards EnterpriseOne Inventory Management and JD Edwards EnterpriseOne General Accounting:

Type of Information	Setup Tasks
Default location and printers	Define default information for a certain user or workstation terminal, including a branch/plant, an approval route, and a printer output queue.
Tax processing	Set up tax processing information for the system.
Item cross-references	Define item cross-reference numbers to link the internal item numbers to alternate item numbers, such as those maintained by the suppliers.

6.2 Understanding the Setup of Procurement Next Numbers

Next numbers enable the system to automatically assign document numbers. The Next Number Revisions program (P0002) provides 10 unique characters that enable different document types to be numbered independently. The next available number in the Next Numbers - Automatic table (F0002) is retrieved and assigned to the document.

For next numbers:

- Don't omit the next number value.
- Don't change the next number value after you begin processing transactions.

Document numbers can be assigned by next numbers by system or next numbers by company and fiscal year.

For the JD Edwards EnterpriseOne Procurement system, next numbers are set up by system number.

See "Understanding Next Numbers" in the *JD Edwards EnterpriseOne Applications Financial Management Fundamentals Implementation Guide*.

See "Setting Up Next Numbers by System" in the *JD Edwards EnterpriseOne Applications Financial Management Fundamentals Implementation Guide*.

6.3 Defining Order Line Types

This section provides an overview of order line types and discusses how to define order line types.

6.3.1 Understanding Order Line Types

Each purchase order that you enter must contain details about the items or services that you want to order. For each item or service, you must enter a line of detail information that describes the order, including the quantity and cost of the item or service. The system processes the detail line based on a line type.

The line type that you enter for a detail line determines how the transaction affects other systems, such as:

- JD Edwards EnterpriseOne General Accounting from Oracle
- JD Edwards EnterpriseOne Inventory Management
- JD Edwards EnterpriseOne Accounts Payable

For example, you might create a line type for stock items. When you set up the line type, you specify that it affects item availability in the JD Edwards EnterpriseOne Inventory Management system. You also specify that it affects the JD Edwards EnterpriseOne General Accounting and JD Edwards EnterpriseOne Accounts Payable systems. When you assign the line type to a purchase order detail line, the system:

- Increases the quantity of the item in the JD Edwards EnterpriseOne Inventory Management system (upon receipt).
- Creates ledger entries in the JD Edwards EnterpriseOne General Accounting system.
- Creates ledger entries in the JD Edwards EnterpriseOne Accounts Payable system.

The line type for a detail line also determines the cycle through which the system processes the line (based on order activity rules). Examples of other information that you can specify for a line type include:

- Whether the detail line is subject to taxes.
- Whether the system applies freight charges to the detail line.
- Whether a receipt is required for a detail line (this setting can apply to either two-way or three-way voucher match).
- Whether the system edits the F4101 table for nonstock items.

6.3.2 Form Used to Define Order Line Types

Form Name	Form ID	Navigation	Usage
Line Type Constants Revisions	W40205B	Procurement System Setup (G43A41), Order Line Types Click Add on the Work With Line Types form. Sales Order Management Setup (G4241), Order Line Types Click Add on the Work With Line Types form.	Define or modify order line types.

6.3.3 Defining Order Line Types

Access the Line Type Constants Revisions form.

Inv. Interface (inventory interface)

Enter a code that identifies the type of interface to the JD Edwards EnterpriseOne Inventory Management system. Values are:

Y: The monetary amount or unit value of any activity containing this line type will be reflected in inventory. The system also edits the item that you enter to ensure that it is a valid item. Y is the default.

A: The system recognizes the number that you enter as a general ledger account number. The system uses this code in purchasing only. Budget checking is fully functional when you use this interface code.

B: The system performs edits on a nonstock item with a general ledger interface.

The system retrieves price data from the inventory tables, but does not update the quantity on the purchase order. This code is valid only when you have set the G/L Interface field to **Y**. Budget checking is fully functional when you use this interface code.

C: The system edits inventory interface activity against the F4101 table, tracks purchase order quantities, and also tracks against the general ledger. Budget checking is fully functional when you use this interface code.

D: The item in this line is an inventory item that will not affect availability or quantities. This inventory interface should be used only for direct ship orders.

N: The item is not an inventory item.

To verify whether the item exists in the F4101 table, use an inventory interface value of **N** and the check box Edit Item Master for Non-Stock Item.

G/L Offset (general ledger offset)

Enter a code from UDC 41/9 that identifies the G/L offset that the system uses when it searches for the account to which it posts the transaction. If you do not want to specify a class code, you can enter **** (four asterisks) in this field. You can use AAIs to predefine classes of automatic offset accounts for the JD Edwards EnterpriseOne Inventory Management, JD Edwards EnterpriseOne Procurement Management, and JD Edwards EnterpriseOne Sales Order Management systems from Oracle.

You might assign G/L class codes like this:

IN20 Direct Ship Orders

IN60 Transfer Orders

IN80 Stock Sales

The system can generate accounting entries based upon a single transaction. For example, a single sale of a stock item can trigger the generation of accounting entries similar to these:

Sales-Stock (Debit) xxxxx.xx

A/R Stock Sales (Credit) xxxxx.xx

Posting Category IN80

Stock Inventory (Debit) xxxxx.xx

Stock COGS (Credit) xxxxx.xx

The system uses the class code and the document type to find the AAI.

Include in Tax 1

Enter the code that indicates whether the monetary value of this order line is subject to applicable taxes and which taxes to apply. Values are:

Y: The line is subject to applicable taxes.

N: The line is not subject to applicable taxes.

3-8: The line is subject to applicable taxes at the rate indicated by the group number (3-8). The system uses group numbers for VAT (value-added tax).

Sales Journal Col (sales journal column)

Enter the column of the Sales Journal report in which the sales value is printed. Values are:

1: Column 1 receives the sales value (if any).

2: Column 2 receives the sales value (if any).

3: Column 3 receives the sales value (if any).

4: Column 4 receives the sales value (if any).

G/L Interface (general ledger interface)

Select to instruct the system to reflect the monetary amount or unit value of any activity containing this order line type in the general ledger.

A/R Interface (accounts receivable interface)

Select to instruct the system to reflect the monetary amount or unit value of any activity containing this order line type in the JD Edwards EnterpriseOne Accounts Receivable system from Oracle.

A/P Interface (accounts payable interface)

Select to instruct the system to reflect the monetary or unit value of any activity containing this order line type in the JD Edwards EnterpriseOne Accounts Payable system.

S/WM Interface (service and warranty management interface)

Select to have this order line appear on the second document in a series of four documents that relate to this order. For example, you might need to include receiving information in a purchase order that provides instructions about the desired disposition of goods. Although this information is vital to the proper handling of the order, it should not appear on the purchase order that is delivered to the supplier.

Text Line

Select to specify that the line is text only.

Reverse Sign

Select to instruct the system to reverse the sign of the quantity in the line. This code is used to enable easy entry of credit memos.

Apply Freight

Select to instruct the system to calculate freight charges for the line.

Apply Retainage

Select to instruct the system to include the item's values in the calculation of an accounts payable retainage. Select this option only if the interface between the JD Edwards EnterpriseOne Procurement system and the JD Edwards EnterpriseOne Accounts Payable system is active.

Generate Workorder

Select to have the system automatically generate an internal work order for this order detail line.

Include in Cash Discount

Select to have the system include the extended monetary amount of the transaction in the cash discount or payment terms discount calculation.

Include Sales/COGS for Gross Profit (include sales/cost of goods sold for gross profit)

Select to have the system include sales and cost of goods sold in gross profit calculations.

Voucher Match Variance Account

Select to specify that a variance that is generated during voucher match is booked to the variance account. This option is used only with an inventory interface of A or B in the JD Edwards EnterpriseOne Procurement system.

Edit Item Master for Non-Stock Item

Select to indicate whether the system validates the sales order and purchase order line's item against the Item Master table. Select this option only when using nonstock inventory interface.

Protect Price on Sales Order

Select to indicate that this order line appears on the first document in a series of four documents that relate to this order.

For example, you might need to include receiving information in a purchase order that provides instructions about the desired disposition of goods. Although this information is vital to the proper handling of the order, it should not appear on the purchase order that is delivered to the supplier.

Generate Purchase Order

Select to specify whether the system generates a purchase order for the line. Generally, this option is used with the D and N inventory interface.

Call Materials Issue

Select to specify whether the system activates the materials issue function when performing the receipts into stock function.

You use this option only for the JD Edwards EnterpriseOne Procurement system and when you are using the JD Edwards EnterpriseOne Engineer to Order system from Oracle.

Procurement Receipt Required

Select to indicate whether purchase order lines require a receipt. If you select this option, the purchase order line must be received before the voucher match process.

Expense At Voucher

Select to specify whether the system performs expense during voucher match.

When you receive noninventory purchase order lines that have this option selected, no journal entries will be created except for landed cost journal entries. Receipt and tax amounts will be expensed during voucher match. Any variances between receipt and voucher amount will be booked to the variance account or to the expense account based on the value of the Voucher Match Variance Account option in the Line Type Constants program (P40205). Commitments will be relieved when you post the voucher match batch.

This option can be set only when:

- The Inv. Interface value is either **A** or **B**.
- The A/P Interface option is selected.

The A/P interface is a code that indicates that the system reflects the monetary or unit value of any activity containing this order type in the JD Edwards EnterpriseOne Accounts Payable system.

The Expense At Voucher option is not related to the Procurement Receipt Required check box. If the Expense At Voucher option is selected and if the user does a receipt, receipts will not create any journal entries. Expensing will be done during voucher. If the receipt process is bypassed, then the standard two-way match process will occur.

See [Expense at Voucher Match](#).

Non-Billable Retainage

Select to specify whether the system uses a nonbillable expense AAI (financial AAI PCNBRT) for retainage processing during voucher match. This option can be selected for an inventory interface A or B only. For three-way voucher match, both the Non-Billable Retainage and Expense at Voucher options should be selected to use a nonbillable expense AAI.

See [Working with Retainage](#).

Procurement Allow Service Units

Select to specify whether the system allows the entry of service quantity and service unit of measure (UOM).

This field is a field by itself and has no relation to unit cost to calculate the extended cost. If service quantity is used, the Quantity Ordered field in the JD Edwards EnterpriseOne Procurement system cannot be used.

See "Understanding Subcontract Order Detail Information, Service Units for A, P Matching" in the *JD Edwards EnterpriseOne Applications Subcontract Management Implementation Guide*.

6.4 Setting Up Order Activity Rules

This section provides an overview of order activity rules, lists prerequisites, and discusses how to set up order activity rules.

6.4.1 Understanding Order Activity Rules

For each item or service that you enter on a purchase order, you must enter a line of detail information that describes the order, including the quantity and cost of the item or service. You must set up order activity rules to establish the sequence of steps through which you process each detail line, for example:

1. Enter order
2. Approve order
3. Print order
4. Receive order

You can set up multiple sets of activity rules. You must assign each set of rules to a certain order type (purchase order, requisition, and so on) and line type. For example, you can specify that a set of activity rules apply only to purchase order detail lines that have a line type of S (stock items).

To save time, you can copy an existing order activity rule by accessing a current combination of an order type and a line type and making the necessary changes.

You must assign status codes to each step in activity rules. Status codes identify the current status of a detail line and the next status to which to advance the line. You must define status codes in ascending numerical order. For example, you can set up status codes for stock line types for purchase orders in the following way:

Last	Next	Description
220	230	Enter Order
230	280	Approval Process

Last	Next	Description
280	400	Print Purchase Order
400	999	Receive Order

You can change the progression of steps by indicating alternate next status codes. For example, using the preceding activity rules, you can bypass the Print Purchase Order step for orders that you send electronically. To do this, you must assign an alternate next status code (400) to the Approval Process step. You can then assign the alternate code to detail lines in the approval process.

You can specify that the system write a record to the F43199 table when a detail line enters a certain step in the activity rules.

You cannot delete an order activity rule if records are in the system for which the status matches any of the statuses that are assigned to the order activity rule.

6.4.2 Prerequisites

Before you set up order activity rules, you must:

- Verify that you have set up status codes in the Activity/Status Codes (40/AT) UDC table.
- Verify that you have set up order types in the Document Type (00/DT) UDC table.
- Verify that the correct order line types exist.

6.4.3 Form Used to Set Up Order Activity Rules

Form Name	Form ID	Navigation	Usage
Order Activity Rules - Revisions	W40204A	Procurement System Setup (G43A41), Order Activity Rules Click the Add button on the Work With Order Activity Rules form.	Set up or modify order activity rules.

6.4.4 Setting Up Order Activity Rules

Access the Order Activity Rules - Revisions form.

Figure 6–1 Order Activity Rules - Revisions form

Last Status	Last Status Description	Next Status	Other 1	Other 2	Other 3	Other 4	Other 5	Ledger Y/N
216	Order Outside Purchasing	220	400					N
220	Enter Purchase Order	230	280	400				Y
225	Order Rejected	230						N
230	Approval Process #1	280	220	400				N
280	Print Purchase Order	380	400		300	370		N
282	Receive EDI P O Acknowledgment	380	400	300				N
300	Record Supplier Acknowledgment	380	400					N
325	Order Revised by Acknowledge	362	370	380	400			N
362	Receive EDI PO Change Ack.	370	325	380	400			N
370	Record Supplier Shipment	380	400					N
380	Print Purchase Receiver	400						N
400	Record Purchase Receipt	999	400					N
999	Complete - Ready to Purge							N

Order Type Next Number

Enter a code that tells the system which next number series to use when creating order numbers for this order type. Ten Next Number series are available.

This field addresses:

- Purchase requisitions that carry order numbers differently bid requests and purchase orders.
- Blanket sales orders numbered in a different number range from standard sales orders.

Other 1 - Other 5

Enter additional statuses that can be performed as the next step in the order process. These fields are optional.

Although this is not the preferred or expected next step, this field is an allowed override. The system does not allow you to initiate an order line step or status not defined as either the expected next status or an allowed status. Other allowed status codes let you bypass processing steps. These codes are often referred to in processing options as override next status codes.

Ledger Y/N (ledger yes/no)

Enter a code that determines whether the system writes a record to the F42199 table for Oracle’s JD Edwards EnterpriseOne Sales Order Management and to the F43199 table for JD Edwards EnterpriseOne Procurement. Values are:

Y: The system writes a record for selected fields to the history table.

N: The system does not write a record to the history table.

6.5 Setting Up Procurement Constants

This section provides an overview of procurement constants, lists prerequisites, and discusses how to:

- Define branch/plant constants.
- Define pricing constants.
- Define item availability.
- Define system constants.
- Define application control constants.

6.5.1 Understanding Procurement Constants

A constant is information that you associate with either the entire system or a specific branch/plant. The system uses constants as default information in many JD Edwards EnterpriseOne systems.

After you determine the information that you want to use throughout the system, you can enter the appropriate values or change any predefined values.

6.5.2 Prerequisites

Before you can set up procurement constants, you must:

- Create an address book record for each branch/plant.
- Set up a branch/plant named ALL.
- Set up each branch/plant as a business unit.

6.5.3 Forms Used to Set Up Procurement Constants

Form Name	Form ID	Navigation	Usage
Work With Branch/Plant Constants	W41001B	Procurement System Setup (G43A41), Branch/Plant Constants	Review or select existing branch/plant constants.
Branch/Plant Constants	W41001H	Click Add on the Work With Branch/Plant Constants form.	Set up branch/plant constants.
Pricing Constants	W41001D	Select a branch/plant on the Work With Branch/Plant Constants form, and then select Price Constants from the Form menu.	Set up pricing constants.
Item Availability Definition	W41001G	Select a branch/plant on the Work With Branch/Plant Constants form, and then select Availability from the Row menu.	Define item availability.

Form Name	Form ID	Navigation	Usage
System Constants	W41001F	Select a branch/plant on the Work With Branch/Plant Constants form, and then select Sys. Constants from the Form menu.	Set up system constants.
Application Constants	W41001E	Select a branch/plant on the Work With Branch/Plant Constants form, and then select App. Constants from the Form menu.	Set up application constants.

6.5.4 Defining Branch/Plant Constants

Access the Branch/Plant Constants form.

Branch/plant constants enable you to customize the processing of daily transactions for each branch/plant in the distribution and manufacturing systems.

Note: If you use the JD Edwards EnterpriseOne Warehouse Management system from Oracle, you must define the warehouse information on the Branch Location Definition form, which is contained in the Branch/Plant Constants program (P41001). Otherwise, you should define at least location length information.

Symbol Customer/Supplier

Enter a character that identifies the customer's or supplier's number in the system. When you enter a number preceded by this character, the system recognizes the number as the customer's or supplier's number. The system then uses the cross-reference table to match the number to the item number. You must complete this field if you want the system to perform cross-referencing.

Commitment Method

Enter a code that exists in the Inventory Commitment Method (H40/CM) UDC to indicate the method that the system uses to commit lot items from inventory. Values are:

1: The normal commitment method for inventory. The system commits inventory from the primary location and then from secondary locations.

The system commits inventory from the locations with the most inventory before committing inventory from locations with the least. The system commits back orders to the primary location.

2: The inventory commitment method by lot number. The system commits inventory by lot number, starting with the lowest lot number and committing orders to available lots.

3: The inventory commitment method by lot expiration date. The system commits inventory from the locations with the earliest expiration date first. The system considers only locations with expiration dates greater than or equal to the sales order or parts list requested date.

Specific Commitment (Days)

Enter a number that the system uses to determine when to commit inventory to an order in sales order processing. This value in days is added to current date and compared with the promised ship date for the order line. If the promised date is greater than the calculated date, then the order line will be future committed in the F41021 table. Enter **999** to eliminate future commits.

Number of Days in Year

Enter the number of days in a year that the company is open for business. This field is required. You must specify a number from 252 to 365. The JD Edwards EnterpriseOne Procurement system uses this number to calculate the Economic Order Quantity (EOQ).

Supplier Cross Ref. Code (supplier cross-reference code)

Enter a value from the Cross Reference Type Code (41/DT) UDC that identifies the type of cross-reference set up for this supplier. Examples of values include:

- 1: Substitutes
- 2: Replacements
- 3: Bar codes
- 4: Customer numbers
- 5: Supplier numbers

Purchasing

Enter a value from the Cost Method (40/CM) UDC that indicates the cost method that the system uses to determine the cost of the item for purchase orders. Cost methods 01 through 19 are reserved.

Sales/Inventory Costing Method

Enter a value from the Cost Method (40/CM) UDC that indicates the cost method that the system uses to calculate the cost of goods sold for the item. Cost methods 01 through 19 are reserved.

Current Inventory Period

Enter the number (from 1 to 14) that identifies the current accounting period. The system uses this number to generate error messages, such as PBCO (posted before cut off) and PACO (posted after cut off).

Purchase Order Issue Cost

Enter the amount that the JD Edwards EnterpriseOne Procurement system uses to calculate the EOQ. This cost should be the estimate of the cost of materials, labor, and overhead that you incur when you issue a single purchase order. The default value is 0.00.

Inventory Carrying Cost (%) (inventory carrying cost (percent))

Enter the percentage of inventory investment that the JD Edwards EnterpriseOne Procurement system uses to calculate EOQ. The default is 0.00. Enter the percentage as a decimal value.

General Ledger Explanation

Enter a code that exists in the General Ledger Explanation (H41/PR) UDC. The JD Edwards EnterpriseOne Inventory Management system uses this value to select the default description that appears on the second line of a journal entry in the general ledger. Values are:

- 1: Item master description (the default).

2: Primary item number.

Approval Route Code

Enter a code that determines to whom an order is routed for approval.

Backorders Allowed

Select this option to allow backorders for this item. You can allow backorders by item using the Item Master (P4101) program or the Item Branch/Plant (P41026) program, by customer using the Customer Billing Instructions program (P03013), or by branch/plant using the Branch/Plant Constants program (P41001).

Interface G/L (interface general ledger)

Select to specify that inventory transactions processed through this branch/plant create general ledger entries.

Write Units to Journal Entries

Select to specify that the system moves units to the general ledger after the system records a journal entry.

Location Control

Select to specify that the system uses only those locations that exist in the Location Master table (F4100).

Warehouse Control

Select to specify that the system create warehouse transactions for the branch/plant.

Quality Control

Select to specify that the system enables the JD Edwards EnterpriseOne Quality Management system (system 37) for the branch/plant.

Use Product Cost Detail

Select to specify that the programs in the distribution system use the detailed product cost method of product costing. If you do not select this option, the distribution programs use the total cost method.

Foreign Depot

Select to indicate that another company owns the branch/plant. The Bulk and Packed Load Confirmation programs use this code to determine whether the depot from which product is being loaded is a foreign depot. If it is a foreign depot, you must enter a valid borrow agreement during load confirmation.

Inventory Lot Creation

Select to specify that the inventory transaction programs create new lot or serial numbers in the system.

If you do not select this option, the system does not enable the inventory transaction programs to create new lot numbers in the system.

6.5.5 Defining Pricing Constants

Access the Pricing Constants form.

You can define pricing constants to enable you to enter advanced pricing information in the JD Edwards EnterpriseOne Procurement and JD Edwards EnterpriseOne Sales Order Management systems.

Advanced Sales Pricing (Y/N)

Select to specify that the system use advanced sales pricing. If the system includes the advanced pricing module, you can use this feature.

Advanced Procurement Pricing (Y/N)

Select to specify that the system use the JD Edwards EnterpriseOne Advanced Pricing system for procurement.

Require Price Approval (Y/N)

Select to specify that all price changes are provided through the price approval workflow.

Promotion System Flag

Enter a code from the Promotion System Flag (40P/PS) UDC to specify whether to use a promotion system.

Multiple Promotions Resolution Flag

Enter a code from the Promotion Resolution Flag (40P/PR) UDC to specify which promotion to use when multiple promotions exist.

6.5.6 Defining Item Availability

Access the Item Availability Definition form.

You must define how you want the system to calculate item availability for each branch/plant. Item availability affects how the system calculates back orders, cancellations, and customer delivery times.

Note: If you are using the JD Edwards EnterpriseOne Configurator system from Oracle, you must set the Check Availability field in the Configurator Constants program (P3209) to check availability during sales order entry. If the system finds the exact item and string match, a window displays all locations containing the specific configuration.

Quantity Soft Committed to SO WO (quantity soft committed to sales order work order)

Select to enable the system to include in the item availability calculation the number of units that are soft committed to sales orders or work orders. Selecting this option reduces the quantity available.

Quantity Hard Committed to SO (quantity hard committed to sales order)

Select to enable the system to include in the item availability calculation the number of units that are hard committed to sales orders. Selecting this option reduces the quantity available.

Quantity Future Committed to SO (quantity future committed to sales order)

Select to enable the system to include in the item availability the quantity on any sales order for which the requested shipment date is beyond the specific commitment days. Selecting this option reduces the quantity available.

Quantity Hard Committed to WO (quantity hard committed to work order)

Select to enable the system to include in the item availability the number of units that are hard committed to a specific location and lot for work orders. Selecting this option reduces the quantity available.

Other Quantity 1 SO (other quantity 1 sales order)

Select to enable the system to include in the item availability the quantity specified as an additional reduction in the item availability calculation. Selecting this option reduces the quantity available.

Other Quantity 2 SO (other quantity 2 sales order)

Select to enable the system to include in the item availability the quantity specified as an additional reduction in the item availability calculation. Selecting this option reduces the quantity available.

Quantity on Hold

Select to enable the system to include in the item availability the number of units on hold. Selecting this option reduces the quantity available.

Safety Stock

Select to enable the system to include in the item availability the number of units reserved as safety stock. Selecting this option reduces the quantity available.

Quantity on Purchase Order Receipts

Select to enable the system to include in the item availability the number of units on purchase orders. Selecting this option increases the quantity available.

Quantity on PO - Other 1 (quantity on purchase order - other 1)

Select to enable the system to include in the item availability the number of units on other purchase orders. Selecting this option increases the quantity available.

Quantity on Work Order Receipts

Select to enable the system to include in the item availability the number of units on work orders. Selecting this option increases the quantity available.

Quantity in Transit

Select to enable the system to include in the item availability the number of units in transit. Selecting this option increases the quantity available.

Quantity in Inspection

Select to enable the system to include in the item availability the units in inspection. Selecting this option increases the quantity available.

Quantity in Operation 1

Select to enable the system to include in the item availability the number of units in one operation of the receipt routing. Selecting this option increases the quantity available.

Quantity in Operation 2

Select to enable the system to include in the item availability the number of units in one operation of the receipt routing. Selecting this option increases the quantity available.

6.5.7 Defining System Constants

Access the System Constants form.

Figure 6–2 System Constants form

Branch/Plant Constants - System Constants

Unit of Measure Conversion by Branch
 Update Average Cost On-Line
 ECS Control
 Internet Enable PPAT Messages
 Scientific Rounding
 Use Customer Set
 Ship Ascending Date Rule
 Enable Sales Taxed Prices

By Sold To By Ship To

Allow Duplicate Lots	2
Sales Price Retrieval UOM	1
Purchase Price Retrieval UOM	2
Sales Price Based On Date	
Purchase Rebate Category Code	3
Preference Schedule	
Pref Retrieval UOM	
Accelerated Pricing Resolution Engine	

Set up system constants to determine how the system performs certain functions. For example, assume that you have several branch/plants and you use different units of measure for the items in each branch/plant. You can set a system constant to automatically convert units of measure by branch.

Unit of Measure Conversion by Branch

Select to enable the system to display the item-specific conversion table when you add an item to a specific branch/plant. If you do not select this option, the system displays the item-specific conversion table for all branch/plants from the Item Master table.

Update Average Cost On-Line

Select to enable the system to calculate a new average cost immediately after any transaction occurs that affects the average cost of an item. If you do not select this option, the system calculates a new average cost when you run the Average Cost Update program.

ECS Control (energy and chemical system control)

Select to enable the system to use the JD Edwards EnterpriseOne Energy and Chemical System application from Oracle.

Allow Duplicate Lots

Enter a value from the Duplicate Lots Allowed (40/DU) UDC to specify whether the system is enabled to assign the same lot to multiple items.

Purchase Price Retrieval UOM (purchase price retrieval unit of measure)

Enter a value from the Purchase Price Retrieval UOM (40/PU) UDC table to represent the unit of measure that the system retrieves for the purchase base price (F41061) during purchase order processing. If you specify the unit of measure for transaction or pricing and the system does not find a record in that unit of measure, the system repeats the process using the primary unit of measure of the item.

Purchase Rebate Category Code

Enter a value from the Rebate Distribution Constants (43/RU) UDC table to specify which category code the system uses in the criteria for inclusion comparison.

Accelerated Pricing Resolution Engine

Select to enable the system to use the Accelerated Pricing Resolution Engine. Values are:

Blank or **0**: Do not enable use.

1: Enable use.

2: Auto load.

Auto load automatically loads the cache when any user processes a transaction using one of the cached tables.

Note: Oracle recommends that you thoroughly read and understand the details of how the Accelerated Pricing Resolution Engine works, its limitations, and how to manage it before you enable it.

6.5.8 Defining Application Control Constants

Access the Application Constants form.

Defining application control constants prevents the system from applying changes that unauthorized personnel make to the general ledger. Also, you can define a constant that requires you to enter batch control information before the system runs a batch processing job. You might enter batch control information to compare the anticipated size of the job to the end result.

You must define management approval and batch control separately for each distribution and manufacturing system that you use.

Figure 6–3 Application Constants form

	System Code	Description	Mgmt Apprv	Batch Ctrl
<input checked="" type="radio"/>	31	Shop Floor Control	Y	
<input type="radio"/>	41	Inventory Mana...	N	N
<input type="radio"/>	42	Sales Managem...	Y	
<input type="radio"/>	43	Procurement	N	N

Mgmt Apprv (management approval)

Enter Y to assign a status of pending to each batch that you create within the listed systems. Enter N to assign a status of approved to each batch.

Batch Ctrl (batch control)

Enter Y to require entry of batch control information.

6.6 Setting Up UDCs

This section discusses the UDCs that you set up to process purchase orders.

6.6.1 Document Type (00/DT)

Set up this UDC with the values that you use to indicate document types used for procurement. For example, *OP* indicates a purchase order.

6.6.2 Schedule Name (40/AS)

Set up this UDC with names for price adjustment schedules that the system uses to identify advanced pricing adjustments. After defining a schedule name, you can attach pricing adjustments to the schedule. You can define adjustment names before or after setting up pricing adjustments.

6.6.3 Average Cost Calculation (40/AV)

Set up this UDC with the programs that the system runs to process taxes during purchase order processing.

6.6.4 Landed Cost Components (40/CA)

Set up this UDC with codes that indicate the types of landed costs applied to items or services. The system uses these values when you enter landed costs for receipts.

6.6.5 Commitment Document Types (40/CT)

JD Edwards EnterpriseOne software provides hard-coded values for the document types that the system uses when you process commitments. When you create an order detail line, the system automatically creates commitments and encumbrances if the

document type exists in the Commitment Document Types (40/CT) UDC and the line type has an inventory interface of A or B.

6.6.6 Item Change Files - (P40821X) (40/IC)

Use this UDC to list tables that the system updates when you change item number information. The processing options for the Item Master program (P4101) and the Non Stock Item Master program (P4101N) use this UDC to specify which table the system updates if you select the option to update selected tables.

6.6.7 Order Templates (40/OT)

Set up values in this UDC with the names of order templates. The system uses the codes that you define when you use the Supplier Template Revisions program (P4015) to create purchase order templates.

6.6.8 Customer Price Groups (40/PC)

Set up this UDC with codes that identify the pricing groups that you associate with suppliers. You assign a pricing group to a supplier when you define the supplier billing instructions.

6.6.9 Item Price Groups (40/PI)

Set up this UDC with values that identify inventory price groups for items. Inventory price groups have unique pricing structures that direct the system to incorporate discounts or markups on items on sales and purchase orders. The discounts or markups are based on the quantity, monetary amount, or weight of the item ordered. When you assign a price group to an item, the item takes on the same pricing structure defined for the inventory price group.

You must assign an inventory price group to the supplier or customer, as well as to the item, for the system to interactively calculate discounts and markups on sales orders and purchase orders.

6.6.10 Print Messages (40/PM)

Set up this UDC with the text messages that the system prints on orders. Examples of text messages are engineering specifications, hours of operation during holiday periods, and special delivery instructions.

6.6.11 G/L Posting Category (41/9)

Set up codes for the general ledger class descriptions for the distribution AAIs. The G/L Posting Category UDC table (41/9) controls which general ledger accounts receive the currency amount of inventory transactions for an item.

6.6.12 Cross Reference Type Code (41/DT)

Set up values in this UDC to specify the type of cross-reference that the system uses when printing a supplier's item number. The system stores the cross-reference information in the F4013 table.

The special handling codes are used by JD Edwards EnterpriseOne Advanced Pricing for promotional items.

6.6.13 Commodity Class Codes (41/P1)

Set up values in this UDC that represent an item property type or classification, such as commodity type, planning family, and so forth. The system uses this code to sort and process like items.

6.6.14 Commodity Sub Class Codes (41/P2)

Set up values in this UDC that represent an item property type or classification, such as commodity type, planning family, and so forth. The system uses this code to sort and process like items.

6.6.15 Supplier Rebate Codes (41/P3)

Set up values in this UDC to describe different rebates negotiated with a supplier. You can use this UDC when entering purchasing classification codes in the Item Master program. The system uses these codes for sorting and categorizing items.

6.6.16 Master Planning Family (41/P4)

Set up values in this UDC to define master planning families for the items in the system. Master planning families enable you to group items for planning purposes.

6.6.17 Landed Cost Rule (41/P5)

Set up values in this UDC to identify types of landed costs. The landed cost rule determines purchasing costs that exceed the actual price of an item, such as broker fees or commissions. You set up landed cost rules on the Landed Cost Revisions form.

6.6.18 Price Category Type (42/CT)

Set up values in this UDC to identify the basis for price rules, for example, purchase order discounts or order repricing. In procurement, you select the appropriate value from this UDC when you set up price discount rules for suppliers.

6.6.19 Freight Handling Code (42/FR)

Set up values in this UDC to indicate who is responsible for paying the freight charges to the carrier and at what point ownership is transferred. You use this UDC in the purchasing instructions for the supplier.

6.6.20 Hold Codes (42/HC)

Set up values in this UDC to identify why orders are on hold. This UDC is not hard-coded and has no special handling code logic.

6.6.21 Certification Status (43/CR)

Set up values in this UDC to indicate whether a supplier is certified to sell this item. The code that you enter determines how the system manages orders that you enter for the supplier and item.

6.6.22 Movement Code (43/MC)

JD Edwards EnterpriseOne provides hard-coded values for this UDC that the system uses when you use receipt routing.

6.6.23 Model Log Types (43/ML)

Set up values in this UDC to establish values that the system uses when you create model logs.

6.6.24 Operation Codes (43/OC)

Set up values in this UDC to identify operations or steps within a receipt route.

6.6.25 Outstanding Log Types (43/OL)

JD Edwards EnterpriseOne provides hard-coded values for this UDC that the system uses when you enter log information.

6.6.26 Procurement Rebate Order Type (43/RB)

Set up values in this UDC to identify types of rebates.

6.6.27 Route Codes (43/RC)

Set up values in this UDC to identify receipt routes. Each receipt route consists of a series of operations through which the system directs items upon receipt. The system uses the values that you establish when you set up receipt routes.

6.6.28 Rebate Status (43/RS)

Set up values in this UDC to define the status of the rebate agreement. The status can be pending or active. The value **A** (active) is hard-coded to indicate that the rebate information will be updated.

6.6.29 Rebate Type (43/RT)

JD Edwards EnterpriseOne provides hard-coded values that you use to indicate whether a rebate is a percentage of the quantity purchased or a fixed currency amount.

6.6.30 View Progress Payments (43B/VW)

Set up values in this UDC to use as the default for the type of voucher match that you specify in the Voucher Match program (P4314).

6.6.31 Transaction Set Purpose Code (47/PU)

Set up values in this UDC to define the purpose of JD Edwards EnterpriseOne Electronic Data Interchange (EDI) transactions that you send or receive.

6.7 Setting Up AAls

This section provides an overview of AAI tables for the JD Edwards EnterpriseOne Procurement system, AAI tables for the financial system, and discusses how to:

- Set processing options for Distribution AAls (P40950).
- Set up distribution AAls.

6.7.1 Understanding AAI Tables for the JD Edwards EnterpriseOne Procurement System

You set up AAIs to determine the accounts to which the system distributes general ledger entries.

In the JD Edwards EnterpriseOne Procurement system, the system creates journal entries when you receive an inventory item. You set up AAIs to indicate the accounts for which the system creates the journal entries. You also can enter memo text for each AAI.

In the JD Edwards EnterpriseOne Subcontract Management system from Oracle, AAIs define the links among the JD Edwards EnterpriseOne Subcontract Management, JD Edwards EnterpriseOne Job Cost, and JD Edwards EnterpriseOne General Accounting systems.

The JD Edwards EnterpriseOne Procurement system uses multiple AAI tables, each of which applies to a certain type of transaction. In each table, you specify a general ledger account for each unique combination of company, document type, and general ledger class.

For example, you can set up an AAI table for inventory receipt transactions. Each time you enter a receipt for an inventory item, the system determines the general ledger account to which to debit the receipt based on the company, document type, and general ledger class for the receipt.

The system stores AAIs in the Distribution/Manufacturing - AAI Values table (F4095).

6.7.1.1 AAIs for Purchase Order Entry

These AAI tables determine which accounts are debited and credited when you enter a purchase order:

Table	Description
4310	Account derived for commitments or purchase order line from the inventory interface of C (stock-based purchases).
4315	Account derived for commitments or purchase order line from the inventory interface of B (nonstock-based purchases).

6.7.1.2 AAIs for Receipts and Voucher Match

These AAI tables determine which accounts are debited and credited when you enter purchase order receipts or create vouchers:

Table	Description
4310	Journal entry debit to an inventory evaluation account that the PO Receipts program (P4312) creates.
4315	Journal entry debit to a nonstock inventory account that the PO Receipts program creates when you are not using an account number on the purchase order.
4320	Journal entry credit or debit to a received not-vouchered account that the PO Receipts program and the Voucher Match program (P4314) create.

Table	Description
4322	Journal entry credit to the account on 4322 AAI instead of using the account in the 4320 AAI. The receipt line will not be vouchered because the A/P interface is disabled in the line type constants. Note: A/P Interface check box (API) is cleared in the Line Type Constants program (P40205).

6.7.1.3 AAls for Variances

These AAI tables determine which accounts are debited and credited when a variance exists in the cost of an item:

Table	Description
4330	Journal entry credit or debit to a receipt cost/actual cost paid variance account that is created from the Voucher Match program (P4314).
4332	Journal entry credit or debit to an actual cost paid variance/cost of sales account that is created from the Voucher Match program.
4335	Journal entry credit or debit to a standard cost/actual cost variance account that is created from the PO Receipts program (P4312).
4337	Journal entry debit to a manufacturing material burden account that is created from the PO Receipts program. (Used with standard costs.)
4340	Journal entry credit or debit to record an exchange rate variance that is created from the Voucher Match program. Variance occurs if the purchasing rate differs between the time of receipt and the time of voucher creation.

AAI 4338 (reprice variance/inventory) and AAI 4339 (reprice variance/non inventory) are used in Oracle's JD Edwards EnterpriseOne Grower Management and JD Edwards EnterpriseOne Procurement systems.

See "Setting Up AAls" in the *JD Edwards EnterpriseOne Applications Grower Management Implementation Guide*.

6.7.1.4 AAls for Tax Liabilities

These AAI tables determine which accounts are debited and credited when you work with tax liabilities:

Table	Description
4350	Journal entry debit for accrued purchasing taxes that is created from the PO Receipts (P4312) and Voucher Match (P4314) programs.
4355	Journal entry credit to a tax received but not vouchered temporary liability account that is created from the PO Receipts program.

6.7.1.5 AAls for Receipt Routing

This AAI table determines which accounts are debited and credited when you process items through a receipt route:

Table	Description
4375	Journal entry debit to an inventory disposition account that is created during the receipt routing process. Typically, this is a result of goods being damaged. However, payment is still required.

6.7.1.6 AAls for Landed Costs

These AAI tables determine which accounts are debited and credited when you work with landed costs:

Table	Description
4385	Journal entry debit for landed costs/expense adjustments that is created while one of these programs is running: the PO Receipts program (P4312), the Purchase Receipts Inquiry program (P43214), or the Voucher Match program (P4314).
4390	Journal entry credit for landed costs/expense adjustments that is created while one of these programs is running: the PO Receipts program, the Purchase Receipts Inquiry program, or the Voucher Match program.

6.7.1.7 AAls for Zero Balance Adjustments

These AAI tables determine which accounts are debited and credited when you work with zero balance adjustments:

Table	Description
4400	Journal entry to credit an inventory evaluation account that is created from the PO Receipts program (P4312) when receipt results in on-hand quantity ending at zero, with a remaining general ledger cost. Typically, this is the result of a transaction reversal at a different cost from the original transaction.
4405	Journal entry to debit an inventory evaluation account that is created from the PO Receipts program (P4312). This debit occurs when receipt results in on-hand quantity ending at zero, with a remaining general ledger cost. Typically, this is the result of a transaction reversal at a different cost from the original transaction.

6.7.2 Understanding AAI Tables for the Financial System

Two categories of AAls relate to the JD Edwards EnterpriseOne Procurement Management system. Each of these categories has a unique prefix that defines the way it is used in the system.

See "Setting Up Automatic Accounting Instructions" in the *JD Edwards EnterpriseOne Applications Financial Management Fundamentals Implementation Guide*.

6.7.2.1 AAls for Freight Distribution (PCFRTD)

Use this AAI to determine which account to use when you enter freight distribution. You must define the PCFRTD AAI before the Voucher Match program (P4314) can process freight distribution.

6.7.2.2 AAls for Non-Billable Retainage (PCNBRT)

Use this AAI to determine which account to use for nonbillable retainage. You must define the PCNBRT AAI before the Progress Payments program (P4314) can process vouchers with nonbillable retainage.

6.7.3 Form Used to Set Up AAls

Form Name	Form ID	Navigation	Usage
Account Revisions	W40950D	Procurement System Setup (G43A41), Automatic Accounting Instructions Select a row on the Work With AAls form, and then select Details from the Row menu. Subcontract System Setup (G43D41), Automatic Accounting Instructions Select a row on the Work With AAls form, and then select Details from the Row menu.	Set up AAls.

6.7.4 Setting Processing Options for Distribution AAls (P40950)

Processing options enable you to specify the default processing for programs and reports.

6.7.4.1 Defaults

These processing options enable you to specify default information for the Distribution AAls program (P40950).

AAI Table Number

Enter a number to use to specify sequence and retrieve accounting information.

Availability to Distribution AAI Tables

Enter **1** if the Cost Type field should be available to these Distribution AAI tables: 4122, 4124, 4134, 4136, 4220, 4240, and 4310.

6.7.5 Setting Up Distribution AAls

Access the Account Revisions form.

Obj Acct (object account)

Enter the portion of a general ledger account that refers to the division of the cost code (for example, labor, materials, and equipment) into subcategories. For example, you can divide the cost code for labor into regular time, premium time, and burden.

If you use a flexible chart of accounts and the object account is set to six digits, you should use all six digits. For example, entering **000456** is not the same as entering **456** because, if you enter **456**, the system enters three blank spaces to fill a six-digit object.

6.8 Creating Tolerance Rules

This section provides an overview of tolerance rules and discusses how to create a tolerance rule.

6.8.1 Understanding Tolerance Rules

You create tolerance rules to determine how much a detail line can change before it exceeds tolerance. For example, you enter a receipt for which the quantity exceeds more than 10 percent of the quantity entered on the purchase order. You can have the system prevent the transaction from exceeding tolerance.

You can set the tolerance rule by item, item category code, or company. You create tolerance rules to specify the number or percentage by which these values can change:

- Quantity
- Unit cost
- Extended amount

You can set tolerance rules for three types of transactions:

- Receiving.
- Creating vouchers.
- Creating purchase orders through requisition consolidation and blanket release.

If a detail line exceeds tolerance, the system either displays an error message or prevents you from entering the transaction, depending on how you set the processing options. During voucher match, you can also specify that the system assign a pay status code to lines exceeding tolerance.

If you do not specify a percentage or amount for the quantity, unit cost, and extended amount categories, the system will not perform tolerance checking for the category that you leave blank. The system performs tolerance checking only for transactions that exceed the tolerance rule range.

You can prevent the system from allowing any tolerance by specifying a zero tolerance. When you select the option to enter a zero tolerance for a percentage or amount, you cannot receive, voucher, or release over the amount on the original purchase order line.

6.8.1.1 Tolerance Rules in the VMA Process (Release 9.1 Update)

The voucher match automation process utilizes a tolerance to match invoice lines with receipts, when the receipt amount is greater than the invoices amount.

You can apply this tolerance only when you use automation rules 02 or 03. You specify whether to use this tolerance in the processing option in the VMA UBE program (R4304020).

See [10. Apply tolerance on receipt amount greater than the invoice amount. \(Release 9.1 Update\)](#)

The system applies this tolerance based on the tolerance rules in the standard Purchasing Tolerance Rules program (P4322).

Note: You can apply this tolerance only when you run the VMA UBE program (R4304020). You cannot apply this tolerance when you match invoices by using the Voucher Match Process Workbench program (P4314WB).

6.8.2 Form Used to Create Tolerance Rules

Form Name	Form ID	Navigation	Usage
Purchasing Tolerance Rules Revisions	W4322A	Procurement System Setup (G43A41), Tolerance Rules Click Add on the Work With Purchasing Tolerance Rules form.	Create tolerance rules.

6.8.3 Creating a Tolerance Rule

Access the Purchasing Tolerance Rules Revisions form.

Function (Program)

Enter a value from the Function Type (43/FT) UDC table to specify the function for which the tolerance rule applies.

Item Number, Commodity Class, and Company

Complete one of these fields. The system displays an error message when you click OK when you complete more than one of these fields.

Zero Tolerance

Select to specify that no variations are accepted for any tolerance field for which you do not complete a tolerance percentage.

Tolerance Percentage

Enter a percentage above which the system accepts a purchase order line without issuing a warning message. The percentage is based on the line quantity and is used during the receiving process. If you leave this field blank, the system does not perform tolerance checking unless you select the corresponding Zero Tolerance option to specify that no variance is allowed.

Enter this percentage in whole numbers. For example, enter 10 percent as **10**.

Tolerance Units

Enter the number of units above which the system accepts a purchase order line without issuing a warning message. The unit is based on the line quantity and is used during the receiving process. If you leave this field blank, the system does not perform tolerance checking unless you select the corresponding Zero Tolerance option to specify that no variance is allowed.

Tolerance Amount

Enter the amount above which the system accepts a purchase order line without issuing a warning message. The amount is based on the line price and is used during the receiving process. If you leave this field blank, the system does not perform tolerance checking unless you select the corresponding Zero Tolerance option to specify that no variance is allowed.

6.9 Setting Up Rounding Tolerance Rules For Voucher Match Automation (Release 9.1 Update)

This section provides an overview of rounding tolerance rules for voucher match automation and discusses how to set up rounding tolerance rules for voucher match automation.

6.9.1 Understanding Rounding Tolerance Rules for Voucher Match Automation

The voucher match automation process enables you to automatically match invoices to receipts and purchase orders. You can assign one of five automation rules to each supplier, or you can elect to not assign an automation rule to a supplier that is excluded from this process.

When you assign automation rule 05 to a supplier, the system applies a rounding tolerance rule while processing the voucher match, if you set a processing option in the Voucher Match Automation UBE for Automation Rule 02, 03, 04, 05 program (R4304020) to do so. You use the Rounding Tolerance Rules (P43221) program to set up rounding tolerance rules.

You can set up rounding tolerance by company only, or by a combination of a company and supplier. When you run the voucher match automation process for records for which rounding tolerance is enabled, the system applies the rounding tolerance rule set up for a combination of a company and supplier if one exists. If a rounding tolerance rule does not exist for the combination of company and supplier, then the process applies the rounding tolerance rule that exists for the company. If no record exists for the company, then the system does not apply any rounding tolerance.

You can set up rounding tolerance to enable negative tolerance, positive tolerance, or both negative and positive tolerance. The tolerance amount that you enter must be less than 1.00. For example, you can enter **.99** or **.375**, but you cannot enter **1.50**. If you want to enable only negative or only positive tolerance, you can set up one type and either select the Zero Tolerance option or leave the other type blank.

The currency setup for a company defines how many decimal places the system saves to the Rounding Tolerance Rules table (F43221). If you enter a value with more decimal places than allowed by the company's currency setup, the system rounds the amount to the closest decimal amount allowed. For example, if your company's currency enables two decimal places and you enter **.375**, the system saves the value in the F43221 table as **.38**. The system applies the saved value when you run the voucher match automation process with rounding tolerance enabled. Note that the system does *not* create journal entries for the variance that results from the rounding difference between the voucher and the receipt amounts.

To use rounding tolerance rules, the currency code assigned to the company must have decimals enabled. You enable decimals for a currency in the Designate Currency Codes program (P0013). If you attempt to set up a rounding tolerance rule for a company whose currency does not allow decimals, then the Rounding Tolerance program issues an error message and does not allow you to create the rounding tolerance rule.

6.9.2 Forms Used to Set Up Rounding Tolerance for Voucher Match Automation

Form Name	Form ID	Navigation	Usage
Work With Rounding Tolerance Rules	W43221A	Automation Voucher Processing (G43B15), Rounding Tolerance Rules	Review and select existing rounding tolerance rules.
Rounding Tolerance Rules Revision	W43221B	Click Add on the Work With Rounding Tolerance Rules form.	Enter positive and negative amounts by supplier or company; or indicate that no tolerance is allowed.

6.9.3 Setting Up Rounding Tolerance Rules for Voucher Match Automation

Access the Rounding Tolerance Rules Revision form.

Figure 6–4 Rounding Tolerance Rules Revisions

Company

Enter the company for which you set up the rounding tolerance. You must specify a company.

Supplier

Enter the supplier for which you set up the rounding tolerance. This field is optional.

Positive Amount

Enter the positive tolerance amount. The amount that you enter must be a value between and including 0.01 to 0.99.

Negative Amount

Enter the negative tolerance amount. The amount you enter must be between and including -0.01 to -0.99.

Zero Tolerance

Select this option to prevent rounding tolerance. You can select the Zero Tolerance option for negative tolerance, positive tolerance, or for both negative and positive tolerance.

Note: When you select the Zero Tolerance option for positive tolerance, the system populates the amount field with 999,999,999,999.00. When you select the Zero Tolerance option for negative tolerance, the system populates the amount field with 999,999,999,999.00-.

6.10 Setting Up Order Hold Information

This section provides an overview of order hold information, lists a prerequisite, and discusses how to enter order hold information.

6.10.1 Understanding Order Hold Information

You can put an order on hold to prevent it from being processed. When you assign a hold code to an order, the system does not allow you to process the order until you release the hold.

Note: Procurement holds must be set up at the order level. Procurement does not support line level holds.

You must set up the individual hold codes that you intend to assign to orders. Each hold code can identify a certain type of hold. For example, you might set up a hold code to identify orders that exceed budget. Administrative holds and approval holds also exist. You might set up another hold code to identify orders that exceed the maximum order amount.

Predefined system-assigned hold codes also exist. The system automatically assigns budget holds to orders if you set processing options for the Purchase Orders program (P4310) accordingly. The system automatically assigns approval holds after you have set the processing options for Purchase Orders (P4310) accordingly and the order is awaiting approval. The system also assigns a hold code to an order if you have entered a hold code for the supplier.

You can specify the person who is responsible for reviewing and releasing a certain type of order hold. You must specify a password for each hold code. Only those individuals who know the password can release an order to which the hold code is assigned.

6.10.2 Prerequisite

Verify that you have set up hold codes in the Hold Codes (42/HC) UDC table.

6.10.3 Forms Used to Set Up Order Hold Information

Form Name	Form ID	Navigation	Usage
Work With Hold Order Constants	W42090A	Procurement System Setup (G43A41), Order Hold Information Subcontract System Setup (G43D41), Order Hold Information	View or select existing order hold records.

Form Name	Form ID	Navigation	Usage
Order Hold Information	W42090B	Click Add on the Work With Hold Order Constants form.	Enter order hold information.

6.10.4 Entering Order Hold Information

Access the Order Hold Information form.

Hold Code

Enter a code from the Hold Codes (40/HC) UDC table to specify why an order is placed on hold.

Person Responsible

Enter the address book number of the person who is responsible for reviewing and releasing orders placed on hold.

Limit Type

Enter a value from the Limit Type (42/LM) UDC table to specify the type of value the system validates. For example, you might enter a value to specify an amount or a percentage.

Code Type

Enter a value from the Code Type (42/TC) UDC table to specify the hold code that applies at the order level. For credit holds, the hold code applies to the whole order. Procurement holds do not support line level holds.

Age From

Enter a value from the Aging Period (H40/AP) UDC code to specify the aging period that the system uses when you specify a credit check based on the aging of the customer's accounts receivable.

Allowable % (allowable percentage)

Enter a number that informs the system of the percentage of total receivables to accept in the column specified in the Age From field. You must complete the Allowable % field when aging credit checking is used.

For example, if the customer has a total accounts receivable balance of 10,000 with 2,500 of that in the 31-60 day column. the age from value is 3 (31-60 days) and the acceptable percent value is 10 (10%). Therefore, this customer could have as much as 1,000 (10,000 × 10%) in columns 3 through 6 and still pass this credit check. Because the customer has more, the system will place its orders on hold.

Upper Limit

Enter the amount that the system uses as the high end of a range of acceptable margin percentages or amounts. Complete this field when you want to establish a maximum gross margin percentage or amount for an order or an individual order line.

Lower Limit

Enter the amount that the system uses as the low end of a range of acceptable margin percentages or amounts. Complete this field when you want to establish a maximum gross margin percentage or amount for an order or an individual order line.

Password

Enter a value that the system requires before it releases a held order. Only users with access to the password can release an order. Do not enter blanks anywhere in the password.

6.11 Setting Up Landed Costs

This section provides an overview of landed costs, lists prerequisites, and discusses how to set up landed costs.

6.11.1 Understanding Landed Costs

Landed costs are costs that exceed the purchase price of an item. They are generally associated with the expected delivery charges of an order, but might also be for broker fees, commissions, and so on. Landed costs are additional fees incurred to deliver an *individual item* into inventory. Landed costs cannot be applied to the total cost of a purchase order. Also, landed costs are not taxable.

You can assign landed costs to a specific item and branch/plant or to a cost rule (a group of landed costs to which you assign a name). You set up landed cost rules in the Landed Cost Rule (41/P5) UDC table. After you create a cost rule, you can assign it to an inventory item, a supplier, a purchase order, or a detail line. By assigning landed costs, you can track the actual cost of purchasing an item.

When you assign landed costs to an item or cost rule, you define the calculation for each landed cost on a per item basis. You can add landed costs for an item based on:

- A percentage of the unit price.
- A monetary amount.
- A specific rate multiplied by the weight or volume of the item.

For each landed cost, you can specify:

- The effective dates.
- The supplier to which the cost is paid.
- The general ledger class code to which you apply the cost.

The general ledger class code determines the general ledger accounts for which the system creates journal entries for landed costs. You use AAI tables 4385 and 4390 to specify landed cost accounts.

You can also specify:

- Whether to match the cost using the voucher entry program.
- Whether to include the cost in item cost updates.

The system searches for landed costs that apply to a detail line in this order:

1. Landed costs that are assigned to the item/branch on Landed Cost Revisions.
2. A cost rule assigned to the detail line.
3. A cost rule assigned to the purchase order.
4. A cost rule assigned to the item and branch/plant on the Item/Branch Plant Info form.
5. A cost rule assigned to the item on the Item Master Revisions form.

You determine at which point the system adds landed costs to a detail line. For example, you can add landed costs during the receipt process, the voucher match process, or as a standalone process.

6.11.2 Prerequisites

Before you can set up landed costs, you must:

- Set up the landed cost rules in UDC table 41/P5.
- Set up the landed cost level in UDC table 40/CA.

6.11.3 Forms Used to Set Up Landed Costs

Form Name	Form ID	Navigation	Usage
Work With Landed Cost	W41291B	Procurement System Setup (G43A41), Landed Cost Revisions	Work with landed costs.
Landed Cost Revisions	W41291A	Click the Add button on the Work With Landed Cost form.	Set up landed cost parameters and attach them to an item or to a cost rule.

6.11.4 Setting Up Landed Costs

Access the Landed Cost Revisions form.

You associate the parameters of a landed cost, such as the general ledger category code, with a landed cost rule or an item. To associate the parameters with a landed cost rule, complete the Landed Cost Rule field. To associate the parameters with an item, complete the Item Number and Branch/Plant fields.

Landed Cost Rule

Enter a value from the Landed Cost Rule (41/P5) UDC table to which you associate landed cost parameters.

Cost Level

Enter a value from the Landed Cost Components (40/CA) UDC table to identify an add-on cost. This code also specifies the sequence of the cost add-ons for a particular item or group of items.

Percent of Cost

Enter a percentage of the item's primary purchasing cost that the system adds as a landed cost component to the base cost of the item as indicated on a purchase order.

Plus Amount

Enter an amount that the system adds to the indicated cost to equal the total cost amount.

Weight Rate

Enter the weight that the system multiplies by the unit weight that you specify for an inventory item. The system uses this amount to calculate a landed cost component.

Volume Rate

Enter the volume that the system multiplies by the unit volume that you specify for an inventory item. The system uses this amount to calculate a landed cost component.

Based on Level

Enter a value from the Landed Cost Components (40/CA) UDC table to identify the basis of cost for an item. If you use this code, you can roll costs based on a previous level total.

Include In Cost (Y/N)

Enter Y to include the landed cost in the item's unit cost.

Voucher Y/N

Enter **Y** to display the landed cost during voucher match. The system creates a receipt record in the F43121 table and the landed cost can be vouchered in the Voucher Match program. The Landed Cost Code (LAND) field in the receipt record will contain a value of **2**.

Enter **N** to create a record in the F43121 table but prevent the landed costs from being vouchered in the Voucher Match program. The Landed Cost Code (LAND) field in the receipt record will contain a value of **3**. The receipt record is necessary if the receipt is reversed.

Note: Journal entries are still created when the value is **N**. As a result, you may want the Landed Cost AAIs (4385/4390) pointed to the same general ledger account to cancel the entries.

6.12 Setting Up Nonstock Items

This section provides an overview of nonstock items and discusses how to:

- Set processing options for Non Stock Item Master (P4101N).
- Set up nonstock items.

6.12.1 Understanding Nonstock Items

You can define information for items that you do not account for as part of the inventory. You add and maintain nonstock item information only at the item level, not at the branch/plant level. The Non Stock Item Revisions form is similar to the Item Master Revisions form. However, it contains only those fields that pertain to nonstock items.

Operating resources are the nonstock goods and services and other internal business processes that a company manages that are necessary for the day-to-day operations of an enterprise. This table lists examples of operating resources:

Resource Type	Examples
Goods	<ul style="list-style-type: none"> ■ Maintenance, repair, and operating supplies ■ Capital equipment ■ Vehicle fleet ■ Computer equipment and software ■ Office equipment and supplies ■ Magazines and books ■ Marketing and promotional materials ■ Real estate
Services	<ul style="list-style-type: none"> ■ Maintenance ■ Advertising ■ Capital services ■ Contracts ■ Printing ■ Recruiting and outplacement

You can access additional forms that enable you to define and maintain further information about a nonstock item, including:

- Default units of measure
- Multiple language descriptions
- Text messages

For each nonstock item that you set up, the system creates a record in the F4101 table.

6.12.2 Form Used to Set Up Nonstock Items

Form Name	Form ID	Navigation	Usage
Non Stock Item Revisions	W4101NA	Non-Stock Purchasing System Setup (G43B41), Non-Stock Item Master Click Add on the Work With Non Stock Items form.	Set up nonstock items.

6.12.3 Setting Processing Options for Non Stock Item Master (P4101N)

Processing options enable you to specify the default processing for programs and reports.

6.12.3.1 Defaults

These processing options specify default information that the system uses in the Non-Stock Item Master program (P4101N).

1. Primary UOM (Default = EA) (1. primary unit of measure (default = each))

Enter a value from the Unit of Measure (00/UM) UDC that identifies the unit of measure that the system uses to express the quantity of an item, for example, EA (each) or KG (kilogram).

2. Weight UOM (Default = LB) (2. weight unit of measure (default = pounds))

Enter a value from the Unit of Measure (00/UM) UDC that identifies the unit of measure that the system uses to indicate weight for this item. You can specify ounces, grams, kilograms, and so on as weight standards. The system uses this unit of measure for the item or overrides it for an individual item or container.

6.12.3.2 Process

This processing option specifies how the system processes information in the Non-Stock Item Master program (P4101N).

1. Transfer Changes to F4102

Enter 1 to transfer changes made to the 2nd (LITM) and 3rd (AITM) item numbers to the Item Branch (F4102) item record.

6.12.3.3 Versions

This processing option specifies a version of the Non-Stock Item Master program (P4101N).

1. Item Master

Enter the version that the system uses for the Item Master program (P4101). If you leave this processing option blank, the system uses version ZJDE0001.

6.12.4 Setting Up Nonstock Items

Access the Non Stock Item Revisions form.

Figure 6–5 Non Stock Item Revisions form

Non-Stock Item Master - Non Stock Item Revisions			
Work With Non Stock Items			
Non Stock Item Revisions			
Product Number	OF8060	Item Number (Short)	729328
Catalog Number	OF8060		
Description	Rolling Chair	Weight	LB
Description		Search Text	Rolling Chair
Stocking Type	N Non-Stock Item	Commodity Class	Add purchase cat P1 codes
G/L Class	NS40 Non-Inventor	Commodity Sub Class	Add purchase cat P2 codes
Unit of Measure	EA Each	Supplier Rebate Code	Add supplier rebate P3 cod
Line Type	N Non-Stock	Master Planning Family	Add master planning family
Buyer Number		Landed Cost Rule	Add landed cost rule here F
Preferred Carrier			
Commodity Code	FURNITURE Office Furniture	UNSPSC Code	

Preferred Carrier

Enter the address book number that the system uses as the default carrier for the item.

Commodity Class

Enter a value from the Commodity Class (41/P1) UDC that represents an item property type or classification, such as commodity type, planning family, and so forth. The system uses this code to sort and process like items.

This field is one of six classification categories that are available primarily for purchasing purposes.

Commodity Sub Class

Enter a value from the Commodity Sub Class Codes (41/P2) UDC table that represents an item property type or classification, such as commodity type, planning family, and so forth. The system uses this code to sort and process like items.

This field is one of six classification categories that are available primarily for purchasing purposes.

Master Planning Family

Enter a value from the 41/P4 UDC table that represents an item property type or classification, such as commodity type or planning family. The system uses this code to sort and process like items.

This field is one of six classification categories that are available primarily for purchasing purposes.

Commodity Code

Enter a value to be used for reporting purposes only.

If JD Edwards EnterpriseOne Requisition Self Service is purchased, you can set up a commodity tree and attach items to the tree. Then the commodity code is supplied on the PO Detail automatically.

UNSPSC Code (United Nations Standard Products and Services Code)

Displays a value for information only. The UNSPSC code has standard settings. A download of these values is stored.

If JD Edwards EnterpriseOne Requisition Self Service is purchased, you can associate this code with the commodity code tree.

6.13 Defining Print Messages

This section provides an overview of print messages and lists the forms used to define print messages.

6.13.1 Understanding Print Messages

Print messages can be used internally and externally to notify employees and suppliers about specific information. Print messages consist of predefined text that you can attach to:

- Item records
- Supplier master
- Purchase order header
- Purchase order header clauses

See "Understanding Subcontract Orders, Subcontract Order Clauses" in the *JD Edwards EnterpriseOne Applications Subcontract Management Implementation Guide*.

See [Forms Used to Enter Order Header Information](#).

- Purchase order detail lines

Print messages are shared with the JD Edwards EnterpriseOne Inventory Management and JD Edwards EnterpriseOne Sales Order Management systems. Examples of text used in messages are:

- Engineering specifications.
- Hazardous materials safety sheets.
- Hours of operation during holiday periods.
- Special delivery instructions.

A print message consists of a message name, description, and corresponding attachments.

After a print message has been created, you need to specify on which documents the message will appear.

6.13.2 Forms Used to Define Print Messages

Form Name	Form ID	Navigation	Usage
User Defined Codes	W0004AI	Enter UDC in the Fast Path field.	Find UDC 40/PM and add a code to identify a print message.

Form Name	Form ID	Navigation	Usage
Print Message Revisions	W40162C	Procurement System Setup (G43A41), Print Message Revisions Click Add on the Work With Print Message form. Select a print message on the Work With Print Message form and click Select.	Set up and maintain print messages.
Media Object Viewer	N/A	On Print Message Revisions, select Attachments from the Form menu.	Enter print message text in the attachment.
Document Selection	W40162A	On Print Message Revisions, select Doc Selection from the Form menu.	Select documents on which the message should print.
Document Type Exceptions	W40162B	On Document Selection, select Doc Typ Exception from the Row menu.	Define document type exceptions.

6.14 Setting Up Templates for Purchase Orders

This section provides an overview of purchase order templates, lists prerequisites, and discusses how to:

- Set processing options for Order Template Revisions (P4015).
- Create a purchase order supplier template.
- Create a purchase order user template.
- Revise a template in batch mode.
- Set processing options for Supplier History Template Rebuild (R43815).

6.14.1 Understanding Purchase Order Templates

You can set up templates to streamline the order entry process. Templates contain items that you frequently order and the quantity in which you usually order them. You can access templates during purchase order entry to select items to order.

Each template contains a specific group of items. You can create standard templates for general use, or you can specify the supplier to which a template applies. You can also create a user template based on the user's most commonly ordered items.

When you set up an order template, you enter the items and item quantities to include on the template. You can have the system enter items on a template based on existing purchase orders that you select. You can also create or revise a template in batch mode using information from existing purchase orders.

An order template is a group of items that you order frequently. You use order templates during purchase order entry to select items to order.

You can create templates that are specific to a certain supplier. This kind of template is useful when you frequently order the same items from a supplier. You can also create

standard templates that are not specific to a supplier. Instead, they contain items that are ordered frequently from different suppliers. You may also want to create a template based on a specific user and the items most commonly ordered by that user.

You can quickly create a supplier template or update an existing template based on items and item quantities on existing purchase orders. Based on the purchase orders that you select, the system adds items and item quantities to a template.

6.14.2 Prerequisites

Before you can create purchase order templates, you must:

- Set up names of order templates in the Order Template (40/OT) UDC table.
- Set the processing option for the Supplier History Template Rebuild program (R43815) so that the system can retrieve historical purchase-order information and add it to the purchase order template.
- If you are creating a purchase order user template based on a user's most commonly ordered items, in the Supplier Template Revisions program (P4015), set the processing option for Desired Format to **4**, or User.

6.14.3 Forms Used to Set Up Templates for Purchase Orders

Form Name	Form ID	Navigation	Usage
Work With Available Order Templates	W4015A	Procurement Advanced & Technical Ops (G43A31), Supplier Template Revisions	Work with available order templates.
Order Template Revisions	W4015B	Click Add on the Work With Available Order Templates form.	Revise order templates. Create a template using existing purchase orders.
Work With Purchase Order History	W40215D	On the Order Template Revisions form, select Order History from the Form menu.	Work with purchase order history.
Work With Order Details	W4310G	Select an order on the Work With Purchase Order History form, and then select Details from the Row menu.	Work with order details.

6.14.4 Setting Processing Options for Order Template Revisions (P4015)

Processing options enable you to specify the default processing for programs and reports.

6.14.4.1 Display

These processing options specify how the system displays information in the Order Template Revisions program (P4015).

1. Enter the Desired Format

Enter a code that determines the format in which you can enter order templates. Values are:

- 1: Sold To
- 2: Ship To
- 3: Suppliers
- 4: User

2. Customer Self-Service Mode

Enter a code that determines how the system processes Customer Self Service information. Values are:

- Blank: The system uses standard processing.
- 1: The system uses Java/HTML processing.
- 2: The system uses Microsoft Windows processing.

6.14.4.2 Versions

These processing options determine which version of various programs the system uses. If you leave either of these processing options blank, the system uses version ZJDE0001.

1. Customer Service Inquiry (P4210)

Specify the version of the Customer Service Inquiry program (P4210) that the system uses.

2. Open Purchase Orders (P4310)

Specify the version of the Open Purchase Orders program (P4310) that the system uses.

6.14.5 Creating a Purchase Order Supplier Template

Access the Order Template Revisions form.

Figure 6–6 Order Template Revisions form

Item Number	Usual Quantity	UM	Seq No.	Effective From	Effective Thru	Item Description	Item Description 2
210	10		5	03/27/1997	12/31/2041	Mountain Bike, Red	
220	5		10	03/27/1997	12/31/2041	Touring Bike, Red	
221	5		15	03/27/1997	12/31/2041	Touring Bike, Blue	
222	5		20	03/27/1997	12/31/2041	Touring Bike, Green	
			25				

Supplier Name

Leave this field blank if the order template that you are creating is not specific to a supplier.

6.14.6 Creating a Purchase Order User Template

Access the Order Template Revisions form.

User

Specify a value for the user. This field is available to you only if you have specified a user format in the processing options of the Supplier Template Revision program (P4015).

6.14.7 Revising a Template in Batch Mode

Select Procurement Advanced & Technical Ops (G43A31), Supplier Template Rebuild.

Use the Supplier History Template Rebuild program (R43815) to create a new order template in batch mode. The system adds items to the new template based on existing orders. Use processing options to define the criteria that the system uses to build a new template.

The Supplier History Template Rebuild program creates templates by compiling and applying the supplier item history from the F4311 table.

6.14.8 Setting Processing Options for Supplier History Template Rebuild (R43815)

Processing options enable you to specify the default processing for programs and reports.

6.14.8.1 Default

These processing options specify default information for the Supplier History Template Rebuild program (R43815).

1. Enter the Order Template to be created

Specify the template name. The template contains a list of items that you frequently order. The items are often grouped based on the product type, such as fuels, lubricants, and packaged goods.

2. Effective From Date

Specify the date when a transaction, contract, obligation, preference, or policy rule becomes effective.

3. Effective Thru Date (effective through date)

Specify the date on which a transaction, text message, agreement, obligation, or preference has expired or been completed.

6.14.8.2 Process

These processing options determine how the system processes information in the Supplier History Template Rebuild program (R43815).

1. History

Specify a code that determines who the history applies to. Values are:

- 1:** The system creates a new template based on supplier history.
- 2:** The system creates a new template based on buyer history.

3: The system creates a new template based on ship to history.

4: The system creates a new template based on the transaction originator history.

2. Calculate the Average Quantity

Specify whether the system calculates the average quantity for the usual quantity.

Values are:

Blank: The system does not calculate the average quantity for the usual quantity.

1: The system calculates the average quantity for the usual quantity.

3. Data Sequence or Ordered Items

Specify whether the system uses a data sequence or the most frequently ordered items.

Values are:

1: Use a data sequence.

2: Use the most frequently ordered items.

4. Maximum Lines

Enter the maximum number of lines in the template that the system can display.

5. Minimum

Enter the minimum number of times that an item must be ordered before the system includes that item on the template.

6. Supplier/Item Relationship

Specify whether the system includes the supplier/item relationship on the template.

Values are:

Blank: Do not include the supplier/item relationship on the template.

1: Include the supplier/item relationship on the template.

6.15 Creating Model Logs

This section provides an overview of model logs, lists a prerequisite, and discusses how to create a model log.

6.15.1 Understanding Model Logs

A model log is a set of standard submittal and transmittal information or other information that you can copy into an order. A submittal is information that you need to receive from a subcontractor or supplier, such as proof of insurance and so on. A transmittal is information that you need to send to a subcontractor, such as permission to proceed and so on. You create a model log if you have many orders that use the same standard log information.

6.15.2 Prerequisite

Verify that you have set up model logs in the Model Log Types (43/ML) UDC table.

6.15.3 Form Used to Create Model Logs

Form Name	Form ID	Navigation	Usage
Model Logs	W4303C	Procurement System Setup (G43A41), Order Model Log Revisions Enter a model log on the Work with Model Logs form, and click Add. Subcontract System Setup (G43D41), Order Model Log Revisions Enter a model log on the Work with Model Logs form, and click Add.	Create a model log.

6.15.4 Creating a Model Log

Access the Model Logs form.

Figure 6–7 Model Logs form

Log Type	Description	Status Type	Explanation -Remark-	Issue Date	Expired Date	Required Date	P E
S	Signed Order		Submit Signed Purchase Order				Y
S	Approval Drawings		Submit Drawings for Approval				Y
S	As Built Drawings		Submit Final Drawings				Y
T	Manufacturing Schedule		Review Manufacturing Schedule				N

Model Log

Enter a value from the Model Log Types (43/ML) UDC table to identify the model log to which you add log types. You must complete this field before you access the Model Logs form.

Log Type

Enter a value from the Commitment Log Type (00/LG) UDC table to identify the type of information in a log entry. The log type is used to group similar types of entries.

Status Type

Enter a code from the STSC (H00/SX) UDC table to specify whether the requirements for the log line have been satisfied. Values are:

Blank: The requirements have not been satisfied, the log line is not active, or no status is required.

Y: The requirements have been satisfied.

N: The requirements have not been satisfied.

Issue Date

Enter the date that the log entry was issued. For example, the effective date for an insurance policy is entered in the Issue Date field.

Expired Date

Enter the expiration date of the log entry. For example, in the case of a submittal requirement for an insurance certificate, the termination date for the policy would be entered in the Expired Date field. The termination date would then be used by the Log Report/Update program (R43300) or the Logs (F4305) Report/Update program (R43540) to update the status field. If the expired date is earlier than the date that you run the program, the system sets the status to **N** for the log entry.

P E (pay effect)

Enter **Y** to issue a warning message if log requirements are not met. Various warning messages appear during progress payment entry when outstanding log requirements exist.

Generally, you enter **Y** when the submittal requirement is of such importance that regular payments to the subcontractor can be suspended if the submittal requirement is not properly satisfied. This code is normally used with submittal log entries.

ID Code (identification code)

Enter an identification code associated with the log entry. The field can be used for abbreviated report identification.

6.16 Setting Up Hierarchical Logs

This section provides an overview of hierarchical logs and discusses how to:

- Set up log hierarchy levels.
- Activate log functionality.
- Set up log view options.

6.16.1 Understanding Hierarchical Logs

Log information is supplemental to the information contained in an order. Checks and balances are put in place during the progress payment function to enforce compliance with the logs. Log information is typically specific to the vendor and not on a contract-by-contract basis. However, bonding can be at a job or contract level. Logs can be entered and modified at multiple hierarchical levels. Log details can be added at an individual contract level or at global levels, such as company, subcontractor, project, or job. These individual levels can then be activated or deactivated based on the business process.

Entry of logs is available from contract entry as well as any time during the project. The logs and hierarchies are maintained in the Log Master table (F4305).

See "JD Edwards EnterpriseOne Subcontract Management Reports" in the *JD Edwards EnterpriseOne Applications Subcontract Management Implementation Guide*.

Note: If you currently use the Log Master Revisions program (P4303) for single-level logs at the contract level, you can run conversion programs and use the hierarchical logs feature.

Note: You can use either the Log Master Revisions program (P4303) or the Logs Entry program (P4305) to create and maintain log information. You cannot use both log programs in the system. Purchase Order Entry and Voucher Match read UDC 40/VF and call the Log Master Revisions program or the Logs Entry program based on the setting in the UDC.

6.16.2 Forms Used to Set Up Hierarchical Logs

Form Name	Form ID	Navigation	Usage
Work With User Defined Codes	W0004AA	Enter UDC in the Fast Path field.	Set up log hierarchy levels. Activate log functionality. Set up log view options.
Log Hierarchy Constants	W4304A	Subcontract System Setup (G43D41), Log Hierarchy Constants	Activate log hierarchy levels.

6.16.3 Setting Up Log Hierarchy Levels

Access the Work With User Defined Codes form.

Find UDC 43/LL and set up the log hierarchy levels.

6.16.4 Activating Log Functionality

Access the Work With User Defined Codes form.

Find UDC 40/VF and activate log functionality for the system by specifying the 04 - Logs code in the Vertical Feature UDC.

Note: Purchase Order Entry and Voucher Match read UDC 40/VF and call the Log Master Revisions (P4303) program or the Logs Entry (P4305) program based on the setting in the UDC.

6.16.5 Setting Up Log View Options

Access the Work With User Defined Codes form.

Find UDC 43/VO and set up the log view options for procurement.

Setting Up Supplier Information

This chapter contains the following topics:

- [Section 7.1, "Setting Up Supplier and Item Information"](#)
- [Section 7.2, "Defining Supplier Prices and Discount Rules"](#)

7.1 Setting Up Supplier and Item Information

This section provides an overview of supplier and item information setup, lists prerequisites, and discusses how to:

- Set processing options for Supplier Master (P04012).
- Define supplier purchasing instructions.
- Set processing options for Supplier/Item Relationships (P43090).
- Create supplier and item relationships.
- Set up guidelines for delivery performance.
- Set processing options for Supplier Analysis Summary (P43230).
- Set up guidelines for acceptable items.
- Define a summary of supplier performance information.
- Define a supplier hyperlink. (Release 9.1 Update)

7.1.1 Understanding Supplier and Item Information Setup

The system processes an order based on the items that you purchase and the supplier from whom you make the purchases. For example, you can define purchasing instructions for a supplier so that each time you enter an order, the system retrieves default values for that supplier.

You can specify the items that you purchase from a supplier to create supplier and item relationships. For each item, you can enter information such as whether the supplier is certified to sell the item. If a supplier is not certified to sell an item, the system does not let you enter the item on a purchase order for the supplier.

You can review information about the quality of a supplier's services, including delivery performance and the condition of items upon receipt. To ensure that this information is accurate, you must set up guidelines so that the system can recognize on-time deliveries and items in acceptable condition.

You can review a summary of performance information to compare suppliers' costs and services for a certain item. Before you can review this information, you must

define performance factors that might include the number of returned items, last-in costs, average lead times, and so on.

7.1.1.1 Supplier Purchasing Instructions

You can define purchasing instructions for a supplier so that each time you enter an order for the supplier, the system retrieves default values such as a landed cost rule, a price rule, a print message, and so on.

You can use purchasing instructions to specify item restrictions for a supplier. Item restrictions determine which items you can or cannot purchase from a supplier. If you restrict the purchase of certain items, you cannot enter the items on a purchase order for the supplier.

You can define purchasing instructions for a ship-to address as well as a supplier. The system retrieves the carrier for a purchase order, as well as delivery instructions, based on purchasing instructions that are set up for the ship-to address.

You also can enter advanced pricing information by entering an adjustment schedule when you are defining purchasing instructions. Before you enter advanced pricing information, verify that you have activated the pricing constants.

You can activate the JD Edwards EnterpriseOne Advanced Pricing system for a supplier when you are defining purchasing instructions.

You also can specify limitations for a supplier, such as minimum and maximum order amounts for a supplier. You can also specify whether you can create vouchers based on receipt information.

You also can specify whether the system prints only prices on a purchase order, or both prices and adjustments.

Changes that you make to purchasing instructions do not affect orders that you already created.

7.1.1.2 Voucher Match Automation Setup for Suppliers (Release 9.1 Update)

Voucher match automation (VMA) is a process in which you automatically match records in the Voucher Transaction - Batch Upload (F0411Z1) table to receipt records in the Purchase Order Receiver File (F43121) and purchase order records in the Purchase Order Detail File (F4311). During the process, the system creates either standard or logged vouchers that the system matches to receipts and purchase orders.

You can define information to run the voucher match automation process using the Voucher Match Automation fields in the supplier master.

7.1.1.2.1 Voucher Match Automation Rules for Suppliers The automation rule is a code that determines the rules by which the process matches invoices to receipts and purchase orders. When you run the VMA process, for each record in the F0411Z1 table that is flagged as a record for voucher match automation, the system uses the automation rule that exists in the F0411Z1 table to determine the rules to use when performing the match. If no automation rule exists for the record in the F0411Z1 table, then the process accesses the supplier's record in the Supplier Master table (F0401) to obtain the default automation rule to use to match the invoice to receipts and purchase orders.

If you run the VMA process and the process does not find a valid automation rule in either the F0411Z1 or F0401 table, then the process does not perform the match or create vouchers.

7.1.1.2.2 Order and Item Information for the VMA Process

You can specify in the supplier master record whether you want to require that purchase order, item information, or both purchase order and item information be used in the VMA process. If you specify that the information is required, the VMA process compares the order, item, or both order and item information in the invoice to the order and item information in the receipt line and purchase order lines. The process matches or suggests matches only between invoice lines and receipt lines for which the specified information matches.

If you select the Order Information Required option in the supplier master record, you must upload the order number for each supplier invoice line to the Voucher Transaction Batch Upload (F0411Z1) table before you use the VMA process to match invoice lines to receipt and purchase order lines. If you upload additional order information, such as the order type, order suffix, order company and order line number, the VMA process uses those values in addition to the order number when matching invoice lines to receipt and purchase order lines.

If you select the Item Information Required option in the supplier master record, one of these conditions must exist, or the VMA process generates an error for the invoice line:

- The short item number must exist in the F0411Z1 record.
- The short item number must exist in the Voucher Transaction Batch Upload - Voucher Match Automation table (F0411Z1T).
- The second item number must exist in the F0411Z1T table.

If you provide the second item number and do not provide the short item number, the VMA process uses the second item number to retrieve the short item number from the Item Master table (F4101).

- The customer/supplier item number must exist in the F0411Z1T table.

If you provide the customer/supplier item number and do not provide the short item number, the VMA process uses the customer/supplier item number to retrieve the short item number from the F4101.

The VMA process retrieves the short item number to use when it matches records or suggests matches. If you include the short item number as well as the second item number or the customer/supplier item number, the VMA process validates that all of the item numbers provided are associated with the same item.

If you select the option to require order information and do not include the required information in the F0411Z1 records, then the VMA process does not generate matches or suggestions for those invoice lines. If you select the option to require item information and do not include the required information in the F0411Z1T records, then the VMA process does not generate matches or suggestions for those invoice lines. For both options, the process generates an error message if required information is missing.

You can use the Batch Voucher Revisions program (P0411Z1) to add the missing information to the record and then reprocess the record. Or, you can use the Voucher Match Process Workbench program (P4314WB) to change the status of the record so that you can manually match the record outside of the VMA process.

See Also:

[Understanding Proof, Final and Suggest Modes](#)

[Populate the Voucher Transaction - Batch Upload Table \(F0411Z1\)](#)

[Populate the Voucher Transaction Batch Upload - Voucher Match Automation Table \(F0411Z1T\)](#)

7.1.1.2.3 Suggestion Processing for VMA Process (Release 9.1 Update) You can specify in the supplier master record whether to run the voucher match automation process in suggest mode. The voucher match automation process creates suggestions based on the setup in the supplier master record, or in the processing options in the Voucher Match Automation UBE programs (R4304016, R4304020, and R4304021).

See [Suggestion Processing \(Release 9.1 Update\)](#)

7.1.1.2.4 Partial Receipts for VMA Process (Release 9.1 Update) You specify in the supplier master record whether to allow the matching of invoices to partial receipts in the VMA process. You can match invoices to partial receipts only when you use automation rule 02, 04 or 06 in the VMA process.

See [Partial Receipts for VMA Process \(Release 9.1 Update\)](#)

7.1.1.2.5 Single Voucher Per Invoice for VMA Process (Release 9.1 Update) You specify in the supplier master record whether to always generate a single voucher for an invoice with one or more pay items in the voucher match automation process. You can also specify to generate a single voucher per invoice in the processing option in the Voucher Match Automation Driver program (R4304010).

See [Single Voucher Per Invoice for VMA Process \(Release 9.1 Update\)](#)

7.1.1.3 Managing Supplier/Item Relationships

You can create relationships between a supplier and the items that you purchase from the supplier. For example, if you purchase widgets from AAA Supply Company, you can create a relationship between the AAA Supply Company and the widget item. You can define information for the relationship, such as:

- The status of the relationship (whether you can purchase the item from the supplier).
- The receipt route for the relationship.
- The price of the item (when you purchase it from the supplier).

You can manually create supplier and item relationships or you can have the system create them for you when you purchase items from a supplier.

You also can have the system create a supplier and item relationship when you:

- Enter a purchase order.
- Enter a receipt.
- Create a voucher.

You must set processing options for the appropriate program to capture supplier analysis information.

You also can create relationships for items for which master information does not yet exist. You can set a processing option for the Supplier/Item Relationships program

(P43090) to specify whether you want the system to prompt you to enter standard item master information or nonstock item master information.

The system stores information for item and supplier relationships in the F43090 table. You must run the Supplier/Item Relationships Rebuild program (R43900) to initially update the fields in this table.

7.1.1.4 Monitoring Supplier Delivery Performance

You can determine whether a supplier has a history of delivering a specific item on time by reviewing delivery performance information. To ensure that this information is accurate, you must define how you want the system to calculate on-time deliveries.

An order is on time if you receive it the same day that the supplier promised to deliver it. You can allow a certain number of days before or after the promised date that the order can still be on time. For example, you can allow two late days and two early days. If the promised date for an order is 3/15, the order is not late unless you receive it after 3/17, and it is not early unless you receive it before 3/13.

You can also specify the percentage of an order that must be delivered for the system to determine the receipt date. For example, you can specify that you must receive 90 percent of an order for the system to use the receipt date to determine whether the delivery is on time, early, or late.

7.1.1.5 Monitoring Supplier Quality

You can determine whether a supplier has a history of delivering a specific item in good condition by reviewing quality performance information. To ensure that this information is accurate, you must indicate how you want the system to identify acceptable and unacceptable items.

Quality performance information includes the percentages of an item that were acceptable and unacceptable in a fiscal period. The system calculates each percentage based on how you categorize items that you remove from a receipt route, including:

- Returns
- Reworks
- Scrap
- Rejects
- Adjustments

You must specify which categories reflect acceptable and unacceptable items. For example, if you specify that the scrap category is unacceptable, each time you remove an item from a receipt route as scrap, the system classifies the item as unacceptable.

You must use receipt routing to capture quality information.

7.1.1.6 Defining a Summary of Supplier Performance Information

You can review a summary of performance information to compare suppliers' costs and services for a certain item. Before you can review this information, you must define the performance factors that you want to compare, such as:

- The average unit cost for an item.
- The last cost you paid for an item.
- The percentage of on-time deliveries.
- The average number of days that it takes to deliver the item (lead time).

You must set up a column for each performance factor that you want to review. You must specify the title of the column, values, and calculations. You can also specify the decimal placement and number format, and you can assign help text.

You can create formats to review multiple performance factors (columns). You can assign up to four columns to a format. You can also create paths so that you can scroll through multiple formats. After you set up columns, formats, and paths, you can assign them to the Work With Supplier Analysis Summary form.

7.1.2 Prerequisites

Before you complete the tasks in this section, verify that these user-defined codes (UDCs) are set up:

- Item Restrictions (H40/ED)
- Quantity Quality Status (H43/AC)
- Unit of Measure (00/UM)
- Evaluated Receipts (40/ER)
- Order Templates (40/OT)
- Customer Price Groups (40/PC)
- Certification Status (43/CR)
- Formula Descriptions (43/FM)
- Supplier Rebate Code (43/RA)
- Route Codes (43/RC)
- Rebate Level (43/RL)
- Route Type Code (43/RV)

7.1.3 Forms Used to Set Up Supplier and Item Information

Form Name	Form ID	Navigation	Usage
Work With Supplier Master	W04012D	Supplier Management (G43A16), Purchasing Instructions	Review existing purchasing instructions.
Supplier Master Revision	W04012A	Click Add on the Work With Supplier Master form.	Define supplier purchasing instructions.
Item Restriction Revisions	W40131B	Select Item Restrictions from the Form menu on the Supplier Master Revision form.	Define supplier purchasing instructions.
Work With Supplier/Item Relationships	W43090A	Supplier Management (G43A16), Supplier/Item Information	Set up guidelines for delivery performance. Review existing supplier and item relationships.

Form Name	Form ID	Navigation	Usage
Supplier/Item Relationships	W43090B	Click Add on the Work With Supplier/Item Relationships form.	Create supplier and item relationships, and set up guidelines for delivery performance.
Supplier/Item Additional Route	W43094A	Select Additional Routes from the Form menu on the Supplier/Item Relationships form.	Create routes for items from suppliers.
Quality Analysis	W43230L	Supplier Management (G43A16), Quality Analysis	Review existing quality information for a supplier.
Quality Classification	W43230J	Select Quality Definition from the Form menu on the Quality Analysis form.	Set up guidelines for acceptable items.
Work With Inquiry Columns	W51COLC	Supplier Management (G43A16), Define Inquiry Columns	Review existing inquiry columns.
Define Inquiry Columns	W51COLD	Click Add on the Work With Inquiry Columns form.	Define a summary of supplier performance information. Add inquiry columns and information that defines the columns.
Work With Inquiry Formats	W51FMTI	Supplier Management (G43A16), Inquiry Formats Window	Review existing inquiry formats
Define Inquiry Formats	W51FMTQ	Click Add on the Work With Inquiry Formats form.	Add columns to formats that you create.
Work With Inquiry Paths	W51PTB	Supplier Management (G43A16), Inquiry Paths	Review existing paths.
Define Inquiry Paths	W51PTC	Click Add on the Work With Inquiry Paths form.	Create new paths.
Work With Supplier Analysis Summary	W43230A	Supplier Management (G43A16), Summary	Review supplier analysis information by the columns established in the Define Inquiry Columns form.
Work With Supplier Analysis Summary	W43230A	Supplier Management (G43A16), Summary	Review supplier analysis information by the columns established in the Define Inquiry Columns form.

7.1.4 Setting Processing Options for Supplier Master (P04012)

Processing options enable you to specify the default processing for programs and reports.

7.1.4.1 Entry

1. Tax ID

Specify whether the system displays the Tax ID field when you add a supplier record. If you choose not to display, you can specify whether to hide or disable this field. When you disable a field, the system displays it as gray and the user cannot enter data in it. Values are:

Blank: Display this field.

1: Hide this field.

2: Disable this field.

7.1.4.2 Defaults

1. Search Type

Specify the default value that is used in the Search Type field on the Work with Supplier Master form. Use the search button for a list of valid search types. If you leave this processing option blank, the system uses **V** (Suppliers) as the default value.

2. Amount Currency Code

Specify the default currency code for the A/B Amount Code field. If you leave this processing option blank and the A/B Amount Code field on the Supplier Master Revision form is blank, the system uses the currency code of the company assigned to the Business Unit field on the Address Book Revision form. The A/B Amount Code field appears on the Supplier Master Revision form only if multicurrency is activated in the General Accounting Constants program.

7.1.4.3 Versions

1. Supplier Master MBF (P0100043) Version

Specify the version for the Supplier Master MBF (Master Business Function). If you leave this processing option blank, the system uses the default version ZJDE0001.

2. Address Book (P01012) Version

Specify the version of the Address Book program (P01012) that the system will use. If you leave this processing option blank, the system uses the default version ZJDE0001.

7.1.5 Defining Supplier Purchasing Instructions

Access the Supplier Master Revision form.

7.1.5.1 Purchasing 1

Select Purchasing 1.

Supplier Price Group

Enter a value from the Customer Price Groups (40/PC) UDC that identifies a customer group. You can group customers with similar characteristics, such as comparable pricing.

Order Template

Enter a value from the Order Templates (40/OT) UDC to specify a template of items that you frequently order. The items are often grouped based on the product type, such as fuels, lubricants, and packaged goods.

7.1.5.2 Purchasing 2

Select Purchasing 2.

Invoice Copies

Displays the number of invoice copies required by the customer.

Item Restrictions

Enter a value from the Item Restrictions (H40/ED) UDC to designate whether restrictions have been placed on the sale of items to this customer. Values are:

Blank: No restrictions have been placed on the sale of items.

I: A customer can be sold only those items that are set up on the Item Restrictions form.

E: A customer cannot be sold the items that are set up on the Item Restrictions form.

Max Order Value (maximum order value)

Enter the value above which an order is placed on hold. If you attempt to enter an order for which the total is more than the maximum order value, the system displays an error message.

This field is maintained as an integer without decimals.

Min Order Value (minimum order value)

Enter the value below which an order is placed on hold. If you attempt to enter an order for which the total is less than the minimum order value, the system displays an error message.

This field is maintained as an integer without decimals.

Volume Display U/M (volume display unit of measure)

Enter a value from the Unit of Measure (00/UM) UDC that identifies the unit of measure that the system uses to display volume for this branch/plant. The system enters a value in this field from Branch/Plant Constants - Page 2 (P410012). You can override this default value.

Weight Display U/M (weight display unit of measure)

Enter a value from the Unit of Measure (00/UM) UDC that identifies which unit of measure the system should use to display the weight of individual order lines and the order as a whole for this customer when you use the order summary form.

Price Pick List

Enter the code that indicates whether net price information prints on the purchase order. Values are:

Y: Print net prices.

N: Do not print prices.

2: Print base price adjustments and net prices.

Evaluated Receipt

Enter a value from the Evaluated Receipts (40/ER) UDC that indicates whether an order is eligible for the evaluated receipt settlement process. An evaluated receipt

settlement indicates that you have an agreement with the supplier to create vouchers based on the items that you receive. You use the Evaluated Receipt Settlement (R43800) procedure to create vouchers from receipt records. As a result, the supplier does not send you invoices and you can bypass the Voucher Match procedure. Values are:

N: Not eligible for evaluated receipt settlement processing.

Y: Eligible for evaluated receipt settlement processing.

I: Receipt transaction is in process.

T: Eligible for evaluated receipt settlement processing. However, a tolerance error occurred during the receipt process.

R: Eligible for evaluated receipt settlement processing. However, the receipt is currently in the receipt routing process.

V: A voucher has been created for the receipt transaction using the evaluated receipt settlement process.

Rebate Level

Enter a value from the Rebate Level (43/RL) UDC that indicates the organizational level upon which the rebate system is based.

Rebate Active

Enter a value from the Supplier Rebate Code (43/RA) UDC that indicates whether rebates are active.

Automation Rule (Release 9.1 Update)

Enter the automation rule that the system uses when matching receipts in the voucher match automation process. The system uses the automation rule that you specify here if the record in the Voucher Transactions - Batch Upload table (F0411Z1) does not include an automation rule.

You do not have to assign an automation rule unless you want to specify a default rule to use in the voucher match automation process.

Values are:

01: Exact Match of Invoice Line to Purchase Order Line to Receipt Line. Each invoice line received from the supplier will be matched to a single purchase order line and a single receipt line. The amounts must match exactly between the invoice, purchase order, and receipt lines. When you specify Automation Rule 01, the system matches using the Voucher Match Automation UBE for Automation Rule 01 program (R4304016).

02: Match of Invoice Line to Receipt Line, Standard Tolerance Applied. Each invoice line received from the supplier will be matched to a single purchase order line and to a single receipt line. The amount of the invoice line and the receipt line can be different based on allowed standard tolerance limits. When you specify Automation Rule 02, 03, 04, 05 program (R4304020).

03: Match of Invoice Line to Purchase Order Line to Multiple Receipt Lines, Standard Tolerance Applied. Each invoice line received from the supplier will be matched to a single purchase order line and to the total of one or more receipt lines for the purchase order. The amount of the invoice line and the purchase order line can be different based on allowed standard tolerance limits. When you specify Automation Rule 03, the system matches using the Voucher Match Automation UBE for Automation Rule 02, 03, 04, 05 program (R4304020).

04: Exact Match of Invoice Line to Receipt Line. Each invoice line received from the supplier will be matched to a single purchase order line and to a single receipt line. The amount of the invoice line and the receipt line must match exactly. When you specify Automation Rule 04, the system matches using the Voucher Match Automation UBE for Automation Rule 02, 03, 04, 05 program (R4304020).

05: Match of Invoice Line to Purchase Order Line to Multiple Receipt Lines, Rounding Tolerance Applied. Each invoice line received from the supplier will be matched to a single purchase order line and to the total of one or more receipt lines for the purchase order. The amount of the invoice line and the purchase order line can be different based on allowed rounding tolerance limits. When you specify Automation Rule 05, the system matches using the Voucher Match Automation UBE for Automation Rule 02, 03, 04, 05 program (R4304020).

06: Exact Match of Invoice to Multiple Receipt Lines across Multiple Purchase Orders. Each invoice line received from the supplier is matched to multiple receipt lines, which can be on multiple purchase orders. The total amount of the receipts must exactly match the invoice line. No tolerance or rounding issues may exist. When you specify Automation Rule 06, the system performs the match using the Voucher Match Automation UBE for Automation Rule 06 program (R4304021).

Order Information Required (Release 9.1 Update)

Select this option if order information is mandatory for each invoice. Clear the option if order information is not mandatory.

When you select this option, you must provide order information in the supplier invoice records that you enter in the Voucher Transaction - Batch Upload (F0411Z1) table. If you do not include the required information in the F0411Z1 record, then the VMA process does not generate matches or suggestions for those invoice lines. Instead, the process issues an error message for the invoice line. You can use the Voucher Match Process Workbench program to manually match the invoices to receipts and purchase orders.

See [Order and Item Information for the VMA Process](#)

Item Information Required (Release 9.1 Update)

Select this option if item information is mandatory for each invoice. Clear the option if item information is not mandatory.

When you select this option, you must provide item information in the supplier invoice records that you enter in the Voucher Transaction - Batch Upload (F0411Z1) and Voucher Transaction Batch Upload - Voucher Match Automation (F0411Z1T) tables. If you do not include the required information in the F0411Z1 and F0411Z1T records, then the VMA process does not generate matches or suggestions for those invoice lines. Instead, the process issues an error message. You can use the Voucher Match Process Workbench program to manually match the invoices to receipts and purchase orders.

See [Order and Item Information for the VMA Process](#)

Suggestion Required (Release 9.1 Update)

Select this option to perform suggestion processing for the supplier during the voucher match automation process. Clear this option to automatically match supplier invoices during the voucher match automation process.

See [Suggestion Processing \(Release 9.1 Update\)](#)

Partial Receipt Allowed (Release 9.1 Update)

Select this option if you want the system to suggest or match invoices with partially received orders during the voucher match automation process. Clear this option to ensure that the supplier's invoices match only with closed purchase orders during the voucher match automation process.

See [Partial Receipts for VMA Process \(Release 9.1 Update\)](#)

Single Voucher Per Invoice (Release 9.1 Update)

Select this option to generate a single voucher for an invoice with one or more pay items in the voucher match automation process. Clear this option to create a separate voucher for each line of the invoice during the voucher match automation process.

See [Single Voucher Per Invoice for VMA Process \(Release 9.1 Update\)](#)

7.1.6 Setting Processing Options for Supplier/Item Relationships (P43090)

Processing options enable you to specify the default processing for programs and reports.

7.1.6.1 Process

These processing options specify default values for this application.

Cross Ref. Type for Supplier Item (Default VN) (cross-reference type for supplier item [default vendor part number])

Specify the cross-reference type for the supplier item. The default value is VN.

Standard Item Master

Enter **1** to automatically display the Standard Item Master application when adding a new item.

Non-Stock Item Master

Enter **1** to automatically display the Non-Stock Item Master application when adding a new item.

Supplier Prices

Enter **1** to automatically display the Supplier Prices application when adding a new item.

Work Order Completion Mode

Enter **1** for work order completion mode.

7.1.6.2 Versions

This processing option specifies the version for each program that the system calls.

Item Master Maintenance (P4101)

Enter the version of the Item Master program (P4101) to use. If you leave this processing option blank, the system uses ZJDE0001.

7.1.7 Creating Supplier and Item Relationships

Access the Supplier/Item Relationships form.

Figure 7-1 Supplier/Item Relationships form

Supplier/Item Information - Supplier/Item Relationships			
<input type="button" value="Save"/> <input type="button" value="X"/> <input type="button" value="Form"/> <input type="button" value="Tools"/>			
Branch/Plant	<input type="text" value="30"/>		
Supplier	<input type="text" value="4341"/> International Supply Company		
Item Number	<input type="text" value="2001"/> Cro-Moly Frame, Red		
Certification Status	<input type="text"/>	Effective Date	<input type="text" value="04/25/1997"/>
		Expiration Date	<input type="text" value="12/31/2041"/>
Routing Information			
Normal Route Code	<input type="text"/>	Route Type Code	<input type="text"/>
Alt Route Code	<input type="text"/>		
Analysis Information			
Average Unit Cost	<input type="text"/>		
Leadtime Quantity %	<input type="text" value="90.00"/>	Average Leadtime	<input type="text" value="21.00"/>
Frequency Days	<input type="text"/>	Days Allowed Early	<input type="text"/>
Frequency Number	<input type="text"/>	Days Allowed Late	<input type="text"/>

Certification Status

Enter a value from the Certification Status (43/CR) UDC that indicates whether the supplier is certified to sell this item. The code that you enter determines how the system manages orders that you enter for the supplier and item. Values are:

Blank: You can place orders for the item from the supplier.

1: The system prohibits you from purchasing this item from the supplier.

2: The system displays a warning message if you enter an order for this item from the supplier.

Normal Route Code

Enter a value from the Route Codes (43/RC) UDC that identifies a receipt route. Each receipt route consists of a series of operations through which the system directs items upon receipt.

Alt Route Code (alternate route code)

Enter a value from the Route Codes (43/RC) UDC that identifies an alternate receipt route. Each receipt route consists of a series of operations through which the system directs items upon receipt.

An item can have a normal receipt route and an alternate receipt route. The system directs an item through the alternate receipt route intermittently based on the number of days or number of receipts that you specify.

Route Type Code

Enter a value from the Route Type Code (43/RV) UDC that qualifies the routing for an Item/Supplier combination. Examples would include specific routing types for Advanced Ship Notices (ASNs) (EDI 856 Ship Notice/Manifest transactions) and for transfers.

7.1.8 Setting Up Guidelines for Delivery Performance

Access the Supplier/Item Relationships form.

Leadtime Quantity % (leadtime quantity percentage)

Enter the percentage of an order that you must receive before the system calculates lead time. Lead time is the number of days between the date that you enter an order detail line and the date that you receive the order.

For items in a receipt route, the system determines the receipt date based on the date at which the items arrive at the operation flagged for receipt acknowledgement.

Days Allowed Early

Enter the number of days before the promised date for which delivery of the item is acceptable. For example, you enter 2 to indicate that the supplier can deliver the item a maximum of two days early to qualify for an on-time delivery.

Days Allowed Late

Enter the number of days after the promised date for which delivery of the item is acceptable. For example, enter 2 to indicate that the supplier can deliver the item a maximum of two days later than the promised date to qualify for an on-time delivery.

7.1.9 Setting Processing Options for Supplier Analysis Summary (P43230)

These processing options enable you to specify the default processing for programs and reports.

7.1.9.1 Display

These processing options control the types of information that the system displays.

1. Enter a '1' to display suppliers associated with an item

Specify how to display items associated with a supplier. Values are:

Blank: Display all items associated with a supplier.

1: Display suppliers associated with an item.

2. Enter a '1' to display Quality Information; '2' for Delivery Information; or a '3' for Cost Information.

Specify the type of information displayed. Values are:

Blank: 1 will be used.

1: Display Quality Information.

2: Delivery Information.

3: Cost Information.

3. Enter the specific costing method (01 - 08) to be displayed as the Inventory Cost.

Enter a value from UDC 40/CM that specifies the basis for calculating item costs. Cost methods 01 through 19 are reserved for use by JD Edwards EnterpriseOne.

4. Enter the cost that should be compared against the paid cost for variance information. 1 = Inventory Cost; 2 = Ordered Cost; 3 = Receipt Cost. If left blank, '2' will be used.

Enter the cost that should be compared against the paid cost for variance information.

Blank: 2 will be used.

1: Inventory Cost

2: Ordered Cost

3: Receipt Cost

5. Enter the default inquiry FORMAT to be displayed OR

Enter a value that identifies a format, which is a sequence of up to four columns. It is an alphanumeric code.

6. Enter the default inquiry PATH you wish to be on.

Enter a value that identifies a path, which is a sequence of formats. It is an alphanumeric code.

Note: Enter a value for the format or path processing option but not both. If a value is entered for both processing options, the format overrides the path.

7.1.10 Setting Up Guidelines for Acceptable Items

Access the Quality Classification form.

A/N (acceptable/ not acceptable)

Enter a value from the Quantity Quality Status (H43/AC) UDC to specify whether a quantity received is acceptable or not acceptable.

7.1.11 Defining a Summary of Supplier Performance Information

Access the Define Inquiry Columns form.

Review supplier analysis information by the columns selected on this form.

Column Name

Enter an alphanumeric code that identifies a column. A column represents a performance factor, such as the average unit cost for an item and the last cost that you paid for an item. For example, you can review performance factors to compare suppliers' costs and services for a certain item.

The system adds the value that you enter to a list of available column names.

Column Heading 1

Enter a name for the first line in the heading that describes the column on the Job Status Inquiry form. The system automatically centers this line for the column.

Formula

Enter values from the Formula Descriptions (43/FM) UDC table together with the mathematical operators that are required to determine an amount or quantity for this column. You can use a single predefined value or multiple predefined values with mathematical operators to enter a formula.

Note: Select Formula Values from the Form menu to access the 43/FM UDC.

Acceptable mathematical operators are:

+: Add.

-: Subtract.

*: Multiply.

/: Divide.

(): Left and right parentheses for nesting.

For example, you can enter this formula to have the system calculate on-time percentages:

$$20 / (20 + 21 + 22)$$

The preceding formula equals on-time percentages for these reasons:

20 is the value in UDC 43/FM for on-time amounts.

21 is the value in UDC 43/FM for early amounts.

22 is the value in UDC 43/FM for late amounts.

Decimal Positions

Enter the number of characters that appear to the right of the decimal point. For example, if you enter **2**, the amount or quantity in this column would have two characters to the right of the decimal point, such as 7.00.

Edit Code

Enter a value from the Edit Codes (98/EC) UDC that determines the format of numeric data. By entering different codes, you can change the appearance of the values that appear or print.

Multiplier

Enter the factor by which the amounts or unit quantities in a column are multiplied.

The result of the calculation in the Formula field is multiplied by this factor before it appears on the Job Status Inquiry form.

For example, if you want to scale down extremely large numbers to thousands, enter **001**. If you want percentages to be displayed as whole numbers, enter **100**.

Glossary Item

Enter the item in the F9201 table that describes the information that a column represents. Typically, a column contains information about a supplier's performance to enable you to compare suppliers' costs and services for a certain item.

The related glossary description appears when you access field help for the column.

Sequence

Enter a value from the Sequence/ Ascending /Descending (H43/SQ) UDC to specify whether the system displays information in ascending or descending order.

7.1.12 Defining a Supplier Hyperlink (Release 9.1 Update)

Access the Supplier Page Hyperlink Revisions form.

Figure 7-2 Supplier Page Hyperlink Revisions form

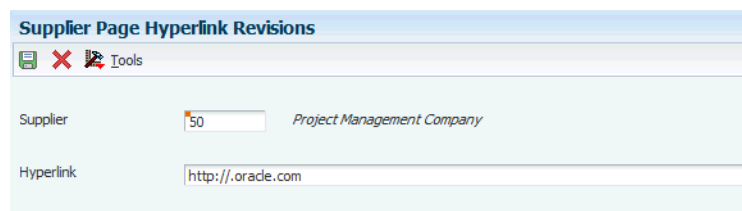

Supplier

Enter the supplier number for which you set up the hyperlink.

Hyperlink

Enter the hyperlink for the supplier. You can access the website for the hyperlink from the Order Details form in the Purchase Order Entry program (P4310).

7.2 Defining Supplier Prices and Discount Rules

This section provides an overview of supplier prices and discount rules, lists prerequisites, and discusses how to:

- Set processing options for Supplier Catalog Maintenance (P41061).
- Enter supplier prices.
- Create price discount rules for purchasing.
- Attach price discount rules to items and suppliers.

7.2.1 Understanding Supplier Prices and Discount Rules

The system processes an order based on the items that you purchase and the supplier from whom you make the purchases. For example, you can define purchasing instructions for a supplier so that each time you enter an order, the system retrieves default values for that supplier. You set up supplier prices, catalogs, price rules, and discount rules to manage how you order from suppliers, and how each supplier's prices and discounts apply to the orders.

7.2.1.1 Defining Supplier Prices and Catalogs

The price that you pay for an item might differ depending on the supplier from whom you purchase the item and whether a discount applies to the item. You can maintain supplier prices for items and provide discount information so that the system retrieves the correct unit cost for an item when you enter a purchase order.

The price for an item might vary depending on the supplier from whom you purchase it. For example, one supplier might charge 1.00 for an item while another supplier might charge 1.25 for the same item. You can enter the price that each supplier charges for an item.

You might receive a discount for an item based on the quantity that you purchase. Discount rules may also be called quantity breaks. Pricing on quantity breaks provides lower per unit prices based on higher quantity thresholds. For example, you might receive a 20 percent discount if you purchase 100 or more items. You can have the system apply a discount to the price of an item by creating price rules and attaching them to the items and suppliers to which they pertain.

You can enter prices for an item based on the supplier from whom you purchase the item. For example, a clock from AAA Supply Company might cost 5.00. If you purchase the same clock from Acme Supply Company, it might cost 7.00. When you enter a purchase order, the system can retrieve a unit cost for an item based on the price that you entered for the supplier.

You must enter supplier prices by catalog. A catalog is a group of items along with the price for each item. Each catalog is unique to a supplier. You can enter all of the items that you purchase from a supplier in one catalog, or you can create multiple catalogs to classify a supplier's items by seasonal changes, different product lines, and so on.

If you enter item prices for a supplier without specifying the name of a catalog, the system automatically creates a default catalog for the supplier. You might want to use default catalogs if you plan to maintain only one catalog for each supplier.

A supplier might charge a different price for the same item depending on the time of year that you purchase the item. For example, the same calendar might cost 10.00 in January and 5.00 in October. You can enter the same item at a different price in multiple catalogs, with different effective dates for each price.

When you enter an item on a purchase order, the system searches the supplier's catalogs to retrieve a unit cost. It searches the default catalog first (if it exists), and then all other catalogs in alphabetical order. After the system locates an item, it verifies the effective dates. If the current date falls within the effective dates, the system enters the unit cost on the purchase order.

The system retrieves the unit cost for a purchase order detail line based on either the transaction unit of measure (UOM) or the purchasing UOM for the line. You use system constants to specify which UOM the system uses for price retrieval.

7.2.1.2 Price Rules and Discounts

The price for an item might vary depending on the quantity that you purchase. For example, if you purchase one clock, the price might be 5.00. If you purchase 100 clocks, the price for each clock might be 4.00. When you enter an item in a catalog, you can specify price breaks based on the quantity that you purchase.

You might receive a discount on an item based on the quantity that you purchase. For example, if the price for an item is 5.00, you might receive a 20 percent discount if you purchase 100 items and a 30 percent discount if you purchase 200 items. You can have the system apply a discount to the unit cost of an item when you enter a purchase order.

You must create inventory price rules to provide discount information. For each price rule, you must specify:

- The quantity you must purchase.
- The discount you will receive (percentage, monetary amount, or flat rate) based on each purchase quantity.
- Effective dates for each discount.

A price rule can apply to a single item or multiple items. For example, you can set up a price rule that applies to a specific office supply or a group of office supplies. After you create a price rule, you must attach it to the items to which it applies and the supplier from whom you purchase the items.

You can create multiple levels for a price rule, each of which represents a certain purchase quantity. For example, you might set up these levels:

- Level one – 20 percent discount for the purchase of up to 100 items.
- Level two – 30 percent discount for the purchase of 101 to 200 items.
- Level three – flat rate for the purchase of 201 items to 1,000 items.

If you enter a purchase order for a supplier and item to which you have attached the preceding rule, the system applies a discount to the unit cost of the item based on the quantity that you purchase. For example, if the cost of the item is normally 10.00 and you purchase 150 items, the system calculates a unit cost of 7.00.

A supplier might provide you a discount on a specific item up to a maximum purchase limit. For example, you might have an agreement to purchase up to 200 hammers at a special price of 4.00 each. After you purchase 200 hammers, the price returns to normal. You can create a contract price rule to cover this type of discount.

You create a contract price rule the same way that you create a standard price rule, except that you must:

- Specify that the rule is a contract price.
- Name the rule after the short item number to which the rule applies.
- Indicate the number of items you can purchase at the contract price.

You do not need to attach the contract price rule to the item. The system retrieves the contract price based on the short item number when you enter a purchase order.

If you create a contract price rule for an item, the price that you specify will override all other price rules that are applicable to the item.

The system tracks the quantity that has been purchased against the contract price rule to date.

7.2.1.3 Attaching Price Discount Rules to Items and Suppliers

You can create an inventory price rule to apply a discount to the unit cost of an item. After you create a price rule, you must attach it to the items to which it applies and the suppliers from whom you purchase the items. The system discounts the unit cost of an item when you enter a purchase order.

After you create an inventory price rule, you can attach it to branch/plant information for an item or you can attach it to a purchase order detail line. If a price rule is standard for an item, you probably want to attach the rule to branch/plant information. If the price rule varies for an item, you can enter a different price rule each time you enter a purchase order.

If you attach a price rule to an item, you must also attach the price rule to the supplier from whom you purchase the item. Before you attach a price rule to a supplier, you can review any price levels that currently apply to a supplier on Work With Pricing Rules. For example, you might have attached a price rule in the item branch/plant information that you entered.

Before you attach a new price rule to a supplier, you might want to remove the existing price rule by selecting Remove Level from the Row menu on the Customer Pricing Rules form.

You can use one of two methods to attach price rules to a supplier:

- Attach price rules to a certain supplier.
- Attach price rules to a supplier price group and then attach the price group to a supplier.

If the same price rules apply to multiple suppliers, you can save time by attaching price rules to a price group and then attaching the price group to the suppliers. If price rules vary among suppliers, you might want to attach individual price rules to each supplier.

7.2.2 Prerequisites

Before you define supplier prices and discount rules:

- Verify that all items for which you enter supplier prices have a purchase price level of 1 or 2 in master information.

These price levels direct the system to retrieve unit costs for purchase orders based on suppliers.

- Set processing options to indicate whether you can add new items to catalogs and create records in the F4101 table.
- Enter catalog names in UDC table 40/CN.
- Set up names of price rules in UDC table 40/PI.

Before you attach price discount rules to items and suppliers, you must set up names of price groups on UDC table 40/PC.

7.2.3 Forms Used to Define Supplier Prices and Discount Rules

Form Name	Form ID	Navigation	Usage
Supplier Catalog Revisions	W41061A	Price Management (G43A17), Supplier Catalog Maintenance Click the Add button on the Work With Supplier Catalogs form.	Enter supplier prices.
Inventory Pricing Rules	W4271A	Price Management (G43A17), Inventory Pricing Rules Click Add on the Work With Pricing Rules form.	Create price discount rules for purchasing.
Customer Pricing Rules	W4271B	Price Management (G43A17), Supplier Pricing Rules On the Work With Pricing Rules form, select the line that contains the price discount rule that you want to attach, and select Customer Rules from the Form menu.	Attach price discount rules to items and suppliers.

7.2.4 Setting Processing Options for Supplier Catalog Maintenance (P41061)

Processing options enable you to specify the default processing for programs and reports.

7.2.4.1 Defaults

These processing options specify default information that the system uses for purchase order processing.

Item Master Creation Processing

Specify whether the system enables the creation of an item master record, and whether a warning message is displayed. Values are:

Blank: The system does not enable the creation of a record.

1: The system creates a record and issues a warning.

2: The system creates a record with no errors or warnings.

Stocking Type

Specify a value from the Stocking Type Code (41/I) UDC to specify the default type of stock. If you leave this processing option blank, the system uses a value of N (nonstock).

Line Type Default (Required)

Specify a value that exists in the Line Type Control Constants File table (F40205). The system uses the value that you enter as the default value. If you leave this processing option blank, the system uses a line type of B.

G/L Class Code (Required) (general ledger class code)

Specify a value that exists in the G/L Posting Category (41/9) UDC to specify the default value for the posting category code. You must complete this processing option.

7.2.5 Entering Supplier Prices

Access the Supplier Catalog Revisions form.

Catalog Name

Enter a value from the Catalog Names (40/CN) UDC to establish a name of the price group for the items of a supplier.

Quantity Break

Enter the quantity of units that are affected by this transaction.

Effective From

Enter the date from which the price is effective. If you do not enter effective dates, the system enters the current date through the last day of the century.

Effective Thru (effective through)

Enter the last day of a date range for the price. If you do not enter effective dates, the system enters the current date through the last day of the century.

7.2.6 Creating Price Discount Rules for Purchasing

Access the Inventory Pricing Rules form.

Pricing Rule

Enter a value from the Item Price Groups (40/PI) UDC that the system uses to classify inventory by pricing rules.

Typically, these categories correspond to the major sections in the inventory price book. You can set up as many detail categories as you need. A single code can be used for sales, purchasing, order/basket, and contract pricing. If you set up a contract rule, it must equal the short number for the item under contract.

Price Method

Enter a value from the (42/CT) UDC that indicates the basis for the price rule. You must enter P for purchase order discounts.

Contract Pricing

Enter a value from the Pricing Type (42/PT) UDC to specify a special pricing relationship between the item and one or more of the customers. The inventory pricing rule code for a contract is the item number. Values are:

Blank: No contract.

C: Indicates contract price.

If you indicate that a pricing type is a contract, you must enter the quantity that can be sold at this contract price and the contract number, if one exists. You must also attach the contract pricing rule to the customer or customer group for the rule to become effective.

Level

Enter an alphanumeric code that determines the sequence in which the system displays the rules within the pricing group. You define levels when you set up the pricing groups.

You must enter a value in the Level field for each discount that is applicable to the rule.

Up To Quantity

Enter the volume or quantity breaks commonly used in pricing tables. If the quantity on the first level of a rule is 5, then the pricing logic on this level applies only to sales of 5 or fewer items. If the quantity in the next level is 10, then the pricing logic applies to sales of 6 through 10 items. 99,999,999 indicates all quantities.

Basis

Enter a value from the Cost/Price Basis (H42/CB) UDC. The system uses the value that you enter to determine the order's net price.

For pricing and repricing, values are:

1: Last-in cost

5: Future cost

P: Unit price

2: Average cost

6: Lot cost

3: Memo cost 1

7: Standard cost

4: Current cost

In sales order repricing, the system bases all reprice calculations on either the unit cost or price in the sales detail. Enter **P** if you want the system to use unit price in the sales order as the basis for reprice calculations.

Otherwise, enter a value between **1** and **8** to use the unit cost in the sales detail as the base on value for all reprice calculations.

Factor Value

Enter the discount that the system uses when it calculates the price of an item attached to this inventory pricing rule. Discounts can be expressed as multipliers, additional amounts, or deductible amounts. For example, a 10 percent discount would be expressed as **0.90**. You can use the same factor for markups over cost. For example, a 10 percent markup would be expressed as **1.10**.

Type

Enter a value from the FVTY (H00/FV) UDC that indicates whether the factor value is a multiplier (percentage) or an additional/deductible cash amount (USD) when applied to the price of an order.

Override Price

Enter a price that overrides all other rules or prices.

7.2.7 Attaching Price Discount Rules to Items and Suppliers

Access the Customer Pricing Rules form.

Figure 7-3 Customer Pricing Rules form

Supplier Pricing Rules - Inventory Pricing Rules

Pricing Rule: BICYCLE Bicycles Contract Pricing (C)

Price Method: Blank - Pricing Category 42/CT

Records 1 - 4

	Level *	Up To Quantity	Basis *	Factor Value	Type	Override Price	Effective Date	Expiration Date	Contract Quantity
<input checked="" type="radio"/>	3	99,999,999	P	.8500	%		04/17/1997	12/31/2041	0
<input type="radio"/>	2	499	P	.9000	%		04/17/1997	12/31/2041	0
<input type="radio"/>	1	99	P	1.0000	%		04/17/1997	12/31/2041	0
<input type="radio"/>									

Customer Price Group

Enter a value from the Customer Price Group (40/PC) UDC that identifies a customer group. You can group customers with similar characteristics, such as comparable pricing.

Applied Levels Only

Select to include preference customer group information that is related to the customer number specified.

If a price rule has multiple levels, you must select the highest level of the rule to make all lower levels apply. To select a specific level, you must select Applied Levels Only, in which case only the level that you select applies.

Setting Up Rebates

This chapter contains the following topics:

- [Section 8.1, "Understanding Setup for Rebates"](#)
- [Section 8.2, "Entering Basic Rebate Agreement Information"](#)
- [Section 8.3, "Defining Conditions for Obtaining a Rebate"](#)
- [Section 8.4, "Defining Purchase Limits for Rebate Amounts"](#)

8.1 Understanding Setup for Rebates

For the system to track rebates, you must provide information about the agreements that you have with your suppliers. This information includes:

- Basic information about each agreement, such as the supplier providing the rebate and the effective dates of the rebate.
- The items that you must purchase or the account numbers that you must purchase against to obtain the rebate.
- The quantity or amount that you must purchase for the rebate.
- The amount of the rebate or the percentage of purchases that determines the rebate amount.

If several of your suppliers have the same parent company, you might want to track rebate information at the parent level instead of at the supplier level. You can set up procurement instructions for each supplier to specify the level at which to track rebate information.

When you enter orders, the system applies purchase quantities and amounts toward rebates. You must specify the order types from which the system applies purchases to rebates. For example, you can have the system apply quantities and amounts from purchase orders, blanket orders, or both.

Important: Ensure that you specify the correct order types from which the system applies purchases to rebates. For example, if you use blanket orders to purchase items, you must specify the blanket order type. If blanket orders are prerequisites to purchase orders, you specify only the purchase order type. Otherwise, the system applies the same quantity and amount from both the blanket order and the purchase order.

8.2 Entering Basic Rebate Agreement Information

This section provides an overview of basic rebate agreement information, lists a prerequisite, and discusses how to enter basic rebate agreement information.

8.2.1 Understanding Basic Rebate Agreement Information

When a supplier offers you a rebate for purchasing certain goods and services, you set up a rebate agreement. You can have an unlimited number of rebate agreements for each supplier. For each agreement, you specify basic information, such as:

- The agreement number.
- The supplier who is offering the rebate.
- The effective dates of the agreement.
- The status of the agreement, such as active or pending.
- The person to whom the system directs messages when a rebate is due.

You can also specify whether the rebate is based on purchase quantities or amounts and whether the rebate is an amount or a percentage of the purchase amount.

If you specify that a rebate agreement is based on purchase quantities, you must enter a unit of measure for the rebate agreement.

You can have the system assign a number to each of your rebate agreements or you can enter your own number. If the system assigns a number, the system increases the last rebate agreement number for the supplier by one. If it is the first rebate agreement for the supplier, the system assigns the number 1.

You can also specify a currency for a rebate agreement; if you do so, you must enter the thresholds, or purchase limits, for the agreement in that currency. When you enter purchase orders for rebate items in another currency, the system converts the purchase order currency to the rebate currency.

You can enter a memo about a rebate agreement. When a memo exists, the system displays a paper clip icon next to the rebate agreement in the detail area on the Work With Purchase Agreements form.

If the terms of the agreement are not yet final, you can set up a pending rebate agreement for a supplier. You can also specify that all rebate agreements for a certain supplier are pending. If you use procurement instructions to specify that all rebate agreements for a supplier are pending (inactive), the system changes the status to active when you enter a new active rebate agreement for the supplier.

The system stores rebate agreement information in the F4340 table.

8.2.2 Prerequisite

Set up the order types from which the system applies purchases to rebates in the Rebate Order Type (43/RB) user-defined code (UDC) table.

8.2.3 Form Used to Enter Basic Rebate Agreement Information

Form Name	Form ID	Navigation	Usage
Purchase Rebate Agreement Revisions	W4340B	Price Management (G43A17), Purchase Rebate Agreement	Enter basic rebate agreement information.
		Click Add on the Work With Purchase Agreements form.	Revise a purchase rebate agreement.

8.2.4 Entering Basic Rebate Agreement Information

Access the Purchase Rebate Agreement Revisions form.

Agreement Seq Number (agreement sequence number)

Enter the sequence number that distinguishes rebate agreements for a specific supplier. You can enter an agreement number, or the system assigns a number by increasing the last agreement number for the supplier by one.

Rebate Status

Enter a value from the Rebate Status (43/RS) UDC table that defines the status of the rebate agreement. The status can be pending or active. The value **A** (active) is hard-coded to indicate that the rebate information will be updated.

Threshold Type

Enter a value from the Threshold Type (43/TT) UDC table that indicates whether the threshold is in number of units or amount. Depending on the type that you indicate, the system uses the name Threshold Units or Threshold Amount.

Rebate Type

Enter a value from the Rebate Type (43/RT) UDC table that indicates whether the rebate is a percentage of the quantity purchased or a fixed currency amount.

Administrator

Enter the address book number of a manager or planner.

A processing option for some forms enables you to enter a default value for this field based on values for category codes 1 (Phase), 2, and 3. You set up the default values on the Default Managers and Supervisors form. After you set up the default values and set the processing option, the system automatically displays the default information on any work orders that you create if the category code criterion is met. You can either accept or override the default value.

Stop Messages

Enter a value from the Stop Messages (43/SM) UDC table to specify whether the system sends messages to the person identified in the Administrator field.

8.3 Defining Conditions for Obtaining a Rebate

This section provides an overview of rebate conditions, lists a prerequisite, and lists the forms used to define conditions for obtaining a rebate.

8.3.1 Understanding Rebate Conditions

After you enter basic information about a rebate agreement, you must specify inclusion rules that indicate what must be purchased to obtain the rebate. The system applies purchases toward a rebate agreement based on:

- Item number.
- Account number against which you are purchasing.
- Items to which you assigned a particular category code value.

You can enter item numbers or account numbers when you must purchase specific items or services to obtain the rebate. You can enter stock or nonstock items for a rebate agreement.

You can enter a category code value to specify a group of items from which you can make purchases. The system applies purchases to the rebate agreement each time that you purchase an item that is assigned the category code value.

The system applies purchase order transactions to a rebate agreement by comparing the items or services purchased to the inclusion rules that are set up for each rebate agreement. The system begins searching on the agreement with the lowest sequence number.

For the system to apply purchases to a rebate agreement:

- The agreement must have an active status.
- The purchase transaction date must be within the effective dates that you specified for the agreement.
- The supplier rebate code on Purchasing Instructions (P04012) must be set to active.

A single purchasing transaction cannot apply to more than one purchasing agreement.

Each time that you enter an order detail line, you must specify a line type. The inventory interface for the line type, which you specify in Order Line Types (P40205), determines the order in which the system searches through inclusion rules for a rebate agreement to find a match:

- **A** represents the account number and category code.
- **B** represents the account number and item number.
- **D** represents the item number and category code.
- **N** represents the category code.
- **Y** represents the item number and category code.

The system stores information about the items, account numbers, and purchasing code values that are applicable to a rebate agreement in the F4342 table.

8.3.2 Prerequisite

Specify the purchasing category (P1–P5) that you will use to enter category code values for rebates. You specify this value in the System Constants program (P41001). If you do not specify a purchasing category, the system uses purchasing category code **1** (P1) as the default value.

8.3.3 Form Used to Define Conditions for Obtaining a Rebate

Form Name	Form ID	Navigation	Usage
Inclusion Rules Maintenance	W4340E	Price Management (G43A17), Rebate Inclusion Rules Select a supplier on the Work With Purchase Agreements form, and then select Inclusion Rules from the Row menu.	Define conditions for obtaining a rebate. Maintain inclusion rules. Specify an object account, which is the portion of a general ledger account that refers to the division of the cost code (for example, labor, materials, and equipment) into subcategories. For example, you can divide the cost code for labor into regular time, premium time, and burden. If you use a flexible chart of accounts and the object account is set to six digits, you should use all six digits. For example, entering 000456 is not the same as entering 456 because, if you enter 456 , the system enters three blank spaces to fill a six-digit object.

8.4 Defining Purchase Limits for Rebate Amounts

This section provides an overview of purchase limits and discusses how to:

- Set processing options for Purchase Agreements Maintenance (P4340).
- Define purchase limits for rebate amounts.

8.4.1 Understanding Purchase Limits

After you define the conditions for obtaining a rebate, you must enter the quantity of items or the financial amount that you must purchase before you can receive a rebate. For example, you enter either 500 widgets or 500.00 worth of widgets. Each quantity or financial amount is referred to as a threshold. When you enter multiple thresholds, you must enter threshold quantities or amounts in ascending order.

If you set up multiple thresholds, you must enter the total rebate amount that you have received from the supplier in the Amount Purchased field on the Rebate Adjustments Revision form. When you meet the next rebate threshold for the agreement, the system subtracts the received amount from the rebate that you are now due.

Next, you enter information about the type of rebate that you are to receive. The rebate type indicates whether the rebate is a specific predetermined financial amount or a

percentage of the total purchase amount. For example, if you purchase 100 widgets, the supplier gives you a 50.00 rebate. However, if you purchase 500 widgets, the supplier gives you a 15 percent rebate on the total purchase amount of the widgets.

You must enter the entire financial amount or percentage that you are to receive for each threshold, regardless of other thresholds for which you might have already received a rebate. For example, you should receive 100.00 for purchasing 100 widgets, and 500.00 for purchasing 500 widgets. When you purchase 500 widgets, you are entitled to a total rebate of 500.00, regardless of the 100.00 that you might already have received.

If you are entitled to a rebate regardless of the quantity or amount that you purchase, you can enter a threshold quantity of zero.

Important: You must base threshold quantities on the unit of measure that you specify for the purchase rebate agreement. When you enter purchase orders for rebate items, the system converts the purchasing unit of measure to the rebate unit of measure if necessary.

The system stores information about the thresholds and rebates that are applicable to a rebate agreement in the F4341 table.

8.4.2 Form Used to Define Purchase Limits for Rebate Amounts

Form Name	Form ID	Navigation	Usage
Threshold Maintenance	W4340D	Price Management (G43A17), Purchase Rebate Agreement Select a supplier on the Work With Purchase Agreements form, and select Thresholds from the Row menu.	Define purchase limits for rebate amounts.

8.4.3 Setting Processing Options for Purchase Agreements Maintenance (P4340)

Processing options enable you to specify the default processing for programs and reports.

8.4.3.1 Display

This processing option specifies the type of information that the system displays on the Rebate Adjustment form.

1. Rebate Adjustment

Enter **1** to enable entry of quantity and amount on the Rebate Adjustment form. If this field is left blank, the window is display-only.

8.4.4 Defining Purchase Limits for Rebate Amounts

Access the Threshold Maintenance form.

Threshold Quantity

Enter the total quantity of an item that must be reached to qualify for a rebate. You can establish multiple threshold values for a single rebate agreement.

Rebate Percentage

Enter the percentage of actual purchases that the supplier pays when the associated rebate threshold is reached.

You must express a percentage as a whole number (for example, enter **10** to express 10 percent).

Note that the supplier pays a rebate amount if the rebate type specifies a fixed amount.

Setting Up Purchase Order Commitments

A *commitment* is the recognition of a future obligation.

This chapter contains the following topics:

- [Section 9.1, "Setting Up Commitment Tracking"](#)

9.1 Setting Up Commitment Tracking

This section provides an overview of commitment tracking and discusses how to:

- Set up commitments.
- Set up commitment relief.

9.1.1 Understanding Commitment Tracking

You can set up commitment tracking to monitor purchasing obligations for a specific job or project. Each time you enter an order detail line, the system recognizes the amount on the line as a commitment and applies it to a job or project. You can review individual commitments and the total amount of outstanding commitments for a specific job or project.

Commitment tracking applies only to purchases for nonstock items and services. You must charge each order detail line to a general ledger account number. The number represents the job or project for which you are tracking commitments.

You must specify the order types for which the system is to track commitments in UDC table 40/CT. For example, if you want the system to track commitments on orders and requisitions, you must specify these order types.

For a detail line to be eligible for commitment tracking, it must have a line type with an inventory interface code of A, B, or C. These codes indicate that the line is charged directly to a general ledger account number.

Each time you enter a purchase order detail line for which commitment tracking is applicable, the system records the amount in the purchase amount (PA) ledger and the purchase unit (PU) ledger.

The PA ledger contains committed purchase amounts. The PU ledger contains committed purchase units.

When you receive goods or create a voucher for purchases, the system relieves commitment amounts by subtracting them from the total commitment amount for the job or project.

You set up commitment relief to determine whether the system relieves commitments automatically. When you specify automatic commitment relief and you are using a

formal receiving process, the system relieves commitments when you post either receipts or vouchers to the general ledger. If you use an informal receiving process, the system relieves open commitments when you post vouchers to the general ledger.

Important: When you are completing commitment relief, the Job Cost Projections field must be set to **No** if you are in a non-job cost environment. Note that the default value in the Job Cost Projections field is **Yes**.

9.1.2 Forms Used to Set Up Commitment Tracking

Form Name	Form ID	Navigation	Usage
User Defined Codes	W0004AI	Commitment Setup/Rebuilds (G43B411), Commitment Document Types On the Work With User Defined Codes form, click Add. Encumbrance Setup/Rebuilds (G43C411), Encumbrance Document Types On the Work With User Defined Codes form, click Add. Subcontract Setup/Rebuild (G43D411), Commitment Document Types On the Work With User Defined Codes form, click Add.	Set up commitments.

Form Name	Form ID	Navigation	Usage
Job Cost Constants	W0026A	Commitment Setup/Rebuilds (G43B411), Commitment Relief On the Work with Job Cost Constants form, click Add. Encumbrance Setup/Rebuilds (G43C411), Encumbrance Relief Constants On the Work with Job Cost Constants form, click Add. Subcontract Setup/Rebuild (G43D411), Commitment Relief Constants On the Work with Job Cost Constants form, click Add.	Set up commitment relief.

9.1.3 Setting Up Commitments

Access the User Defined Codes form.

Find UDC 40/CT.

9.1.4 Setting Up Commitment Relief

Access the Job Cost Constants form.

Commitment Relief

Enter a code that specifies whether the system automatically relieves open commitments when you post accounts payable vouchers to the general ledger.

These vouchers are related to noninventory purchase orders and contract progress payments. Values are:

Y: Automatically relieve open commitments.

N: Do not automatically relieve open commitments.

Entering Purchase Orders

This chapter contains the following topics:

- [Section 10.1, "Understanding Purchase Order Entry"](#)
- [Section 10.2, "Setting Processing Options for Purchase Orders \(P4310\)"](#)
- [Section 10.3, "Entering Order Header Information"](#)
- [Section 10.4, "Entering Order Detail Information"](#)

See Also:

- "Entering Purchase Orders for Brazil" in the *JD Edwards EnterpriseOne Applications Localizations for Brazil Implementation Guide*.

10.1 Understanding Purchase Order Entry

Each time you want to purchase goods or services, you must enter a purchase order. You enter orders to specify details about the goods or services you are purchasing, to indicate the supplier from whom you are purchasing, and to specify other pertinent information.

An order consists of two parts:

- Header information - general information that relates to the entire order, such as the supplier name and order dates.
- Detail information - line-by-line details about the items or services you want to order, such as item numbers, quantities, and costs.

You can enter header information and detail information separately. Depending on the volume of orders and the amount of header information you need to enter, you use processing options to select one of these methods to enter orders:

- Enter header information first, followed by detail information.
- Enter detail information only, allowing the system to apply limited default values for header information.

The system maintains header and detail information in two separate tables:

- Purchase Order Header table (F4301)
- Purchase Order Detail File table (F4311)

Several tools are available to help you create orders. These tools allow you to generate multiple orders at the same time, locate item and supplier information, and so forth.

You can have the system check orders to verify that costs do not exceed budget limits. You can place an order on hold if it exceeds budget or for any other reason. You can review up-to-date commitment, budget, log, and order hold information.

After you generate orders, you can make changes to the orders and print the orders.

10.1.1 Supplier Classification Codes

Classification codes capture information about a supplier in the supplier's address book record in the JD Edwards EnterpriseOne Address Book system. At the time a purchase order is created, the classification code fields are populated for the order header and order detail sections of a purchase order.

The classification codes reside on the Order Header - Additional Information form (W4310H) and the Order Header - Additional Information II form (W4310M). The codes are display-only during purchase order entry and voucher match. The supplier information is then passed to the accounts payable ledger record.

The classification code field values are stored in the Purchase Order Header table (F4301).

When copying a purchase order, classification codes are retrieved from the supplier's address book record and added to the order.

See [Entering Additional Order Header Information](#).

10.1.2 Additional Properties and Category Codes

Additional properties and category codes capture user-defined information for a purchase order. At the time a purchase order is created, you manually enter values for fields on the Additional Properties and Category Codes tabs of the Order Header form or the Order Detail form.

The Additional Properties tab includes multiple user-defined fields that:

- Vary in size and format.
- Work with or without table validation.
- Are optional or required.

Note: If you enter values in the user-defined fields on the Additional Properties and Category Codes tabs on the Order Header form, then the fields on these tabs are display-only on the Order Detail form.

To access the user-defined fields, you must enable the Display Additional Properties Tab and Display Category Codes on Header Tab and Detail Grid processing options on the Display tab of the P4310 program.

You can also set the Address Book Field Required processing option to specify whether the Address Book 01 and Address Book 02 fields on the Additional Properties tab are required. This processing option is used with the Display Additional Properties Tab processing option on the Display tab of the P4310 program. If the Address Book fields are required, then the Display Additional Properties Tab processing option must be enabled.

The user-defined field values from the Additional Properties and Category Codes tabs are stored in the Purchase Order Header table (F4301). The user-defined fields are not stored in the Purchase Order Receiver File table (F43121).

The Category Code 01 through Category Code 04 fields appear in the detail grid of the form. These fields are independent from the category codes on the Order Header form. The values in the fields on the Order Header form do not populate the fields on the Order Detail form. The user-defined field values are stored in the Purchase Order Detail File table (F4311).

Note: Purchase orders created directly in P4310 provide access to the user-defined fields on the Additional Properties and Category Codes tabs on the Order Header or Order Detail form. Purchase orders not created directly in P4310, such as transfer orders, direct ship orders, and order generation programs, do not provide access to the user-defined fields. Once the purchase order is generated, you can then access the order in P4310 to enter values in the user-defined fields.

Note: Purchase orders created through sourcing using the Analyze Event program (P43Q50), through supplier self-service using the SRM - PO Acknowledgement program (P43S01), or through EDI using the EDI Inbound P.O. Acknowledgment program (R47021) do not handle the user-defined fields. Additionally, sourcing does not handle service unit fields.

You can also set the Display Location and Lot fields for a Job or Project processing option on the Display tab of the P4310 program. Setting this processing option displays the Location and Lot fields in the grid for a job or project. This processing option is used with the Jargon and Header Business Unit processing option on the Display tab. If the Jargon and Header Business Unit processing option is set to a value of **1** or **2**, then this processing option is used. If the Jargon and Header Business Unit processing option is set to any value other than **1** or **2**, then this processing option is not used.

See [Entering Order Header Information](#).

10.1.3 Purchase Order Clauses

Clauses specify the print messages associated with a purchase order. Examples of text used in messages are engineering specifications, hours of operation during holiday periods, and special delivery instructions. You assign a user-defined code (UDC) to each print message in UDC 40/PM. You then associate a print message with a specific purchase order on the Clauses form (W4310K). The purchase order clauses are stored in the Purchase Order Clauses table (F4320).

To access the Clauses form, you must select the Enable Form Exit for Clauses processing option on the Display tab of the P4310 program. If enabled, the Clauses form is accessed from the Form menu on the Order Header and Order Detail forms.

See [Defining Print Messages](#).

10.1.4 Retention

Subcontract retention is the percentage of a committed amount that is held until a specified date after the order is complete. Retention processing applies to ongoing projects and only applies to inventory interface of A and B.

Before entering an order that includes retention, select the Display Retainage Indicator processing option on the Display tab of the Purchase Orders program (P4310). When you enter an order that has retainage, select the Retainage Indicator check box on the order header form. This field notifies the A/P clerk during the voucher match process to double-check the invoice from the supplier to see if there was an amount retained on the invoice. The Retainage Indicator check box can be used with or without the Retainage Percentage field.

See [Working with Retainage](#).

10.2 Setting Processing Options for Purchase Orders (P4310)

Processing options enable you to specify the default processing for programs and reports.

For programs, you can specify options such as the default values for specific transactions, whether fields appear on a form, and the version of the program that you want to run.

10.2.1 Defaults

These processing options enable you to enter default information that the system uses for purchase order processing.

1. Order Type

Enter a value that exists in the Document Type - All Documents (00/DT) UDC to specify the default value for the order type. The system populates the Order Type field of the Order Header form with this value.

2. Line Type

Enter a value to specify how the system processes lines on a transaction. The line type affects the systems with which the transaction interfaces (JD Edwards EnterpriseOne General Ledger, JD Edwards EnterpriseOne Job Cost, JD Edwards EnterpriseOne Accounts Payable, Oracle's JD Edwards EnterpriseOne Accounts Receivable, and JD Edwards EnterpriseOne Inventory Management). The line type also specifies the conditions for including a line on reports and in calculations. You define line types in the Order Line Types program (P40205).

The system populates the Ln Ty (line type) field on the Order Detail form.

3. Beginning Status

Enter a value that exists in the Activity/Status Codes (40/AT) UDC to specify the default value for the beginning status for the order. The value that you enter must be set up for the order type and the line type that you are using.

4. Override Next Status

Enter a value that exists in the Activity/Status Codes (40/AT) UDC to specify the next status code for all new or modified purchase order lines. You enter next status codes for combinations of order type and line type by using the Order Activity Rules program (P40204). If you leave this processing option blank, the system uses the next status code in the order activity rules as the default value.

Do not use this processing option if you are using approval processing.

5. Unit of Measure

Enter a value that exists in the Unit of Measure (00/UM) UDC to specify the default unit of measure that the system displays in the Transaction Unit of Measure field.

6. Line Number Increment

Enter a whole number that the system uses to automatically increase the order lines on the order incrementally.

7. Default Tax Rate/Area (Release 9.1 Update)

Specify where the system locates default tax rate/area information to use as the default during order entry. Values are:

Blank: The system uses the tax rate/area that is associated with the address book record for the supplier. The system retrieves the tax explanation code from the supplier address book record in the Supplier Master table (F0401) table.

Note: If the system calls this version from the Order Release program (P43060), then the tax information comes from the original order.

If the tax rate area is blank for the original order, then the tax information comes from the address book record in the Supplier Master table.

1: The system uses the default tax rate/area from the address book number for the ship-to address number. The information that the system uses is located in the tax information section of the F0401 table.

(Release 9.1 Update) If the alternate tax rate/area assignment functionality is enabled for the company, the system overrides the default tax rate/area and uses the alternate tax rate/area assignment instead. See "Procurement Management" in the *JD Edwards EnterpriseOne Applications Tax Processing Implementation Guide*.

8. Transaction Unit of Measure

Specify where the system locates transaction unit of measure information to use as the default during order entry. Values are:

Blank: The system uses the purchasing unit of measure from the F4101 table. The transaction unit of measure directly relates to the number that you have entered in the Quantity field on the Purchase Order Entry form. If you select an item from a catalog in Purchase Order Entry, the unit of measure in the catalog overrides the value that you enter in this field. If you have entered a value in the Unit of Measure field, you should not enter a value in this field.

1: The system uses the primary unit of measure from the F4101 table as the default for the transaction unit of measure.

9. Landed Cost Rule

Enter a value from the Landed Cost Rule (41/P5) UDC to specify the landed cost rule that the system uses to populate the Cost Rule field on the Order Header - Additional Information form.

10. Header to Detail

Specify whether the system updates information in the detail lines when you change header information. Values are:

Blank: You must use the Populate form exit on the Order Header form to manually apply header to detail changes. Use the Define form exit on the Order Header form to select which fields on the Order Detail form you want to update with changes to header information. After you make changes to the header information, the Order Detail form appears.

1: The system automatically loads header changes to the detail lines.

11. Work Order Status

Enter a value that exists in the Work Order Status (00/SS) UDC that the system uses as a default value when the purchase order quantity or promise date changes. This processing option applies to purchase orders that have been created for outside operations by processing work orders with the Order Processing program (R31410). If you change the quantity or promise date after the system creates a purchase order, the system updates the work order status to the value you enter in this processing option. If you leave this processing option blank, the system does not change the work order status.

12. Account Description

Specify where the system locates the account description to use as the default value in order entry. Values are:

Blank: The system retrieves the account description from the account that consists of the business unit, object, and subsidiary.

1: The system retrieves the account description from the account that consists of the business unit and the subsidiary. Typically, the account is a nonposting header account. Note that the object account will not be used when the system retrieves the account description.

13. Line Sequence

Specify how the system assigns line numbers on a change order. Values are:

Blank: The system assigns unique line numbers on a continuous, incremental basis. When there are multiple change orders, the system assigns line numbers on a continuous, incremental basis rather than starting over with line number sequencing for each change order.

1: The system starts the sequencing process over for each change order. If you enter **1**, the system retains and increments the line number sequence within each individual change order; but for the next change order, the system starts over with the line number sequencing.

14. Cost Rule Selection

Specify where the system locates default cost rule selection information to use as the default during order entry. Note that if this is the version that is being called from the Order Release program, then the cost rule information comes from the F0401 table and not from the original order. Values are:

Blank: The system uses the cost rule selection that is associated with the address book number for the supplier. The system retrieves the cost rule explanation code from the supplier address book number record in the F0401 table.

1: The system uses the default cost rule selection from the address book number for the ship to. The information that the system uses is located in the cost rule information section of the F0401 table.

10.2.2 Display

These processing options enable you to control the types of information that the system displays.

1. Suppress Closed Lines

Specify if closed lines are suppressed. Values are:

Blank: The system does not suppress closed or canceled lines.

1: The system suppresses closed or canceled lines. When the system suppresses closed or canceled lines, any line with a status of 999 will not appear in the detail area. However, the record for the line remains in the F4311 table.

2. Status Code Protection

Specify whether the system enables the change of status codes. Values are:

Blank: Status codes can be changed.

1: Status codes cannot be changed. You can review the codes, but you cannot change them. Regardless of the status code, the system protects the last and next status when you have activated status code protection.

3. Order Type Protection

Specify whether the system enables the change of order types. Values are:

Blank: You can change the order type.

1: The order type (also known as the document type) cannot be changed. You can review the order type, but you cannot change it.

4. Kit Display

Specify whether the system displays kit component lines or only the parent line. Values are:

Blank: The system displays only the parent line. However, both the parent line and all component lines are written to the F4311 table.

1: The system displays kit component lines. You must first create the purchase order and then inquire upon the purchase order to display the kit component lines.

5. Cost Protection

Specify whether the system enables changes to costs. Values are:

Blank: The cost fields appear on the form and can be overridden.

1: The costs fields appear on the form, but they cannot be changed.

2: The system hides cost information. The Cost field does not appear, although the system still writes the cost information to the F4311 table. The system uses cost information from the costs tables as the default. Examples of the costs tables are the F4105 table and the F41061 table. The cost table that the system uses for the default information depends on the way that the system is set up.

6. Detail Line Protection

Enter a value from the Activity/Status Codes (40/AT) UDC to specify the next status at which detail lines are protected from change. The entire detail line is protected when the next status is greater than or equal to this status. If you leave this processing option blank, the system does not protect detail lines from change.

7. Free Goods Catalog

Specify whether the system displays free goods catalog warnings. Values are:

Blank: No warning.

1: Issue warning.

8. Order Header Protection

Specify whether order header information is read-only or can be modified. Values are:

Blank: Order header information can be changed.

1: Order header information is read-only.

9. Jargon and Header Business Unit

Specify which description appears for the Business Unit field that appears on the Order Header form and the Order Detail form. For example, if you leave this processing option blank, the MCU field displays the description **Branch/Plant**. Values are:

Blank: Branch/plant.

1: Job.

2: Project.

3: Business unit.

10. Account Protection

Specify whether the account number information is protected after the detail line is partially received or vouchered. Values are:

Blank: The account number information is not protected.

1: The account number information is protected.

11. Display Additional Properties Tab

Specify whether the system enables the Additional Properties tab. This processing option controls the display of the Additional Properties tab on the Purchase Order Header and Purchase Order Detail forms. Values are:

Blank: Disable. Do not display the Additional Properties tab.

1: Enable. Display the Additional Properties tab.

12. Display Category Codes on Header Tab and Detail Grid

Specify whether the system enables the Category Codes tab. This processing option controls the appearance of the Category Codes tab on the Purchase Order Header and Purchase Order Detail forms. This processing option also controls the appearance of the Category Codes in the detail grid. Values are:

Blank: Disable. Do not display the Category Codes tab.

1: Enable. Display the Category Codes tab.

13. Enable Form Exit for Clauses

Specify whether the system enables the Form exit for Clause. Values are:

Blank: Disable

1: Enable

14. Display Location and Lot fields for a Job or Project

Specify whether the Location and Lot fields appear in the grid for a job or project. This processing option is used with the Jargon and Header Business Unit processing option on the Display tab. If the Jargon and Header Business Unit processing option is set to a value of **1** or **2**, then this processing option is used. If the Jargon and Header Business Unit processing option is set to any value other than **1** or **2**, then this processing option is not used. Values are:

Blank: Do not display.

1: Display.

15. Address Book Field Required

Specify whether the Address Book 01 and Address Book 02 fields on the Additional Properties tab are required. This processing option is used with the Display Additional

Properties Tab processing option on the Display tab. If the Address Book fields are required, then the Display Additional Properties Tab processing option must be enabled. Values are:

Blank: Not required.

1: Address Book 1 required.

2: Address Book 2 required.

3: Address Book 1 and Address Book 2 required.

16. Display Retainage Indicator

Specify whether the Retainage Indicator field appears on the Order Header and Order Detail forms.

This processing option is used with line type constants. If the Non-Billable Retainage option is selected on the line type constants, then retention can be used.

The Retainage Indicator field is a visual indication that the accounts payable clerk uses to verify whether retainage occurred on the invoice and if it should be applied to the voucher. Values are:

Blank: Do not display

1: Display

17. Display Service Units

Specify whether the system displays the Service Quantity and Service UoM fields in the grid on the Order Detail form. This processing option is used with line type constants. If the Procurement Allow Service Units option is selected on the line type constants, then service quantity and service UOM can be used. The Ordered Quantity and Service Quantity fields cannot be used together. Service quantity is a memo field and does not have any validation. Values are:

Blank: Do not display

1: Display

10.2.3 Interfaces

These processing options enable you to enter interface information.

1. Business Unit Validation

Specify how the system validates the branch/plant. Values are:

Blank: The system validates the branch/plant against the F0006 table. Typically, you use this processing option when you are performing services expenditure purchasing. When you leave this processing option blank, the Ship To address book number from the address book number in the F0006 table is used. You can access the Business Unit Master table through the Revise Single Business Unit program.

1: The system validates the branch/plant against the F41001 table. If you are performing stock purchasing, enter 1 for this processing option. When you enter 1, the system uses the address book number in the F41001 table as the default for the Ship To address book number.

2. PBCO Warning (post before cutoff warning)

Specify whether you want to receive a PBCO (Post Before Cutoff) warning. Values are:

Blank: The system compares the general ledger date on the purchase order to the general accounting period for the company and business unit that are on the purchase

order. The PBCO warning ensures that you are not recording purchases in a previous general accounting period.

1: Do not issue the PBCO warning. Typically, you use this value when you are performing services or expenditure-type purchasing.

3. PACO Warning (post after cutoff warning)

Specify whether you want to receive a PACO (Post After Cutoff) warning. Values are:

Blank: The system compares the general ledger date on the purchase order with the current period in the General Accounting Constants for the company and business unit that are on the purchase order. The PACO warning occurs when you try to create a purchase order with a general ledger date that exceeds two periods beyond the current general ledger period.

1: Do not issue the PACO warning.

4. Quantity Update

Specify which quantity fields the system updates. Before you set this processing option, always check the way that you have defined availability in the Branch/Plant Constants program. Values are:

Blank: The system updates the Quantity on PO field (alias PREQ).

1: Update the Quantity On Other POs field (alias OT1A) in the F4102 or F4100 tables. Use this value when you are entering requisitions, quotes, blanket orders, or other order types for which you do not want to affect the current on-purchase order quantity.

5. Supplier Analysis

Specify whether the system to capture supplier analysis information. Values are:

Blank: The system does not capture supplier analysis information.

1: The system records information such as item numbers, dates, and quantities for every purchase order in the F43090 table. To make supplier analysis most effective, enter **1** for this processing option and set the processing options for the Purchase Order Receipts program (P4312) and the Voucher Match program (P4314) to capture the same information.

6. Edit Supplier Master

Specify whether the system validates the supplier number against the F4330 table. Values are:

Blank: The system does not validate the supplier number.

1: The system validates the supplier number.

7. Financial AAIs (financial automatic accounting instructions)

Specify whether to use financial automatic accounting instructions (AAIs) or distribution AAIs. Additionally, the system uses this processing option to determine which description appears for the Business Unit field (MCU) that appears on the Order Header form and the Order Detail form. For example, if you leave this processing option blank, the MCU field displays the description **Branch/Plant**. Values are:

Blank: The system uses distribution AAIs.

1: The system uses financial AAIs CD, CT, or CR.

10.2.4 Processing

These processing options enable you to control how the system processes information.

1. New Supplier Information

Specify whether you can add new supplier information through the Address Book Revisions program (P0101). Values are:

Blank: The system does not access the Address Book Revisions program (P0101).

1: Automatically access the Address Book Revisions program (P0101). You can add a supplier as you need to, rather than having to stop the task that you are performing to add a supplier. Consider the security restrictions for Address Book records. You may not want to provide all users with the ability to enter supplier address book records.

2. Order Templates

Specify whether you want to review order templates. Values are:

Blank: Do not display available order templates.

1: Automatically display available order templates. If you set this processing option to automatically displays available order templates and you access the Order Header form, the system displays the order templates before displaying the Order Detail form. If you access the Order Detail form first, the system displays the order templates when you move the cursor to the detail area for the first time.

3. Subsystem Printing

Specify whether you want to automatically print a purchase order using the subsystem. Values are:

Blank: Do not print a purchase order by using the subsystem.

1: Automatically print the purchase order by using the subsystem. Note that you need to submit the version of the Purchase Order Print program (R43500) that is designated for subsystem processing.

4. Blanket Releases

Specify whether the system automatically processes blanket releases. Values are:

Blank: The system does not automatically process blanket releases.

1: The system automatically processes blanket releases for all branch/plants. If more than one blanket order exists for the supplier/item combination, the system displays a check mark in the row header that is located in the detail area and an X in the Blanket Exists column. To select a blanket order, select the appropriate option from the Row menu.

2: The system automatically processes blanket releases for a specific branch/plant. If there is more than one blanket order for the supplier and item combination, then the system displays a check mark in the row header that is located in the detail area and an X in the Blanket Exists column. To select a blanket order, select the appropriate option from the Row menu.

5. Header Display

Specify whether the Order Header form appears before the Order Detail form. Values are:

Blank: Display the Order Detail form.

1: Display the Order Header form before the Order Detail form.

6. Agreement Search

Specify how the system searches for agreements. This processing option applies only if you are using the JD Edwards EnterpriseOne Procurement system with the JD Edwards EnterpriseOne Agreement Management system from Oracle. Values are:

Blank: Do not search for agreements.

1: Assign an agreement if there is only one agreement in the system. If the system finds multiple agreements, the system displays a check mark in the row header that is located in the detail area and an X in the Agreement Exists column. You must use a row exit to select an agreement.

2: Display all agreements.

3: Search for the agreement that has the earliest expiration date.

7. Base Order Protection

Specify whether base order information can be changed. The base order is the original contract or order. The base order detail lines are identified as change order number 000. Typically, you use this processing option to prevent changes from being made to the original order. Values are:

Blank: You can change the base order information.

1: The base order information cannot be changed.

8. Project/Job Validation

Specify whether the values for the branch/plant and general ledger account business unit must be the same. Values are:

Blank: The values for the general ledger account business unit and the header business unit can be different.

1: The values for the general ledger account business unit and the header business unit (branch/plant, job, and so on) are the same.

9. Exclusive Adjustment Hold

Use this processing option to place the order on hold if you apply advanced pricing to the item and have chosen mutually exclusive adjustments for the item's adjustment groups.

10. Logs Entry Display

Specify whether the system automatically displays logs when adding an order or a contract. Values are:

Blank: The system does not automatically display logs.

1: The system automatically displays logs.

10.2.5 Duplication

These processing options enable you to enter default information that the system uses for duplicate orders.

1. Duplicate Order Type

Enter the type of document. This UDC (00/DT) also indicates the origin of the transaction. There are reserved document type codes for vouchers, invoices, receipts, and time sheets, which create automatic offset entries during the post program. (These entries are not self-balancing when you originally enter them.) You must enter a value that has been set up in UDC table 00/DT. These prefixes for document types are predefined; do not change them:

P: Accounts Payable documents.

R: Accounts Receivable documents.

T: Payroll documents.

I: Inventory documents.

O: Purchase Order documents.

J: General Accounting/Joint Interest Billing documents.

S: Sales Order Processing documents.

2. Beginning Status Code

Specify the beginning status, which is the first step in the order process. You must use a UDC (40/AT) that has been set up on the Order Activity Rules form for the order type and the line type that you are using.

3. Next Status Code (Optional)

Specify the next step in the order process. You must use a UDC (40/AT) that has been set up on the Order Activity Rules form for the order type and the line type that you are using. The override status is another allowed step in the process.

4. Copy Selection

Specify the information that the system copies. You must activate this processing option if you want the system to copy line attachment text and order attachment text when generating quotes or requisitions into purchase orders. Values are:

Blank: Copy no information.

1: Copy only line text.

2: Copy line text and order text.

3: Copy only order text.

10.2.6 Cross Ref

These processing options enable you to enter cross-reference codes.

1. Substitute Items

Specify the default cross-reference code that the system uses for retrieving substitute items. The value that you enter is used as the default on the Substitute Item Search and Select form.

If there is more than one substitute item, the system displays a check mark in the row header that is located in the detail area and an X in the Substitute Exists column.

2. Obsolete Items

Specify the cross-reference code for retrieving item replacements for obsolete items. The value that you enter is used as the default on the Substitute Item Search and Select form.

If there is more than one replacement item, the system displays a check mark in the row header that is located in the detail area and an X in the Replacement Exists column.

3. Promotional Items

Specify the cross-reference code that the system uses to retrieve promotional items.

10.2.7 Order Inquiry

These processing options enable you to enter status and date information.

1. From Status Code

Specify the first code in the range of status codes for order detail lines. The system uses this status as the default on the Additional Selection form.

2. Thru Status Code (through status code)

Specify the last code in the range of status codes for order detail lines. The system uses this status as the default on the Additional Selection form.

3. Last Status

Specify whether the system uses the last status or next status for the Open Order Inquiry program (P4310). Values are:

Blank: The system uses the next status code as the default for the from and thru status codes.

1: The system uses the last status code as the default for the from and thru status codes.

4. Date

Specify the date that the system checks to ensure that the date is within the date range. Values are:

Blank: The system checks the Requested Date.

1: The system checks the Transaction Date.

2: The system checks the Promised Date.

3: The system checks the Original Promise Date.

4: The system checks the Receipt Date.

5: The system checks the Cancel Date.

6: The system checks the General Ledger Date.

10.2.8 Versions

These processing options enable you to control which version of various programs the system uses.

1. Supply/Demand Inquiry (P4021)

Define the version that the system uses when you use the Supply/Demand Inquiry program.

2. Supplier Analysis (P43230)

Define the version that the system uses when you are using the Supplier Analysis program.

3. Supplier Master (P04012)

Define the version that the system uses when you are using the Supplier Master program.

4. PO Print on Demand (R43500)

Define the version that the system uses when you are using the Purchase Order Print On Demand program. The system uses the version that you select to print an order when you access the appropriate row exit on a form.

5. Item Availability Summary (P41202)

Define the version that the system uses when you are using the Item Availability Summary program.

6. Approval Review (P43081)

Define the version that the system uses when you are using the Approval Review program.

7. Receipt Routing (P43250)

Define the version that the system uses when you are using the Receipt Routing program.

8. Open Receipts (P43214)

Define the version that the system uses when you are using the Open Receipts program.

9. Revision Audit Summary (P4319)

Define the version that the system uses when you are using the Revision Audit Summary program.

10. Purchase Ledger (P43041)

Define the version that the system uses when you are using the Purchase Ledger program.

11. Open Order Inquiry (P4310)

Define the version that the system uses when you are using the Open Order Inquiry program.

12. Financial Status Inquiry (P44200)

Define the version that the system uses when you are using the Financial Status Inquiry program.

13. Inbound Transportation (P4915)

Define the version that the system uses when you are using the Inbound Transportation program.

14. Preference Profile (R40400)

Specify the version of the Preference Profiles program that the system uses to process orders based on preferences that are activated on the Preference Selection form.

15. Configurator (P3210)

Specify the version that the system uses when you use the Configured Item Revisions program.

16. Blanket Release (P43216)

Specify which version that the system uses with the Blanket Order Release program.

17. Logs Entry (P4305)

Specify the version that the system uses with the Logs Entry program.

18. Requisition Self Service (P43E10)

Define the version used by the system when you are using the Self Service Requisition program.

19. Style Matrix Entry (PCW10)

Specify the version of the Matrix Entry program (PCW10) that the system uses to display the style matrix data.

This processing option is enabled only if the Use Apparel Management Module system constant (SY41F) is enabled in the EnterpriseOne System Control program (P99410).

If you leave this option blank, then the system uses ZJDE0003 as the default version.

10.2.9 Currency

These processing options enable you to enter currency information.

1. Tolerance

Specify a currency tolerance limit percentage to ensure that the currency amount does not fluctuate by an amount greater than the tolerance percentage as compared with the F0015 table.

If you work with multiple currencies, create a separate version of this program for each currency. The amount you specify in this processing option is currency specific.

2. Currency Code

Specify the currency code in which to view as-if amounts. This setting enables you to view domestic or foreign amounts in a currency other than the currency in which the amounts were originally entered.

If you leave this processing option blank, the system displays as-if amounts in the currency in which they were originally entered.

As-if currency amounts are stored in a temporary memory, and are not written to a table.

3. As of Date

Specify an as-of date for the as-if Currency Code processing option. The system uses this date to retrieve the exchange rate from the F0015 table.

If you specify a currency code in the Currency Code processing option and leave this processing option blank, the system uses the system date.

The F0015 table must contain a valid exchange rate between the domestic or foreign currency and the as-if currency. This rate is based on the as-of date.

10.2.10 Approvals

These processing options enable you to enter approval-processing information.

1. Route Code

Specify which code the system uses for approval processing. Values are:

Blank: The system does not perform approval processing.

1: Use the Originator's address as the default value.

2: Use the Originator's user profile as the default value.

3: Use the Branch/Plant route code as the default value.

4: Use the Default Locations route code as the default value.

2. Awaiting Approval Status

Enter the next status for the system to use when the order enters the approval route.

3. Approved Status

Enter the next status for the system to use when the order is automatically approved.

4. Reapprove Changed Lines

Specify whether the system activates approval processing for certain types of modifications to a purchase order line that was already approved. Values are:

Blank: The system does not activate approval processing.

1: The system activates approval processing when any fields for the purchase order line are modified.

2: The system activates approval processing only when certain critical fields, which are activated through the Approval Fields Constants program (P43080), are modified.

3: The system activates approval processing only when the standard critical fields are modified.

5. Approval Hold Code

Specify a hold code that the system uses when placing the order on hold for the approval process. If you leave this processing option blank, the system does not place the order on hold.

10.2.11 Budgeting

These processing options enable you to enter budgeting information.

1. Budget Hold Code

Specify the hold code that the system uses for budget holds. After you enter a hold code, the system activates the budget checking process. Budget checking ensures that when a detail line exceeds the budget for an account, the system places the entire order on hold.

2. Budget Ledger Type

Specify the ledger type that contains the budgets.

If you specify a budget ledger type, the system retrieves only that budget ledger type. If you leave this processing option blank, the system retrieves all budget ledger types that were specified in the Ledger Type Master Setup program (P0025) and that are contained in the F0025 table.

3. Level of Detail

Specify the value (3 through 9) for the level of detail that the system uses during the budget checking process. If you leave this processing option blank, the system uses a default value of 9.

You can use this processing option with the processing option for level of detail accumulation.

4. Budget Total Method

Specify the method by which the system calculates the budget. If you leave this processing option blank, the system uses the job cost budget calculation method. Values are:

Blank: The system uses the job cost budget calculation method.

1: The system uses the job cost budget calculation method:

Original budget + period amounts for the current year + previous year postings.

2: The system uses the standard financial budget calculation method:

Sum of period amounts for the current year.

3: The system uses the standard financial spread calculation method:

Original budget + period amounts for the current year.

5. Period Accumulation Method

Indicate the time period that the system uses when accumulating the budget. Values are:

Blank: Use the total annual budget to accumulate the budget.

1: Accumulate the budget through the current period.

6. Tolerance Percentage

Specify the percentage by which the detail line amount can exceed the budget before the system places the order on budget hold.

7. Hold Warning

Specify whether the system displays a warning message about detail line amounts that exceed the budget. Values are:

Blank: The system does not display a warning, but it does place the order on hold.

1: The system displays a warning and places the order on hold.

2: The system displays a warning, but it does not place the order on hold.

8. Budget Accumulation Level of Detail (Release 9.1 Update)

Specify whether the system uses the Level of Detail processing option value (under the Budgeting tab) to accumulate budget amounts. Values are:

Blank: The system determines the budget amount from the account entered in the purchase order detail line.

1: The system determines the budget checking account from the values in the purchase order detail account and the Level of Detail processing option. The system then calculates the budget amount by accumulating the budget amounts of all the child accounts of the budget checking account.

9. Exclude Subledger/Type (Release 9.1 Update)

Specify whether the system excludes the subledger and subledger type when validating the budget information. Values are:

Blank: The system includes only those accounts that have a subledger and a subledger type specified in the purchase order detail.

1: The system does not consider the subledger and subledger type. All of the accounts (with and without a subledger and a subledger type) are considered for budget checking.

10. Job Cost Account Sequence

Specify the job cost account sequence that the system uses for budgeting. Values are:

Blank: The system uses the standard account sequence (for example, cost center, object, and subsidiary).

1: The system uses the job cost sequence (for example, job, cost code, and cost type).

11. Include Taxes

Specify whether the system includes taxes for taxable lines in budget calculations. Values are:

Blank: Do not include taxes.

1: Include taxes.

12. Include Prior Year Balance Forward Amount

Specifies whether the budget amount from the previous year, should be included/added to the available budget amount for the current year, during budget calculation. Values are:

Blank: Include the prior year balance amount with the budget amount for the current year.

1: Do not include the prior year balance amount with the budget amount for the current year.

Note: This processing option takes effect only when the Budget Total Method is set to 2.

10.2.12 Interop

These processing options enable you to enter interoperability information.

1. Purchase Order Before/ After Image Processing

Specify whether the system captures a record of a transaction before the transaction was changed or whether the system captures records of a transaction before and after a transaction was changed. Values are:

Blank: Capture a record of a transaction after the transaction was changed.

1: Capture two records; one record of the transaction before it was changed and one record after it was changed.

2. Purchase Order Transaction Type

Enter a transaction type for the export transaction.

If you leave this field blank, the system does not perform export processing.

3. Work Order Before/ After Image Processing

Specify whether the system writes the before image for the work order header. Values are:

Blank: The system does not include the image.

1: The system includes the image.

4. Work Order Transaction Type

Specify the default transaction type for the work order header that the system uses when processing export transactions. If you leave this field blank, the system does not perform export processing.

10.2.13 Order Revision

These processing options enable you to control revisions to orders.

1. Revision Tracking

Specify whether the system allows revisions to an order. Values are:

Blank: The system does not perform order revision tracking.

1: Allow revisions to existing orders only.

2: Allow both revisions to an existing order as well as the addition of new lines to the order.

2. Next Status

Specify the next status code at which the system begins tracking order revision audit information. The system does not record revisions to detail lines if the lines' statuses precede the status code that you enter in this processing option.

The system stores revision information in the F43199 table. You can access this table through the Order Revision Inquiry program (P4319).

3. Text Entry

Specify whether the system allows you to enter text when you are entering a revision. Values are:

Blank: Do not allow users to enter text when they are entering a revision.

1: Allow users to automatically enter text when entering a revision.

The system displays a text entry window when the order is accepted.

10.2.14 Self-Service

This processing option enables you to specify whether the system activates self-service functionality.

1. Supplier Self-Service

Specify whether to activate Supplier Self-Service for use in a Java/HTML environment. This functionality allows suppliers to view their orders online. Values are:

Blank: Do not activate Supplier Self-Service.

1: Activate Supplier Self-Service.

10.2.15 Product Variants

These processing options are used with the Product Variants functionality.

1. Inventory Parent

Specify whether the system displays the Matrix Order form when you are working with a matrix parent item. When you enter a matrix parent item on the order detail and the Matrix Order form is not displayed, the parent item will be treated as an inventory item instead of a matrix parent. Values are:

Blank: The system displays the Matrix Order form.

1: The system does not display the Matrix Order form.

10.2.16 Workflow

These processing options enable you to specify how the system processes workflow information.

1. Price Changes Notify

Specify the recipient of the email that the system automatically sends when the unit cost/lump sum changes on the order. Values are:

Blank: Do not send email.

1: Send email to purchase order originator.

2: Send email to project manager (MPM only).

3: Send email to buyer.

- 4: Send email to purchase order originator, project manager (MPM only), and buyer.

Note: Manufacturing Project Management (MPM) is now Oracle's JD Edwards EnterpriseOne Engineer to Order.

2. Planned Delivery Date Changes Notify

Specify the recipient of the email that the system automatically sends when the promised delivery date on the order changes. Values are:

Blank: Do not send email.

- 1: Send email to purchase order originator.
2: Send email to project manager (MPM only).
3: Send email to buyer.
4: Send email to purchase order originator, project manager (MPM only), and buyer.

Note: Manufacturing Project Management (MPM) is now JD Edwards EnterpriseOne Engineer to Order.

3. Quantity Changes Notify

Specify the recipient of the email that the system automatically sends when the quantity of the order changes. Values are:

Blank: Do not send email.

- 1: Send email to purchase order originator.
2: Send email to project manager (MPM only).
3: Send email to buyer.
4: Send email to purchase order originator, project manager (MPM only), and buyer.

Note: Manufacturing Project Management (MPM) is now JD Edwards EnterpriseOne Engineer to Order.

4. Order Hold Notify

Specify the recipient of the e-mail that the system automatically sends when the order goes on hold. This processing option applies to B1 holds only.

Values are:

Blank: Do not send email.

- 1: Send email to purchase order originator.
2: Send email to project manager (MPM only).
3: Send email to buyer.
4: Send email to purchase order originator, project manager (MPM only), and buyer.

Note: Manufacturing Project Management (MPM) is now JD Edwards EnterpriseOne Engineer to Order.

10.2.17 Transfer Order

These processing options enable you to specify how the system processes transfer orders.

1. Create Item Branch Record if one does not exist for the receiving B/P when Entering a Transfer Order

Specify whether the system creates an item branch record if one does not already exist in the receiving branch/plant.

2. Project Transfer Order Line Type

Specify the line type that the system uses for the purchase order that is created from a sales transfer order. Ensure that the line type has been defined with an inventory interface of C by accessing the Line Type Constants program (P40205). When the line type has an inventory interface of C, the system performs financial commitments for purchase orders that are associated with the Engineering Project Management system.

Note: The Engineering Project Management (EPM) system is now JD Edwards EnterpriseOne Engineer to Order.

10.2.18 Style

These processing options are used with the Style Item functionality.

1. Display Matrix Entry (PCW10)

Specify whether the system displays the Matrix Entry form for style items. Values are:

Blank: Do not display the Matrix Entry form for style items. This processing option may be left blank to create blanket orders for a parent level style item.

1: Display the Matrix Entry form for style items.

2. Collection

Specify a default collection that displays in the purchase order header.

The system stores collection codes in the Collection Detail table (FCW07).

Also, the combination of collection, season code, and season year must be defined as a valid collection using the Collections program (PCW07). If the combination is not valid, then all three values will be left blank on the purchase order header.

3. Season Code

Specify a default season code that is used in the purchase order header. Enter a value from the user-defined table 41F/SE.

Also, the combination of collection, season code, and season year must be defined as a valid collection using the Collections program (PCW07). If the combination is not valid, then all three values will be left blank on the purchase order header.

4. Season Year

Specify a default season year that is used in the purchase order header. Enter a value from the user-defined table 41F/SY.

Also, the combination of collection, season code, and season year must be defined as a valid collection using the Collections program (PCW07). If the combination is not valid, then all three values will be left blank on the purchase order header.

5. Validate Items Against Collection

Specify whether the items that are entered into the grid are validated against the collection. Also, you can specify whether or not to issue a warning or error when you validate items. Values are:

Blank: Do not validate items. You can enter any items into the grid.

1: Issue a warning if the item entered is not part of the collection.

2: Issue an error if the item entered is not part of the collection.

6. Prefix for Collection Templates

Specify a symbol used to prefix the collection template entered in the Item Number field to display the Matrix Entry form with a collection template.

Collection templates are a subset of items belonging to a collection. When entering a purchase order, generally an item number is entered and the Matrix Entry form displays the item only. To display a collection template, you must prefix the template by the special symbol that is specified in this processing option.

For example, if the symbol is * (asterisk) and the template name is M06, then typing *M06 in the order line will display Matrix Entry (PCW10) using collection template M06.

7. Send Address Number for Split Percentage to Matrix Entry (PCW10)

Specify the customer for which the system retrieves the category code values in order to identify the split percentage in the Matrix Entry program (PCW10). This processing option value determines whether to send the Ship To or Supplier customer number to the Matrix Entry program. Valid values are:

Blank: Send Ship To customer number.

1: Send Supplier customer number.

8. Item Search and Select

Specify whether to override the standard item number visual assist. Values are:

Blank: Displays the standard item visual assist.

1: Uses the Item Search & Select program (PCW41011) to display the style items for selection.

This processing option is enabled only if the Use Apparel Management Module system constant (SY41F) is enabled in the EnterpriseOne System Control program (P99410).

10.3 Entering Order Header Information

This section provides an overview of order header information entry, lists a prerequisite, and discusses how to:

- Use real-time summarization in the Purchase Orders program (P4310).
- Enter order header information.
- Enter additional order header information.

10.3.1 Understanding Order Header Information Entry

To generate an order, you must provide information about the supplier who is to fill the order, the branch/plant that is requesting the order, and the shipping address for the order. This information is called order header information.

The header information that you enter determines how the system processes the order. For example:

- Supplier information determines the address to which the order is sent, the payment terms for the order, and so forth.
- Origination information determines the business unit accountable for the order and the address to which the goods and services are to be delivered.
- Tax information determines how the system calculates taxes for the order.

Header information also includes the date the order is placed, the date the order is due, and reference information, such as the employee entering the order.

Using the processing options for Order Entry, you can display a header form before the detail form. Depending on how you set the processing options, certain fields can display on the header form. If you bypass the header form, you must enter limited header information on the detail form. Based on the supplier and branch/plant that you enter, the system applies default values to the fields on the header form.

10.3.1.1 Header Information for International Orders

If you purchase goods or services from international suppliers, you might need to enter order amounts in different currencies, such as Canadian dollars, Japanese yen, and the euro. Before you can do this, you must enter these types of information on the header form:

- Whether the supplier uses a foreign currency.
- The type of currency that the supplier uses.

The system completes the Currency field on the Order Header form with the default currency, if any, that you establish for the supplier. This value is the default value from the supplier master.

- The base currency for the company.
- The exchange rate for the currency.

The system displays this information from the JD Edwards EnterpriseOne Multicurrency system from Oracle.

10.3.1.2 Supplier Information

You might have different arrangements with each of the suppliers in regard to terms of payment, freight handling, invoice methods, and so forth. When you enter order header information, you must specify the supplier from whom you are requesting the order and any specific arrangements to which you and the supplier have agreed.

You can set up procurement instructions to specify the arrangements that you have with each of the suppliers. When you enter a supplier on an order, the system retrieves the instructions for that supplier. You can modify the instructions to suit a specific order.

To enter a supplier for an order, the supplier must exist in the JD Edwards EnterpriseOne Address Book system. If this is not the case, you can enter the supplier in the JD Edwards EnterpriseOne Address Book system when you enter order header information. You can also enter master information for the supplier if the information does not already exist.

If you have set up purchasing instructions for a supplier, the system supplies default values for several of the fields on the Order Header form, based on the supplier you

enter for the order. Additionally, you can access the Work With Supplier Master form through the Supplier Master form exit on the Order Header form.

You can enter a temporary address for the supplier by accessing the Order Address Information form.

10.3.1.3 Information for a Specific Branch/Plant

You generate an order for a specific branch/plant, business unit, project, or job within the company. In most instances, goods are shipped to the same branch/plant that requests the order. However, you might want to ship the goods to another location.

You must specify the branch/plant, business unit, project, or job for which you are placing an order. When you enter a branch/plant, the system retrieves the ship-to address from Branch/Plant Constants provided that the ship-to address exists in the address book. If you want to ship the order to a different shipping address, you can override the ship-to address number.

10.3.1.4 Delivery and Shipping Instructions

You can enter instructions for the delivery of an order. For example, you can specify that goods be delivered to a certain dock at the warehouse. You can have the system retrieve default delivery instructions set up for the ship-to address in the Supplier Master table (F0401).

When you enter an order, you might request that the supplier deliver the order by a specific date. If the supplier cannot deliver the order by the date you request, you can specify the date that the supplier promises to deliver the order. In addition, you can specify the date that you place the order and the date that the order expires.

The system automatically creates a corresponding direct ship purchase order when a direct ship sales order is created in Oracle's JD Edwards EnterpriseOne Sales Order Management. If you change the date that the supplier promises to deliver for the direct ship purchase order, the system automatically changes the delivery date on the corresponding sales order.

10.3.1.5 Taxes on Orders

In most business environments, you are required to pay taxes on the items you purchase. You can have the system calculate taxes for an order based on the tax information that you enter for the order.

The system provides default values for tax fields based on the master information that you have set up for the supplier. You can use the Purchase Order program (P4310) processing options to specify that the system retrieve the default value for the tax rate area from the master information for the ship-to address.

If you are using the Vertex Sales Tax Q Series system with JD Edwards EnterpriseOne software, the system retrieves default GeoCodes to determine the tax rate to apply to the order.

Assuming that an order has more than one item, you can change tax information to accommodate each item or service. Then taxes are applicable for the item or service only if you have specified that the detail line is taxable.

10.3.1.6 Alternate Tax Rate/Area Assignment Functionality for Purchase Order Headers (Release 9.1 Update)

You can set up the company, the branch/plant of the company, the ship-to, and supplier entities to use the alternate tax rate/area assignment functionality. When you add or modify a purchase order with one of these entities, the system:

- Checks whether the alternate tax rate/area assignment functionality is enabled for the company of the branch/plant.
- Verifies that the VAT registration number (Tax ID) exists for the Ship To and Supplier entities.
- Retrieves the purchase order tax rate/area from the alternate tax rate/area assignment setup based on the Branch/Plant, Ship To, and Supplier country codes.

If the branch/plant belongs to a company with the alternate tax rate/area assignment company constant enabled, the system assigns the alternate tax rate/area assignment based on the ship-to and supplier companies, and the branch/plant information. Otherwise, the system uses the default tax rate/area you set up in a processing option.

On the Order Header form, the system:

- Retrieves the alternate tax rate/area when the business unit that you enter in the Branch/Plant field corresponds to a company for which you have set up the alternate tax rate/area assignment functionality, and the ship-to and supplier specified are also set up to use the functionality. If the company of the branch/plant is not set up to use the alternate tax rate/area assignment functionality, then the system retrieves the tax rate/areas according to the value you set in the Default Tax/Rate Area processing option.
- Updates the value in the Tax Rate/Area field if you change the Supplier or Ship To values. If you leave the Ship To field blank and then click OK, the system retrieves the ship to value from the branch/plant setup.
- Recalculates the tax rate/area if you modify the Supplier or the Ship To fields after you manually change the Tax Rate/Area field.

Does not update the Tax Rate/Area field if you manually change the Tax Rate/Area value after changing the Supplier or Ship To fields.

See Also:

"Setting Up Alternate Tax Rate/Area Assignment Functionality" in the *JD Edwards EnterpriseOne Applications Tax Processing Implementation Guide*.

"Procurement Management" in the *JD Edwards EnterpriseOne Applications Tax Processing Implementation Guide*.

10.3.1.7 Approval Processing

To use approval processing, which requires that orders be approved before continuing through the procurement cycle, you can set the approval processing options for Order Entry. If you use approval processing, the name of the approval route appears on the header form. Verify that the name of the approval route is correct when you set the processing options, because you cannot change the name after you enter an order.

10.3.1.8 Advanced Pricing Information

You also can enter Advanced Pricing information by entering an adjustment schedule on the Additional Information form, which you can access from the Supplier Master

Revision form. Before you enter Advanced Pricing information, verify that you have activated the pricing constants.

10.3.1.9 Additional Order Header Information

At some point, you might need to include additional information in an order. For example, you might include:

- The individual who placed the order.
- The buyer responsible for procuring items and services on the order.
- The company responsible for delivering the order.
- A confirmation number, document number, or job number for the order.
- Miscellaneous notes.

You can enter reference information for an order when you enter header information. The reference information is primarily for informational purposes.

You can attach miscellaneous notes to an order as notes to be printed on the order.

See Also:

- [Understanding Supplier and Item Information Setup.](#)
- [Entering Tax Information for a Detail Line.](#)
- "Adding Address Book Records" in the *JD Edwards EnterpriseOne Applications Address Book Implementation Guide.*

10.3.2 Prerequisite

Set the appropriate processing option on the Processing tab to enable access to the JD Edwards EnterpriseOne Address Book.

10.3.3 Forms Used to Enter Order Header Information

Form Name	Form ID	Navigation	Usage
Work With Order Headers	W4310I	Purchase Order Processing (G43A11), Enter Purchase Orders	Review existing order header information.
Purchase Order Summary	W4301SWA	Select the visual assists for the Amount or Foreign Amount fields in the QBE line of the Work With Order Headers form.	Use real-time summarization in the Purchase Orders program (P4310).

Form Name	Form ID	Navigation	Usage
Order Header	W4310B	<p>Click Add on the Work With Order Headers form.</p> <p>Alternatively, select an order on the Work With Order Headers form, and click the Select button.</p>	<p>Enter tax, messages, order date, and other supplier and order information.</p> <p>Note: The Order Header form appears only if the Header Display processing option on the Processing tab of the Enter Purchase Orders program is set to display the header form first.</p>
Clauses	W4310K	Select Clauses from the Form menu on the Order Header form.	Specify the print message clauses associated with a purchase order.
Order Header - Additional Information	W4310H	Select Additional Info from the Form menu on the Order Header form.	Enter additional information for the order, such as freight and landed costs rules, and delivery information. View supplier classification codes.
Order Address Information	W4006B	Select Order Addresses from the Form menu on the Order Header form.	Enter a temporary address for a supplier that applies to only this order. You can also enter a temporary address change for the ship-to entity.
Order Detail	W4310A	Click OK on the Order Header form.	View order details.
Order Header - Additional Information II	W4310M	Select Additional Info from the Form menu on the Order Detail form.	View supplier classification codes.
Media Object Viewer	N/A	Select Attachments from the Form menu on the Order Header form.	Enter reference information for an order.

10.3.4 Using Real-Time Summarization in the Purchase Orders Program (P4310)

Access the Purchase Order Summary form.

Figure 10–1 Purchase Order Summary form

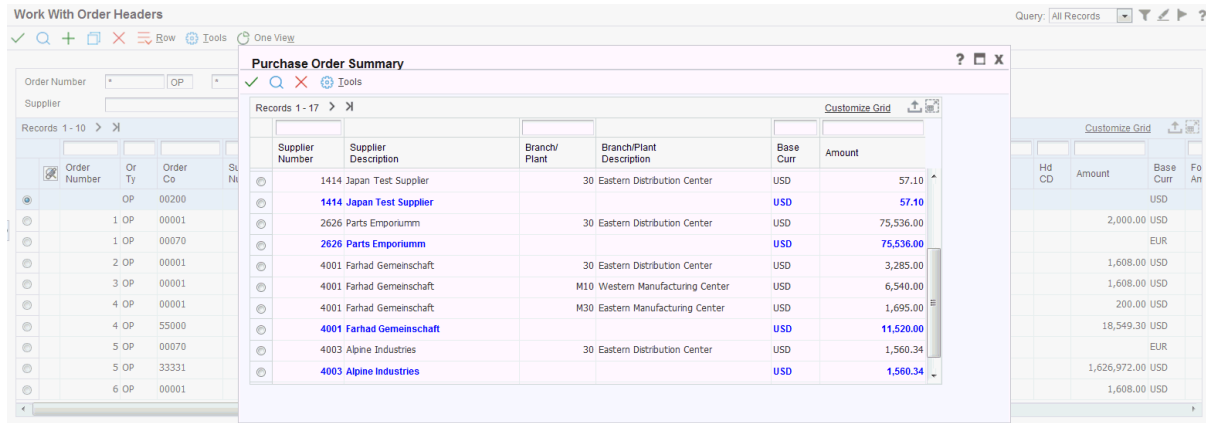

In selected JD Edwards EnterpriseOne programs, you can use real-time summarization to quickly review aggregated totals, instead of scrolling to the end of the grid to review the totals.

On the Work With Order Headers form, search for records to populate the grid and then click the visual assists on the Amount and Foreign Amount fields in the QBE line to view the aggregated totals. When you select the visual assist, the system displays the Purchase Order Summary form from the Purchase Order Summary program (P4301SW).

When viewing domestic amounts, the value in the Amount field is aggregated by supplier number, branch plant, and currency, and is totaled by supplier number and base currency. When viewing foreign amounts, the value in the Foreign Amount field is aggregated by supplier number, branch plant, and transaction currency, and is totaled by supplier number and transaction currency.

After you view the aggregated totals on the Purchase Order Summary form, you click Cancel to return to the Work With Order Headers form, or you can select a record to view the detailed transactions on the Work With Order Headers form. If you select a record on the Purchase Order Summary form, the system populates the header fields and QBE fields of the Work With Order Headers form to display the detail records associated with that aggregated total. You can delete or change the values in these fields if you want to search for additional records.

10.3.5 Entering Order Header Information

Access the Order Header form.

10.3.5.1 Order Header

Order Number /Order Type

Displays the order number from the next numbering scheme that you establish for purchase orders for system 43 when you click OK on the Order Header form. Alternatively, you can manually enter an order number.

The system displays the order type that you establish as the default value in the Order Type processing option.

Order Date

Displays the current date which you can change. This date determines which effective level the system uses for inventory pricing.

Requested

Enter the date that an item is scheduled to arrive or that an action is scheduled for completion.

Promised Delivery

Enter the promised shipment date for the purchase order. The Supply and Demand programs use this date to calculate Available to Promise information. This date represents the day that the item can be shipped from the warehouse.

Cancel Date

Enter the date that the order should be canceled if the goods are not received from the supplier. This is a memo-only field and does not cause the system to perform any type of automatic processing.

Print Message

Enter a value from the Print Messages (40/PM) UDC to identify a message that the system prints on the order.

Tax Expl Code (tax explanation code)

Enter a value from the Tax Explanation Codes (00/TX) UDC to identify how the system calculates tax and general ledger distribution amounts. The system uses the tax explanation code with the tax rate area and tax rules to determine how the tax is calculated. Each transaction pay item can be defined with a different tax explanation code.

Tax Rate/Area

Enter a value from the Tax Areas table (F4008) that identifies a tax or geographic area that has common tax rates and tax authorities. The system uses the tax rate area with the tax explanation code and tax rules to calculate tax and general ledger distribution amounts when you create an invoice or voucher.

Certificate

Enter the number that tax authorities issue to tax-exempt individuals and companies to identify their tax-exempt status.

Payment Terms

Enter a value that specifies the terms of payment, including the percentage of discount available if the invoice is paid by the discount due date.

Hold Code

Enter a value from the Hold Codes (42/HC) UDC to identify why an order is on hold.

Retainage % (retainage percentage)

Enter the rate of retainage (referred to as *hold back* in some countries) that applies to the contract. This rate is a percentage of each payment. It is expressed as a decimal fraction. For example, a retainage rate of 10 percent is expressed as 10. The retainage rate cannot be greater than 99.9% (.999) or less than zero.

Retainage Indicator

Select to provide a visual indication that the accounts payable clerk uses to verify whether retainage occurred on the invoice and if it should be applied to the voucher. This value is independent from the value of the Retainage % field. The system does not require a value in the Retainage Percent field if the Retainage Indicator is selected. The system does not perform any functionality based upon this field setting.

10.3.5.2 Additional Properties

The Additional Properties tab appears only if the Display Additional Properties Tab processing option on the Display tab of the P4310 program is set to enable the tab.

Property 01 through Property 12

Enter a one-character, user-defined value associated with a purchase order.

Property 13

Enter a 30-character, user-defined value associated with a purchase order.

Date 01 and Date 02

Enter a user-defined date associated with a purchase order.

Date and Time 01 and Date and Time 02

Enter a user-defined universal date associated with a purchase order. This date and time are associated with a time zone.

Address Book 01 and Address Book 02

Enter a user-defined name or number that identifies an address book record. You can use this number to locate and enter information about the address book record. If you enter a value other than the address book number (AN8), such as the long address or tax ID, you must precede it with the special character that is defined in the Address Book constants. When the system locates the record, it returns the address book number to the field.

For example, if address book number 4100 (Total Solutions) has a long address TOTAL and an * distinguishes it from other entries (as defined in the Address Book constants), you could type *TOTAL into the field, and the system would return 4100.

You must set the Address Book Field Required processing option on the Display tab of the Enter Purchase Orders program to indicate if field values are required or not required.

10.3.5.3 Category Codes

The Category Codes tab appears only if the Display Category Codes on Header Tab and Detail Grid processing option on the Display tab of the P4310 program is set to enable the tab.

Category Code 01

Enter a value from UDC 43/C1 that is associated with a purchase order.

Category Code 02

Enter a value from UDC 43/C2 that is associated with a purchase order.

Category Code 03

Enter a value from UDC 43/C3 that is associated with a purchase order.

Category Code 04

Enter a value from UDC 43/C4 that is associated with a purchase order.

Category Code 05

Enter a value from UDC 43/C5 that is associated with a purchase order.

Category Code 06

Enter a value from UDC 43/C6 that is associated with a purchase order.

Category Code 07

Enter a value from UDC 43/L1 that is associated with a purchase order.

Category Code 08

Enter a value from UDC 43/L2 that is associated with a purchase order.

Category Code 09

Enter a value from UDC 43/L3 that is associated with a purchase order.

Category Code 10

Enter a value from UDC 43/L4 that is associated with a purchase order.

Category Code 11

Enter a value from UDC 43/L5 that is associated with a purchase order.

Category Code 12

Enter a value from UDC 43/L6 that is associated with a purchase order.

10.3.6 Entering Additional Order Header Information

Access the Order Header - Additional Information form.

10.3.6.1 Additional Information

Pricing Group

Enter a value that exists in the Customer Price Groups (40/PC) UDC that identifies the pricing group that is associated with this customer or supplier.

Freight Handling Code

Enter a value that exists in the Freight Handling Code (42/FR) UDC that identifies when you take responsibility of the goods so that freight charges are applied accordingly.

Cost Rule

Enter a value that exists in the Landed Cost Rule (41/P5) UDC that indicates the landed cost rule for an item.

The landed cost rule determines purchasing costs that exceed the actual price of an item, such as broker fees or commissions. You set up landed cost rules on the Landed Cost Revisions form.

Send Method

Enter a value that exists in the Send Method (00/SM) UDC that indicates the method used to send documents to a supplier. There is no automatic processing associated with this field. Instead, the code can be used as data selection criteria for certain procedures.

Evaluated Receipt

Enter a value that exists in the Evaluated Receipts (40/ER) UDC that indicates if an order is eligible for the evaluated receipt settlement process. An evaluated receipt settlement indicates that you have an agreement with the supplier to create vouchers based on the items that you receive. You use the Evaluated Receipt Settlement (R43800) program to create vouchers from receipt records. As a result, the supplier does not send you invoices and you can bypass the Voucher Match procedure.

Supplier SO

Enter an alphanumeric value used as a cross-reference or secondary reference number. Typically, this is the customer number, supplier number, or job number.

Reference

Enter reference numbers, such as the supplier's bid document number, quote document, sales order, work order, or job number.

Delivery Instructions Line 1

Enter text that describes the delivery instructions for this order. The system retrieves this information from purchasing instructions for the ship-to address if the information is set up.

Delivery Instructions Line 2

Enter additional text that describes the delivery instructions for this order. The system retrieves this information from purchasing instructions for the ship-to address if the information is set up.

Adjustment Schedule

Enter a value that exists in the Adjustment Schedule (40/AS) UDC that identifies a price and adjustment schedule. A price and adjustment schedule contains one or more adjustment types for which a customer or an item might be eligible. The system applies the adjustments in the sequence that you specify in the schedule. You link customers to a price and adjustment schedule through the customer billing instructions. When you enter a sales order, the system copies the schedule attached to the sold to address into the order header. You can override this schedule at the detail line level.

10.3.6.2 Supplier Classification Codes**Classification Code 01**

Displays the supplier classification code from the JD Edwards EnterpriseOne Address Book system. This code classifies an address book entity using a value from UDC 01/CA.

Classification Code 02

Displays the supplier classification code from the JD Edwards EnterpriseOne Address Book system. This code classifies an address book entity using a value from UDC 01/CB.

Classification Code 03

Displays the supplier classification code from the JD Edwards EnterpriseOne Address Book system. This code classifies an address book entity using a value from UDC 01/CC.

Classification Code 04

Displays the supplier classification code from the JD Edwards EnterpriseOne Address Book system. This code classifies an address book entity using a value from UDC 01/CD.

Classification Code 05

Displays the supplier classification code from the JD Edwards EnterpriseOne Address Book system. This code classifies an address book entity using a value from UDC 01/CE.

10.4 Entering Order Detail Information

This section provides an overview of order detail information entry, lists prerequisites, and discusses how to:

- Enter detail lines by item number.
- Enter detail lines by account number.
- Enter multiple account distributions.
- Enter tax information for a detail line.
- Enter discount terms for a detail line.
- Enter reporting codes for a detail line.
- Enter change orders.
- Enter substitute or replacement items.
- Enter kit orders.
- Copy change orders.

10.4.1 Understanding Order Detail Information Entry

After you enter header information for an order, such as the supplier to fill the order and the branch/plant requesting the order, you must enter information about each item or service that you want to procure on the Order Detail form. For each item or service, you must enter a line of detail that describes:

- The item or service that you want to procure.
- The quantity that you want to procure.
- The cost of the item or service.

Depending on the business objectives, you can use these methods to enter order detail lines:

- By item number.
- By general ledger account number.

If you run an inventory operation in which you stock items for resale, internal use, or manufacturing purposes, you must enter detail lines by item number. If you purchase goods or services for internal use or for use on a certain job or project, you can enter detail lines by account number, item number, or both.

For stock items, you enter the item numbers set up in the JD Edwards EnterpriseOne Inventory Management system to make purchases. After you enter an item number on a detail line, the system:

- Validates that the item exists in the JD Edwards EnterpriseOne Inventory Management system.
- Retrieves information for the item from the JD Edwards EnterpriseOne Inventory Management system.

The system provides default values for detail lines based on the header information on an order. The system retrieves information, such as the cost, description, and unit of measure for the item and enters it on the detail line. You can add and change the information for each detail line based on what is relevant to the purchasing process. For example, if you purchase items for inventory, you must specify the unit of measure for the item. You can also specify the location where the item is stored upon receipt,

and the weight, volume, lot, and manufacturing information for the item. You can specify an asset identifier and landed cost rules. You also can attach notes, or narrative text, to each detail line.

If the supplier has an internet home page set up with items that it offers, you can preview supplier information in the electronic catalog before entering the order detail information. On the Order Detail form, you can use a form exit to preview supplier information.

You can enter tax information for each detail line to have the system calculate taxes on the goods or services you are purchasing. If the supplier provides a discount on the order, you can enter the terms of the discount. By assigning reporting codes to a detail line, you can group items for reporting purposes.

If the supplier uses a different currency than the company's base currency, you must enter costs in foreign currency.

You can replace an existing item on a detail line with a substitute or replacement item. For example, if the supplier is out of the item you entered on a detail line, you can review a list of alternative items and select a replacement item.

For an existing order, you can use the Order Detail form to review summary information such as items, account numbers, order quantities, prices, extended volumes and weights, total tax amount, and total monetary amount.

You might need to cancel a detail line if you no longer want to purchase the items or services that the line contains. When you cancel a line, the system closes the line and assigns it a last status of 980 (canceled order entry) and a next status of 999, which indicates that the purchasing process for the line is complete. If you want the closed line to appear when you are reviewing the order, you can set the processing options for Order Entry. If you want the closed line deleted from the system, you must run a purge.

The system provides many grid formats when the software is shipped. For many of the interactive versions, some grid columns have been hidden to save on web performance. If you interact with a version and do not see a certain grid column, select the grid option for All Grid Columns.

The system automatically creates a corresponding direct ship purchase order when a direct ship sales order is created in JD Edwards EnterpriseOne Sales Order Management. If you change the cost values for the direct ship purchase order, the system automatically changes the cost values on the corresponding sales order.

After you enter all detail lines on the purchase order, the system displays a warning message if the value of the order either exceeds the maximum order value or is below the minimum order value that is specified for the supplier in the purchasing instructions.

You determine how the system processes information on each detail line. For example, you can direct the system to update the availability of an item in the JD Edwards EnterpriseOne Inventory Management system upon receipt. As another example, you can have the system retrieve the unit cost of the item you are ordering provided you assign a line type (such as Y, B, or D) to the detail line that tells the JD Edwards EnterpriseOne Procurement system to interface with the JD Edwards EnterpriseOne Inventory Management system. You must enter a line type for each detail line to indicate how the transaction works with other JD Edwards EnterpriseOne systems.

If you work in a noninventory environment, you might frequently purchase items for use in a specific job or project. Even in an inventory environment, you might purchase items that you do not account for as part of the inventory, such as office supplies. In either of these cases, you can enter item numbers to purchase nonstock items provided

that you specify a line type of N or B to indicate that the transaction does not affect the JD Edwards EnterpriseOne Inventory Management system.

Another example of how the detail line information that you enter affects other systems is general ledger information. The general ledger class code that you enter for a detail line determines the inventory account and the received not vouchered account for which the system creates journal entries. The system creates these entries when you enter a receipt.

10.4.1.1 Detail Lines by Account Number

If you work in an environment in which you purchase services or goods for internal use or for use in a certain job or project, you can charge purchases against general ledger account numbers. You enter a detail line for each account number against which you are purchasing. This allows the general ledger to reflect expenses by job or project.

When you enter detail lines by account number, you can have the system perform commitment and budget tracking. For example, a certain account number represents the office supply expenses. Each time you purchase goods against the account number, you can have the system:

- Track the amount and quantity of office supplies that you are committed to purchase.
- Validate that the cost of the supplies does not exceed the budget for office supplies.

You determine how the system processes information on each detail line. For example, you can require that the system process a line based on both an account number and an item number. You must enter a line type for each detail line to indicate how the transaction works with other JD Edwards EnterpriseOne systems.

If you are making an account-based entry, you must enter an inventory interface of A or B.

If you are entering a lump sum for a detail line, you must enter an inventory interface of A or N.

A final example of how the detail line information that you enter affects other systems is general ledger information. The system tracks purchasing expenses in the general ledger based on the general ledger class code that you enter for a detail line. The general ledger class code determines the received not vouchered account to which the system applies a credit if you enter a formal receipt.

10.4.1.2 Multiple Account Distribution

When you enter order detail lines that have an inventory interface of A or B, you can use the Account Distribution Entry program (P4316) to distribute by percentages, amounts, or quantities among multiple accounts. You can use the following JD Edwards EnterpriseOne Procurement functionality with multiple account distribution:

- Commitments.
- Approval processing.
- Budgeting.
- Taxes (proportioned on the F4311 table level).
- Order revisions.
- Audit history.

- Service units for accounts payable (A/P) matching.
See "Understanding Subcontract Order Detail Information, Service Units for A, P Matching" in the *JD Edwards EnterpriseOne Applications Subcontract Management Implementation Guide*.
- Expense at voucher match.
See Expense at Voucher Match.
- Freight distribution.
See "Understanding Subcontract Vouchers, Freight Vouchering" in the *JD Edwards EnterpriseOne Applications Subcontract Management Implementation Guide*.

When you are working with this functionality with multiple account distribution, the system processes information on the F4316 table level. (Without multiple account distribution, the system would process information on the F4311 level.)

If you change the quantity or amount on a purchase order detail line and are using multiple account distribution functionality, the system automatically redistributes the quantity or amount in the Account Distribution Entry program (P4316) and updates commitments.

If you copy a purchase order that contains multiple account distribution, the system retains the multiple account distribution for the new purchase order.

When you access detail lines that contain a multiple distribution from the F4311 table, the system displays the account number on the F4311 table level as *****ACCOUNT DISTRIBUTION*****.

10.4.1.3 Shipment Information

If you use JD Edwards EnterpriseOne Transportation Management from Oracle, you can set up processing so that the system automatically creates shipment for a purchase order based on the order type and line type combination that you define in the UDC tables (49/SD). The shipment is a request to transport goods from the supplier to the branch/plant. If you do not enter a carrier and mode of transport during order entry, the system retrieves default carrier and transport information from any of these:

- Item Branch/Plant Information
- Customer Master Information
- Inventory Commitment Preference

When you review routing options in JD Edwards EnterpriseOne Transportation Management, you can review and revise the carrier and mode of transport. If you do not specify a carrier in either of the master tables or during order entry, the system populates the carrier and mode of transport based on the Carrier transportation preference.

10.4.1.4 Tax Information for a Detail Line

You can enter tax information that is specific to a detail line. This tax information determines whether taxes apply to the items or services on the detail line, and how the system calculates the taxes.

The system retrieves default tax information for each detail line based on the tax information that you entered for the order. If tax information for the detail line differs from that for the rest of the order, you can change the tax information to accommodate the detail line. You can use the alternate tax rate/area assignment functionality when

the entities in the transactions are in the European Union and the company of the transaction is set up to use the alternate tax rate/area assignment functionality.

See *Alternate Tax Rate/Area Assignment Functionality in Purchase Order Detail Lines (Release 9.1 Update)*

If you are using the Vertex Sales Tax Q Series system with JD Edwards EnterpriseOne software, the system retrieves default GeoCodes to determine the tax rate to apply to the order.

See *Compatibility of the Vertex Sales Tax Q Series System*.

10.4.1.5 Alternate Tax Rate/Area Assignment Functionality in Purchase Order Detail Lines (Release 9.1 Update)

When you enable the alternate tax rate/area assignment functionality for the company of the transaction, the system updates the tax rate/area on the Order Detail form in this manner:

- Retrieves the alternate tax/rate area specified in the header, if you do not enter a tax rate/area for a detail line.

When you update header information to the detail, the system retrieves the appropriate tax rate/area if you copy to the detail line only the Ship To field. If you copy both the Ship To and Tax Rate/Area fields, then the system copies the existing values and does not change the tax rate/area.

- Changes the value in the Tax Rate/Area to blank when you change the branch/plant and the new value is associated with a different company. The system then retrieves the appropriate new tax rate/area for the changed value. The system also changes the tax rate/area to blank and retrieves the appropriate new value when you change the Ship To field.
- Does not update the Tax Rate/Area field for changes in the Branch/Plant or Ship To fields if you manually change the Tax Rate/Area value.

See Also:

"Setting Up Alternate Tax Rate/Area Assignment Functionality" in the *JD Edwards EnterpriseOne Applications Tax Processing Implementation Guide*.

"Procurement Management" in the *JD Edwards EnterpriseOne Applications Tax Processing Implementation Guide*.

10.4.1.6 Discount Terms for a Detail Line

You can enter discount terms on a detail line to have the system calculate a discount on the items that you purchase. For example, a supplier might offer a 10 percent discount on certain items.

You can enter a specific discount factor for a detail line. The system enters a cost for the item on the detail line based on the discount factor. For example, to specify a 10 percent discount for an item, you enter a discount factor of 0.90. If the unit cost for the item is usually 10.00, the system enters a unit cost of 9.00.

You can also specify a discount for an item based on a price rule. The system applies a discount to the unit cost of the item based on the discount set up for the price rule. The system retrieves a default price rule for an item if:

- You have attached a price rule to branch/plant information for the item.

- You have attached the price rule to the supplier from whom you are purchasing the item (or to the price group for the supplier).

10.4.1.7 Reporting Codes for a Detail Line

You might want to group detail lines with similar characteristics so that you can generate reports based on the group. For example, you can group all detail lines for electrical items so that you can produce a report that lists open order information for electrical items. To group detail lines, you assign reporting codes to each line. The reporting codes are default codes that are associated with the classification codes for an item on the Item/Branch Plant Info. form.

Five categories of reporting codes are available for purchasing. Each category represents a specific group of codes. For example, you might have a category for commodities. Within this category would be different codes, each of which represents a specific type of commodity, such as aluminum or copper.

10.4.1.8 Change Orders

You can change commitment details after you enter them by creating a change order, which updates the commitment information and creates a record of changes to the order. For example, to increase the committed amount for an order by 100, you enter a change order for 100.

You can set the display and process processing options for Order Entry to determine whether you can change original commitment information by line item or if you must enter a change order.

The system maintains a record after you make a change. After you enter change order information, you can enter descriptive text for each line item of the contract.

Note that if you are using the JD Edwards EnterpriseOne Advanced Pricing system for JD Edwards EnterpriseOne Procurement, change orders are not priced with adjustment schedules.

10.4.1.9 Substitute or Replacement Items

You might enter an order for an item, but the supplier does not have the quantity available to fill the order. You can review a list of substitute items and select an item to replace the item on a detail line. If the system notifies you that the item on a detail line is obsolete, you can review and select a replacement for the item.

The substitutes or replacements that the system displays are based on the cross-reference types from the JD Edwards EnterpriseOne Inventory Management system that you specify in the processing options for the Order Entry program and the Purchase Order Workbench program.

You can specify whether you want to review substitute or replacement items after you enter a detail line. You can have the system replace the item number, the item description, and the cost on a detail line with that of a substitute or replacement item.

10.4.1.10 Kit Orders

Kits are comprised of component items that are associated to a parent item. Kits are useful if the company sells combinations of products. For example, if the company sells stereo systems, you can set up a kit with a parent name of stereo. The stereo kit can contain components such as speakers and a compact disc player, which you typically want to sell together. You can have an item number for the kit that you enter on a purchase order, but the parent item, stereo, is not stocked as an inventory item.

When you enter an item number for a kit, you can review the preselected components and the quantities that comprise the kit. You can also select any optional items that you want to include on the purchase order.

If you change quantity information for the kit, you must manually adjust the corresponding cost information. If you need to cancel component lines, you must cancel each line individually.

10.4.1.11 Service Units for A/P Matching

You can perform lump sum processing for services purchase order lines that have an inventory interface of A and B only. Lump sum processing is the ability to identify and enforce the basis for the matching required for accounts payable (A/P) by line item (such as dollars, hours per unit, or unit price). Thus, you can enter units on a service line but perform vouchering based upon the extended amount and only use the quantity for recording.

You use the Service Quantity and Service UoM fields to enter service units for informational purposes (memo only). The service units provide the ability to have quantity and units of measure on an order with no logic for any calculations. The system does not validate against the values and any changes to these fields do not cause any recalculation of the extended amount.

In all respects, the line is treated like a pure account based line with all interfaces to commitments, receipts, voucher match, and other programs that work with that line. The system bypasses the validation of units entered during voucher match and matches on amount only. You can add service units at voucher match even if services units were not added at order entry. Commitments are made and relieved upon changes to the extended amount field only. Thus, service unit information will flow to the general ledger record but have no bearing on the commitment process.

Service units are passed to the Account Ledger (F0911), P.O. Detail Ledger File (F43199), and Account Balances (F0902) tables when writing entries.

To activate service units, select the Procurement Allow Service Units option on the Line Type Constants Revisions form. The system validates that the service units flag is checked for noninventory interface A and B only. Also set the Display Service Units processing option on the Display tab of the P4310 processing options.

If the processing option is set, the Service Quantity and Service UoM fields appear on the Order Detail form (W4310A). Although both the Service Quantity and Original Quantity fields appear on the Order Detail form, you cannot use both fields for a line.

When the system updates the P.O. Detail Ledger File table (F43199) to create the purchase order ledger for commitment, service units do not affect regular units.

Note: Purchase orders not created directly in P4310, such as transfer orders, direct ship orders, and order generation programs, do not provide access to the Service Quantity and Service UoM fields. Once the purchase order is generated, you can then access the order in P4310 to enter values in these fields.

Additionally, sourcing using the Analyze Event program (P43Q50) does not handle service unit fields.

See Defining Order Line Types.

See Setting Processing Options for Purchase Orders (P4310).

See Multiple Account Distribution.

See Entering Detail Lines by Item Number.

10.4.2 Prerequisites

Before you enter order detail information:

- Set the Order Entry processing options to have the system enter a current status code and a next status code for each detail line.

These codes determine the next process that the detail line goes through in the purchasing process.

- Set the Order Entry processing options to indicate the method by which the system updates detail lines with changes to header information.

If you do not set the processing options to automatically update the header information, you must do so manually on the Order Header form by selecting Header To Detail/Define, which enables you to specify which fields to update, and then Header To Detail/Populate from the Form menu.

- Before you enter kit orders, you must verify that you have set the appropriate processing option in the Purchase Orders program (P4310) that displays kit component lines.

Also verify that kit items have been set up.

10.4.3 Forms Used to Enter Order Detail Information

Form Name	Form ID	Navigation	Usage
Order Detail	W4310A	Purchase Order Processing (G43A11), Enter Purchase Orders Click the Add button on the Work With Order Headers form. Alternatively, select an order on the Work With Order Headers form and select Detail Revision from the Row menu.	Enter order detail information. Enter user-defined values for additional properties and category codes. See Entering Order Header Information .
Clauses	W4310K	Select Clauses from the Form menu on the Order Detail form.	Specify the print message clauses associated with a purchase order.
Order Detail - Page I	W4310F	Select Additional Info 1 from the Row menu on the Order Detail form.	Enter order detail information.
Order Detail - Page II	W4310E	Select Additional Info 2 from the Row menu on the Order Detail form.	Enter order detail information.

Form Name	Form ID	Navigation	Usage
Order Header - Additional Information II	W4310M	Select Additional Info from the Form menu on the Order Detail form.	View supplier classification codes. See Entering Additional Order Header Information .
Account Distribution Entry	W4316A	Select an order detail line on the Order Detail form, and then select Account Distribution from the Row menu.	Distribute by percentage, quantity, or amount among multiple accounts. Note: The system enables you to select a method (percentage, quantity, or amount) when you are entering account distribution information. However, if you change an order detail line, the system does not allow you to change the original method by which you distributed among multiple accounts.
Substitute Items	W41043C	Select Substitute Items or Obsolete Items from the Row menu on the Order Detail form.	Enter substitute or replacement items.
Kit Selection	W41351A	Select Kits from the Row menu on the Order Detail form.	Enter kit orders.

10.4.4 Entering Detail Lines by Item Number

Access the Order Detail form.

Figure 10–2 Order Detail form

Enter Purchase Orders - Order Detail

Form Row Tools

Order Detail | Line Defaults | Additional Properties | Category Codes | Style

Order Number: 4894 OP 00001 Branch/Plant: 30

Supplier: 4343 Parts Emporium Order Revision:

Ship To: 6031 Eastern Distribution Center Order Date: 12/12/2011

Hold Code: [Order Attachment](#)

Retainage %: Retainage Indicator

Currency: USD Exchange Rate: Base: USD Foreign

Records 1 - 2

<input type="checkbox"/>	<input checked="" type="checkbox"/>	Item Number	Quantity Ordered	Tr. UoM	Unit Cost	Extended Cost	Pu. UoM	Ln Ty	Description 1	Line Number	Branch/Plant
<input type="checkbox"/>	<input checked="" type="checkbox"/>	220	1	EA	550.0000	550.00	EA	S	Touring Bike, Red	1.000	30
<input type="checkbox"/>	<input type="checkbox"/>										

This image is described in surrounding text.

Branch/Plant

Enter a code that identifies a separate entity within a business for which you want to track costs. For example, a business unit might be a warehouse location, job, project, work center, branch, or plant. You can assign a business unit to a document, entity, or person for purposes of responsibility reporting. For example, the system provides reports of open accounts payable and accounts receivable by business unit to track equipment by responsible department. Business unit security might prevent you from viewing information about business units for which you have no authority.

Tr. UoM (transaction unit of measure)

Enter a value from UDC 00/UM that indicates the quantity in which the system expresses an inventory item. Examples of transaction units of measure are CS (case) and BX (box).

Sec Quantity Ordered (secondary quantity ordered)

Enter a value that indicates an alternate quantity for the item. This field is used with the Sec UoM (secondary unit of measure) field.

Sec UoM (secondary unit of measure)

Enter a value from UDC 00/UM that indicates an alternate unit of measure for the item.

Extended Cost

Displays a value that is equal to the number of units multiplied by the unit price.

Ln Ty (line type)

Enter a code that controls how the system processes lines on a transaction. Line type controls the systems with which the transaction interfaces, such as JD Edwards EnterpriseOne General Ledger, JD Edwards EnterpriseOne Job Cost, JD Edwards EnterpriseOne Accounts Payable, JD Edwards EnterpriseOne Accounts Receivable, and JD Edwards EnterpriseOne Inventory Management. Line type also specifies the conditions under which a line prints on reports, and it is included in calculations. Values are:

S: Stock item.

J: Job cost.

N: Nonstock item.

F: Freight.

T: Text information.

M: Miscellaneous charges and credits.

W: Work order.

Asset ID (asset identifier)

Enter a 25-character alphanumeric code that you can use as an alternate asset identification number. You might use this number to track assets by the manufacturer's serial number. You are not required to use a serial number to identify an asset. Every serial number that you enter must be unique.

Report Code 1

Enter a code that differentiates segments of inventory in ways that are meaningful to those personnel who are responsible for the buying function in an organization. Depending upon the nature of inventory, this code might be used to establish attributes such as color, country of origin, primary content, seasonality, and rebate group.

G/L Offset (general ledger offset)

Enter a code that determines the trade account that the system uses as the offset when you post invoices or vouchers. The system concatenates the value that you enter to the AAI item RC (for Accounts Receivable) or PC (for Accounts Payable) to locate the trade account. For example, if you enter **TRAD**, the system searches for the AAI item RCTRAD (for receivables) or PCTRAD (for payables).

You can assign up to four alphanumeric characters to represent the general ledger offset or you can assign the three-character currency code (if you enter transactions in a multicurrency environment). You must, however, set up the corresponding AAI item for the system to use; otherwise, the system ignores the general ledger offset and uses the account that is set up for PC or RC for the company specified.

If you set up a default value in the G/L Offset field of the customer or supplier record, the system uses the value during transaction entry unless you override it.

Do not use code 9999. It is reserved for the post program and indicates that offsets should not be created.

Job Typ (job type)

Displays the job type from the JD Edwards EnterpriseOne Contract and Service Billing system. You may override the job type on the purchase order line.

If you override the job type, enter a value that defines a job within your organization. You can use a value from UDC 06/G. You associate pay and benefit information with a job type and apply that information to the employees linked to that job type.

Note: If you have selected the Project and Gov Contract Accounting Used option in the Service Billing Constants program (P48091), the system displays and enables the Job Typ field on the Order Detail (W4310A) and Contract Detail (W4310A) forms.

See "Entering Contract-Specific Labor Categories for Subcontract Management" in the *JD Edwards EnterpriseOne Applications Project and Government Contract Accounting Implementation Guide*.

Category Code 01

Enter a value from UDC 43/C1 that is associated with a purchase order.

Category Code 02

Enter a value from UDC 43/C2 that is associated with a purchase order.

Category Code 03

Enter a value from UDC 43/C3 that is associated with a purchase order.

Category Code 04

Enter a value from UDC 43/C4 that is associated with a purchase order.

Service Quantity

Enter a value that represents the number of units committed for a nonstock item or service line on a purchase order. This field is a field by itself and has no relation with unit cost to calculate the extended cost. If service units are used, the Quantity Ordered field on the Order Detail form in JD Edwards EnterpriseOne Procurement system cannot be used.

Service UoM (service unit of measure)

Enter a value from UDC 00/UM that specifies the unit of measure for the quantity committed for a nonstock item or service line on a purchase order.

10.4.5 Entering Detail Lines by Account Number

Access the Order Detail form.

10.4.5.1 Line Defaults

Select Line Defaults.

Account Number

Enter a value that identifies an account in the general ledger. Use one of these formats to enter account numbers:

- Standard account number (business unit.object.subsidiary or flex format).
- Third general ledger number (maximum of 25 digits).
- Account ID number. The number is eight digits long.
- Speed code, which is a two-character code that you concatenate to the AAI item SP. You can then enter the code instead of an account number.
- The first character of the account number indicates its format. You define the account format in the General Accounting constants.

Subsidiary

Enter a value to identify a subset of an object account. Subsidiary accounts include detailed records of the accounting activity for an object account.

If you are using a flexible chart of accounts and the object account is set to six digits, you must use all six digits. For example, entering **000456** is not the same as entering **456** because if you enter **456**, the system enters three blank spaces to fill a six-digit object.

Obj Acct (object account)

Enter a value for the portion of a general ledger account that refers to the division of the Cost Code (for example, labor, materials, and equipment) into subcategories. For example, you can divide the Cost Code for labor into regular time, premium time, and burden.

If you use a flexible chart of accounts and the object account is set to six digits, you should use all six digits. For example, entering **000456** is not the same as entering **456** because if you enter **456**, the system enters three blank spaces to fill a six-digit object.

Subledger

Enter a code that identifies a detailed, auxiliary account within a general ledger account. A subledger can be an equipment item number or an address book number. If you enter a subledger, you must also specify the subledger type.

Sub Type (subledger type)

Enter a value from UDC 00/ST that is used with the Subledger field to identify the subledger type and how the system performs subledger editing. On the User Defined Codes form, the second line of the description controls how the system performs editing. This is either hard-coded or user-defined. Values include:

- A: Alphanumeric field, do not edit.
- N: Numeric field, right justify and zero fill.
- C: Alphanumeric field, right justify and blank fill.

Note: You can click the Search button in the Tr. UoM field and Pu. UoM field to access the Unit of Measure Lookup form, where you can select from a list of valid units of measure for the item that you are entering on the purchase order.

10.4.6 Entering Multiple Account Distributions

Access the Account Distribution Entry form.

Figure 10–3 Account Distribution Entry form

Account Number	G/L Date	Distributed Percentage	Distributed Amount	Distributed Quantity	Account Description	Cost Center	Obj Acct
30.1469	06/06/2005	60.0000	3,182.08		6 Non-Stock for Sale	30	1469
40.1469	06/06/2005	40.0000	2,121.39		4 Non-Stock for Sale	40	1469
	06/06/2005						

This image is described in surrounding text.

Distribute by

Enter the multiple account distribution type. Values are:

1: Split by percentage (default)

2: Split by fixed amount

3: Split by fixed quantity

Distributed Percentage

Enter the percentage that the system uses for creating the general ledger distribution.

Distributed Amount

Enter the amount that the system uses for creating the general ledger distribution.

Distributed Quantity

Enter the quantity that the system uses for creating the general ledger distribution.

10.4.7 Entering Tax Information for a Detail Line

Access the Order Detail form.

Taxable

Enter a code that indicates whether the item is subject to sales tax when you purchase it. The system calculates tax on the item only if the supplier is also taxable.

Expl Code (explanation code)

Enter a value from hard-coded UDC 00/EX that controls the algorithm that the system uses to calculate tax and general ledger distribution amounts. The system uses the tax explanation code with the tax rate area and tax rules to determine how the tax is calculated. Each transaction pay item can be defined with a different tax explanation code.

Rate/Area

Enter a code that identifies a tax or geographic area that has common tax rates and tax authorities. The system validates the code you enter against the F4008 table. The system uses the tax rate area with the tax explanation code and tax rules to calculate tax and general ledger distribution amounts when you create an invoice or voucher.

10.4.8 Entering Discount Terms for a Detail Line

Access the Order Detail form.

Discount Factor

Enter a value for the factor that the system applies to the unit price of an inventory item to determine the net price. The system retrieves this value from the inventory pricing rules if you have assigned a rule to this item. The pricing rule setup determines if the system multiplies the unit price by this value or adds to or deducts from the unit price.

Item Price Group

Enter a value from UDC 40/PI that identifies an inventory price group for an item.

Inventory price groups have unique pricing structures that direct the system to incorporate discounts or markups on items on sales and purchase orders. The discounts or markups are based on the quantity, monetary amount, or weight of the item ordered. When you assign a price group to an item, the item takes on the same pricing structure defined for the inventory price group.

You must assign an inventory price group to the supplier or customer, as well as to the item, for the system to interactively calculate discounts and markups on sales orders and purchase orders.

Pricing Cat. Level (pricing category level)

Enter a value to identify a price level. A pricing category or price rule can contain a variety of levels. Within each price rule, each level is defined by its effective date range and allowed quantity, and whether it is based on the item's cost, price, or an amount specified as an override.

10.4.9 Entering Reporting Codes for a Detail Line

Access the Order Detail - Page II form.

10.4.10 Entering Change Orders

Access the Order Detail form.

10.4.11 Entering Substitute or Replacement Items

Access the Order Detail form.

10.4.12 Entering Kit Orders

Access the Kit Selection form.

Sel (selection)

Select components for inclusion in the order. An * indicates the component is selected.

O (option)

Indicates whether a component is standard or optional within a bill of material or kit processing. Values are:

S: Standard (default)

This item is standard and is always included in any transaction involving the bill of material or kit item.

O: Optional

This item is optional in order entry. You can specify whether the item will be included in a particular sale.

F: Feature

The item has features that you must specify at order entry.

10.4.13 Copying Change Orders

Access the Order Detail form.

You can copy a change order and then modify it. This feature saves you time when you have similar change orders for many orders.

Quantity Ordered

Displays either a transacted quantity or the units.

Unit Cost

Displays the price charged for the unit of measure in the adjoining field. Use these fields, for example, if the primary unit of measure is EA (each), but you typically use a list price per box.

Extended Cost

Displays a value that is equal to the number of units multiplied by the unit price.

If you want to add a new line to the order, you must first scroll through all existing detail lines to the first blank line to ensure that the system assigns the correct number to each detail line.

Working with Purchase Orders

This chapter contains the following topics:

- [Section 11.1, "Working with Special Order-Entry Features"](#)
- [Section 11.2, "Working with Budgets"](#)
- [Section 11.3, "Working with Orders on Hold"](#)
- [Section 11.4, "Working with Log Information"](#)
- [Section 11.5, "Printing Orders by Batch"](#)
- [Section 11.6, "Printing Orders Individually"](#)
- [Section 11.7, "Working with Order Information"](#)

11.1 Working with Special Order-Entry Features

This section provides an overview of special order-entry features and discusses how to:

- Duplicate an order.
- Set processing options for Purchase Order Workbench (P43101).
- Enter orders for multiple suppliers.
- Select a supplier for an item.
- Enter items using supplier catalogs.
- Enter items using order templates.
- Create orders from existing detail lines.

11.1.1 Understanding Special Order-Entry Features

You can use several timesaving features to enter order information; for example, you can duplicate an order to create another order, and you can also create orders for multiple suppliers simultaneously. Other features let you quickly locate item and supplier information and enter the information on purchase order detail lines.

Order entry has several special features.

11.1.1.1 Order Duplication

To avoid entering the same information for multiple orders, you can duplicate an order. You can also duplicate an order to create a new type of order from an existing

order, for example, to create an order from a requisition. You cannot duplicate orders that are on hold.

You can also duplicate an order to create a certain type of order from the original order. You set the processing options for Order Entry to specify the order type code for the duplicate orders. For example, you enter the order type code for purchase orders (usually OP) if you want the system to create a purchase order every time you duplicate a requisition. You must also specify the status codes for detail lines on the duplicate order, and you must indicate whether the system duplicates notes that are attached to the original order.

Note: If you copy a purchase order that has the Retainage Indicator check box selected, then the duplicate purchase order will also have this check box selected, irrespective of the processing option.

See [Entering Order Header Information](#).

See [Working with Retainage](#).

Note: If the source purchase order has service units, then the duplicate order also has service units, irrespective of the processing option.

See [Setting Processing Options for Purchase Orders \(P4310\)](#).

See “Understanding Subcontract Order Detail Information, Service Units for A, P Matching” in the *JD Edwards EnterpriseOne Applications Subcontract Management Implementation Guide*.

See [Entering Detail Lines by Item Number](#).

11.1.1.2 Orders for Multiple Suppliers

You can enter orders for multiple suppliers simultaneously instead of entering a separate order for each supplier. You specify the items you want to purchase and the supplier from whom you want to purchase each item on the Purchase Order Workbench form.

If the supplier has an internet home page set up with items that they offer, you can preview supplier and item information in the electronic catalog before entering the order.

You cannot order from a supplier who has a noncertified status. If the supplier has a partially certified status, the system displays a warning message before generating the order. If you need to change a supplier's certification status, you can do so on the Supplier/Item Relationships form.

After you enter the items, you must direct the system to create purchase orders. The system combines items for each supplier on a separate purchase order; the information for each detail line comes from master information for the item or procurement instructions for the supplier. You can review the orders that the system generates using the Order Detail form.

11.1.1.3 Choice of Suppliers

When you order an item, you must specify the supplier from whom you want to purchase the item. You can review all suppliers that provide a particular item and the

price that each supplier charges for the item on the Supplier Price Comparison form. The system displays only those items for which:

- Costs are maintained at the branch/plant level.
- Purchase prices are maintained at the supplier level.

After you identify the supplier from whom you want to order the item, you can specify the quantity you want to order and return the information to the Purchase Order Workbench (P43101).

11.1.1.4 Supplier Catalogs

Suppliers might organize their products into different catalogs due to seasonal changes in products, different product lines, and so forth. If you maintain items in catalogs on the system, you can use the catalogs to locate and select items to order.

After you locate a catalog, you can select the items that you want to order. The system enters each item that you select on an order detail line, along with the unit price for the item as specified in the catalog. If the supplier has an internet home page set up with items that it offers, you can preview item information in the electronic catalog. On the Catalogs - Item Selection form, you can use a form exit to preview item information.

Note that an item can have different prices, each based on the amount that you purchase. You can review all item prices for the items in a catalog on the Catalogs - Item Selection form. An item that has multiple prices appears several times, and each listing represents a different purchase quantity and the price that applies to that quantity.

11.1.1.5 Order Templates

You can use order templates to locate lists of items that you frequently order and to select items that you want to order.

Each order template contains a specific group of items. When you enter a purchase order, you can select to review a certain template. From the template, you select the items you want to order, and the system returns the items to the purchase order.

The order templates can be specific to a supplier or they can be generic, in which case you do not usually purchase the items on the template from any specific supplier. If you access order templates before entering a supplier on the purchase order, you can review a list of generic templates.

11.1.1.6 Creation of Orders from Existing Detail Lines

You can avoid manually entering purchase orders by having the system create new purchase orders based on existing detail line information. If the detail lines you are working with are applicable to several different suppliers, the system creates a separate purchase order for each supplier.

If there are multiple detail lines for a supplier, it is because each line pertains to a different branch/plant. The system uses the Next Numbers program to assign a single purchase order number to each supplier. You can also assign the order numbers manually.

You can use processing options to specify default values for the orders that the system creates. These values include the order type and the beginning status code. You can also indicate special processing for the new orders, such as approval routes and budget checking.

Creating purchase orders from existing detail lines is the final procedure for several different JD Edwards EnterpriseOne Procurement system programs, including:

- Purchase Order Workbench.
- Generate Purchase Orders from Requisitions.
- Generate Purchase Orders from Blanket Orders.
- Generate Quotes from Requisitions.
- Purchase Order Generator.

11.1.1.7 Supplier Classification Codes

When using the Purchase Order Generator (P43032), Generate POs from Requisitions/Blanket Order Release (P43060), and Quote Order Release (P43360) programs to release blanket, requisition, and quote orders, the purchase order that is generated contains the supplier classification codes from the supplier's address book record in the JD Edwards EnterpriseOne Address Book system.

See [Entering Additional Order Header Information](#).

See "Supplier Classification Codes" in the *JD Edwards EnterpriseOne Applications Subcontract Management Implementation Guide*.

11.1.1.8 Additional Properties and Category Codes

Additional properties and category codes capture user-defined information for a purchase order. At the time a purchase order is created, you manually enter values for fields on the Additional Properties and Category Codes tabs of the Order Header or Order Detail forms.

Purchase orders created directly in P4310 provide access to the user-defined fields on the Additional Properties and Category Codes tabs of the Order Header or Order Detail forms. Purchase orders not created directly in P4310, such as transfer orders, direct ship orders, and order generation programs, do not provide access to the user-defined fields. Once the purchase order is generated, you can then access the order in P4310 to enter values in the user-defined fields.

If you copy a purchase order that has values in the additional properties and category codes user-defined fields, then the duplicate purchase order will also have field values, irrespective of the processing options.

Note: Purchase orders created through sourcing using the Analyze Event program (P43Q50), through supplier self-service using the SRM - PO Acknowledgement program (P43S01), or through EDI using the EDI Inbound P.O. Acknowledgment program (R47021) do not handle the user-defined fields.

See "Understanding Subcontract Orders, Additional Properties and Category Codes" in the *JD Edwards EnterpriseOne Applications Subcontract Management Implementation Guide*.

See [Entering Order Header Information](#).

11.1.1.9 Service Units for A/P Matching

You can enter service unit information for services purchase order lines during the purchase order entry process. Service units are informational only so the system does not perform any validation against the values.

Set the Display Service Units processing option on the Display tab of the Purchase Order Workbench program (P43101) to display the Service Quantity and Service UoM fields on the Purchase Order Workbench (W43101B) and Items Selected for Order (W43032B) forms.

Purchase orders created through sourcing using the Analyze Event program (P43Q50), through supplier self-service using the SRM - PO Acknowledgement program (P43S01), or through EDI using the EDI Inbound P.O. Acknowledgment program (R47021) do not handle the service unit fields.

See “Understanding Subcontract Order Detail Information, Service Units for A, P Matching” in the *JD Edwards EnterpriseOne Applications Subcontract Management Implementation Guide*.

11.1.1.10 Alternate Tax Rate/Area Assignment Functionality in the Purchase Order Workbench Program (Release 9.1 Update)

You can work with the alternate tax rate/area assignment functionality when you work in the Purchase Order Workbench program. If the company of the transaction is set up to use the alternate tax rate/area assignment functionality, then on the Purchase Order Workbench form, the system:

- Retrieves the alternate tax rate/area when the business unit that you enter in the Branch/Plant field corresponds to a company for which you have set up the alternate tax rate/area assignment functionality, and the ship-to and supplier specified are also set up to use the functionality. If the company of the branch/plant is not set up to use the alternate tax rate/area assignment functionality, then the system retrieves the default value.
- Updates the value in the Tax Rate/Area field if you change the Ship To value. If you leave the Ship To field blank and then click OK, the system retrieves the ship to value from the branch/plant setup.
- Does not update the Tax Rate/Area field for changes in the Ship To field if you manually change the Tax Rate/Area value.

Note that in this application, you cannot change the supplier.

See Also:

“Setting Up Alternate Tax Rate/Area Assignment Functionality” in the *JD Edwards EnterpriseOne Applications Tax Processing Implementation Guide*.

“Procurement Management” in the *JD Edwards EnterpriseOne Applications Tax Processing Implementation Guide*.

11.1.2 Forms Used to Work with Special Order-Entry Features

Form Name	Form ID	Navigation	Usage
Work With Order Headers	W4310I	Purchase Order Processing (G43A11), Enter Purchase Orders	Work with order headers.
Order Detail	W4310A	Select an order on the Work With Order Headers form, and then click the Copy button.	Review and modify order details. Duplicate an order.

Form Name	Form ID	Navigation	Usage
Purchase Order Workbench	W43101B	Purchase Order Processing (G43A11), Purchase Order Workbench	Access forms to work with purchase orders.
Supplier Price Comparison	W43103C	On Purchase Order Workbench, select Price Comparison from the Form menu.	Locate suppliers for an item to compare prices.
Supplier Catalog Search & Select	W41061CA	On Purchase Order Workbench, select Catalogs from the Form menu.	Access a list of available catalogs.
Catalogs - Item Selection	W41061WB	Select a catalog on the Supplier Catalog Search & Select form, and click the Select button.	View items on separate detail lines on a purchase order. Click OK for the system to automatically generate a separate purchase order for each supplier from whom you are ordering items. If you do not want the system to automatically generate separate purchase orders, you must first cancel the orders before exiting Purchase Order Workbench.
Work With Available Order Templates	W4015A	On the Purchase Order Workbench form, select Order Templates from the Form menu.	Work with available order templates.
Order Templates	W40215A	Select a template on the Work With Available Order Templates form, and click the Select button.	Order items on a template. You can order all items on the template in their usual quantities by selecting Preload With Usual from the Form menu.
Suppliers Selected for Order	W43032A	On the Purchase Order Workbench form, select Review Order(s) from the Form menu.	Verify that all releases are combined into a separate line for each supplier and branch/plant.
Items Selected for Order	W43032B	On the Suppliers Selected for Order form, select an order and select Details from the Row menu.	Make changes to information about the individual items or accounts to be included on the order.

11.1.3 Duplicating an Order

Access the Order Detail form.

On Order Detail, change the order dates and other information, as necessary. If you want to add a new line to the order, you must scroll through all existing detail lines to the first blank line to ensure that the system assigns the correct number to each detail line.

11.1.4 Setting Processing Options for Purchase Order Workbench (P43101)

Processing options enable you to specify the default processing for programs and reports.

11.1.4.1 Defaults

These processing options enable you to enter default information that the system uses for purchase order processing.

1. Order Type

Enter a value that exists in the Document Type - All Documents (00/DT) user-defined code (UDC) table to specify the default value for the order type. The system populates the Order Type field of the Order Header form with this value.

2. Line Type

Enter a value to specify how the system processes lines on a transaction. The line type affects the systems with which the transaction interfaces (JD Edwards EnterpriseOne General Ledger, JD Edwards EnterpriseOne Job Cost, JD Edwards EnterpriseOne Accounts Payable, Oracle's JD Edwards EnterpriseOne Accounts Receivable, and JD Edwards EnterpriseOne Inventory Management). The line type also specifies the conditions for including a line on reports and in calculations. You define line types in the Order Line Types program (P40205).

The system populates the Ln Ty (line type) field on the Order Detail form.

3. Beginning Status

Enter a value from the Activity/Status Codes (40/AT) UDC to specify the default value for the beginning status for the order. The value that you enter must be set up for the order type and the line type that you are using.

4. Override Next Status

Enter a value that exists in the Activity/Status Codes (40/AT) UDC to specify the next status code for all new or modified purchase order lines. You enter next status codes for combinations of order type and line type by using the Order Activity Rules program (P40204). If you leave this processing option blank, the system uses the next status code in the order activity rules as the default value.

Do not use this processing option if you are using approval processing.

5. Unit of Measure

Enter a value that exists in the Unit of Measure (00/UM) UDC to specify the default unit of measure that the system displays in the Transaction Unit of Measure field.

6. Line Number Increment

Enter a whole number that the system uses to automatically increase, by this increment, the order lines on the order.

7. Default Tax Rate/Area

Specify where the system locates default tax rate/area information to use as the default during order entry. Values are:

Blank: The system uses the tax rate/area that is associated with the address book number for the supplier. The system retrieves the tax explanation code from the supplier address book number record in the F0401 table. If this version is being called from the Order Release program, then the tax information comes from the F0401 table and not from the original order.

1: The system uses the default tax rate/area from the address book number for the ship-to address number. The information that the system uses is located in the tax information section of the F0401 table.

(Release 9.1 Update) If the alternate tax rate/area assignment functionality is enabled for the company, the system overrides this default tax rate/area and uses the alternate tax rate/area assignment instead. See “Setting Up Alternate Tax Rate/Area Assignment Functionality” in the *JD Edwards EnterpriseOne Applications Tax Processing Implementation Guide* and “Procurement Management” in the *JD Edwards EnterpriseOne Applications Tax Processing Implementation Guide*.

8. Transaction Unit of Measure

Specify where the system locates transaction unit of measure information to use as the default during order entry. Values are:

Blank: The system uses the purchasing unit of measure from the F4101 table. The transaction unit of measure directly relates to the number that you entered in the Quantity field on the Purchase Order Entry form. If you select an item from a catalog in Purchase Order Entry, the unit of measure in the catalog overrides the value that you enter in this field. If you entered a value in the Unit of Measure field, you should not enter a value in this field.

1: The system uses the primary unit of measure from the F4101 table as the default for the transaction unit of measure.

9. Landed Cost Rule

Enter a value from the Landed Cost Rule (41/P5) UDC to specify the landed cost rule that the system uses to populate the Cost Rule field on the Order Header - Additional Information form.

10. Header to Detail

Specify whether the system updates information in the detail lines when you change header information. Values are:

Blank: You must use the Populate form exit on the Order Header form to manually apply header to detail changes. Use the Define form exit on the Order Header form to select which fields on the Order Detail form you want to update with changes to header information. After you make changes to the header information, the Order Detail form appears.

1: The system automatically loads header changes to the detail lines.

11. Work Order Status

Enter a value from the Work Order Status (00/SS) UDC that the system uses as a default value when the purchase order quantity or promise date changes. This processing option applies to purchase orders that have been created for outside operations by processing work orders with the Order Processing program (R31410). If you change the quantity or promise date after the system creates a purchase order, the system updates the work order status to the value you enter in this processing option. If you leave this processing option blank, the system does not change the work order status.

12. Account Description

Specify where the system locates the account description to use as the default value in order entry. Values are:

Blank: The system retrieves the account description from the account that consists of the business unit, object, and subsidiary.

1: The system retrieves the account description from the account that consists of the business unit and the subsidiary. Typically, the account is a nonposting header account. Note that the object account will not be used when the system retrieves the account description.

13. Line Sequence

Specify how the system assigns line numbers on a change order. Values are:

Blank: The system assigns unique, incremental line numbers on a continuous basis. For multiple change orders, the system assigns incremental line numbers on a continuous basis rather than starting over with line number sequencing for each change order.

1: The system starts the sequencing process over for each change order. If you enter 1, the system retains and increases the line number sequence within each individual change order; for the next change order, however, the system starts over with the line number sequencing.

14. Cost Rule Selection

Specify where the system locates default cost rule selection information to use as the default during order entry. Note that if this is the version that is being called from the Order Release program, then the cost rule information comes from the F0401 table and not from the original order. Values are:

Blank: The system uses the cost rule selection that is associated with the address book number for the supplier. The system retrieves the cost rule explanation code from the supplier address book number record in the F0401 table.

1: The system uses the default cost rule selection from the address book number for the ship to. The information that the system uses is located in the cost rule information section of the F0401 table.

11.1.4.2 Display

These processing options enable you to control the types of information that the system displays.

1. Suppress Closed Lines

Specify if closed lines are suppressed. Values are:

Blank: The system does not suppress closed or canceled lines.

1: The system suppresses closed or canceled lines. When the system suppresses closed or canceled lines, any line with a status of 999 will not appear in the detail area. However, the record for the line remains in the F4311 table.

2. Status Code Protection

Specify whether the system enables the change of status codes. Values are:

Blank: Status codes can be changed.

1: Status codes cannot be changed. You can review the codes, but you cannot change them. Regardless of the status code, the system protects the last and next status when you have activated status code protection.

3. Order Type Protection

Specify whether the system enables the change of order types. Values are:

Blank: You can change the order type.

1: The order type (also known as the document type) cannot be changed. You can review the order type, but you cannot change it.

4. Kit Display

Specify whether the system displays kit component lines or only the parent line. Values are:

Blank: The system displays only the parent line. However, both the parent line and all component lines are written to the F4311 table.

1: The system displays kit component lines. You must first create the purchase order and then inquire upon the purchase order to display the kit component lines.

5. Cost Protection

Specify whether the system enables changes to costs. Values are:

Blank: The cost fields appear on the form and can be overridden.

1: The costs fields appear on the form, but cannot be changed.

2: The system hides cost information. The Cost field does not appear, although the system still writes the cost information to the F4311 table. The system uses cost information from the costs tables as the default. Examples of the costs tables are the F4105 table and the F41061 table. The cost table that the system uses for the default information depends on the way that the system is set up.

6. Detail Line Protection

Enter a value from the Activity/Status Codes (40/AT) UDC to specify the next status at which detail lines are protected from change. The entire detail line is protected when the next status is greater than or equal to this status. If you leave this processing option blank, the system does not protect detail lines from change.

7. Free Goods Catalog

Specify whether the system displays free goods catalog warnings. Values are:

Blank: No warning.

1: Issue warning.

8. Order Header Protection

Specify whether order header information is read-only or can be modified. Values are:

Blank: Order header information can be changed.

1: Order header information is read-only.

9. Jargon and Header Business Unit

Specify which description appears for the Business Unit field that appears on the Order Header form and the Order Detail form. For example, if you leave this processing option blank, the MCU field displays the description **Branch/Plant**. Values are:

Blank: Branch/plant.

1: Job.

2: Project.

3: Business unit.

10. Account Protection

Specify whether the account number information is protected after the detail line is partially received or vouchered. Values are:

Blank: The account number information is not protected.

1: The account number information is protected.

11. Display Additional Properties Tab

Specify whether the system enables the Additional Properties tab. This processing option controls the display of the Additional Properties tab in the Purchase Order Header and Purchase Order Detail forms. Values are:

Blank: Disable. Do not display the Additional Properties tab.

1: Enable. Display the Additional Properties tab.

12. Display Category Codes on Header Tab and Detail Grid

Specify whether the system enables the Category Codes tab. This processing option controls the display of the Category Codes tab in the Purchase Order Header and Purchase Order Detail forms. This processing option also controls the display of the Category Codes in the detail grid. Values are:

Blank: Disable. Do not display the Category Codes tab.

1: Enable. Display the Category Codes tab.

13. Enable Form Exit for Clauses

Specify whether the system enables the Form exit for Clause. Values are:

Blank: Disable

1: Enable

14. Display Location and Lot fields for a Job or Project

Specify whether the Location and Lot fields display in the grid for a job or project. This processing option is used with the 9. Jargon and Header Business Unit processing option on the Display tab. If the 9. Jargon and Header Business Unit processing option is set to a value of 1 or 2, then this processing option is used. If the 9. Jargon and Header Business Unit processing option is set to any value other than 1 or 2, then this processing option is not used. Values are:

Blank: Do not display.

1: Display.

15. Address Book Field Required

Specify whether the Address Book 01 and Address Book 02 fields on the Additional Properties tab are required. This processing option is used with the 11. Display Additional Properties Tab processing option on the Display tab. If the Address Book fields are required, then the 11. Display Additional Properties Tab processing option must be enabled. Values are:

Blank: Not required.

1: Address Book 1 required.

2: Address Book 2 required.

3: Address Book 1 and Address Book 2 required.

16. Display Retainage Indicator

Specify whether the Retainage Indicator field displays on the Order Header and Order Detail forms. The field is display-only on the Order Detail form.

The Retainage Indicator field is a visual indication that the accounts payable clerk uses to verify whether retainage occurred on the invoice and if it should be applied to the voucher. Values are:

Blank: Do not display

1: Display

17. Display Service Units

Specify whether the system displays the Service Quantity and Service UoM fields in the grid. This processing option is used with line type constants. If the Procurement Allow Service Units option is selected on the line type constants, then service quantity and service UOM can be used. The Ordered Quantity and Service Quantity fields cannot be used together. Service quantity is a memo field and does not have any validation. Values are:

Blank: Do not display

1: Display

11.1.4.3 Interfaces

These processing options enable you to enter interface information.

1. Business Unit Validation

Specify how the system validates the branch/plant. Values are:

Blank: The system validates the branch/plant against the F0006 table. Typically, you use this processing option when you are performing services expenditure purchasing. When you leave this processing option blank, the Ship To address book number from the address book number in the F0006 table is used. You can access the Business Unit Master table through the Revise Single Business Unit program.

1: The system validates the branch/plant against the F41001 table. If you are performing stock purchasing, enter **1** for this processing option. When you enter **1**, the system uses the address book number in the F41001 table as the default for the Ship To address book number.

2. PBCO Warning (post before cutoff warning)

Specify whether you want to receive a PBCO (Post Before Cutoff) warning. Values are:

Blank: The system compares the general ledger date on the purchase order to the general accounting period for the company and business unit that are on the purchase order. The PBCO warning ensures that you are not recording purchases in a previous general accounting period.

1: Do not issue the PBCO warning. Typically, you use this value when you are performing services or expenditure-type purchasing.

3. PACO Warning (post after cutoff warning)

Specify whether you want to receive a PACO (Post After Cutoff) warning. Values are:

Blank: The system compares the general ledger date on the purchase order with the current period in the General Accounting Constants for the company and business unit that are on the purchase order. The PACO warning occurs when you try to create a purchase order with a general ledger date that exceeds two periods beyond the current general ledger period.

1: Do not issue the PACO warning.

4. Quantity Update

Specify which quantity fields the system updates. Before you set this processing option, always check the way that you have defined availability in the Branch/Plant Constants program. Values are:

Blank: The system updates the Quantity on PO field (alias PREQ).

1: Update the Quantity On Other POs field (alias OT1A) in the F4102 or F4100 tables. Use this value when you are entering requisitions, quotes, blanket orders, or other order types for which you do not want to affect the current on-purchase order quantity.

5. Supplier Analysis

Specify whether the system to capture supplier analysis information. Values are:

Blank: The system does not capture supplier analysis information.

1: The system records information such as item numbers, dates, and quantities for every purchase order in the F43090 table. To make supplier analysis most effective, enter **1** for this processing option and set the processing options for the Purchase Order Receipts program (P4312) and the Voucher Match program (P4314) to capture the same information.

6. Edit Supplier Master

Specify whether the system validates the supplier number against the F4330 table. Values are:

Blank: The system does not validate the supplier number.

1: The system validates the supplier number.

7. Financial AAIs (financial automatic accounting instructions)

Specify whether to use financial automatic accounting instructions (AAIs) or distribution AAIs. Additionally, the system uses this processing option to determine which description appears for the Business Unit field (MCU) that appears on the Order Header form and the Order Detail form. For example, if you leave this processing option blank, the MCU field displays the description **Branch/Plant**. Values are:

Blank: The system uses distribution AAIs.

1: The system uses financial AAIs CD, CT, or CR.

11.1.4.4 Processing

These processing options enable you to control how the system processes information.

1. New Supplier Information

Specify whether you can add new supplier information through the Address Book Revisions program (P0101). Values are:

Blank: The system does not access the Address Book Revisions program (P0101).

1: Automatically access the Address Book Revisions program (P0101). You can add a supplier as you need to, rather than having to stop the task that you are performing to add a supplier. Consider the security restrictions for Address Book records. You may not want to provide all users with the ability to enter supplier address book records.

2. Order Templates

Specify whether you want to review order templates. Values are:

Blank: Do not display available order templates.

1: Automatically display available order templates. If you set this processing option to automatically display available order templates and you access the Order Header form, the system displays the order templates before displaying the Order Detail form. If you access the Order Detail form first, the system displays the order templates when you move the cursor to the detail area for the first time.

3. Subsystem Printing

Specify whether you want to automatically print a purchase order using the subsystem. Values are:

Blank: Do not print a purchase order by using the subsystem.

1: Automatically print the purchase order by using the subsystem. Note that you need to submit the version of the Purchase Order Print program (R43500) that is designated for subsystem processing.

4. Blanket Releases

Specify whether the system automatically processes blanket releases. Values are:

Blank: The system does not automatically process blanket releases.

1: The system automatically processes blanket releases for all branch/plants. If more than one blanket order exists for the supplier/item combination, the system displays a check mark in the row header that is located in the detail area and an X in the Blanket Exists column. To select a blanket order, select the appropriate option from the Row menu.

2: The system automatically processes blanket releases for a specific branch/plant. If there is more than one blanket order for the supplier and item combination, then the system displays a check mark in the row header that is located in the detail area and an X in the Blanket Exists column. To select a blanket order, select the appropriate option from the Row menu.

5. Header Display

Specify whether the Order Header form appears before the Order Detail form. Values are:

Blank: Display the Order Detail form.

1: Display the Order Header form before the Order Detail form.

6. Agreement Search

Specify how the system searches for agreements. This processing option applies only if you are using the JD Edwards EnterpriseOne Procurement system with the JD Edwards EnterpriseOne Agreement Management system from Oracle. Values are:

Blank: Do not search for agreements.

1: Assign an agreement if there is only one agreement in the system. If the system finds multiple agreements, the system displays a check mark in the row header that is located in the detail area and an X in the Agreement Exists column. You must use a row exit to select an agreement.

2: Display all agreements.

3: Search for the agreement that has the earliest expiration date.

7. Base Order Protection

Specify whether base order information can be changed. The base order is the original contract or order. The base order detail lines are identified as change order number

000. Typically, you use this processing option to prevent changes from being made to the original order. Values are:

Blank: You can change the base order information.

1: The base order information cannot be changed.

8. Project/Job Validation

Specify whether the values for the branch/plant and general ledger account business unit must be the same. Values are:

Blank: The values for the general ledger account business unit and the header business unit can be different.

1: The values for the general ledger account business unit and the header business unit (branch/plant, job, and so on) are the same.

9. Exclusive Adjustment Hold

Use this processing option to place the order on hold if you apply advanced pricing to the item and have chosen mutually exclusive adjustments for the item's adjustment groups.

10. Logs Entry Display

Specify whether the system automatically displays logs when adding an order or a contract. Values are:

Blank: The system does not automatically display logs.

1: The system automatically displays logs.

11.1.4.5 Duplication

These processing options enable you to enter default information that the system uses for duplicate orders.

1. Duplicate Order Type

Enter the type of document. This UDC (00/DT) also indicates the origin of the transaction. There are reserved document type codes for vouchers, invoices, receipts, and time sheets, which create automatic offset entries during the post program. (These entries are not self-balancing when you originally enter them.) You must enter a value that has been set up in UDC table 00/DT. These prefixes for document types are predefined; do not change them:

P: Accounts Payable documents.

R: Accounts Receivable documents.

T: Payroll documents.

I: Inventory documents.

O: Purchase Order documents.

J: General Accounting/Joint Interest Billing documents.

S: Sales Order Processing documents.

2. Beginning Status Code

Specify the beginning status, which is the first step in the order process. You must use a UDC (40/AT) that has been set up on the Order Activity Rules form for the order type and the line type that you are using.

3. Next Status Code (Optional)

Specify the next step in the order process. You must use a UDC (40/AT) that has been set up on the Order Activity Rules form for the order type and the line type that you are using. The override status is another allowed step in the process.

4. Copy Selection

Specify the information that the system copies. You must activate this processing option if you want the system to copy line attachment text and order attachment text when generating quotes or requisitions into purchase orders. Values are:

Blank: Copy no information.

1: Copy only line text.

2: Copy line text and order text.

3: Copy only order text.

11.1.4.6 Cross Ref

These processing options enable you to enter cross-reference codes.

1. Substitute Items

Specify the default cross-reference code that the system uses for retrieving substitute items. The value that you enter is used as the default on the Substitute Item Search and Select form.

If there is more than one substitute item, the system displays a check mark in the row header that is located in the detail area and an X in the Substitute Exists column.

2. Obsolete Items

Specify the cross-reference code for retrieving item replacements for obsolete items. The value that you enter is used as the default on the Substitute Item Search and Select form.

If there is more than one replacement item, the system displays a check mark in the row header that is located in the detail area and an X in the Replacement Exists column.

3. Promotional Items

Specify the cross-reference code that the system uses to retrieve promotional items.

11.1.4.7 Order Inquiry

These processing options enable you to enter status and date information.

1. From Status Code

Specify the first code in the range of status codes for order detail lines. The system uses this status as the default on the Additional Selection form.

2. Thru Status Code (through status code)

Specify the last code in the range of status codes for order detail lines. The system uses this status as the default on the Additional Selection form.

3. Last Status

Specify whether the system uses the last status or next status for the Open Order Inquiry program (P4310). Values are:

Blank: The system uses the next status code as the default for the from and thru status codes.

1: The system uses the last status code as the default for the from and thru status codes.

4. Date

Specify the date that the system checks to ensure that the date is within the date range. Values are:

Blank: The system checks the Requested Date.

1: The system checks the Transaction Date.

2: The system checks the Promised Date.

3: The system checks the Original Promise Date.

4: The system checks the Receipt Date.

5: The system checks the Cancel Date.

6: The system checks the General Ledger Date.

11.1.4.8 Versions

These processing options enable you to control which version of various programs the system uses.

1. Supply/Demand Inquiry (P4021)

Define the version that the system uses when you use the Supply/Demand Inquiry program.

2. Supplier Analysis (P43230)

Define the version that the system uses when you are using the Supplier Analysis program.

3. Supplier Master (P04012)

Define the version that the system uses when you are using the Supplier Master program.

4. PO Print on Demand (R43500)

Define the version that the system uses when you are using the Purchase Order Print On Demand program. The system uses the version that you select to print an order when you access the appropriate row exit on a form.

5. Item Availability Summary (P41202)

Define the version that the system uses when you are using the Item Availability Summary program.

6. Approval Review (P43081)

Define the version that the system uses when you are using the Approval Review program.

7. Receipt Routing (P43250)

Define the version that the system uses when you are using the Receipt Routing program.

8. Open Receipts (P43214)

Define the version that the system uses when you are using the Open Receipts program.

9. Revision Audit Summary (P4319)

Define the version that the system uses when you are using the Revision Audit Summary program.

10. Purchase Ledger (P43041)

Define the version that the system uses when you are using the Purchase Ledger program.

11. Open Order Inquiry (P4310)

Define the version that the system uses when you are using the Open Order Inquiry program.

12. Financial Status Inquiry (P44200)

Define the version that the system uses when you are using the Financial Status Inquiry program.

13. Inbound Transportation (P4915)

Define the version that the system uses when you are using the Inbound Transportation program.

14. Preference Profile (R40400)

Specify the version of the Preference Profiles program that the system uses to process orders based on preferences that are activated on the Preference Selection form.

15. Configurator (P3210)

Specify the version that the system uses when you use the configurator program.

16. Blanket Release (P43216)

Specify which version that the system uses with the Blanket Order Release program.

17. Logs Entry (P4305)

Specify the version that the system uses with the Logs Entry program.

18. Requisition Self Service (P43E10)

Define the version used by the system when you are using the Self Service Requisition program.

11.1.4.9 Currency

These processing options enable you to enter currency information.

1. Tolerance

Specify a currency tolerance limit percentage to ensure that the currency amount does not fluctuate by an amount greater than the tolerance percentage as compared with the F0015 table.

If you work with multiple currencies, create a separate version of this program for each currency. The amount you specify in this processing option is currency specific.

2. Currency Code

Specify the currency code in which to view as if amounts. This enables you to view domestic or foreign amounts in a currency other than the currency in which the amounts were originally entered.

If you leave this processing option blank, the system displays as if amounts in the currency in which they were originally entered.

As if currency amounts are stored in a temporary memory, and are not written to a table.

3. As of Date

Specify an as of date for the as if Currency Code processing option. The system uses this date to retrieve the exchange rate from the F0015 table.

If you specify a currency code in the Currency Code processing option and leave this processing option blank, the system uses the system date.

A valid exchange rate between the domestic or foreign currency and the as if currency must exist in the F0015 table, based on the as of date.

11.1.4.10 Approvals

These processing options enable you to enter approval-processing information.

1. Route Code

Specify which code the system uses for approval processing. Values are:

Blank: The system does not perform approval processing.

1: Use the Originator's address as the default value.

2: Use the Originator's user profile as the default value.

3: Use the Branch/Plant route code as the default value.

4: Use the Default Locations route code as the default value.

2. Awaiting Approval Status

Enter the next status for the system to use when the order enters the approval route.

3. Approved Status

Enter the next status for the system to use when the order is automatically approved.

4. Reapprove Changed Lines

Specify whether the system activates approval processing for certain types of modifications to a purchase order line that already has been approved. Values are:

Blank: The system does not activate approval processing.

1: The system activates approval processing when any fields for the purchase order line have been modified.

2: The system activates approval processing only when certain critical fields, which are activated through the Approval Fields Constants program (P43080), have been modified.

3: The system activates approval processing only when the standard critical fields have been modified.

5. Approval Hold Code

Specify a hold code that the system uses when placing the order on hold for the approval process. If you leave this processing option blank, the system does not place the order on hold.

11.1.4.11 Budgeting

These processing options enable you to enter budgeting information.

1. Budget Hold Code

Specify the hold code that the system uses for budget holds. After you enter a hold code, the system activates the budget checking process. Budget checking ensures that when a detail line exceeds the budget for an account, the system places the entire order on hold.

2. Budget Ledger Type

Specify the ledger type that contains the budgets.

If you specify a budget ledger type, the system retrieves only that budget ledger type. If you leave this processing option blank, the system retrieves all budget ledger types that were specified in the Ledger Type Master Setup program (P0025) and are contained in the F0025 table.

3. Level of Detail

Specify the value (3 through 9) for the level of detail that the system uses during the budget checking process. If you leave this processing option blank, the system uses a default value of 9.

You can use this processing option with the processing option for level of detail accumulation.

4. Budget Total Method

Specify the method by which the system calculates the budget. If you leave this processing option blank, the system uses the job cost budget calculation method. Values are:

Blank: The system uses the job cost budget calculation method.

1: The system uses the job cot budget calculation method:

Original budget + period amounts for the current year + previous year postings

2: The system uses the standard financial budget calculation method:

Sum of period amounts for the current year.

3: The system uses the standard financial spread calculation method:

Original budget + period amounts for the current year.

5. Period Accumulation Method

Indicate the time period that the system uses when accumulating the budget. Values are:

Blank: Use the total annual budget to accumulate the budget.

1: Accumulate the budget through the current period.

6. Tolerance Percentage

Specify the percentage by which the detail line amount can exceed the budget before the system places the order on budget hold.

7. Hold Warning

Specify whether the system displays a warning message about detail line amounts that exceed the budget. Values are:

Blank: The system does not display a warning, but it does place the order on hold.

1: The system displays a warning and places the order on hold.

2: The system displays a warning, but it does not place the order on hold.

8. Budget Accumulation Level of Detail (Release 9.1 Update)

Specify whether the system uses the Level of Detail processing option value (under the Budgeting tab) to accumulate budget amounts. Values are:

Blank: The system determines the budget amount from the account entered in the purchase order detail line.

1: The system determines the budget checking account from the values in the purchase order detail account and the Level of Detail processing option. The system then calculates the budget amount by accumulating the budget amounts of all the child accounts of the budget checking account.

9. Exclude Subledger/Type (Release 9.1 Update)

Specify whether the system excludes the subledger and subledger type when validating the budget information. Values are:

Blank: The system includes only those accounts that have a subledger and a subledger type specified in the purchase order detail.

1: The system does not consider the subledger and subledger type. All of the accounts (with and without a subledger and a subledger type) are considered for budget checking.

10. Job Cost Account Sequence

Specify the job cost account sequence that the system uses for budgeting. Values are:

Blank: The system uses the standard account sequence (for example, cost center, object, and subsidiary).

1: The system uses the job cost sequence (for example, job, cost code, and cost type).

11. Include Taxes

Specify whether the system includes taxes for taxable lines in budget calculations. Values are:

Blank: Do not include taxes.

1: Include taxes.

12. Include Prior Year Balance Forward Amount

Specifies whether the budget amount from the previous year, should be included/added to the available budget amount for the current year, during budget calculation. Values are:

Blank: Include the prior year balance amount with the budget amount for the current year.

1: Do not include the prior year balance amount with the budget amount for the current year.

Note: This processing option takes effect only when the Budget Total Method is set to 2.

11.1.4.12 Interop

These processing options enable you to enter interoperability information.

1. Purchase Order Before/ After Image Processing

Specify whether the system captures a record of a transaction before the transaction was changed or whether the system captures records of a transaction before and after a transaction was changed. Values are:

Blank: Capture a record of a transaction after the transaction was changed.

1: Capture two records; one record of the transaction before it was changed and one record after it was changed.

2. Purchase Order Transaction Type

Enter a transaction type for the export transaction.

If you leave this field blank, the system does not perform export processing.

3. Work Order Before/ After Image Processing

Specify whether the system writes the before image for the work order header. Values are:

Blank: The system does not include the image.

1: The system includes the image.

4. Work Order Transaction Type

Specify the default transaction type for the work order header that the system uses when processing export transactions. If you leave this field blank, the system does not perform export processing.

11.1.4.13 Order Revision

These processing options enable you to control revisions to orders.

1. Revision Tracking

Specify whether the system allows revisions to an order. Values are:

Blank: The system does not perform order revision tracking.

1: Allow revisions to existing orders only.

2: Allow both revisions to an existing order as well as the addition of new lines to the order.

2. Next Status

Specify the next status code at which the system begins tracking order revision audit information. The system does not record revisions to detail lines if the lines' statuses precede the status code that you enter in this processing option.

The system stores revision information in the F43199 table. You can access this table through the Order Revision Inquiry program (P4319).

3. Text Entry

Specify whether the system allows you to enter text when you are entering a revision. Values are:

Blank: Do not allow users to enter text when they are entering a revision.

1: Allow users to automatically enter text when entering a revision.

The system displays a text entry window when the order is accepted.

11.1.4.14 Self-Service

This processing option enables you to specify whether the system activates self-service functionality.

1. Supplier Self-Service

Specify whether to activate Supplier Self-Service for use in a Java/HTML environment. This functionality allows suppliers to view their orders online. Values are:

Blank: Do not activate Supplier Self-Service.

1: Activate Supplier Self-Service.

11.1.4.15 Matrix

This processing option enables you to specify the appearance of the Matrix Order form.

1. Inventory Parent

Specify whether the system displays the Matrix Order form when you are working with a matrix parent item. When you enter a matrix parent item on the order detail and the Matrix Order form is not displayed, the parent item will be treated as an inventory item instead of a matrix parent. Values are:

Blank: The system displays the Matrix Order form.

1: The system does not display the Matrix Order form.

11.1.4.16 Workflow

These processing options enable you to specify how the system processes workflow information.

1. Price Changes Notify

Specify the recipient of the email that the system automatically sends when the unit cost/lump sum changes on the order. Values are:

Blank: Do not send email.

1: Send email to purchase order originator.

2: Send email to project manager (MPM only).

3: Send email to buyer.

4: Send email to purchase order originator, project manager (MPM only), and buyer.

Note: Manufacturing Project Management (MPM) is now Oracle's JD Edwards EnterpriseOne Engineer to Order.

2. Planned Delivery Date Changes Notify

Specify the recipient of the email that the system automatically sends when the promised delivery date on the order changes. Values are:

Blank: Do not send email.

1: Send email to purchase order originator.

2: Send email to project manager (MPM only).

3: Send email to buyer.

4: Send email to purchase order originator, project manager (MPM only), and buyer.

Note: Manufacturing Project Management (MPM) is now JD Edwards EnterpriseOne Engineer to Order.

3. Quantity Changes Notify

Specify the recipient of the email that the system automatically sends when the quantity of the order changes. Values are:

Blank: Do not send email.

1: Send email to purchase order originator.

- 2: Send email to project manager (MPM only).
- 3: Send email to buyer.
- 4: Send email to purchase order originator, project manager (MPM only), and buyer.

Note: Manufacturing Project Management (MPM) is now JD Edwards EnterpriseOne Engineer to Order.

4. Order Hold Notify

Specify the recipient of the email that the system automatically sends when the order goes on hold. Values are:

Blank: Do not send email.

- 1: Send email to purchase order originator.
- 2: Send email to project manager (MPM only).
- 3: Send email to buyer.
- 4: Send email to purchase order originator, project manager (MPM only), and buyer.

Note: Manufacturing Project Management (MPM) is now JD Edwards EnterpriseOne Engineer to Order.

11.1.4.17 Transfer Order

These processing options enable you to specify how the system processes transfer orders.

1. Create Item Branch Record if one does not exist for the receiving B/P when Entering a Transfer Order

Specify whether the system creates an item branch record if one does not already exist in the receiving branch/plant.

2. Project Transfer Order Line Type

Specify the line type that the system uses for the purchase order that is created from a sales transfer order. Ensure that the line type has been defined with an inventory interface of C by accessing the Line Type Constants program (P40205). When the line type has an inventory interface of C, the system performs financial commitments for purchase orders that are associated with the Engineering Project Management system.

Note: The Engineering Project Management (EPM) system is now JD Edwards EnterpriseOne Engineer to Order.

11.1.5 Entering Orders for Multiple Suppliers

Access the Purchase Order Workbench form.

11.1.6 Selecting a Supplier for an Item

Access the Purchase Order Workbench form.

11.1.7 Entering Items Using Supplier Catalogs

Access the Work With Order Headers form.

11.1.8 Entering Items Using Order Templates

Access the Purchase Order Workbench form.

11.1.9 Creating Orders from Existing Detail Lines

Access the Order Detail form.

11.2 Working with Budgets

If you set up budgets for jobs, projects, departments, and so forth, you might want to verify that the purchase amounts you incur do not exceed these budgets. You can compare budget amounts to actual amounts you have spent and to the amounts that you are committed to spend in the future.

This section provides an overview of budget checking, lists a prerequisite, and discusses how to review a budget.

11.2.1 Understanding Budget Checking

You use budget checking to identify the detail line amounts that exceed the budget for a specific job, project, department, and so forth.

Note: To work with budgets, you must enter purchase order detail lines by account numbers.

Each time you enter or change a purchase order, the system checks the account number for each detail line and compares it to the available budget for the account. If the detail line amount exceeds the available budget amount, the system places the entire order on hold. You can set a budgeting processing option in the Purchase Orders program (P4310) to provide a warning message that a detail line amount exceeds the available budget amount, but the system will still place the order on hold. The system allows no further processing of the order until you remove the budget hold. You must set up budget hold codes for each business unit.

The system calculates available budget amounts by subtracting actual amounts (AA ledger) and committed amounts (PA Ledger) from the budget amount that you specify for an account number. The system uses this budget calculation:

Available Budget = Original Budget Changes – Actual amounts spent – Commitments – Encumbrances

The system uses this budget calculation for ledgers:

Available Budget = BA or JA Ledger Amounts – AA Ledger Amounts – PA Ledger Amounts

You use the processing options on the Budgeting tab from Order Entry to activate budget checking and to specify information such as:

- The budget ledger from which the system retrieves budget amounts.
- The hold code the system assigns to detail lines that exceed budget.
- The percentage by which a detail line can exceed budget before being put on hold.
- The method by which the system determines budget amounts.

Do not use the JA ledger type for budgeting. The system reserves this ledger type for JD Edwards EnterpriseOne Job Cost.

To further understand budget checking, review these topics:

- Search scenarios for level of detail.
- Budget totaling.
- Calculating available budget to date for the fiscal year.

See [Search Scenarios for Level of Detail](#).

See [Budget Totaling](#).

11.2.1.1 Search Scenarios for Level of Detail

When you create an account, you assign each account number a level of detail. The range for the level of detail is one through nine, with one being the highest and nine being the lowest.

You enter the level of detail in the processing option for the system to search for the available budget. This processing option also controls how the system accumulates the actual and committed and encumbered amounts for the account.

11.2.1.2 Budget Amount Accumulation (Release 9.1 Update)

The system does not roll up the budget if:

- The level of detail of account that you enter on the purchase order detail line is same as the level of detail entered in the processing option.
- The level of detail that you enter in the processing option does not exist in the chart of accounts.
- The level of detail that you enter in the processing option is lower than the level of detail in the purchase order account.

The system calculates the available budget on the account. If the detail line exceeds the available budget then the system applies a budget hold to the line.

The system rolls up the budget if the account number that you enter on the purchase order detail line does not have the same level of detail that you enter in the processing option, and the level of detail of the account is lower than the level of detail that you enter in the processing option.

The system determines the budget checking account based on the level of detail of purchase order account and the level of detail in the processing option. After determining the budget checking account, the system accumulates budgets from the child accounts that belong to the budget checking account, such that the level of detail of child accounts is lower than the level of detail entered in the processing option.

Note: The system accumulates the budget only when the Budget Accumulation Level of Detail processing option is set to 1.

11.2.1.3 Example: Calculating the Budget Checking Account (Release 9.1 Update)

To determine the budget checking account, the system considers the value in the level of detail account in the detail line, and the Level of Detail processing option value. The system then calculates the budget amount by accumulating the budget amounts of all the child accounts of the budget checking account. The following illustration is a graphic example of the budget checking account.

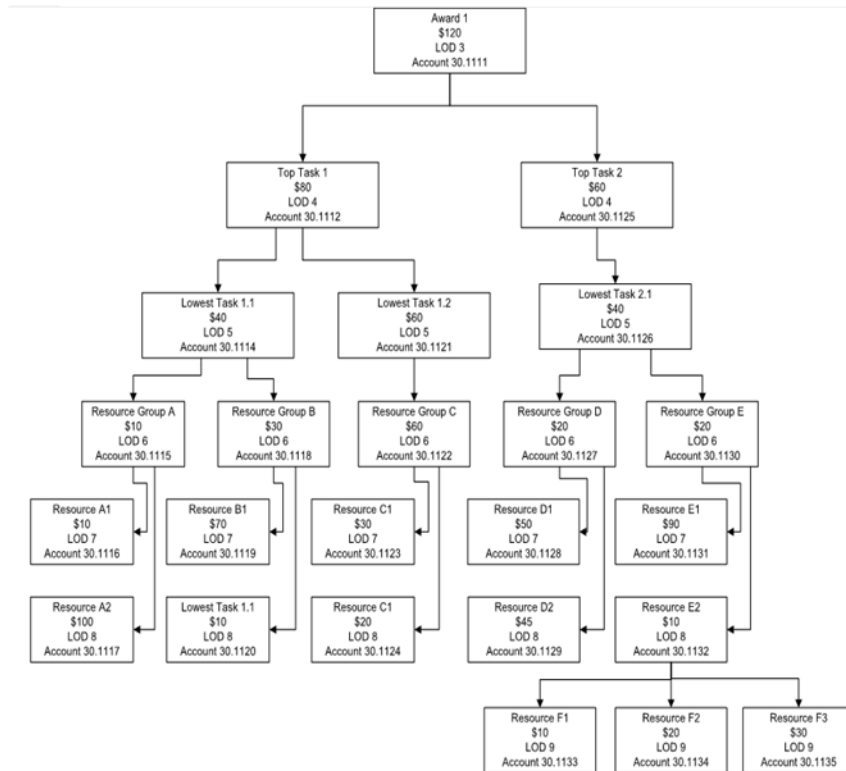
Figure 11–1 Example: Calculating Budget Checking Account

Assume that the budget account defined in the purchase order detail line is 30.1130, and the Level of Detail is 5 in the processing option. The budget checking account is determined as 30.1126. The following accounts are rolled-up:

- 30.1126
- 30.1127
- 30.1128
- 30.1129
- 30.1130
- 30.1131
- 30.1132
- 30.1133
- 30.1134
- 30.1135

11.2.1.4 Actual and Committed Amount Accumulation (Release 9.1 Update)

If you set the budget accumulation processing option to accumulate, then the system accumulates budgets from the accounts that have a lower level of detail than the level of detail that you enter in the processing option.

To accumulate the actual and committed amounts for the account, the system considers the budget entry for a period. The budget amount is considered for the period it is created. However, the actual and committed amounts are considered throughout the financial year.

The system calculates the total committed amount from the current purchase order amount plus the actual retrieved amount plus the committed amount. The calculation is as follows:

$$\text{Total commitment} = (\text{BA}) + (\text{PA} + \text{AA})$$

where, PA= Committed amount

AA= Actual retrieved amount

BA= Current purchase order amount

If the total budget amount is less than or equal to the actual and committed amount, the system displays a warning message that the account is over budget.

If the total budget amount is less than the actual and committed amount, plus the current purchase order amount, the system displays a warning message that the detail line amount is exceeding the budget.

For example, the following illustration shows that the budget entry for the first period is USD 275. The budget entry for the fifth period is USD 4. Therefore, the total budget available for the financial year is 275+4=USD 279.

Note that the committed value is defined for the third and eighth period of the financial year.

Figure 11–2 Example: Actual and Committed Amount

Periods	1	2	3	4	5	6	7	8	9	10	11	12	13	14
BA	275				4									
PA			6					7						
AA														

Scenario 1: If you want to create a purchase order for the fourth period, you can create the purchase order for 275-13=USD 262.

The available budget amount until the fourth period is only USD 275, and the total commitment available throughout the annual period is 13. Therefore, you can create a purchase order for USD 262. If the amount exceeds USD 262, the system displays an over budget warning message.

Scenario 2: If you want to create a purchase order for the sixth period, you can create the purchase order for 279-13=USD 266.

The available budget amount until the sixth period is only 275+4=USD 279, and the total commitment available throughout the annual period is 13. Therefore, you can create a purchase order for USD 266. If the amount exceeds USD 266, the system displays an over budget warning message.

11.2.1.5 Budget Totaling

Use the Budget Total Method processing option of Purchase Order Workbench to specify how the system calculates the budget total.

The system uses these fields in the F0902 table for budgeting:

- BORG - the original or beginning budget.
- AN01 through AN12 - the net posting fields which contain changes in the current year.
- AYPC - the balance forward field contains a sum of the prior year's changes, which the system rolls into the current year.

Enter **1** in this processing option for job cost accounting. The system adds the amounts in the fields. The total of these fields is the budget amount the system uses for budget checking.

Note: The original budget cannot be spread when you enter a **1** in this processing option.

Enter **2** in this processing option for Public Sector and Not-For-Profit entities. Use this method when the system spreads an original budget to the net posting fields. The system calculates the total budget from the net posting fields to use in budget checking.

Enter **3** in this processing option for Profit entities. You enter changes to the budget in the net posting fields. The system adds the net posting fields and the original budget to determine the budget amount to use in budget checking. Use this method when an original budget is not spread to the net posting fields.

11.2.1.6 Budget Review

You might want to compare the amounts you have budgeted for goods and services to the amounts that you have actually spent and to the amounts you are committed to spend in the future. For each account you can review:

- The budget amount.
- The actual amount you have spent.
- The total amount of commitments through a certain date.
- The variance between the budget amount and the amount you have spent or are committed to spend in the future.
- The transactions that have affected a certain account and the journal entries that relate to a particular transaction.

See Also:

- “Setting Processing Options for Trial Balance, Ledger Comparison (P09210A)” in the *JD Edwards EnterpriseOne Applications General Accounting Implementation Guide*.

11.2.2 Prerequisite

To work with budgets, ensure that commitments are set up and processed.

See [Setting Up Commitment Tracking](#).

See [Processing Purchase Order Commitments](#).

11.2.3 Form Used to Work with Budgets

Form Name	Form ID	Navigation	Usage
Trial Balance/Ledger Comparison	W09210AA	Purchasing Inquiries (G43B112), Budget Comparison Purchasing Inquiries (G43C112), Budget Comparison	Work with budgets.

11.2.4 Reviewing a Budget

Access the Trial Balance/Ledger Comparison form.

Ledger Type 1

Enter a value from UDC 09/LT that specifies the type of ledger, such as AA (Actual Amounts), BA (Budget Amount), or AU (Actual Units). You can set up multiple, concurrent accounting ledgers within the general ledger to establish an audit trail for all transactions.

LT 1 Thru Date (ledger type 1 through date)

Enter a date that identifies the financial period to which the transaction will be posted. You define financial periods for a date pattern code that you assign to the company record. The system compares the date that you enter on the transaction to the fiscal date pattern assigned to the company to retrieve the appropriate fiscal period number, as well as to perform date validations.

Level Of Detail

Enter a number used to summarize and classify accounts in the general ledger by level of detail. Level 9 is the most detailed and Level 1 is the least detailed. Levels 1 and 2 are reserved for company and business unit totals. Levels 8 and 9 are reserved for job cost posting accounts in the JD Edwards EnterpriseOne Job Cost system. Examples of the other levels are:

- 3: Assets, Liabilities, Revenues, Expenses.
- 4: Current Assets, Fixed Assets, Current Liabilities, and so on.
- 5: Cash, Accounts Receivable, Inventories, Salaries, and so on.
- 6: Petty Cash, Cash in Banks, Trade Accounts Receivable, and so on.
- 7: Petty Cash - Dallas, Petty Cash - Houston, and so on.
- 8: More Detail.
- 9: More Detail.

Do not skip levels of detail when you assign a level of detail to an account. Nonsequential levels of detail cause rollup errors in financial reports.

Variance Period Balance

Enter a number that identifies the amount that the system will add to the account balance of the associated account number. Enter credits with a minus sign (-) either before or after the amount.

Ledger 1 Period Balance

Enter a number that identifies the amount that the system will add to the account balance of the associated account number. Enter credits with a minus sign (-) either before or after the amount.

11.3 Working with Orders on Hold

This section provides an overview of orders on hold, lists a prerequisite, and discusses how to:

- Enter order holds.
- Set processing options for Held Order Release (P43070).
- Release order holds.

11.3.1 Understanding Orders on Hold

You can place an order on hold to prevent it from being processed. You might place an order on hold for reasons such as:

- You have yet to settle prices and terms with the supplier.
- You are not sure if you want to use the supplier.
- The supplier's minimum order amount is not being met.
- The order exceeds the budget.

You cannot print or receive orders on hold. You must release the hold to continue processing the order. To release an order on hold, you must have the correct password.

When you place an order on hold, you prevent it from being processed. You might want to put an order on hold if you have yet to reach price negotiations with the supplier or if the order exceeds budget.

Two types of order holds are available: budget holds and regular holds. Budget holds are for orders that exceed the budget. Regular holds are for all other holds.

11.3.2 Prerequisite

Set up hold codes and assign a responsible individual to each hold code.

11.3.3 Form Used to Work with Orders on Hold

Form Name	Form ID	Navigation	Usage
Work With Held Orders	W43070A	Order Generation/Approve/Release (G43A13), Release Held Orders	Work with held orders.
		Order Generation/Approve/Release (G43B13), Release Held Orders (Budget)	
		Order Generation/Approve/Release (G43D13), Release Held Orders	

11.3.4 Entering Order Holds

You can put an order on hold in one of three ways:

- Assign a hold code to the order on the order entry form.
- Assign a hold code to a supplier on purchasing instructions so that each time you enter an order for the supplier the system assigns the hold code to the order.
- Specify a budget hold code in the processing options for the Enter Orders program.

If budget checking is activated, the system assigns the hold code to orders when detail lines exceed budget.

11.3.5 Setting Processing Options for Held Order Release (P43070)

Processing options enable you to specify the default processing for programs and reports.

11.3.5.1 Defaults

These processing options enable you to enter default information that the system uses for held order release processing.

1. Order Type

Enter a value from UDC 00/DT that identifies the type of document. This code also indicates the origin of the transaction. JD Edwards EnterpriseOne has reserved document type codes for vouchers, invoices, receipts, and time sheets, which create automatic offset entries during the post program. (These entries are not self-balancing when you originally enter them.) These document types are defined by JD Edwards EnterpriseOne and should not be changed:

P: Accounts Payable documents.

R: Accounts Receivable documents.

T: Payroll documents.

I: Inventory documents.

O: Purchase Order Processing documents.

J: General Accounting/Joint Interest Billing documents.

S: Sales Order Processing documents.

2. Release Code

Enter a value to specify the release code at the time the held order was released.

11.3.5.2 Display

These processing options enable you to control the types of information that the system displays.

1. Enter a '1' to display SO's, else display PO's

Enter a value to specify the type of order to display. Values are:

Blank: Display purchase orders.

1: Display sales orders.

2. Enter 'Y' to display previously released orders

Enter a value to display previously released orders. Values are:

Y: Display previously released orders.

11.3.5.3 Versions

These processing options control which version the system uses when you call other programs from the Held Order Release program. You can define different versions in accordance with the business processes.

1. Sales Order Entry (P4210)

Specify the version of Sales Order Entry. If this processing option is left blank, the ZJDE0001 version will be used.

2. Purchase Order Entry (P4310)

Specify the version of Purchase Order Entry. If this processing option is left blank, the ZJDE0001 version will be used.

3. Print Pick Slip (R42520)

Specify the version of Print Pick Slip. If this processing option is left blank, the ZJDE0001 version will be used.

4. Ship and Debit (R45100)

Specify the version of Ship and Debit. If this processing option is left blank, the ZJDE0001 version will be used.

5. Manufacturing Work Order (P48013) (Applicable to Release of Sales Orders only)

Specify the version of Manufacturing Work Order. If this processing option is left blank, the ZJDE0001 version will be used.

11.3.5.4 Process

These processing options enable you to control how the system processes information.

1. Automatic printing of Pick Slip

Enter a value to specify the printing of pick slips. Values are:

Blank: Do not print pick slips.

1: Print pick slips.

2. Enter the release status code of the work order

Enter a value from UDC 00/SS that describes the status of a work order, rate schedule, or engineering change order. Any status change from 90 through 99 triggers the system to automatically update the completion date.

3. Ship and Debit Processing

Specify whether the system uses subsystem processing or batch processing (R45100) to identify and adjust ship and debit agreements when you run the Release Held Orders program. Values are:

Blank: Do not use subsystem processing or batch processing.

1: Use subsystem processing.

2: Use batch processing.

4. Parent or Ship To Credit Hold Release Processing (Sales Only)

Specify if the system allows users to inquire-and-release credit hold sales orders by parent or ship to address numbers (sales only). Values are:

Blank: Do not allow inquire-and-release by parent or ship to address.

1: Allow inquire-and-release by parent or ship to address.

11.3.5.5 Warehouse

These processing options enable you to enter warehouse information.

1. Enter the request processing mode

Indicates whether a controlled update record has been processed as requested, updated, or rejected. Values are:

Blank: The record has been requested for approval.

0: The record requested for approval has been rejected.

1: The record requested for approval has been updated to the master file.

2. If processing pick requests using the subsystem, enter the version

Enter the version the system will use.

3. Override next status for sales order lines for which requests have been generated

Specify a value.

11.3.5.6 Prepayment

These processing options enable you to enter prepayment information.

1. Release Authorization Hold and Advance Prepayment Status.

Specify whether the system releases the authorization hold and advances the status. The system can release the authorization hold only if authorization has been received.

2. Release Settlement Hold and Advance Prepayment Status.

Specify whether the system releases the settlement hold and advances the status. The system releases the settlement hold only when settlement has been received.

11.3.6 Releasing Order Holds

Access the Work With Held Orders form.

To have the system process an order that is on hold, you must release the hold. You can review all holds on a specific order and select the holds that you want to release.

For budget holds, you can review the budget before releasing budget hold orders by accessing Trial Balance/Ledger Comparison from the Release Held Orders (Budget) program. Note that you cannot use Release Held Orders (Budget) to release an order on budget hold if the order is assigned an approval route. In that case, you must use the Approval Review program to approve and release the order.

11.4 Working with Log Information

This section provides an overview of log information, lists prerequisites, and discusses how to:

- Set processing options for Logs Entry (P4305).
- Enter log information.
- Run the log report/update.
- Set processing options for Log Report/Update (R43300).
- Copy information from a model log.

11.4.1 Understanding Log Information

Log information is supplemental to the information contained in an order. It includes details such as submittals and transmittals. A submittal is information that you need to receive from a subcontractor or supplier, for example, proof of insurance and licensing. A transmittal is information that you need to send to a subcontractor or supplier, such as permission to proceed. Logs can also include information relevant to the order such as meeting dates, notes, and so forth.

Checks and balances are put in place during the progress payment function to enforce compliance with the logs. You can assign dates to log information so that the system issues an outstanding submittal warning when you try to make payments before you

receive all of the submittals. For example, if you require a subcontractor or supplier to submit insurance information to you before you make a payment against the order, you can specify for outstanding submittal warnings. The system then warns you if you try to make a payment before you receive the information. Thus, a hold code is placed on the payment until the requirement is satisfied.

You can enter new log information into a contract, or you can copy log information into an order from a model log. A model log is a set of standard log information that you can copy into the contracts and then modify for each contract. The copy feature saves you time when you have log information that is duplicated across many orders.

Log information is typically specific to the vendor and not on a contract-by-contract basis. However, bonding can be at a job or contract level. Logs can be entered and modified at multiple hierarchical levels. Log details can be added at an individual contract level or at global levels, such as company, subcontractor, project, or job. These individual levels can then be activated or deactivated based on the business process.

You can enter logs from contract entry at any time during the project. The logs and hierarchies are maintained in the Log Master table (F4305).

You can view log details through multiple online views and reports. You can search and view all levels of a hierarchical log with the Logs Entry program (P4305) by setting the processing options to specify the contract type and log view options. You can use the Log Hierarchy Constants program (P4304) to review outstanding logs.

The F4305 Logs Report program (R43050) prints logs at different hierarchies for you to review. The Logs (F4305) Report/Update program (R43540) allows you to specify whether you want to print and review associated text and contract management reports when running the report. You can also specify whether the system changes the log status code. You can also use the Order Detail Print report (R4401P) to print contract details for the logs at either all hierarchical levels or at just the contract level.

See "JD Edwards EnterpriseOne Subcontract Management Reports" in the *JD Edwards EnterpriseOne Applications Subcontract Management Implementation Guide*.

If you are currently using the Log Master Revisions program (P4303) for single-level logs at the contract level, data is stored in the Log Master table (F4303). You can run conversion programs and use the hierarchal logs feature.

Note: You can use either the Log Master Revisions program (P4303) or the Logs Entry program (P4305) to create and maintain log information. You cannot use both log programs in the system. Purchase Order Entry and Voucher Match read UDC 40/VF and call the Log Master Revisions or Logs Entry program based on the setting in the UDC.

11.4.2 Prerequisites

Before you can use hierarchical logs, you must:

- Set up log hierarchy levels in UDC 43/LL.
- Activate log hierarchy levels in the Log Hierarchy Constants program (P4304).
- Activate log functionality in UDC 40/VF.
- Set up log view options in UDC 43/VO.

See [Setting Up Hierarchical Logs](#).

11.4.3 Forms Used to Work with Log Information

Form Name	Form ID	Navigation	Usage
Work With Order Headers	W4310I	Purchase Order Processing (G43A11), Enter Purchase Orders	Work with order headers. Note: The Order Header form appears only if the Header Display processing option on the Processing tab of the Enter Purchase Orders program is set to display the header form first.
Work With Order Details	W4310G	Purchasing Inquiries (G43A112), Open Orders	Work with order details.
Work With Logs	W4305A	Select an order on the Work With Order Headers form, and then select Log Details from the Row menu.	Enter log information. Review log details.
Work with Model Logs	W4303B	Purchase Order Processing (G43A11), Order Log Revisions Enter an order on the Log Details form, and select Model Log from the Form menu. Subcontract Processing (G43D11), Order Log Revisions Enter an order on the Log Details form, and select Model Log from the Form menu.	Copy log information from a model log. Access model logs, which contain standard log information that you can copy into the orders. Note that before you use the Work with Model Logs form, you must create model log information.

11.4.4 Setting Processing Options for Logs Entry (P4305)

Processing options enable you to specify the default processing for programs and reports.

11.4.4.1 Default

1. Contract Type

Specify the type of contract.

Certain document type codes are reserved for vouchers, invoices, receipts and time sheets, which create automatic offset entries during the post program.

Enter a value already set up in UDC 00/DT.

2. Log View Option

Specify the default for the Log View option.

Enter a value already set up in UDC 43/VO.

11.4.4.2 Versions

Specify which version of the Voucher Match program (P4314) the system uses.

1. Progress Payments (P4314)

Specify the version of Progress Payments (P4314) that the system uses to determine how to display open and outstanding logs.

11.4.5 Entering Log Information

Access the Work With Logs form.

Enter log information to identify information that is relevant to an order. The system provides you with multiple detail lines in which you can enter log information. After you enter log information, you can enter descriptive text for each line item within the log. You can also delete any of the log information for a contract.

Status Code

Enter a code that specifies whether the requirements for the log line were satisfied. Values are:

Blank: The requirements were not satisfied, the log line is not active, or no status is required.

Y: The requirements were satisfied.

N: The requirements were not satisfied.

Pay Effect

Enter a code that indicates whether the submittal requirement is of such importance that regular payments to the subcontractor can be suspended if the submittal requirement is not properly satisfied. This code is normally used with submittal log entries. Values are:

Y: Issue warning messages if log requirements are not met.

N: Do not issue warning messages.

If Pay Effect is set to **Y**, various warning messages can appear during progress payment entry when outstanding log requirements exist.

The outstanding log warning is set up in the Pay Effect field. For an outstanding log warning to occur, the status of the log must be **N**, the Pay Effect field must be set to **Y**, and the required and expired dates must be earlier than the system date. The system also checks for all log types in the Outstanding Log Types UDC (43/OL).

11.4.6 Running the Log Report/Update

Select Subcontract Reports (G43D111), Log Report/Update.

You can run the Log Report/Update to update the value of the Pay Effect field in the F4303 table. The report displays this information:

- Log items and text that relate to a contract.
- Submittal and transmittal status information.

When you run the report, you can specify whether to update the status of expired logs to not complete, which creates an outstanding submittal warning. You can review the information on the report to determine whether to post payments against contracts that have expired logs.

11.4.7 Setting Processing Options for Log Report/Update (R43300)

Processing options enable you to specify the default processing for programs and reports.

11.4.7.1 Print Options

Change Log Status

Specify whether you want the system to change unsatisfied, expired logs that have a Pay Effect of Y to a Status of N. Values are:

Blank: Do not update the status of the logs.

1: Change unsatisfied, expired logs with a Pay Effect of Y to a Status of N.

Print Contract Management Report

Specify whether the system prints a contract management report. If left blank, no report will print. Values are:

Blank: Do not print.

1: Print.

Print Associated Log Text

Specify whether the system prints associated log text. Values are:

Blank: Do not print.

1: Print.

11.4.8 Copying Information from a Model Log

Access the Work with Model Logs form.

Note: You can use both the Log Master Revisions program (P4303) and the Logs Entry program (P4305) with model logs.

11.5 Printing Orders by Batch

This section provides an overview of batch printing and discusses how to:

- Print by batch.
- Set processing options for Purchase Order Print (R43500).
- Set processing options for Purchase Order Print Output (R43501).

11.5.1 Understanding Batch Printing

After you enter orders, you can print them to review the orders and then send them to the appropriate suppliers. The system prints the orders in the language that is specified for the supplier in the supplier master table.

You can also print orders to a work file, which enables you to customize the report. Before you customize a report, you must retrieve the appropriate address information and attachments or notes. The Purchase Order Print Output program (R43501) is a starting point for the customized report. You can either use it as an example of how to write the custom report in JD Edwards EnterpriseOne system 55 or you can modify R43501 to fit your requirements. The Purchase Order Print program (R43500) calls the R43501 program via the processing options.

You cannot print orders that are on hold or any order line with a Last Status Code of **980** (canceled in entry). Orders with all other statuses print from P4310 unless designated in the R43500 data selection criteria.

You can print orders by batch so you can review the orders and then send them to the appropriate suppliers.

Use the processing options to specify which information prints on orders. You can have the system print:

- Taxes.
- Open item information only.
- Supplier item numbers.
- Foreign and domestic currencies.
- Exchange rates (for foreign currency users).
- Messages.
- Supplier classification codes.
- Additional properties.
- Category codes.
- Service units.

If you selected to use service units, the system prints the Service Quantity and Service UoM fields instead of the Quantity Ordered and Tr. UoM fields. The system prints service unit information for both purchase order and multiple account distribution lines.

The system can automatically print adjustments on the report if you set the Price Picklist field to print prices and adjustments when you define the purchasing instructions.

Note: If you have selected the Project and Gov Contract Accounting Used option in the Service Billing Constants program (P48091), then the system prints contract-related fields on the subcontract orders.

See "Printing Contract-Related Fields for Government Contracts on Subcontract Orders" in the *JD Edwards EnterpriseOne Applications Project and Government Contract Accounting Implementation Guide*.

11.5.1.1 Supplier Classification Codes

The classification code field values are stored in the Purchase Order Header table (F4301) and may be added to the purchase order report. To print the supplier classification codes on the report, set the Vendor Type Classification processing option on the Report Display tab of the R43500 program. The classification codes print in a separate section after the header section is printed.

You can also print the classification codes on the report generated by the Purchase Order Print Output program (R43501).

See "Understanding Subcontract Orders, Supplier Classification Codes" in the *JD Edwards EnterpriseOne Applications Subcontract Management Implementation Guide*.

11.5.1.2 Additional Properties and Category Codes

The user-defined field values are stored in the Purchase Order Header table (F4301) and may be added to the purchase order report. To print the additional properties and category codes on the report, set the Additional Properties Display and Category Code Display processing options on the Report Display tab of the R43500 program. The user-defined field values are printed after the order header information.

The detail lines of a purchase order may contain user-defined values for four category code fields. These field values print with the detail line information.

You can also print the additional properties and category codes on the report generated by the Purchase Order Print Output program (R43501).

See "Understanding Subcontract Orders, Additional Properties and Category Codes" in the *JD Edwards EnterpriseOne Applications Subcontract Management Implementation Guide*.

11.5.1.3 Purchase Order Clauses

The purchase order clauses are stored in the Purchase Order Clauses table (F4320) and may be added to the purchase order report. To print the purchase order clauses on the report, set the Purchase Order Clauses processing option on the Report Display tab of the R43500 program. The clauses section prints after the properties section.

You can also print the purchase order clauses on the report generated by the Purchase Order Print Output program (R43501).

See "Understanding Subcontract Orders, Subcontract Order Clauses" in the *JD Edwards EnterpriseOne Applications Subcontract Management Implementation Guide*.

11.5.1.4 Record Reservation (Release 9.1 Update)

The JD Edwards EnterpriseOne software provides record reservation capability within the Purchase Order Print program (R43500). Record reservation helps to ensure the integrity of the data and prevent data loss. While printing a purchase order using the R43500 program, you can enable the system to update the next status of the order in addition to other details. To avoid simultaneous updating of the same records, the system reserves (locks) records so that they cannot be updated by any other program. Thus, the system does not allow you to edit a record that has been locked by a different user or application.

When a program that uses record reservation is interrupted, orphaned reservation records might remain in the Business Object Reservation table (F00095). This can occur, for example, when technicians are working with a server, or when a workstation shuts down without warning. If an interruption stops one of the programs in the Purchase Order Print program before it releases the reservations that it creates, you cannot update the records until the orphaned reservations are removed.

You can use the Remove Business Object Reservation program (P00095) to release unwanted record reservations. This program stores reservation information in the Business Object Reservation table (F00095).

11.5.2 Printing by Batch

Select Purchase Order Processing (G43A11), Print Purchase Orders.

11.5.3 Setting Processing Options for Purchase Order Print (R43500)

Processing options enable you to specify the default processing for programs and reports.

11.5.3.1 Status Codes

These processing options enable you to specify the range of status codes that you want the system to update when you print purchase orders, and whether you want the system to update the status codes.

1. Next Status Code From (optional)

Specify the start of the status code range that you want the system to update. You must use a UDC (40/AT) that has been set up on the Order Activity Rules form for the order type and line type that you are using.

2. Next Status Code Thru (required)

Specify the end of the status code range that you want the system to update. You must use a UDC (40/AT) that has been set up on the Order Activity Rules form for the order type and line type that you are using.

3. Next Status Code Override (optional)

Specify the next status code that you want the system to update. The override status is another allowed step in updating status codes. You must enter a UDC (40/AT) that has been set up on the Order Activity Rules form for the order type and line type that you are using.

4. Status Update

Specify whether the system updates the status on an order. Status codes are UDCs (40/AT) that you set up on the Order Activity Rules form for the order type and line type that you are using. Values are:

Blank: Update to the next status.

1: Do not update to the next status.

2: Update next status of all lines, but only print lines that have been changed. If no lines have been changed, then all lines will print.

11.5.3.2 Tax Information

This processing option enables you to specify the tax information that the system includes when printing a purchase order.

1. Print Tax

Specify the tax information that the system includes when printing a purchase order. Values are:

1: Tax information prints by group.

2: Tax information prints by area.

3: Tax information prints by authority.

2. Tax Rate/Area passed to Vertex

Specify where the system locates Tax Rate/Area information to use during vertex calculations.

Blank: The system uses the Tax Rate/Area of the Supplier.

1: The system uses the Tax Rate/Area of the Ship To.

This processing option is used when vertex is on.

Note: The Default Tax Rate/Area processing option on the Defaults tab of the Purchase Orders program should have the same value as this processing option while creating purchase orders.

11.5.3.3 Report Display

These processing options enable you to select the information that the system includes in the report, such as quantities and amounts, exchange rates, global messages, and notes.

1. Quantity & Amount Display

Specify whether the system prints the original quantity and amount or the open quantity and amount. Values are:

Blank: Print original quantity and amount.

1: Print open quantity and amount.

2. Exchange Rate Display

Specify whether the system prints the exchange rate. Values are:

Blank: Do not print the exchange rate.

1: Print the exchange rate.

3. Global Message to be printed

Specify the text messages that you want the system to print on each order. Examples of text messages are engineering specifications, hours of operation during holiday periods, and special delivery instructions.

Text messages are UDCs that are set up in 40/PM.

4. Purchase Order Note Display

Specify whether the system prints the purchase order note. Examples of notes are the name of the individual who placed the order, the buyer responsible for procuring the items and services on the order, the company responsible for delivering the order, confirmation numbers and job numbers. Values are:

Blank: Do not print the purchase order note.

1: Print the purchase order note.

5. Report Heading Display

Specify whether to suppress the printing of the report title and company name when you use preprinted forms. Values are:

Blank: Print the default report title and company name.

1: Do not print the report title and company name.

6. Purchasing Agent Name Display

Specify whether the system prints the purchasing agent on the purchase order. Values are:

Blank: Do not print the purchasing agent name on the purchase order.

1: Print the purchasing agent name on the purchase order.

7. Additional Properties Display

Specify whether the system prints the user-defined field values from the Additional Properties tab. Values are:

Blank: Do not print the additional properties.

1: Print the additional properties.

8. Category Code Display

Specify whether the system prints the user-defined field values from the Category Codes tab. Values are:

Blank: Do not print the category codes.

1: Print the category codes.

9. Purchase Order Clauses

Specify whether the system prints purchase order clauses. Values are:

Blank: Do not print purchase order clauses.

1: Print purchase order clauses.

10. Vendor Type Classification

Specify whether the system prints the vendor type classification. These are the supplier classification codes from the JD Edwards EnterpriseOne Address Book system that appear on the purchase order and voucher. Values are:

Blank: Do not print the vendor type classification.

1: Print the vendor type classification.

11.5.3.4 Item Number Display

These processing options enable you to specify how the system displays item numbers.

1. Item No. Display

Specify whether the system prints either The item number only or both The item number and the supplier's item number. Values are:

1: Print only the item number.

2: Print both the item number and the supplier's item number.

2. Enter Cross Reference Type

Specify the type of cross-reference that the system uses when printing a supplier's item number. The system stores the cross-reference information in the F4013 table.

Cross-reference information is UDCs that are set up in 41/DT.

11.5.3.5 Order Revision

These processing options enable you to specify both the order revisions that the system prints and which order lines appear.

1. To print Order Revision

Specify whether the system prints a specific order revision, the entire purchase order, or the latest order revision. To print a specific order revision, enter the order revision number. Other values are:

Blank: Print the entire purchase order.

*: Print the latest order revision.

2. Lines for a Revision

Specify whether the system prints only revised order lines or all order lines. Values are:

Blank: Print only revised lines for a revision.

1: Print all lines on the order for a revision.

11.5.3.6 Currency

This processing option enables you to specify whether the system prints amounts in domestic or foreign currency.

1. Amount Display

Specify whether the system prints amounts in domestic or foreign currency. Values are:

Blank: Print amounts in domestic currency.

1: Print amounts in foreign currency.

11.5.3.7 EDI

These processing options enable you to specify which Electronic Data Interchange (EDI) information the system displays.

1. EDI Processing Selection

Specify whether the system prints a purchase order or uses EDI processing or both. Values are:

Blank: Print purchase order only.

1: Print purchase order and create output to EDI.

2: Use EDI processing only.

2. EDI Transaction

Specify whether the system enters the EDI transaction as a purchase order or a quote order. Values are:

1: Enter the EDI transaction as a purchase order.

2: Enter the EDI transaction as a quote order.

3. EDI Document Type

Specify the EDI document type that the system creates in an EDI transaction.

In a non-EDI environment, the document type would be consistent with the order type (DCTO) assigned at order entry time, an invoice document type, a voucher document type, and so on.

4. EDI Transaction Set Number

Specify how the system categorizes the type of EDI transaction.

5. EDI Transaction Format

Specify a specific mapping structure used to process both inbound and outbound EDI transactions. This option does not apply to non-EDI transactions.

6. Trading Partner ID (trading partner identification)

Specify the party with whom you are trading documents in this EDI transaction.

7. Transaction Set Purpose

Specify the purpose of the transaction set.

Transaction set purpose codes are UDCs that you set up in 47/PU when you send and receive EDI documents. The system uses the action code each time the Transaction Set Purpose field appears in a table.

8. EDI Shipping Schedule Message

Specify whether the system creates an EDI shipping schedule message. Values are:

Blank: Do not create an EDI shipping schedule message.

1: Create an EDI shipping schedule message.

9. Shipping Schedule Qualifier

Specify a shipping schedule qualifier. Shipping schedule qualifier codes identify the type of date used when defining a shipping or delivery time in a schedule or forecast. You can enter a valid qualifier value or leave the option blank. Values are:

Blank: The system uses Kanban.

AB: Authorized delivery-based.

AS: Authorized shipment-based.

BB: Production-based.

DL: Delivery-based.

JS: Buyer production sequence schedule.

KB: Kanban signal.

PD: Planned delivery.

PS: Planned shipment.

SH: Shipment-based.

ZZ: Mutually defined.

11.5.3.8 Versions

These processing options enable you to customize the printed purchase orders.

1. Print Option

Specify whether the system routes the purchase order information to a work file and launches a second UBE to read the work file, and prints the purchase order. For example, use this option when you need to customize the layout of the Purchase Order Print program.

The Print Purchase Orders program (R43500) processes the orders and performs the necessary logic (such as calculating taxes). Values are:

Blank: Launch the Purchase Order Print program (R43500).

1: Launch a secondary UBE.

If you leave this option blank, the system will not route the purchase order information to a work file and will not launch a second UBE.

2. Name of 2nd UBE

Works with the Print Option processing option. Specify the name of the second UBE program to be launched. If you leave this option blank, the system launches the default Purchase Order Print program (R43501).

3. Second UBE Version

Define the version that the system uses when you use the Purchase Order Print program (R43501). Enter a valid version or leave this option blank. If you leave this option blank, the system uses the ZJDE0001 version.

When you select a version, review the version's processing options to ensure that the version meets the needs.

If you set the Print Option processing option to **1** and leave the Name of 2nd UBE processing option blank, the system uses the default Purchase Order Print program (R43501).

11.5.3.9 Project and Gov Contracting

This processing option enables you to specify whether the system prints flow down clause messages.

1. Flow Down Clauses Message to be printed

Specify the print message for a project and government contract with flow down clauses that you want the system to print on each order.

Text messages are UDCs that are set up in UDC 40/PM.

11.5.4 Setting Processing Options for Purchase Order Print Output (R43501)

Processing options enable you to specify the default processing for programs and reports.

11.5.4.1 Report Display

These processing options enable you to select the information that the system includes in the report, such as exchange rates, global messages, and notes.

1. Enter a '1' to print the Exchange Rate

Specify whether the system prints the exchange rate. Values are:

Blank: Do not print the exchange rate.

1: Print the exchange rate.

2. Enter the Global Print Message to print on each order

Specify the text messages that you want the system to print on each order. Examples of text messages are engineering specifications, hours of operation during holiday periods, and special delivery instructions.

Text messages are UDCs that are set up in 40/PM.

3. Enter a '1' to print Purchase Order Note

Specify whether the system prints the purchase order note. Examples of notes are the name of the individual who placed the order, the buyer responsible for procuring the items and services on the order, the company responsible for delivering the order, confirmation numbers and job numbers. Values are:

Blank: Do not print the purchase order note.

1: Print the purchase order note.

4. Enter a '1' to suppress the report title and company name from printing

Specify whether to suppress the printing of the report title and company name when you use preprinted forms. Values are:

Blank: Print the default report title and company name.

1: Do not print the report title and company name.

5. Enter a '1' to print the Purchasing Agent on the Purchase Order

Specify whether the system prints the purchasing agent on the purchase order. Values are:

Blank: Do not print the purchasing agent name on the purchase order.

1: Print the purchasing agent name on the purchase order.

6. Flow Down Clauses Message to be printed

Specify the print message for a project and government contract with flow down clauses that you want the system to print on each order.

Text messages are UDCs that are set up in 40/PM.

7. Additional Properties Display

Specify whether the system prints the user-defined field values from the Additional Properties tab. Values are:

Blank: Do not print the additional properties.

1: Print the additional properties.

8. Category Code Display

Specify whether the system prints the user-defined field values from the Category Codes tab. Values are:

Blank: Do not print the category codes.

1: Print the category codes.

9. Purchase Order Clauses

Specify whether the system prints purchase order clauses. Values are:

Blank: Do not print purchase order clauses.

1: Print purchase order clauses.

10. Vendor Type Classification

Specify whether the system prints the vendor type classification. These are the supplier classification codes from the JD Edwards EnterpriseOne Address Book system that appear on the purchase order and voucher. Values are:

Blank: Do not print the vendor type classification.

1: Print the vendor type classification.

11.6 Printing Orders Individually

This section provides an overview of individual order printing and discusses how to print on demand interactively.

11.6.1 Understanding Individual Order Printing

You can print orders individually so you can review them before sending them to the appropriate suppliers. If you have set the processing options in Order Entry for the system to store purchase order information for Electronic Data Interchange (EDI), you can send the orders to the suppliers using the JD Edwards EnterpriseOne Electronic Data Interchange system.

You can have the system print three types of messages on an order:

- Print messages
- Attachments
- Global messages

You create print messages using the Purchase Orders program (P4310). After you create a print message, you can assign it to an order or detail line during order entry.

You use processing options in Order Entry to specify whether attachments print. You can assign an attachment to an order or to detail lines during order entry.

You also use processing options to specify whether global messages print. Global messages always print at the top of orders.

Printing orders is usually a step in the sequence of processing orders. You set up these steps in Order Activity Rules. Once you print an order, you can have the system move the order to the next step in the process, or you can leave the order where it is so that you can print it again. You use processing options in Order Entry to specify whether the system updates status codes for orders after they print.

You might want to print orders twice, once to review the orders and again to update status codes. You can access these two versions of the print program through the processing options for Order Entry:

- Print Purchase Orders
- Reprint Purchase Orders

You might want to use one version to review orders and the other to update status codes for orders.

If you print an order that is on hold, the system prints a blank page.

11.6.2 Forms Used to Print Orders Individually

Form Name	Form ID	Navigation	Usage
Work With Order Headers	W4310I	Purchase Order Processing (G43A11), Enter Purchase Orders	Work with order headers.
Order Detail	W4310A	On the Work With Order Headers form, select an order and then select Detail Revision from the Row menu.	Revise order details.
Printer Selection	W986162B	Select a detail line on the Order Detail form, and select Print Order from the Form menu. Select an order on the Work With Order Headers form, and then select Print Order from the Row menu.	Specify how to print an order.

11.6.3 Printing on Demand Interactively

Access the Work With Order Headers form.

11.7 Working with Order Information

You can review open order information and print a variety of reports that contain information about orders.

This section provides an overview of order-related tasks and discusses how to:

- Review financial status information.
- Print order detail information.
- Set processing options for Order Detail Print (R4401P).

11.7.1 Understanding Order-Related Tasks

You can review information about orders by accessing forms in the software and by viewing reports.

11.7.1.1 Open-Order Review

Before you enter an order, you might want to determine if an item is currently on order. You can review open orders, which are orders that contain items and services that you have yet to receive. You can specify the order number, supplier, item, account number, and so on for the open detail lines you want to review.

You also can review open quantities for purchase orders, requisitions, blanket orders, and so forth by choosing the type of order for which you want to review detail lines.

You can review additional information for each open detail line that appears, including the quantity ordered, the quantity open, the quantity received, and the quantity for which vouchers have been created. You can also access address numbers, dates, and tax information.

11.7.1.2 As-If Currency Review

Regardless of whether you enter a purchase order in a domestic or foreign currency, you can review amounts as if they were entered in a different currency. As-if currency processing enables you to review purchase orders as if they were entered in a currency other than the currency in which they were actually entered. For example, a Canadian company that enters a foreign currency purchase order in the euro can review the purchase order amounts as if they were entered in the Japanese yen (JPY), and then compare the JPY amounts to the domestic (CAD) and foreign (EUR) currency amounts.

One of the advantages of as if currency processing is that it does not affect disk space. The as-if currency amounts are not written to a table; instead, they are stored in temporary memory. Although this has no effect on disk space, it can affect processing time.

To review purchase order amounts in an as-if currency, you must enter a default currency code and an exchange rate date in the processing options for the Purchase Orders program (P4310). This data activates the As If Currency field on the Work with Order Details form.

The system retrieves the exchange rate from the F0015 table and calculates the as-if currency amounts based on the base (domestic) currency of the purchase order. Because of fluctuating exchange rates, the as-if currency amount you are reviewing might not be the same amount as the actual voucher or payment.

11.7.1.3 Change Order Review

After you enter a change order, you might need to review all of the changes. You can specify criteria such as the order number, supplier, item, and account number for the change order you want to review.

You can review additional information for each change order that appears, including the quantity ordered, the quantity open, the quantity received, and the quantity for which vouchers have been created. You can also access address numbers, dates, and tax information.

11.7.1.4 Summary and Detail Information Review

You can review summary information for an order, including items, account numbers, order quantities, prices, and extended volumes and weights. You can also review the total tax and monetary amount for the entire order.

You can review a detailed summary of information about an order or change order. For example, you can review information about vouchers, retainage, or changes made to an order.

11.7.1.5 Financial Status Review

You can review up-to-the-minute details of the financial status information for any order. You can also review the financial details of any progress payment voucher that relates to an order.

Financial status information includes:

- Order details
- Amount units billed
- Amount paid
- Amount retained
- Amount units open

If you have multicurrency selected, you can review financial information in foreign or domestic currency using the Foreign option on the Work With Financial Status Inquiry form. The system automatically converts the amounts based on the exchange rate that you specify.

See Also:

- [JD Edwards EnterpriseOne Procurement Management Reports.](#)

11.7.2 Forms Used to Work with Order Information

Form Name	Form ID	Navigation	Usage
Work With Order Details	W4310G	Purchasing Inquiries (G43A112), Open Orders	Work with order details. Open specific orders to review.
Work With Contract Detail		Subcontract Inquiries (G43D112), Open Orders	

Form Name	Form ID	Navigation	Usage
Additional Selection Criteria	W43041F	On the Work With Order Details form, select Added Selections from the Form menu.	Enter additional selection criteria.
Purchase Order Detail Inquiry	W430301C	Select a detail line on Work With Order Details, and then select Order Detail from the Row menu.	Review additional information for an open detail line.
Order Detail	W4310A	Select an order on the Work With Order Details form, and then select Change Orders, View All Chg Order from the Row menu.	Review change orders.
Order Entry - Summary Order Information	W430114A	Select an order on the Work With Order Details form, and then select Order Summary from the Row menu.	Review order summary information.
Order Recap	W4310C	Select an order on the Work With Order Details form, and then select Order Recap from the Row menu.	Review order detail information.
Work With Financial Status Inquiry	W44200A	Select an order on the Work With Order Details form, and then select Financial Status from the Row menu.	Review financial status information.
Supplier Ledger Inquiry	W0411G	On the Work With Financial Status Inquiry form, select Supplier Ledger from the Form menu.	Access voucher information.

11.7.3 Reviewing Financial Status Information

Access the Supplier Ledger Inquiry form.

Document Number

Enter a number that identifies the original document, such as a voucher, invoice, or journal entry. On entry forms, you can assign the document number or let the system assign it using the Next Numbers program (P0002). Matching document numbers (DOCM) identify related documents in the JD Edwards EnterpriseOne Accounts Receivable from Oracle and JD Edwards EnterpriseOne Accounts Payable systems. Examples of original and matching documents are:

- Accounts Payable
- Original document - voucher
- Matching document - payment
- Accounts Receivable
- Original document - invoice

- Matching document - receipt

Note that in the JD Edwards EnterpriseOne Accounts Receivable system, these transactions simultaneously generate original and matching documents: deductions, unapplied receipts, chargebacks, and drafts.

Doc Co (document company)

Enter a number that, with the document number, document type, and general ledger date, uniquely identifies an original document, such as an invoice, voucher, or journal entry.

If you use the Next Numbers by Company/Fiscal Year feature, the Automatic Next Numbers program (X0010) uses the document company to retrieve the correct next number for that company.

If two or more original documents have the same document number and document type, you can use the document company to locate the desired document.

Doc Type (document type)

Enter a value from UDC 00/DT that identifies the origin and purpose of the transaction. The system reserves several prefixes for document types, such as vouchers, invoices, receipts, and time sheets. The reserved document type prefixes for codes are:

P: Accounts payable documents.

R: Accounts receivable documents.

T: Time and pay documents.

I: Inventory documents.

O: Purchase order documents.

S: Sales order documents.

Invoice Date

Enter the date of the supplier's invoice to you.

G/L Date (general ledger date)

Enter a date that identifies the financial period that the transaction will be posted to. The company constants table for general accounting specifies the date range for each financial period. You can have up to 14 periods.

Due Date

Enter the date the discount is due. If there is no discount, the system displays the net due date in this field.

If you leave this field blank during voucher entry, the system calculates the due date using the invoice date and the payment terms code. If you leave the Payment Terms field blank, the system calculates the discount due date and net due date based on the payment terms you specified for the supplier on the Supplier Master Revision form.

The net due date does not appear on the voucher entry forms. It is calculated or assigned by the system based on the value entered in the Discount Due Date field. If the Discount Due Date field is blank, the system calculates it and the net discount date. If you enter a discount due date manually, the net discount date is assigned the same date. If you change the discount due date to a value other than blank after the net due date is calculated or assigned, the net discount date calculated previously is not changed.

Gross Amount

Enter a value that specifies the total amount of the invoice or voucher pay item. The gross amount might include the tax amount, depending on the tax explanation code. The system does not decrease the gross amount when payments are applied. When you void a transaction, the system clears the Gross Amount field.

11.7.4 Printing Order Detail Information

Select Purchasing Reports (G43A111), Print Order Detail.

11.7.5 Setting Processing Options for Order Detail Print (R4401P)

Processing options enable you to specify the default processing for programs and reports.

11.7.5.1 Display**1. Log Information**

Specify whether the system prints the log information associated with subcontracts. Values are:

Blank: Do not print log information.

1: Print only subcontract level logs.

2: Print logs at all hierarchical levels.

2. Text (future)

For future use. Specify whether to print text. Values are:

Blank: Do not print text.

1: Print text.

3. Tax information

Specify whether to print or suppress tax information. Values are:

Blank: Print tax information

1: Suppress tax information

Using Receipt Processing

This chapter contains the following topics:

- [Section 12.1, "Understanding the Receiving Process"](#)
- [Section 12.2, "Printing Purchase Receivers"](#)
- [Section 12.3, "Entering Receipts"](#)
- [Section 12.4, "Entering Cascading Receipts"](#)
- [Section 12.5, "Reviewing Journal Entries for Receipt Transactions"](#)
- [Section 12.6, "Printing Receipt Information"](#)

See Also:

- "Working With Procurement Processes for Brazil" in the *JD Edwards EnterpriseOne Applications Localizations for Brazil Implementation Guide*.

12.1 Understanding the Receiving Process

You can use either an informal or formal receiving process to acquire the goods and services that you requested on a purchase order. You must use the formal receiving process if you purchase items to inventory; you can use the informal or formal receiving process if you purchase items or services to the general ledger.

This section discusses:

- Informal receiving process.
- Formal receiving process.

12.1.1 Informal Receiving Process

An informal receiving process is one in which you enter receipt information at the same time that you create a voucher. If you create a voucher for 50 pens, the system determines that you received 50 pens.

When you use an informal receiving process, the system creates a single record in the F43121 table when you create a voucher. The system also creates a liability for the purchase at that time.

12.1.2 Formal Receiving Process

A formal receiving process is one in which you enter details of a receipt before you create vouchers. You create vouchers based on the receipt information. For example, if you enter a receipt for 50 pens, you must create a voucher for 50 pens.

To accurately account for the receipt of goods, the formal receiving process is likely to include:

- Taking physical receipt of items.
- Identifying details of the receipt.
- Recording details of the receipt.

You can use purchase receivers in the formal receipt process to manually record the receipt of goods upon delivery. You can then enter that information into the system.

You can eliminate the use of purchase receivers if you use terminals to enter receipt information upon delivery or if you use copies of original purchase orders as receiving forms.

When you use a formal receiving process, the system creates a receipt record in the F43121 table after you enter a receipt. The system also creates a liability for the purchase at that time. When you create a voucher, the system creates another record in the F43121 table.

12.2 Printing Purchase Receivers

This section provides an overview of purchase receivers and discusses how to:

- Set processing options for Purchase Receiver Print (R43510).
- Print receivers in batch mode.
- Print receivers for individual orders.

12.2.1 Understanding Purchase Receivers

A purchase receiver is a document that you use to manually record the receipt of goods upon delivery. A purchase receiver provides you with:

- Original purchase order information.
- Quantities that you have yet to receive.
- A column for recording receipt quantities or amounts.

You might need a purchase receiver to:

- Review purchase order information for incoming goods.
- Confirm information about the items that you receive.
- Record receipt information to enter in the system.

You determine the information that prints on purchase receivers. Processing options enable you to specify whether to print:

- Price information
- Order quantities
- Cross-reference numbers
- Foreign currency amounts

Note: If the Display Service Units processing option on the Display tab of the PO Receipts program (P4312) is set to display service units, then the system prints the Service Quantity and Service UoM fields on the purchase receiver.

See "Understanding Subcontract Order Detail Information, Service Units for A, P Matching" in the *JD Edwards EnterpriseOne Applications Subcontract Management Implementation Guide*.

See "Understanding Subcontract Vouchers, Service Units for A, P Matching" in the *JD Edwards EnterpriseOne Applications Subcontract Management Implementation Guide*.

You can set up order activity rules to print purchase receivers as a step in the purchase order process. After you print a purchase receiver, you can have the system advance the order to the next step in the purchasing process. You can also have the system leave the order at its current status. To advance an order, the system updates the status codes for detail lines if you have set the processing options for Purchase Receiver Print (R43510) to enable the system to update the status codes.

You can print purchase order receivers in batch mode or by an individual order.

When you print purchase receivers in batch mode, you might have to print a second purchase receiver for some orders. For example, you might receive a partial order, in which case you must print a second receiver to record the remaining balance of the order. You can enter specific purchase orders for which to print purchase receivers using the Purchase Receiver Print program (R43510).

12.2.2 Setting Processing Options for Purchase Receiver Print (R43510)

Processing options enable you to specify the default processing for programs and reports.

12.2.2.1 Edits

These processing options enable you to enter information that the system uses when editing records.

1. Enter a '1' to prevent updating the Next Status Code

Specify whether the system updates the next status code.

2. Enter an override Next Status Code

Specify a user-defined code (UDC) from 40/AT that indicates the next step in the order flow of the line type.

3. Enter the route type to be used for retrieving the routing operation codes. If left blank, the program will search for route type equivalent to blank

Specify a code that qualifies the routing for an item and supplier combination. Examples include specific routing types for Advance Ship Notices (ASNs) (EDI 856 Ship Notice/Manifest transactions) and for transfers.

12.2.2.2 Print (Release 9.1 Update)

These processing options enable you to enter the types of information that the system prints on the Purchase Receiver Print report (R43510).

1. Enter a '1' to inhibit printing of Cost Information

Specify whether the system prints cost information.

2. Enter a '1' to inhibit printing of Quantity Information

Specify whether the system prints quantity information.

3. Enter a '1' to print the Supplier Item Number

Specify whether the system prints the supplier item number.

Note: If the supplier item number is not defined, the system prints the primary item number.

4. Enter the type of Cross Reference Number

Specify a code from UDC table 41/DT that identifies the type of cross-reference that is set up for this customer.

5. Enter a '1' to print associated text

Specify whether the system prints associated text.

6. Enter a '1' to print routing operation codes

Specify whether the system prints routing operation codes.

7. Enter a '1' to print multiple accounts information

Specify whether the system prints information about multiple accounts.

12.2.2.3 Currency

This processing option enables you to specify whether the system prints amounts in a foreign currency.

1. Enter a '1' to print amounts in Foreign Currency

Specify whether the system prints amounts in a foreign currency.

12.2.3 Printing Receivers in Batch Mode

Select Purchase Order Processing (G43A11), Print Purchase Receivers.

You can use purchase receivers to manually record receipt information for goods upon delivery. You can print purchase receivers in batch mode based on the criteria that you specify when performing the Print Purchase Receivers procedure.

12.2.4 Printing Receivers for Individual Orders

Select Purchasing Reports (G43A111), Print Purchase Receiver.

12.3 Entering Receipts

This section provides an overview of receipt information, lists a prerequisite, and discusses how to:

- Set processing options for PO Receipts (P4312).
- Enter receipt information.

12.3.1 Understanding Receipt Information

After you receive the goods on a purchase order, you must record the details of the receipt. The system uses receipt information to:

- Update item quantities and costs in the JD Edwards EnterpriseOne Inventory Management system.
- Update general ledger accounts.

When you receive goods, you must verify that the details of the receipt correspond to the information on the purchase order. You must verify item numbers, quantities, units of measure, costs, and so forth. If the receipt details differ from those on the purchase order, you must adjust the purchase order detail lines to reflect the receipt. For example, if landed costs, such as delivery charges or import taxes, apply to the item's purchase price, you enter these costs for the order during the receipt process.

The system also enables the pricing and repricing of purchase order items at receipt. Pricing and repricing at receipts for matrix items and quality attributes enables you to account for price changes that must be reflected when an item is received.

When a direct ship order is created in JD Edwards EnterpriseOne Sales Order Management, the system automatically creates a corresponding purchase order. For a direct ship order, you must enter a receipt to update the corresponding sales order with the new status information. However, if you enter a partial receipt, the system splits the corresponding order detail lines on the direct ship sales order and updates only the order detail line that was received.

If you work in an inventory environment, you can specify the warehouse location in which to store items upon receipt. If a certain location is full, you can assign items to multiple locations. If you group items by lot, you can assign items to a single lot or to multiple lots. If necessary, you can specify serial numbers for these items.

If the receiving branch/plant has license plate functionality activated, you use the processing options on the Warehouse tab and license plate branch/plant constants to process license plate information for adding inventory to the location.

Each time you receive an order, the system:

- Creates a receipt record in the F43121 table.
- Updates item quantities (availability and commitment) in the F41021 table.
- Adds a new record to the F4111 table.
- Updates the appropriate accounts in the F0911 table.

Each time you cancel or reverse a receipt, the system updates the same tables that were updated when you entered the original receipt.

12.3.1.1 Entering Receipt Information

You must enter receipt information to verify the receipt of goods or services on a purchase order. You must verify the quantity, cost, and so forth for each order that you receive.

If you are entering a receipt that has many purchase order detail lines, you might want to enter the information using the network. If you are entering a receipt for a kit, you can enter receipt information for the components only. You cannot enter a receipt for the parent item.

To enter a receipt, you must first locate the open purchase-order detail lines that correspond to the receipt. An open detail line contains items that have not yet been received. The system retrieves all open detail lines for the item number, purchase order number, or account number that you specify. You can set the processing options for PO Receipts (P4312) to display cost information and to determine whether you can change costs for the order detail lines.

When you enter receipts for purchase order lines, you can use the Account Distribution Inquiry program (P43126) to review multiple account distribution records that the system stores in the F4316 table. After you enter a receipt for a purchase order for which lines are distributed among multiple accounts (only for inventory interfaces of A or B), the system updates item quantities and costs, and then writes and updates records to these tables:

- F4311 (updates records).
- F4316 (updates records).
- F43121 (writes records).
- F43126 (writes records).
- F43199 (writes records only if you are using audit history).
- F0911 (writes records).

For each F4316 record, the system creates general ledger transactions and stores the records in the F0911 table before updating commitments.

If the Display Service Units processing option on the Display tab of the PO Receipts program (P4312) is selected, then the Service Quantity and Service UoM fields appear on the PO Multiple A/c inquiry form (W43126A).

Note: Multiple account distribution functionality does not apply to receipt routing, multiple locations, and landed costs.

See [Service Units for A/P Matching](#).

When receipts are created, you can postpone the posting of the amounts to the expense account and then expense the amounts at voucher match.

See [Expense at Voucher Match](#).

You use the PO Receipts program to enter receipts for purchased components of a configured item. You use an option on the Row menu to view the configuration.

See "Understanding Purchase Orders for Components of a Configured Item" in the *JD Edwards EnterpriseOne Applications Configurator Implementation Guide*.

See "Understanding Configured Items and Procurement, Purchase Order Receipt Entry for Configured Items" in the *JD Edwards EnterpriseOne Applications Configurator Implementation Guide*.

12.3.1.2 Reviewing Foreign and Domestic Currency

You can review amounts in both foreign and domestic currencies using the Foreign field on the PO Receipts form. If you change costs for an order line, ensure that you do so in the appropriate currency mode.

You can use processing options for PO Receipts to specify how to use the exchange rate. For example, you can:

- Use the exchange rate that applies on the general ledger date.
- Prevent changes to the exchange rate.

When you receive orders in a foreign currency, the system creates journal entries for two different ledgers:

- The AA ledger for base currency amounts.

- The CA ledger for foreign currency amounts.

12.3.1.3 Adjusting Purchase Order Detail Lines

If the detail lines on a purchase order differ from the details of the actual receipt, you must adjust the purchase order detail lines to reflect the receipt. For example, if the order quantity on a detail line is 20 but you receive a quantity of 10, you must change the quantity on the detail line to 10. You specify whether to close the remaining balance on the line or to keep it open.

12.3.1.4 Receiving Matrix Items

When matrix child items are received, the tolerance must be calculated and any applicable warnings issued. To receive matrix child items:

1. Set the Inventory Parent processing option on the Matrix tab of the Purchase Orders program (P4310) to **1** so that the matrix parent does not expand.
2. Enter a purchase order for a matrix parent item.
3. Set the Quantity and Amount processing option on the Tolerance tab of the PO Receipts program (P4312) to **2** to display an error message when the order is out of tolerance.
4. Access the PO Receipts program and select the purchase order that is entered for the matrix parent item.
5. Select Matrix Orders from the Row menu and select matrix child items by entering quantities.

Matrix parent item quantity is displayed in the Control Quantity field. If you entered more quantity for the matrix child items than for the matrix parent item, the system displays a warning.

6. Process through the warning message, and the selected matrix child items are added to the purchase order receipt.
7. Click OK to receive the items.

See [Understanding Pricing in Procurement](#).

12.3.1.5 Pricing and Repricing at Receipts

You can price and reprice items at receipt based on quality attributes and changes in pricing. The system uses contracts and price adjustments to calculate the new item price at receipts.

See [Understanding Pricing in Procurement](#).

12.3.1.6 Service Units for A/P Matching

You can enter service unit information for services purchase order lines during the purchase order receipt process. Service units are informational only so the system does not perform any validation against the values.

You activate service units by selecting the Procurement Allow Service Units option on the Line Type Constants Revisions form. The system validates that the service units field is checked for inventory interface A and B only.

Set the Display Service Units processing option on the Display tab of the PO Receipts program (P4312) to display the Service Quantity and Service UoM fields on the Work With Purchase Orders to Receive (W4312F) and Purchase Order Receipts (W4312A) forms.

See [Setting Processing Options for PO Receipts \(P4312\)](#).

See [Entering Receipt Information](#).

See [Defining Order Line Types](#).

See "Understanding Subcontract Order Detail Information, Service Units for A, P Matching" in the *JD Edwards EnterpriseOne Applications Subcontract Management Implementation Guide*.

12.3.1.7 Record Reservation (Release 9.1 Update)

The JD Edwards EnterpriseOne software provides record reservation capability within the PO Receipts program (P4312). Record reservation helps to ensure the integrity of the data and prevent data loss. To avoid simultaneous processing of the same records, the system reserves (locks) records for processing by any other program. Thus, the system does not allow you to edit a record that has been locked by a different user or application.

When a program that uses record reservation is interrupted, orphaned reservation records might remain in the Business Object Reservation table (F00095). This can occur, for example, when technicians are working with a server, or when a workstation shuts down without warning. If an interruption stops one of the programs in the PO Receipts program before it releases the reservations that it creates, you cannot update the records until the orphaned reservations are removed.

You can use the Remove Business Object Reservation program (P00095) to release unwanted record reservations. This program stores reservation information in the Business Object Reservation table (F00095).

The JD Edwards EnterpriseOne software provides an additional feature to enable record reservation based on the item and branch/plant combination for the P4312 program when it is used along with the Landed Cost Selection program (P43291). When a user attempts to receive an order with the same item and branch/plant combination and if the record is reserved by another user, the system generates an error or a warning based on the setting of the Receiving Mode processing option for the PO Receipts program. The system displays a record reservation error message if the Receiving Mode processing option is set to 1 or 2, and a warning message if the Receiving Mode processing option is set to 3 or 4.

To activate this additional record reservation feature, you must define a UDC code P4312LCRR in UDC (00/RR), with the Special Handling Code field set to 1. You must also set the Landed Costs processing option for the P4312 program to 1.

Note: If two or more users attempt to receive an order with the same item and branch/plant combination at the same time, one or more of the users may get a transaction error.

12.3.2 Prerequisite

In the processing options for the Purchase Orders program (P4310), ensure that the processing option in the Defaults section for line sequencing is set to **0**. If this processing option is set to **1**, you will have difficulty receiving change orders.

12.3.3 Forms Used to Enter Receipts

Form Name	Form ID	Navigation	Usage
Work With Purchase Orders to Receive	W4312F	Purchase Order Processing (G43A11), Enter Receipts by PO	Enter receipt information. Work with purchase orders to receive.
Purchase Order Receipts	W4312A	On Work With Purchase Orders to Receive, locate a purchase order and click the Select button.	Review and modify purchase order receipt details.
Account Distribution Inquiry	W43126A	On Purchase Order Receipts, locate the purchase order, and then select Account Distribution from the Row menu.	Review account distribution information (inquiry only).

12.3.4 Setting Processing Options for PO Receipts (P4312)

Processing options enable you to specify the default processing for programs and reports.

12.3.4.1 Defaults

These processing options define the default information that the PO Receipts program (P4312) uses.

1. Inquiry Order Type

Specify the type of document. This UDC (00/DT) also indicates the origin of the transaction. Document type codes are reserved for vouchers, invoices, receipts, and time sheets, which create automatic offset entries during the post program. (These entries are not self-balancing when you initially enter them.) These prefixes for document types are predefined; do not change them:

P: Accounts Payable documents.

R: Accounts Receivable documents.

T: Payroll documents.

I: Inventory documents.

O: Purchase Order documents.

J: General Ledger/Joint Interest Billing documents.

S: Sales Order Processing documents.

2. Receipt Document Type

Specify the type of document. This UDC (00/DT) also indicates the origin of the transaction. Document type codes are reserved for vouchers, invoices, receipts, and time sheets, which create automatic offset entries during the post program. (These entries are not self-balancing when you originally enter them.) These prefixes for document types are predefined; do not change them:

P: Accounts Payable documents.

R: Accounts Receivable documents.

T: Payroll documents.

I: Inventory documents.

O: Purchase Order documents.

J: General Ledger/Joint Interest Billing documents.

S: Sales Order Processing documents.

12.3.4.2 Status Default

These processing options control which status codes the system uses for receipts.

1. Acceptable Incoming Status Code 1 through 3. Acceptable Incoming Status Code 3

Specify a next status. Orders are eligible for receipt when they have the next status that you specify for this processing option.

Before you complete this processing option, review the order activity rules that you have set up.

4. Outgoing Status for Partial Receipts

Specify the next status that the order moves to after a partial receipt.

Before you complete this processing option, review the order activity rules that you have set up.

5. Outgoing Status for Closing

Specify the next status that the order moves to after the system closes or fully receives the detail line.

Use status code 999 for closed or fully received detail lines.

6. Outgoing Status for Canceling

Specify the next status that the order moves to after the system cancels a detail line.

Use status code 999 for canceled detail lines.

12.3.4.3 Display

These processing options control the information that appears in the PO Receipts program (P4312) and whether they can be changed.

1. Sales Order Backorders

Specify how you want to release backordered sales orders. Values are:

Blank: The system does not release sales orders.

1: The system automatically displays the Sales Order Backorder Release form.

2. Lot Information

Specify whether the system displays lot information, such as the Lot field and the Expiration Date field. Values are:

Blank: Do not display lot information.

1: Display the lot information fields.

2: Display and protect the lot information fields.

3. Cost Protection

Specify whether you can change costs. Values are:

Blank: The cost fields appear on the form and can be overridden.

1: The cost fields appear on the form, but cannot be overridden.

2: The system hides cost information.

4. Kits

Specify whether the system displays kit component lines or only the parent line.

Values are:

1: The system displays kit parents (FUTURE).

2: The system displays kit components.

5. Receiving Mode

Specify the mode that the system uses to receive detail lines. Values are:

1: Receive by purchase order

2: Receive by item

3: Receive by general ledger account

4: Receive by shipment number

When you select only one detail line on the Work With Receipts menu, the system displays all the detail lines on the Receipt Revisions menu that meet the criteria of the mode that you have entered.

For example, if you enter **1** for the receiving mode and select one detail line on the Work With Receipts form, the system displays all lines for the purchase order. If you enter **2** for the receiving mode and select one detail line on the Work With Receipts form, the system displays all lines for the selected item.

If you enter **3** for the receiving mode and select one detail line on the Work With Receipts form, the system displays all lines for the general ledger account. If you enter **4** for the receiving mode and select one detail line on the Work With Receipts form, the system displays all lines for the shipment number.

6. Display Service Units

Specify whether the system displays the Service Quantity and Service UoM fields in the grid. This processing option is used with line type constants. If the Procurement Allow Service Units option is selected on the line type constants, then service quantity and service unit of measure (UOM) can be used.

The Quantity and Service Quantity fields cannot be used together. Service quantity is a memo field and does not have any validation. Values are:

Blank: Do not display

1: Display

12.3.4.4 Process

These processing options specify whether you are able to perform procedures such as:

- Updating supplier information.
- Specifying a lot number to use as a default value.
- Automatically selecting all detail lines for a receipt.
- Entering serial number information.
- Entering quantity information manually or automatically.

- Reviewing or updating landed cost information.
- Printing a receipt traveler document.
- Recording supplier analysis information.
- Sending a message to a receipt originator automatically.
- Specifying a sales order status for direct ship receipt.

1. Supplier Update Mode

Specify whether the system updates the supplier number in the F4102 table. Values are:

Blank: The system does not update the supplier number.

1: Update the supplier number in the F4102 table if the value for the supplier number is zero.

2: Update the supplier number in the F4102 table regardless of the value for the supplier number.

2. Lot Default

Specify whether the system uses default lot and location information in the Purchase Order Receipts program (P4312). Values are:

Blank: The system does not use default lot and location information.

1: The system uses the location and lot number from the primary item balance location in the F41021 table.

3. Option Default

Specify whether the system automatically selects all detail lines for receipt, which prevents you from having to manually select each detail line. Values are:

Blank: Do not automatically select all detail lines for receipt.

1: Automatically select all detail lines for receipt.

4. Serial Numbers

Specify whether the system enables you to enter serial number information. Note that before you enter serial number information, you should verify that you have entered **Y** (yes) in the Serial Number Required Y/N field on the Item Branch Revisions form. Values are:

Blank: You cannot enter serial number information in the F4220 table.

1: You can enter serial number information in the F4220 table.

5. Quantity Entry

Specify manual or automatic entry of quantity information. Values are:

Blank: The system uses the open quantity as the default value for this field.

1: Enter the quantity manually.

6. Landed Costs

Specify whether to manually apply landed costs or whether the system automatically applies landed costs. Note that you can manually apply landed costs after a receipt on the Receipts Inquiry form, which you access through the Standalone Landed Cost program (P43214). Values are:

Blank: Do not apply any landed costs.

1: Display the Landed Cost Selection form, where you can review or update the information.

2: Automatically apply the landed cost rule without displaying the Landed Cost Selection form.

If you are applying landed costs to an item that is in the Receipt Routing process, you must specify a value of **2** for this processing option.

7. Receipt Traveler Document

Specify whether the system prints a receipt traveler document after each receipt. The system uses the version that you specified on the Versions tab. Values are:

Blank: Do not print a receipt traveler document after each receipt.

1: Automatically print a receipt traveler document after each receipt.

8. Supplier Analysis

Specify whether the system captures supplier analysis information. Values are:

Blank: The system does not capture supplier analysis information.

1: The system records information such as item numbers, dates, and quantities for every purchase order in the F43090 table. To make supplier analysis most effective, enter **1** for this processing option and set the processing options for the Purchase Order Entry program (P4310) and the Voucher Match program (P4314) to capture the same information.

9. Text Deletion

Reserved for future use.

10. Direct Ship Status

Specify the sales order status for direct ship receipt. The status that you enter in this field determines the next status of the sales order.

Before you complete this processing option, review the order activity rules.

11. Receipt Routing

Specify whether to activate receipt routing. Values are:

Blank: Do not activate receipt routing.

1: Activate standard receipt routing.

2: Activate Supplier Relationship Management (SRM) receipt into route.

Note: SRM is Oracle's JD Edwards EnterpriseOne Supply Management module.

12. Enter the default route type to be used to search for a receipt route

Enter a code that qualifies the routing for an item and supplier combination. Examples would include specific routing types for ASNs (EDI 856 Ship Notice/Manifest transactions) and for transfers. If you leave this processing option blank, the program will search for route type equivalent to blank.

13. Journal Entries

Specify whether to summarize journal entries. If you are tracking commitments using the PA or PU ledgers, you cannot use this processing option. Values are:

Blank: Do not summarize journal entries.

1: Summarize journal entries.

14. Activate Blind Materials Issue (EPM) (activate blind materials issue [engineering project management])

Specify whether to activate the Materials Issue function. You can activate the Material Issue function only if you are using the JD Edwards EnterpriseOne Engineer to Order (ETO) system from Oracle and are working with an ETO receipt. Also, you must set the Call Materials Issue flag in the F40205 table. Values are:

Blank: Do not activate the Materials Issue function.

1: Activate the Materials Issue function.

15. Allow Negative On-Hand Quantity

Specify whether the system will continue processing a receipt if the system calculates negative on-hand quantity. Values are:

Blank: The system will continue processing the receipt, and will not issue a warning or an error.

1: The system will continue processing the receipt, but will issue a warning.

2: The system will not continue processing the receipt, and will issue an error.

16. Activate Automatic G/L Batch Posting (activate automatic general ledger batch posting)

Specify whether to enable the automatic posting of General Ledger batches when the program closes. Values are:

Blank: Manual post

1: Auto post

17. Price At Receipt

Specify whether the system will price at receipt. Values are:

Blank: Do not price at receipt

1: Price at receipt

18. Price at Receipt Warning

Specify whether to show a warning that advanced pricing may change the final unit cost. Values are:

Blank: Do not issue a warning.

1: Issue a warning if processing the receipt may alter the final unit cost.

19. Dual UOM Costing (dual unit of measure costing)

Specify whether to display the secondary unit cost field in addition to the current unit cost field. The secondary unit cost field will appear if this processing option is selected. Values are:

Blank: Do not display the secondary unit cost field.

1: Display the secondary unit cost field.

20. Lot Number Override

Specify whether the system overrides the lot number with the production number. Values are:

Blank: The system does not override the lot number.

1: The system overrides the lot number with the production number.

21. Production Number On Hand Consumption

Specify how the PO Receipts program (P4312) selects production number on hand quantity from the Item Location Tag File table (F41021T).

Production number on hand is consumed whenever on hand quantity is not available to continue the transaction.

If you process inventory selection blindly, then the system consumes production number on hand quantity in the following order:

1. Generic inventory.
2. Inactive production numbers.
3. Orphaned production numbers.
4. Production number with the farthest end item demand date.

If you process inventory selection interactively, then you can select the production number from the options available on the Select Inventory for Consumption form (W42054A). Valid values are:

Blank: The program performs blind selection of inventory.

1: The program enables interactive selection of inventory.

22. Country of Origin Required Default

Specify how the system processes the country of origin default value when you activate the Country of Origin Required flag at the item branch level. Values are:

Blank: The system does not use the default country of origin value. Use this option when you want users to acknowledge the country of origin by manually entering it.

1: Specify that the system uses the default country of origin value from the item branch record. This option allows you to edit the country of origin value before you add a new lot.

2: Specify that the system uses the default country of origin value from the item branch record. This option does not allow you to edit the country of origin value before you add a new lot.

12.3.4.5 Tolerance

These processing options specify how the system performs tolerance checking for detail lines.

1. Quantity and Amount

Specify whether the system checks to determine whether a detail line's quantity and amount exceed the tolerance percentage. To check the tolerance, you can access the Tolerance Setup program (P4322). Values are:

Blank: Do not check quantities and amounts to determine whether they exceed tolerance.

- 1: Display a warning when the detail line exceeds the tolerance.
- 2: Display an error message when the detail line exceeds the tolerance.

2. Date

Specify whether the system checks to determine whether a detail line's date is outside of the tolerance date range. To check the tolerance date range, you can access the Supplier/Item Information program (P43090). Values are:

Blank: The system does not check receipt dates for detail lines to determine whether they exceed tolerance.

1: The system displays a warning when the receipt date in the detail line is outside of the tolerance date range.

2: The system displays an error message when the receipt date in the detail line is outside of the tolerance date range.

12.3.4.6 Warehousing

These processing options specify how the PO Receipts program (P4312) interfaces with the JD Edwards EnterpriseOne Warehouse Management system.

1. Putaway Mode

Specify how the system processes putaway requests. Values are:

Blank: Do not create a putaway request. If you do not create putaway using the Purchase Order Receipts program (P4312), the items that you receive will remain in the receiving location. Then you can create putaway requests manually or create them by reversing the receipt of the purchase order. To do this, set this processing option to create putaway requests by reversing the purchase order receipt and receiving the purchase order again.

1: Create a putaway request only. You must create location suggestions and confirm location suggestions separately.

2: Create a putaway request and process the request using the subsystem.

3: Receive goods directly into the reserved locations, and do not create requests or suggestions.

2. License Plate Number Generation Method

Specify what license plate number generation method should be used. Values are:

00: Use license plate constants.

01: Use manual entry.

02: Create user-defined formula.

03: Create Electronic Product Code (EPC) number.

3. Build default UOM structure (build default unit of measure structure)

Specify the UOM structure that the system uses to create license plate number automatically. License plates are created only for item UOM that have the license plate flag selected in the Item Unit of Measure Definition (P46011) application. Values are:

Blank: The system uses the default item UOM structure.

1: The system uses the default item UOM structure, excluding levels higher than the transaction UOM.

4. Assign Items to License Plate Window (P46L30)

Specify whether the system automatically displays the Assign/Remove Items to License Plate (W46L30B) form. This processing option applies only if you are using license plate functionality in the JD Edwards EnterpriseOne Warehouse Management system and license plate numbers are not created automatically by the system. Values are:

Blank: The system does not automatically display the assign items to license plate window.

1: The system automatically displays the assign items to license plate window.

12.3.4.7 Currency

These processing options specify which date the system uses as the effective date and whether the exchange rate can be changed.

1. Effective Date

Specify which date the system uses as the effective date. Values are:

Blank: Order date

1: General ledger date

2: Today's date

2. Protect Rate

Specify whether you can change the exchange rate. Values are:

Blank: You can change the exchange rate.

1: You cannot change the exchange rate.

12.3.4.8 Versions

These processing options enable you to enter the version for each application. If you leave any of these processing options blank, the system uses the ZJDE0001 version.

1. Open Order Inquiry (P4310)

Enter the version that the system uses when you are using the Open Order Inquiry program.

2. Sales Order Backorder Release (P42117)

Enter the version that the system uses when you are using the Sales Order Backorder Release program.

3. Receipt Traveler (P43512)

Enter the version that the system uses when you are using the Receipt Traveler Release program.

4. Receipt Routing (P43250)

Enter the version that the system uses when you are using the Receipt Routing program.

5. Putaway Requests (R46171)

Specify which version of the Putaway Requests program to use. If you leave this processing option blank, the system uses XJDE0001.

6. Pick Requests (R46171)

Specify which version of the Location Selection Driver program the system uses to create pick requests during planned cross docking.

7. Online Reservations (P46130)

Specify which version of the Online Reservations program the system uses.

8. Purchase Order Entry (P4310)

Enter the version that the system uses when you are using the Purchase Order Entry program.

9. G/L Journal Entries (P0900049)

Enter the version that the system uses when you are using the G/L Journal Entries program. You can review versions for this program only in the interactive versions list.

10. Landed Cost Selection (P43291)

Enter the version that the system uses when you are using the Landed Cost Selection program.

11. Test Results Revisions (P3711)

Enter the version that the system uses when you are using the Test Results Revision program.

12. Blind Materials Issue (P31113)

Specify which version the system uses when performing the Materials Issue from Receipts function. If you leave this processing option blank, the system uses version ZJDE0009.

13. General Ledger Post (R09801)

Specify the version of the General Ledger Post Report program (R09801) to use for automatic posting of the G/L batch. If you leave this processing option blank, the system will use version ZJDE0009.

14. Price Check and Availability (P4074)

Specify the version that the system uses when you are using the Check Price History and Availability program (P4074). When you choose a version, review the version's processing options to ensure that the version meets the business needs.

15. Matrix Order Entry (P41902)

Specify which version of the Matrix Order Entry program (P41902) is available to you from the Sales Order application. If you leave this processing option blank, the system uses version ZJDE0001.

12.3.4.9 Flex Acct

This processing option specifies whether you are working with flexible accounting.

1. Flex Accounting

Specify whether flexible accounting is activated. Activate flexible accounting if you are using JD Edwards EnterpriseOne Advanced Cost Accounting from Oracle, or if you are working with flexible sales accounting. Values are:

Blank: Do not activate flexible accounting.

1: Activate flexible accounting.

12.3.4.10 Bulk

This processing option specifies how the system processes bulk transaction information.

1. Quantities

Specify how the system records bulk transaction quantities. Values are:

Blank: Quantities are purchased and received in standard mode.

1: The system records the difference between ambient and standard quantities that are received as a temperature gain or temperature loss.

2: The system updates the unit cost as the extended cost divided by the standard quantity.

2. Variance Limit (Release 9.1 Update)

Specify the variance limit to be allowed in the system while receiving the bulk items. Values are:

Blank or 0: Do not allow variance.

Numeric value: Allow variance. Enter a numeric value to specify its absolute value as the variance limit. For example, if you enter 1.00 as the numeric value, the system considers the variance limit from -1.00 to 1.00. If the variance amount is within the specified limit, the system uses DMAAI 4332 to write the variance amounts to the appropriate tables.

Note: Numeric Value option is applicable only if the [1. Quantities](#) processing option is set to **1** (Calculate temperature gain or loss) or **2** (Update unit cost).

12.3.4.11 Interop

This processing option enables you to specify whether the system performs outbound interoperability processing.

1. Transaction Type

Specify a transaction type for the interoperability transaction. If you leave this processing option blank, the system will not perform outbound interoperability processing.

12.3.4.12 Workflow

These processing options enable you to specify how the system performs the workflow notification process.

1. Receipt Email

Specify the recipient of the email that the system automatically sends when goods are received. Values are:

- 1: Send email to the buyer.
- 2: Send email to the person who originated the transaction.
- 3: Send email to both the buyer and the person who originated the transaction.

2. Completion Email

Specify the recipient of the email that the system automatically sends when an item is received that is related to a work order. Values are:

Blank: Do not send email.

- 1: Send email to the planner.

3. Notify Unit Cost Changes

Specify the recipient of the email that the system automatically sends when the unit cost/lump sum changes on a purchase order detail line during receipts. Values are:

Blank: Do not send email.

- 1: Send email to purchase order originator.
- 2: Send email to project manager (MPM only).
- 3: Send email to buyer.
- 4: Send email to purchase order originator, project manager (MPM only), and buyer.

Note: Manufacturing Project Management (MPM) is now Oracle's JD Edwards EnterpriseOne Engineer to Order.

4. Notify Quantity Changes

Specify the recipient of the email that the system automatically sends when the quantity on the order changes. Values are:

Blank: Do not send email.

1: Send email to purchase order originator.

2: Send email to project manager (MPM only).

3: Send email to buyer.

4: Send email to purchase order originator, project manager (MPM only), and buyer.

12.3.4.13 Cross Docking

These processing options enable you to specify how the system performs cross docking operations.

1. Cross Docking

Specify how the system performs opportunistic cross docking operations. Values are:

Blank: Do not cross dock.

1: Use opportunistic cross docking.

2: Use planned cross docking.

3: Use both planned and opportunistic cross docking.

2. Pick Request

Specify whether the system creates a pick request when performing cross docking during the purchase order receipts process. Values are:

Blank: The system does not create a pick request.

1: The system creates a pick request.

3. Override Next Status for Sales Orders

Specify the default next status code (40/AT) for the sales order only if you are using cross docking during the purchase order receipts process. If you leave this processing option blank, the system uses the sales order next status that is contained in the order activity rules.

4. From Sales Order Status

Specify the from status code (40/AT) for the sales order only if you are using planned cross docking during the purchase order receipts process.

5. Thru Sales Order Status (through sales order status)

Specify the through status code (40/AT) for the sales order only if you are using planned cross docking during the purchase order receipts process.

12.3.4.14 Cascade Receipt

These processing options specify how the system processes cascading receipts.

1. Cascade Receipt

Specify whether the system activates the cascade receipts process. Besides setting this processing option, you must also set the processing option for receiving mode (located on the Display tab) to **2** if you want the system to activate the cascade receipts process. Values are:

Blank: Do not activate the cascade receipts process.

1: Activate the cascade receipts process.

2. Tolerance Checking

Specify whether the system applies a quantity that has slightly exceeded the customer's required shipment quantity to the next open purchase order during the cascading receipts process. Values are:

Blank: The system can apply the quantity in excess to the next open purchase order.

1: The system performs tolerance checking by quantity.

2: The system performs tolerance checking by percentage.

3. Tolerance Checking by Quantity

Specify whether the system performs tolerance checking. Values are:

Blank: The system does not perform tolerance checking.

1: The system performs tolerance checking.

4. Tolerance Checking by Percentage

Specify the percentage that the system uses for tolerance checking. If you leave this processing option blank, the system does not perform tolerance checking.

12.3.4.15 WIM

This processing option specifies activation of the wine industry module.

1. Wine Industry Module

Specify whether the system activates wine industry module processing or whether this is a regular item receipt. Values are:

Blank: Do not activate wine industry module processing. (This is a receipt for a regular item, not a wine-related item.)

1: Activate wine industry module processing.

12.3.4.16 Matrix**1. Inventory Parent**

Specify whether the system displays the matrix order form for the inventory parent. Values are:

Blank: Display Matrix Order form.

1: Do not display Matrix Order form.

2. Receipt Option for Inventory Parent

Specify the receiving options for a purchase order line by selecting a value from UDC 43/PR.

12.3.4.17 Configurator

These processing options specify how the system processes receipts for components of configured items.

1. Update Related Orders

Specify whether the system updates the work order parts list or sales order detail lines related to the receipt of purchase orders for the components of configured items. The relationship between orders is established by the Configured Item Revisions program (P3210) during configured item order entry. Values are:

Blank: Do not update related orders.

1: Update related orders.

2. Process Work Order Inventory Issues

Specify whether the system automatically processes work order inventory issues if a related work order is generated by the JD Edwards EnterpriseOne Configurator system and the work order has an attached parts list. Values are:

Blank: Do not process work order inventory issues.

1: Process work order inventory issues.

Selecting a value of **1** automatically issues purchase order receipt items to the work order parts list.

3. Version of Work Order Inventory Issues

Specify the version of the Work Order Inventory Issues program (P31113) that the system uses to perform the Materials Issue function. Review the processing options for the specified version to ensure that they are set appropriately. If you leave this processing option blank, the system uses version ZJDE0001.

4. Version of Sales Order Entry

Specify the version of the Sales Order Entry program, either P4210 or P42101, that the system uses to perform the Sales Order Detail update function. Review the processing options for the specified version to ensure that they are set appropriately. If you leave this processing option blank, the system uses version ZJDE0001.

5. Sales Order Cutoff Status

Specify the sales order cutoff status. If a sales order has the next status (NXTR) value that is beyond the value specified in this processing option, then the sales order detail lines will not be updated. Review the order activity rules before completing this processing option. If you leave this processing option blank, the system uses status 999.

6. Work Order Cutoff Status

Specify the work order cutoff status. If a work order status is beyond the value specified in this processing option, then the work order parts list will not be updated. If you leave this processing option blank, the system uses the value specified in the manufacturing constants (SRS1 field in the F3009 table).

See "Understanding Purchase Orders for Components of a Configured Item" in the *JD Edwards EnterpriseOne Applications Configurator Implementation Guide*.

See "Understanding Configured Items and Procurement, Purchase Order Receipt Entry for Configured Items" in the *JD Edwards EnterpriseOne Applications Configurator Implementation Guide*.

12.3.5 Entering Receipt Information

Access the Work With Purchase Orders to Receive form.

Service Quantity

Enter a value that represents the number of units committed for a nonstock item or service line on a purchase order. This field is a field by itself and has no relation with unit cost to calculate the extended cost. If service units are used, the Quantity Ordered field on the Order Detail form in JD Edwards EnterpriseOne Procurement system cannot be used.

Service UoM (service unit of measure)

Enter a value from UDC table 00/UM that specifies the unit of measure for the quantity committed for a nonstock item or service line on a purchase order.

12.4 Entering Cascading Receipts

This section provides an overview of cascading receipts, lists prerequisites, and discusses how to:

- Enter cascading receipt information.
- Assign items to multiple locations and lots.
- Assign serial numbers.
- Set processing options for Purchase Receipts Inquiry (P43214).
- Reverse a receipt.

12.4.1 Understanding Cascading Receipts

The PO Receipts program (P4312) enables you to automatically apply the total received quantity of an item to multiple purchase orders in a supplier's shipment. This process is known as cascading receipts functionality. Provided that you set the processing options for entering receipts by item and for activating the cascading receipts functionality, you do not have to manually apply quantities to multiple purchase orders for the supplier. The system provides you with all the open purchase orders for the item that are within the same branch/plant, are purchased by the same supplier, and are sorted by promised delivery date.

To begin using cascading receipts functionality, you first enter the total quantity of an item that you have received. Next, you select the first purchase order line to which the system automatically applies the total received quantity. The system continues applying the total received quantity by promised date until all open purchase order lines for the item and supplier have been satisfied.

If you use tolerance checking for cascading receipts functionality and a balance of total received quantity exists, then the system evaluates the total received quantity that remains. If the quantity is less than the tolerance quantity or percentage that you specified in the appropriate processing option on the Cascade Receipt tab in the PO Receipts program (P4312), then the system applies the balance to the last purchase order line. If you do not use tolerance checking for cascading receipts functionality and a balance of total received quantity exists, then the system applies the balance to the next open purchase order for the supplier.

12.4.1.1 Entering Cascading Receipt Information

You cannot use the cascading receipts process for receiving quantity into multiple locations.

As the system satisfies each purchase order line with a quantity, the system updates the Rec Opt field with a value of **1** (receive purchase order line) and continues satisfying purchase order lines until satisfying the total quantity of units to receive. If the number of purchase order lines exceeds the grid's capacity, then after the system satisfies all purchase order lines in the grid, the system provides you with a warning message that indicates the quantity that you have received thus far and instructs you on how to scroll down to the next series of purchase order lines in the grid and continue the cascade receipts process.

12.4.1.2 Assigning Items to Multiple Locations and Lots

If you work in an inventory environment, you must assign items to a storage location at the time of receipt. The system assigns an item to its primary location unless you specify otherwise. If a receipt quantity exceeds the limit for a location, you can assign the items to multiple locations. For example, if you receive 100 pens, you can assign 50 to one location and 50 to another location.

You can assign a lot number to each order that you receive. You can also assign multiple lots to an order. For example, if you receive a large quantity of batteries, you can assign them all to one lot or you can assign them to different lots based on their expiration dates.

12.4.1.3 Assigning Serial Numbers

To monitor individual items, you can assign each item a serial number. You must assign unique serial numbers to items for which you have specified advanced serial number processing in item master information. For example, if you receive televisions, you must assign a unique serial number to each television that you receive.

The quantities that you enter cannot exceed the total quantity on the detail line. The system replaces the single detail line on Purchase Order Receipts with a detail line for each quantity that you specified on Select Multiple Locations.

12.4.1.4 Reversing a Receipt

You can reverse a receipt as long as you have not yet created a voucher for the receipt. You might need to do this if you recorded a receipt by mistake or you recorded the wrong receipt. If the order has been vouchered, the voucher must be reversed first in order to reverse the receipt.

If you are reversing a receipt for an item that goes through a receipt routing process, you must move it back to the first operation in the route before you can reverse the receipt. You must also reverse all dispositions.

When you reverse a receipt, the system accounts for the order as if it were never received. It reverses all accounting and inventory transactions.

12.4.1.5 Service Units for A/P Matching

You can enter service unit information for services purchase order lines during the purchase order receipt process. Service units are informational only so the system does not perform any validation against the values.

You activate service units by selecting the Procurement Allow Service Units option on the Line Type Constants Revisions form. The system validates that the service units field is checked for inventory interface A and B only.

If the Display Service Units processing option on the Display tab of the Purchase Receipts Inquiry program (P43214) is set to display service units, then the system displays the Service Quantity and Service UoM fields on the Work With Purchase

Receipts form (W43214A). The service unit fields also display on the Purchase Receipt Detail (W43214F) and Purchase Receipt Detail - Supplier Self-Service (W43214G) forms instead of the Quantity Received and Trans UOM fields.

See [Setting Processing Options for PO Receipts \(P4312\)](#).

See [Service Units for A/P Matching](#).

See [Entering Receipt Information](#).

See [Defining Order Line Types](#).

See "Understanding Subcontract Order Detail Information, Service Units for A, P Matching" in the *JD Edwards EnterpriseOne Applications Subcontract Management Implementation Guide*.

12.4.1.6 Record Reservation (Release 9.1 Update)

The JD Edwards EnterpriseOne software provides record reservation capability within the Purchase Receipts Inquiry program (P43214). Record reservation helps to ensure the integrity of the data and prevent data loss. To avoid simultaneous processing of the same records, the system reserves (locks) records for processing by any other program. Thus, the system does not allow you to edit a record that has been locked by a different user or application.

When a program that uses record reservation is interrupted, orphaned reservation records might remain in the Business Object Reservation table (F00095). This can occur, for example, when technicians are working with a server, or when a workstation shuts down without warning. If an interruption stops one of the programs in the Purchase Receipts Inquiry program before it releases the reservations that it creates, you cannot update the records until the orphaned reservations are removed.

You can use the Remove Business Object Reservation program (P00095) to release unwanted record reservations. This program stores reservation information in the Business Object Reservation table (F00095).

12.4.1.7 Transaction Processing (Release 9.1 Update)

Transaction processing ensures data integrity for specific programs and tables. If a database error or server failure occurs while the system is committing records to the database, you must roll back all table updates related to the transactions from the database so that the system can maintain data integrity. Transaction processing enables the system to store data in a queue until issuing a commit command, at which time the system moves the data to the corresponding table.

The system creates boundaries for each process that is covered by transaction processing. A transaction boundary includes all data elements that constitute a transaction. When a database error or server failure occurs, the system generates a work flow message indicating that the system has returned to its original state before the failure occurred.

12.4.2 Prerequisites

Before you enter cascading receipts, in the PO Receipts program (P4312), you must:

- Set the processing option for the receiving mode, which is located on the Display tab, to 2 (receive by item).
- Ensure that the processing option for the receipt option default value, which is located on the Process tab, is blank.

- Set the appropriate processing options for cascading receipts and tolerance checking, which are located on the Cascade Receipts tab.

12.4.3 Forms Used to Enter Cascading Receipts

Form Name	Form ID	Navigation	Usage
Work With Purchase Orders to Receive	W4312F	Purchase Order Processing (G43A11), Enter Receipts by Item Purchase Order Processing (G43A11), Enter Receipts by PO	Enter cascading receipt information. Assign items to multiple locations and lots. Assign serial numbers. Work with purchase orders to receive.
Purchase Order Receipts	W4312A	Select a line on the Work With Purchase Orders to Receive form, and then click the Select button.	Perform tasks that are related to purchase order receipts.
Select Multiple Locations	W42053B	Select a detail line on the Purchase Order Receipts form, and then select Multiple Locations from the Row menu.	Select multiple locations.
Work With Purchase Receipts	W43214A	Receipts Matching and Posting (G43A15), Open Receipts by Supplier	Reverse a receipt. Work with purchase receipts.
Reversal Verification	W43214H	Select a receipt on the Work With Purchase Receipts form, select Reverse Receipt from the Row menu, and then click Confirm Reversal.	Verify the reversal of a receipt.

12.4.4 Entering Cascading Receipt Information

Access the Purchase Order Receipts form.

Container I.D. (container identifier)

Enter a code on the container or a code that you assign to the container in which the items on this purchase order or order line were shipped to you. You can assign container information to an order during receipts entry.

Supplier Remark

Enter any pertinent information. This is a free-form field.

12.4.5 Assigning Items to Multiple Locations and Lots

Access the Work With Purchase Orders to Receive form.

12.4.6 Assigning Serial Numbers

Access the Work With Purchase Orders to Receive form.

12.4.7 Setting Processing Options for Purchase Receipts Inquiry (P43214)

Processing options enable you to specify the default processing for programs and reports.

12.4.7.1 Defaults

These processing options enable you to enter default information that the system uses for Purchase Receipts Inquiry.

1. Order Type

Enter a value from UDC 00/DT that identifies the type of document. This code also indicates the origin of the transaction. JD Edwards EnterpriseOne has reserved document type codes for vouchers, invoices, receipts, and time sheets, which create automatic offset entries during the post program. (These entries are not self-balancing when you originally enter them.) These document types are defined by JD Edwards EnterpriseOne and should not be changed:

P: Accounts Payable documents

R: Accounts Receivable documents

T: Payroll documents

I: Inventory documents

O: Purchase Order Processing documents

J: General Accounting/Joint Interest Billing documents

S: Sales Order Processing documents

2. Currency Code

Enter a code that identifies the currency of a transaction.

12.4.7.2 Display

This processing option enables you to work with service units.

1. Display Service Units

Specify whether the system displays the Service Quantity and Service UoM fields in the grid on the form. This processing option is used with line type constants. If the Procurement Allow Service Units option is selected on the line type constants, then service quantity and service UOM can be used. The Ordered Quantity and Service Quantity fields cannot be used together. Service quantity is a memo field and does not have any validation. Values are:

Blank: Do not display

1: Display

12.4.7.3 Versions

These processing options control which version of various programs the system uses.

1. PO Inquiry (P4310)

Specify the version that the system uses when you use the PO Inquiry program.

2. A/P Ledger Inquiry (P0411)

Specify the version that the system uses when you use the A/P Ledger Inquiry program.

3. Receipt Reversal (P4312)

Specify the version that the system uses when you use the Receipt Reversal program.

4. Receipt Routing Movement (P43250)

Specify the version that the system uses when you use the Receipt Routing Movement program.

5. Landed Cost Selection (P43291)

Specify the version that the system uses when you use the Landed Cost Selection program.

6. General Ledger Post (R09801)

Specify the version of the General Ledger Post Report program (R09801) to use for automatic posting of the general ledger batch. If you leave this processing option blank, the system uses the ZJDE0009 version.

12.4.7.4 Process

These processing options control how the system processes information.

1. Allow reversals/Apply landed cost

Specify whether the system allows reversals or applies landed cost. Values are:

- 1: Allow reversals.
- 2: Apply landed cost.

2. Allow negative on-hand quantity

Specify whether the system will continue processing an order if negative on-hand quantity occurs upon receipt reversal. Values are:

Blank: The system will issue a warning if on-hand quantity is negative upon receipt reversal. The system will continue to process the order with the negative on-hand quantity.

1: The system will issue an error message if on-hand quantity is negative upon receipt reversal. The system will not allow the processing of the reversal.

3. Activate Automatic G/L Batch Posting

Specify whether to enable the automatic posting of General Ledger batches when the program closes. Values are:

- Blank: Manual post. Do not automatically post batch.
- 1: Auto post. Automatically post batch.

4. Apply Landed Cost to Partially Stocked quantities of Partially Received quantities with Routing turned on

Specify whether the system applies landed cost to partially stocked quantities of partially received quantities with routing turned on. Values are:

- Blank: Do not apply.
- 1: Apply.

You set this processing option on only when applying landed cost to quantities partially received into routing and partially moved into stock.

Before turning this processing option on, specific conditions must be met. You use this processing option for a special case where first a partial receipt is made with receipt routing turned on, and then quantities are partially moved to stock.

If this processing option is set to 1, then the Apply Landed Cost to Partially Stocked quantities of Partially Received quantities with Routing turned on processing option on the Process tab of the Purchase Receipts Inquiry program (P43214) must also be set to 1.

Note:

- Use this processing option only when applying standalone landed cost using the Purchase Receipts Inquiry program based on the conditions outlined above.
- Do not apply blind landed cost with this processing option set to 1.
- Use this processing option for partially received quantities only.
- Apply landed cost to the quantities that are moved to stock.
- Set this processing option to blank (off) if the above conditions are not satisfied and the system will work normally.
- Use of this processing option may result in some performance deterioration.

5. Production Number On Hand Consumption

Specify how the Purchase Receipts Inquiry program (P43214) selects production number on hand quantity from the Item Location Tag File table (F41021T).

Production number on hand is consumed whenever on hand quantity is not available to continue the transaction.

If you process inventory selection blindly, then the system consumes production number on hand quantity in the following order:

1. Generic inventory.
2. Inactive production numbers.
3. Orphaned production numbers.
4. Production number with the farthest end item demand date.

If you process inventory selection interactively, then you can select the production number from the options available on the Select Inventory for Consumption form (W42054A). Values are:

Blank: The program performs blind selection of inventory.

1: The program enables interactive selection of inventory.

12.4.7.5 Landed Cost

This processing option enables you to work with landed costs.

1. Journal entries

Specify how journal entries are written for landed cost. Value are:

Blank: Journal entries are written in detail.

1: Journal entries are summarized.

12.4.7.6 Self-Service

This processing option enables you to select self-service functionality.

1. Supplier Self-Service

Specify the activation of Supplier Self-Service for use in a Java/HTML environment. This functionality enables suppliers to view their receipts online. Values are:

Blank: Do not activate Supplier Self-Service.

1: Activate Supplier Self-Service.

12.4.8 Reversing a Receipt

Access the Work With Purchase Receipts form.

12.5 Reviewing Journal Entries for Receipt Transactions

This section provides an overview of journal entry review for receipt transactions and discusses how to:

- Review journal entries for receipt transactions.
- Post receipts.

12.5.1 Understanding Journal Entry Review for Receipt Transactions

The system creates journal entries each time you enter or reverse a receipt. You can review the journal entries for accuracy and then post them to the general ledger.

When you enter a formal receipt, the system creates journal entries that:

- Debit an inventory account if it is a stocked line, otherwise debit the general ledger account.
- Credit a received not vouchered account.

The system retrieves account numbers for which to create journal entries from AAIs. A separate AAI table exists for inventory accounts and received not vouchered accounts. The system retrieves an account number from each table based on the company, business unit, and general ledger category code that applies to a receipt.

For example, you enter a receipt for 100.00 worth of inventory items. The items have a general ledger category code of IN20 and were purchased for business unit A in company 100. When you enter a receipt, the system retrieves the inventory account number and the received not vouchered account number for company 100, business unit A, and the IN20 general ledger category code to create the journal entries.

If you enter purchase order detail lines by account number, the system charges each receipt against the account number on the detail line. The system retrieves a received not vouchered account number from AAIs.

If tax is applicable to a receipt, the system also creates tax accrual entries. If you apply landed costs at the time of receipt, the system creates entries for accrued landed costs.

You might use a standard cost method to determine the inventory cost for an item. The standard cost for an item remains consistent unless you manually change it. If a variance exists between the standard cost and the price at which you purchase an item, the system creates journal entries to account for the variance. You specify variance accounts in AAIs.

You use processing options to specify whether the system creates separate journal entries for each detail line or summarizes the entries for all lines.

When you reverse a receipt, the system automatically reverses the corresponding journal entries.

12.5.2 Reviewing Journal Entries for Receipt Transactions

Select Receipts Matching and Posting (G43A15), Review G/L Receipts Journal.

12.5.3 Posting Receipts

To post receipts, select Receipts Matching and Posting (G43A15), G/L Receipt Post.

After you review journal entries, you can post them to the general ledger using the General Ledger Post program (R09801).

When you run the General Ledger Post program, the system performs these processes:

- Selects qualified batches of unposted transactions from the F0911 table.
- Edits and verifies each transaction.
- Posts accepted transactions to the F0902 table.
- Marks each transaction and batch header as posted in the F0911 table and the F0011 table.
- Updates the amount relieved in the F4311 table for nonstock items.

See Also:

- "Setting Processing Options for General Ledger Post (R09801)" in the *JD Edwards EnterpriseOne Applications Financial Management Fundamentals Implementation Guide*.

12.6 Printing Receipt Information

This section provides an overview of receipt information printouts and discusses how to:

- Print open orders.
- Print the status of open orders.
- Set processing options for Open Purchase Order Status (R43525).
- Print receipt information by supplier.

12.6.1 Understanding Receipt Information Printouts

You can print receipt information that is specific to purchase orders, suppliers, business units, and so forth.

You can print the Open Purchase Order Status report to review purchase orders containing items that are overdue. For each purchase order that you specify, you can review this detail line information:

- Original order quantity.
- Received quantity.
- Quantity open to receive.
- Days overdue.

Information for this report prints in this order:

- User ID
- Supplier

- Order number
- Line number

A total open amount is provided for:

- Each purchase order
- Each supplier
- Each user
- The entire report

12.6.2 Printing Open Orders

Select Purchasing Reports (G43A111), Print Open Purchase Orders.

You can print a list of all suppliers from whom you have a specific item on order. You can review the order quantity and the quantity and amount that are left to receive from each supplier. You can also use the Open POs by Item report to review open order information for specific items or account numbers, or to review the dates when you expect to receive items.

12.6.3 Printing the Status of Open Orders

Select Purchasing Reports (G43A111), Open Purchase Order Status.

12.6.4 Setting Processing Options for Open Purchase Order Status (R43525)

Processing options enable you to specify the default processing for programs and reports.

12.6.4.1 Print

This processing option enables you to enter the as-of date for the report.

1. Enter the "As Of" Date for the report. This date will determine the days overdue and will be used for thru-date processing

Enter the as-of date, which determines the days overdue and is used by the system for through date processing.

12.6.5 Printing Receipt Information by Supplier

Select Purchasing Reports (G43A111), Inventory Receipts Register.

You can print the Inventory Receipts Register report to review all items that you have received from a supplier. This report contains the following information for each detail line that pertains to a supplier:

- Item number or account number.
- Date that the order was received.
- Received quantity and amount.

In an inventory environment, you can use this report as a receipt traveler document, which you can attach to items so that personnel in the warehouse can reference receipt information. In this case, only the detail line that pertains to a specific receipt appears on the report.

Creating Vouchers

This chapter contains the following topics:

- [Section 13.1, "Understanding Voucher Creation"](#)
- [Section 13.2, "Reviewing Open Receipts"](#)
- [Section 13.3, "Entering Landed Costs"](#)
- [Section 13.4, "Creating Vouchers"](#)
- [Section 13.5, "Working with Retainage"](#)
- [Section 13.6, "Creating Multiple Vouchers from Receipt Records"](#)
- [Section 13.7, "Logging Invoices Before Receiving Goods"](#)
- [Section 13.8, "Printing Voucher Information"](#)

13.1 Understanding Voucher Creation

This section lists a prerequisite and discusses voucher creation.

13.1.1 Prerequisite

Set up accounts payable payment processing.

See "Entering Supplier Information, Understanding Supplier Master Information" in the *JD Edwards EnterpriseOne Applications Accounts Payable Implementation Guide*.

13.1.2 Voucher Creation

Before you can pay a supplier for the goods and services you purchase, you must create a voucher that:

- Indicates that the terms of a transaction are met.
- Specifies the amount to pay to the supplier.
- Notifies the Accounts Payable system to cut a check.

You can create a voucher based on an invoice and receipts. This method is called the three-way voucher match. You use this method to verify that invoice information corresponds to the receipt records. For example, if a supplier bills you for 100.00 worth of goods, you must verify that you received 100.00 worth of goods.

If you do not record receipt information, you can use the two-way voucher match. You use this method to verify that invoice information corresponds to purchase order detail lines and then you create vouchers.

You can also create vouchers:

- In batch mode using only receipt information.

You use this method when you have an agreement with suppliers that the receipt records are sufficient for creating vouchers and that invoices are unnecessary. For example, if receipt records indicate that you received 100.00 worth of goods, the system creates a voucher for 100.00 worth of goods.

- For withholding a portion of the gross payment as retainage.

Retainage is a percentage of a committed amount that is held until a specified date after the order is complete. For example, if you create a voucher for 100.00 with retainage of 10 percent, the actual payment will be 90.00, with 10.00 held as retainage. You release retainage by entering a payment voucher for the amount that you want to release.

See [Working with Retainage](#).

- To make progress payments on an order.
- For units if you are paying against a unit based order.

In a unit-based order, you specify payments based on the number of units completed. You should enter either the number of units for which you are paying or the gross payment. The system then calculates the other value based on the price per unit.

You can review the receipt records for which you must create vouchers. After you locate this information, you can enter landed costs (costs in excess of an item's purchase price) for the items you have received.

If you receive an invoice before you take receipt of the goods and services, you can create a preliminary voucher to account for the billing amount. After you receive the goods or services on the invoice, you can redistribute the amounts to the appropriate general ledger accounts.

13.2 Reviewing Open Receipts

This section provides an overview of open-receipts review and discusses how to review open receipts.

13.2.1 Understanding Open-Receipts Review

You can review open receipts, which are receipts for which you have not yet created vouchers. You might do this to determine the receipts for which you must create vouchers. You can review the amount and quantity open for each receipt.

If you need to check an order to see whether any vouchers have already been created, you can use the Vouchered option on the Work With Purchase Receipts form to search for order detail lines for which a voucher has been created. The system displays the order detail lines with the quantity and amount that are entered on the voucher.

See Also:

- [Setting Processing Options for Purchase Receipts Inquiry \(P43214\)](#).

13.2.2 Form Used to Review Open Receipts

Form Name	Form ID	Navigation	Usage
Work With Purchase Receipts	W43214A	Receipts Matching and Posting (G43A15), Open Receipts by Supplier	Review open receipts.

13.2.3 Reviewing Open Receipts

Access the Work With Purchase Receipts form.

Quantity Not Vouchered

Displays the original quantity for the order detail line, plus or minus any changes to that quantity, minus all quantities shipped, received, and vouchered to date.

Amount Not Vouchered

Displays the amount of the order, invoice, or voucher that is still unpaid or open.

When you enter a document (for example, an order, invoice, or voucher), the open amount is the original amount of that document. If you change the original amount, the open amount is reduced by the net change. For example, payments, shipments, or receipts against a document result in a reduction of the open balance.

13.3 Entering Landed Costs

When you purchase items, it is not uncommon to pay extra costs for delivery fees, harbor fees, broker fees, import taxes and so on. These costs are called landed costs. You can enter landed costs for items during the receipt process or as a stand-alone process.

This section provides overviews of landed cost entry during the receipt process and landed cost entry as a stand-alone process, lists prerequisites, and discusses how to:

- Set processing options for Landed Cost Selection (P43291).
- Enter landed costs.

See Also:

- "Entering Landed Costs and Freight Notes for Brazil" in the *JD Edwards EnterpriseOne Applications Localizations for Brazil Implementation Guide*.

13.3.1 Understanding Landed Cost Entry During the Receipt Process

You can enter landed costs when you enter receipt information. You might use this process if landed cost information is available to you when you receive items.

To enter landed costs during the receipt process, you must set the Landed Costs processing option in Purchase Order Receipts (P4312) to apply landed costs. After you enter a receipt, the system displays the landed costs that apply to the items so that you can review or change the costs.

You also can set the Landed Costs processing option in Purchase Order Receipts (P4312) to automatically apply the landed cost rule without displaying the Landed Cost Selection form.

When landed cost is enabled during the purchase order receipt process, landed cost writes general ledger records. The use of service units for A/P matching does not change the landed cost functionality.

See "Understanding Subcontract Vouchers, Service Units for A, P Matching" in the *JD Edwards EnterpriseOne Applications Subcontract Management Implementation Guide*.

13.3.1.1 Record Reservation (Release 9.1 Update)

The JD Edwards EnterpriseOne software provides record reservation capability within the Landed Cost Selection program (P43291). Record reservation helps to ensure the integrity of the data and prevent data loss. To avoid simultaneous processing of the same records, the system reserves (locks) records for processing by any other program. Thus, the system does not allow you to edit a record that has been locked by a different user or application.

When a program that uses record reservation is interrupted, orphaned reservation records might remain in the Business Object Reservation table (F00095). This can occur, for example, when technicians are working with a server, or when a workstation shuts down without warning. If an interruption stops one of the programs in the Landed Cost Selection program before it releases the reservations that it creates, you cannot update the records until the orphaned reservations are removed.

You can use the Remove Business Object Reservation program (P00095) to release unwanted record reservations. This program stores reservation information in the Business Object Reservation table (F00095).

The JD Edwards EnterpriseOne software provides an additional feature to enable record reservation based on the item and branch/plant combination for the P43291 program when it is used along with the PO Receipts program (P4312). When a user attempts to receive an order with the same item and branch/plant combination, the system generates an error if the record is already reserved by another user.

To activate this additional record reservation feature, you must define a UDC code P4312LCRR in UDC (00/RR), with the Special Handling Code field set to 1. You must also set the Landed Costs processing option for the PO Receipts program (P4312) to 1.

Note: If two or more users attempt to receive an order with the same item and branch/plant combination at the same time, one or more of the users may get a transaction error.

13.3.2 Understanding Landed Cost Entry as a Stand-Alone Process

You might enter landed costs as a stand-alone process if landed cost information is not available to you upon receipt of an item. You can access the Stand-Alone Landed Cost option from the Receipts Matching and Posting (G43A15) menu.

Landed costs are only applicable to items for which you record receipt information. When you enter landed costs for items, the system only allows you to work with the landed costs that have been set up and assigned to the item. For each item you receive, you can review, change, and enter the landed costs assigned to the item.

After you enter landed costs for items, the system might create a separate landed cost detail line for which you must create a voucher. Whether you must create this additional voucher depends on how you set up each landed cost. You can review landed cost detail lines on the Voucher Match form.

When landed cost is enabled during the purchase order receipts process, landed cost writes general ledger records. The use of service units for A/P matching does not change the landed cost functionality.

See "Understanding Subcontract Vouchers, Service Units for A, P Matching" in the *JD Edwards EnterpriseOne Applications Subcontract Management Implementation Guide*.

When you enter landed costs, you also can run the Copy Cost Components program (R41891), which copies simulated or frozen cost information from the F30026 table to the F41291 table.

13.3.3 Prerequisites

Before you enter landed costs, you must:

- Define landed costs and landed costs rules in the Landed Cost Revisions program (P41291).
- Assign landed cost rules to items, purchase orders, or detail lines, as necessary.
- Verify that processing options are set appropriately for the program in which you enter landed costs.

13.3.4 Form Used to Enter Landed Costs

Form Name	Form ID	Navigation	Usage
Landed Cost Selection	W43291A	Receipts Matching and Posting (G43A15), Stand-Alone Landed Cost Select a receipt record on the Work With Purchase Receipts form, and then select Apply Landed Cost from the Row menu.	Enter landed costs.

13.3.5 Setting Processing Options for Landed Cost Selection (P43291)

Processing options enable you to specify the default processing for programs and reports.

13.3.5.1 Flex Account

This processing option enables you to specify flex account processing.

1. Flex Accounting

Specify the activation of flex accounting. Values are:

Blank: Flex accounting will not be used.

1: Flex accounting will be used.

13.3.5.2 Process

1. Apply Landed Cost to Partially Stocked quantities of Partially Received quantities with Routing turned on

Specify whether the system applies landed cost to partially stocked quantities of partially received quantities with routing turned on. Values are:

Blank: Do not apply.

1: Apply.

You set this processing option on only when applying landed cost to quantities partially received into routing and partially moved into stock.

Before turning this processing option on, specific conditions must be met. You use this processing option for a special case where first a partial receipt is made with receipt routing turned on, and then quantities are partially moved to stock.

If this processing option is set to 1, then the Apply Landed Cost to Partially Stocked quantities of Partially Received quantities with Routing turned on processing option on the Process tab of the Purchase Receipts Inquiry program (P43214) must also be set to 1.

Note:

- Use this processing option only when applying standalone landed cost using the Purchase Receipts Inquiry program based on the conditions outlined above.
- Do not apply blind landed cost with this processing option set to 1.
- Use this processing option for partially received quantities only.
- Apply landed cost to the quantities that are moved to stock.
- Set this processing option to blank (off) if the above conditions are not satisfied and the system will work normally.
- Use of this processing option may result in some performance deterioration.

13.3.6 Entering Landed Costs

Access the Landed Cost Selection form.

13.4 Creating Vouchers

This section provides overviews of voucher creation and management of invoices received in an alternate currency, lists prerequisites, and discusses how to:

- Set processing options for A/P Standard Voucher Creation Entry (P0411).
- Set processing options for Voucher Match (P4314).
- Set processing options for Freight Distribution (P43147).
- Select receipt records to match to a voucher.
- Select order detail lines to match to a voucher.
- Select order detail lines for freight charges.
- Record cost changes to an invoice.

13.4.1 Understanding Voucher Creation

You must create a voucher before you can pay a supplier for purchases. You usually create a voucher for the billing amount on an invoice. Three-way voucher match and two-way voucher match are the two methods of creating a voucher.

Using the three-way voucher match method, you verify that a billing amount is correct by matching it to the receipt records. For example, if a supplier bills you for 10.00 worth of items, you can check the receipt records to see that you received 10.00 worth

of items. For the three-way voucher match (formal receipt process), you create a voucher from an invoice. You must locate the receipt records that correspond to the invoice and match them to the invoice. For example, if a supplier has sent you an invoice for 100.00, you must locate and match the receipt records for the 100.00 worth of items that correspond to the invoice. Note that you can select multiple receipt records to match on a single voucher.

Note (Release 9.1 Update): Invoice lines that are processed using the Voucher Match Automation process cannot be matched using the Voucher Match program (P4314).

See [Chapter 14, "Understanding the Voucher Match Automation Process \(Release 9.1 Update\)"](#)

The total amount of the receipt records you match to an invoice must equal the amount on the invoice. For example, if two receipt records correspond to an invoice and each receipt record is for 200.00, the invoice amount must equal 400.00 to perform a match.

If an invoice reflects a partial order, you can change the quantity or amount of a receipt record to match the invoice. The system leaves the remaining balance of the receipt record open. For example, if a receipt record reflects 100 items but the invoice amount reflects 50 items, you can change the receipt record quantity to 50. You can create a voucher for the remaining 50 items at a later time.

If you match receipt records to invoices to create vouchers, you cannot cancel a receipt record. Instead, you must reverse the voucher in Match Voucher to Open Receipt (P0411) and then reverse the receipt in Open Receipts by Supplier (P43214).

The system creates a voucher interactively when you match receipt records to an invoice.

Using the two-way voucher match method, you create a voucher from the order detail line. For example, you can make progress payments on a contract or an order.

You can create a voucher for units if you are paying against a unit based order. In a unit-based order, you specify payments based on the number of units completed. You should enter either the number of units for which you are paying or the units and gross payment together. The system then calculates the remaining value based on the price per unit.

For example, if you enter a voucher for 1000 square feet of drywall at a cost of 0.25 per square foot (Receipt or Order cost), the system calculates the gross payment as 250.00. Conversely, if you enter a voucher for 250.00 with 1000 units, the system calculates the unit price as 0.25.

If you have activated multicurrency, the system calculates the total values based on the currency that you select. For example, if you enter a voucher for 1000 units at 0.25 per unit, the system calculates the total payment in the currency you specify.

If you are entering a voucher for a kit, you can enter voucher information at the component level only.

You might need to reverse a voucher. For example, you might have to return the items for which you created the voucher.

You also might need to make a correction to an invoice adjustment that reflects a price change to an item or an error on a previous invoice. To make the change, you must create a new voucher that reflects the adjustment to the previous voucher.

For the two-way voucher match (informal receipt process), you do not record receipt information. You must match order detail lines to invoices to create vouchers. For example, if a supplier sends you an invoice for 100.00, you must locate and match the order detail lines that contain the corresponding 100.00 worth of items. Note that you can select multiple order detail lines to match on a single voucher.

When you add landed costs to receipt records before the voucher match process, the system might create separate detail lines for the landed costs depending on how you have set up the costs. To create a voucher for the landed costs, locate and match the landed cost line to the appropriate invoice.

You might receive an invoice for goods or services that were never entered on a purchase order. You can set processing options for the Voucher Match program (P4314) to allow you to enter new purchase order detail lines to match an invoice. The processing options enable you to indicate whether the system adds new lines to an existing purchase order (you specify the order number, order company, order type, and order change number) or create a new purchase order. The processing options also enable you to indicate the line type and status codes for new detail lines.

You must purchase against account numbers to enter new detail lines during the voucher match process. You cannot add stock-based order detail lines during the voucher match process.

When you try to create a voucher against an order line for which a receipt is required, you receive an error.

When you try to create a voucher against an order that has a payment hold, any of these might occur:

- You receive a soft warning, which indicates an outstanding log warning. You can enter and process payments as usual.
- The new payments automatically have a pay status of H, which indicates that the contract hold code automatically holds payments against an order. You must manually change each voucher to approved pay status.
- The system does not allow you to enter a payment voucher, which indicates that the vendor hold code for the supplier is set to not allow any payments.
- You cannot enter payment vouchers until the hold is removed.

You can also enter a specific tax amount for each receipt record on the Voucher Match form. If you enter a tax amount, you must also enter the tax rate/area and an explanation for the tax.

To account for variances in the exchange rate, you can set up automatic accounting instructions (AAIs). If you enter a new exchange rate during the voucher match process, the system creates journal entries to account for the variance between costs incurred at the old exchange rate and costs incurred at the new exchange rate.

You might receive an invoice adjustment that reflects a price change to an item or an error to a previous invoice. Typically, you make price changes for products such as gasoline or for other commodity items. For example, you receive an invoice for 100 items that cost 10.00 each and later receive another invoice that adjusts the cost of the items to 9.00 each. You can create a new voucher that reflects an adjustment to the previous voucher.

You can inquire upon and adjust multiple account distribution. You can use multiple account distribution functionality only for transactions with an inventory interface of A or B. A purchase order must have account distribution information set up before you can use the functionality during voucher matching.

During two-way voucher match, the system retrieves account distribution information from the F4316 table and creates records in the F43126 table. Then the system updates the F0911 table with amounts based on the account distribution. To summarize how tables are affected by multiple account distribution during two-way voucher match:

- F4311: The system updates records in this table.
- F4316: The system updates records in this table.
- F43121: The system writes records to this table.
- F43126: The system writes records to this table.
- F0911: The system writes records to this table.
- F0411: The system writes records to this table based on the F4311 table.

During three-way voucher match, the system creates vouchers based on the quantity or amount received, and creates or updates records in various tables. To summarize how tables are affected by multiple account distribution during three-way voucher match:

- F43121: The system writes records to and updates this table.
- F43126: The system writes records to and updates this table.
- F0911: The system writes records to this table.
- F0411: The system writes records to this table based on the F43121 table.

Regardless of whether you are performing two-way or three-way voucher match, the system creates general ledger entries for these based on the F4316 level or F43126 level:

- Amount to Voucher.
- Amount Variance (except Landed Costs).
- COGS Amount Variance.
- Exchange Variance.
- Tax Payable.
- Non-Recoverable Tax.
- Tax Variance.

Regardless of whether you are performing two-way or three-way voucher match, the system creates general ledger entries for these based on the F4311 level or F43121 level:

- Retainage Payable (using AAI PCRETN).
- Deferred VAT Payable (using AAI PCVATP).
- Deferred VAT Recoverable Tax (using AAI PCVATD).
- Landed Cost (using AAI 4385).

You can change account distribution information when you are performing voucher match by using the Account Distribution Adjustment program (P43146). However, you cannot change the distribution method (percent, amount, or quantity). You enter the distribution information for the new accounts and negate the distribution information in the original accounts. Note that for the new distribution accounts, the system does not write records to the F43126 table and to the F4316 table.

Note: If you add a new line during voucher match (for example, you might be charged for freight and add that cost as a new line), you cannot use multiple account distribution for the new line.

If the Display Service Units processing option on the Display tab of the P4314 program is selected, then the Service Quantity and Service UoM fields appear in both the header and the grid of the PO Multiple A/c Distribution form (W43146A).

See "Understanding Subcontract Vouchers, Service Units for A, P Matching" in the *JD Edwards EnterpriseOne Applications Subcontract Management Implementation Guide*.

13.4.1.1 Alternate Tax Rate/Area Assignment Functionality in the Voucher Match Program (Release 9.1 Update)

If the company of the voucher is set up to use the alternate tax rate/area assignment functionality.

On the Voucher Match form, the system retrieves the alternate tax rate/area when you complete the Supplier and Branch/Plant fields and the supplier and branch plant are set up to use the alternate tax rate/area assignment functionality.

The system completes the Tax Rate/Area of the Line Defaults with the alternate tax rate/area if it is enabled. If the functionality is not enabled, then the system uses the tax rate/area associated with the supplier. The system uses the line default value when you enter additional lines. If no default value exists in the Line Defaults and the line that you enter requires a tax rate/area, the system uses the tax rate/area of the previous line.

When you match receipts on the Receipt to Match or Order to Match forms, the system retrieves the tax rate/area from the original lines.

See Also:

"Setting Up Alternate Tax Rate/Area Assignment Functionality" in the *JD Edwards EnterpriseOne Applications Tax Processing Implementation Guide*.

"Procurement Management" in the *JD Edwards EnterpriseOne Applications Tax Processing Implementation Guide*.

13.4.1.2 Supplier Classification Codes

Classification codes capture information about a supplier in the supplier's address book record in the JD Edwards EnterpriseOne Address Book system. At the time a voucher is created, the classification code fields are populated from the supplier's address book record in order to report vendor information at the time of payment.

The classification codes are display-only on the Voucher Match form (W4314A). The classification code field values are not written to the Purchase Order Receiver table (F43121).

The supplier information is then passed to the accounts payable ledger record, where the values are stored in the Accounts Payable Ledger table (F0411).

See [Entering Additional Order Header Information](#).

13.4.1.3 Retention

Subcontract retention is the percentage of a committed amount that is held until a specified date after the order is complete. Retention processing applies to ongoing projects and only applies to inventory interface of A and B.

See [Working with Retainage](#).

13.4.1.4 Expense at Voucher Match

In a commercial, cost-reimbursable, project-related environment, the assumption is that an expense will be included on the next invoice to the client as soon as an expense is posted to the project. This expense must also be paid to the vendor in a timely fashion. Because payments depend on the vendor invoice, not the receipt of the goods, the expense cannot be billed until the vendor invoice is received. When receipts are created, the amounts should not be posted to the expense account but must be postponed and then expensed at voucher match.

To postpone expensing until the time of voucher match, you select Expense At Voucher on the Line Type Constants Revisions form (W40205B) in the Line Type Constants program (P40205). You set this option for inventory interfaces A and B only. When this option is set, journal entries will not be created for the received goods or service during the purchase order receipts process. Only voucher match will post the amounts to the expense accounts on the purchase order.

If Expense At Voucher is selected in Line Type Constants (P40205), then you must also select A/P Interface. The A/P Interface is a code that indicates that the system reflects the monetary or unit value of any activity containing this order type in Accounts Payable.

You may also select Voucher Match Variance Account on the Line Type Constants Revisions form to indicate the account to which the system books a variance. This field is used with an inventory interface of A or B only.

When you perform two- or three-way match, you use purchase order receipts to perform a physical receipt of the service line or item on the order. The PO Receipts program does not update the expense or received not vouchered (RNV) accounts.

The Expense At Voucher option is not related to the Procurement Receipt Required option. If Expense At Voucher is selected and Procurement Receipt Required is cleared on the Line Type Constants Revisions form, then you may or may not create a receipt. If the receipt process is performed, then expensing is postponed until voucher match. Thus, receipts do not create any journal entries. If the receipt process is not performed, then the standard two-way voucher match will occur.

After you receive the invoice from the supplier, you perform voucher match, which updates the expense and AP Trade accounts. The system does not create an RNV entry (AAI 4320) for this line during voucher match. The system performs commitment relief as well as the following calculations:

$$(\text{Expense}) = (\text{Debit Receipt Amount})$$

$$(\text{Variance (or Expense)}) = (\text{Debit Variance Amount})$$

$$(\text{AP Trade}) = (\text{Voucher Amount})$$

When you are performing voucher match on a purchase order line, the receipt amount is booked to the expense account. Based on the Voucher Match Variance Account setting in Line Type Constants, the variance (if any) will be booked either to the expense accounts on the purchase order or to the variance accounts (AAIs 4330 and 4340). The AP Trade account is credited with the voucher amount.

When landed cost is enable during the purchase order receipt process, landed cost writes general ledger records. The use of service units for A/P matching does not change the landed cost functionality.

Note: Landed costs are not affected if Expense At Voucher is selected; thus, the accounts for AAIs 4385 and 4390 are created during the receipt process.

Note: If Receipt Routing is selected and the order is set up to go into route, a hard error will be issued.

See [Defining Order Line Types](#).

See [Entering Receipt Information](#).

13.4.1.5 Service Units for A/P Matching

You can enter service unit information for services purchase order lines during the voucher match process. Service units are informational only, so the system does not perform any validation against the values.

Service units must be activated by selecting the Procurement Allow Service Units option on the Line Type Constants Revisions form. The system validates that the service units flag is selected for noninventory interface A and B only.

Select the Display Service Units processing option on the Display tab of the P4314 processing options.

If the processing option is selected, the Service Quantity and Service UoM fields appear on the Voucher Match Header (W4314A), Receipt to Match (W4314B), Orders to Match (W4314C), and Voucher Match Reversal (W4314H) forms. Although both the Service Quantity and Original Quantity fields are shown on the voucher match forms, you cannot use both fields for a line.

See [Defining Order Line Types](#).

See "Understanding Subcontract Order Detail Information, Service Units for A, P Matching" in the *JD Edwards EnterpriseOne Applications Subcontract Management Implementation Guide*.

See [Entering Detail Lines by Item Number](#).

See [Setting Processing Options for Voucher Match \(P4314\)](#).

13.4.1.6 Freight Vouchering

Typically, freight charges are spread only to inventory line items because calculation of freight is based on item characteristics such as weight or volume. However, freight charges can also be charged to nonstock items and service lines. You spread invoiced transportation freight charges from the supplier to the appropriate services lines so that each nonstock line absorbs a proportion of the overall transportation cost associated with the service.

When vouchering during two- or three-way voucher match, you apply the freight charges proportionately to those lines to which freight applies. You distribute freight charges from a supplier to different general ledger accounts for lines with an inventory interface of A and B only. You determine the amount to assign to the job of each line that you can distribute by percentage or amount. You use either the same job and

account code as the base charge or the same job as the base charge with a different object account code from the base charge.

On the Voucher Match program (P4314), select the Freight Distribution (P43147) processing option on the Versions tab to call a version of the Freight Distribution program (P43147). Also, set the processing options on the Freight Distribution tab.

Set the processing options for the version of P43147 called by P4314.

During voucher match, select 5 in the OP (match processing) field (from UDC 43/VM) on the Voucher Match form to enable freight distribution on the line.

The Freight Distribution program is called dynamically when the line is exited for any changes made to the freight line. You can also select Distribute Freight on the Row menu to call the Freight Distribution program.

The Freight Distribution program enables you to distribute the freight charge that is created during voucher match and allocate the amounts to the jobs of existing lines on the voucher. The system displays existing voucher lines of inventory interface A and B.

A freight distribution line with inventory interface of A does not allow a quantity for the line. You must enter an amount and a valid account number. The supplier number for the voucher is used for the freight line.

On the Freight Distribution Revision form (W43147A), you select to distribute by percentage or amount. For a multiple account distribution line, the parent line (from the F4311 table) is not displayed but the multiple account lines (from the F4316 table) are displayed.

When you exit a detail line, the Distributed and Remaining field values are recalculated. The total amount must either equal zero or equal the amount on the line from voucher match.

The freight account, either the account on the line or the account determined by the financial AAI, appears in the grid. You cannot override this account on the form.

Note: The system uses financial AAI PCFRD for freight distribution.

If you return to the Voucher Match form and change the amount on the voucher line, then you have to return to the Freight Distribution Revisions form to modify the amounts if distributing by amount. You can also return to the Freight Distribution Revisions form to make overrides.

If you return to the Voucher Match form and select additional lines for vouchering, the system assigns zero amounts to the lines. You must manually modify the amount or percentage for these lines using the Freight Distribution Revisions form.

The Freight Distribution workfile record (F43147) is deleted at the completion of the transaction. Purchase Order Detail File (F4311) records are not created for the freight line during voucher match. The system creates general ledger and accounts payable records.

Taxes are allowed for a freight line.

The following functionality is not supported when you are using freight distribution:

- Service units for accounts payable matching.
- Retainage.
- Landed cost.

To perform a voucher match reversal for a line with a 5 in the OP field, you must manually remove the record from the F0911 table. You cannot perform a reversal at shipment confirmation.

See [Understanding AAI Tables for the Financial System](#).

See "Selecting Order Detail Lines for Freight Vouchering" in the *JD Edwards EnterpriseOne Applications Subcontract Management Implementation Guide*.

13.4.2 Understanding Management of Invoices Received in an Alternate Currency

If you enter a purchase order in a domestic or foreign currency and the supplier submits an invoice in an alternate currency, you cannot automatically match the domestic or foreign purchase order to the invoice. Instead, you must manually convert the alternate currency invoice amount to the domestic or foreign currency and then enter the voucher with that (domestic or foreign currency) amount.

For example, if a French company enters an order in Canadian dollars (CAD) and the supplier submits the invoice in Japanese yen (JPY), you must manually convert the invoice amount to the domestic (EUR) or foreign (CAD) currency and then enter the voucher for that amount. Likewise, if a Canadian company enters an order in Japanese yen and the supplier submits the invoice in U.S. dollars, you must manually convert the invoice amount to CAD or JPY and then enter the voucher for that amount.

For future transactions, consider changing the currency code on the supplier master record so that orders, vouchers, and payments for the supplier are processed using the alternate currency.

13.4.3 Prerequisites

Before you complete the tasks in this section:

- Review all processing options for Standard Voucher Entry and Voucher Match.
- Specify the voucher match version.
- Set up financial AAI PCFRTD to support freight vouchering.

13.4.4 Forms Used to Create Vouchers

Form Name	Form ID	Navigation	Usage
Supplier Ledger Inquiry	W0411G	Receipts Matching and Posting (G43A15), Match Voucher to Open Receipt	Select records and order detail lines to match to a voucher. If you use Match Voucher to Open Receipt, you must set processing options to perform voucher match processing.
Voucher Match	W4314A	Click the Add button on the Supplier Ledger Inquiry form.	Select records and order detail lines to match to a voucher. View supplier classification codes on the Supplier Classification Codes tab.

Form Name	Form ID	Navigation	Usage
Select Receipts to Match	W4314B	Select Receipts to Match from the Form menu on the Voucher Match form.	Select records to match to a voucher.
Select Orders To Match	W4314C	Select Orders To Match from the Form menu on the Voucher Match form.	Select order detail lines to match to a voucher.
Work With Freight Audit History	W4981A	Select Freight To Match from the Form menu on the Voucher Match form.	Select order detail lines for freight charges.
Account Distribution Adjustment	W43146A	Select Account Distribution from the Row menu on the Voucher Match form.	Change account distribution.
Freight Distribution Revisions	W43147B	Select a row with 5 in the OP field and then select Distribute Freight from the Row menu on the Voucher Match form. Alternatively, select 5 in the OP field and click off the row.	Enter freight distribution.
Recost Vouchers	W4314B	Select Recost Vouchers from the Form menu on the Voucher Match form.	Create a new voucher that reflects the cost difference between the original voucher and the new cost.

13.4.5 Setting Processing Options for A/P Standard Voucher Entry (P0411)

Processing options enable you to specify the default processing for programs and reports.

13.4.5.1 Display

These processing options enable you to specify how the system groups and displays Supplier Ledger Inquiry data.

1. Recurring Vouchers

Specify recurring vouchers as the default voucher type. Values are:

Blank: The system displays all vouchers (no default criteria).

1: The system displays only recurring vouchers.

When you enter **1**, the program places a check mark in the Recurring Vouchers option on the Supplier Ledger Inquiry form.

2. Summarized Vouchers

Specify whether vouchers appear with multiple pay items in a summarized, single pay item format. Values are:

Blank: The system displays all vouchers (no default criteria).

1: The system displays only summarized vouchers.

When you enter **1**, the program places a check mark in the Summarize option on the Supplier Ledger Inquiry form.

3. Display Domestic and Foreign

Specify whether the system displays both domestic and foreign amount fields in the detail areas of the Enter Voucher-Payment Information and MultiCompany-Single Supplier forms for voucher entry. Values are:

Blank: Do not display domestic and foreign amount fields.

1: Display domestic and foreign amount fields. These fields will appear on the form:

- Domestic Gross Amount
- Domestic Discount Available
- Domestic Taxable Amount
- Domestic Tax
- Domestic Non-Taxable
- Foreign Gross Amount
- Foreign Discount Available
- Foreign Taxable Amount
- Foreign Tax
- Foreign Non-Taxable

13.4.5.2 Currency

These processing options enable you to have the system display amounts in a currency other than the currency in which the amounts are stored on the system. These processing options enable you to view amounts in a different currency as a hypothetical scenario only; the amounts that appear in the different currency are not saved to the system when you exit the Standard Voucher Entry program.

1. As If Currency

Specify a currency in which to view domestic or foreign amounts when in a currency other than the currency in which the amounts were originally entered. Specify the currency code in which to view the as if currency. For example, to view domestic or foreign U.S. dollar amounts in the euro, specify **EUR**.

If you leave this processing option blank, the system does not display the As If Currency Code field in the header, nor does it display the As If Amount and As If Open Amount columns in the detail area.

As if currency amounts are stored in a temporary memory, and are not written to a table.

2. As Of Date

Specify an as of date for the As If Currency processing option. The system uses this date to retrieve the exchange rate from the F0015 table.

If you specify a currency code in the As If Currency processing option and leave this processing option blank, the system uses the system date.

A valid exchange rate between the domestic or foreign currency and the as if currency must exist in the F0015 table, based on the as of date.

13.4.5.3 Manual Payments

These processing options enable you to control the manual creation of payments.

1. Manual Payment Creation

Specify whether to generate manual payments instead of automatic payments. This option applies only to manual payments without voucher match and is not available in multi-company and multi-voucher modes. Values are:

Blank: The system displays no payment information.

1: Generate manual payments (without voucher match).

If you enter **1**, click Add on Supplier Ledger Inquiry. Then complete the Enter Voucher - Payment Information form, and click OK. Complete the Payment Information form for manual payment processing.

2. Duplicate Payments

Specify the type of message that appears when you attempt to generate or edit a duplicate payment number. Use this option only if you enter **1** for Manual Payment Creation. The message indicates that you have used that payment number previously. Values are:

Blank: Error

1: Warning

3. Automatic Payment Number Assignment

Specify whether to automatically assign payment numbers to manual payments based on the bank account's next number. Values are:

Blank: You manually assign payment numbers (default).

1: The system assigns payment numbers based on the bank account's next number.

13.4.5.4 Purchasing

This processing option enables you to define how the program processes vouchers that contain purchase order information.

1. Voucher Delete

Specify the type of message that appears when you attempt to delete vouchers that contain purchase order information. For example, indicate what the system does when you attempt to delete a voucher that contains a purchase order from the Supplier Ledger Inquiry form. Values are:

Blank: Do not permit editing (default).

1: Warning.

2: Error.

If a conflict exists between this processing option and the Voucher Message processing option for Voucher Entry MBF, the value set here overrides the value set in Voucher Message processing options.

13.4.5.5 Voucher Match

These processing options enable you to process matched vouchers from the JD Edwards EnterpriseOne Procurement system rather than standard vouchers.

1. Match Processing

Specify the voucher match program to run. If you run the voucher match program, you can select either the three-way voucher match or the two-way voucher match. Values are:

Blank: Run Standard Voucher Entry (P0411).

1: Run Voucher Match (P4314) in the JD Edwards EnterpriseOne Procurement system. Alternatively, on the Non-Stock PO Processing menu (G43B11), select one of these:

- Receive & Voucher POs.
- Match Voucher to Open Receipt.

The Voucher Match program (P4314) does not access the Master Business Function (MBF) processing options (P0400047). Therefore, the MBF processing option settings do not affect Voucher Match processing.

You might want to reverse a voucher. For example, you reverse a voucher when you return the items for which you created the voucher. If the voucher has been posted, the system reverses the corresponding journal entries. If the voucher has not been posted, the system deletes the entries.

Do not delete a voucher in the JD Edwards EnterpriseOne Accounts Payable system if you created the voucher in the JD Edwards EnterpriseOne Procurement system. The voucher should be deleted in the JD Edwards EnterpriseOne Procurement system.

2. Voucher Match Version

Enter a specific version number to override the default value for the Voucher Match program (P4314) in the JD Edwards EnterpriseOne Procurement system. You must complete this processing option if you enter 1 in the Match Processing processing option.

13.4.5.6 Multi Company

This processing option enables you to process vouchers for multiple companies rather than standard vouchers.

1. Multi-Company Single Supplier

Specify whether to process vouchers that represent expenses for multiple internal companies. These multi-company vouchers expenses are distributed to different general ledger and offset bank accounts, but to the same supplier. Values are:

Blank: Enter a standard voucher.

1: Enter a multi-company single supplier voucher.

The manual payment function is not available for this type of voucher processing.

Alternatively, access this processing option by choosing Multi-Company Single Supplier from the Other Voucher Entry Methods menu (G04111).

13.4.5.7 Multi Vouchers

This processing option enables you to enter multiple vouchers rather than standard vouchers.

1. Multiple Vouchers

Specify whether to enable entry of multiple vouchers for one or more suppliers. Unlike the standard voucher entry method, which is a two-step process, the multiple voucher entry methods are a single-step process. Values are:

Blank: Enter a standard voucher.

1: Enter multiple vouchers with a single supplier.

2: Enter multiple vouchers with multiple suppliers.

You can use the multiple-voucher entry methods to add vouchers only. To change, delete, or void them, you must use the standard voucher entry method.

Also, the manual payment function is not available for this type of voucher processing. For additional information, as well as other limitations to multiple voucher entry, consult the documentation or online help for Entering Multiple Vouchers.

Alternatively, access this processing option by choosing either Multi Voucher - Single Supplier or Multi Voucher - Multi Supplier from the Other Voucher Entry Methods menu (G04111).

13.4.5.8 Logging

These processing options enable you to enter logged vouchers rather than standard vouchers.

1. Voucher Logging

Specify whether to enter a voucher before you assign it a general ledger account. At a later time, you can redistribute the voucher to the correct general ledger accounts.

You can specify a default general ledger account for preliminary distribution, as well as a suspense trade account for logged vouchers. To do this, use automatic accounting instruction (AAI) PP (Preliminary Distribution for Voucher Logging) and PQ (Suspense A/P Trade Account for Voucher Logging). To use AAI PQ, select the Use Suspense Account option in the Company Names and Numbers program (P0010). From the Organization & Account menu (G09411), select Company Names and Numbers. Values are:

Blank: Enter a standard voucher (default).

1: Enter a logged voucher.

When you enter **1** in this processing option, the program adds a selected Logged option to the Supplier Ledger Inquiry form, and the program ignores the selections you make for Prepayments.

Alternatively, from the Other Voucher Entry Methods menu (G04111), select Voucher Logging Entry.

This processing option functions with the Voucher Logging processing option on the Logging tab of Voucher Entry MBF (P0400047). You must enter **1** in both Voucher Logging processing options for the system to process logged vouchers. If the Voucher Logging processing options for A/P Standard Voucher Entry and Voucher Entry MBF are set for logged vouchers, the system ignores the processing options on the Prepayments tab of A/P Standard Voucher Entry (P0411).

2. G/L Date (general ledger date)

Specify whether to use the system date as the default general ledger date for a logged voucher. Values are:

Blank: Enter date manually during the data entry process.

1: Use the system date as the default general ledger date.

If you enter **1** in this processing option, you cannot override the date, since you have designated the system date.

13.4.5.9 Prepayments

These processing options enable you to specify how the program processes prepayments. Use prepayments to pay for goods or services before you receive an invoice.

1. G/L Offset Account

Enter the code for the general ledger offset account that the system uses to create prepayment pay items. You must enter a value to allow automatic creation of prepayment pay items. If you leave this processing option blank (default), the system uses the Standard Voucher Entry program.

Use this processing option to set up AAIs (AAI item PCxxx) to predefine classes of automatic offset accounts for accounts.

For example, you can assign general ledger offsets as follows:

- Blank or 4110 - Trade Accounts Payable.
- RETN or 4120 - Retainage Payable.
- OTHR or 4230 - Other Accounts Payable (see accounts payable class code - APC).
- PREP or 4111 - Prepayment A/P Trade Account.

2. G/L Distribution Account

Specify the general ledger distribution account that the system uses for creating prepayment pay items.

You can use one of these formats for account numbers:

- Structured account (business unit.object.subsidiary).
- 25-digit unstructured number.
- 8-digit short account ID number.
- Speed code.

The first character of the account indicates the format of the account number.

You define the account format in the General Accounting Constants program (P000909).

Use this processing option only if you enter a value in the G/L Offset Account processing option.

3. Pay Status Code

Enter the default pay status code for prepayments. The pay status code is a user-defined code (UDC) (00/PS) that indicates the current payment status of a voucher. Values are:

P: The voucher is paid in full.

A: The voucher is approved for payment, but not yet paid. This applies to vouchers and automatic cash applications.

H: The voucher is on hold pending approval.

R: Retainage.

%: Withholding applies to the voucher.

?: Other codes. All other codes indicate reasons that the payment is being withheld.

The JD Edwards EnterpriseOne Accounts Payable system does not print payments for any codes other than the codes provided in this valid codes list.

Use this processing option only if you enter a value in the G/L Offset Account processing option.

4. Number of Days

Enter the number of days to add to the due date of the negative prepayment pay items.

5. Tax Area

Specify whether to display the Prepayment Tax form for prepayments. You use the Prepayment Tax form to assign tax codes to negative pay items that are different from the tax codes for the corresponding positive pay items. This is necessary, for example, when tax laws treat positive pay items and negative pay items differently. Otherwise, the system automatically generates a negative pay item for each positive pay item, assigning each negative pay item the same tax area code and tax explanation code as its corresponding positive pay item.

If you specify a tax area code and tax explanation code on the Prepayment Tax form, the new codes appear on all negative pay items, overriding the original tax area codes and tax explanation codes on the positive pay items. For example, if there are several positive pay items, each of which specify a different tax area code and tax explanation code, but you specify a particular tax area code and tax explanation code on the Prepayment Tax form, the system assigns the tax area code and tax explanation code you specify on the Prepayment Tax form to all negative pay items. Values are:

Blank: Do not display the Prepayment Tax form.

1: Display the Prepayment Tax form.

Use this processing option only if you enter a value in the G/L Offset Account processing option.

6. Prepayment Tax Area Code

Enter a default code that identifies a tax or geographic area that has common tax rates and tax distribution. The system uses this code to properly calculate the tax amount. The tax rate/area must be defined to include the tax authorities (for example, state, county, city, rapid transit district, or province), and their rates. To be valid, a code must be set up in the F4008 table.

Typically, U.S. sales and use taxes require multiple tax authorities per tax rate/area, whereas value-added tax (VAT) requires only one tax.

Use this processing option only if you enter **1** in the Tax Area processing option.

7. Prepayment Tax Explanation Code

Specify a default tax explanation code for transactions with a certain supplier. This tax explanation code is a UDC (00/EX) that controls how a tax is assessed and distributed to the general ledger revenue and expense accounts.

Use this processing option only if you enter **1** in the Tax Area processing option.

13.4.5.10 Versions

These processing options enable you to override the default Master Business Function and Journal Entry Master Business Function versions.

1. Voucher Master Business Function Version

Specify a version number to override Standard Voucher Entry processing (version ZJDE0001 for application P0400047).

2. Journal Entry Master Business Function Version

Specify a version number to override Journal Entry processing (version ZJDE0001 for application P0900049).

3. Pay When Paid Manual Link Version

Specify a version number for the Pay When Paid Manual Link application (version ZJDE0001 for application P03B470).

Blank: Use version number ZJDE0001 (default).

Or enter a specific version number.

Note: Only persons responsible for system-wide setup should change this version number.

4. Netting (P03B455) Version

Specify the version of Netting (P03B455) to use. If you leave this processing option blank, the system uses version ZJDE0002.

13.4.5.11 Process

These processing options enable you to restrict changes to vouchers when you use Supplier Ledger Inquiry and specify whether suppliers can view vouchers and payments.

1. Voucher Entry Mode

Specify whether the system allows changes to vouchers after you select them from the Supplier Ledger Inquiry form. If you leave this field blank, the system allows you to make changes to existing vouchers that you select from the Supplier Ledger Inquiry form. If you enter 1 in this field, the system restricts you to inquiries of existing vouchers that you select from the Supplier Ledger Inquiry form. Values are:

Blank: Allow changes to the selected voucher.

1: Do not allow changes to the selected voucher.

2. Supplier Self Service Mode

Specify whether to activate the Supplier Self-Service function for use in Java/HTML. The Self-Service function allows suppliers to view their own vouchers and payments. Values are:

Blank: Do not activate Supplier Self-Service function.

1: Activate Supplier Self-Service function.

13.4.5.12 Edits

This processing option enables you to specify whether the Fixed Asset ID is required when entering a voucher.

1. Fixed Asset ID (fixed asset identifier)

Specify whether to require an Asset ID if an account is in the AAI asset account range. Values are:

Blank: Do not require an Asset ID in the journal entry.

1: Require an Asset ID in the journal entry.

13.4.5.13 Pay When Paid

1. Pay When Paid Voucher

Specify whether to enter a Pay When Paid Voucher. Values are:

Blank: Enter a standard voucher (default).

1: Enter a Pay When Paid voucher.

When you enter **1** in this processing option, the program flags the voucher as a Pay When Paid voucher.

Note: This processing option functions with the Pay When Paid Pay Status Code processing option on the Defaults tab of Voucher Entry MBF (P0400047). You must enter the pay status to be associated with Pay When Paid vouchers.

13.4.6 Setting Processing Options for Voucher Match (P4314)

Processing options enable you to specify the default processing for programs and reports.

13.4.6.1 Defaults

These processing options enable you to define the default information that the system uses during Voucher Match (P4314).

1. Inquiry Order Type

Enter the type of document. This UDC (00/DT) also indicates the origin of the transaction. There are reserved document type codes for vouchers, invoices, receipts, and time sheets, which create automatic offset entries during the post program. (These entries are not self-balancing when you originally enter them.) You must enter a value that has been set up in UDC 00/DT. These prefixes for document types are predefined; do not change them:

P: Accounts Payable documents.

R: Accounts Receivable documents.

T: Payroll documents.

I: Inventory documents.

O: Purchase Order documents.

J: General Ledger/Joint Interest Billing documents.

S: Sales Order Processing documents.

2. Voucher Document Type

Enter the type of document. This UDC (00/DT) also indicates the origin of the transaction. There are reserved document type codes for vouchers, invoices, receipts, and time sheets, which create automatic offset entries during the post program. (These entries are not self-balancing when you originally enter them.) You must enter a value that has been set up in UDC table 00/DT.

These prefixes for document types are predefined; do not change them:

P: Accounts Payable documents.

R: Accounts Receivable documents.

T: Payroll documents.

I: Inventory documents.

O: Purchase Order documents.

J: General Ledger/Joint Interest Billing documents.

S: Sales Order Processing documents.

13.4.6.2 Display

These processing options enable you to specify whether the system displays certain types of voucher match information, such as the approver number and reporting code.

1. Approver Number

Specify whether to display the approver number code. Values are:

Blank: Do not display the approver number code.

1: Display the approver number code.

2. Reporting Code

Specify whether the column for Reporting Code 007 appears in the detail area on Voucher Match.

Blank: Do not display the column for Reporting Code 007.

1: Display the column for Reporting Code 007.

3. Account Number

Specify how the system displays the account number. Values are:

Blank: The account number is displayed as one field.

1: The account number is displayed in three individual fields (Business Unit, Object Account, and Subsidiary).

4. Business Unit

Specify the text that describes the Business Unit field (alias MCU). This processing option affects only the header area on Voucher Match, not the detail area. Values are:

Blank: The field appears as Branch/Plant.

1: The field appears as Job.

2: The field appears as Project.

3: The field appears as Business Unit.

5. Display Retainage Indicator

Specify whether the Retainage Indicator column appears in the grid on the Voucher Match form. The Retainage Indicator field is a visual indication that the accounts payable clerk uses to verify whether retainage occurred on the invoice and if it should be applied to the voucher. Values are:

Blank: Do not display

1: Display

6. Display Service Units

Specify whether the system displays the Service Quantity and Service UoM fields in the grid. This processing option is used with line type constants. If the Procurement Allow Service Units option is selected on the line type constants, then service quantity and service UOM can be used.

The Quantity To Voucher and Service Quantity fields cannot be used together. Service quantity is a memo field and does not have any validation. Values are:

Blank: Do not display

1: Display

13.4.6.3 Process

These processing options enable you to control the values that the system uses for information and processes.

1. From Status Code

Specify the beginning status code (40/AT) in a range of next status codes. The system uses the range when selecting orders to match.

This processing option does not apply when the system is selecting receipts to match.

2. Thru Status Code (through status code)

Specify the ending status code (40/AT) in a range of next status codes. The system uses the range when selecting orders to match.

This processing option does not apply when the system is selecting receipts to match.

3. Outgoing Receipt Next Status Code

Specify a code that represents the next status that the order will move to after a partial payment.

When a partial payment exists, the system updates the status in the F4311 table for a two-way match and updates the status in the F43121 table for a three-way match so that the statuses in those two tables match the status that you enter for this processing option.

4. Cancel Status Code

Specify the next status that the order moves to after the system cancels a voucher.

When a voucher is canceled, the system updates the status in the Purchase Order Detail table for a two-way match and updates the status in the F43121 table for a three-way match to ensure that the statuses match the status that you enter for this processing option.

5. Quantity/Amount

Specify whether you manually enter the quantity information or the system automatically enters quantity information. Values are:

Blank: Automatically load the quantity/amount.

1: Manually enter the quantity/amount to a voucher.

6. Tolerance

Specify whether the system checks to determine if the quantity and amount of a detail line exceed the tolerance percentage. To check the tolerance, you can access the Purchasing Tolerance Rules program (P4322). You can enter a valid pay status or any of these values:

Blank: Do not check quantities and amounts to determine whether they exceed tolerance.

1: Display a warning when the detail line exceeds the tolerance.

2: Display an error message when the detail line exceeds the tolerance.

7. Supplier Analysis

Specify whether the system captures supplier analysis information. Values are:

Blank: The system does not capture supplier analysis information.

1: The system records information such as item numbers, dates, and quantities for every purchase order in the F43090 table. To make supplier analysis most effective, enter **1** for this processing option and set the processing options for the Purchase Orders program (P4310) and the PO Receipts program (P4312) to capture the same information.

8. Orders Per Voucher

Specify whether the system allows multiple orders per voucher. Values are:

Blank: Allow multiple orders per voucher.

1: Allow only one order per voucher.

9. Branch/Plant Retrieval

Specify which business unit or project number that the system uses to generate the general ledger bank account and the accounts payable trade account.

The system uses the business unit that you specify for the voucher.

Values are:

Blank: The system retrieves the business unit for each purchase order detail line.

1: The system retrieves the business unit in the purchase order header record.

2: The system retrieves the business unit from the JD Edwards EnterpriseOne Address Book.

3: The system retrieves the business unit from the header information in the Voucher Match program (P4314).

4: The system retrieves the project number from the business unit for each purchase order detail line.

5: The system retrieves the project number from the business unit in the purchase order header record.

6: The system retrieves the project number from the business unit in the JD Edwards EnterpriseOne Address Book.

7: The system retrieves the project number from the business unit in the header information that is contained in the Voucher Match program (P4314).

10. Direct Ship Integrity Cost Update

Specify whether to allow cost updates to the sales order when the order is a direct ship order. Values are:

Blank: Do not update cost.

1: Update cost.

11. Lot Cost Update

Specify whether to update the lot cost of an item (method 06) when matching an order at a variance. Values are:

Blank: Do not update lot cost.

1: Update lot cost.

12. Threshold Warning

Specify whether the system displays a warning for voucher total gross amounts that exceed the threshold that has been set for the subcontractor/supplier. The threshold is stored in the F4355 table. Values are:

Blank: The system does not display a warning.

1: The system displays a warning.

13. Threshold Pay Status Code

Specify the pay status code (00/PS) that the system assigns to lines on the voucher whose total gross amount exceeds the threshold. The threshold is defined for the subcontractor or supplier in the Subcontractor Threshold program (P4355).

14. Dual UOM Costing (dual unit of measure costing)

Specify whether the system displays the secondary unit cost field in addition to the current unit cost field. The secondary unit cost field will appear if this processing option is selected. Values are:

Blank: Do not display the secondary unit cost field.

1: Display the secondary unit cost field.

13.4.6.4 Summarization

These processing options enable you to control whether the system summarizes accounts payable and general ledger information.

1. A/P (accounts payable)

Specify whether to summarize accounts payable entries. Values are:

Blank: Do not summarize accounts payable entries.

1: Summarize accounts payable entries.

2. G/L (general ledger)

Specify whether to summarize general ledger entries. Values are:

Blank: Do not summarize general ledger entries.

1: Summarize general ledger entries.

13.4.6.5 New Order Line

These processing options enable you to control how new order detail lines are added to a purchase order when you are creating a voucher.

1. Order Line Entry

Specify whether the system automatically creates purchase order detail lines for lines that you add to a voucher. Values are:

Blank: You cannot add lines to a voucher.

1: Do not create corresponding purchase order detail lines when new lines are added to a voucher.

2: Create corresponding purchase order detail lines when new lines are added to a voucher.

2. Line Type

Specify how the system processes lines on a transaction. The line type affects the systems with which the transaction interfaces (JD Edwards EnterpriseOne General Ledger, JD Edwards EnterpriseOne Job Cost, JD Edwards EnterpriseOne Accounts

Payable, JD Edwards EnterpriseOne Accounts Receivable from Oracle, and JD Edwards EnterpriseOne Inventory Management). The line type also specifies the conditions for including a line on reports and in calculations. Some examples of values, which have been defined on the Line Type Constants Revisions form (P40205), are:

J: Job cost, subcontracts, or purchasing to the general ledger.

B: General ledger account and item number.

N: Non-stock item.

F Freight.

T: Text information.

M: Miscellaneous charges and credits.

This processing option applies only if you enter a value of **1** or **2** in the Order Line Entry processing option, which also is on the New Order Lines tab.

You can only use a line type that has an inventory interface of A, which validates the account number.

3. Last Status Code

Specify the beginning status, which is the first step in the order process. You must use a UDC (40/AT) that has been set up on the Order Activity Rules form for the order type and the line type that you are using.

4. Next Status Code

Specify the next step in the order process. You must use a UDC (40/AT) that has been set up on the Order Activity Rules form for the order type and the line type that you are using.

The override status is another allowed step in the process.

5. Explanation/Remark

Specify whether to pass the default account number description in the Description1 field or the user remark in the Description2 field to the Explanation/Remark field in the Account Ledger table (F0911). Values are:

Blank: Use the Description1 value as the remark in the F0911 table.

1: Use the Description2 value as the remark in the F0911 table.

13.4.6.6 Retainage

These processing options enable you to specify whether the system uses the retainage percentage or the retainage amount as a default value in the Voucher Match program (P4314), and also whether the system applies taxes to the retained or vouchered amount.

1. Default

Specify whether to automatically load the retainage percentage or amount from the order header. Values are:

Blank: Do not load the retainage percentage or amount from the order header.

1: Automatically load the retainage percentage or amount from the order header.

2. Taxes (Only apply to 'C' and 'V' type of taxes.)

Specify whether the system applies taxes to the retained or vouchered amount. Values are:

Blank: Do not apply taxes to the retained or vouchered amount.

1: Apply taxes to the retained or vouchered amount.

13.4.6.7 Logs

These processing options enable you to control whether the system displays a warning message when outstanding logs exist and also indicate which pay status code the system should use for a voucher when outstanding logs exist.

1. Warning Message

Specify whether the system displays an outstanding log detail warning message and when it displays the message. Values are:

Blank: Do not display the outstanding log detail warning message.

1: Display the outstanding log detail warning message when the system verifies the status, pay effective date, and pay expiration date.

2: Display the outstanding log detail warning message when the system verifies the status, pay effective date, required date, and pay expiration date.

2. Pay Status Code

Specify the pay status code that the system uses as a default value for the voucher when an outstanding log exists.

Typically, you use a pay status code that indicates that the pay item is on hold.

13.4.6.8 Currency

These processing options enable you to control which date the system uses as the effective date and also whether the exchange rate can be changed.

1. Effective Date

Specify which date the system uses as the effective date. Values are:

Blank: Use today's date as the effective date.

1: Use the general ledger date as the effective date.

2: Use the invoice date as the effective date.

2. Protect Rule

Specify whether you can change the exchange rate. Values are:

Blank: You can change the exchange rate.

1: You cannot change the exchange rate.

13.4.6.9 Flex Accounts

This processing option enables you to control whether you are working with flexible accounting.

1. Flex Accounting

Specify whether flexible accounting is activated. Activate flexible accounting if you are using Oracle's JD Edwards EnterpriseOne Advanced Cost Accounting, or if you are working with flexible sales accounting. Values are:

Blank: Do not activate flexible accounting.

1: Activate flexible accounting.

13.4.6.10 Versions

These processing options enable you to enter the version for each application. If you leave any of these processing options blank, the system uses the ZJDE0001 version.

1. Order Entry (P4310)

Enter the version that the system uses when you are using the Order Entry program.

2. AP Master Business Function (P0400047)

Enter the version that the system uses when you are using the Accounts Payable program. You can only review versions for this program in the interactive versions list.

3. GL Master Business Function (P0900049)

Enter the version that the system uses when you are using the General Ledger program. You can only review versions for this program in the interactive versions list.

4. Open Receipts Inquiry (P43214)

Enter the version that the system uses when you are using the Open Receipts Inquiry program.

5. Stand Alone Landed Cost (P43214)

Enter the version that the system uses when you are using the Stand-alone Landed Cost program.

6. Freight Audit History (P4981)

Specify which version of the Freight Audit History program that the system uses for matching freight.

7. Supplier Ledger Inquiry (P0411)

Specify the version that the system uses when you are using the Supplier Ledger Inquiry program.

8. Purchase Order Logs (P4305)

Specify the version that the system uses when you use the Logs Entry program (P4305).

9. Freight Distribution (P43147)

Specify the version that the system uses when you use the Freight Distribution program (P43147).

13.4.6.11 Workflow

These processing options enable you to specify workflow options.

1. Notify Amount Changes

Specify who to notify of a change in the amount. Values are:

Blank: Do not send any notification emails.

1: Purchase order originator.

2: Project manager.

3: Buyer.

4: Originator, Buyer and Project manager.

2. Notify Quantity Changes

Specify who to notify of a change in the quantity. Values are:

Blank: Do not send any notification emails.

- 1: Purchase order originator.
- 2: Project manager.
- 3: Buyer.
- 4: Originator, Buyer and Project manager.

13.4.6.12 Progress Payment

These processing options enable you to determine how the system processes progress payments in the JD Edwards EnterpriseOne Subcontract Management system.

1. Interface

Specify whether to activate the Progress Payment interface. Values are:

Blank: Supplier/Subcontractor Ledger Inquiry

1: Progress Payment

If you are using Standard Voucher Match, this processing option should not be set.

2. Match Type Default

Specify the default for the match type. You must enter a value that is already set up in UDC table 43B/VW.

3. Option Default

Specify the default progress payment option displayed in the detail area of the Progress Payments/Voucher Match form when you select lines to pay from the Work With Contracts form. Values are:

Blank: Bypass payment of line.

1: Match quantity and amount.

4. Extended Amount

Specify whether extended amount is calculated if quantity is changed. Values are:

Blank: Extended amount is not calculated.

1: Extended amount is calculated.

5. Batch

Specify whether to use the same batch number. Values are:

Blank: Do not use same batch number.

1: Use the same batch number.

6. Activate Type of Payment and Current Payment Fields

Specify whether the system activates the payment functionality type and displays the payment type fields, Type of Payment and Current Payment (Domestic or Foreign), in the Supplier Self-Service applications. Values are:

Blank: Do not activate the payment functionality type and hide the Type of Payment and Current Payment fields.

1: Activate the payment functionality type and the Type of Payment and Current Payment fields.

7. Type of Payment Options

Specify the type of payment option. This processing option is used only when the Type of Payment and Current Payment fields processing option is activated. Values are:

Blank: Actual Amount

1: Cumulative Percentage

2: Cumulative Amount

8. Prevent Payment of Paid Lines

Specify whether to pay more than 100 percent on a paid line. This applies to nonstock lines only. Values are:

Blank: Prevent payment on a previously fully paid line.

1: Allow payment on a previously fully paid line.

13.4.6.13 Redistribution

This processing option enables you to determine how the system processes logged recurring vouchers after redistribution.

1. Calculate Last Chance Variance for the voucher after it has been redistributed.

Specify whether the system records variance amounts in the general ledger for amount variances. The system records these variances by using DMAAI 4330. Values are:

Blank: The system does not record variance amounts.

1: The system records variance amounts.

2. Paid Logged Vouchers

Specify whether to redistribute paid logged vouchers. Values are:

Blank: Do not allow redistribution of paid logged vouchers.

1: Allow redistribution of paid logged vouchers.

13.4.6.14 Freight Distribution

This processing option enables you to determine how the system processes lines on a freight distribution transaction.

1. Freight Distribution Line Type

Specify how the system processes lines on a transaction. The line type affects the systems with which the transaction interfaces (JD Edwards EnterpriseOne General Accounting, JD Edwards EnterpriseOne Job Cost, JD Edwards EnterpriseOne Accounts Payable, JD Edwards EnterpriseOne Accounts Receivable, and JD Edwards EnterpriseOne Inventory Management systems). The line type also specifies the conditions for including a line on reports and in calculations.

You can only use a line type that has an inventory interface of A, which validates the account number.

13.4.7 Setting Processing Options for Freight Distribution (P43147)

Processing options enable you to specify the default processing for programs and reports.

13.4.7.1 Display

1. Account Number

Specify how the system displays the account number on the Freight Distribution Revisions form. Values are:

Blank: Displays the account number as one field.

1: Displays the account number in three individual fields. These fields are Cost Center, Obj Acct (object account), and Sub (subsidiary).

13.4.7.2 Process

These processing options enable you to control the values that the system uses for information and processes.

1. Account

Specify whether to use financial AAI PCFRTD. The system uses the values in the Or Ty (order type) and Cost Center fields from the line to determine the freight distribution account. Values are:

Blank: Use the account on the line.

1: Use the financial AAI to determine the account.

2. Default Distribution

Specify the initial distribution of the freight amount. Values are:

Blank: Do not perform any default distribution.

1: Distribute a proportion of the freight based upon the amount of the line against the amount of the entire voucher.

2: Distribute a proportion of the freight equally to each voucher line.

13.4.8 Selecting Receipt Records to Match to a Voucher

Access the Supplier Ledger Inquiry form.

Retained Amount

Enter the total amount held back (referred to as hold back in some countries) on the contract amount. The amount retained cannot be less than zero or greater than the amount to voucher.

Percentage Retained

Enter the rate of retainage (referred to as *hold back* in some countries) that applies to the contract. This rate is a percentage of each payment. It is expressed as a decimal fraction. For example, a retainage rate of 10 percent is expressed as 10. The retainage rate cannot be greater than 99.9 percent (.999) or less than zero.

Tax

Enter tax liability. Of the total taxes calculated for this document (invoice, voucher, and so forth), the monetary value of the tax liability attributable to the first of five possible taxing authorities who may comprise the tax area.

13.4.9 Selecting Order Detail Lines to Match to a Voucher

Access the Supplier Ledger Inquiry form.

Percentage Retained

Enter the rate of retainage (referred to as hold back in some countries) that applies to the contract. This rate is a percentage of each payment. It is expressed as a decimal fraction. For example, a retainage rate of 10 percent is expressed as 10. The retainage rate cannot be greater than 99.9 percent (.999) or less than zero.

Tax

Enter the tax liability. Of the total taxes calculated for this document (invoice, voucher, and so forth), the monetary value of the tax liability attributable to the first of five possible taxing authorities who may comprise the tax area.

13.4.10 Selecting Order Detail Lines for Freight Charges

Access the Supplier Ledger Inquiry form.

You might need to manually match freight charges to a voucher. Freight charges are calculated by the JD Edwards EnterpriseOne Transportation Management system.

13.4.11 Selecting Order Detail Lines for Freight Vouchering

Access the Freight Distribution Revisions form.

You enter freight information specific to each detail line on the form.

Distribute By

Enter the freight distribution type. Values are:

- 1: Distribute by amount
- 2: Distribute by percentage

Freight Distribution Percentage

Displays the freight distribution percentage that the system uses to calculate the amount that the system then uses to create the general ledger record during voucher match.

Freight Distribution Amount

Enter the freight distribution amount that the system uses to create the general ledger record during voucher match.

Freight Distribution Business Unit

Displays the business unit from the general ledger account number.

Freight Distribution Object Account

Displays the portion of a general ledger account that refers to the division of the cost code (for example, labor, materials, and equipment) into subcategories. For example, you can divide the cost code for labor into regular time, premium time, and burden.

Note: If you use a flexible chart of accounts and the object account is set to six digits, Oracle recommends that you use all six digits. For example, entering 000456 is not the same as entering 456 because, if you enter 456, the system enters three blank spaces to fill a six-digit object.

Freight Distribution Subsidiary

Displays a subset of an object account. Subsidiary accounts include detailed records of the accounting activity for an object account.

Freight Distribution Account Number

Enter the freight distribution account number. The system writes a general ledger record to this account for freight distribution during voucher match.

Freight Distribution Subledger

Enter a code that identifies a detailed, auxiliary account within a general ledger account. A subledger can be an equipment item number or an address book number. If you enter a subledger, you must also specify the subledger type.

Freight Distribution Subledger Type

Enter a value from UDC 00/ST that the system uses with the Freight Distribution Subledger field to identify the subledger type and how the system performs subledger editing.

On the User Defined Codes form, the second line of the description controls how the system performs editing. This value is either hard-coded or user defined. Values include:

A: Alphanumeric field, do not edit.

N: Numeric field, right justify and zero fill.

C: Alphanumeric field, right justify and blank fill.

You may select one of the following options from the Form menu to apply to all detail lines on the form:

Clear Distributions

Select to zero any existing freight distribution for this freight distribution line. Click the Find button to refresh the grid.

Amount Default

Select to override any existing freight distribution for this freight distribution line. The voucher line amounts are totaled and the freight amount is distributed to each voucher line based upon the ratio of the voucher line amount and the total voucher amount. Click the Find button to refresh the grid.

For example, the freight amount is 200 USD. The grid has two voucher lines. The first line is for 1000 USD, and the second line is for 3000 USD. The system distributes 25 percent, or 50 USD, to line one and 75 percent, or 150 USD, to line two.

Note: The Amount Default option functions the same as the Default Distribution processing option on the Process tab of the P43147 program when the value is set to 1 to distribute by amount.

Line Default

Select to override any existing freight distribution for this freight distribution line. The freight amount is distributed to each voucher line evenly. Click Find to refresh the grid.

For example, the freight amount is 200 USD. The grid has four voucher lines. The system will distribute 50 USD to each line.

Note: The Line Default option functions the same as the Default Distribution processing option on the Process tab of the P43147 program when the value is set to 2 to distribute each line equally.

13.4.12 Recording Cost Changes to an Invoice

Access the Supplier Ledger Inquiry form.

13.5 Working with Retainage

This section provides an overview of retainage, lists prerequisites, and discusses how to:

- Enter a voucher with retainage.
- Enter a voucher to release retainage.

13.5.1 Understanding Retainage

You can create a voucher withholding a portion of the gross payment as retainage. Retaining is also called a *hold back*. Retainage is the percentage of a committed amount that is held until a specified date. For example, you pay the retained amount after the completion of the contract, service, or receipt of all items on an order. If you create a voucher for 100 with retainage of 10 percent, the actual payment will be 90, with 10 held as retainage. You release retainage by entering a payment voucher for the amount that you want to release. Note that you can release retainage and create a voucher at the same time.

For example, you issue a purchase order for 1000 against a billable job account. You receive an invoice from the vendor which may or may not indicate the retainage amount. You create a voucher for 1000 with retainage of 10 percent. Thus, the actual payment will be 900, with 100 held as retainage. The 1000 creates a debit to the billable job account per the purchase order with a 900 credit to the A/P trade account. The retainage of 100 creates a credit to the A/P retainage account. This fully relieves the 1000 commitment.

When appropriate, you release retainage either with or without a subsequent invoice from the vendor. In either event, the initiation of retention release is a manual process. You release retainage by entering a payment voucher for the amount that you want to release. In this example, the payment of 100 creates a credit to the A/P trade account and also creates a 100 debit to the A/P retainage account.

This diagram illustrates the T account changes for a 1000 line with 10 percent retainage:

Figure 13–1 T account changes for retainage example**Voucher Match with Retainage**

Job Expense Acct	AP Retainage	AP Trade
1000	100	900

Release Retainage

AP Retainage	AP Trade
100	100

You can create a voucher with retainage that is applied to the entire voucher, or you can apply retainage by line item of the voucher.

Use the tax with retainage processing option to defer tax on retainage. If you activate the processing option for tax with retainage and if you use a tax type of C or V, the system calculates amounts differently. It subtracts retainage from the original taxable amount and recalculates new amounts.

A partial release of retainage indicates that there is still an unpaid amount of retainage. A final release of retainage indicates that no retainage remains to be paid. You can release retainage for individual vouchers or for groups of vouchers. You can create a voucher with retainage to match a receipt or purchase order and release a retainage at the same time.

Note: In some industries, subcontract retention may be called retainage. Thus, the terms *retainage* and *retention* may be used interchangeably.

13.5.1.1 Retention

Retention is used in a commercial cost-reimbursable project-related environment. Retention is a percentage of a committed amount that is held until a specified date after the order is complete. Retention processing applies to on-going projects and applies only to services lines. Retention is not applicable to inventory-based purchase order lines where the full cost of the product is due upon receipt of the product.

Retention typically follows the same rules as the client contract rules. The accounting requirement when vouchering is to distribute the net amount to a billable account on the job and the retained amount to a nonbillable account on the job. The retained amount must be charged to a nonbillable account, and only the billable amount is charged to a billable account and submitted for payment. Note that the vendor may or may not indicate retainage on the invoice.

For example, you issue a purchase order for 1000 against a billable job account. You receive an invoice from the vendor which may or may not indicate the retainage amount. You create a voucher for 1000 with retainage of 10 percent. Thus, the actual payment will be 900, with 100 held as retainage. The payment of 900 creates a debit to the billable job account per the purchase order (credit to the A/P trade account). The retainage of 100 creates a debit to a nonbillable account on the job (credit to the A/P retainage account). This fully relieves the 1000 commitment.

When appropriate, you release retainage either with or without a subsequent invoice from the vendor. In either event, the initiation of retention release is a manual process. You release retainage by entering a payment voucher for the amount that you want to release. In this example, the payment of 100 creates a debit to the billable job account per the purchase order (credit to the A/P trade account) and also creates a 100 credit to a nonbillable account on the job (debit to the A/P retainage account).

This diagram illustrates the T account changes for a 1000 line with 10 percent retainage:

Figure 13–2 T account changes for nonbillable retainage example

Voucher Match with Retainage

Job Expense Acct	Non-Billable	AP Retainage	AP Trade
900	100	100	900

Release Retainage

Job Expense Acct	Non-Billable	AP Retainage	AP Trade
100	100	100	100

The commitment is not affected because it was already relieved. To facilitate entry of the initial voucher, provide an indication that retention applies to the purchase order when entering the voucher.

In the JD Edwards EnterpriseOne system, you use retainage functionality to automate the recording of retention to nonbillable accounts for transactions with an inventory interface of A or B only. To enable the subcontract retention functionality in the JD Edwards EnterpriseOne system, you must:

1. Select the Non-Billable Retainage option on the Line Type Constants Revisions form (W40205B).

New journal ledger entries are created if this subcontract retention option is selected.

2. Perform two-way voucher match.

The system supports multiple partial matches.

Note: If you want to perform three-way voucher match, you must select the Expense At Voucher option on the Line Type Constants Revisions form (W40205B).

3. Ensure that the retainage amount is not zero.

Before entering an order that includes retention, select the Display Retainage Indicator processing option on the Display tab of the Purchase Orders program (P4310). When you enter an order that has retainage, select the Retainage Indicator check box on the order header form. This field notifies the A/P clerk during the voucher match process to double-check the invoice from the supplier to see if there was an amount retained on the invoice. The Retainage Indicator check box can be used with or without the Retainage Percentage field.

Note: When using the Purchase Order Generator (P43032), Generate POs from Requisitions/Blanket Order Release (P43060), and Quote Order Release (P43360) programs to release blanket, requisition, and quote orders, the order that is generated contains the retainage indicator value. The value of the Retainage Indicator field is brought over from the source order, irrespective of the processing option setting.

Note: The system does not support retention in Purchase Order Workbench (P43101), sourcing, electronic data interchange (EDI), XPI, transfer orders, direct ship orders, re-cost voucher, and freight to match.

You can display the Retainage Indicator field in the detail grid on the Voucher Match form by setting the Display Retainage Indicator processing option on the Display tab of the Voucher Match program (P4314). The system retrieves the retainage indicator setting from the order header. You also set the processing options on the Retainage tab of the P4314 program.

When performing voucher match, you can relieve commitments to billable and nonbillable accounts. The setting of the Non-Billable Retainage option on the Line Type Constants Revisions form determines whether the system uses the new nonbillable automatic accounting instruction (AAI) for retainage. Select this option to specify that the system use the financial AAI nonbillable retainage (PCNBRT) for retainage processing during voucher match. If the Non-Billable Retainage option is not selected, then the system uses the previous functionality for expensing retainage.

You select the Voucher Match Variance Account option in the Line Type Constants (P40205) program to indicate to which account the system books a variance. A variance that is generated during voucher match can be booked to a variance account or to the expense account for the order detail line.

For three-way voucher match, select both the Non-Billable Retainage and Expense at Voucher options to use a nonbillable expense AAI.

You can release retainage and create a voucher at the same time. The Retainage Indicator field that appears on the form signals the accounts payable clerk to verify whether retainage occurred on the invoice and whether it should be applied to the

voucher. The Retainage Indicator field is independent of the Retainage % field, and the system will not require a retainage percentage if the Retainage Indicator option is selected. Thus, the system does not perform any functionality based on the Retainage Indicator field.

The commitment is relieved when you are posting a voucher with nonbillable retainage. The system retrieves the nonbillable received not vouchered (RNV) amount from the Purchase Order Detail Non-Billable table (F4317) and adds it to the billable RNV amount (input value from the General Ledger Post program (R09801) when you are posting a voucher with nonbillable retainage. Thus, the system processes voucher match with nonbillable retainage and nonbillable retainage release.

During voucher match, the system calculates the billable and nonbillable general ledger amounts, both domestic and foreign amounts.

The system uses the following calculations during voucher match:

- $(\text{Billable Amount}) = (\text{GL Amount}) \times (1 - (\text{Retainage Percent}))$
- $(\text{Non-Billable Amount}) = (\text{GL Amount}) - (\text{Billable Amount})$

The retainage to release amount is computed based on the PO Detail (F4311) level and proportioned to the PO Non-Billable (F4317) level based on percentage. The system uses the following calculations during release retainage:

- $(\text{Released Amount}) = (\text{F4317.NonBillableAmount}) * (\text{Released Percent})$
- $(\text{Retained Amount}) = (\text{F4317.NonBillableAmount}) - (\text{Released Amount})$

The system also calculates the released percentage when releasing nonbillable retainage. This percentage is required for partial release and rounding issues. The system uses the following calculations for released percentage:

- $(\text{Released Percentage}) - (\text{Domestic}) = (\text{F43121T.RETA}) / (\text{F4311T.RETA})$
- $(\text{Released Percentage}) - (\text{Foreign}) = (\text{F43121T.REFA}) / (\text{F4311T.REFA})$

The nonbillable amount is always equal to the retained amount unless you are using B, C, and V tax types. The nonbillable amount is the sum of one or more future billable amounts.

When you close an order, the system does not provide a reminder or force payment of any retention.

If you reverse a voucher, then the accounting entries are reversed as they were entered. The system performs the following transactions:

- Updates the Purchase Order Receiver File table (F43121).
- Reverses F4317 records to update the nonbillable amount.
- Reverses Purchase Order Receiver Non-Billable (F43127) records.
 - Deletes F43127 records that have a match type 3 (reversed by voucher match application).
 - Updates F43127 records that have match types of 2 (created by voucher match application) and 3 (reversed by voucher match application).

See [Defining Order Line Types](#).

See [Understanding AAI Tables for the Financial System](#).

See [Setting Processing Options for Purchase Orders \(P4310\)](#).

See [Setting Processing Options for Voucher Match \(P4314\)](#).

13.5.2 Prerequisites

Before you complete the tasks in this section, set the processing options on the Voucher Match program (P4314) to apply taxes to retainage.

To enable the retention functionality in the JD Edwards EnterpriseOne system, you must:

- Select the Non-Billable Retainage option on the Line Type Constants Revisions form (W40205B).
- Set up financial AAI PCNBRT.
- Set the processing options on the Purchase Orders program.
- Set processing options on the Voucher Match program.
- Perform a two-way voucher match.

Note: If you want to perform a three-way voucher match, you must select the Expense At Voucher option on the Line Type Constants Revisions form (W40205B).

- Ensure that the retainage amount is not zero.

13.5.3 Forms Used to Work with Retainage

Form Name	Form ID	Navigation	Usage
Supplier Ledger Inquiry	W0411G	Receipts Matching and Posting (G43A15), Match Voucher to Open Receipt	Enter a voucher with retainage, and enter a voucher to release retainage. If you use Match Voucher to Open Receipts, you must set processing options to perform voucher match processing.
Voucher Match	W4314A	Click the Add button on the Supplier Ledger Inquiry form.	Enter a voucher with retainage, and enter a voucher to release retainage.
Select Orders To Match	W4314C	Select Orders To Match from the Form menu on the Voucher Match form.	Enter a voucher with retainage, enter a voucher to release retainage, and enter a voucher with retainage and release retainage at the same time.

13.5.4 Entering a Voucher with Retainage

Access the Supplier Ledger Inquiry form.

Retained Amount

Enter the amount retained.

13.5.5 Entering a Voucher to Release Retainage

Access the Supplier Ledger Inquiry form.

Percentage Retained

Enter the amount retained by percent. If you are working with receipt records, you cannot increase the receipt quantity to reflect an invoice. You must first receive the additional quantity using the PO Receipts program (P4312). If you increase the amount for a receipt record, the system creates journal entries to account for the variance.

13.6 Creating Multiple Vouchers from Receipt Records

This section provides an overview of creation of multiple vouchers from receipt records and discusses how to:

- Create multiple vouchers from receipt records.
- Set processing options for Evaluated Receipt Settlement (R43800).
- Review and post journal entries for voucher transactions.
- Verify that voucher amounts balance.
- Set processing options for Voucher Journal Report (R04305).

13.6.1 Understanding Creation of Multiple Vouchers from Receipt Records

You might have an agreement with certain suppliers that the receipt records are sufficient for creating vouchers. When such an agreement exists, the supplier does not need to send you an invoice, and you can avoid manually matching receipt records to invoices to create vouchers.

You can run the Evaluated Receipt Settlement program (R43800) to review the receipts for which the system will create vouchers. You can also identify the receipts with errors so that you can correct them. After you have corrected any errors, you can run the program in final mode to create vouchers. You indicate the receipts for which the system:

- Edits for errors.
- Calculates taxes and discounts.
- Creates vouchers.
- Generates journal entries.

The system does not create vouchers for receipt items in a routing process until they are moved to an on-hand status. When the receipt items go through the routing process, the system assigns the receipt record an evaluated receipt value of **R** (in routing) in the F43121 table. When the items become on-hand, the system changes the value to **Y** (yes), so that you can create a voucher.

The system creates vouchers for landed costs if:

- The receipt record for which you are entering landed costs is eligible for the Evaluated Receipt Settlement program (Evaluated Receipt field in the F43121 table is set to **Y**).
- You can create vouchers for the landed cost supplier using the Evaluated Receipt Settlement program (Evaluated Receipt field on Purchasing Instructions (P40205) is set to **Yes**).

After the system creates the vouchers, you work with them as you would with any standard voucher.

Important: To create vouchers for a supplier in batch mode, you must set the Evaluated Receipt field in Purchasing Instructions to **Y** before you create purchase orders for the supplier. This is the default for each purchase order that you enter for the supplier. You can override this default for individual detail lines. If you set the Evaluated Receipt field in Purchasing Instructions to **N**, you cannot override the value on purchase orders.

The system gets receipt information from the F43121 table to generate vouchers in batch mode. You must use a formal receipt process to create vouchers in batch mode.

When you run Evaluated Receipt Settlement, the system generates two reports. If you run the program in proof mode, the first report contains all receipts for which the system will create vouchers. If you run the program in final mode, the report contains the voucher number, voucher amount, and so forth, for each receipt.

The second report lists all receipts for which vouchers cannot be created due to errors.

13.6.1.1 Journal Entries for Voucher Transactions

The system generates journal entries when you create a voucher so that the appropriate purchasing expenses and liabilities reflect in the general ledger. After the system generates journal entries, you can review the entries and post them to the general ledger.

To ensure the integrity of the data, you can verify that voucher amounts balance between the accounts payable ledger and the general ledger.

When you create a voucher for items that you formally receive, the system creates a journal entry that debits a received not vouchered account. When you create a voucher for items that you do not formally receive, the system creates a journal entry that debits an expense account.

The system creates accounts payable offsetting entries when you post the voucher journal entries to the general ledger.

If a variance exists between the cost of goods or services on a purchase order or receipt record and the cost on the voucher, the system creates journal entries for the variance. You must specify variance accounts in the AAIs.

If you charge purchases against general ledger account numbers (expense accounts), the line type you assign to a detail line determines whether the system charges a variance to the expense account or a variance account.

You can review the journal entries that the system creates for a voucher using the Voucher Journal Review program (P0011). You can review the amount of each entry and the account to which each amount is debited or credited.

13.6.1.2 Variance Accounts

This table describes important information about variance accounts:

Account	Description
Variance accounts for weighted average costs	<p>If you purchase items to inventory, you might sell some of the items before you create a voucher. If you maintain a weighted average inventory cost for the items, you must set up two variance accounts in AAls, one for the items sold and the other for the items remaining.</p> <p>For example:</p> <ul style="list-style-type: none"> ■ You buy 10 items at 10.00 for a total of 100.00 ■ You sell two of the items ■ You create a voucher for 90.00 (the supplier bills you for 9.00 each) <p>A variance exists of 10.00. If you do not set up two variance accounts, the system applies the entire 10.00 variance to the 8 items that remain in stock. This causes the weighted average cost of the items to be inaccurate.</p> <p>When you set up two variance accounts, the system applies an 8.00 variance to the items that remain in stock and a 2.00 variance to the items sold. This enables the system to calculate the correct weighted average cost for the items that remain in stock.</p> <p>You must set up AAI table 4332 to have the system create a separate variance for items no longer in stock.</p>

13.6.2 Creating Multiple Vouchers from Receipt Records

Select Receipts Matching and Posting (G43A15), Evaluated Receipt Settlement.

13.6.3 Setting Processing Options for Evaluated Receipt Settlement (R43800)

Processing options enable you to specify the default processing for programs and reports.

13.6.3.1 Versions

1. In-bound Match Program (R470412)

Specify the version of the In-bound Match program. If left blank, the system uses version number XJDE0001.

13.6.3.2 Processing

1. Invoice Number

Specify the method that the system uses to assign an invoice number. Values are:

Blank: The system assigns invoice numbers by using EDI next numbers.

1: The system assigns invoice numbers by using values in the Supplier Remark field.

2. G/L Date Defaults (general ledger date defaults)

Specify the general ledger date that the system uses on the voucher. The system uses this processing option with the G/L Date processing option. Values are:

Blank: The system uses the receipt date as the G/L date.

1: The system uses today's date as the G/L date.

2: The system uses the date that is specified in the G/L Date processing option.

3. G/L Date (general ledger date)

Specify the general ledger date that you want the system to use when it creates a voucher. If you leave this processing option blank, the system uses the G/L Date Defaults processing option to determine the date.

4. Receipt Summary Method

Specify the method that the system uses to summarize the receipt. Values are:

Blank: Summarize by order.

1: Summarize by supplier.

2: Summarize by invoice.

5. Invoice Date Defaults

Specify the date that the system uses for the invoice date on the voucher. Values are:

Blank: The system uses the receipt date.

1: The system uses today's date.

2: The system uses the date that is contained in the Invoice Date processing option.

3: The system uses the order date.

6. Invoice Date

Specify the invoice date that the system uses when creating a voucher. If you leave this processing option blank, the system uses the date that is contained in the Invoice Date Defaults processing option. Otherwise, you can manually enter a date.

13.6.4 Reviewing and Posting Journal Entries for Voucher Transactions

Select Receipts Matching and Posting (G43A15), Voucher Journal Review or G/L Voucher Post.

See [Reviewing Journal Entries for Receipt Transactions](#).

13.6.5 Verifying the Voucher Amounts Balance

Select Receipts Matching and Posting (G43A15), Print Voucher Journal.

You can review journal entries for voucher transactions and verify that they balance in the general ledger and the accounts payable ledger by printing the Voucher Journal Report (R04305).

For each voucher transaction that prints, you can compare the gross amount in the F0411 table to the corresponding general ledger distribution entries in the F0911 table. The system does not include records with a foreign currency ledger type (CA) in the general ledger comparison total.

13.6.6 Setting Processing Options for Voucher Journal Report (R04305)

Processing options enable you to specify the default processing for programs and reports.

13.6.6.1 Print Options

These processing options enable you to select the account number that prints on the report.

1. Account Number Format

Specify the format for the system to use when printing the account number. Values are:

- 1: The system prints the account number in Business Unit.Object.Subsidiary format.
- 2: The system prints the short account ID.
- 3: The system prints the third (unstructured) account number.

2. VAT Receivable Amounts

Specify which files will be used to print the VAT receivable amounts. Values are:

- Blank: The system prints only the tax amounts from the F0411 table.
- 1: The system prints the tax amounts from the F0018 table as well as the F0411 table.

13.7 Logging Invoices Before Receiving Goods

This section provides an overview of invoice logging and discusses how to:

- Log invoices to create preliminary vouchers.
- Create a permanent voucher from a preliminary voucher.
- Print logged invoice information.
- Set processing options for Logged Voucher Detail (R43428).

13.7.1 Understanding Invoice Logging

You can log invoice information prior to receiving the goods or services on an invoice so that the billing amount reflects in the general ledger. When you log invoice information, the system creates a preliminary voucher from which you can create a permanent voucher when you receive the goods or services.

After you create a preliminary voucher, the system generates journal entries that distribute the voucher amount to a general ledger suspense account. After you create the permanent voucher, the system generates journal entries that redistribute the voucher amount to the actual general ledger accounts.

You might want to record invoice information promptly, prior to receiving the goods or services on the invoice. You can log invoice information to create a preliminary voucher, from which the system creates journal entries to account for the billing amount.

After you enter invoice information, you must specify the suspense account for which the system is to debit the voucher amount.

You can create a permanent voucher from a preliminary voucher after you receive the goods and services on the corresponding invoice. Because the preliminary voucher already contains much of the necessary information, creating the permanent voucher is a simple process.

To create a permanent voucher, you must locate the preliminary voucher and select the receipt records that match the invoice. After you do this, the system creates the permanent voucher.

13.7.2 Forms Used to Log Invoices Before Receiving Goods

Form Name	Form ID	Navigation	Usage
Supplier Ledger Inquiry	W0411G	Other Voucher Entry Methods (G04111), Voucher Logging Entry	Log invoices to create preliminary vouchers.
Enter Voucher - Payment Information	W0411A	Click the Add button on the Supplier Ledger Inquiry form.	Log invoices to create preliminary vouchers.
Journal Entry Prompt	W0411B	Click the OK button on the Enter Voucher - Payment Information form.	Log invoices to create preliminary vouchers.
Work With Voucher JE Redistribution	W042002A	Other Voucher Entry Methods (G04111), Voucher JE Redistribution	Create a permanent voucher from a preliminary voucher.
Voucher Match	W4314A	Select a voucher on the Work With Voucher JE Redistribution form, and then select Redistribute PO from the Row menu.	Create a permanent voucher from a preliminary voucher.

13.7.3 Logging Invoices to Create Preliminary Vouchers

Access the Supplier Ledger Inquiry form.

13.7.4 Creating a Permanent Voucher from a Preliminary Voucher

Access the Work With Voucher JE Redistribution form.

13.7.5 Printing Logged Invoice Information

Select Purchasing Reports (G43A111), Logged Voucher Detail.

If you log invoices on the system before taking receipt of the goods or services, you can print the Logged Voucher Detail report to review preliminary voucher information. You can use this report to identify the preliminary vouchers that are ready for distribution. You can also review invoice and purchase order information, including:

- Invoice number.
- Invoice date.
- Gross amount.
- Purchase order number.
- Received date (if applicable).
- Amount open to voucher.
- Voucher number.

If you do not enter purchase order information when you log a voucher, the system does not print purchase order information on the report.

You can use processing options to determine whether the report prints only logged vouchers for which receipt records have been entered.

13.7.6 Setting Processing Options for Logged Voucher Detail (R43428)

Processing options enable you to specify the default processing for programs and reports.

13.7.6.1 Display

1. Print Vouchers that have quantity received for their attached purchase order

Specify whether to only print vouchers that have quantity received for their attached purchase order. Specify a value of **1** in this processing option.

13.8 Printing Voucher Information

You can print reports containing voucher information that is specific to purchase orders, receipts, and suppliers.

This section discusses how to:

- Print voucher information by detail line.
- Set processing options for Received/Vouchered Status Report (R43412).
- Print open voucher information by receipt.
- Print voucher amounts for suppliers.
- Set processing options for Supplier Analysis Report (R04602).

13.8.1 Printing Voucher Information by Detail Line

Select Purchasing Reports (G43A111), Vouchered/Received Status.

You can review voucher information by purchase order detail line. For example, if you entered a purchase order containing a detail line for 100 widgets, you can produce a report that identifies:

- The quantity and amount received to date.
- The received quantity and amount for which a voucher has been created.
- The received quantity and amount for which a voucher has not been created.

You can specify the branch/plant, supplier, and purchase order number for the detail lines that print. You might use this report to determine the total amount open to voucher for a supplier or branch/plant.

When you run the Received/Vouchered Status report, the system organizes detail lines by branch/plant or business unit, depending on whether you use an inventory or non-inventory environment.

13.8.2 Setting Processing Options for Received/Vouchered Status Report (R43412)

Processing options enable you to specify the default processing for programs and reports.

13.8.2.1 Display

These processing options enable you to specify how the system displays information on the report.

1. Select G/L Cost Center or Branch/Plant

Specify whether the system prints general ledger cost information or branch/plant information. Values are:

Blank: The system prints branch/plant information.

1: The system prints general ledger cost information.

2. Select Foreign or Domestic Currency

Specify whether the system prints information in foreign or domestic currency. Values are:

Blank: The system prints information in domestic currency.

1: The system prints information in foreign currency.

13.8.3 Printing Open Voucher Information by Receipt

Select Purchasing Reports (G43A111), Voucher Reconciliation.

You can review open voucher information for individual receipt records. For example, if you received 100 widgets on June 30, you can identify:

- The remaining quantity for which you must create a voucher.
- The remaining amount for which you must create a voucher.
- The tax on the remaining amount.

You can use the Received Not Vouchered Reconciliation report to reconcile receipts to the F0902 table.

Each time you record a formal receipt, the system creates a journal entry that credits a Received Not Vouchered account. You can review this account number for each receipt. You usually sequence the report information by that account number.

This report contains information from the F43121 table.

13.8.4 Printing Voucher Amounts for Suppliers

Select Purchasing Reports (G43A111), Supplier Analysis.

You can print the Supplier Analysis report to review all suppliers for whom you have created vouchers during the past year and the total voucher amount for each supplier. You can also print this report to compare the total voucher amount year-to-date to the total voucher amount for the previous year.

Suppliers appear in descending order of the total voucher amount. This report does not include those suppliers with a year-to-date voucher balance of zero.

13.8.5 Setting Processing Options for Supplier Analysis Report (R04602)

Processing options enable you to specify the default processing for programs and reports.

13.8.5.1 Currency

1. Currency

Enter a code that indicates the currency that is used by the supplier. The system uses this currency as the default currency when you enter vouchers for the supplier. You can override the default currency when you enter a voucher. If you leave this processing option blank, the report is stated in U.S. dollars (USD).

Note: This option is only used if multi-currency is turned on.

Understanding the Voucher Match Automation Process (Release 9.1 Update)

This chapter contains the following topics:

- [Section 14.1, "Common Terms"](#)
- [Section 14.2, "Understanding the Voucher Match Automation Process"](#)
- [Section 14.3, "Understanding Validations and Requirements for Matching"](#)

Important: The voucher match automation process enables you to automatically match invoices to purchase order receipts and create vouchers. Based on the voucher match automation setup, the process creates:

- A single voucher for an invoice
You can set up the Duplicate Invoice Edit constant to restrict duplicate supplier invoices. This allows the system to generate a single voucher for an invoice during the voucher match automation process.
 - A voucher for each line of an invoice
You must set up the Duplicate Invoice Edit constant to allow duplicate supplier invoices. This enables the system to generate a voucher for each line of an invoice during the voucher match automation process.

This processing enables the system to process individual supplier invoice lines that have receipts that can be matched. This processing may conflict with your business requirements.
-
-

14.1 Common Terms

This list describes common terms used in this chapter:

Amounts

Unless otherwise specified, the taxable amount of invoices, vouchers, receipts, and purchase orders.

The process matches the taxable amount of the receipts and purchase orders to the records in the Purchase Order Receiver File (F43121) or Accounts Payable Ledger table (F0411).

Automation Rule

The code that determines the rules that the system uses to match invoices to receipts and purchase orders. Each automation rule enables different features, such as exact matching, matching to accumulated receipts, and tolerance rules.

See [Automation Rules](#)

Capture

Any method used to identify the details of an invoice received from a supplier and load the details to the Voucher Transaction - Batch Upload table (F0411Z1). The method can include scanning invoices, data entry, or the electronic transfer processes.

Logged Vouchers

A preliminary voucher in which amounts are written to a suspense account instead of a final expense account. Many companies use logged vouchers to account for supplier invoices for which they have not yet received the goods or services.

Manual Match

An action, or status, that you can select to remove the invoice line from the voucher match automation process. If you change the status of an invoice line to Manual Match, you can use a method outside of the voucher match automation process to match the invoice line to receipts.

Multiple Receipts

In the voucher match automation process, receipts that are recorded against more than one receipt document number.

Process Type

A code in the Voucher Transaction - Batch Upload table (F0411Z1) that indicates the status of a record for the voucher match automation process. You assign process type 1 (newly added) to new records that you add to the F0411Z1 table. The system changes the process type to 2 (logged voucher/ready for match) when it generates logged vouchers during the voucher match automation process. The system changes the process type to 4 (matched) when a successful match occurs for a record with a process type of 1 or 2.

Redistribution

The process of reversing the accounting entries for a logged voucher. When the system redistributes amounts, it credits the suspense account that was debited when the logged voucher was created, and debits the final expense account.

Rounding Tolerance

A tolerance that you can set up in the Rounding Tolerance Rules program (P43221) and apply to matched amounts when you use automation rule 05. This type of tolerance is unique to the voucher match automation process.

Contrast Rounding Tolerance with *Standard Tolerance*.

Single Voucher Per Invoice

An option to generate a single voucher for an invoice using voucher match automation process. You specify in the supplier master record or in the processing option of the VMA driver UBE (R4304010) whether to generate a single voucher for an invoice in the voucher match automation process. The single voucher per invoice feature enables you to comply with the legal requirements of some countries to generate a single voucher for an invoice regardless of the number of lines on the invoice.

Standard Vouchers

In the voucher match automation process, a voucher created when the system matches a record that has a process type of **1** in the F0411Z1 table to one or more receipts in the Purchase Order Receiver File (F43121). A corresponding purchase order line must exist in the Purchase Order Detail File (F4311) for each receipt line matched.

Standard Tolerance

A tolerance that you set up by function type in the Tolerance Rules program (P4322). You can create standard tolerance rules for items, commodity classes or companies. The voucher match automation process uses the standard tolerance that you set up for voucher matching when you enable tolerance for automation rules 02 and 03.

Contrast Standard Tolerance with *Rounding Tolerance*.

Note: For the VMA process, you can also specify whether to apply tolerance on receipts with an amount greater than the invoice amount.

See [Tolerance Rules in the VMA Process \(Release 9.1 Update\)](#)

Suggest Mode

A mode that you can use instead of proof or final mode. In suggest mode, the process suggests matches between supplier invoice lines and receipt and purchase order lines. After you run the VMA process in suggest mode, you can use the Voucher Match Process Workbench program (P4314WB) to review and manage the suggested matches.

The voucher match automation process creates suggestions based on the setup in the supplier master and the processing options in the Voucher Match Automation UBE programs (R4304016, R4304020 and R4304021).

See [Suggestion Processing \(Release 9.1 Update\)](#)

Voucher Match Automation UBE Programs

Collectively, the batch programs that include the logic to automatically match invoices or logged vouchers to receipts and purchase orders. To use the voucher match automation process, you run the Voucher Match Automation Driver program (R4304010), which launches each of these Voucher Match Automation Matching UBE programs:

- Voucher Match Automation UBE for Automation Rule 01 (R4304016)
- Voucher Match Automation UBE for Automation Rule 02, 03, 04, 05 (R4304020)
- Voucher Match Automation UBE for Automation Rule 06 (R4304021)

14.2 Understanding the Voucher Match Automation Process

Note: The voucher match automation (VMA) process creates or updates records in the Accounts Payable Ledger (F0411), Account Ledger (F0911), Voucher Transaction - Batch Upload (F0411Z1), Voucher Transaction Batch Upload - Voucher Match Automation (F0411Z1T), and Purchase Order Receiver File (F43121) tables when you run the process in final mode. Many sections in this chapter explain when the process updates tables. Unless otherwise noted, those explanations assume that the process is run in final mode.

If you run the VMA process in suggest mode, the process updates or creates the F0411Z1T table with the invoice match status and the receipts that have been suggested. The process also updates the data item FUF3 in the F43121 to reserve the receipts for the suggestions.

See [Effect of Processing Options on Process Output](#)

The voucher match automation (VMA) process enables you to set up and run an automated process to:

- Create logged vouchers (optional).
- Perform a 3-way voucher match to redistribute a previously created logged voucher.
- Perform a 3-way voucher match to create a new voucher.
- Suggest matches for invoice and receipt lines so that you can review them prior to approving and performing the match.

To use the VMA process, you populate the F0411Z1 and F0411Z1T tables with records for the invoices that you receive from your suppliers and assign one of six automation rules to the supplier or to individual invoice lines. The automation rules determine the guidelines that the process uses to match invoice lines to receipts and purchase orders, such as matching multiple receipts to an invoice line or allowing or disallowing standard or rounding tolerance.

When you run the Voucher Match Automation Driver program (R4304010), the program selects records from the F0411Z1 table, and then launches several other programs that:

- Create logged vouchers if you specify to do so.
- Perform a 3-way match according to the automation rule assigned to the invoice or supplier.
- Creates suggestions for receipts to match to the invoice line and reserves the receipts until the suggestion has been processed.
- Redistribute logged voucher amounts when the logged voucher is matched to a receipt and purchase order.
- Purge processed F0411Z1 records if you specify to do so.

The VMA process also provides an interactive workbench in which you can review the results of the batch process as well as manage the suggestions created by the process. Using the workbench, you can approve, reject, clear, and process suggested matches. You can also use the workbench to manually suggest the receipts to match to invoice lines or automatically suggest invoice lines to match to receipt and purchase order lines for selected records.

See [Using the Voucher Match Process Workbench](#).

14.2.1 Voucher Match Automation EnterpriseOne Page (Release 9.1 Update)

The Voucher Match Automation EnterpriseOne page helps you to easily access the forms to set up the voucher match automation process, to process the invoices, and to post and pay the vouchers.

Figure 14–1 Voucher Match Automation E1 page



14.2.2 Business Process Flows

In a typical business, you generate purchase orders when you order goods from a supplier, and your supplier ships the goods to you. You create receipt records in the JD Edwards EnterpriseOne Procurement Management system to log the receipt of the supplier shipments. Your supplier also sends you an invoice that generally includes the information about what was shipped and the cost to you for the goods shipped.

When you use the VMA process, you capture supplier invoice information and upload it to the Voucher Transaction - Batch Upload (F0411Z1) and Voucher Transaction Batch Upload - Voucher Match Automation (F0411Z1T) tables. You can use a scanning process, a batch upload process, the Batch Voucher Upload program (P0411Z1), or other methods to populate the tables with the information required for the process. You then run the Voucher Match Automation Driver program (R4304010) manually, or run it from a scheduled job.

You must capture item information for the F0411Z1T table only when you set up the supplier master record to require item information for matching. If you do not require item information for matching, the VMA process will create the F0411Z1T table record as it attempts to create matches. However, Oracle recommends that you create a record in the F0411Z1T for all records in the F0411Z1 table prior to running the VMA process because doing so improves processing time.

This illustration shows how the voucher match automation process fits within the basic business flow of entering purchase orders, receipts, and invoices:

Figure 14–2 Process Flow A: VMA and Basic Business Flow

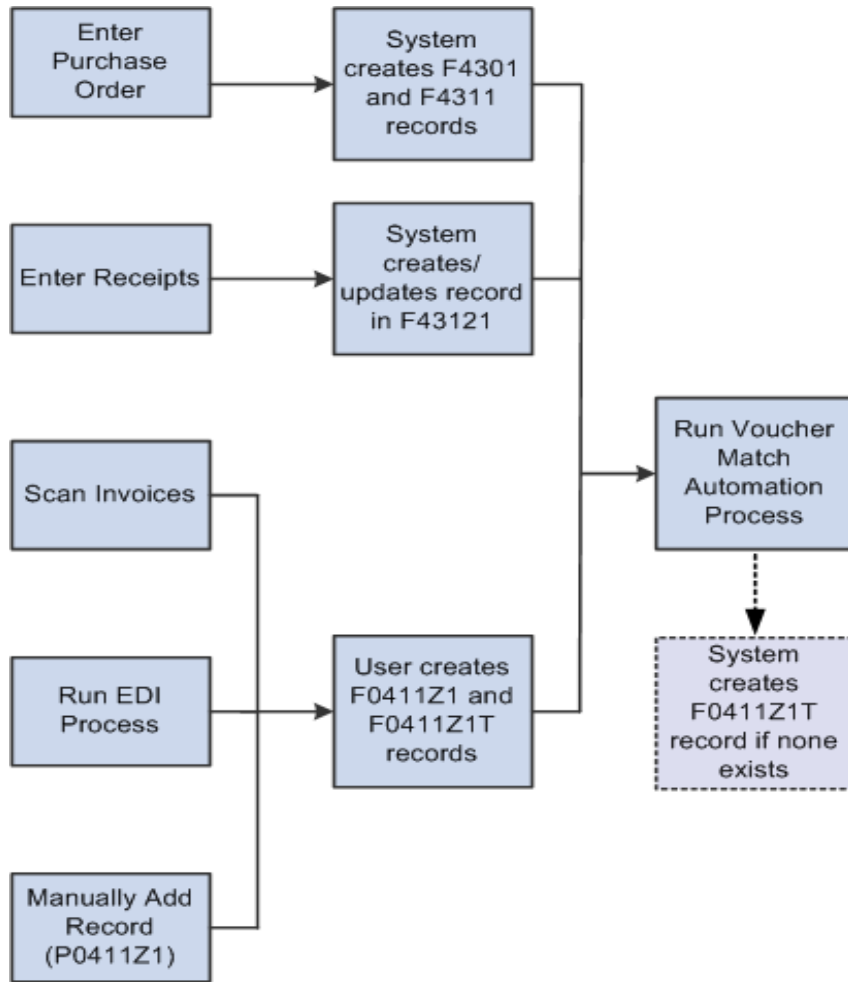

The Voucher Match Automation Driver program creates logged vouchers if you have set up the process to do so, and attempts to match invoice records in the F0411Z1 table to receipt records in the Purchase Order Receiver File (F43121) and the Purchase Order Detail File (F4311). If you run the process in final mode and the match is successful, the process updates the Accounts Payable Ledger (F0411), Account Ledger (F0911), and F43121 tables. If you run the process in suggest mode and the system successfully processes the invoice lines, the system creates suggested matches between the invoice, receipt, and purchase order lines. You can review and manage the suggested matches in the Voucher Match Automation Process Workbench program (P4314WB). For both final and suggest modes, the process provides reports that show the matched or suggested records.

If you process records in final or suggest mode and the process cannot create a match or suggestion, the report includes a statement that a match was not found. You can check the Work Center for messages for warnings or errors that prevented the process from matching invoice lines to receipts and purchase orders.

The VMA process works as a continuous flow. If a valid record is not matched or suggested because no matching receipt was found, then the process attempts to match the invoice record to a receipt record, or create a suggestion, the next time you run the process. The valid invoice records are processed each time you run the process, unless:

- You delete the record from the F0411Z1 and F0411Z1T tables using the Batch Voucher Revisions program (P0411Z1).

- You change the invoice match status of the record to Manual Match.

Changing the invoice match status to Manual Match removes the invoice line from the voucher match automation process. You can use the Voucher Match Process Workbench program (P4314WB) to change the status, and then use another program or process, such as the Voucher Match program (P4314), to complete the match.

See [Using the Voucher Match Process Workbench](#)
- The invoice match status is 1 (suggested) or 2 (rejected).

If you want to complete matches for invoices with an invoice match status of 3 (approved) by running the Voucher Match Automation UBE programs, you set the Process Approved Suggestions processing option to do so.

This illustration shows the continuous flow that the VMA process uses to process records in the F0411Z1 table:

Figure 14–3 Process Flow B: VMA Continuous Process

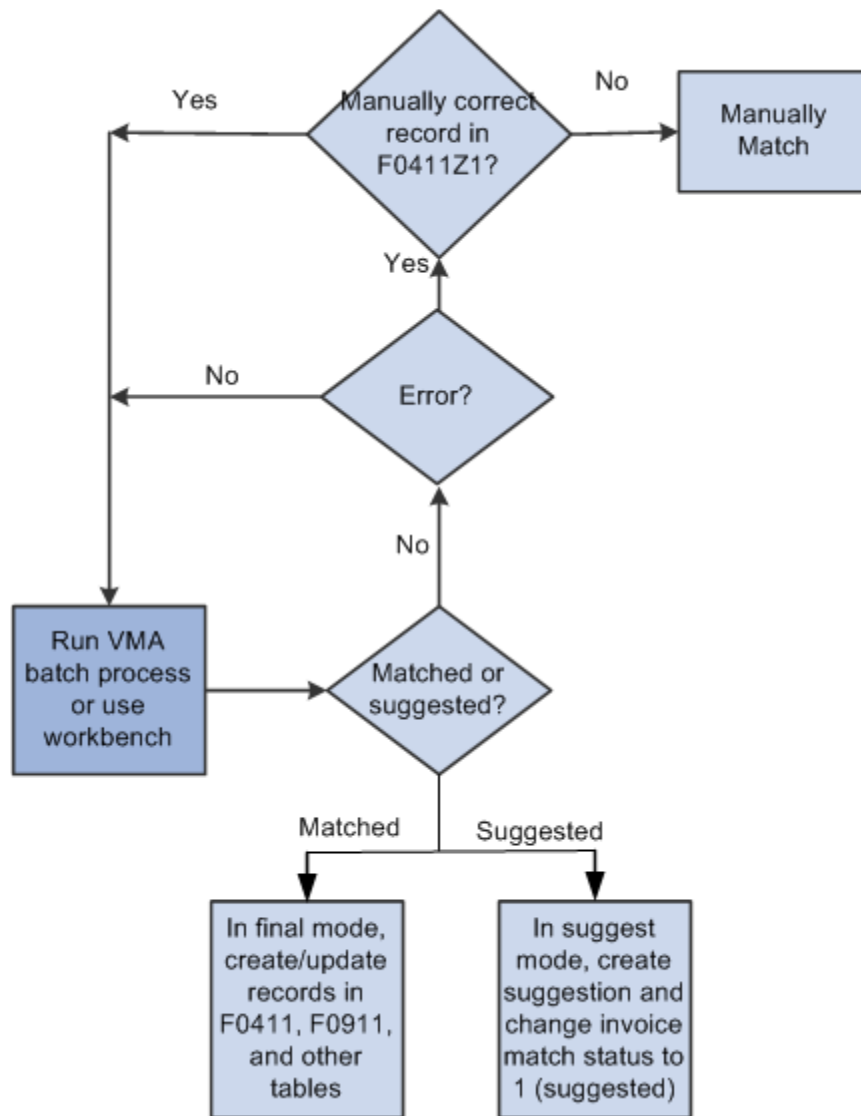

14.2.3 Voucher Match Automation Process Flow

When you run the Voucher Match Automation Driver program, the process runs several subprocesses, such as those for creating logged vouchers and those for matching receipts and purchase orders to invoice records.

This process flow illustrates the overall process for the VMA process. The process flow includes the names of related subprocesses for which illustrations exist in this implementation guide.

Figure 14–4 Process Flow C: Overall Process Flow for the Voucher Match Automation Process

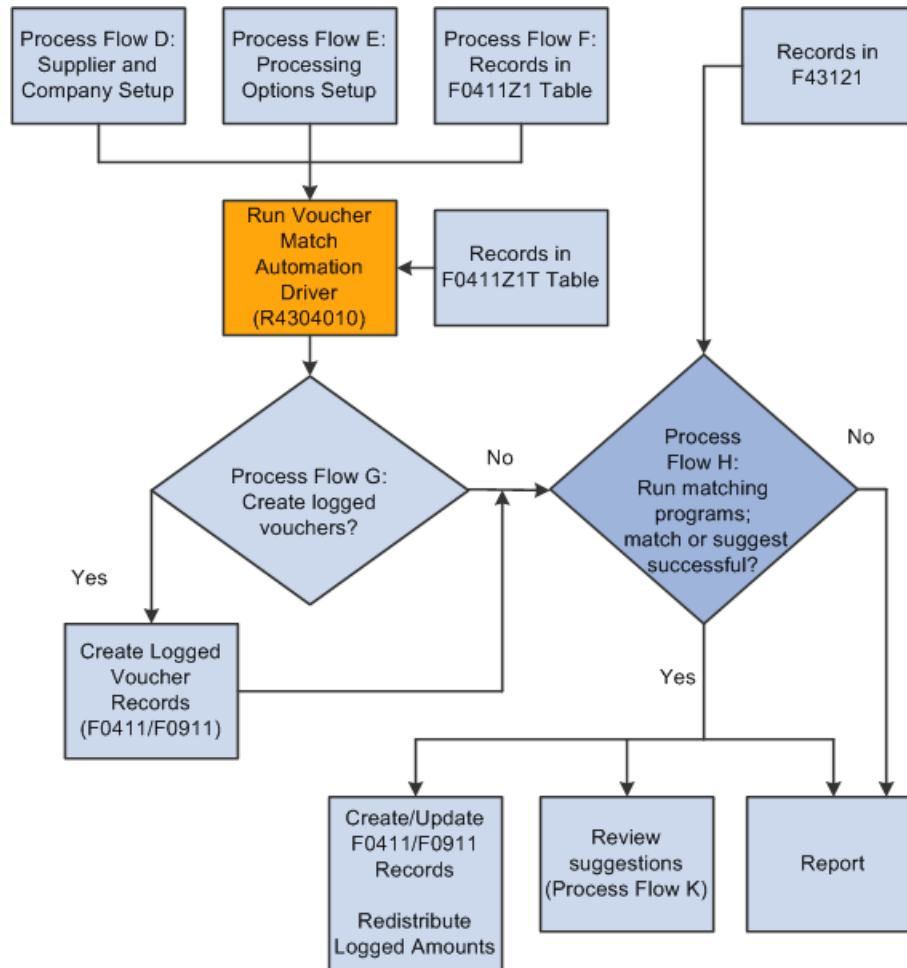

When you run the Voucher Match Automation Driver program, the process:

- Looks for setup information for the supplier and company.
See [Figure 14–17, "Process Flow D: Supplier and Company Setup \(Release 9.1 Update\)"](#)

- Determines the automation rule to use.

The process uses the automation rule that exists in the invoice record, or uses the automation rule assigned to the supplier master record if the automation rule is not specified in the invoice record.

- Reads the processing option values in the Voucher Match Automation Driver program, and the processing option values in the programs called by the Voucher Match Automation Driver program.

See [Figure 15–1, "Process Flow E: Processing Options"](#)

- Runs validations and uses processing option values to determine which records to select for processing.

The Voucher Match Automation Driver program launches each of the Voucher Match Automation UBE programs and uses the processing options in the Voucher Match Automation UBE programs to further define the F0411Z1 records to process. The Voucher Match Automation UBE programs are:

- Voucher Match Automation UBE for Automation Rule 01 (R4304016)
- Voucher Match Automation UBE for Automation Rule 02, 03, 04, 05 (R4304020)
- Voucher Match Automation UBE for Automation Rule 06 (R4304021)

See [Automation Rules](#)

- Runs the Batch Voucher Processor Report program (R04110ZA) to create logged vouchers, if you have the processing option in the Voucher Match Automation Driver program set to do so.

See [Figure 14–16, "Process Flow G: Create Logged Vouchers"](#)

- Attempts to create matches or suggestions between the records in the Voucher Transaction - Batch Upload (F0411Z1) table and records in the Purchase Order Receiver File (F43121) and Purchase Order Detail File (F4311).

The records in the F0411Z1 table must have corresponding records in the F0411Z1T table if you specified in the supplier master record that item information is required for matching.

The records in the F43121 table must have corresponding valid records in the F4311 table.

For logged vouchers, the process matches the logged vouchers to receipts and purchase orders, and then redistributes the logged voucher amounts. For invoice records with no logged voucher record, the process creates standard vouchers for matches between F0411Z1, F43121, and F4311 records.

- Generates reports for proof, suggest, and final modes.

Note: If you run the VMA process in suggest mode, the process creates suggested matches between the invoice lines and the receipt and purchase order lines. You use the Voucher Match Process Workbench program to review and manage the suggestions, and then either complete the match in the Voucher Match Process Workbench program, or run the VMA batch programs in final mode to complete the match. When you review and manage suggested matches, the system updates or creates the record in the F0411Z1T table that corresponds to the invoice line in the F0411Z1 table.

See [Figure 15–2, "Process Flow K: Voucher Match Process Workbench Program"](#)

See [Section 15.4, "Using the Voucher Match Process Workbench"](#)

14.2.4 Populate the Voucher Transaction - Batch Upload Table (F0411Z1)

Before you can use the voucher match automation process, you must populate the Voucher Transaction - Batch Upload (F0411Z1) table with the supplier invoice records. You can populate the table using a batch upload process, by scanning invoices, or other methods.

This graphic illustrates the methods that you can use to populate the F0411Z1 table, and the fields that you must populate for the VMA process:

Figure 14–5 Process Flow F: Populate the F0411Z1 Table

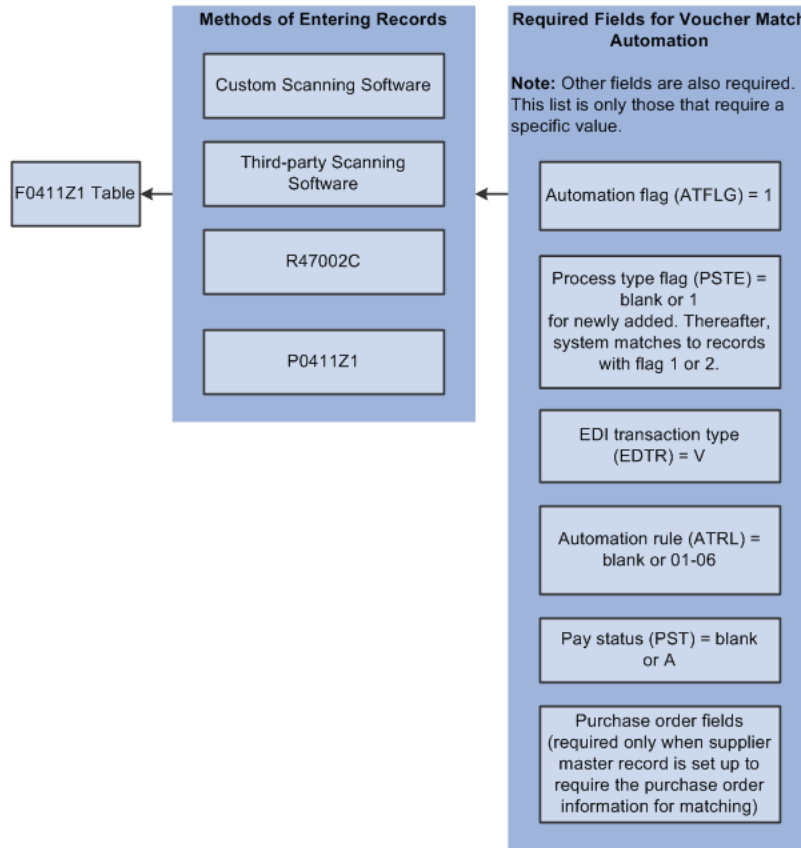

You should create a record in the F0411Z1 table for each line in the supplier invoice that you receive.

In addition to the required fields that you must populate for any batch voucher in the F0411Z1 table, you must provide specific values for some of the fields for the records that you upload for the voucher match automation process.

Note: The Automation Rule (ATRL) field is not listed in the table of required fields because you are not required to populate the field. However, Oracle recommends that you populate the field for each record. If a value exists for the automation rule in the F0411Z1 table, then the process does not need to check the supplier master record for an automation rule. Eliminating the fetch from the supplier master record increases processing speed.

The system enables the Automation Rule field only when the value in the Automation Flag field (data item ATFLG) is 1.

This table lists required fields and the specific value, if any, required for specific fields:

Field	Required Value	Comment
User ID (EDUS)	Any value	A value is required in this field, but no specific value is required.
Transaction Number (EDTN)	Any value	A value is required in this field, but no specific value is required.
Line Number (EDLN)	Any value	A value is required in this field, but no specific value is required.
Successfully Processed (EDSP)	0	The initial value that you upload must be 0. The system changes this value to 1 when it successfully matches the record to receipt records.
Transaction Action (EDTC)	A	The initial value that you upload must be A (added).
Transaction Type (EDTT)	V	The initial value that you upload must be V (voucher).
Batch Number (EDBT)	Any value.	A value is required in this field, but no specific value is required.
Address Number (AN8)	Any valid address book record.	You enter the address book number of the supplier in this field.
G/L Date (DGJ)	Any value.	You enter the GL date of the invoice in this field.
Company (CO)	A valid company number from the F0010 table.	You enter the company number in this field.
Gross Amount (AG)	An amount.	You enter the gross amount of the invoice in this field.
Foreign or Domestic (CCRM)	The value F or D.	If you enter F (foreign), you must also enter a value in the Currency Amount (ACR) field.
Currency Code (CRCD)	Any valid code.	Any valid code.
Business Unit (MCU)	Any valid value.	Any valid value.
Automation Flag (ATFLG)	The value 1.	The initial value that you upload must be 1 (process using the automation process).
Purchase Order (PO)	The purchase order number for which the invoice was generated.	You must upload a value for this field only when you specify in the supplier master record that order information is required to match an invoice line to a receipt line.
Process Type (PSTE)	The value 1.	The initial value that you upload must be 1 (newly added) or blank. If the value is blank, then the VMA process changes the value to 1 when it selects the record for processing.
Invoice Level Processing Required (INVLYN) (Release 9.1 Update)	Y or N	Based on the setup in the Single Voucher Per Invoice field of the supplier master, the system displays the Single Voucher field with Y/N in the Voucher Match Process Workbench program (P4314WB). When the value is Y, the Voucher Match Process Workbench program creates a single voucher for an invoice.

Note: Records in the F0411Z1 table that have the Automation Flag set to **1** can be processed by only the VMA process. However, you can use the Batch Voucher Revisions program (P0411Z1) to modify certain fields in the F0411Z1 table and to delete records from the F0411Z1 table.

See "Understanding Batch Voucher Processing" in the *JD Edwards EnterpriseOne Applications Accounts Payable Implementation Guide*.

See Also: "Mapping Voucher Transactions to Batch Input Tables" in the *JD Edwards EnterpriseOne Applications Accounts Payable Implementation Guide*.

14.2.5 Populate the Voucher Transaction Batch Upload - Voucher Match Automation Table (F0411Z1T)

The VMA process uses the F0411Z1T table to hold values for the invoice match status and item number information. If you set up your suppliers to require item information on their invoices, you must also populate the Voucher Transaction Batch Upload - Voucher Match Automation table (F0411Z1T) with the item information. If you specify in the supplier master record that you require this information, then the VMA process performs or suggests matches only when the information matches.

See [Order and Item Information for the VMA Process](#)

Note: You must populate the F0411Z1T table with item information if you require that information for matching or the process will not match records.

The system does not require you to populate the F0411Z1T record if you do not require the item information; the process will create a record so that it can store the invoice match status. However, Oracle recommends that you create a corresponding record in the F0411Z1T table for each record in the F0411Z1 table. If you create the records for the F0411Z1T table, the system does not have to create the record when it processes matches and suggested matches. Requiring the system to create the record in the F0411Z1T table increases processing time.

You can populate the F0411Z1T table using scanning software, or your own custom programming. JD Edwards EnterpriseOne software does not provide a method to populate the F0411Z1T table other than the standard import data function.

See "Importing Data from an External Spreadsheet to a Grid" in the *JD Edwards EnterpriseOne Tools Foundation Guide*.

This list describes the fields that you must populate:

- User ID
- Batch Number
- Transaction Number
- Line Number

If you require item information to match supplier invoice lines to receipts and purchase orders, then you must complete at least one of these fields:

- Short Item Number
- 2nd Item Number
- Item Number - Customer/Supplier

14.2.6 Automation Rules

The voucher match automation (VMA) process uses automation rules to determine the logic that the system uses to match each supplier invoice to receipts and purchase orders. You can assign automation rules to the records that you upload to the F0411Z1 table. If you do not assign an automation rule to the F0411Z1 records, then the system uses the default automation rule that you assign to each supplier on the Purchasing 2 tab of the Supplier Master Revision form in the Supplier Master Revision program (P04012).

See [Defining Supplier Purchasing Instructions](#)

If no valid automation rule exists in the F0411Z1 record or in the supplier master record, then the VMA process issues an error message and does not attempt to match the F0411Z1 record to receipts and purchase orders.

This process flow illustrates how the system determines the automation rule to use:

Figure 14–6 Process Flow J: Source of Automation Rule

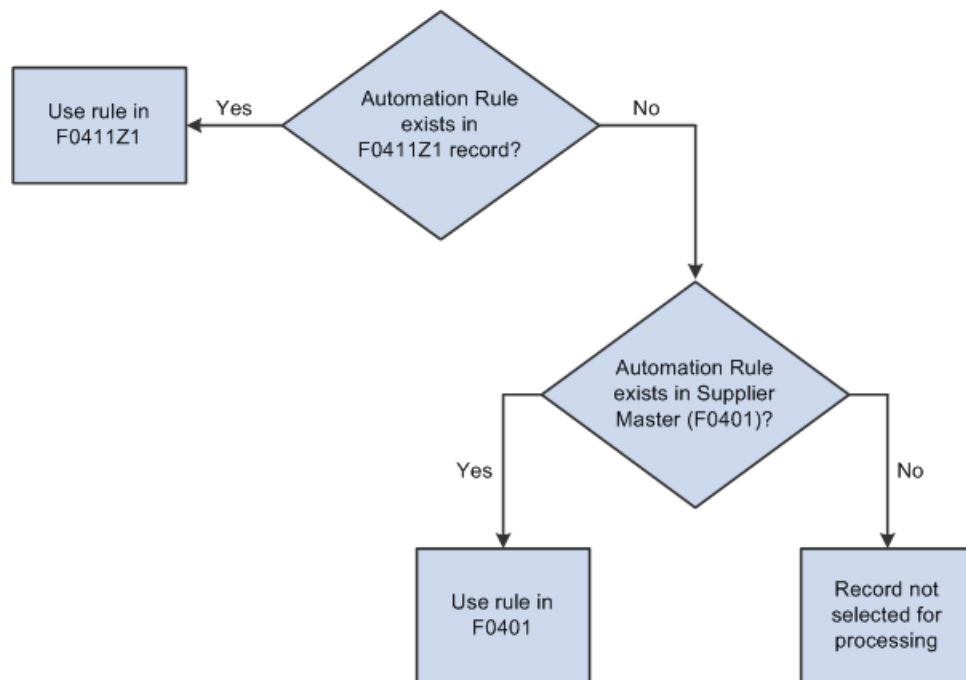

This table describes the automation rules that you can assign to records in the F0411Z1 table or to suppliers:

Automation Rule	Description	Match Invoice Line to Single Purchase Order Line	Match Invoice Line to Single Receipt Line	Match Invoice Line to Multiple Receipt Lines	Type of Tolerance Allowed
01	Exact Match of Invoice Line to Purchase Order Line to Receipt Line (Automation Rule 01)	Yes	Yes	No	None
02	Match of Invoice Line to Receipt Line, Standard Tolerance Applied (Automation Rule 02)	Yes	Yes	No	Standard VMA tolerance for receipt amount greater than the invoice amount. This tolerance uses the tolerance values defined in the standard tolerance. (Release 9.1 Update)
03	Match of Invoice Line to Purchase Order Line to Multiple Receipt Lines, Standard Tolerance Applied (Automation Rule 03)	Yes	No	Yes	Standard VMA tolerance for receipt amount greater than the invoice amount. This tolerance uses the tolerance values defined in the standard tolerance. (Release 9.1 Update)
04	Exact Match of Invoice Line to Receipt Line (Automation Rule 04)	Yes	Yes	No	None
05	Match of Invoice Line to Purchase Order Line to Multiple Receipt Lines, Rounding Tolerance Applied (Automation Rule 05)	Yes	No	Yes	Rounding
06	Exact Match of Invoice to Multiple Receipt Lines across Multiple Purchase Orders (Automation Rule 06)	No	No	Yes	None

14.2.6.1 Exact Match of Invoice Line to Purchase Order Line to Receipt Line (Automation Rule 01)

When you run the Voucher Match Automation Driver program, that program runs the Voucher Match Automation UBE for Automation Rule 01 program (R4304016) to match invoices and receipts for invoice lines assigned automation rule 01.

When you assign automation rule 01, each invoice line received from the supplier is matched to a single purchase order line and a single receipt line. The amounts must match exactly between the invoice, purchase order, and receipt lines. The supplier must ship the entire quantity on a purchase order line together and must invoice the entire quantity on a purchase order line as one line on the invoice. No tolerance limits apply or rounding issues are allowed.

Note: The process performs a match when the open quantity on the purchase order is 0. The open quantity becomes 0 when you receive all the quantity or when you receive a partial quantity and close the remainder.

This illustration shows how the process matches an invoice, receipt and purchase order line for invoice lines assigned automation rule 01:

Figure 14–7 Automation Rule 01

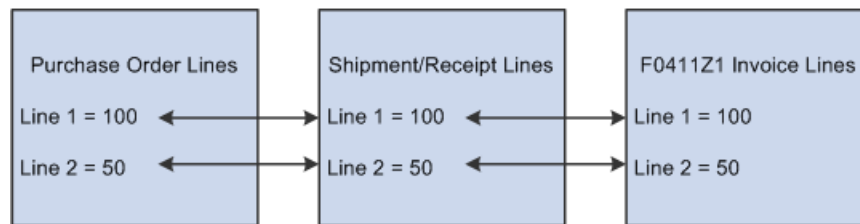

See Also:

[Create and Match Standard Vouchers](#) and [Create and Match Logged Vouchers](#)

14.2.6.2 Match of Invoice Line to Receipt Line, Standard Tolerance Applied (Automation Rule 02)

When you run the Voucher Match Automation Driver program, that program runs the Voucher Match Automation UBE for Automation Rule 02, 03, 04, 05 program (R4304020) to match invoices and receipts for invoice lines assigned automation rule 02.

When you use automation rule 02, each invoice line received from the supplier is matched to a single receipt line. The amount of the invoice line and the receipt line can be different based on allowed standard tolerance limits. The supplier can ship a purchase order line in multiple shipments, then invoice for each shipment for each purchase order line. Prices are set, but can vary based on allowed standard tolerance limits.

Note: The process performs a match when the open quantity on the purchase order is 0. The open quantity becomes 0, when you receive all the quantity or when you receive a partial quantity and close the remainder.

(The following paragraph pertains to a Release 9.1 update.) However, when you enable partial receipts in the supplier master, the system performs the match even if the purchase order is not closed.

See [Partial Receipts for VMA Process \(Release 9.1 Update\)](#)

When matching receipt lines to invoice lines, automation rule 02 applies the standard tolerance that you have set up for voucher matching in the Tolerance Rules program (P4322). You must specify in a processing option in the R4304020 program that you want to apply standard tolerance when matching invoice lines that are assigned automation rule 02.

(The following paragraph pertains to a Release 9.1 update.) The VMA process utilizes a tolerance to match invoice lines with receipts, when the receipt amount is greater than the invoices amount. You can apply this tolerance only when you use automation rules 02 or 03. You specify this tolerance in a processing option in the Voucher Match Automation UBE for Automation Rule 02, 03, 04, 05 program (R4304020).

See [10. Apply tolerance on receipt amount greater than the invoice amount. \(Release 9.1 Update\)](#).

Note: Automation rules 02 and 04 are similar; they each enable multiple shipments and require that each receipt line has a separate invoice line. The difference between the rules 02 and 04 is that rule 02 enables tolerance and rule 04 requires an exact match.

This illustration shows how the process matches invoice, receipt and purchase order lines for invoice lines assigned automation rule 02:

Figure 14–8 Automation Rule 02

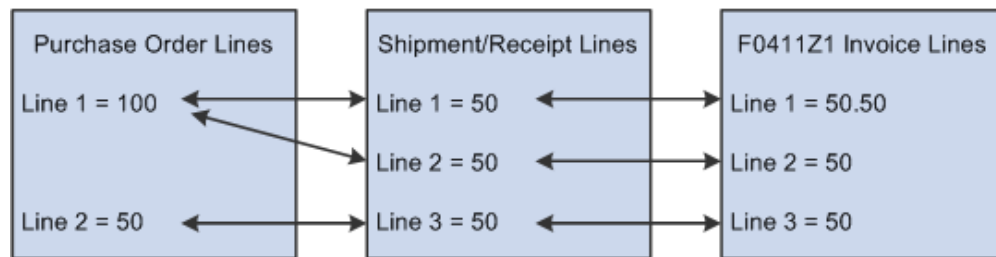

See Also:

[Create and Match Standard Vouchers](#) and [Create and Match Logged Vouchers](#)

14.2.6.3 Match of Invoice Line to Purchase Order Line to Multiple Receipt Lines, Standard Tolerance Applied (Automation Rule 03)

When you run the Voucher Match Automation Driver program, that program runs the Voucher Match Automation UBE for Automation Rule 02, 03, 04, 05 program

(R4304020) to match invoices and receipts for invoice lines assigned automation rule 03.

When you use automation rule 03, each invoice line received from the supplier is matched to a single purchase order line and to the total of one or more receipt lines for the purchase order. The amount of the invoice line and the purchase order line can be different based on allowed standard tolerance limits. The supplier can ship a purchase order line in multiple shipments, but must invoice the entire quantity of one purchase order line in one invoice line. Prices are set, but can be variable based on allowed standard tolerance limits.

Note: The process performs a match when the open quantity on the purchase order is 0. The open quantity becomes 0 when you receive all the quantity or when you receive a partial quantity and close the remainder.

When matching receipt lines to invoice lines, automation rule 03 applies the standard tolerance that you have set up for voucher matching in the Tolerance Rules program (P4322). You must specify in a processing option in the R4304020 program that you want to apply standard tolerance when matching invoice lines that are assigned automation rule 03.

(The following paragraph pertains to a Release 9.1 update.) The VMA process utilizes a tolerance to match invoice lines with receipts, when the receipt amount is greater than the invoices amount. You can apply this tolerance only when you use automation rules 02 or 03. You specify this tolerance in a processing option in the Voucher Match Automation UBE for Automation Rule 02, 03, 04, 05 program (R4304020).

See [10. Apply tolerance on receipt amount greater than the invoice amount. \(Release 9.1 Update\)](#)

Note: Automation rules 03 and 05 are similar; they both enable multiple shipments and require that each purchase order line have a separate invoice line. The difference between the rules is that automation rule 03 allows standard tolerance and automation rule 05 allows rounding tolerance.

This illustration shows how the process matches invoice, receipt and purchase order lines for invoice lines assigned automation rule 03:

Figure 14–9 Automation Rule 03

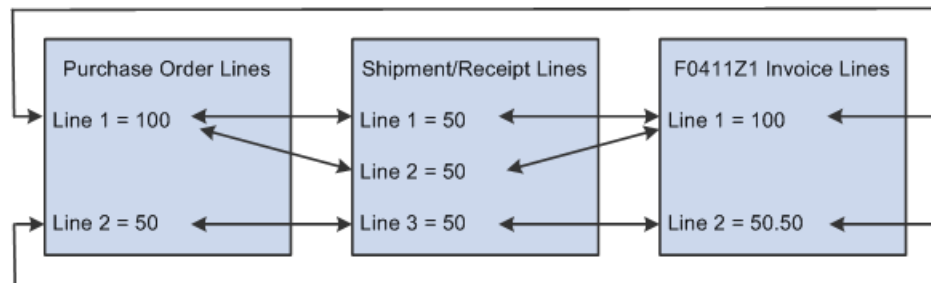

Note: If you use the Voucher Match Process Workbench program to work with suggested matches, note that you can select only receipts for a single purchase order to match to an invoice line. For example, in the example in figure 14-8, the system would match lines 1 and 2 of the receipt line to invoice line 1 because receipt lines 1 and 2 are both associated with purchase order line 1. The system would not allow you to match receipt lines 1 and 3 to invoice line 1 because receipt lines 1 and 3 are associated with different purchase order lines.

See Also:

[Create and Match Standard Vouchers](#) and [Create and Match Logged Vouchers](#)

14.2.6.4 Exact Match of Invoice Line to Receipt Line (Automation Rule 04)

When you run the Voucher Match Automation Driver program, that program runs the Voucher Match Automation UBE for Automation Rule 02, 03, 04, 05 program (R4304020) to match invoices and receipts for invoice lines assigned automation rule 04.

When you use automation rule 04, each invoice line received from the supplier is matched to a single receipt line. The amount of the invoice line and the receipt line must match exactly. The supplier can ship a purchase order line in multiple shipments then invoice for each shipment for each purchase order line. No tolerance limits apply or rounding issues are allowed.

Note: The process performs a match when the open quantity on the purchase order is 0. The open quantity becomes 0 when you receive all the quantity or when you receive a partial quantity and close the remainder.

(The following paragraph pertains to a Release 9.1 update.) However, when you enable partial receipts in the supplier master, the system performs the match even if the purchase order is not closed.

See [Partial Receipts for VMA Process \(Release 9.1 Update\)](#).

Note: Automation rules 02 and 04 are similar; they each enable multiple shipments and require that each receipt line has a separate invoice line. The difference between the rules 02 and 04 is that rule 02 enables tolerance and rule 04 requires an exact match.

This illustration shows how the process matches invoice, receipt and purchase order lines for invoice lines assigned automation rule 04:

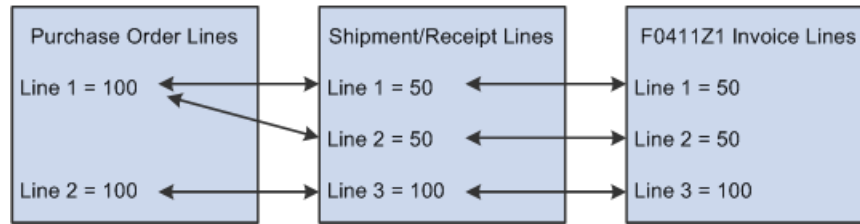
Figure 14–10 Automation Rule 04**See Also:**

[Create and Match Standard Vouchers](#) and [Create and Match Logged Vouchers](#)

14.2.6.5 Match of Invoice Line to Purchase Order Line to Multiple Receipt Lines, Rounding Tolerance Applied (Automation Rule 05)

When you run the Voucher Match Automation Driver program, that program runs the Voucher Match Automation UBE for Automation Rule 02, 03, 04, 05 program (R4304020) to match invoices and receipts for invoice lines assigned automation rule 05.

When you use automation rule 05, each invoice line received from the supplier is matched to a single purchase order line and to the total of one or more receipt lines for the purchase order. The amount of the invoice line and the purchase order line can be different based on allowed rounding tolerance limits. The supplier can ship a purchase order line in multiple shipments, but must invoice the entire quantity of one purchase order line in one invoice line. Prices are set, but can be variable based on allowed rounding tolerance limits.

Note: The process performs a match when the open quantity on the purchase order is 0. The open quantity becomes 0 when you receive all the quantity or when you receive a partial quantity and close the remainder.

When matching receipt lines to invoice lines, automation rule 05 applies the rounding tolerance that you set up in the Rounding Tolerance Rules program (P43221). You must specify in a processing option in the R4304020 program that you want to apply rounding tolerance when matching invoice lines that are assigned automation rule 05.

Important!: When you use automation rule 05, the system matches invoice and receipt records, within the rounding tolerance specified, based on the taxable amounts. When the process calculates the tax amounts, the tax amount calculated for the invoice and receipt records might be different because automation rule 05 allows matching of invoice and receipt amounts that are not identical. The process does not create the journal entries for the variance when you use automation rule 05. You must manually enter the journal entries to balance your accounts before you post the batches generated by the process

You can use automation rule 02 or automation rule 03 to apply standard tolerance instead of rounding tolerance. When you use automation rules 02 and 03, the system generates the journal entries for variance amounts.

Note: Automation rules 03 and 05 are similar; they both enable multiple shipments and require that each purchase order line have a separate invoice line. The difference between the rules is that automation rule 03 allows standard tolerance and automation rule 05 allows rounding tolerance.

This illustration shows how the process matches invoice, receipt and purchase order lines for invoice lines assigned automation rule 05:

Figure 14–11 Automation Rule 05

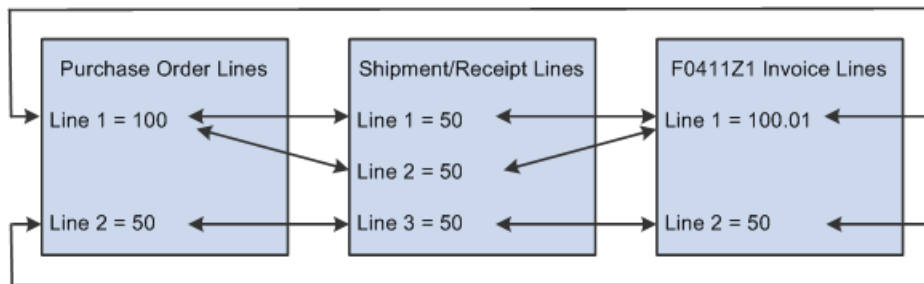

Note: If you use the Voucher Match Process Workbench program to work with suggested matches, note that you can select only receipts for a single purchase order to match to an invoice line. For example, in the example in figure 14-10, the system would match lines 1 and 2 of the receipt line to invoice line 1 because receipt lines 1 and 2 are both associated with purchase order line 1. The system would not allow you to match receipt lines 1 and 3 to invoice line 1 because receipt lines 1 and 3 are associated with different purchase order lines.

See Also:

[Create and Match Standard Vouchers](#) and [Create and Match Logged Vouchers](#)

14.2.6.6 Exact Match of Invoice to Multiple Receipt Lines across Multiple Purchase Orders (Automation Rule 06)

When you run the Voucher Match Automation Driver program, that program runs the Voucher Match Automation UBE for Automation Rule 06 program (R4304021) to match invoices and receipts for invoice lines assigned automation rule 06.

When you use automation rule 06, each invoice line received from the supplier will be matched to multiple receipt lines, which can be on multiple purchase orders. The amounts must exactly match to these receipts; no tolerance or rounding issues may exist.

When you run the VMA process for invoice lines assigned automation rule 06, the process runs an algorithm that attempts to find matches between various combinations of receipt lines to match the invoice line amount. If the process does not find an exact match between the invoice line and one or more receipt lines, then the process skips to the next invoice line in the data set and begins the algorithm again.

Note: The process performs a match when the open quantity on the purchase order is 0. The open quantity becomes 0 when you receive all the quantity or when you receive a partial quantity and close the remainder.

(The following paragraph pertains to a Release 9.1 update.) However, when you enable partial receipts in the supplier master, the system performs the match even if the purchase order is not closed.

See [Partial Receipts for VMA Process \(Release 9.1 Update\)](#).

This illustration shows how the process matches invoice, receipt and purchase order lines for invoice lines assigned automation rule 06:

Figure 14–12 Automation Rule 06

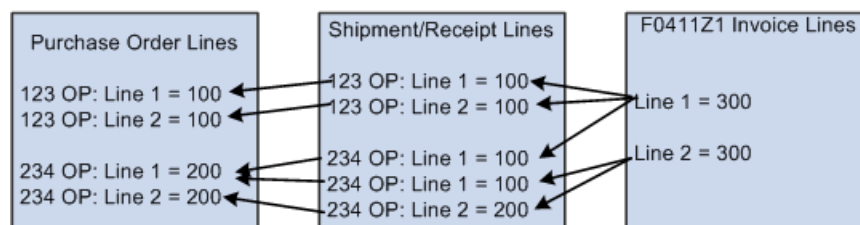

14.2.7 Suggestion Processing (Release 9.1 Update)

You can specify in the supplier master record whether to run the voucher match automation process in suggest mode. The voucher match automation process creates suggestions based on the setup in the Suggestion Required option in the supplier master, and the Proof, Final or Suggest Mode processing option in the Voucher Match Automation UBE programs (R4304016, R4304020 and R4304021).

See [Suggestion Required \(Release 9.1 Update\)](#).

The voucher match automation process creates proof matches, suggestions or final matches based on the following criteria:

- When you select the proof mode in the processing option, irrespective of the setup in the supplier master, the system creates a proof match.

- When you select the suggest mode in the processing option, irrespective of the setup in the supplier master record, the system creates suggestions for the unprocessed invoices. If the Process Approved Invoices processing option is set to 1, the system creates final matches for the approved invoices.
- When you select the final mode in the processing option, and if you have selected the Suggestion Required option for the supplier, the system creates suggestions for that supplier's invoices. However, if the Process Approved Invoices processing option is set to 1, the system creates final matches for the approved invoices of that supplier.
- In the final mode, if you have not selected the Suggestions Required option for the supplier, the system performs final matches for that supplier's invoices.

This illustration shows how the system determines how to create suggestions during the voucher match automation process.

Figure 14–13 Source of Suggestion Processing in VMA

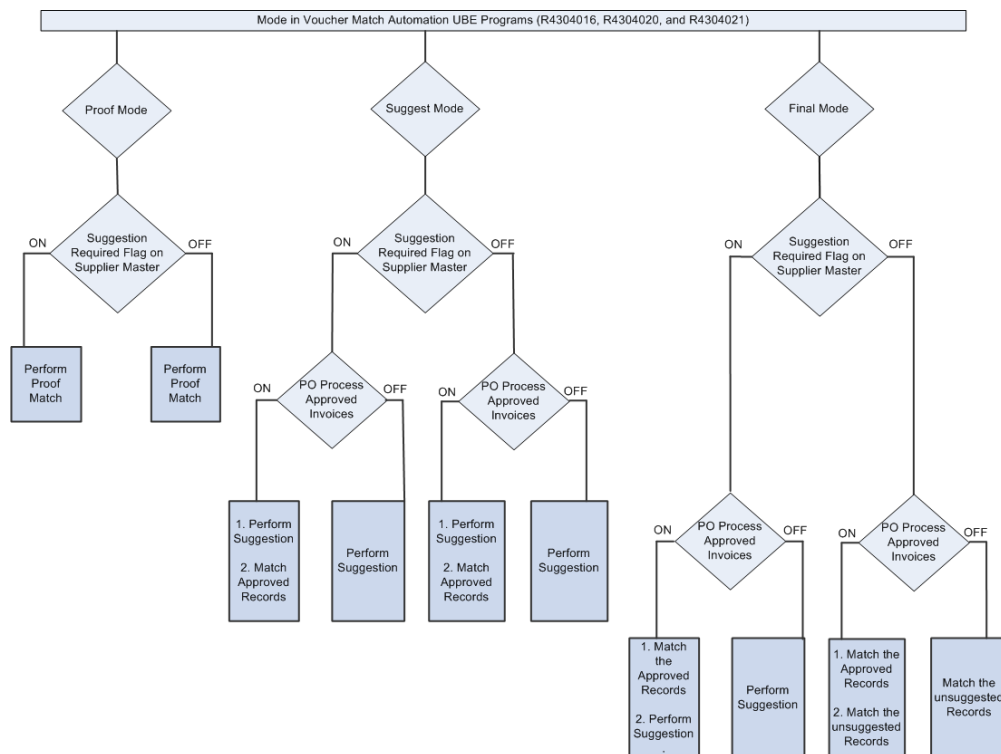

See also [Understanding Proof, Final and Suggest Modes](#).

14.2.8 Partial Receipts for VMA Process (Release 9.1 Update)

You can run the voucher match automation process to match partial receipts. You specify in the supplier master record whether to allow the matching of invoices to partial receipts in the VMA process. You can match invoices to partial receipts only when you use automation rule 02, 04 or 06 in the VMA process. When you enable partial receipts for voucher match automation process, the system performs the match even if the open quantity on the purchase order is not 0.

You can match the partial receipts by:

- Using the Voucher Match Process Workbench program (P4314WB)

- Running the Voucher Match Automation UBE for Automation Rule 02, 03, 04, 05 program (R4304020)
- Running the Voucher Match Automation UBE for Automation Rule 06 program (R4304021).

See [Partial Receipt Allowed \(Release 9.1 Update\)](#)

14.2.9 Single Voucher Per Invoice for VMA Process (Release 9.1 Update)

The voucher match automation process provides an option to generate a single voucher for an invoice regardless of the number of lines on the invoice. The single voucher per invoice option enables you to comply with the country-specific legal requirements for generating a single voucher for an invoice, regardless of the number of lines on the invoice.

You select the Single Voucher Per Invoice option in the supplier master to generate a single voucher for an invoice. You can also specify to generate a single voucher for an invoice in the processing option in the Voucher Match Automation Driver program (R4304010). If you have specified to generate a single voucher for an invoice in the supplier master, the system will always create a single voucher for an invoice, regardless of whether the Single Voucher Per Invoice option is set in the Voucher Match Automation Driver program.

See [Single Voucher Per Invoice \(Release 9.1 Update\)](#)

This illustration shows how the system determines to create a single voucher for an invoice in the voucher match automation process.

Figure 14–14 *Generating Single Voucher per Invoice*

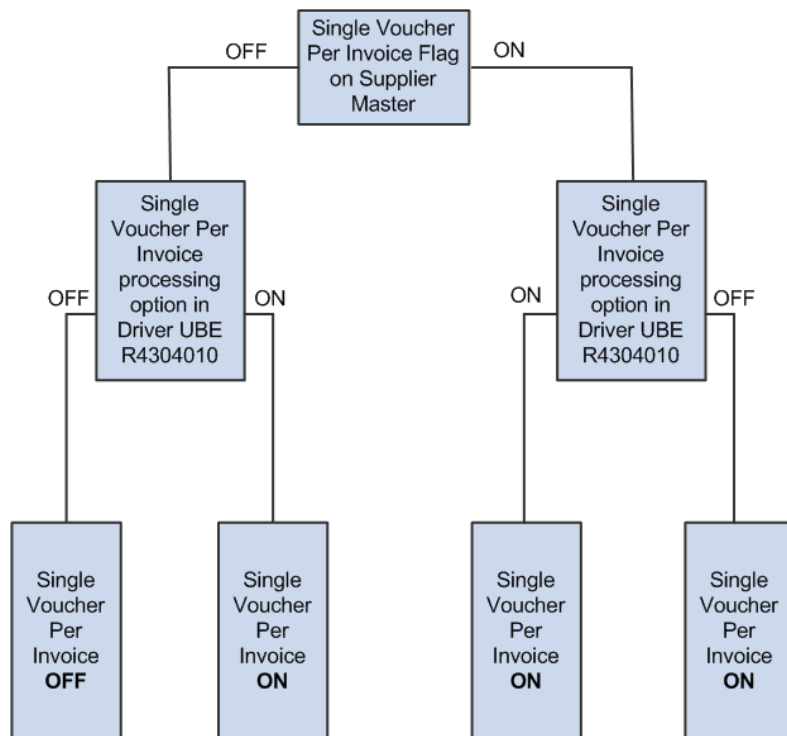

Note: If you use the Voucher Match Process Workbench program (P4314WB) to match the invoices, you must select the Single Voucher Per Invoice option in the supplier master to generate a single voucher for an invoice.

When the Single Voucher per Invoice option is set for an invoice, the system stops trying to match for an invoice based on the value set for the Match Process for Single Voucher Per Invoice processing option in the Voucher Match Automation Matching UBE programs (R4304016, R4304020, and R4304021). You can set the processing option to:

- Stop at the first occurrence of the error.

When you set the processing option as blank, and if an invoice line fails to match, the system stops the matching process for that invoice and proceeds to the next invoice.

- Attempt all lines

When you set the processing option to 1, and if an invoice line fails to match, the system proceeds with the matching process to the next invoice line of the same invoice.

By trying to find matches for all of the invoice lines, you can review the report and easily find out which lines could find the matches and which lines could not.

See [3. Match Process for Single Voucher Per Invoice \(Release 9.1 Update\)](#)

Note: When you select Single Voucher Per Invoice option, you must ensure that supplier, company, automation rule, currency code - from, currency mode and base currency of all of the invoice lines are the same.

When the Single Voucher Per Invoice option is set for an invoice and if the automation rules are different for the invoice lines, the system processes the invoice matching based on the value that is set for the Validate Automation Rule processing option in the Voucher Match Automaton Driver program (R434010). When you set the processing option as blank, the system does not process an invoice if the invoice lines do not have the same automation rule. When you set the processing option to 1, the system processes the invoice with the automation rule of the first line with a warning. When you set the processing option to 2, the system processes the invoice with the automation rule of the first line without warning.

See [2. Validate Automation Rules](#)

14.2.10 Create and Match Standard Vouchers

Note: This section discusses processes and table updates for final mode. See [Using the Voucher Match Process Workbench](#) for information about how the system processes records in suggest mode.

You can use the voucher match automation (VMA) process to create standard vouchers and match them to receipt records in the Purchase Order Receiver File (F43121). A corresponding record for the receipt must exist in the Purchase Order

Detail File (F4311). Additionally, if you specify in the supplier master record that item information is required, a record that corresponds to the invoice record in the F0411Z1 table must exist in the F0411Z1T table.

You set the Create Logged Voucher processing option in the Voucher Match Automation Driver program (R4304010) to specify whether to create standard vouchers (leave the processing option blank) or create logged vouchers (enter 1 in the processing option). When you run the Voucher Match Automation Driver program with the processing option set to generate standard vouchers (the Create Logged Voucher processing option is blank), the program:

1. Selects valid F0411Z1 records to process based on the values in the Data Selection specified in the Voucher Match Automation Driver program.

In addition to using the values in the Data Selection, the Voucher Match Automation Driver program also uses these validation criteria when selecting records:

- The value for the Automation Flag field is **1**.
- The value for the automation rule is a valid value.
- The value for the EDI Transaction Type (data item EDTR) is **V**.
- The pay status is **A**, **P**, or **#**.

Only records with a pay status of **A**, **P**, or **#** are eligible for processing using the voucher match automation (VMA) process. You can specify one of these values in the Pay Status processing option of the Voucher Match Automation UBE programs to restrict the VMA process to match only invoice lines with the specified pay status type.

- A corresponding record exists in the F0411Z1T table with item information that matches the item information in the selected F0411Z1 record if the supplier master record indicates that the item information is required.
 - The invoice match status in the F0411Z1T table must be blank (unprocessed) or 3 (approved). For invoices with an invoice match status of 3, the process creates vouchers only when you set the Process Approved Invoices processing option to process approved records.
2. Runs all of the Voucher Match Automation UBE programs to process all valid records with all automation rules.

The VMA process refines the data set of F0411Z1 records based on the processing options in the Voucher Match Automation UBE programs.

3. Processes records in the refined data set of F0411Z1 records that have a process type of 1 or 2.
 - When the F0411Z1 record has a process type of 1, the program attempts to match the F0411Z1 record to one or more records in the F43121 table and one or more records in the Purchase Order Detail File (F4311), according to the automation rule. Records with a process type of 1 are:
 - * Newly added records.
 - * Records unmatched during a previous run of the process because no matching receipt was found.
 - * Records for which errors occurred during a previous run of the process.

If the VMA process successfully matches the F0411Z1 record to one or more records in the F43121 table and one or more records in the F4311 table, the

VMA process changes the process type to 4. The VMA process creates records in the F0411 and F0911 tables using the standard voucher creation functionality. The process generates a batch number for each successfully matched record. Information about the matched records appears in the reports generated by the process.

Notes: The VMA process creates or updates records in the F0411, F0911, and F43121 tables when you run the process in final mode.

If the process runs in final or suggest mode over a dataset that includes records for which the invoice match status is 3 (approved), and you set the Process Approved Invoices processing option to 1 (process), the process updates the F0411Z1T record to show an invoice match status of 4 (matched after suggestion).

See [Understanding Proof, Final and Suggest Modes](#) and [Using the Voucher Match Process Workbench](#)

The Voucher Match Automation Driver UBE program (R4304010) updates some fields that have blank values when it selects records to process in both proof and final mode. See [Validation of Records in the Voucher Transactions - Batch Upload Table \(F0411Z1\)](#)

If you populate the purchase order fields in the F0411Z1 tables, the VMA process matches the invoice records to only the corresponding purchase orders and receipts.

If you populate the item number fields in the F0411Z1 table, the VMA process matches the invoice records to only the corresponding purchase orders and receipts with the same item information.

Some of the processing options in the Voucher Match program (P4314) affect how the system processes records during the voucher match automation process. Verify that the processing options are set to process records as you expect. See [Setting Processing Options for Voucher Match \(P4314\)](#)

If the VMA process does not successfully match the record in the F0411Z1 table to one or more records in the F43121 and F4311 tables, then the process type for the F0411Z1 record remains 1, and the VMA process does not create records in the F0411 and F0911 tables. Unmatched records appear in the report with a message stating that no match was found. Records are unmatched if the process does not find matching receipts and purchase orders, or if the record failed the validations. Check the Work Center for unmatched records to view warning and error messages.

- When the F0411Z1 record has a process type of 2, the VMA process has already created a corresponding logged voucher record in the F0411 table. The process attempts to match the corresponding logged voucher record in the F0411 table to one or more records in the F43121 and F4311 tables, according to the automation rule.

Note: When you leave the Create Logged Voucher processing option blank to prevent the process from *creating* logged vouchers, it does not prevent the system from matching to receipts the logged vouchers that were created when you previously ran the VMA process with the Create Logged Voucher processing option set to create logged vouchers.

If the VMA process successfully matches the F0411 record to one or more records in the F43121 table, the VMA process updates the logged voucher records in the F0411 and F0911 tables using the standard logged voucher redistribution functionality. The VMA process changes the process type from 2 to 4 for the F0411Z1 records for which the process successfully matched the corresponding F0411 records. The newly matched records appear in the reports generated by the VMA process.

If the VMA process does not successfully match the logged voucher record in the F0411 table to one or more records in the F43121 and F4311 tables, then the process type for the F0411Z1 record that corresponds to the logged voucher remains 2. The record appears in the report with a message stating that record is available for manual matching. Check the Work Center for warning and error messages.

This graphic illustrates how the VMA process runs the Voucher Match Automation UBE programs, and the results of successful and unsuccessful matches in final mode:

Figure 14–15 Process Flow H: Matching Receipts to Invoices

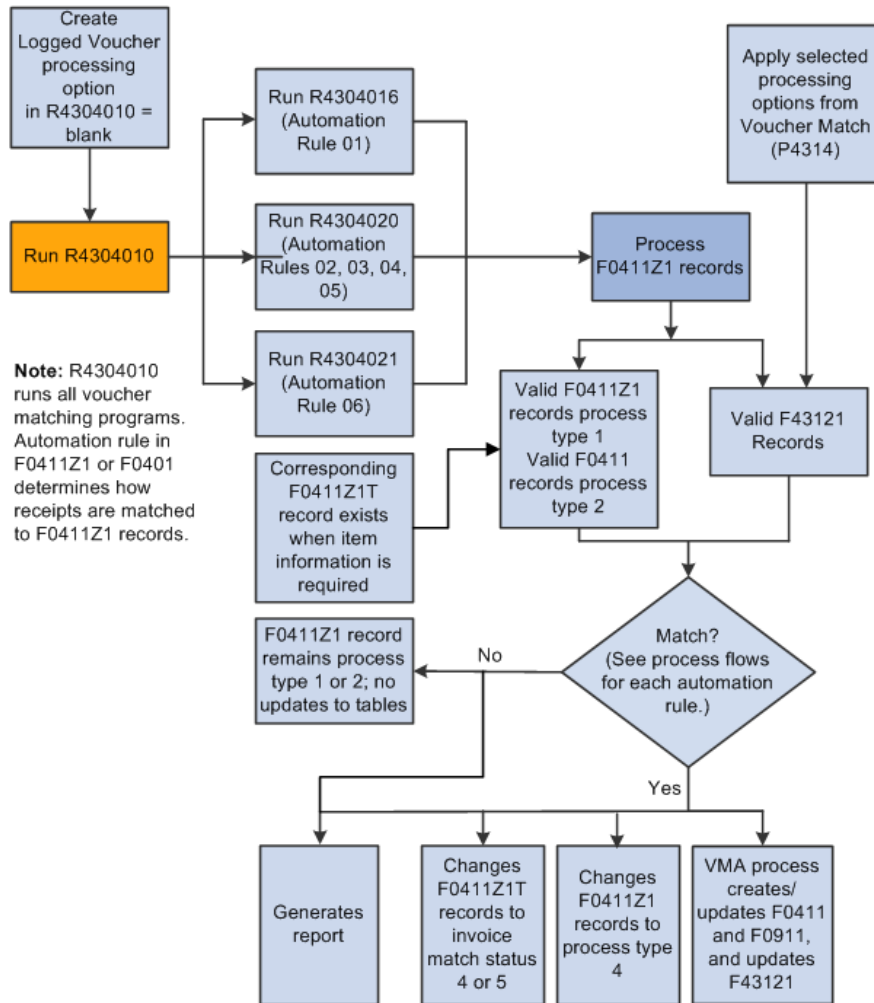

The VMA processes uses automatic accounting instructions (AAIs) to create voucher entries for standard vouchers in the same manner as it uses AAIs to create standard vouchers through the Voucher Match (P4314) program.

See "Setting Up Automatic Accounting Instructions" in the *JD Edwards EnterpriseOne Applications Financial Management Fundamentals Implementation Guide* and "Setting Up AAIs for Accounts Payable" in the *JD Edwards EnterpriseOne Applications Accounts Payable Implementation Guide*.

14.2.11 Create and Match Logged Vouchers

Note: This section discusses processes and table updates for final mode. See [Using the Voucher Match Process Workbench](#) for information about how the system processes records in suggest mode.

You can use the voucher match automation (VMA) process to create logged vouchers and match the logged vouchers to receipt records in the F43121 table and purchase orders in the Purchase Order Detail File (F4311). You enter 1 in the Create Logged Voucher processing option in the Voucher Match Automation Driver program (R4304010) to create logged vouchers using the VMA process. Additionally, if you

specify in the supplier master record that item information is required, a record that corresponds to the invoice record in the F0411Z1 table must exist in the F0411Z1T table.

Note: The Voucher Entry MBF program (P0400047) includes a processing option in which you specify whether to create logged vouchers. The VMA process does not use the Voucher Logging processing option in the Voucher Entry MBF program.

When you run the Voucher Match Automation Driver program with the Create Logged Voucher processing option set to **1**, the process:

- Selects valid F0411Z1 records to process based on the values in the Data Selection specified in the Voucher Match Automation Driver program.

In addition to using the values in the Data Selection, the Voucher Match Automation Driver program also uses these validation criteria when selecting records:

- The value for the Automation Flag field is **1**.
- The value for the EDI Transaction Type (data item EDTR) is **V**.
- The pay status is **A**, **P**, or **#**.

Only records with a pay status of **A**, **P**, or **#** are eligible for processing using the voucher match automation (VMA) process. You can specify one of these values in the Pay Status processing option of the Voucher Match Automation UBE programs to restrict the VMA process to match only invoice lines with the specified pay status type.

- A corresponding record exists in the F0411Z1T table with item information that matches the item information in the selected F0411Z1 record if the supplier master record indicates that the item information is required.
- The invoice match status in the F0411Z1T table must be blank (unprocessed) or 3 (approved). For invoices with an invoice match status of 3, the process creates vouchers only when you set the Process Approved Invoices processing option to process approved records.
- Runs the Batch Voucher Processor Report program (R04110ZA) to generate logged vouchers.

The Batch Voucher Processor Report program uses the same AAIs to create voucher records and journal entries in the F0411 and F0911 tables as it uses when you create logged vouchers outside of the voucher match automation process.

See "Setting Up AAIs for Accounts Payable" and "Processing Logged Vouchers" in the *JD Edwards EnterpriseOne Applications Accounts Payable Implementation Guide*.

For successfully processed records, changes the process type of the F0411Z1 records from 1 (new or unmatched) to 2 (logged voucher).

If the process cannot create a logged voucher because of a validation error in the F0411Z1 record, the system generates an error message in the Work Center. The process does not change the process type for F0411Z1 records that it is unable to process, and does not retain updates to other fields in the F0411Z1 for unprocessed records.

- Runs all of the Voucher Match Automation UBE programs to process all valid records with all automation rules.

The VMA process refines the data set of F0411Z1 records based on the processing options in the Voucher Match Automation UBE programs.

- Attempts to match the logged vouchers in the F0411 table that correspond to the process type 2 records in the F0411Z1 table to one or more records in the F43121 and F4311 tables.

The VMA process selects the newly created logged vouchers and the logged vouchers that you created during previous runs of the process. The VMA process then attempts to match each F0411 record to one or more receipts and purchase orders, according to the automation rule.

If the VMA process successfully matches the F0411 record to one or more records in the F43121 and F4311 tables, the VMA process:

- Redistributes logged voucher amounts in the F0411 and F0911 tables in the same manner as amounts are redistributed when you use the Voucher Match program (P4314).

The VMA process uses the version of the Voucher Match program (P4314) that you specify in a processing option.

You can specify different versions of the Voucher Match program in the different Voucher Match Automation UBE programs (R4304016 and R4304020).

Notes: The VMA process creates or updates records in the database tables when you run the process in final mode. See [Understanding Proof, Final and Suggest Modes](#)

If the process runs in final or suggest mode over a dataset that includes records for which the invoice match status is 3 (approved), and you set the Process Approved Invoices processing option to 1 (process), the process updates the F0411Z1T record to show an invoice match status of 4 (matched after suggestion).

The Voucher Match Automation Driver UBE program (R4304010) updates some fields that have blank values when it selects records to process in both proof and final mode. See [Validation of Records in the Voucher Transactions - Batch Upload Table \(F0411Z1\)](#)

If you populate the purchase order fields in the F0411Z1 tables, the VMA process matches the invoice records to only the corresponding purchase orders and receipts.

If you populate the item number fields in the F0411Z1 table, the VMA process matches the invoice records to only the corresponding purchase orders and receipts with the same item information.

If you populate the Document Number and Document Type fields in the F0411Z1 tables, the VMA process overwrites the values when it creates the F0411 records for the logged vouchers.

- Changes the process type in the F0411Z1 table to 4 (matched).
- Generates one batch number for all vouchers that are created.
- Lists information about the matched records in the reports generated by the process.

The process generates a separate report for each voucher matching program.

- If the process does not successfully match the process type 2 records in the F0411 table to one or more records in the F43121 and F4311 tables, the process type remains 2.

The process does not update records in the F0411 and F0911 tables for records that are not matched. Unmatched records appear in the report with a message stating that no match was found. Records are unmatched if the process does not find matching receipts and purchase orders, or if the record failed the validations. Check the Work Center for unmatched records to view warning and error messages.

This illustration shows the process flow to create logged vouchers:

Figure 14–16 Process Flow G: Create Logged Vouchers

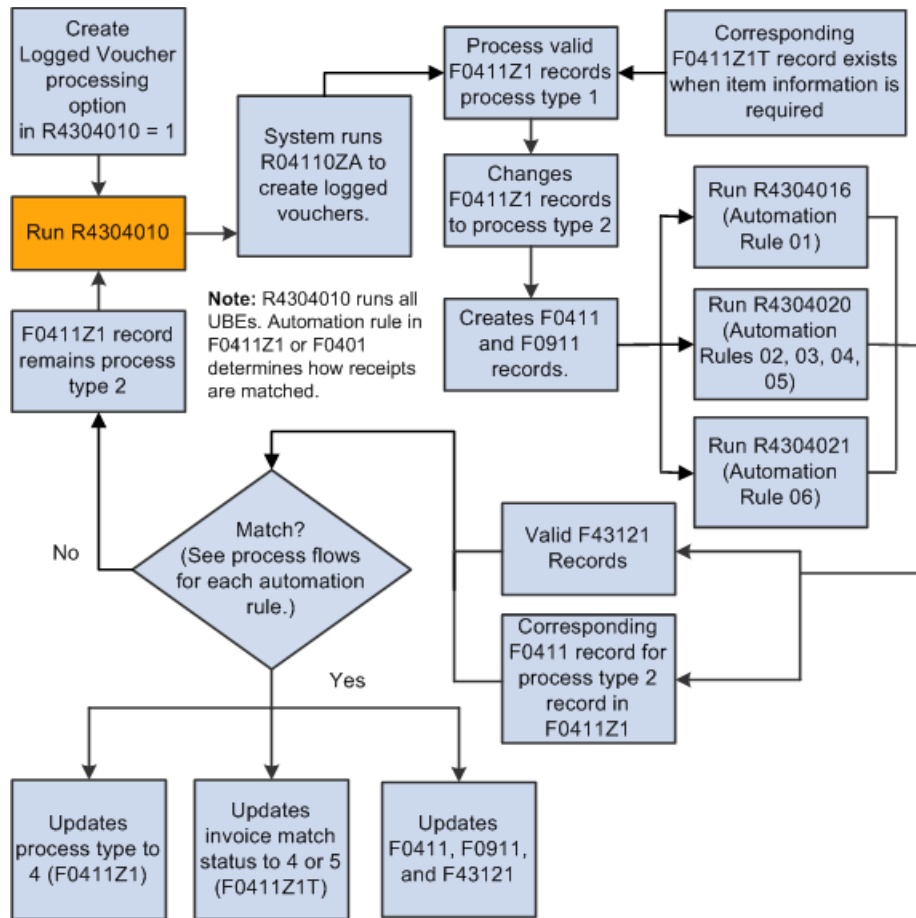

14.2.12 Setup for Voucher Match Automation (Release 9.1 Update)

Before you can use the voucher match automation process, you must set up certain elements in your system to enable the process. This process flow shows the elements that you must set up for your company and suppliers:

Figure 14–17 Process Flow D: Supplier and Company Setup (Release 9.1 Update)

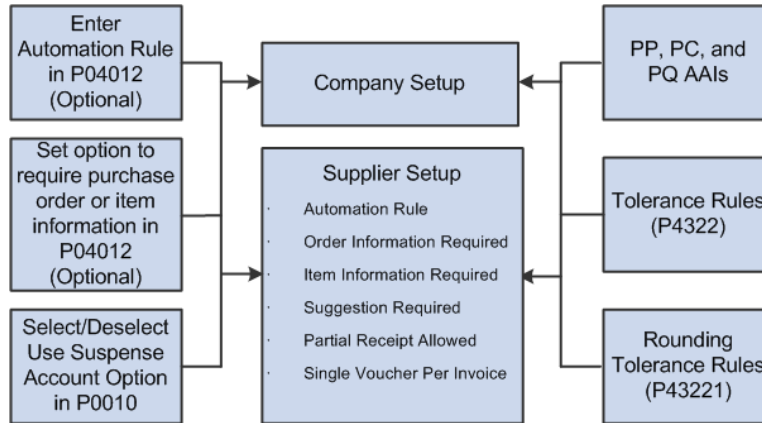

You must set up:

- Automatic accounting instructions (AAIs)

Verify that the AAIs that you use for creating standard and logged vouchers are set up in your system. In particular, verify that these AAIs are appropriately set up:

 - PB (payables bank)
 - PC (payables trade)
 - PP (preliminary distribution)
 - PQ (suspense trade account)

See "Setting Up AAIs for Accounts Payable" in the *JD Edwards EnterpriseOne Applications Accounts Payable Implementation Guide*.
- Company

When the system creates logged vouchers, it writes the credit entry using either AAI PQ or AAI PC. Select the Use Suspense Account option in the Company Constants program (P0010) to have the system use AAI PQ. Clear the option to have the system use AAI PC.
- Automation rule

You enter an automation rule in the Purchasing 2 tab of the Supplier Master Information program. The system uses the value as a default value for records in the Voucher Transactions - Batch Upload table (F0411Z1) that do not include a value for the automation rule.

See [Automation Rules](#)
- Options to require item or purchase order information (optional)

See [Order and Item Information for the VMA Process](#)
- Suggestion Required (Release 9.1 Update)

You select this option to perform suggestion processing for the invoices during the voucher match automation process.

See [Suggestion Processing \(Release 9.1 Update\)](#)
- Partial Receipt Allowed (Release 9.1 Update)

You select this option for the system to suggest or match invoices with partially received orders during the voucher match automation process.

See [Partial Receipts for VMA Process \(Release 9.1 Update\)](#)

- Single Voucher Per Invoice (Release 9.1 Update)

You select this option to create a single voucher for an invoice, with multiple pay items, during the voucher match automation process. Clear this option to create a voucher for each line of an invoice during the voucher match automation process.

See [Single Voucher Per Invoice for VMA Process \(Release 9.1 Update\)](#)

- Standard tolerance

Automation rules 02 and 03 enable you to use tolerance rules that you set up in the Tolerance Rules program (P4322). You specify in a processing option whether to apply standard tolerance when processing records that are assigned automation rule 02 or 03.

See [Creating Tolerance Rules](#)

See [Setting Processing Options for Voucher Match Automation UBE for Automation Rule 02, 03, 04, 05 \(R4304020\)](#)

Note: When you use standard tolerance, the system uses DMAAI 4330 to write records for the variance to the F0411 and F0911 table. Before you run the VMA process, verify that DMAAI 4330 is set up.

- Rounding tolerance

Automation rule 05 enables you to use rounding tolerance rules that you set up in the Rounding Tolerance Rules program (P43221). You specify in a processing option whether to apply rounding tolerance when processing records that are assigned automation rule 05. The system does *not* create journal entry records for rounding tolerance variances.

See [Setting Up Rounding Tolerance Rules For Voucher Match Automation \(Release 9.1 Update\)](#)

- Tolerance on receipt amount greater than the invoice (Release 9.1 Update)

This tolerance is applicable when you use automation rule 02 or 03. You use the processing option in the Voucher Match Automation UBE for Automation Rule 02, 03, 04, 05 program (R4304020) to specify whether to apply tolerance on receipts with an amount greater than the invoice amount. To use this tolerance, you need to run the Voucher Match Automation UBE for Automation Rule 02, 03, 04, 05 program (R4304020).

See [10. Apply tolerance on receipt amount greater than the invoice amount. \(Release 9.1 Update\)](#)

- Processing options and versions

The VMA process includes the Voucher Match Automation Driver program (R4304010) that launches the Voucher Match Automation Matching UBE programs (R4304016, R4304020, and R4304021) that match the invoices and logged vouchers to receipts. All of these batch programs include processing options. The process also uses processing option values from other programs that are called during the matching process. You must set up the processing options and versions used for the VMA process before you begin processing invoices using this process.

See [Setting Processing Options for the Voucher Match Automation Process](#)

14.2.13 Troubleshooting the Voucher Match Automation Process

This table includes troubleshooting information for the voucher match automation process:

Questions	Answers
<p>What do I do with a record in the F0411Z1 table that won't process?</p>	<p>Records remain at a process type 1 if the VMA process cannot find a match or if the records do not pass all validations. If you create logged vouchers, the VMA process changes the process type of a valid record from 1 to 2. When the system successfully processes a process type 1 or 2 records it changes the process type to 4.</p> <p>If you determine that a record will not process, you can:</p> <ul style="list-style-type: none"> ■ If the process type is 1: <ul style="list-style-type: none"> ■ Use the Batch Voucher Revisions program to delete the record from the F0411Z1 table, and then use the Standard Voucher Entry program (P0411) or Voucher Match program (P4314) to create a voucher and match it to an open receipt. ■ Use the Voucher Match Process Workbench program (P4314WB) to change the invoice match status to 6 (manual match). Changing the invoice match status removes the record from the control of the VMA process and enables you to use the Standard Voucher Entry program (P0411) or Voucher Match program (P4314) to create a voucher and match it to an open receipt. ■ If the process type is 2 (logged voucher exists), use the Batch Voucher Revisions program to delete the record from the F0411Z1 table, and then either: <ul style="list-style-type: none"> ■ Use the Voucher JE Redistribution program (P042002) to manually redistribute the logged voucher. ■ Delete or void the record for the logged voucher that exists in the F0411 and F0911 tables. <p>You can also verify that values in the fields in the F0411Z1 table are complete and accurate.</p>
<p>I want to create standard vouchers for invoices that I can match to receipts now, and create logged vouchers for the invoices that don't yet have a matching receipt. How do I do that?</p>	<p>To create both standard vouchers and logged vouchers, you must run the Voucher Match Automaton Driver program (R434010) twice. Run it with Create Logged Voucher processing option blank (prevent the creation of logged vouchers) to match F0411Z1 records to existing receipts, and then run it with the Create Logged Voucher processing option set to 1 (create logged vouchers) for valid F0411Z1 records that were not matched to receipts.</p>
<p>The supplier master record for one of my suppliers doesn't have an automation rule set up. Can I still use the voucher match automation process to process invoices for that supplier?</p>	<p>Yes. The process uses the automation rule in the supplier master record only when an automation rule does not exist for the invoice in the F0411Z1 table. You can use the P0411Z1 program to add or modify the automation rule for records with a process type of 1 (newly added).</p>

Questions	Answers
Can I change the automation rule for one invoice for a supplier?	Yes. After you capture and upload supplier invoice information to the F0411Z1 table, you can use the P0411Z1 program to change the automation rule for an invoice as long as the process type for the record is 1.
I have the Create Logged Vouchers processing option in the Voucher Match Automation Driver program set to generate logged vouchers, but the process didn't create logged vouchers. What could be wrong?	<p>Verify that the Final Mode processing option in the Batch Voucher Processor Report program (R04110ZA) is set to 1.</p> <p>You can set processing options in the Batch Voucher Processor Report program that cause the process to send warning messages to the Workflow. You can troubleshoot errors using the warning messages as well as the report generated by the Batch Voucher Processor Report program.</p>
I ran the Voucher Match Automation UBE programs in proof mode and the report lists process type 1 records that can be matched to receipts. However, when I run the programs in final mode, the process isn't matching any of the process type 1 records to receipts. What could be wrong?	<p>Verify that the Create Logged Voucher processing option in the Voucher Match Automation Driver program (R4304010) is blank (off). If the value in the Create Logged Voucher processing option is 1 (on), the Voucher Match Automation Driver program runs the Batch Voucher Processor Report program (R04110ZA). If the Batch Voucher Processor Report program runs in final mode, it creates logged vouchers from the process type 1 records, so no process type 1 records are matched to receipts. If the Batch Voucher Processor Report program runs in proof mode, the report generated by the automation process shows the process type 1 records for which the process can create logged vouchers. If the Create Logged Voucher processing option is on, the process does not match the process type 1 records to receipts because you set the Create Logged Voucher processing option indicating that you want to create logged vouchers from process type 1 records instead of matching the records to receipts.</p> <p>See also Understanding Proof, Final and Suggest Modes</p>
I have logged vouchers that I created outside of the voucher match automation process. Can I automatically match them to receipt records using the VMA process?	No. The VMA process matches receipts to logged vouchers only if the logged voucher was created using the VMA process.
What are some tips for improving system performance?	<p>You can follow these guidelines to optimize system performance:</p> <ul style="list-style-type: none"> ■ Schedule the Voucher Match Automation Driver UBE program (R4304010) to run when few users are on the system. <p>The voucher match automation process utilizes record reservation and will run more efficiently if records are not in use by other users or processes.</p> ■ When you populate the F0411Z1 table, provide a value for the automation rule. <p>If the records does not include an automation rule, the process accesses the supplier master record to obtain the automation rule. Eliminating the need to access the supplier master record for this purpose saves processing time.</p>

14.3 Understanding Validations and Requirements for Matching

When you run the Voucher Match Automation Driver program, the program launches the Batch Voucher Processor Report program (R04110ZA) to generate logged vouchers if the processing option in the driver program is set to do so. The Voucher Match Automation Driver program also runs the Voucher Match Automation UBE programs (R4304016, R4304020 and R4304021) that include the logic for processing records that are assigned one of six automation rules.

When you run the VMA process to create logged vouchers, the automation process selects records from the F0411Z1 table and creates corresponding records in the F0411 and F0911 tables. The process then matches the F0411 records to records in the F43121 table. When you run the VMA process to create standard vouchers, the process selects records from the F0411Z1 table to match to records in the F43121 and F4311 tables. For

both logged and standard voucher creation, a purchase order record that corresponds to the receipt record must exist in the Purchase Order Detail File (F4311). Additionally, for both logged and standard vouchers, if you specify in the supplier master record that purchase order or item information is required, then the VMA process also validates that a record that corresponds to the invoice line in the F0411Z1 table exists in the F0411Z1T table.

Each record in the F0411Z1, F0411Z1T, and F43121 tables must pass validations before the process determines whether the records can be processed. Though the record validations apply to records processed for any of the automation rules, the logic that the programs apply for each automation rule also determine how records in the F0411Z1 or F0411 table (for logged vouchers) are matched to the records in the F43121 table.

The process provides reports that show the matched records. For records that the process cannot match, the report includes a statement that no match was found. You can check the Work Center for messages for warnings or errors that prevented the process from matching invoice lines to receipts and purchase orders. If you run the VMA process in suggest mode, you can also view in the Voucher Match Process Workbench program (P4314WB) the invoice lines that have errors and cannot be processed. Use the Exceptions Exist and Exception Description fields in the Voucher Match Process Workbench program to identify the records that have errors.

14.3.1 Validation of Records in the Voucher Transactions - Batch Upload Table (F0411Z1)

This list describes the validations that the VMA process performs when selecting records to process:

- Automation flag must be 1 (data item ATFLG).
- EDI transaction type must be V (data item EDTR).
- Process type flag for newly added records must be 1 (data item PSTE).

Note: If you create a record and leave the Process Type Flag field blank, the Voucher Match Automation Drive UBE program (R4304010) populates the field with the value 1 and updates the record in the F0411Z1 table when you run the process in proof or final mode.

The system selects for processing records with process type 1 or 2 (logged voucher exists).

- A corresponding record exists in the F0411Z1T table if the supplier record indicates that order or item information is required for matching.

The F0411Z1T record is also required to track the invoice match status assigned by the system. The process will create the corresponding F0411Z1T record from the F0411Z1 record if no F0411Z1T record exists only when no other required information, such as the item information, is missing from the F0411Z1 table.

- Automation rule must be blank or a valid value of 01 - 06.

If the invoice record in the F0411Z1 table does not have a valid automation rule, the Voucher Match Automation Drive UBE program locates the automation rule in the supplier master record and updates the F0411Z1 table with the value when you run the process in proof or final mode. If a valid rule does not exist for the record, then the record is not processed.

14.3.2 Record Selection from the F0411Z1 Table

If the F0411Z1 records include the required values, the process selects the records to attempt to match to F43121 records using the data selection set for the Voucher Match Automation Driver program. Note that the process does not use data selection from the Voucher Match Automation UBE programs.

Additional record selection includes these factors:

- The record must be included in the data set that you set up in Data Selection in the Voucher Match Automation Driver program.
- If the supplier master record indicates that item or order information is required, then the item or order information must exist in the F0411Z1 table or the corresponding F0411Z1T table.

If the required information does not exist, then the process does not select the F0411Z1 record for processing.

- The invoice match status is blank (unprocessed) or 3 (approved) in the corresponding record in the F0411Z1T table.

The process selects and processes approved records only when you set the Process Approved Invoices processing option in the Voucher Match Automation UBE programs to 1 (process approved suggestions) and run the programs in final or suggest mode.

- The G/L date, minimum and maximum gross invoice amounts, line types, and date range are validated against values in the processing options of the Voucher Match Automation UBE programs.
- The gross amount cannot be 0, but negative invoice amounts are processed.
- The effective currency date is validated against the value in the Effective Date processing option in the version of the Voucher Match program (P4314) that you specify to run.

14.3.3 Validation of Records in the Purchase Order Receiver File (F43121)

The VMA process selects records from the F43121 table when the match type of the record is 1. The VMA process attempts to match F0411Z1 records with a process type of 1 to F43121 records with a match type of 1 (no voucher exists). For logged vouchers (process type 2), the process attempts to match the F43121 record to the F0411 record that corresponds to the F0411Z1 record.

When a record in the F43121 table is selected by the process or by the user to match to an invoice line, the process writes a value to the FUF3 (Future Use 3) field in the F43121 table. Receipt records for which the value is other than blank (unprocessed) or 3 (approved) are not selected for matching to other invoice lines. If the receipt record has a status of 3, then the VMA process enables you to complete the match in the Voucher Match Process Workbench program (P4314WB). Or, you can run the VMA process with the Process Approved Invoices processing option in the Voucher Match Automation UBE programs set to 1 (process approved suggestions).

14.3.4 Validation of Records in the Purchase Order Detail Table (P4311) (Release 9.1 Update)

The VMA process verifies that a purchase order line exists for the receipt line that it matches to invoice lines. The purchase order line associated with the receipt line must be fully received and have a status of 999 (closed).

(The following paragraph pertains to a Release 9.1 update.) However, if you have selected the Partial Receipts Allowed option in the supplier master, the system matches invoices to the purchase orders that are not fully received and are not at status 999 (closed).

14.4 Understanding Batch Voucher Processing for the Voucher Match Automation Process

See Also:

"Processing Batch Vouchers" in the *JD Edwards EnterpriseOne Applications Procurement Management Implementation Guide*.

When you run the Voucher Match Automation Driver program (R4304010) to match F0411Z1 records to receipts and purchase orders, the program processes only those records in the F0411Z1 table that include these values:

- Automation Flag (data item ATFLG) is equal to **1**.
When you enter **1**, the record is enabled for processing by the VMA process. If you leave this field blank when you create a record, the system populates the field with **1** if the record is otherwise valid. You can set a processing option in the Batch Vouchers Revisions program (P0411Z1) to automatically populate the Automation Flag field with **1** when you enter or copy a record in the F0411Z1 table.
- EDI Transaction Type (data item EDTR) is equal to **V**.
- Process Type (data item PSTE) is equal to **1** for newly created F0411Z1 records, or equal to **2** for logged vouchers.

When you add records using a batch process or when you manually add a record, you must enter **1** for this field or leave it blank to enable the process to populate the field with **1**. The system changes the process type to **2** when you generate logged vouchers using the VMA process, and changes the value to **4** when the VMA process successfully matches the record to a receipt and purchase order.

A record corresponding to the F0411Z1 table must exist in the Voucher Transaction Batch Upload - Voucher Match Automation (F0411Z1T) table if the supplier master record indicates that item information is required.

14.4.1 Adding and Modifying Records for the Voucher Match Automation Process (Release 9.1 Update)

You can add records to the F0411Z1 and F0411Z1T tables by using a batch process or by using the Batch Vouchers Revisions program (P0411Z1). When you add records that you want to match to receipts and purchase order using the VMA process, you must provide specific data for the process.

When you enable processing by the VMA process (the value in the Automation Flag field is **1**), the system:

- Does not populate the F0911Z1 table when you run the Batch Voucher Processor Report (R04110ZA) or when you manually add a record using the Batch Voucher Revisions program (P0411Z1).
- Does not display the G/L Distribution form because records with a value of **1** are processed by only the VMA process.

Instead, the VMA process populates the account distribution information using automatic accounting instructions (AAIs).

See "Setting Up Automatic Accounting Instructions" in the *JD Edwards EnterpriseOne Applications Financial Management Fundamentals Implementation Guide*.

- Restricts the data that you can modify, based on the process type of the record.
For example, you can modify the Automation Rule field (data item ATRL) if the process type is 1, but you cannot modify it if the process type is 2. You cannot modify any fields if the process type is 4.
- Restricts the data that you can modify, when you select the Single Voucher Per Invoice option. (Release 9.1 Update)
When you select the Single Voucher Per Invoice option, the system disables the automation rule field in the grid and you cannot override the value on the grid level. The system enters a default value from the supplier master record in the Automation Rule field that is in the header.
- Restricts how you purge records from the F0411Z1 table.

Item information is required in the invoice information if you set up the supplier master record to use item information. When you add item information using the Batch Voucher Revisions program, the system adds the data to the F0411Z1T table.

Using the Voucher Match Automation Process (Release 9.1 Update)

This chapter includes the following topics:

- [Section 15.1, "Understanding Proof, Final and Suggest Modes"](#)
- [Section 15.2, "Setting Processing Options for the Voucher Match Automation Process"](#)
- [Section 15.3, "Running the Voucher Match Automation Process"](#)
- [Section 15.4, "Using the Voucher Match Process Workbench"](#)
- [Section 15.5, "Purging Matched VMA Records From the F0411Z1 and F0411Z1T Tables"](#)

See Also:

[Understanding the Voucher Match Automation Process \(Release 9.1 Update\)](#)

15.1 Understanding Proof, Final and Suggest Modes

You can run the Voucher Match Automation UBE programs (R4304016, R4304020 and R4304021) in proof, final, or suggest mode.

When you run the programs in proof mode, the system:

- Enables you to determine the matches proposed by the system by setting values in the supplier master record, setting processing options, and using data selection.
- Enables you to view a report of the proposed matches.
- Does not reserve the receipt records for the invoices.

All receipt records remain available to match to other invoice lines.

When you run the programs in suggest mode, the process:

- Enables you to determine the suggested matches by setting values in the supplier master record, setting processing options, and using data selection.
- Enables you to review the suggested matches in the Voucher Match Process Workbench program (P4314WB) and approve, reject, modify, and process matches suggested by the system.

When you process matches in the Voucher Match Process Workbench program, you create the final records using the same validations that the system uses when you run the Voucher Match Automation UBE programs in final mode. You can

also run the Voucher Match Automation Driver UBE to process the suggestions that you approved in the workbench.

See [Using the Voucher Match Process Workbench](#)

- Reserves the receipt records for suggested matches.
If records are in use by the voucher match automation process, such as when a record is at a status of suggested, rejected, or approved, you cannot create other suggestions or matches for the records unless you clear the suggestion in the workbench. Clearing the suggestion releases the record reservation.
- Enables you to view a report of the suggested matches.

When you run the programs in final mode, the process:

- Enables you to determine the matches proposed by the system by setting values in the supplier master record, setting processing options, and using data selection.
- Enables you to match receipt lines to invoice lines based on the matches that the process determines, and write records to the database tables.
- Enables you to complete the match for approved suggestions.

15.1.1 Effect of Processing Options on Process Output

The Voucher Match Automation UBE programs (R4304016, R4304020 and R4304021) include a processing option in which you specify whether to run the programs in proof, final or suggest mode. The Batch Voucher Processor Report program (R04110ZA) also includes a processing option in which you specify whether to run the program in proof or final mode. The Voucher Match Automation Driver program (R4304010) always runs the Voucher Match Automation UBE programs, and runs the Batch Voucher Processor Report program only when you set a processing option to create logged vouchers.

(The following paragraph pertains to a Release 9.1 update.) By setting the Suggestion Required option in the supplier master, the system processes that supplier's invoices in suggestion mode during the run of the VMA UBEs. See [Suggestion Processing \(Release 9.1 Update\)](#) for information on how the system determines to run the voucher match automation in the suggest mode.

Because you can specify to run the Voucher Match Automation UBE programs and the Batch Voucher Processor Report program in different modes, and can specify whether or not to run the Batch Voucher Processor Report, you can produce different results based on the processing option values.

This table lists the effect of the Mode processing options in the Voucher Match Automation UBE programs, the Batch Voucher Processor Report, and the Create Logged Voucher processing option in the Voucher Match Automation Driver program.

Create Logged Voucher Processing Option Value	Mode in Batch Voucher Processor Report (R04110ZA)	Mode in Voucher Match Automation UBE Programs (R4304016, R4304020, and R4304021)	Effect of Processing Option Values
Blank (off)	NA The program does not run.	Blank (proof)	<p>The process generates a report of the process type 1 and process type 2 F0411Z1 records for which matching receipts exist in the F43121 table, but does not generate or update database records for the match.</p> <p>In this scenario, the system generates a report that shows the process types 1 and 2 records in the F0411Z1 table that can be matched, the records for which no match exists, and the records that cannot be matched because of errors.</p> <p>Note that when you run the Voucher Match Automation UBE programs in proof mode, the system does not process invoice records in the F0411Z1T table that are at status 3 (approved); it processes only those records that have a blank (unprocessed) status.</p>
blank (off)	NA The program does not run.	2 (suggest)	<p>The process generates a report of the process type 1 and process type 2 F0411Z1 records for which matching receipts exist in the F43121 table, but does not generate or update database records for the match, except to update the receipts suggested and the invoice match status in the F0411Z1T table. The report shows the process type 1 and 2 records in the F0411Z1 table that can be matched, the records for which no match exists, and the records that cannot be matched because of errors.</p> <p>The process reserves the receipt records in the F43121 table for the matches that it suggests so that the receipt records cannot be matched to other invoice lines until you take action on the suggested matches.</p> <p>If you have invoice records in the F0411Z1T table that are at status 3 (approved) and you set the Process Approved Invoices processing option in the Voucher Match Automation UBE programs to 1 (process approved suggestions), the system completes the approved matches, updating the appropriate tables.</p>

Create Logged Voucher Processing Option Value	Mode in Batch Voucher Processor Report (R04110ZA)	Mode in Voucher Match Automation UBE Programs (R4304016, R4304020, and R4304021)	Effect of Processing Option Values
Blank (off)	NA The program does not run.	1 (final)	<p>The process does not create new logged vouchers, but matches process type 1 and existing process type 2 records in the F0411Z1 table to receipt records in the F43121 table and purchase order records in the Purchase Order Receiver File (F4311). It also creates or updates records in all affected database tables and generates a report showing the successful and unsuccessful matching attempts for process type 1 and 2 records.</p> <p>(The following paragraph pertains to a Release 9.1 update.) However, if you have selected the Suggestion Required option for the supplier, the system creates suggestions for that supplier's invoices.</p> <p>If you have invoice records in the F0411Z1T table that are at status 3 (approved) and you set the Process Approved Invoices processing option in the Voucher Match Automation UBE programs to 1 (process approved suggestions), the system completes the approved matches in final mode, updating the appropriate tables.</p>
1 (on)	Blank (proof)	Blank (proof)	<p>The Batch Voucher Processor Report program generates a report stating the number of records for which logged vouchers can be created.</p> <p>For process type 2 records, the Voucher Match Automation UBE programs generate PDF reports that list the vouchers that can be matched and those that cannot be matched. The Voucher Match Automation UBE programs do not generate information for process type 1 records.</p> <p>Note that when you run the Voucher Match Automation UBE programs in proof mode, the system does not process invoice records in the F0411Z1T table that are at status 3 (approved); it processes only those records that have a blank (unprocessed) status.</p>

Create Logged Voucher Processing Option Value	Mode in Batch Voucher Processor Report (R04110ZA)	Mode in Voucher Match Automation UBE Programs (R4304016, R4304020, and R4304021)	Effect of Processing Option Values
1 (on)	Blank (proof)	1 (suggest)	<p>The Batch Voucher Processor Report program generates a report stating the number of records for which logged vouchers can be created.</p> <p>For process type 2 records, the Voucher Match Automation UBE programs generate PDF reports that list the vouchers that can be matched and those that cannot be matched. The Voucher Match Automation UBE programs do not generate information for process type 1 records.</p> <p>The process reserves the receipt records in the F43121 table for the matches that it suggests so that the receipt records cannot be matched to other invoice lines until you take action on the suggested matches.</p> <p>If you have invoice records in the F0411Z1T table that are at status 3 (approved) and you set the Process Approved Invoices processing option in the Voucher Match Automation UBE programs to 1 (process approved suggestions), the system completes the approved matches, updating the appropriate tables.</p>

Create Logged Voucher Processing Option Value	Mode in Batch Voucher Processor Report (R04110ZA)	Mode in Voucher Match Automation UBE Programs (R4304016, R4304020, and R4304021)	Effect of Processing Option Values
1 (on)	Blank (proof)	1 (final)	<p>The Batch Voucher Processor Report program generates a report that shows the total of logged voucher records that can be created.</p> <p>The Voucher Match Automation UBE programs match process type 2 records in the F0411Z1 table to receipts, but do not create new logged vouchers.</p> <p>The Voucher Match Automation UBE programs generate reports showing matched and unmatched records process type 2 records, and creates or updates database tables. The programs do not list process type 1 records for which no logged vouchers are created.</p> <p>If you have invoice records in the F0411Z1T table that are at status 3 (approved) and you set the Process Approved Invoices processing option in the Voucher Match Automation UBE programs to 1 (process approved suggestions), the system completes the approved matches in final mode, updating the appropriate tables.</p>
1 (on)	1 (final)	Blank (proof)	<p>The Batch Voucher Processor Report program creates logged voucher records for the process type 1 records and does <i>not</i> match them to receipts.</p> <p>The Voucher Match Automation UBE programs generate reports that list the process type 2 records that were matched and those that were not matched. The Voucher Match Automation UBE programs do not generate information for process type 1 records.</p> <p>Note that when you run the Voucher Match Automation UBE programs in proof mode, the system does not process invoice records in the F0411Z1T table that are at status 3 (approved); it processes only those records that have a blank (unprocessed) status.</p>

Create Logged Voucher Processing Option Value	Mode in Batch Voucher Processor Report (R04110ZA)	Mode in Voucher Match Automation UBE Programs (R4304016, R4304020, and R4304021)	Effect of Processing Option Values
1 (on)	1 (final)	1 (suggest)	<p>The Batch Voucher Processor Report program creates logged voucher records for process type 1 records; creates suggestions for the logged vouchers that are created, and those that existed in the system prior to running the process.</p> <p>The Voucher Match Automation UBE programs generate reports that list the process type 2 records that were matched and those that were not matched. The Voucher Match Automation UBE programs do not generate information for process type 1 records.</p> <p>The process reserves the receipt records in the F43121 table for the matches that it suggests so that the receipt records cannot be matched to other invoice lines until you take action on the suggested matches.</p> <p>If you have invoice records in the F0411Z1T table that are at status 3 (approved) and you set the Process Approved Invoices processing option in the Voucher Match Automation UBE programs to 1 (process approved suggestions), the system completes the approved matches, updating the appropriate tables.</p>

Create Logged Voucher Processing Option Value	Mode in Batch Voucher Processor Report (R04110ZA)	Mode in Voucher Match Automation UBE Programs (R4304016, R4304020, and R4304021)	Effect of Processing Option Values
1 (on)	1 (final)	1 (final)	<p>The Batch Voucher Processor Report program creates logged vouchers from process type 1 records, and changes the process type for those records to process type 2. It then matches the new and existing process type 2 records to receipts and purchase orders and updates the database tables. The report generated by the Batch Voucher Processor Report program states the number of logged vouchers created.</p> <p>(The following paragraph pertains to a Release 9.1 update.) However, if you have selected the Suggestion Required option for the supplier, the system creates suggestions for that supplier's invoices.</p> <p>The Voucher Match Automation UBE programs generate reports showing matched and unmatched records for process type 2 records, and creates or updates database tables. The programs do not list process type 1 records for which no logged vouchers are created.</p> <p>If you have invoice records in the F0411Z1T table that are at status 3 (approved) and you set the Process Approved Invoices processing option in the Voucher Match Automation UBE programs to 1 (process approved suggestions), the system completes the approved matches in final mode, updating the appropriate tables.</p>

15.2 Setting Processing Options for the Voucher Match Automation Process

This section provides an overview of processing options for the voucher match automation process and discusses how to:

- Set processing options for Voucher Match Automation Driver (R4304010).
- Set processing options for Voucher Match Automation UBE for Automation Rule 01 (R4304016) and Voucher Match Automation UBE for Automation Rule 06 (R4304021).
- Set processing options for Voucher Match Automation UBE for Automation Rule 02, 03, 04, 05 (R4304020).

15.2.1 Understanding Processing Options for the Voucher Match Automation Process

The Voucher Match Automation Driver program and the Voucher Match Automation UBE programs that the driver program launches include processing options in which you specify the versions of related programs that the process runs to perform certain tasks. In the Voucher Match Automation Driver program, you specify versions for these programs, or leave the processing options blank to use the XJDE0001 version:

- Voucher Match Automation UBE for Automation Rule 01 (R4304016)
- Voucher Match Automation UBE for Automation Rule 02, 03, 04, 05 (R4304020)
- Voucher Match Automation UBE for Automation Rule 06 (R4304021)
- Batch Voucher Processor Report (R04110ZA)

In each of the Voucher Match Automation UBE programs (R4304016, R4304020, and R4304021), you specify a version of the Voucher Match program (P4314) that the process runs to generate or update voucher records. You can specify a different version of the Voucher Match program in each of the Voucher Match Automation UBE programs, specify the same version in each program, or leave the Voucher Match (P4314) processing option blank to use the default version ZJDE0001.

In each version of the Voucher Match program, and in the Batch Voucher Processor Report program, you specify versions of the Voucher Entry MBF (P0400047) and Journal Entry MBF (P0900049) programs. The Voucher Match program includes processing options in which you specify versions of additional programs. However, the voucher match automation program does not run the additional programs.

This process flow shows the programs for which you need to specify versions and how the processing option values for the versions are passed to related programs:

Figure 15–1 Process Flow E: Processing Options

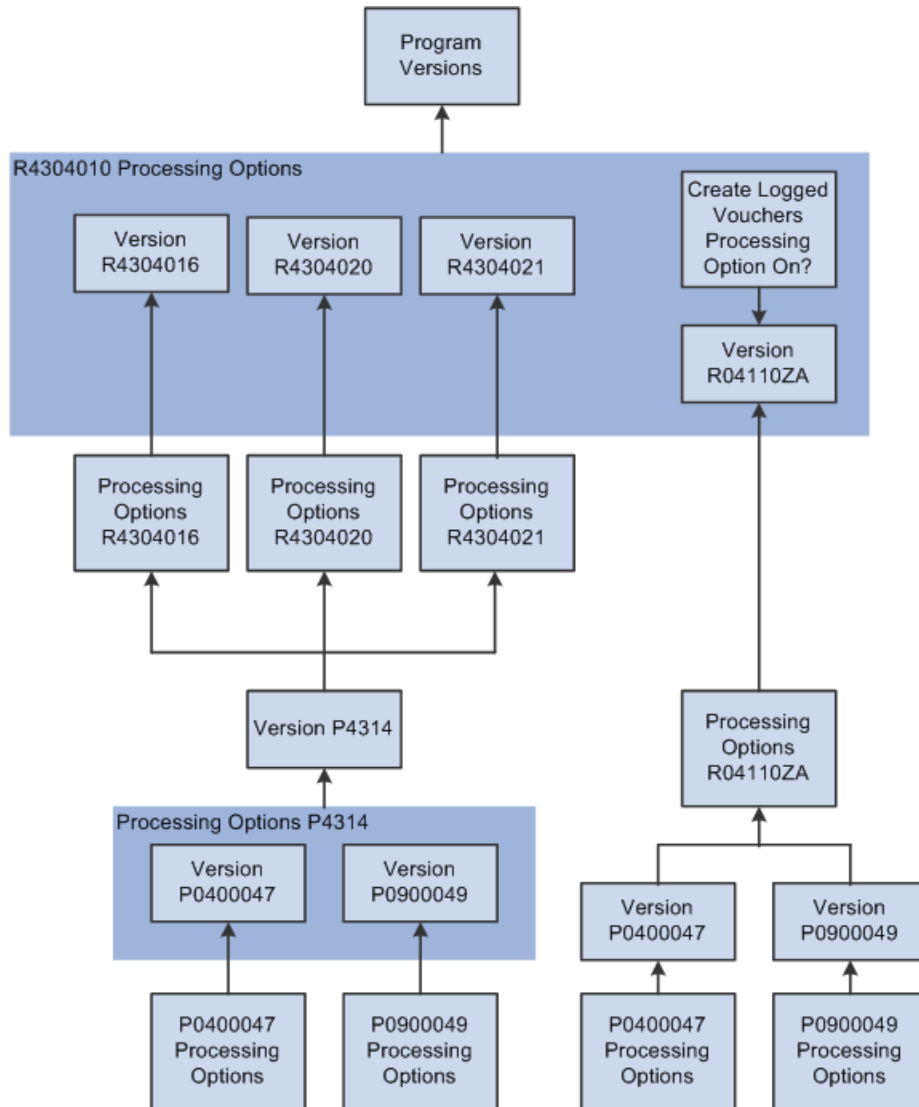

15.2.1.1 Setting Processing Options for Voucher Match (P4314)

Some processing options in the Voucher Match program do not affect the VMA process. For example, progress payments, freight distribution, and subcontract payments are not supported in the VMA process, so the process does not read the values for the processing options that affect those situations.

Some processing options in the Voucher Match program affect VMA processing in only certain circumstances. This table describes what you should know about the effect of the Voucher Match program processing options on the VMA process:

Topic	Comments
Processing options on the Defaults, Display, New Order Line, Retainage, Logs, Progress Payments, and Freight Distribution tabs	The processing options on these tabs do not affect the VMA process, so you can leave the processing options on these tabs blank.

Topic	Comments
Process tab	<p>Consider these factors when setting the processing options on the Process tab:</p> <ul style="list-style-type: none"> ■ The VMA process uses the tolerance processing options that you set in the R4304020 program and ignores the value that you specify in the Tolerance processing option in the Voucher Match program. ■ The VMA process uses the value that you specify in the Supplier Analysis, Company Retrieval From Branch/Plant, Direct Ship Integrity Cost Update, and Lot Cost Update processing options in the same manner as the Voucher Match program uses them when you use the Voucher Match program in interactive mode. <p>The VMA process ignores all of the other processing options on the Process tab.</p>
Summarization tab	<p>The VMA process summarizes the general ledger records for automation rules 03 and 05 when you set the G/L processing option to do so.</p> <p>The VMA process does not summarize accounts payable records, so you can leave the A/P processing option blank.</p>
Currency tab	<p>The VMA process reads the value in the Effective Date processing option when you run the process for non-logged vouchers. The VMA process does not read the value in the Protect Rule processing option.</p>
Flex Accounts	<p>The VMA process reads the value in the Flex Accounting processing option.</p>
Versions tab	<p>The VMA process reads the values in the AP Master Business Function and the GL Master Business Function processing options. The process ignores the values in the other processing options on the Versions tab.</p>
Workflow tab	<p>The VMA process reads the value in the Notify Amount Changes processing option when you run the R4304020 program. It does not read the value when you run the R4304016 program for automation rule 01.</p> <p>The VMA process ignores the value in the Notify Quantity Changes for both the R4304016 and R4304020 programs.</p>
Redistribution tab	<p>The VMA process reads the values in the Calculate Last Chance Variance and Paid Logged Vouchers processing options when you run the VMA process for logged vouchers.</p> <p>If you leave the Calculate Last Chance Variance processing option blank, in a particular situation, the VMA process will match voucher records to receipt records but you will not be able to post the records. To avoid discrepancies in the matching and posting of records, Oracle recommends that you enter 1 in the Calculate Last Chance Variance processing option in the version of the Voucher Match program that you use to process logged vouchers.</p> <p>See Calculate Last Chance Variance for Foreign Currency Transactions</p>

15.2.1.1.1 Calculate Last Chance Variance for Foreign Currency Transactions For transactions in a foreign currency, the VMA process calculates the conversion to domestic-currency amounts and performs tolerance validations on the domestic-currency amounts. The process uses the tolerance and rounding rules that you set up for automation rules 02, 03, and 05. Even though the process applies the tolerance validations to

domestic-currency amounts, the foreign-currency amounts of the logged voucher and the receipt must match exactly. If the foreign amounts do not match exactly, then the process does not match the records *except* when the records meet these criteria:

- The Calculate Last Chance Variance processing option is blank (off).
- The automation rule used for the record is 02 or 03.
- The foreign-currency amounts for the voucher and receipt do not match exactly and the domestic-currency amounts do match exactly.

For matched records that meet the criteria described in this section, you must manually enter a record in the Account Ledger table (F0911) to balance the records. After you enter the account ledger record, you can post the batch.

Note: You can avoid the necessity of entering a manual record by always running the VMA process for logged vouchers with the Calculate Last Chance Variance processing option set to **1** (on). If you run the process with the Calculate Last Chance Variance processing option on, the VMA process does not match voucher and receipt records in batches that you cannot post.

15.2.1.2 Setting Processing Options for Batch Voucher Processor Report (R04110ZA)

When you set the Create Logged Voucher processing option in the Voucher Match Automation Driver program to **1**, the voucher match automation process runs the Batch Voucher Processor Report program to generate logged voucher records. The voucher match automation process uses most of the processing options from the Batch Voucher Processor Report program.

This table lists the processing options that the voucher match automation process does *not* use, or *uses differently* from when you run the Batch Voucher Processor Report program outside of the voucher match automation process.

Tab	Processing Option	Comments
Process	Enter a '1' to process the batch information in Final mode.	<p>You enter 1 to cause the Batch Voucher Processor Report program to create logged voucher records in the F0411 and F0911 tables. If you enter 1, the process will always generate the logged voucher records for valid F0411Z1 records.</p> <p>The Voucher Match Automation UBE programs (R4304016, R4304020, and R4304021) also have a processing option in which you specify whether to run the process in proof, final, or suggest mode. These processing options determine whether the system matches the logged vouchers to receipts.</p> <p>You can set the Mode processing options differently in the voucher matching and Batch Voucher Processor Report programs to generate different sets of records.</p> <p>See Understanding Proof, Final and Suggest Modes</p>

Tab	Processing Option	Comments
Process	Enter a '1' to automatically purge processed transactions from the batch file.	The voucher match automation process ignores the value in this processing option. Instead, the process uses the Purge Processed Records processing option in the Voucher Match Automation UBE programs to determine whether to purge records. See Purging Matched VMA Records From the F0411Z1and F0411Z1T Tables

15.2.2 Setting Processing Options for Voucher Match Automation Driver (R4304010)

Processing options enable you to specify default processing values.

15.2.2.1 Versions

1. Voucher Match Automation UBE for Automation Rule 01 (R4304016)

Use this processing option to specify the version of the Voucher Match Automation UBE for Automation Rule 01 program (R4304016) to run. If you leave this processing option blank, the system runs version XJDE0001.

2. Voucher Match Automation UBE for Automation Rule 02, 03, 04, 05 (R4304020)

Use this processing option to specify the version of the Match Automation UBE for Automation Rule 02, 03, 04, 05 program (R4304020) to run. If you leave this processing option blank, the system runs version XJDE0001.

3. Voucher Match Automation UBE for Automation Rule 06 (R4304021)

Use this processing option to specify the version of the Match Automation UBE for Automation Rule 06 program (R4304021) to run. If you leave this processing option blank, the system runs version XJDE0001.

3. Version of the Batch Voucher Processor Report (R04110ZA)

Use this processing option to specify the version of the Batch Voucher Processor Report program (R04110ZA). The system uses this processing option when the value in the Create Logged Voucher processing option is 1.

15.2.2.2 Logged Voucher

1. Create Logged Voucher

Use this processing option to specify whether to create logged vouchers. Values are:

Blank: Do not create logged vouchers.

1: Create logged vouchers.

15.2.2.3 Process (Release 9.1 Update)

1. Single Voucher Per Invoice

Use this processing option to specify whether to create a single voucher for a supplier's invoice that has one or more pay items. Valid values are:

Blank: Create a separate voucher for each invoice line.

1: Create a single voucher for each invoice with one or more pay items.

2. Validate Automation Rules

Use this processing option to specify how to process an invoice when the system detects different automation rules on an invoice that has one or more pay items. This processing option is applicable when Single Voucher Per Invoice processing option is set to 1. Values are:

Blank: Do not process an invoice if all the pay items do not have the same automation rule.

1: Process the invoice with the automation rule of the first line and issue a warning message.

2: Process the invoice with the automation rule of the first line with no message.

15.2.3 Setting Processing Options for Voucher Match Automation UBE for Automation Rule 01 (R4304016) and Voucher Match Automation UBE for Automation Rule 06 (R4304021)

Processing options enable you to specify default processing values.

Note: The Voucher Match Automation UBE for Automation Rule 01 and Voucher Match Automation UBE for Automation Rule 06 programs do not appear on a menu because you do not directly run the programs. Instead, the Voucher Match Automation Driver program runs the programs as part of the voucher match automation process. Access the processing options for the Voucher Match Automation UBE for Automation Rule 01 and Voucher Match Automation UBE for Automation Rule 06 programs from the Batch Versions program (P98305W). You can enter **BV** in the Fast Path to access the Batch Versions program.

15.2.3.1 Defaults

1. Proof, Final, or Suggest Mode

Use this processing option to specify whether the system processes records in proof, final, or suggest mode. In proof mode, for records with process type 2, the system generates a report that lists the number of records that will be processed, and those that will not be processed due to errors. In final mode, the system generates a report that shows the records that are processed and those that were not processed due to errors, and updates the appropriate tables. In suggest mode, the system generates a report, updates the invoice match status, and reserves the receipts.

Values are:

Blank: Run in proof mode.

1: Run in final mode.

2: Run in suggest mode.

2. G/L Date

Use this processing option to specify the general ledger (G/L) date of the records that the system creates or updates during the voucher match automation process. If you leave this processing option blank, the system uses the current date.

3. Maximum Invoice Amount

Use this processing option to specify the maximum invoice amount that the system will process in the voucher match automation process. The system compares the amount that you enter here to the taxable amount for the invoice line. The process utilizes the Amount to Distribute, Gross Amount, and Taxable Amount fields in the line to determine the taxable amount.

If the domestic taxable amount exceeds the value in the processing option, the system does not process the invoice record.

4. Minimum Date for Selection

Use this processing option to specify the earliest G/L date in a range of G/L dates that the system uses to select records from the Voucher Transaction - Batch Upload table (F0411Z1). If you leave this processing option blank and populate the Maximum Date for Selection processing option, the system uses the current date as the earliest G/L date in the range of G/L dates.

If you leave this processing option blank and the Maximum Date for Selection processing option blank, the system processes all valid records without limiting the data selection by date range.

The date in this processing option must be earlier than or equal to the date in the Maximum Date for Selection processing option.

5. Maximum Date for Selection

Use this processing option to specify the latest G/L date in a range of G/L dates that the system uses to select records from the Voucher Transaction - Batch Upload table (F0411Z1). If you leave this processing option blank and populate the Minimum Date for Selection processing option, the system uses the current date as the earliest G/L date in the range of dates.

If you leave this processing option blank and the Minimum Date for Selection processing option blank, the system processes all valid records without limiting the data selection by date range.

The date in this processing option must be later than or equal to the date in the Minimum Date for Selection processing option.

6. Process Approved Invoices

Use this processing option to specify whether the system will complete the VMA process for approved suggestions. When the system completes the process, it updates the database tables as it does in final mode. Values are:

Blank: Do not process approved suggestions

1: Process approved suggestions

15.2.3.2 Process**1. Pay Status**

Use this processing option to specify the pay status that the system uses to select logged voucher records from the Accounts Payable Ledger table (F0411). The system uses the pay status specified here to select logged voucher records that were generated using the voucher match automation (VMA) process. Logged vouchers that were generated outside of the VMA process are not eligible for automated matching to receipts and purchase orders. Values are:

A: Approved for payment

P: Paid in full

#: Payment in process

If you leave this processing option blank, the system selects records with pay statuses of A, P and #.

2. Purge Processed Records

Use this processing option to specify whether to purge the successfully processed invoices (process type = 4) from the Voucher Transactions - Batch Upload table (F0411Z1). Valid values are:

Blank: Do not purge records

1: Purge records

Note: If you do not set this processing option to purge records from the F0411Z1 table, you can run the Purge Batch Vouchers Entries program (R0411Z1P) to purge records.

3. Match Process for Single Voucher Per Invoice (Release 9.1 Update)

Use this processing option to specify how to perform the matching process for the Single Voucher Per Invoice option. This processing option is applicable only when you select the Single Voucher Per Invoice option. Values are:

Blank: Do not proceed when an invoice line fails to match.

1: Proceed matching for other lines when an invoice line fails to match.

15.2.3.3 Line Types

Line Type 1, Line Type 2, Line Type 3, Line Type 4, and Line Type 5

Use these processing options to specify the line types to omit from processing. The system does not process records with a line type that you specify. If you leave the line type processing options blank, the system processes all line types.

15.2.3.4 Versions

1. Voucher Match (P4314)

Specify the version of the Voucher Match program (P4314) to run. If you do not specify a version, the system uses version ZJDE0001.

15.2.3.5 Print

1. Data Selection

Use this processing option to specify whether to print the data selection and processing option details on the report. Values are:

Blank: Do not print data selection and processing option detail.

1: Print data selection and processing option detail.

If you enter **1**, the system prints the Voucher Match Automation Driver UBE (R4304010) data selection, then the data selected in the voucher match automation UBE for the version setup and its processing option values.

15.2.4 Setting Processing Options for Voucher Match Automation UBE for Automation Rule 02, 03, 04, 05 (R4304020)

Processing options enable you to specify default processing values.

Note: The Voucher Match Automation UBE for Automation Rule 02, 03, 04, 05 program does not appear on a menu because you do not directly run the program. Instead, the Voucher Match Automation Driver program runs the Voucher Match Automation UBE for Automation Rule 02, 03, 04, 05 program as part of the voucher match automation process. Access the processing options for the Voucher Match Automation UBE for Automation Rule 02, 03, 04, 05 program from the Batch Versions program (P98305W). You can enter **BV** in the Fast Path to access the Batch Versions program.

Note: These processing options apply to automation rules 02, 03, 04, and 05. To apply different processing option values to the records processed under different automation rules, you must:

1. Set up multiple versions of the R4304020 program.
 2. Set up multiple versions of the R4304010 program.
 3. Assign each version of the R4304020 program to a different version of the R4304010 program.
 4. Run each version of the R4304010 program.
-

15.2.4.1 Defaults

1. Proof, Final, or Suggest Mode

Use this processing option to specify whether the system processes records in proof, final, or suggest mode. In proof mode, the system generates a report that lists the number of records that will be processed for records with process type 2, and those that will not be processed due to errors. In final mode, the system generates a report that shows the records that are processed; those that were not processed due to errors; and updates the appropriate tables. In suggest mode, the system generates a report, updates the invoice match status, and reserves the receipts.

Values are:

Blank: Run in proof mode.

1: Run in final mode.

2: Run in suggest mode.

2. G/L Date

Use this processing option to specify the general ledger (G/L) date of the records that the system creates or updates during the voucher match automation process. If you leave this processing option blank, the system uses the current date.

3. Maximum Invoice Amount

Use this processing option to specify the maximum invoice amount that the system will process in the voucher match automation process. The system compares the amount that you enter here to the taxable amount for the invoice line. The process utilizes the Amount to Distribute, Gross Amount, and Taxable Amount fields in the line to determine the taxable amount.

If the taxable amount exceeds the value in the processing option, the system does not process the invoice record.

4. Minimum Date for Selection

Use this processing option to specify the earliest G/L date in a range of G/L dates that the system uses to select records from the Voucher Transaction - Batch Upload table (F0411Z1). If you leave this processing option blank and populate the Maximum Date for Selection processing option, the system uses the current date as the earliest date in the range of dates.

If you leave this processing option blank and the Maximum Date for Selection processing option blank, the system processes all valid records without limiting the data selection by date range.

The date in this processing option must be earlier than or equal to the date in the Maximum Date for Selection processing option.

5. Maximum Date for Selection

Use this processing option to specify the latest G/L date in a range of dates that the system uses to select records from the Voucher Transaction - Batch Upload table (F0411Z1). If you leave this processing option blank and populate the Minimum Date for Selection processing option, the system uses the current date as the earliest date in the range of dates.

If you leave this processing option blank and the Minimum Date for Selection processing option blank, the system processes all valid records without limiting the data selection by date range.

The date in this processing option must be later than or equal to the date in the Minimum Date for Selection processing option.

6. Apply standard tolerances for Automation Rule 02

Use this processing option to specify whether to apply standard tolerance when the system processes records assigned automation rule 02. Values are:

Blank: Do not apply tolerance. If you leave this processing option blank, the system attempts to exactly match the invoice or logged voucher to a receipt. If no exact match is found, the program generates an error message for the F0411Z1 record stating that no match was found.

1: Apply the standard tolerance as set up in the Tolerance Rules program (P4322).

7. Apply standard tolerances for Automation Rule 03

Use this processing option to specify whether to apply standard tolerance when the system processes records assigned automation rule 03. Values are:

Blank: Do not apply tolerance. If you leave this processing option blank, the system attempts to exactly match the invoice or logged voucher to a receipt. If no exact match is found, the program generates an error message for the F0411Z1 record stating that no match was found.

1: Apply the standard tolerance as set up in the Tolerance Rules program (P4322).

8. Apply rounding tolerances for Automation Rule 05

Use this processing option to specify whether to apply rounding tolerance when the system processes records assigned automation rule 05. Values are:

Blank: Do not apply tolerance. If you leave this processing option blank, the system attempts to exactly match the invoice or logged voucher to a receipt. If no exact match is found, the program generates an error message for the F0411Z1 record stating that no match was found.

1: Apply the rounding tolerance as set up in the Rounding Tolerance Rules program (P43221).

9. Process Approved Invoices

Use this processing option to specify whether the system completes the VMA process for approved suggestions. When the system completes the process, it updates the database tables as it does in final mode. Values are:

Blank: Do not process approved suggestions

1: Process approved suggestions

10. Apply tolerance on receipt amount greater than the invoice amount. (Release 9.1 Update)

Use this processing option to specify whether to apply the VMA tolerance for receipts with an amount greater than the invoice amount. Tolerance can only be applied on invoice lines containing automation rule 02 or 03. Values are:

Blank: Do not apply tolerance.

1: Apply tolerance rules as set up in the standard Purchasing Tolerance Rules program (P4322)

Note: When this processing option is set to 1, ensure that the invoice contains the purchase order details, which includes Order Number, Order Type, Order Company, Order Suffix, and Order Line Number. Order Number is mandatory.

To apply this tolerance for the invoice, run the VMA UBE program (R4304020). You cannot apply this tolerance when you match invoices using the Voucher Match Process Workbench program (P4314WB).

See [Tolerance Rules in the VMA Process \(Release 9.1 Update\)](#).

15.2.4.2 Process (Release 9.1 Update)

1. Pay Status

Use this processing option to specify the pay status that the system uses to select logged voucher records from the Accounts Payable Ledger table (F0411). The system uses the pay status specified here to select logged voucher records that were generated using the voucher match automation (VMA) process. Logged vouchers that were generated outside of the VMA process are not eligible for automated matching to receipts and purchase orders. Values are:

A: Approved for payment

P: Paid in full

#: Payment in process

If you leave this processing option blank, the system selects records with pay statuses of A, P and #.

2. Purge Processed Records

Use this processing option to specify whether to purge the successfully processed invoices (process type = 4) from the Voucher Transactions - Batch Upload table (F0411Z1). Valid values are:

Blank: Do not purge records

1: Purge records

Note: If you do not set this processing option to purge records from the F0411Z1 table, you can run the Purge Batch Vouchers Entries program (R0411Z1P) to purge records.

3. Match Process for Single Voucher Per Invoice (Release 9.1 Update)

Use this processing option to specify how to perform the matching process for the Single Voucher Per Invoice option. This processing option is applicable only when you select the Single Voucher Per Invoice option. Values are:

Blank: Do not proceed when an invoice line fails to match.

1: Proceed matching for other lines when an invoice line fails to match.

15.2.4.3 Line Types

Line Type 1, Line Type 2, Line Type 3, Line Type 4, and Line Type 5

Use these processing options to specify the line types to omit from processing. The system does not process records with a line type that you specify. If you leave the line type processing options blank, the system processes all line types.

15.2.4.4 Versions

1. Voucher Match (P4314)

Specify the version of the Voucher Match program (P4314) to run. If you do not specify a version, the system uses version ZJDE0001.

15.2.4.5 Print

1. Data Selection

Use this processing option to specify whether to print the data selection and processing option details on the report. Values are:

Blank: Do not print data selection and processing option detail.

1: Print print data selection and processing option detail.

If you enter **1**, the system prints the Voucher Match Automation Driver UBE (R4304010) data selection, then the data selected in the voucher match automation UBE for the version setup and its processing option values.

15.3 Running the Voucher Match Automation Process

Select one of these options from the Voucher Automation Processing (G43B15) menu:

- Voucher Match Automation - Non logged voucher
The system runs version XJDE0001 when you select this option.
- Voucher Match Automation - Logged voucher
The system runs version XJDE0002 when you select this option.

Note: When you run any version of the Automation Match Voucher process, the system runs versions of the Voucher Match Automation UBE programs (R4304016, R4304020, and R4304021). When you run the XJDE0002 version of the Automation Match Voucher process, the system also runs the Batch Voucher Processor Report (R04110ZA).

15.4 Using the Voucher Match Process Workbench

This section provides an overview of the Voucher Match Process Workbench program (P4314WB) and discusses how to:

- Set processing options for Voucher Match Process Workbench.
- Review, approve, and process a suggestion.
- Clear suggestions and create new suggestions.
- Match an unprocessed record to receipts.
- Replace a suggested receipt line with a different receipt.
- Return an invoice line to Unprocessed status.

15.4.1 Understanding the Voucher Match Process Workbench

Before you can work with the VMA process, you populate the Voucher Transactions - Batch Upload table (F0411Z1) with your supplier invoice information. If you require that the item information in the supplier invoice matches the item information in the receipt and purchase order, you must also populate the Voucher Transactions Batch Upload - Voucher Match Automation table (F0411Z1T). If you do not populate the F0411Z1T table for supplier invoice lines that do not require item information, the system generates the record.

The F0411Z1T table includes an invoice match status. Newly created and unprocessed records have a blank value for the invoice match status. When you run the Voucher Match Automation programs (R4304016, R4304020, and R4304021) in suggest mode, the process changes the invoice match status in the F0411Z1T table to 1 (suggested). You can then use the Voucher Match Process Workbench program (P4314WB) to take action on the records.

As you use the Voucher Match Process Workbench program to view and manage records in the F0411Z1 table, the process changes the invoice match status. For example, you can approve or reject the suggested match. Both of those actions change the status of the invoice records.

Note: You can perform certain actions, such as approving, rejecting, and creating suggestions, from both the Selected Invoices and the Suggestion/Receipt Details subforms. When you perform actions from the Selected Invoices form, you can perform the action on multiple records, but you cannot review the suggestions for each record. When you perform actions from the Suggestion/Receipt Details subform, you review and perform the action for each record individually.

After you review and approve the matches between the invoice, receipt, and purchase order lines, whether by running the VMA batch process or using the workbench to complete the match, the process changes the status to show that the invoice line is

matched. The process then updates the database tables to show that invoice is matched to the receipt and purchase order lines.

This image shows the process flow for working in the Voucher Match Process Workbench program:

Figure 15–2 Process Flow K: Voucher Match Process Workbench Program

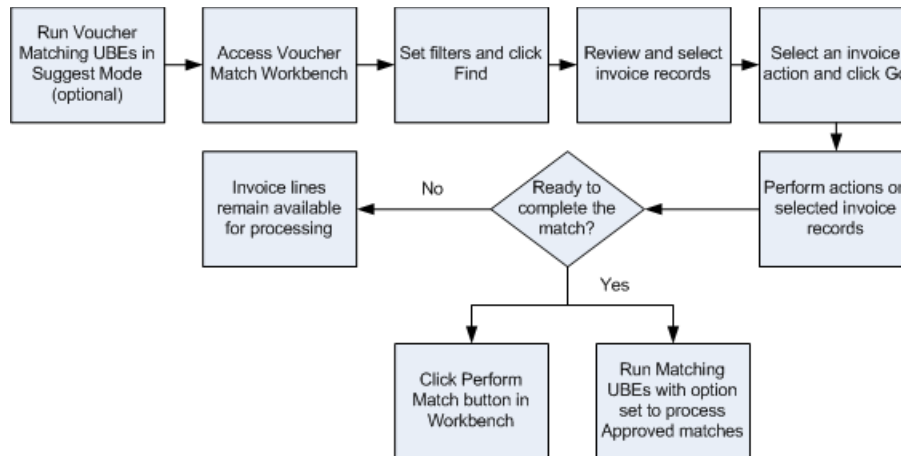

You can use the Voucher Match Process Workbench program to manage records for which you used the Voucher Match Automation programs to create suggested matches, and to work with records for which suggestions were not created. For records that you did not process as suggestions, you must create suggestions in the workbench before you can approve them. You must approve suggestions before you can complete the match and update database tables.

See [Invoice Match Status](#) for information about the statuses and actions you can perform.

You can select and perform actions on multiple records in the workbench. However, because the records must be at specific statuses for specific actions, the system displays a warning message if you attempt to perform a disallowed action on one or more of the selected records. Oracle recommends that you select only records with the same invoice match status when you select multiple records.

You can work with records from the F0411Z1 table for which logged vouchers exist, and you can create logged vouchers using the Voucher Match Process Workbench program. When you complete matches for logged vouchers, the system redistributes the voucher amounts to the final accounts and updates the Accounts Payable Ledger (F0411) and Account Ledger (F0911) tables.

15.4.1.1 Create Single Voucher for an Invoice (Release 9.1 Update)

You can set up the supplier master to create a single voucher for an invoice. When you select the Single Voucher Per Invoice option in the supplier master, the system displays Y in the Single Voucher field in the Voucher Match Process Workbench program (P4314WB). The system generates a single voucher for an invoice when the Single Voucher field is Y for an invoice. When you clear the Single Voucher Per Invoice option in the supplier master, the system displays N in the Single Voucher field and creates a separate voucher for each invoice line.

See [Single Voucher Per Invoice for VMA Process \(Release 9.1 Update\)](#)

If you have opted to generate a single voucher for an invoice, the system displays a single row for that invoice in the Selected Invoices subform. You use the Invoice Details subform to review the invoice lines of that invoice.

See [Invoice Details Subform \(Release 9.1 Update\)](#)

If the system fails to match all of the invoice lines to generate a single voucher, it displays the invoice as Partially Processed in the Invoice Status field on the Selected Invoices subform. Partially Processed status implies that the invoice lines are not in the same status.

15.4.1.2 Create Suggestions and Matches

You can create suggestions for records that have an invoice match status of unprocessed. Records are unprocessed if no suggestion exists, including records for which you have cleared the suggestions for the invoice records.

When you create suggestions in the Voucher Match Process Workbench program, the system performs validations on the invoice and receipt records and enables you to create suggestions for only the invoice and receipt records that pass the validations. For example, if you set up your supplier master records to require that item information is used for matching, the workbench lists as available for suggestions only those receipt records that include the same item information as the invoice record.

The system also performs the same validations when you perform matches in the Voucher Match Process Workbench program as it performs when you run the Voucher Match Automation programs (R4304016, R4304020, R4304021) in final mode. You run the Voucher Match Automation programs by running the Voucher Match Automation Driver program (R4304010). For example, whether you perform a match in the workbench or by running the batch programs, the process uses the automation rule assigned to the invoice line to determine whether the match must be exact or can be within a standard or rounding tolerance.

15.4.1.3 Invoice Match Status

Invoice match statuses exist in the Voucher Transactions Batch Upload - Voucher Match Automation table (F0411Z1T). When you initially upload data to the F0411Z1 table, or when the system creates a record, each invoice line has an invoice match status of unprocessed. See [Populate the Voucher Transaction Batch Upload - Voucher Match Automation Table \(F0411Z1T\)](#).

As you work with the invoice lines, the status changes to reflect the actions that have been performed on the record. The current status of the record determines the actions that you can perform. This list describes the invoice match statuses:

- **Blank: Unprocessed**
Records in the F0411Z1T table are unprocessed when they:
 - Have never been suggested for matches.
 - Were suggested for matches but have had the suggestions cleared.
 - Have not had actions taken against them that assign a different invoice match status. For example, when you match, approve, or reject an invoice line, the system assigns an invoice match status that reflects those actions.
- **1: Suggested**
Invoice records have a status of Suggested when they were matched to receipt records in suggest mode and you have not taken an action that changes the status.
- **2: Rejected**

Invoice records have a status of Rejected when you use the option to reject the suggested match between an invoice and receipt record. The system maintains the record reservation for the receipt lines so that they cannot be matched to other invoices. To enable matching to other receipts, you must clear the suggestion.

- **3: Approved**

Suggested matches are approved when you use the option to approve the match. After you approve matches, you must take further action to complete the match, either in the Voucher Match Process Workbench program or by running the VMA process.

- **4: Successfully Matched After Suggestion**

The system assigns this invoice match status after an approved suggestion is processed to complete the match.

- **5: Successfully Matched Without Suggestion**

The system assigns this status for records that it matches when you run the Voucher Match Automation UBEs (R4304016, R4304020, and R4304021) in final mode for unprocessed records. Unprocessed records are those for which no suggestion was made, and those for which a suggestion was made and then cleared.

- **6: Manually Match**

The system assigns this status to the invoice record when you select the Manually Match action for a record. If you select this action, you cannot match the invoice line to a receipt and purchase order in the Voucher Match Process Workbench program or the VMA process. You must use the Voucher Match program (P4314) to match the invoice line to a receipt line.

When you select the Manually Match option, the system changes the Automation Flag and Automation Rule fields in the F0411Z1 table to blank, and the Invoice Match Status in the F0411Z1T table to 6 (manual match), so that the records must be processed outside of the VMA process.

15.4.1.4 Search Function

You can specify criteria for these fields when searching for invoice records:

- Company

- Invoice dates

- Supplier

- Invoice Status

- All

- Approved

- Records are at an Approved status after you select the Approve option in the workbench.

- Matched

- Records are at a Matched status after you run the VMA process in final mode for the record. You can run the batch process in final mode, or you can manually match the record in the workbench.

- Rejected

Records are at a Rejected status after you select the Reject option for a suggestion. The process maintains record reservation on the receipts for rejected suggestions.

- Suggested

Records are at a Suggested status after you run the VMA batch process in suggest mode, or after you create a suggestion in the workbench either manually or automatically.

- Unprocessed

Records are at an Unprocessed status after they are added to the F0411Z1 table, but before you run the VMA batch process in suggest or final mode, or before you manually change the record status in the workbench. Note that records for which you run the VMA batch process in proof mode remain at the unprocessed status.

15.4.1.5 Selected Invoices Subform

After you click the Find button in the Selected Invoices subform, the program displays the F0411Z1 records that match your search criteria. Note that if the record does not pass validations, the record includes the warning message in the Exceptions Description field. You cannot select for processing records with errors.

You select one or more records in the Selected Invoices subform, and then select the action to perform from the Invoice Action field. All records that you select must enable the same action; otherwise, the system issues an error message.

This table lists the actions that you can perform for the records in the Select Invoices subform and the invoice match status that enables the action:

User Action	Invoice Match Status Before Action	Result
Create logged voucher	Blank (unprocessed)	<p>When you select this action, the process creates a record in the F0411 and F0911 tables and updates the process type in the F0411Z1 table to 2 (Logged voucher exists).</p> <p>The invoice match status in the F0411Z1T table remains blank.</p> <p>When you create a logged voucher, and if you have opted to generate a single voucher for an invoice, the system creates a single logged voucher for all of the lines of that invoice. (Release 9.1 Update)</p> <p>To generate a single voucher for an invoice, you must ensure that supplier, company, automation rule, currency code-from, currency mode and base currency are the same for all of the invoice lines of the invoice. If there is a mismatch in the invoice lines, the system does not process the invoice.</p>

User Action	Invoice Match Status Before Action	Result
Manually match	Blank	<p>The invoice match status in the F0411Z1T table changes from blank to 6 (manually matched). The system also changes the Automation Rule and Automation Flag fields in the F0411Z1 table to blank. If you perform this action, you cannot match the invoice line to a receipt and purchase order in the VMA process or Voucher Match Process Workbench program.</p> <p>You cannot change the invoice match status to Manual Match for logged vouchers. If the process type is 2 (logged voucher exists), you must complete the match in the VMA process.</p> <p>When you select the Manually Match option, and if you have opted to generate a single voucher for an invoice, the system matches the invoice only if all of the lines match. (Release 9.1 Update)</p>
Review/Suggestion Receipt	Blank 1 (Suggested) 2 (Rejected) 3 (Approved)	<p>The process collapses the Selected Invoices subform and expands the Suggestion/Receipt Details subform. For unprocessed records, the system also displays the Select Receipts subform.</p> <p>No records are updated unless you take action on the Suggestion/Receipt Details subform.</p> <p>See Suggestion/Receipt Details Subform</p> <p>When you select the Review/Suggestion Receipt option, and if you have opted to generate a single voucher for an invoice, the system displays all of the lines of that invoice in the Suggestion/Receipt Details subform. (Release 9.1 Update)</p>
View voucher	4 (Matched after suggestion) 5 (Matched without suggestion)	<p>The process collapses the Selected Invoices subform and expands the View Voucher subform. No records are updated.</p>
Approve suggestion	1 (Suggested) 2 (Rejected)	<p>The process updates the invoice match status in the F0411Z1T table to 3 and makes the invoice line eligible for actions that you can perform for invoice lines with an invoice match status of 3.</p> <p>Note that when you select this action on the Selected Invoices subform, the system changes the invoice match status without displaying the details of the suggestion. If you want to view the suggestion before you approve it, use the Approve All Suggestions action from the Suggestion/Receipt Details subform.</p> <p>When you select the Approve Suggestion option, and if you have opted to generate a single voucher for an invoice, the system approves the suggestion when all of the lines of that invoice are in Suggested status. (Release 9.1 Update)</p>

User Action	Invoice Match Status Before Action	Result
Reject suggestion	1 (Suggested) 3 (Approved)	<p>The process updates the invoice match status in the F0411Z1T table to 2 and retains the record reservation for the receipt. Before you can complete a match for the invoice, you must either release the record reservation on the receipts by clearing all suggestions, or you must approve the suggestion. If you approve the suggestion, you reverse the decision to reject it.</p> <p>Note that when you select this action on the Selected Invoices subform, the system changes the invoice match status without displaying the details of the suggestion. If you want to view the suggestion before you reject it, use the Reject All Suggestions action from the Suggestion/Receipt Details subform.</p> <p>When you select the Reject Suggestion option for a Suggested invoice line, and if you have opted to generate a single voucher for an invoice, the system rejects the suggestion for that invoice line. When you select an approved invoice line, the system rejects the suggestions for that invoice line and rest of the lines in that invoice changes to Suggested status. (Release 9.1 Update)</p>
Create suggestion	Blank	<p>The process creates suggestions for the selected invoice lines using the same logic and validations that it uses when you run the batch process.</p> <p>Note that when you select this action on the Selected Invoices subform, the system changes the invoice match status and creates the suggestion without showing you the details of the receipts selected for the suggestion. If you want to view the suggestion before you create it, use the Manual Suggest or Automatic Suggest button on the Suggestion/Receipt Details subform.</p> <p>For successfully suggested invoice lines, the process changes the invoice match status in the F0411Z1T table to 1.</p> <p>When you select the Create Suggestion option, and if you have opted to generate a single voucher for an invoice, the system finds matches and creates suggestions for the invoice lines. If the system does not find matches for any invoice lines, those invoice lines remain in the Unprocessed status. (Release 9.1 Update)</p> <p>To generate a single voucher for an invoice, you must ensure that supplier, company, automation rule, currency code-from, currency mode and base currency are the same for all the invoice lines of the invoice. If there is a mismatch in the invoice lines, the system does not process the invoice.</p>

User Action	Invoice Match Status Before Action	Result
Clear suggestion	1 (Suggestions) 2 (Rejected) 3 (Approved)	<p>The process updates the invoice match status in the F0411Z1T table to blank. The invoice line becomes eligible for any action that you can perform on unprocessed invoice lines.</p> <p>When you select the Clear Suggestion option for a Suggested or Rejected invoice line, and if you have opted to generate a single voucher for the invoice, the system clears the suggestion for that invoice line. When you select an approved invoice line, the system clears the suggestions for that invoice line and rest of the lines in that invoice changes to the Suggested status. (Release 9.1 Update)</p>
Match suggestion	3 (Approved)	<p>The process updates the invoice match status in the F0411Z1T table to 4 and updates the process type in the F0411Z1 table to 4 (matched). Using this action produces the same result as running the batch programs in final mode.</p> <p>Note that when you select this action on the Selected Invoices subform, the system performs the match in final mode without displaying the details of the suggestion. If you want to view the suggestion before you complete the match, use the Perform Match button on the Suggestion/Receipt Details subform.</p> <p>When you select the Match Suggestion option, and if you have opted to generate a single voucher for an invoice, the system processes all of the lines of that invoice. The system creates or re-distributes vouchers for that invoice with a single voucher document. (Release 9.1 Update)</p>

15.4.1.6 Invoice Details Subform (Release 9.1 Update)

You use the Invoice Details subform to review the invoice details. When you select the link in the Single Voucher field of the Selected Invoices subform, the Voucher Match Process Workbench program displays the Invoice Details subform.

15.4.1.7 Suggestion/Receipt Details Subform

You use the Suggestion/Receipt Details subform to manage the receipts that have been suggested for the invoice line. You can also use this form to manually suggest receipts for the invoice line.

The Voucher Match Process Workbench program displays the Suggestion/Receipt Details subform when you:

1. Select records on the Selected Invoices subform for which the Review Suggestion/Receipt invoice action is valid.
2. Select the Review Suggestion/Receipt invoice action and then click the Go button on the Selected Invoices subform.
3. Select the link in the EDI Invoice field.

The Suggestion/Receipt Details subform displays the receipts for the invoice lines that you selected in the Selected Invoices subform. If you selected multiple records on the

Selected Invoices subform, the Suggestion/Receipt Details subform displays the receipt information for the first selection. The receipts that the system displays are limited to those that pass validations that make them eligible for matching to the invoice. For example, if you specify in the processing options to omit certain line types, receipt lines with those line types do not appear on the form. Likewise, if you specify in the supplier master record that the purchase order information is required for matching, the system displays only records for which the purchase order information on the invoice line and receipt lines are the same.

The Suggestion/Receipt Details form includes fields for the invoice amount, receipts total, and variance. Use these fields to determine whether the selected receipts can be matched to the invoice line. As you select receipts for unprocessed invoice lines, remove selections, or reject suggested receipts, the system changes the values in the fields so that you can track whether the invoice and receipt lines match.

You can use the Previous and Next buttons to move between multiple invoice records if you selected multiple records on the Selected Invoices form. The Previous, Next, and Return buttons are not labeled, but you can see the name of the button if you place your cursor over the buttons. You can use the Return button to close the Suggestion/Receipt Details subform and to go back to the Selected Invoices subform.

Note: You must use the Return button to go back to the Selected Invoices form. If you merely expand the Selected Invoices form, the system prevents you from taking an action unless all actions on the Suggestion/Receipt Detail subform are complete.

This image shows the (unlabeled) Previous, Next, and Return buttons that appear on the right side of the Suggestion/Receipt Details subform:

Figure 15–3 Previous, Next, and Return Buttons

The screenshot shows the Voucher Match Process Workbench interface. The 'Selected Invoices' subform is expanded to show 'Suggestion/Receipt Details'. The form displays the following information:

- Manual Suggest: Automatic Suggest: Perform Match: Actions: -- Select One --
- ED I Invoice: IC9031241-2035-1-2.000
- Company: 00001 Financial/Distribution Company
- Supplier: 2323 VMA Simple Part SUPPLIER
- Invoice Status: Suggested
- Automation Rule: 02 1 Receipt Line
- Business Unit: 30
- Invoice Number: 5245
- Invoice Amount: 2,055.00 USD
- Receipts Total: 2,055.00
- Variance:

At the bottom of the subform, there is a table with the following columns: Order Number, Order Type, Change Order, Order Company, No of Lines, Line Number, Document Number, Item Number, Amount Received, Quantity Received, Supplier, and Supplier Description. The table contains one record:

Order Number	Order Type	Change Order	Order Company	No of Lines	Line Number	Document Number	Item Number	Amount Received	Quantity Received	Supplier	Supplier Description
5245	OP	000	00001	2	1.000	5002 VMA		2,055.00	2055.0000	2323 VMA Simple Part SUPPLI	

You select records on the Suggestion/Receipt Details subform and then select an action. This table lists the actions that you can perform for the records on the Suggestion/Receipt Details subform and the invoice match status that enables the action.

User Action	Invoice Match Status Before Action	Result
Manually suggest	Blank (unprocessed)	<p>After you select receipts on the Receipts Detail form, you click the Manual Suggest button. The system creates a suggestion for the selected records according to the automation rule, processing options, supplier setup, and other factors.</p> <p>The process updates the invoice match status in the F0411Z1T table to 1 (suggested). The process type in the F0411Z1 table remains 1 (newly added or unmatched).</p>
Automatically suggest	Blank (unprocessed)	<p>When you click the Automatic Suggest button, the process creates suggestions for the selected invoice lines using the same logic and validations that it uses when you run the batch process. The suggested matches then appear on the Select Receipts subform. You cannot manually select the receipts; they are displayed for information purposes only. Note that after you use this action, you must approve, reject, or clear the suggested match to continue processing the suggestion.</p> <p>The process updates the invoice match status in the F0411Z1T table to 1 (suggested). The process type in the F0411Z1 table remains 1 (newly added or unmatched).</p> <p>When you select the Automatically Suggest option, and if you have opted to generate a single voucher for an invoice, the system finds matches and creates suggestions for the invoice lines. If the system does not find matches for any invoice lines, all of the invoice lines remain in the Unprocessed status. (Release 9.1 Update)</p> <p>To generate a single voucher for an invoice, you must ensure that supplier, company, automation rule, currency code-from, currency mode and base currency are the same for all the invoice lines of the invoice. If there is a mismatch in the invoice lines, the system does not process the invoice.</p>
Perform match	3 (approved)	<p>When you click the Perform Match button, the process completes the match of the invoice and receipt and:</p> <ul style="list-style-type: none"> ■ Updates or creates the records in the F0411, F0911, and F43121 tables. ■ Updates the invoice match status in the F0411Z1T table to 4 (matched after suggestion). ■ Updates the process type in the F0411Z1 table to 4 (matched). <p>When you select the Perform Match option, and if you have opted to generate a single voucher for an invoice, the system processes all of the lines of that invoice. The system creates or re-distributes vouchers for that invoice with a single voucher document with multiple pay items. (Release 9.1 Update)</p>

User Action	Invoice Match Status Before Action	Result
Approve all suggestions	1 (suggested)	<p>When you select the Approve All Suggestions action on the Suggestion/Receipt Details form, the system updates the invoice status in the F0411Z1T table to 3 (approved). Note that the system applies the action to all receipt lines approved for the invoice, not just the line that you select.</p> <p>When you select the Approve All Suggestions option, and if you have opted to generate a single voucher for an invoice, the system approves the suggestion when all of the lines of that invoice are suggested. (Release 9.1 Update)</p>
Reject all suggestions	1 (suggested)	<p>When you select the Reject All Suggestions action on the Suggestion/Receipt Details form, the system updates the invoice match status in the F0411Z1T table to 2 (rejected). Note that the system applies the action to all receipt lines associated with the invoice, not just the line that you select.</p> <p>The system retains the record reservation for the receipt lines that were suggested for the invoice. You cannot create suggestions or match the receipt lines to other invoices unless you clear the suggestions.</p> <p>Before you can process a suggestion or match for an invoice line for which you have rejected the suggestions, you must either:</p> <ul style="list-style-type: none"> <li data-bbox="938 1073 1442 1241"> <p>■ Clear all suggestions</p> <p>When you clear the suggestions, the process makes the receipt lines available for matching to other invoice lines. After you clear the suggestions, you must manually or automatically create new suggestions.</p> <li data-bbox="938 1262 1442 1377"> <p>■ Approve all suggestions</p> <p>If you approve a suggestion after you reject it, the system retains the record reservation and enables you to complete the match.</p> <p>When you select the Reject All Suggestions option for a Suggested invoice line, and if you have opted to generate a single voucher for an invoice, the system rejects the suggestion for that invoice line. When you select an Approved invoice line, the system rejects the suggestions for that invoice line and rest of the lines in that invoice changes to Suggested status. (Release 9.1 Update)</p>

User Action	Invoice Match Status Before Action	Result
Clear all suggestions	1 (suggested) 2 (rejected) 3 (approved)	<p>When you select receipts on the Suggestion/Receipt Details form and then select the Clear All Suggestions action, the system:</p> <ul style="list-style-type: none"> ■ Removes the record reservation for receipts that were associated with the invoice line. ■ If the invoice line has a status of Approved, Rejected, or Suggested, updates the invoice status in the F0411Z1T table to blank (unprocessed). <p>Note that the system applies the action to all receipt lines associated with the invoice, not just the line that you select.</p> <p>When you select the Clear All Suggestions option for a Suggested or Rejected invoice line, and if you have opted to generate a single voucher for the invoice, the system clears the suggestion for that invoice line. When you select an approved invoice line, the system clears the suggestions for that invoice line and rest of the lines in that invoice changes to the Suggested status. (Release 9.1 Update)</p>
Remove selected receipts	blank	<p>When you select receipts on the Suggestion/Receipt Details form and then select the Remove Suggested Receipts action, the system removes the selected receipts from the grid area and makes the receipt line available for matching to a different invoice line.</p>

15.4.1.8 Select Receipts Subform

The system displays the Select Receipts subform and the Suggestion/Receipt Details subform when you select unprocessed records on the Selected Invoices subform and then select the Review/Suggestion Receipt action.

The process displays on the Select Receipts subform only those receipts that pass all validations for the invoice line. For example, the process validates that the company, supplier, and currency in the invoice line and receipt line are the same; and that the receipt meets the criteria specified in the automation rule and processing options. When you select a receipt in the Select Receipts subform, the process moves the receipt to the Suggestion/Receipt Details subform. You can then choose to create a manual suggestion or use one of several other actions.

Note: The automation rule that is assigned to the invoice line determines whether you can select one receipt only or multiple receipts. Additionally, some automation rules enable rounding or standard tolerance. You can create a suggestion only when the receipts that you select are allowed under the automation rule assigned to the invoice line.

15.4.1.9 Vouchers Details Subform

The system displays the Voucher Details subform when you select to view the vouchers for matched records. If you selected multiple invoice lines in the Selected Invoices form, you can use the Next and Previous arrows to display the voucher information for each of the selected lines. You can use the Return arrow to return to the Selected Invoices form.

15.4.1.10 GL Distribution Subform

When you select the Show G/L Distribution option on the Voucher Details subform, the system opens the GL Distribution subform so that you can review the GL distribution information. You cannot make changes on this form.

15.4.2 Forms Used to Manage Suggested Matches

Form Name	Form ID	Navigation	Usage
Voucher Match Process Workbench	W4314WBB	Automation Voucher Processing (G43B15), Voucher Match Process Workbench	Work with invoice records that exist in the F0411Z1 table.

15.4.3 Setting Processing Options for Voucher Match Process Workbench (P4314WB)

The Voucher Match Process Workbench program uses the values that you specify in these processing options when you click the Perform Match button on the Suggestion/Receipt Details subform.

15.4.3.1 Defaults

1. G/L Date

Use this processing option to specify the general ledger (G/L) date of the records that the system creates or updates during the voucher match automation process. If you leave this processing option blank, the system uses the current date.

2. Maximum Invoice Amount

Use this processing option to specify the maximum invoice amount that the system can process in the voucher match automation process. The system compares the amount that you enter here to the taxable amount for the invoice line. The process utilizes the Amount to Distribute, Gross Amount, and Taxable Amount fields in the line to determine the taxable amount.

If the domestic taxable amount exceeds the value in the processing option, the system does not process the invoice record.

3. Apply standard tolerances for Automation Rule 02

Use this processing option to specify whether to apply standard tolerance when the system processes records that are assigned automation rule 02. Values are:

Blank: Do not apply tolerance. If you leave this processing option blank, the system attempts to exactly match the invoice or logged voucher to a receipt. If no exact match is found, the program generates a warning message for the F0411Z1 record stating that no match was found.

1: Apply the standard tolerance as set up in the Tolerance Rules program (P4322).

4. Apply standard tolerances for Automation Rule 03

Use this processing option to specify whether to apply standard tolerance when the system processes records that are assigned automation rule 03. Values are:

Blank: Do not apply tolerance. If you leave this processing option blank, the system attempts to exactly match the invoice or logged voucher to a receipt. If no exact match is found, the program generates an error message for the F0411Z1 record stating that no match was found.

1: Apply the standard tolerance as set up in the Tolerance Rules program (P4322).

5. Apply rounding tolerances for Automation Rule 05

Use this processing option to specify whether to apply rounding tolerance when the system processes records that are assigned automation rule 05. Values are:

Blank: Do not apply tolerance. If you leave this processing option blank, the system attempts to exactly match the invoice or logged voucher to a receipt. If no exact match is found, the program generates an error message for the F0411Z1 record stating that no match was found.

1: Apply the rounding tolerance as set up in the Rounding Tolerance Rules program (P43221).

15.4.3.2 Line Types

Line Type 1, Line Type 2, Line Type 3, Line Type 4, and Line Type 5

Use these processing options to specify the line types to omit from processing. The system does not process records with a line type that you specify. If you leave the line type processing options blank, the system processes all line types.

15.4.3.3 Versions

1. Voucher Match (P4314)

Specify the version of Voucher Match program that the system uses when you perform matches in the Voucher Match Process Workbench program. If you do not specify a version, the system uses version ZJDE0001.

2. AP Master Business Function (P0400047) Version

Enter the version that the system uses when you are using the Accounts Payable program. You can review versions for this program only in the interactive versions list.

3. GL Master Business Function (P0900097) Version

Enter the version that the system uses when you are using the General Ledger program. You can review versions for this program only in the interactive versions list.

15.4.4 Reviewing, Approving, and Processing a Suggestion

To review and approve a suggestion, and then process the suggestion:

1. Access the Voucher Match Process Workbench form.

Figure 15–4 Voucher Match Process Workbench form (Release 9.1 Update)

The screenshot shows the 'Voucher Match Process Workbench' interface. At the top, there are search filters for 'Company', 'Invoice Date From', 'Supplier', and 'Invoice Status'. Below these is a 'Selected Invoices' section with a dropdown for 'Invoice Action'. A table displays one record with the following columns: Single Voucher, Invoice Status, EDI Invoice, Supplier, Supplier Description, Invoice Date, G/L Date, and Invoice Number.

2. Complete the fields in the header area to specify your search criteria, and then click Find.

To work with suggested matches, set the Invoice Status field to Suggested before you click Find.

Figure 15–5 Voucher Match Process Workbench form: after Find (Release 9.1 Update)

This screenshot shows the same interface as Figure 15-4, but after a search. The 'Invoice Status' dropdown is now set to 'Suggested'. The 'Selected Invoices' table now contains 13 records. The columns are: Single Voucher, Invoice Status, EDI Invoice, Supplier, Supplier Description, Invoice Date, G/L Date, and Invoice Number.

Single Voucher	Invoice Status	EDI Invoice	Supplier	Supplier Description	Invoice Date	G/L Date	Invoice Number
Y	Suggested	BR9071534-1527-1	4345	E&D World Wide Company	10/19/2013	10/19/2013	25432534532454
N	Suggested	BR9071534-2082-1-1.000	4345	E&D World Wide Company	11/07/2013	11/07/2013	5324542543254
Y	Suggested	BR9071534-643-1	4343	Parts Emporium	09/30/2013	09/30/2013	1233334
Y	Partially Processed	DM9051171-603-1	4343	Parts Emporium	09/30/2013	09/30/2013	3445555
Y	Suggested	DM9051171-644-1	4343	Parts Emporium	10/01/2013	10/01/2013	5464545
Y	Suggested	DM9051171-654-1	4343	Parts Emporium	10/02/2013	10/02/2013	343434
Y	Suggested	IC9016551-1800-1	4347	S&J Contracting	10/22/2013	10/22/2013	5185
Y	Suggested	IC9016551-1806-1	4346	Travel Company, The	10/22/2013	10/22/2013	5186

3. On the Selected Invoices subform, select the records that you want to review, select Review Suggestion/Receipt from the Action list, and then click the Go button.

Figure 15–6 Suggestion/Receipt subform: first look

This screenshot shows the 'Suggestion/Receipt Details' subform. It displays information for a selected invoice, including 'Manual Suggest', 'Automatic Suggest', and 'Perform Match' options. The details include: EDI Invoice (BR9071534-1527-1-1.000), Business Unit (30), Company (00001 - Financial/Distribution Company), Invoice Number (25432534532454), Supplier (4345 - E&D World Wide Company), Invoice Amount (109.00 USD), Invoice Status (Suggested), Receipts Total (109.00), and Automation Rule (01 - 1 Order and Receipt Line). Below this is a table for 'Records 1 - 1' with columns: Order Number, Order Type, Change Order, Order Company, No of Lines, Line Number, Document Number, Item Number, Amount Received, Quantity Received, Supplier, and Supplier Description.

Order Number	Order Type	Change Order	Order Company	No of Lines	Line Number	Document Number	Item Number	Amount Received	Quantity Received	Supplier	Supplier Description
5174	OP	000	00001	1	1.000	4845	210	109.00	109.0000	4345	E&D World

The system displays the Suggestion/Receipt Details form. If you selected multiple invoice lines, the system displays the first line. You can move to the next line by clicking the Next arrow.

Note that if you select invoice lines for which the Review Suggestion/Receipt action is not valid, the system displays a warning message. You can avoid a warning for an invalid action by always working with invoice lines that are at the same status.

4. On the Suggestion/Receipt Details form, select Approve All Suggestions from the Actions list, and then click the Go button.

Figure 15–7 Suggestion/Receipt subform: after approval

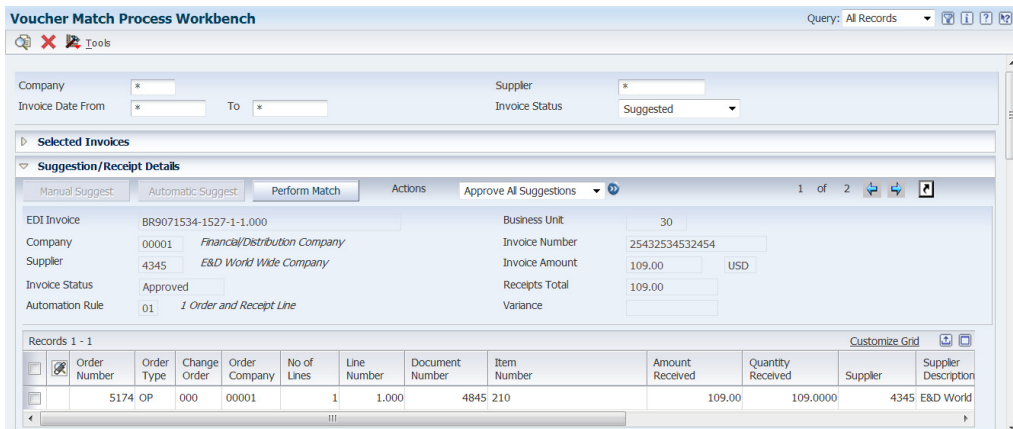

The system changes the invoice status from suggested to approved and enables the Perform Match button.

5. Click the Perform Match button.

Figure 15–8 Suggestion/Receipt subform: after match

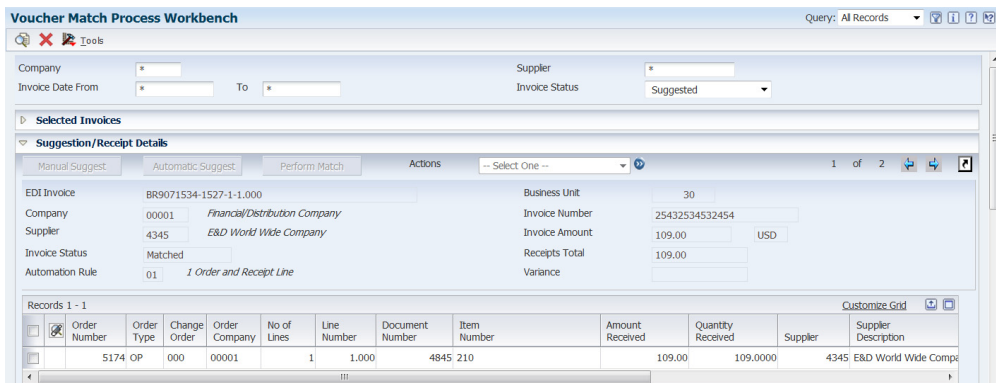

The system verifies that the selected receipt meets parameters set by the automation rule, supplier master record, and processing option. If the receipt is a valid receipt for the invoice, the system updates the F0411, F0911, and F43121 tables with values that show that the invoice line is matched to the receipt line. The system also updates the process type in the F0411Z1 record to 4 (matched), and updates the invoice status in the F0411Z1T table to 4 (matched after suggestion). The value in the Invoice Status field changes to Matched.

Note: As an alternative to completing the match in the Voucher Match Process Workbench program, you can approve the match in the workbench, and then run the Voucher Match Automation Driver program (R4304010) to run the Voucher Match Automation Matching UBE programs (R4304016, R4304020, and R4304021). If you set the Process Approved Invoices processing option to 1 (process), the system completes the match for approved suggestions and updates the database tables.

15.4.5 Clearing Suggestions and Creating New Suggestions

To clear existing suggestions for an invoice and then manually create new suggestions:

1. Access the Voucher Match Process Workbench form.

Figure 15–9 Voucher Match Process Workbench: first look (Release 9.1 Update)

The screenshot shows the 'Voucher Match Process Workbench' application window. At the top, there are search filters for 'Company', 'Invoice Date From', 'Supplier', and 'Invoice Status'. Below these is a 'Selected Invoices' subform with an 'Invoice Action' dropdown set to '-- Select One --'. The main data grid is empty, showing only the column headers: Single Voucher, Invoice Status, EDI Invoice, Supplier, Supplier Description, Invoice Date, G/L Date, and Invoice Number.

2. Complete the fields in the header area to specify your search criteria, and then click Find.

To work with suggested matches, set the Invoice Status field to Suggested.

Figure 15–10 Voucher Match Process Workbench form: after Find (Release 9.1 Update)

The screenshot shows the same application window after a search. The 'Invoice Status' dropdown is now set to 'Suggested'. The data grid contains 13 records. The first two records are highlighted in blue. The grid columns are: Single Voucher, Invoice Status, EDI Invoice, Supplier, Supplier Description, Invoice Date, G/L Date, and Invoice Number.

Single Voucher	Invoice Status	EDI Invoice	Supplier	Supplier Description	Invoice Date	G/L Date	Invoice Number
Y	Suggested	BR9071534-1527-1	4345	E&D World Wide Company	10/19/2013	10/19/2013	25432534532454
N	Suggested	BR9071534-2082-1-1.000	4345	E&D World Wide Company	11/07/2013	11/07/2013	5324542543254
Y	Suggested	BR9071534-643-1	4343	Parts Emporium	09/30/2013	09/30/2013	1233334
Y	Partially Processed	DM9051171-603-1	4343	Parts Emporium	09/30/2013	09/30/2013	3445555
Y	Suggested	DM9051171-644-1	4343	Parts Emporium	10/01/2013	10/01/2013	5464545
Y	Suggested	DM9051171-654-1	4343	Parts Emporium	10/02/2013	10/02/2013	343434
Y	Suggested	IC9016551-1800-1	4347	S&J Contracting	10/22/2013	10/22/2013	5185
Y	Suggested	IC9016551-1806-1	4346	Travel Company, The	10/22/2013	10/22/2013	5186

3. On the Selected Invoices subform, select the records that you want to review, select Review Suggestion/Receipt from the Invoice Action list, and then click the Go button.

The system displays the Suggestion/Receipt Details form. If you selected multiple invoice lines, the system displays the first line. You can move to the next line by clicking the Next arrow.

Figure 15–11 Suggestion/Receipt Details subform: first look

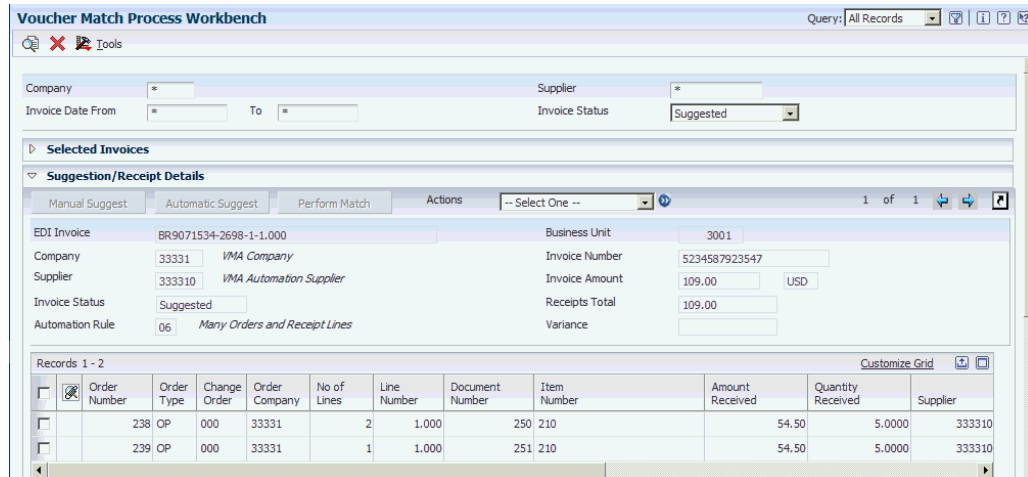

Note that if you select invoice lines for which the Review Suggestion/Receipt action is not valid, the system displays a warning message. You can avoid an error for an invalid action by always working with invoice lines that are at the same status.

4. On the Suggestion/Receipt Details subform, select Clear All Suggestions from the Action list, and then click the Go button.

The system displays a confirmation window. If you choose to continue, the system changes the invoice status from suggested to unprocessed and enables the Manual Suggest and Automatic Suggest buttons. The system also displays the Select Receipts subform.

Figure 15–12 Suggestion/Receipt Details and Select Receipts subforms

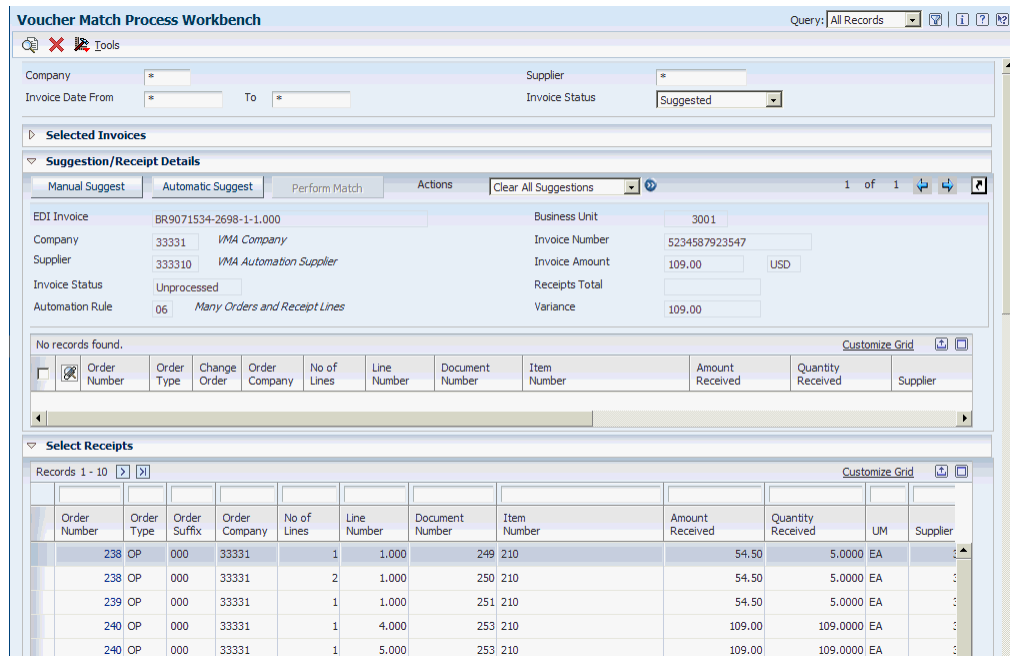

5. Create the new suggestion by performing one of the following steps:

- Select receipts in the Receipt Details subform to move the receipts to the Suggestion/Receipt Details subform, and then click Manual Suggest.
- Click the Automatic Suggest button.

Figure 15–13 Suggestion/Receipt Details subform: after Manual Suggest

Voucher Match Process Workbench Query: All Records

Company: * Supplier: *
 Invoice Date From: * To: * Invoice Status: Suggested

Selected Invoices

Suggestion/Receipt Details

Manual Suggest Automatic Suggest Perform Match Actions Clear All Suggestions 1 of 1

EDI Invoice: BR9071534-2698-1-1.000 Business Unit: 3001
 Company: 33331 VMA Company Invoice Number: 5234587923547
 Supplier: 333310 VMA Automation Supplier Invoice Amount: 109.00 USD
 Invoice Status: Suggested Receipts Total: 109.00
 Automation Rule: 06 Many Orders and Receipt Lines Variance:

Order Number	Order Type	Change Order	Order Company	No of Lines	Line Number	Document Number	Item Number	Amount Received	Quantity Received	Supplier
240	OP	000	33331	1	4.000	253	210	109.00	109.0000	333310

For both manual and automatic suggestions, the system validates that the proposed match passes validations and then changes the invoice match status to 1 (Suggested) in the F0411Z1T table.

15.4.6 Matching an Unprocessed Record to Receipts

You might choose to create suggestions in the Voucher Match Process Workbench program instead of using the VMA batch processes to create the suggestions. You can create suggestions for unprocessed records, and then process the suggestions that you create.

1. Access the Voucher Match Process Workbench form.
2. Complete the fields in the header area to specify your search criteria, and then click Find.

To work with unprocessed records, set the Invoice Status field to Unprocessed.

Figure 15–14 Voucher Match Process Workbench: unprocessed invoices (Release 9.1 Update)

Voucher Match Process Workbench Query: All Records

Company: * Supplier: *
 Invoice Date From: * To: * Invoice Status: Unprocessed

Selected Invoices

Invoice Action: Review Suggestion/Receipt

Records 1 - 16

Single Voucher	Invoice Status	EDI Invoice	Supplier	Supplier Description	Invoice Date	G/L Date	Invoice Number	Gross Amount
N	Unprocessed	BR9071534-116-4-1.000	4345	E&D World Wide Company	09/03/2013	09/03/2013	T25432542543	
N	Unprocessed	BR9071534-116-4-2.000	4345	E&D World Wide Company	09/03/2013	09/03/2013	T25432542543	
N	Unprocessed	BR9071534-116-4-3.000	4345	E&D World Wide Company	09/03/2013	09/03/2013	T25432542543	
Y	Unprocessed	BR9071534-119-1	4345	E&D World Wide Company	09/03/2013	09/03/2013	S4322542534	
Y	Unprocessed	BR9071534-120-1	4345	E&D World Wide Company	09/03/2013	09/03/2013	S4322542534	
N	Unprocessed	BR9071534-121-1-1.000	4345	E&D World Wide Company	09/03/2013	09/03/2013	S425325254	
N	Unprocessed	BR9071534-121-1-2.000	4345	E&D World Wide Company	09/03/2013	09/03/2013	S425325254	
N	Unprocessed	BR9071534-121-1-3.000	4345	E&D World Wide Company	09/03/2013	09/03/2013	S425325254	

- On the Selected Invoices subform, select the records that you want to work with, select Review Suggestion/Receipt from the Invoice Action list, and then click the Go button.

The system displays the Suggestion/Receipt Details form and the Receipt Details subform.

Figure 15–15 Suggestion/Receipt Details subform and Receipt Detail subform

The screenshot shows the Voucher Match Process Workbench interface. At the top, there are search filters for Company, Supplier, Invoice Date From, To, and Invoice Status (set to Unprocessed). Below this is the 'Selected Invoices' section, which is currently empty. The main area is the 'Suggestion/Receipt Details' subform, which includes fields for EDI Invoice (BR9071534-3336-1-7,000), Company (33331, IMA Company), Supplier (333310, IMA Automation Supplier), Invoice Number (25342543546), Invoice Amount (109.00- USD), Receipts Total, and Variance (109.00-). Below these fields is a table with the message 'No records found.' and a 'Customize Grid' button. The bottom section is the 'Select Receipts' subform, which displays a table of receipt lines. The table has columns for Order Number, Order Type, Order Suffix, Order Company, No of Lines, Line Number, Document Number, Item Number, Amount Received, Quantity Received, UM, and Supplier. The data rows are as follows:

Order Number	Order Type	Order Suffix	Order Company	No of Lines	Line Number	Document Number	Item Number	Amount Received	Quantity Received	UM	Supplier
241	OP	000	33331	1	4,000	254	210	109.00-	109.0000-	EA	:
241	OP	000	33331	1	5,000	254	210	109.00-	109.0000-	EA	:
241	OP	000	33331	1	6,000	254	210	109.00-	109.0000-	EA	:
247	OP	000	33331	1	1,000	260	210	109.00-	109.0000-	EA	:
247	OP	000	33331	1	2,000	260	210	109.00-	109.0000-	EA	:

- Click the order number on the Receipt Details form to select the receipt.

The system moves the record from the Receipt Details subform to the Suggestion/Receipt Details subform and changes the values in the Receipts Total and Variance fields. Note that the automation rule assigned to the invoice line determines whether you can match more than one receipt to the invoice line. You must select each line (if allowed) individually.

Figure 15–16 Suggestion/Receipt Details subform: receipt moved from Receipt Details subform

Voucher Match Process Workbench Query: All Records

Company * Supplier *
 Invoice Date From * To * Invoice Status Unprocessed

Selected Invoices

Suggestion/Receipt Details

Manual Suggest Automatic Suggest Perform Match Actions Clear All Suggestions 1 of 3

EDI Invoice BR9071534-3336-1-7.000 Business Unit 3001
 Company 33331 VMA Company Invoice Number 25342543546
 Supplier 333310 VMA Automation Supplier Invoice Amount 109.00- USD
 Invoice Status Unprocessed Receipts Total 109.00-
 Automation Rule 06 Many Orders and Receipt Lines Variance

Order Number	Order Type	Change Order	Order Company	No of Lines	Line Number	Document Number	Item Number	Amount Received	Quantity Received	Supplier
247	OP	000	33331	1	1.000	260	210	109.00-	109.0000-	333310

Select Receipts

Order Number	Order Type	Order Suffix	Order Company	No of Lines	Line Number	Document Number	Item Number	Amount Received	Quantity Received	UM	Supplier
241	OP	000	33331	1	4.000	254	210	109.00-	109.0000-	EA	
241	OP	000	33331	1	5.000	254	210	109.00-	109.0000-	EA	
241	OP	000	33331	1	6.000	254	210	109.00-	109.0000-	EA	
247	OP	000	33331	1	2.000	260	210	109.00-	109.0000-	EA	

- When the amount in the Variance field is 0 or within the allowed tolerance, if the automation rule enables tolerance, click the Manual Match button to create the suggestion.

Note: Instead of selecting receipts and using the Manual Suggest button, you can click the Automatic Suggest button to have the system create the suggestion.

The system changes the invoice status to Suggested.

Figure 15–17 Suggestion/Receipt Details subform: after Manual Suggest

Voucher Match Process Workbench Query: All Records

Company * Supplier *
 Invoice Date From * To * Invoice Status Unprocessed

Selected Invoices

Suggestion/Receipt Details

Manual Suggest Automatic Suggest Perform Match Actions Clear All Suggestions 1 of 3

EDI Invoice BR9071534-3336-1-7.000 Business Unit 3001
 Company 33331 VMA Company Invoice Number 25342543546
 Supplier 333310 VMA Automation Supplier Invoice Amount 109.00- USD
 Invoice Status Suggested Receipts Total 109.00-
 Automation Rule 06 Many Orders and Receipt Lines Variance

Order Number	Order Type	Change Order	Order Company	No of Lines	Line Number	Document Number	Item Number	Amount Received	Quantity Received	Supplier
247	OP	000	33331	1	1.000	260	210	109.00-	109.0000-	333310

- On the Suggestion/Receipt Details form, select Approve All Suggestions from the Action list, and then click the Go button.

The system changes the invoice status from suggested to approved and enables the Perform Match button.

Figure 15–18 Suggestion/Receipt Details subform: after Approve All Suggestions

Voucher Match Process Workbench Query: All Records

Company: * Supplier: *
 Invoice Date From: * To: * Invoice Status: Unprocessed

Selected Invoices

Suggestion/Receipt Details

Manual Suggest Automatic Suggest Perform Match Actions Approve All Suggestions 1 of 3

EDI Invoice BR9071534-3336-1-7,000 Business Unit 3001
 Company 33331 VMA Company Invoice Number 25342543546
 Supplier 333310 VMA Automation Supplier Invoice Amount 109.00- USD
 Invoice Status Approved Receipts Total 109.00-
 Automation Rule 06 Many Orders and Receipt Lines Variance

Order Number	Order Type	Change Order	Order Company	No of Lines	Line Number	Document Number	Item Number	Amount Received	Quantity Received	Supplier
247	OP	000	33331	1	1,000	260	210	109.00-	109.0000-	333310

- On the Suggestion/Receipt Details form, select the approved record and then click Perform Match.

The system updates the F0411, F0911, and F43121 tables with values that show that the invoice line is matched to the receipt line. The system also updates the process type in the F0411Z1 record to 4 (matched), and updates the invoice status in the F0411Z1T table to 4 (matched after suggestion).

Figure 15–19 Suggestion/Receipt Detail subform: after Perform Match

Voucher Match Process Workbench Query: All Records

Company: * Supplier: *
 Invoice Date From: * To: * Invoice Status: Unprocessed

Selected Invoices

Suggestion/Receipt Details

Manual Suggest Automatic Suggest Perform Match Actions Approve All Suggestions 1 of 3

EDI Invoice BR9071534-3336-1-7,000 Business Unit 3001
 Company 33331 VMA Company Invoice Number 25342543546
 Supplier 333310 VMA Automation Supplier Invoice Amount 109.00- USD
 Invoice Status Matched Receipts Total 109.00-
 Automation Rule 06 Many Orders and Receipt Lines Variance

Order Number	Order Type	Change Order	Order Company	No of Lines	Line Number	Document Number	Item Number	Amount Received	Quantity Received	Supplier
247	OP	000	33331	1	1,000	260	210	109.00-	109.0000-	333310

Note: As an alternative to completing the match in the Voucher Match Process Workbench program, you can approve the match in the workbench, and then run the Voucher Match Automation Driver program (R4304010) to run the Voucher Match Automation Matching UBE programs (R4304016, R4304020, and R4304021). If you set the Process Approved Invoices processing option to 1 (process), the system completes the match for approved suggestions and updates the database tables.

15.4.7 Replacing a Suggested Receipt Line with a Different Receipt Line

Some of the voucher match automation rules enable you to match multiple receipt lines to an invoice line. If you do not want to complete a match using the exact receipt lines that the system suggests, you can remove one or more of the receipt lines and replace them with different receipt lines.

1. Access the Voucher Match Process Workbench form.

Figure 15–20 Voucher Match Process Workbench form (Release 9.1 Update)

The screenshot shows the 'Voucher Match Process Workbench' interface. At the top, there are search filters for Company, Invoice Date From, To, Supplier, and Invoice Status. Below these is the 'Selected Invoices' subform, which contains a table with columns: Single Voucher, Invoice Status, EDI Invoice, Supplier, Supplier Description, Invoice Date, G/L Date, and Invoice Number. The table currently shows one record.

2. Complete the fields in the header area to specify your search criteria, and then click Find.

To work with suggested matches, set the Invoice Status field to Suggested.

3. On the Selected Invoices subform, select the records that you want to review, select Review Suggestion/Receipt from the Invoice Action list, and then click the Go button.

Figure 15–21 Suggestion/Receipt Details subform: multiple receipts

The screenshot shows the 'Voucher Match Process Workbench' interface with the 'Suggestion/Receipt Details' subform expanded. It displays details for an EDI Invoice, including Company (33331, IMA Company), Supplier (333310, IMA Automation Supplier), Invoice Status (Suggested), and Automation Rule (06, Many Orders and Receipt Lines). Below this is a table with columns: Order Number, Order Type, Change Order, Order Company, No of Lines, Line Number, Document Number, Item Number, Amount Received, and Qu Rec. The table shows two records.

Order Number	Order Type	Change Order	Order Company	No of Lines	Line Number	Document Number	Item Number	Amount Received	Qu Rec
301	OP	000	33331	1	1.000	296	210	100.00	
294	OP	000	33331	1	1.000	291	210	100.00	

The system displays the Suggestion/Receipt Details subform. If you selected multiple invoice lines, the system displays the first line. You can move to the next line by clicking the Next arrow.

4. Select the receipt line that you want to remove, select Remove Selected Receipts from the Actions list, and then click the Go button.

Figure 15–22 Select Receipts subform: after removing receipt from grid

Voucher Match Process Workbench

Query: All Records

Manual Suggest Automatic Suggest Perform Match Actions Remove Selected Receipts

EDI Invoice: DL9070144-3772-1-2.000 Business Unit: 3001

Company: 33331 VMA Company Invoice Number: JKHCHJ

Supplier: 333310 VMA Automation Supplier Invoice Amount: 200.00 USD

Invoice Status: Unprocessed Receipts Total: 100.00

Automation Rule: 06 Many Orders and Receipt Lines Variance: 100.00

Order Number	Order Type	Order Company	No of Lines	Line Number	Document Number	Item Number	Amount Received
301	OP	000 33331	1	1.000	296	210	100.00

Select Receipts

Order Number	Order Type	Order Company	No of Lines	Line Number	Document Number	Item Number	Amount Received	Quant Received
294	OP	000 33331	1	1.000	291	210	100.00	

You can select multiple receipt lines to remove.

Note that the system changes the invoice status to Unprocessed. The Receipts Total and Variance fields reflect the changes caused by removing receipts from the proposed suggestion.

The process displays the Receipt Details form and lists the receipts that meet the criteria for matching to the invoice record.

5. Select the receipt that you want to add to the receipts for the invoice line.

You select a receipt by clicking on the order number. The process moves the receipt line to the grid in the Suggestion/Receipt Details subform and adjusts amounts in the Receipts Total and Variance fields. If the automation rule assigned to the invoice enables a match to multiple receipts, you can select more receipts to move to the grid in the Suggestion/Receipt Details subform.

6. When you are satisfied with the receipt selection, click the Manual Suggest button to create the suggestion using the remaining original receipts and your newly selected receipts.

The system changes the invoice match status to Suggested. You can now approve and complete the match.

15.4.8 Returning an Invoice Line to Unprocessed Status

You might need to return an invoice line to an unprocessed status. For example, if you approve or reject a suggestion and then change your mind, you must return the invoice line to the unprocessed status before you can create suggestions for the invoice line. You can return to the unprocessed status those invoices with a current invoice match status of Approved, Rejected, or Suggested.

15.4.8.1 Method 1: No Review

1. Access the Voucher Match Process Workbench form.
2. Complete the fields in the header area to specify your search criteria, and then click Find.

Figure 15–23 Voucher Match Process Workbench: after Find (Release 9.1 Update)

The screenshot shows the 'Voucher Match Process Workbench' interface. At the top, there are search filters for 'Company', 'Supplier', 'Invoice Date From', 'To', and 'Invoice Status' (set to 'Rejected'). Below the filters is the 'Selected Invoices' subform, which includes an 'Invoice Action' dropdown set to '-- Select One --'. The main area displays a table with 4 records. The table columns are: Single Voucher, Invoice Status, EDI Invoice, Supplier, Supplier Description, Invoice Date, G/L Date, Invoice Number, and Gross Amount.

Single Voucher	Invoice Status	EDI Invoice	Supplier	Supplier Description	Invoice Date	G/L Date	Invoice Number	Gross Amount
<input type="checkbox"/>	Y	Rejected	IC9016551-1933-1	2323 VMA Simple Part SUPPLIER	10/25/2013	10/25/2013	5198	
<input type="checkbox"/>	Y	Rejected	IC9031241-696-1	88888 Parts Emporium	10/03/2013	10/03/2013	189	
<input type="checkbox"/>	Y	Partially Processed	IC9031241-711-1	88888 Parts Emporium	10/03/2013	10/03/2013	189	
<input type="checkbox"/>	Y	Partially Processed	IC9031241-752-1	88888 Parts Emporium	10/04/2013	10/04/2013	18945	

3. On the Selected Invoices subform, select the records that you want to return to an unprocessed status.

You can select invoice records with a status of Approved, Rejected, or Suggested.

Figure 15–24 Selected Invoices: selected records (Release 9.1 Update)

This screenshot is identical to Figure 15–23, but the second record in the table (Invoice Status: Rejected, EDI Invoice: IC9031241-696-1) is highlighted, indicating it has been selected.

4. Select Clear All Suggestions from the Invoice Action list, and then click the Go button.

The system removes the cleared records from the list of Approved, Suggested, or Rejected records, and changes the invoice match status to Unprocessed. You can locate the record by searching for unprocessed records.

You can now create new suggestions for these invoices or select the Manually Match action to make the invoices and receipts available for matching in the Voucher Match program (P4314).

15.4.8.2 Method 2: Review before Returning to Unprocessed

1. Access the Voucher Match Process Workbench form.
2. Complete the fields in the header area to specify your search criteria, and then click Find.

Figure 15–25 Selected Invoices subform: after Find (Release 9.1 Update)

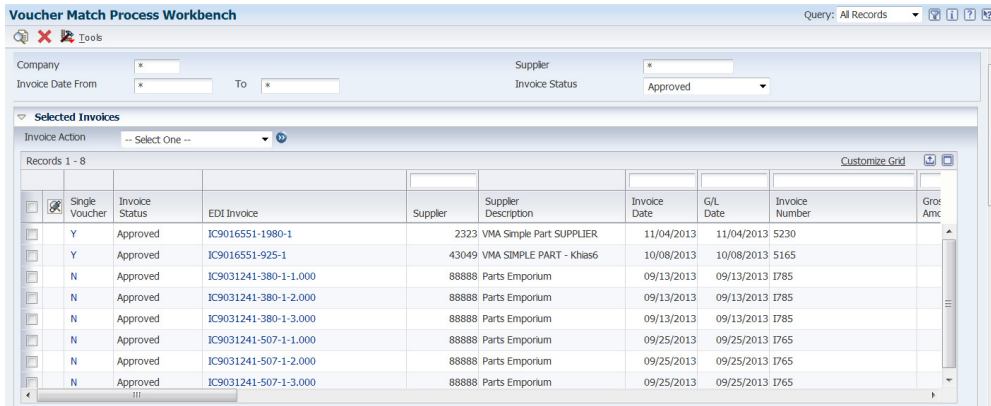

- On the Selected Invoices subform, select the records that you want to review, select Review Suggestion/Receipt from the Invoice Action list, and then click the Go button.

Figure 15–26 Suggestion/Receipt Details subform

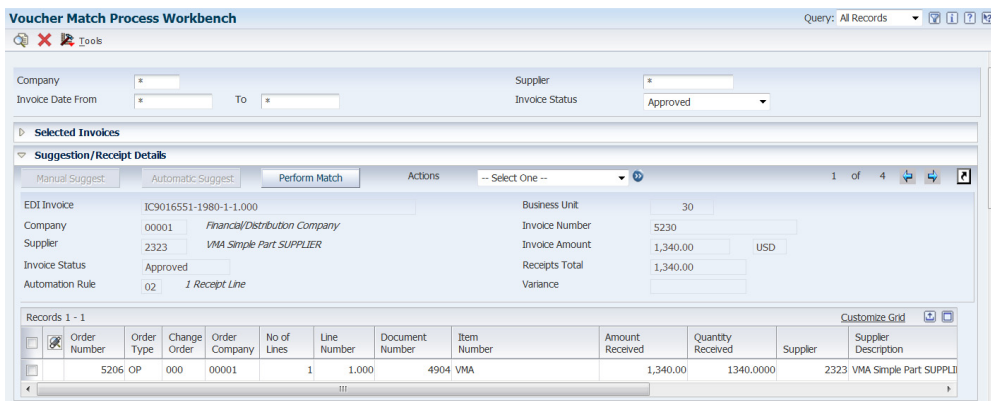

The system displays the Suggestion/Receipt Details subform. If you selected multiple invoice lines, the system displays the first line. You can move to the next line by clicking the Next arrow.

- Select Clear All Selections from the Action list, and then click Go.

The system changes the invoice status to Unprocessed and displays the Receipt Details subform.

Figure 15–27 Suggestion/Receipt Details and Receipt Details subforms

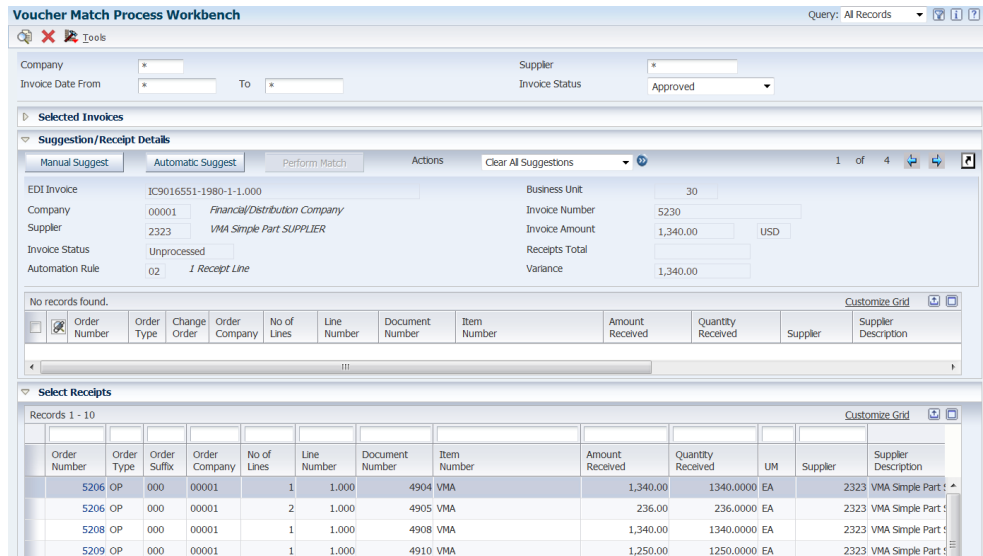

You can now create new suggestions for the invoice or select the Manually Match action to make the invoice and receipts available for matching in the Voucher Match program (P4314).

15.5 Purging Matched VMA Records From the F0411Z1 and F0411Z1T Tables

This section provides an overview of methods to purge matched VMA records from the F0411Z1 table; and discusses how to purge matched records from the Voucher Transactions - Batch Upload (F0411Z1) and Voucher Transactions Batch Upload - Voucher Match Automation (F0411Z1T) tables.

See Also: "Purging Processed Batch Vouchers" in the *JD Edwards EnterpriseOne Applications Accounts Payable Implementation Guide*.

15.5.1 Understanding Methods to Purge Matched VMA Records from the F0411Z1 and F0411Z1T Tables

You can use the Batch Vouchers Revisions program (P0411Z1) to delete VMA records from the F0411Z1 and F0411Z1T tables when these conditions apply to the records:

- If the process type is 1 (newly added or unmatched) or 4 (matched), you can delete the record.
- If the process type is 2 (logged voucher exists), you can delete the record, and you must *manually* delete the existing F0411 record for the transaction.

Important: The VMA process changes the process type from 1 to 2 when you run the VMA process to generate logged vouchers. When the system creates logged vouchers, it creates records in the F0411 table. Deleting a record from the F0411Z1 table does *not* delete the associated records in the F0411 table. You must use the Standard Voucher Entry program (P0411) to delete the records from the F0411 table.

You can purge matched records from the F0411Z1 table automatically as you run the voucher match automation process, or you can manually run a program to purge the matched records. Matched records have a process type (data item PSTE) of 4.

Note: When you purge records from the F0411Z1 table, the system also deletes the corresponding records in the F0411Z1T table.

To automatically purge process type 4 records as you run the voucher match automation process, set the Purge Processed Records processing option in one of the Voucher Match Automation Matching UBE programs to **1**. The programs that include the Purge Processed Records processing option are:

- Voucher Match Automation UBE for Automation Rule 01 (R4304016).
- Voucher Match Automation UBE for Automation Rule 02, 03, 04, 05 (R4304020).
- Voucher Match Automation UBE for Automation Rule 06 (R4304021).

When you set the processing option to **1**, the system purges records with a process type of 4. When you purge records, the system purges *all* records that have a process type of 4. The program does not use any data selection in the Voucher Match Automation Matching UBE programs to determine which process type 4 records to purge. For example, the Voucher Match Automation Matching UBE programs include processing options that enable you to specify the line types to omit from processing. When you purge records, the system purges process type 4 records with any line type regardless of the values that you specify in the line type processing options.

Note:

The system calls the Batch Voucher Processor Report program (R04110ZA) when you create logged vouchers during the voucher match automation process. The Batch Voucher Processor Report program includes a processing option that you can set to purge processed records from the F0411Z1 table. However, the voucher match automation process does *not* use the purge processing option in the Batch Voucher Processor Report program.

If you do not want to automatically purge all matched records from the F0411Z1 and F0411Z1T tables, leave blank the Purge Processed Records processing option in all of the Voucher Match Automation Matching UBE programs. If you do not automatically purge matched records, you can purge the records using one of these methods:

- Manually run the Purge Batch Vouchers program.
- Delete records individually by using the Batch Voucher Revisions (P0411Z1) program.

15.5.2 Purging Matched Records from the F0411Z1 and F0411Z1T Tables

To purge matched records, complete one of these steps:

- Run a version of one of these programs with the Purge Processed Records processing option set to **1**:
 - Voucher Match Automation UBE for Automation Rule 01 (R4304016)
 - Voucher Match Automation UBE for Automation Rule 02, 03, 04, 05 (R4304020).

- Voucher Match Automation UBE for Automation Rule 06 (R4304021).

You run these programs from the Voucher Match Automation Driver program (R4304010).

- Select Batch Voucher Processing (G04311), Purge Batch Voucher Entries.

See Also "Purging Processed Batch Vouchers" in the *JD Edwards EnterpriseOne Applications Accounts Payable Implementation Guide*.

Processing Special Orders

This chapter contains the following topics:

- [Section 16.1, "Understanding Special Order Processing"](#)
- [Section 16.2, "Working with Requisitions"](#)
- [Section 16.3, "Working with Blanket Orders"](#)
- [Section 16.4, "Working with Quote Orders"](#)
- [Section 16.5, "Creating Orders from Price Quotes"](#)
- [Section 16.6, "Working with Order Revisions"](#)
- [Section 16.7, "Generating Purchase Orders"](#)
- [Section 16.8, "Working with the Stocked Item Reorder Point Batch Purchase Order Generator"](#)

16.1 Understanding Special Order Processing

A special order requires different handling than a regular order. In many instances, a special order is a prerequisite to an actual order. Examples of special orders include:

- Requisitions - preliminary requests for items and services.
- Blanket Orders - large orders for which you want to receive periodic disbursements.
- Quote Orders - requests for supplier price quotes.
- Order Revisions - orders for which the system tracks modifications to orders.

You enter most special orders in the same way that you enter orders. You distinguish a special order by its order type and order activity rules. For example, when you work with a requisition, you usually enter an order type of OR (requisition order). When you work with a blanket order, you usually enter an order type of OB (blanket order), and so forth.

Based on the line types, activity rules, and status codes that you set up for special orders, each special order type follows a different process cycle in the JD Edwards EnterpriseOne Procurement system.

See [Setting Up Order Activity Rules](#).

The system provides you with the necessary tools to create a requisition, generate a quote from the requisition, and then generate a purchase order from the quote. The number of suppliers from whom you can solicit quotes is unlimited, the number of items quoted is unlimited, and the number of purchase orders that you can create is

unlimited. Processing all of these tasks online improves efficiency, links all of the documents together, and provides an audit trail of the necessary information to create purchase orders or quote orders.

When you are using the Purchase Order Generator (P43032), Generate POs from Requisitions/Blanket Order Release (P43060), and Quote Order Release (P43360) programs to release blanket, requisition, and quote orders, the purchase order that is generated contains the retainage indicator value. The value of the Retainage Indicator field is brought over from the source purchase order irrespective of the processing option setting.

See [Working with Retainage](#).

Note: Service units are not reduced when a blanket order, quote, or requisition is released.

See [Entering Purchase Orders](#).

16.1.1 Supplier Classification Codes

When you are using the Purchase Order Generator (P43032), Generate POs from Requisitions/Blanket Order Release (P43060), and Quote Order Release (P43360) programs to release blanket, requisition, and quote orders, the purchase order that is generated contains the classification codes from the supplier's address book record in the JD Edwards EnterpriseOne Address Book system.

See "Supplier Classification Codes" in the *JD Edwards EnterpriseOne Applications Subcontract Management Implementation Guide*.

See [Entering Additional Order Header Information](#).

16.1.2 Additional Properties and Category Codes

Additional properties and category codes capture user-defined information for a purchase order. At the time a purchase order is created, you manually enter values for fields on the Additional Properties and Category Codes tabs on the Order Header form or the Order Detail form.

The system performs the following processing for special purchase orders:

- If you release a blanket, requisition, or quote order, then the system pulls over the values in the user-defined fields when the purchase order is generated.

Note: Blanket orders released by the P4310 program do not carry over the values in the user-defined fields on the Additional Properties and Category Codes tabs on the Order Header or Order Detail forms.

- If you generate a purchase order from a source purchase order that has user-defined fields, then the target purchase order also has user-defined fields irrespective of the processing option setting.
- If you generate a purchase order from two or more blanket, requisition, or quote orders, then the user-defined values from the first order header are used.
- If consolidation is used for order details, then the user-defined field values from the first order details are used.

- If one order header is created for multiple lines from different blanket, requisition, or quote orders, then the header information of the first order is used.
- If you release multiple blanket orders to one purchase order, the user-defined field values from the first blanket order are used in the header.

Note: Purchase orders created directly in P4310 provide access to the user-defined fields on the Additional Properties and Category Codes tabs on the Order Header form or the Order Detail form. Purchase orders not created directly in P4310, such as transfer orders, direct ship orders, and order generation programs, do not provide access to the user-defined fields. When the purchase order is generated, you can access the order in P4310 to enter values in the user-defined fields.

See "Additional Properties and Category Codes" in the *JD Edwards EnterpriseOne Applications Subcontract Management Implementation Guide*.

See [Display](#).

See [Entering Order Header Information](#).

16.2 Working with Requisitions

This section provides overviews of requisitions and requisition detail lines, lists prerequisites, and discusses how to set processing options for Generate POs from Requisitions/Blanket Order Release (P43060).

16.2.1 Understanding Requisitions

The company might require you to submit a requisition for the items and services that you want to procure. You usually enter a requisition to obtain approval for goods and services before creating an order. You enter a requisition in the same way that you enter an order. For example, to order office supplies, you enter a detail line for each office supply that you want to order.

When you enter a requisition, you can enter the address book number as the ship-to address so that the requisition can be traced back to you. If you have a purchasing department that manages requisitions, you can enter a purchasing agent on a requisition in place of the supplier. This reference enables the purchasing agent to easily locate requisitions to create orders.

You use the same procedures to print requisitions as you do to print orders, although you must specify the order type for requisitions.

After a requisition is approved, you create an order from the requisition using one of these methods:

- Duplicate a requisition.
- Select requisition detail lines to include on an order.

You duplicate a requisition to create an order when you must create recurring orders from the same requisition. For example, if you have a requisition for office supplies that you order every month, you can duplicate the same requisition to create each recurring order.

When you duplicate a requisition to create an order, the system does not close the requisition. You duplicate a requisition the same way that you duplicate an order.

You select individual requisition detail lines to create orders when you want to close the detail lines so that the lines cannot be used again. For example, if you have a requisition for office supplies that you want to order only once, you must select the requisition detail lines so that they cannot be used again.

16.2.2 Understanding Requisition Detail Lines

You can create an order for an item quantity or an amount that is less than the quantity or amount on a requisition detail line. If you specify a lesser quantity or amount, the system releases that quantity or amount from the detail line, and you choose whether the balance remains open. The system closes a requisition detail line after the entire quantity is released for an order.

To specify whether unit costs appear for each detail line and whether the costs can be changed, you can set the processing options for Generate Orders from Requisitions which is accessed from the Requisition & Quote Management menu (G43A12).

You can also set the processing options to specify whether the system performs a tolerance check before creating an order for a requisition.

You can create an order for a requisition by selecting all detail lines on the requisition. You can also:

- Combine detail lines from multiple requisitions to create a single order.
- Select detail lines from a single requisition to create multiple orders.

You can combine detail lines from multiple requisitions to create a single order. You use this method to combine items and services for the same supplier. For example, if you receive two separate requisitions for staplers, you can combine the requisition detail lines to create a single order.

You can also separate detail lines on a requisition to create multiple orders. You do this when different suppliers provide the items or services on a requisition. For example, if you receive a requisition that contains an order for a stapler and an order for a chair, you can generate an order for the stapler and another for the chair.

You can enter service unit information for service order lines during the requisition process. Service units are informational only, so the system does not perform any validation against the values.

If the Display Service Units processing option on the Display tab of the Order Entry program (P4310) is set to display the Service Quantity and Service UoM fields, then these fields appear on the Order Release form (W43060A).

See "Service Units for A, P Matching" in the *JD Edwards EnterpriseOne Applications Subcontract Management Implementation Guide*.

16.2.3 Prerequisites

Before you select requisition detail lines for orders:

- Set the processing option for versions, Purchase Order Entry (P4310), to create a purchase order.
- Create tolerance rules in Purchasing Tolerance Rules (P4322) to have the system perform tolerance checking.

16.2.4 Forms Used to Work with Requisitions

Form Name	Form ID	Navigation	Usage
Work With Order Headers	W4310I	Requisition and Quote Management (G43A12), Enter Requisitions	Locate an existing requisition or enter a new requisition.
Work With Contract Headers		Requisition & Quote Management (G43D12), Enter Requisitions	
Order Header	W4310B	Click Add to enter a requisition on the Work With Order Headers form.	Enter a requisition.
Order Detail	W4310A	Select an order and click Copy on the Work With Order Headers form.	Duplicate a requisition to create a purchase order.
Work With Order Release	W43060B	Requisition and Quote Management (G43A12), Generate POs from Reqs Requisition & Quote Management (G43D12), Generate Orders from Reqs	Select requisition detail lines for orders. Work with an order release.
Order Release	W43060A	Select a detail line on the Work With Order Release form, and click the Select button.	Review and modify order release fields.

16.2.5 Setting Processing Options for Generate POs from Requisitions/Blanket Order Release (P43060)

Processing options enable you to specify the default processing for programs and reports.

16.2.5.1 Defaults

These processing options define the default information that the system uses during Generate Purchase Orders from Requisitions/Blanket Order Release (P43060).

1. Default Order Type

Specify the type of document that you want to create.

This code also indicates the original document type of the transaction.

Document types are user-defined codes (UDCs) (00/DT) that you set up. There are reserved specific document type codes for vouchers, invoices, receipts, and time sheets for which the system creates automatic offset entries during the post program. (These entries are not self-balancing when you originally enter them.) These document types are predefined; do not change them:

P: Accounts Payable documents.

R: Accounts Receivable documents.

T: Payroll documents.

I: Inventory documents.

O: Purchase Order documents.

J: General Ledger and Joint Interest Billing documents.

S: Sales Order documents.

16.2.5.2 Display

These processing options specify whether the system displays certain types of information, such as status codes, and what fields the system protects, hides, or displays.

1. Incoming Status Code 1

Specify one of the three acceptable statuses at which the order must be to appear in the grid. Enter a code from UDC 40/AT that has been set up on the Order Activity Rules form for the order type and the line type that you are using.

2. Incoming Status Code 2

Specify one of the three acceptable statuses at which the order must be to appear in the grid. Enter a code from UDC 40/AT that has been set up on the Order Activity Rules form for the order type and the line type that you are using.

3. Incoming Status Code 3

Specify one of the three acceptable statuses at which the order must be to appear in the grid. Enter a code from UDC 40/AT that has been set up on the Order Activity Rules form for the order type and the line type that you are using.

4. Price Field Display

Specify whether to display, protect, or hide the Unit Cost field. Values are:

Blank: Display the Unit Cost field. You can edit the value in the field.

1: Protect the Unit Cost field. You cannot edit the value in the field.

2: Do not display the Unit Cost field.

5. Account Number Field Display

Specify whether to protect the Account Number field. Values are:

Blank: Do not protect the Account Number field.

1: Protect the Account Number field.

6. Release Amount Display

Specify whether to display the Release Amount field. Values are:

Blank: Do not display the Release Amount field.

1: Display the Release Amount field.

16.2.5.3 Process

These processing options specify information such as whether the system checks the tolerance percentage of orders and how the system consolidates lines when releasing multiple orders and lines.

1. Tolerance Checking

Specify whether the system checks to determine whether the quantity and amount of a detail line exceed the tolerance percentage or amount. To check the tolerance value, access the Tolerance Setup program (P4322). Values are:

Blank: Do not perform tolerance checking.

1: The system performs tolerance checking and displays a warning message if the amount is above the tolerance level.

2: The system performs tolerance checking and does not allow release of the purchase order if the amount is above the tolerance level.

2. Item Consolidation

Specify whether to consolidate lines when releasing multiple orders and lines. Values are:

Blank: Do not consolidate items.

1: Consolidate lines by supplier, item, account, branch/plant, unit of measure, and requested date.

2: Consolidate lines by supplier, item, account, branch/plant, unit of measure, requested date, and unit cost.

For example, when you use a processing option value of **1** or **2**, and you release two lines with the same supplier, item, branch/plant, unit of measure, and requested date, each for a quantity of 10, then the system creates one line with a quantity of 20 on the new order.

3. Unit Cost Retrieval Upon Supplier Change

Specify whether to retrieve the cost from the original order or from the unit cost based upon when the supplier is changed on the Order Release form. Values are:

Blank: Retrieve the cost from the original order.

1: Retrieve the cost from the unit cost upon which it is based.

4. Override Transaction UOM (override transaction unit of measure)

Specify whether the system overrides the unit of measure (UOM) in the original order. Values are:

Blank: Maintain the UOM in the original order. The purchase order generated has the same UOM as the original order.

1: Override the UOM based on the setting in the Unit of Measure processing option on the Defaults tab of the Purchase Orders program (P4310). The UOMs in blanket orders are converted to the UOM set in the Unit of Measure processing option in the Purchase Orders program.

16.2.5.4 Versions

These processing options specify the version for each application. If you leave any of these processing options blank, the system uses version ZJDE0001.

1. Purchase Order Entry (P4310)

Specify the version that the system uses when you access the Purchase Order Entry program.

When you specify a version, review its processing options to ensure that it meets the needs.

2. Purchasing Ledger Inquiry (P43041)

Specify the version that the system uses when you access the Purchasing Ledger Inquiry program.

When you specify a version, review its processing options to ensure that it meets the needs.

3. Open Order Inquiry (P4310)

Specify the version that the system uses when you access the Open Order Inquiry program.

When you specify a version, review its processing options to ensure that it meets the needs.

4. Supplier Master Inquiry (P04012)

Specify the version that the system uses when you access the Supplier Master Inquiry program.

When you specify a version, review its processing options to ensure that it meets the needs.

16.3 Working with Blanket Orders

This section provides an overview of blanket orders and lists the forms used to work with blanket orders.

16.3.1 Understanding Blanket Orders

You can enter a blanket order when you have an agreement with a supplier to purchase a certain quantity or amount of goods over a period of time. When you enter a blanket order, you must specify the entire quantity or amount of the item or service that you want to order. For example, if you have an agreement with a supplier to purchase 100 widgets a month over the next 12 months, you must enter a blanket order for 1200 widgets.

You enter and print a blanket order in the same way that you enter and print a purchase order. To enter a blanket order, you must enter a single detail line for the entire blanket order quantity or amount. To print a blanket order, you must specify the order type.

Each time you are ready to receive a portion of the goods or services on a blanket order, you must release the quantity or amount for which you want to create a purchase order. For example, if you have a blanket order for 1200 widgets and you want to receive 100, you must locate the blanket order detail line and release 100 widgets.

For each blanket order on the system, you can view the original quantity on the order, the quantity or amount released to date, and the quantity or amount left to release.

Note: Blanket orders released by the P4310 program do not carry over the values in the user-defined fields on the Additional Properties and Category Codes tabs on the Order Header form or the Order Detail form.

See Also:

- [R43640 – Open Purchase Order by Request Date.](#)
- [Processing Options for Open Purchase Order by Request Date \(R43640\).](#)
- "Additional Properties and Category Codes" in the *JD Edwards EnterpriseOne Applications Subcontract Management Implementation Guide*.
- [Entering Order Header Information.](#)

16.3.1.1 Alternate Tax Rate/Area Assignment Functionality for Blanket Order Releases (Release 9.1 Update)

You can use the alternate tax rate/area assignment functionality when the company of the branch/plant is set up to use the functionality. On the Order Release form, if you change the values in the Branch/Plant, Ship To, or Supplier fields and the company of the branch/plant is set up to use the alternate tax rate/area assignment functionality, the system retrieves the alternate tax rate/area. If the entities are not set up for the functionality, then the system retrieves the default value.

See Also:

"Setting Up Alternate Tax Rate/Area Assignment Functionality" in the *JD Edwards EnterpriseOne Applications Tax Processing Implementation Guide*.

"Procurement Management" in the *JD Edwards EnterpriseOne Applications Tax Processing Implementation Guide*.

16.3.2 Forms Used to Work with Blanket Orders

Form Name	Form ID	Navigation	Usage
Work With Order Headers	W4310I	Requisition and Quote Management (G43A12), Enter Requisitions	Locate an existing requisition or enter a new requisition.
Work With Contract Headers		Requisition & Quote Management (G43D12), Enter Requisitions	
Order Detail	W4310A	Purchase Order Processing (G43A11), Blanket Orders	Enter blanket orders.
		Select Add to enter a blanket order on the Work With Order Headers form.	
Work With Order Release	W43060B	Order Generation/Approve/Release (G43A13), Generate POs from Blanket	Work with an order release.

Form Name	Form ID	Navigation	Usage
Order Release	W43060A	Select detail lines on the Work With Order Release form, and click the Select button.	Review and modify order release fields.

16.4 Working with Quote Orders

This section provides an overview of quote orders and discusses how to:

- Print requests for quote orders.
- Set processing options for Request For Quote Report (R43530).
- Set processing options for Quote Response Entry (P4334).

16.4.1 Understanding Quote Orders

Before you procure an item or service, you might want to gather and compare price quotes from different suppliers. You can work with quote orders to:

- Obtain price quotes for items or services.
- Identify the supplier offering the best price or delivery date for an item or service.
- Create a purchase order.

16.4.1.1 Item Entry

You must enter the items for which you want to receive price quotes on a quote order. For each item, you must enter a detail line just as you would on an order.

You can request a price quote for a single quantity or for multiple quantities of an item. You can enter multiple quantities for items for which you expect to receive a price break for purchasing larger quantities. When the quote contains multiple lines, a quote response can be requested for the entire order or for individual line items.

You also might want to obtain price quotes after you get approval for the items and services on a requisition. You can create quote orders using detail lines from requisitions. The procedure for this is identical to that for creating orders from requisitions. On the Order Detail form, you can use the Original Orders function to review:

- A list of all requisitions from which the line was created.
- Who requested the items.
- The quantities requested.

The system maintains the requisition information to create the detail lines on quote orders in the F4332 table.

16.4.1.2 Supplier Entry

After you enter items on a quote order, you must enter the suppliers from whom you want to obtain price quotes. You can specify the suppliers who are to provide price quotes for all items or individual items on the quote order. This diagram shows the process of selecting suppliers for a quote:

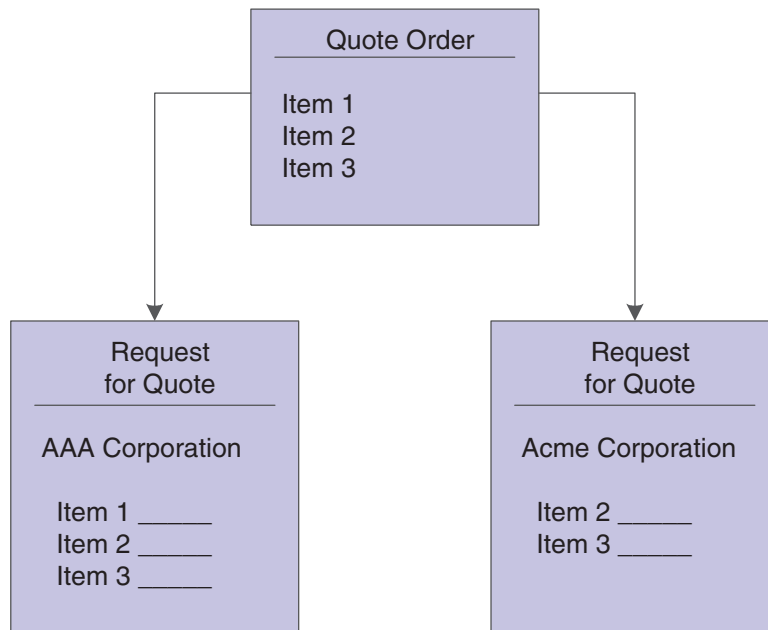
Figure 16–1 *Selecting suppliers for quote*

16.4.1.3 Quote Order Creation from Requisitions

After you get approval for the items or services on a requisition, you might want to obtain price quotes. You can create quote orders using detail lines from requisitions. The procedure for this is identical to that for creating purchase orders from requisitions.

If a detail line on a quote order was created from multiple requisitions, you can review:

- A list of all requisitions from which the line was created.
- The person or persons requesting the items.
- The quantities requested.

To review this information, you must select the detail line on Order Detail and then select Original Orders from the Row menu.

The system maintains information about requisitions consolidated to create detail lines on quote orders in the F4332 table.

16.4.1.4 Print Requests for Quote Orders

For each supplier from whom you are requesting price quotes, you can generate a form on which to record price quote information. Each form applies to a specific quote order. The supplier's name and address appear on the form, as well as the items for which you are requesting price quotes.

You can have the supplier fill out the form, or you can gather the information and fill out the form yourself. You can record a price quote for each item as well as the dates through which each price quote is effective. You can then use the form to enter price quote information into the system.

You run Print Quote Request to select the quote orders for which to print request forms. After you enter price quote information in the system, you can print these forms to review existing price quotes for a supplier.

16.4.1.5 Supplier Price Quotes Entry

After a supplier provides you with price quotes for items or services, you must enter the price quotes into the system. After you enter price quotes from all suppliers, you can compare the price quotes to identify the supplier with the best price.

You must enter supplier price quotes based on a specific quote order. If you requested that the supplier provide price quotes for different quantities of an item, you can enter a price quote for each quantity.

The system maintains individual price quote information for suppliers in the F4330 table.

16.4.2 Forms Used to Work with Quote Orders

Form Name	Form ID	Navigation	Usage
Work With Order Headers	W4310I	Requisition and Quote Management (G43A12), Enter Quote Orders Requisition & Quote Management (G43D12), Enter Quote Orders	Work with order information.
Order Detail	W4310A	Select a quote order on the Work With Order Headers form, and then click the Select button.	Enter information about order details. Request price quotes for a single quantity. Request price quotes for multiple quantities. Create quote orders from requisitions. Enter suppliers to provide quotes. Enter supplier price quotes.
Quote Price Breaks	W4331A	Select a detail line on the Order Detail form, and then select Quote Price Breaks from the Row menu.	Indicate the items for which you expect to receive price breaks.
Quote Supplier Entry	W4330A	Select Quote Suppliers from the Form menu on the Order Detail form. Select a detail line on the Order Detail form, and then select Quote Suppliers from the Row menu.	Indicate the suppliers from whom you want to receive a price quote.
Work With Suppliers	W4334B	Requisition and Quote Management (G43A12), Enter Quote Response	Work with supplier information.

Form Name	Form ID	Navigation	Usage
Quote Response Entry	W4334A	Select the detail line that contains the order number and supplier on the Work With Suppliers form, and then click the Select button.	Enter information about price quotes.

16.4.3 Printing Requests for Quote Orders

Select Requisition and Quote Management (G43A12), Print Quote Orders.

Alternatively, select Requisition & Quote Management (G43D12), Print Quote Orders.

16.4.4 Setting Processing Options for Request For Quote Report (R43530)

Processing options enable you to specify the default processing for programs and reports.

16.4.4.1 Report Display

1. Print Associated Text

Specify whether to print associated text. Values are:

Blank: Do not print the orders-associated text on the report.

1: Print the orders-associated text on the report.

2. Print Comment Lines

Specify whether to print comment lines on the report. Values are:

Blank: Do not print comment lines.

1: Print comment lines.

16.4.4.2 Item Number

1. Print both our item number and the supplier item number

Specify whether to print our item number and the supplier item number. Values are:

Blank: Print only our item number.

1: Print both our item number and the supplier item number.

2. Print only quotes that have not been previously printed

Specify whether to print only quotes that have not been previously printed or to print all. Values are:

Blank: Print all quotes.

1: Print only quotes that have not been previously printed.

16.4.5 Setting Processing Options for Quote Response Entry (P4334)

Processing options enable you to specify the default processing for programs and reports.

16.4.5.1 Default

Order Type

Specify the type of document that you want to create.

This code also indicates the original document type of the transaction.

Document types are UDCs (00/DT) that you set up. There are reserved specific document type codes for vouchers, invoices, receipts, and time sheets for which the system creates automatic offset entries during the post program. (These entries are not self-balancing when you originally enter them.) These document types are predefined; do not change them:

P: Accounts Payable documents.

R: Accounts Receivable documents.

T: Payroll documents.

I: Inventory documents.

O: Purchase Order documents.

J: General Ledger and Joint Interest Billing documents.

S: Sales Order documents.

16.4.5.2 Self-Service

Supplier Self-Service

Specify whether to activate Supplier Self-Service for use in a Java/HTML environment. This functionality enables suppliers to enter prices for quote orders online. Values are:

Blank: Do not activate Supplier Self-Service.

1: Activate Supplier Self-Service.

16.5 Creating Orders from Price Quotes

This section provides an overview of creation of orders from price quotes and discusses how to:

- Set processing options for Quote Order Release (P43360).
- Create an order from a price quote.

16.5.1 Understanding Creation of Orders from Price Quotes

After you enter supplier price quotes for an item or service, you can compare price quotes to identify the supplier with the best price and select a price quote for which to create an order.

After you select a price quote for which to create an order, you can:

- Close the quote order detail line (if fully released) so that you can no longer create orders from the line.
- Leave the quote order detail line open so that you can create recurring orders from the line.

You use processing options to specify which of the methods you want to use. Closed detail lines do not appear on the Quote Order Release form.

You can compare price quotes for an item by locating the quote order detail line that contains the item. You can review the item description for the detail line and all suppliers who have provided price quotes for the item.

You can enter service unit information for service order lines during the order creation process. Service units are informational only, so the system does not perform any validation against the values.

If the Display Service Units processing option on the Display tab of the Order Entry program (P4310) is set to display the Service Quantity and Service UoM fields, then these fields appear on the Quote Order Release form (W43360H).

See "Service Units for A, P Matching" in the *JD Edwards EnterpriseOne Applications Subcontract Management Implementation Guide*.

16.5.2 Forms Used to Create Orders from Price Quotes

Form Name	Form ID	Navigation	Usage
Quote Order Release	W43360H	Requisition and Quote Management (G43A12), Generate POs from Quotes Requisition & Quote Management (G43D12), Generate Orders from Quotes	Create an order from a price quote.
Quote Price Breaks	W4331A	Select a row on the Quote Order Release form, and then select Price Breaks from the Row menu.	Review price breaks for an item.

16.5.3 Setting Processing Options for Quote Order Release (P43360)

Processing options enable you to specify the default processing for programs and reports.

16.5.3.1 Defaults

This processing option specifies default information that the system uses in the Quote Order Release program (P43360).

Order Type

Specify the type of document that you want to create.

This code also indicates the original document type of the transaction.

Document types are UDCs (00/DT) that you set up. There are reserved specific document type codes for vouchers, invoices, receipts, and time sheets for which the system creates automatic offset entries during the post program. (These entries are not self-balancing when you originally enter them.) These document types are predefined; do not change them:

P: Accounts Payable documents.

R: Accounts Receivable documents.

T: Payroll documents.

I: Inventory documents.

O: Purchase Order documents.

J: General Ledger and Joint Interest Billing documents.

S: Sales Order documents.

16.5.3.2 Display

This processing option specifies the types of information that the system displays.

1. Next Acceptable Status Code 1 through 3. Next Acceptable Status Code 3

Specify an acceptable next status.

16.5.3.3 Process

This processing option specifies how the system processes information.

Enter a '1' to reduce the open quantity in the Quote Order by the released amount. If left blank, the quantity open for the quote will remain unchanged, allowing you to continuously release the full quote quantity/ amount.

Specify whether the system reduces the open quantity in the quote order by the released amount. Values are:

Blank: The system does not reduce the open quantity.

1: The system reduces the open quantity.

16.5.3.4 Versions

These processing options enable you to enter the version of various programs that the system uses with the Quote Order Release program (P43360).

1. Purchase Order Entry (P4310)

Specify the version that the system uses when you access the Purchase Order Entry program.

When you specify a version, review its processing options to ensure that it meets the needs.

2. Purchasing Ledger Inquiry (P43041)

Specify the version that the system uses when you access the Purchasing Ledger Inquiry program.

When you specify a version, review its processing options to ensure that it meets the needs.

3. Open Order Inquiry (P430301)

Specify the version that the system uses when you access the Open Order Inquiry program.

When you specify a version, review its processing options to ensure that it meets the needs.

4. Supplier Master Inquiry (P0401)

Specify the version that the system uses when you access the Supplier Master Inquiry program.

When you specify a version, review its processing options to ensure that it meets the needs.

5. Supplier Analysis (P43230)

Specify the version that the system uses when you access the Supplier Analysis program.

When you specify a version, review its processing options to ensure that it meets the needs.

16.5.4 Creating an Order from a Price Quote

Access the Quote Order Release form.

Figure 16–2 Quote Order Release form

Generate POs from Quotes - Quote Order Release

Form Row Tools

Order Number * OQ * Branch/Plant *

Item Number Currency Code USD

Account *

Supplier *

Buyer *

Records 1 - 9

	Release Quantity	Responded Price/ Amount	Curr Code	UM	Supplier Price/ Amount	Release Amount	Service Quantity	Service UoM	Supplier	Supplier Name	Item Number
<input type="radio"/>	100.0000	5.0000							1281	Multiples Branch Plant ...	
<input type="radio"/>		2.0000	USD	EA	2.0000		.0000		1281	Multiples Branch Plant Suppli	QUOTES1
<input type="radio"/>	70.0000	540.6131							4399	SRM Domestic Supplier ...	
<input type="radio"/>		.0000	USD	EA	.0000		.0000		4343	Parts Emporium changed	11115
<input type="radio"/>		.0000	USD	EA	.0000		.0000		4399	SRM Domestic Supplier	11115
<input checked="" type="radio"/>		.0000				40.00			26969	Dell computer	
<input type="radio"/>		45.0000	CAD	EA	34.5000		.0000		26970	Vendor 2	69694
<input type="radio"/>		38.0000	USD	EA	38.0000		.0000		26971	NEW TEST ADDRESS	69694
<input type="radio"/>											

Supplier

Enter the purchasing agent that is assigned to the quote order. Do not use this field to enter suppliers responding with price quotes.

Release Quantity

Enter the release quantity that indicates the price for the system to use for the order if the supplier provided price quotes for multiple item quantities. You are now ready to generate orders for the price quotes that you have chosen. The system warns you if you attempt to exit.

Responded Price/Amount

Displays the price quote if the supplier has provided price quotes for multiple quantities of an item. If a supplier did not return a price quote by the date you required, you cannot use the price quote. The system does not display a release line for late quotes. To activate the line, you must change the response date for the supplier using the Quote Supplier Entry program (P4330).

16.6 Working with Order Revisions

This section provides an overview of order revisions and discusses how to:

- Create order revisions.
- Set processing options for PO/Change Order Summary (P4319).
- Review order revision information.

- Print order revision information.
- Set processing options for Order Revisions History Report (R43535).

16.6.1 Understanding Order Revisions

You can track changes to orders to review information about changes that have occurred. For example, if you entered an order for 5 gallons of paint and then decided to change the order to 10 gallons of paint, you could review the changed information that created the new order for paint.

When you work with order revisions, you can review information such as:

- The number of times an order was revised.
- The number of times each detail line on an order has been revised.
- The order revision to which each detail line change corresponds.
- The information that was revised on a detail line, such as the item number, the costs, and so forth.
- The reason for the revisions.
- The person who made the revisions.
- The dates that the revisions took effect.

You can have the system create an order revision each time you enter or modify an order. For example, if you enter an order for 5 gallons of blue paint, the system creates order revision 000. If you modify the order to 7 gallons of blue paint, the system creates order revision 001. You can locate order revision 000 to review the information about the original order. You can locate order revision 001 to review information about the current order, including the fields modified.

When you review an order, the last order revision that was created appears. The number of revisions to each detail line also appears.

The order revision value for the order indicates the number of times the order has changed. The order revision value for each detail line indicates the order revision number for the order that applied the last time that you changed the detail line.

You use processing options to activate revision tracking. You can specify whether the system enables:

- Revisions to existing orders only.
- The addition of new orders and revisions to existing orders.
- No order revision processing.

You can specify the status at which revision tracking begins. You can also enter notes each time you create an order revision.

The system creates order revisions only when you revise detail lines. It does not create order revisions when you revise header information.

The system maintains order revision information in these tables:

Table Name	Description
F4301	The system maintains the number of times an order is revised.

Table Name	Description
F4311	The system maintains current information for order detail lines, including the number of times each line was revised.
F43199	The system stores original order information as well as information about each order revision. You do not have to activate the Purchasing ledger in order activity rules for revision tracking to occur. Order revision records have a ledger type of CO (change order).

16.6.2 Forms Used to Work with Order Revisions

Form Name	Form ID	Navigation	Usage
Work With Order Headers	W4310I	Purchase Order Processing (G43A11), Enter Purchase Orders	Create order revisions. Work with order headers.
Order Detail	W4310A	Select an order on the Work With Order Headers form, and select Detail Revision from the Row menu.	Review and revise order details.
Work With Order Revisions Summary	W4319A	Purchasing Inquiries (G43A112), Order Revisions Inquiry Subcontract Inquiries (G43D112), Order Revisions Inquiry	Review order revision information. Work with an order revisions summary.
Order Revisions Detail	W4320A	Select an order revision on the Work With Order Revisions Summary form, and click the Select button.	Review order revision details.
Order Revision History	W43205A	Select a detail line on the Order Revisions Detail form, and click the Select button.	Review all revisions that apply to a certain detail line.

16.6.3 Creating Order Revisions

Access the Work With Order Headers form.

16.6.4 Setting Processing Options for PO/Change Order Summary (P4319)

Processing options enable you to specify the default processing for programs and reports.

16.6.4.1 Defaults

These processing options enable you to enter default information that the system uses in the PO/Change Order Summary program (P4319).

Order Type

Specify the type of document that you want to create.

This code also indicates the original document type of the transaction.

Document types are UDCs (00/DT) that you set up. There are reserved specific document type codes for vouchers, invoices, receipts, and time sheets for which the system creates automatic offset entries during the post program. (These entries are not self-balancing when you originally enter them.) These document types are predefined; do not change them:

P: Accounts Payable documents.

R: Accounts Receivable documents.

T: Payroll documents.

I: Inventory documents.

O: Purchase Order documents.

J: General Ledger and Joint Interest Billing documents.

S: Sales Order documents.

16.6.4.2 Versions

These processing options specify the version of various programs that the system uses with the PO/Change Order Summary program (P4319).

Purchase Order Entry (P4310)

Specify the version that the system uses when you access the Purchase Order Entry program.

When you specify a version, review its processing options to ensure that it meets the needs.

Change Order Print (R43535)

Specify the version that the system uses when you access the Change Order Print program.

When you specify a version, review its processing options to ensure that it meets the needs.

Purchase Order Print (R43500)

Specify the version that the system uses when you access the Purchase Order Print program.

When you specify a version, review its processing options to ensure that it meets the needs.

16.6.5 Reviewing Order Revision Information

Access the Work With Order Revisions Summary form.

Figure 16–3 Work With Order Revisions Summary form

Order Number	Or Ty	Order Co	User	Date Updated	Supplier	Branch Plant	Order Revision	Description
1 OP 00001	SS7057173			10/04/2004	8125		4381	0 Original Order
1 OP 00050	TV5860675			07/25/2008	530920	YOGCA92		0 Original Order
1 OP 00200	KM5673360			10/01/2004	938613	M30		0 Original Order
1 OP 03862	IC8897115			10/04/2004	4343	30		0 Original Order
1 OP 06780	IC9016560			03/28/2005	98771		1979	0 Original Order
1 OP 07496	IC9016560			03/25/2005	7496344		1978	0 Original Order
1 OP 10327	CB5639014			10/17/2004	10108	1032719		0 Original Order
1 OP 16223	CS6943106			02/08/2008	1686361		PMD09	0 Original Order
2 OP 00050	TV5860675			07/25/2008	530920	YOGCA92		0 Original Order
2 OP 01077	IC9016560			03/24/2005	9212		1977	0 Original Order

16.6.6 Printing Order Revision Information

Select Purchasing Reports (G43A111), Print Order Revisions History.

Alternatively, select Subcontract Reports (G43D111), Print Order Revisions History.

You can print the Order Revisions History report to review information about order revisions. The report lists this information:

- The number of revisions to each detail line.
- The latest detail line revisions.
- A history of all detail line revisions.

16.6.7 Setting Processing Options for Order Revisions History Report (R43535)

Processing options enable you to specify the default processing for programs and reports.

16.6.7.1 Display

These processing options specify how the system displays information on the Order Revisions History Report (R43535).

1. Specify Revision Number

Specify which revision numbers the system displays. Values are:

Blank: The system displays all revision numbers.

*: The system displays only the last revision number.

2. Specify Lines to Print

Specify which lines the system prints. Values are:

Blank: The system prints only those lines that have changed.

1: The system prints all lines that make up a revision.

3. Print line history

Specify whether the system prints all history records for each detail line printed.

Values are:

Blank: The system does not print all history records.

1: The system prints all history records for each detail line printed.

16.7 Generating Purchase Orders

This section provides an overview of purchase order generation, lists prerequisites, and discusses how to:

- Set processing options for PO Generator (P43011).
- Generate purchase orders.

16.7.1 Understanding Purchase Order Generation

You can have the system generate purchase orders for stock and nonstock items. You can have the system suggest the items and quantities to order. The system bases ordering suggestions on current demand (sales backorders) or historical demand (sales history). You can review the suggestions to determine whether to generate the purchase order for the item and quantity. You can also change the suggestions before generating the order.

The system will not enable you to generate purchase orders if certain combinations of data exist. Some invalid combinations of data include:

- A supplier and a nonstock item.
- A buyer and a nonstock item.
- An item that uses only a second purchasing code.
- A supplier and buyer.

The system displays an error message if the data combination is invalid.

The PO Generator program (P43011) also contains zero reorder point functionality, which the system uses to calculate the reorder point for an item when the inventory level of the item is equal to zero. For example, you would reorder an item if the item is not in stock.

To enable zero reorder point functionality, you use the Item Branch program (P41026) to select the appropriate option for additional system information, and then you complete the Order Policy Code and Value Order Policy fields. Assuming that you enter a value of **0** in the Order Policy Code field, the value in the Value Order Policy field determines how the PO Generator program works. When the Value Order Policy field contains a value of:

- **0**, the system generates purchase orders normally.
- **1**, the system overrides the value in the Reorder Point Input field with a value of **0**.
- **2**, then the system disables the rows in the detail area when you are working with the PO Generator program.

16.7.1.1 Calculations for Order Quantities

The system bases calculations for the Suggested Order Quantity (SOQ) on the Order Policy Code field. If the Order Policy Code field contains a value of:

- Blank, **0**, or **3**, the system uses this calculation:
$$\text{SOQ} = \text{Economic Order Quantity} + \text{Reorder Point} - \text{Quantity Available}$$
- **1**, the system uses this calculation:

SOQ = Reorder Point – Quantity Available

- 2, the system uses the amount in the Value Order Policy field on the Plant/Manufacturing Data tab of the Additional System Info form in the Item Branch Information program.

If the SOQ is:

- Greater than the Maximum Reorder Quantity field on the Quantities form in the Item Branch/Plant Information program, the system uses the maximum reorder quantity amount.
- Less than the Minimum Reorder Quantity field on the Quantities form in the Item Branch/Plant Information program, the system uses the minimum reorder quantity amount.

Note: You can run several other batch programs to have the system calculate a suggested reorder point. Consider running the Sales Order Purchase Order Generator program (R437001) and the Stocked Item Reorder Point Batch Purchase Order Generator program (R437002), which conserve system resources.

The Suggested Reorder Stock Items program (P4371) displays the calculated suggestions of the system and enables you to apply blanket orders when necessary.

16.7.2 Prerequisites

Before you generate purchase orders:

- In the Branch/Plant Constants program (P41001), verify that these fields are complete: Number of Days in Year, Purchase Order Issue Cost, and Inventory Carrying Cost (percent).
- In the Supplier/Item Relationships program (P43090), verify that the Average Leadtime field is completed for each item/supplier combination.
- In the Item Branch program (P41026), verify that the supplier is set up.
- In the Cost Revisions program (P4105), verify that the average cost is set up in the Cost Method field.
- In the Item Branch program (P41026), verify that quantity information is set up.
- In the Item Master program (P4101), verify that the order policy code is set up.

16.7.3 Forms Used to Generate Purchase Orders

Form Name	Form ID	Navigation	Usage
Work With Stocked Item Reorder Point	W43011A	Order Generation/Approve/Release (G43A13), Purchase Order Generator Select items to view.	Generate purchase orders. View existing orders by supplier.

Form Name	Form ID	Navigation	Usage
Select Item for Purchase	W43011C	On the Work With Stocked Item Reorder Point form, select the item for which you want to generate a purchase order, and then select Details from the Row menu.	Generate purchase orders. Review or modify order information.
Generated Purchase Orders	W43032C	Select Generate Order from the Form menu on the Work With Stocked Item Reorder Point form.	Generate purchase orders. Review lines on a purchase order.

16.7.4 Setting Processing Options for PO Generator (P43011)

Processing options enable you to specify the default processing for programs and reports.

16.7.4.1 Display

These processing options specify whether the system displays certain types of information, such as category codes, stocking type, and costs, and whether you can change the cost information.

1. Category Code 1

Enter a value from UDC (41/P1) that specifies the commodity class for which you want to review information. An asterisk specifies all codes. The system retrieves category code information from the F4102 table.

This code represents an item property type or classification, such as commodity type or planning family. The system uses this code to sort and process similar items.

This field is one of six classification categories that are available primarily for purchasing purposes.

2. Category Code 2

Enter a value from UDC (41/P1) that specifies the commodity class for which you want to review information. An asterisk specifies all codes. The system retrieves category code information from the F4102 table.

This code represents an item property type or classification, such as commodity type or planning family. The system uses this code to sort and process similar items.

This field is one of six classification categories that are available primarily for purchasing purposes.

3. Cost Protection

Specify whether you can change costs. The system retrieves cost information from either the F4105 table or, if you are working with supplier/item relationships, the F41061 table. The system also determines the table from which to retrieve cost information by checking the value in the Purchase Price Level field in the F4101 table. If the Purchase Price Level field contains a value of **1** or **2**, the system retrieves cost information from the F41061 table and then from the F4105 table. If the Purchase Price Level field contains a value of **3**, the system retrieves cost information only from the F4105 table.

Values are:

Blank: Display cost fields and allow changes.

1: Display cost fields and do not allow changes to the values.

2: Do not display the cost fields.

4. Stocking Type

Specify which stocking type for the system to display. The system retrieves information about stocking types from the F4102 table.

This UDC (41/I) indicates how you stock an item (for example, as finished goods or as raw materials). These stocking types are hard-coded and you should not change them:

0: Phantom

B: Bulk floor stock

C: Configured item

E: Emergency/corrective maintenance

F: Feature

K: Kit or parent item

N: Nonstock item

The first character of Description 2 indicates whether the item is purchased (P) or manufactured (M).

16.7.4.2 Process

These processing options specify information such as the unit of measure, line types for stock and nonstock items, the blanket order type, and how the system calculates the requested date.

1. Transaction Unit of Measure

Specify the unit of measure for the system to use as the default for the Transaction Unit of Measure field. This unit of measure is associated with the quantity that is being purchased. Values are:

Blank: Use the Purchasing Unit of Measure.

1: Use the Primary Unit of Measure from the F4101 table.

To review the values for the Primary Unit of Measure and the Purchasing Unit of Measure, select the Weights and Measures tab on the Item Master Information form.

2. Stocked Line Type

Specify how the system processes lines on a transaction. The line type affects the systems with which the transaction interacts (JD Edwards EnterpriseOne General Ledger, JD Edwards EnterpriseOne Job Cost, JD Edwards EnterpriseOne Accounts Payable, JD Edwards EnterpriseOne Accounts Receivable from Oracle, and JD Edwards EnterpriseOne Inventory Management). The line type also specifies the conditions for including a line on reports and in calculations. Some examples of values, which have been defined on the Line Type Constants Revisions form, are:

S: Stock item.

J: Job cost, subcontracts, or purchasing to the general ledger.

B: General ledger account and item number.

N: Nonstock item.

F: Freight.

T: Text information.

M: Miscellaneous charges and credits.

W: Work order.

If you specify a line type for this processing option, the system uses the line type for purchase orders that the system creates for all items that are processed using this version.

Do not specify a line type for both this processing option and the next processing option (Line Type for Non-Stock) on the Process tab. If you do specify a line type for stock items and nonstock items, the system uses only the line type that you specify for this processing option (stock).

3. Non-Stocked Line Type

Specify how the system processes lines on a transaction. The line type affects the systems with which the transaction interacts (JD Edwards EnterpriseOne General Ledger, JD Edwards EnterpriseOne Job Cost, JD Edwards EnterpriseOne Accounts Payable, JD Edwards EnterpriseOne Accounts Receivable, and JD Edwards EnterpriseOne Inventory Management). The line type also specifies the conditions for including a line on reports and in calculations. Some examples of values, which have been defined on the Line Type Constants Revisions form, are:

S: Stock item.

J: Job cost, subcontracts, or purchasing to the general ledger.

B: General ledger account and item number.

N: Nonstock item.

F: Freight.

T: Text information.

M: Miscellaneous charges and credits.

W: Work order.

If you specify a line type for this processing option, the system uses the line type for purchase orders that the system creates for all items that are processed using this version.

Do not specify a line type for both this processing option and the previous processing option (Line Type for Stock) on the Process tab. If you do specify a line type for both stock items and nonstock items, the system uses only the line type that you specify for stock items.

4. Blanket Order Type for Release

Specify the order type that is associated with blanket purchase order processing. If you leave this processing option blank, the system does not perform automatic blanket order release processing.

5. Requested Date

Specify how to calculate the requested date. Values are:

Blank: Do not add lead time to the order date. If the requested date is blank, the system uses today's date.

1: Add lead time to the order date to produce the requested date.

The system retrieves lead time information from the F43090 table in the JD Edwards EnterpriseOne Inventory Management system.

16.7.4.3 Cross Ref

These processing options specify how the system processes cross-references to substitute and obsolete items.

1. Substitute items

Specify the default cross-reference code that the system uses to retrieve substitute items. The value that you enter is used as the default on the Substitute Item Search and Select form. The code that you enter must be a value in the UDC table (41/DT) for cross-reference codes.

To retrieve the substitute item, the system retrieves the cross-reference code for an item from the F4104 table.

If more than one substitute item exists, the system displays a check mark in the row header that is located in the detail area and in the Substitute Exists column.

2. Obsolete Items

Specify the cross-reference code that the system uses to retrieve item replacements for obsolete items. The system uses the value that you enter as the default on the Substitute Item Search and Select form.

The system activates the replacement process if these conditions are met:

- The item being replaced has a stocking type of O (obsolete) in the F4101 table.
- You have specified a cross-reference code for this processing option.

16.7.4.4 Sales Select

These processing options specify how the system displays and processes information for open orders.

1. Maximum Status

Specify the status that open sales order lines should not exceed when you review open orders.

If you specify a status for this processing option, the system displays only the orders for which the status is equal to or less than the status that you enter when you use the row exit for open orders.

2. Default Line Type

Specify how the system processes lines on a transaction. The line type affects the systems with which the transaction interacts (JD Edwards EnterpriseOne General Ledger, JD Edwards EnterpriseOne Job Cost, JD Edwards EnterpriseOne Accounts Payable, JD Edwards EnterpriseOne Accounts Receivable, and JD Edwards EnterpriseOne Inventory Management). The line type also specifies the conditions for including a line on reports and in calculations. Some examples of values, which have been defined on the Line Type Constants Revisions form, are:

S: Stock item.

J: Job cost, subcontracts, or purchasing to the general ledger.

B: General ledger account and item number.

N: Nonstock item.

F: Freight.

T: Text information.

M: Miscellaneous charges and credits.

If you complete this processing option, the system displays only the orders with a line type that is equal to the line type that you enter when you use the row exit for open orders.

3. Backorders

Specify whether to display back orders. Values are:

Blank Do not display backorders.

1: Display backorders. The system displays backorders when you use the selection from the Row menu for open orders.

16.7.4.5 Versions

These processing options specify the version for each application. If you leave any of these processing options blank, the system uses version ZJDE0001.

1. PO Entry Version (P4310)

Specify the version that the system uses when you access the Order Entry program (P4310).

Review the processing options for the version to ensure that the version meets the needs.

2. Blanket Order Release Version (P43060)

Specify the version that the system uses when you access the Blanket Order Release program (P43060).

Review the processing options for the version to ensure that the version meets the needs.

3. Open Sales Order (P4210)

Specify the version that the system uses when you access the Open Sales Order program (P4210).

Review the processing options for the version to ensure that the version meets the needs.

4. Supplier Analysis Version (P43230)

Specify the version that the system uses when you access the Supplier Analysis program (P43230).

Review the processing options for the version to ensure that the version meets the needs.

5. Supplier Master Version (P0401I)

Specify the version that the system uses when you access the Supplier Master program (P0401I).

Review the processing options for the version to ensure that the version meets the needs.

16.7.5 Generating Purchase Orders

Access the Work With Stocked Item Reorder Point form.

Suggested Order Quantity

Displays a value that is calculated by the P.O. Generator program, Buyer's Inquiry program, and Buying Guide report with these variables:

AVAL: Available inventory, as calculated from on-hand quantity less committed quantity plus quantity on PO, including quantity in receipt routing.

ROP: Reorder point, taken from the ROP in the branch inventory record of the primary storage location (assuming that the ROP is not missing); or the ROP as calculated (see the definition of ROPC for more information). The system calculates reorder point as in the following way:

$$\text{ROP} = (\text{Annual Sales} \times \text{Lead Time Days}) \div \text{Number of Days in Year} + \text{Safety Stock}$$

If Safety Stock is not stated on the Quantities form, then the system uses this formula:

$$\text{ROP} = ((\text{Annual Sales} \times \text{Lead Time Days}) \div \text{Number of Days in Year}) + \text{square root of } ((\text{Annual Sales} \times \text{Lead Time Days}) \div \text{Number of Days in Year})$$

EOQ: Economic order quantity (or reorder quantity ROQ), taken from the ROQ in the branch inventory record of the primary storage location (assuming that the ROQ is not missing); or the calculated EOQ (see the definition of EOQ for more information). The system calculates Economic Order Quantity in the following way:

$$\text{EOQ} = \text{Square root of } ((2 \times \text{Purchase Order Issue Cost} \times \text{Annual Sales}) \div (\text{Inventory Carrying Cost} \times \text{Average Cost}))$$

The calculation is:

- 1 If AVAL > ROP, then SOQ = Zero
- 2 If AVAL = ROP, then SOQ = EOQ
- 3 If AVAL < ROP, then SOQ = EOQ + (ROP – AVAL)

16.8 Working with the Stocked Item Reorder Point Batch Purchase Order Generator

This section provides overviews of the Stocked Item Reorder Point Batch Purchase Order Generator program (R437002) and the Suggested Reorder Stock Items program (P4371) and discusses how to:

- Run Stocked Item Reorder Point Batch Purchase Order Generator.
- Set processing options for Stocked Item Reorder Point Batch Purchase Order Generator (R437002).
- Set processing options for Suggested Reorder Stock Items (P4371).
- Work with suggestions for reordering items.

16.8.1 Understanding the Stocked Item Reorder Point Batch Purchase Order Generator Program (R437002)

Use the Stocked Item Reorder Point Batch Purchase Order Generator program (R437002) to generate purchase orders by using batch processing. You also can use this program to create a list of items that the system suggests for reordering. Three options are available for running this report:

- Final mode
 - The system automatically generates purchase orders.
- Proof mode
 - The system generates a report that contains a list of items that the system suggests for reordering. The system stores only the information in the F4371 table.

You can use the Suggested Reorder Stock Items program (P4371) to review the suggestions from the system and reorder items by creating purchase orders online.

16.8.2 Understanding the Suggested Reorder Stock Items Program (P4371)

After you run the Stocked Item Reorder Point Batch Purchase Order Generator program (R437002), you can use the Suggested Reorder Stock Items program (P4371) to:

- Review online the items that the system suggests that you reorder.
- Generate purchase orders automatically or interactively for items that you want to reorder.
- Release quantities from multiple blanket orders (if blanket orders exist).
- Select the items that you want to reorder.
- Change cost and quantity information for order detail lines.
- Purge the F4371 table.

Note: When you are finished working with suggestions for reordering items, the system gives the option of purging the records that are contained in the Suggested Reorder Stock Items table (F4371).

16.8.3 Forms Used to Work with the Stocked Item Reorder Point Batch Purchase Order Generator

Form Name	Form ID	Navigation	Usage
Work With Suggested Reorder Stock Items	W4371A	Order Generation/Approve/Release (G43A13), Suggested Reorder Stock Item	Work with suggestions for reordering items.
Suggested Reorder Stock Items Detail	W4371D	On the Work With Suggested Reorder Stock Items form, select the row that contains the item that you want to review, and then select Details from the Row menu.	Work with suggestions for reordering items.
Suppliers Selected for Order	W43032A	On the Work With Suggested Reorder Stock Items form, select the row that contains the item that you want to review, and then click the Select button.	Work with suggestions for reordering items.

16.8.4 Running Stocked Item Reorder Point Batch Purchase Order Generator

Select Order Generation/Approval/Release (G43A13), Print Stock Item Reorder Point.

16.8.5 Setting Processing Options for Stocked Item Reorder Point Batch Purchase Order Generator (R437002)

Processing options enable you to specify the default processing for programs and reports.

16.8.5.1 Display

This processing option specifies how the system displays information on the report.

1. Display Costs

Specify whether the system displays cost information. Values are:

Blank: The system displays cost information.

1: The system hides cost information.

16.8.5.2 Process

These processing options specify how the system processes information for the Stocked Item Reorder Point Batch Purchase Order Generator program (R437002).

1. Transaction Unit of Measure

Specify the unit of measure that the system uses as the default for the Transaction Unit of Measure field. This unit of measure is associated with the quantity that is being purchased. To review the values for the primary unit of measure and the purchasing unit, select the Weights and Measures tab on the Item Master Information form. Values are:

Blank: Use the purchasing unit of measure.

1: Use the primary unit of measure from the F4101 table.

2. Stocked Line Type

Specify a line type that the system uses to process lines in a transaction. The line type affects the systems with which the transaction interacts (JD Edwards EnterpriseOne General Ledger, JD Edwards EnterpriseOne Job Cost, JD Edwards EnterpriseOne Accounts Payable, JD Edwards EnterpriseOne Accounts Receivable, and JD Edwards EnterpriseOne Inventory Management). The line type also specifies the conditions for including a line on reports and in calculations. Do not specify a line type for both this processing option and the next processing option (Line Type for Non Stock) on the Process tab. If you do specify a line type for both stock type and nonstock type, the system uses only the line type that you specify for stock types. Values are:

S: Stock item.

J: Job cost, subcontracts, or purchasing to the general ledger.

B: General ledger account and item number.

N: Nonstock item.

F: Freight.

T: Text information.

M: Miscellaneous charges and credits.

W: Work order.

3. Non-Stocked Line Type

Specify a line type that the system uses to process lines in a transaction. The line type affects the systems with which the transaction interacts (JD Edwards EnterpriseOne

General Ledger, JD Edwards EnterpriseOne Job Cost, JD Edwards EnterpriseOne Accounts Payable, JD Edwards EnterpriseOne Accounts Receivable, and JD Edwards EnterpriseOne Inventory Management). The line type also specifies the conditions for including a line on reports and in calculations. Do not specify a line type for both this processing option and the next processing option (Line Type for Non Stock) on the Process tab. If you do specify a line type for both stock type and nonstock type, the system uses only the line type that you specify for stock types. Values are:

S: Stock item.

J: Job cost, subcontracts, or purchasing to the general ledger.

B: General ledger account and item number.

N: Nonstock item.

F: Freight.

T: Text information.

M: Miscellaneous charges and credits.

W: Work order.

4. Requested Date

Specify how the system calculates the requested date. Values are:

Blank: Do not add lead time. If you leave this processing option blank, the system uses today's date.

1: Add lead time to the order date to produce the requested date.

5. Proof Mode

Specify whether the system generates purchase orders in proof mode or final mode. Values are:

Blank: The system generates purchase orders in proof mode.

1: The system generates purchase orders in final mode.

2: The system generates purchase orders in proof mode and saves the records in a work file.

16.8.5.3 Blankets

These processing options specify how the system processes blanket orders.

1. Generate Order for Item with Multiple Blankets

Specify whether to generate a purchase order for an item that has multiple blanket orders without releasing any blanket orders. Values are:

Blank: Generate a purchase order for the item and do not release any blanket orders.

1: Do not generate a purchase order from an item that has multiple blanket orders, but display a message on the report indicating that a purchase order was not generated and the reason.

2. Blanket Order Type

Specify the type of document to create.

This code also indicates the original document type of the transaction.

Document types are UDCs (00/DT) that you set up. There are reserved document type codes for vouchers, invoices, receipts, and time sheets for which the system creates automatic offset entries during the post program. (These entries are not self-balancing

when you originally enter them.) These document types are predefined; do not change them:

P: Accounts Payable documents.

R: Accounts Receivable documents.

T: Payroll documents.

I: Inventory documents.

O: Purchase Order documents.

J: General Accounting and Joint Interest Billing documents.

S: Sales Order documents.

16.8.5.4 Versions

This processing option specifies the version of the Order Entry Version (P4310) that the system uses.

1. Purchase Order Entry Version (P4310)

Enter the version of the Order Entry program (P4310) that the system uses. If you leave this processing option blank, the system uses ZJDE0001.

16.8.6 Setting Processing Options for Suggested Reorder Stock Items (P4371)

Processing options enable you to specify the default processing for programs and reports.

16.8.6.1 Default

These processing options enable you to enter default information that the system uses for processing.

1. Protect Cost Fields

Specify whether the system allows modifications to cost fields. Values are:

Blank: The system allows modifications to cost fields.

1: The system does not allow modifications to cost fields.

2. Costs

Specify whether to display the cost fields.

Blank: Display all cost fields.

1: Hide cost fields.

3. Protect Quantity Fields

Specify whether the system allows modifications to quantity fields. Values are:

Blank: The system allows modifications to quantity fields.

1: The system does not allow modifications to quantity fields.

4. Blanket Order Type

Specify the order type for blanket orders.

16.8.6.2 Versions

These processing options specify which version of various programs the system uses.

1. Enter Purchase Orders (P4310)

Specify the version that the system uses when you use the Enter Purchase Orders program.

2. Release Blanket Orders Version (P43060)

Specify the version that the system uses when you use the Release Blanket Orders program.

16.8.7 Working with Suggestions for Reordering Items

Access the Work With Suggested Reorder Stock Items form.

Processing Approvals

This chapter contains the following topics:

- [Section 17.1, "Understanding Approval Processing"](#)
- [Section 17.2, "Working with Approval Routes"](#)
- [Section 17.3, "Working with Orders Awaiting Approval"](#)
- [Section 17.4, "Approving or Rejecting Orders"](#)
- [Section 17.5, "Setting Up Field Constants for Approval Processing"](#)

17.1 Understanding Approval Processing

The company might require you to obtain approval for the items or services that you purchase. After you enter a purchase order, subcontract order, requisition, or blanket order, and so on, you can require that the proper authorities approve the order before the system processes it. This approval eliminates the unauthorized purchase of items.

The orders that you enter might require approval from different persons, based on the department in which you work or the amount of purchases that you want to make. You must set up approval routes to specify the persons responsible for approving orders. You can then assign those routes to orders.

If you originate orders, you can check the current status of an order. The status indicates the person from whom the order is awaiting approval and the persons who have already approved the order. You will receive a message when an order is fully approved or rejected.

If you are responsible for approving orders, you can review all orders awaiting approval and select orders to approve or reject. You can provide explanations for approving or rejecting an order.

If the originator is also an approver, then the order goes for approvals to the approver who is above the originator irrespective of the originator's position in the route or the amount of the order. However, the amount of the order should at least exceed the approval limit of the first approver.

When you set up the purchasing cycle, you must determine which order types (purchase orders, subcontract orders, requisitions, and so forth) require approval. For each order type, you must set up order activity rules to include the approval process.

The system maintains historical information about order approvals in the F4209 table.

See [Setting Up Order Activity Rules](#).

17.1.1 Mobile Applications for Approving Purchase Orders (Release 9.1 Update)

The following mobile applications are available, and can be used to approve purchase orders on a mobile device:

- Purchase Order Approval (Smartphone and Tablet)

These applications require system administrator configuration before they are available to individual users. Contact your system administrator to determine whether these applications are available for use.

Additionally, see the following topic in the JD Edwards EnterpriseOne Applications Mobile Enterprise Applications Implementation Guide:

- Purchase Order Approval Mobile Applications

17.2 Working with Approval Routes

This section provides an overview of approval routes, lists prerequisites, and discusses how to:

- Set processing options for Approval Level Revisions (P43008).
- Create an approval route.
- Transfer approval authority.

17.2.1 Understanding Approval Routes

The company might require you to obtain approval for the items and services that you want to purchase. You can create approval routes and assign them to orders to ensure that the appropriate personnel authorize purchases.

The persons who must approve orders might differ based on the department in which you work, the items you are purchasing, and so forth. You can create multiple approval routes, each of which consists of a different group of persons. Each route must be specific to a particular type of order, such as purchase orders, subcontract orders, requisitions, and so forth. If a person assigned to multiple approval routes leaves the company or goes on vacation, you can transfer approval authority to another person.

After you create an approval route, you can assign it to an order. The system does not allow further processing of the order until it is fully approved.

17.2.1.1 Approval Route Creation

You must set up approval routes to specify the persons who are responsible for approving an order. After you assign an approval route to an order, the system does not process the order until the persons on the route approve the order, which ensures that all purchases are authorized by the appropriate personnel.

The persons responsible for approving each order might differ based on the department in which you work, the items that you want to purchase, and so on. You can create multiple approval routes, each of which contains a different group of persons.

Depending on the cost of the items or services that you want to purchase, you might need to obtain approval for an order from several persons. For each person that you enter on an approval route, you must specify the amount that an order must exceed to require that person's approval. You must enter persons in ascending order by amount. For example, here are the approvers for approval route A:

Approval Amount	Responsible Person
100	Dwight Akin
1,000	Ray Allen
5,000	Dominique Abbot

Using approval route A, if the order total is:

- Less than 100.00, the system automatically approves it.
- 100.00 or more, Dwight Akin must approve it.
- 1,000.00 or more, Dwight Akin and Ray Allen must approve it.
- 5,000.00 or more, all three persons must approve it.

If you change the approval amount for a person, pending approvals are not affected.

You can bypass persons on an approval route. For example, using the same example, Dominique Abbot can approve any order before Dwight Akin or Ray Allen and bypass them in the approval process.

You might want to assign the same approval amount to multiple persons so that if one is not available to approve an order, another is available who can. Only the first person on the approval route with the lowest address book number will receive a message that an order is awaiting approval, although any of the persons can approve the order. The same person cannot appear more than once in a table.

You might want to assign a budget approver to an approval route to release orders on hold due to exceeding the budget. The budget approver must approve the order and release the hold before other persons on the approval route can approve the order. If an order is not on budget hold, it skips the budget approver and goes to the first person on the route.

You must assign a unique name to each approval route that you enter. You must also specify the type of order to which the route applies (for example, purchase orders, subcontract orders, requisitions, blanket orders, and so on).

The system uses electronic mail messages to notify each applicable person and an approval route that an order is awaiting approval. Persons are notified in the order that their name appears on the route.

If you delete or add a person on an approval route, the system redirects pending approvals to the appropriate person but does not resend electronic mail messages.

17.2.1.2 Approval Route Assignment

After you create an approval route, you can assign it to an order to ensure that the order obtains approval from the appropriate persons. The system allows no further processing of the order until it is fully approved.

You must assign an approval route to an order before you enter the order. You use processing options to enter a specific approval route or to specify the location from which the system retrieves an approval route. You can specify these locations:

- The user profile for the person entering the order.
- The address book record for the person entering the order.
- Branch/plant constants.
- Default locations and printers.

If you specify the user profile or address book location, the system uses the identification number or the address book number of the user for the approval route. In this case, you must create a separate route for each user. You might want to use this method if each user requires a unique approval route.

If most of the orders that are generated in a branch/plant require approval from the same persons, you might retrieve an approval route from branch/plant constants. You can also assign a primary approval route to each user as you enter default location and printer information.

Approval routes are applicable at the order level, not at the detail level. For example, all items and services on an order must be approved before the system processes the order. After you enter an order, you cannot change its assigned approval route.

17.2.1.3 Transfer of Authority

You must create approval routes to specify the persons responsible for approving an order. You might include a specific person on several approval routes if the person is responsible for approving all orders that exceed a specific amount.

You can transfer approval authority from one person to another. You might do this if a person leaves the company or takes an extended vacation. When you transfer approval authority, the system permanently changes all approval routes on which the person currently exists.

You should not transfer authority from one person on a route to another person who is lower on the route. However, when you transfer authority from one person on a route to a person who has just been added to the route, the system redirects pending approvals to the new individual, but does not resend electronic mail messages.

17.2.2 Prerequisites

Before you create approval routes:

- Verify that each person you enter on an approval route has both a user ID and an address book number.
- Determine the approvers and their approval authority for each route.
- Include approval processing in the order activity rules for applicable order types.
- Assign the approval route to the branch/plant.

17.2.3 Forms Used to Work with Approval Routes

Form Name	Form ID	Navigation	Usage
Work With Approval Level Revisions	W43008A	Order Generation/Approve/Release (G43A13), Approval Level Revisions Order Generation/Approve/Release (G43D13), Approval Level Revisions	Create an approval route.

Form Name	Form ID	Navigation	Usage
Approval Level Revisions	W43008C	Click the Add button on the Work With Approval Level Revisions form.	Create an approval route. Add or modify approval levels.
Work With Approval Delegation	W43280A	Order Generation/Approve/Release (G43A13), Approval Delegation Order Generation/Approve/Release (G43D13), Approval Delegation	Transfer approval authority. Work with approval delegation.
Approval Delegation	W43280C	Select an approver and a route on the Work With Approval Delegation form, and then click the Select button.	Transfer approval authority.

17.2.4 Setting Processing Options for Approval Level Revisions (P43008)

Processing options enable you to specify the default processing for programs and reports.

17.2.4.1 Defaults

1. Order Type

Enter a code that identifies the type of order, for example, **SO** for sales orders.

17.2.5 Creating an Approval Route

Access the Approval Level Revisions form.

From Amount

Enter a number that indicates the lower end of the range of amounts for which this approver is responsible when approving orders. The message *Budget* indicates that this approver is the budget approver.

Responsible

Enter text that names or describes an address. This 40-character alphabetic field appears on a number of forms and reports. You can enter dashes, commas, and other special characters, but the system cannot search on them when you use this field to search for a name.

17.2.6 Transferring Approval Authority

Access the Work With Approval Delegation form.

Review all approval routes to which the person from whom you are transferring authority (the approver) is currently assigned, and then select a route for which to delegate authority. On Approval Delegation, specify the individual to whom you are now delegating authority.

17.3 Working with Orders Awaiting Approval

This section provides an overview of approval messages and orders awaiting approval and discusses how to:

- Review approval messages for orders.
- Set processing options for Purchase Order Approvals (P43081).
- Review orders awaiting approval.

17.3.1 Understanding Approval Messages and Orders Awaiting Approval

You can locate all orders that await the approval and select orders to review for approval or rejection. You must approve an order to authorize the purchase of items and services. You can reject an order if you disapprove of the purchases.

When you approve an order, the system either updates the order to an approved status or sends the order to the next person on the approval route. If you reject an order, the system returns a rejection message to the originator of the order and allows no further processing of the order.

If you originate orders, you can review the status of all of the orders (approved, rejected, pending). If an order has been rejected, you can amend the order to resubmit it for approval. If an order is pending, you can identify the next person responsible for approving the order and verify that the person is available to approve the order.

The system notifies you by electronic mail when a specific order requires the approval. The system also notifies you if an order that you originated has been approved or rejected.

17.3.1.1 Approval Messages for Orders

After you enter an order with an assigned approval route, the system notifies those persons responsible for approving the order. The system notifies the first person on the approval route by electronic mail that the order requires approval. If the person approves the order, the system performs one of the following actions:

- Sends a message to the next person responsible for approving the order.
- Updates the order to an approved status (if no other approvals are necessary) and sends an approval message to the order originator.

If a person rejects the order, the system returns a rejection message to the originator. If the originator amends the order, the system restarts the approval process.

You can use electronic mail messaging (email) for the approval process even if you do not use the JD Edwards EnterpriseOne Electronic Mail system from Oracle on a company-wide basis. You can access the messages from the email form that is set up specifically for approval processing or from any email form on which you have a mailbox. If you use the approval processing email form, processing options enable you to determine which mailboxes appear on the form. This diagram illustrates approval processing:

Figure 17-1 Approval Route process

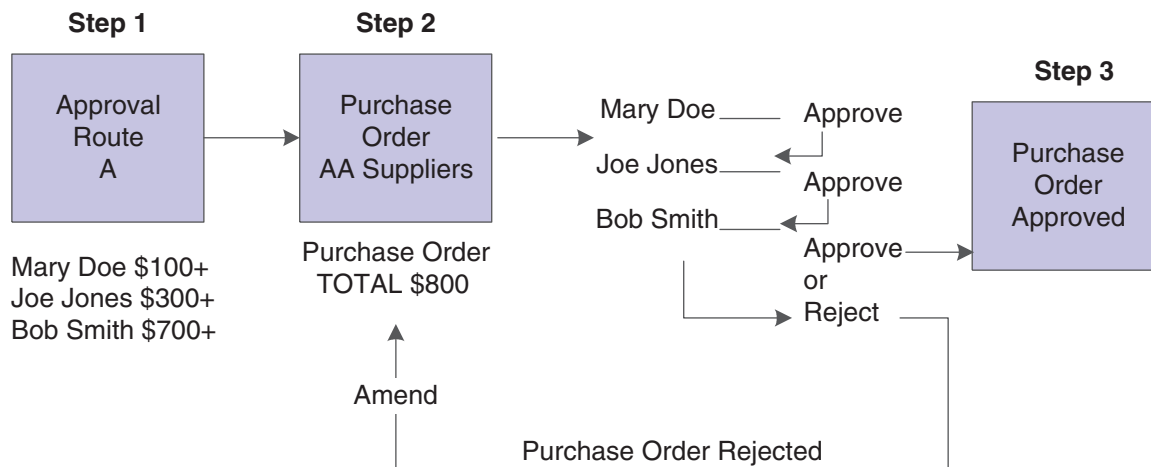

17.3.1.2 Orders Awaiting Approval

You can locate all orders that await approval and select individual orders to review for approval or rejection. You can also locate all orders that you originated to review the status of each, such as approved, rejected, or pending.

You locate orders based on the address book number. You can also locate orders based on the age of the order to identify orders that require immediate attention. If you originate orders, you can specify that only approved or rejected orders appear.

You can access an order's status summary to identify who is responsible for approving the order and to review a history of the actions that have occurred to that order. You can identify those persons who have:

- Approved the order.
- Not yet approved the order.
- Rejected the order.
- Been bypassed in the approval process by a person with a higher level of authority.

To review a status summary for an order on budget hold, you must specify the budget hold code in the processing options for the Purchase Order Approvals program (P43081).

17.3.2 Forms Used to Work with Orders Awaiting Approval

Form Name	Form ID	Navigation	Usage
Work With Orders Awaiting Approval	W43081A	Order Generation/Approve/Release (G43A13), Orders Awaiting Approval	Review orders awaiting approval. Work with orders awaiting approval.
		Order Generation/Approve/Release (G43D13), Orders Awaiting Approval	

Form Name	Form ID	Navigation	Usage
Work With Approval Status Summary	W43081C	Select an order on the Work With Orders Awaiting Approval form, and then select Status Summary from the Row menu.	View the current status of an order.

17.3.3 Reviewing Approval Messages for Orders

Select Order Generation/Approve/Release (G43A13), Review Approval Notification.

Alternatively, select Order Generation/Approve/Release (G43D13), Review Approval Notification.

17.3.4 Setting Processing Options for Purchase Order Approvals (P43081)

Processing options enable you to specify the default processing for programs and reports.

17.3.4.1 Process

These processing options specify how the system processes approval information.

1. Awaiting Approval Status

Enter a value from UDC 40/AT that specifies the next standard step that is in the processing cycle for this order type. You set up the steps for the processing cycle on the Order Activity Rules form.

2. Approved Status

Enter a value from UDC 40/AT that indicates the next step in the order flow of the line type.

3. Rejected Status

Enter a value from UDC 40/AT that indicates the last step that this order line has successfully completed in the processing cycle.

4. Budget Hold Code

Enter a value from UDC 42/HC that identifies why an order is on budget hold.

5. Approvals Hold Code

Enter a value from UDC 42/HC that identifies why an order is on hold.

17.3.4.2 Defaults

These processing options specify default values that the system uses during approval processing.

1. Order Type

Enter a value from UDC 00/DT that identifies the type of document. This code also indicates the origin of the transaction. Document type codes exist for vouchers, invoices, receipts, and time sheets, which create automatic offset entries during the post program. (These entries are not self-balancing when you originally enter them.) Do not change these document types:

P: Accounts Payable documents.

R: Accounts Receivable documents.

T: Payroll documents.

I: Inventory documents.

O: Purchase order processing documents.

J: General Accounting/Joint Interest Billing documents.

S: Sales order processing documents.

2. Enter '1' to protect address number from input

Enter a code that enables you to prevent other users from entering or changing the address number.

17.3.4.3 Versions

These processing options specify alternate versions of programs that the system uses during approval processing.

1. Order Entry (P4310)

Enter an alternate version of the Order Entry program.

2. Budget Comparison (P09210)

Enter an alternate version of the Budget Comparison program.

3. Release Held Orders (P43070)

Enter an alternate version of the Release Held Orders program.

4. Open Order Inquiry (P4310)

Enter an alternate version of the Open Order Inquiry program.

17.3.5 Reviewing Orders Awaiting Approval

Access the Work With Orders Awaiting Approval form.

Orders older than days

Enter a number that indicates the age of an order and limits the quantity of orders that the system displays.

The age of an order is the difference (in days) between the order date and today's date. The system displays only orders that are as old as or older than the number of days that you enter.

For example, assume today is May 15. These orders exist:

May 15 - Order # 104

May 14 - Order # 103

May 13 - Order # 102

If you leave this field blank, the system displays all orders. If you enter 1 in this field, the system displays only orders 103 and 102.

Waiting more than days

Enter a number that indicates the quantity of days that an order has been awaiting approval and limits the quantity of orders that the system displays.

If you enter a number in this field, the system displays only those orders that have been awaiting approval for at least the number of days that you specify.

Approval action occurs when one of these events takes place:

- An order is entered (originated).
- The order is approved.
- The order is rejected.
- The order is amended.

Queued for Approval

Displays the status of the order. The approval action determines whether an order is:

- Queued for approval - Display orders that require approval.
This selection is used by an approver inquiring on orders that require approval.
- Waiting approval - Display orders not yet approved.
This selection is used for the originator of the order inquiring on its status.
- Approved - Display orders that have been approved.
This selection is used by the originator of the order inquiring on its status.
- Rejected - Display orders that have been rejected.
This selection is used by the originator of the order inquiring on its status.

17.4 Approving or Rejecting Orders

This section provides an overview of order approval and rejection, lists a prerequisite, and lists the forms used to approve or reject orders.

17.4.1 Understanding Order Approval and Rejection

You must approve an order to authorize the purchase of items and services. After you approve all detail lines on an order, the system processes the order. You can reject detail lines on an order if you do not want the system to process the order. You can also provide explanations for rejecting detail lines.

If you enter the final approval for an order or if you reject an order, the system sends a message to the originator of the order. The originator can amend a rejected order, in which case the system resubmits the order to you for approval. You can identify an amended detail line by the carat (>) that appears next to the line.

You can use several methods to provide explanations for rejections. You can:

- Define up to eight different categories that represent a specific rejection explanation.
- Enter a brief remark for the entire order.
- Enter a brief remark for each detail line.
- Enter unlimited text for the order.
- Enter unlimited text for a detail line.

If you are a budget approver, you must approve and release orders that are on budget hold using the Approval Review program (P43081) before the system can further process the orders.

Once the budget approver has approved the order, it is sent to the approver directly above the budget approver on the approval route, regardless of the purchase order amount.

Note: Budget Approver and Money Approver are two different roles. It is not recommended to have the same person responsible for both roles.

17.4.2 Prerequisite

Create definitions and column headings for the applicable UDCs on the Approval/Rejections Reasons form.

17.4.3 Forms Used to Approve or Reject Orders

Form Name	Form ID	Navigation	Usage
Work With Orders Awaiting Approval	W43081A	Order Generation/Approve /Release (G43A13), Approval Review Order Generation/Approve /Release (G43D13), Approval Review	Work with orders awaiting approval.
Purchase Order Requisition Approval	W43081B	Select an order on the Work With Orders Awaiting Approval form, and then select Approval Review from the Row menu.	Approve or reject an order.

17.5 Setting Up Field Constants for Approval Processing

This section provides an overview of field constants for approval processing, lists a prerequisite, and discusses how to set up field constants for approval processing.

17.5.1 Understanding Field Constants for Approval Processing

After an order detail line has gone through the approval process and has been approved, you might need to create a mechanism for requiring reapproval if changes are made to the order detail line after it has reached an approved status. Provided that you have been granted the appropriate authority by the system administrator, you can use the Approvals Fields Constants program (P43080) to specify which fields that you use during approval processing trigger a reapproval to all open order lines if changes are made to any order detail lines that have an approved status. You can indicate which fields do and do not trigger reapprovals by activating and deactivating the appropriate fields.

The fields that you can activate and deactivate are contained in the F4311 and F43080 tables.

The reapproval functionality is no longer associated with the Override Next Status processing option in the Purchase Order Entry program (P4310). If you have specified an override next status and are using approval processing, note that unexpected results may occur; verify that the override next status is correct for the business process.

17.5.2 Prerequisite

Ensure that you have activated approval processing by setting the appropriate processing options on the Approvals tab in the Purchase Orders program (P4310).

17.5.3 Form Used to Set Up Field Constants for Approval Processing

Form Name	Form ID	Navigation	Usage
Approvals Critical Fields	W43080A	Procurement System Setup (G43A41), Approval Critical Fields	Set up field constants for approval processing. Approve critical fields.

17.5.4 Setting Up Field Constants for Approval Processing

Access the Approvals Critical Fields form.

Show All

Specify whether the system displays a particular field in the detail area. If you select this option, the system displays the corresponding field.

Show Selected

Specify whether the system displays a particular field in the detail area. If you select this option, the system displays the corresponding field.

Show Unselected

Specify whether the system displays a particular field in the detail area. If you select this option, the system displays the corresponding field.

This chapter contains the following topics:

- [Section 18.1, "Understanding Receipt Routing"](#)
- [Section 18.2, "Creating Receipt Routes"](#)
- [Section 18.3, "Defining Payment Eligibility for Item Removal"](#)
- [Section 18.4, "Activating Receipt Routing"](#)
- [Section 18.5, "Defining Sample Requirements and Item Specifications"](#)
- [Section 18.6, "Working with Items in a Receipt Route"](#)
- [Section 18.7, "Removing Items from a Receipt Route"](#)
- [Section 18.8, "Reviewing the History of Items in a Receipt Route"](#)

18.1 Understanding Receipt Routing

You might want to track items from the moment that they leave a supplier's warehouse until they arrive in stock. Depending on the operation, several stops might exist between the two points, such as the dock, the staging area, inspection, and so forth.

You use receipt routing to track and move items through a series of operations that make up a receipt route.

You must define the operations that make up each receipt route. You must also determine the logistical and accounting updates that the system performs as you process items through a receipt route. After you create a receipt route, you can assign it to an item based on the supplier who provides the item. This diagram illustrates a typical receipt route:

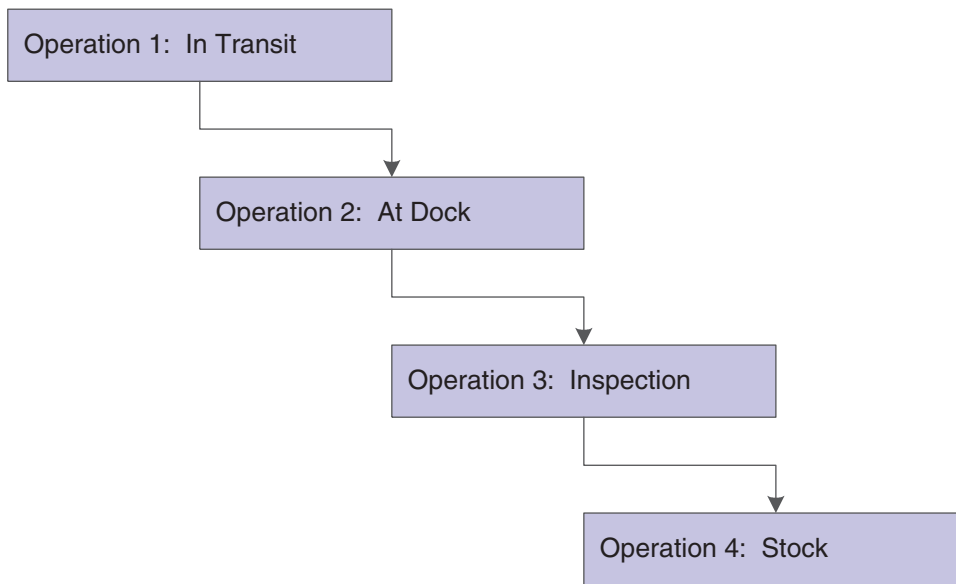
Figure 18–1 Example of a receipt route

Each time you enter a receipt for items, the system enters the items in the first operation of the receipt route. You must enter the items in subsequent operations of the receipt route. During each operation, you can:

- Remove items from the route due to returns, rejects, and so forth.
- Have the system automatically generate replacement orders for items that you return.

18.2 Creating Receipt Routes

This section provides overviews of definition of operations and journal entry creation for items in receipt routes, lists prerequisites, and discusses how to create a receipt route.

18.2.1 Understanding Definition of Operations

You can monitor items from the moment that they leave a supplier's warehouse. You create receipt routes to determine the series of operations through which you process items until the items become part of the inventory.

You must define the operations that make up each receipt route. You must also determine the updates that occur as you transfer items to each operation. For example, you specify the operation at which items become on-hand inventory. When you enter items at the on-hand operation, the system creates journal entries to reflect the items in inventory, and you can create a voucher to pay for the items.

You can direct the system to create journal entries each time you transfer items to and from an operation in a receipt route. You do this so that the value of the items at each operation appears in the general ledger. For example, you might want the general ledger to reflect the value of items currently at the dock.

When you create a receipt route, you must indicate whether to pay for items that you remove (disposition) from the route based on the reason that you remove them. For example, you might want to pay for items that you rework but not for pay items that you return.

A receipt route is a series of operations through which you process items upon receipt. These operations might include:

- Transit
- Dock
- Staging area
- Inspection
- Stock

To create a receipt route, you must define the series of operations that make up the route. For example, you can create a receipt route that is made up of two operations, staging area and stock and another receipt route that is made up of three operations—staging area, inspection, and stock.

You determine the updates that the system performs as you process items through a receipt route by specifying at which operation:

- Items are available to promise.
- Items are received for supplier performance purposes.
- Items are at an on-hand status.

Each update field on the Work With Receipts Routing Codes form represents a field in the F41021 table. The system maintains balances of inventory items in this table. You can have the system update the availability of an item at any operation in a receipt route. For example, you might want the ability to promise items to customers (enter sales orders) when the items arrive at the dock instead of waiting until the items are in stock.

You access the Item Availability Definition form from the Branch/Plant Constants form to indicate which fields the system uses to calculate item availability. For example, you can specify that the system add the balance in the Update Transit Quantity field to the current on-hand balance to calculate availability.

You must specify at which operation the system records the receipt date for items. For example, you can specify that the system record the receipt date when items arrive at the dock. The system compares the receipt date to the date that the supplier promised to deliver the items to determine supplier performance.

You must specify at which operation the item is eligible for payment. When you transfer items to the payment eligible operation, the system creates journal entries to reflect a liability for the items and you can create a voucher to pay for the items. The system also updates:

- Item costs.
- Landed costs.
- Cost variances.
- Item transaction histories (Cardex).

18.2.2 Understanding Journal Entry Creation for Items in Receipt Routes

You determine when the system creates journal entries for items in a receipt route so that the value of the item is reflected in the general ledger. The system automatically creates journal entries when you enter items at the operation at which they are eligible for payment and at the last operation in the route.

You can direct the system to create journal entries each time you transfer items to and from a certain operation in a receipt route so that the general ledger reflects the value of items at each operation. For example, you might want the general ledger to reflect the value of all items that are at the dock.

You must enter a general ledger category for each operation at which the system creates journal entries (unless the system creates entries at the last operation only). The general ledger category directs the system to retrieve an account number from the Routing Operation automatic accounting instruction (AAI) table for which to:

- Debit the value of items that you transfer to the operation.
- Credit the value of items that you transfer from the operation.

You can have the system create journal entries at an operation that precedes the payment-eligible operation. For example, you might want the general ledger to reflect the value of items at the dock even though you do not pay for the items until they are in stock. To account for items that are not yet payment-eligible, the system:

- Debits a routing operation account (to reflect items at the operation).
- Credits a prior to receipts/completions liability account (to reflect a preliminary liability for the items).

When you enter items at the payment-eligible operation, the system credits a received not vouchered account to reflect the liability. The system debits:

- An inventory account (if the payment-eligible operation is also the last operation in the route and no prior journal entries exist).
- A prior to receipts/completions liability account (if this account was credited prior to the payment-eligible operation).
- A routing operation account (if the payment-eligible operation is the first operation at which the system creates journal entries).

When you enter items at the last operation in a receipt route, the system debits an inventory account to reflect the value of the items in stock. The system credits:

- A received not voucher account (if the last operation is also the payment-eligible operation and no prior journal entries exist).
- A routing operation account (if items were previously debited to another operation).

After you create a voucher for items in a receipt route, you cannot transfer the items back to an operation that precedes the payment-eligible operation. For example, a receipt route has a dock, inspection, and stock operation. Inspection is the operation at which items are payment-eligible. After you create a voucher, you cannot transfer the items back to the dock unless you reverse the voucher.

After you enter items in the operation at which they are eligible for payment, you can create a voucher to pay for the items. The system creates an offsetting entry for the received not vouchered account when you create a voucher. When you post that entry to the general ledger, the system credits the accounts payable trade account.

See Also:

- [Reviewing and Posting Journal Entries for Voucher Transactions.](#)

18.2.3 Prerequisites

Before creating receipt routes, you must:

- Set up receipt route codes in user-defined code (UDC) table 43/RC.
- Set up operation codes in UDC table 43/OC.

18.2.4 Forms Used to Create Receipt Routes

Form Name	Form ID	Navigation	Usage
Work With Receipts Routing Codes	W43091B	Receipt Routing (G43A14), Receipt Routing Definition	Create a receipt route. Work with receipts routing codes.
Receipt Routing Definition	W43091D	Click the Add button on the Work With Receipts Routing Codes form.	Define operations in a receipt route.

18.2.5 Creating a Receipt Route

Access the Work With Receipts Routing Codes form.

Route Code

Enter a value from UDC 43/RC that identifies a route on a receipt route. Each receipt route consists of a series of operations through which the system directs items upon receipt.

Oper Seq (operation sequence)

Enter the sequence in which the system performs the operations or steps of the route.

Oper Code (operation code)

Enter a value from UDC 43/OC that represents an operation or step within the receipt route.

Update Transit

Enter a value that indicates whether to update the Quantity in Transit field in the F41021 table as soon as a quantity moves into this operation.

You can enter **Y** only once in this column for a route code.

Update Insp (update inspection)

Enter a value that indicates whether to update the Quantity in Inspection field in the F41021 table as soon as a quantity moves into this operation.

You can enter **Y** only once in this column for each route.

Update Op 1 (update operation 1) and Update Op 2 (update operation 2)

Enter a value that indicates whether to update the Quantity in Operation 1 field in the F41021 table as soon as a quantity moves into this operation.

You can enter **Y** in this column only once for each route code.

Update O/H (update on hand)

Enter a value that indicates whether to update the Quantity on Hand field in the F41021 table as soon as a quantity moves into this operation.

You can enter **Y** in the last operation only.

Rec (receipt acknowledgement)

Enter a code that determines at which operation the system records the receipt date for items in the receipt route. Based on the receipt date, the system calculates supplier

performance information such as lead-time days for an item and on-time deliveries. You can enter **Y** in this column only once for each route.

Pay (payment eligible)

Indicates at which operation the goods are eligible for payment. The system automatically updates the Pay (payment eligible) field for the same operation at which you update the on-hand balance. When quantity is moved to this operation, the system updates the open quantity and open amount in the Purchase Order Receiver File table (F43121) so that they can be vouchered in the Voucher Match program. The system uses this field to determine whether the quantity is eligible for payment when the quantity is dispositioned out of the routing process. Each quantity disposition has its own setup. This must be the last operation in the route. You can enter a sequence number if the order in which you want the operations to occur differs from the order in which you enter the operations.

Note: You can enter **Y** in this column only once for each route.

18.3 Defining Payment Eligibility for Item Removal

This section provides an overview of item removal and lists the forms used to define payment eligibility for item removal.

18.3.1 Understanding Item Removal

As you process items through a receipt route, you might need to return, rework, scrap, reject, or adjust items. When you create a receipt route, you must indicate whether to pay for items that you remove (disposition) from the route based on the reason that you remove them. For example, you might want to pay for items that you rework, but not pay for items that you return.

You must specify the removal categories (returns, reworks, scrap, rejects, or adjustments) for which items are payable. For example, if you specify that the scrap category is payable, the system determines that you must pay for items that you classify as scrap.

If items that you remove from a receipt route are payable, the system creates journal entries to reflect a liability for the items. The system credits a received not vouchered account and debits a disposition account based on the general ledger category that you specify for the removal category.

18.3.2 Forms Used to Define Payment Eligibility for Item Removal

Form Name	Form ID	Navigation	Usage
Work With Receipts Routing Codes	W43091B	Receipt Routing (G43A14), Receipt Routing Definition	Work with receipts routing codes.
Receipt Routing Definition	W43091D	Select a receipt route on the Work With Receipts Routing Codes form, and then click the Select button.	Define payment eligibility for item removal. Review and modify a receipt routing definition.

Form Name	Form ID	Navigation	Usage
Routing Disposition Setup	W43DAC	Select Disposition Setup from the Form menu on the Receipt Routing Definition form.	Define payment eligibility for item removal.

18.4 Activating Receipt Routing

This section provides an overview of receipt routing activation, lists a prerequisite, and discusses how to assign receipt routes to items.

18.4.1 Understanding Receipt Routing Activation

Receipt routing enables you to monitor the status of the items that you receive and determine when the items will be available to distribute. To activate receipt routing, you must:

- Assign receipt routes to items.
- Initiate receipt routing.

You must assign a receipt route to an item to determine the operations through which the system processes the item upon receipt, such as transit, staging, inspection, stock, and so forth. You must then activate receipt routing to process items through receipt routes.

You can assign both a standard receipt route and an alternate receipt route to an item. Upon receipt, the system enters an item in its standard receipt route unless you have also specified an alternate receipt route. An alternate route is one that the system sends an item through intermittently. For example, you can assign an alternate route to an item so that every fifth shipment that you receive is inspected.

You must assign an alternate receipt route to an item to have the system process the item through a different series of operations based on a number of days or a number of receipts. For example, you can assign an alternate route to an item to have every fifth shipment of the item go through an inspection operation. You must assign receipt routes to an item based on the supplier who provides the item.

You can specify the quantity or percentage of items that must be received to enter an item in its alternate route. You can also define sampling requirements and item specifications for inspection purposes.

You use processing options for the receipts entry program to initiate the receipt routing process. After you initiate receipt routing, the system enters an item into its assigned receipt route when you enter a receipt.

See Also:

- [Setting Processing Options for Supplier/Item Relationships \(P43090\)](#).

18.4.2 Prerequisite

Create receipt routes.

18.4.3 Forms Used to Activate Receipt Routing

Form Name	Form ID	Navigation	Usage
Work With Supplier/Item Relationships	W43090A	Receipt Routing (G43A14), Routing/Analysis Revisions	Locate and review receipt routes for items.
Supplier/Item Relationships	W43090B	Select an item on the Work With Supplier/Item Relationships form, and then click the Select button.	Assign receipt routes to items.

18.4.4 Assigning Receipt Routes to Items

Access the Supplier/Item Relationships form.

Normal Route Code

Enter a value from UDC 43/RC that identifies a receipt route. Each receipt route consists of a series of operations through which the system directs items upon receipt.

Alt Route Code (alternate route code)

Enter a value from UDC 43/RC that identifies an alternate receipt route. Each receipt route consists of a series of operations through which the system directs items upon receipt.

An item can have a normal receipt route and an alternate receipt route. The system directs an item through the alternate receipt route intermittently based on the number of days or number of receipts that you specify.

Route Type Code

Enter a code that qualifies the routing for an item and supplier combination.

Frequency Days

Enter a number that determines how often the system directs an item to the alternate receipt route, based on days. For example, you enter 3 in this field. If January 1 was the last date for the alternate receipt route, the system directs the next receipt performed on or after January 4 to the alternate receipt route.

Frequency Number

Enter a number that determines how often the system directs an item to the alternate receipt route, based on receipts. For example, if you enter 5 in this field, the system directs every fifth receipt of the item to the alternate receipt route.

18.5 Defining Sample Requirements and Item Specifications

This section provides an overview of sample requirements and item specifications, lists a prerequisite, and discusses how to define sample requirements and item specifications.

18.5.1 Understanding Sample Requirements and Item Specifications

You might assign an alternate receipt route to an item to have the item inspected intermittently. After you assign an alternate route to an item, you can specify the quantity of the item that must be received before the system processes the item

through its alternate route. You can also specify sample requirements for inspection purposes, including:

- The quantity or percentage of receipt items to use for inspection.
- The quantity or percentage of the sample size that must pass inspection before the receipt is considered acceptable.

After you enter sample requirements for an item, you can add specifications or any other text that applies to the item. Sample requirements and item specifications are for informational purposes only. You can review this information when you move or remove items in a receipt route.

18.5.2 Prerequisite

Assign an alternate route to the item for which you want to define sample requirements and specifications.

18.5.3 Forms Used to Define Sample Requirements and Item Specifications

Form Name	Form ID	Navigation	Usage
Work With Sample Size Tables	W43093B	Receipt Routing (G43A14), Inspection/Sample Size Table	Locate and review sample requirements and item specifications.
Inspection/Sample Size Table	W43093A	Click the Add button on the Work With Sample Size Tables form.	Define sample requirements and item specifications.

18.5.4 Defining Sample Requirements and Item Specifications

Access the Inspection/Sample Size Table form.

From Quantity

Enter the quantity of the item that you must receive before the system sends the item through the test receipt route.

Sample Quantity

Enter the number of units that should be inspected through receipt routing based on the units received.

Sample Percentage

Enter the percentage of units that should be inspected based on the units received.

Acceptance Quantity

Enter the number of units that must pass inspection for any of the units to be accepted.

Acceptance Percentage

Enter the percentage of units that must pass inspection for any of the units to be accepted.

18.6 Working with Items in a Receipt Route

This section provides an overview of item-related tasks and discusses how to:

- Set processing options for Receipt Routing Movement and Disposition (P43250).

- Review the current operation for items.
- Transfer items to operations.

18.6.1 Understanding Item-Related Tasks

You can monitor items from the moment that they leave a supplier's warehouse. For example, you can process shipments of items through transit, the dock, the staging area, and inspection before updating the status of the items to on-hand.

The receipt route for an item determines the series of operations through which you process an item after you take receipt. For example, if a receipt route includes four operations, such as transit, dock, inspection, and stock, the system enters the item in the transit operation when you enter a receipt. You must transfer the item to each subsequent operation in the route.

You can remove (disposition) items from a receipt route. For example, you might reject an item that does not pass inspection. In this case, the system removes the quantity that you reject from the receipt route. If you return an item, you can generate an order to replace the items.

You can review information about the transfer and removal of items in a receipt route. For example, you can determine the amount of time that a shipment of items was at the dock before it was transferred to stock. You can also review the quantity of items in a shipment that did not pass inspection.

18.6.1.1 Transferring Items to Operations

The receipt route that you assign to an item determines the series of operations through which you process the item upon its receipt (for example, transit, staging, and stock). The system enters an item into the first operation of the route upon receipt. You must transfer the item to subsequent operations in the route.

You can set processing options to determine the operations to which you can transfer items in a receipt route. For example, if the order of operations is staging, inspection, and stock, you can transfer items to:

- The next operation only (for example, staging to inspection and inspection to stock).
- Any subsequent operation (for example, staging to stock).
- Any operation (for example, stock to staging).

When you transfer items to the last operation in a receipt route, the system updates the items to a received (on-hand) status.

18.6.2 Forms Used to Work with Items in a Receipt Route

Form Name	Form ID	Navigation	Usage
Work With Routing Statuses	W43250K	Receipt Routing (G43A14), Status Inquiry	Review the current operation for items. Transfer items to operations. Work with routing statuses.

Form Name	Form ID	Navigation	Usage
Receipt Routing Movement	W43250L	Select a line item on the Work With Routing Statuses form, and then click the Select button.	Transfer items to operations.

18.6.3 Setting Processing Options for Receipt Routing Movement and Disposition (P43250)

Processing options enable you to specify the default processing for programs and reports.

18.6.3.1 Defaults

These processing options define the default information that the system uses when you are working with the Receipt Routing Movement and Disposition program (P43250).

1. Order Type (Optional)

Specify the type of document. This UDC (00/DT) also indicates the origin of the transaction. Reserved document type codes exist for vouchers, invoices, receipts, and time sheets, which create automatic offset entries during the post program. (These entries are not self-balancing when you originally enter them.) These prefixes for document types are predefined; do not change them:

P: Accounts Payable documents

R: Accounts Receivable documents

T: Payroll documents

I: Inventory documents

O: Purchase Order documents

J: General Ledger/Joint Interest Billing documents

S: Sales Order Processing documents

If you enter a document type, the system displays only the orders with the document type that you specify. If you leave this processing option blank, the system displays all orders.

You can create different versions that correspond to the different document types that you use.

2. Operation Code (Optional)

Specify the From operation code. The system displays only the orders that contain the From operation code that you specify. This UDC (43/OC) represents an operation or step within the receipt route.

18.6.3.2 Display

These processing options specify whether the system displays information such as operations that move quantity to inventory.

1. Move Quantity to Inventory

Specify whether the program displays operations that move quantity to inventory. Values are:

Blank: Do not display operations that move quantity to inventory.

1: Display operations that move quantity to inventory.

The system retrieves information about the operations that move quantity to inventory from the F43091 table. Review the operations that move quantity to inventory on the Receipt Routing Definition form. Operations that move quantity to inventory are designated by a check mark in the Stock column.

2. Show Shipment and Pack Information

Specify whether the system displays UCC 128 information. Values are:

Blank: The system displays UCC 128 information.

1: The system does not display UCC 128 information. If you enter **1**, the system does not display the EPC Number field.

18.6.3.3 Process

These processing options specify which values the system uses for operations in the receipt route.

1. 'To Operation' Control

Specify the operation in the receipt route that the system uses as the To operation. Values are:

Blank: The system allows only the next operation in the receipt route to be selected.

1: The system allows only the next operation in the receipt route to be selected.

2: The system allows the current operation or any next operation in the receipt route to be selected.

3: The system allows any operation in the receipt route to be selected.

2. Last Status Code

Specify a last status code for replacement processing. If you are adding an order line for a replacement item on the purchase order, you can enter a last status code for the new order line.

Before you complete this processing option, review the order activity rules that you have set up, and also ensure that you have activated replacement processing.

To ensure that replacement processing is activated, review the Receipt Routing and Disposition form and make sure that the Replacement option is selected. If the Replacement option is not selected, the system will not create a purchase order for the replacement item.

3. Next Status Code

Specify a next status code for replacement processing. If you are adding an order line for a replacement item on the purchase order, you can enter a next status code for the new order line.

Before you complete this processing option, review the order activity rules that you have set up, and also ensure that you have activated replacement processing.

To ensure that replacement processing is activated, review the Receipt Routing and Disposition form and make sure that the Replacement option is selected. If the Replacement option is not selected, the system will not create a purchase order for the replacement item.

4. Replacement Line Type

Specify how the system processes lines on a transaction. The line type affects the systems with which the transaction interacts (JD Edwards EnterpriseOne General Ledger, JD Edwards EnterpriseOne Job Cost, JD Edwards EnterpriseOne Accounts Payable, JD Edwards EnterpriseOne Accounts Receivable from Oracle, and JD Edwards EnterpriseOne Inventory Management). The line type also specifies the conditions for including a line on reports and in calculations. Some examples of values, which have been defined on the Line Type Constants Revisions form, are:

S: Stock item

J: Job cost, subcontracts, or purchasing to the general ledger

B: General ledger account and item number

N: Nonstock item

F: Freight

T: Text information

M: Miscellaneous charges and credits

W: Work order

The system uses the line type that you specify for the new order line that represents the replacement item. You cannot use this processing option unless replacement processing is activated.

To ensure that replacement processing is activated, review the Receipt Routing and Disposition form and make sure that the Replacement option is selected. If the Replacement option is not selected, the system will not create a purchase order for the replacement item.

5. Enter the name of the function use for Tare/Pack Number Validation

Specify whether the system validates the tare number or pack number. Values are:

Blank: The system does not validate the tare number or pack number.

1: The system validates the tare number or pack number.

6. Credit Line Type

Specify how the system processes lines on a transaction. The line type affects the systems with which the transaction interacts (JD Edwards EnterpriseOne General Ledger, JD Edwards EnterpriseOne Job Cost, JD Edwards EnterpriseOne Accounts Payable, JD Edwards EnterpriseOne Accounts Receivable, and JD Edwards EnterpriseOne Inventory Management). The line type also specifies the conditions for including a line on reports and in calculations. Some examples of values, which have been defined on the Line Type Constants Revisions form, are:

S: Stock item

J: Job cost, subcontracts, or purchasing to the general ledger

B: General ledger account and item number

N: Nonstock item

F: Freight

T: Text information

M: Miscellaneous charges and credits

W: Work order

7. Option Default

Specify whether the system automatically selects all detail lines for receipt, which prevents you from having to manually select each detail line. Values are:

Blank: The system does not automatically select all detail lines for receipt.

1: The system automatically selects all detail lines for receipt.

8. Update Price in Receipt Routing

Enter a code that indicates whether the system will price the order at receipt time. Values are:

Blank: The system will not recalculate the purchase price at receipt time.

1: The system will recalculate the purchase price at receipt time based on the advanced pricing options that have been entered.

18.6.3.4 Versions

These processing options enable you to enter the version for each application. If you leave any of these processing options blank, the system uses version ZJDE0001.

1. Receipts by Purchase Order (P4312)

Specify the version that the system uses when you access the Receipts by Purchase Order program. You use the Receipts by Purchase Order program when you are moving items to an operation that is set up to move quantities into inventory. This application also uses the version to determine how to process license plate information.

Review the version's processing options to ensure that the version meets the needs.

2. Work Order Completions (P31114)

Specify the version that the system uses when you access the Work Order Completions program.

Review the version's processing options to ensure that the version meets the needs.

3. Open Receipts (P43214)

Specify the version that the system uses when you select the option from the Row menu to access the Open Receipts program.

Review the version's processing options to ensure that the version meets the needs.

4. Open Orders (P4310)

Specify the version that the system uses when you select the option from the Row menu to access the Open Orders program.

Review the version's processing options to ensure that the version meets the needs.

5. Purchase Orders (P4310)

Specify the version that the system uses when you select the Row menu to the Purchase Orders program.

Review the version's processing options to ensure that the version meets the needs.

6. Test Results Revisions (P3711)

Specify the version that the system uses when you select the Row menu for the Test Results Revisions program. Before you define the version, be sure that you have already set up the F43093 table.

Review the version's processing options to ensure that the version meets the needs.

7. Unscheduled Deliveries (P49655)

Specify the version that the system uses when you access the Unscheduled Deliveries program.

Review the version's processing options to ensure that the version meets the needs.

8. Routing Ledger Inquiry (P43252)

Specify which version of the Routing Ledger Inquiry program the system uses.

18.6.3.5 Workflow**1. Disposition Email**

Specify the recipient of the email that the system automatically sends when each disposition of an item is complete. Values are:

Blank: The system does not send email.

1: The system sends email to the purchase order originator.

The system retrieves the purchase order originator information from the F4311 table.

2. Disposition Email

Specify the recipient of the email that the system automatically sends after the disposition of an item. Values are:

Blank: The system does not send email.

1: The system sends email to the project manager.

Note: This applies to Oracle's JD Edwards EnterpriseOne Engineer to Order system only.

3. Disposition Email

Specify the recipient of the email that the system automatically sends after the disposition of an item. Values are:

Blank: The system does not send email.

1: The system sends email to the buyer.

The system retrieves the buyer information from the F4102 table.

4. Disposition Email

Specify the recipient of the email that the system automatically sends after the disposition of an item. Values are:

Blank: The system does not send email.

1: The system sends email to the supplier.

The system retrieves the supplier information from the F4311 table.

5. Completion Email

Specify the recipient of the email that the system sends for work order completions. Values are:

Blank: The system does not send email.

1: The system sends email to the planner.

The system retrieves the planner information from the F4102 table.

18.6.3.6 Interop

This processing option specifies information such as the transaction type for an interoperability transaction.

1. Transaction Type

Specify a transaction type for the interoperability transaction. For example, the transaction type JDERR represents the receipt routing transaction.

If you leave this processing option blank, the system does not perform outbound interoperability processing.

18.6.3.7 Transportation

This processing option specifies information about in transit, unscheduled deliveries.

1. Intransit Unscheduled Delivery Operation Code

Specify the operation in the receipt route that the system uses for unscheduled deliveries. If a quantity is moved to this operation and Inbound Transportation information exists, the system launches the Unscheduled Deliveries program (P49655).

18.6.3.8 Rentals (Release 9.1 Update)

1. Sales Order (P4210)

Specify the version of the Sales Order Entry program (P4210) that the system uses for rental contract sales orders.

If you leave this processing option blank, the system uses the ZJDE0001 version.

2. Service Order (P17714)

Specify the version of the Work Order Revisions program (P17714) that the system uses for rental contract service orders.

If you leave this processing option blank, the system uses the ZJDE0001 version.

18.6.4 Reviewing the Current Operation for Items

Access the Work With Routing Statuses form.

You can review the current operation for items in a receipt route. For example, if you recently received a shipment of items and the receipt route for the items includes a dock and inspection operation, you can review the quantity of the item at the dock and the quantity of the item being inspected.

18.6.5 Transferring Items to Operations

Access the Work With Routing Statuses form.

Qty At Op (quantity at operation)

Enter the number of units currently at this operation.

Receipt Line Number

Enter a number that represents the number of lines on a sales order or purchase order, or the number of receivers recorded during the receipt process. This field is used in voucher matching.

18.7 Removing Items from a Receipt Route

This section provides an overview of removal and reversal of items and discusses how to remove an item from a receipt route.

18.7.1 Understanding Removal and Reversal of Items

This section discusses item removal and reversal.

18.7.1.1 Removal of Items

You might need to remove (disposition) items from a receipt route. For example, you can return items to the supplier or reject items that do not pass inspection. You must use one of these categories to indicate the quantity of items that you want to remove from the receipt route:

- Returns
- Reworks
- Scrap
- Rejects
- Adjustments

You can enter text about the removal of items for any of the categories.

Before you remove items from a receipt route, you might want to review the sample requirements that are set up for a receipt route. You can also review item specifications that are set up for a receipt route.

After you remove items from a receipt route, the system subtracts the quantities that you enter from the quantity at the current operation. If you need to reverse the removal, you must use the Ledger Inquiry program. For example, if you removed items by classifying them as scrap and then later decide to use the items, you can reverse the removal transaction. The system adds the removed quantity back to the receipt route and creates the appropriate journal entries, if necessary.

The system creates journal entries for the items that you remove if you have specified that the removal category is payable. For example, if you specified that the scrap category is payable, the system creates journal entries for items that you remove due to scrap.

If you decide to return an item, the system automatically credits the original purchase order. You can generate a new purchase order line to replace the returned items. The system adds the line to the original purchase order.

18.7.1.2 Item Reversals

You might inadvertently enter a receipt for an item. You can reverse the receipt for an item that the system processes through a receipt route.

When you move an item to the last operation in its receipt route, the system updates the item to an on-hand status. If you inadvertently move the item to the last operation, you can reverse the on-hand status by moving the item back to a previous operation in the receipt route.

You must set processing options for the Receipt Routing Movement and Disposition program (P43250) to allow item movement to any operation to perform reversals. You must also set processing options for items that have completed their route to appear.

If you did not intend for an item to enter receipt routing, you must reverse the initial receipt using the Purchase Receipts Inquiry program (P43214), which removes the item from the receipt route. The item must be at the first operation in the receipt route.

If you removed items from the receipt route due to returns, rejects, and so forth, you must reverse the item removals before you can reverse the receipt.

18.7.1.3 Service Units for A/P Matching

You can enter service unit information for services purchase order lines during the voucher match process. Service units are informational only, so the system does not perform any validation against the values.

Service units must be activated by selecting the Procurement Allow Service Units option on the Line Type Constants Revisions form. The system validates that the service units check box is selected for noninventory interface A and B only.

Set the Display Service Units processing option on the Display tab of the P4314 processing options.

If the processing option is set, the Service Quantity and Service UoM fields appear on the Voucher Match Reversal form (W4314H). Although both the Service Quantity and Original Quantity fields are shown on the voucher match reversal form, you cannot use both fields for a line.

See [Defining Order Line Types](#).

See "Service Units for A/P Matching" in the *JD Edwards EnterpriseOne Applications Subcontract Management Implementation Guide*.

See [Entering Detail Lines by Item Number](#).

See "Service Units for A/P Matching" in the *JD Edwards EnterpriseOne Applications Subcontract Management Implementation Guide*.

See [Setting Processing Options for Voucher Match \(P4314\)](#).

18.7.2 Forms Used to Remove Items from a Receipt Route

Form Name	Form ID	Navigation	Usage
Working With Routing Statuses	W43250K	Receipt Routing (G43A14), Status Inquiry	Work with routing statuses.
Routing Disposition	W43253A	Select a detail line on the Work With Routing Statuses form, and then select Disposition from the Row menu.	Remove an item from a receipt route. Review and modify the routing disposition.
Replacement Information	W43251A	Select Replacement from the Form menu on the Routing Disposition form.	Update replacement information.

18.7.3 Removing an Item from a Receipt Route

Access the Routing Disposition form.

Qty Returned (quantity returned)

Enter the number of units that were returned to the supplier through receipt routing.

You can return goods for credit or for replacement. The system writes these transactions as new lines on the original purchase order.

Qty Reworked (quantity reworked)

Enter the number of units that will be reworked as a result of receipt routing.

Reason

Enter a value from UDC 42/RC that explains the purpose for a transaction. For example, you can indicate the reason that you are returning items.

Qty Scrapped (quantity scrapped)

Enter the number of units that were scrapped through receipt routing.

Qty Rejected (quantity rejected)

Enter the number of units that were rejected during receipt routing.

Qty Adjusted (quantity adjusted)

Enter the number of units that were adjusted during receipt routing.

18.8 Reviewing the History of Items in a Receipt Route

This section provides an overview of item history and discusses how to:

- Set processing options for Routing Ledger Inquiry (P43252).
- Review the history of items in a receipt route.

18.8.1 Understanding Item History

You can review information about the transfer of items from one operation to another in a receipt route. For example, you can review when a group of items was moved from inspection to stock, as well as who moved the items and on what date. You can also determine how long the items were at a certain operation.

You can also review information about the removal of items from a receipt route. For example, you can review the quantity of items in a shipment that did not pass inspection and the quantity of items that were returned to the supplier.

You can specify whether to review transfer or removal transactions. You can indicate the operations for which you want to review transfers. For example, you can review only those transfers for which items at the dock were moved to staging.

18.8.1.1 Record Reservation (Release 9.1 Update)

The JD Edwards EnterpriseOne software provides record reservation capability within the Routing Ledger Inquiry program (P43252). Record reservation helps to ensure the integrity of the data and prevent data loss. To avoid simultaneous processing of the same records, the system reserves (locks) records for processing by any other program. Thus, the system does not allow you to edit a record that has been locked by a different user or application.

When a program that uses record reservation is interrupted, orphaned reservation records might remain in the Business Object Reservation table (F00095). This can occur, for example, when technicians are working with a server, or when a workstation shuts down without warning. If an interruption stops one of the programs in the Routing Ledger Inquiry program before it releases the reservations that it creates, you cannot update the records until the orphaned reservations are removed.

You can use the Remove Business Object Reservation program (P00095) to release unwanted record reservations. This program stores reservation information in the Business Object Reservation table (F00095).

18.8.2 Form Used to Review the History of Items in a Receipt Route

Form Name	Form ID	Navigation	Usage
Work With Receipt Routing Ledger	W43252D	Receipt Routing (G43A14), Ledger Inquiry	Review the history of items in a receipt route. Work with the receipt routing ledger.

18.8.3 Setting Processing Options for Routing Ledger Inquiry (P43252)

Processing options enable you to specify the default processing for programs and reports.

18.8.3.1 Display

1. Show Shipment and Pack Information

Specify whether the system displays shipment and pack information. Values are:

Blank: Display

1: Do not display

18.8.3.2 Process

1. Enter the name of the function to use for Tare/Pack number validation

Specify a business function name that the system uses when validating the Serial Shipping Container Code (SSCC) number. For example, you might specify that business function CalculateUCC128CheckDigit. Function CalculateandValidateCheckDigit is available. If you leave this processing option blank, no tare/pack number validation will be performed.

18.8.4 Reviewing the History of Items in a Receipt Route

Access the Work With Receipt Routing Ledger form.

Figure 18–2 Work With Receipt Routing Ledger form

Ledger Inquiry - Work With Receipt Routing Ledger

Batch Order Suffix

Order Number * * Line * G/L Date 07/12/2005

Item Number * Shipment Number *

Supplier * Tare Number *

Pack Number *

EPC Number *

Records 1 - 10

	From Oper	To Oper	Rev	Remark	Qty	UM	G/L Date	Date Updated	Time	User	Rpl Y/N	Program ID	Work Stn ID	Ord Co	Or Ty	Move Code
☑	--->	CONS	N	Moved	100.0000	EA		10/01/2004	142737	KM5673360	N	EP4312	DENMLPS6	00200	OP	MOV
○	DOCK	INSP	N	Moved	1.0000	EA		03/24/2005	45716	IC9016560		EP43250	DENPS4	01077	OP	MOV
○	--->	DOCK	N	Moved	1.0000	EA		03/24/2005	43653	IC9016560	N	EP4312	DENPS4	01077	OP	MOV
○	--->	INSP	N	Moved	100.0000	EA		03/25/2005	43459	IC9016560	N	EP4312	DENPS4	07496	OP	MOV
○	--->	TRAN	N	Moved	1.0000	EA		12/22/2004	71959	KH5712189	N	EP4312	DENPS4	07600	HP	MOV
○	--->	TRAN	N	Moved	1.0000	EA		12/22/2004	73035	KH5712189	N	EP4312	DENPS4	07600	HP	MOV
○	--->	TRAN	N	Moved	1.0000	EA		02/09/2005	70837	KH5712189	N	EP4312	DENPS4	07600	HP	MOV
○	--->	CONS	N	Moved	100.0000	EA		09/09/2004	161343	KM5673360	N	EP4312	DENMLPS6	00200	OP	MOV
○	CONS	STK	N	Moved	15.0000	EA		09/16/2004	155230	KM5673360		EP43250	DENMLPS6	00200	OP	MOV

From Oper (from operation)

Enter a value from UDC 43/OC that indicates the routing operation or step from which items were moved.

To Oper (to operation)

Enter a value from UDC 43/OC that indicates the routing operation or step to which items were moved.

Rev (reversal)

Enter a code that indicates whether the transaction is eligible for reversal or has already been reversed. Values are:

Blank: The transaction is eligible to be reversed.

N: The transaction is not eligible to be reversed.

Y: Transaction has been reversed.

R: Transaction is a reversal audit record.

Move Code

Enter a value from UDC 43/MC that indicates the movement of the quantity. You can move quantity from one operation to another, or you can disposition quantity out of the routing process.

Container I.D. (container identifier)

Enter the code to assign to a container in which the items on this purchase order or order line were shipped to you. You can assign container information to an order during receipts entry.

Managing Suppliers

You can manage the relationships that you have with suppliers and the items that they provide. You enter initial information about each item that you purchase from a supplier and the system monitors delivery, quality, and cost performance on behalf of the supplier. You can compare performance information to determine the best suppliers from whom to make purchases.

This chapter contains the following topics:

- [Section 19.1, "Understanding Conversion of Supplier Limit Amounts"](#)
- [Section 19.2, "Generating Supplier Prices in an Alternate Currency"](#)
- [Section 19.3, "Managing Supplier Performance Information"](#)
- [Section 19.4, "Updating Supplier and Item Analysis Records"](#)

19.1 Understanding Conversion of Supplier Limit Amounts

To convert limit amounts for multiple suppliers from one currency to another, you can run the Address Book Conversion - F0401 program (R890401E). This program converts supplier currency codes and address book amounts. In the JD Edwards EnterpriseOne Procurement system, the address book amounts are the supplier minimum and maximum order values. Access the Address Book Conversion - F0401 program from Batch Versions.

When you enter minimum and maximum order values for a supplier, you typically enter them as rounded numbers, which are stored without decimals in the F0401 table. When you convert these amounts to a different currency, you can specify a rounding factor in the processing options. For example, to round converted minimum and maximum order amounts to the nearest 50, you specify a rounding factor of 50.

19.1.1 Example: Rounding Converted Limit Amounts

Limit amounts are credit limit amounts and minimum and maximum order amounts that you assign to a customer or supplier master record. Limit amounts are usually rounded numbers and are stored without decimals.

See Also

- "Understanding Supplier Currency Conversion" in the *JD Edwards EnterpriseOne Applications Multicurrency Processing Implementation Guide*.

This example describes how the Address Book Conversion - F03012 (R8903012E) and Address Book Conversion - F0401 (R890401E) programs round converted limit amounts when converting from Canadian dollars (CAD) to U.S. dollars (USD) if you enter a rounding factor in the processing options.

In this example, the exchange rate is 1 CAD = 0.63492 USD and the rounding factor is 50. The conversion programs round converted limit amounts up or down, as described in this table:

Converted Limit Amounts	Description
Round Up	<p>The conversion program converts 8,000 CAD to 5,079.36 USD. It rounds 5,079.36 USD up to 5,100 based on this calculation:</p> <p>Converted Amount ÷ Rounding Factor = Q with a remainder of R. If R is greater than or equal to one-half of the rounding factor, then subtract R from the rounding factor and add that amount to the converted amount.</p> <p>In this example, 5,079 USD ÷ 50 = 101 with a remainder of 29, which is greater than one-half of 50. Subtract 29 from 50 (50 - 29 = 21) and add 21 to 5,079 to get a rounded value of 5,100.</p>
Round Down	<p>The conversion program converts 12,000 CAD to 7,619.05 USD. It rounds 7,619.05 down to 7,600 based on this calculation:</p> <p>Converted Amount ÷ Rounding Factor = Q with a remainder of R. If R is less than one-half of the rounding factor, then subtract R from the converted amount.</p> <p>In this example, 7,619 USD ÷ 50 = 152 with a remainder of 19, which is less than one-half of 50. Subtract 19 from 7,619 to get a rounded value of 7,600.</p>

19.2 Generating Supplier Prices in an Alternate Currency

This section provides an overview of the generation of supplier prices in an alternate currency and discusses how to:

- Generate supplier prices in an alternate currency.
- Set processing options for Supplier/Catalog Purchase Price Generation by Currency (R4106101).

19.2.1 Understanding the Generation of Supplier Prices in an Alternate Currency

You can create new supplier prices in a different currency for multiple records at one time by running the Supplier/Catalog Purchase Price Generation by Currency program (R4106101). This program generates new prices based on existing records.

The Supplier/Catalog Purchase Price Generation by Currency program is especially useful if you need to create multiple supplier price records in a different currency. For example, you might use this program if the company is about to conduct business with a supplier that uses a currency in which you do not have supplier price records. If you need to create a new price for an individual record, simply update the existing record on the Supplier Catalog Revisions form; you do not have to run the Supplier/Catalog Purchase Price Generation by Currency program.

When you run the Supplier/Catalog Purchase Price Generation by Currency program, you control the currency and exchange rate in which to create new supplier prices by specifying this information in the processing options:

- Date as of when you want to create records.
If the expiration date of a price is greater than or equal to this date, a new supplier price is created.
- Currency of the existing records.
This is the original currency code that you want to base the new records on.
- Currency in which you want to create new records.
- Exchange rate to use to calculate the amount.
- Method (divide or multiply) to use for the exchange rate calculation.

The Supplier/Catalog Purchase Price Generation by Currency program copies the original supplier price, calculates a new price, and creates a price record with the new currency amount. Specifically, the program:

- Creates new prices one currency at a time to avoid confusion about which currency new records are based on.
- Creates only one new supplier price record for each unit of measure. It does not create one price record for each currency.

For example, assume that the program generates new supplier prices in the Japanese yen (JPY) based on existing prices in the Canadian dollar. A record for a certain unit of measure already has a supplier price in JPY. The program does not generate another supplier price in JPY because both records for that unit of measure would have the same key. The exception to this rule is when currency codes that are associated with a supplier, item, or branch/plant have different effective through dates. Depending on the dates, the program might create more than one new price.

Run the Supplier/Catalog Purchase Price Generation by Currency program first in proof mode, and then in final mode as follows:

- Proof.
Review the audit report to ensure that the records generated by the program are accurate. If the audit report is not accurate, change the processing option and data selection values accordingly and rerun the program in proof mode.
- Final.
When you are satisfied with the audit report created in proof mode, run the program in final mode. Review the new supplier price records on the audit report. If you review a new record on the Supplier Catalog Revisions form, notice that the new record is sequenced alphabetically along with the existing records on the form and that amounts are rounded according to the decimal places that are set up in the data dictionary.
If necessary, adjust the new price manually on the Supplier Catalog Revisions form. For example, if the program creates a new price for 50,000 JPY as 675.1155 CAD, you might adjust the new amount to 675 CAD.

19.2.1.1 Example: Generating New Supplier Prices

This example describes an item with supplier price records before and after generating a new supplier price in a different currency.

19.2.1.2 Before Generating New Supplier Prices

An existing item has these supplier price records:

Unit Price	Currency Code
2,000.00	CAD
1,297.81	EUR
820.10	GBP

The processing options for the Supplier/Catalog Purchase Price Generation by Currency program (R4106101) are set as follows:

- Mode = 1 (final)
- Date = June 30, 2008
- Convert to = USD
- Convert from = GBP
- Exchange rate = 1.65810
- Method = 1 (multiplier)

Even though several currency amounts are associated with the item number, the program generates only one new USD amount based on the GBP amount.

19.2.1.3 After Generating New Supplier Prices

After you run the Supplier/Catalog Purchase Price Generation by Currency program, the new price record is 1,277.80 USD, based on the 820.10 GBP record. The original 820.10 GBP record remains so that you can continue to pay suppliers in that currency, as needed.

Unit Price	Currency Code
2,000.00	CAD
1,297.81	EUR
820.10	GBP
1,277.80	USD

19.2.1.4 Data Selection for Supplier/Catalog Purchase Price Generation by Currency

Typically, companies will generate new supplier prices for all suppliers within a specific branch/plant. If the company has multiple branch/plants with different currencies, you can run the Supplier/Catalog Purchase Price Generation by Currency program (R4106101) multiple times. You can also generate new supplier prices by item number or any other value in the data selection.

If the company has items that are at purchase price level 1 and you want to make sure that you generate new prices for those items, designate <Blank> for branch/plant in the data selection if you are not generating new prices for all branch/plants.

19.2.2 Generating Supplier Prices in an Alternate Currency

Typically, companies will select r Procurement Advanced & Technical Ops (G43A31), Generate Purchase Price by Currency.

19.2.3 Setting Processing Options for Supplier/Catalog Purchase Price Generation by Currency (R4106101)

Processing options enable you to specify the default processing for programs and reports.

19.2.3.1 Process

These processing specify default information that the system uses when generating the report.

1. Mode

Specify whether to run the program in proof or final mode. Values are:

Blank: Proof mode.

1: Final mode.

2. Date

Specify the date that the system uses to determine which purchase price records will be generated. If the expiration date of a purchase price is greater than or equal to the date entered, the system generates a new purchase price record. To use the system date, leave this processing option blank.

19.2.3.2 Currency

These processing options specify default currency information.

1. To Currency Code (Required)

Specify the currency code that the system uses for To conversions. This processing option is mandatory.

2. From Currency Code (Required)

Specify the currency code that the system uses for From conversions. This processing option is mandatory.

3. Exchange Rate (Required)

Specify the exchange rate for the conversion. This processing option is mandatory.

4. Operation

Specify whether the system multiplies or divides the current purchase price. Values are:

Blank: Divide the current purchase price by the exchange rate.

1: Multiply the current purchase price by the exchange rate.

19.3 Managing Supplier Performance Information

This section provides an overview of supplier performance information, lists prerequisites, and discusses how to:

- Review supplier delivery performance.
- Review supplier quality performance.
- Review supplier cost performance.

19.3.1 Understanding Supplier Performance Information

You can review performance information to determine which suppliers are most likely to provide you with the best costs and services for an item. Performance information includes the quality of service that is provided by a supplier for a certain item and the costs charged by the supplier.

You can review supplier performance information that is specific to:

- Delivery of an item.
- Acceptability of an item.
- Cost of an item.

You can also review a summary of performance information for all suppliers who provide a specific item. For example, you can compare the average unit cost and lead time (average number of days to deliver an item) for all suppliers who provide you with Item A.

To store performance information, you must set processing options for the Purchase Orders program (P4310), PO Receipts program (P4312), A/P Standard Voucher Entry program (P0411), and Voucher Match program (P4314) to capture supplier analysis information.

The system retrieves supplier performance information from the F43090 and F43121 tables.

19.3.1.1 Reviewing Supplier Delivery Performance

Before you order an item from a supplier, you can determine whether the supplier has made timely deliveries in the past. You can review the percentage of items that a supplier has delivered on time, early, and late in each fiscal period (usually a month) to determine whether the supplier is likely to make timely deliveries in the future.

You can review the quantity, amount, or number of receipts for an item that was on time, early, or late. For example, if you acquired 100 bicycles in June from AAA Bicycle Company, you can identify that 10 were delivered early, 80 were on time, and 10 were late. If you review amounts, you can identify that 1,000.00 was early, 8,000.00 was on time, and so on.

You can also review delivery information for each receipt in a fiscal period. For example, you might have entered five receipts of 20 bicycles to acquire 100 bicycles in June. You can review the promised and delivery dates, and the quantity that was on time, early, or late for each of the five receipts.

19.3.1.2 Reviewing Supplier Quality Performance

Before you order an item from a supplier, you might determine whether the supplier has a history of delivering the item in good condition. You can review the percentage of acceptable items from a supplier in each fiscal period (usually a month) to determine whether the supplier is likely to provide acceptable items in the future.

You can review the quantity of an item that was acceptable in each fiscal period, as well as the percentage. For example, you can review that you acquired 100 bicycles in June from AAA Bicycle Company, of which 95 were acceptable and 5 were unacceptable.

You can also review the acceptable quantity for each receipt that you entered in a fiscal period. For example, you might have entered five receipts of 20 bicycles to acquire 100 bicycles in June. You can review acceptable and unacceptable quantities for each of the five receipts.

The system can track item acceptability only for those items that are processed through a receipt route.

19.3.1.3 Reviewing Supplier Cost Performance

You might want to review the average unit cost you paid to a supplier for an item in each fiscal period (usually a month). You can compare this cost to the average cost for the item on purchase orders and the average cost at the time of receipt to determine whether the price remains consistent.

You can have the system calculate a percentage variance between the cost you paid for an item and another cost, such as the receipt cost. For example, if the supplier specified an average cost of 0.50 when you entered a receipt for an item but then billed you an average cost of 1.00, the system displays a 100-percent variance. In this case, you would probably determine why the variance exists. You use processing options to specify the cost to compare to the paid cost.

You can also review the inventory cost for an item. You specify the cost method that the system uses to determine the inventory cost, such as last-in, first-out (LIFO). Using this cost method, the inventory cost reflects the cost of the last item you received.

You can review costs for each receipt you entered in the fiscal period. For example, if an item had an average receipt cost of 10.00, you can review the cost for the item each time you entered a receipt, which might have been 9.00 at one receipt and 11.00 at another receipt.

19.3.1.4 Reviewing a Summary of Supplier Performance Information

You can compare a variety of performance information for all suppliers who provide a certain item to determine the best supplier from whom to purchase the item. For example, for each supplier who provides you with the same item, you can compare:

- The average unit cost for the item.
- The last cost that was paid for the item.
- The percentage of on-time deliveries.
- The average number of days that it takes to deliver the item (lead time).

You select the information that appears.

See Also:

- [Setting Processing Options for Supplier Analysis Summary \(P43230\)](#).

19.3.2 Prerequisites

Before you review a summary of supplier performance information, you must:

- Define the performance factors (columns) that you can review on the Work With Supplier Analysis Summary form (for example, average unit cost, last cost paid, and so on).
- Define formats that contain the columns you want to review and assign a format to the Work With Supplier Analysis Summary form using processing options.
- Define paths (multiple formats) and assign a path to the Work With Supplier Analysis Summary form using processing options.

19.3.3 Forms Used to Manage Supplier Performance Information

Form Name	Form ID	Navigation	Usage
Delivery Analysis	W43230L	Supplier Management (G43A16), Delivery Analysis	Review supplier delivery performance.
Delivery Analysis Details	W43230O	Select a detail line on the Delivery Analysis form, and then select Delivery Details from the Row menu.	Review supplier delivery performance.
Receipt Detail Information	W43230K	Select a receipt on the Delivery Analysis Details form, and then select Receipt Details from the Row menu.	Review receipt detail information.
Quality Analysis	W43230L	Supplier Management (G43A16), Quality Analysis	Review supplier quality performance.
Quality Analysis Details	W43230O	Select a detail line on the Quality Analysis form, and select Quality Details from the Row menu.	Review supplier quality performance.
Cost Analysis	W43230L	Supplier Management (G43A16), Cost Analysis	Review supplier cost performance.
Cost Analysis Details	W43230O	Select a detail line on the Cost Analysis form, and select Cost Details from the Row menu.	Review supplier cost performance.
Work With Supplier Analysis Summary	W43230A	Supplier Management (G43A16), Summary	Review a summary of supplier performance information.

19.3.4 Reviewing Supplier Delivery Performance

Access the Delivery Analysis form.

Quantity On-time

Enter the number of items that you received on time from this supplier during the fiscal period. To determine whether a receipt is on time, the system compares the receipt date to the promised date. If it finds a difference between the two, it uses the number of days allowed early or late to determine whether the receipt is on time. You set up the number of days that you consider to be an acceptable time window for delivery performance (days allowed early or late) on the Supplier/Item Relationship form.

For example, suppose that you have an order set up in the following way:

- Promised Date - December 5.
- Receipt Date - December 7.
- Days Allowed Late - 3 days.

The order is late if received three days after December 5, or after December 8.

Because you received this order on December 7, the order is on time.

19.3.5 Reviewing Supplier Quality Performance

Access the Quality Analysis form.

Quantity Dispositioned

Displays the original quantity of the order line, plus or minus any changes to that quantity, less all quantities shipped, received, or vouchered to date. This field may also represent the actual quantity received.

19.3.6 Reviewing Supplier Cost Performance

Access the Cost Analysis form.

Inventory Unit Cost

Displays the amount per unit, derived by dividing the total cost by the unit quantity.

Ordered Unit Cost

Displays the unit cost of one item, as purchased from the supplier, excluding freight, taxes, discounts, and other factors that might modify the actual unit cost that you record when you receive the item.

Percent Cost Variance

Displays the percentage variance between the cost paid, and either the inventory cost, ordered cost, or the received cost.

19.4 Updating Supplier and Item Analysis Records

This section provides an overview of updates to supplier and item analysis records and discusses how to:

- Update supplier and item analysis records.
- Set processing options for Supplier/Item Relationships Rebuild (R43900).

19.4.1 Understanding Updates to Supplier and Item Analysis Records

After you install a new release of the JD Edwards EnterpriseOne Procurement system, you must run the Supplier/Item Relationships Rebuild program (R43900) to update supplier and item analysis records. The procedure updates new fields in the F43090 table based on the receipt data in the F43121 table.

When you use the Supplier/Item Relationships Rebuild program to update the supplier and item analysis records, you can assign a route code for new supplier/item relationships.

After you run the Supplier/Item Relationships Rebuild program, you can have the system maintain supplier analysis information interactively when you enter purchase orders, receipts, and vouchers.

Important: You should run the Supplier/Item Relationships Rebuild program only when installing a new release of JD Edwards EnterpriseOne. If data becomes corrupted at a later date and you need to update the records, contact the JD Edwards EnterpriseOne help desk for assistance.

19.4.2 Updating Supplier and Item Analysis Records

Select Procurement Advanced & Technical Ops (G43A31), Supplier Analysis Regeneration.

19.4.3 Setting Processing Options for Supplier/Item Relationships Rebuild (R43900)

Processing options enable you to specify the default processing for programs and reports.

19.4.3.1 Route

This processing option specifies route information for the Supplier/Item Relationships Rebuild program.

Route - Normal Route Code

Specify a code to assign when a new supplier record or item records are added. If you leave this processing option blank, the system does not assign a route code.

Processing Rebates

This chapter contains the following topics:

- [Section 20.1, "Understanding Rebates"](#)
- [Section 20.2, "Reviewing Summary Information for Rebate Agreements"](#)
- [Section 20.3, "Reviewing Purchasing Transactions for a Rebate"](#)
- [Section 20.4, "Changing the Quantity or Amount Applied to a Rebate"](#)
- [Section 20.5, "Updating Rebate Information"](#)

20.1 Understanding Rebates

Some of your suppliers might offer you cash rebates if you purchase a certain quantity or amount of their items and services. You can set up the JD Edwards EnterpriseOne Procurement system to track rebates.

To track rebates, you must enter information about each rebate agreement. When you enter, change, or cancel an order, the system applies the appropriate purchases toward the rebate agreement.

You can view the current status of each rebate agreement, including:

- The purchases necessary to obtain the rebate.
- The purchases you have made that apply to the rebate.
- The amount of each rebate.

With this information, you can identify rebates that your business is likely to obtain. You can also identify rebates that are unobtainable, which might change your price negotiations in the future.

You can have the message center alert you when you are within a range of meeting the purchase requirements for a rebate.

20.2 Reviewing Summary Information for Rebate Agreements

This section provides an overview of rebate status information and lists the forms used to review summary information for rebate agreements.

20.2.1 Understanding Rebate Status Information

Before you purchase from a supplier, you might want to determine whether the purchases apply to a rebate. You can review summary information for each rebate agreement that you have with a particular supplier, including:

- The threshold that you must reach to obtain the rebate.
- The total purchases that you have made toward the agreement to date.
- The amount of the rebate that you receive if you reach the next threshold.
- The last threshold that you reached if multiple thresholds exist for the agreement.
- The rebate amounts that you have received to date.

You can also select an agreement that enables you to view individual purchasing transactions.

If you find that the total purchase quantity or purchase amount that the system has accumulated and applied towards a rebate agreement is incorrect, you can change the quantity or the amount.

The system retrieves purchases to date and rebate amounts received for an agreement from the F4340 table. It retrieves transaction details for rebate agreements from the F4343 table.

You might want to determine whether you are eligible to receive a rebate or whether you are close to obtaining a specific rebate. For each agreement, you can review:

- The purchases required for the rebate.
- The quantity or amount of purchases that you have made to date.
- The rebate amount that you can receive.

You can also view agreement information such as effective dates, the last rebate threshold reached, the rebate amount that you have received to date, and so on.

20.2.2 Forms Used to Review Summary Information for Rebate Agreements

Form Name	Form ID	Navigation	Usage
Work With Rebate History Inquiry	W43243A	Price Management (G43A17), Rebate History Summary Inquiry	Review summary information for rebate agreements. Work with the rebate history.
Rebate History Details	W43243B	Select a row for a customer on the Work With Rebate History Inquiry form, and then click the Select button.	View rebate history details.

20.3 Reviewing Purchasing Transactions for a Rebate

You might want to review information about the individual purchasing transactions that the system has applied toward a rebate. You can display order detail line transactions that pertain to an agreement and the purchase orders on which the transactions were entered.

This section lists the forms used to review purchasing transactions for a rebate.

20.3.1 Forms Used to Review Purchasing Transactions for a Rebate

Form Name	Form ID	Navigation	Usage
Work With Rebate History Inquiry	W43243A	Price Management (G43A17), Rebate History Detail Inquiry	Work with rebate history.
Rebate History Details	W43243B	Select a row for a customer on the Work With Rebate History Inquiry form, and then click the Select button.	View rebate history details.

20.4 Changing the Quantity or Amount Applied to a Rebate

This section provides an overview of the purchase quantity or amount and discusses how to change the quantity or amount applied to a rebate.

20.4.1 Understanding the Purchase Quantity or Amount

The purchase quantity or amount that the system has accumulated and applied toward a rebate agreement might be incorrect. For example, you might have returned some of the rebate items that you purchased. You can override the current calculations by entering a new purchase quantity or amount.

When you change a quantity or amount, you can also add a memo that explains why you are making the adjustment.

20.4.2 Forms Used to Change the Quantity or Amount Applied to a Rebate

Form Name	Form ID	Navigation	Usage
Work With Purchase Agreements	W4340A	Price Management (G43A17), Purchase Rebate Agreement	Work with purchase agreements.
Rebate Adjustments Revision	W4340C	Select a supplier on the Work With Purchase Agreements form, and then select Rebate Adjustments from the Row menu.	Change the quantity or amount applied to a rebate.

20.4.3 Changing the Quantity or Amount Applied to a Rebate

Access the Rebate Adjustments Revision form.

Amount Purchased

Displays the amount purchased to date. The system updates this accumulator if you have set the threshold type to indicate that the rebate agreement is based on a purchase amount.

Quantity Purchased

Displays the quantity (total number of units) purchased to date. The system updates this accumulator if you have set the threshold type to indicate that the rebate agreement is based on a quantity.

20.5 Updating Rebate Information

This section provides an overview of how to update rebate information and discusses how to:

- Run the Rebate Report.
- Set processing options for Rebate Report (R43400).

20.5.1 Understanding How to Update Rebate Information

You must run the Rebate Batch Report program (R43400) to:

- Have the system determine whether you are due a rebate.
- Send an electronic mail message to the rebate administrator.

The system tracks the quantity and amount of purchases that apply to a rebate agreement. You must run the Rebate Batch Report program to have the system compare this quantity or amount to that which is required to obtain the rebate.

You can have the system send a message to the rebate administrator when you meet the purchasing requirements for a rebate agreement or when you are within a certain range of meeting the requirements. For example, if you must purchase 100 items to obtain a rebate, you might want the rebate administrator to receive a message when you have purchased 90 items.

You must run the Rebate Batch Report program to have the system send a message. You use processing options to specify whether the system sends a message and to define a range. For example, if you want the system to send a message when you have purchased 90 of the 100 items that are required to obtain a rebate, you enter a range of 10 percent.

The following information appears in the message to the rebate administrator:

- Supplier number
- Agreement sequence number
- Threshold amount
- Actual purchases
- Effective through date

You can specify a rebate administrator for each rebate agreement.

20.5.2 Running the Rebate Report

Select Receipts Matching and Posting (G43A15), Rebate Report.

20.5.3 Setting Processing Options for Rebate Report (R43400)

Processing options enable you to specify the default processing for programs and reports.

20.5.3.1 Message

Messages

Enter **1** to send messages to the agreement administrator. If you leave this processing option blank, no message is sent.

Percentages

Enter the percentage within the threshold to trigger sending a message. If you leave this processing option blank, the system uses ten percent.

20.5.3.2 Details**Rebate History Details**

Enter 1 to print the rebate history details. If you leave this processing option blank, no details are printed.

Updating Orders

This chapter contains the following topics:

- [Section 21.1, "Understanding Order Updates"](#)
- [Section 21.2, "Updating Status Codes"](#)
- [Section 21.3, "Revising Purchase Dates"](#)

21.1 Understanding Order Updates

You can revise a purchase order after you have entered it into the system if a change has occurred since you entered the order. For example, if you need to fill a purchase order quickly, you can manually update the status code so that it bypasses some of the normal purchasing procedures. If you want to delay an order, or if the supplier cannot get the items to you by the promised date, you can revise the requested or promised dates. Also, you can review the inventory and create a purchase order for items that you want to reorder.

21.2 Updating Status Codes

This section provides an overview of status code updates and discusses how to:

- Set processing options for PO Speed Status Update (P43025).
- Update status codes.

21.2.1 Understanding Status Code Updates

The system processes detail lines through the purchase order processing cycle based on the last and next status codes that have been assigned to each line. After a detail line completes a step in the processing cycle, the system updates the status codes.

You can manually update the next status code for detail lines to bypass a particular step, if necessary.

You cannot update detail lines to a closed status unless you use the Order Entry program (P4310).

21.2.2 Form Used to Update Status Codes

Form Name	Form ID	Navigation	Usage
Work with PO Speed Status Update	W43025A	Order Generation/Approve/Release (G43A13), Status Code Update	Update status codes.

21.2.3 Setting Processing Options for PO Speed Status Update (P43025)

Processing options enable you to specify the default processing for programs and reports.

21.2.3.1 Default Values

1. Enter the default order type

Enter a value from user-defined code (UDC) 00/DT that identifies the type of document. This code also indicates the origin of the transaction. The system has reserved document type codes for vouchers, invoices, receipts, and time sheets, which create automatic offset entries during the post program. (These entries are not self-balancing when you originally enter them.) These document types are defined by the system and should not be changed:

P: Accounts Payable documents.

R: Accounts Receivable documents.

T: Payroll documents.

I: Inventory documents.

O: Purchase Order Processing documents.

J: General Accounting/Joint Interest Billing documents.

S: Sales Order Processing documents.

2. Enter the default last status code

Enter a value from UDC 40/AT that specifies the last step in the processing cycle that this order line has successfully completed.

3. Enter the default next status code

Enter a value from UDC 40/AT that indicates the next step in the order flow of the line type.

4. Enter the default update next status code

Enter a value from UDC 40/AT that indicates the next step in the order flow of the line type.

5. Enter a '1' to protect the update next status code

Enter 1 to protect the update next status code.

21.2.3.2 Versions

Enter Purchase Order Entry version

Specify the version of purchase order entry to be used by the system.

21.2.4 Updating Status Codes

Access the Work with PO Speed Status Update form.

Next Status - Update To

Enter a value from UDC 40/AT that specifies the next standard step in the processing cycle for this order type. You set up the steps for the processing cycle on the Order Activity Rules form.

21.3 Revising Purchase Dates

This section provides an overview of purchase date revisions and discusses how to set processing options for Purchasing Date Revisions (P43100).

21.3.1 Understanding Purchase Date Revisions

The requested date or promised date for an order might change after you have entered the order in the system. You can follow manual procedures and simultaneously revise these dates for multiple orders.

After you change a requested or promised date, the system records the new date in the F4311 table. If you have already taken receipt of items, the dates in the F43121 table are not affected.

21.3.2 Form Used to Revise Purchase Dates

Form Name	Form ID	Navigation	Usage
Purchasing Date Revisions	W43100C	Order Generation/Approve/Release (G43A13), Purchasing Date Revisions	Revise purchase dates.

21.3.3 Setting Processing Options for Purchasing Date Revisions (P43100)

Processing options enable you to specify the default processing for programs and reports.

21.3.3.1 Defaults

This processing option enables you to enter default information that the system uses for processing.

Status Code - Next

Specify a value from UDC 40/AT indicating the next step in the order flow of the line type.

21.3.3.2 Self-Service

This processing option specifies whether the system activates self-service functionality.

Enable Workflow on Promised Date changed

Specify whether the system generates an email message to either the buyer (if the system finds a buyer number) or the originator (if the system does not find a buyer number) when a supplier changes a promised delivery date by using the internet. When the promised delivery date is approved by the buyer or originator, the system

updates either the promised date and the next status code (if you set the override next status code) or only the promised date on the purchase order. Values are:

Blank: Do not send email.

1: Send email to the buyer or the originator for approval.

Processing Purchase Order Commitments

This chapter contains the following topics:

- [Section 22.1, "Understanding Commitment Processing"](#)
- [Section 22.2, "Understanding How to Review Commitment Information for Orders"](#)
- [Section 22.3, "Understanding the Commitment Integrity Verification Process"](#)
- [Section 22.4, "Working with Commitments and Encumbrances"](#)
- [Section 22.5, "Running the Commitment Integrity Report"](#)
- [Section 22.6, "Purging PA Ledger Detail Records"](#)
- [Section 22.7, "Rebuilding a Commitment Audit Trail"](#)
- [Section 22.8, "Posting Committed Costs to Jobs"](#)
- [Section 22.9, "Performing Encumbrance Rollover"](#)

22.1 Understanding Commitment Processing

A commitment is the recognition of a future obligation. In Public Sector and Government, a commitment is referred to as an *encumbrance*. A commitment or encumbrance is created when an order for goods or services is charged to a general ledger account. You create commitment purchase orders using nonstock purchase order entry or services/expenditures purchase order entry. Each time you enter an order detail line, you can have the system track the amount that you are obligated to pay and apply it to a job or project.

For example, you might be working on a pavement resurfacing project. Each time that you enter an order for goods or services to complete the project, you can have the system create a commitment or encumbrance for the order amount.

In addition, you can roll over a commitment or encumbrance to the next fiscal year.

For example, local governments and municipalities normally have the authority to expend funds for one fiscal year. As a result, purchase orders and subcontracts with open balances are often canceled at the end of the fiscal year. To prevent these purchase orders and subcontracts from being canceled and to retain the recognition of these open balances, you must roll them forward to the new fiscal year.

A commitment is created when goods or services that are chargeable to a budgeted or appropriated expense are ordered or contracted. The commitment is relieved when the goods or services are received, which creates a liability of either a Received Not Vouchered or an Accounts Payable Ledger record.

You can monitor individual commitments for a job or project to verify the types of purchases that are being made. You can review the total commitment amount for a job or project to verify that it does not exceed the budget.

A functional server program called Update Commitment Ledger (X00COM) is used to create and relieve commitments and encumbrances. The system uses the Update Commitment Ledger (X00COM) to create appropriate entries for JD Edwards EnterpriseOne Procurement system commitments.

Note: The system can create commitments only for document types that you have defined in user-defined code (UDC) table 40/CT and for line types that use an inventory interface of A, B, or C.

22.1.1 Creation of an Encumbrance or Commitment

You can create order detail lines using either of these programs:

- Purchase Orders (P4310)
- Blanket Order Release (P43060)

When you create an order detail line, the system verifies that the document type exists in UDC 40/CT, verifies that the line type has an inventory interface of A, B, or C, and automatically creates commitments and encumbrances.

If you create a purchase order from a requisition, you can track pre-encumbrances in addition to encumbrances. A pre-encumbrance is the recognition of a future obligation from which you can commit budget amounts based on that request. When you generate the purchase order from the requisition, the system relieves the pre-encumbrance as you release quantities and closes the requisition. In addition, as you generate purchase orders, the system creates commitments for the resulting purchase order amounts.

22.1.2 Relief of an Encumbrance or Commitment

A commitment is relieved at the time of receipt (three-way match) or voucher (two-way match). When you cancel purchase order lines, receive goods, or create vouchers for purchases, you can have the system relieve commitments. To do this, the system subtracts the individual commitment amount from the total commitment amount for the job or project.

Use the Commitment Relief constant in the Job Cost Constants program (P0026) to establish the criteria that the system uses to automatically relieve open commitments when you run the general ledger posting program for:

- Vouchers that are matched in a two-way environment.
- Purchase order receipts that are matched in a three-way environment.

Just receiving or vouchering an order does not relieve the commitment. The General Ledger Post Report program (R09801) calls the Update Commitment Ledger program (X00COM) that actually relieves the commitment. Committed amounts are relieved from the PA ledger and are added to the Actual Amount (AA) ledger.

When vouchers or receipts are posted, the system:

- Relieves the commitment.
- Creates an audit trail in the P.O. Detail Ledger File - Flexible Version table (F43199).

- Recalculates the amounts in the account balances ledgers, if necessary.
- Changes the exchange rate of selected purchase orders and restates the domestic commitment amounts, if necessary.

When you inquire on commitments, the receipt general ledger date, not the original purchase order general ledger date, is used to relieve the commitment.

If the Expense At Voucher option is selected on the Line Type Constants Revisions form, then the system relieves commitments when posting the voucher match batch. This applies to two-way and three-way voucher match. Expense at voucher works like two-way match. The expense is vouchered as a three-way match but because there are no general ledger records from receipts the expense at voucher functions like a two-way match. Thus, the commitment relief is for the voucher amount and not the receipt amount.

See [Understanding Order Line Types](#).

See [Expense at Voucher Match](#).

22.1.3 Files Used for Commitments and Encumbrances

In addition to the entries that are made to the purchasing tables during order entry, receipt processing, and voucher match, the system also maintains commitment information in these tables:

- P.O. Detail Ledger File - Flexible Version (F43199).
- Account Balances (F0902).

22.1.4 F43199 Table

The system creates multiple entries in the F43199 table. Based on change orders, order activity rules, and commitments, the system maintains these multiple ledgers to satisfy business requirements:

- Purchasing Ledger.
- Commitment Audit Trail (PA/PU Ledger).
- Change Order Ledger (CO Ledger).

If you are tracking commitments, an audit trail of the commitment transaction is created in the F43199 table. The committed amounts are maintained in the PA ledger, and any committed units are maintained in the Purchase Units (PU) ledger. When you review the PA or PU ledger, you will notice that, unlike the purchasing ledger, the Last Status Code and Next Status Code fields are blank.

Each commitment transaction represents one of these situations:

- The entry of an original commitment.
- A change to a commitment.
- A canceled commitment.
- A relieved commitment due to a receipt or payment.

22.1.5 F0902 Table

During order entry, the system creates a commitment entry in the PA and PU ledgers in the F0902 table. Based on the general ledger date, the system creates an entry in the

appropriate accounting period and adds the committed amount to the total budgeted amount.

If the Commitment Relief constant is set to **Y**, the system posts the receipt payment to the PA and PU ledgers in the F0902 table. Based on the general ledger date of the receipt (three-way match) or voucher batches (two-way match), the system relieves the commitment from the appropriate period, as well as the total budgeted amount.

Note: The commitment relief occurs only at the time that the journal entry is posted.

22.2 Understanding How to Review Commitment Information for Orders

You can monitor individual commitment or encumbrance amounts for a job or project to verify the types of purchases being made. You can also review the total commitment or encumbrance amount for a job or project to verify that the amount does not exceed the budget.

After you receive goods or services or create vouchers, you can have the system relieve commitments and encumbrances. The system does this by reducing the total commitment amount for a job or project by the individual commitment amount. If you use a formal receiving process, the system performs commitment relief when you post journal entries for receipts or vouchers to the general ledger. If you use an informal receiving process, the system relieves open commitments when you post vouchers to the general ledger.

The system performs commitment and encumbrance tracking only on order types that you specify in UDC 40/CT. If an order is on hold, the system does not create commitments or encumbrances for the order until you release the hold.

The system tracks commitments and encumbrances only for detail lines that you charge directly to a general ledger account number. These are detail lines to which you assign a line type with an inventory interface of A or B.

Each time that you enter a purchase-order detail line for which commitment tracking is applicable, the system records the amount in the PA ledger, which contains committed purchase amounts in domestic currency, and the PU ledger, which contains committed purchase units.

You can review individual commitment transactions for:

- A branch/plant.
- An account number.
- A supplier.
- An order number and type.

You can also review the total amount of all commitments, relieved commitments, and open commitments for each of the preceding items.

Each commitment transaction represents one of these situations:

- The entry of an original commitment.
- A change to a commitment.
- A canceled commitment.
- A relieved commitment due to a receipt or payment.

You can review details for each transaction, such as the account number, order number, line number, and supplier, as well as who generated the transaction and when.

The system retrieves commitment transaction information from the F43199 table.

22.3 Understanding the Commitment Integrity Verification Process

To ensure commitment integrity for commitments and encumbrances, you:

- Run the Commitment Integrity Report (R40910).
- Purge PA ledger detail records.
- Rebuild a commitment audit trail.
- Post committed costs to jobs.

You should run the Commitment Integrity Report (R40910) in proof mode and never in final mode. If the report displays variances, you should run the Purge, Rebuild and Post process.

The Purge, Rebuild and Post process can assist in correcting data integrity issues in the Account Balances (F0902) and P.O. Detail Ledger (F43199) Purchase Amount (PA) ledger record files.

When you run the Commitment Integrity Report for purge, rebuild, and post purposes, delete only PA ledger records (per fiscal year) for those accounts that appear to have integrity issues on the report.

The process consists of running three batch applications:

- Ledger Purge (R43199P).
- Create F43199 Commitment Audit Trail (R00993).
- Repost Committed Costs (R00932).

This process deletes and rewrites the PA ledger records to the P.O. Detail Ledger table (F43199) and reposts the amounts to the Account Balances table (F0902) based on the Purchase Order Detail (F4311) and Purchase Order Receiver (F43121) records.

22.4 Working with Commitments and Encumbrances

This section lists prerequisites and discusses how to:

- Set processing options for Commitment Inquiry (P40230A).
- Review commitment information for orders.

22.4.1 Prerequisites

Before working with commitments and encumbrances:

- Set up the document types for pre-encumbrances and commitments in UDC 40/CT.
- To relieve commitments, set the Commitment Relief value for the transaction company or company 00000 in the F0026 table.

See [Setting Up Commitment Tracking](#).

22.4.2 Form Used to Work with Commitments and Encumbrances

Form Name	Form ID	Navigation	Usage
Work With Commitment Inquiry	W40230AA	Purchasing Inquiries (G43B112), Commitment Inquiry	Review commitment information for orders.
		Purchasing Inquiries (G43C112), Encumbrance Inquiry	Work with commitment inquiries.
		Subcontract Inquiries (G43D112), Commitment Inquiry	

22.4.3 Setting Processing Options for Commitment Inquiry (P40230A)

Processing options enable you to specify the default processing for programs and reports.

22.4.3.1 Default

This processing option specifies default information that the system uses for commitment inquiry.

Order Type

Enter a value from UDC 00/DT that identifies the type of document. This code also indicates the origin of the transaction. JD Edwards EnterpriseOne has reserved document type codes for vouchers, invoices, receipts, and time sheets, which create automatic offset entries during the post program. (These entries are not self-balancing when you originally enter them.) These document types are defined by JD Edwards EnterpriseOne and should not be changed:

P: Accounts Payable documents.

R: Accounts Receivable documents.

T: Payroll documents.

I: Inventory documents.

O: Purchase Order Processing documents.

J: General Accounting/Joint Interest Billing documents.

S: Sales Order Processing documents.

22.4.3.2 Display

This processing option specifies the type of information that the system displays.

Enter '1' for Change Orders else Commitments

Enter a value to specify the display of change orders or commitments.

Enter **1** to perform change orders.

22.4.3.3 Versions

This processing option specifies which version of various programs the system uses.

Order Entry (P4310)

Specify the version that the system uses when you use the Order Entry program.

22.4.4 Reviewing Commitment Information for Orders

Access the Work With Commitment Inquiry form.

Figure 22–1 Work With Commitment Inquiry form

Order Number	Or Ty	Order Co	Chg No.	Line Number	Dist. Line Number	Supplier	Supplier Description	Amount Committed	Amount Relieved	Amount Open
1	OP	00050	000	1.000		530920	Sub Labor Job Reqd Hrs Reqd	999.48		
1	OP	00050	000	1.000		530920	Sub Labor Job Reqd Hrs Reqd		999.48	
Order Total										
2	OP	00050	000	1.000		530920	Sub Labor Job Reqd Hrs Reqd	4,550.00		
2	OP	00050	000	1.000		530920	Sub Labor Job Reqd Hrs Reqd		4,550.00	
Order Total										
3	OP	00050	000	1.000		530920	Sub Labor Job Reqd Hrs Reqd	5,555.55		
3	OP	00050	000	1.000		530920	Sub Labor Job Reqd Hrs Reqd		5,555.55	
Order Total										
4	OP	00050	000	1.000		530920	Sub Labor Job Reqd Hrs Reqd	3,333.33		

22.5 Running the Commitment Integrity Report

This section provides an overview of the Commitment Integrity Report and discusses how to:

- Run the Commitment Integrity Report.
- Set processing options for Commitment Integrity Report (R40910).

22.5.1 Understanding the Commitment Integrity Report

You can run the Commitment Integrity Report to compare the open order amounts against the committed amounts and amount balances, and to review any variances.

The Commitment Integrity Report (R40910) displays variances between the:

- Purchase Order Detail table (F4311) and the PA ledger types in the P.O. Detail Ledger records (F43199).
- PA ledger types in the P.O. Detail Ledger records (F43199) and the Account Balances table (F0902).

Two comparisons are made to identify out-of-balance conditions between files.

The detail file and the audit file are compared on a to-date basis, which means that all data in the files is summed regardless of date. The detail file is not date sensitive and does not contain information such as when you made changes to the open amount.

The system compares the audit file and the balances file on a through-period-end basis. The system uses the date that you enter in the first processing option to determine the period end date to use. This comparison is period-sensitive because that is the lowest level of detail that is stored in the balances file.

The columns under Balance to Date on the left side of the report are Purchase Order Detail File (F4311), P.O. Detail Ledger File - Flexible Version (F43199), and Variance. The amounts reported by account number and subledger are:

- Open amount in the detail file.
- Total of the Commitment Audit Trail transactions.
- Difference between the two columns.

The columns under Balance as of xx/xx/xx on the right side of the report are P.O. Detail Ledger File - Flexible Version (F43199), Account Balances (F0902), and Variance. The amounts reported by account number and subledger are:

- Total of the Commitment Audit Trail transactions.
- Account Balances total.
- Difference between the two columns.

Variances occur between the F4311 table and the Commitment Audit Trail under these conditions:

- Unposted receipt or voucher batches.
To confirm that all O and V batches are posted, run the Unposted Batches report (R007011).
- Orders on budget hold.
The system does not create an encumbrance until an order is released from budget hold.

If you find an inconsistency in the commitments that cannot be resolved, you can correct the information in the PA ledger. All entries in the PA and PU ledgers are based on the F4311 table. You can rebuild this information from the F4311 table and correct any inconsistencies in the F0902 table.

Note: You should run the Commitment Integrity Report in proof mode and never in final mode. If the report displays variances, you should run the Purge, Rebuild and Post process.

22.5.2 Running the Commitment Integrity Report

Select Purchasing Reports (G43C111), Encumbrance Integrity Report.

Alternatively, select Purchasing Reports (G43B111), Commitment Integrity Report.

22.5.3 Setting Processing Options for Commitment Integrity Report (R40910)

Processing options enable you to specify the default processing for programs and reports.

22.5.3.1 Default

This processing option specifies default information that the system uses for processing.

1. Enter the effective date to use in the comparison between the Audit Trail and Account Balance files

Specify the date that identifies the beginning date to use in the search for records. All records with a date greater than or equal to the date specified are returned. Leave this processing option blank to use today's date as the default.

22.5.3.2 Process

These processing options specify how the system processes information.

1. Commitment Variance Display

Specify whether to print only accounts with commitment variances. If you leave this processing option blank, then the system prints all accounts with and without variances. Values are:

Blank: Print all accounts with and without commitment variances.

1: Print all accounts with commitment variances.

2. Process Mode

Specify whether to run the program in proof or final mode. In proof mode, the system compares the Purchase Order Detail File table (F4311) to the P.O. Detail Ledger File - Flexible Version table (F43199) to date, and also compares the F43199 table to the Account Balances table (F0902), based on the Effective Date processing option. In final mode, the system displays these comparisons and writes temporary records to the F43199 and F0902 tables to remove the variances. You should run the purge, rebuild, and repost programs to bring all records into balance. Values are:

Blank: Proof mode

1: Final mode

3. Enter a '1' to display Manufacturing Encumbrances

Specify whether the system processes financial encumbrances that are associated with manufacturing work orders. Values are:

Blank: The system processes only financial encumbrances that are related to purchase orders and subcontracts.

1: The system processes financial encumbrances that are related to purchase orders, subcontracts, and manufacturing work orders.

22.6 Purging PA Ledger Detail Records

This section provides an overview of PA ledger detail records purge and discusses how to:

- Purge PA ledger detail records.
- Set processing options for Ledger (F43199) Purge (R43199P).

22.6.1 Understanding PA Ledger Detail Records Purge

The Ledger (F43199) Purge (R43199P) program purges the existing PA ledger type records from the P.O. Detail Ledger table (F43199).

The selection criteria must be specific to select only the PA ledger type records to avoid serious damage to the system and data. You should create a backup of the file that is affected before you purge the records. All users must be denied access to the P.O. Detail Ledger table (F3199) while the Ledger (F43199) Purge program is being run.

Note: Data selection must be LT (Ledger Type) = PA.

22.6.2 Purging PA Ledger Detail Records

Select Data File Purges (G43A311), P.O. Ledger (F43199).

22.6.3 Setting Processing Options for Ledger (F43199) Purge (R43199P)

Processing options enable you to specify the default processing for programs and reports.

22.6.3.1 Process

These processing options specify how the system processes information.

1. Archive Purged Records

Specify whether to archive purged records. Values are:

Blank: Do not archive purged records.

1: Archive purged records.

2. Archive Environment

Enter the environment that the purged records will be archived to. This processing option is required if the purged records are being archived. The archive environment and data source must be different from the source environment and data source.

3. Archive Table Name

Enter the name of the table that the purged records will be archived to. If this processing option is left blank, the name of the table that is being purged is used. This table will be created by the purge program.

22.7 Rebuilding a Commitment Audit Trail

This section provides an overview of a commitment audit trail, lists prerequisites, and discusses how to rebuild a commitment audit trail.

22.7.1 Understanding a Commitment Audit Trail

A commitment audit trail is a history of commitment balances. For example, you might want to create a commitment audit trail to track amounts on purchase orders and changes to those purchase orders.

If you locate data inconsistencies among any of these tables, you can correct the commitment audit trail:

- F4311
- F43199
- F0902

If the business needs change after you install the JD Edwards EnterpriseOne Procurement system, you might need to create a commitment audit trail for the orders. You can run the Create F43199 Commitment Audit Trail program (R00993) to create a history of commitment balances.

When you run the Create F43199 Commitment Audit Trail program, the system creates an audit trail record of commitments against an order with an account number. When you create an audit trail, the system reads the F4311 table and writes the audit trail data, one line at a time, to the F43199 table. Purchase orders that have audit trails have a PA ledger type in the F43199 table.

The system processes only detail lines that have a document type that is specified in the UDC table for commitment document types (40/CT). Additionally, the system does not create a commitment audit trail for records in which an audit trail already exists. Therefore, to re-create a commitment, you must first purge existing records.

22.7.2 Prerequisites

You must purge the commitment information that currently exists in the F43199 table. Verify that you are deleting information only from the PA ledger.

See [Purging Data](#).

Before you correct a commitment audit trail:

- Verify that the data inconsistencies are in the F43199 table and not in the F0902 table. If the data inconsistencies are in only the F0902 table, you can correct the inconsistencies by running Repost Committed Costs (R00932) to repost the F0902 table.

Note: You can also verify commitment integrity by running the Commitment Integrity Report (R40910).

- Back up the F4311, F43199, and F0902 tables.

22.7.3 Rebuilding a Commitment Audit Trail

Select Commitment Setup/Rebuilds (G43B411), Create Commitment Audit Trail.

Alternatively, select Encumbrance Setup/Rebuilds menu (G43C411), Create Encumber. Audit Trail.

If you locate data inconsistencies between any of these tables, you can correct the commitment audit trail:

- F4311
- F43199
- F0902

To correct the commitment audit trail, you must purge the current commitment audit trail to prevent duplicating the commitment amounts in the new commitment audit trail. Purge only records in the F43199 table with a ledger type of PA and a next status and last status of blank. Select the data dictionary alias:

- Ledger Type (LT)
- Next Status (NXTR)
- Last Status (LTTR)

Important: Use caution when selecting records to purge. The F43199 table contains records for the Purchasing ledger (blank ledger type), Change Order ledger (CO ledger type), rollovers (RO ledger type), and commitment records (PA/PU ledger type). If you purge purchasing ledger, change order, and rollover ledger records, you cannot recover the records.

Note: You can use selection criteria to narrow the scope of information that the system purges and uses to create the new audit trail. For example, you can use account numbers, contract numbers, or order numbers. The selection criteria that you use to purge the audit trail must be the same criteria that you use to create the new audit trail. If they are not, unpredictable results may occur.

After you purge the F43199 table, you must create a new commitment audit trail. The system creates the new commitment audit trail from records in the F4311 table for both open and closed orders. Open orders have records in the audit trail for the original commitment amount and any amounts that have been partially relieved. All partially relieved records for each order are summarized into one relief record. Closed orders have two records posted in the commitment audit trail: one record for the original commitment amount and another for the commitment relief.

After you create the new commitment audit trail, run Repost Committed Costs (R00932) to repost the PA ledger records in the Account Balances table. The system adds the new information in the audit trail and posts these amounts to the Account Balances table.

22.8 Posting Committed Costs to Jobs

This section provides an overview of posting committed costs to jobs and discusses how to:

- Post committed costs to jobs.
- Set processing options for Repost Committed Costs (R00932).

22.8.1 Understanding Posting Committed Costs to Jobs

Run the Post Committed Costs to Jobs program (R00932) to track job costs. When you run this program, the system recalculates the amounts in the F0902 table for the PA and PU ledgers. The system also recalculates monthly amounts in the F0902 table based on information in the F43199 table.

For the most efficient processing, limit the data selection. The batch application is run over the Account Master table (F0901). These parameters can be used in the data selection:

- AID (Account ID)
- CO (Company)
- MCU (Business Unit)
- OBJ (Object Account)
- SUB (Subsidiary)

22.8.2 Posting Committed Costs to Jobs

Select Commitment Setup/Rebuilds (G43B411), Post Committed Costs to Jobs.

Alternatively, select Encumbrance Setup/Rebuilds (G43C411), Post Encumbered Costs to Acct.

Alternatively, select Subcontract Setup/Rebuild (G43D411), Post Committed Cost to Job.

22.8.3 Setting Processing Options for Repost Committed Costs (R00932)

Processing options enable you to specify the default processing for programs and reports.

22.8.3.1 Process

These processing options specify how the system processes information.

1. Fiscal Year From

Specify the fiscal year in which to begin reposting committed costs. If this processing option is left blank, a zero will be supplied, causing the from fiscal year to be 00. Specify the year at the end of the first period rather than the year at the end of the fiscal period. For example, a fiscal year begins October 1, 2008, and ends September 30, 2009. The end of the first period is October 31, 2008. Specify the year 08 rather than 09.

2. Fiscal Year Thru (fiscal year through)

Specify the fiscal year in which to end reposting committed costs. If this processing option is left blank, the from fiscal year will be used.

3. Enter a '1' to process Manufacturing Encumbrances

Specify whether the system processes financial encumbrances that are associated with manufacturing work orders. Values are:

Blank: The system processes only financial encumbrances that are related to purchase orders and subcontracts.

1: The system processes financial encumbrances that are related to purchase orders, subcontracts, and manufacturing work orders.

22.9 Performing Encumbrance Rollover

This section provides an overview of encumbrance rollover and discusses how to:

- Perform encumbrance rollover.
- Set processing options for Encumbrance Rollover (R4317).

22.9.1 Understanding Encumbrance Rollover

The Encumbrance Rollover program (R4317) provides an automated batch process to enable the carryover of prior year's encumbrances into the current year. This must be done to ensure correct budgeting because any monies that are left over from the prior year must be rolled over into the current year or be lost. This program displays an accurate audit trail of these rolled-over amounts, as well as providing a report that displays the previous and new relevant information. The rollover reduces the manual effort that is required of employees who work in environments with a high volume of transactions.

The Encumbrance Rollover program:

1. Updates lines in the Purchase Order Detail table (F4311).

Cancel committed lines on a purchase order or subcontract to ensure that no further payment processing can be made against those lines.

For subcontracts, the purge code must be R. For purchase orders, the system updates the next status to 999 (closed).

2. Decommits (current year) and recommits (new year) accounts in the Account Balances table (F0902).

These lines are assigned to a new account that is created especially for this rollover. This account is controlled through the distribution automatic accounting instruction (AAI) 4430.

3. Creates an Audit Trail report (R4317).
4. Creates a history record in the P.O. Detail Ledger table (F43199).

Many industries use the term *decommit* to relieve commitments. When you relieve or decommit commitments and encumbrances, the system creates an RO ledger type record. You should not purge the RO records because they must be used to create or rebuild commitments.

Encumbrance rollover will be run as a batch program at year's end. Encumbrances at year-end represent the estimated amount of expenditures ultimately to result if unperformed subcontracts and open purchase orders in process are completed.

Typically, local governments and municipalities have the authority to expend their funds only for one fiscal year. As a result, purchase order and subcontract open balances are often canceled at fiscal year end. However, other approaches commonly used involve the recognition of these open balances and *rolling them forward* to the new fiscal year.

Note: All data selection takes place from the Purchase Order Detail table (F4311).

22.9.1.1 Encumbrance Rollover Timing

The Encumbrance Rollover program is a very *time-sensitive* process. This program must be run on the last day of the fiscal year to avoid data integrity issues. Integrity issues should be resolved prior to the last day of the fiscal year so that the program can be run without error.

If the program cannot be run on the last day of the fiscal period, clients should manually close lines and open new lines in the new fiscal year with the new account.

22.9.2 Performing Encumbrance Rollover

Select Procurement Advanced & Technical Ops (G43A31), Encumbrance Rollover.

Alternatively, select Non-Stock Procurement Advanced & Technical Ops (G43B31), Encumbrance Rollover.

22.9.3 Setting Processing Options for Encumbrance Rollover (R4317)

Processing options enable you to specify the default processing for programs and reports.

22.9.3.1 Defaults

These processing options specify default information that the system uses for processing.

1. Rollover Method:

Specify how the system processes year-end encumbrance amounts. The method that you use depends on the business requirements. Values are:

Blank: Rollover is canceled with no further action. No amount is recommitted to a new general ledger date or account.

1: Roll over the year-end encumbrance amount to the next year using a new general ledger date.

2: Roll over the year-end encumbrance amount to the next year using a new general ledger date and a new account number.

2. G/L Class Code: (general ledger class code)

Specify the general ledger class code to use to retrieve the AAIs. You can enter a general ledger class code or leave the field blank to use the general ledger class code from the purchase order detail line. If you are processing subcontracts with account reclassification, you must enter a general ledger class code. If you are processing both purchase orders and subcontracts, the general ledger class code that you enter will be used for both. This code determines the accounts receivable account (class) that is offset when you post invoices. The code that you enter in this field can be alphanumeric or can match the object code of the general ledger account number. Values are:

Blank: Use the general ledger class code from the purchase order detail line.

Note: Do not use code 9999. The system reserves this code for the post program and indicates that offsets will not be created.

3. Ledger Type:

Specify the ledger type that the system uses for the history record in the P.O. Detail Ledger table (F43199). This is a UDC (09/LT) that specifies the type of ledger, such as AA (actual amounts), BA (budget amount), or AU (actual units).

4. New G/L Date: (new general ledger date)

Specify the general ledger date for the current year's encumbrance rollover. This date identifies the financial period to which the transaction is posted. You set up the date range for each financial period in general accounting constants.

5. Decommit G/L Date: (decommit general ledger date)

Specify the general ledger date to decommit, or relieve, the encumbrance. This date identifies the financial period to which the transactions will be posted. You set up the date range for each financial period in the general accounting constants.

22.9.3.2 Process

This processing option specifies how the system processes information.

1. Process mode

Specify whether to run the encumbrance rollover in proof or final mode. When you run the encumbrance rollover in proof mode, the system does not update the status or any applicable tables. When you run the encumbrance rollover in final mode, the system updates the status and all applicable tables. Whether you run the encumbrance rollover in proof or final mode, you can print journal entries and errors. Values are:

Blank: Run the encumbrance rollover in proof mode.

1: Run the encumbrance rollover in final mode.

22.9.3.3 MFG Edits

These processing options specify manufacturing information.

1. Enter a '1' to process Manufacturing Encumbrances

Specify whether to process financial encumbrances that are related to manufacturing work orders. Values are:

Blank: Process financial encumbrances that are related to purchase orders and subcontracts.

1: Process financial encumbrances that are related to purchase orders, subcontracts, and manufacturing work orders.

2. Work Order Close Status

Specify the work order status that the system uses to close open work orders. You can also use this processing option to specify the work order status that the system uses to determine whether an order is open. The system processes only work orders for which the status is less than the closed work order status that you specify in this processing option. If you leave this processing option blank, the system uses status 99 (close) as the default.

Using Customer and Supplier Self-Service

This chapter contains the following topics:

- [Section 23.1, "Reviewing Receipts on the Web"](#)
- [Section 23.2, "Reviewing Orders on the Web"](#)
- [Section 23.3, "Responding to Requests for Quotes"](#)

23.1 Reviewing Receipts on the Web

Suppliers use their item numbers or can enter the order numbers to review order information, such as original quantity, units relieved, amount relieved, and original amount.

This section lists a prerequisite and lists the forms used to review receipts on the web.

23.1.1 Prerequisite

You must set the processing options for Purchase Receipts Inquiry (P43214) for the suppliers to review receipt information.

See [Setting Processing Options for Purchase Receipts Inquiry \(P43214\)](#).

23.1.2 Form Used to Review Receipts on the Web

Form Name	Form ID	Navigation	Usage
Purchase Receipts Inquiry	W43214A	Supplier Self-Service (G43S11), Purchase Receipts Inquiry	Review receipts on the web.

23.2 Reviewing Orders on the Web

This section provides an overview of order review and discusses how to review orders.

23.2.1 Understanding Order Review

Orders convey much of the information needed by suppliers to fulfill the organization's orders. However, after the order is shipped it is often difficult for suppliers to get any more information from customers regarding not only that particular order, but also what the next order might be and when it might be needed.

To review orders or agreements in a standard environment, the suppliers are usually assisted by personnel in the organization who are familiar with the system as well as the process requirements. When you create a supplier self-service environment on the web, you enable the suppliers access to specific information pertaining to orders that you have placed with them.

Suppliers use their item numbers or can enter the order numbers to review information for an order such as original quantity, units relieved, amount relieved, and original amount, purchase agreements, and promised date.

23.2.2 Reviewing Orders

Select Supplier Self-Service (G43S11), and activate the Self-Service processing option for the applicable program.

23.3 Responding to Requests for Quotes

This section provides an overview of self-service response to requests for quotes, lists a prerequisite, and discusses how to set processing options for Quote Response Entry (P4334).

23.3.1 Understanding Self-Service Response to Requests for Quotes

Self-service functionality enables suppliers to enter data directly into the procurement system, which can be very beneficial in areas such as responding to a request for quote. Authorized suppliers can access the designated website and enter their response directly into the system, which reduces transcription errors and possible confusion that can occur in other methods of communication from the supplier.

Suppliers use their item number or can enter the order number to review information for an order, such as original quantity, units relieved, amount relieved, and original amount.

23.3.2 Prerequisite

You must set the processing options for Quote Response Entry (P4334) for the suppliers to review quote information.

23.3.3 Form Used to Respond to Requests for Quotes

Form Name	Form ID	Navigation	Usage
Quote Inquiry	W4334B	Supplier Self-Service (G43S11), Respond to Request for Quote	Respond to requests for quotes.

23.3.4 Setting Processing Options for Quote Response Entry (P4334)

Processing options enable you to specify the default processing for programs and reports.

23.3.4.1 Default

This processing option enables you to specify the default order type.

Order Type

Specify the type of document that you want to create.

This code also indicates the original document type of the transaction.

Document types are user-defined codes (UDCs) (00/DT) that you set up. Specific document type codes are reserved for vouchers, invoices, receipts, and time sheets for which the system creates automatic offset entries during the post program. (These entries are not self-balancing when you originally enter them.) These document types are predefined; do not change them

P: Accounts Payable documents.

R: Accounts Receivable documents.

T: Payroll documents.

I: Inventory documents.

O: Purchase Order documents.

J: General Ledger and Joint Interest Billing documents.

S: Sales Order documents.

Enter a value or select one from the User Defined Code form.

23.3.4.2 Self-Service

This processing option enables you to specify which type of self-service you are using.

Supplier Self-Service

Specify whether you are using Supplier Self-Service. Values are:

Blank: Customer Self-Service.

1: Supplier Self-Service.

This chapter contains the following topics:

- [Section 24.1, "Understanding Data Purge Programs"](#)
- [Section 24.2, "Purging Data"](#)

24.1 Understanding Data Purge Programs

When data becomes obsolete or you need more disk space, you can use purge programs to remove data from files.

The system provides purges for removing data from files where the selection criteria needs to be specific. Purges are programs that have predefined criteria that the system checks before removing any data so that you avoid removing associated data that is located in other files.

Important: You must know the proper procedures and consequences of purging data to avoid serious damage to the system and data. Purging data is typically performed by a system administrator or operations personnel. Only those employees who understand the purging process and its results should be allowed access to this procedure.

You can run these purge programs in JD Edwards EnterpriseOne Procurement:

- Detail (F4311) Purge (R4311P).
- Receiver (F43121) Purge (R43121P).
- Ledger (F43199) Purge (R43199P).
- F4301 Purchase Order Header Purge (R4301P).
- Close Text Lines (R43960).
- F43001 Purge Transaction Records (R43001P).

This program purges the Procurement Self-Service Transaction Log table (F43001).

- Purge Purchase Order Dispatch (R4333WFP).

This program purges the Purchase Order Dispatch Work File table (F4333WF).

24.1.1 Considerations

When you run the F4301 Purchase Order Header Purge program (R4301P), the system purges records only if no active detail lines exist. Therefore, before you run the F4301 Purchase Order Header Purge program, you should run the Detail F4311 Purge program (R4311P).

The R4301P purges the Purchase Order Detail Non-Billable (F4317) and Purchase Order Receiver Non-Billable (F43127) tables and also purges the values in the supplier classification code fields.

Unlike the other purge programs, the Close Text Lines program (R43960) does not delete data. The program moves text lines to a status of 999 for an order that is closed.

To run the Close Text Lines program, you submit a batch job using the Available Versions form. You run the Close Text Lines program the same way that you run reports or any other type of batch job.

24.1.2 Prerequisites

Before you purge data:

- Create a purge environment, which enables you to save purged records and prevents the records from being overwritten when you upgrade the software.
- Back up the files that will be affected.
- Determine the data that you want to purge.
- Verify that no users are working with the data that you want to purge.

24.2 Purging Data

This section discusses how to:

- Purge data.
- Run the F43001 Purge Transaction Records program (R43001P).
- Run the Purge Purchase Order Dispatch program (R4333WFP).

24.2.1 Forms Used to Purge Data

Form Name	Form ID	Navigation	Usage
Available Versions	W98305WA	Data File Purges (G43A311), any option	Purge data.
Table Conversion Prompting	W98305WO	Select a version on the Available Versions form, and then click the Select button.	Specify purge settings.

24.2.2 Purging Data

Access the Available Versions form.

Use this procedure to run any of the purge programs in the JD Edwards EnterpriseOne Procurement system (with the exception of the Close Text Lines purge).

To purge data:

1. Select a version.

2. On Table Conversion Prompting, select the Properties option and click Submit.
3. On the properties window, select the Select Environments tab.
4. Select the From and To environments, which enable you to specify the environment from which to purge data and the environment in which to store purged data.
5. Select the Data Selection tab and specify the information to purge.
The system automatically displays processing options for the purge program.
6. Click OK.
7. Complete the processing options according to these guidelines:
 - For the first processing option, enter **1** to save purged records.
You cannot save purged records unless you have created a purge environment. If you leave this processing option blank, the system deletes all purged records.
 - For the second processing option, enter a new name for the environment that stores purged records.
By renaming the environment before you run a purge program, you can store the records from each purge separately. Otherwise, the system overwrites the data each time that you run the purge program. Before completing this processing option, ensure that you have specified that you want the system to save purged records. After completing this processing option, you must complete the third processing option, which enables you to enter the data source name.
 - For the third processing option, enter the name of the data source for the purged records.
Before completing this processing option, ensure that you have specified that you want the system to save purged records and that you have entered a new environment name.
8. To run the purge program, click OK.
To exit without running the purge program, click Cancel.

24.2.3 Running the F43001 Purge Transaction Records Program (R43001P)

Select System Administration Tools (GH9011), Batch Versions.

Alternatively, enter **BV** in the Fast Path field.

24.2.4 Running the Purge Purchase Order Dispatch Program (R4333WFP)

Select System Administration Tools (GH9011), Batch Versions.

Alternatively, enter **BV** in the Fast Path field.

A

Tables Used by JD Edwards EnterpriseOne Procurement Management

This appendix contains the following topics:

- [Section A.1, "Tables Used by JD Edwards EnterpriseOne Procurement Management"](#)

A.1 Tables Used by JD Edwards EnterpriseOne Procurement Management

This table lists the tables that are used by JD Edwards EnterpriseOne Procurement Management. They are listed in alphanumeric order by table number.

Table	Description
Address Book Master (F0101)	Stores names, address numbers, search types, and address-book category-code information for an individual or company that is assigned an address book number.
Supplier Master (F0401)	Stores supplier-specific information.
Distribution/Manufacturing Constants (F4009)	Stores information that specifies whether the item unit-of-measure conversions are unique for each item or applicable to each item in the warehouse.
Order Templates (F4015)	Stores information about order templates.
Print Messages (F4016)	Stores predefined messages that print on documents such as sales orders and purchase orders.
Order Activity Rules (F40203)	Stores information about order activity rules, such as order type, line type, last status, and next status.
Distribution/Manufacturing - AAI Record Type (F4090)	Stores record types for automatic accounting instructions (AAIs).
Distribution/Manufacturing - AAI Values (F4095)	Stores AAI information, such as AAI table number, company, document type, G/L category code, and cost type.
Item Master (F4101)	Stores basic information about each item, such as item number, description, search keys, category codes, and default units of measure.

Table	Description
Item Location File (F41021)	Stores each item's quantity information, general ledger class, and lot status in each location.
Item Cost File (F4105)	Stores inventory cost records.
Supplier Price/Catalog File (F41061)	Stores unit cost for an item based on branch/plant and supplier.
Held Orders (F4209)	Stores historical information about order approvals.
Procurement Self-Service Transaction Log (F43001)	Stores Procurement self-service transaction log information.
Approval Levels (F43008)	Stores information about approval levels.
Purchase Order Header (F4301)	Stores header information for the purchase order. Also stores the supplier classification codes from the address book.
PO Header Work File (F4301Z)	Stores header information for the purchase order in a temporary work file. Also stores the supplier classification codes from the address book.
Purchase Order Header Unedited Transaction Table (F4301Z1)	Stores purchase-order header information for Procurement outbound interoperability. This includes the supplier classification codes from the address book and the user-defined fields. The records for the F4320 table are not written to any Z file.
Log Master (F4303)	Stores information for logs, such as job number, change request number, log type, log number, status, submittals, transmittals, and dates.
Log Models (F4303M)	Stores information for model logs.
Log Hierarchy Constants (F4304)	Stores log hierarchy levels.
Log Master (F4305)	Stores information for logs at five levels, such as contract level logs, company level logs, subcontractor level logs, project level logs, and job level logs.
Approvals Fields Constants (F43080)	Stores information about the fields that are activated and deactivated for reapproval processing.
Supplier/Item Relationships (F43090)	Stores information for item and supplier relationships, such as status of the relationship, receipt route for the relationship, and price of the item.
Receipt Routing Master File (F43091)	Stores information about the operations that move quantity to inventory.
Purchase Order Receipt Routing File (F43092)	Stores information for receipt routings.
Receipt Routing Work File (F43092Z)	Stores information for receipt routings in a temporary work file.
Receipt Routing Unedited Transaction Table (F43092Z1)	Stores receipt routing information for Procurement outbound interoperability.
Inspection/Sample Size Table (F43093)	Stores test result information.
Supplier Item Additional Routes (F43094)	Stores routing information for supplier items.

Table	Description
Receipt Routing Ledger File (F43099)	Stores receipt routing ledger information.
Supplier and Branch Plant Relationship (F43100)	Stores information about supplier and branch/plant relationships.
Purchase Order Detail File (F4311)	Stores the detail information for the purchase order. This includes the category codes 01 through 04 fields. The Job Typ field for Project and Government Contract Accounting is stored in this table. The column GBCFG (Generated by Configurator) has a flag that indicates that the purchase order has a related configured order.
Purchase Order Detail Tag File (F4311T)	Stores additional purchase order detail information in a tag file to the F4311 table.
Purchase Order Generator File (F4311Z)	Stores purchase order information.
Purchase Order Detail Unedited Transaction Table (F4311Z1)	Stores purchase order detail information for Procurement outbound interoperability. This includes the user-defined fields. The records for the F4320 table are not written to any Z file.
Purchase Order Receiver File (F43121)	Stores receipt record and voucher record information with details such as open quantity and open amount. The Job Typ field for Project and Government Contracting is stored in this table.
Purchase Order Receiver Tag File (F43121T)	Stores additional receipt and voucher record information in a tag file to the F43121 table.
Receiver workfile (F43121Z)	Stores receipt record and voucher record information in a temporary work file.
Receipts Unedited Transaction Table (F43121Z1)	Stores purchase order receipt information for Procurement outbound interoperability.
Purchase Order Receiver Multiple Account (F43126)	Stores multiple account information for purchase order receivers.
Purchase Order Receiver Multiple Account Tag File (F43126T)	Stores additional information about multiple accounts for purchase order receivers in a tag file to the F43126 table.
Purchase Order Receiver Non-Billable (F43127)	Stores receipt information regarding nonbillable purchase-order detail lines.
Sales Order/Purchasing Text Detail Lines (F4314)	Stores the text information for detail lines on sales and purchase orders.
Voucher Match Multiple Account Tag File (F43146T)	Stores multiple account information for voucher match in a tag file to the F43146 table.
Freight Distribution Workfile (F43147)	Stores freight distribution information.
Voucher Match Selection File (F4314Z)	Stores voucher match information. The Job Typ field for Project and Government Contract Accounting is stored in this table.
Purchase Order Multiple Account File (F4316)	Stores multiple account distribution information for purchase orders.
Model Purchase Order Multiple Account File (F4316M)	Stores multiple account distribution information for model purchase orders.

Table	Description
Purchase Order Multiple Account Tag File (F4316T)	Stores additional multiple account distribution information for purchase orders in a tag file to the F4316 table.
Purchase Order Detail Non-Billable (F4317)	Stores information about purchase order detail lines that are nonbillable.
Approval/Rejection Reasons (F4318)	Stores information about approval and rejection reasons.
P.O. Detail Ledger File - Flexible Version (F43199)	Stores detail information for each purchase order line, such as item number, price, quantity ordered, and purchase amount (PA) ledger type.
Supplier Schedule Master File (F4321)	Stores most of the data that controls scheduling arrangements with the supplier. This table also contains information that is required for creating and maintaining the schedule, such as ship lead time, schedule days, ship pattern, shipment quantity, and delivery location. The system uses information from the Supplier Schedule Master File table for each line item on a blanket order that you use in the supplier scheduling process.
Supplier Schedule Master File (F43211)	Stores the data that identifies predetermined split percentages between suppliers, by item.
SRS Ship Dates (F43213)	Stores shipment dates for supplier release scheduling.
Purchasing Tolerance Rules (F4322)	Stores the purchasing tolerance rule settings, such as unit price tolerance and extended tolerance amounts.
Supplier Selection File (F4330)	Stores supplier information, such as individual price quote information.
Quantity Breaks File (F4331)	Stores information about quantity price breaks.
Multiple Requisition File (F4332)	Stores requisition information to create the detail lines on quote orders.
Purchase Order Dispatch Work File (F4333WF)	Stores dispatch information about purchase orders in a temporary work file.
Purchase Rebate Master File (F4340)	Stores information about purchase order rebates.
Purchase Rebate Threshold File (F4341)	Stores purchase rebate threshold information.
Purchase Inclusion Rules (F4342)	Stores purchase inclusion rule information.
Purchase Rebate History (F4343)	Stores standard procurement rebate information.
Supplier Page Hyperlinks (F4350)	Stores supplier information.
Supplier Page Hyperlinks (F4351)	Stores supplier information.
Subcontractor Threshold (F4355)	Stores information for the threshold that has been set for the subcontractor or supplier.
Open Purchase Order by Item Work File (F43632Z)	Stores open purchase order information by item. This is a temporary work file.

Table	Description
Suggested Reorder Stock Items (F4371)	<p>Stores information from the Stocked Item Reorder Point Batch Purchase Order Generator program (R437002) report that contains a list of items that the system suggests for reordering.</p> <p>When you are finished working with suggestions for reordering items, the system gives the option of purging the records that are contained in the Suggested Reorder Stock Items table (F4371).</p>
Summary Voucher Match (F43800)	Stores summary information for voucher matching.
Requisition Order Header (F43E01)	Stores requisition header information, such as order company, order number, order type, business unit, order date, order amount, currency, number of detail lines, number of completed detail lines, number of canceled detail lines, requisition header status, and requisition title.

Delivered Workflow for JD Edwards EnterpriseOne Procurement Management

This appendix contains the following topics:

- [Section B.1, "Delivered Workflow for JD Edwards EnterpriseOne Procurement Management"](#)

See Also:

- *JD Edwards EnterpriseOne Tools Workflow Tools Guide.*

B.1 Delivered Workflow for JD Edwards EnterpriseOne Procurement Management

This section discusses the JD Edwards EnterpriseOne Procurement Management workflow.

B.1.1 Purchase Order Acknowledgement Approval

This section discusses the Purchase Order Acknowledgement Approval workflow.

B.1.1.1 Description

Workflow Description

During workflow processing, the system determines whether Quantity, Unit Cost, Extended Amount, or Promised Delivery Date exceeds the tolerance that is defined by the buyer. If Quantity, Unit Cost, Extended Amount, or Promised Delivery Date exceeds the tolerance, then the system changes the order line status to Awaiting Approval, as defined in the processing option, and sends the order line to the buyer's distribution list for approval.

Workflow Trigger

When the system is acknowledging an order line, if the Quantity, Unit Cost, Extended Amount, or Promised Delivery Date exceeds tolerance, then the system changes the order line status to Awaiting Approval and sends an approval message to the associated distribution list.

Workflow Action

The buyer in the distribution list receives a message in the Awaiting Approval queue in the Work Center. Upon receipt, the buyer can approve or reject the message.

B.1.1.2 Workflow Objects

System

43

Workflow Object Name

K43181

Object IDs

W43S01B, W43S01E

Event Description / Function Names

Button Clicked, Button Clicked

Sequence / Line Numbers

47, 48

B.1.2 Promised Date Change

This section discusses the Promised Date Change workflow.

B.1.2.1 Description

Workflow Description

During workflow processing, the system sends a message to an approver if the Promised Delivery Date has changed on a purchase order.

Workflow Trigger

When the Promised Delivery Date has changed, the system sends a message to a reviewer.

Workflow Action

When the Promised Delivery Date has changed, the system sends a message to a reviewer. If the reviewer approves the date, the system updates the date. Otherwise, the system does not update the date. The system also sends a message to the originator whether the date is approved or rejected.

B.1.2.2 Workflow Objects

System

43

Workflow Object Name

PROMISED DT

Object ID

N4301790

Event Description / Function Name

StartWorkFlowProcessOnTheWeb

Sequence / Line Number

2

JD Edwards EnterpriseOne Procurement Management Reports

This appendix contains the following topics:

- [Section C.1, "JD Edwards EnterpriseOne Procurement Management Reports: A to Z"](#)
- [Section C.2, "JD Edwards EnterpriseOne Procurement Management Selected Reports"](#)

C.1 JD Edwards EnterpriseOne Procurement Management Reports: A to Z

This table lists the JD Edwards EnterpriseOne Procurement Management Reports, sorted alphanumerically by report ID.

Report ID and Report Name	Description	Navigation
R43415 Purchase Order Summary by Supplier	Prints purchase order information by supplier, then by business unit.	Select Purchasing Reports (G43A111), PO Summary.
R43420 Purchase Ledger Report	Lists original detail line information and changes that have been made to the quantity or extended amount on each detail line.	Select Purchasing Reports (G43A111), Purchases Journal. Select Subcontract Reports (G43D111), Purchase Journal.
R43640 Open Purchase Order by Request Date	Prints the open quantity or monetary amount for each item and the date through which each item remains open based on the request date. A separate report page prints for each supplier that you specify.	Select Purchasing Reports (G43A111), Print PO by Requested Date.

C.2 JD Edwards EnterpriseOne Procurement Management Selected Reports

This section provides detailed information, including processing options, for individual reports. The reports are listed alphanumerically by report ID.

C.2.1 R43415 – Purchase Order Summary by Supplier

This report prints purchase order information by supplier, then by business unit. You can review individual amounts for each purchase order, including the amount received and the amount open. You can also review the total amount for all purchase orders. If a purchase order contains detail lines for multiple branch or plants, the same order might appear several times based on the branch or plant.

There are no processing options for this report.

C.2.2 R43420 – Purchase Ledger Report

The Purchase Ledger Report includes a history of changes to order detail line. This report lists original detail line information and changes that have been made to the quantity or extended amount on each detail line.

For each order that prints, you can review:

- The sum of the original detail line amounts.
- The sum of the detail line changes.
- The sum of the current detail line amounts.

Information for this report comes from the F43199 table. This report is applicable only if you set up order activity rules to create ledger records.

There are no processing options for this report.

C.2.3 R43640 – Open Purchase Order by Request Date

You might want to review information about the items that are currently on order from a supplier. When you generate the PO by Requested Date report, you can review the open quantity or monetary amount for each item and the date through which each item will remain open based on the request date.

You use processing options to specify the aging columns in which open quantities or monetary amounts appear. Processing options significantly affect the data presentation for this report. A separate report page prints for each supplier that you specify.

C.2.4 Processing Options for Open Purchase Order by Request Date (R43640)

Processing options enable you to specify the default processing for programs and reports.

Use these processing options to specify the aging columns in which open quantities or monetary amounts appear. Processing options significantly affect the data presentation for this report.

C.2.4.1 Periods

These processing options enable you to control the period information that the system displays.

Period 1: Open thru day # (period 1: open through day number)

Specify the number of days in the future to query for responses due.

Period 2: End of Period 1 thru day

Specify the number of days in the past to query for quote requests received.

Period 3: End of Period 2 thru day

Specify the number of days for period 2.

Period 4: End of Period 3 thru day

Specify the number of days for period 3.

C.2.4.2 Print

These processing options enable you to specify how the system prints information.

Print Order

Enter 1 to print the records in descending order.

Enter '1' for Period 4 to include POs greater than range (enter '1' for period 4 to include purchase orders greater than range)

Enter 1 to include purchase order that are outside of the range for period 4.

Glossary

Approval Route Code

Enter a code that determines to whom an order is routed for approval.

Branch/Plant

Enter an alphanumeric code that identifies a separate entity within a business for which you want to track costs. For example, a business unit might be a warehouse location, job, project, work center, branch, or plant.

You can assign a business unit to a document, entity, or person for purposes of responsibility reporting. For example, the system provides reports of open accounts payable and accounts receivable by business unit to track equipment by responsible department.

Business unit security might prevent you from viewing information about business units for which you have no authority.

Buyer

Enter the address book number that identifies who is responsible for setting up and maintaining the correct stocking levels for each inventory item.

Discount Factor

Enter the factor that the system applies to the unit price of an inventory item to determine the net price. The system retrieves this value from the inventory pricing rules if you have assigned a rule to this item. The pricing rule setup determines if the system multiplies the unit price by this value or adds to or deducts from the unit price.

Evaluated Receipts

Enter a code that indicates if an order is eligible for the evaluated receipt settlement process. An evaluated receipt settlement indicates that you have an agreement with the supplier to create vouchers based on the items that you receive. You use the Evaluated Receipt Settlement (R43800) procedure to create vouchers from receipt records. As a result, the supplier does not send you invoices and you can bypass the Voucher Match procedure. Values are:

N: Not eligible for evaluated receipt settlement processing.

Y: Eligible for evaluated receipt settlement processing.

I: Receipt transaction is in process.

T: Eligible for evaluated receipt settlement processing. However, a tolerance error occurred during the receipt process.

R: Eligible for evaluated receipt settlement processing. However, the receipt is currently in the receipt routing process.

V: A voucher has been created for the receipt transaction using the evaluated receipt settlement process.

Extended Cost

Enter a value that is equal to the number of units multiplied by the unit price.

Freight Handling Code

Enter a code that exists in the Freight Handling Code (42/FR) UDC that indicates the method by which supplier shipments are delivered. For example, the supplier could deliver to the dock, or you could pick up the shipment at the supplier's dock. You can also use these codes to indicate who has responsibility for freight charges. For example, you can have a code indicating that the customer legally takes possession of goods as soon as they leave the supplier warehouse and is responsible for transportation charges to the destination.

G/L Category and G/L Offset (general ledger category and general ledger offset)

Enter a value from the G/L Posting Code (41/9) UDC that identifies the general ledger offset that system uses when it searches for the account to which it posts the transaction. If you do not want to specify a class code, enter **** (four asterisks) in this field.

You can use automatic accounting instructions (AAIs) to predefine classes of automatic offset accounts for the JD Edwards EnterpriseOne Inventory Management system from Oracle, JD Edwards EnterpriseOne Procurement system from Oracle, and JD Edwards EnterpriseOne Sales Order Management system from Oracle. You might assign general ledger class codes as follows:

IN20: Direct ship orders

IN60: Transfer orders

IN80: Stock sales

The system can generate accounting entries based upon a single transaction. For example, a single sale of a stock item can trigger the generation of accounting entries similar to:

Sales-Stock (Debit) xxxxx.xx

Accounts Receivable Stock Sales (Credit) xxxxx.xx

Posting Category: IN80

Stock Inventory (Debit) xxxxx.xx

Stock COGS (Credit) xxxxx.xx

The system uses the class code and the document type to find the AAI.

Hold Code

Enter a code that exists in the Hold Codes (42/HC) UDC that identifies why an order is on hold.

Item Price Group

Enter a code that exists in the Item Price Groups (40/PI) UDC that identifies an inventory price group for an item. Inventory price groups have unique pricing structures that direct the system to incorporate discounts or markups on items on sales

and purchase orders. The discounts or markups are based on the quantity, monetary amount, or weight of the item ordered. When you assign a price group to an item, the item takes on the same pricing structure defined for the inventory price group. You must assign an inventory price group to the supplier or customer, as well as to the item, for the system to interactively calculate discounts and markups on sales orders and purchase orders.

Landed Cost Rule

Enter a code that exists in the Landed Cost Rule (41/P5) UDC that indicates the landed cost rule for an item. The landed cost rule determines purchasing costs that exceed the actual price of an item, such as broker fees or commissions. You set up landed cost rules on the Landed Cost Revisions form.

Last Status

Enter a code that exists in the Activity/Status Codes (40/AT) UDC that indicates the last step in the processing cycle that this order line has successfully completed.

Ledger Type

Enter a code that exists in the Ledger Types (09/LT) UDC that specifies the type of ledger, such as **AA** (Actual Amounts), **BA** (Budget Amount), or **AU** (Actual Units). You can set up multiple, concurrent accounting ledgers within the general ledger to establish an audit trail for all transactions.

Line Type

Enter a code that controls how the system processes lines on a transaction. It controls the systems with which the transaction interfaces, such as Oracle's JD Edwards EnterpriseOne General Ledger, Oracle's JD Edwards EnterpriseOne Job Cost, Oracle's JD Edwards EnterpriseOne Accounts Payable, Oracle's JD Edwards EnterpriseOne Accounts Receivable, and JD Edwards EnterpriseOne Inventory Management. It also specifies the conditions under which a line prints on reports, and it is included in calculations. Values are:

- S:** Stock item
- J:** Job cost
- N:** Nonstock item
- F:** Freight
- T:** Text information
- M:** Miscellaneous charges and credits
- W:** Work order

Next Status

Enter a code that exists in the Activity/Status Codes (40/AT) UDC that indicates the next step in the order flow of the line type.

Order Type

Enter a code that exists in the Document Type (00/DT) UDC that identifies the type of document. This code also indicates the origin of the transaction. There are reserved document type codes for vouchers, invoices, receipts, and time sheets, which create automatic offset entries during the post program. (These entries are not self-balancing when you originally enter them.)

These document types are predefined and should not be changed:

P: Accounts Payable documents.

R: Accounts Receivable documents.

T: Payroll documents.

I: Inventory documents.

O: Purchase Order Processing documents.

J: General Ledger/Joint Interest Billing documents.

S: Sales Order Processing documents.

Pricing Rule

Enter a code that exists in the Item Price Groups (40/PI) UDC to classify inventory by pricing rules. Typically, these categories correspond to the major sections in the inventory price book. You can set up as many detail categories as you need. You can use a single code for sales, purchasing, order/basket, and contract pricing. If you set up a contract rule, it must equal the short number for the item under contract.

Print Message

Enter a value from the Print Messages (40/PM) UDC to specify with print message to use. Examples of text used in messages are engineering specifications, hours of operation during holiday periods, and special delivery instructions.

Subledger

Enter a code that identifies a detailed, auxiliary account within a general ledger account. A subledger can be an equipment item number or an address book number. If you enter a subledger, you must also specify the subledger type.

Supplier

Enter the name or number that identifies an address book record. You can use this field to enter and locate information. If you enter a value other than the address book number (AN8), such as the long address or tax ID, you must precede it with the special character that is defined in the Address Book constants. When the system locates the record, it returns the address book number into the field.

Tax Explanation Code

Enter a code that exists in the Tax Explanation Codes (00/EX) UDC that controls the algorithm that the system uses to calculate tax and general ledger distribution amounts. The system uses the tax explanation code with the tax rate area and tax rules to determine how the tax is calculated. Each transaction pay item can be defined with a different tax explanation code.

Tax Rate/Area

Enter a code that identifies a tax or geographic area that has common tax rates and tax authorities. The system validates the code you enter against the Tax Areas table (F4008). The system uses the tax rate area with the tax explanation code and tax rules to calculate tax and general ledger distribution amounts when you create an invoice or voucher.

Unit Cost

Enter the price charged for the unit of measure in the adjoining field. Use these fields, for example, if the primary unit of measure is **EA** (each), but you typically use a list price per box.

Index

A

- AAIs, 2-1
- Account Balances table (F0902), 22-3
- Account Distribution Adjustment form, 13-15
- Account Distribution Entry form, 10-42, 10-46
- Account Distribution Entry program (P4316), 10-36
- Account Distribution Inquiry form, 12-9
- Account Distribution Inquiry program (P43126), 12-5
- account numbers, 10-36
- Account Revisions form, 6-26
- accounts payable, 1-1
- accounts payable matching, 10-40, 11-4, 12-7, 12-24, 13-12, 18-18
- activity rules
 - discussing, 2-7
 - example, 2-7
 - setting up, 6-8
- actual and committed amount accumulation, 11-27
- additional properties, 10-2, 11-4, 11-40, 16-2
- Additional Selection Criteria form, 11-51
- address book, 1-2
- Address Book Master table (F0101), A-1
- alternate tax rate/area assignment
 - blanket order release, 16-9
 - purchase order detail, 10-38
 - purchase order header, 10-26
 - Purchase Order Workbench program, 11-5
 - voucher match, 13-10
- A/P Standard Voucher Entry program (P0411)
 - processing options, 13-15
 - usage, 13-7
- Application Constants form, 6-12, 6-18
- application control constants, 6-18
- Approval Delegation form, 17-5
- Approval Level Revisions form, 17-5
- Approval Level Revisions program (P43008)
 - processing options, 17-5
 - usage, 17-2
- Approval Levels table (F43008), A-2
- approval processing
 - activating, 10-26
 - approving orders, 17-10
 - bypassing the budget approver, 17-3
 - delegating authority, 17-4
 - overview, 2-3, 17-1
 - rejecting orders, 17-10
 - reviewing approval messages, 17-3, 17-6, 17-8
 - reviewing orders awaiting approval, 17-7, 17-9
 - reviewing persons responsible for approvals, 17-7
 - setting up field constants, 17-11
 - transferring approval authority, 17-4
 - transferring authority, 17-5
- Approval Route Process diagram, 17-6
- approval routes
 - assigning, 17-3
 - assigning a budget approver, 17-3
 - assigning to orders, 10-26
 - changing, 17-3
 - creating, 17-2, 17-5
 - overview, 17-2
- Approval/Rejection Reasons table (F4318), A-4
- Approvals Critical Fields form, 17-12
- Approvals Fields Constants program (P43080), 17-11
- Approvals Fields Constants table (F43080), A-2
- audit trail for commitments, 22-10
- automatic accounting instructions, 2-1
 - setting up, 6-22
 - setting up financial system AAIs, 6-25
 - setting up for distribution, 6-27
 - setting up for procurement, 6-23
 - setting up for purchase order entry, 6-23
 - setting up for receipt routes, 6-25
 - setting up for receipts, 6-23
 - setting up for tax liabilities, 6-24
 - setting up for variances, 6-24
 - setting up for vouchers, 6-23
 - setting up freight distribution AAIs, 6-26
 - setting up landed costs, 6-25
 - setting up non-billable retainage AAIs, 6-26
 - setting up zero balance adjustments, 6-25
 - using for receipts, 12-30
 - using for variances, 13-44
 - using in receipt routing, 18-3
- Available Versions form, 24-2

B

- batch printing, 11-38
- blanket orders

- assigning tolerance rules, 6-27
- creating purchase orders, 16-8
- printing, 16-8
- releasing, 16-8
- working with, 16-8
- branch/plant constants
 - setting up, 6-12
 - setting up item availability, 6-15
- Branch/Plant Constants form, 6-11
- budget amount accumulation, 11-26
- budget approver, 17-3
- budget holds
 - entering, 11-31
 - releasing, 11-34
 - releasing for orders awaiting approval, 17-10
- budget totaling, 11-28
- budgets
 - activating checking, 11-25
 - checking, 11-25
 - reviewing, 11-29, 11-30
 - setting up checking, 11-25
 - working with, 11-25
- Business Interface Integration Objects, 1-6

C

- calculations for order quantities, 16-22
- cascading receipts
 - entering information, 12-23, 12-26
 - overview, 12-23
- catalogs
 - entering, 7-17
 - selecting items from, 11-24
 - setting up supplier default, 7-17
 - using the electronic, 11-2, 11-3
 - viewing electronic, 10-35
- Catalogs - Item Selection form, 11-6
- category codes, 10-2, 11-4, 16-2
 - printing, 11-40
- change orders
 - copying, 10-48
 - entering, 10-39
 - reviewing, 11-50
- clauses
 - printing for purchase orders, 11-40
- Clauses form, 10-28, 10-41
- Close Text Lines program (R43960), 24-1
- Commitment Inquiry program (P40230A)
 - processing options, 22-6
- Commitment Integrity report (R40910)
 - usage, 22-7
- Commitment Integrity Report program (R40910)
 - processing options, 22-8
 - running, 22-8
- commitment integrity verification process
 - understanding, 22-5
- commitment relief
 - setting up, 9-3
- commitment tracking
 - understanding, 9-1

- commitments
 - correcting an audit trail, 22-11
 - creating, 22-2, 22-5
 - creating an audit trail, 22-10
 - entering change orders, 10-39
 - maintaining tables, 22-3
 - overview, 22-1
 - posting to jobs, 22-12
 - relieving, 9-1, 22-2
 - reviewing, 22-4
 - reviewing information for orders, 22-7
 - setting up, 9-1, 9-3, 22-1
 - tracking, 9-1
 - understanding, 22-1
 - using ledgers for, 22-4
 - working with, 22-5
 - working with the audit trail, 22-10
- common fields, i
- constants
 - defining application control, 6-18
 - defining pricing, 6-14
 - defining system, 6-16
 - setting up, 6-11
 - setting up branch/plant, 6-12
- contract pricing, 7-18
- Cost Analysis Details form, 19-8
- Cost Analysis form, 19-8
- cost performance for suppliers, 19-7
- costs
 - creating variances, 13-43
 - entering extended, 10-36
 - entering for items, 7-17
 - entering in multicurrencies, 10-35
 - recording changes to an invoice, 13-35
 - retrieving for items, 10-35
 - setting up landed, 6-33
 - using standard, 12-30
 - using weighted average, 13-44
- currency
 - performing conversions, 19-1
 - reviewing as if, 11-49
 - types for contracts, 11-50
- customer and supplier self-service
 - overview, 5-1
 - setup, 5-1
- Customer Pricing Rules form, 7-20, 7-23

D

- data
 - purging, 24-2
- dates
 - entering for an order, 10-25
 - revising requested and promised for multiple orders, 21-3
- Define Inquiry Columns form, 7-7
- Define Inquiry Formats form, 7-7
- Define Inquiry Paths form, 7-7
- Delivery Analysis Details form, 19-8
- Delivery Analysis form, 19-8

- delivery performance
 - reviewing for suppliers, 19-6
 - setting up guidelines for, 7-13
 - setting up guidelines for suppliers, 7-5
- Detail (F4311) Purge program (R4311P), 24-1
- detail information
 - printing for orders, 11-53
 - reviewing for orders, 11-50
- detail lines
 - adding notes, 10-35
 - canceling, 10-35
 - creating orders from existing, 11-25
 - creating purchase orders from existing, 11-3
 - defining, 10-34
 - entering by account number, 10-36
 - entering by item number, 10-35, 10-42
 - entering discount terms, 10-38
 - entering reporting codes, 10-39
 - entering substitute or replacement items, 10-39
 - entering tax information, 10-37
 - printing voucher information, 13-48
 - reviewing, 10-35
- discount rules, 7-17
 - attaching price to items and suppliers, 7-23
 - creating price for purchasing, 7-21
- discounts
 - attaching to suppliers, 7-19
 - entering for detail lines, 10-38
 - entering rules, 7-18
- distribution AAls
 - setting up, 6-27
- Distribution AAls program (P40950)
 - processing options, 6-26
- Distribution/Manufacturing - AAI Record Type table (F4090), A-1
- Distribution/Manufacturing - AAI Values table (F4095), A-1
- Distribution/Manufacturing Constants table (F4009), A-1
- Document Selection form, 6-39
- Document Type Exceptions form, 6-39

E

- EDI, 1-3, 2-1
- electronic catalog, 11-2, 11-3
- electronic catalogs, 10-35
- electronic data exchange, 2-1
 - overview, 1-3
- Electronic Data Interchange
 - storing purchase order information for, 11-47
- electronic data interchange, 1-3
- electronic mail messages, 17-3, 17-6, 17-8
- Encumbrance Rollover program (R4317)
 - processing options, 22-14
 - running, 22-14
 - usage, 22-13
- encumbrance rollover timing, 22-14
- encumbrance rollovers, 22-13
- encumbrances, 2-1

- creating, 22-2, 22-5
- maintaining tables, 22-3
- performing rollovers, 22-13
- relieving, 22-2
- reviewing, 22-4
- understanding, 22-1
- using ledgers for, 22-4
- working with, 22-5
- Enter Voucher - Payment Information form, 13-47
- environments, 2-6
- evaluated receipt settlement, 13-43
- Evaluated Receipt Settlement program (R43800)
 - processing options, 13-44
- Example of a Receipt Route diagram, 18-1
- exchange rates, 11-50
- expense at voucher match, 13-11
- extended costs, 10-36

F

- F0101 table, A-1
- F0401 table, A-1
- F0411Z1 (Voucher Transactions - Batch Upload)
 - purging, 15-47
- F0411Z1T
 - Voucher Transaction Batch Upload - Voucher Match Automation, 14-5
- F0411Z1T (Voucher Transaction Batch Upload - Voucher Match Automation), 14-12
- F0411Z1T (Voucher Transactions Batch Upload - Voucher Match Automation)
 - purging, 15-47
- F0902 table, 22-3
- F4009 table, A-1
- F4015 table, A-1
- F4016 table, A-1
- F40203 table, A-1
- F4090 table, A-1
- F4095 table, A-1
- F4101 table, A-1
- F41021 table, A-2
- F4105 table, A-2
- F41061 table, A-2
- F4209 table, A-2
- F43001 Purge Transaction Records program (R43001P)
 - running, 24-3
 - usage, 24-1
- F43001 table, A-2
- F43008 table, A-2
- F4301 Purchase Order Header Purge program (R4301P), 24-1
- F4301 table, 16-18, A-2
- F4301Z table, A-2
- F4301Z1 table, A-2
- F4303 table, A-2
- F4303M table, A-2
- F4304 table, A-2
- F4305 table, A-2
- F43080 table, A-2
- F43090 table, A-2

- F43091 table, A-2
- F43092 table, A-2
- F43092Z table, A-2
- F43092Z1 table, A-2
- F43093 table, A-2
- F43094 table, A-2
- F43099 table, A-3
- F43100 table, A-3
- F4311 table, 16-19, A-3
- F4311T table, A-3
- F4311Z table, A-3
- F4311Z1 table, A-3
- F43121 table, A-3
- F43121T table, A-3
- F43121Z table, A-3
- F43121Z1 table, A-3
- F43126 table, A-3
- F43126T table, A-3
- F43127 table, A-3
- F4314 table, A-3
- F43146T table, A-3
- F43147 table, A-3
- F4314Z table, A-3
- F4316 table, A-3
- F4316M table, A-3
- F4316T table, A-4
- F4317 table, A-4
- F4318 table, A-4
- F43199 table, 16-19, 22-3, A-4
- F4321 table, A-4
- F43211 table, A-4
- F43213 table, A-4
- F4322 table, A-4
- F4330 table, A-4
- F4331 table, A-4
- F4332 table, A-4
- F4333WF table, A-4
- F4340 table, A-4
- F4341 table, A-4
- F4342 table, A-4
- F4343 table, A-4
- F4350 table, A-4
- F4351 table, A-4
- F4355 table, A-4
- F43632Z table, A-4
- F4371 table, A-5
- F43800 table, A-5
- F43E01 table, A-5
- field constants
 - setting up for approval processing, 17-11
- financial status
 - reviewing for orders, 11-50
- financial status information, 11-51
- freight distribution
 - setting up automatic accounting instructions for, 6-26
- Freight Distribution program (P43147)
 - processing options, 13-32
- Freight Distribution Revisions form, 13-15
- Freight Distribution Workfile table (F43147), A-3

- freight vouchering, 13-12

G

- general ledger, 1-1
- Generate POs from Requisitions/Blanket Order
 - Release program (P43060)
 - processing options, 16-5
 - usage, 16-3
- Generated Purchase Orders form, 16-24
- global implementation steps, 1-4

H

- Held Order Release program (P43070)
 - processing options, 11-32
- Held Orders table (F4209), A-2
- hierarchical logs
 - overview, 6-45
 - setting up, 6-45
- holds
 - assigning to subcontract payments, 13-8
 - overview, 2-1
 - setting up order, 6-31

I

- implementation steps
 - global, 1-4
 - overview, 1-3
 - procurement, 1-5
- Inclusion Rules Maintenance form, 8-5
- Inspection/Sample Size Table (F43093), A-2
- Inspection/Sample Size Table form, 18-9
- Integration, 1-6
- integration
 - accounts payable, 1-1
 - address Book, 1-2
 - electronic data interchange, 1-3
 - general ledger, 1-1
 - job costing, 1-2
 - logistics, 1-2
 - manufacturing, 1-2
 - product, 1-1
- Inventory Pricing Rules form, 7-20
- invoices
 - entering, 13-47
 - logging prior to receiving goods, 13-46
 - printing logged information, 13-47
 - receiving in an alternate currency, 13-14
 - recording cost changes, 13-35
- Item Availability Definition form, 6-11
- Item Cost File table (F4105), A-2
- item costs, 10-35
- Item Information Required option, 7-3, 7-11
- Item Location File table (F41021), A-2
- Item Master table (F4101), A-1
- Item Restriction Revisions form, 7-6
- item specifications
 - defining, 18-9
 - understanding, 18-8

items

- adding, 7-4
 - assigning multiple locations and lots to receipts, 12-24
 - assigning receipt routes, 18-8
 - assigning to multiple locations and lots, 12-26
 - choosing suppliers from whom to purchase, 11-24
 - creating supplier relationships, 7-4
 - defining specifications for receipt routes, 18-8
 - dispositioning from receipt routes, 18-6
 - entering detail lines, 10-35
 - entering discount rules, 7-18
 - entering for quotes, 16-10
 - entering nonstock, 10-36
 - entering supplier prices, 7-17
 - monitoring supplier quality, 7-5
 - ordering using supplier catalogs, 11-24
 - ordering with templates, 11-3
 - printing a receipt register, 12-32
 - removing from a receipt route, 18-18
 - removing from receipt routes, 18-17
 - reordering, 16-30
 - reversing receipt routes, 18-17
 - reviewing history, 18-19
 - reviewing the receipt route history, 18-19, 18-20
 - reviewing the receipt route status, 18-16
 - setting up guidelines for acceptable, 7-5, 7-15
 - setting up information, 7-1
 - setting up nonstock, 6-35
 - transferring operations, 18-10, 18-16
 - updating availability during receipt routing, 18-3
 - working with receipt routes, 18-10
- Items Selected for Order form, 11-6

J

- Job Cost Constants form, 9-3
- job costing, 1-2
- journal entries
 - creating variances, 13-43
 - items removed from a receipt route, 18-6
 - reviewing and posting voucher transactions, 13-45
 - reviewing for receipt transactions, 12-31
 - reviewing for receipts, 12-30
 - reviewing items removed from a receipt route, 18-17
 - reviewing variances, 12-30
 - updating for items in a receipt route, 18-3
- Journal Entry Prompt form, 13-47

K

- Kit Selection form, 10-42
- kits
 - changing quantity and cost information, 10-40
 - entering components, 10-39
 - entering kit orders, 10-39
 - entering parent items, 10-39

L

- Landed Cost Revisions form, 6-34
- Landed Cost Selection form, 13-5
- Landed Cost Selection program (P43291)
 - processing options, 13-5
 - usage, 13-4
- landed costs
 - creating vouchers, 13-4, 13-8, 13-42
 - entering, 12-5, 13-3
 - entering as a stand-alone process, 13-4
 - entering during the receipt process, 13-3
 - overview, 6-33
 - setting up, 6-33, 6-34
 - setting up automatic accounting instructions for, 6-25
 - using automatic accounting instructions for, 6-33
- Ledger (F43199) Purge program (R43199P), 24-1
 - processing options, 22-10
 - running, 22-9
 - usage, 22-9
- ledgers, 22-4
- level of detail
 - using search scenarios, 11-26
- Line Type Constants Revisions form, 6-4
- line types
 - discussing, 2-7
 - setting up, 6-3
 - setting up for commitments, 22-4
- locations
 - assigning multiple to receipts, 12-24
 - assigning receipt items, 12-24
- Log Hierarchy Constants form, 6-46
- Log Hierarchy Constants table (F4304), A-2
- log hierarchy levels
 - setting up, 6-46
- log information
 - entering, 11-37
- Log Master table (F4303), A-2
- Log Master table (F4305), A-2
- Log Models table (F4303M), A-2
- Log Report/Update program (R43300)
 - processing options, 11-38
 - running, 11-37
- log view options
 - setting up, 6-46
- Logged Voucher Detail program (R43428)
 - processing options, 13-48
- Logged Voucher Detail report (R43428)
 - usage, 13-48
- logistics, 1-2
- logs
 - activating functionality, 6-46
 - copying from a model log, 11-38
 - creating model, 6-43
 - overview, 11-34
 - setting up hierarchy levels, 6-46
 - setting up view options, 6-46
 - working with information, 11-34
- Logs Entry program (P4305)
 - processing options, 11-36

lots assigning to receipt items, 12-24
lump sums, 10-36

M

manual purchase price overrides, 4-3
manufacturing, 1-2
matrix items
 generating receipts, 4-2
 overview, 4-2
 processing tolerance, 4-2
 receiving, 12-7
maximum price adjustments, 4-2
Media Object Viewer form, 6-39, 10-28
minimum price adjustments, 4-2
model logs
 copying, 11-38
 creating, 6-43, 6-44
Model Logs form, 6-44
Model Purchase Order Multiple Account File table
 (F4316M), A-3
multicurrency
 entering for vouchers, 13-8
 entering on orders, 10-24, 10-35
 reviewing receipts, 12-6
multiple account distribution
 updating tables, 13-8
 usage, 10-36
Multiple Requisition File table (F4332), A-4

N

next numbers
 overview, 6-3
 setting up, 6-3
Non Stock Item Revisions form, 6-36, 6-37
non-billable retainage
 setting up automatic accounting instructions
 for, 6-26
Non-Stock Item Master program (P4101N)
 processing options, 6-36
 usage, 6-35
nonstock items
 entering on detail lines, 10-36
 overview, 6-35
 setting up, 6-35, 6-37
notes
 adding for detail lines, 10-35
 adding for orders, 10-25

O

obsolete items, 10-39
Open Purchase Order by Item Work File table
 (F43632Z), A-4
Open Purchase Order by Request Date report
 (R43640)
 processing options, C-2
 usage, C-2
Open Purchase Order by Request report (R43640)
 usage, C-1

Open Purchase Order Status program (R43525)
 processing options, 12-32
open receipts
 reviewing, 13-2
operations in receipt routes, 18-2
order activity rules, 2-1
 setting up, 6-9
Order Activity Rules - Revisions form, 6-9
Order Activity Rules table (F40203), A-1
Order Address Information form, 10-28
Order Detail - Page I form, 10-41
Order Detail - Page II form, 10-41
Order Detail form, 10-28, 10-41, 10-42, 11-5, 11-48,
 11-51, 16-5, 16-9, 16-12, 16-19
order detail information
 discussing, 10-1
 entering, 10-34
 viewing default fields, 10-35
order detail lines
 choosing freight charges to match to
 vouchers, 13-34
 selecting for freight vouchering, 13-34
Order Detail Print program (R4401P)
 processing options, 11-53
Order Entry - Summary Order Information
 form, 11-51
order generation, 2-2
Order Header - Additional Information form, 10-28
Order Header - Additional Information II
 form, 10-28, 10-42
Order Header form, 10-28, 16-5
order header information
 accessing, 10-24
 discussing, 10-1
 entering, 10-23
order hold information
 entering, 6-32
Order Hold Information form, 6-32
order holds
 checking, 11-31
 entering, 11-31
 overview, 6-31
 releasing, 11-34
 setting up, 6-31
Order Information Required option, 7-3, 7-11
order line types
 defining, 6-4
 overview, 2-1
 setting up, 6-3
order processing cycle, 2-6
Order Recap form, 11-51
Order Release form, 16-5, 16-10
Order Revision History form, 16-19
order revisions
 activating, 16-18
 creating, 16-18
 overview, 16-18
 printing information, 16-21
 recording changes, 16-17
 reviewing, 16-20

- Order Revisions Detail form, 16-19
- Order Revisions History report (R43535)
 - printing, 16-21
 - processing options, 16-21
- Order Template Revisions form, 6-40, 6-41
- Order Template Revisions program (P4015)
 - processing options, 6-40
 - usage, 6-39
- order templates
 - creating, 6-39
 - creating for purchase order supplier, 6-41
 - creating for purchase order user, 6-42
 - entering items using, 11-25
 - overview, 2-1
 - revising, 6-42
 - setting up, 6-39
- Order Templates form, 11-6
- Order Templates table (F4015), A-1
- orders, 11-49, 21-1
 - adjusting detail lines, 12-7
 - calculating quantities, 16-22
 - canceling detail lines, 10-35
 - creating from a price quote, 16-17
 - creating from existing detail lines, 11-25
 - duplicating, 11-1, 11-6
 - entering dates, 10-25
 - entering header information, 10-23
 - entering in multicurrencies, 10-24
 - entering information for a specific
 - branch/plant, 10-25
 - entering notes, 10-25
 - entering origination information, 10-24
 - entering reference information, 10-25
 - entering supplier information, 10-24
 - entering tax information, 10-25
 - printing by batch, 11-40
 - printing clauses, 10-3
 - printing detail information, 11-53
 - printing individually, 11-47
 - printing messages, 11-48
 - printing on demand interactively, 11-48
 - processing, 2-6
 - putting on hold, 11-31
 - reviewing changes, 11-50
 - reviewing commitment information, 22-7
 - reviewing detail information, 11-50
 - reviewing financial status, 11-50
 - reviewing financial status information, 11-51
 - reviewing open, 11-49
 - reviewing related information, 11-49
 - reviewing summary information, 11-50
 - reviewing via self-service, 23-1
 - revising, 16-17
 - using price quotes to create, 16-14
- overview, 1-1

P

- P04012 program
 - processing options, 7-8

- P041051 program, 13-47
- P0411 program
 - processing options, 13-15
 - usage, 13-7, 13-47
- P042002 program, 13-47
- P4015 program
 - processing options, 6-40
 - usage, 6-39
- P40230A program
 - processing options, 22-6
- P40950 program, 6-27
 - processing options, 6-26
- P4101N program
 - processing options, 6-36
 - usage, 6-35
- P41061 program
 - processing options, 7-20
 - usage, 7-21
- P42090 program, 6-32
- P4271 program
 - usage, 7-21
- P43008 program
 - processing options, 17-5
 - usage, 17-2
- P43011 program
 - processing options, 16-24
 - usage, 16-28
- P43025 program
 - processing options, 21-2
- P4303 program, 6-43
- P4305 program
 - processing options, 11-36
- P43060 program
 - processing options, 16-5
 - usage, 16-3, 16-28
- P43070 program
 - processing options, 11-32
- P43080 program, 17-11
- P43081 program
 - processing options, 17-8
 - usage, 17-6
- P43090 program
 - processing options, 7-12
- P4310 program
 - processing options, 10-4
 - usage, 10-2, 10-24
- P43100 program
 - processing options, 21-3
- P43101 program
 - processing options, 11-7
- P4312 program
 - processing options, 12-9
- P43126 program, 12-5
- P4314 program
 - processing options, 13-23
- P43147 program
 - processing options, 13-32
- P4314WB
 - Voucher Match Process Workbench
 - overview, 15-21

- P4314WB (Voucher Match Process Workbench)
 - create suggestions, 15-23
 - invoice match status, 15-23
 - processing options, 15-33
- P4316 program, 10-36
- P4319 program
 - processing options, 16-19
- P43205 program, 16-20
- P43214 program
 - processing options, 12-27
 - usage, 13-2
- P4322 program, 6-28
- P43221 (Rounding Tolerance Rules), 6-29
- P43230 program
 - processing options, 7-14
- P43250 program
 - processing options, 18-11
 - usage, 18-16
- P43252 program
 - processing options, 18-20
- P43291 program
 - processing options, 13-5
 - usage, 13-4
- P4331 program, 16-12
- P4334 program
 - processing options, 16-13, 23-2
 - usage, 23-2
- P43360 program
 - processing options, 16-15
- P4340 program
 - processing options, 8-6
- P4371 program
 - processing options, 16-33
 - usage, 16-30
- P470412 program, 13-43
- PA ledger, 22-4
- Partial Receipt Allowed, 7-12
- payment eligibility for item removal, 18-6
- performance information
 - defining a summary of supplier, 7-15
- performance information for suppliers, 7-5, 19-6
- P.O. Detail Ledger File - Flexible Version table (F43199), 22-3, A-4
- P.O. Detail Ledger File table (F43199), 16-19
- PO Generator program (P43011)
 - processing options, 16-24
- PO Header Work File table (F4301Z), A-2
- PO Receipts program (P4312)
 - processing options, 12-9
- PO Receiver Non-Billable table (F43127), A-3
- PO Speed Status Update program (P43025)
 - processing options, 21-2
- PO/change Order Summary program (P4319)
 - processing options, 16-19
- Post Committed Costs to Jobs program (R00932)
 - processing options, 22-13
 - running, 22-12
 - usage, 22-12
- price breaks, 11-3
- price discount rules
 - attaching to items and suppliers, 7-23
 - creating for purchasing, 7-21
- price matrix, 4-2
- price quotes
 - creating an order from, 16-17
 - creating orders from, 16-14
 - entering, 16-12
 - entering items for which to request, 16-10
 - printing requests, 16-13
 - working with, 16-10
- price rules for detail lines, 10-38
- prices
 - entering supplier, 7-17
 - entering supplier discounts, 7-18
- pricing
 - overview, 4-1
 - repricing at receipts, 4-4
 - repricing for procurement, 4-4
 - using manual purchase price overrides, 4-3
 - using matrix items, 4-2
 - using maximum price adjustments, 4-2
 - using minimum price adjustments, 4-2
 - using on quality attributes, 4-3
 - using price matrix, 4-2
- pricing constants, 6-14
- Pricing Constants form, 6-11
- pricing on quality attributes, 4-3
- Print Message Revisions form, 6-39
- print messages
 - creating, 11-48
 - defining, 6-38
 - overview, 6-38
- Print Messages table (F4016), A-1
- Printer Selection form, 11-48
- procurement
 - common fields, i
 - features, terms, and concepts, 2-4
 - implementation steps, 1-5
 - overview, 1-1
 - setting up automatic accounting
 - instructions, 6-23
 - workflow, B-1
- procurement pricing, 4-1
- Procurement Self-Service Transaction Log table (F43001), A-2
- product integration, 1-1
- PU ledger, 22-4
- Purchase Agreements Maintenance program (P4340)
 - processing options, 8-6
- Purchase Inclusion Rules table (F4342), A-4
- Purchase Ledger report (R43420), C-1, C-2
- Purchase Order Approvals program (P43081)
 - processing options, 17-8
 - usage, 17-6
- purchase order clauses, 10-3
 - printing, 11-40
- Purchase Order Detail File table (F4311), 16-19, A-3
- Purchase Order Detail Inquiry form, 11-51
- Purchase Order Detail Non-Billable table (F4317), A-4

- Purchase Order Detail Tag File table (F4311T), A-3
- Purchase Order Detail Unedited Transaction Table (F4311Z1), A-3
- Purchase Order Dispatch Work File table (F4333WF), A-4
- purchase order entry
 - setting up automatic accounting instructions for, 6-23
- Purchase Order Entry program (P4310)
 - processing options, 10-4
 - usage, 10-2, 10-24
- Purchase Order Generator File table (F4311Z), A-3
- Purchase Order Header table (F4301), 16-18, A-2
- Purchase Order Header Unedited Transaction Table (F4301Z1), A-2
- Purchase Order Multiple Account File table (F4316), A-3
- Purchase Order Multiple Account Tag File table (F4316T), A-4
- Purchase Order Print Output program (R43501)
 - processing options, 11-46
 - usage, 11-38
- Purchase Order Print program (R43500)
 - processing options, 11-41
 - usage, 11-38
- Purchase Order Receipt Routing File table (F43092), A-2
- Purchase Order Receipts form, 12-9, 12-26
- Purchase Order Receiver File table (F43121), A-3
- Purchase Order Receiver Multiple Account table (F43126), A-3
- Purchase Order Receiver Multiple Account Tag File table (F43126T), A-3
- Purchase Order Receiver Tag File table (F43121T), A-3
- Purchase Order Requisition Approval form, 17-11
- Purchase Order Summary by Supplier report (R43415), C-1, C-2
- purchase order supplier template
 - creating, 6-41
- purchase order user template
 - creating, 6-42
- Purchase Order Workbench form, 11-6
- Purchase Order Workbench program (P43101)
 - processing options, 11-7
- purchase orders
 - approving, 17-10
 - entering for multiple suppliers, 11-24
 - generating automatically, 16-22
 - generating by batch, 16-29
 - receiving, 2-1
 - rejecting, 17-10
 - reviewing approval status, 17-6
 - reviewing open, 12-32
 - reviewing orders awaiting approval, 17-7, 17-9
 - revising dates, 21-3
 - setting up default values, 7-2
 - tracking commitments and encumbrances for, 22-5
 - using blanket orders to create, 16-8

- Purchase Rebate Agreement Revisions form, 8-3
- Purchase Rebate History table (F4343), A-4
- Purchase Rebate Master File table (F4340), A-4
- Purchase Rebate Threshold File table (F4341), A-4
- Purchase Receipts Inquiry form, 23-1
- Purchase Receipts Inquiry program (P43214)
 - processing options, 12-27
 - usage, 13-2
- Purchase Receiver Print program (R43510)
 - processing options, 12-3
 - usage, 12-3
- purchase receivers
 - discussing, 12-2
 - printing, 12-3
 - printing in batch mode, 12-4
 - printing individual orders, 12-4
- Purchasing Date Revisions form, 21-3
- Purchasing Date Revisions program (P43100)
 - processing options, 21-3
- purchasing instructions
 - defining for suppliers, 7-8
- purchasing methods, 2-2
- Purchasing Tolerance Rules Revisions form, 6-28
- Purchasing Tolerance Rules table (F4322), A-4
- Purge Purchase Order Dispatch program (R4333WFP)
 - running, 24-3
 - usage, 24-1
- purges
 - overview, 24-1
 - programs, 24-1

Q

- Quality Analysis Details form, 19-8
- Quality Analysis form, 7-7, 19-8
- quality attributes, 4-3
- Quality Classification form, 7-7
- quality performance
 - reviewing for suppliers, 19-6
 - setting up guidelines for suppliers, 7-5
- quantity breaks, 7-17
- Quantity Breaks File table (F4331), A-4
- Quote Inquiry form, 23-2
- Quote Order Release form, 16-15, 16-17
- Quote Order Release program (P43360)
 - processing options, 16-15
- quote orders
 - closing, 16-14
 - entering, 16-10
 - overview, 2-1
 - selecting suppliers, 16-10
 - using requisitions to create, 16-10
 - working with, 16-10
- Quote Price Breaks form, 16-12, 16-15
- Quote Response Entry form, 16-13
- Quote Response Entry program (P4334)
 - processing options, 16-13, 23-2
 - usage, 23-2
- Quote Supplier Entry form, 16-12

R

- R00932 program
 - processing options, 22-13
 - running, 22-12
 - usage, 22-12
- R04305 program
 - processing options, 13-45
 - usage, 13-45
- R04602 report
 - printing, 13-49
 - processing options, 13-49
- R40910 program
 - processing options, 22-8
 - running, 22-8
- R40910 report
 - usage, 22-7
- R4106101 program
 - data selection, 19-4
 - processing options, 19-5
 - running, 19-4
- R43001P program
 - running, 24-3
 - usage, 24-1
- R4301P program, 24-1
- R4304010
 - Voucher Match Automation Driver program, 14-6
- R4304016 (Voucher Match Automation UBE for Automation Rule 01 program), 15-14
- R4304020 (Voucher Match Automation UBE for Automation Rule 02, 03, 04, 05), 15-17
- R4304021 (Voucher Match Automation UBE for Automation Rule 06 program), 15-14
- R4311P program, 24-1
- R43121P program, 24-1
- R4317 program
 - processing options, 22-14
 - running, 22-14
 - usage, 22-13
- R43199P program, 24-1
 - processing options, 22-10
 - running, 22-9
 - usage, 22-9
- R43300 program
 - processing options, 11-38
 - running, 11-37
- R4333WFP program
 - running, 24-3
 - usage, 24-1
- R43400 report
 - processing options, 20-4
 - running, 20-4
 - usage, 20-4
- R43412 report
 - printing, 13-48
 - processing options, 13-48
- R43415 report, C-1, C-2
- R43420 report, C-1, C-2
- R43428 program
 - processing options, 13-48
- R43428 report
 - usage, 13-48
- R43450 report, 13-49
- R43500 program
 - processing options, 11-41
 - usage, 11-38
- R43501 program
 - processing options, 11-46
 - usage, 11-38
- R43510 program
 - processing options, 12-3
 - usage, 12-3
- R43525 program
 - processing options, 12-32
- R43530 report, 16-11
 - processing options, 16-13
- R43535 report
 - printing, 16-21
 - processing options, 16-21
- R43632 program, 12-32
- R43640 report
 - processing options, C-2
 - usage, C-1, C-2
- R437002 program
 - processing options, 16-31
 - running, 16-30
 - usage, 16-29
- R43800
 - processing options, 13-44
- R43815 program
 - processing options, 6-42
- R43900 program
 - processing options, 19-10
 - running, 19-10
 - usage, 19-9
- R43960 program, 24-1
- R4401P program
 - processing options, 11-53
- R7404010 (Voucher Match Automation Driver), 15-13
- Rebate Adjustments Revision form, 20-3
- rebate agreements
 - changing the quantity or amount applied to, 20-3
 - defining inclusion rules for, 8-4
 - defining purchase limits for amounts, 8-5
 - entering, 8-3
 - entering basic information, 8-2
 - reviewing purchasing transactions for, 20-2
 - reviewing summary information for, 20-1
 - setting up, 8-1
 - updating information, 20-4
 - working with status information, 20-1
- Rebate History Details form, 20-2, 20-3
- Rebate Report (R43400)
 - processing options, 20-4
 - running, 20-4
 - usage, 20-4
- rebates
 - changing the quantity or amount applied to an agreement, 20-3

- defining conditions for obtaining, 8-4
- defining purchase limits for amounts, 8-5
- entering, 8-3
- entering basic information, 8-2
- overview, 20-1
- reviewing purchasing transactions for agreements, 20-2
- reviewing summary information for agreements, 20-1
- setting up, 8-1
- updating information, 20-4
- working with status information, 20-1
- Receipt Detail Information form, 19-8
- receipt information
 - using printouts, 12-31
- receipt processing, 2-2
- receipt records, 13-7
- Receipt Route Operations UDC (43/OC), 18-5
- receipt routes
 - activating, 18-7
 - assigning alternate, 18-7, 18-9
 - assigning standard, 18-7
 - assigning to items, 18-8
 - creating, 18-2
 - creating journal entries for items, 18-3
 - defining operations, 18-2
 - defining sample requirements, 18-8
 - defining specifications, 18-8
 - example, 18-1
 - overview, 18-1
 - removing items, 18-17
 - removing items from, 18-18
 - replacing returned items, 18-17
 - reversing item removals, 18-17
 - reversing item transfers, 18-17
 - reversing receipts, 12-24
 - reviewing item specifications, 18-17
 - reviewing sample requirements, 18-17
 - reviewing the current status of items, 18-16
 - reviewing the history of items, 18-19, 18-20
 - reviewing the ledger, 18-19
 - setting up automatic accounting instructions for, 6-25
 - setting up disposition categories, 18-6
 - setting up item removal categories, 18-6
 - transferring items to operations, 18-10, 18-16
 - understanding journal entries, 18-3
 - working with items, 18-9
- Receipt Routes UDC (43/RC), 18-5
- receipt routing, 2-3
- Receipt Routing Definition form, 18-5, 18-6
- Receipt Routing Ledger File table (F43099), A-3
- Receipt Routing Master File table (F43091), A-2
- Receipt Routing Movement and Disposition program (P43250)
 - processing options, 18-11
 - usage, 18-16
- Receipt Routing Movement form, 18-11
- Receipt Routing Unedited Transaction Table (F43092Z1), A-2
- Receipt Routing Work File table (F43092Z), A-2
- receipt transactions
 - reviewing journal entries for, 12-31
- receipts
 - assigning lots, 12-24
 - assigning serial numbers, 12-24
 - assigning tolerance rules, 6-27
 - canceling, 13-33
 - closing the balance, 13-33
 - creating routes, 18-2
 - entering, 12-4
 - entering cascading, 12-23
 - entering information, 12-23
 - entering landed cost during process, 13-3
 - performing partial, 13-33
 - posting, 12-31
 - pricing at, 4-4
 - printing information, 12-31
 - printing information by supplier, 12-32
 - printing open, 12-32
 - printing open voucher information, 13-49
 - printing the status, 12-32
 - processing formal, 12-2
 - processing informal, 12-1
 - reversing, 12-24, 12-30
 - reversing items out of receipt routing, 18-17
 - reviewing journal entries, 12-30
 - selecting order detail lines, 13-33
 - selecting records to match to a voucher, 13-33
 - setting up automatic accounting instructions for, 6-23
 - using automatic accounting instructions for, 12-30
- Receipts Unedited Transaction Table (F43121Z1), A-3
- Received Not Vouchered Reconciliation report (R43450), 13-49
- Received/Vouchered Status Report (R43412)
 - printing, 13-48
 - processing options, 13-48
- Receiver (F43121) Purge program (R43121P), 24-1
- Receiver workfile table (F43121Z), A-3
- record information, 13-33, 13-34
- Recost Vouchers form, 13-15
- reference information for orders, 10-25
- Replacement Information form, 18-18
- replacement items, 10-39
- reporting codes for detail lines, 10-39
- repricing for procurement, 4-4
- Request For Quote Report (R43530), 16-11
 - processing options, 16-13
- requests for quotes
 - responding via self-service, 23-2
- Requisition Order Header table (F43E01), A-5
- requisitions
 - approving, 17-10
 - assigning tolerance rules, 6-27
 - creating quote orders, 16-10
 - overview, 16-3
 - printing, 16-3

- rejecting, 17-10
- releasing, 16-4
- reviewing orders awaiting approval, 17-7, 17-9
- working with, 16-3
- retainage, 10-3, 13-11, 13-37
 - entering a voucher with, 13-41
- retainage records
 - creating vouchers, 13-36
 - matching to create vouchers, 13-36
 - releasing, 13-42
- retention, 10-3, 13-11, 13-37
- returned items
 - replacing, 18-17
- Reversal Verification form, 12-26
- reverse
 - performing for vouchers, 13-7
- reviewing as if currency, 11-49
- rounding tolerance rules, 6-29
- Rounding Tolerance Rules (P43221), 6-29
- Rounding Tolerance Rules Revision form, 6-30
- Routing Disposition form, 18-18
- Routing Disposition Setup form, 18-7
- Routing Ledger Inquiry program (P43252)
 - processing options, 18-20

S

- Sales Order/Purchasing Text Detail Lines table (F4314), A-3
- sales orders, 10-39
- sample requirements
 - defining, 18-9
 - understanding, 18-8
- Select Item for Purchase form, 16-24
- Select Multiple Locations form, 12-26
- Select Orders To Match form, 13-15, 13-41
- Select Receipts to Match form, 13-15
- Selected Invoices subform
 - allowable actions, 15-25
- Selecting Suppliers for Quote diagram, 16-10
- self service
 - addressing prerequisites, 5-2
 - setup overview, 5-2
- self-service
 - activating processing options, 5-3
 - addressing security issues, 5-2
 - responding to requests for quotes, 23-2
 - reviewing orders on the web, 23-1
 - reviewing receipts on the web, 23-1
 - setting up, 5-2
- serial numbers
 - assigning, 12-27, 18-16
 - assigning to receipt items, 12-24
- service units, 10-40, 11-4, 12-7, 12-24, 13-12
 - displaying on quote orders, 16-15
 - displaying on requisitions, 16-4
 - printing, 11-39
- services units, 18-18
- shipment information, 10-37
- single voucher for an invoice, 15-22

- Single Voucher Per Invoice, 7-12
- special order entry, 11-1
- special order processing, 2-2
- SRS Ship Dates table (F43213), A-4
- standard cost variances, 12-30
- Status Code Progression diagram, 2-7
- status codes
 - setting up, 6-8
 - updating, 21-1, 21-3
- Stocked Item Reorder Point Batch Purchase Order Generator program (R437002)
 - processing options, 16-31
 - running, 16-30
 - usage, 16-29
- Subcontract Management, 2-6
- subcontract orders
 - approving, 17-10
 - holding payments, 13-8
 - rejecting, 17-10
 - reviewing approval status for, 17-6
 - reviewing orders awaiting approval, 17-7, 17-9
- subcontract retention, 13-11, 13-37
- Subcontractor Threshold table (F4355), A-4
- substitute items, 10-39
- Substitute Items form, 10-42
- suggest mode, 14-3
- Suggested Reorder Stock Items Detail form, 16-30
- Suggested Reorder Stock Items program (P4371)
 - processing options, 16-33
 - usage, 16-30
- Suggested Reorder Stock Items table (F4371), A-5
- Suggestion Required option, 7-11
- Suggestion/Receipt Details subform
 - allowable actions, 15-29
 - Previous and Next buttons, 15-29
 - Return button, 15-29
- summary information
 - reviewing for orders, 11-50
- Summary Voucher Match table (F43800), A-5
- supplier
 - suggestion required, 14-21
- Supplier Analysis Report (R04602)
 - processing options, 13-49
- Supplier Analysis report (R04602)
 - printing, 13-49
- Supplier Analysis Summary program
 - processing options, 7-14
- Supplier and Branch Plant Relationship table (F43100), A-3
- supplier and item relationships
 - creating, 7-12
- Supplier Catalog Revisions form, 7-20
- Supplier Catalog Revisions program (P41061)
 - processing options, 7-20
- Supplier Catalog Search & Select form, 11-6
- supplier classification codes, 10-2, 11-4, 13-10, 16-2
 - printing, 11-39
- Supplier History Template Rebuild program (R43815)
 - processing options, 6-42
- Supplier Item Additional Routes table (F43094), A-2

- Supplier Ledger Inquiry form, 11-51, 13-14, 13-41, 13-47
- supplier management, 2-3
- Supplier Master program (P04012)
 - processing options, 7-8
- Supplier Master Revision form, 7-6
- Supplier Master table (F0401), A-1
- Supplier Page Hyperlinks table (F4350), A-4
- Supplier Page Hyperlinks table (F4351), A-4
- supplier performance information
 - defining a summary of, 7-15
- Supplier Price Comparison form, 11-6
- Supplier Price/Catalog File table (F41061), A-2
- supplier prices, 7-17
 - entering, 7-21
- supplier purchasing instructions
 - defining, 7-8
- Supplier Schedule Master File table (F4321), A-4
- Supplier Schedule Master File table (F43211), A-4
- Supplier Selection File table (F4330), A-4
- Supplier/Catalog Purchase Price Generation by Currency program (R4106101)
 - data selection, 19-4
 - processing options, 19-5
 - running, 19-4
- Supplier/Item Additional Route form, 7-7
- Supplier/Item Relationships form, 7-7, 7-12, 18-8
- Supplier/Item Relationships program (P43090)
 - processing options, 7-12
- Supplier/Item Relationships Rebuild program (R43900)
 - processing options, 19-10
 - running, 19-10
 - usage, 19-9
- Supplier/Item Relationships table (F43090), A-2
- suppliers
 - accessing electronic catalog information, 11-2
 - assigning automation rules, 7-2, 7-10
 - attaching discount rules, 7-19
 - capturing performance information, 19-6
 - converting limit amounts, 19-1
 - creating item relationships, 7-4
 - defining certification status for, 11-2
 - defining purchasing instructions, 7-8
 - entering price discounts, 7-18
 - entering price quotes, 16-12
 - entering prices, 7-17
 - generating new prices example, 19-3
 - generating prices in alternate currencies, 19-2
 - monitoring quality, 7-5
 - performing currency conversion, 19-1
 - printing quote order requests, 16-13
 - printing receipt information, 12-32
 - reviewing cost performance, 19-7
 - reviewing delivery performance, 19-6
 - reviewing performance information, 19-6
 - reviewing quality performance, 19-6
 - reviewing summary performance information, 19-7
 - setting up contract pricing, 7-18

- setting up delivery performance guidelines, 7-5
- setting up information, 7-1
- setting up purchasing instructions, 7-2
- setting up quality performance guidelines, 7-5
- setting up summary performance information, 7-5
 - specifying for purchasing, 11-2
- Suppliers Selected for Order form, 11-6, 16-30
- system
 - defining constants, 6-16
 - setting up constants, 6-15
- System Constants form, 6-12, 6-16

T

- T Account Changes for Nonbillable Retainage diagram, 13-38
- T Account Changes for Retainage diagram, 13-36
- Table Conversion Prompting form, 24-2
- tax information
 - entering for detail lines, 10-37
 - entering for orders, 10-25
 - entering for vouchers, 13-8
 - setting up automatic accounting instructions for, 6-24
 - using vertex, 3-1
- templates
 - ordering items, 11-3
- Threshold Maintenance form, 8-6
- tolerance on receipt amount greater than the invoice amount., 6-27
- tolerance rules
 - creating, 6-27, 6-28
 - overview, 6-27
- Trial Balance/Ledger Comparison form, 11-29

U

- UDCs, 2-1
- updating, 21-1
- User Defined Codes form, 6-38, 9-2
- user-defined code lists
 - rebate order types (43/RB), 8-2
- user-defined codes, 2-1
 - average cost calculation (40/AV), 6-19
 - certification status (43/CR), 6-21
 - commitment document types (40/CT), 6-20
 - commitment order types (40/CT), 9-1
 - commodity class codes (41/PI), 6-21
 - commodity sub class codes (41/P2), 6-21
 - cross reference type code (41/DT), 6-20
 - customer price groups (40/PC), 6-20
 - document type (00/DT), 6-19
 - freight handling code (42/FR), 6-21
 - G/L posting category (41/9), 6-20
 - hold codes (42/HC), 6-21, 6-31
 - item change files (40/IC), 6-20
 - item price groups (40/PI), 6-20
 - landed cost components (40/CA), 6-19
 - landed cost levels (41/CA), 6-34

- landed cost rule (41/P5), 6-21
- landed cost rules (41/P5), 6-34
- master planning family (41/P4), 6-21
- model log types (43/ML), 6-22
- model logs (43/ML), 6-43
- movement code (43/MC), 6-21
- operation codes (43/OC), 6-22
- order templates (40/OT), 6-20, 6-40
- order types (00/DT), 6-9
- outstanding log types (43/OL), 6-22
- price category type (42/CT), 6-21
- print messages (40/PM), 6-20
- procurement rebate order type (43/RB), 6-22
- rebate status (43/RS), 6-22
- rebate type (43/RT), 6-22
- receipt route operations (43/OC), 18-5
- receipt routes (43/RC), 18-5
- route codes (43/RC), 6-22
- schedule name (40/AS), 6-19
- setting up, 6-19
- status codes (40/AT), 6-9
- supplier rebate codes (41/P3), 6-21
- transaction set purpose code (47/PU), 6-22
- view progress payments (43B/VW), 6-22

V

variances

- calculating actual costs, 13-43
- creating for standard costs, 12-30
- setting up automatic accounting instructions for, 6-24
- using weighted average costs, 13-44

vertex, 3-1

VMA

- Partial Receipt Allowed option, 7-12
- Single Voucher Per Invoice option, 7-12
- Tolerance for receipts with an amount greater than the invoice amount, 6-27

VMA Tolerance, 6-27

Voucher Journal Report (R04305)

- processing options, 13-45
- usage, 13-45

voucher match automation

- apply rounding tolerance for automation rule 05, 15-18, 15-34
- apply standard tolerance for automation rule 02, 15-18, 15-33
- apply standard tolerance for automation rule 03, 15-18, 15-34
- automation flag in F0411Z1, 14-11
- automation rule, 7-10
- automation rules
 - overview, 14-13
 - rule 01 illustration, 14-15
 - rule 01 overview, 14-15
 - rule 02, 15-18, 15-33
 - rule 02 illustration, 14-16
 - rule 02 overview, 14-15
 - rule 03, 15-18, 15-34

- rule 03 illustration, 14-17
- rule 03 overview, 14-16
- rule 04 illustration, 14-18
- rule 04 overview, 14-18
- rule 05, 15-18, 15-34
- rule 05 illustration, 14-20
- rule 05 overview, 14-19
- rule 06 overview, 14-21
- source of rule, 14-34
- usage table, 14-13

Batch Voucher Processor Report (R04110ZA), 15-21

- capture invoice data, 14-2
- F0411Z1 table, 15-48
- final mode, 15-2
- invoice match status overview, 15-23
- invoice records, 14-10
- item information required, 7-3
- Item Information Required option, 7-3
- logged vouchers
 - automatic accounting instructions, 14-29
 - Batch Voucher Processor Report program (R04110ZA), 14-29
 - data selection, 14-30
 - enabling, 14-28
 - logged voucher selection for matching, 14-30
 - matching records, 14-35
 - overview, 14-28
 - process flow illustration, 14-31
 - process steps, 14-29
 - record selection, 14-29
 - redistribution, 14-30
 - resolving issues, 14-35
 - successful creation, 14-29
 - successful match of process type 3 records, 14-30
 - successful matching of logged vouchers to receipts, 14-30
 - unsuccessful creation, 14-29
 - unsuccessful matching of logged vouchers to receipts, 14-31
- manual match, 14-2
- Order Information Required option, 7-3
- overall process, 14-8
- overview, 14-4
- Partial Receipts Allowed, 7-4
- partial receipts allowed, 14-22
- process flows
 - basic business flow, 14-5
 - continuous process, 14-7
 - create logged vouchers, 14-31
 - matching receipts to invoices, 14-27
 - populating the F0411Z1 table, 14-10
 - processing options, 15-9
 - source of automation rule, 14-13
 - supplier and company setup, 14-31
- process steps, 14-8
- process steps for standard vouchers, 14-25
- process type in F0411Z1 table, 14-11
- process types, 14-2

- processing mode, 15-1
- processing mode differences, 15-2
- processing options
 - Batch Voucher Processor Report (R04110ZA), 15-12
 - overview, 15-9
 - Voucher Match Automation Driver program (P4304010), 15-13
 - Voucher Match Automation UBE for Automation Rule 01 program (R4304016), 15-14
 - Voucher Match Automation UBE for Automation Rule 02, 03, 04, 05, 15-17
 - Voucher Match Automation UBE for Automation Rule 06 program (R4304021), 15-14
 - Voucher Match program (P4314), 15-9, 15-10
- proof mode, 15-1
- purchase order information, 7-3
- purchase order records, 14-35
- purging records, 15-16, 15-19, 15-48
- record selection from F0411Z1, 14-25, 14-37
- required fields in the F0411Z1 table, 14-11
- rounding tolerance, 14-2
- rounding tolerance rules, 6-29
- Rounding Tolerance Rules (P43121), 14-33
- Selected Invoices subform, 15-25
- setting up
 - automatic accounting instructions, 14-32
 - automation rules, 14-32
 - companies, 14-32
 - processing options, 14-33
 - rounding tolerance, 14-33
 - suppliers, 7-2, 14-31
- Single Voucher Per Invoice, 7-4
- single voucher per invoice, 14-23
- standard tolerance, 14-3
- standard vouchers
 - also create logged vouchers, 14-34
 - automatic accounting instructions, 14-28
 - change process type to 4, 14-25, 14-27
 - overview, 14-24
 - process flow of matching receipts to invoices, 14-27
 - process type 1, 14-25
 - process type 2 records, 14-26
 - resolving issues, 14-35
 - successful match for process type 1 records, 14-25
 - successful match for process type 2 records, 14-27
 - unsuccessful match for process type 1 records, 14-26
 - unsuccessful match for process type 2 records, 14-27
- suggest mode, 14-3, 15-1
- Suggestion Required, 7-4
- suggestion required, 14-21
- supplier setup, 7-3
- system performance optimization, 14-35
- troubleshooting, 14-34
- unprocessed records, 14-34
- unsuccessful matches, 14-36
- validation of records in F0411Z1 table, 14-36
- validation of records in F4311 table, 14-37
- validation of records in F43121 table, 14-37
- variance accounting, 14-20
- Voucher Match Automation Driver UBE (R4304010), 15-20
- Voucher Match Automation UBE for Automation Rule 01 (R4304016), 15-21
- Voucher Match Automation UBE for Automation Rule 02, 03, 04, 05 (R4304020), 15-21
- Voucher Match Process Workbench (P4314WB), 15-21
- Voucher Match program (P4314), 15-9, 15-10, 15-16
- Voucher Transaction Batch Upload table (F0411Z1), 14-10
- Voucher Match Automation Driver program R4304010, 14-6
- Voucher Match Automation Driver program (R4304010), 15-13
- Voucher Match Automation UBE for Automation Rule 01 program (R4304016), 15-14
- Voucher Match Automation UBE for Automation Rule 02, 03, 04, 05 (R4304020), 15-17
- Voucher Match Automation UBE for Automation Rule 06 program (R4304021), 15-14
- voucher match automation UBE programs, 14-3
- Voucher Match form, 13-14, 13-41, 13-47
- Voucher Match Multiple Account Tag File table (F43146T), A-3
- Voucher Match Process Workbench (P4314WB) process flow, 15-22
- Voucher Match Process Workbench (P4314WB) clearing suggestions and creating new suggestions, 15-37
- create suggestions, 15-23
- GL Distribution subform, 15-33
- Invoice Details subform, 15-28
- invoice match status, 15-23
- matching an unprocessed record to receipts, 15-39
- overview, 15-21
- processing options, 15-33
- replacing a suggested receipt line with a different receipt line, 15-43
- returning an invoice line to unprocessed status, 15-44
- review, approve, and process a suggestion, 15-34
- Select Receipts subform, 15-32
- Selected Invoices subform, 15-25
- Suggestion/Receipt Details subform, 15-28
- Voucher Details subform, 15-33
- Voucher Match program (P4314) processing options, 13-23
- Voucher Match Selection File table (F4314Z), A-3
- Voucher Transaction Batch Upload - Voucher Match Automation

F0411Z1T, 14-5
 Voucher Transaction Batch Upload - Voucher Match
 Automation table (F0411Z1T), 14-12
 Voucher Transactions - Batch Upload (F0411Z1)
 purging, 15-47
 Voucher Transactions Batch Upload - Voucher Match
 Automation (F0411Z1T)
 purging, 15-47
 vouchers
 adding new purchase order detail lines, 13-8
 assigning tolerance rules, 6-27
 creating, 13-1
 creating for landed costs, 13-4, 13-8
 creating from preliminary vouchers, 13-46
 creating preliminary, 13-46
 creating using receipt records, 13-42
 creating using records, 13-7
 creating using retainage records, 13-36
 entering to release retainage, 13-42
 entering with retainage, 13-41
 expensing at match, 13-11
 generating journal entries, 13-43
 matching individual records to create, 13-7
 matching order detail lines to create, 13-34
 posting, 13-45
 printing by receipt, 13-49
 printing information, 13-48
 printing information by detail line, 13-48
 reversing, 13-7
 reviewing journal entries, 13-43
 selecting receipt records to match, 13-33
 setting up automatic accounting instructions
 for, 6-23
 verifying that amounts balance, 13-45

W

Work With Approval Delegation form, 17-5
 Work With Approval Level Revisions form, 17-4
 Work With Approval Status Summary form, 17-8
 Work With Available Order Templates form, 6-40,
 11-6
 Work With Branch/Plant Constants form, 6-11
 Work With Commitment Inquiry form, 22-6, 22-7
 Work With Contract Detail form, 11-50
 Work With Contract Headers form, 16-5, 16-9
 Work With Financial Status Inquiry form, 11-51
 Work With Freight Audit History form, 13-15
 Work With Held Orders form, 11-31
 Work With Hold Order Constants form, 6-31
 Work With Inquiry Columns form, 7-7
 Work With Inquiry Formats form, 7-7
 Work With Inquiry Paths form, 7-7
 Work With Landed Cost form, 6-34
 Work With Logs form, 11-36
 Work with Model Logs form, 11-36
 Work With Order Details form, 6-40, 11-36, 11-50
 Work With Order Headers form, 10-27, 11-5, 11-36,
 11-48, 16-5, 16-9, 16-12, 16-19
 Work With Order Release form, 16-5, 16-9

Work With Order Revisions Summary form, 16-19,
 16-20
 Work With Orders Awaiting Approval form, 17-7,
 17-11
 Work with PO Speed Status Update form, 21-2, 21-3
 Work With Purchase Agreements form, 20-3
 Work With Purchase Order History form, 6-40
 Work With Purchase Orders to Receive form, 12-9,
 12-26
 Work With Purchase Receipts form, 12-26, 13-3
 Work With Rebate History Inquiry form, 20-2, 20-3
 Work With Receipt Routing Ledger form, 18-20
 Work With Receipts Routing Codes form, 18-5, 18-6
 Work With Routing Statuses form, 18-10
 Work With Sample Size Tables form, 18-9
 Work With Stocked Item Reorder Point form, 16-23
 Work With Suggested Reorder Stock Items
 form, 16-30
 Work With Supplier Analysis Summary form, 7-7,
 19-8
 Work With Supplier Master form, 7-6
 Work With Supplier/Item Relationships form, 7-6,
 18-8
 Work With Suppliers form, 16-12
 Work With User Defined Codes form, 6-46
 Work With Voucher JE Redistribution form, 13-47
 workbench
 entering orders for multiple suppliers, 11-2
 explaining Purchase Order Workbench, 11-2
 workflow
 promised date change, B-2
 purchase order acknowledgement approval, B-1
 Working With Routing Statuses form, 18-18

Z

zero balance adjustments
 setting up automatic accounting instructions
 for, 6-25