

SeeBeyond ICAN Suite

eIndex Enterprise Data Manager User's Guide

Release 5.0.1



The information contained in this document is subject to change and is updated periodically to reflect changes to the applicable software. Although every effort has been made to ensure the accuracy of this document, SeeBeyond Technology Corporation (SeeBeyond) assumes no responsibility for any errors that may appear herein. The software described in this document is furnished under a License Agreement and may be used or copied only in accordance with the terms of such License Agreement. Printing, copying, or reproducing this document in any fashion is prohibited except in accordance with the License Agreement. The contents of this document are designated as being confidential and proprietary; are considered to be trade secrets of SeeBeyond; and may be used only in accordance with the License Agreement, as protected and enforceable by law. SeeBeyond assumes no responsibility for the use or reliability of its software on platforms that are not supported by SeeBeyond.

SeeBeyond, e*Gate, and e*Way are the registered trademarks of SeeBeyond Technology Corporation in the United States and select foreign countries; the SeeBeyond logo, e*Insight, and e*Xchange are trademarks of SeeBeyond Technology Corporation. The absence of a trademark from this list does not constitute a waiver of SeeBeyond Technology Corporation's intellectual property rights concerning that trademark. This document may contain references to other company, brand, and product names. These company, brand, and product names are used herein for identification purposes only and may be the trademarks of their respective owners.

© 2003 by SeeBeyond Technology Corporation. All Rights Reserved. This work is protected as an unpublished work under the copyright laws.

This work is confidential and proprietary information of SeeBeyond and must be maintained in strict confidence.

Version 20031120142535.

Contents

List of Figures	7
-----------------	---

Chapter 1

Introduction	9
Document Purpose and Scope	9
Intended Audience	9
Using this Guide	10
Document Organization	10
Writing Conventions	10
Special Notation Conventions	10
Mouse Conventions	11
Supporting Documents	12
Online Documents	12
SeeBeyond Web Site	12

Chapter 2

Getting Started	13
eIndex Global Identifier	13
Features of eIndex	13
Learning about the EDM	15
Learning about Member Profiles	16
Member Profile Components	16
System Records	18
Single Best Record	18
Survivor Calculator	18
Member Profile Indicators	18
System Record and SBR Components	19
The Person Object	19
Address Objects	20
Phone Objects	20
Alias Objects	20
AuxId Objects	20
Comment Objects	20
Identification Numbers for each Member	21
EUID	21

Local ID	21
Auxiliary ID	21
Working with the Enterprise Data Manager	21
Logging on to the EDM	22
Navigation Tips	23
Navigating the EDM Functions	23
Navigating the Search Pages	24
Navigating the Detail Pages	25
Logging Off the EDM	25

Chapter 3

Searching for Member Profiles	26
Learning About Member Queries	26
About the Person Search Function	26
The Simple Person Lookup Page	26
The Advanced Person Lookup (Alpha) Page	27
The Advanced Person Lookup (Phonetic) Page	27
The Comparison Lookup Page	27
The Search Result page	27
Types of Searches	28
EUID Lookup	28
Social Security Number Lookup	28
Local ID Lookup	28
Advanced Person Lookup (Alpha)	28
Advanced Person Lookup (Phonetic)	29
Comparison Lookup	29
Searching for Member Profiles	29
Performing an EUID Lookup	29
Performing a Social Security Number Lookup	30
Performing a Local ID Lookup	31
Performing an Advanced Alphanumeric Lookup	31
Performing an Advanced Phonetic Lookup	33
Performing an EUID Comparison Lookup	35
Working with Search Results	36
Viewing the Results of a Search	36
Sorting the Results of Your Search	39
Selecting a Profile from the Results List	40

Chapter 4

Viewing Member Profiles	41
Member Profile Views	41
The View/Edit Page	41
The Tree View	41
Information Fields	43
Member Profile Comparisons	43
Member Profile Transaction Histories	43

Member Profile Merge Histories	44
The Audit Log	44
Viewing Member Profiles	44
Viewing a Member's Demographic Information	45
Viewing a Member's Addresses	48
Viewing a Member's Telephone Numbers	50
Viewing a Member's Aliases	52
Viewing a Member's Auxiliary IDs	54
Viewing Comments Associated with a Member	56
Comparing Member Information	58
Viewing a Transaction History	58
Comparing Member Information	63
Comparing two Member Profiles	63
Comparing Records in one Member Profile	64
Viewing a Merge History	66
Viewing a Merge History Tree	66
Viewing a Member Profile From a Merge History Tree	68
Viewing the Audit Log	68

Chapter 5

Maintaining Member Profiles 73

Member Profile Maintenance	73
Matching Probability Weights	73
Merging Profiles	73
Surviving and Non-surviving Profiles	74
System Record Merges	74
Undoing a Merge	74
Assumed Matches	74
Potential Duplicates	75
Handling Potential Duplicates	75
Merge	75
Resolve	75
Update Tips	75
Concurrent Users	76
Updating the SBR versus System Records	76
EDM Overwrite Capabilities	76
VIP Updates	76
Adding a Member Profile	77
Step 1: Obtain Information about the Member	77
Step 2: Specify a System and Local ID	77
Step 3: Specify Demographic Information	79
Step 4: Specify Alias Information	80
Step 5: Specify Address Information	81
Step 6: Specify Telephone Information	82
Step 7: Specify Auxiliary IDs	83
Step 8: Add Comments to the Member Profile	84
Step 9: Save the Member Profile	85

Maintaining Member Information	86
Modifying Demographic Information	86
Maintaining Address Information	87
Adding Addresses to a Member Profile	88
Modifying Address Information	89
Deleting Addresses from a Member Profile	89
Maintaining Telephone Information	90
Adding Telephone Numbers to a Member Profile	90
Modifying Telephone Information	91
Deleting Telephone Numbers from a Member Profile	91
Maintaining Alias Information	92
Adding an Alias to a Member Profile	93
Modifying a Member's Alias Information	93
Deleting an Alias from a Member Profile	94
Maintaining Auxiliary ID Information	94
Adding an Auxiliary ID to a Member Profile	95
Modifying Auxiliary ID Information	96
Deleting an Auxiliary ID from a Member Profile	96
Maintaining Comment Information	97
Adding a Comment to a Member Profile	97
Modifying a Comment in a Member Profile	98
Deleting a Comment from a Member Profile	98
Locking and Unlocking SBR Fields	99
Locking an SBR Field	99
Unlocking an SBR Field	100
Maintaining System Record Information	101
Adding a System Record to a Member Profile	101
Deactivating a System Record	102
Reactivating a System Record	102
Changing Member Profile Status	103
Deactivating a Member Profile	103
Reactivating a Member Profile	104
Working with Potential Duplicates	105
Finding Potential Duplicates	105
Merging Potential Duplicates	110
Resolving Potential Duplicates	111
Working with Assumed Matches	112
Finding Assumed Matches	112
Reversing an Assumed Match	115
Combining Member Information	115
Merging Member Profiles	116
Merging System Records	117
Unmerging Member Information	118
Unmerging Member Profiles	119
Unmerging System Records	120

Glossary	121
-----------------	------------

Index	126
--------------	------------

List of Figures

Figure 1	Member Profile Components	17
Figure 2	EDM Logon Page	22
Figure 3	Main Menu Navigation Tools	23
Figure 4	Search Page Navigation Tools	24
Figure 5	Sample View/Edit Page	25
Figure 6	Simple Person Lookup Page	30
Figure 7	Advanced Person Lookup (Alpha) Page	32
Figure 8	Advanced Person Lookup (Phonetic)	34
Figure 9	Comparison Lookup Page	36
Figure 10	Search Results List	37
Figure 11	Address Information Page	38
Figure 12	Telephone Information Page	38
Figure 13	Member Profile Tree View	42
Figure 14	Expanded Member Profile Tree View	42
Figure 15	View/Edit Page - Demographic Information	45
Figure 16	View/Edit Page - Address Information	49
Figure 17	View/Edit Page - Telephone Information	51
Figure 18	View/Edit Page - Alias Information	53
Figure 19	View/Edit Page - Auxiliary IDs	55
Figure 20	View/Edit Page - Comments	57
Figure 21	Transaction History Comparison Page	59
Figure 22	Transaction History Search Page	60
Figure 23	Transaction History Results	61
Figure 24	Comparison Page - Two Member Profiles	63
Figure 25	Selecting Two Profiles to Compare	64
Figure 26	Comparison Page - One Member Profile	65
Figure 27	Selecting one Profile to Compare	66
Figure 28	Merge History Tree	67
Figure 29	Audit Log Detail page	69
Figure 30	Audit Log Search Page	70
Figure 31	Audit Log Result page	71
Figure 32	Create System Record - System and Local ID	78

List of Figures

Figure 33	Create System Record - Demographic Information	79
Figure 34	Create System Record - Alias Information	80
Figure 35	Create System Record - Address Information	81
Figure 36	Create System Record - Telephone Information	82
Figure 37	Create System Record - Auxiliary IDs	83
Figure 38	Create System Record - Comment Information	85
Figure 39	View/Edit Page - Demographic Information	87
Figure 40	View/Edit Page - Address Information	88
Figure 41	View/Edit Page - Telephone Information	90
Figure 42	View/Edit Page - Alias Information	92
Figure 43	View/Edit Page - Auxiliary ID Information	95
Figure 44	View/Edit Page - Comment Information	97
Figure 45	Locked fields in an SBR	99
Figure 46	Unlocked Fields in an SBR	100
Figure 47	View/Edit Page - System Records	101
Figure 48	View/Edit Page - Deactivate	103
Figure 49	View/Edit Page - Reactivate	104
Figure 50	Potential Duplicate Comparison Page	105
Figure 51	Matching Review Search Page	106
Figure 52	Potential Duplicate Search Results List	107
Figure 53	Associated Records List	108
Figure 54	Assumed Match Page	112
Figure 55	Matching Review Search Page	113
Figure 56	Assumed Match Results List	114
Figure 57	Comparison Page - Merging Member Profiles	116
Figure 58	Merging System Records	117
Figure 59	Unmerge Page	119

Introduction

This guide provides information and instructions for using the Enterprise Data Manager (EDM) for the SeeBeyond® eIndex Global Identifier (eIndex). eIndex is an enterprise-wide master person index that maintains information about the people who participate throughout your business, linking information from different locations and computer systems. The EDM allows you to monitor and maintain the information stored in eIndex database.

This chapter provides an overview of this guide and the conventions used throughout, as well as a list of supporting documents and information about using this guide.

1.1 Document Purpose and Scope

This guide provides the information you need to quickly get started with the EDM. It includes navigational instructions, functional instructions, and background information about the application's features. This guide also provides step-by-step instructions for all of the functions of the EDM, such as adding and updating member profile information, identifying duplicate member profiles, merging and unmerging member profiles, and deactivating member profiles. It also includes information on searching for member profiles, viewing a transaction history, and comparing member profiles.

This guide does not include information or instructions on setting up security, configuring eIndex, or working with eGate components. These topics are covered in the appropriate user guide (for more information, see [“Supporting Documents” on page 12](#)).

1.1.1. Intended Audience

Any user who needs to review, monitor, or modify data in the eIndex database should read this guide. Intermediate or advanced users who need a refresher on using some of the basic functions of eIndex should also read this guide. A thorough knowledge of eIndex is not needed to understand this guide. It is presumed the user is familiar with basic Web browser tools, and with the types of information stored in the eIndex database.

1.1.2. Using this Guide

For best results, skim through the guide to familiarize yourself with the locations of essential information you need. The beginning of each chapter provides introductory information on the topics covered in that chapter. This introductory material contains background and explanatory information you may need to understand before moving into the more detailed information later in the chapter.

1.1.3. Document Organization

This guide is divided into five chapters that cover the topics shown below.

- **Chapter 1 “Introduction”** gives a general preview of this document—its purpose, scope, and organization—and provides sources of additional information.
- **Chapter 2 “Getting Started”** gives a general summary of eIndex and the available functions in the EDM, as well as instructions for logging on and off the EDM.
- **Chapter 3 “Searching for Member Profiles”** gives background information and instructions for searching for member information and viewing search results.
- **Chapter 4 “Viewing Member Profiles”** gives background information about member profiles, transaction histories, and profile comparisons, along with instructions for viewing this information.
- **Chapter 5 “Maintaining Member Profiles”** gives instructions for adding and updating member profiles, comparing profiles, resolving potential duplicate profiles, and merging and unmerging profiles.

1.2 Writing Conventions

Before you start using this guide, it is important to understand the special notation and mouse conventions observed throughout this document.

1.2.1. Special Notation Conventions

The following special notation conventions are used throughout this guide.

Table 1 Special Notation Conventions

Text	Convention	Example
Titles of publications	Title caps in <i>italic</i> font	<i>eIndex Global Identifier User's Guide</i>
Button, Icon, Command, Function, and Menu Names	Bold text	<ul style="list-style-type: none"> ▪ Click OK to save and close. ▪ From the File menu, select Exit.
Parameter, Variable, and Method Names	Bold text	<ul style="list-style-type: none"> ▪ Use the executeMatch() method. ▪ Enter the field-type value.

Table 1 Special Notation Conventions (Continued)

Text	Convention	Example
Command Line Code and Code Samples	Courier font (variables are shown in <i>bold italic</i>)	<ul style="list-style-type: none"> ▪ bootstrap -p <i>password</i> ▪ <tag>Person</tag>
Hypertext Links	Blue text	For more information, see “Writing Conventions” on page 10.
File Names and Paths	Bold text	In the Address field, type http://<host>:<port>/<app_name>stcedm.
Notes	Bold Italic text	<i>Note: If a toolbar button is dimmed, you cannot use it with the selected component.</i>

Additional Conventions

Windows Systems—The eIndex system is fully compliant with Windows NT, Windows 2000, and Windows XP platforms. When this document refers to Windows, such statements apply to all three Windows platforms.

1.2.2. Mouse Conventions

You can use either a single-button mouse or a multiple-button mouse with the EDM. If you use a multiple-button mouse, the left mouse button is the primary button, unless the mouse is configured differently.

The instructions in this guide may require you to use the mouse in a variety of ways:

- **Point** means to position the mouse pointer until the tip of the pointer rests on whatever you want to point to on the screen.
- **Click** means to press and then immediately release the left mouse button without moving the mouse.
- **Double-click** means to click the left mouse button twice in rapid succession.
- **Right-click** means to click the right mouse button once.
- **Drag** means to point and then hold down the mouse button as you move the mouse. **Drop** means to let go of the mouse button to place the dragged information where you want it to be moved.
- **Move** means to point to an object on the screen and then drag the mouse to move the object to a screen location of your choice.
- **Highlight** means to select an area of text by dragging the mouse over the desired portion of text that appears on a window.
- **Select** means to point to a list of information on an EDM page, and then click once to choose the data you want. The information becomes highlighted when selected.
- **Expand** means to double-click a row of information on an expandable list to display more details. The details appear on another row, below the row you double-click.

- **Collapse** means to double-click a row of information on an expandable list to hide the details that appear on the following row.

1.3 Supporting Documents

SeeBeyond has developed a suite of user's guides and related publications that are distributed in an electronic library. The following documents may provide information useful in using the EDM for eIndex. In addition, complete documentation of the Java API is provided in Javadoc format.

- *eIndex Global Identifier User's Guide*
- *eIndex Global Identifier Configuration Guide*
- *eIndex Global Identifier Reference Guide*

1.4 Online Documents

The documentation for the SeeBeyond ICAN Suite is distributed as a collection of online documents. These documents are viewable with the Acrobat Reader application from Adobe Systems. Acrobat Reader can be downloaded from:

<http://www.adobe.com>

1.5 SeeBeyond Web Site

The SeeBeyond Web site is your best source for up-to-the-minute product news and technical support information. The site's URL is:

<http://www.SeeBeyond.com>

Getting Started

This chapter provides information about eIndex and how the EDM helps to monitor and maintain member information. It also provides information about the design of the EDM and instructions for logging on to and off of the EDM.

2.1 eIndex Global Identifier

eIndex is an enterprise-wide master person index that maintains the most current information about the people who participate in your business enterprise. eIndex creates a single, consistent view of all member data by providing an automatic, common identification process regardless of the location or system from which the data originates. Member records from various locations are cross-referenced using an enterprise-wide unique identifier (EUID) assigned to each profile by eIndex. By creating EUIDs, eIndex can identify many types of participants, such as customers, employees, contacts, and so on.

The identification and demographic information for all members is centralized in one shared index. eIndex is designed specifically to support scattered business locations and disparate information systems across an enterprise, as well as various applications from multiple vendors. Maintaining a centralized database for multiple systems enables eIndex to integrate data throughout the enterprise while allowing local systems to continue operating independently. eIndex makes it easy to find information that was previously scattered among multiple systems.

2.1.1. Features of eIndex

eIndex is designed to uniquely identify, match, and maintain information throughout a business enterprise. The components of eIndex are highly configurable, allowing eIndex to be customized for your specific data processing needs. Primary features of eIndex include:

- **Centralized Information**

eIndex maintains a centralized database, enabling the integration of data records throughout the enterprise while allowing local systems to continue operating independently. The index stores copies of local system records and the single best record (SBR), which represents the most accurate and complete data for each member. This database is the central location of all member information and identifiers, and is accessible throughout the enterprise. Records from various

systems are cross-referenced using the EUID assigned by eIndex to each member profile.

▪ **Configurability**

Before deploying eIndex, you can customize the components and processing capabilities of the system. The configurable components include:

- ♦ The types of objects to index
- ♦ The types of data stored in eIndex
- ♦ The standardization and match engines to use
- ♦ Matching, standardization, and phonetic conversion rules
- ♦ Survivorship and weighting rules for determining the SBR
- ♦ The types of queries available
- ♦ How queries are blocked, or grouped, for match processing
- ♦ EDM appearance
- ♦ Searches available to the EDM
- ♦ Local ID validation rules

▪ **Cross-referencing**

eIndex is a global cross-indexing application, matching records across disparate source systems and simplifying the process of sharing data between systems. eIndex uses the local identifiers assigned by your existing systems as a reference for cross-indexing, allowing you to maintain your current systems and practices.

▪ **Data Cleansing**

eIndex uses configurable matching algorithm logic to uniquely identify member profiles, and to identify duplicate and potential duplicate records. eIndex provides the ability to easily merge or resolve duplicates, and can be configured to automatically merge records that are found to be duplicates of one another.

▪ **Data Updates**

eIndex provides the ability to add, update, deactivate, merge, and delete data in the database tables through messages received from external systems or the EDM. Records received from external systems and the EDM are checked for potential duplicates during processing. Data updates from external systems can occur in real time or as batch processes.

▪ **Identification**

eIndex employs configurable probabilistic matching technology. This technology uses a matching algorithm to formulate an effective statistical measure of how closely records match. Using a state-of-the-art algorithm in real-time mode and establishing a common method of locating member records, eIndex consistently and precisely identifies objects within an enterprise.

▪ **Integration**

Relying on the eGate Integrator, eIndex provides the power and flexibility to identify, route, and transform data to and from any system or application throughout your business enterprise. It can accept incoming transactions and

distribute updates to any external system, providing seamless integration with the systems in your enterprise.

- **Matching Algorithm**

eIndex is designed to use the SeeBeyond Match Engine or the Ascential™ INTEGRITY™ matching algorithm to provide a matching probability weight between member records. Both algorithms provide the flexibility to create user-defined matching thresholds, which control how potential duplicates and automatic merges are determined. You can configure eIndex to use the match engine of your choice.

- **Unique Identifier**

eIndex assigns an enterprise-wide unique identifier (EUID) to each object added to the database. The index uses the EUID to cross-reference the local IDs assigned to each member by the various computer systems throughout the enterprise.

2.2 Learning about the EDM

The Enterprise Data Manager (EDM) is a web-based interface that allows you to perform various actions against the eIndex database to monitor and maintain data. The EDM provides the ability to search for, add, update, deactivate, merge, unmerge, and compare member profiles. You can also view and correct potential duplicate profiles, view transaction histories, and view an audit log.

Using the EDM, you can perform the following functions.

- **View a Member's History**

The system provides a complete transaction history of each member profile by recording all changes to each member's data. This allows you to view before and after images of a profile for each change made. The table also records the user ID of the person who made the changes. This history is maintained for both the local system records and the SBR.

- **Search for Member Profiles**

Using the EDM, you can search for specific members or sets of members. The EDM allows you to perform different types of searches using different combinations of data elements, and returns a list of potential matches to your search criteria. eIndex also parses address components, so you can search for a member record by their street address. For certain searches, the results are assigned a matching weight that indicates the probability of a match.

- **Maintain Member Data**

The EDM supports all the necessary features for maintaining member profiles. It allows you to add new profiles; view, update, deactivate, or reactivate existing profiles; and compare profiles for similarities and differences. You can also view each local system record associated with an SBR.

- **Compare Member Data**

The EDM allows you to compare two member profiles in a side-by-side comparison so you can evaluate the differences or similarities between the two profiles. You can also compare different objects within one member profile in the same comparison

view. For example, you can compare the profile's SBR with a record from System A; or you can compare a profile's record from System A with its record from System B.

- **View and Resolve Potential Duplicates**

Using algorithm matching logic, eIndex has the ability to identify potential duplicate records, and the EDM provides the functionality to correct the duplication. Profiles that are potential duplicates can be viewed online in a side-by-side comparison. Potential duplication is resolved by either merging the profiles in question or removing their potential duplicate flags.

- **Merge and Unmerge Profiles**

You can compare potential duplicate profiles and then merge the profiles if you find them to be actual duplicates of one another. Using the merge feature, you can determine which profile to retain as the active record. The EDM also allows you to merge system records between member profiles, and to specify which information from each system record to preserve in the resulting record. If two member profiles or system records are merged in error, you can unmerge them, returning them to their original status prior to the merge. You can also view a history of merges for each record by viewing their merge tree.

- **Add and View Comments**

You can add free-text comments to a member profile or system record to provide additional information about the member that may not be included in the standard eIndex fields.

- **Audit Log**

The system administrator can specify that a log be maintained of each instance that member data is accessed from the EDM. This log provides information such as the user ID of the user who accessed the data, the type of action that was performed against the data, and the date and time of access. From the audit log, you can also view a transaction history for each transaction that caused an audit log entry.

- **Security**

Security is provided through the integration or application server, and includes basic access to the database through user logon IDs and passwords, as well as access to specific functions and actions of eIndex. Access can be restricted by functions, actions within the functions, data element, and user ID.

2.3 Learning about Member Profiles

2.3.1. Member Profile Components

A member profile, also known as an *enterprise object*, is a set of information that describes characteristics of an individual member in eIndex. Figure 1 illustrates an EUID tree for a member profile, which shows all components of a profile.

Figure 1 Member Profile Components

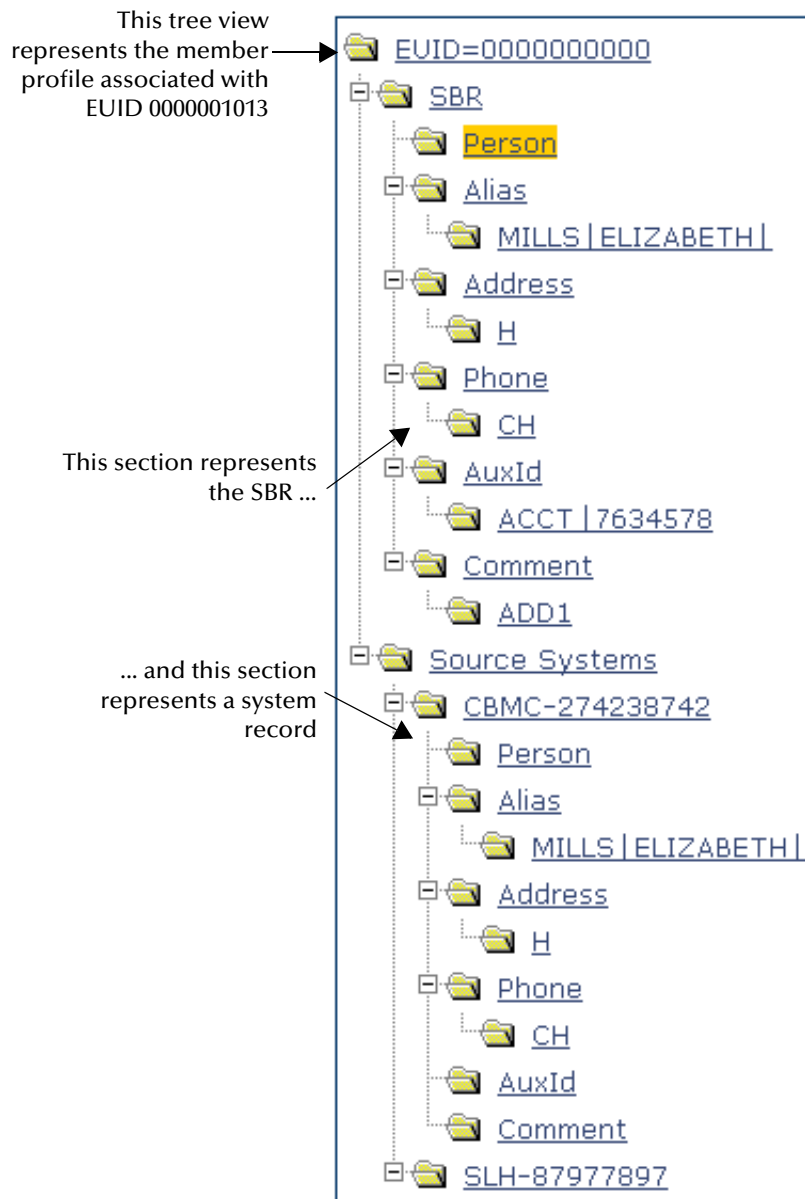

A member profile contains two types of records:

- **System Records**

A *system record* is a set of information from an external system that shares data with eIndex. A member profile may contain several system records.

- **Single Best Record**

The *single best record* (SBR) is a set of information derived from the best information from each system record in a member profile (as determined by the survivor calculator). Each member profile has only one SBR.

System Records

System records are different from the SBR in that each system record contains a system and local ID pair and only contains data from a specific system. The information in the system records of a member profile is used to determine the best value for the SBR in that profile. If a member profile only contains one system record, the SBR will be identical to that system record. However, if a member profile contains multiple system records, the SBR may be identical to one system record but will more likely include a combination of information from all system records. Certain actions against a system record will cause the SBR to be updated, such as updating, deactivating, or merging a system record. Each active member profile must have at least one active system record. If all system records in a profile are deactivated, then the entire profile will also be deactivated.

Single Best Record

The single best record (SBR) for a member profile is made up of a combination of information from all active system records associated with that member profile. The SBR represents the information that is determined by eIndex to be the most reliable and current of all system records in a member profile. The SBR is dynamic, and is recalculated each time an update is made to an associated system record, a merge or unmerge affects the member profile, or a system record in the profile is deactivated or reactivated. You can use the overwrite capability of the EDM to update the SBR directly, or you can update a system record and allow the survivor calculator to determine how to update the SBR (for more information, see **“Survivor Calculator”** below).

If you use the overwrite capability to update a field, that field remains locked and cannot be updated by changes to system records until the field is unlocked. For more information about the overwrite function and locked fields, see **“EDM Overwrite Capabilities” on page 76**.

Survivor Calculator

The survivor calculator determines which information from each system record in a member profile is stored in the SBR for that profile. The calculator uses information defined by the system administrator to calculate the SBR. By default, the survivor calculator uses a *weighted strategy* for most fields, using the relative reliability assigned to each system in combination with the reliability given to the most recently updated value.

For some fields, such as alias and auxiliary IDs, a union strategy is used. This means that all unique alias names and auxiliary IDs from all systems are included in the SBR. For detailed information about the survivor calculator and configuring the survival strategy, see the *eIndex Global Identifier User’s Guide*.

2.3.2. Member Profile Indicators

In eIndex, a member profile can have three different statuses: active, inactive, or merged. The EDM uses special characters in the EUID tree to indicate profiles that have a status other than active. The EDM also uses indicators in the EUID tree to denote the

type of profile you are viewing when a side-by-side comparison of the same EUID is displayed. For example, when a transaction history is displayed, the previous image of the profile appears in parentheses. Table 2 lists and describes each indicator.

Table 2 Member Profile Indicators

Indicator	Status
No indicator.	The status of the profile is active.
Tilde (~)	The status of the profile is inactive or merged. For example, EUID=~1001002135 . This indicator is also used with local IDs to indicate a merged or inactive system record.
Brackets ([])	Brackets indicate that the records displayed are the same version of the same profile. This is used on the Comparison page when comparing different components of the same profile. The EUID on the left appears in brackets. For example, EUID=[1001002135] .
Parentheses ()	When a transaction or merge history is displayed, the EUID representing the previous version of the displayed profile appears in parentheses. This profile represents the status of the profile before the transaction or merge occurred. For example, EUID=(1001002135) .

2.3.3. System Record and SBR Components

In eIndex, each system record and SBR in a member profile contains a set of sub-objects that store different types of information about the member. Generally, a record contains a parent object and several child objects. By default, the parent object is a person object, which is associated with these child objects: address, telephone, alias, auxiliary ID, and comment. A record can have only one parent object, but can have multiple child objects and multiple instances of each child object, with each instance being identified by a unique field. For example, a record can only contain one member name and social security number (contained in the parent object), but could have multiple addresses and telephone numbers (contained in child objects). Each address must be of a different type, such as a home address, billing address, or mailing address.

The Person Object

The person object is the primary object in a system record or SBR, and stores demographic information about a member. Each record can have only one person object. By default, the person object of the SBR contains the information from each system that is determined to be the best information by the survivor calculator. By default, certain fields must be entered in the person object in order to save a member profile. By default, these fields include first and last names, date of birth, and gender.

Address Objects

Address objects store a member's address information in a system record or SBR. Each address is identified by an address type. Each system record or SBR can store multiple addresses, but can only store one address of each type. For example, a record can have a home and a business address, but cannot have two home addresses. By default, the survivor calculator determines which system record addresses to store in the SBR by looking at all system record addresses. If each address type is unique, then all addresses are included in the SBR. If there are multiple addresses of one type, the survivor calculator determines which address to store in the SBR.

Phone Objects

Phone objects store a member's telephone numbers in a system record or SBR. Each telephone number is identified by a phone type. Each system record or SBR can store multiple telephone numbers, but can only store one number of each type. For example, a record can have a home and a cellular telephone number, but cannot have two home telephone numbers. By default, the survivor calculator determines which system record telephone numbers to store in the SBR by looking at all system record numbers. If each phone type is unique, then all telephone numbers are included in the SBR. If there are multiple telephone numbers of one type, the survivor calculator determines which number to store in the SBR.

Alias Objects

Alias objects store nicknames, maiden names, or any other names used by a member. Each system record or SBR can have multiple alias names. By default, all unique alias names from each system record in a member profile are included in the SBR. If two system records contain identical alias objects, then only one of those objects is stored in the SBR.

AuxId Objects

AuxId objects store a member's auxiliary IDs in a system record or SBR. Auxiliary IDs are identifiers assigned to a member that are not necessarily unique to each member. For example, it can be used to store a credit card number for a joint credit card, an account number for a joint checking account, or an insurance policy number for a policy that covers each member in a family. Each system record or SBR can store multiple auxiliary IDs. By default, all auxiliary IDs from each system record in a member profile are included in the SBR. If two system records contain identical auxiliary ID objects, then only one of those objects is stored in the SBR.

Comment Objects

Additional information about members appears in the form of comments. Comment objects contain free-form fields in which you can enter information about a member that does not appear in standard EDM fields. Each comment you add to a member profile must include a comment code that is unique to the member. This code is used to identify the comment. By default, the survivor calculator determines which system

record comments to store in the SBR by looking at all system record comments. If each comment type is unique, then all comments are included in the SBR. If there are multiple comments of one type, the survivor calculator determines which comment to store in the SBR.

Comments can be used by administrators to store information about such issues as resolving or merging potential duplicates or reasons for merging or unmerging profiles. They can also be used to store additional information about a member, such as recording information from a conversation with the member.

2.3.4. Identification Numbers for each Member

Each member in eIndex is assigned a unique identification number in addition to the local IDs assigned by individual systems. Each member has one unique identification number throughout your organization, and a unique identification number within each system with which they are registered. Members may also have several auxiliary IDs, meaning that they may share these identification numbers with other members.

EUID

Every member in the eIndex system is assigned an enterprise-wide unique identification number. This number is the same for that member regardless of the system from which the member information originates. This number is called the enterprise-wide unique identifier (EUID), and is used to cross-reference member profiles in order to accurately identify the members throughout your organization.

Local ID

A local ID is a unique local identification number that is assigned to a member in each system at which they are registered. These numbers are assigned using a numbering system unique to each local system, and are used internally by the systems to identify member profiles. eIndex uses a member's EUID to cross-reference their local IDs in different systems.

Auxiliary ID

An auxiliary ID is an identification code that does not necessarily uniquely identify a single member within the database, but might identify a group of members. For example, if a family shares the same account or insurance policy, every member of the family would have the same identification code for that account or policy.

2.4 Working with the Enterprise Data Manager

The EDM is a web-based application, which means you access the application through an internet browser. The EDM uses standard web-based features, such as hyperlinks, data fields, and action buttons, to help you enter information and navigate through the

different EDM pages. This section provides basic information about the design of the EDM, logging on and off the EDM, and using online help.

2.4.1. Logging on to the EDM

Before you can use the EDM, you must first log on to the application by entering the correct URL in your Web browser, and then specifying your logon ID and password. Make sure you have a user ID and password for eIndex before logging on. The integration server running the eIndex application must be started before you can log on to the EDM.

Important: After a certain period of inactivity, the EDM will automatically log off. This value is specified in the file *web.xml* (located in <logicalhost_home>\stcis\catalina\conf). The default time is 30 minutes. If you are automatically logged off, you must re-enter the URL to log back on.

Figure 2 EDM Logon Page

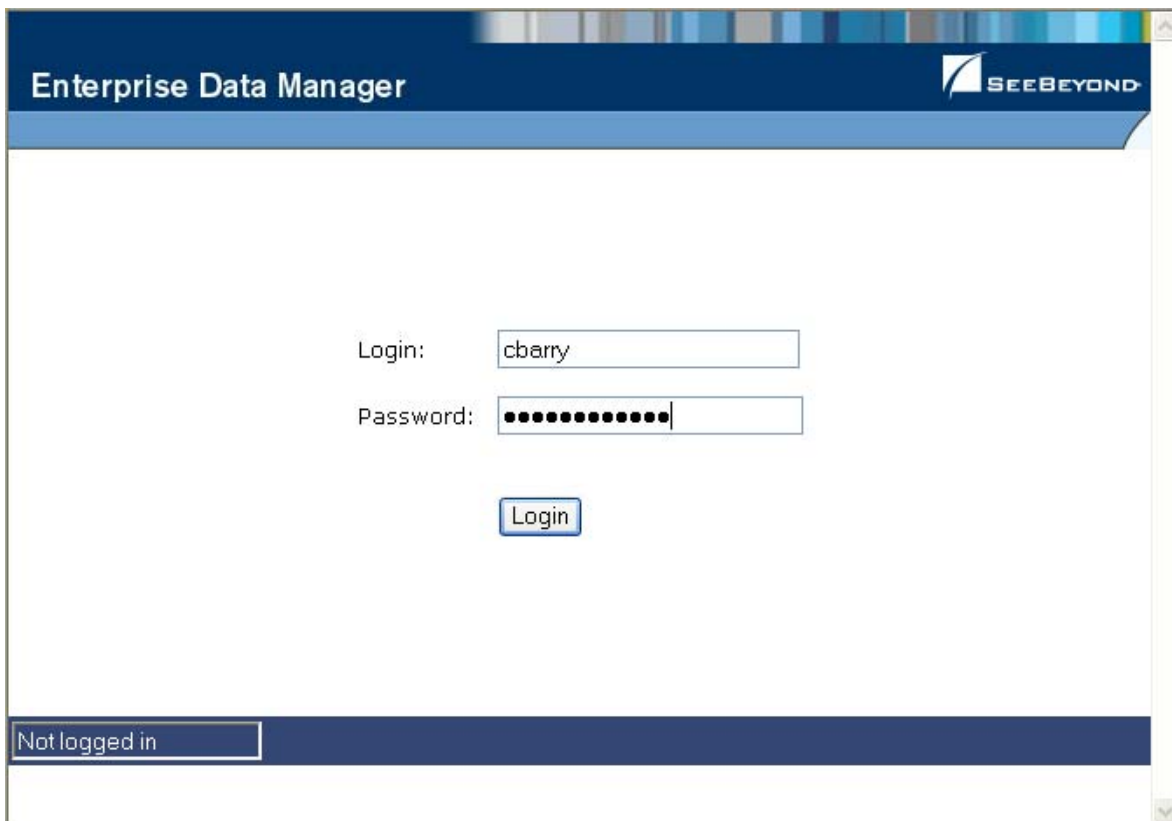

To log on to the EDM

- 1 Launch a Web browser (Internet Explorer 6.0 with SP1).
- 2 In the Address field, enter the appropriate URL.

The logon page appears.

Note: The default URL is: `http://<host>:<port>/<app_name>edm`, where `<host>` is the name of the server machine, `<port>` is the port number used by the EDM (by default, this is 18003), and `<app_name>` is the name of the index application specified in the eIndex Project. See your system administrator for more information. (System administrators, the host and port values are listed in the **Web Container Configuration** section of the **SIS Properties** window in Enterprise Designer.)

- 3 Enter your logon ID and password in the appropriate fields.
- 4 Click **Login**. The EDM Search page appears.

2.4.2. Navigation Tips

The EDM provides hyperlinks and command buttons to help you access and move through the EDM pages.

Navigating the EDM Functions

The actions you can perform on the EDM are grouped into four primary functions: Person Search, Matching Review, History, and Create System Record. The main menu on all EDM pages provides hyperlinks to each of these functions, as shown in Figure 2. The first page to appear for each function, except the Create System Record function, is a search page. The names of these headings can be modified for your application.

Figure 3 Main Menu Navigation Tools



- **Person Search**

The Person Search function allows you to perform a search for a member profile or set of member profiles in eIndex. From the associated pages, you can compare two member profiles, compare records in one member profile, view all information for one member profile, update a member profile, view a transaction history of a member profile, view a member's potential duplicates, or merge member profiles or system records.

- **Matching Review**

The Matching Review function allows you to perform a search for potential duplicate profiles or for any profiles that were updated by an assumed match. From the associated pages, you can compare, merge, or resolve potential duplicate profiles, and you can view and reverse assumed match transactions.

- **History**

The History function allows you to perform a search for transaction histories or audit log entries. From the Transaction History pages, you can compare information

about a member before and after a transaction occurred, select member profiles to unmerge, and view a merge history for a member profile. The audit log pages allow you to view information about transactions in which data about a member was accessed through the EDM.

- **Create System Record**
The Create System Record function allows you to create new member profiles by creating a system record. When you save the information in the system record, eIndex automatically generates the SBR using the survivor calculator.

Navigating the Search Pages

When you perform a search for member information using the Person Search, History, or Matching Review functions, information appears in three different pages. The *Search page* displays the fields you can use as search criteria, the *Search Result page* displays a list of search result profiles, and the *detail pages* display the member profiles you selected from the results list. Once you perform a search, you can navigate back through these pages using the hyperlinks provided in a secondary menu below the main menu, as shown in Figure 4. The Matching Review page for potential duplicate searches, includes an additional results page called the *Associated Records* page.

Figure 4 Search Page Navigation Tools



The behavior of the commands on the secondary menu for Person Search, Matching Review, and History is described in Table 3.

Table 3 Secondary Menu Navigational Tools

Menu Option	Description
Search	Returns to the original search page with the search criteria filled in.
Search Result	Returns to the search results list.
<Detail Page Name>	This is the name of the current detail page. Clicking this menu option does not perform any action unless you perform a merge from the Comparison page. In this case the Comparison option becomes active and returns to the Comparison page.
Back to Person Search	This option becomes available when you select Transaction History or Potential Duplicate from the View/Edit page. It returns to the View/Edit page.

Navigating the Detail Pages

The detail pages display an EUID tree view of the member profile on the left, and the detailed information for the selected tree-view object on the right. If you are viewing a comparison of member profiles, the tree views appear in the outer sections of the page, with the detailed information in the center. Figure 5 illustrates the View/Edit page, and shows the tree view on the left with the person object of the SBR selected. The detailed information displayed on the right is associated with the selected person object. When you select a different object from the tree view, the detailed information in the right portion of the page changes accordingly.

Figure 5 Sample View/Edit Page

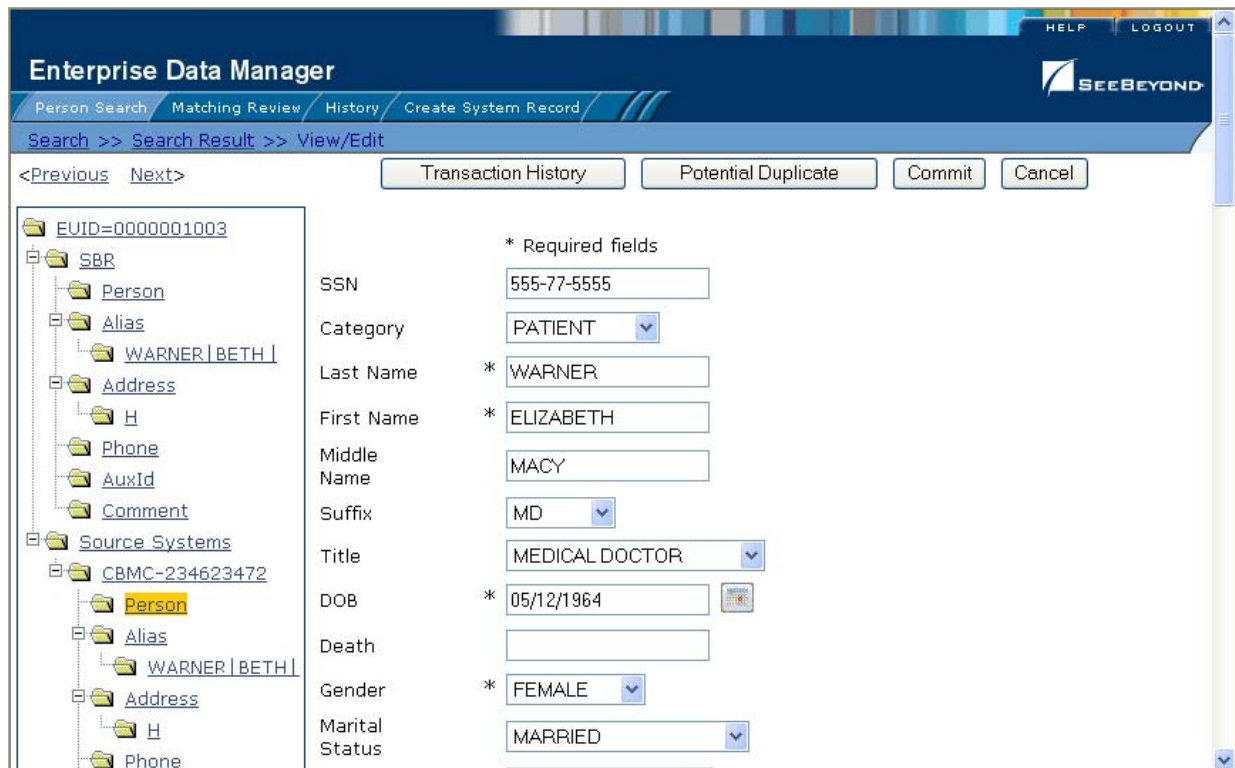

2.4.3. Logging Off the EDM

Before you exit the EDM, make sure you have saved any changes.

To exit the EDM

- 1 In the upper right corner of the page, click the **Log Off** button.
- 2 On the confirmation dialog that appears, click **Yes**.

Searching for Member Profiles

Before you can view or modify a member profile, you must perform a search for the profile using the search tools provided by the EDM. This chapter presents the background information and the step-by-step instructions you need to find member information using the EDM. This chapter does not describe the additional search capabilities provided on the History or Matching Review pages. The History searches are described in [Chapter 4](#), and the Matching Review pages are described in [Chapter 5](#).

The information in this chapter is based on the default configuration for eIndex, and the appearance of your EDM will vary from the descriptions and illustrations depending on how your application is configured.

3.1 Learning About Member Queries

Before you can view or update member information, you need to perform a search for the member. There are several different search capabilities within the EDM. You can perform lookups for specific member profiles using unique identifiers such as the EUID or local ID, and you can perform broader searches using standard demographic information and parsed address components as criteria.

3.1.1 About the Person Search Function

By default, the Person Search tab includes four different search pages: Simple Person Lookup, Advanced Person Lookup (Alpha), Advanced Person Lookup (Phonetic), and Comparison Lookup. The design of the search functionality provides flexibility in designing database queries. You can narrow a search for a specific member or a range of members using various search fields located on the search pages. You can enter search criteria on the Advanced Person Lookup pages, and then view your search results on the Search Result page. When you select a specific member from the Search Result page, detailed information for that member appears on the View/Edit page.

The Simple Person Lookup Page

The Simple Person Lookup page of the Person Search function allows you to perform lookups using unique identifiers to find a specific member profile. By default, the unique identifiers you can use as search criteria include the EUID, local ID and system, or social security number (SSN). When you perform this type of search, the Search Result page is generally bypassed and the View/Edit page appears displaying

information about the matching profile. An exception to this is when different member profiles contain the same or very similar SSNs. Performing a search for one of these profiles brings up the Search Result page with a list of matching profiles.

The Advanced Person Lookup (Alpha) Page

The Advanced Person Lookup (Alpha) page of the Person Search function allows you to perform searches against the database using a combination of demographic and address fields as criteria. The member profiles returned by these searches are not assigned a matching probability weight to indicate how closely they match the search criteria. The searches performed on this page are exact match searches, meaning that they only return profiles that exactly match the criteria you specify. The only exception is the street address fields, which are parsed and standardized before searching for matching profiles. Most other fields in this search allow wildcard characters if the exact value is unknown.

The Advanced Person Lookup (Phonetic) Page

The Advanced Person Lookup (Phonetic) page of the Person Search function allows you to perform searches against the database using pre-defined combinations of demographic and address fields as criteria. The member profiles returned by these searches are assigned a matching probability weight to indicate how closely they match the search criteria. The searches performed on this page are not exact match searches, and allow for misspellings and for nicknames. By default, you can only search on the following data combinations; however, your system administrator may have modified the required combinations.

- ◆ First Name and Last Name
- ◆ Address Line 1 and, optionally, Address Line 2
- ◆ Last Name, Address Line 1, and, optionally, Address Line 2
- ◆ Social Security Number
- ◆ First Name, DOB, and Gender
- ◆ Last Name and Mother's Maiden Name

The Comparison Lookup Page

The Comparison Lookup page of the Person Search function allows you to perform a search for multiple member profiles by entering their EUIDs. You can then select two of the resulting records to view on the Comparison page. Use this type of search if you want to compare member profiles and you know the EUIDs of the member profiles to compare.

The Search Result page

The Search Result page of the Person Search function displays a list of member profiles found in the database that closely match the search criteria you entered. The results list appears in a table, with the number of profiles returned for the search displayed above

the table. This page displays information to help you identify the correct member profile, such as the EUID, name, date of birth, address information, and status. This page also displays a list of the search criteria entered for the search that returned the displayed list. For more information about search results and the Search Result page, see [“Working with Search Results” on page 36](#).

3.1.2. Types of Searches

There are several different methods of searching for members, depending on the search criteria you enter. The search pages of the Person Search function are organized into different sections that allow you to perform different types of searches based on specific categories of criteria. On the Simple Person Lookup page, you can only perform one type of search at a time, using the fields from only one search section.

***Note:** The names of the search types are configurable. This section describes the searches by their default names and by their default search criteria. See your system administrator if you have questions about how your search pages are configured.*

EUID Lookup

You can perform an EUID Lookup using the field in the **Enterprise Unique ID** section of the Simple Person Lookup page. Enter the member's EUID number to perform an exact match search against the database.

Social Security Number Lookup

A Social Security Number Lookup is used to perform an exact match search against the database using the member's social security number (SSN) for search criteria. This type of search is performed in the **SSN** section of the Simple Person Lookup page.

Local ID Lookup

The Local ID section of the Simple Person Lookup page consists of two fields. The System and the Local ID fields are required to perform a local ID lookup. To increase search accuracy, you can only select a system listed in the drop-down list. The Local ID field is case-sensitive.

Advanced Person Lookup (Alpha)

You can perform an alphanumeric search on the Advanced Person Lookup (Alpha) page, using a combination of demographic and address fields as criteria. Using a combination of required and optional fields, you can form a search as precise or general as you prefer. An alphanumeric search looks for profiles that exactly match the criteria as you entered it, without allowing for misspellings or typographic errors. You can use wildcard characters for alphanumeric searches.

Advanced Person Lookup (Phonetic)

The Advanced Person Lookup (Phonetic) function differs from the alphanumeric lookup in that it returns phonetic variations of the entered name or street address, allowing room for misspellings, typographic errors, and misspellings. Name and address criteria for phonetic searches are not sensitive to case or to diacritical marks. You can include any combination of address fields in the search, and you can perform partial searches on the street address by only entering the street name. An address search uses the parsed street address field components and the phonetic version of the street name.

Comparison Lookup

The Comparison Lookup function provides a simple way to search for two or more records to compare in a side-by-side comparison. You can enter up to five EUIDs as search criteria, and all records matching any of the specified EUIDs are returned.

3.2 Searching for Member Profiles

This section provides the step-by-step instructions you need to follow to perform the various types of searches available on the EDM. The search types include:

- EUID Lookup
- Social Security Number Lookup
- Local ID Lookup
- Advanced Alphanumeric Lookup
- Advanced Phonetic Lookup
- Comparison Lookup

Note: To move from one field to another on the search pages without using the mouse, press the **Tab** key.

3.2.1. Performing an EUID Lookup

To search for a a member profile using only a member's EUID, you need to enter the EUID number in the EUID Search section of the Simple Person Lookup page. This type of search should result in only one matching profile.

Figure 6 Simple Person Lookup Page

The screenshot shows the 'Simple Person Lookup' page in the Enterprise Data Manager. The page is titled 'Search' and has a 'Search Types' dropdown menu set to 'Simple Person Lookup'. There are 'Search' and 'Clear' buttons. Below this are three sections: 'SSN' with an input field, 'Enterprise Unique ID' with an input field labeled 'EUID', and 'Local ID' with a 'System' dropdown menu and an input field labeled 'Local ID'.

To perform an EUID lookup

- 1 On the Person Search page, select **Simple Person Lookup** from the **Search Type** drop-down list.
- 2 In the Enterprise Unique ID section, enter the member's EUID.
- 3 Click **Search** or press **Enter** to initiate the search.

The View /Edit page appears, displaying detailed information about the member whose EUID you entered.

3.2.2. Performing a Social Security Number Lookup

To search for a member profile using only the member's social security number, use the SSN section of the Simple Person Lookup page (see Figure 6 for an illustration of this page). While this type of search should result in only one matching profile, there may be several resulting matches.

To perform a social security number lookup

- 1 On the Person Search page, select **Simple Person Lookup** from the **Search Type** drop-down list.
- 2 In the SSN section, enter the social security number of the person you want to find.
- 3 Click **Search** or press **Enter** to initiate the search.

If there are multiple matching profiles, the Search Result page appears with a list of matching profiles. If there is only one matching profile, the Search Result page is bypassed, and the View /Edit page appears.

3.2.3. Performing a Local ID Lookup

To search for a member profile by their local ID in a specific system, you need to enter this information in the Local ID section of the Simple Person Lookup page. This type of search should result in only one matching profile. If the Local ID field contains alphabetic characters, the criterion is case-sensitive.

To perform a local ID lookup

- 1 On the Person Search page, select **Simple Person Lookup** from the **Search Type** drop-down list.
- 2 Enter your search criteria in the Local ID section (for more information, see “**About Local ID Lookup Fields**” following this procedure).
- 3 Click **Search** or press **Enter** to initiate the search.

The Search Result page is bypassed, and the View/Edit page appears.

About Local ID Lookup Fields

The fields in the Local ID section of the Simple Person Lookup page allow you to search for a member by their local ID. There are no defaults for these fields, and both fields are required for the search.

Table 4 Local ID Lookup Fields

In this field ...	type or select ...
System	The computer system, such as a registration system, for which the member's local ID is known.
Local ID	The member's unique identification code at the specified system. <i>Note: If alphabetic characters are entered in this field, the search is case-sensitive.</i>

3.2.4. Performing an Advanced Alphanumeric Lookup

To perform an advanced alphanumeric search for a member profile, you need to specify identifying information for the member, such as their first and last names, on the Advanced Person Lookup (Alpha) page. This type of search may result in several matching profiles.

Figure 7 Advanced Person Lookup (Alpha) Page

To perform an advanced alphanumeric lookup

- 1 On the Person Search page, select **Advanced Person Lookup (Alpha)** from the **Search Type** drop-down list.
- 2 In the Demographics and Address sections, enter search criteria for the member you want to find (for more information, see **“About Alphanumeric Search Fields”** following this procedure).
- 3 Click **Search** or press **Enter** to initiate the search.

The Search Result page appears with a list of matching profiles. If only one matching profile is returned, the View/Edit page appears.

Important: *The system administrator can choose whether to display the EUID field or the local ID and system fields on this page. Any values entered into these optional fields take precedence over information entered into other search fields. For example, if an invalid EUID is entered but valid first and last names are entered, no results are returned due to the invalid EUID. The EUID field takes precedence over the local ID and system fields.*

About Alphanumeric Search Fields

The alphanumeric search fields, located in the Demographics and Address sections of the Advanced Person Lookup (Alpha) page, allow you to specify search criteria for the member you want to find. You should make your search as specific as possible. This type of search allows wildcard characters. Use a percent sign (%) to indicate any unknown characters.

Note: These fields are defined by default, but your implementation might be configured differently.

Table 5 Advanced Alphanumeric Search Fields

In this field ...	type or select ...
Demographics	
Last Name	The last name of the member you want to find.
First Name	The first name of the member you want to find.
Middle Name	The middle name or initial of the member you want to find.
DOB	The date of birth for the member you want to find. <i>Tip: You can click the calendar icon to the left of this field to bring up a calendar from which you can select a date. To select today's date, click Today on the calendar dialog.</i>
Gender	The gender of the member you want to find.
Mother's Maiden Name	The maiden name of the member's mother.
SSN	The social security number of the member you want to find.
Maiden Name	The maiden name of the member you want to find.
Category	The type of member profile for which you are searching, such as customer, employee, patient, and so on.
Address	
Address Type	The type of address you are entering as criteria, such as home, billing, office, and so on.
Address Line 1	The street address of the member you are looking for. Enter only a street number and street name in this field, and do not enter a street type or direction.
City	The city in which the address is located.
State	The state in which the address is located.
Postal Code	The zip code of the address.

3.2.5. Performing an Advanced Phonetic Lookup

To perform an advanced phonetic search for a member profile, you need to specify identifying information for the member, such as their first and last names, on the Advanced Person Lookup (Phonetic) page. This search may return several profiles.

Figure 8 Advanced Person Lookup (Phonetic)

The screenshot shows the 'Enterprise Data Manager' interface. At the top, there are navigation tabs: 'Person Search', 'Matching Review', 'History', and 'Create System Record'. The 'Person Search' tab is active. Below the tabs, there is a 'Search' section with a 'Search Types' dropdown menu set to 'Advanced Person Lookup (Phonetic)'. There are 'Search' and 'Clear' buttons. Below this, there are two main sections: 'Demographics' and 'Address'. The 'Demographics' section includes input fields for 'Last Name', 'First Name', 'DOB', 'Gender', 'Mother's Maiden Name', and 'SSN'. The 'Address' section includes input fields for 'Address Line 1' and 'Address Line 2'. The interface is branded with 'SEE BEYOND' in the top right corner.

To perform an advanced phonetic lookup

- 1 On the Person Search page, select **Advanced Person Lookup (Phonetic)** from the **Search Type** drop-down list.
- 2 In the Demographics and Address sections, enter search criteria for the member you want to find in one of the allowed combinations.

By default, the combinations are as follows:

- ◆ First Name and Last Name
- ◆ Address Line 1 and, optionally, Address Line 2
- ◆ Last Name, Address Line 1, and, optionally, Address Line 2
- ◆ Social Security Number
- ◆ First Name, DOB, and Gender
- ◆ Last Name and Mother's Maiden Name

For more information about these fields, see “**About Phonetic Search Fields**” following this procedure).

Note: *The system administrator may have modified the phonetic search criteria so it is different from the above list. If you are unsure of the required criteria combinations, see your system administrator.*

- 3 Click **Search** to initiate the search.

The Search Result page appears with a list of matching profiles.

Important: The system administrator can choose whether to display the EUID field or the local ID and system fields on this page. Any values entered into these optional fields take precedence over information entered into other search fields. For example, if an invalid EUID is entered but valid first and last names are entered, no results are returned due to the invalid EUID. The EUID field takes precedence over the local ID and system fields.

About Phonetic Search Fields

The phonetic search fields, located in the Demographics and Address sections of the Advanced Person Lookup (Phonetic) page, allow you to specify search criteria for the member you want to find. You should make your search as specific as possible. This type of search does not allow wildcard characters.

The Address section consists of fields that are parsed once the search is initiated. Parsed fields are separated into their various components and then standardized before the search is carried out. Parsed fields may include any of the Address Lines 1 through 4 fields, depending on how parsing is configured.

Table 6 Advanced Phonetic Search Fields

In this field ...	type or select ...
Demographics	
Last Name	The last name of the member you want to find.
First Name	The first name of the member you want to find.
DOB	The date of birth for the member you want to find. Tip: You can click the calendar icon to the left of this field to bring up a calendar from which you can select a date. To select today's date, click Today on the calendar dialog.
Gender	The gender of the member you want to find.
Mother's Maiden Name	The maiden name of the member's mother.
SSN	The social security number of the member you want to find.
Address	
Address Line 1	The first line of the street address for the member.
Address Line 2	The second line of the street address for the member.

3.2.6. Performing an EUID Comparison Lookup

To perform a search by EUID for multiple profiles to compare, you need to specify each EUID on the Comparison Lookup page. You can enter from two to five EUIDs to compare in the search results list, and then select one or two of the resulting profiles to compare their information.

Figure 9 Comparison Lookup Page

The screenshot shows the 'Enterprise Data Manager' interface. At the top, there's a dark blue navigation bar with the title 'Enterprise Data Manager' and several tabs: 'Person Search', 'Matching Review', 'History', and 'Create System Record'. Below the navigation bar, there's a 'Search' section. On the right side of this section, there's a 'Search Types' dropdown menu currently set to 'Comparison Lookup'. Below the dropdown, there's a text prompt: 'Specify up to 5 Enterprise Unique IDs'. To the right of this prompt are two buttons: 'Search' and 'Clear'. Below the prompt, there's a section titled 'Enterprise Unique IDs' which contains five input fields, each labeled 'EUID1' through 'EUID5'.

To perform an EUID comparison lookup

- 1 On the Person Search page, select **Comparison Lookup** from the **Search Type** drop-down list.
- 2 Enter at least two, and up to five, EUIDs.
- 3 Click **Search** or press **Enter** to initiate the search.

The Search Result page appears with a list of matching profiles.

3.3 Working with Search Results

This section of the chapter describes the Search Result page and how to sort and select the profiles that match the searches you perform. The criteria that you entered for a search appear above the results list table on the result page.

3.3.1. Viewing the Results of a Search

The matching profiles that result from a member search appear in table format on the Search Result page. The table displays a limited number of fields contained in the SBR of the member profile.

Figure 10 Search Results List

Enterprise Data Manager

Person Search Matching Review History Create System Record

Search >> Search Result New Search

Advanced Person Lookup (Alpha) criteria: Person.Gender: F Person.LastName: **WAR%** Person.FirstName: **ELIZABETH**

Records 1 - 5 of 5 <Previous Next>

Compare <input type="checkbox"/> Compare Records	EUID	Last Name	First Name	Middle Name	DOB	Gender	Mother's Maiden Name	SSN	Maiden Name	Category	Addr Type
<input type="checkbox"/>	0000000000	WARREN	ELIZABETH		05/14/1964	F	MARTIN	555665555	MILLS	CG	H
<input type="checkbox"/>	0000001003	WARNER	ELIZABETH	MACY	05/12/1964	F		555775555		PT	H
<input type="checkbox"/>	0000001004	WARREN	LIZBETH	ANN	05/13/1968	F		229992222		PT	H
<input type="checkbox"/>	0000002003	WARRING	ELIZABETH	MARY	05/14/1960	F		717171717			
<input type="checkbox"/>	0000002004	WARNER	LIZBETH		05/14/1960	F		313131313			

To view the profiles on the Search Result page

- 1 Perform a search for the member whose profile you want to access.
If more than one record matches the criteria, the Search Result page appears.
- 2 In the results list, view the information presented for each returned profile to determine which profile you want to view (for information about the fields contained in the results list, see **“About Results Fields”** following this procedure).
- 3 If an address or telephone number field is included in the results list and contains an ellipsis (“...”), you can click the ellipsis to view additional address or telephone information, as shown in Figure 11 and Figure 12.

Figure 11 Address Information Page



Figure 12 Telephone Information Page

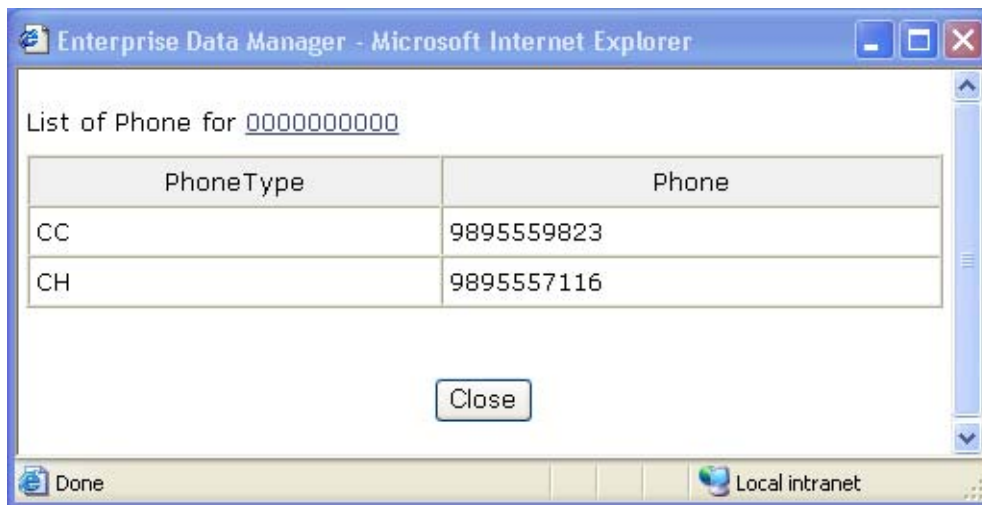

- 4 When you are finished viewing the additional address or telephone information, click **Close**.
- 5 To view the following page of results, click **Next>**.
- 6 To return to the previous page of results, click **<Previous**.
- 7 To select a profile to display on the View/Edit page, click the EUID of that profile.
- 8 To perform a new search, click **New Search** in the upper portion of the page.

About Results Fields

The fields located on the Search Result page display information to help you to identify the appropriate member. The fields listed in the following table describe the default

fields in the results list. Your list may differ depending on how your EDM has been configured

Table 7 Search Result page Fields

This field ...	displays this information ...
EUID	The enterprise-wide unique identification number assigned to the member by eIndex.
Last Name	The last name of the member.
First Name	The first name of the member.
Middle Name	The middle name of the member.
DOB	The date the member was born.
Gender	The gender of the member.
Mother's Maiden Name	The maiden name of the member's mother.
SSN	The member's social security number.
Maiden Name	The member's maiden name.
Category	The person category assigned to the member profile.
Address Type	The type of address information being displayed.
Address Line 1	The first line of the member's street address.
Address Line 2	The second line of the member's street address.
Phone Type	The type of telephone information being displayed.
Phone	A telephone number for the member.
Status	The status of the member profile.
Weight	A matching probability weight that indicates how closely each profile matches the criteria you entered. <i>Note: This field only appears in the results of a phonetic search.</i>

3.3.2. Sorting the Results of Your Search

The matching profiles that result from a member search appear in table format on the Search Result page. By default, the results are sorted by EUID, but you can sort the results by any column in the table.

To sort the profiles on the Search Result page

- 1 Perform an advanced search for the member whose profile you want to access.
- 2 In the results list that appears on the Search Result page, click the column heading of the column by which you want to sort the results (for more information, see “About Results Fields” earlier in this chapter).

3.3.3. Selecting a Profile from the Results List

From the search results list, you can select one member profile to view detailed information for that profile, or you can select two member profiles to compare the information in both profiles.

To select a profile to view

- 1 Perform an advanced search for the member profiles you want to view.
- 2 To view detailed information for one member profile, click the EUID of that profile. The View /Edit page appears, displaying the person object for that profile.
- 3 To compare two member profiles, select the check boxes to the left of each profile you want to compare, and then click **Compare Records**.

The Comparison page appears, displaying a side-by-side comparison of the two profiles.

- 4 To compare different components of one member profile, select the check box to the left of the profile you want to view, and then click **Compare Records**.

The Comparison page appears, displaying a side-by-side comparison of two instances of the same member profile.

Note: *Note: Once a comparison check-box is selected in the search results list, it remains checked until you deselect it. If you return to the Search Result page from the Comparison page, deselect the selected check boxes before making another selection.*

Viewing Member Profiles

This chapter presents the background information and the step-by-step instructions you need to view and compare member information using the EDM. The information in this chapter is based on the default configuration for eIndex, and the appearance of your EDM may vary depending on how your system administrator configured eIndex.

4.1 Member Profile Views

Before you can view member information, you need to perform a search for the member using one of the search techniques described under [“Searching for Member Profiles” on page 29](#). Once you retrieve a search results list, you can view a member’s detailed information, compare member profiles, view a merge transaction history for a profile, and view a history of all transactions for a profile.

4.1.1. The View/Edit Page

When you select a profile on the Search Result page, detailed information about the selected member appears on the View/Edit page. This page is divided into two sections. The left side of the page is a tree view that displays the EUID, the components of the SBR, and the components of each system record. You can select a component from the EUID tree to display detailed information about that component in the right portion of the page. The View/Edit page displays the selected member’s identification, demographic, alias, and local ID information, and you can select an address, telephone number, auxiliary ID, or system record to view additional information. From the View/Edit page, you can perform several actions, such as viewing a transaction history for the member, viewing potential duplicate profiles, deactivating the profile, updating member information, and so on.

The Tree View

A tree view on the left side of the View/Edit page displays an outline of the profile, including the SBR and any associated system records. This is called the EUID tree.

Figure 13 Member Profile Tree View



You can expand this tree view to view the different types of information contained in the SBR and in each system record. A plus sign (+) to the left of an item indicates that the item contains additional information. For addresses and telephone numbers, only the address or phone type appears in the tree; and for comments, only the comment code appears. For aliases, each alias name appears in the tree.

Figure 14 Expanded Member Profile Tree View

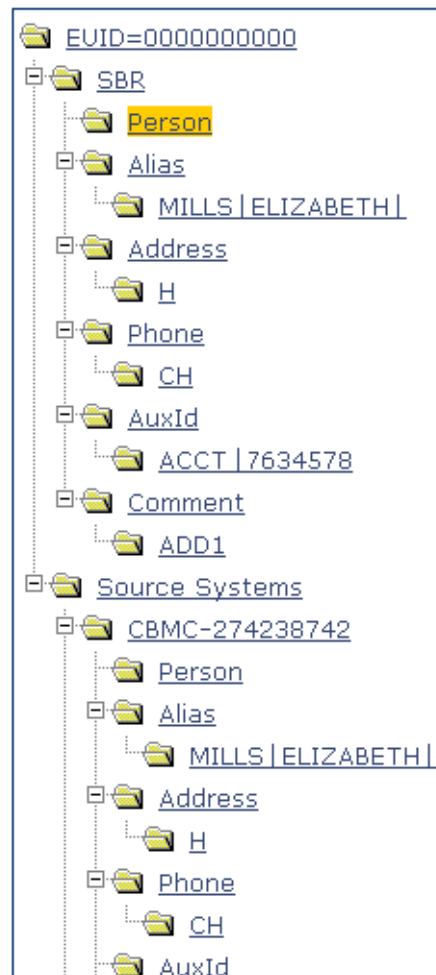

Information Fields

The right side of the View/Edit page displays detailed information about the item that is selected in the EUID tree. For example, selecting an address type under the SBR entry in the EUID tree displays the detailed information for that address type in the SBR. Selecting “Person” under a source system record in the EUID tree displays demographic information for that person as it is stored in that system record. The information contained in a member’s system record may be different from that stored in the member’s SBR.

By default, you can view the selected member's demographic, alias, address, telephone, auxiliary ID, and local ID information for both the SBR and associated system records. For more information about member profiles, see [“Learning about Member Profiles” on page 16](#)).

4.1.2. Member Profile Comparisons

You can compare two different member profiles by selecting the profiles to compare from a search results list. You can also compare different components of one member profile. The Comparison page allows you to view the selected profiles or components of one profile in a side-by-side comparison. Like the View/Edit page, the Comparison page displays an EUID tree for each profile, from which you can select the type of information you want to compare. This design allows you to compare one member’s SBR with another’s SBR, one member’s system records with another’s system records, or one member’s SBR with another’s system records. You can also compare a profile’s SBR with one of its own system records or two system records from one profile. This gives you a complete comparison between member profiles and between the different records in a member profile.

From the Comparison page, you can merge member profiles or system records if they are found to represent the same member.

4.1.3. Member Profile Transaction Histories

You can view a history of all transactions performed against member profiles either by performing a search as described in [“Searching for Member Profiles” on page 29](#), or by performing a Transaction History search on the History page. The second type of search is described in this chapter. You can trace the events that modified a member profile from the time the profile was added to eIndex to the most previous transaction, including merged and deactivated profiles.

The Transaction History page allows you to view a side-by-side comparison of one member profile before and after a transaction occurred against that profile. Like the Comparison page, the Transaction History page displays an EUID tree for each profile, from which you can select the type of information you want to compare. For a true comparison, be sure the type of information you are viewing is the same on both sides of the page. You can also compare an SBR against an SBR, an SBR against a system record, or a system record against a system record.

4.1.4. Member Profile Merge Histories

On the Merge History page, you can display a history of the merges that have affected a specific member profile. The merge history appears in an EUID tree format on the left side of the page. The top level displays the EUID of the current active profile. The two profiles at the second level show you the EUIDs of the profiles that were merged to form the top-level profile. If there are profiles listed at the third level, they display the EUIDs of the profiles that were merged to form the profile above them. There may be several levels of merges displayed in a member's merge history.

The right side of the page displays information about the merge transactions that involved the EUID that is selected in the EUID tree on the left. You can select a specific transaction to view a transaction history comparison for that merge transaction.

4.1.5. The Audit Log

The audit log allows you to track and view all instances in which information about the members in eIndex was accessed through the EDM. If audit logging is enabled, an audit log entry is created each time the EDM accesses database tables that contain member information. The audit log keeps a record of each time the tables are accessed, along with the database function used to access the tables, the logon ID of the user accessing the tables, the date and time the tables were accessed, and the EUIDs of the member profiles that were accessed. This allows you to closely monitor access to the person records in the eIndex database and supports HIPAA privacy regulations. The audit log is enabled and disabled in the Enterprise Data Manager file in the eIndex Project.

4.2 Viewing Member Profiles

Member profiles are displayed on the View/Edit page, with a series of pages you can select and view. Each page except the Person page displays the same four fields in the upper portion of the page to help you identify the member. These fields are First Name, Last Name, Date of Birth, and Gender. You can view information contained in both the SBR and any associated system records.

This section provides the instructions you need to view information associated with a member profile. The following procedures are included in this section.

- Viewing a Member's Demographic Information
- Viewing a Member's Addresses
- Viewing a Member's Telephone Numbers
- Viewing a Member's Aliases
- Viewing a Member's Local IDs
- Viewing a Member's Auxiliary IDs
- Viewing Comments Associated With a Member

Important: The system administrator can customize the appearance of the EDM. The information included in the following topics describes the field names and tab names as they appear in the default version of the EDM. The appearance of your EDM GUI may differ from the following descriptions.

4.2.1. Viewing a Member's Demographic Information

You can view the demographic information that is contained in a member's SBR or in any of the associated system records for that member.

A member's SBR contains the demographic information that is determined to be the most current and accurate information about that person from all local systems. By default, when the View/Edit page first appears, the Person page of the SBR is visible.

The system records associated with a member profile contain the demographic information that is stored in the external systems that share information with eIndex. The information in a member's system records might not match the information stored in the member's SBR.

Figure 15 View/Edit Page - Demographic Information

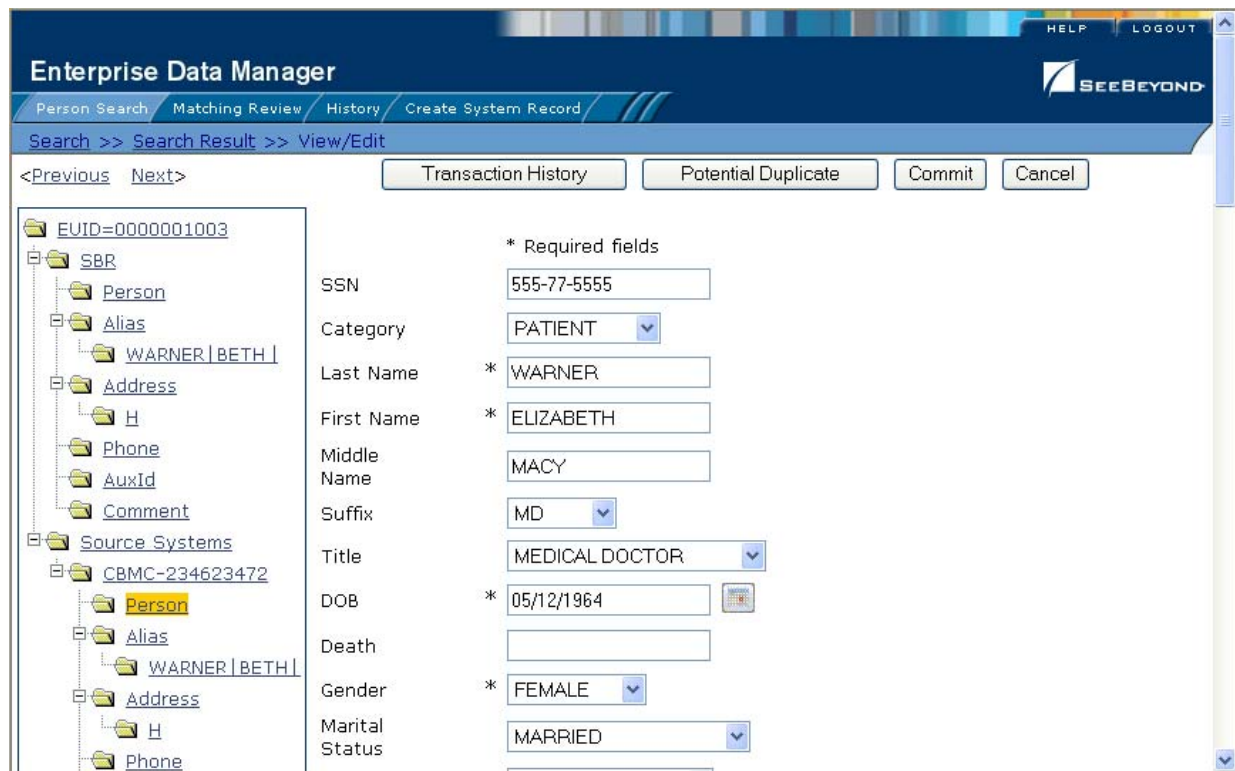

To view demographic information

- 1 Perform a search for the member whose information you want to view as described in "Searching for Member Profiles" in Chapter 3).
- 2 On the Search Result page, click the EUID of the member profile you want to view.

The View/Edit page appears with the Person object of the SBR selected. For information about the fields on this page, see “About Demographic Fields” following this procedure.

- 3 To view demographic data in a system record:
 - ◆ In the EUID tree in the left portion of the page, expand **Source Systems**.
 - ◆ Expand the system code and local ID you want to view.
 - ◆ Under the expanded system code and local ID, click **Person**.

Note: *If you change the view to a different page, you can return to the Person page for the SBR by clicking **Person** under **SBR** in the EUID tree on the left side of the page.*

- 4 From the View/Edit page, you can do any of the following:
 - ◆ To view additional demographic information about the member, use the scrollbar on the right side of the page.
 - ◆ To modify member information, follow the appropriate procedure under “[Maintaining Member Information](#)” on page 86.
 - ◆ To view a history of transactions for the displayed profile, click **Transaction History** in the upper portion of the View/Edit page (for more information, see “[Viewing a Transaction History](#)” on page 58).
 - ◆ To view potential duplicates of the displayed profile, click **Potential Duplicate** in the upper portion of the View/Edit page (for more information, see “[Handling Potential Duplicates](#)” on page 75).
 - ◆ To view detailed information for the following member in the search results list, click **Next>** in the upper portion of the page.
 - ◆ To view detailed information for the preceding member in the search results list, click **<Previous** in the upper portion of the page.

About Demographic Fields

The fields located on the Person page of the View/Edit page allow you to view detailed demographic information about a member.

Note: *The demographic are configurable, and might have been modified or removed. For more information about fields on your EDM that differ from those listed below, see the system administrator. The field descriptions below describe only the fields in the default configuration of eIndex.*

Table 8 Demographic Fields

This field ...	displays this information ...
SSN	The member's social security number.
Category	The type of member whose profile appears, such as employee, patient, customer, vendor, and so on.
Last Name	The member's last name.
First Name	The member's first name

Table 8 Demographic Fields

This field ...	displays this information ...
Middle Name	The middle name or initial of the member.
Suffix	The suffix to the member's name, such as III, Sr., or M.D.
Title	The member's title, such as Ph.D., Medical Doctor, or Reverend.
DOB	The month, day, and year that the member was born.
Death	An indicator of whether the member is deceased.
Gender	The gender of the member.
Marital Status	The member's marital status, such as married, single, divorced, or widowed.
Race	The racial background of the member, such as Asian, White, or Hispanic.
Ethnic Group	The ethnic or cultural background of the member, such as European, French Canadian, or African American.
Religion	The name of the member's religion or denomination, such as Agnostic, Catholic, or Buddhist.
Language	The member's first language.
Spouse's Name	The first name of the member's spouse.
Mother's Name	The first name of the member's mother.
Mother's Maiden Name	The maiden name of the member's mother.
Father's Name	The first name of the member's father.
Maiden Name	The maiden name of the member.
POB City	The city in which the member was born.
POB State	The state in which the member was born.
POB Country	The country in which the member was born.
VIP Flag	An indicator that specifies the VIP status of the member.
Veteran Status	An indicator that specifies whether the member is a war veteran.
Driver License	The driver's license number of the member.
DOD	The month, day, and year of the member's death.
Death Certificate	The ID number of the member's death certificate.
Nationality	The nation to which the member belongs.
Citizenship	The country of which the member is a citizen.
Pension No	The ID number of the member's pension account.
Pension Exp. Date	The expiration date of the member's pension.

Table 8 Demographic Fields

This field ...	displays this information ...
Repatriation No.	The member's repatriation number.
District of Residence	The member's district of residence (DOR).
Lga Code	The member's Lga code.
Military Branch	The military branch in which the member served or is currently serving.
Military Rank	The military rank achieved by the member in the specified military branch.
Military Status	The member's current status in the specified military branch (such as active or inactive).
Class 1-5	These fields may have been customized or removed to suit your company's specific requirements. For more information about these fields, see the system administrator.
String 1-10	These fields may have been customized or removed to suit your company's specific requirements. For more information about these fields, see the system administrator.
Date 1-5	These fields can only store dates, and may have been customized or removed to suit your company's specific requirements. For more information about these fields, see the system administrator.

4.2.2. Viewing a Member's Addresses

You can view the address information contained in a member's SBR or in any of the associated system records for that member. You can perform several actions against the displayed member profile, such as viewing a transaction history, modifying member information, and so on (for more information see step 5 under **"To view demographic information"** earlier in this chapter).

A member's SBR contains the address information that is determined to be the most current and accurate information about that person from all local systems. The system records associated with a member profile contain the address information that is stored in the external systems that share information with eIndex. The information in a member's system records might not match the information stored in the member's SBR.

Figure 16 View/Edit Page - Address Information

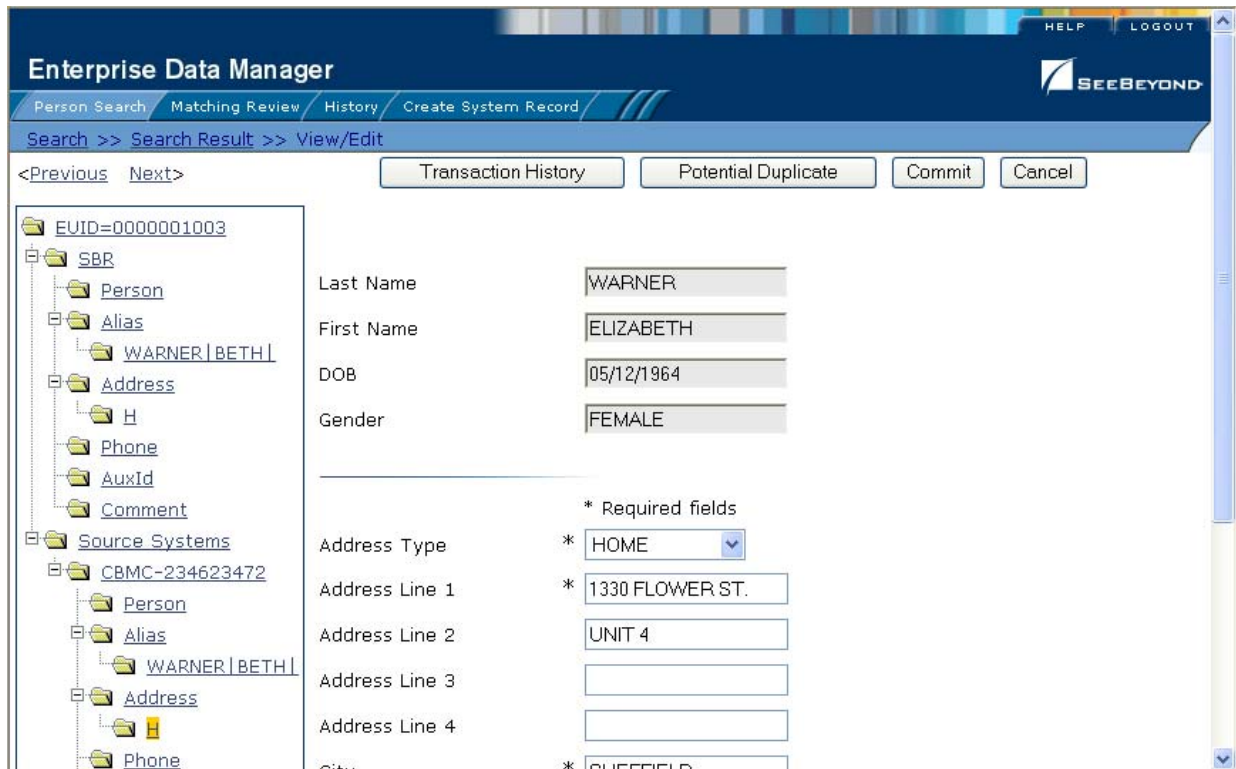

To view address information

- 1 Perform a search for the member whose information you want to view as described in “**Searching for Member Profiles**” in **Chapter 3**).
- 2 On the Search Result page, click the EUID of the member profile you want to view. The View /Edit page appears.
- 3 To view an address in the SBR:
 - ◆ In the EUID tree in the left portion of the page, expand **SBR**.
 - ◆ Under **SBR**, expand **Address**.
 - ◆ Under **Address**, click the address type for the address you want to view. The Address page appears.
- 4 To view an address in a system record:
 - ◆ In the EUID tree in the left portion of the page, expand the system code and local ID you want to view.
 - ◆ Under the expanded system code and local ID, expand **Address**.
 - ◆ Under **Address**, click the address type for the address you want to view. The Address page appears.

For information about the fields on this page, see “**About Address Fields**” following this procedure.

About Address Fields

The fields located on the Address page of the View/Edit page allow you to view detailed address information for the displayed member profile. Header fields appear at the top of the page to help you identify the member whose profile you are viewing.

Note: *The Address fields are configurable, and may have been modified or removed. For more information about fields on your Addresses page that differ from those listed below, see the system administrator. The field descriptions below describe only fields in the default eIndex configuration.*

Table 9 Address Fields

This field ...	displays this information ...
Identifying Fields	
Last Name	The member's last name.
First Name	The member's first name
DOB	The month, day, and year that the member was born.
Gender	The gender of the member.
Address Fields	
Address Type	The type of address displayed, such as home, work, billing, and so on.
Address 1 through Address 4	Up to four lines of the member's home address.
City	The city in which the member's address is located.
State	The state in which the member's address is located.
Postal Code	The zip code of the member's address.
Postal Code Extension	The 4-digit extension to the member's zip code.
County	The county in which the address is located.
Country	The country in which the address is located.

4.2.3. Viewing a Member's Telephone Numbers

You can view the telephone numbers contained in a member's SBR or in any of the associated system records for that member. You can perform several actions against the displayed member profile, such as viewing a transaction history, modifying member information, and so on (for more information see step 5 under **"To view demographic information" on page 45** earlier in this chapter.

A member's SBR contains the telephone information that is determined to be the most current and accurate information about that person from all local systems.

The system records associated with a member profile contain the telephone information that is stored in the external systems that share information with eIndex. The information in a member's system records might not match the information stored in the member's SBR.

Figure 17 View/Edit Page - Telephone Information

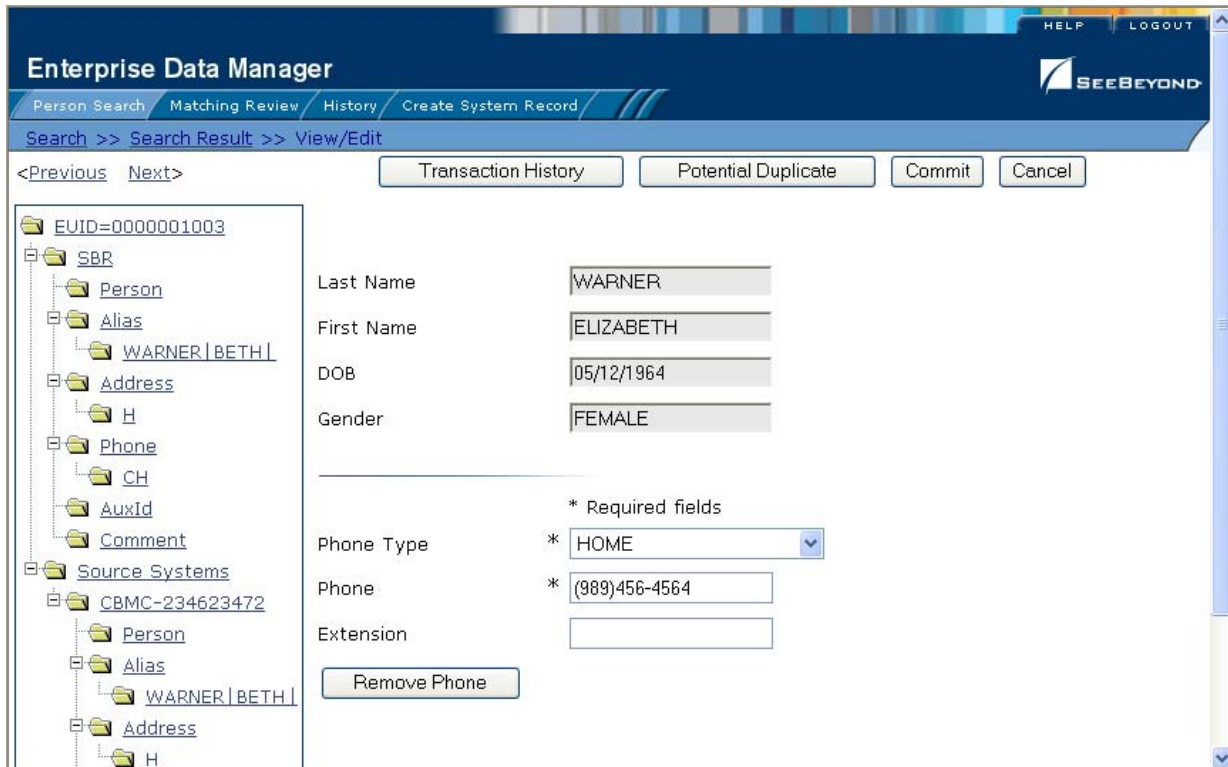

To view telephone numbers

- 1 Perform a search for the member whose information you want to view as described in “Searching for Member Profiles” in Chapter 3).
- 2 On the Search Result page, click the EUID of the member profile you want to view. The View/Edit page appears.
- 3 To view a telephone number in the SBR:
 - ◆ In the EUID tree in the left portion of the page, expand **SBR**.
 - ◆ Under **SBR**, expand **Phone**.
 - ◆ Under **Phone**, click the phone type for the telephone number you want to view. The Telephone page appears.
- 4 To view a telephone number in a system record:
 - ◆ In the EUID tree in the left portion of the page, expand the system code and local ID you want to view.
 - ◆ Under the expanded system code and local ID, expand **Phone**.
 - ◆ Under **Phone**, click the phone type for the telephone number you want to view. The Phone page appears.

For information about the fields on this page, see “About Telephone Fields” following this procedure.

About Telephone Fields

The fields located on the Phone page of the View/Edit page allow you to view detailed telephone information for the displayed member profile. Header fields appear at the top of the page to help you identify the member whose profile you are viewing.

Note: *The fields on the Phone page are configurable, and may have been modified or removed. For more information about fields on your Phone page that differ from those listed below, see the system administrator. The field descriptions below describe the fields in the default eIndex configuration.*

Table 10 Telephone Fields

This field ...	displays this information ...
Identifying Fields	
Last Name	The member's last name.
First Name	The member's first name
DOB	The month, day, and year that the member was born.
Gender	The gender of the member.
Telephone Fields	
Phone Type	The type of telephone number you are viewing, such as home, work, cellular, and so on.
Phone	The telephone number for the specified Phone Type.
Ext	The extension to the telephone number, if any.

4.2.4. Viewing a Member's Aliases

You can view the alias names contained in a member's SBR or in any of the associated system records for that member. You can perform several actions against the displayed member profile, such as viewing a transaction history, modifying member information, and so on (for more information see step 5 under ["To view demographic information" on page 45](#)).

A member's SBR contains the alias names from all of the associated system records, and any alias names that were added specifically to the SBR.

The system records associated with a member profile contain the alias information that is stored in the external systems that share information with eIndex. The information in a member's system records might not match the information stored in the member's SBR.

Figure 18 View/Edit Page - Alias Information

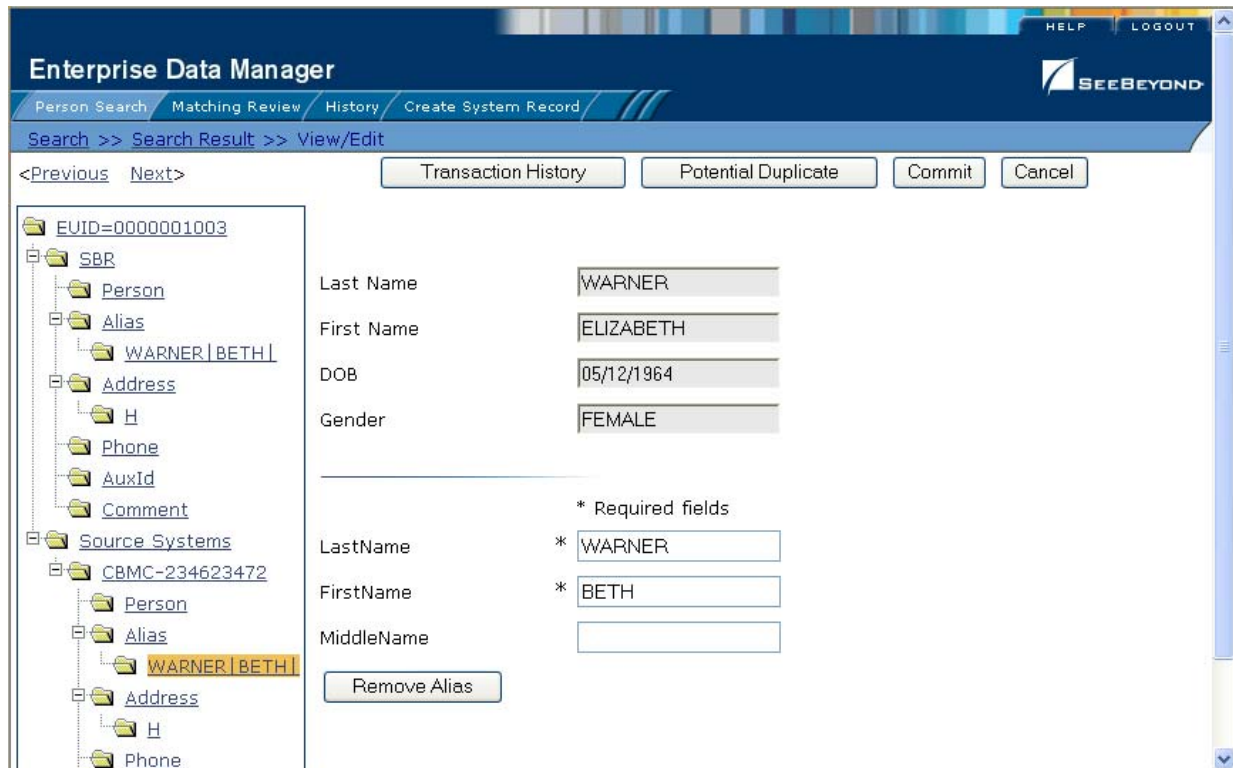

To view alias names

- 1 Perform a search for the member whose information you want to view as described in “Searching for Member Profiles” in Chapter 3).
- 2 On the Search Result page, click the EUID of the member profile you want to view. The View /Edit page appears.
- 3 To view an alias in the SBR:
 - ◆ In the EUID tree in the left portion of the page, expand **SBR**.
 - ◆ Under **SBR**, expand **Alias**.
 - ◆ Under **Alias**, click the alias name you want to view. The Alias page appears.
- 4 To view an alias in a system record:
 - ◆ In the EUID tree in the left portion of the page, expand the system code and local ID you want to view.
 - ◆ Under the expanded system code and local ID, expand **Alias**.
 - ◆ Under **Alias**, click the alias name you want to view. The Alias page appears.

For information about the fields on this page, see “About Alias Fields” following this procedure.

About Alias Fields

The fields located on the Alias page of the View/Edit page allow you to view a member's aliases. These names may include nicknames, middle names, or any other names that were previously used by the member. Header fields appear at the top of the page to help you identify the member whose profile you are viewing.

Note: *The fields on the Alias page are configurable, and may have been modified or removed. For more information about fields on your Aliases page that differ from those listed below, see the system administrator. The field descriptions below describe fields in the default eIndex configuration.*

Table 11 Alias Fields

This field ...	displays this information ...
Identifying Fields	
Last Name	The member's last name.
First Name	The member's first name
DOB	The month, day, and year that the member was born.
Gender	The gender of the member.
Alias Fields	
Last Name	The last name of the member's alias name.
First Name	The first name of the member's alias name.
Middle Name	The middle name of the member's alias name.

4.2.5. Viewing a Member's Auxiliary IDs

You can view the auxiliary IDs contained in a member's SBR or in any of the associated system records for that member. You can perform several actions against the displayed member profile, such as viewing a transaction history, modifying member information, and so on (for more information see step 5 under **"To view demographic information"** earlier in this chapter).

A member's SBR contains the auxiliary IDs from all of the associated system records, and any auxiliary IDs that were added specifically to the SBR. The system records associated with a member profile contain the auxiliary IDs that are stored in the external systems that share information with eIndex. The information in a member's system records might not match the information stored in the member's SBR.

Figure 19 View/Edit Page - Auxiliary IDs

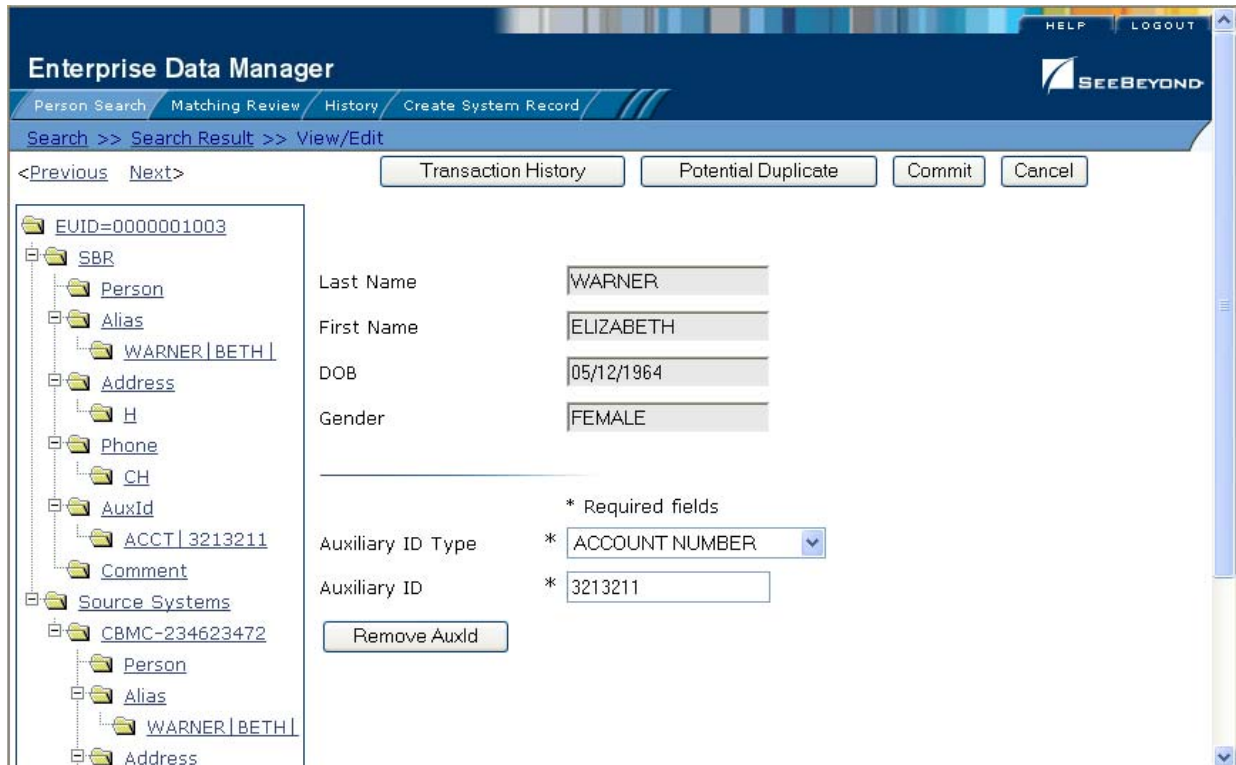

To view auxiliary IDs

- 1 Perform a search for the member whose information you want to view as described in “**Searching for Member Profiles**” in [Chapter 3](#)).
- 2 On the Search Result page, click the EUID of the member profile you want to view. The View/Edit page appears.
- 3 To view an auxiliary ID in the SBR:
 - ◆ In the EUID tree in the left portion of the page, expand **SBR**.
 - ◆ Under **SBR**, expand **AuxId**.
 - ◆ Under **AuxId**, click the auxiliary ID type you want to view. The Auxiliary ID page appears.
- 4 To view an auxiliary ID in a system record:
 - ◆ In the EUID tree in the left portion of the page, expand the system code and local ID you want to view.
 - ◆ Under the expanded system code and local ID, expand **AuxId**.
 - ◆ Under **AuxId**, click the auxiliary ID type you want to view. The Auxiliary ID page appears.

For information about the fields on this page, see “**About Auxiliary ID Fields**” following this procedure.

About Auxiliary ID Fields

The fields located on the Auxiliary ID page of the View/Edit page allow you to view a member's auxiliary IDs assigned within your organization. Header fields appear at the top of the page to help you identify the member whose profile you are viewing.

Note: *The fields on the Auxiliary ID page are configurable, and may have been modified or removed. For more information about fields on this page that differ from those listed below, see the system administrator. The field descriptions below describe the fields in the default eIndex configuration.*

Table 12 Auxiliary ID Fields

This field ...	displays this information ...
Identifying Fields	
Last Name	The member's last name.
First Name	The member's first name
DOB	The month, day, and year that the member was born.
Gender	The gender of the member.
Auxiliary ID Fields	
Auxiliary ID Type	The type of auxiliary ID displayed.
Auxiliary ID	The identification code assigned to the member that corresponds with the specified ID Name.

4.2.6. Viewing Comments Associated with a Member

You can view the comments associated with a member's SBR or in any of the associated system records for that member. You can perform several actions against the displayed member profile, such as viewing a transaction history, modifying member information, and so on (for more information see step 5 under ["To view demographic information" on page 45](#)).

A member's SBR contains the comments associated with all of the associated system records, and any comments that were added specifically to the SBR. The system records associated with a member profile contain the comments that are stored in the external systems that share information with eIndex. The information in a member's system records might not match the information stored in the member's SBR.

Figure 20 View/Edit Page - Comments

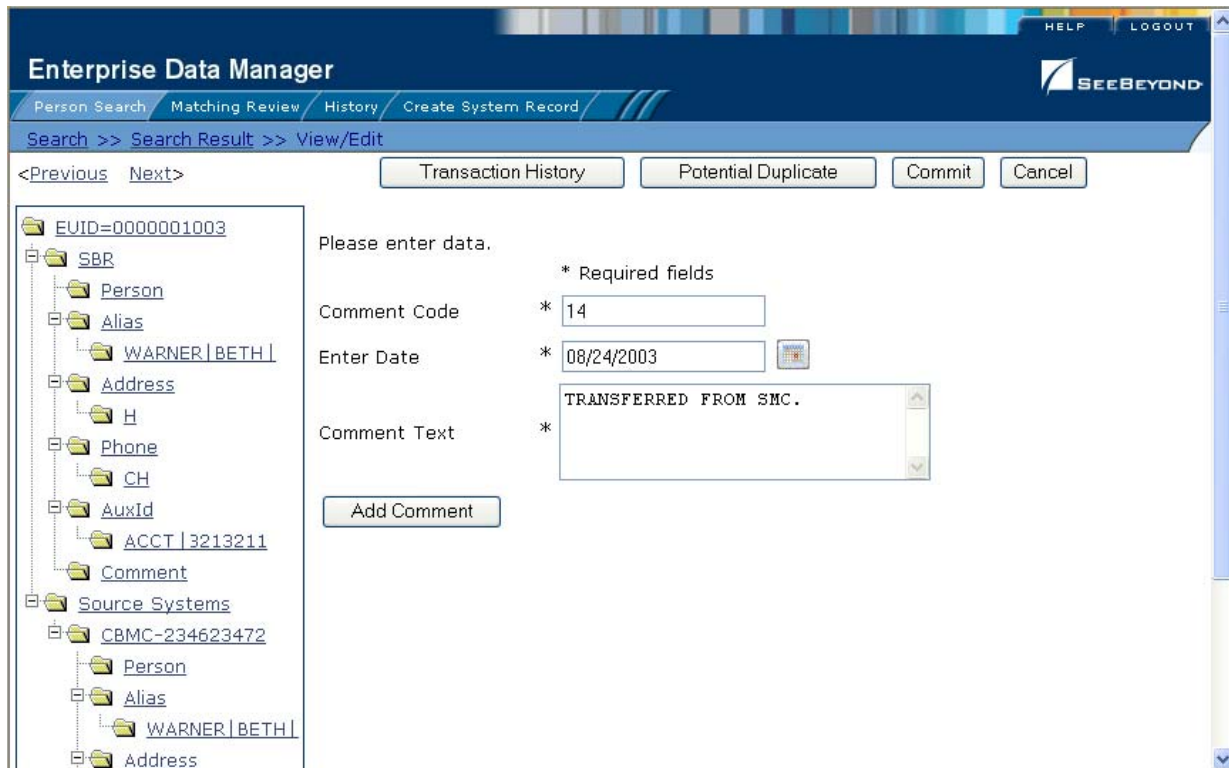

To view comments

- 1 Perform a search for the member whose information you want to view as described in “**Searching for Member Profiles**” in **Chapter 3**).
- 2 On the Search Result page, click the EUID of the member profile you want to view. The View/Edit page appears.
- 3 To view a comment in the SBR:
 - ◆ In the EUID tree in the left portion of the page, expand **SBR**.
 - ◆ Under **SBR**, expand **Comment**.
 - ◆ Under **Comment**, click the comment code of the comment you want to view. The Comment page appears.
- 4 To view a comment in a system record:
 - ◆ In the EUID tree in the left portion of the page, expand the system code and local ID you want to view.
 - ◆ Under the expanded system code and local ID, expand **Comment**.
 - ◆ Under **Comment**, click the comment code of the comment you want to view. The Comment page appears.

For information about the fields on this page, see “**About Comment Fields**” following this procedure.

About Comment Fields

The fields located on the Comments page of the View/Edit page allow you to view any comments associated with a member profile. Header fields appear at the top of the page to help you identify the member whose profile you are viewing.

Note: *The fields on the Comments page are configurable, and may have been modified or hidden by the system administrator. For more information about fields on this page that differ from those listed below, see the system administrator. The field descriptions below describe the fields in the default eIndex configuration.*

Table 13 Comment Fields

This field ...	displays this information ...
Identifying Fields	
Last Name	The member's last name.
First Name	The member's first name
DOB	The month, day, and year that the member was born.
Gender	The gender of the member.
Comment Fields	
Comment Code	An identification code for the comment that must be unique to each system record. The code must also be unique to the member profile in order for all comments to appear in the SBR.
Enter Date	The date and time that the displayed comment was created.
Comment Text	The text of the comment.

4.3 Comparing Member Information

This section provides the step-by-step instructions you need in order to compare member information in eIndex. You can compare a member profile before and after a specific transaction occurred or you can compare two different member profiles. The procedures described in this section are:

- Viewing a Transaction History
- Comparing Member Profiles

4.3.1. Viewing a Transaction History

Using the History function, you can view historical information for a specific member, and compare the member's profile before and after a specific transaction occurred to determine what information was modified as a result of the transaction. The Transaction History page contains an EUID tree for the before image and one for the after image. You can select the type of information to view, and whether to view SBR or system record information, from the EUID trees.

Figure 21 Transaction History Comparison Page

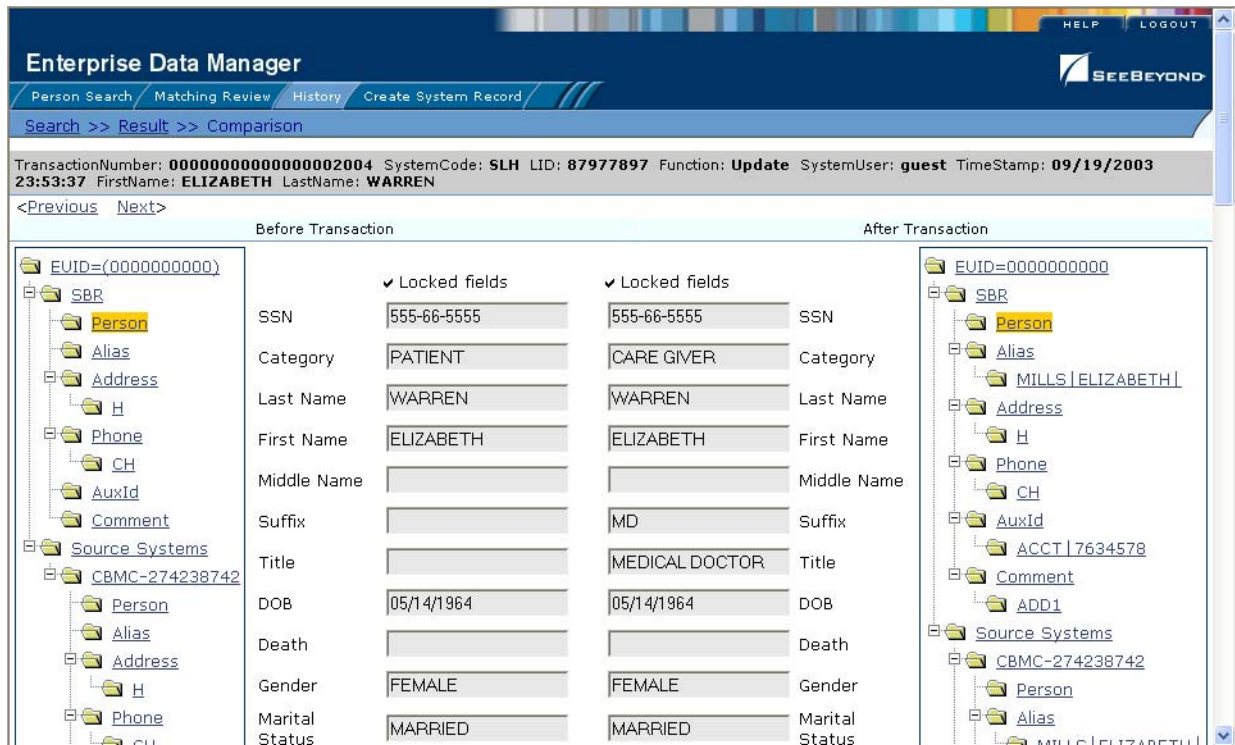

To view a transaction history

- 1 Obtain information about the member, such as their EUID, a system in which they were registered, or a specific transaction performed against the member's profile.
- 2 To access a transaction history, you can perform a search for a member profile, display the profile on the View/Edit page, and then click **Transaction History**, or you can perform the following steps.
- 3 On the EDM main menu, click **History**.
The Transaction History Search page appears.

Figure 22 Transaction History Search Page

Enterprise Data Manager

Person Search / Matching Review / History / Create System Record

SEE BEYOND

Search

Search Types: History Search

Search Clear

Enter as much information as possible to narrow the search

EUID:

From Date: 11/01/2003

To Date: 12/01/2003

System User:

Function:

From Time:

To Time:

- 4 Select **History Search** from the **Search Type** drop-down list.
- 5 Enter the search criteria for the member you want to view (for more information, see “**About Transaction History Search Fields**” following this procedure).
- 6 On the Transaction History page, click **Search**.

The Transaction History Result page appears with a list of matching profiles (for more information, see “**About Transaction History Results Fields**” following this procedure).

Figure 23 Transaction History Results

Transaction No.	EUID1	EUID2	System	LID1	LID2	Function	System User	Timestamp	First Name	Last Name
00000000000000000001	0000000000		CBMC	274238742		Add	eview	09/19/2003 23:15:19	ELIZABETH	WARREN
000000000000000002004	0000000000		SLH	87977897		Update	guest	09/19/2003 23:53:37	ELIZABETH	WARREN
000000000000000002001	0000001000		WHC	8798798		Add	eview	09/19/2003 23:32:54	EDITH	WARTON
000000000000000002005	0000001003		CBMC	234623472		Add	eview	09/20/2003 00:09:28	ELIZABETH	WARNER
000000000000000004006	0000001003					Update	guest	09/20/2003 23:25:19	ELIZABETH	WARNER
000000000000000004007	0000001003					Update	guest	09/20/2003 23:25:44	ELIZABETH	WARNER
000000000000000004008	0000001003					Update	guest	09/20/2003 23:27:11	ELIZABETH	WARNER
000000000000000002006	0000001004		CBMC	742472034		Add	eview	09/20/2003 00:16:18	LIZBETH	WARREN

- 7 On the Transaction History Result page, click the transaction number of the transaction you want to view.
The Transaction History page appears, displaying information in the SBR.
- 8 Select the type of information you want to view from the EUID trees on both sides of the page (for more information, review the instructions and field descriptions under **“Viewing Member Profiles” on page 44**).

Note: The image on the left side of the page reflects the member’s information before the transaction occurred. The image on the right reflects the member’s information after the transaction occurred. If the record you selected has no historical data, then the message **“There is nothing to show in this area.”** appears in the left side of the page.

About Transaction History Search Fields

The fields located on the Transaction History Search page allow you to specify search criteria for the transactions you want to view. The System field allows you to narrow the search to only the records within a specific entity of the organization.

Table 14 Transaction History Search Fields

In this field ...	type or select ...
EUID	The member's enterprise-wide unique global identifier assigned by eIndex.
Function	The type of transaction that caused the member's profile to change.
From Date	The beginning date for the search. The query is performed for transactions that fall between the From Date and To Date .
From Time	The beginning time for the search. The query is performed for transactions that fall between the From Time and To Time on the specified dates.
To Date	The ending date for the search.
To Time	The ending time for the search.
System User	The logon ID of the user who performed the transaction for which you are searching.

About Transaction History Results Fields

The fields located on the Transaction History Result page help you to identify a specific member profile and transaction to view. The last two fields in this list are configurable and may have been changed for your implementation.

Table 15 Transaction History Results Fields

This field ...	displays this information ...
Transaction No	The sequential identification code of the transaction that cause the transaction history record.
EUID1	The enterprise-wide unique identification number of the first member profile involved in the transaction.
EUID2	The enterprise-wide unique identification number of the second member profile involved in the transaction.
System	The name of the system in which the transaction that created the transaction history record occurred.
LID1	The local ID of the first system record involved in the transaction.
LID2	The local ID of the second system record involved in the transaction. This is only used for system record merges, unmerges, and transfers.
Function	The type of transaction that changed the member profile and caused the transaction history record to be written. Transaction types include adds, merges, updates, and so on.
System User	The logon ID of the user who performed the transaction.
Timestamp	The date and time the transaction occurred.
First Name	The member's first name.

Table 15 Transaction History Results Fields

This field ...	displays this information ...
Last Name	The member's last name.

4.3.2. Comparing Member Information

Using the Comparison function of the EDM, you can compare two member profiles side-by-side to check for similarities and differences. You can also compare different components of the same member profile. Select the type of information to view, and whether to view SBR or system record information, from the EUID trees.

Comparing two Member Profiles

To compare two different member profiles, you must perform a search for the profiles to compare and then select them from the results list. The Comparison page contains an EUID tree on each side of the page, one for each profile you are comparing.

Figure 24 Comparison Page - Two Member Profiles

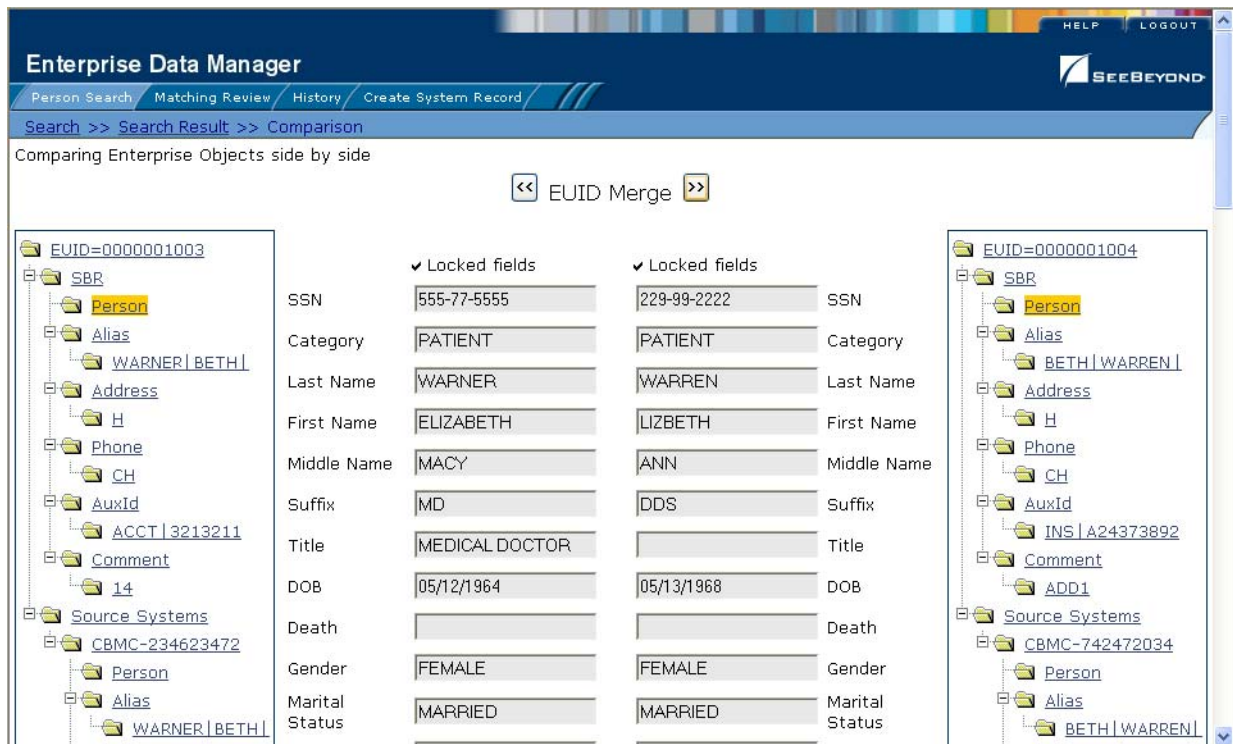

To compare two member profiles

- 1 Perform a search for the member profiles you want to compare, as described in [Chapter 3, "Searching for Member Profiles"](#).

Note: If you know the EUIDs of the member profiles to compare, use the Comparison Lookup to retrieve those profiles.

- 2 On the search results list, select the check boxes to the left of the two member profiles you want to compare.

Figure 25 Selecting Two Profiles to Compare

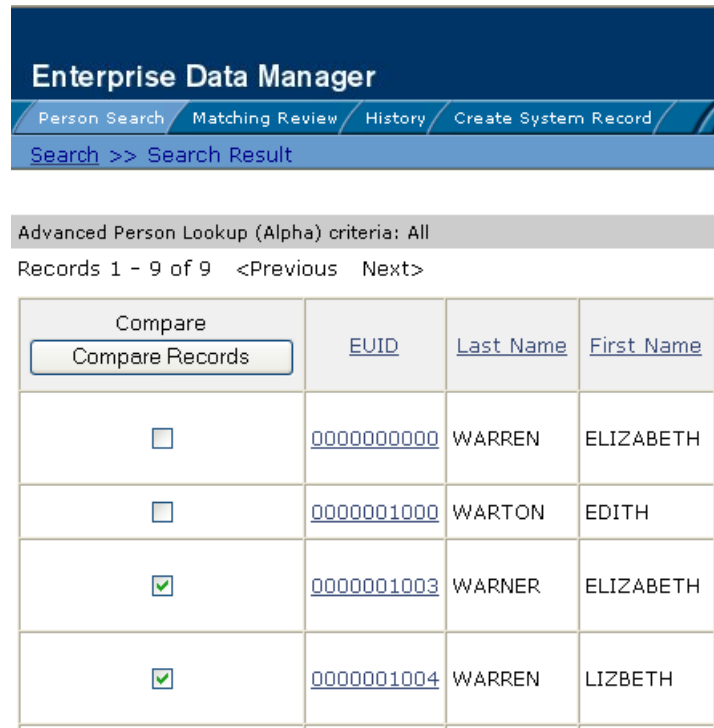

- 3 In the first cell of the results table, click **Compare Records**.
The Comparison page appears with SBR information displayed.
- 4 To view and compare different types of information, select the type of information you want to view from the EUID trees on both sides of the page (for more information, review the instructions and field descriptions under **“Viewing Member Profiles” on page 44**).
- 5 To merge member information, do either of the following:
 - ♦ To combine the two member profiles, see **“Merging Member Profiles” on page 116**.
 - ♦ To combine two system records in the displayed member profiles, see **“Merging System Records” on page 117**.

Comparing Records in one Member Profile

To compare different components of one member profile, you must perform a search for that profile and then select it from the results list. The Comparison page contains an

EUID tree on each side of the page, both containing the most current version of the profile you are comparing.

Figure 26 Comparison Page - One Member Profile

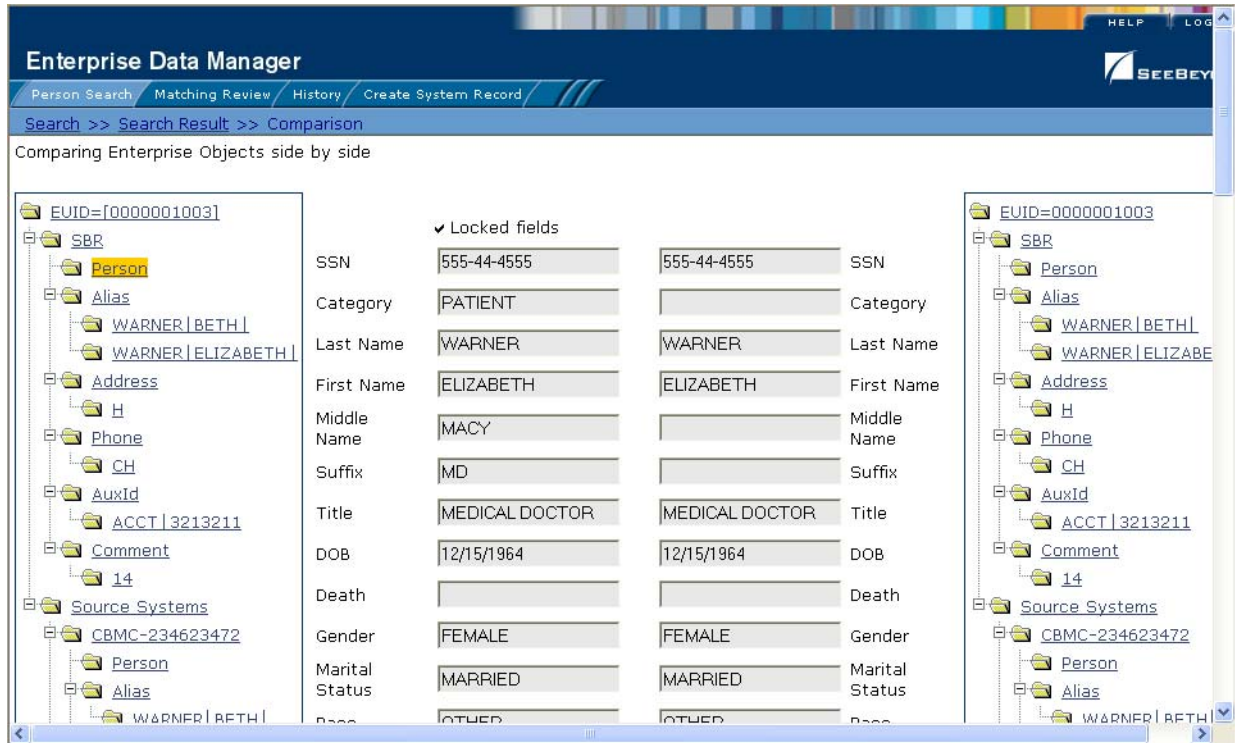

To compare records in one member profile

- 1 Perform a search for the member profile you want to view, as described in [Chapter 3, "Searching for Member Profiles"](#).
- 2 On the search results list, select the check box to the left of the member profile you want to compare.

Figure 27 Selecting one Profile to Compare

The screenshot shows the Enterprise Data Manager interface. At the top, there are navigation tabs: Person Search, Matching Review, History, and Create System Record. Below the tabs is a search bar with 'Search >> Search Result'. A grey bar indicates 'Advanced Person Lookup (Alpha) criteria: All'. Below that, it says 'Records 1 - 9 of 9 <Previous Next>'. The main table has a header row with a 'Compare' column containing a 'Compare Records' button, and columns for 'EUID', 'Last Name', 'First Name', and a partial 'M' column. The table contains four rows of data. The third row is selected, indicated by a green checkmark in the 'Compare' column.

Compare	EUID	Last Name	First Name	M
<input type="checkbox"/>	0000000000	WARREN	ELIZABETH	
<input type="checkbox"/>	0000001000	WARTON	EDITH	
<input checked="" type="checkbox"/>	0000001003	WARNER	ELIZABETH	M.
<input type="checkbox"/>	0000001004	WARREN	LIZBETH	AM

- 3 In the first cell of the results table, click **Compare Records**.
The Comparison page appears with SBR information displayed.
- 4 To view and compare different types of information, select the type of information you want to view from the EUID trees on both sides of the page (for more information, review the instructions and field descriptions under **“Viewing Member Profiles” on page 44**).
- 5 To merge two system records in the displayed member profile, see **“Merging System Records” on page 117**.

4.4 Viewing a Merge History

When you have a member profile displayed on the Transaction History page, you can display a history of all merges performed against the profile, allowing you to trace the origin of certain information contained in the profile. You can view a history for each merge transaction in the merge history tree.

4.4.1. Viewing a Merge History Tree

eIndex tracks all merges performed against each member profile in the database. You can view a history of merges that affect a specific member profile, and view each EUID that was merged to form the final merge result profile. The merge history appears in a

tree structure in the left portion of the Merge History page, showing each pair of profiles that were merged under the displayed member profile. In the right portion of the page, transaction details are displayed for the EUID that is highlighted in the EUID tree.

Figure 28 Merge History Tree

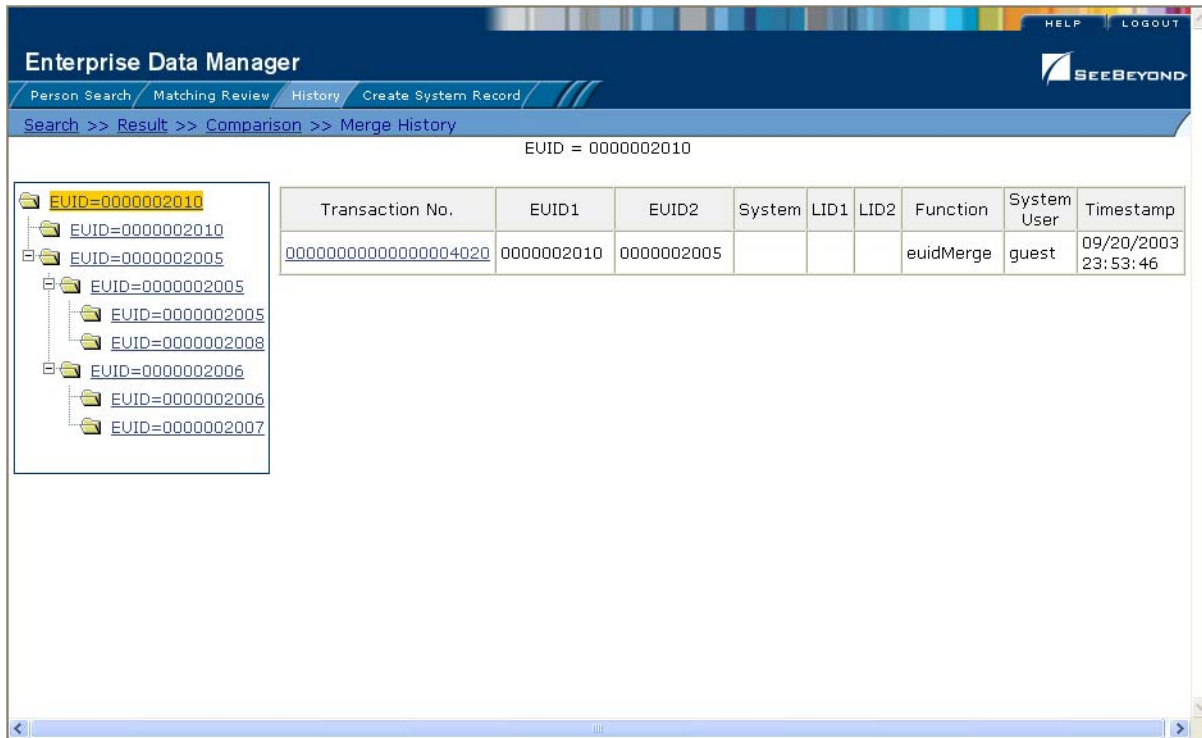

To view a member's merge history

- 1 On the Transaction History Search page, perform a search for the member whose merge history you want to view (for more information, see [“Viewing a Transaction History” on page 58](#)).
- 2 On the Transaction History Result page, click the transaction number to the left of the EUID whose merge history you want to view.
The Transaction History page appears.
- 3 In the upper portion of the page, click **Merge Tree**.
The Merge History page appears with the merge tree on the left and transaction summaries in the right.
- 4 To view a summary of merge transactions for a merged profile, select the EUID of that profile in the merge tree on the left.
The transaction summary appears in the right portion of the page.
- 5 To view transaction information for two merged profiles, click the profile above the merged pair.

Transaction information appears in the right portion of the page.

4.4.2. Viewing a Member Profile From a Merge History Tree

When you view a member's merge history, you can also view a transaction history of any merged pair in the merge history list. The profiles you display from the merge history list contain the information about the profile before the merge occurred.

To view a member profile from a merge history tree

- 1 Display a merge history tree, as described in “**Viewing a Merge History Tree**” earlier in this section.
- 2 Expand the merge history tree in the left portion of the Merge History page until you see the EUID of the member profile you want to view, and then highlight that EUID.
- 3 In the transaction list in the right portion of the page, click the transaction ID for the merge transaction you want to view.

The Transaction History page appears, displaying transaction details for the transaction you selected.

4.5 Viewing the Audit Log

Using the Audit Log function, you can view a record of each instance an EDM user accessed information about any member in the eIndex database. The audit log includes instances in which a member profile appeared in a search results list; was viewed or compared; was added, updated, or deactivated; or was merged or unmerged.

Figure 29 Audit Log Detail page

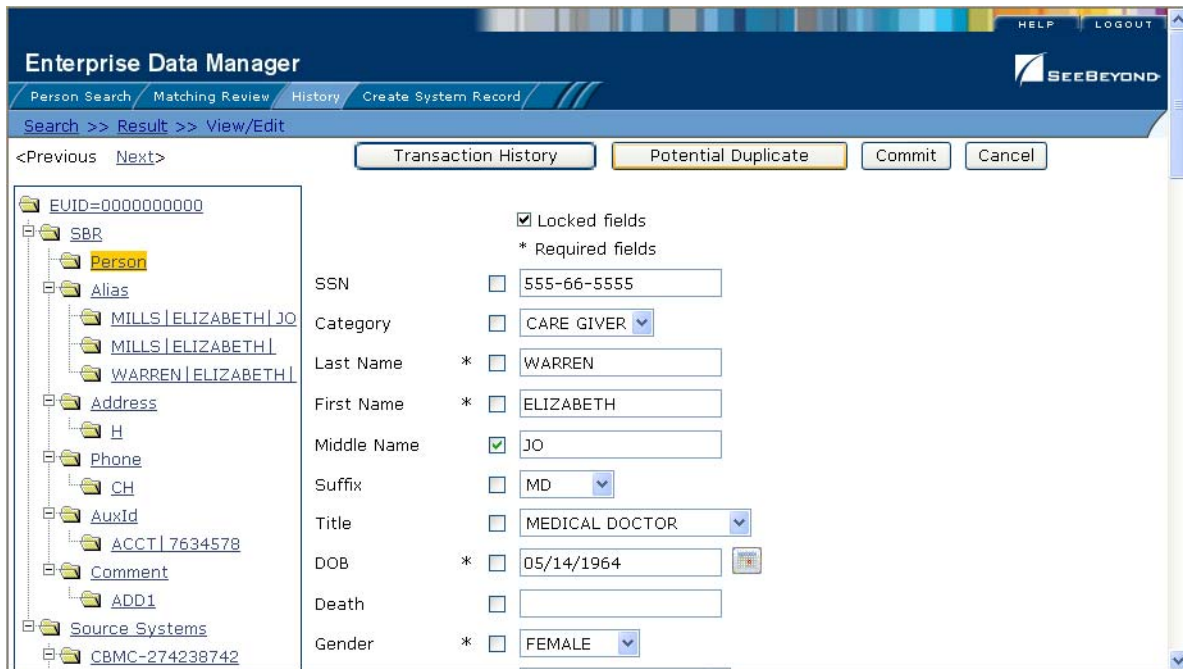

To view the audit log

- 1 Obtain information about the instances you want to view, such as the EUID, a time frame for when they occurred, the type of function that caused the audit log entries, the user who performed the functions, and so on.
- 2 On the EDM main menu, click **History**.
The History Search page appears with the Transaction History Search page displayed.
- 3 Select **Audit Log History** from the **Search Type** drop-down list.

Figure 30 Audit Log Search Page

Enterprise Data Manager

Person Search Matching Review History Create System Record

Search

Enter as much information as possible to narrow the search

EUID

Function

From Date

To Date

Search Types

Type

Create User

From Time

To Time

- 4 On the Audit Log Search page, enter the search criteria for the audit log entries you want to view (for more information see “**About Audit Log Search Fields**” following this procedure).

- 5 In the right portion of the page, click **Search**.

The Audit Log Result page appears with a list of instances in which the data was accessed. For information about the fields displayed on this page, see “**About Audit Log Results Fields**” following this procedure.

Figure 31 Audit Log Result page

Audit ID	EUID1	EUID2	Type	Function	Detail	Create User	Create Date
000000000000000000000000	0000000000		Person	EO Search Result	View EO Search Result	eview	09/21/2003 00:02:42
000000000000000000000001	0000001000		Person	EO Search Result	View EO Search Result	eview	09/21/2003 00:02:42
000000000000000000000002	0000001003		Person	EO Search Result	View EO Search Result	eview	09/21/2003 00:02:42
000000000000000000000003	0000001004		Person	EO Search Result	View EO Search Result	eview	09/21/2003 00:02:43
000000000000000000000004	0000002000		Person	EO Search Result	View EO Search Result	eview	09/21/2003 00:02:43
000000000000000000000005	0000002001		Person	EO Search Result	View EO Search Result	eview	09/21/2003 00:02:43
000000000000000000000006	0000002002		Person	EO Search Result	View EO Search Result	eview	09/21/2003 00:02:43
000000000000000000000007	0000002003		Person	EO Search Result	View EO Search Result	eview	09/21/2003 00:02:43
000000000000000000000008	0000002004		Person	EO Search Result	View EO Search Result	eview	09/21/2003 00:02:43
000000000000000000000009	0000002009		Person	EO Search Result	View EO Search Result	eview	09/21/2003 00:02:43

6 To view additional information about a specific Audit Log entry, click an EUID in the row containing the entry you want to view.

The View /Edit page appears.

7 To view details for the previous entry in the results list, click **<Previous**.

8 To view details for the following entry in the results list, click **Next>**.

About Audit Log Search Fields

The fields located on the Audit Log Search page allow you to enter search criteria about the audit log entries you want to view.

Table 16 Audit Log Search Fields

In this field ...	type or select ...
EUID	The member's enterprise-wide unique global identifier assigned by eIndex.
Type	The category type for the records whose audit log entries you want to view.
Function	The type of function that created the audit log entries you want to view.
Create User	The logon ID of the user whose transactions you want to view.
From Date	The beginning date for the search. The query is performed for audit log entries that fall between the From Date and To Date .

Table 16 Audit Log Search Fields

In this field ...	type or select ...
From Time	The beginning time for the search. The query is performed for audit log entries that fall between the From Time and To Time on the specified dates.
To Date	The ending date for the search.
To Time	The ending time for the search.

About Audit Log Results Fields

The fields located on the Audit Log Result page display information about the instances in which member data was accessed, where those instances match the search criteria you entered.

Table 17 Audit Log Results Fields

This field ...	displays this information ...
Audit ID	The unique ID code in the audit log for the audit log entry.
EUID1	The EUID of the first member profile whose information was accessed.
EUID2	The EUID of the second member profile whose information was accessed in the same transaction (as would occur in the case of a profile comparison or merge).
Type	The category type of the member represented by the EUID.
Function	The primary function that was used to access information.
Detail	Specific information about the actions taken against the profile, such as the EDM page that was accessed or the type of function performed against a profile.
Create User	The logon ID of the user who accessed the information.
Create Date	The date and time that the person information was accessed.

Maintaining Member Profiles

The EDM allows you to monitor and maintain information in the eIndex database, including adding, updating, merging, and unmerging records. This chapter presents the background information and the step-by-step instructions you need to add and maintain information using the EDM.

The information in this chapter is based on the default configuration for eIndex, and the appearance of your EDM will vary from the descriptions and illustrations depending on how your application is configured.

5.1 Member Profile Maintenance

Member profile maintenance involves a number of tasks that you can perform to ensure that your database contains the most current and accurate information. The tasks you can perform include editing, adding, and deleting member information, detecting and fixing profiles that are potential duplicates of each other, merging and unmerging member profiles or system records, and deactivating member profiles or system records that are no longer active.

5.1.1. Matching Probability Weights

When you add a new member profile to eIndex, the new profile is automatically checked for any similarities between profiles that already exist in the database. A matching probability weight between existing profiles and the new profile is then calculated using matching algorithm logic. This weight indicates how closely two profiles match each other. If the matching probability weight for two profiles is above a specific number (defined in the eIndex configuration files), the profiles are considered to be potential duplicates. If the weight between two profiles is high enough, they might be automatically merged (for more information, see [“Assumed Matches” on page 74](#)).

5.1.2. Merging Profiles

As described above, you can merge member profiles that are found to represent the same member, and you can merge system records between member profiles. During a system record merge, you can specify which fields from each record to retain in the final, merged system record. After a member profile merge, all information from all the

system records involved in the merge are stored in the surviving profile. You may need to review the final merge result profile to determine which, if any, system records should be deactivated.

The SBR for the surviving profile is determined by the survivor calculator, taking into account all system records involved in the merge. If you merge two profiles that have duplicate child objects (for example, each profile has an Office address) and the union survivor calculator is used, then the most recently modified of the two child objects is stored in the SBR.

Surviving and Non-surviving Profiles

When you perform a member profile merge, you are working with two member profiles. The *non-surviving profile* is the profile that is not retained after the merge. The *surviving profile* is retained after the merge. During a member profile merge, the system records in the non-surviving profile are transferred to the surviving profile, and the non-surviving profile is given a status of "Merged". The SBR for the surviving member profile is recalculated based on the existing system records for that profile along with the newly merged system records. The EUID of the surviving profile is always retained. The information that is discarded during a merge is stored in the transaction table, making it possible to restore the profiles to their previous status if they were merged in error.

System Record Merges

You can merge two system records together if they originated from the same system. If you merge the only active system record in a member profile into another system record, that member profile will be deactivated (since there are no active system records remaining, there is nothing from which to create the SBR). The member profile from which the system record is merged is called the *merge from* profile. The member profile into which the system record is merged is called the *merge to* profile. During a system record merge, you can select fields from the non-surviving system record to be retained in the surviving system record.

Undoing a Merge

If you merge two member profiles or system records in error, you can unmerge the profiles or records, and return them to their original states. Any modifications that were made to the surviving member profile or system record after the merge are lost. If a system record merge caused the "merge from" member profile to be deactivated, unmerging the system records reactivates that profile.

Assumed Matches

If you add a new member profile and eIndex determines that the member you are adding already exists in the database, eIndex assumes the profiles are a match and updates the existing member profile. This is known as an *assumed match* or an *automatic merge*. An assumed match only occurs when the probability of a match between the new profile and the existing profile is above the match threshold specified by your system administrator.

5.1.3. Potential Duplicates

Potential duplicates are two member profiles that possibly represent the same member. If you add a new member and eIndex determines that the member you are adding may already exist in the database, the two profiles are listed as potential duplicates of one another. Profiles are listed as potential duplicates if the probability of a match between the two profiles is above the duplicate threshold but below the match threshold. Because member information is entered from various sources, a member profile may have several potential duplicates. In this case, it is important to identify the potential duplicates, and to determine whether the profiles represent the same member.

5.1.4. Handling Potential Duplicates

The Matching Review function allows you to locate any profiles that are similar enough that they could represent the same member. You can compare potential duplicate profiles side-by-side to determine if they do represent the same member. Once you have determined whether the profiles are duplicates, you can use one of the following methods to correct the potential duplicate listing.

Merge

If you conclude that the profiles represent the same member, you need to determine which EUID to retain, and then merge the profiles. For a description of the merge process, see [“Merging Profiles” on page 73](#).

Resolve

If you conclude that two potential duplicate profiles do not represent the same member, you can mark the profiles as being resolved. Doing this does not change any information for either profile, but it flags them as not being potential duplicates of one another. There are two methods of resolving potential duplicates.

- **Resolve**
This type of resolution allows the profiles to be listed as potential duplicates again if one of the profiles is updated and, after its potential duplicates are re-evaluated, the profiles still have a matching weight above the duplicate threshold.
- **Resolve Permanently**
This type of resolution marks the profiles as not being duplicates, and does not allow the pair to be listed as duplicates after any future updates to either record. This is a permanent resolution.

5.1.5. Update Tips

This section discusses special circumstances for updating member profiles, such as what happens when two users update the same profile at the same time and how the SBR is updated versus system records.

Concurrent Users

If you have the same member profile open for editing as another EDM user, only the user who commits their changes first will be able to save their changes. If you try to commit changes after the first user clicks Commit, the following error message appears and you will be unable to commit your changes.

Unable to update: Enterprise Object has been modified by another client.

In order to update the profile with your changes, you must reload the profile by performing a search for that profile. You can then edit the profile and commit your changes.

Updating the SBR versus System Records

Every time a system record is updated, the survivor calculator determines whether the new information should be populated into the SBR. This includes updates from the EDM and from local systems. Typically, when you update information in a member profile, you update the system record, which kicks off the survivor calculator. However, the EDM also allows you update the SBR directly by selecting an “overwrite” check box. Use this capability cautiously, since fields updated in the SBR cannot be overwritten by new information from local systems until the overwrite check box is deselected. You can only update an SBR, or select or clear the overwrite check box, if you have explicit security permissions to do so.

EDM Overwrite Capabilities

EDM overwrite capabilities allow you to override the survivor calculator’s version of the SBR and update the SBR directly. The overwrite is accomplished by selecting the overwrite check box for each field you update in the SBR. If you update an SBR field, the overwrite check box is automatically selected so you can save the changes to the database (if you have SBR update permission).

When you update an SBR from the EDM and select the overwrite check boxes next to the updated fields, the fields are automatically updated in the SBR, regardless of the value specified by the survivor calculator. In addition, those fields become “locked” and cannot be updated by any system messages or the survivor calculator until the overwrite check boxes are cleared. When a field is unlocked, the survivor calculator immediately recalculates the best value for that field based on the system records in the member profile.

If a field in a child object, such as the Address or Phone object, is locked, then the key field (in this case, Address Type or Phone Type), is automatically locked. When you add a child object (such as a telephone number or address) directly to the SBR, all fields in that object are automatically locked and cannot be overwritten by the survivor calculator.

VIP Updates

In order to view or modify the fields that are masked by a profile’s VIP status, you must have VIP access permissions. If you do not have VIP access permissions, you cannot

add or update a child object, such as an address or telephone number, that contains fields affected by the VIP mask.

5.2 Adding a Member Profile

This section provides the step-by-step instructions you need in order to add member profiles to the eIndex database. When you add a member profile, you are actually creating a system record. eIndex calculates the SBR portion of the member profile as you create the system record. Adding a member profile includes the following steps:

- **Step 1: Obtain Information about the Member** on page 77
- **Step 2: Specify a System and Local ID** on page 77
- **Step 3: Specify Demographic Information** on page 79
- **Step 4: Specify Alias Information** on page 80
- **Step 5: Specify Address Information** on page 81
- **Step 6: Specify Telephone Information** on page 82
- **Step 7: Specify Auxiliary IDs** on page 83
- **Step 8: Add Comments to the Member Profile** on page 84
- **Step 9: Save the Member Profile** on page 85

Note: Steps 4 through 8 are optional, and can be performed in any order. You must specify certain information in steps 2 and 3 in order to add a member profile to the database, and you must complete “Step 9: Save the Member Profile” after you specify member information.

5.2.1. Step 1: Obtain Information about the Member

Before you begin to add a new member to eIndex, you should obtain certain information about the member. For example, by default you must enter the member's first and last names, SSN, date of birth in order to save the member profile. You should provide as much information as is available for each member. If necessary, review the descriptions of the fields you encounter while adding a new member. These descriptions, provided throughout this section, will help you to determine the information you need to specify for each new member.

5.2.2. Step 2: Specify a System and Local ID

Each member profile is associated with at least one system record. Before you add demographic data to a member profile, you must specify the member's local ID in a specific system. This creates the system record component of the member profile.

Figure 32 Create System Record - System and Local ID

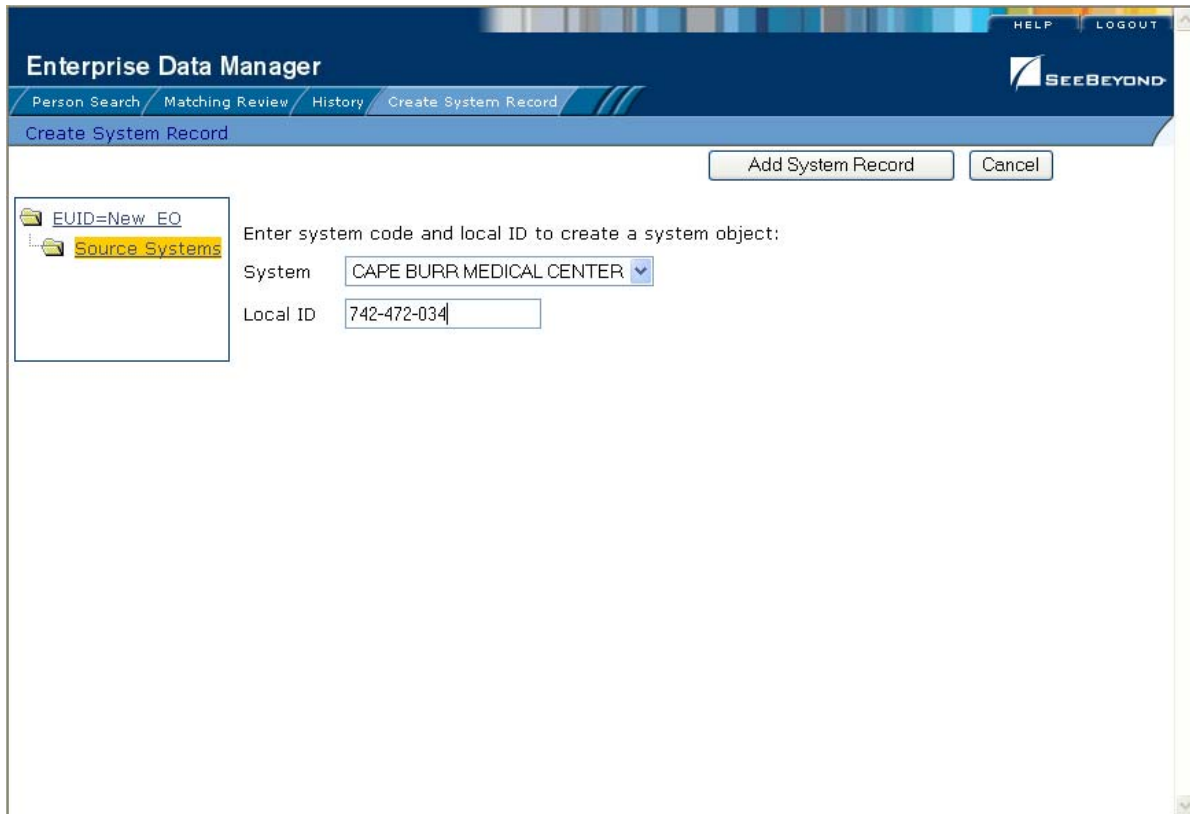

To specify a system and local ID

- 1 Complete **“Step 1: Obtain Information about the Member”**.
- 2 On the EDM main menu, select **Create System Record**.
The Create System Record page appears.
- 3 On the Create System Record page, enter system information for the new member (for more information, see **“About System Fields”** following this procedure).
- 4 Click **Add System Record**.
The page changes to display demographic fields.
- 5 Continue to **“Step 3: Specify Demographic Information”**.

About System Fields

The fields located on the first page of the Create System Record page allow you to specify system information for the member you are adding.

Table 18 System and Local ID Fields

Field	Description
System	The name of the system that assigned a local ID to the member.

Table 18 System and Local ID Fields

Field	Description
Local ID	The local ID assigned to the member by the system specified.

5.2.3. Step 3: Specify Demographic Information

When you add a new member to the eIndex database, you need to enter certain information such as the member's name, social security number, and certain demographic information.

Figure 33 Create System Record - Demographic Information

The screenshot shows the 'Create System Record' form in the Enterprise Data Manager. The form is titled 'Create System Record >> Enter Data' and includes buttons for 'Commit', 'Cancel', and 'New Record'. On the left, a tree view shows the hierarchy: EUID=New_EO > Source_Systems > CBMC-742472034 > Person. The main form area contains the following fields:

- SSN: 229-99-2222
- Category: PATIENT
- Last Name: * WARREN
- First Name: * LIZBETH
- Middle Name: ANN
- Suffix: DDS
- Title: (empty)
- DOB: * 05/13/1968
- Death: (empty)
- Gender: * FEMALE
- Marital Status: MARRIED
- Race: OTHER
- Ethnic: IRISH

A legend indicates that fields marked with an asterisk (*) are required.

To specify demographic information

- 1 Complete “**Step 2: Specify a System and Local ID**”.
- 2 On the Create System Record page, enter the member's demographic information (for more information, see “[About Demographic Fields](#)” on page 46).
- 3 Do one of the following:
 - ♦ To specify additional information about the member, continue to “**Step 4: Specify Alias Information**”.

- ◆ To save the member profile without specifying additional information, skip to **“Step 9: Save the Member Profile”**.

5.2.4. Step 4: Specify Alias Information

After you specify the required demographic information for a member, you can specify any alias names for that member. Once you add an alias, it will appear in the member profile tree on the left side of the Create System Record page.

Figure 34 Create System Record - Alias Information

The screenshot shows the 'Enterprise Data Manager' interface. The breadcrumb trail is 'Create System Record >> Enter Data'. On the left, a tree view shows the hierarchy: EUID=New_EO > Source_Systems > CBMC-742472034 > Person > Alias (highlighted). The main content area has the text 'Please enter data.' and a list of fields: 'LastName' with value 'BETH', 'FirstName' with value 'WARREN', and 'MiddleName' which is empty. An 'Add Alias' button is located below the 'MiddleName' field. At the top right of the form area are buttons for 'Commit', 'Cancel', and 'New Record'.

To specify alias information

- 1 Complete **“Step 3: Specify Demographic Information”**.
- 2 In the EUID tree in the left portion of the Create System Record page, select **Alias**. The page changes to display alias fields.
- 3 On the Create System Record page, enter the member's alias information (for more information, see **“About Alias Fields” on page 54**).
- 4 In the lower left portion of the page, click **Add Alias**.
- 5 Repeat steps 3 and 4 for each alias name you want to add.
- 6 If you add an alias name in error, highlight the alias in the EUID tree, and then click **Remove Alias**. The alias name is removed from the tree.

- 7 Do one of the following:
 - ♦ To specify additional information about the member, continue to **“Step 5: Specify Address Information”**.
 - ♦ To save the member profile without specifying additional information, skip to **“Step 9: Save the Member Profile”**.

5.2.5. Step 5: Specify Address Information

When you add a new member to the eIndex database, you can specify information about the various addresses associated with a member, such as their home and business addresses.

Figure 35 Create System Record - Address Information

The screenshot shows the 'Enterprise Data Manager' interface. The breadcrumb trail is 'Create System Record >> Enter Data'. The left-hand tree view shows a hierarchy: EUID=New_EO > Source_Systems > CBMC-742472034 > Person > Alias > BETH | WARREN | > Address (highlighted). The main form area is titled 'Please enter data.' and contains the following fields:

- Address Type: * HOME (dropdown)
- Address Line 1: * 1330 SHORELINE DR.
- Address Line 2: UNIT 10
- Address Line 3: (empty)
- Address Line 4: (empty)
- City: * SHEFFIELD
- State: CONNECTICUT (dropdown)
- Postal Code: * 09877
- Postal Code Extension: (empty)
- County: CAPE BURR
- Country: UNITED STATES (dropdown)

Buttons at the top right include 'Commit', 'Cancel', and 'New Record'. A button labeled 'Add Address' is located at the bottom left of the form area.

To specify address information

- 1 Complete **“Step 4: Specify Alias Information”**.
- 2 In the EUID tree in the left portion of the Create System Record page, select **Address**. The page changes to display address fields.
- 3 On the Create System Record page, fill in the address fields (for more information, see **“About Address Fields” on page 50**).
- 4 In the lower portion of the page, click **Add Address**.

- 5 Repeat steps 3 and 4 for each address you need to add to the member profile.
- 6 If you add an address in error, highlight the address type in the EUID tree, and then click **Remove Address**. The address is removed from the EUID tree.
- 7 Do one of the following:
 - ♦ To specify additional information about the member, continue to “**Step 6: Specify Telephone Information**”.
 - ♦ To save the member profile without specifying additional information, skip to “**Step 9: Save the Member Profile**”.

5.2.6. Step 6: Specify Telephone Information

When you add a new member to the eIndex database, you can specify information about the various telephone numbers associated with a member, such as their home, cellular, and business telephone numbers.

Figure 36 Create System Record - Telephone Information

The screenshot displays the 'Enterprise Data Manager' interface for 'Create System Record - Telephone Information'. The top navigation bar includes 'Person Search', 'Matching Review', 'History', and 'Create System Record'. The breadcrumb trail shows 'Create System Record >> Enter Data'. On the left, a tree view shows the hierarchy: EUID=New_EO > Source Systems > CBMC-742472034 > Address > Phone (highlighted). The main form area contains the following fields and controls:

- Buttons: Commit, Cancel, New Record
- Text: Please enter data.
- Label: * Required fields
- Phone Type: * HOME (dropdown menu)
- Phone: * (989)555-2738 (text input)
- Extension: (text input)
- Button: Add Phone

To specify telephone information

- 1 Complete “**Step 5: Specify Address Information**”.
- 2 In the EUID tree in the left portion of the Create System Record page, select **Phone**. The page changes to display telephone fields.

- 3 On the Create System Record page, fill in the telephone fields (for more information, see [“About Telephone Fields” on page 52](#)).
- 4 In the lower portion of the page, click **Add Phone**.
- 5 Repeat steps 3 and 4 for each telephone number you need to add to the member profile.
- 6 If you add a telephone number in error, highlight the telephone type in the EUID tree, and then click **Remove Phone**. The number is removed from the tree.
- 7 Do one of the following:
 - ♦ To specify additional information about the member, continue to **“Step 7: Specify Auxiliary IDs”**.
 - ♦ To save the member profile without specifying additional information, skip to **“Step 9: Save the Member Profile”**.

5.2.7. Step 7: Specify Auxiliary IDs

When you add a new member to the database, you can specify auxiliary IDs for the member. These IDs do not necessarily uniquely identify the member profile, and several profiles may have the same ID.

Figure 37 Create System Record - Auxiliary IDs

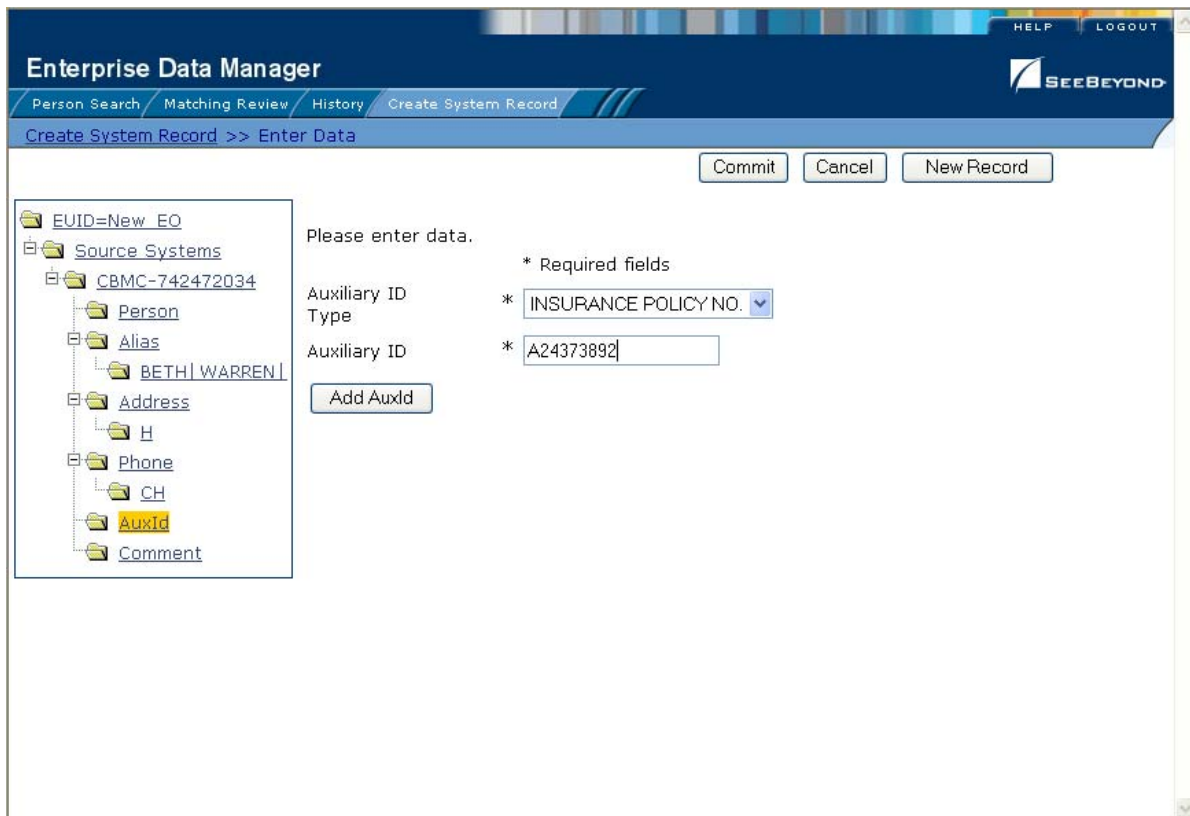

To specify auxiliary IDs

- 1 Complete “**Step 6: Specify Telephone Information**”.
- 2 In the EUID tree in the left portion of the Create System Record page, select **AuxId**. The page changes to display auxiliary ID fields.
- 3 On the Create System Record page, fill in information about the auxiliary ID (for more information, see “**About Auxiliary ID Fields**” on page 56).
- 4 In the lower portion of the page, click **Add AuxId**.
- 5 Repeat steps 3 and 4 for each auxiliary ID you need to add to the member profile.
- 6 If you add an auxiliary ID in error, highlight the auxiliary ID in the EUID tree, and then click **Remove AuxId**. The auxiliary ID is removed from the tree.
- 7 Do one of the following:
 - ♦ To specify additional information about the member, continue to “**Step 8: Add Comments to the Member Profile**”.
 - ♦ To save the member profile without specifying additional information, skip to “**Step 9: Save the Member Profile**”.

5.2.8. Step 8: Add Comments to the Member Profile

When you add a new member to the eIndex database, you can specify miscellaneous information about the member or member profile in the form of free-text comments.

Figure 38 Create System Record - Comment Information

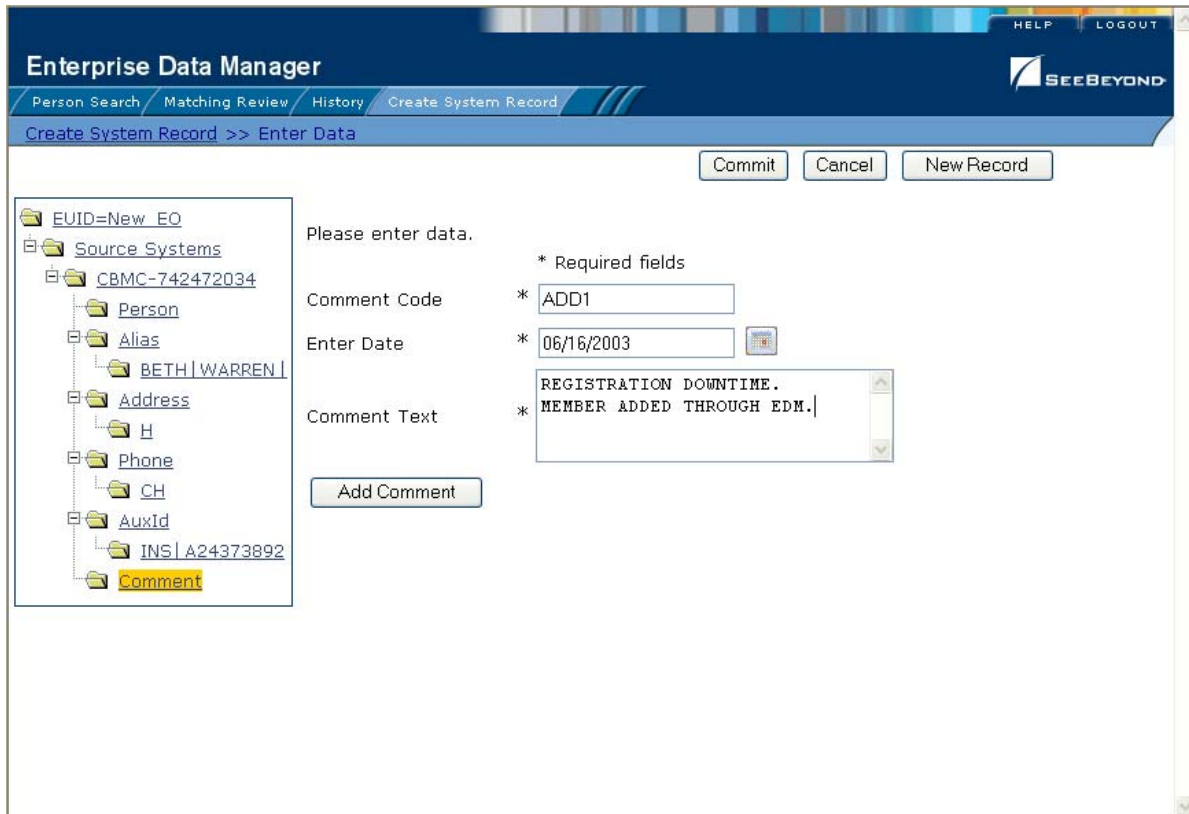

To add comments to the member profile

- 1 Complete “**Step 7: Specify Auxiliary IDs**”.
- 2 In the EUID tree in the left portion of the Create System Record page, select **Comment**. The page changes to display comment fields.
- 3 On the Create System Record page, fill in the comment fields (for more information, see “**About Comment Fields**” on page 58).
- 4 In the lower portion of the page, click **Add Comment**.
- 5 Repeat steps 3 and 4 for each comment you need to add to the member profile.
- 6 If you add a comment in error, highlight the comment code in the EUID tree, and then click **Remove Comment**. The comment is removed from the tree.
- 7 Continue to “**Step 9: Save the Member Profile**”.

5.2.9. Step 9: Save the Member Profile

After you have specified all of the required information for a member profile, you must save the profile to the database or the information you entered will be lost.

To save the member profile

- 1 Complete “**Step 8: Add Comments to the Member Profile**”.

- 2 In the upper portion of the page, click **Commit**.

A confirmation dialog appears.

Note: *The confirmation dialog informs you whether a new profile was added to the database, a new profile was added and it has potential duplicates, or an existing profile was updated with the information you entered.*

- 3 On the confirmation dialog, click **OK**.

The new member profile is saved to the database.

- 4 To add another member profile, click **New Record**, and then repeat “**Step 1: Obtain Information about the Member**” through this step.

5.3 Maintaining Member Information

This section provides step-by-step instructions for maintaining up-to-date and accurate member information in your database. You can maintain information in both the SBR and the system records for a member profile. Member maintenance includes these procedures:

- Modifying demographic information
- Adding, modifying, and deleting addresses
- Adding, modifying, and deleting telephone numbers
- Adding, modifying, and deleting aliases
- Adding, modifying, and deleting auxiliary IDs
- Adding, modifying, and deleting comments
- Adding, updating, deactivating, and reactivating system records
- Locking and unlocking SBR fields
- Deactivating and reactivating a member
- Finding, resolving, and merging potential duplicates
- Finding and reversing assumed matches
- Merging and unmerging member profiles or system records

5.3.1. Modifying Demographic Information

If a member's demographic information changes, you can update the member's information in either the SBR or the affected system record. If you update the system record, then the survivor calculator determines what changes, if any, should be made to the SBR. You must have overwrite permissions to update the SBR directly.

Figure 39 View/Edit Page - Demographic Information

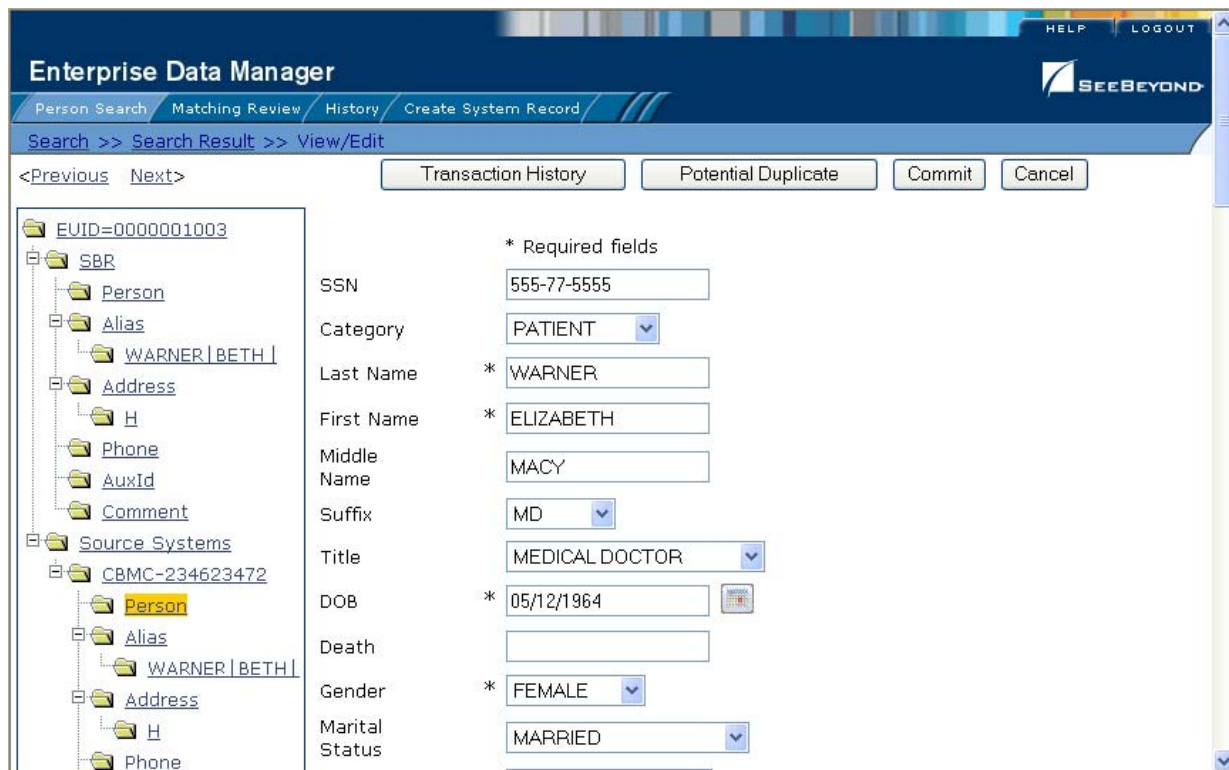

To modify demographic information in a member profile

- 1 Using one of the search methods described in [Chapter 3](#), display the member profile you want to modify on the View/Edit page.
- 2 Do one of the following:
 - ◆ To modify the SBR, select **Person** under **SBR** in the EUID tree in the left portion of the View/Edit page.
 - ◆ To modify a system record, select **Person** under that system record in the EUID tree in the left portion of the View/Edit page.
- 3 Modify any open fields in the right portion of the page (for more information, see [“About Demographic Fields” on page 46](#)).
- 4 If you are working in the SBR, select the overwrite check box to the left of the field for each field you modify.
- 5 When you are done modifying information, click **Commit**.

The page refreshes, and, if you modified a system record, the SBR is recalculated based on the new information.

5.3.2. Maintaining Address Information

You can add, modify, and delete addresses in a member profile. If you make any of these modifications to the system record, the survivor calculator determines what

changes, if any, should be made to the SBR. You can only modify information in the SBR if you have overwrite permissions.

Figure 40 View/Edit Page - Address Information

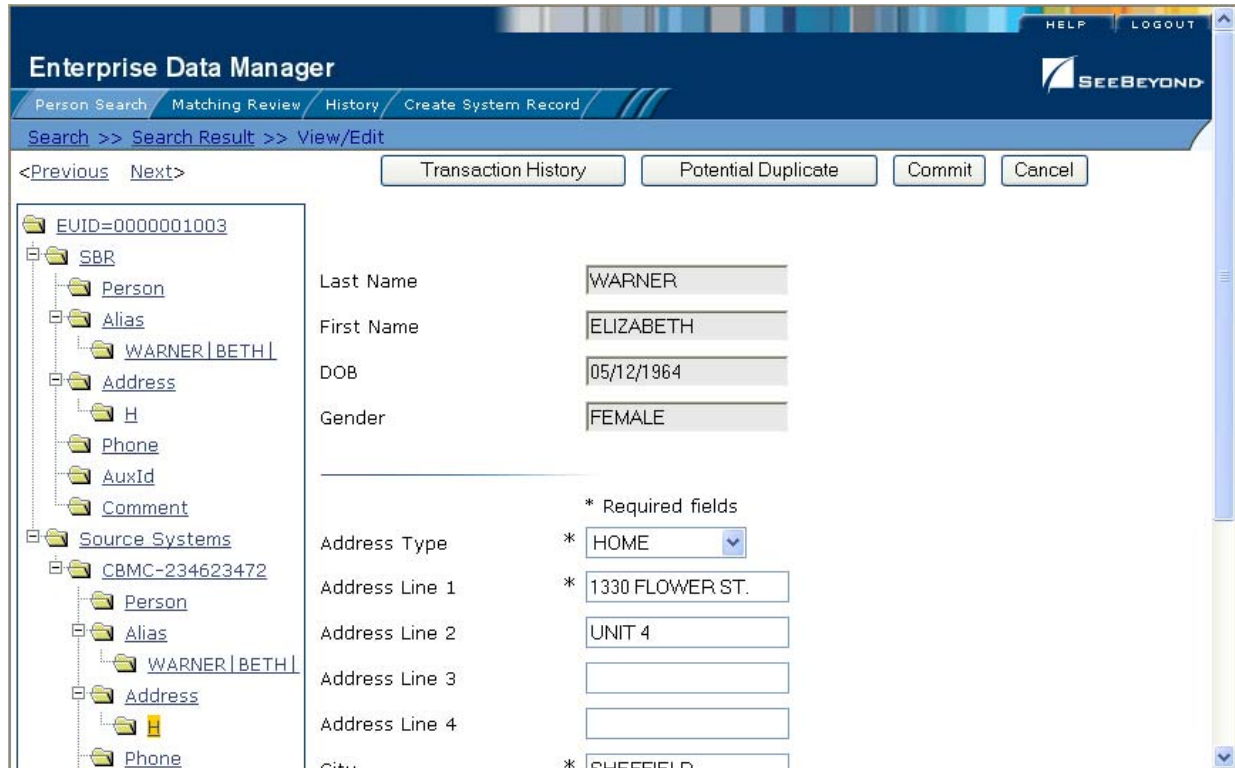

Adding Addresses to a Member Profile

If a member submits additional address information, you may need to add a new address record to the SBR or to the affected system record. You can only add one address of each address type to each SBR or each system record. If you update a system record with an address type that already exists in the SBR, the new address information will not appear in the SBR.

To add an address to a member profile

- 1 Using one of the search methods described in [Chapter 3](#), display the member profile you want to modify on the View/Edit page.
- 2 Do one of the following:
 - ♦ To add an address to the SBR, select **Address** under **SBR** in the EUID tree in the left portion of the View/Edit page.
 - ♦ To add an address to a system record, select **Address** under that system record in the EUID tree in the left portion of the View/Edit page.
- 3 Enter the new address information in the fields in the right portion of the page (for more information, see [“About Address Fields” on page 50](#)).

- 4 In the lower left portion of the page, click **Add Address**.
- 5 In the upper portion of the page, click **Commit**.

The page refreshes, and, if you modified a system record, the SBR is recalculated based on the new information.

Note: *If you added the address to the SBR, all fields in the address record are automatically locked, and will not be updated by incoming system messages until they are unlocked.*

Modifying Address Information

If a member submits additional address information, you may need to modify an address record in the SBR or the affected system record.

To modify an address in a member profile

- 1 Using one of the search methods described in [Chapter 3](#), display the member profile you want to modify on the View/Edit page.
- 2 Do one of the following:
 - ♦ To modify the SBR, select **Address** under **SBR** in the EUID tree in the left portion of the View/Edit page.
 - ♦ To modify a system record, select **Address** under that system record in the EUID tree in the left portion of the View/Edit page.
- 3 Select the address type of the address to modify.
- 4 Modify any open fields in the right portion of the page (for more information, see [“About Address Fields” on page 50](#)).
- 5 If you are working in the SBR, select the overwrite check box to the left of the field for each field you modify.
- 6 In the upper portion of the page, click **Commit**.

The page refreshes, and, if you modified a system record, the SBR is recalculated based on the new information.

Deleting Addresses from a Member Profile

If an address for a member is entered incorrectly, or the member no longer uses an existing address, you can delete the obsolete address from the affected system record. Once an address is deleted from a user profile, the deletion cannot be undone.

To delete an address from a member profile

- 1 Using one of the search methods described in [Chapter 3](#), display the member profile you want to modify on the View/Edit page.
- 2 Select **Address** under that system record in the EUID tree in the left portion of the View/Edit page.
- 3 Under the **Address** node, select the address type of the address you want to remove.

- 4 In the lower left portion of the page, click **Remove Address**.
- 5 In the upper portion of the page, click **Commit**.

The page refreshes, and the SBR is recalculated based on the new information.

5.3.3. Maintaining Telephone Information

You can add, modify, and delete telephone numbers in a member profile. If you make any of these modifications to the system record, the survivor calculator determines what changes, if any, should be made to the SBR. You can only modify information in the SBR if you have overwrite permissions.

Figure 41 View/Edit Page - Telephone Information

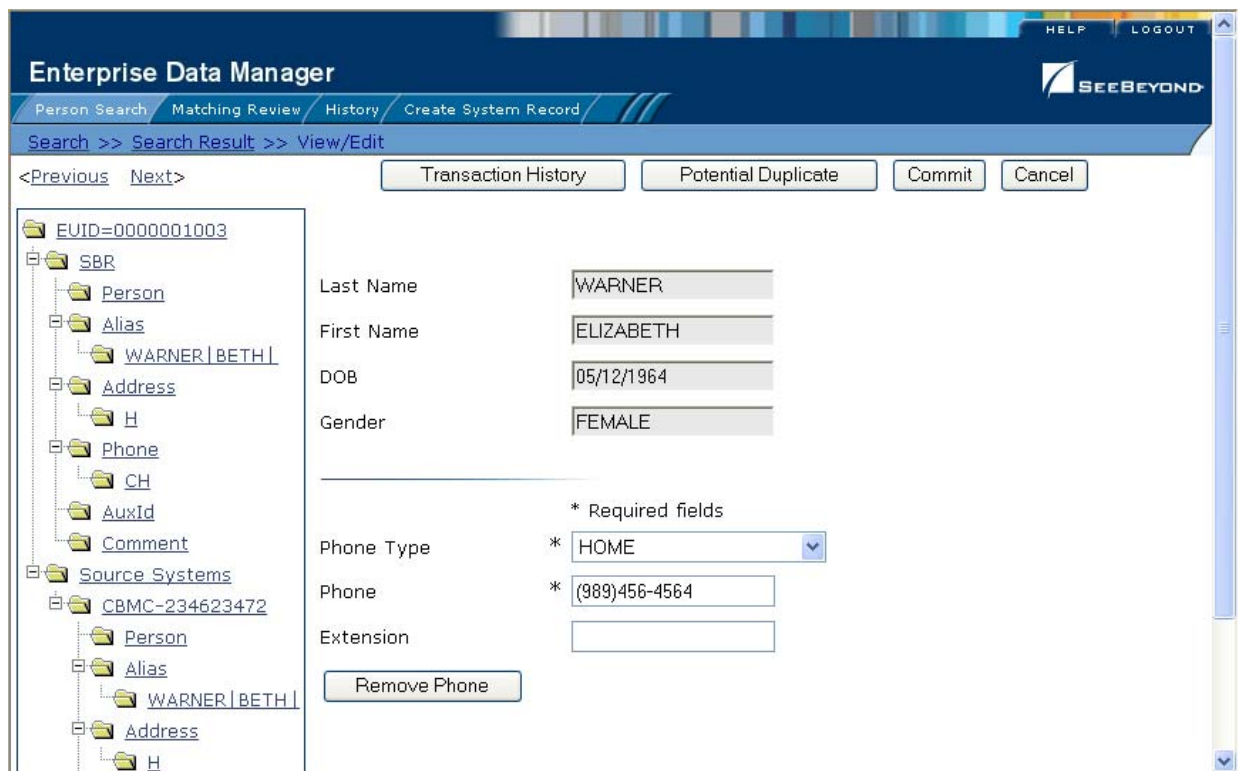

Adding Telephone Numbers to a Member Profile

If a member submits additional telephone information, you may need to add a new telephone record to the SBR or to the affected system record. You can only add one telephone number of each phone type to each SBR or each system record. If you update a system record with a phone type that already exists in the SBR, the new telephone information will not appear in the SBR.

To add a telephone number to a member profile

- 1 Using one of the search methods described in [Chapter 3](#), display the member profile you want to modify on the View/Edit page.

- 2 Do one of the following:
 - ♦ To add a telephone number to the SBR, select **Phone** under **SBR** in the EUID tree in the left portion of the View/Edit page.
 - ♦ To add a telephone number to a system record, select **Phone** under that system record in the EUID tree in the left portion of the View/Edit page.
- 3 Enter the new telephone information in the fields in the right portion of the page (for more information, see [“About Telephone Fields” on page 52](#)).
- 4 In the lower left portion of the page, click **Add Phone**.
- 5 In the upper portion of the page, click **Commit**.

The page refreshes, and, if you modified a system record, the SBR is recalculated based on the new information.

Note: If you added the telephone number to the SBR, all fields in the telephone record are automatically locked, and will not be updated by incoming system messages until they are unlocked.

Modifying Telephone Information

If a member changes telephone numbers, you can update their telephone numbers in the SBR or the affected system record.

To modify a telephone number in a member profile

- 1 Using one of the search methods described in [Chapter 3](#), display the member profile you want to modify on the View/Edit page.
- 2 Do one of the following:
 - ♦ To modify the SBR, select **Phone** under **SBR** in the EUID tree in the left portion of the View/Edit page.
 - ♦ To modify a system record, select **Phone** under that system record in the EUID tree in the left portion of the View/Edit page.
- 3 Select the phone type of the telephone number to be modified.
- 4 Modify any open fields in the right portion of the page (for more information, see [“About Telephone Fields” on page 52](#)).
- 5 If you are working in the SBR, select the overwrite check box to the left of the field for each field you modify.
- 6 In the upper portion of the page, click **Commit**.

The page refreshes, and, if you modified a system record, the SBR is recalculated based on the new information.

Deleting Telephone Numbers from a Member Profile

If a telephone number for a member is entered incorrectly, or the member no longer uses an existing number, you can delete the obsolete number from the affected system

record. Once a telephone number is deleted from a user profile, the deletion cannot be undone.

To delete a telephone number from a member profile

- 1 Using one of the search methods described in [Chapter 3](#), display the member profile you want to modify on the View/Edit page.
- 2 Select **Phone** under that system record in the EUID tree in the left portion of the View/Edit page.
- 3 Under the **Phone** node, select the phone type of the telephone number you want to remove.
- 4 In the lower left portion of the page, click **Remove Phone**.
- 5 In the upper portion of the page, click **Commit**.

The page refreshes, and the SBR is recalculated based on the new information.

5.3.4. Maintaining Alias Information

You can add, modify, and delete alias names in a member profile. If you make any of these modifications to the system record, the survivor calculator determines what changes, if any, should be made to the SBR. You can only modify information in the SBR if you have overwrite permissions.

Figure 42 View/Edit Page - Alias Information

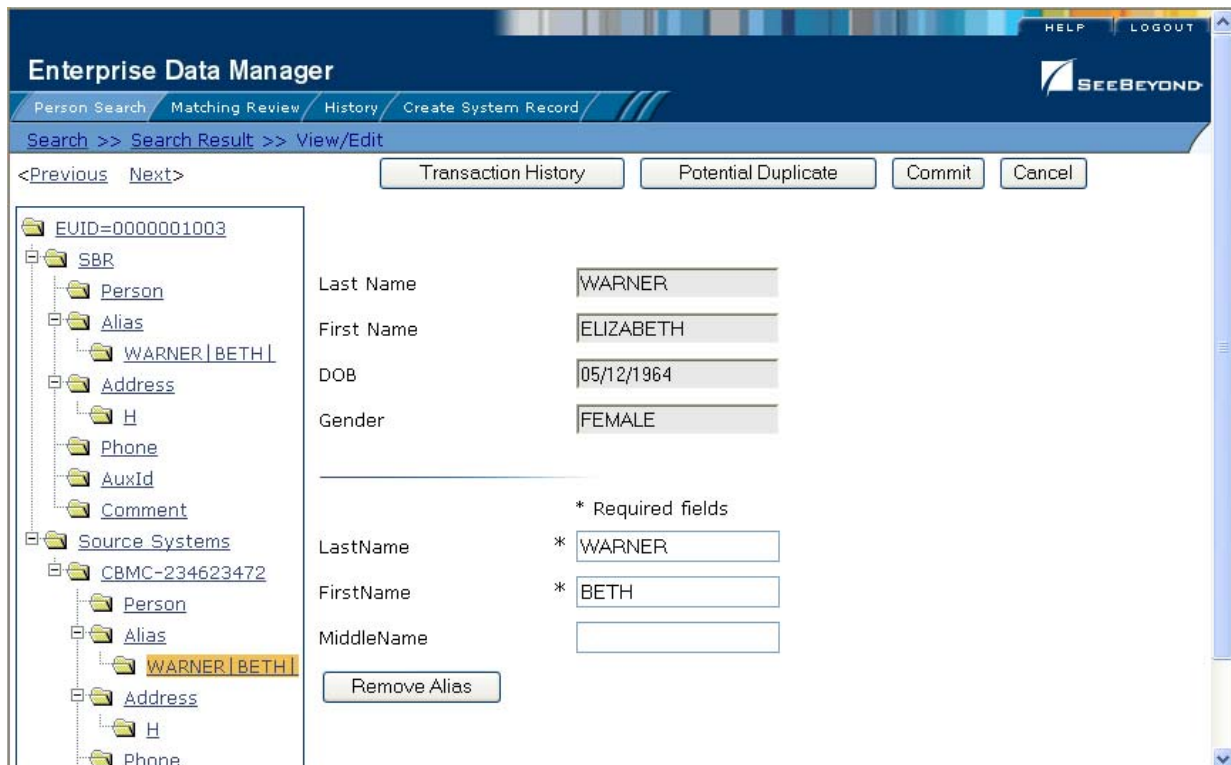

Adding an Alias to a Member Profile

If you find that a member is known by a name other than those recorded in eIndex, you can add the name as an alias to the member's profile, either in the SBR or the affected system record.

To add an alias to a member profile

- 1 Using one of the search methods described in [Chapter 3](#), display the member profile you want to modify on the View/Edit page.
- 2 Do one of the following:
 - ♦ To add an alias to the SBR, select **Alias** under **SBR** in the EUID tree in the left portion of the View/Edit page.
 - ♦ To add an alias to a system record, select **Alias** under that system record in the EUID tree in the left portion of the View/Edit page.
- 3 Enter the new alias information in the fields in the right portion of the page (for more information, see [“About Alias Fields” on page 54](#)).
- 4 In the lower left portion of the page, click **Add Alias**.
- 5 In the upper portion of the page, click **Commit**.

The page refreshes, and, if you modified a system record, the SBR is recalculated based on the new information.

Note: *If you added the alias name to the SBR, all fields in the alias record are automatically locked, and will not be updated by incoming system messages until they are unlocked.*

Modifying a Member's Alias Information

If an alias was entered in error for a member profile, you can modify the alias in the SBR or the affected system record.

To modify an alias in a member profile

- 1 Using one of the search methods described in [Chapter 3](#), display the member profile you want to modify on the View/Edit page.
- 2 Do one of the following:
 - ♦ To modify the SBR, select **Alias** under **SBR** in the EUID tree in the left portion of the View/Edit page.
 - ♦ To modify a system record, select **Alias** under that system record in the EUID tree in the left portion of the View/Edit page.
- 3 Select the alias folder containing the alias information you want to modify.
- 4 Modify any open fields in the right portion of the page (for more information, see [“About Alias Fields” on page 54](#)).
- 5 If you are working in the SBR, select the overwrite check box to the left of the field for each field you modify.

- 6 In the upper portion of the page, click **Commit**.

The page refreshes, and, if you modified a system record, the SBR is recalculated based on the new information.

Deleting an Alias from a Member Profile

If an existing alias name for a member is no longer valid or was entered in error, you can delete the obsolete alias from the affected system record. Once an alias is deleted from a user profile, the deletion cannot be undone.

To delete an alias from a member profile

- 1 Using one of the search methods described in [Chapter 3](#), display the member profile you want to modify on the View/Edit page.
- 2 Select **Alias** under that system record in the EUID tree in the left portion of the View/Edit page.
- 3 Under the **Alias** node, select the alias you want to remove.
- 4 In the lower left portion of the page, click **Remove Alias**.
- 5 In the upper portion of the page, click **Commit**.

The page refreshes, and the SBR is recalculated based on the new information.

5.3.5. Maintaining Auxiliary ID Information

You can add, modify, and delete auxiliary IDs in a member profile. If you make any of these modifications to the system record, the survivor calculator determines what changes, if any, should be made to the SBR. You can only modify information in the SBR if you have overwrite permissions.

Figure 43 View/Edit Page - Auxiliary ID Information

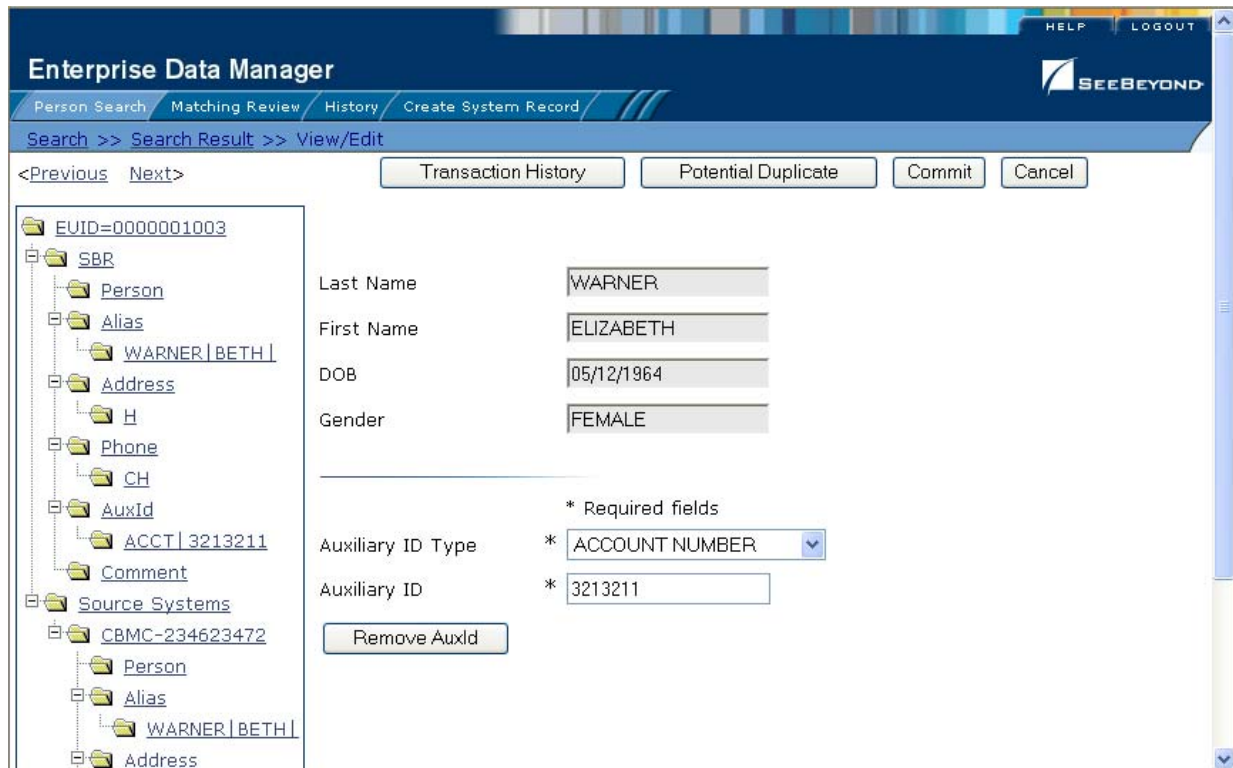

Adding an Auxiliary ID to a Member Profile

Once you have saved a member profile, you can add auxiliary IDs to that profile either in the SBR or the affected system record. You can add multiple IDs of the same type to a member profile. If you add the ID to a system record, then the survivor calculator determines what changes, if any, should be made to the SBR.

To add an auxiliary ID to a member profile

- 1 Using one of the search methods described in [Chapter 3](#), display the member profile you want to modify on the View/Edit page.
- 2 Do one of the following:
 - ♦ To add an auxiliary ID to the SBR, select **AuxId** under **SBR** in the EUID tree in the left portion of the View/Edit page.
 - ♦ To add an auxiliary ID to a system record, select **AuxId** under that system record in the EUID tree in the left portion of the View/Edit page.
- 3 Enter the new auxiliary ID information in the fields in the right portion of the page (for more information, see [“About Auxiliary ID Fields” on page 56](#)).
- 4 In the lower left portion of the page, click **Add AuxId**.
- 5 In the upper portion of the page, click **Commit**.

The page refreshes, and, if you modified a system record, the SBR is recalculated based on the new information.

Note: *If you added the auxiliary ID to the SBR, all fields in the auxiliary ID record are automatically locked, and will not be updated by incoming system messages until they are unlocked.*

Modifying Auxiliary ID Information

If an auxiliary ID was entered in error for a member profile, you can modify the ID in the SBR or the affected system record.

To modify an auxiliary ID in a member profile

- 1 Using one of the search methods described in [Chapter 3](#), display the member profile you want to modify on the View/Edit page.
- 2 Do one of the following:
 - ♦ To modify the SBR, select **AuxId** under **SBR** in the EUID tree in the left portion of the View/Edit page.
 - ♦ To modify a system record, select **AuxId** under that system record in the EUID tree in the left portion of the View/Edit page.
- 3 Select the ID type of the auxiliary ID you want to modify.
- 4 Modify any open fields in the right portion of the page (for more information, see [“About Auxiliary ID Fields” on page 56](#)).
- 5 If you are working in the SBR, select the overwrite check box to the left of the field for each field you modify.
- 6 In the upper portion of the page, click **Commit**.

The page refreshes, and, if you modified a system record, the SBR is recalculated based on the new information.

Deleting an Auxiliary ID from a Member Profile

If an existing auxiliary ID for a member is no longer valid or was entered in error, you can delete the obsolete ID from the affected system record. Once an auxiliary ID is deleted from a user profile, the deletion cannot be undone.

To delete an auxiliary ID from a member profile

- 1 Using one of the search methods described in [Chapter 3](#), display the member profile you want to modify on the View/Edit page.
- 2 Select **AuxId** under that system record in the EUID tree in the left portion of the View/Edit page.
- 3 Under the **AuxId** node, select the auxiliary ID you want to remove.
- 4 In the lower left portion of the page, click **Remove AuxId**.
- 5 In the upper portion of the page, click **Commit**.

The page refreshes, and the SBR is recalculated based on the new information.

5.3.6. Maintaining Comment Information

You can add, modify, and delete comments in a member profile. If you make any of these modifications to the system record, the survivor calculator determines what changes, if any, should be made to the SBR. You can only modify information in the SBR if you have overwrite permissions.

Figure 44 View/Edit Page - Comment Information

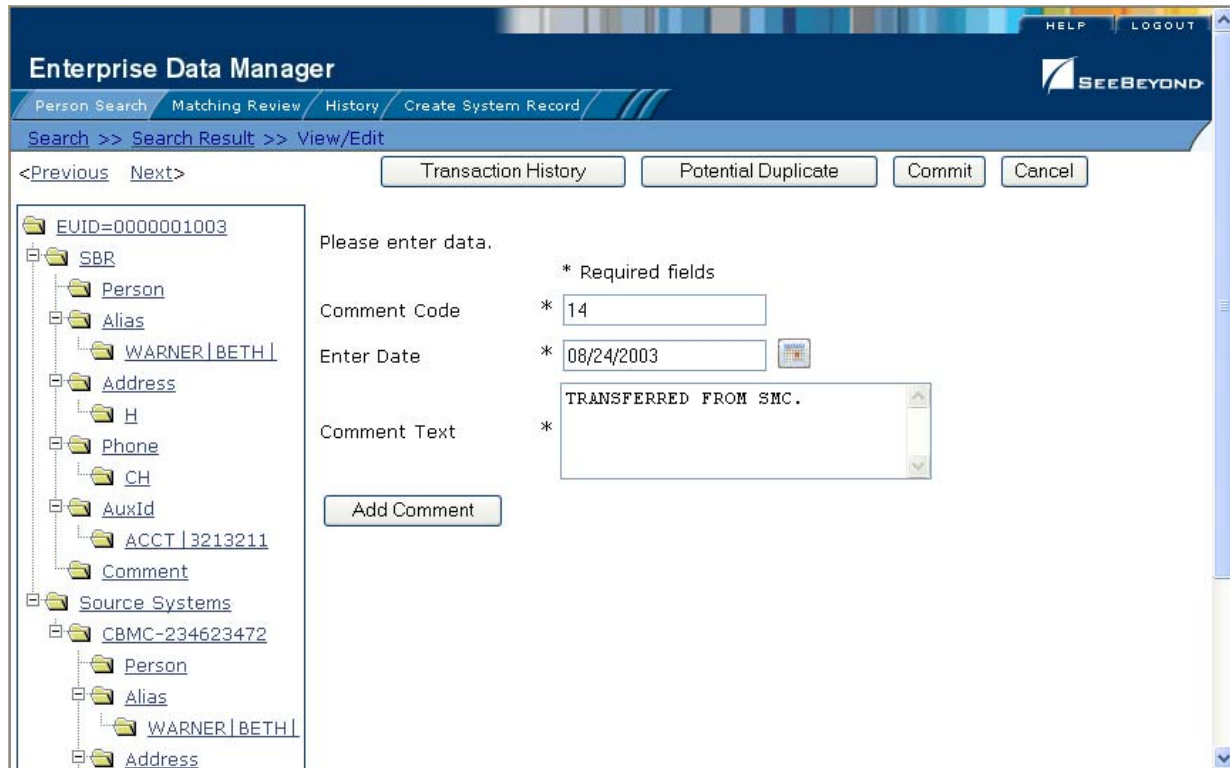

Adding a Comment to a Member Profile

If you need to record additional information about a member, you can add a comment to the member's profile, either in the SBR or a system record. Comments can include any information that you feel is relevant for the member profile, such as a reason for deactivating a profile, notes about possible duplicate profiles, and so on.

To add a comment to a member profile

- 1 Using one of the search methods described in [Chapter 3](#), display the member profile you want to modify on the View/Edit page.
- 2 Do one of the following:
 - ♦ To add a comment to the SBR, select **Comment** under **SBR** in the EUID tree in the left portion of the View/Edit page.
 - ♦ To add a comment to a system record, select **Comment** under that system record in the EUID tree in the left portion of the View/Edit page.

- 3 Enter the new comment information in the fields in the right portion of the page (for more information, see [“About Comment Fields” on page 58](#)).
- 4 In the lower left portion of the page, click **Add Comment**.
- 5 In the upper portion of the page, click **Commit**.

The page refreshes, and, if you modified a system record, the SBR is recalculated based on the new information.

***Note:** If you added the comment to the SBR, all fields in the comment record are automatically locked, and will not be updated by incoming system messages until they are unlocked.*

Modifying a Comment in a Member Profile

You can modify existing comments in the SBR and in the system records of a member profile.

To modify a comment in a member profile

- 1 Using one of the search methods described in [Chapter 3](#), display the member profile you want to modify on the View/Edit page.
- 2 Do one of the following:
 - ♦ To modify the SBR, select **Comment** under **SBR** in the EUID tree in the left portion of the View/Edit page.
 - ♦ To modify a system record, select **Comment** under that system record in the EUID tree in the left portion of the View/Edit page.
- 3 Select the comment code of the comment you want to modify.
- 4 Modify any open fields in the right portion of the page (for more information, see [“About Comment Fields” on page 58](#)).
- 5 If you are working in the SBR, select the overwrite check box to the left of the field for each field you modify.
- 6 In the upper portion of the page, click **Commit**.

The page refreshes, and, if you modified a system record, the SBR is recalculated based on the new information.

Deleting a Comment from a Member Profile

Once you have added a comment to a member profile, you can delete the comment from the affected system record if it is no longer useful or accurate. Once a comment is deleted from a user profile, the deletion cannot be undone.

To delete a comment from a member profile

- 1 Using one of the search methods described in [Chapter 3](#), display the member profile you want to modify on the View/Edit page.
- 2 Select **Comment** under that system record in the EUID tree in the left portion of the View/Edit page.

- 3 Under the **Comment** node, select the comment code of the comment you want to remove.
- 4 In the lower left portion of the page, click **Remove Comment**.
- 5 In the upper portion of the page, click **Commit**.

The page refreshes, and the SBR is recalculated based on the new information.

5.3.7. Locking and Unlocking SBR Fields

Unless a field in an SBR is locked for overwrite, the value for that field is recalculated by the survivor calculator each time the member profile is updated. If you determine that a value in the SBR is the most accurate data and should not be updated, you can lock the field. If you unlock a locked field, the value of that field is automatically recalculated by the survivor calculator as soon as the unlock action is committed.

Locking an SBR Field

When you lock a field in an SBR, that field can only be updated through the EDM by a user who has overwrite permissions. Locking a field in the SBR removes the survivor calculator from the update process for that field, and any updates made to or by system records will not update the locked fields in the SBR.

Figure 45 Locked fields in an SBR

The screenshot shows the 'Enterprise Data Manager' interface. At the top, there is a navigation bar with 'Person Search', 'Matching Review', 'History', and 'Create System Record'. Below this, there are buttons for 'Transaction History', 'Potential Duplicate', 'Commit', and 'Cancel'. The main area displays a tree view on the left with nodes for 'SBR', 'Person', 'Alias', 'Address', 'Phone', 'AuxId', 'Comment', and 'Source Systems'. The right side shows a form for editing the SBR, with fields for SSN, Category, Last Name, First Name, Middle Name, Suffix, Title, DOB, Death, and Gender. The 'Locked fields' checkbox is checked, and the 'Required fields' section is visible. The 'First Name' field is locked, indicated by a green checkmark in the lock column.

To lock a field in the SBR

- 1 Using one of the search methods described in [Chapter 3](#), display the member profile containing the field you want to lock on the View/Edit page.

- 2 In the EUID tree, select the component in the SBR containing the field you want to lock.
- 3 If necessary, update the value of the field to be locked.
- 4 Select the overwrite check box to the left of the field.
- 5 In the upper portion of the page, click **Commit**.

The field is now locked and cannot be edited by updates to system records until the lock is removed.

Unlocking an SBR Field

Once you unlock a field for overwrite in an SBR, the SBR is recalculated by the survivor calculator and the field can be updated by changes made to system records.

Figure 46 Unlocked Fields in an SBR

To unlock an SBR field

- 1 Using one of the search methods described in [Chapter 3](#), display the member profile containing the field you want to unlock on the View/Edit page.
- 2 In the EUID tree, select the object in the SBR containing the field you want to unlock.
- 3 Clear the overwrite check box to the left of the field you want to unlock.
- 4 In the upper portion of the page, click **Commit**.

The field is now unlocked and can be edited by updates to system records. The SBR is recalculated by the survivor calculator.

5.3.8. Maintaining System Record Information

You can add, modify, deactivate, and reactivate system records in a member profile. If you make any of these modifications, the survivor calculator determines what changes, if any, should be made to the SBR.

For instructions on modifying specific information in a system record, see the preceding sections, which describe how to maintain various types of information in a member profile.

Figure 47 View/Edit Page - System Records

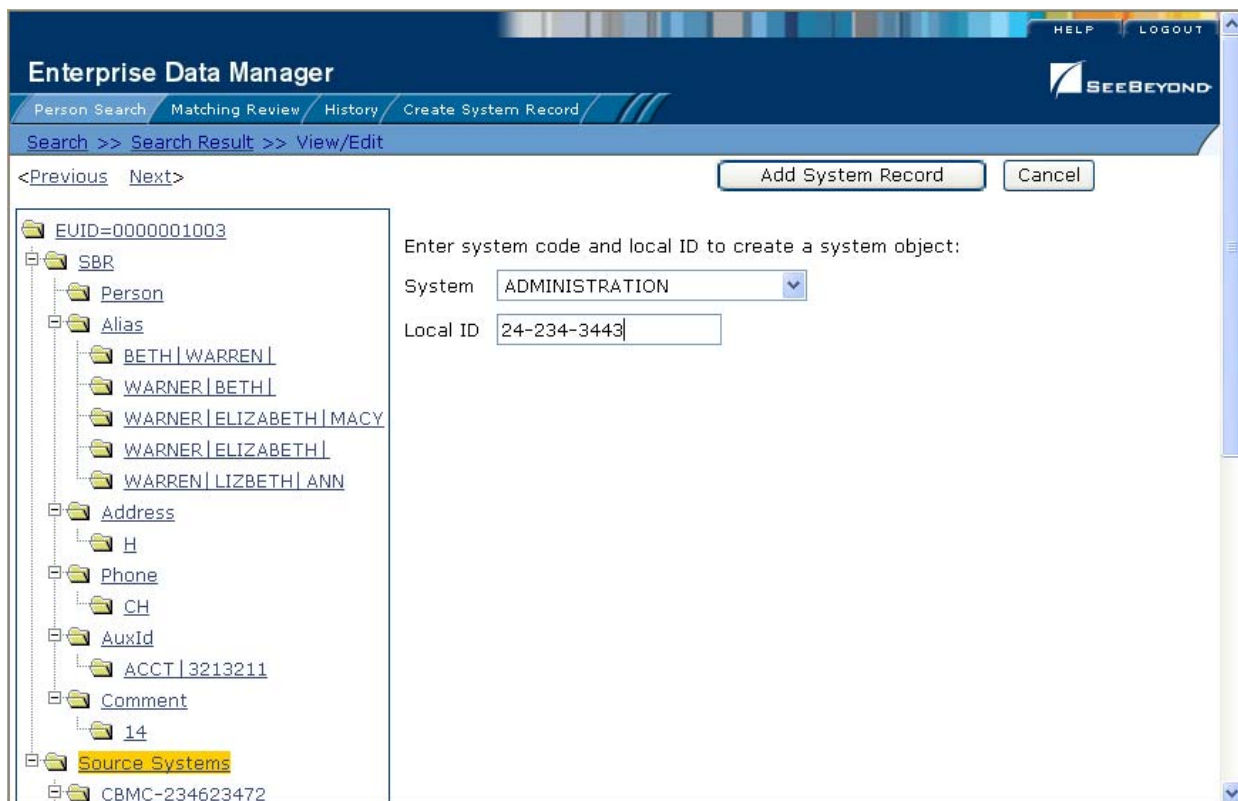

Adding a System Record to a Member Profile

If you find a member has local IDs in addition to those already recorded in eIndex, you can add the local IDs to the member's profile by adding a system record to the profile. To add a local ID to a member profile, you need to specify information such as the system that assigned the local ID, certain demographic information, and the local ID. When you add a system record to a member profile, the survivor calculator determines what changes, if any, should be made to the SBR.

You cannot add a new local ID and system pair to a member profile if that same local ID and system pair already exists in another member profile.

To add a system record to a member profile

- 1 Using one of the search methods described in [Chapter 3](#), display the member profile you want to modify on the View/Edit page.
- 2 In the EUID tree in the left portion of the page, select **Source Systems**.
- 3 Follow “**Step 2: Specify a System and Local ID**” through “**Step 9: Save the Member Profile**” under “**Adding a Member Profile**” on [page 77](#).

When you commit the changes, the page refreshes and the SBR is recalculated based on the new information.

Note: You only need to enter required fields in order to save the new system record. Required fields are indicated by an asterisk (*).

Deactivating a System Record

If an existing local ID for a member becomes obsolete, you can deactivate the system record with that local ID for the member profile. A member profile must have at least one active local ID; if you deactivate a member’s last active system record, the entire profile is deactivated. When you deactivate a system record from a member profile, the survivor calculator determines what changes, if any, should be made to the SBR.

To deactivate a system record

- 1 Using one of the search methods described in [Chapter 3](#), display the member profile you want to modify on the View/Edit page.
- 2 In the EUID tree in the left portion of the page, expand **Source Systems**, and then select the system code and local ID of the system record you want to deactivate.
- 3 Click **Deactivate <system-ID>**, where *system* is the system code and *ID* is the local ID number for the system record you want to deactivate.
- 4 In the upper portion of the page, click **Commit**.

The page refreshes and the SBR is recalculated based on the new information.

Reactivating a System Record

If a system record was deactivated in error or is no longer inactive, you can easily reactivate the system record.

To reactivate a system record

- 1 Using one of the search methods described in [Chapter 3](#), display the member profile you want to modify on the View/Edit page.
- 2 In the EUID tree in the left portion of the page, expand **Source Systems**, and then select the system code and local ID of the system record you want to reactivate.
- 3 Click **Activate <system-ID>**, where *system* is the system code and *ID* is the local ID number for the system record you want to reactivate.

- 4 In the upper portion of the page, click **Commit**.

The page refreshes and the SBR is recalculated based on the new information.

5.3.9. Changing Member Profile Status

You can change the status of a member profile from active to inactive, or from inactive to active. Deactivating a member profile deactivates all system records associated with that profile.

Figure 48 View/Edit Page - Deactivate

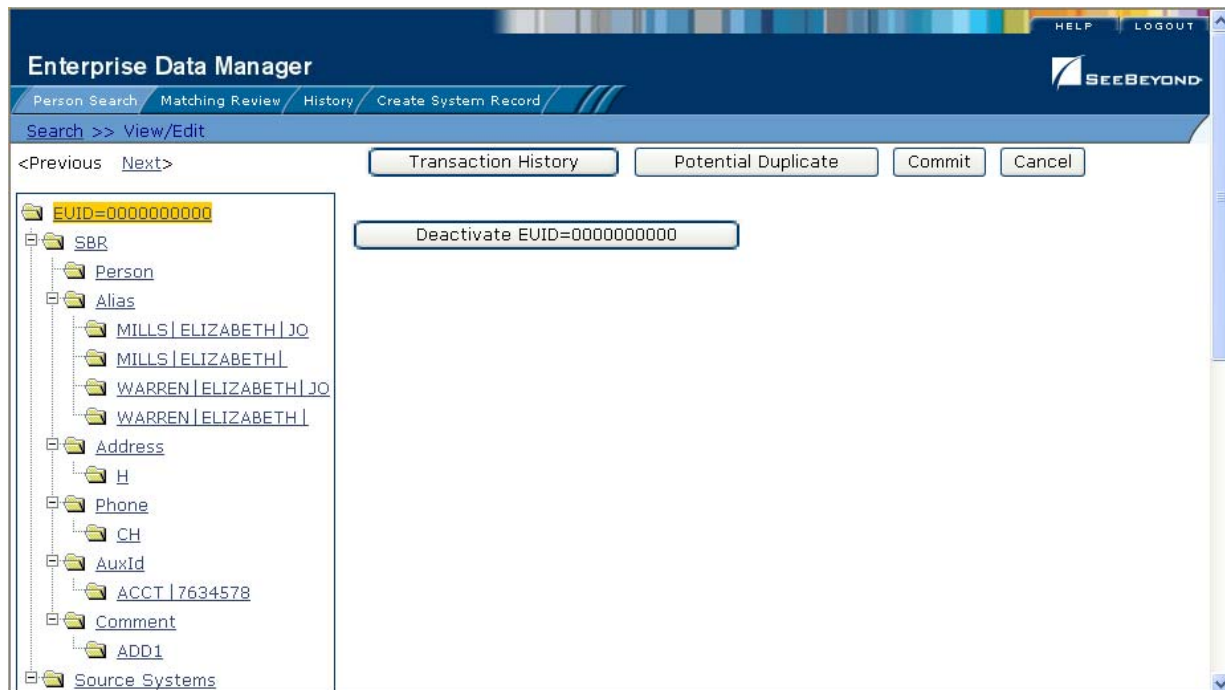

Deactivating a Member Profile

If a member profile is no longer active, you cannot delete the member profile, but you can deactivate that member profile. Deactivated profiles cannot be modified, and in some cases, cannot be viewed. If you deactivate a profile in error, you can reactivate it if needed.

To deactivate a member profile

- 1 Using one of the search methods described in [Chapter 3](#), display the member profile you want to update on the View/Edit page.
- 2 In the EUID tree in the left portion of the page, highlight the EUID number of the member profile.
- 3 Click **Deactivate EUID=<EUID_number>**, where **<EUID_number>** is the EUID of the member profile to deactivate.

- 4 On the Deactivate Complete dialog, click **OK**.

The profile is deactivated in the database, and a tilde (~) appears next to this EUID when it is displayed on any of the EDM pages.

Reactivating a Member Profile

If a member profile is deactivated in error, or becomes active again, you can reactivate that profile. Reactivating a profile returns the profile to its status just prior to when it was deactivated.

Important: When you reactivate a member profile, all system records associated with that profile are changed to active status, regardless of their prior status. Review each system record to verify that its status is correct after the reactivation.

Figure 49 View/Edit Page - Reactivate

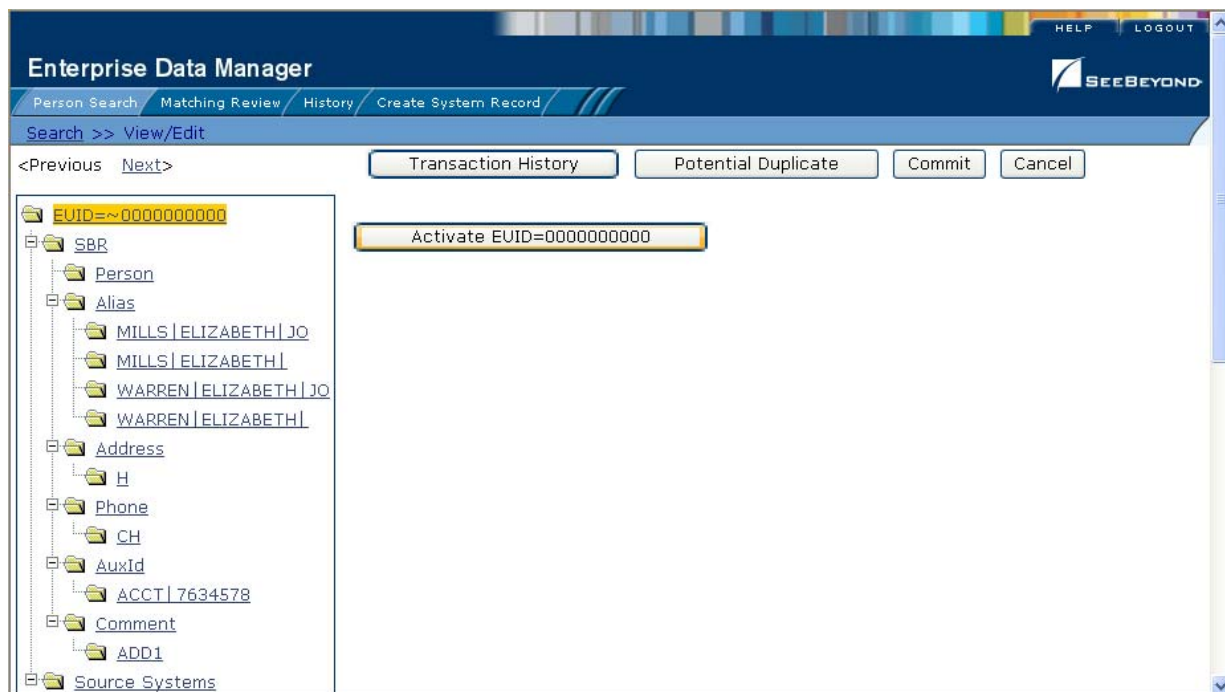

To reactivate a member profile

- 1 Using one of the search methods described in [Chapter 3](#), display the member profile you want to update on the View/Edit page.
- 2 In the EUID tree in the left portion of the page, highlight the EUID number of the member profile.
- 3 Click **Activate EUID=<EUID_number>**, where **<EUID_number>** is the EUID of the member profile to deactivate.
- 4 On the Activate Complete dialog, click **OK**.

The profile is reactivated in the database, and the tilde (~) no longer appears next to the EUID when it is displayed on any of the EDM pages.

5.3.10. Working with Potential Duplicates

The Matching Review function of the EDM allows you to view any member profiles that are marked as potential duplicates by eIndex. You can also view potential duplicates that have been resolved. This section provides instructions for finding and viewing potential duplicate profiles and then fixing the potential duplication by either merging or resolving the two profiles.

Finding Potential Duplicates

You can easily find and compare potential duplicate profiles using the EDM. Potential duplicate profiles are located based on the matching probability weight that indicates how closely two profiles match.

Figure 50 Potential Duplicate Comparison Page

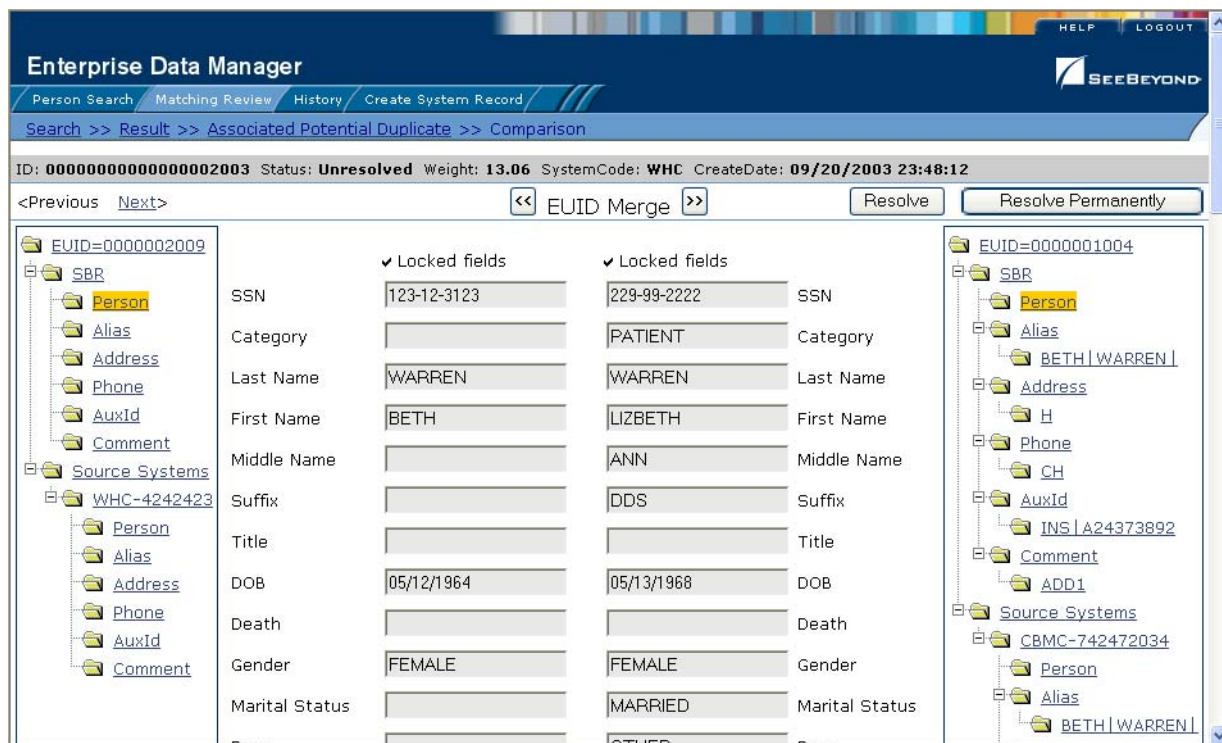

To find potential duplicates

- 1 Obtain information about the member whose potential duplicates you want to view, such as a system in which they are registered or the logon ID of the user who created the member profile.
- 2 On the EDM, select **Matching Review**. The Matching Review Search page appears.

Figure 51 Matching Review Search Page

- 3 On the Matching Review Search page, enter your search criteria (for more information, see “**About Matching Review Search Fields**” following this procedure).
- 4 In the upper portion of the page, click **Search for Potential Duplicate**. The Potential Duplicate Result page appears (for more information, see “**About Potential Duplicate Results Fields**” following this procedure).

Figure 52 Potential Duplicate Search Results List

Enterprise Data Manager

Person Search / Matching Review / History / Create System Record

Search >> Result

New Search

Potential Duplicate search criteria: create_start_date: 09/01/2003 create_start_time: 12:00:00 create_end_date: 09/30/2003 create_end_time: 12:00:00

Records 1 - 5 of 5 < Previous Next >

ID	EUID1	EUID2	Status	Reason	Weight	System	Create Date
00000000000000000000002000	0000002004	0000002003	Unresolved		13.76	SLH	09/20/2003 23:19:03
00000000000000000000002001	0000002006	0000002005	Unresolved		17.14	SLH	09/20/2003 23:45:59
00000000000000000000002002	0000002008	0000002007	Unresolved		13.84	CBMC	09/20/2003 23:47:42
00000000000000000000002003	0000002009	0000001004	Unresolved		13.06	WHC	09/20/2003 23:48:12
00000000000000000000002004	0000002009	0000000000	Unresolved		10.63	WHC	09/20/2003 23:48:12

- To re-sort the member profiles in the results list, click the heading of the column by which you want to sort.

Note: Clicking a header once sorts the profiles in ascending order; clicking the heading a second time sorts the profiles in descending order.

- In the Results list, click the ID of the pair of potential duplicate profiles you want to compare.
- Do one of the following:
 - If the profiles you selected have additional potential duplicates, then the Associated Records page appears. Continue to step 8.

Figure 53 Associated Records List

ID	EUID1	EUID2	Status	Reason	Weight	System	Create Date
00000000000000002003	0000002009	0000001004	Unresolved		13.06	WHC	09/20/2003 23:48:12
00000000000000002004	0000002009	0000000000	Unresolved		10.63	WHC	09/20/2003 23:48:12

- ◆ If the profiles do not have additional duplicates, the Comparison page appears with the two profiles displayed side-by-side (see Figure 50). Skip to step 9.
- 8 On the Associated Records page, click the ID of the pair of profiles you want to compare. The Comparison page appears (see Figure 50).
The selected profiles appear side-by-side.
 - 9 You can compare additional SBR information for each profile.
For information about the fields displayed on this page, see the field descriptions listed in the section “**Viewing Member Profiles**” in Chapter 3 of this guide.
 - ◆ To compare address information, expand the **Address** row under **SBR**, and then select an address type in both the right and left EUID trees.
 - ◆ To compare telephone information, expand the **Phone** row under **SBR**, and then select a telephone type in both the right and left EUID trees.
 - ◆ To compare alias information, expand the **Alias** row under **SBR**, and then select an alias name in both the right and left EUID trees.
 - ◆ To compare auxiliary ID information, expand the **AuxId** row under **SBR**, and then select an auxiliary ID type in both the right and left EUID trees.
 - ◆ To compare comment information, expand the **Comment** row under **SBR**, and then select a comment code in both the right and left EUID trees.
 - 10 You can compare information contained in each system record for each profile.
For information about the fields displayed on this page, see the field descriptions listed in the section “**Viewing Member Profiles**” in [Chapter 4](#) of this guide.

- ♦ To compare address information, expand the **Address** row under the right and left system records, and then select an address type in each.
 - ♦ To compare telephone information, expand the **Phone** row under the right and left system records, and then select a telephone type in each.
 - ♦ To compare alias information, expand the **Alias** row under the right and left system records, and then select the alias name you want to view in each.
 - ♦ To compare auxiliary ID information, expand the **AuxId** row under the right and left system records, and then select an auxiliary ID type in each.
 - ♦ To compare comment information, expand the **Comment** row under the right and left system records, and then select a comment code in each.
- 11 To view the following entry in the potential duplicate results list, click **Next>**.
 - 12 To view the previous entry in the potential duplicate results list, click **<Previous**.
 - 13 To return to the potential duplicates results list, click **Result**.

About Matching Review Search Fields

The fields located on the Matching Review Search page allow you to specify information about the potential duplicate or assumed match profiles you want to view.

Table 19 Matching Review Search Fields

In this field ...	type or select ...
EUID	The enterprise-wide unique identification number of one of the profiles you want to view.
Status	The potential duplicate status of the profiles you want to view. Possible values for this field are Unresolved , Resolved , or Permanently Resolved .
System	The system with which the member profile that caused the potential duplicate flag is associated (such as a registration system).
Local ID	The local ID associated with the member profile in the specified system.
Create Date From	A beginning create date for the profiles you want to view. The query is performed for transactions that fall between the Create Date From (and Create Time From) and the To Create Date (and To Create Time).
Create Time From	The beginning create time for the profiles you want to view.
To Create Date	The ending create date for the profiles you want to view.
To Create Time	The ending create time for the profiles you want to view.

About Potential Duplicate Results Fields

The fields located in the potential duplicate results list help you to identify a potential duplicate pair to display on the Comparison page.

Table 20 Potential Duplicate Results Fields

This field ...	displays this information ...
ID	The Potential Duplicate ID of the transaction that caused the potential duplicate pair.
EUID1	The enterprise unique identification number of the member profile whose addition to the database created the potential duplicate listing.
EUID2	The enterprise unique identification number of the member who was flagged as a potential duplicate with the profile identified by the EUID1.
Status	The potential duplicate status of the potential duplicate pair.
Reason	The reason that the profiles were listed as potential duplicates.
Weight	The matching probability weight between the two profiles in each row.
System	The system with which the member profile identified by EUID1 is associated.
Create Date	The date and time that the transaction that caused the potential duplicate listing occurred.

Merging Potential Duplicates

When you compare two potential duplicate profiles, you might find that the member profiles represent the same person, or that a system record from one profile actually belongs in the other profile. You can perform either a member profile merge or a system record merge to correct this.

To combine member profiles

- 1 Compare two potential duplicate profiles, as described in **“Finding Potential Duplicates” on page 105**.
- 2 Determine which of the two profiles you want to keep, and then click the **EUID Merge** arrows pointing toward that profile.
The merge result profile appears, allowing you to view the profile that will be saved after the merge.
- 3 Click **Confirm** to finalize the merge, or **Cancel** to return to the Comparison page and review the profiles again.

To combine system records

- 1 Compare the system records from two potential duplicate profiles, as described in **“Finding Potential Duplicates” on page 105**.
- 2 Determine which of the two system records you want to keep.

- 3 Highlight both system records to be merged, and then click the **LID Merge** arrows pointing toward the system record you want to keep.
- 4 To retain any fields from the non-surviving system record, select the check box next to the fields you want to keep.
- 5 To specify which child objects to retain:
 - ♦ Compare the child objects to determine which to retain and which to remove.
 - ♦ For each child object you do not want to save in the new system record, click **Remove** *<child_type>* beneath that child object (where *<child_type>* is the type of child object to remove).

Important: *If you do not specify which child objects to retain, the survivor calculator determines which to save in the surviving system record. By default, all unique child objects are retained, but any child objects with the same unique key value are retained according to survivor strategies. For example, if one system record has an office address and the other has a home address, both addresses are kept; but if both system records have a home address, the survivor calculator determines which is kept.*

- 6 In the upper portion of the page, click **Merge**.
The merge result record appears, allowing you to view the information that will be saved in the SBR after the merge.
- 7 Click **Confirm** to finalize the merge, or **Cancel** to return to the Comparison page and review the profiles again.

Resolving Potential Duplicates

When you compare two potential duplicate profiles and determine that they do not represent the same member, you need to resolve the two profiles to flag the profiles as not being potential duplicates. There are two types of resolution. *Resolve* removes a potential duplicate flag, but if one of the resolved profiles is updated the records may be listed as potential duplicates again. *Resolve Permanently* flags the two profiles as being permanently resolved.

To resolve two potential duplicate profiles

- 1 Compare two potential duplicate profiles, as described in **“Finding Potential Duplicates” on page 105**.
- 2 Do one of the following:
 - ♦ To flag the potential duplicate profiles as resolved but still allow the potential duplicate listing to be reinstated in the future, click **Resolved** on the Comparison page.
 - ♦ To flag the potential duplicate profiles as resolved and never allow the potential duplicate listing to be reinstated, click **Resolve Permanently** on the Comparison page.
- 3 On the confirmation dialog that appears, click **OK**.

The potential duplicate flag is removed, and the profiles are no longer regarded as possible duplicates of one another.

5.3.11. Working with Assumed Matches

The Matching Review function of the EDM allows you to view any member profiles that were automatically updated by eIndex as a result of an assumed match. You can reverse the assumed match if necessary. This section provides instructions for finding profiles updated by an assumed match and then reversing the update if necessary.

Finding Assumed Matches

You can easily find member profiles that were updated by an assumed match using the Matching Review function of the EDM. When you search for assumed matches, you can select a member profile to view from a results list.

Figure 54 Assumed Match Page

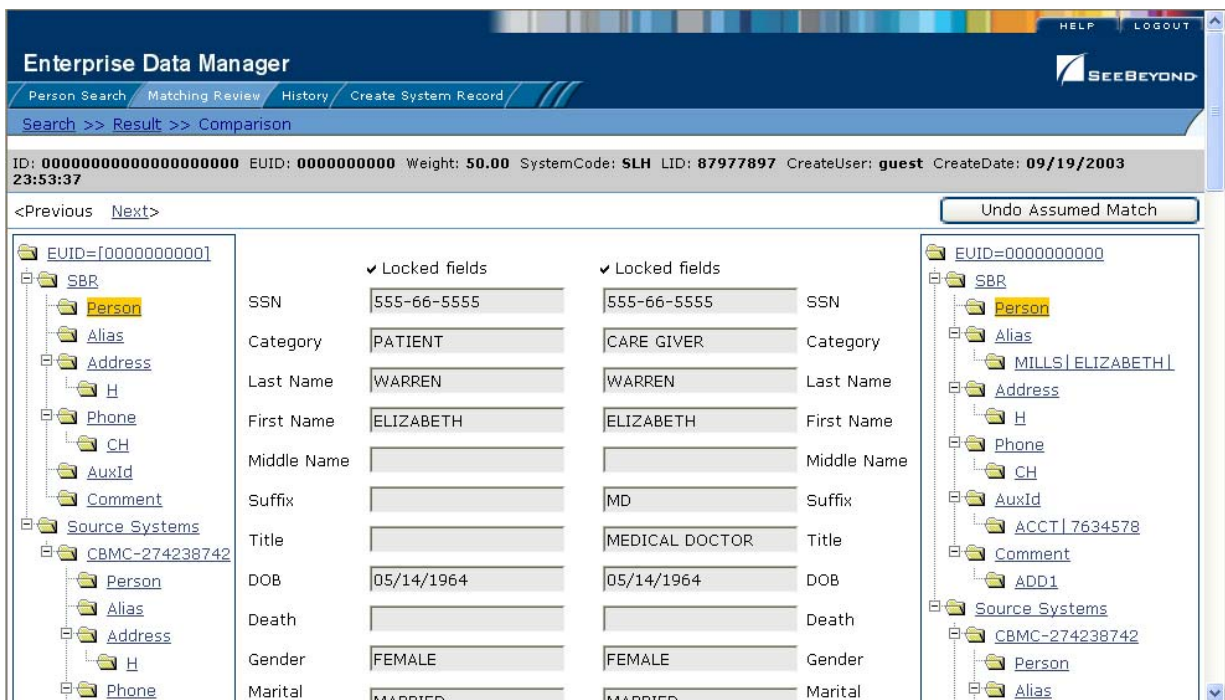

To find assumed matches

- 1 Obtain information about the member profile you want to view, such as their EUID, a system in which they are registered, or the logon ID of the user who added the record that caused the update.
- 2 On the EDM, select **Matching Review**. The Matching Review Search page appears.

Figure 55 Matching Review Search Page

Enterprise Data Manager

Person Search Matching Review History Create System Record

SEARCH

Enter as much information as possible to narrow the search

Search for Potential Duplicate

Search for Assumed Match Clear

EUID

System

Create Date From

To Create Date

Status

Local ID

Create Time From

To Create Time

- 3 On the Matching Review Search page, enter the search criteria (for more information, see [“About Matching Review Search Fields”](#) on page 109).
- 4 In the upper portion of the page, click **Search for Assumed Match**. The Assumed Match Result page appears (for more information, see [“About Assumed Match Results Fields”](#) following this procedure).

Figure 56 Assumed Match Results List

ID	EUID	Weight	System	Local ID	Create User	Create Date
000000000000000000000000	0000000000	50.0	SLH	87977897	guest	09/19/2003 23:53:37
00000000000000000000001000	0000002006	31.205359	CBMC	123131212	guest	09/20/2003 23:46:34

- To re-sort the member profiles in the results list, click the heading of the column by which you want to sort.

Note: Clicking a header once sorts the profiles in ascending order; clicking the heading a second time sorts the profiles in descending order.

- In the Results list, click the ID of the assumed match profile you want to view. The Assumed Match page appears with the demographic information of the SBR displayed.
- To view additional information about the member, review the instructions provided under **“Viewing Member Profiles” on page 44.**
- To view the following entry in the assumed match results list, click **Next>**.
- To view the previous entry in the assumed match results list, click **<Previous**.
- To return to the assumed match results list, click **Result**.

About Assumed Match Results Fields

The fields located in the assumed match results list help you to identify an assumed match transaction to display on the Comparison page.

Table 21 Assumed Match Results Fields

This field ...	displays this information ...
ID	The Assumed Match ID of the transaction that caused the assumed match.

Table 21 Assumed Match Results Fields

This field ...	displays this information ...
EUID	The enterprise unique identification number of the member profile that was updated by the assumed match.
Weight	The matching probability weight between the updated profile and the record that caused the assumed match.
System	The system with which the record that cause the assumed match is associated.
Local ID	The local ID in the above system for the record that caused the assumed match.
Create User	The logon ID of the user who added the profile that created the assumed match.
Create Date	The date and time that the transaction that caused the assumed match occurred.

Reversing an Assumed Match

If you find that an assumed match was made in error, you can reverse the assumed match. This process returns the updated member profile to its status just prior to the assumed match update, and creates a new member profile for the record that caused the assumed match.

To reverse an assumed match

- 1 View the assumed match profile, as described in [“Finding Assumed Matches” on page 112](#).

- 2 In the upper portion of the page, click **Undo Assumed Match**.

A confirmation dialog appears, providing the EUID number of the new profile that will be created as a result of reversing the match.

- 3 On the confirmation dialog, click **OK**.

The assumed match is undone, the updated profile is returned to its state prior to the assumed match, and a new member profile is created.

5.3.12. Combining Member Information

When you determine that two member profiles represent the same member, you need to merge the profiles to form one profile that contains the member's most current information. The resulting profile is known as the Merge Result Record. You can display the member profiles to merge using the Person Search function or the Matching Review function. This section describes how to merge records using the Person Search function. For information about merging records using the Matching Review function, see [“Merging Potential Duplicates” on page 110](#).

Merging Member Profiles

When you merge member profiles, all of the system records associated with the non-surviving member profile are transferred into the surviving member profile. The non-surviving profile is given a status of merged, and is no longer active. The SBR of the surviving profile is recalculated based on the new system records that were added to the profile due to the merge.

Figure 57 Comparison Page - Merging Member Profiles

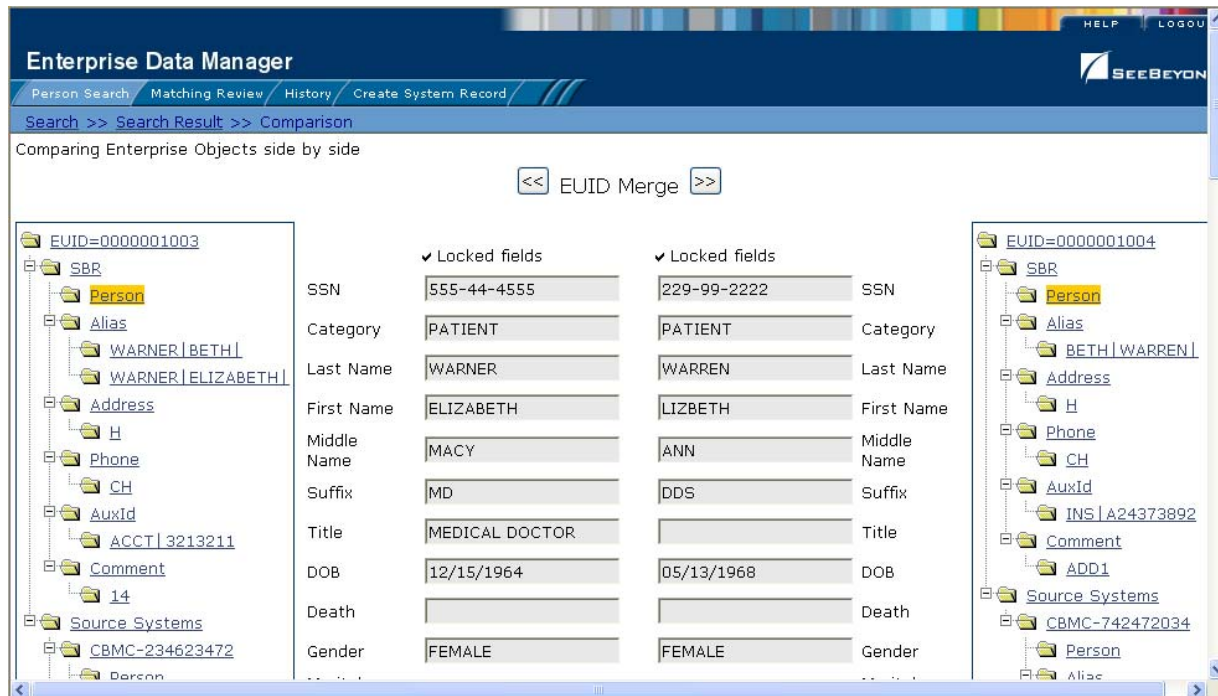

To merge member profiles

- 1 Perform a search for the member profiles you want to merge using any of the search procedures described in the section **“Searching for Member Profiles”** on page 29.
- 2 Select the check boxes to the left of the two profiles you want to merge in the results list.
- 3 In the first cell of the results table, click **Compare Records**.
The Comparison page appears.
- 4 Determine which of the two profiles you want to keep, and then click the **EUID Merge** arrows pointing toward that profile.
The merge result profile appears, allowing you to view the profile that will be saved after the merge.
- 5 Click **Confirm** to finalize the merge, or **Cancel** to return to the Comparison page and review the profiles again.

Merging System Records

You can merge a system record from one member profile into a system record from another member profile, as long as the system records originated from the same system. You can also specify which, if any, information to save from the non-surviving system record. When you merge system records, the non-surviving system record is transferred into the member profile of the surviving system record, and is given a status of merged.

Figure 58 Merging System Records



To merge system records

- 1 Perform a search for the member profiles whose system records you want to merge using any of the search procedures described in the section [“Searching for Member Profiles” on page 29](#).
- 2 Select the check boxes to the left of the two profiles containing the system records you want to merge.
- 3 In the first cell of the results table, click **Compare Records**.
The Comparison page appears.
- 4 Determine which system record you want to keep, and highlight the Person object of the those system records in the EUID trees.
Two LID Merge arrow buttons appear at the top of the page.
- 5 Click the **LID Merge** arrows pointing toward the profile containing the system record that will be kept.

- 6 To retain any fields from the non-surviving system record, select the Person objects in the system objects to merge, and then select the check box next to the fields you want to keep.
- 7 To specify which child objects to retain:
 - ♦ Compare the child objects to determine which to retain and which to remove.
 - ♦ For each child object you do not want to save in the new system record, click **Remove** <child_type> beneath that child object (where <child_type> is the type of child object to remove).

Important: *If you do not specify which child objects to retain, the survivor calculator determines which to save in the surviving system record. By default, all unique child objects are retained, but any child objects with the same unique key value are retained according to survivor strategies. For example, if one system record has an office address and the other has a home address, both addresses are kept; but if both system records have a home address, the survivor calculator determines which is kept.*

- 8 In the upper portion of the page, click **Merge**.

The merge result record appears, allowing you to view the information that will be saved in the SBR after the merge.

- 9 Click **Confirm** to finalize the merge, or **Cancel** to return to the Comparison page and review the profiles again.

After you merge two system records, the surviving system record is updated, and the non-surviving system record is transferred to the “merge to” member profile and is marked as merged. The SBRs for both member profiles involved in the merge are recalculated. If the “merge from” member profile no longer has any system records, it is deactivated.

5.3.13. Unmerging Member Information

If two member profiles or system records are merged in error, you can unmerge the profiles or system records. The unmerge function is accessed from the Transaction History window.

Figure 59 Unmerge Page

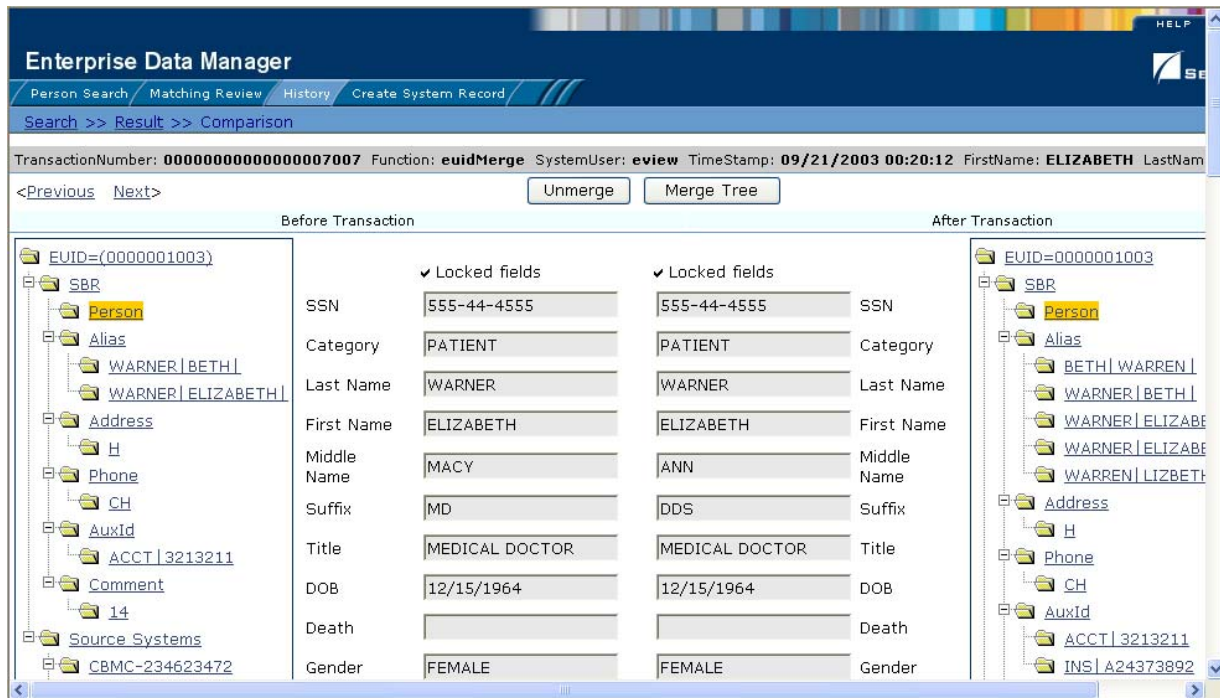

Unmerging Member Profiles

If two member profiles are merged in error, the profiles can easily be separated by unmerging the two profiles. When you unmerge two member profiles, they are separated back into two separate profiles, the system records are returned to their original profiles, and any changes that were made to the system records after the merge are retained. Any system records that were added while the profiles were merged are associated with the profile that was active at the time.

To unmerge two merged member profiles

- 1 Obtain information about the member profile that is still active after the merge process, such as the EUID, the system that caused the merge, and so on.
- 2 Perform a search for the merge transaction, as described in [“Viewing a Transaction History” on page 58](#).

Note: You can also access the Transaction History Search Result page by displaying the active profile on the View/Edit page, and then clicking **Transaction History**.

- 3 From the Results list, select the merge transaction you want to unmerge. This must be the most recent merge transaction for the profile, and must have a function of **eidMerge**.

The Transaction History page appears.

Note: *The profiles that appear on the Transaction History page display the information contained in surviving member profile before and after the merge occurred.*

- 4 In the upper portion of the page, click **Unmerge**.
The page changes to display side-by-side images of how the records will appear after they are unmerged.
- 5 Do one of the following:
 - ♦ To finalize the unmerge, click **Confirm** in the upper portion of the page.
 - ♦ To cancel the unmerge and return to the Transaction Comparison page, click **Cancel** in the upper portion of the page.

Unmerging System Records

If two system records are merged in error, the records can easily be separated by unmerging the two system records. When system records are unmerged, the system record that became inactive is reactivated and, if the system record was merged from a different member profile, it is returned to its original profile. The SBR is recalculated for both affected member profiles. Any changes made to the surviving system record following the merge are retained after the unmerge transaction.

To unmerge two merged system records

- 1 Obtain information about either member profile involved in the merge, such as the EUID, the system that caused the merge, and so on.
- 2 Perform a search for the merge transaction, as described in [“Viewing a Transaction History” on page 58](#).

Note: *You can also access the Transaction History Search Result page by displaying the active profile on the View/Edit page, and then clicking **Transaction History**.*

- 3 From the Results list, select the merge transaction you want to unmerge. This must be the most recent merge transaction for the system record, and has a function of **lidMerge**.

The Transaction History page appears.

Note: *The profiles that appear on the Transaction History page display the information contained in the member profile into which the system record was merged both before and after the merge occurred.*

- 4 In the upper portion of the page, click **Unmerge**.
The page changes to display side-by-side images of how the records will appear after they are unmerged.
- 5 Do one of the following:
 - ♦ To finalize the unmerge, click **Confirm** in the upper portion of the page.
 - ♦ To cancel the unmerge and return to the Transaction Comparison page, click **Cancel** in the upper portion of the page.

Glossary

alias

An alternative name by which a member may be known, such as a nickname or maiden name.

alphanumeric search

A type of search that looks for records that precisely match the specified criteria. This type of search does not allow for misspellings or data entry errors, but does allow the use of wildcard characters.

assumed match

When the matching weight between two records is at or above a weight you specify, (depending on the configuration of matching parameters) the objects are an assumed match and are merged automatically (see “Automatic Merge”).

automatic merge

When two records are assumed to be matches of one another (see “Assumed Match”), the system performs an automatic merge to join the records rather than flagging them as potential duplicates.

auxiliary ID

An identification code that may be assigned to several members in the database. For example, if a family uses a single account or insurance policy, each family member is assigned the same identification code for that account or policy.

Blocking Query

The query used during matching to search the database for possible matches to a new or updated record. This query makes multiple passes against the database using different combinations of criteria. The criteria is defined in the Candidate Select file.

Candidate Select file

The eIndex configuration file that defines the queries you can perform from the Enterprise Data Manager (EDM) and the queries that are performed for matching.

candidate selection

The process of performing the blocking query for match processing. See *Blocking Query*.

candidate selection pool

The group of possible matching records that are returned by the blocking query. These records are weighed against the new or updated record to determine the probability of a match.

comment

Free-text information that you can associate with a member profile to insert any data you choose about the member.

deactivate

When you deactivate a member profile or system record, that profile or record is no longer active and cannot be modified or merged.

drop-down lists

A list of options that you can use to enter information into certain fields in the Enterprise Data Manager (EDM). These fields have a down-arrow button on the right side that, when clicked, display a drop-down list of options for that field.

duplicate threshold

The matching probability weight at or above which two records are considered to potentially represent the same person.

EDM

See *Enterprise Data Manager*.

Enterprise Data Manager

Also known as the EDM, this is the web-based interface that allows monitoring and manual control of the master index database. The configuration of the EDM is stored in the Enterprise Data Manager file in the eIndex Project.

enterprise object

See *member profile*.

EUID

The enterprise-wide unique identification number assigned to each member profile in the master index. This number is used to cross-reference member profiles and to uniquely identify each member throughout your organization.

local ID

A unique identification code assigned to a member in a specific local system. A member profile may have several local IDs in different systems.

main menu

The uppermost menu on the EDM pages. You can access all of the primary functions of the master index from this menu.

master person index

A database application that stores and cross-references information about the members in a business organization, regardless of the computer system from which the information originates.

matching probability weight

An indicator of how closely two records match one another. The weight is generated using matching algorithm logic, and is used to determine whether two records represent the same member.

matching threshold

The lowest matching probability weight at which two records can be considered a match of one another.

matching weight or match weight

See *matching probability weight*.

member

Any person who participates within your business enterprise. A member could be a customer, employee, patient, and so on.

member profile

A set of information that describes characteristics of one member. A profile includes demographic and identification information about a member and contains a single best record and one or more system records.

merge

To join two member profiles or system records that represent the same person into one member profile.

merge history

A tree structure that displays a history of the profiles that have been merged together to form the selected member profile.

merged profile

See *non-surviving profile*.

non-surviving profile

A member profile that is no longer active because it has been merged into another member profile. Also called a *merged profile*.

object

A component of a member profile, such as a person object, which contains all of the demographic data about a person, or an address object, which contains information about a specific address type for a person.

page

The portion of the browser window that displays the information for a specific function. For example, the Search page displays search criteria fields and is accessed by clicking the Person Search function.

phonetic search

A search that returns phonetic variations of the entered search criteria, allowing room for misspellings and typographic errors.

potential duplicates

Two different member profiles that have a high probability of representing the same member. The probability is determined using matching algorithm logic.

probabilistic weighting

A process during which two records are compared for similarities and differences, and a matching probability weight is assigned based on the fields in the match string. The higher the weight, the higher the likelihood that two records match.

probability weight

See *matching probability weight*.

SBR

See *single best record*.

single best record

Also known as the SBR, this is the best representation of a member's information. The SBR is populated with information from all source systems based on the survivor strategies defined for each field. It is a part of a member profile and is recalculated each time a system record is updated.

survivor calculator

The logic that determines which fields from which source systems should be used to populate the SBR.

survivorship

Refers to the logic that determines which fields are used to populate the SBR. The survivor calculator defines survivorship.

system

A computer application within your company where information is entered about the members in eIndex and that shares this information with eIndex (such as a registration system). Also known as "source system" or "external system".

system record

A component of a member profile that contains the member's information as it appears in an external system. The information in a member's SBR is a combination of data from each system record in that profile.

tab

A heading on an application window that, when clicked, displays a different type of information. For example, click the Create System Record tab to display the Create System Record page.

Threshold file

An eIndex configuration file that specifies duplicate and match thresholds, EUID generator parameters, and which blocking query defined in the Candidate Select file to use for matching.

transaction history

A stored history of a member's profile. This history displays changes made to a member's information as well as merges, unmerges, and so on.

unmerge

To unmerge two previously merged member profiles or system records. When you perform an unmerge, each profile or system record is returned to its status prior to the merge.

Index

A

- accessing the EDM 21, 22
- Address 1 through Address 4 fields 50
- address fields 50
- address information 48
 - adding 81, 88
 - deleting 89
 - modifying 87, 89
- Address Line 1 field
 - in Advanced Person Lookup (Alpha) 33
 - in Advanced Person Lookup (Phonetic) 35
 - in search results 39
- Address Line 2 field
 - in Advanced Person Lookup (Phonetic) 35
 - in search results 39
- address objects 20
- address pop-up 37
- Address Type field
 - in Advanced Person Lookup (Alpha) 33
 - in search results 39
 - on detail pages 50
- Advanced Person Lookup (Alpha) 26, 27, 28, 31
 - default fields 32
- Advanced Person Lookup (Phonetic) 26, 27, 29, 33
 - default field combinations 34
 - default search fields 35
- alias fields 54
- alias information 52
 - adding 80, 93
 - deleting 94
 - modifying 92, 93
- alias objects 20
- alphanumeric search 31
- alphanumeric search fields 32
- Associated Records page 108
- assumed match 74
- assumed match results fields 114
- assumed matches 112
 - finding 112
 - reversing 115
- Audit ID field 72
- audit log 44
 - overview 16
- Audit Log function 68

- Audit Log History button 69
- Audit Log Result fields 72
- Audit Log Search fields 71
- automatic merge 73, 74
- AuxId objects 20
- Auxiliary ID field 56
- auxiliary ID fields 56
- Auxiliary ID Type field 56
- auxiliary IDs 21, 54
 - adding 83, 95
 - deleting 96
 - modifying 94, 96

B

- Back to Person Search navigation tool 24
- brackets status indicator 19

C

- calendar icon 33, 35
- Category field
 - in Advanced Person Lookup (Alpha) 33
 - in search results 39
 - on detail pages 46
- changes, saving 85
- child object
 - about 19
 - multiple instances of 19
- Citizenship field 47
- City field
 - in Advanced Person Lookup (Alpha) 33
 - on the detail pages 50
- Class 1-5 fields 48
- Comment Code field 58
- comment fields 58
- comment objects 20
- Comment Text field 58
- comments 16, 56
 - adding 84, 97
 - deleting 98
 - modifying 97, 98
- comparing member profiles 43, 63
- Comparison function 63
- Comparison Lookup 27, 29, 35
- Comparison Lookup page 26
- Comparison page 43
- concurrent users 76
- configurable components 14
- Country field 50
- County field 50
- Create Date field
 - in assumed match results 115
 - in audit log results 72

- in potential duplicate results 110
- Create Date From field
 - in potential duplicate search 109
- Create System Record function 24
- Create Time From field
 - in potential duplicate search 109
- Create User field
 - in assumed match results 115
 - in audit log results 72
 - in audit log search 71

D

- Date 1-5 fields 48
- deactivating
 - member profiles 103
 - system records 102
- Death Certificate field 47
- Death field 47
- demographic data 45
- demographic fields 46
- demographic information
 - adding 79
 - modifying 86
- demographic searches 27
- Detail field
 - in audit log results 72
- detail page 24
- District of Residence field 48
- DOB field
 - in Advanced Person Lookup (Alpha) 33
 - in Advanced Person Lookup (Phonetic) 35
 - in search results 39
 - on the detail pages 47, 50, 52, 54, 56, 58
- document conventions 11
- DOD field 47
- Driver License field 47
- duplicate threshold 75

E

- EDM
 - See Enterprise Data Manager
- EDM overwrite 18, 76, 99
- eGate Integrator 14
- eIndex
 - about 13
- Enter Date field 58
- Enterprise Data Manager
 - overview 15–16
- enterprise object 16
- Ethnic Group field 47
- EUID 15
- EUID field

- in assumed match results 115
- in audit log search 71
- in potential duplicate search 109
- in search results 39
- in transaction history search 62
 - on search pages 32, 35
- EUID Lookup 28, 29
- EUID Merge arrows 116
- EUID tree 25, 41, 43
- EUID1 field
 - in audit log results 72
 - in potential duplicate results 110
 - in transaction history results 62
- EUID2 field
 - in audit log results 72
 - in potential duplicate results 110
 - in transaction history results 62
- euidMerge 119
- EUIDs 21
- exiting the EDM 25
- Ext field 52

F

- Father's Name field 47
- features 13–15
- fields
 - locked 18, 76, 99
 - locking 99
 - unlocking 100
- First Name (alias) field 54
- First Name field
 - in Advanced Person Lookup (Alpha) 33
 - in Advanced Person Lookup (Phonetic) 35
 - in search results 39
 - in transaction history results 62
 - on the detail pages 46, 50, 52, 54, 56, 58
- From Date field
 - in audit log search 71
 - in transaction history search 62
- From Time field
 - in audit log search 72
 - in transaction history search 62
- Function field
 - in audit log results 72
 - in audit log search 71
 - in transaction history results 62
 - in transaction history search 62
- functions
 - Create System Record 23
 - History 23
 - Matching Review 23
 - Person Search 23

G

- Gender field
 - in Advanced Person Lookup (Alpha) 33
 - in Advanced Person Lookup (Phonetic) 35
 - in search results 39
 - on the detail pages 47, 50, 52, 54, 56, 58

H

- History function 23, 58
- History page 43
- history records 43
- history results fields 62
- History Search 60
- History Search fields 61

I

- ID field
 - in assumed match results 114
 - in potential duplicate results 110
- identification numbers 21
- information fields 43
- INTEGRITY 15

L

- Language field 47
- Last Name (alias) field 54
- Last Name field
 - in Advanced Person Lookup (Alpha) 33
 - in Advanced Person Lookup (Phonetic) 35
 - in search results 39
 - in transaction history results 63
 - on the detail pages 46, 50, 52, 54, 56, 58
- Lga Code field 48
- LID Merge arrows 117
- LID1 field
 - in transaction history results 62
- LID2 field
 - in transaction history results 62
- lidMerge 120
- local ID
 - specifying 77
- Local ID field
 - in assumed match results 115
 - in Local ID Lookup 31
 - in potential duplicate search 109
 - on search pages 32
 - on the Create System Record page 79
- Local ID Lookup 28, 31
- Local ID Lookup fields 31
- local IDs 21

- local system records 13
- locked fields 18, 76, 99
- locking fields 99
- logging off 25
- logging on 21, 22

M

- Maiden Name field
 - in Advanced Person Lookup (Alpha) 33
 - in search results 39
 - on the detail pages 47
- Marital Status field 47
- match threshold 75
- matching probability weights 73
- Matching Review 23
- Matching Review function 75, 105, 112
- Matching Review Search fields 109
- member profile merges
 - non-surviving profile 74
 - surviving profile 74
- member profiles
 - about 16
 - adding 77–86
 - address objects 20
 - alias objects 20
 - AuxId objects 20
 - comment objects 20
 - comparing 15, 43, 63
 - components 16, 19
 - deactivating 103
 - demographic data 45
 - merge history 44
 - merging 73, 115, 116
 - person objects 19
 - phone objects 20
 - reactivating 104
 - saving changes 85
 - status 103
 - status indicators 18
 - transaction history 43, 58
 - unmerging 119
 - viewing 44–58
- merge
 - member profiles 115, 116
 - potential duplicates 110
 - reversing 74
 - system records 74, 117–118
- merge from profile
 - in system record merges 74
- merge function, overview 16
- merge history 44
 - tree 66
 - viewing 66

Index

- viewing details 68
- merge result record 115
- merge status 74
- merge to profile
 - in system record merges 74
- merging
 - duplicate system records 110
 - potential duplicate profiles 110
- merging profiles, about 73
- Middle Name (alias) field 54
- Middle Name field
 - in Advanced Person Lookup (Alpha) 33
 - in search results 39
 - on the detail pages 47
- Military Branch field 48
- Military Rank field 48
- Military Status field 48
- Mother's Maiden Name field
 - in Advanced Person Lookup (Alpha) 33
 - in Advanced Person Lookup (Phonetic) 35
 - in search results 39
 - on the detail pages 47
- Mother's Name field 47

N

- Nationality field 47
- non-surviving profile 74

O

- overwrite feature 18, 99

P

- parent object 19
- parenthesis status indicator 19
- Pension Exp. Date field 47
- Pension No field 47
- person objects 19
- Person Search function 23, 26
 - Advanced Person Lookup (Alpha) 27
 - Advanced Person Lookup (Phonetic) 27
 - Comparison Lookup 27
 - Search Result page 27
 - Simple Person Lookup page 26
- Phone field
 - in search results 39
 - on the detail pages 52
- phone fields 52
- phone information 50
 - adding 82
- phone objects 20

- Phone Type field
 - in search results 39
 - on the detail pages 52
- phonetic search 34
- phonetic search fields 35
- POB City field 47
- POB Country field 47
- POB State field 47
- Postal Code Extension field 50
- Postal Code field
 - in Advanced Person Lookup (Alpha) 33
 - on the detail pages 50
- potential duplicate results fields 110
- potential duplicate search fields 109
- potential duplicates 16, 73, 75
 - finding 105
 - merging 75
 - merging profiles 110
 - merging system records 110
 - resolving 75, 111
 - resolving permanently 75, 111
- probabilistic matching 14
- probability weights 73

R

- Race field 47
- reactivating
 - member profiles 104
 - system records 102
- Reason field
 - in potential duplicate results 110
- Religion field 47
- Repatriation No. field 48
- Resolve 111
- Resolve Permanently 111

S

- SBR
 - See single best record
- Search navigation tool 24
- search overview 15
- Search page 24
- Search Result navigation tool 24
- Search Result page 24, 27, 36
 - default fields 38
- search results
 - selecting a member profile 40
 - sorting 39
 - viewing 36
- search types 28
 - Advanced Person Lookup (Alpha) 28, 31
 - Advanced Person Lookup (Phonetic) 29, 33

- Comparison Lookup 29, 35
- EUID Lookup 28, 29
- Local ID Lookup 28, 31
- Social Security Number Lookup 28, 30
- security 16
- SeeBeyond Match Engine 15
- SeeBeyond Web site 12
- Simple Person Lookup 26
- Simple Person Lookup page 26, 29
- single best record 13, 17
 - updating 76
- Social Security Number Lookup 28, 30
- Spouse's Name field 47
- SSN field
 - in Advanced Person Lookup (Alpha) 33
 - in Advanced Person Lookup (Phonetic) 35
 - in search results 39
 - on the detail pages 46
- State field 50
 - in Advanced Person Lookup (Alpha) 33
- status
 - changing 103
- Status field
 - in potential duplicate results 110
 - in potential duplicate search 109
 - in search results 39
- status indicators
 - brackets 19
 - parenthesis 19
 - tilde 19
- String 1-10 fields 48
- Suffix field 47
- surviving profile 74
- survivor calculator 18, 76
 - overriding 76, 99
- System field
 - in assumed match results 115
 - in Local ID Lookup 31
 - in potential duplicate results 110
 - in potential duplicate search 109
 - in transaction history results 62
 - on the Create System Record page 78
- system fields 78
- system record merge
 - merge from profile 74
 - merge to profile 74
- system records 17
 - adding 101
 - deactivating 102
 - merging 74, 117–118
 - modifying 101
 - reactivating 102
 - unmerging 120
 - updating 76

- System User field
 - in transaction history results 62
 - in transaction history search 62

T

- telephone fields 52
- telephone information 50
 - adding 82, 90
 - deleting 91
 - modifying 90, 91
- telephone pop-up 37
- tilde status indicator 19
- Timestamp field 62
- Title field 47
- To Create Date field 109
- To Create Time field 109
- To Date field
 - in audit log search 72
 - in transaction history search 62
- To Time field
 - in audit log search 72
 - in transaction history search 62
- transaction histories 58
- transaction history 15
- transaction history results fields 62
- transaction history search fields 61
- Transaction No field 62
- tree view 25, 41, 43
- Type field
 - in audit log results 72
 - in audit log search 71

U

- unlocking fields 100
- unmerge 74
 - member profiles 119
 - system records 120
- unmerge function
 - overview 16
- URL 22

V

- Veteran Status field 47
- View/Edit page 41–43
- viewing member profiles 44–58
- VIP Flag field 47

W

- Weight field

Index

in assumed match results **115**
in potential duplicate results **110**
in search results **39**
weighted strategy **18**