

REVISIONS			
LTR	DESCRIPTION	DATE	APPROVED
A	RELEASED PER ECN # 14948	03/31/06	M.BRYAN
B	REVISED PER ECN# 17282	04/02/07	M.BRYAN

NOTES: UNLESS OTHERWISE SPECIFIED

- INSTALL ALL CABLE ASSEMBLIES WITH DRESSED BEND RADII IN ACCORDANCE WITH TEKELEC CABLE BEND RADIUS SPECIFICATION 906-0020-01.
- ALL INTERCONNECTION POINTS SHALL BE STRAIN RELIEVED BY POSITIVE MECHANICAL FEATURES OR FASTENERS FOR LENGTH CONFIGURATIONS.
- THIS DIAGRAM AND ALL PART NUMBERS SHOWN ARE FOR REFERENCE ONLY. REFERENCE CABLE PART NUMBERS WITH XX FOR THE DASH NUMBER ARE LENGTHS THAT ARE SITE SPECIFIC.
- NO ADDITIONS, DELETIONS, SUBSTITUTIONS OR MODIFICATIONS WITHOUT PRIOR WRITTEN TEKELEC APPROVAL.
- SEE TEKELEC P/N 820-2410-01 FOR CURRENT HARDWARE LIST.
- ALL POWER CABLES ARE CONNECTED WITH THE RED LEAD TO -48VDC TERMINAL AND THE BLACK LEAD TO RETURN TERMINAL.
- 48 VDC, RTN, AND GND PRIMARY CABLING EXITING THE FRAME SHALL BE 6 AWG. SEE TABLES D, E AND F FOR LENGTH CONFIGURATIONS.
- 4-PORT SERIAL CABLE, SUPPLIED WITH PCI SERIAL CARD. PORT NUMBERS 1 THRU 4 ARE LOCATED ON THE FOUR DB-9 CONNECTORS. PORT 0 IS THE DB-44 CONNECTOR THAT INTERFACES WITH THE PCI SERIAL CARD.
- USE LABEL PN 617-0009-01 TO MAKE LABEL SET FOR FROM AND TO ON CABLES INDICATED IN TABLES A, B, G, H, J & K. EACH CABLE INDICATED WILL REQUIRE 2 LABELS ONE AS SHOWN IN THE TABLES AND ONE WITH FROM AND TWO REVERSED AS SHOWN IN DETAIL K. PERMANENTLY PRINT LABELS WITH .09 HIGH BLACK CHARACTERS. CENTER TEXT APPROXIMATELY AS SHOWN. MAX 23 CHARACTERS PER LINE. SEE DETAIL L FOR PLACEMENT OF LABELS ON CABLES. CABLES IDENTIFIED AS FIELD LABEL WILL BE LABELED AT INSTALLATION.
- INSTALL THE WAN MODULES (SEE DETAIL T) IN ROUTER A AND B AS REQUIRED SEE SALES ORDER FOR CORRECT PART NO. INSTALL THE WIC MODULE (SEE DETAIL R) IN ROUTER A.
- COMPONENT MINIMUM HARDWARE/OS REQUIREMENTS.

ROUTER A AND B
 -96MB RAM
 -32MB FLASH
 -IOS=12.3(16)

Switches A AND B:
 -24MD RAM
 -8MB flash
 -IOS=12.1(22 EA5) Enhanced Image

MRV CONSOLE SERVER:
 -PPICBOOT=3.0
 -LINUXIMG=3.2 and above

870-2248-10
 BP-1 SEE DETAIL E

870-2248-10
 SEE DETAIL E
 BP-2

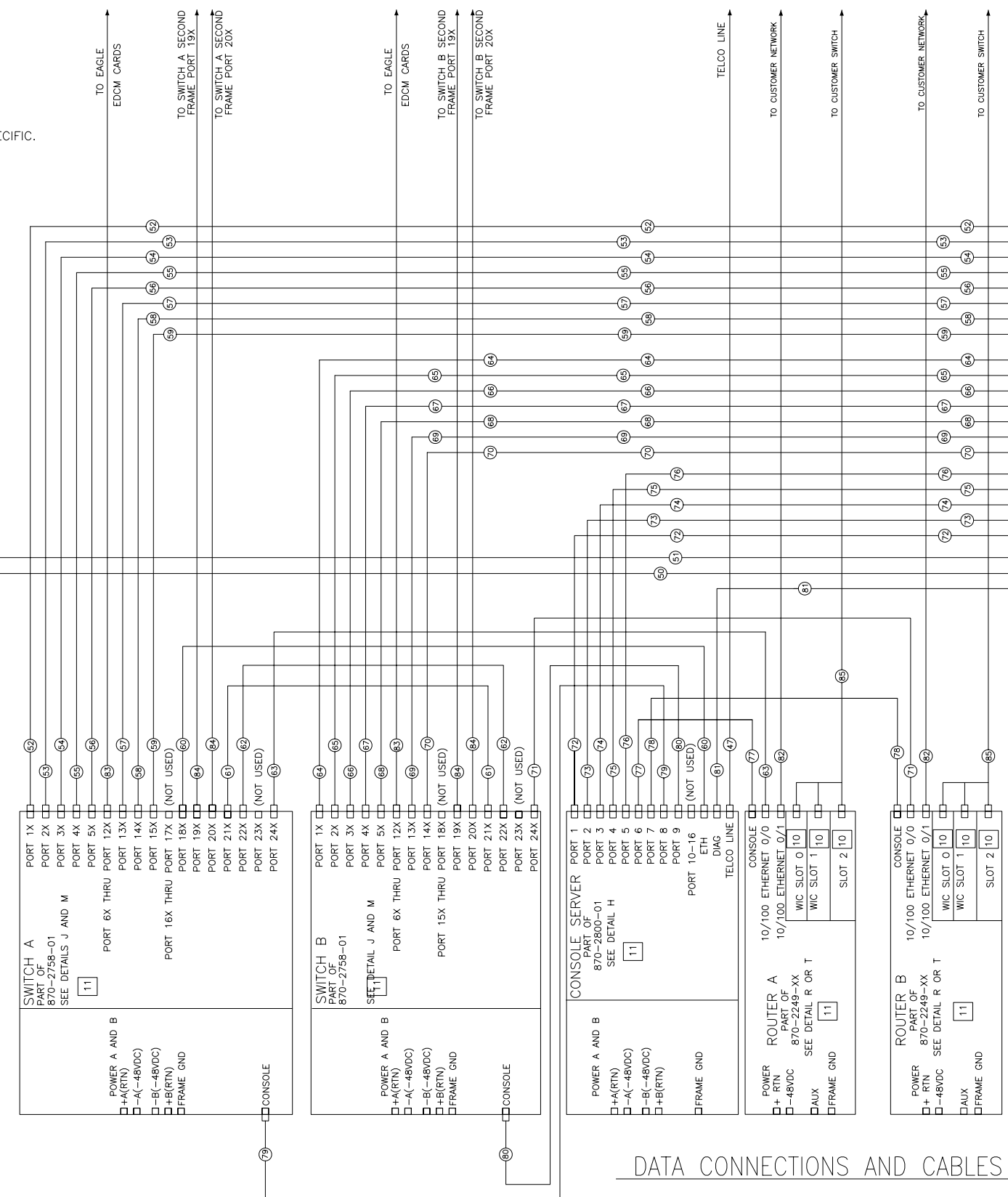

DOCUMENT CONTROL
 PRODUCTION RELEASED

DATA CONNECTIONS AND CABLES

UNLESS OTHERWISE SPECIFIED:
 2D NOT SCALE DRAWING.
 DIMENSIONS ARE IN INCHES.
 INTERPRET DIMENSIONS IN ACCORDANCE WITH ANSI Y14.5M-82.
 DEBURR AND BREAK SHARP EDGES .005-.015.
 MACHINED SURFACE FINISH 12.5.
 TOLERANCES: .xxx+ ±.010 .

STANDARD HOLE TOLERANCES:	HOLE DIA	TOLERANCES
	.013 THRU .125	+ .004 - .001
	.126 THRU .250	+ .005 - .001
	.251 THRU .500	+ .006 - .001
	.501 THRU .750	+ .008 - .001
	.751 THRU 1.000	+ .010 - .001
	1.001 THRU 2.000	+ .012 - .001

CONTRACT NO.		APPROVALS		DATE	
NEXT ASSY		MBRYAN		12/05	
USED ON		HHASTINGS		3/15/06	
APPLICATION		APPROVED		MBRYAN	
FINISH		APPROVED			
MATERIAL		APPROVED			

TEKELEC		26580 W. Agoura Road, Calabasas, California 91302	
INTERCONNECT DIAGRAM_SCS SYS_T1000_DC FRAME ASSY			
SIZE	CAGE CODE	DRAWING NO.	REV.
D		892-0073-01	B
SCALE: NONE	FILE NAME: 892-0073-01_REV_B.DWG	SHEET 1	OF 6

THIS DOCUMENT AND THE DATA DISCLOSED HEREIN OR HEREWITH IS PROPRIETARY AND IS NOT TO BE REPRODUCED, USED OR DISCLOSED IN WHOLE OR PART TO ANYONE WITHOUT THE WRITTEN PERMISSION OF TEKELEC. COPYRIGHT, TEKELEC 1996.

DWG 892-0073-01

C

B

A

D

C

B

A

8

7

6

5

4

3

2

1

REVISIONS			
LTR	DESCRIPTION	DATE	APPROVED

DWG NO: 892-0073-01
 SHEET: 2
 REV: B

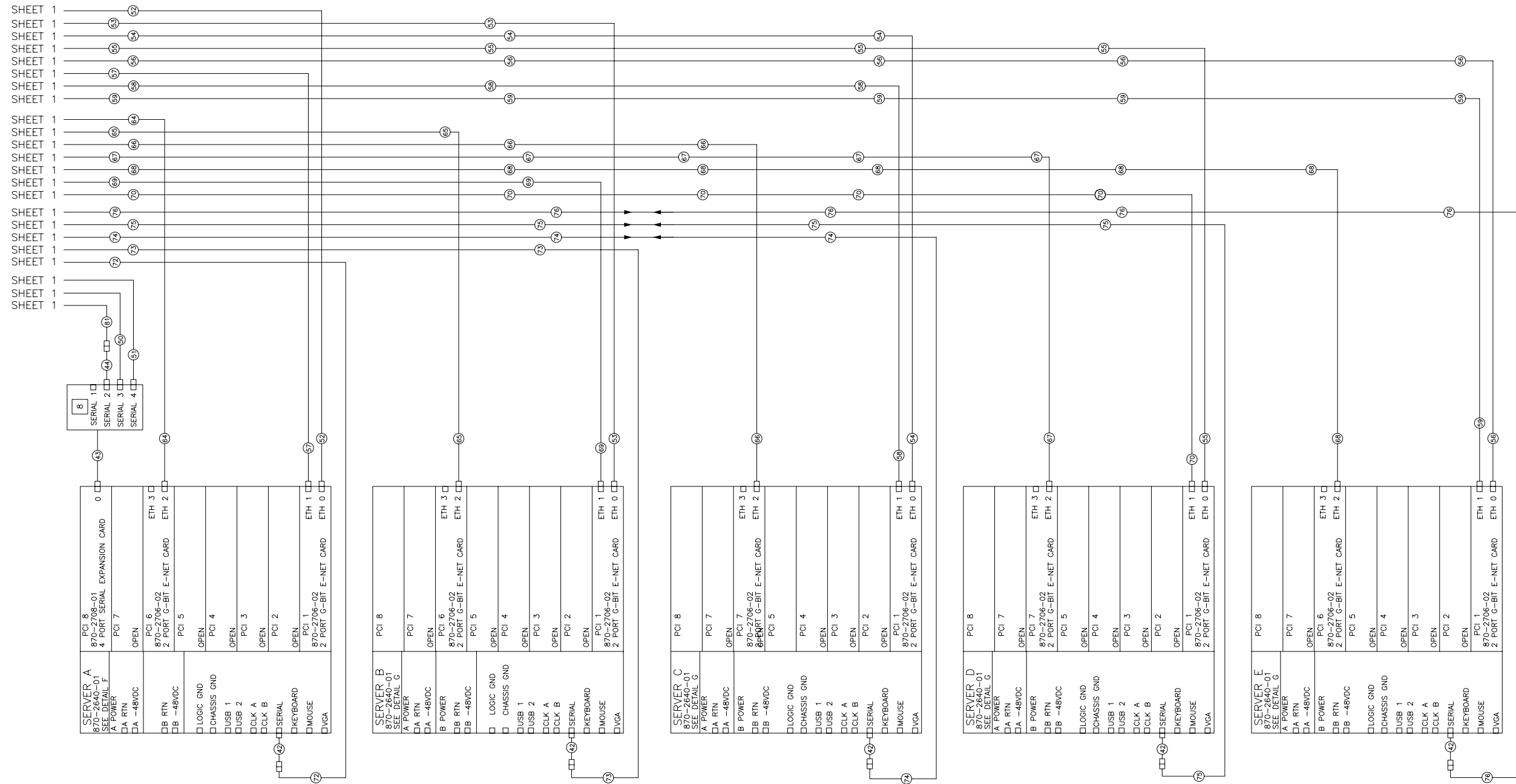

DATA CONNECTIONS AND CABLES

D	SIZE	CAGE CODE	DRAWING NO.	REV.
			892-0073-01	B
SCALE: NONE		FILE NAME: 892-0073-01_REV_B.DWG	SHEET 2 OF 6	

THIS DOCUMENT AND THE DATA DISCLOSED HEREIN OR HERETO IS PROPRIETARY AND IS NOT TO BE REPRODUCED, USED OR DISCLOSED IN WHOLE OR PART TO ANYONE WITHOUT THE WRITTEN PERMISSION OF TEKELEC. COPYRIGHT, TEKELEC, 1996.

REVISIONS			
LTR	DESCRIPTION	DATE	APPROVED

DWG NO. 892-0073-01 3 REV B

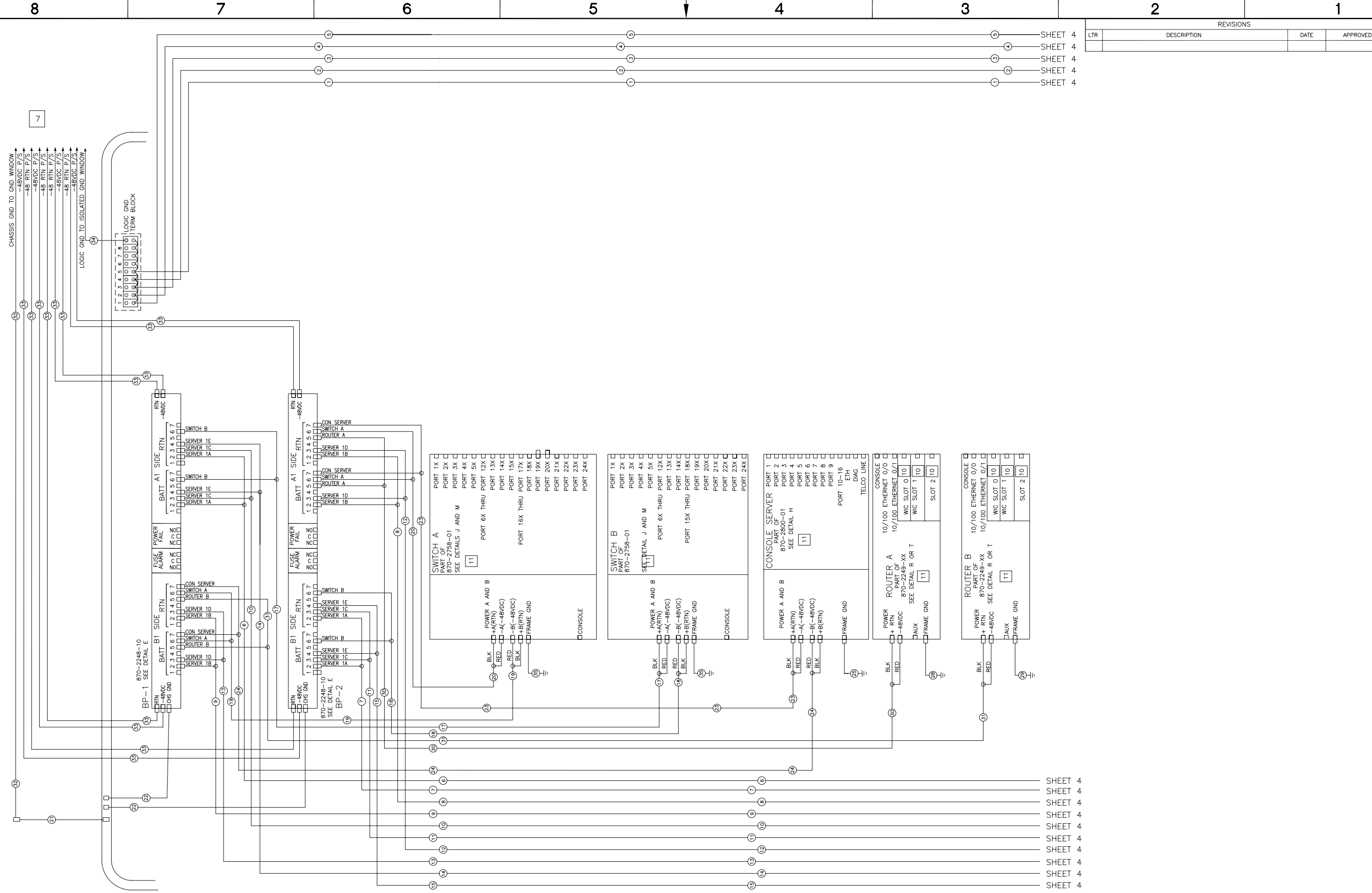

SHEET 4
 SHEET 4
 SHEET 4
 SHEET 4

SHEET 4
 SHEET 4
 SHEET 4
 SHEET 4
 SHEET 4
 SHEET 4
 SHEET 4
 SHEET 4
 SHEET 4

POWER CONNECTIONS AND CABLES

SIZE	CAGE CODE	DRAWING NO.	REV.
D		892-0073-01	B

THIS DOCUMENT AND THE DATA DISCLOSED HEREIN OR HEREWITH IS PROPRIETARY AND IS NOT TO BE REPRODUCED, USED OR DISCLOSED IN WHOLE OR PART TO ANYONE WITHOUT THE WRITTEN PERMISSION OF TEKELC. COPYRIGHT, TEKELC 1996.

SCALE: NONE FILE NAME: 892-0073-01_REV_B.DWG SHEET 3 OF 6

REVISIONS			
LTR	DESCRIPTION	DATE	APPROVED

DWG NO. 892-0073-01 4 B

B

A

SHEET 3
 SHEET 3
 SHEET 3
 SHEET 3

SHEET 3
 SHEET 3
 SHEET 3
 SHEET 3
 SHEET 3
 SHEET 3
 SHEET 3
 SHEET 3

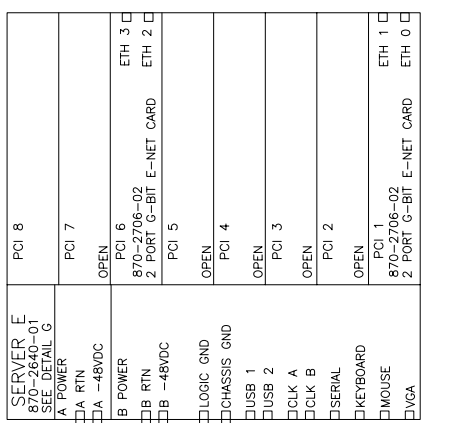
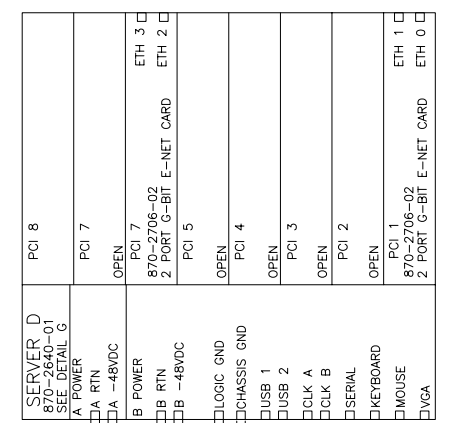
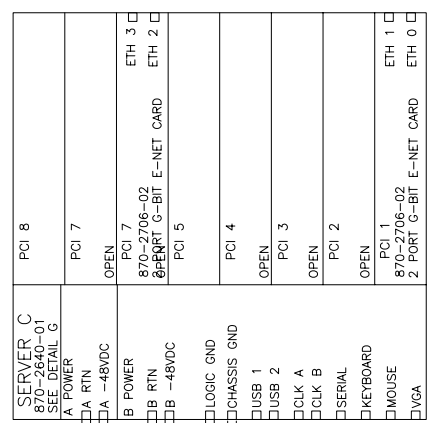
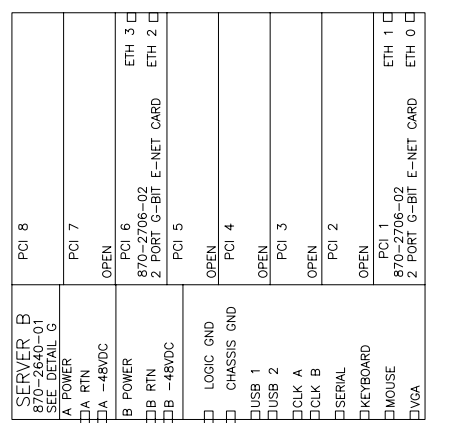
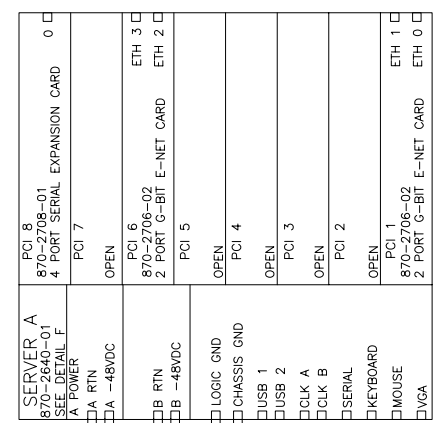

POWER CONNECTIONS AND CABLES

SIZE	CAGE CODE	DRAWING NO.	REV.
D		892-0073-01	B

THIS DOCUMENT AND THE DATA DISCLOSED HEREIN OR HEREWITH IS PROPRIETARY AND IS NOT TO BE REPRODUCED, USED OR DISCLOSED IN WHOLE OR PART TO ANYONE WITHOUT THE WRITTEN PERMISSION OF TEKELEC. COPYRIGHT, TEKELEC 1996.

SCALE: NONE | FILE NAME: 892-007301_REV_B.DWG | SHEET 4 OF 6

TABLE A - POWER CABLE PART NUMBERS

ITEM NO.	TEKELEC P/N	QTY	LENGTH	RUN LIST AND LABEL INFORMATION FOR FROM AND TO	LABEL REQUIRED
1	830-0989-05	1	116.00 INCHES	FROM: LOGIC GND TERM BLK 5 / TO: SERVER 1E LOGIC GND	YES
2	830-0989-04	1	106.00 INCHES	FROM: LOGIC GND TERM BLK 4 / TO: SERVER 1D LOGIC GND	YES
3	830-0989-03	1	99.00 INCHES	FROM: LOGIC GND TERM BLK 3 / TO: SERVER 1C LOGIC GND	YES
4	830-0989-02	1	92.00 INCHES	FROM: LOGIC GND TERM BLK 2 / TO: SERVER 1B LOGIC GND	YES
5	830-0989-01	1	86.00 INCHES	FROM: LOGIC GND TERM BLK 1 / TO: SERVER 1A LOGIC GND	YES
6	830-0988-01	1	96.00 INCHES	FROM: SERVER 1A - A PWR / TO: BP1-2A	YES
7	830-0988-02	1	87.00 INCHES	FROM: SERVER 1A - B PWR / TO: BP2-2B	YES
8	830-0988-03	1	100.00 INCHES	FROM: SERVER 1B - A PWR / TO: BP2-2A	YES
9	830-0988-04	1	97.00 INCHES	FROM: SERVER 1B - B PWR / TO: BP1-2B	YES
10	830-0988-05	1	110.00 INCHES	FROM: SERVER 1C - A PWR / TO: BP1-3A	YES
11	830-0988-06	1	101.00 INCHES	FROM: SERVER 1C - B PWR / TO: BP2-3B	YES
12	830-0988-07	1	114.00 INCHES	FROM: SERVER 1D - A PWR / TO: BP2-3A	YES
13	830-0988-08	1	111.00 INCHES	FROM: SERVER 1D - B PWR / TO: BP1-3B	YES
14	830-0988-09	1	128.00 INCHES	FROM: SERVER 1E - A PWR / TO: BP1-4A	YES
15	830-0988-10	1	119.00 INCHES	FROM: SERVER 1E - B PWR / TO: BP2-4B	YES
16	830-0927-01	5	48.00 INCHES	FROM: FRAME GROUND / TO: SERVER 1A FROM: FRAME GROUND / TO: SERVER 1B FROM: FRAME GROUND / TO: SERVER 1C FROM: FRAME GROUND / TO: SERVER 1D FROM: FRAME GROUND / TO: SERVER 1E	YES
17	830-1013-01	1	41.00 INCHES	FROM: SWITCH B - A PWR / TO: BP1-6A	NO
18	830-1013-04	1	30.00 INCHES	FROM: SWITCH B - B PWR / TO: BP2-6B	NO
19	830-1013-02	1	32.00 INCHES	FROM: SWITCH A - B PWR / TO: BP1-6B	NO
20	830-1013-03	1	37.00 INCHES	FROM: SWITCH A - A PWR / TO: BP2-6A	NO
21	830-0715-03	1	84.00 INCHES	FROM: FRAME GROUND / TO: GROUND WINDOW	NO
22	830-0830-01	2	N/A	FROM: CIRCUIT BREAKER / TO: FRAME GND	NO
23	830-0868-27	1	41.00 INCHES	FROM: CON SERVER A PWR / TO: BP2-7A	YES
24	830-0868-28	1	37.00 INCHES	FROM: CON SERVER B PWR / TO: BP1-7B	YES
25	830-1015-02	1	18.00	FROM: CONSOLE SERVER / TO: FRAME GND	YES
26	NOT USED				
27	NOT USED				
28	830-0823-01	1	22.00	FROM: ROUTER A / TO: FRAME GND	YES
29	830-0823-01	1	22.00	FROM: ROUTER B / TO: FRAME GND	YES
30	830-0869-07	1	49.00	FROM: ROUTER A - A PWR / TO: BP2-5A	YES
31	830-0869-08	1	54.00	FROM: ROUTER B - A PWR / TO: BP1-5B	YES
32	CHASSIS GND (FIELD ROUTED)	1	SITE SPECIFIC	SEE TABLE F	FIELD LABEL
33	-48VDC AND 48V RTN (FIELD ROUTED)	8	SITE SPECIFIC	SEE TABLE E	FIELD LABEL
34	LOGIC GROUND	1	SITE SPECIFIC	SEE TABLE D	FIELD LABEL
35	830-1015-01	2	22.00 INCHES	FROM: SWITCH A AND B / TO: FRAME GROUND	YES

TABLE B - DATA CABLE PART NUMBERS

ITEM NO.	TEKELEC P/N	QTY	LENGTH	RUN LIST AND LABEL INFORMATION FOR FROM AND TO	LABEL REQUIRED
42	830-1011-01	5	NA	ADAPTER FROM MAIN SERIAL PORTS ON SERVER 1A-1E	NO
43	870-2708-01	1	NA	4 PORT SERIAL CABLE SUPPLIED WITH PCI CARD	NO
44	830-1012-01	1	NA	ADAPTER FROM SERVER 1A, PCI SLOT 8, SERIAL CARD PORT 2	NO
45	NOT USED				NO
46	NOT USED				NO
47	830-0680-01	1		RJ11 TO RJ11 PHONE LINE	NO
50	830-0961-01	1	72 INCHES	FROM: BP1 ALARM / TO: SERVER A PCI SLOT 8 SERIAL PORT 3	YES
51	830-0961-01	1	72 INCHES	FROM: BP2 ALARM / TO: SERVER A PCI SLOT 8 SERIAL PORT 4	YES
52	830-0724-06	1	6 FT	FROM: SWITCH A PORT 1X / TO: SERVER A PCI SLOT 1 ETH 0	YES
53	830-0724-07	1	7 FT	FROM: SWITCH A PORT 2X / TO: SERVER B PCI SLOT 1 ETH 0	YES
54	830-0724-67	1	8 FT	FROM: SWITCH A PORT 3X / TO: SERVER C PCI SLOT 1 ETH 0	YES
55	830-0724-67	1	8 FT	FROM: SWITCH A PORT 4X / TO: SERVER D PCI SLOT 1 ETH 0	YES
56	830-0724-02	1	10 FT	FROM: SWITCH A PORT 5X / TO: SERVER E PCI SLOT 1 ETH 0	YES
57	830-0724-06	1	6 FT	FROM: SWITCH A PORT 13X / TO: SERVER A PCI SLOT 1 ETH 1	YES
58	830-0724-67	1	8 FT	FROM: SWITCH A PORT 14X / TO: SERVER C PCI SLOT 1 ETH 1	YES
59	830-0724-02	1	10 FT	FROM: SWITCH A PORT 15X / TO: SERVER E PCI SLOT 1 ETH 1	YES
60	830-0724-65	1	3 FT	FROM: SWITCH A PORT 18X / TO: CONSOLE SERVER ETH PORT	YES
61	830-0723-01	1	1 FT	FROM: SWITCH A PORT 21X / TO: SWITCH B PORT 21	YES
62	830-0723-01	1	1 FT	FROM: SWITCH A PORT 22X / TO: SWITCH B PORT 22	YES
63	830-0724-06	1	6 FT	FROM: SWITCH A PORT 24X / TO: ROUTER A ETH PORT 0/0	YES
64	830-0724-06	1	6 FT	FROM: SWITCH B PORT 1X / TO: SERVER A PCI SLOT 6 ETH 2	YES
65	830-0724-07	1	7 FT	FROM: SWITCH B PORT 2X / TO: SERVER B PCI SLOT 6 ETH 2	YES
66	830-0724-67	1	8 FT	FROM: SWITCH B PORT 3X / TO: SERVER C PCI SLOT 6 ETH 2	YES
67	830-0724-67	1	8 FT	FROM: SWITCH B PORT 4X / TO: SERVER D PCI SLOT 6 ETH 2	YES
68	830-0724-02	1	10 FT	FROM: SWITCH B PORT 5X / TO: SERVER E PCI SLOT 6 ETH 2	YES
69	830-0724-07	1	6 FT	FROM: SWITCH B PORT 13X / TO: SERVER B PCI SLOT 1 ETH 1	YES
70	830-0724-67	1	8 FT	FROM: SWITCH B PORT 14X / TO: SERVER D PCI SLOT 1 ETH 1	YES
71	830-0724-06	1	6 FT	FROM: SWITCH B PORT 24X / TO: ROUTER B ETH PORT 0/0	YES
72	830-1005-06	1	6 FT	FROM: CONSOLE SERVER PORT 1X / TO: SERVER A MAIN SERIAL PORT	YES
73	830-1005-06	1	6 FT	FROM: CONSOLE SERVER PORT 2X / TO: SERVER B MAIN SERIAL PORT	YES
74	830-1005-07	1	7 FT	FROM: CONSOLE SERVER PORT 3X / TO: SERVER C MAIN SERIAL PORT	YES
75	830-1005-08	1	8 FT	FROM: CONSOLE SERVER PORT 4X / TO: SERVER D MAIN SERIAL PORT	YES
76	830-1005-08	1	8 FT	FROM: CONSOLE SERVER PORT 5X / TO: SERVER E MAIN SERIAL PORT	YES
77	830-0990-04	1	4 FT	FROM: CONSOLE SERVER PORT 6X / TO: ROUTER A CONSOLE PORT	YES
78	830-0990-04	1	4 FT	FROM: CONSOLE SERVER PORT 7X / TO: ROUTER B CONSOLE PORT	YES
79	830-0990-03	1	3 FT	FROM: CONSOLE SERVER PORT 8X / TO: SWITCH A CONSOLE PORT	YES
80	830-0990-03	1	3 FT	FROM: CONSOLE SERVER PORT 9X / TO: SWITCH B CONSOLE PORT	YES
81	830-0990-03	1	3 FT	FROM: CONSOLE SERVER DIAG PORT / TO: SERVER A PCI SLOT 8 SERIAL PORT 2	YES
82	830-0724-XX	2	SITE SPECIFIC	TO CUSTOMER NETWORK - RJ45 STRAIGHT THRU	FIELD LABEL
83	830-0978-XX	AR	SITE SPECIFIC	SWITCH A AND B PORTS 6X - 12X TO EAGLE	FIELD LABEL
84	830-0724-XX	4	SITE SPECIFIC	SWITCH A AND B SECOND FRAME PORTS 19X AND 20X	FIELD LABEL
85	CUSTOMER SUPPLIED	2	SITE SPECIFIC	TO CUSTOMERS SWITCH	FIELD LABEL

REVISIONS			
LTR	DESCRIPTION	DATE	APPROVED

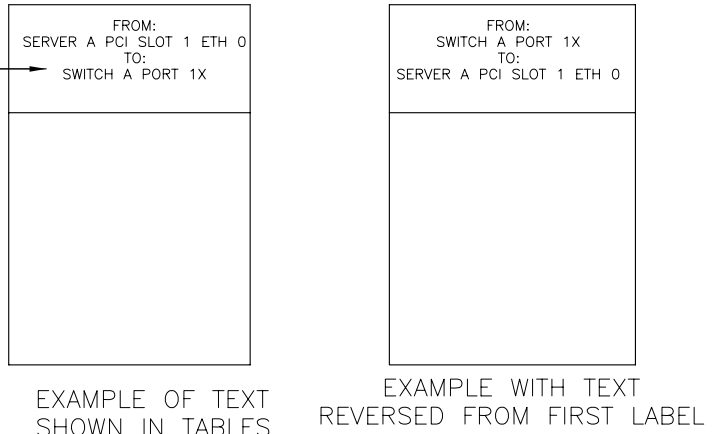

DETAIL K [9] CABLE LABEL EXAMPLE USING CABLE ITEM NO. 38

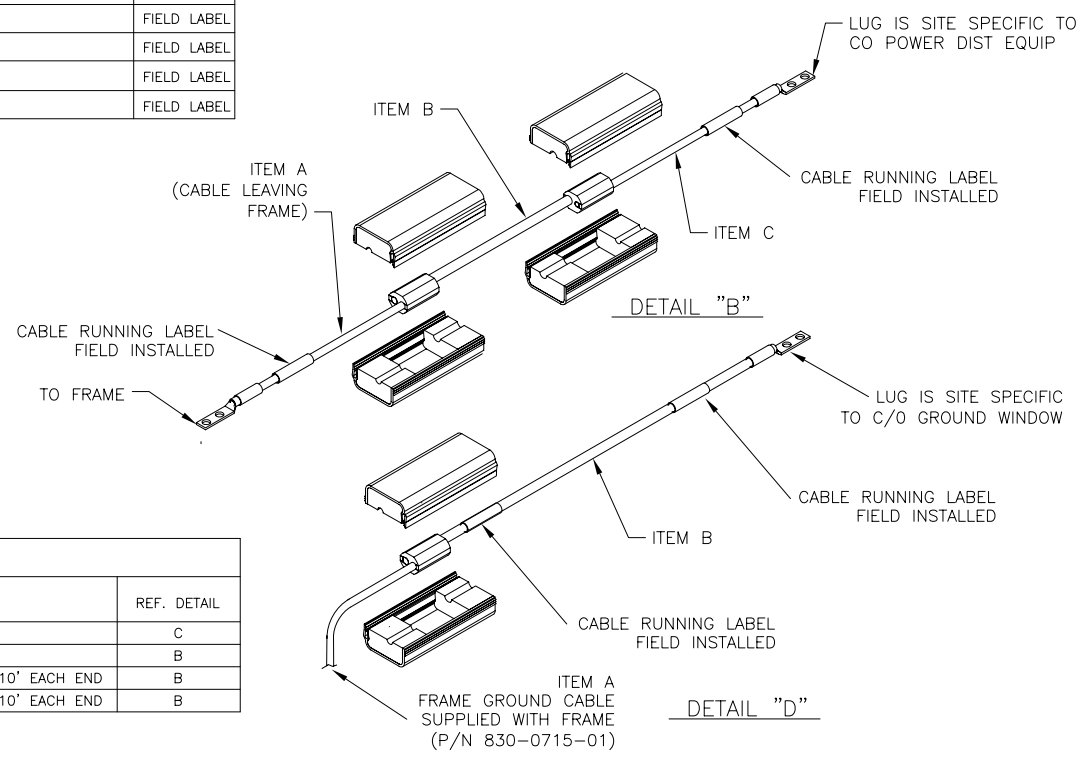
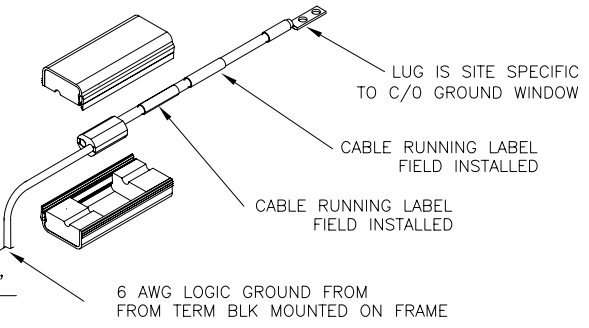
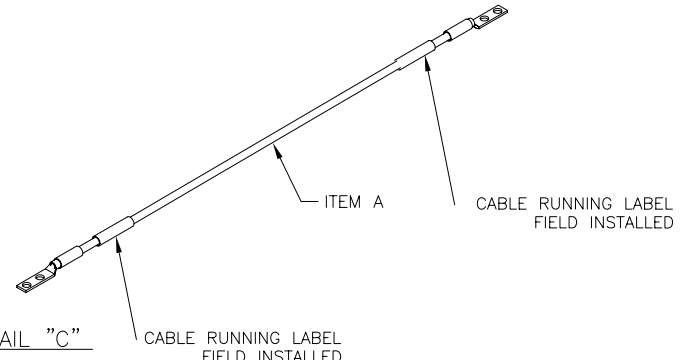

TABLE D - LOGIC GROUND CABLING

DISTANCE	PRIMARY CABLE PART NUMBER	CABLE AWG	TERMINAL LUG P/N	HEAT SHRINK PART NUMBER	COMMENT	REF. DETAIL
0'-40'	690-0131-01	6	502-0085-01	804-0228-01	CABLE LENGTH IS SITE-SPECIFIC	C
40'-160'	690-0108-07	1/0	804-0977-01	804-0229-01	CABLE LENGTH IS SITE-SPECIFIC	A

TABLE E - 48VDC & 48VRTN CABLING COMPONENTS

DISTANCE	ITEM A				ITEM B		ITEM C	HALF TAP SPLICE P/N	HTAP SOFT COVER P/N	COMMENT	REF. DETAIL
	CABLE P/N	CABLE AWG	TERMINAL LUG P/N	HEAT SHRINK P/N	CABLE P/N	CABLE AWG	CABLE CONSTRUCTION				
0' - 40'	690-0108-01	6	502-0085-01	804-0228-01	N/A	--	N/A	NONE REQUIRED	NONE REQUIRED	CABLE LENGTH IS SITE-SPECIFIC	C
40' - 65'	690-0108-01	6	502-0085-01	804-0228-01	690-0108-04	4	SITE SPECIFIC	T&B 63125	T&B HTC40	CABLE LENGTH IS SITE-SPECIFIC	B
65' - 100'	690-0108-01	6	502-0085-01	804-0228-01	690-0108-06	2	SITE SPECIFIC	T&B 63125	T&B HTC40	CABLE LENGTH IS SITE-SPECIFIC, HTAPPED STUBS <= 10' EACH END	B
100' - 160'	690-0108-01	6	502-0085-01	804-0228-01	690-0108-03	1/0	SITE SPECIFIC	T&B 63125	T&B HTC40	CABLE LENGTH IS SITE-SPECIFIC, HTAPPED STUBS <= 10' EACH END	B

TABLE F - SYSTEM FRAME GROUND CABLING

DISTANCE	CABLE P/N	CABLE AWG	ITEM A (830-0715-01 SUPPLIED WITH FRAME)		ITEM B		HTAP (A TO B CONNECTION)		COMMENT	REF. DETAIL
			TERMINAL LUG P/N	HEAT SHRINK P/N	CABLE P/N	CABLE AWG	H TAP P/N			
0' - 40'	690-0131-01	6	502-0085-01	804-0228-01	690-0131-01	6	804-0865-01		CABLE LENGTH IS SITE-SPECIFIC	D
40' - 160'	690-0108-01	6	502-0085-01	804-0228-01	690-0108-07	1/0	804-0865-01		CABLE LENGTH IS SITE-SPECIFIC	D

REVISIONS			
LTR	DESCRIPTION	DATE	APPROVED

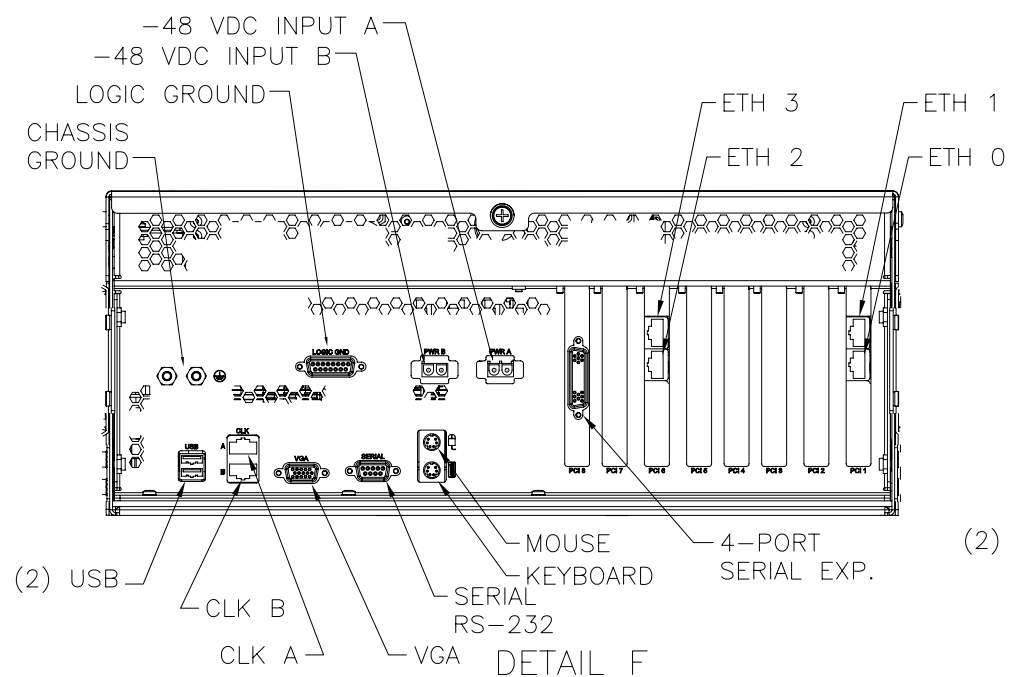

DETAIL F
SERVER A REAR VIEW
870-2640-01 W/ PCI CARDS:
SLOT 1 -870-2706-02
SLOT 6 -870-2706-02
SLOT 8 -870-2708-01

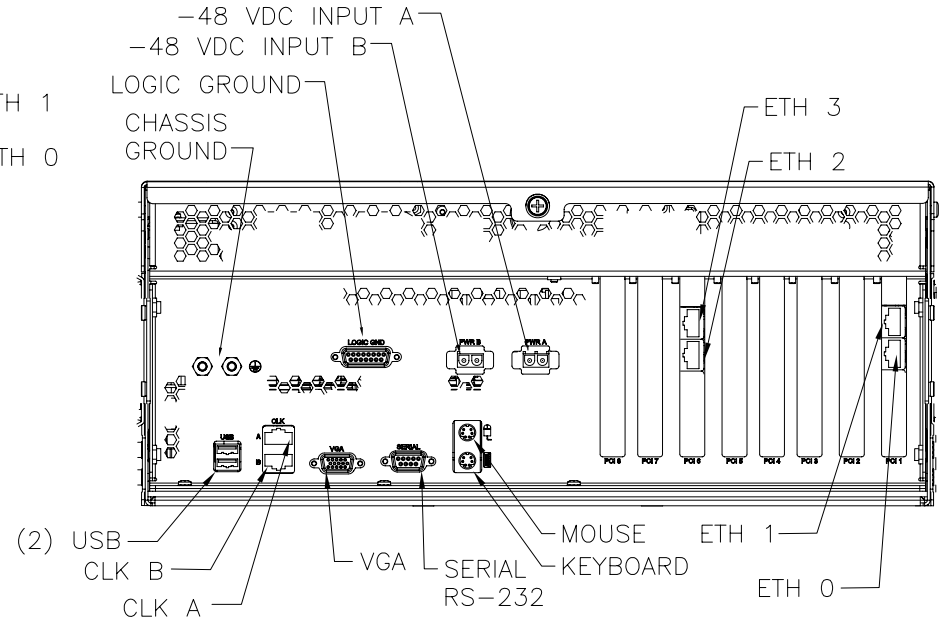

DETAIL B
SERVER 1B - 1E (REAR VIEW)
870-2640-01 W/ PCI CARDS:
SLOT 1 -870-2706-02
SLOT 6 -870-2706-02

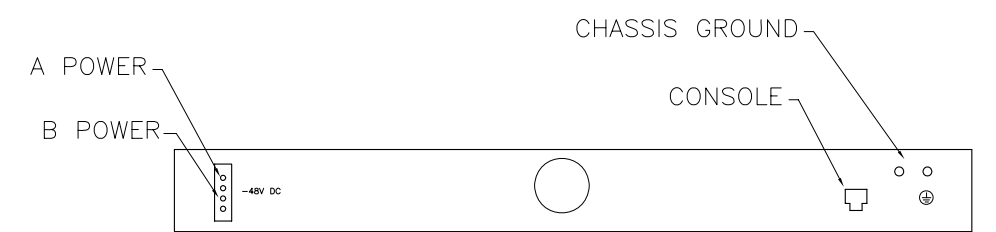

DETAIL J
REAR VIEW-SWITCH
870-2758-01

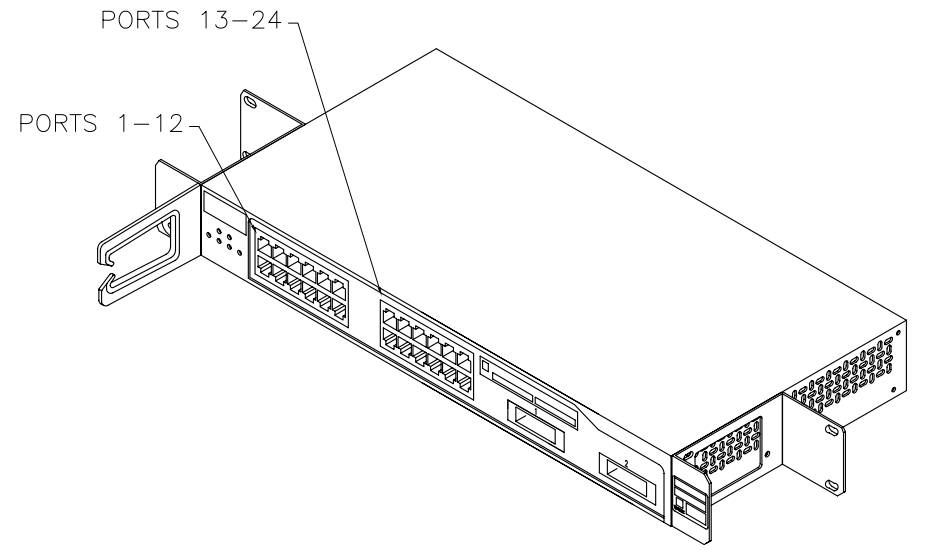

DETAIL M
ISO VIEW OF THE FRONT-SWITCH
870-2758-01

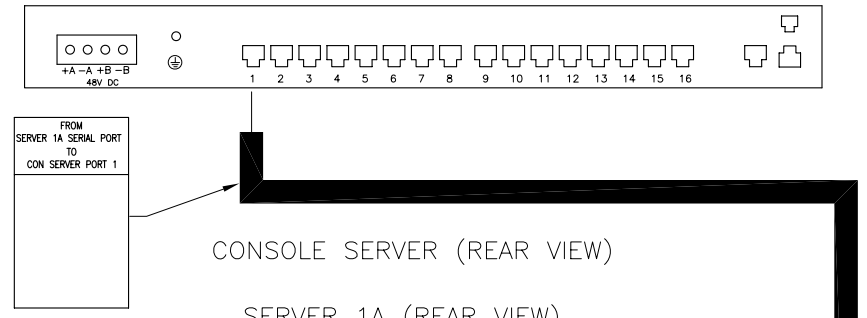

CONSOLE SERVER (REAR VIEW)
SERVER 1A (REAR VIEW)

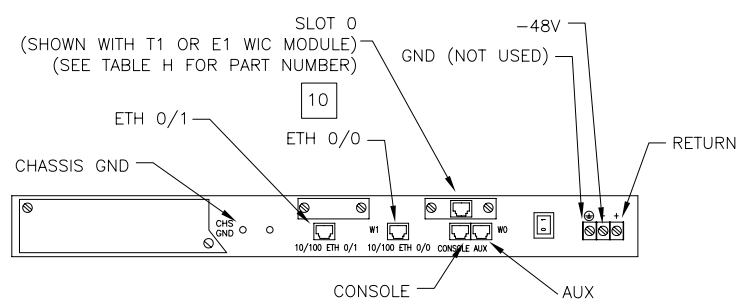

DETAIL "T"
ROUTER (REAR VIEW)
870-2711-XX

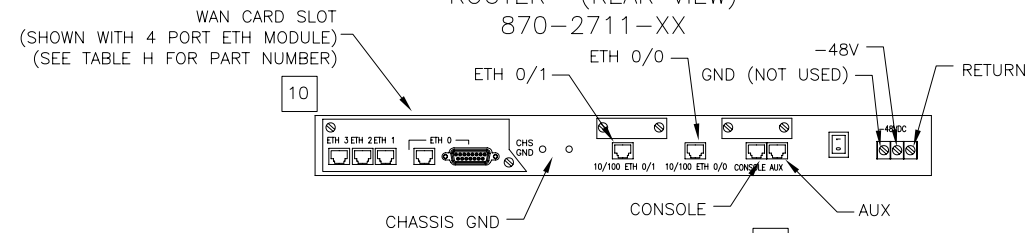

DETAIL "R"
ROUTER (REAR VIEW)
870-2711-XX

ROUTER CARD MODULE TABLE H				
COMPONENT	PART NO.	QTY	LOCATION	COMMENT
WAN T1 MODULE	804-1710-02	2	DETAIL T	REQUIRED FOR T1 APPLICATION
WAN E1 MODULE	804-1962-02	2	DETAIL T	REQUIRED FOR E1 APPLICATION
4 PORT ETH MODULE	804-1540-01	1	DETAIL R	REQUIRED FOR IP APPLICATION

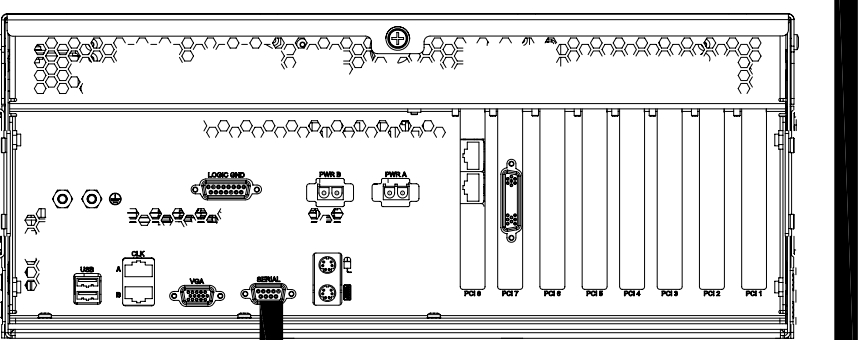

DETAIL L
CABLE LABEL PLACEMENT
TYPICAL FOR ALL CABLES
INDICATED IN TABLES A AND B
USING CABLE ITEM NO. 38

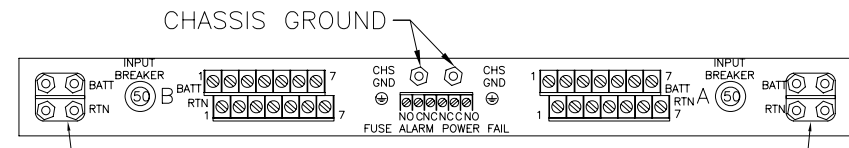

DETAIL E
CIRCUIT BREAKER (REAR VIEW)
870-2248-10

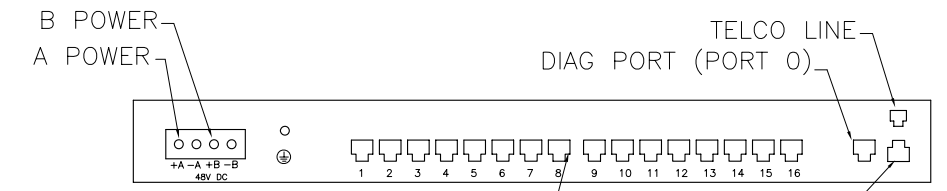

DETAIL H
REAR VIEW- CONSOLE SERVER
870-2800-01

SIZE	CAGE CODE	DRAWING NO.	REV.
D		892-0073-01	B

THIS DOCUMENT AND THE DATA DISCLOSED HEREIN OR HERETH IS PROPRIETARY AND IS NOT TO BE REPRODUCED, USED OR DISCLOSED IN WHOLE OR PART TO ANYONE WITHOUT THE WRITTEN PERMISSION OF TEKELEC. COPYRIGHT, TEKELEC 1996.

SCALE: NONE FILE NAME: 892-0073-01_REV_B.DWG SHEET 6 OF 6

892-0073-01 6 B
 8
7
6
5
4
3
2
1
 D
C
B
A