

Oracle® Communications
EAGLE

Database Administration - IP7 User's Guide

Release 46.3

E72175 Revision 1

June 2016

This software and related documentation are provided under a license agreement containing restrictions on use and disclosure and are protected by intellectual property laws. Except as expressly permitted in your license agreement or allowed by law, you may not use, copy, reproduce, translate, broadcast, modify, license, transmit, distribute, exhibit, perform, publish, or display any part, in any form, or by any means. Reverse engineering, disassembly, or decompilation of this software, unless required by law for interoperability, is prohibited.

The information contained herein is subject to change without notice and is not warranted to be error-free. If you find any errors, please report them to us in writing.

If this is software or related documentation that is delivered to the U.S. Government or anyone licensing it on behalf of the U.S. Government, then the following notice is applicable:

U.S. GOVERNMENT END USERS: Oracle programs, including any operating system, integrated software, any programs installed on the hardware, and/or documentation, delivered to U.S. Government end users are "commercial computer software" pursuant to the applicable Federal Acquisition Regulation and agency-specific supplemental regulations. As such, use, duplication, disclosure, modification, and adaptation of the programs, including any operating system, integrated software, any programs installed on the hardware, and/or documentation, shall be subject to license terms and license restrictions applicable to the programs. No other rights are granted to the U.S. Government.

This software or hardware is developed for general use in a variety of information management applications. It is not developed or intended for use in any inherently dangerous applications, including applications that may create a risk of personal injury. If you use this software or hardware in dangerous applications, then you shall be responsible to take all appropriate fail-safe, backup, redundancy, and other measures to ensure its safe use. Oracle Corporation and its affiliates disclaim any liability for any damages caused by use of this software or hardware in dangerous applications.

Oracle and Java are registered trademarks of Oracle and/or its affiliates. Other names may be trademarks of their respective owners.

Intel and Intel Xeon are trademarks or registered trademarks of Intel Corporation. All SPARC trademarks are used under license and are trademarks or registered trademarks of SPARC International, Inc. AMD, Opteron, the AMD logo, and the AMD Opteron logo are trademarks or registered trademarks of Advanced Micro Devices. UNIX is a registered trademark of The Open Group.

This software or hardware and documentation may provide access to or information about content, products, and services from third parties. Oracle Corporation and its affiliates are not responsible for and expressly disclaim all warranties of any kind with respect to third-party content, products, and services unless otherwise set forth in an applicable agreement between you and Oracle. Oracle Corporation and its affiliates will not be responsible for any loss, costs, or damages incurred due to your access to or use of third-party content, products, or services, except as set forth in an applicable agreement between you and Oracle.

Table of Contents

Chapter 1: Introduction.....	16
Overview.....	17
Scope and Audience.....	17
Documentation Admonishments.....	17
Manual Organization.....	18
My Oracle Support (MOS).....	18
Emergency Response.....	19
Related Publications.....	19
Customer Training.....	19
Locate Product Documentation on the Oracle Help Center Site.....	20
Maintenance and Administration Subsystem.....	20
EAGLE Database Partitions.....	21
Chapter 2: IP7 Secure Gateway Overview.....	24
Introduction.....	25
Hardware, Applications, and Functions.....	25
IP Connections.....	26
Point-to-Point Connectivity (IPLIM or IPLIMI Application).....	37
Point-to-Multipoint Connectivity (SS7IPGW and IPGWI).....	37
SNMP Agent Implementation.....	43
Mixed Networks Using the ANSI/ITUMTP Gateway Feature.....	46
IETF Adapter Layer Support.....	50
Overview.....	50
IP Signaling Gateway (IPSG).....	60
Chapter 3: IETF M2PA Configuration Procedures.....	62
Adding IETF IPLIMx Components.....	64
Adding an IPLIMx Card.....	65
Adding an IPLIMx Signaling Link.....	73
Configuring an IP Link.....	93
Adding an IP Host.....	112
Configuring an IP Card.....	116
Adding an IP Route.....	128

Adding an M2PA Association.....	135
Activating the Large MSU Support for IP Signaling Feature.....	149
Removing IETF M2PA Components.....	158
Removing an IPLIMx Card.....	158
Removing an IPLIMx Signaling Link.....	161
Removing an IP Host Assigned to an IPLIMx Card.....	171
Removing an IP Route.....	176
Removing an M2PA Association.....	180
Changing IETF M2PA Components.....	184
Changing the Attributes of an M2PA Association.....	184
Changing the Buffer Size of a M2PA Association.....	199
Changing the Host Values of a M2PA Association.....	210
Changing the Link Value of a M2PA Association to another Link Value on the Same IPLIMx Card.....	228
Configuring SCTP Retransmission Control for a M2PA Association.....	237
Changing a M2PA Timer Set.....	245
Changing the SCTP Checksum Algorithm Option for M2PA Associations.....	253
Turning Off the Large MSU Support for IP Signaling Feature	271

Chapter 4: IETF M3UA and SUA Configuration Procedures.....274

Adding IETF M3UA and SUA Components.....	276
Adding an IPGWx Card.....	277
Configuring an IPGWx Linkset.....	286
Adding a Mate IPGWx Linkset to another IPGWx Linkset.....	315
Adding an IPGWx Signaling Link.....	329
Configuring an IP Link.....	343
Adding an IP Host.....	362
Configuring an IP Card.....	366
Adding an IP Route.....	378
Adding an M3UA or SUA Association.....	385
Adding a New Association to a New Application Server.....	396
Adding an Existing Association to a New Application Server.....	405
Adding a New Association to an Existing Application Server.....	416
Adding an Existing Association to an Existing Application Server.....	428
Adding a Routing Key Containing an Application Server.....	440
Adding a Network Appearance.....	460
Activating the Large MSU Support for IP Signaling Feature.....	467
Removing IETF M3UA and SUA Components.....	476
Removing an IPGWx Card.....	476
Removing an IPGWx Signaling Link.....	479

Removing a Mate IPGWx Linkset from another IPGWx Linkset.....	488
Removing an IP Host Assigned to an IPGWx Card.....	500
Removing an IP Route.....	505
Removing a M3UA or SUA Association.....	509
Removing an Association from an Application Server.....	513
Removing a Routing Key Containing an Application Server.....	519
Removing a Network Appearance.....	528
Changing IETF M3UA and SUA Components.....	531
Changing IP Options.....	531
Changing the Attributes of a M3UA or SUA Association.....	535
Changing the Buffer Size of a M3UA or SUA Association.....	553
Changing the Host Values of a M3UA or SUA Association.....	564
Configuring SCTP Retransmission Control for a M3UA or SUA Association.....	580
Changing an Application Server.....	589
Changing the CIC Values in an Existing Routing Key Containing an Application Server....	595
Changing the Routing Context Value in an Existing Routing Key.....	605
Changing the SCTP Checksum Algorithm Option for M3UA and SUA Associations.....	612
Changing a UA Parameter Set.....	633
Turning Off the Large MSU Support for IP Signaling Feature.....	645

Chapter 5: End Office Support.....648

Overview.....	649
End Office Support Configuration.....	658
Adding an End Node Internal Point Code.....	659
Removing an End Node Internal Point Code.....	663

Chapter 6: IPSG M2PA and M3UA Configuration Procedures.....666

Adding IPSG Components.....	668
Adding an IPSG Card.....	669
Adding an IPSG M2PA Linkset.....	676
Adding an IPSG M3UA Linkset.....	696
Configuring an IP Link.....	716
Adding an IP Host.....	735
Configuring an IP Card.....	739
Adding an IP Route.....	751
Adding an IPSG M2PA Association.....	758
Adding an IPSG M3UA Association.....	771
Adding an IPSG M2PA Signaling Link.....	779
Adding an IPSG M3UA Signaling Link.....	800
Adding a Network Appearance.....	825

Activating the Large MSU Support for IP Signaling Feature.....	832
Removing IPSP Components.....	841
Removing an IPSP Card.....	841
Removing an IPSP Linkset.....	845
Removing an IP Host Assigned to an IPSP Card.....	858
Removing an IP Route.....	864
Removing an IPSP Association.....	868
Removing an IPSP M2PA Signaling Link.....	873
Removing an IPSP M3UA Signaling Link.....	882
Removing a Network Appearance.....	890
Changing IPSP Components.....	893
Changing an IPLIMx Card to an IPSP Card.....	893
Configuring IP Options.....	906
Configuring IPSP M3UA Linkset Options.....	910
Changing an IPSP M2PA Linkset.....	915
Changing an IPSP M3UA Linkset.....	933
Changing the Attributes of an IPSP Association.....	958
Changing the Buffer Size of an IPSP Association.....	977
Changing the Host Values of an IPSP Association.....	991
Configuring an IPSP Association for SCTP Retransmission Control.....	1010
Changing the SCTP Checksum Algorithm Option for IPSP M2PA Associations.....	1019
Changing the SCTP Checksum Algorithm Option for IPSP M3UA Associations.....	1036
Changing an M2PA Timer Set.....	1052
Changing a UA Parameter Set.....	1060
Turning Off the Large MSU Support for IP Signaling Feature	1072

Appendix A: Reference Information.....1075

Maximum Card Capacity for Different Card Types.....	1076
Requirements for EAGLEs Containing more than 1200 Signaling Links.....	1076
Determining the Number of High-Speed and Low-Speed Signaling Links.....	1076
Enabling the Large System # Links Controlled Feature.....	1078

Glossary.....1091

List of Figures

Figure 1: EAGLE Database Partitions (E5-Based Control Cards).....	22
Figure 2: SCTP Association Database Relationships.....	27
Figure 3: IP Connections using an E5-ENET Card running the IPGWx Applications.....	29
Figure 4: Typical SCTP Association Configuration.....	30
Figure 5: IP Connections using E5-ENET Cards running the IPLIMx Applications.....	31
Figure 6: Multi-Homed Associations on E5-ENET Cards running the IPLIMx Applications.....	33
Figure 7: Multi-Homed Associations on E5-ENET Cards running the IPGWx Applications.....	34
Figure 8: Multi-Homed Association Database Relationships.....	34
Figure 9: EAGLE Network (STP Connectivity via MTP-over-IP).....	37
Figure 10: IP Network (SCP Connectivity via TCAP-over-IP).....	38
Figure 11: IP Network (SEP connectivity via ISUP, Q.BICC, and TUP-over-IP).....	39
Figure 12: Complex Network with ANSI, ITU-I, and ITU-N Nodes.....	47
Figure 13: AS/Association Relationship.....	51
Figure 14: SG/MGC/MG Network Diagram.....	51
Figure 15: IPLIMx Protocol Stack with SCTP as the Transport Layer.....	52
Figure 16: IPGWx Protocol Stack with SCTP as the Transport Layer.....	52
Figure 17: M2PA in the IP7 Signaling Gateway.....	55
Figure 18: SCTP Connectivity.....	57
Figure 19: IP Signaling Gateway Database Relationships.....	61
Figure 20: Adding an IPLIMx Card.....	70
Figure 21: Adding an IPLIMx Signaling Link.....	88
Figure 22: Configuring an IP Link.....	103

Figure 23: Adding an IP Host.....	115
Figure 24: Configuring an IP Card.....	124
Figure 25: Adding an IP Route.....	133
Figure 26: Adding an M2PA Association.....	146
Figure 27: Activating the Large MSU Support for IP Signaling Feature.....	154
Figure 28: Removing an IPLIMx Card.....	160
Figure 29: Removing an IPLIMx Signaling Link.....	169
Figure 30: Removing an IP Host Assigned to an IPLIMx Card.....	175
Figure 31: Removing an IP Route.....	179
Figure 32: Removing an M2PA Association.....	183
Figure 33: Changing the Attributes of an M2PA Association.....	195
Figure 34: Changing the Buffer Size of a M2PA Association.....	206
Figure 35: Changing the Host Values of a M2PA Association.....	221
Figure 36: Changing the Link Value of a M2PA Association to another Link Value on the Same IPLIMx Card.....	233
Figure 37: Configuring the SCTP Retransmission Control for a M2PA Association.....	244
Figure 38: Changing an M2PA Timer Set.....	252
Figure 39: Changing the SCTP Checksum Algorithm Option for M2PA Associations.....	268
Figure 40: Turning Off the Large MSU Support for IP Signaling Feature.....	273
Figure 41: Adding an IPGWx Card.....	283
Figure 42: Configuring an IPGWx Linkset.....	308
Figure 43: Adding a Mate IPGWx Linkset to another IPGWx Linkset.....	323
Figure 44: Adding an IPGWx Signaling Link.....	337
Figure 45: Configuring an IP Link.....	353
Figure 46: Adding an IP Host.....	365

Figure 47: Configuring an IP Card.....	374
Figure 48: Adding an IP Route.....	383
Figure 49: Adding an IPGWx M3UA or SUA Association.....	392
Figure 50: Adding a New Association to a New Application Server.....	402
Figure 51: Adding an Existing Association to a New Application Server.....	412
Figure 52: Adding a New Association to an Existing Application Server.....	423
Figure 53: Adding an Existing Application to an Existing Application Server.....	435
Figure 54: Adding a Routing Key Containing an Application Server.....	455
Figure 55: Adding a Network Appearance.....	464
Figure 56: Activating the Large MSU Support for IP Signaling Feature.....	472
Figure 57: Removing an IPGWx Card.....	478
Figure 58: Removing an IPGWx Signaling Link.....	486
Figure 59: Removing a Mate IPGWx Linkset from another IPGWx Linkset.....	496
Figure 60: Removing an IP Host Assigned to an IPGWx Card.....	504
Figure 61: Removing an IP Route.....	508
Figure 62: Removing a M3UA or SUA Association.....	512
Figure 63: Removing an Association from an Application Server.....	517
Figure 64: Removing a Routing Key Containing an Application Server.....	526
Figure 65: Removing a Network Appearance.....	530
Figure 66: Changing IP Options.....	534
Figure 67: Changing the Attributes of a M3UA or SUA Association.....	545
Figure 68: Changing the Buffer Size of an M3UA or SUA Association.....	560
Figure 69: Changing the Host Values of a M3UA or SUA Association.....	574
Figure 70: Configuring SCTP Retransmission Control for a M3UA or SUA Association.....	587
Figure 71: Changing an Application Server.....	593

Figure 72: Changing the CIC Values in an Existing Routing Key Containing an Application Server.....	603
Figure 73: Changing the Routing Context Value in an Existing Routing Key.....	610
Figure 74: Changing the SCTP Checksum Algorithm Option for M3UA and SUA Associations.....	629
Figure 75: Changing a UA Parameter Set.....	644
Figure 76: Turning the Large MSU Support for IP Signaling Feature Off.....	647
Figure 77: An EAGLE with End Office Support and VXi Node.....	652
Figure 78: Network Before an EAGLE with End Office, Node P is to Migrate.....	653
Figure 79: Network After an EAGLE with End Office, Node P has Migrated.....	653
Figure 80: Original Network with Deployed EAGLE.....	654
Figure 81: New Network with an EAGLE Using End Office and End Node R.....	654
Figure 82: Network before Two Signaling End Points Migrate from PSTN to IP.....	655
Figure 83: Network after Two Signaling End Points Migrate from PSTN to IP.....	655
Figure 84: The EAGLE Simultaneously Acts as STP and End Office.....	656
Figure 85: Three Multiple-Element End Office Nodes.....	657
Figure 86: Mated Pair Supports Two End Office Nodes.....	658
Figure 87: Adding an End Node Internal Point Code.....	662
Figure 88: Removing an End Node Internal Point Code.....	665
Figure 89: Adding an IPSP Card.....	675
Figure 90: Adding an IPSP M2PA Linkset.....	691
Figure 91: Adding an IPSP M3UA Linkset.....	711
Figure 92: Configuring an IP Link.....	726
Figure 93: Adding an IP Host.....	738
Figure 94: Configuring an IP Card.....	747
Figure 95: Adding an IP Route.....	756

Figure 96: Adding an IPSP M2PA Association.....	767
Figure 97: Adding an IPSP M3UA Association.....	777
Figure 98: Adding an IPSP M2PA Signaling Link.....	794
Figure 99: Adding an IPSP M3UA Signaling Link.....	818
Figure 100: Adding a Network Appearance.....	829
Figure 101: Activating the Large MSU Support for IP Signaling Feature.....	837
Figure 102: Removing an IPSP Card.....	844
Figure 103: Removing an IPSP Linkset.....	851
Figure 104: Removing an IP Host Assigned to an IPSP Card.....	862
Figure 105: Removing an IP Route.....	867
Figure 106: Removing an IPSP Association.....	871
Figure 107: Removing an IPSP M2PA Signaling Link.....	880
Figure 108: Removing an IPSP M3UA Signaling Link.....	887
Figure 109: Removing a Network Appearance.....	892
Figure 110: Changing IPLIMx Card to IPSP Card.....	902
Figure 111: Configuring IP Options.....	909
Figure 112: Configuring IPSP M3UA Linkset Options.....	914
Figure 113: Changing an IPSP M2PA Linkset.....	928
Figure 114: Changing an IPSP M3UA Linkset.....	950
Figure 115: Changing the Attributes of an IPSP Association.....	972
Figure 116: Changing the Buffer Size of an IPSP Association.....	987
Figure 117: Changing the Host Values of an IPSP Association.....	1004
Figure 118: Configuring an IPSP Association for SCTP Retransmission Control.....	1017
Figure 119: Changing the SCTP Checksum Algorithm Option for IPSP M2PA Associations.....	1033
Figure 120: Changing the SCTP Checksum Algorithm Option for IPSP M3UA Associations.....	1048

Figure 121: Changing an M2PA Timer Set.....	1059
Figure 122: Changing a UA Parameter Set.....	1071
Figure 123: Turning Off the Large MSU Support for IP Signaling Feature	1074
Figure 124: Enabling the Large System # Links Controlled Feature.....	1084

List of Tables

Table 1: Admonishments.....	17
Table 2: Ethernet Interface and Signaling Link Combinations.....	28
Table 3: Uni-Homed and Multi-Homed Node Combinations.....	32
Table 4: SS7 Full Routing Keys per IPGWx Functionality.....	40
Table 5: Example SS7 Routing Key Table.....	41
Table 6: Routing Key Lookup Hierarchy.....	42
Table 7: SNMP Object Groups.....	44
Table 8: Deviations from SNMP Protocols.....	45
Table 9: Nodes and Point Codes in Complex Network Example.....	47
Table 10: Sample SCTP Endpoints.....	58
Table 11: Sample SCTP Associations.....	59
Table 12: Sample SCTP Associations.....	59
Table 13: IPLIMx Card Types.....	65
Table 14: M2PA IPLIMx Signaling Link Parameter Combinations.....	84
Table 15: Valid Subnet Mask Parameter Values.....	94
Table 16: Sample IP Routing Table.....	128
Table 17: Valid Subnet Mask Parameter Values.....	129
Table 18: M2PA Association Fields and Default Values.....	135
Table 19: Change M2PA Association Parameters.....	184
Table 20: M2PA Timers.....	245
Table 21: IPGWx Card Types.....	278
Table 22: Signaling Link Fair Share Example.....	288

Table 23: IPGWx Signaling Link Parameter Combinations.....	334
Table 24: Valid Subnet Mask Parameter Values.....	344
Table 25: Sample IP Routing Table.....	378
Table 26: Valid Subnet Mask Parameter Values.....	379
Table 27: M3UA and SUA Association Fields and Default Values.....	385
Table 28: Examples of IPGWx Card Provisioning Limits.....	396
Table 29: Examples of IPGWx Card Provisioning Limits.....	405
Table 30: Examples of IPGWx Card Provisioning Limits.....	416
Table 31: Examples of IPGWx Card Provisioning Limits.....	428
Table 32: Service Indicator Text String Values.....	440
Table 33: Routing Key Parameter Combinations for Adding a Routing Key Containing an Application Server.....	442
Table 34: Service Indicator Text String Values.....	519
Table 35: Routing Key Parameter Combinations for Removing Routing Keys.....	520
Table 36: Change M3UA and SUA Association Parameters.....	535
Table 37: Examples of IPGWx Card Provisioning Limits.....	565
Table 38: Service Indicator Text String Values.....	595
Table 39: Routing Key Parameter Combinations for Changing the Range of CIC Values in an Existing Routing Key	596
Table 40: Routing Key Parameter Combinations for Splitting the Range of CIC Values in an Existing Routing Key.....	598
Table 41: Service Indicator Text String Values.....	605
Table 42: Valid PVALUE Parameter Values if PARM=1.....	634
Table 43: Valid PVALUE Parameter Values if PARM=2.....	635
Table 44: Valid PVALUE Parameter Values if PARM=3.....	636
Table 45: Valid PVALUE Parameter Values if PARM=4.....	637

Table 46: Sample IPC Values.....	650
Table 47: Signaling Link Fair Share Example.....	677
Table 48: Signaling Link Fair Share Example.....	697
Table 49: Valid Subnet Mask Parameter Values.....	717
Table 50: Sample IP Routing Table.....	751
Table 51: Valid Subnet Mask Parameter Values.....	752
Table 52: IPSP M2PA Association Fields and Default Values.....	758
Table 53: IPSP M3UA Association Fields and Default Values.....	771
Table 54: IPSP M2PA Signaling Link Parameter Combinations.....	791
Table 55: IPSP M3UA Signaling Link Parameter Combinations.....	816
Table 56: Signaling Link Fair Share Example.....	915
Table 57: Signaling Link Fair Share Example.....	934
Table 58: Change IPSP Association Parameters.....	958
Table 59: M2PA Timers.....	1052
Table 60: Valid PVALUE Parameter Values if PARM=1.....	1061
Table 61: Valid PVALUE Parameter Values if PARM=2.....	1062
Table 62: Valid PVALUE Parameter Values if PARM=3.....	1063
Table 63: Valid PVALUE Parameter Values if PARM=4.....	1064
Table 64: MaxTPS Per Card.....	1076

Chapter 1

Introduction

Topics:

- *Overview.....17*
- *Scope and Audience.....17*
- *Documentation Admonishments.....17*
- *Manual Organization.....18*
- *My Oracle Support (MOS).....18*
- *Emergency Response.....19*
- *Related Publications.....19*
- *Customer Training.....19*
- *Locate Product Documentation on the Oracle Help Center Site.....20*
- *Maintenance and Administration Subsystem.....20*
- *EAGLE Database Partitions.....21*

Chapter 1, Introduction, contains general information about the database and the organization of this manual.

Overview

The *Database Administration – IP7 User's Guide* describes the procedures used to configure the EAGLE and its database to implement the IP7 Secure Gateway functionality.

Throughout this manual, these terms are used to refer to either the original card or the EPM-B version or other replacement version of the card unless one of the card types is specifically required.

- E5-ENET - the original E5-ENET or the E5-ENET-B card
- E5-E1T1 - the original E5-E1T1 or the E5-E1T1-B card
- E5-ATM - the original E5-ATM or the E5-ATM-B card
- E5-IPSM - the original E5-IPSM or the E5-ENET-B card that is running the IPSHC GPL
- E5-SM4G - the original E5-SM4G or the E5-SM8G-B card (not an EPM-B card)
- MCPM - the original MCPM or the E5-MCPM-B card



Scope and Audience

This guide is intended for database administration personnel or translations personnel responsible for configuring the EAGLE and its database to implement the IP7 Secure Gateway functionality.

Documentation Admonishments

Admonishments are icons and text throughout this manual that alert the reader to assure personal safety, to minimize possible service interruptions, and to warn of the potential for equipment damage.

Table 1: Admonishments

Icon	Description
 DANGER	Danger: (This icon and text indicate the possibility of <i>personal injury</i> .)
 WARNING	Warning: (This icon and text indicate the possibility of <i>equipment damage</i> .)
 CAUTION	Caution: (This icon and text indicate the possibility of <i>service interruption</i> .)

Icon	Description
	<p>Topple: (This icon and text indicate the possibility of <i>personal injury and equipment damage.</i>)</p>

Manual Organization

Throughout this document, the terms database and system software are used. Database refers to all data that can be administered by the user, including shelves, cards, links, routes, global title translation tables, and gateway screening tables. System software refers to data that cannot be administered by the user, including generic program loads (GPLs).

This document is organized into these sections.

Introduction contains general information about the database and the organization of this manual.

IP7 Secure Gateway Overview describes the basics of the IP7 Secure Gateway functionality.

IETF M2PA Configuration Procedures describes the procedures necessary to configure the EAGLE to provide connectivity between SS7 and IP networks, enabling messages to pass between the SS7 network domain and the IP network domain, using M2PA associations and IPLIMx signaling links.

IETF M3UA and SUA Configuration Procedures describes the procedures necessary to configure the EAGLE to provide connectivity between SS7 and IP networks, enabling messages to pass between the SS7 network domain and the IP network domain, using either M3UA or SUA associations and IPGWx signaling links.

End Office Support describes the procedures necessary to allow the EAGLE to share its true point code (TPC) with an IP-based node without the need for a separate point code for the IP node.

IPSG M2PA and M3UA Configuration Procedures describes the procedures necessary to provision the IP7 Secure Gateway feature.

Reference Information contains the following information that is used by more than one procedure in this manual:

- *Requirements for EAGLEs Containing more than 1200 Signaling Links*
- *Determining the Number of High-Speed and Low-Speed Signaling Links*
- *Enabling the Large System # Links Controlled Feature.*

My Oracle Support (MOS)

MOS (<https://support.oracle.com>) is your initial point of contact for all product support and training needs. A representative at Customer Access Support (CAS) can assist you with MOS registration.

Call the CAS main number at 1-800-223-1711 (toll-free in the US), or call the Oracle Support hotline for your local country from the list at <http://www.oracle.com/us/support/contact/index.html>. When calling, make the selections in the sequence shown below on the Support telephone menu:

1. Select **2** for New Service Request
2. Select **3** for Hardware, Networking and Solaris Operating System Support
3. Select one of the following options:
 - For Technical issues such as creating a new Service Request (SR), Select **1**
 - For Non-technical issues such as registration or assistance with MOS, Select **2**

You will be connected to a live agent who can assist you with MOS registration and opening a support ticket.

MOS is available 24 hours a day, 7 days a week, 365 days a year.

Emergency Response

In the event of a critical service situation, emergency response is offered by the Customer Access Support (CAS) main number at 1-800-223-1711 (toll-free in the US), or by calling the Oracle Support hotline for your local country from the list at <http://www.oracle.com/us/support/contact/index.html>. The emergency response provides immediate coverage, automatic escalation, and other features to ensure that the critical situation is resolved as rapidly as possible.

A critical situation is defined as a problem with the installed equipment that severely affects service, traffic, or maintenance capabilities, and requires immediate corrective action. Critical situations affect service and/or system operation resulting in one or several of these situations:

- A total system failure that results in loss of all transaction processing capability
- Significant reduction in system capacity or traffic handling capability
- Loss of the system's ability to perform automatic system reconfiguration
- Inability to restart a processor or the system
- Corruption of system databases that requires service affecting corrective actions
- Loss of access for maintenance or recovery operations
- Loss of the system ability to provide any required critical or major trouble notification

Any other problem severely affecting service, capacity/traffic, billing, and maintenance capabilities may be defined as critical by prior discussion and agreement with Oracle.

Related Publications

For information about additional publications that are related to this document, refer to the *Related Publications Reference* document, which is published as a separate document on the Oracle Help Center site. See [Locate Product Documentation on the Oracle Help Center Site](#) for more information.

Customer Training

Oracle University offers training for service providers and enterprises. Visit our web site to view, and register for, Oracle Communications training:

<http://education.oracle.com/communication>

To obtain contact phone numbers for countries or regions, visit the Oracle University Education web site:

www.oracle.com/education/contacts

Locate Product Documentation on the Oracle Help Center Site

Oracle Communications customer documentation is available on the web at the Oracle Help Center (OHC) site, <http://docs.oracle.com>. You do not have to register to access these documents. Viewing these files requires Adobe Acrobat Reader, which can be downloaded at <http://www.adobe.com>.

1. Access the Oracle Help Center site at <http://docs.oracle.com>.
2. Click **Industries**.
3. Under the Oracle Communications subheading, click the **Oracle Communications documentation** link.
The Communications Documentation page appears. Most products covered by these documentation sets will appear under the headings “Network Session Delivery and Control Infrastructure” or “Platforms.”
4. Click on your Product and then the Release Number.
A list of the entire documentation set for the selected product and release appears.
5. To download a file to your location, right-click the **PDF** link, select **Save target as** (or similar command based on your browser), and save to a local folder.

Maintenance and Administration Subsystem

The Maintenance and Administration Subsystem (MAS) is the central management point for the EAGLE. The MAS provides user interface, maintenance communication, peripheral services, alarm processing, system disk interface, and measurements. Management and redundancy are provided by use of two separate subsystem processors.

The MAS resides on two separate sets of Maintenance and Administration Subsystem Processor (MASP) cards and a Maintenance Disk and Alarm card (collectively referred to as control cards). The control cards are located in slots 1113 through 1118 of the EAGLE control shelf. The control cards must be E5-based cards.

E5-based Control Cards

The E5-based set of EAGLE control cards consists of the following cards:

- Two Maintenance and Administration Subsystem Processor cards (E5-MASP) cards. Each dual-slot E5-MASP card is made up of the following two modules:
 - Maintenance Communication Application Processor (E5-MCAP) card
 - Terminal Disk Module (E5-TDM) card
- One Maintenance Disk and Alarm card (E5-MDAL card)

Maintenance Communication Application Processor (E5-MCAP) Card

The E5-MCAP card contains the Communications Processor and Applications Processor and provides connections to the IMT bus. The card controls the maintenance and database administration activity and performs both application and communication processing. E5-MCAP cards are located in slots 1113 and 1115 of the control shelf.

Each E5-MCAP card contains two USB ports. One latched USB port is used with removable flash media (“thumb drives”), and one flush-mounted USB port is used with a plug-in flash drive. The removable media drive in the latched USB port is used to install and back up customer data. The flush-mounted USB port is used for upgrade and could be used for disaster recovery.

Terminal Disk Module (E5-TDM) Card

The E5-TDM card provides the Terminal Processor for the 16 I/O ports, and interfaces to the Maintenance Disk and Alarm (E5-MDAL) card and fixed disk storage. The E5-TDM card also distributes Composite Clocks and High Speed Master clocks throughout the EAGLE, and distributes Shelf ID to the EAGLE. Each E5-TDM card contains one fixed SATA drive that is used to store primary and backup system databases, measurements, and Generic Program Loads (GPLs). E5-TDM cards are located in slots 1114 and 1116 of the control shelf.

Maintenance Disk and Alarm (E5-MDAL) Card

The E5-MDAL card processes alarm requests and provides fan control. There is only one E5-MDAL card in a control card set. Critical, major, and minor system alarms are provided for up to 6 individual frames. In addition to the 3 system alarms, the E5-MDAL card provides the system audible alarm. The E5-MDAL card provides control of fans on a per-frame basis, and allows for each fan relay to be set individually. The E5-MDAL card is located in slots 1117 and 1118 of the control shelf.

EAGLE Database Partitions

The data that the EAGLE uses to perform its functions are stored in two separate areas: the fixed disk drives, and the removable media. The following sections describe these areas and data that is stored on them. These areas and their partitions are shown in [Figure 1: EAGLE Database Partitions \(E5-Based Control Cards\)](#).

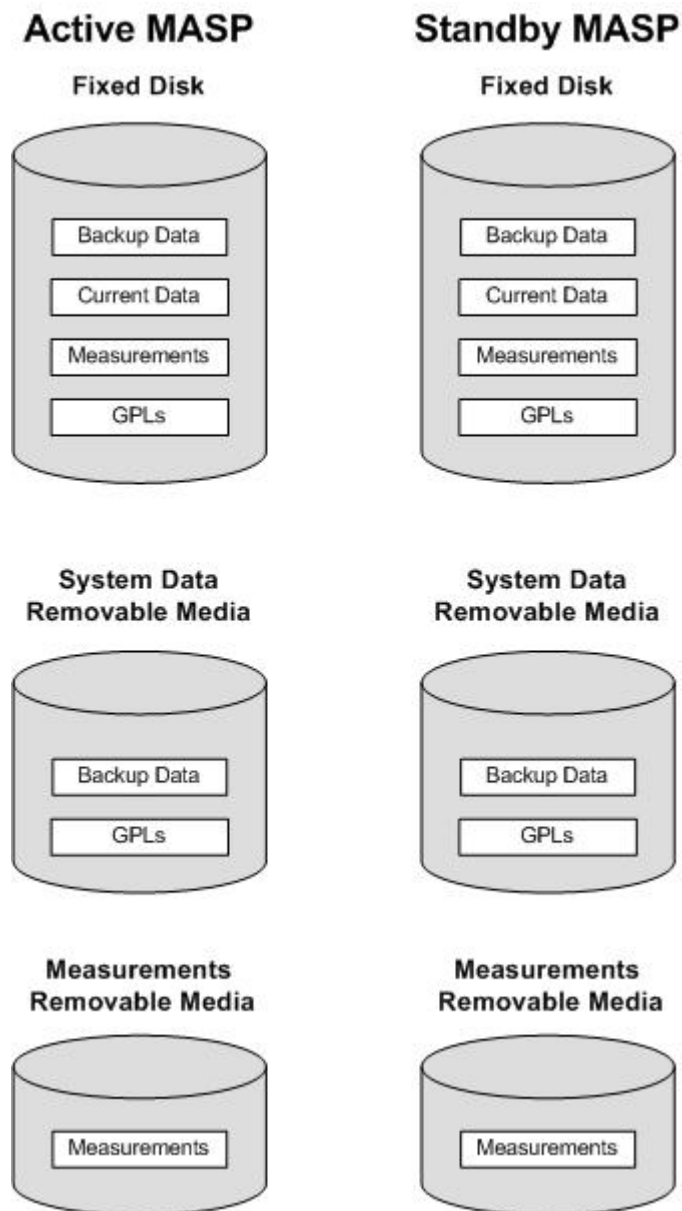

Figure 1: EAGLE Database Partitions (E5-Based Control Cards)

Fixed Disk Drive

There are two fixed disk drives on the EAGLE. The fixed disk drives contain the “master” set of data and programs for the EAGLE. The two fixed disk drives are located on the terminal disk modules (E5-TDMs). Both disks have the same files. The data stored on the fixed disks is partially replicated on the various cards in the EAGLE. Changes made during database administration sessions are sent to the appropriate cards.

The data on the fixed disks can be viewed as four partitions.

- Current partition

- Backup partition
- Measurements partition
- Generic program loads (GPLs) partition

The data which can be administered by users is stored in two partitions on the fixed disk, a current database partition which has the tables which are changed by on-line administration, and a backup database partition which is a user-controlled copy of the current partition.

All of the on-line data administration commands affect the data in the current partition. The purpose of the backup partition is to provide the users with a means of rapidly restoring the database to a known good state if there has been a problem while changing the current partition.

A full set of GPLs is stored on the fixed disk, in the GPL partition. There is an approved GPL and a trial GPL for each type of GPL in this set and a utility GPL, which has only an approved version. Copies of these GPLs are downloaded to the EAGLE cards. The GPL provides each card with its functionality. For example, the `ss7ansi` GPL provides MTP functionality for link interface modules (LIMs).

Measurement tables are organized as a single partition on the fixed disk. These tables are used as holding areas for the measurement counts.

Removable Media

The removable media is used with the E5-MCAP card portion of the E5-MASP in card locations 1113 and 1115.

The removable media is used for two purposes.

- To hold an off-line backup copy of the administered data and system GPLs
- To hold a copy of the measurement tables

Because of the size of the data stored on the fixed disk drives on the E5-TDMs, a single removable media cannot store all of the data in the database, GPL and measurements partitions.

To use a removable media to hold the system data, it must be formatted for system data. To use a removable media to hold measurements data, it must be formatted for measurements data. The EAGLE provides the user the ability to format a removable media for either of these purposes. A removable media can be formatted on the EAGLE by using the `format-disk` command. More information on the `format-disk` command can be found in *Commands User's Guide*. More information on the removable media drives can be found in *Hardware Guide*.

Additional and preformatted removable media are available from the [My Oracle Support \(MOS\)](#).

Chapter 2

IP7 Secure Gateway Overview

Topics:

- *Introduction.....25*
- *Hardware, Applications, and Functions.....25*
- *IP Connections.....26*
- *Point-to-Point Connectivity (IPLIM or IPLIMI Application).....37*
- *Point-to-Multipoint Connectivity (SS7IPGW and IPGWI).....37*
- *SNMP Agent Implementation.....43*
- *Mixed Networks Using the ANSI/ITUMTP Gateway Feature.....46*
- *IETF Adapter Layer Support.....50*
- *IP Signaling Gateway (IPSG).....60*

Chapter 2, IP7 Secure Gateway Overview, describes the basics of the IP7 Secure Gateway functionality.

Introduction

The IP⁷ Secure Gateway functionality in the EAGLE provides connectivity between SS7 and IP networks, enabling messages to pass between the SS7 network domain and the IP network domain, as follows:

- When an EAGLE receives an SS7 formatted message over an SS7 link, the IP⁷ Secure Gateway functionality dynamically converts this message into IP format and routes the re-formatted message over an associated IP link to a destination residing within an IP network.

The IP⁷ Secure Gateway functionality use associations to access the IP domain. Associations identify IP sessions.

- Conversely, when the EAGLE receives an IP formatted message over an IP link, the IP⁷ Secure Gateway functionality dynamically converts this message into SS7 format and routes the re-formatted message over an associated SS7 link to a destination residing within the SS7 signaling network.

Address resolution is not performed in the IP to SS7 direction. It is the responsibility of the sending application to ensure that the appropriate SS7 point code information resides in the IP message to allow a valid SS7 message to be constructed for routing to the SS7 network.

Hardware, Applications, and Functions

The IP7 Secure Gateway functionality is provided by applications that run on IP cards or E5-ENET cards. IP cards provide interfaces between the IMT bus and two 10/100 Base-T IEEE 802.3/DIX Ethernet interfaces. The IP cards, similar to any other Link Interface Module (LIM), use the Interprocessor Message Transport (IMT) bus to communicate with the other cards in the EAGLE. Like other LIMs, the primary job of an IP card is to send and receive SS7 data on a network (in this case, an IP network), and to route that data to other cards in the EAGLE as appropriate.

The IP card can run on the following applications:

- `iplim` or `iplimi` - Both applications support STP connectivity via MTP-over-IP functionality point-to-point connectivity (for more information, see [Point-to-Point Connectivity \(IPLIM or IPLIMI Application\)](#)).

The `iplim` and `iplimi` applications support these types of connections:

- M2PA/SCTP/IP (A, B, C, D, and E links)
- SCP
- SEP
- SCP/SEP

This type of connection is essentially the same as that of a traditional SS7 point-to-point link, except that the traditional MTP2 and 56Kb/s technology is replaced by IP and Ethernet technology.

The `iplim` application supports point-to-point connectivity for ANSI networks. The `iplimi` application supports point-to-point connectivity for ITU networks. With the optional ANSI/ITU MTP Gateway feature and proper configuration, the EAGLE could convert between any of the ANSI, ITU-N, and ITU-I networks, switch traffic between these networks, and perform network

management for each of these networks (for more information, see [Mixed Networks Using the ANSI/ITUMTP Gateway Feature](#)).

The EAGLE can support up to 100 cards running the `iplim` and `iplimi` applications.

- `ss7ipgw` and `ipgwi` - These applications support the following types of point-to-multipoint connectivity for networks:
 - SCP connectivity via SCCP/TCAP-over-IP functionality (for more information, see [Connecting to SCPs with SCCP/TCAP Messages Sent Over the IP Network](#))
 - SEP connectivity via ISUP, Q.BICC, and TUP-over-IP functionality (for more information, see [Connecting SEPs Using ISUP, Q.BICC, and TUP Messages Over the IP Network](#))
 - SCP/SEP connectivity via non-ISUP, non-SCCP, non-Q.BICC, and non-TUP-over-IP functionality (for more information, see [Connecting SCPs and SEPs Using Non-ISUP, Non-SCCP, Non-Q.BICC, and Non-TUP Messages Over the IP Network](#))

The `ss7ipgw` application supports point-to-multipoint connectivity for ANSI networks. The `ipgwi` application supports point-to-multipoint connectivity for ITU networks.

The EAGLE can support a maximum of 125 cards running the `ss7ipgw` and `ipgwi` applications.

In addition to running an `iplim`, `iplimi`, `ss7ipgw`, or `ipgwi` application, each IP card supports the following functions:

- A Simple Network Management Protocol (SNMP) agent. For more information, see [SNMP Agent Implementation](#).
- Message Transfer Part (MTP) status. This function is available only on IP cards that support the `ss7ipgw` or `ipgwi` application. For more information, see [Support for MTP Status Functions](#).

IP Connections

IP connections involve the following assignments:

- Transport protocol – The SCTP transport protocol is specified by the `ent-assoc` and `chg-assoc` commands.
- Adapter protocol – The M3UA, M2PA, or SUA adapter protocol is specified by the `adapter` parameter of the `ent-assoc` and `chg-assoc` commands.
- One or two near-end (local) hosts – The local host is specified by the `lhost` parameter of the `ent-assoc` and `chg-assoc` commands. A second local host can be specified for an association using the `alhost` parameter of the `ent-assoc` and `chg-assoc` commands, allowing the near-end host of the association to be multi-homed. Specifying only one local host for an association allows the association to be uni-homed.
- Far-end (remote) host – The remote host is specified by the `rhost` parameter of the `ent-assoc` and `chg-assoc` commands.
- Near-end (local) transport protocol port – The local transport protocol port is specified by the `lport` parameter of the `ent-assoc` and `chg-assoc` commands.
- Far-end (remote) transport protocol port – The remote transport protocol port is specified by the `rport` parameter of the `ent-assoc` and `chg-assoc` commands.
- SS7 signaling link – specified by the `loc` and `link` parameters of the `ent-slk` command.

The local host is mapped to a particular Ethernet interface on the IP card by linking the local host name of the IP connection to an IP address with the `ent-ip-host` command. The IP address is also assigned to an IP card and to an Ethernet interface on that IP card using the `chg-ip-lnk` command. A signaling link on that card is assigned to the IP connection using the `link` parameter of the `ent-assoc` and `chg-assoc` commands and referencing the signaling link on the IP card.

An SCTP association can establish a connection between one local host and one remote host (a uni-homed association) or between multiple local hosts and a remote host (a multi-homed association). It is possible that the remote host may be multi-homed, but the EAGLE allows only one remote host to be specified for a multi-homed association. If an IP node has multiple IP address associated with it, then an SCTP association originating from this node may take advantage of this added connectivity by establishing an SCTP multi-homed association.

For more information on multi-homed associations, see the [Multi-Homed SCTP Associations](#) section and the [Routing](#) section.

Figure 2: *SCTP Association Database Relationships* shows the components of an SCTP association and how these components interact with each other.

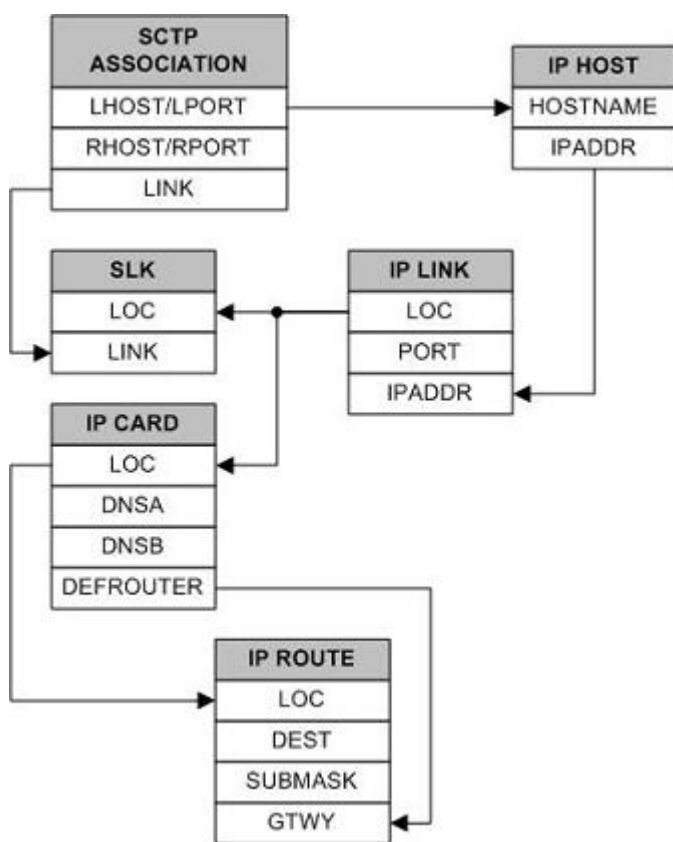

Figure 2: SCTP Association Database Relationships

There is no direct correlation between signaling link ports and Ethernet interfaces. A card can be using Ethernet interface A and signaling link B to transmit data to the remote host. Another scenario could have the card using Ethernet interface B and signaling link A to transmit data to the remote host.

The numbers of signaling link ports and Ethernet interfaces on IP cards varies depending on the card type and application running on the card, as shown in [Table 2: Ethernet Interface and Signaling Link](#)

Combinations. The sections that follow *Table 2: Ethernet Interface and Signaling Link Combinations* describe the IP connections supported by each IP card type. The IP connections described in these sections are uni-homed SCTP associations.

Table 2: Ethernet Interface and Signaling Link Combinations

Card	Application	Ethernet Interface	Signaling Link
E5-ENET	IPLIMx	A and B	A - A7, B - B7
	IPGWx	A and B	A

IP Connection on an E5-ENETCard Running the IPGWx Application

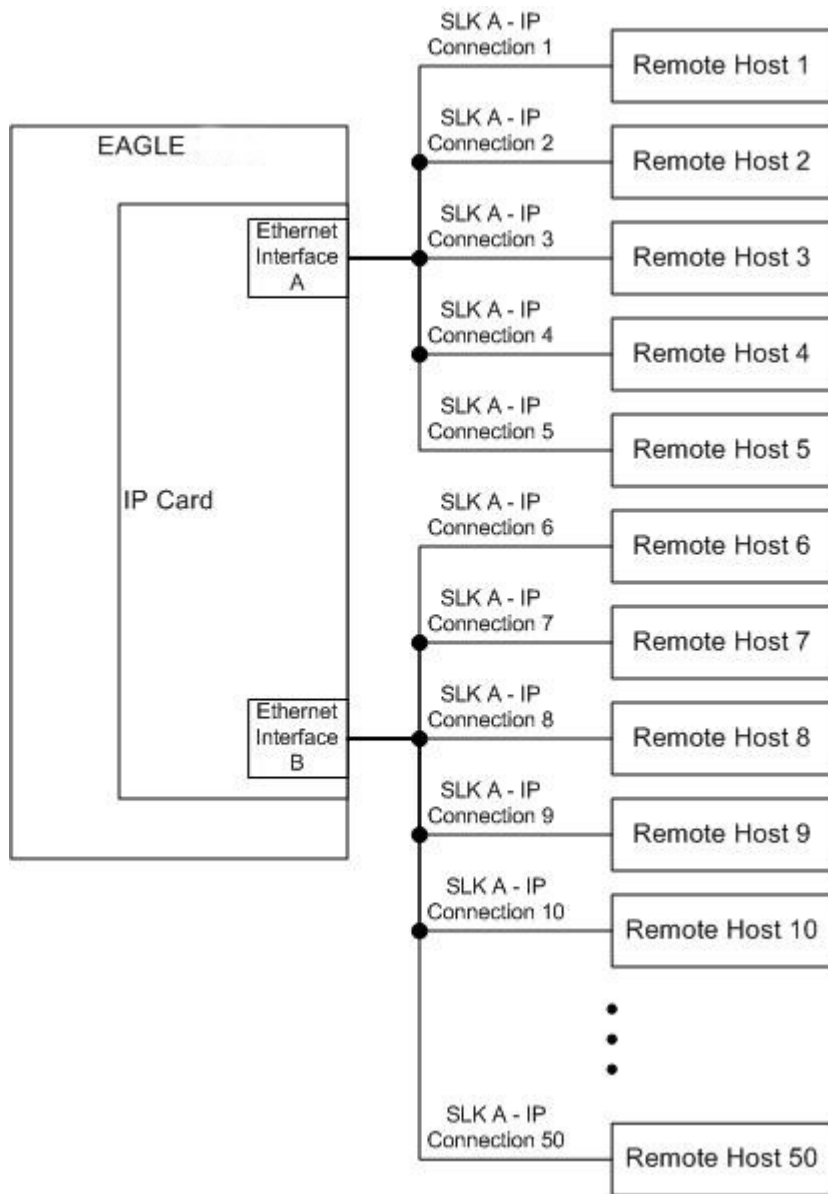

Figure 3: IP Connections using an E5-ENET Card running the IPGWx Applications

The assignment of the transport protocol port number is made through the local host port (`lport`) and remote host port (`rport`) parameters of the `ent-assoc` or `chg-assoc` commands (for an SCTP association).

Figure 4: Typical SCTP Association Configuration shows typical IP connection data for a uni-homed SCTP association and how these components interact with each other.

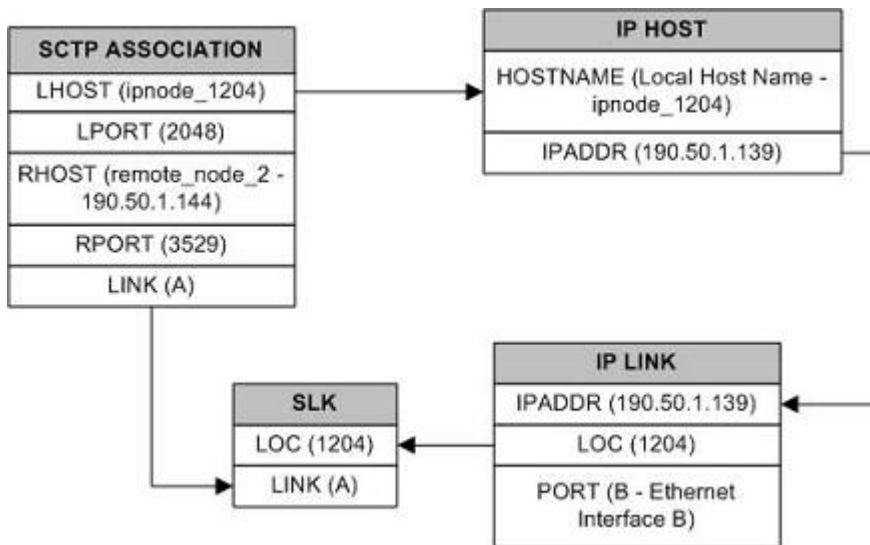

Figure 4: Typical Sctp Association Configuration

The IP connection defined by the Sctp association is from local host ipnode-1204 (190.50.1.139), Sctp port 2048, to remote host remote-node-2 (190.50.1.144), Sctp port 3529, using Ethernet interface B on IP card 1204, and signaling link A on IP card 1204.

IP Connection on an E5-ENETCard Running the IPLIMx Application

E5-ENET cards running the IPLIMx applications can have 16 signaling links (A, B, A1, B1, A2, B2, A3, B3, A4, B4, A5, B5, A6, B6, A7 or B7) and 2 Ethernet interfaces (A or B) resulting in a maximum of 16 IP connections, one for each signaling link. Each link can use either Ethernet interface A or B. The local host and alternate host assigned to a signaling link must use different Ethernet interfaces; they cannot be assigned to the same Ethernet interface. *Figure 5: IP Connections using E5-ENET Cards running the IPLIMx Applications* shows some ways the 16 signaling links and the 2 Ethernet interfaces can be used to establish IP connections.

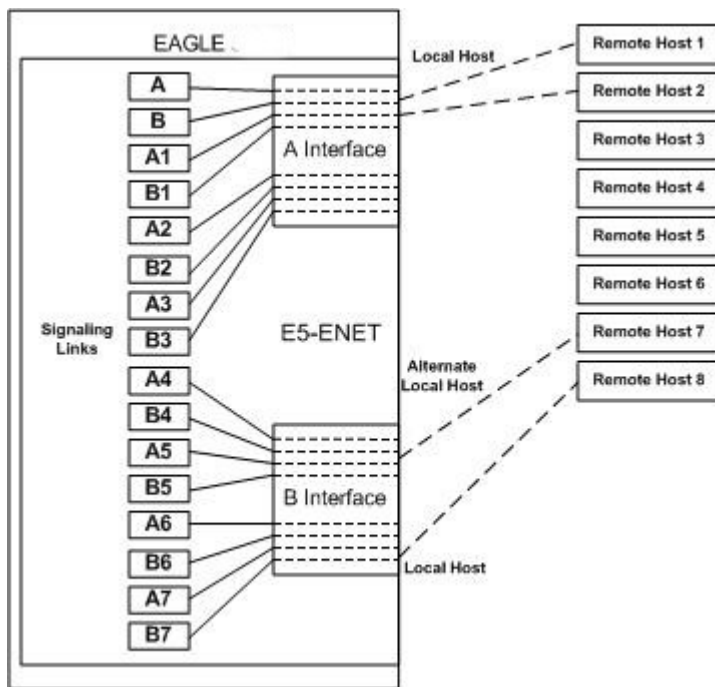

Figure 5: IP Connections using E5-ENET Cards running the IPLIMx Applications

Multi-Homed SCTP Associations

If the IP cards are EDCMs or E5-ENET cards, SCTP associations can have two local hosts, and are referred to as multi-homed associations. A multi-homed association uses both Ethernet interfaces on the IP card. Each Ethernet interface is assigned to a local host. Each local host is assigned to a different local network. One of the local hosts is configured with the `lhost` parameter of the `ent-assoc` or `chg-assoc` commands. The second local host, or alternate local host, is configured with the `alhost` parameter of the `ent-assoc` or `chg-assoc` commands. One of the local hosts references one of the Ethernet interfaces on the IP card and the other local host references the other Ethernet interface on the IP card. The multi-homed SCTP association allows the E5-ENET card to communicate with another node over two networks. Traffic is passed to and from the remote node on either local interface on the card.

An SCTP association can be uni-homed also. A uni-homed association uses only one Ethernet interface (A or B), which is assigned to only one local host. This local host is configured with the `lhost` parameter of the `ent-assoc` or `chg-assoc` commands. For a uni-homed association, the `alhost` parameter is not be specified with the `ent-assoc` or `chg-assoc` commands. A uni-homed association allows the IP card to communicate to another node on one network only. Traffic is passed to and from the remote node on the local interface on the card defined by the `lhost` parameter.

The remote node can be either uni-homed or multi-homed, and is not dependent on whether or not the local node (containing the local hosts) is uni-homed or multi-homed. For example, Node A can be uni-homed and can be connected to a multi-homed Node B, or a multi-homed Node A can be connected to a uni-homed Node B. [Table 3: Uni-Homed and Multi-Homed Node Combinations](#) illustrates the possible combinations.

Table 3: Uni-Homed and Multi-Homed Node Combinations

Node A	Node B
Uni-homed	Uni-homed
Uni-homed	Multi-homed
Multi-homed	Uni-homed
Multi-homed	Multi-homed

Multi-Homed Associations on EDCMs or E5-ENET Cards Running the IPLIMx Application

A multi-homed association on an IPLIMx card uses both Ethernet interfaces to reach the remote host, but only one signaling link. An association, either uni-homed or multi-homed, can be assigned to only one signaling link. That signaling link can be either signaling link A or B. The local and alternate local hosts are assigned to each Ethernet interface on the IP card. The IPLIMx cards are limited to one IP connection per signaling link. Since the IPLIMx cards can have eight signaling links on the card, eight multi-homed associations can be assigned to an IPLIMx card.

Figure 6: Multi-Homed Associations on E5-ENET Cards running the IPLIMx Applications shows the ways a multi-homed IP connection can be established on an IPLIMx card. The remote hosts can be multi-homed, but only one remote host can be specified for each multi-homed association in the EAGLE, so only one remote host is shown in *Figure 6: Multi-Homed Associations on E5-ENET Cards running the IPLIMx Applications*.

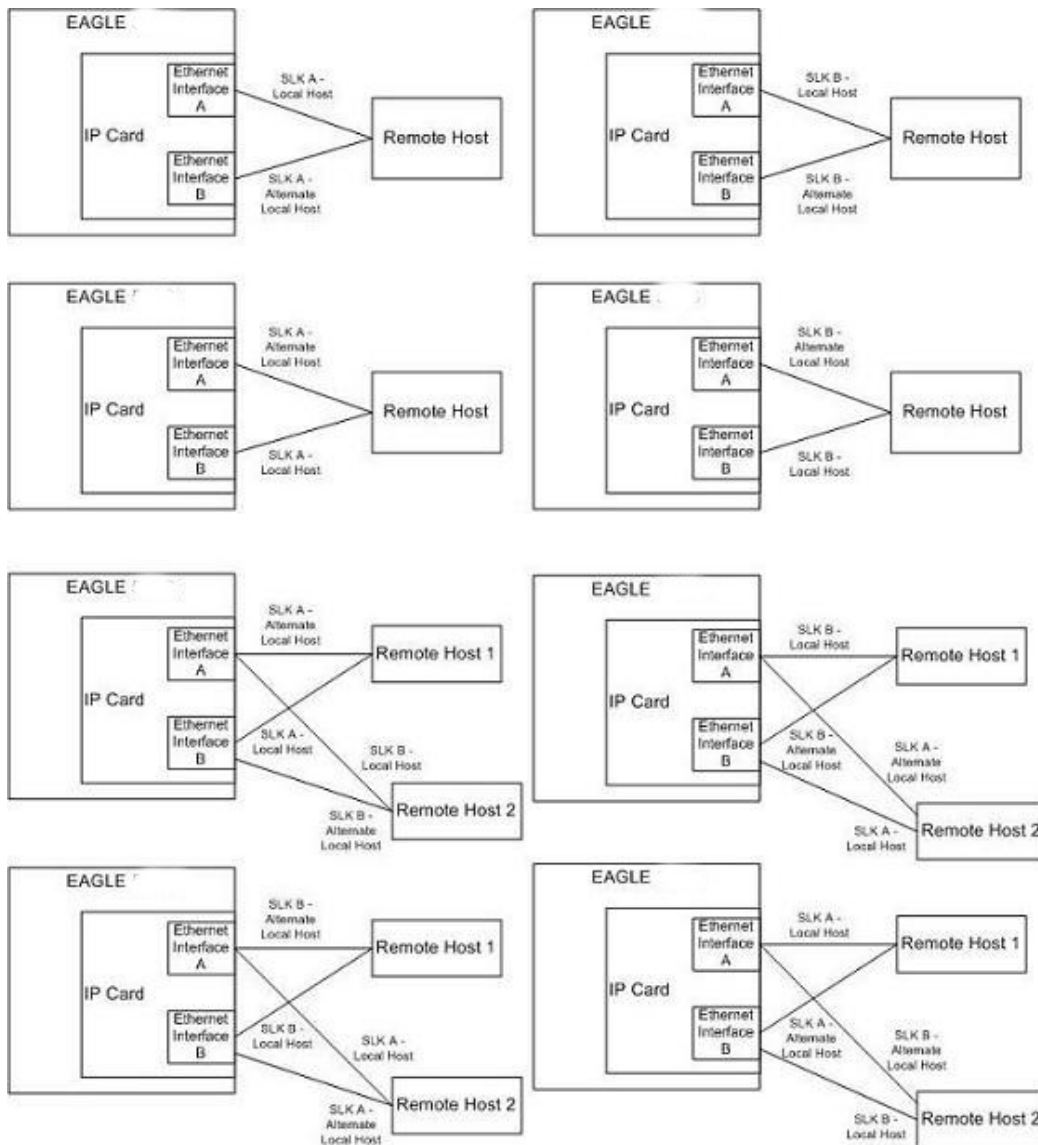

Figure 6: Multi-Homed Associations on E5-ENET Cards running the IPLIMx Applications

Multi-Homed Associations on E5-ENET Cards Running the IPGWx Applications

A multi-homed association on an IPGWx card uses both Ethernet interfaces to reach the remote host, but only one signaling link, signaling link A on the IPGWx card. The local and alternate local hosts are assigned to each Ethernet interface on the IP card. The IPGWx cards can have up to 50 connections for each IPGWx card. The IPGWx card can contain both uni-homed and multi-homed IP connections, as long as the total number of connections does not exceed 50.

Figure 7: Multi-Homed Associations on E5-ENET Cards running the IPGWx Applications shows the way a multi-homed IP connection can be established on an IPGWx card. The remote hosts can be multi-homed, but only one remote host can be specified for each multi-homed association in the EAGLE, so only one remote host is shown in *Figure 7: Multi-Homed Associations on E5-ENET Cards running the IPGWx Applications*.

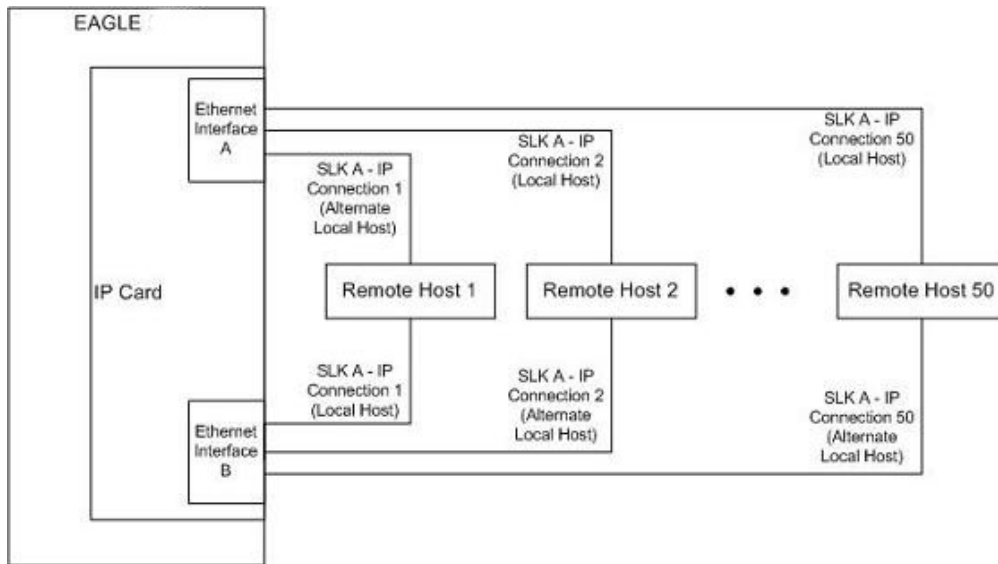

Figure 7: Multi-Homed Associations on E5-ENET Cards running the IPGWx Applications

Figure 8: *Multi-Homed Association Database Relationships* shows the components of the multi-homed SCTP association and how these components interact with each other.

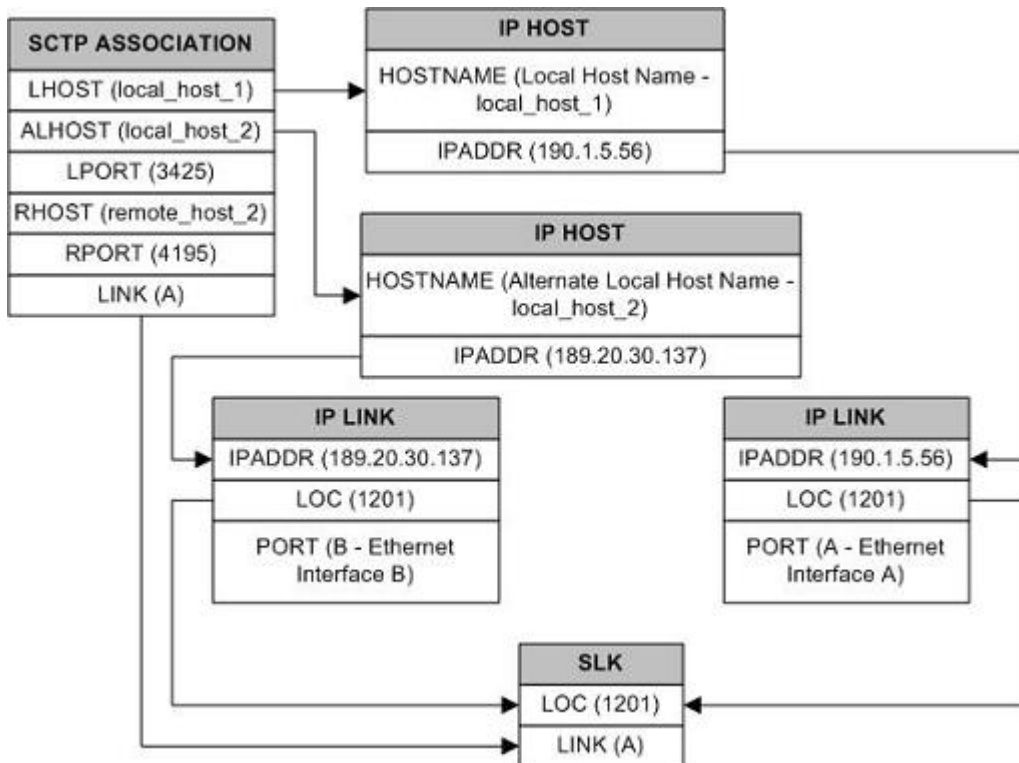

Figure 8: Multi-Homed Association Database Relationships

Using the data shown in [Figure 8: Multi-Homed Association Database Relationships](#), the IP connection is defined as a multi-homed association, connecting to a remote host using local hosts 190.1.5.56 and 189.20.30.137 over SCTP port 3425, using signaling link B on card 1201.

Routing

The IP7 Secure Gateway functionality in the EAGLE support two transport protocols – TCP and SCTP. Although both transport protocols are connection oriented, they differ greatly with respect to operation in a multi-homed host environment. The TCP protocol provides for a point-to-point transport connection. The SCTP protocol implements connections with either point to point, point to multi-point, or multi-point to multi-point connectivity capabilities.

An SCTPIETF connection (association) is defined as a four-tuple as follows:

- local host list – one or more of the local host's IP interface addresses
- local SCTP port
- remote host list – one or more of the remote host's IP interface addresses
- remote SCTP port

Based on this definition for an SCTPIETF connection, and the fact that the IPGWx and IPLIMx applications may utilize both Ethernet interfaces (a multi-homed host), an SCTPIETF association can take advantage of multi-homing and be a multi-homed SCTP endpoint. As a multi-homed endpoint, an SCTPIETF connection remains active and usable as long as at least one of the Ethernet interfaces can be reached by the remote host. Multiple paths through multiple interfaces to the remote host provides a more reliable connection. The SCTPIETF protocol is designed to make such a network outage transparent to the application.

In previous releases, an SCTPIETF endpoint could only operate as a uni-homed host using only the Ethernet A interface. In this mode, any SCTP transmission received on or transmitted out of the Ethernet B interface are silently discarded. By using the Ethernet B interface, the SCTP protocol running on the IP card can provide SCTP multi-homing endpoint support – that is, when an SCTPIETF association is formed, it may list both the Ethernet A and B IP addresses for the respective interfaces. As a multi-homed association endpoint, SCTP data would be allowed to flow on either of the Ethernet interfaces and thus provide more robust network connectivity.

In order to provide more flexible network connectivity, an association can be configured as follows with respect to the Ethernet interfaces:

- Ethernet A interface only (uni-homed)
- Ethernet B interface only (uni-homed)
- Ethernet A and B interface (multi-homed)

The interface mode is specified by the `lhost` and `alhost` parameters of the `ent-assoc` or `chg-assoc` commands.

In previous releases, the `lhost` parameter of the `ent-assoc` or `chg-assoc` commands is used to define the local IP address of the SCTPIETF association endpoint. The IP address would have to be an IP address associated with an Ethernet A interface. With this release, the IP address may be associated with either the Ethernet A or B interfaces. If it is an Ethernet A interface IP address, and the `alhost` parameter is not specified, then the association operates as a uni-homed SCTP endpoint on Ethernet interface A. If it is an Ethernet B interface IP address, and the `alhost` parameter is not specified, then the association operates as a uni-homed SCTP endpoint on Ethernet interface B. An association is configured as an SCTP multi-homed endpoint by specifying both the `lhost` and `alhost` parameter values with values corresponding to the Ethernet interface IP address for the IP card. The `lhost` and `alhost` parameter values represent the IP addresses specified by the `chg-ip-lnk` command for the specific IP card. Traffic cannot be passed between the Ethernet interfaces on the IP card containing a

multi-homed SCTP association. The IP card cannot act as an IP router between the networks defined by the local host and alternate local hosts of a multi-homed association.

A host that is not on the local network, the network identified by the local host's IP address, can be reached only through a gateway router. A gateway router is a device with more than one physical network connection, and can be connected to multiple networks. Unlike a multi-homed host, a gateway router is permitted to route IP messages between the physical Ethernet interfaces on the IP card. The network portion of the gateway router's IP address must be the same as the network portion of the IP address of one of the IP addresses of the Ethernet interfaces on the IP card. The gateway router is configured using the `defrouter` of the `chg-ip-card` command, or using the `ent-ip-rte` command.

Static entries are added to the IP Routing table using the `ent-ip-rte` command. Static routes are usually assigned to give control over which routers are used, allowing different routers to be selected based upon the destination IP address. There are two types of static routes:

- host static IP routes
- network or subnetwork static IP routes

The default route entry is a special static route. If there is not a specific host or network address in the IP Routing table that matches the destination IP address of an outbound datagram, then the datagram is sent to the default router (gateway) specified by the default route.

An IP route is configured using the `ent-ip-rte` command with the location of the IP card, the IP address of the gateway router (the `gtwy` parameter), and the IP address and subnet mask of the destination (that is, host or network). The IP address of the gateway router must be a locally attached IP address (that is, the gateway IP address must share the network portion of one of the two Ethernet interfaces).

When an IP packet is to be transmitted the IP routing table must be interrogated to determine where to send the IP datagram. If the destination IP address is local to the node (that is, directly reachable by an Ethernet interface), then the IP datagram is transmitted directly to the node with that associated IP address. If the destination IP address is determined to not be local to the node, then it must be routed (that is, sent to a gateway to reach its destination).

IP routing requires accessing the IP routing table to select a route. The destination IP address of the outbound datagram is used to search the IP routing table for the most specific route match. The order for selection is:

1. Host route
2. Subnetwork route
3. Network route
4. Aggregated route
5. Default route

Based on this selection order if an IP route is found then the outbound IP datagram will be transmitted to the gateway specified by the route. If no IP route is found (where no default route is specified), then the transmission of the datagram fails due to destination unreachable.

The capability to enter static IP routes provides for flexibility and control with respect to controlling network traffic. An IP card can contain up to 64 IP routes. The EAGLE can contain up to 1024 IP routes.

Point-to-Point Connectivity (IPLIM or IPLIMI Application)

The following sections describe the types of point-to-point connectivity provided, and how routing is accomplished, by the `iplim` or `iplimi` application:

Connecting STPs Over the IP Network

This functionality allows the use of an IP network in place of point-to-point SS7 links to carry SS7MSUs. [Figure 9: EAGLE Network \(STP Connectivity via MTP-over-IP\)](#) shows a diagram of this type of network. For example, the C links between the mated pair of STPs or A/B/D links between STPs can be replaced by an IP network. The IP Secure Gateway functionality is deployed on both ends of the link (point-to-point connection). The EAGLE converts the SS7MSUs to IP packets on one end of the link, and IP packets to SS7MSUs on the other end of the link. The IPLIMx applications support M2PA/SCTP/IP associations over A, B, C, D, and E links.

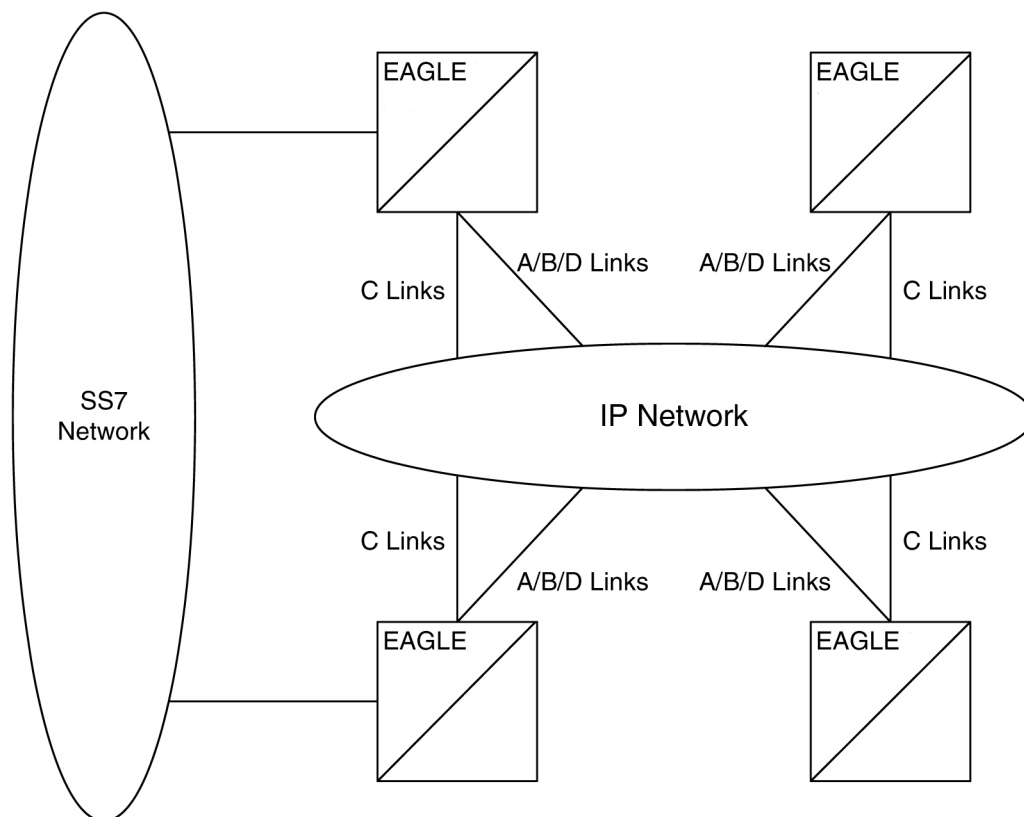

Figure 9: EAGLE Network (STP Connectivity via MTP-over-IP)

Point-to-Multipoint Connectivity (SS7IPGW and IPGWI)

The following sections describe the types of point-to-multipoint connectivity, how routing is accomplished, and the MTP status functions provided by the `ss7ipgw` and `ipgwi` applications:

- [Connecting to SCPs with SCCP/TCAP Messages Sent Over the IP Network](#)
- [Connecting SEPs Using ISUP, Q.BICC, and TUP Messages Over the IP Network](#)
- [Connecting SCPs and SEPs Using Non-ISUP, Non-SCCP, Non-Q.BICC, and Non-TUP Messages Over the IP Network](#)
- [Understanding Routing for SS7IPGW and IPGWI Applications](#)
- [Support for MTP Status Functions](#)

Connecting to SCPs with SCCP/TCAP Messages Sent Over the IP Network

This functionality allows SS7 nodes to exchange SCCP/TCAP queries and responses with an SCP residing on an IP network. [Figure 10: IP Network \(SCP Connectivity via TCAP-over-IP\)](#) shows a diagram of this type of network.

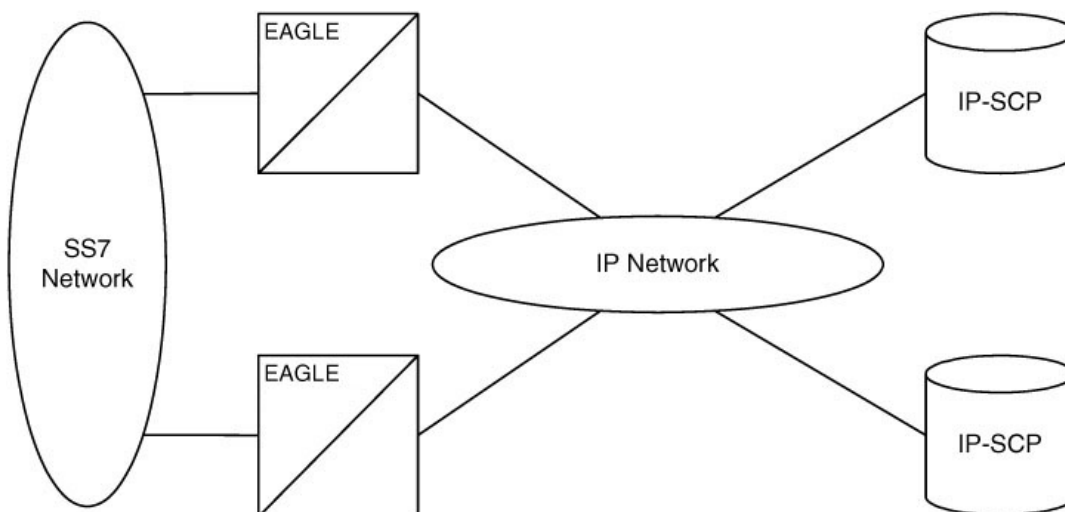

Figure 10: IP Network (SCP Connectivity via TCAP-over-IP)

The EAGLE manages the virtual point codes and subsystem numbers for the IP-SCP. From the SS7 network perspective, the TCAP queries are routed using these virtual point codes/SSNs. The EAGLE maps the virtual point code/SSN to one or more TCP sessions (point-to-multipoint connection), converts the SS7MSUs to IP packets by embedding the SCCP/TCAP data inside IP packets, and routes them over an IP network. The EAGLE also manages application subsystem status from an IP network's perspective and an SS7 network's perspective.

The following sequence of events illustrates this functionality:

1. Traditional SS7 devices route MSUs (such as TCAP Queries) to the EAGLE.
2. The EAGLE performs a global title translation and forwards the translated MSU to the correct IP device based on Point Code and SCCP Subsystem information in the MSU.
3. The TCAP query is processed at the IP-SCP, and the IP-SCP sends a TCAP reply back to the EAGLE.
4. The EAGLE forwards the TCAP reply back to the sender of the original query.

Connecting SEPs Using ISUP, Q.BICC, and TUP Messages Over the IP Network

This point-to-multipoint functionality allows SS7 nodes to exchange ISUP, Q.BICC, and TUP protocol messages with one or more signaling end points (class 4 switches, class 5 switches, VoIP gateways, Media Gateway Controllers, or Remote Access Servers) residing on an IP network. [Figure 11: IP Network \(SEP connectivity via ISUP, Q.BICC, and TUP-over-IP\)](#) shows an example of this type of network.

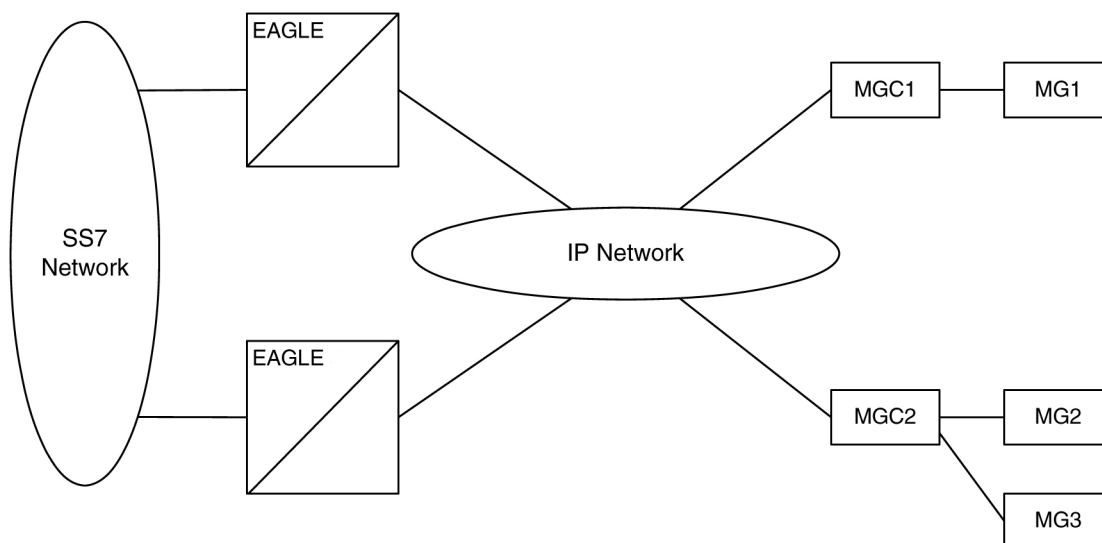

Figure 11: IP Network (SEP connectivity via ISUP, Q.BICC, and TUP-over-IP)

The EAGLE maps the originating point code, destination point code, and circuit identification code to an IP connection. The SEP is provided the originating and destination point codes in the MTP level 3 routing label as part of the passed protocol.

Connecting SCPs and SEPs Using Non-ISUP, Non-SCCP, Non-Q.BICC, and Non-TUP Messages Over the IP Network

This point-to-multipoint functionality allows SS7 nodes to exchange non-ISUP, non-SCCP, non-Q.BICC, and non-TUP protocol messages with one or more IP-based devices residing on an IP network. The network example is similar to the SCP connectivity via SCCP/TCAP-over-IP functionality example shown in [Figure 10: IP Network \(SCP Connectivity via TCAP-over-IP\)](#). The EAGLE maps the destination point code, and service indicator (non-ISUP, non-SCCP, non-Q.BICC, non-TUP) to an IP connection.

Understanding Routing for SS7IPGW and IPGWI Applications

The `ss7ipgw` and `ipgwi` applications can use a single point code, called a virtual point code. This code is assigned to a set of IP devices that it connects to. The EAGLE distinguishes between the devices within the set by using application routing keys and application servers.

Application routing associates SS7 routing keys with application servers. SS7 routing keys define a filter based on SS7 message data. Application servers define the connection between the IP local host/local transport protocol port and IP remote host/remote transport protocol port.

An application server is a logical entity serving a specific routing key. The application server contains a set of one or more unique application server processes, of which one or more is normally actively processing traffic. An application server process is a process instance of an application server and contains an SCTP association. For more information on application servers, application server processes, and SCTP associations, see the [IETF Adapter Layer Support](#) section.

If the routing key filter matches the SS7 message presented for routing to the IP network, the SS7 message is sent to the associated application server.

Only one application server can be associated with each SS7 routing key. One application server can have up to 16 associations. SS7 messages delivered to the IP network using a routing key are distributed over the available application server based on the SLS (signaling link selector) value in the SS7 message.

Routing keys can be fully or partially specified, or specified by default.

Full Routing Keys

For this routing application, all applicable fields in the Message Signaling Unit (MSU) must match the contents of the full routing key. [Table 4: SS7 Full Routing Keys per IPGWx Functionality](#) defines which SS7 message parameters are used to search for a match for full routing keys for each of the functions supported by the `ss7ipgw` and `ipgwi` applications (IPGWx functionality).

Table 4: SS7 Full Routing Keys per IPGWx Functionality

IPGWx Functionality (ANSI and ITU)	SS7 Routing Keys
SCP connectivity via TCAP-over-IP	Destination Point Code Service Indicator (=3) Subsystem Number
SEP connectivity via ISUP-over-IP	Destination Point Code Service Indicator (=5) Originating Point Code CIC Range Start CIC Range End
SEP connectivity via Q.BICC-over-IP	Destination Point Code Service Indicator (=13) Originating Point Code CIC Range Start CIC Range End
SEP connectivity via TUP-over-IP (ITU only)	Destination Point Code Service Indicator (=4) Originating Point Code CIC Range Start CIC Range End
SCP/SEP connectivity via non-ISUP, non-SCCP, non-Q.BICC, non-TUP-over-IP	Destination Point Code Service Indicator (any value other than 3, 4*, 5, and 13)
* The service indicator value of 4 can be used in this instance if the DPC is an ANSI point code.	

Partial Routing Keys

Partially specified routing keys are explicitly, but not completely defined. These routing keys ignore some of the contents of the MSU. The parts of the MSU that are ignored are specific. For example, for the 'ignore cic' partial-key type, the destination point code (dpc), service indicator (si), and originating point code (opc) must be configured, but the circuit identification code (cic) field does not have to be configured. The other types of SS7 partial routing keys are as follows:

- dpc, si, and opc specified (ignore cic for CIC-based messages)
- dpc and si specified (ignore ssn for sccp messages)
- dpc and si specified (ignore opc and cic for CIC-based messages)
- dpc specified (ignore all but the dpc field)
- si specified (ignore all but the si field)

Default Routing Keys

Default routing keys do not need any part of the MSU specified. This routing key can be used to carry any SS7MSU, regardless of the type of MSU or the fields that make up the MSU.

Routing Key Tables

Each IP card has a Routing Key table that maps SS7 routing keys to IP connections, as illustrated by the example in [Table 5: Example SS7 Routing Key Table](#). MSUs that match the parameters in a given row are sent over one of the IP connections shown for that row (up to 16 IP connections can be defined for a single routing key). Multiple IP connections for a given row allow load sharing. In addition, multiple routing keys can be used to send traffic to a single IP connection.

Each IP card's Routing Key table can contain up to 2500 entries. Entries in the Routing Key table are defined by the `ent-appl-rtkey` command entered through the OAM, saved on disk, and reloaded to each IP card upon reset. The routing key entries can be full, partial, or default routing keys. The entries in one IP card's Routing Key table are identical to the entries in the other IP card's table. The entries can be changed by the `chg-appl-rtkey` command or removed by the `dlt-appl-rtkey` command.

[Table 5: Example SS7 Routing Key Table](#) shows a sample Routing Key table that has one entry for an SSCP/TCAP-over-IP connection; one entry each for an ISUP, Q.BICC, and TUP-over-IP connection; and a non-SSCP/non-ISUP/non-Q.BICC/non-TUP connection.

Table 5: Example SS7 Routing Key Table

SS7 DPC Routing Key Parameter	SS7 SI Routing Key Parameter	SS7 SSN Routing Key Parameter	SS7 OPC Routing Key Parameter	CIC START Routing Key Parameter	CIC END Routing Key Parameter	Name of IP Connections that carry traffic for that Routing Key
DPC-SI-SSN routing key for SSCP/TCAP-over-IP connectivity						
5-5-5	03	6	-	-	-	kchlr11201 kchlr21201 kchlr11203 kchlr21203
ISUP-CIC routing key for ISUP-over-IP connectivity						
5-5-6	05	-	4-4-4	1	100	dnmsc11201

SS7 DPC Routing Key Parameter	SS7 SI Routing Key Parameter	SS7 SSN Routing Key Parameter	SS7 OPC Routing Key Parameter	CIC START Routing Key Parameter	CIC END Routing Key Parameter	Name of IP Connections that carry traffic for that Routing Key
						dnmsc21201 dnmsc11203 dnmsc21203
Q.BICC-CIC routing key for Q.BICC-over-IP connectivity						
4363	13	-	5834	48486	48486	lpmsg11204 lpmsg21204 lpmsg31204
TUP-CIC routing key for TUP-over-IP connectivity						
1-44-2	04	-	2-5-1	3948	3948	lpmsg11205 lpmsg21205 lpmsg31205
DPC-SI routing key for non-SCCP/non-ISUP/non-Q.BICC/non-TUP connectivity						
5-5-7	02					sfh1r11204

Routing Key Lookup Hierarchy

To facilitate the delivery of Message Signaling Units (MSUs) that do not match full routing key entries in the Routing Key table, each MSU is processed and delivered according to a specific routing key lookup hierarchy. The hierarchy guarantees that the MSU is delivered to the best possible location based on the MSU's closest match in the Routing Key table, and also prevents MSUs without full routing key matches from being discarded. [Table 6: Routing Key Lookup Hierarchy](#) defines the routing key lookup hierarchy.

Table 6: Routing Key Lookup Hierarchy

Type of MSU	Lookup Order per MSU Type	Segment of MSU that Must Match Routing Key	Routing Key Type
CIC	1	dpc + si + opc + cic	Full
	2	dpc + si + opc (ignore cic)	Partial
	3	dpc + si (ignore opc & cic)	Partial
	4	dpc (ignore si, opc & cic)	Partial
	5	si (ignore dpc, opc & cic)	Partial

Type of MSU	Lookup Order per MSU Type	Segment of MSU that Must Match Routing Key	Routing Key Type
	6	None	Default
SCCP	1	dpc + si + ssn	Full
	2	dpc + si (ignore ssn)	Partial
	3	dpc (ignore si & ssn)	Partial
	4	si (ignore dpc & ssn)	Partial
	5	None	Default
OtherSI	1	dpc + si	Full
	2	dpc (ignore si)	Partial
	2	si (ignore dpc)	Partial
	3	None	Default

When an MSU has an *si* value of 5, 13, or 4 (ITU only), it is a CIC message. Messages with an *si* value of 3 are SCCP messages. All other MSUs are considered OtherSI messages. The EAGLE first tries to match each MSU with a full routing key and second with one of the partial keys as numbered in ascending order in the table. Third, if no segment of the routing key matches either full or partial routing keys, the EAGLE assigns the MSU a default routing key.

Support for MTP Status Functions

This feature, available only on IP cards that support the *ss7ipgw* and *ipgwi* applications, allows the Message Transfer Part (MTP) status of point codes in the SS7 networks to be made available to IP-connected media gateway controllers (MGCs) and IP-SCPs. This feature is similar to the MTP3 network management procedures used in an SS7 network.

This feature enables an IP device to:

- Divert traffic from a secure gateway that is not able to access a point code that the mated secure gateway can access
- Audit point code status
- Build up routing tables before sending traffic
- Be warned about network congestion
- Abate congestion (*ss7ipgw* application only)
- Obtain SS7 User Part Unavailability status

SNMP Agent Implementation

This feature implements a Simple Network Management Protocol (SNMP) agent on each IP card that runs the *ss7ipgw*, *ipgwi*, *iplim*, or *iplimi* applications. SNMP is an industry-wide standard

protocol used for network management. SNMP agents interact with network management applications called Network Management Systems (NMSs).

Supported Managed Object Groups

The SNMP agent maintains data variables that represent aspects of the IP card. These variables are called managed objects and are stored in a management information base (MIB). The SNMP protocol arranges managed objects into groups. [Table 7: SNMP Object Groups](#) shows the groups that are supported.

Table 7: SNMP Object Groups

Group Name	Description	Contents
<i>system</i>	Text description of agent in printable ASCII characters	System description, object identifier, length of time since reinitialization of agent, other administrative details
<i>interfaces</i>	Information about hardware interfaces on the IP card	Table that contains for each interface, speed, physical address, current operational status, and packet statistics
<i>ip</i>	Information about host and router use of the IP	Scalar objects that provide IP-related datagram statistics, and 3 tables: address table, IP-to-physical address translation table, and IP-forwarding table
<i>icmp</i>	Intranetwork control messages, representing various ICMP operations within the IP card	26 scalar objects that maintain statistics for various Internet Control Message Protocol (ICMP) messages
<i>tcp</i>	Information about TCP operation and connections	14 scalar objects that record TCP parameters and statistics, such as the number of TCP connections supported and the total number of TCP segments transmitted, and a table that contains information about individual TCP connections
<i>udp</i>	Information about UDP operation	4 scalar objects that maintain UDP-related datagram statistics, and a table that contains address and port information
<i>snmp</i>	Details about SNMP objects	30 scalar objects, including SNMP message statistics, number of MIB objects retrieved, and number of SNMP traps sent

Supported SNMP Messages

The SNMP agent interacts with up to two NMSs by:

- Responding to *Get* and *GetNext* commands sent from an NMS for monitoring the IP card.
- Responding to *Set* commands sent from an NMS for maintaining the IP card and changing managed objects as specified.
- Sending *Trap* messages to asynchronously notify an NMS of conditions such as a link going up or down. *Traps* provide a way to alert the NMS in a more timely fashion than waiting for a *Get* or

GetNext from the NMS. Two hostnames, DCMSNMPTRAPHOST1 and DCMSNMPTRAPHOST2, are utilized to specify the SNMPNMS to which traps are sent. In this release, only the following traps are supported:

- *coldStart*, sent one time only when the IP stack initialization occurs on the IP card as part of boot processing
- *linkUp*, sent when one of the ports on the IP card initially comes up or recovers from a previous failure
- *linkDown*, sent when one of the ports on the IP card fails

When a trap occurs at the IP card agent, the agent sends the trap to each of the SNMP specific host names that can be resolved to an IP address. Resolution is based on configuration data in the `chg-ip-card` command (or default data) which specifies DNS search order and DNS information.

Deviations from SNMP Protocol

[Table 8: Deviations from SNMP Protocols](#) shows how the EAGLE deviates from the standard SNMP protocol definition.

Table 8: Deviations from SNMP Protocols

Group	Variable Name	Usage	Deviation
<i>system</i>	<i>sysContact</i>	Text identification of contact information for agent	Cannot be set by <i>Set</i> command; may be set only by <code>chg-sg-opts</code> command.
	<i>sysLocation</i>	Physical location of agent	Cannot be set by <i>Set</i> command; internally set using configuration data already available; set to <code><CLLI>-<slot of IP card></code>
	<i>sysName</i>	Administratively assigned name for agent	Cannot be set by <i>Set</i> command; internally set using configuration data already available; set to <code><CLLI>-<slot of IP card></code>
<i>interface</i>	<i>ifAdminStatus</i>	Desired state of the interface	Cannot be set by <i>Set</i> command (to ensure that an NMS does not disrupt SS7 traffic by placing an IP interface in a nonoperable state)
<i>ip</i>	<i>ipForwarding</i> <i>ipDefaultTTL</i> <i>ipRoute Dest</i> <i>ipRouteIfIndex</i> <i>ipRouteMetric1-5</i> <i>ipRouteNextHop</i>	IP route-specific values	Cannot be set by <i>Set</i> command

Group	Variable Name	Usage	Deviation
	<i>ipRouteType</i> <i>iprouteAge</i> <i>ipRouteMask</i>		
	<i>ipNetToMediaIfIndex</i> <i>ipNetToMediaPhysAdress</i> <i>ipNetToMediaNetAddress</i> <i>ipNetToMediaType</i>	IP-address specific information	Can be set by <i>Set</i> command, but not saved across IP card reloads
<i>tcp</i>	<i>tcpConnState</i>	State of a TCP connection	Cannot be set by <i>Set</i> command
<i>snmp</i>	<i>snmpEnableAuthenTraps</i>	Indicate whether agent is permitted to generate authentication failure traps	Cannot be set by <i>Set</i> command

Mixed Networks Using the ANSI/ITUMTP Gateway Feature

The optional ANSI/ITUMTP Gateway feature, now also available for IP networks, and the addition of the *iplimi* and *ipgwi* applications enables the EAGLE to act as an interface between nodes that support ANSI, ITU-I, and ITU-N protocols. For more information on the ANSI/ITUMTP Gateway feature, contact your Oracle Sales Representative.

Figure 12: Complex Network with ANSI, ITU-I, and ITU-N Nodes shows an example of a complex network that includes all these types of nodes. *Table 9: Nodes and Point Codes in Complex Network Example* provides more detail about the nodes, network types, and point codes used in this example.

The following SS7 protocol constraints determine how the network must be configured:

- A linkset is a group of links that terminate into the same adjacent point code. All links in the linkset can transport compatible MSU formats. The network type of the linkset is the same as the network type of the adjacent point code assigned to the linkset.
- When nodes in different networks need to communicate, each node must have either a true point code or an alias point code for each of the network types. For example, if Node 1 (in an ANSI network) needs to communicate to Node 7 (in an ITU-N network), Node 1 must have an ANSI true point code and an ITU-N alias point code, while Node 7 must have an ITU-N true point code and an ANSI alias point code.
- The systems are usually deployed as mated pairs. The links connecting the EAGLE to its mate are C links. Each EAGLE must have a C linkset for each network type that the EAGLE connects to. Therefore, in *Figure 12: Complex Network with ANSI, ITU-I, and ITU-N Nodes*, Nodes 5 and 6 are connected with three linksets, one each for ANSI traffic, ITU-I traffic, and ITU-N traffic.
- To perform routing, the EAGLE must convert the routing labels in MSUs. To perform this conversion, every destination point code (DPC), originating point code (OPC), and concerned point code must be defined in the Routing table. Even if the EAGLE does not route MSUs to these nodes, they must

be provisioned in the Routing table to provision the alias point codes required in the conversion process.

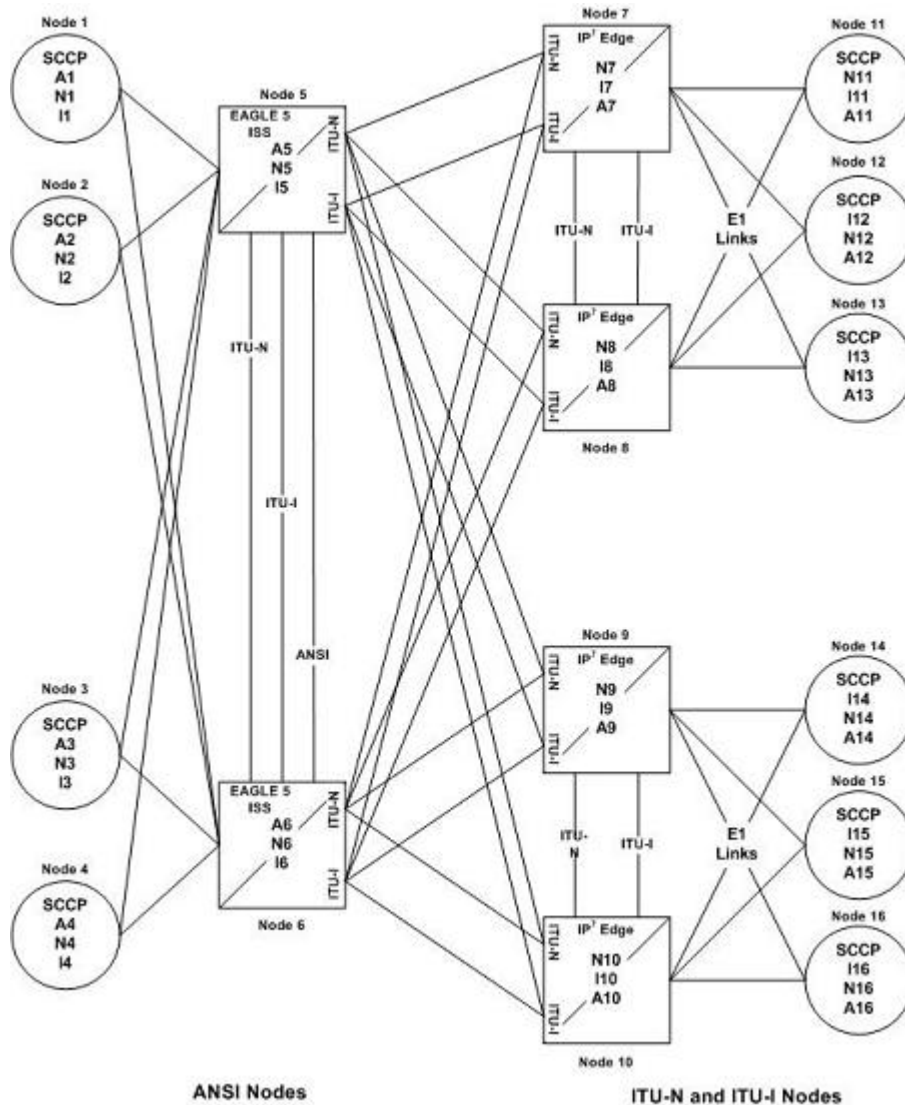

Figure 12: Complex Network with ANSI, ITU-I, and ITU-N Nodes

Table 9: Nodes and Point Codes in Complex Network Example

Node	Node Type	Network Types Supported	True Point Codes	Alias Point Codes
1	SSP	ANSI	A1	N1, I1
2	SSP	ANSI	A2	I2
3	SSP	ANSI	A3	N3, I3
4	SSP	ANSI	A4	N4

Node	Node Type	Network Types Supported	True Point Codes	Alias Point Codes
5	STP (with IP7 Secure Gateway functionality)	ANSI, ITU-N, ITU-I	A5, N5, I5	
6	STP (with IP7 Secure Gateway functionality)	ANSI, ITU-N, ITU-I	A6, N6, I6	
7	STP (with IP7 Secure Gateway functionality)	ITU-N, ITU-I	N7, I7	A7
8	STP (with IP7 Secure Gateway functionality)	ITU-N, ITU-I	N8, I8	A8
9	STP (with IP7 Secure Gateway functionality)	ITU-N, ITU-I	N9, I9	A9
10	STP (with IP7 Secure Gateway functionality)	ITU-N, ITU-I	N10, I10	A10
11	SSP	ITU-N	N11	I11, A11
12	SSP	ITU-I	I12	N12, A12
13	SSP	ITU-I	I13	N13, A13
14	SSP	ITU-N	N14	I14, A14
15	SSP	ITU-I	I15	N15, A15
16	SSP	ITU-I	I16	N16, A16

Notes: 1. A true point code (TPC) defines a destination in the EAGLE's destination point code table. A TPC is a unique identifier of a node in a network. An STP (with IP7 Secure Gateway functionality) must have a TPC for each network type that the EAGLE connects to. An SSP connects to only one type of network, so it has only one TPC.

2. An alias point code is used to allow nodes in other networks to send traffic to and from a EAGLE when that EAGLE does not have a TPC for the same network type.

The configured links and point codes in the complex network shown in [Figure 12: Complex Network with ANSI, ITU-I, and ITU-N Nodes](#) allows most nodes to communicate with other nodes. However, note that Node 2 cannot communicate with Node 13 or Node 16, or with any node in the ITU-N network because Node 2 does not have an ITU-N alias point code.

Routing and Conversion Within a Single Network Type

The following steps demonstrate how an EAGLE routes and converts when an ITU-N node sends an MSU to another ITU-N node. For example, assume that Node 11 in [Figure 12: Complex Network with ANSI, ITU-I, and ITU-N Nodes](#) sends an MSU to Node 14. The MSU is routed from Node 11 to Node 7 to Node 5 to Node 9 to Node 14. The following steps describe the actions performed at Node 5 (an STP with IP7 Secure Gateway functionality):

1. An ITU-N formatted MSU (which has a network identifier=01b and a 14-bit destination point code/originating point code) is received on an `iplimi` card (for this example at location 1103).
2. MSU discrimination is performed with the following substeps:
 - a. Compare the received network identifier (NI) to the list of valid NIs. (Each configured linkset for a receiving link has a defined list of valid NIs.) If the comparison fails, the MSU is discarded and an STP measurement is logged. In this example, the received NI (01b) is valid for an `iplimi` card.
 - b. Extract the NI and destination point code (DPC) from the received MSU.
 - c. Determine whether the destination of the received MSU is this STP. If not (as is the case in this example), the MSU is passed to the STP's routing function.
3. The routing function selects which outgoing link to use by searching a routing table for an entry for the DPC (N14 in this example). The routing table identifies another `iplimi` card (for this example at location 1107) to be used for the outgoing link.
4. Determine whether MSU conversion is required (required when the source network type is not the same as the destination network type). In this example, both Node 11 and Node 14 are ITU-N nodes, so conversion is not required.
5. Forward the MSU across the Interprocessor Message Transport (IMT) bus from location 1103 to location 1107, where the MSU is transmitted out the link towards Node 14.

Routing and Conversion Between Different Network Types

The routing and conversion steps performed by a EAGLE when an ITU-N node sends an MSU to an ITU-I node are the same as the steps shown in the [Routing and Conversion Within a Single Network Type](#) section, except for the conversion step.

For example, assume that Node 11 in [Figure 12: Complex Network with ANSI, ITU-I, and ITU-N Nodes](#) sends an MSU to Node 16. The MSU is routed from Node 11 to Node 7 to Node 5 to Node 9 to Node 16. The following steps describe the actions performed at Node 5 (an EAGLE with IP Secure Gateway functionality):

1. Perform step 1 through step 3 as shown in the [Routing and Conversion Within a Single Network Type](#) section. In this example, assume that the routing function determines that the outgoing link is configured on the IP card at location 1203.
2. Determine whether MSU conversion is required (required when the source network type is not the same as the destination network type). In this example, Node 11 is an ITU-N node and Node 16 is an ITU-I node, so conversion is required. Conversion consists of two phases: Message Transfer Part (MTP) conversion and user part conversion.
3. Perform MTP conversion (also known as routing label conversion). The following parts of the MSU can be affected by MTP conversion:
 - Length indicator — for ITU-N to ITU-I conversion, the length of the MSU does not change
 - Service Information Octet (SIO), Priority — for conversion to ITU, the priority is set to 0. For conversion to ANSI, the priority is set to a default of 0, which can later be changed based on user part conversion.
 - Service Information Octet (SIO), Network Indicator — the NI bits are set to the NI value for the destination node. In this example, NI is set to 00b.
 - Routing Label, Destination Point Code (DPC) — the DPC is replaced with the destination's true point code. In this example, N16 is replaced by I16.
 - Routing Label, Originating Point Code (OPC) — the OPC is replaced with the appropriate network type's alias point code for the originating node. In this example, N11 is replaced with I11.

- Routing Label, Signaling Link Selector (SLS) — no SLS conversion is required between ITU-I and ITU-N nodes. However, if one of the nodes were an ANSI node, conversion would be required between a 5-bit or 8-bit SLS for ANSI nodes and a 4-bit SLS for ITU nodes.
4. Perform user part conversion, if necessary. Currently, only SCCP traffic and only network management messages have the Message Transfer Part (MTP) converted. All other user parts have their data passed through unchanged.
 5. Forward the MSU across the Interprocessor Message Transport (IMT) bus from location 1103 to location 1203, where the MSU is transmitted out the link towards Node 16.

IETF Adapter Layer Support

Overview

The current implementation of the IETF adapter layers in the EAGLE uses three adapter layers: SUA, M3UA, and M2PA. These adapter layers are assigned to SCTP associations which define the connection to the far end. An SCTP association is defined in the EAGLE by the local host name, the local SCTP port, the remote host name, and the remote SCTP port.

The three adapter layers used in the EAGLE are supported depending on the type of IP card being used for the IP connection. The SUA and M3UA adapter layers can be used only on IPGWx cards (cards running either the SS7IPGW or IPGWI applications). The M2PA adapter layer can be used only on IPLIMx cards (cards running either the IPLIM or IPLIMI applications).

SCTP associations on IPGWx cards use routing keys to distinguish between the IP devices being connected to. SCTP associations cannot be assigned directly to routing keys. To get an SCTP association ultimately assigned to a routing key, the IETF adapter layers use the concept of the application server (AS). The SCTP association is assigned to an application server. One or more associations are normally actively processing traffic. A group of associations (up to 16) can be assigned to an application server. An application server, a logical entity serving a specific routing key, is assigned to a routing key. This results in assigning the SCTP association, up to a maximum of 16, to a routing key.

The IETFSUA and M3UA adapter layers are supported on IPGWx cards. These adapter layers support the full implementation of the AS and routing key for the EAGLE. SCTP associations assigned to IPGWx cards can be assigned to application servers and routing keys.

The IETFM2PA adapter layer is supported on IPLIMx cards. The M2PA adapter layer does not support application servers, therefore SCTP associations assigned to M2PA links on IPLIMx cards cannot be assigned to application servers.

Figure 13: AS/Association Relationship shows a typical configuration with four connections (SCTP associations) out of the EAGLE using IPGWx cards. Each association is connected to a process on the far end.

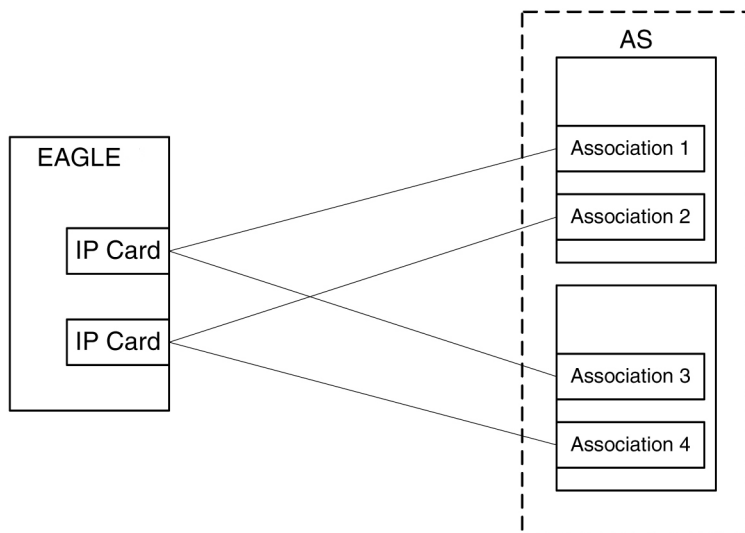

Figure 13: AS/Association Relationship

Feature Components

The EAGLE with IP⁷ Secure Gateway functionality is used as a signaling gateway between the PSTN and IP networks as shown in [Figure 14: SG/MGC/MG Network Diagram](#). This figure shows that signaling gateways interface with media gateway controllers (MGCs) and MGCs interface with media gateways (MGs).

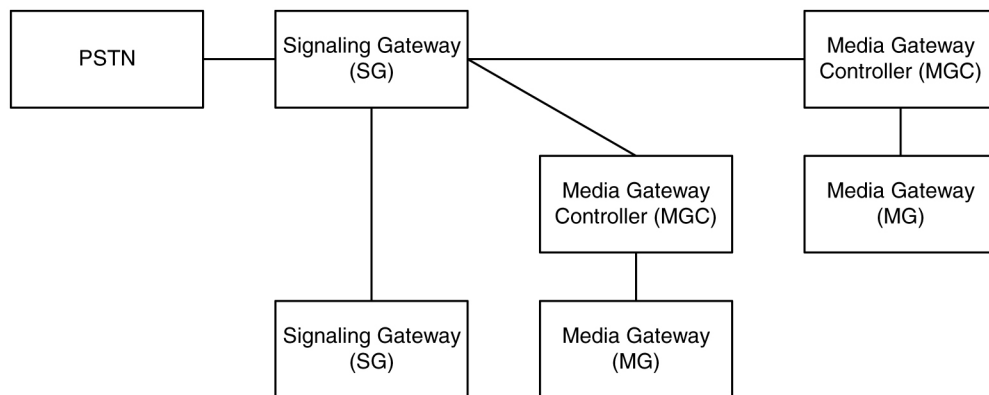

Figure 14: SG/MGC/MG Network Diagram

To provide a signaling gateway solution that will be able to communicate with a larger number of IP devices, the EAGLE needs to be able to communicate with multiple MGCs which are using SCTP as the transport layer and M3UA, M2PA, or SUA as an adapter layer. On an IPLIMx card, the M2PA adapter layer can be used with SCTP as shown in [Figure 15: IPLIMx Protocol Stack with SCTP as the Transport Layer](#). On an IPGWx card, the M3UA and SUA adapter layers can be used with SCTP as shown in [Figure 16: IPGWx Protocol Stack with SCTP as the Transport Layer](#).

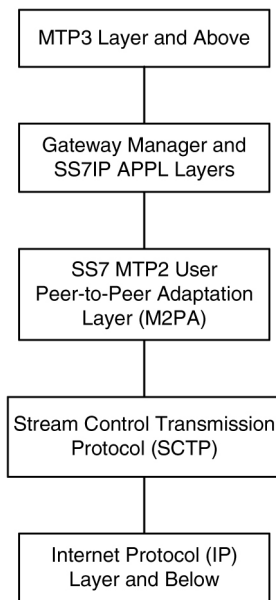

Figure 15: IPLIMx Protocol Stack with SCTP as the Transport Layer

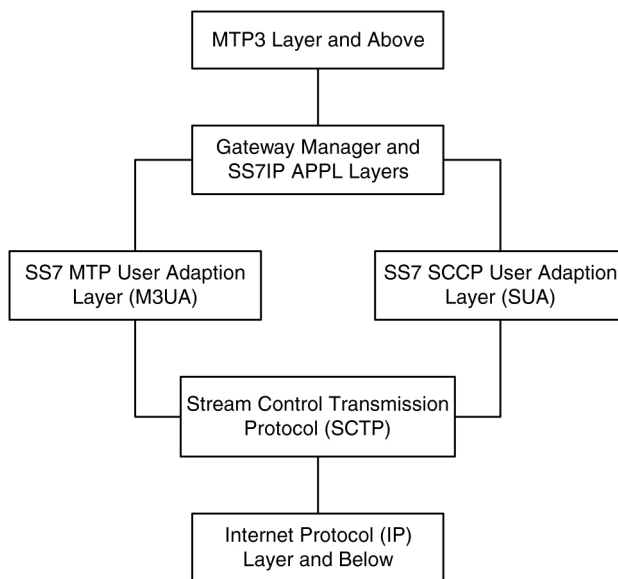

Figure 16: IPGWx Protocol Stack with SCTP as the Transport Layer

SUA Layer

The SUA layer, only supported on IP cards running either the SS7IPGW or IPGWI applications (IPGWx cards), was designed to fit the need for the delivery of SCCP-user messages (MAP & CAP over TCAP, RANAP, etc.) and new third generation network protocol messages over IP between two signaling endpoints. Consideration is given for the transport from an SS7 signaling gateway to an IP signaling node (such as an IP-resident database). This protocol can also support transport of SCCP-user messages between two endpoints wholly contained within an IP network. The layer is expected to meet the following criteria:

- Support for transfer of SS7SCCP-User Part messages (for example, TCAP, RANAP, etc.)
- Support for SCCP connectionless service.
- Support for the seamless operation of SCCP-User protocol peers
- Support for the management of SCTP transport associations between a signaling gateway and one or more IP-based signaling nodes).
- Support for distributed IP-based signaling nodes.
- Support for the asynchronous reporting of status changes to management

Depending upon the SCCP-users supported, the SUA layer supports the four possible SCCP protocol classes transparently. The SCCP protocol classes are defined as follows:

- Protocol class 0 provides unordered transfer of SCCP-user messages in a connectionless manner.
- Protocol class 1 allows the SCCP-user to select the in-sequence delivery of SCCP-user messages in a connectionless manner.
- Protocol class 2 allows the bi-directional transfer of SCCP-user messages by setting up a temporary or permanent signaling connection.
- Protocol class 3 allows the features of protocol class 2 with the inclusion of flow control. Detection of message loss or mis-sequencing is included.

Protocol classes 0 and 1 make up the SCCP connectionless service. Protocol classes 2 and 3 make up the SCCP connection-oriented service.

The SUA layer supports the following SCCP network management functions:

- Coord Request
- Coord Indication
- Coord Response
- Coord Confirm
- State Request
- State Indication
- Pcstate Indication

The SUA layer provides interworking with SCCP management functions at the signaling gateway for seamless inter-operation between the SCN network and the IP network. This means:

- An indication to the SCCP-user at an application server process that a remote SS7 endpoint/peer is unreachable.
- An indication to the SCCP-user at an application server process that a remote SS7 endpoint/peer is reachable.
- Congestion indication to SCCP-user at an application server process.
- The initiation of an audit of remote SS7 endpoints at the signaling gateway.

M3UA Layer

The M3UA layer, supported on only IPGWx cards, was designed to fit the need for signaling protocol delivery from an SS7 signaling gateway to a media gateway controller (MGC) or IP-resident database. The layer is expected to meet the following criteria:

- Support for the transfer of all SS7MTP3-User Part messages (for example, ISUP, SCCP, TUP, etc.)
- Support for the seamless operation of MTP3-User protocol peers
- Support for the management of SCTP transport associations and traffic between a signaling gateway and one or more MGCs or IP-resident databases
- Support for MGC or IP-resident database process fail-over and load-sharing

- Support for the asynchronous reporting of status changes to management

The M3UA layer at an application server provides a set of primitives at its upper layer to the MTP3-Users that is the equivalent of those provided by the MTP Level 3 to its local users at an SS7 SEP. In this way, the ISUP or SCCP layer at an application server process is unaware that the expected MTP3 services are offered remotely from an MTP3 Layer at a signaling gateway, and not by a local MTP3 layer. The MTP3 layer at a signaling gateway may also be unaware that its local users are actually remote user parts over the M3UA layer. The M3UA layer extends access to the MTP3 layer services to a remote IP-based application. The M3UA layer does not provide the MTP3 services.

The M3UA layer provides the transport of MTP-TRANSFER primitives across an established SCTP association between a signaling gateway and an application server process and between IPSPs. The MTP-TRANSFER primitives are encoded as MTP3-User messages with attached MTP3 Routing Labels as described in the message format sections of the SCCP and ISUP recommendations. In this way, the SCCP and ISUP messages received from the SS7 network are not re-encoded into a different format for transport to or from the server processes. All the required MTP3 Routing Label information (OPC, DPC, and SIO) is available at the application server process and the IPSP as is expected by the MTP3-User protocol layer.

At the signaling gateway, the M3UA layer also provides inter-working with MTP3 management functions to support seamless operation of the signaling applications in the SS7 and IP domains. This includes:

- Providing an indication to MTP3-Users at an application server process that a remote destination in the SS7 network is not reachable.
- Providing an indication to MTP3-Users at an application server process that a remote destination in the SS7 network is now reachable.
- Providing an indication to MTP3-Users at an application server process that messages to a remote MTP3-User peer in the SS7 network are experiencing SS7 congestion
- Providing an indication to MTP3-Users at an application server process that a remote MTP3-User peer is unavailable.

The M3UA layer at the signaling gateway maintains the availability of all configured remote application server processes, in order to manage the SCTP Associations and the traffic between the signaling gateway and application server processes. As well, the Active/Inactive state of remote application server processes is also maintained - Active application server processes are those currently receiving traffic from the signaling gateway.

M2PA Layer

The M2PA layer, supported only on IPLIMx cards, is a peer-to-peer protocol and provides mappings for all SS7 messages. In a peer-to-peer mode, either side of the IP connection may initiate the connection.

The M2PA layer lies below MTP3 in the protocol stack. *Figure 17: M2PA in the IP7 Signaling Gateway* shows the protocol layers in three interconnected nodes involving the M2PA layer.

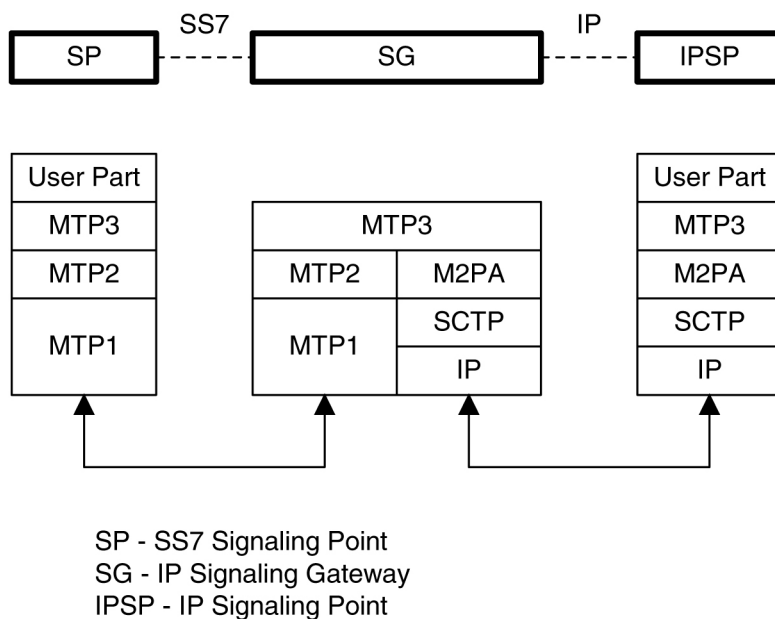

Figure 17: M2PA in the IP⁷ Signaling Gateway

The M2PA layer receives the primitives sent from MTP3 to its lower layer. The M2PA layer processes these primitives or maps them to appropriate primitives at the M2PA/SCTP interface. Likewise, the M2PA layer sends primitives to MTP3 like those used in the MTP3/MTP2 interface.

The M2PA layer provides MTP2 functionality that is not provided by SCTP. This includes:

- Reporting of link status changes to MTP3
- Processor outage procedure
- Link alignment procedure

The M2PA layer allows MTP3 to perform all of its Message Handling and Network Management functions with IPSPs as with other SS7 nodes.

The M2PA layer also supports full retrieval because it assigns sequence numbers to all protocol messages and provides for acknowledgements from the M2PA peer. This means that an M2PA signaling link is able to execute the Change-Over and Change-Back procedures. The M2PA layer makes use of the SS7 Extended Changeover (XCO) and SS7 Extended Changeover Acknowledgement (XCA) messages in order to communicate 24-bit sequence numbers with the peer.

SCTP

SCTP is a protocol designed to operate on top of a non-reliable protocol such as IP, while providing a reliable data delivery to the SCTP user. The SCTP protocol is designed to be a discrete protocol.

Although SCTP is similar in some respects to the Transport Control Protocol (TCP), it differs in several key areas. The two protocols are similar in that they both provide reliable data delivery over a non-reliable network protocol (IP). The SCTP protocol is a more robust and higher performance protocol than TCP.

Broader Definition of Connection Four-Tuple

The TCP protocol defines a connection via a four-tuple – a specific local IP address, local transport protocol port, a specific remote host IP address and remote transport protocol port. The TCP connection is point-to-point and once the session is established the four-tuple can not change. SCTP uses a similar four-tuple concept, but provides for the local and remote IP address values to be a list of IP addresses. SCTP allows a multi-homed host, with multiple network interfaces and more than one way to reach the far-end host, the capability to make use of this additional network connectivity to support the transport of data via the SCTP protocol. Redundancy through the support of multi-homing session end-points is a major SCTP advantage.

Multiple Streams

TCP is a point-to-point byte stream oriented transport protocol. In such a protocol if a single byte is corrupted or lost, then all data that follows must be queued and delayed from delivery to the application until the missing data is retransmitted and received to make the stream valid. With the TCP protocol, all data being transmitted is affected because there is only one path from end-to-end. The SCTP protocol addresses this limitation by providing the capability to specify more than one transport path between the two end-points. In SCTP, the four-tuple – with the multi-homing feature – defines what the SCTP protocol calls an *association*.

The association is composed of one or more uni-directional transport paths called *streams*. The number of inbound and outbound streams is independent of one another and is determined at session initiation time (for example, an association may be composed of three outbound and one inbound stream). In this scheme, a data retransmission only affects a single stream. If an association is defined with multiple streams and a packet is lost on a specific stream, data transmission on the other streams, which form this association, is not blocked. However, this feature is only beneficial if the upper layer application uses it.

In the EAGLE, a maximum of 2 inbound and 2 outbound streams can be defined for an association. Stream 0 in each direction is designated for Link Status messages. Stream 1 is designated for User Data messages. Separating the Link Status and User Data messages onto separate streams allows the adapter layer to prioritize the messages in a manner similar to MTP2. If the peer chooses to configure the association to have only one stream, then the signaling gateway will be able to use only stream 0 for both Link Status messages and User Data messages.

Datagram Stream

While TCP is implemented as a byte-oriented stream protocol, SCTP is based on a datagram-oriented protocol stream. By choosing the datagram as the smallest unit of transport, the SCTP protocol removes the need for the upper layer application to encode the length of a message as part of the message. An SCTP send results in the data being sent as a unit – a datagram – and received at the receiving node as a datagram.

Selective Acknowledgements

TCP acknowledgements are specified as the last consecutive byte in the byte stream that has been received. If a byte is dropped, the TCP protocol on the receiving side cannot pass inbound data to the user until the sender retransmits the lost byte; the stream is blocked. SCTP uses a feature known as *selective acknowledgement* in which each data chunk is identified by a chunk number – the Transmission Sequence Number (TSN) in SCTP terminology – and is explicitly acknowledged at a data chunk granularity. This means that if a data chunk is dropped, only that one data chunk needs to be retransmitted. In SCTP, a dropped data chunk only effects one stream, since ordered transmission of data is only enforced at the stream and not the association level.

Un-order Delivery Capability

The SCTP protocol provides a mechanism for un-ordered datagram delivery. This feature means that a datagram can be transmitted and received independent of datagram sequencing and thus not delayed while awaiting a retransmission. TCP does not provide an equivalent feature of this type.

Enhanced Security

The TCP protocol has a known and easily exploitable vulnerability to denial of service attacks (for example, SYN attacks). This weakness is due to the three-way handshake used by the TCP session-establishment protocol. The TCP session establishment method causes EAGLE resources to be committed prior to actually establishing the session. SCTP uses a four-way handshake where resources are not committed by the host being contacted until the contacting host confirms that it is actually making a contact request to prevent such attacks.

SCTP Connectivity Concepts

The basic connectivity provided by the SCTP protocol is illustrated by [Figure 18: SCTP Connectivity](#):

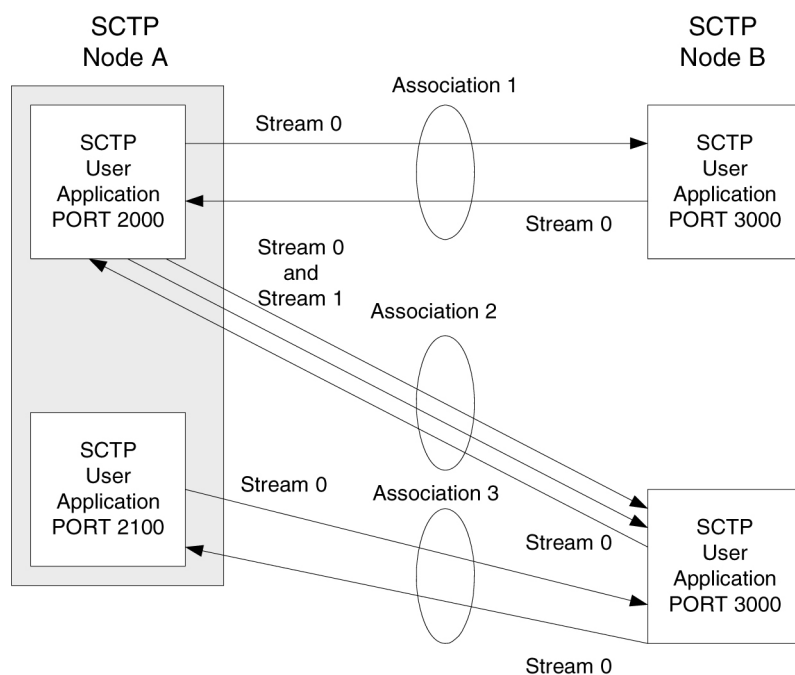

Figure 18: SCTP Connectivity

Key elements of the SCTP connection include:

- Sctp Instance
- Sctp Endpoint
- SctpAssociation
- Sctp Stream

An SCTP instance is defined by the local SCTP port number. Each local SCTP port number requires its own SCTP instance. An SCTP instance as an entity defines the various SCTP characteristics that will apply to “all” SCTP associations that are created as part of the SCTP instance. These include timeout values, maximum receive windows, and so forth.

In *Figure 18: SCTP Connectivity* there are three hosts: SCTP node A, node B and node C. Node A has two SCTP instances: local SCTP port 2000 and 2100. Both node B and node C have a single SCTP instance, local SCTP port 3000 and 3000 respectively. The fact that both node B and C are using port 3000 does not tie them together in any way.

An SCTP endpoint is defined as the logical sender/receiver of SCTP packets. On a multi-homed host, an SCTP endpoint is represented to its peers as a combination of a set of eligible destination transport addresses to which SCTP packets can be sent and a set of eligible source transport addresses from which SCTP packets can be received. All transport addresses used by an SCTP endpoint must use the same port number, but can use multiple IP addresses. A transport address used by an SCTP endpoint must not be used by another SCTP endpoint. In other words, a transport address is unique to an SCTP endpoint.

The concept of SCTP instance clarifies this definition. In *Figure 18: SCTP Connectivity*, IP addresses are not shown, but to illustrate this definition, assume the following:

- Node A is multi-homed having two network interface cards with IP addresses 192.168.110.10 and 192.168.55.10
- Node B has a single network interface card with IP address of 192.168.110.20
- Node C is multi-homed having two network interface cards with IP addresses 192.168.110.30 and 192.168.55.30

Based on these IP addresses from above and the defined port numbers for *Figure 18: SCTP Connectivity*, there are four SCTP endpoints (*Table 10: Sample SCTP Endpoints*).

Table 10: Sample SCTP Endpoints

Node	Local IP Address	Local SCTP Port
Node-1	192.168.110.10 192.168.55.10	2000
Node-1	192.168.110.10 192.168.55.10	2100
Node-2	192.168.110.20	3000
Node-3	192.168.110.30 192.168.55.30	3000

An SCTP association is defined as a protocol relationship between SCTP endpoints, composed of the two SCTP endpoints and protocol state information including verification tags and the currently active set of Transmission Sequence Numbers (TSNs), etc. An association can be uniquely identified by the transport addresses used by the endpoints in the association. Two SCTP endpoints must not have more than one SCTP association between them at any given time.

Based on this definition, given the endpoints listed above and *Figure 18: SCTP Connectivity*, there are three defined SCTP associations.

Table 11: Sample SCTP Associations

Association	Local IP Address	Local SCTP Port	Remote IP Address	Remote SCTP Port
Association-1	192.168.110.10 192.168.55.10	2000	192.168.110.20	3000
Association-2	192.168.110.10 192.168.55.10	2000	192.168.110.30 192.168.55.30	3000
Association-3	192.168.110.10 192.168.55.10	2100	192.168.110.30 192.168.55.30	3000

An SCTP stream is defined as a uni-directional logical channel established from one to another associated SCTP endpoint, within which all user messages are delivered in sequence except for those submitted to the unordered delivery service.

Note:

The relationship between stream numbers in opposite directions is strictly a matter of how the applications use them. It is the responsibility of the SCTP user to create and manage these correlations if they are so desired.

Based on this definition and [Figure 18: SCTP Connectivity](#), there are a total of seven streams for the three associations.

Table 12: Sample SCTP Associations

Association	Stream Number	Local IP Address	Local SCTP Port	Remote IP Address	Remote SCTP Port
Association-1	Stream 0 Out	192.168.110.10 192.168.55.10	2000	192.168.110.20	3000
Association-1	Stream 0 In	192.168.110.10 192.168.55.10	2000	192.168.110.20	3000
Association-2	Stream 0 Out	192.168.110.10 192.168.55.10	2000	192.168.110.30 192.168.55.30	3000
Association-2	Stream 1 Out	192.168.110.10 192.168.55.10	2000	192.168.110.30 192.168.55.30	3000
Association-2	Stream 0 In	192.168.110.10 192.168.55.10	2000	192.168.110.30 192.168.55.30	3000
Association-3	Stream 0 Out	192.168.110.10 192.168.55.10	2100	192.168.110.30 192.168.55.30	3000

Association	Stream Number	Local IP Address	Local SCTP Port	Remote IP Address	Remote SCTP Port
Association-3	Stream 0 In	192.168.110.10 192.168.55.10	2100	192.168.110.30 192.168.55.30	3000

IP Signaling Gateway (IPSG)

The IP Signaling Gateway (IPSG) feature provides a signaling gateway (SG) application as an alternative to the IPLIM and IPGW applications. However, the IPLIM and IPGW applications continue to be supported.

The IPSG feature can run the M2PA and M3UA protocols simultaneously on the same card. The feature also supports ANSI, ITU-N or ITUN-24, and ITU-I simultaneously on one card and one association.

The IPSG feature runs on the E5-ENET card with the IPSG application. An E5-ENET card running the IPSG application is referred to as an IPSG card.

For the M3UA protocol, the IPSG feature equates a linkset with an application server (AS) and equates a signaling link with an application-server/application server process instance (AS-ASP).

Note: The following M3UA application server (AS) procedures are not currently supported by the IP Signaling Gateway (IPSG):

- AS Pending procedure with non-zero T(recovery) timer
- AS Override traffic mode

The connection to the remote host is provided by IPSG M3UA and IPSG M2PA signaling links. An IPSG M3UA signaling link is a signaling link that is assigned to an IPSG linkset whose ADAPTER value is m3ua. An IPSG M2PA signaling link is a signaling link that is assigned to an IPSG linkset whose ADAPTER value is m2pa. A maximum of 32 IPSG M2PA or IPSG M3UA signaling links are supported per IPSG card.

The IPSG M2PA signaling link can run the ANSI or ITU protocol, but not both simultaneously. ANSI and ITU can run on the same IPSG card on separate IPSG M2PA signaling links. ANSI and ITU can run on the same IPSG M3UA signaling link.

A series of three IS-NR link count thresholds are used to control the transition of the IPSG-M3UA links between Allowed, Restricted, and Prohibited states.

M2PA links on IPLIMx and IPSG cards can exist in the same linkset. M3UA links on IPSG and IPGWx cards cannot exist in the same linkset. M2PA and M3UA links cannot exist within the same linkset.

Each IPSG card can host up to 32 SCTP associations. A maximum of 16 M3UA links or 1 M2PA link can be assigned to an association. M3UA and M2PA cannot be mixed on the same association.

The SCTP ADLER-32 or CRC-32 checksum algorithm can be selected for an individual IPLIM, IPGW, or IPSG card.

The adjacent point code (APC) of the IPSG-M3UA linkset is the point code assigned to an AS.

Provisioning for the IP Signaling Gateway feature uses the card, linkset, signaling link, IP card, IP link, IP host, and association database entities. The relationship between these entities is shown in

Figure 19: IP Signaling Gateway Database Relationships. The provisioning for the IP Signaling Gateway feature is shown in *IPSG M2PA and M3UA Configuration Procedures*.

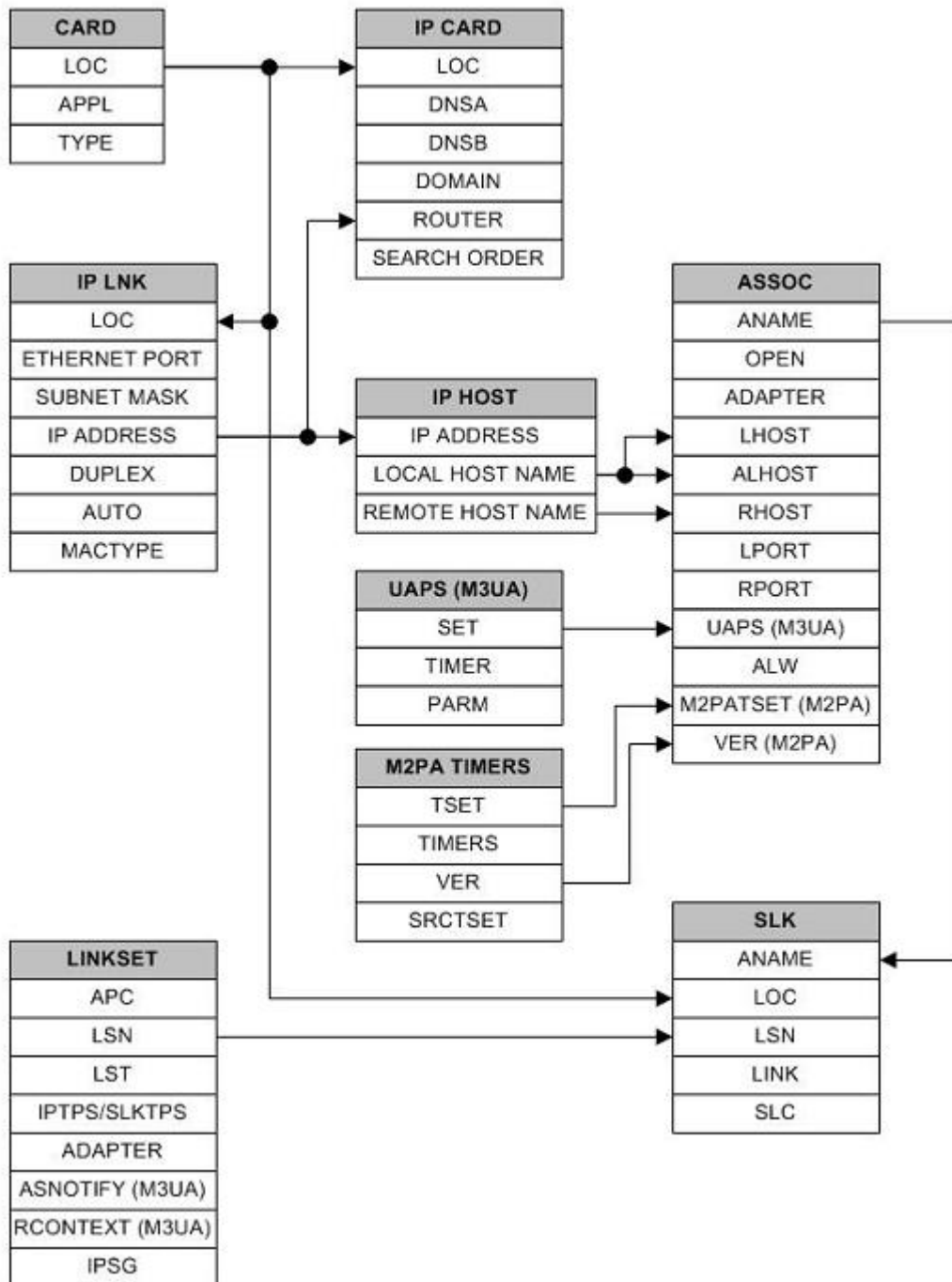

Figure 19: IP Signaling Gateway Database Relationships

Chapter 3

IETF M2PA Configuration Procedures

Topics:

- *Adding IETF IPLIMx Components.....64*
- *Adding an IPLIMx Card.....65*
- *Adding an IPLIMx Signaling Link.....73*
- *Configuring an IP Link.....93*
- *Adding an IP Host.....112*
- *Configuring an IP Card.....116*
- *Adding an IP Route.....128*
- *Adding an M2PA Association.....135*
- *Activating the Large MSU Support for IP Signaling Feature.....149*
- *Removing IETF M2PA Components.....158*
- *Removing an IPLIMx Card.....158*
- *Removing an IPLIMx Signaling Link.....161*
- *Removing an IP Host Assigned to an IPLIMx Card.....171*
- *Removing an IP Route.....176*
- *Removing an M2PA Association.....180*
- *Changing IETF M2PA Components.....184*
- *Changing the Attributes of an M2PA Association.....184*
- *Changing the Buffer Size of a M2PA Association.....199*
- *Changing the Host Values of a M2PA Association.....210*
- *Changing the Link Value of a M2PA Association to another Link Value on the Same IPLIMx Card.....228*
- *Configuring SCTP Retransmission Control for a M2PA Association.....237*
- *Changing a M2PA Timer Set.....245*
- *Changing the SCTP Checksum Algorithm Option for M2PA Associations.....253*

Chapter 3, IETF M2PA Configuration Procedures, describes the procedures necessary to configure the components necessary to establish IP connections using M2PA associations on IPLIMx signaling links.

- *Turning Off the Large MSU Support for IP Signaling Feature271*



Adding IETF IPLIMx Components

This section describes how to configure the components necessary to establish IP connections using M2PA associations on IPLIMx signaling links. IPLIMx signaling links are signaling links assigned to cards running either the IPLIM or IPLIMI applications. The IPLIM application supports point-to-point connectivity for ANSI networks. The IPLIMI application supports point-to-point connectivity for ITU networks.

The configuration of these IP connections consists of these items.

1. Configure the IPLIMx card with the [Adding an IPLIMx Card](#) procedure.
2. Configure the required destination point codes - see Chapter 2, "Configuring Destination Tables," in *Database Administration - SS7 User's Guide*.
3. Configure the required IPLIMx linksets - see Chapter 3, "SS7 Configuration," in *Database Administration - SS7 User's Guide*.
4. Configure the IPLIMx signaling links with the [Adding an IPLIMx Signaling Link](#) procedure. The `ipliml2=m2pa` parameter of the `ent-slk` command must be specified for these signaling links. If the addition of these signaling links will exceed the current number of signaling links the EAGLE is allowed to have, the [Enabling the Large System # Links Controlled Feature](#) procedure will have to be performed to increase the quantity of signaling links.
5. Configure the required routes - see Chapter 3, "SS7 Configuration," in the *Database Administration - SS7 User's Guide*.
6. IP addresses must be assigned to the IPLIMx card configured in step 1 by performing the [Configuring an IP Link](#) procedure. There are other IP link parameters that are assigned to the IPLIMx card when the IPLIMx card is configured. Default values are assigned to these parameters when the IPLIMx card is configured. These values can be displayed by the `rtrv-ip-lnk` command. These values can be changed by performing the [Configuring an IP Link](#) procedure.
7. Local IP hosts, assigned to the IP addresses assigned to step 6, must be configured in the database by performing the [Adding an IP Host](#) procedure. Verify the hosts with the `rtrv-ip-host` command. This establishes a relationship between the IP card related information and the connection related information.
8. When the IP cards are added to the database in step 1, there are IP parameters that control the IP stack that are assigned default values. These parameter values can be displayed by the `rtrv-ip-card` command. These values can be changed by performing the [Configuring an IP Card](#) procedure.
9. Static IP routes provide more flexibility in selecting the path to the remote destination and reduces the dependence on default routers. Static IP routes are provisioned by performing the [Adding an IP Route](#) procedure.
10. Associations specify a connection between a local host/TCP port and a remote host/TCP port. Three types of associations can be provisioned: M2PA, M3UA, and SUA. Associations that are assigned to IPLIMx signaling links must be M2PA associations. The `ipliml2=m2pa` parameter must be assigned to the signaling link that is assigned to an M2PA association. The M2PA association is configured by performing the [Adding an M2PA Association](#) procedure. M3UA and SUA associations are provisioned with the [Adding an M3UA or SUA Association](#) procedure. Associations can be assigned to IPSP signaling links also. These associations are configured by performing the [Adding an IPSP M2PA Association](#) or [Adding an IPSP M3UA Association](#) procedures. A number of fields in the association cannot be configured with the [Adding an M2PA Association](#) procedure and are set to default values. The values of these fields can be displayed using the `rtrv-assoc` command after the [Adding an M2PA Association](#) procedure is performed. These values can be changed by

performing the [Adding an M2PA Association](#) procedure. An IPLIMx card can have one association for each signaling link assigned to the card.

11. There are two versions of M2PA associations, RFC and Draft 6, that can be configured in the database. When an M2PA association is added to the database with [Adding an M2PA Association](#) procedure, the association is configured as an RFC M2PA association. The RFC version of M2PA timer set 1 is also assigned to the association when the M2PA association is added to the database.

There are two different versions, RFC and Draft 6, of M2PA timer sets that can be assigned to M2PA associations. Each version of the M2PA timer sets contains 20 timer sets. The values of these timer sets can be changed with the [Changing a M2PA Timer Set](#) procedure.

The version of the M2PA association and the M2PA timer set assigned to the association can be changed with [Adding an M2PA Association](#) procedure. The M2PA version of the association determines the version of the M2PA timer set that is assigned to the association. For example, if M2PA timer set 3 is assigned to the M2PA association, and the association is an RFC M2PA association, the RFC version of M2PA timer set 3 is used with the association. If M2PA timer set 7 is assigned to the M2PA association, and the association is a Draft 6 M2PA association, the Draft 6 version of M2PA timer set 7 is used with the association.

12. The EAGLE processes messages with a service information field (SIF) that is 272 bytes or smaller. The Large MSU Support for IP Signaling feature allows the EAGLE to process messages with a service indicator value of 6 to 15 and with a SIF that is larger than 272 bytes. Perform the [Activating the Large MSU Support for IP Signaling Feature](#) procedure to enable and turn on the Large MSU Support for IP Signaling feature.

Adding an IPLIMx Card

This procedure is used to add an IPLIMx card to the database using the `ent-card` command. An IPLIMx card runs either the IPLIM or IPLIMI applications. A maximum of 100 IPLIMx cards can be provisioned in the database. [Table 13: IPLIMx Card Types](#) shows the cards that can be provisioned in this procedure.

Table 13: IPLIMx Card Types

Card Type	Part Number
E5-ENET	870-2212-xx
E5-ENET-B	870-2971-xx

The EAGLE can support a combination of E5-ENET and E5-ENET-B cards.

The `ent-card` command uses these parameters.

`:loc` – The location of the card being added to the database.

`:type` – The type of card being added to the database. For this procedure, the value of this parameter is `dcm`.

`:appl` – The application software that is assigned to the card. For this procedure, the value of this parameter is `iplim` for ANSI IP network connections or `iplimi` for ITU IP network connections.

: *force* – If the global title translation feature is on, the *force=yes* parameter allows the LIM to be added to the database even if the current SCCP transactions-per-second threshold is unable to support the additional SCCP transaction-per-second capacity created by adding the IP card. This parameter is obsolete and is no longer used.

Card Slot Selection

The E5-ENET card can be inserted into any card slot, except for card slots that must remain empty to accommodate dual-slot cards, slots 09 and 10 in each shelf, and slots 1113 through 1118.

To provision a E5-ENET card, the shelf containing the E5-ENET card must have HIPR2 cards installed in slots 9 and 10 in that shelf. If HIPR2 cards are not installed in the shelf that the E5-ENET card will occupy, the E5-ENET card will be auto-inhibited when the E5-ENET card is inserted into the shelf.

Enter the *rept-stat-gp1:gp1=hipr2* command to verify whether or not HIPR2 cards are installed in the same shelf as the E5-ENET card being provisioned in this procedure.

Before adding an IPLIMx card, the Eagle STP must have a fan unit, and the fan feature must be turned on. Also, the MFC STP option must be on.

1. Display the cards in the database using the *rtrv-card* command.

This is an example of the possible output. Cards should be distributed throughout the EAGLE for proper power distribution. Refer to *Installation Guide* for the shelf power distribution.

```
rlghncxa03w 09-05-05 08:12:53 GMT 41.0.0
CARD   TYPE      APPL      LSET NAME      LINK SLC LSET NAME      LINK SLC
1101   DSM        VSCCP
1102   TSM        GLS
1113   GSPM      EOAM
1114   TDM-A
1115   GSPM      EOAM
1116   TDM-B
1117   MDAL
1201   LIMDS0    SS7ANSI    sp2             A    0    sp1             B    0
1203   LIMDS0    SS7ANSI    sp3             A    0
1204   LIMDS0    SS7ANSI    sp3             A    1
1206   LIMDS0    SS7ANSI    nsp3            A    1    nsp4            B    1
1216   DCM       STPLAN
1301   LIMDS0    SS7ANSI    sp6             A    1    sp7             B    0
1302   LIMDS0    SS7ANSI    sp7             A    1    sp5             B    1
1303   DCM       IPLIM      ipnode1         A    0    ipnode3         B    1
1305   DCM       IPLIM      ipnode4         A    0
1307   DCM       STPLAN
2101   ENET      IPG
2103   ENET      IPG
2105   ENET      IPG
2107   ENET      IPG
2201   DCM       IPLIM
2203   DCM       IPLIM
2207   DCM       IPLIM
2211   DCM       SS7IPGW
2213   DCM       SS7IPGW
2215   DCM       IPGWI
2217   DCM       IPGWI
2301   DCM       SS7IPGW
2303   DCM       SS7IPGW
2305   DCM       IPGWI
2307   DCM       IPGWI
2311   DCM       IPLIMI
2313   DCM       IPLIMI
```

Continue the procedure by performing one of these steps.

- If the required unprovisioned card slots (see the section [Card Slot Selection](#)) are shown in the `rtrv-card` output, continue the procedure with [Step 4](#).
 - If the required unprovisioned card slots are not shown in the `rtrv-card` output, [Step 2](#) must be performed.
2. Display the shelves in the database by entering the `rtrv-shlf` command. This is an example of the possible output.

```
rlghncxa03w 08-03-05 08:12:53 GMT 38.0.0
SHELF DISPLAY
FRAME SHELF TYPE
1 1 CONTROL
1 2 EXTENSION
1 3 EXTENSION
2 1 EXTENSION
2 2 EXTENSION
2 3 EXTENSION
```

If all the shelves are provisioned in the database, then the remainder of this procedure cannot be performed. There are no available card slots for the new IPLIMx card.

If all the shelves have not been provisioned in the database, continue the procedure with [Step 3](#).

3. Add the required shelf using the `ent-shlf` command with the location of the shelf and the `type=ext` parameter. The shelf location values are 1200, 1300, 2100, 2200, 2300, 3100, 3200, 3300, 4100, 4200, 4300, 5100, 5200, 5300, and 6100. For this example, enter this command.

```
ent-shlf:loc=3100:type=ext
```

When this command has successfully completed, this message should appear.

```
rlghncxa03w 07-05-01 09:12:36 GMT EAGLE5 37.0.0
ENT-SHLF: MASP A - COMPLTD
```

4. Verify that the card to be entered has been physically installed into the proper location (see the section [Card Slot Selection](#)).



CAUTION

Caution: If the versions of the flash GPLs on theIPSG card do not match the flash GPL versions in the database when theIPSG card is inserted into the card slot,UAM 0002 is generated indicating that theseGPL versions do not match. IfUAM 0002 has been generated, perform the alarm clearing procedure forUAM 0002 in*Maintenance Guide* before proceeding with this procedure.

Note: If the card being added in this procedure is not anE5-ENET card, continue the procedure with[Step 10](#).

5. Verify that HIPR2 cards are installed in card locations 9 and 10 in the shelf containing the E5-ENET card being added in this procedure. Enter this command.

```
rept-stat-gpl:gpl=hipr2
```

This is an example of the possible output.

```
rlghncxa03w 09-07-05 08:12:53 GMT 41.1.0
GPL CARD RUNNING APPROVED TRIAL
HIPR2 1109 132-002-000 132-002-000 132-003-000
```

```

HIPR2      1110      132-002-000      132-002-000      132-003-000
HIPR2      1209      132-002-000      132-002-000      132-003-000
HIPR2      1210      132-002-000      132-002-000      132-003-000
HIPR2      1309      132-002-000      132-002-000      132-003-000
HIPR2      1310      132-002-000      132-002-000      132-003-000
HIPR2      2109      132-002-000      132-002-000      132-003-000
HIPR2      2110      132-002-000      132-002-000      132-003-000
HIPR2      2209      132-002-000      132-002-000      132-003-000
HIPR2      2210      132-002-000      132-002-000      132-003-000
HIPR2      2309      132-002-000      132-002-000      132-003-000
HIPR2      2310      132-002-000      132-002-000      132-003-000
Command Completed

```

If HIPR2 cards are installed in the shelf containing the E5-ENET card, continue the procedure with [Step 10](#).

If HIPR or HIPR2 cards are not installed on the shelf containing the E5-ENET card, go to *Installation Guide* and install the HIPR2 cards. Once the HIPR2 cards have been installed, continue the procedure with [Step 10](#).

6. Enter the `rtrv-stpopts` command to verify whether or not the MFC option is on.

This is an example of the possible output.

```

rlghncxa03w 11-10-17 16:02:05 GMT EAGLE5 44.0.0
STP OPTIONS
-----
MFC                               off

```

The `rtrv-stpopts` command output contains other fields that are not used by this procedure. To see all fields displayed by the `rtrv-stpopts` command, see the `rtrv-stpopts` command description in *Commands User's Guide*.

If the MFC option is off, perform the *Configuring the MFC Option* procedure in *Database Administration - System Management User's Guide* to turn on the MFC option.

If the MFC option is on or the MFC Option procedure in *Database Administration - System Management User's Guide* was performed in this step, continue the procedure with [Step 7](#).

The Fan feature must be purchased before you turn this feature on with the `chg-feat` command. If you are not sure if you have purchased the Fan feature, contact your Sales Representative or Account Representative.

7. Enter the `rtrv-feat` command to verify that the Fan feature is on.

If the Fan feature is on, shown in either the `rtrv-feat` output in this step or in [Step 7](#), continue this procedure with [Step 9](#).

If [Step 7](#) was not performed, the FAN field should be set to on.

The `rtrv-feat` command output contains other fields that are not used by this procedure. To see all fields displayed by the `rtrv-feat` command, see the `rtrv-feat` command description in *Commands User's Guide*.

If the Fan feature is off, continue the procedure with [Step 8](#).

8. Turn the Fan feature on by entering this command.

```
chg-feat:fan=on
```

Note: Once the Fan feature is turned on with the `chg-feat` command, it cannot be turned off.

When the `chg-feat` has successfully completed, this message appears.

```
rlghncxa03w 11-10-28 11:43:04 GMT EAGLE5 44.0.0
CHG-FEAT: MASP A - COMPLTD
```

9. The shelf containing the E5-ENET-B card that is being added in this procedure must have fans installed. Verify whether or not fans are installed on the shelf.

If the fans are installed, continue the procedure with [Step 10](#).

If the fans are not installed on the shelf containing the E5-ENET-B card, go to *Installation Guide* and install the fans. After the fans have been installed and tested, continue the procedure with [Step 10](#).

10. Add the card using the `ent-card` command. For this example, enter these commands.

```
ent-card:loc=1311:type=dcm:appl=iplim
ent-card:loc=1313:type=dcm:appl=iplimi
```

When each of these commands have successfully completed, this message should appear.

```
rlghncxa03w 06-10-12 09:12:36 GMT EAGLE5 36.0.0
ENT-CARD: MASP A - COMPLTD
```

11. Verify the changes using the `rtrv-card` command with the card location specified in [Step 10](#). For this example, enter these commands.

```
rtrv-card:loc=1311
```

This is an example of the possible output.

```
rlghncxa03w 06-10-28 09:12:36 GMT EAGLE5 36.0.0
CARD   TYPE     APPL      LSET NAME      LINK SLC LSET NAME      LINK SLC
1311   DCM       IPLIM
```

```
rtrv-card:loc=1313
```

This is an example of the possible output.

```
rlghncxa03w 06-10-28 09:12:36 GMT EAGLE5 36.0.0
CARD   TYPE     APPL      LSET NAME      LINK SLC LSET NAME      LINK SLC
1313   DCM       IPLIMI
```

12. Back up the new changes using the `chg-db:action=backup:dest=fixed` command. These messages should appear, the active Maintenance and Administration Subsystem Processor (MASP) appears first.

```
BACKUP (FIXED) : MASP A - Backup starts on active MASP.
BACKUP (FIXED) : MASP A - Backup on active MASP to fixed disk complete.
```

BACKUP (FIXED) : MASP A - Backup starts on standby MASP.
 BACKUP (FIXED) : MASP A - Backup on standby MASP to fixed disk complete.

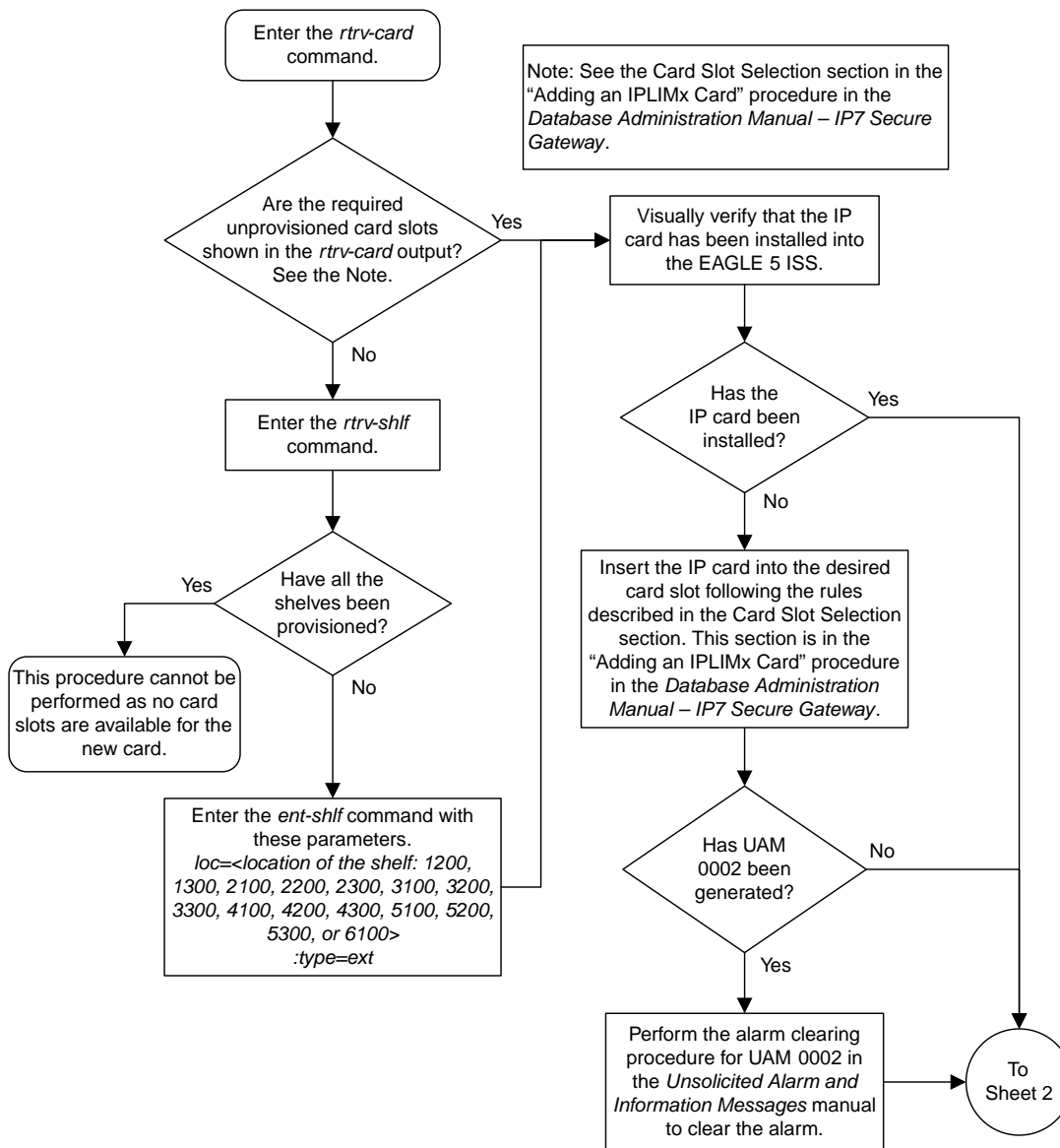

Sheet 1 of 3

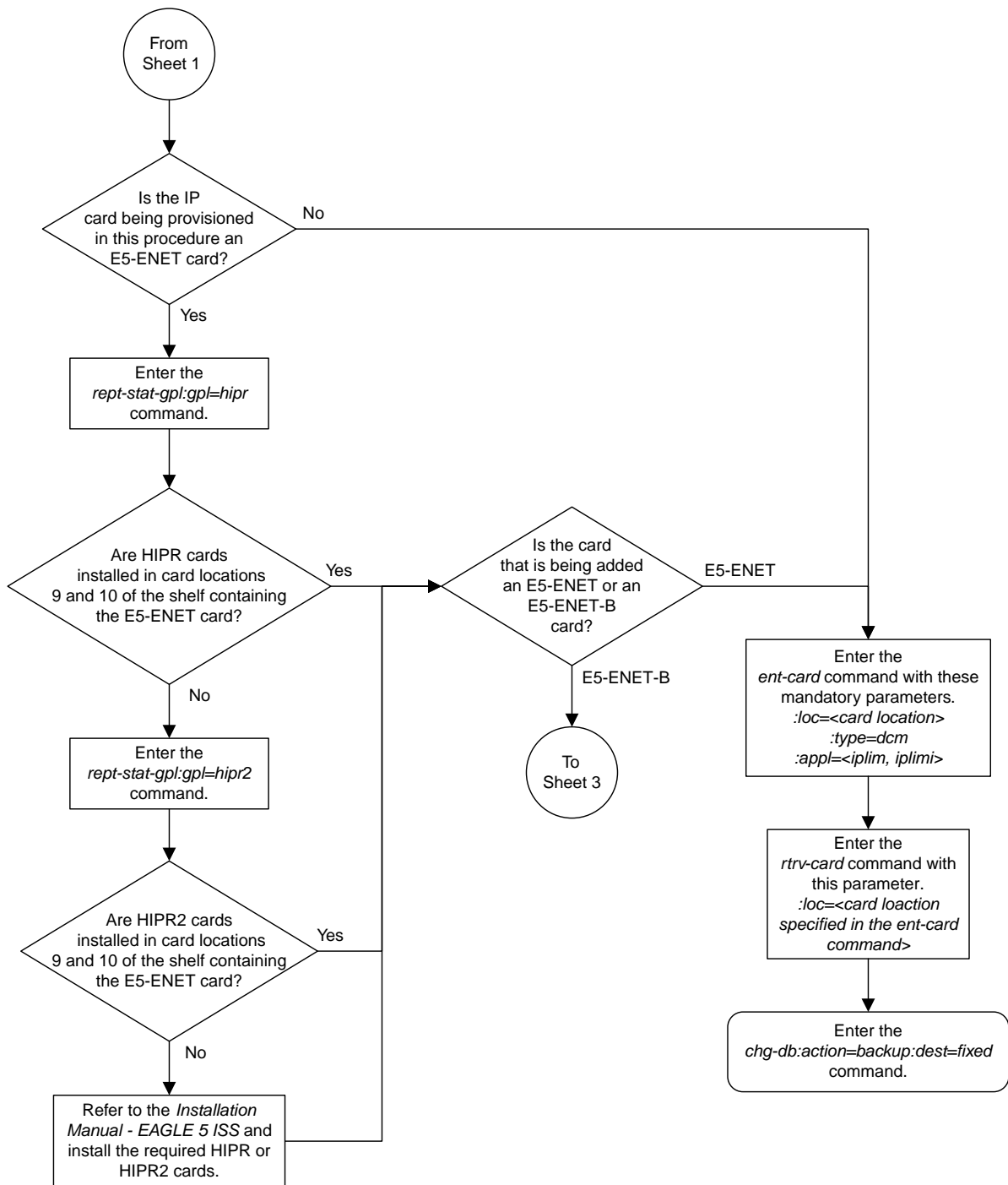

Sheet 2 of 3

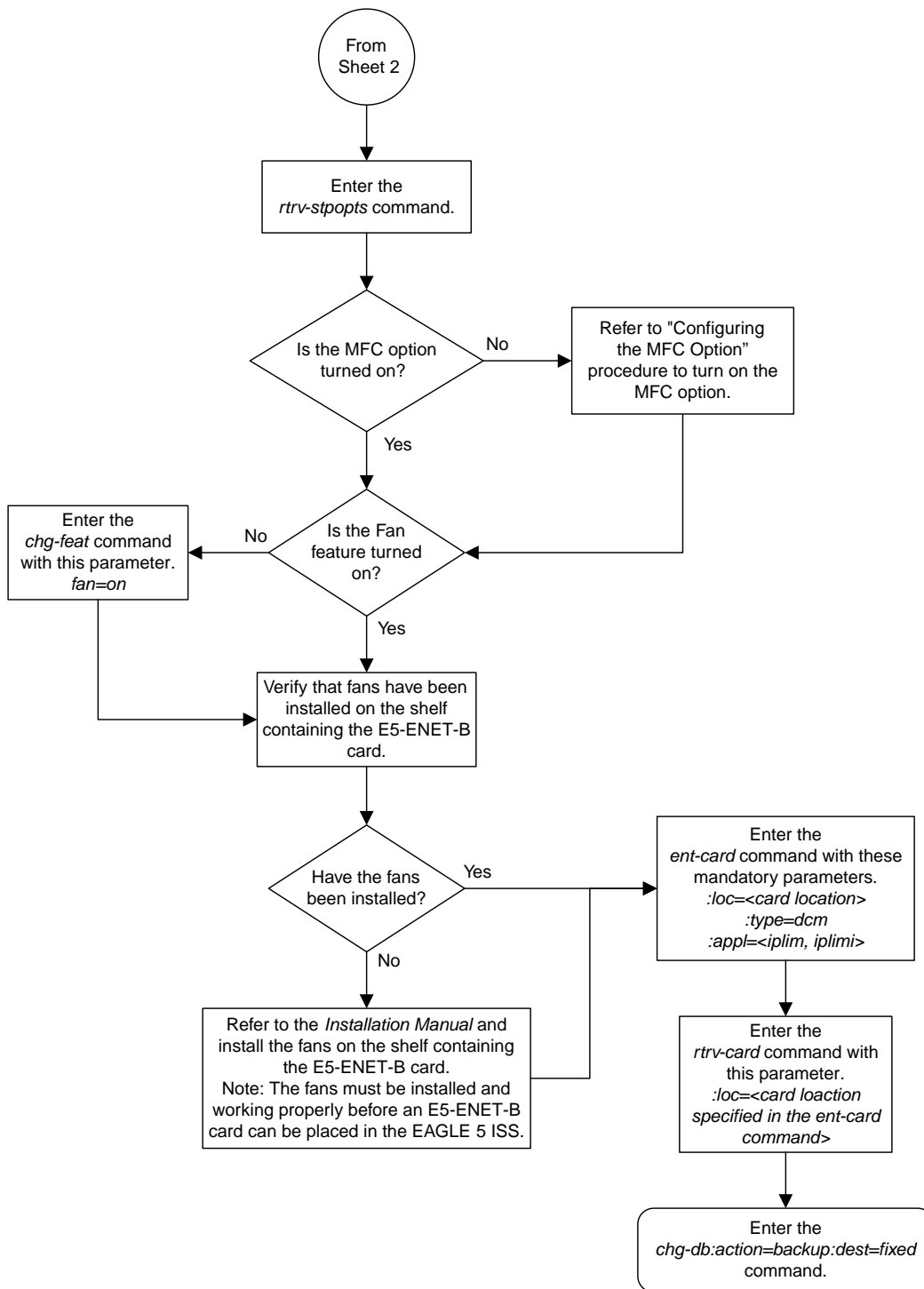

Sheet 3 of 3

Figure 20: Adding an IPLIMx Card

Adding an IPLIMx Signaling Link

This procedure is used to add an IPLIMx signaling link to the database using the `ent-slk` command. The `ent-slk` command uses these parameters.

`:loc` – The card location of the IP card that the IP signaling link will be assigned to. The cards specified by this parameter are IP cards running the IPLIM or IPLIMI applications.

`:link` – The signaling link on the card specified in the `loc` parameter.

`:lsn` – The name of the linkset that will contain the signaling link.

`:slc` – The signaling link code. The SLC must be unique within the linkset. It must be the same at both the EAGLE location and the distant node.

`:ipliml2` – The L2 protocol stack to be assigned to the IP signaling link, M2PA (the default value).

The `ent-slk` command contains other optional parameters that are not used to configure an IPGWx signaling link. These parameters are discussed in more detail in *Commands User's Guide* or in these sections.

- These procedures in this manual:
 - [Adding an IPGWx Signaling Link](#)
 - [Adding an IPSP M3UA Signaling Link](#)
 - [Adding an IPSP M2PA Signaling Link](#)
- These procedures in *Database Administration - SS7 User's Guide*
 - Adding an SS7 Signaling Link
 - Adding an E1 Signaling Link
 - Adding a T1 Signaling Link
 - Adding an ATM High-Speed Signaling Link

These items must be configured in the database before an IP signaling link can be added:

- Shelf – perform the "Adding a Shelf" procedure in *Database Administration - System Management User's Guide*
- Card – perform the [Adding an IPLIMx Card](#) procedure
- Destination Point Code – perform the "Adding a Destination Point Code" procedure in *Database Administration - SS7 User's Guide*.
- Linkset – An IPLIMx signaling link can be assigned to any linkset that does not contain IPGWx signaling links. Perform one of these procedures to add the linkset.
 - "Adding an SS7 Linkset" in *Database Administration - SS7 User's Guide*
 - [Adding an IPSP M2PA Linkset](#)
 - [Adding an IPSP M3UA Linkset](#)

Adding the IPLIMx signaling link to an IPLIMx card that does not contain any IPLIMx signaling links cannot exceed the maximum total provisioned system TPS shown in the `rtrv-tps` output. An IPLIMx card that contains IPLIMx signaling links uses 4000 TPS. If the IPLIMx signaling link is being added to an IPLIMx card that contains other signaling links, no additional TPS is used and the maximum total provisioned system TPS shown in the `rtrv-tps` output will not be exceeded.

If adding the IPLIMx signaling link will exceed the maximum total provisioned system TPS, and the maximum total provisioned system TPS is 500,000, perform the "Activating the HIPR2 High Rate Mode" feature in *Database Administration - System Management User's Guide* to enable and turn on the HIPR2 High Rate Mode feature. When the HIPR2 High Rate Mode feature is enabled and turned on, the maximum total provisioned system TPS is increased to 1,000,000 (1M). If the maximum total provisioned system TPS is 1M, or the maximum total provisioned system TPS is 500,000 and will not be increased, and adding the IPLIMx signaling link will exceed the maximum total provisioned system TPS, the IPLIMx signaling link cannot be added unless the amount of available TPS is reduced enough to allow the IPLIMx signaling link to be added. The available TPS can be reduced by performing one or more of these actions.

- The IP TPS values of some IPGWx linksets have to be changed.
- The MAXSLKTPS values of some IPSG linksets (and the RSVDSLKTPS values if necessary) have to be changed.
- Some ATM high-speed signaling links have to be removed.
- An IPLIMx card that contains signaling links has to be removed.

Verify that the link has been physically installed (all cable connections have been made).

To configure the EAGLE to perform circular routing detection test on the signaling links, "Configuring Circular Route Detection" procedure in the *Database Administration - SS7 User's Guide*.

Note: Circular route detection is not supported in ITU networks.

To provision a EAGLE with more than 1200 signaling links, the EAGLE must have certain levels of hardware installed. See the [Requirements for EAGLEs Containing more than 1200 Signaling Links](#) section for more information on these hardware requirements.

The EAGLE can contain a mixture of low-speed, E1, T1, ATM high-speed, and IP signaling links. The [Determining the Number of High-Speed and Low-Speed Signaling Links](#) section describes how to determine the quantities of the different types of signaling links the EAGLE can have.

Canceling the REPT-STAT-SLK, RTRV-LS, and RTRV-SLK Commands

Because the `rept-stat-slk`, `rtrv-ls`, and `rtrv-slk` commands used in this procedure can output information for a long period of time, the `rept-stat-slk`, `rtrv-ls`, and `rtrv-slk` commands can be canceled and the output to the terminal stopped. There are three ways that the `rept-stat-slk`, `rtrv-ls`, and `rtrv-slk` commands can be canceled.

- Press the F9 function key on the keyboard at the terminal where the `rept-stat-slk`, `rtrv-ls`, or `rtrv-slk` commands were entered.
- Enter the `canc-cmd` without the `trm` parameter at the terminal where the `rept-stat-slk`, `rtrv-ls`, or `rtrv-slk` commands were entered.
- Enter the `canc-cmd:trm=<xx>`, where `<xx>` is the terminal where the `rept-stat-slk`, `rtrv-ls`, or `rtrv-slk` commands were entered, from another terminal other than the terminal where the `rept-stat-slk`, `rtrv-ls`, or `rtrv-slk` commands was entered. To enter the `canc-cmd:trm=<xx>` command, the terminal must allow Security Administration commands to be entered from it and the user must be allowed to enter Security Administration commands. The terminal's permissions can be verified with the `rtrv-secu-trm` command. The user's permissions can be verified with the `rtrv-user` or `rtrv-secu-user` commands.

For more information about the `canc-cmd` command, go to *Commands User's Guide*.

1. Display the maximum number of signaling links the EAGLE can have and the number of signaling links that are currently provisioned by entering the `rtrv-tbl-capacity` command.

This is an example of the possible output.

```
rlghncxa03w 09-07-19 21:16:37 GMT EAGLE5 41.1.0
SLK          table is (          4 of          1200)  1% full
```

Note: The `trv-tbl-capacity` command output contains other fields that are not used by this procedure. If you wish to see all the fields displayed by the `trv-tbl-capacity` command, refer to the `trv-tbl-capacity` command description in *Commands User's Guide*.

If the addition of the new signaling link will not exceed the maximum number of signaling links the EAGLE can have, continue the procedure with [Step 2](#).

If the addition of the new signaling link will exceed the maximum number of signaling links the EAGLE can have, and the maximum number of signaling links is less than 2800, perform the [Enabling the Large System # Links Controlled Feature](#) procedure to enable the desired quantity of signaling links. After the new quantity of signaling links has been enabled, continue the procedure with [Step 2](#).

If the addition of the new signaling link will exceed the maximum number of signaling links the EAGLE can have (in this example, the maximum number of signaling links is 1200), and the maximum number of signaling links is 2800, this procedure cannot be performed. The EAGLE cannot contain more than 2800 signaling links.

2. Display the total provisioned system TPS by entering the `rtrv-tps` command. This is an example of the possible output.

```
rlghncxa03w 10-07-10 16:20:46 GMT EAGLE 42.0.0

CARD      NUM      NUM      RSVD      MAX
TYPE      CARDS   LINKS    TPS       TPS
-----
IPGW      17       16       48000     80000
IPSG      3         7        4200      8000
IPLIM     2         4        8000      8000
ATM       2         2        3668      3668

Total provisioned System TPS (99668 of 500000) 20%
Command Completed.
```

3. Display the cards in the database using the `rtrv-card` command.

This is an example of the possible output.

```
rlghncxa03w 13-06-28 09:12:36 GMT EAGLE5 45.0.0
CARD  TYPE      APPL      LSET NAME  LINK SLC LSET NAME  LINK SLC
1101  DCM        SS7IPGW   ipgwx1     A    0
1102  DCM        SS7IPGW   ipgwx1     A    1
1103  DCM        SS7IPGW   ipgwx1     A    2
1104  DCM        SS7IPGW   ipgwx1     A    3
1105  DCM        SS7IPGW   ipgwx1     A    4
1106  DCM        SS7IPGW   ipgwx1     A    5
1107  DCM        SS7IPGW   ipgwx1     A    6
1108  DCM        SS7IPGW   ipgwx1     A    7
1111  DCM        SS7IPGW   ipgwx2     A    0
```

1112	DCM	SS7IPGW	ipgwx2	A	1			
1113	E5MCAP	OAMHC						
1114	E5TDM-A							
1115	E5MCAP	OAMHC						
1116	E5TDM-B							
1117	E5MDAL							
1201	DCM	SS7IPGW	ipgwx2	A	2			
1202	DCM	SS7IPGW	ipgwx2	A	3			
1203	DCM	SS7IPGW	ipgwx2	A	4			
1204	DCM	SS7IPGW	ipgwx2	A	5			
1205	DCM	SS7IPGW	ipgwx2	A	6			
1206	DCM	SS7IPGW	ipgwx2	A	7			
1207	DSM	VSCCP						
1208	TSM	GLS						
1211	DCM	STPLAN						
1301	DCM	IPLIM	lsniplim	A	0	lsniplim	A1	1
			lsniplim	B1	2			
1302	LIMATM	ATMANSI						
1303	ENET	IPSG	ipsglsn	A	0	ipsglsn	A1	1
			ipsglsn	B1	2	ipsglsn	A2	3
			ipsglsn	A3	4	ipsglsn2	B3	0
1304	LIMATM	ATMANSI						
1305	LIMATM	ATMANSI	lsnds0	A	1			
1306	LIME1ATM	ATMITU	lsnituatm	A	0			
1307	ENET	IPSG	ipsglsn	A	5			
1311	DCM	IPLIM						
1312	LIMDS0	SS7ANSI	lsnds0	A	0			
1317	DCM	IPLIMI	lsniplimi	A	0			
1318	LIMATM	ATMANSI						

If the required card is not in the database, perform the [Adding an IPLIMx Card](#) procedure and add the IPLIMx card to the database.

Note: If the linkset that the signaling link will be added to contains the `multgcs=yes` parameter, the application assigned to the card must be IPLIMI.

An IPLIMx card that contains signaling links uses 4000 TPS. If the card that the new IPLIMx signaling link will be assigned to has other signaling links assigned to it (shown in the `LSET NAME`, `LINK`, and `SLC` columns in the `rtrv-card` output), continue the procedure with [Step 8](#).

If the [Adding an IPLIMx Card](#) procedure was performed in this step, or if the new signaling link will be assigned to an existing IPLIMx card that contains no signaling links, continue the procedure by performing one of these actions.

- If adding the new IPLIMx signaling link will not exceed the maximum total provisioned system TPS, shown in [Step 2](#), continue the procedure with [Step 8](#).
- If adding the new IPLIMx signaling link will exceed the maximum total provisioned system TPS, and the maximum total provisioned system TPS is 500,000 shown, perform the "Activating the HIPR2 High Rate Mode Feature" procedure in *Database Administration - System Management User's Guide* to enable and turn on the HIPR2 High Rate Mode feature. When the HIPR2 High Rate Mode feature is enabled and turned on, the maximum total provisioned system TPS is increased to 1M. After the HIPR2 High Rate Mode feature has been enabled and turned on, continue the procedure with [Step 8](#).
- If the maximum total provisioned system TPS is 1M, or the maximum total provisioned system TPS is 500,000 and will not be increased, and adding the IPLIMx signaling link will exceed the maximum total provisioned system TPS, the IPLIMx signaling link cannot be added unless the amount of available TPS is reduced enough to allow the IPLIMx signaling link to be added. The available TPS can be increased by performing one or more of these actions.

- The IP TPS values of some IPGWx linksets have to be changed. To perform this action, continue the procedure with [Step 6](#).
- The MAXSLKTPS values of some IPSP linksets (and the RSVDSLKTPS values if necessary) have to be changed. To perform this action, continue the procedure with [Step 6](#).
- Some ATM high-speed signaling links have to be removed. To perform this action, continue the procedure with [Step 4](#).
- An IPLIMx card that contains signaling links has to be removed. To perform this action, continue the procedure with [Step 5](#).

4. Display the ATM high-speed signaling links by entering this command.

```
rtrv-slk:type=saal
```

This is an example of the possible output.

```
rlghncxa03w 10-07-19 21:16:37 GMT EAGLE5 42.0.0

LOC LINK LSN          SLC TYPE      LP          ATM
1303 A  lsnds0          1  LIMATM      1  1.544M LINE    VCI  VPI  LL
                    5      0      0

LOC LINK LSN          SLC TYPE      LP          ATM          E1ATM
1306 A  lsnituatm      0  LIME1ATM    21 2.048M LINE    VCI  VPI  CRC4 SI SN
                    5      0      ON   3   0

SLK table is (30 of 1200) 2% full.
```

If ATM high-speed signaling links are shown in the `rtrv-slk` output, perform the "Removing an SS7 Signaling Link" procedure in *Database Administration - SS7 User's Guide* to remove some of the ATM high-speed signaling links.

If ATM high-speed signaling links are not displayed in the `rtrv-slk` output, perform one or more of these actions to increase the available TPS.

Note: If one or more of these actions are not performed to increase the available TPS and the available TPS will not allow the IPLIMx signaling link to be added, the IPLIMx signaling link cannot be added and the remainder of this procedure cannot be performed.

- The IP TPS values of some IPGWx linksets have to be changed. To perform this action, continue the procedure with [Step 6](#).
- The MAXSLKTPS values of some IPSP linksets (and the RSVDSLKTPS values if necessary) have to be changed. To perform this action, continue the procedure with [Step 6](#).
- An IPLIMx card that contains signaling links has to be removed. To perform this action, continue the procedure with [Step 5](#).

If you do not wish to perform other actions to increase the available TPS and the available TPS will allow the IPLIMx signaling link to be added, continue the procedure with [Step 8](#).

5. Display the signaling links that are assigned to IPLIMx cards by entering this command.

```
rtrv-slk:type=iplim
```

This is an example of the possible output.

```
rlghncxa03w 10-07-19 21:16:37 GMT EAGLE5 42.0.0
```

```

LOC LINK LSN          SLC TYPE      ANAME          SLKTPS
1301 A  lsniplim      0  IPLIM      M2PA
1301 A1 lsniplim      1  IPLIM      M2PA
1301 B1 lsniplim      2  IPLIM      M2PA
1317 A  lsniplimi     0  IPLIMI     M2PA

```

```
SLK table is (30 of 1200) 2% full.
```

If IPLIMx cards containing signaling links are shown in the `rtrv-slks` output, perform the [Removing an IPLIMx Card](#) procedure to remove an IPLIMx card and its associated signaling links.

If IPLIMx cards containing signaling links are not displayed in the `rtrv-slks` output, perform one or more of these actions to increase the available TPS.

Note: If one or more of these actions are not performed to increase the available TPS and the available TPS will not allow the IPLIMx signaling link to be added, the IPLIMx signaling link cannot be added and the remainder of this procedure cannot be performed.

- The IP TPS values of some IPGWx linksets have to be changed. To perform this action, continue the procedure with [Step 6](#).
- The MAXSLKTPS values of some IPSP linksets (and the RSVDSLKTPS values if necessary) have to be changed. To perform this action, continue the procedure with [Step 6](#).
- Some ATM high-speed signaling links have to be removed. To perform this action, continue the procedure with [Step 4](#).

If you do not wish to perform other actions to increase the available TPS and the available TPS will allow the IPLIMx signaling link to be added, continue the procedure with [Step 8](#).

6. Display the IPGWx and IPSP linksets by entering this command.

```
rept-stat-iptps
```

This is an example of the possible output.

```

rlghncxa03w 10-07-19 21:16:37 GMT EAGLE5 42.0.0
IP TPS USAGE REPORT
-----
                THRESH  CONFIG/  CONFIG/          TPS   PEAK      PEAKTIMESTAMP
                RSVD    MAX
-----
LSN
ipgwx1          100%    ----    32000  TX:   3700   4000  10-07-19 09:49:19
                RCV:   3650   4000  10-07-19 09:49:19
ipgwx2          100%    ----    16000  TX:   4800   5000  10-07-19 09:49:09
                RCV:   4850   5000  10-07-19 09:49:09
ipgwx3          100%    ----    32000  TX:    427    550  10-07-19 09:49:19
                RCV:    312    450  10-07-19 09:49:19
ipsglsn         100%     600    24000  TX:   4800   5000  10-07-19 09:49:19
                RCV:   4800   5000  10-07-19 09:49:19
ipsglsn2        100%     600     4000  TX:    427    550  10-07-19 09:49:19
                RCV:    312    450  10-07-19 09:49:19
-----
Command Completed.

```

If linksets are displayed in the `rept-stat-iptps` output, continue the procedure with [Step 7](#).

If linksets are not displayed in the `rept-stat-iptps` output, perform one or more of these actions to increase the available TPS.

Note: If one or more of these actions are not performed to increase the available TPS and the available TPS will not allow the IPLIMx signaling link to be added, the IPLIMx signaling link cannot be added and the remainder of this procedure cannot be performed.

- An IPLIMx card that contains signaling links has to be removed. To perform this action, continue the procedure with [Step 5](#).
- Some ATM high-speed signaling links have to be removed. To perform this action, continue the procedure with [Step 4](#).

If you do not wish to perform other actions to increase the available TPS and the available TPS will allow the IPLIMx signaling link to be added, continue the procedure with [Step 8](#).

7. Display the attributes of the linksets shown in [Step 6](#) by entering the `rtrv-ls` command with the name of the linkset shown in [Step 6](#).

For this example enter these commands.

```
rtrv-ls:lsn=ipgwx1
```

This is an example of the possible output.

```
rlghncxa03w 10-07-19 21:16:37 GMT EAGLE5 42.0.0

LSN          APCA   (SS7)   SCRN  L3T  SLT      BEI  LST  LNKS  GWS  GWS  GWS
ipgwx1       001-001-002  none  1    1    no  A    8    off  off  off  no  off
              SPCA           CLLI           TFATCABMLQ  MTPRSE  ASL8
              -----
              4          ---    no

RANDSLS
off

IPSG  IPGWAPC  GTTMODE           CGGTMOD
no    yes    CdPA              no

MATELSN  IPTPS  LSUSEALM  SLKUSEALM
-----  -----  -----  -----
          32000  100%      80%

LOC  LINK  SLC  TYPE
1101 A    0    SS7IPGW
1102 A    1    SS7IPGW
1103 A    2    SS7IPGW
1104 A    3    SS7IPGW
1105 A    4    SS7IPGW
1106 A    5    SS7IPGW
1107 A    6    SS7IPGW
1108 A    7    SS7IPGW

Link set table is (8 of 1024) 1% full.

rtrv-ls:lsn=ipgwx2
```

This is an example of the possible output.

```
rlghncxa03w 10-07-19 21:16:37 GMT EAGLE5 42.0.0

LSN              APCA  (SS7)  L3T SLT          GWS GWS GWS
ipgwx2           001-001-003 none 1 1  no  A  8  off off off no  off
                SPCA          CLLI          TFATCABMLQ MTPRSE ASL8
                -----
                4          ---      no

RANDSLS
off

IPSG  IPGWAPC  GTTMODE          CGGTMOD
no    yes     CdPA          no

MATELSN  IPTPS  LSUSEALM  SLKUSEALM
-----  16000  100%     80%

LOC  LINK  SLC  TYPE
1111 A    0   SS7IPGW
1112 A    1   SS7IPGW
1201 A    2   SS7IPGW
1202 A    3   SS7IPGW
1203 A    4   SS7IPGW
1204 A    5   SS7IPGW
1205 A    6   SS7IPGW
1206 A    7   SS7IPGW
```

Link set table is (8 of 1024) 1% full.

```
rtrv-ls:lsn=ipgwx3
```

This is an example of the possible output.

```
rlghncxa03w 10-07-19 21:16:37 GMT EAGLE5 42.0.0

LSN              APCA  (SS7)  L3T SLT          GWS GWS GWS
ipgwx3           001-001-004 none 1 1  no  A  0  off off off no  off
                SPCA          CLLI          TFATCABMLQ MTPRSE ASL8
                -----
                1          ---      no

RANDSLS
off

IPSG  IPGWAPC  GTTMODE          CGGTMOD
no    yes     CdPA          no

MATELSN  IPTPS  LSUSEALM  SLKUSEALM
-----  32000  100%     80%
```

Link set table is (8 of 1024) 1% full.

```
rtrv-ls:lsn=ipsglsn
```

This is an example of the possible output.

```

rlghncxa03w 10-07-19 21:16:37 GMT EAGLE5 42.0.0

LSN          APCA  (SS7)  SCRN  SET  SET  BEI  LST  LNKS  GWS  GWS  GWS
ipsglsn     003-003-003  none  1   1   no  A   6   off  off  off  no  off

          SPCA          CLLI          TFATCABMLQ  MTPRSE  ASL8
          -----          -----          3          ---    no

RANDSLS
off

IPSG  IPGWAPC  GTTMODE          CGGTMOD
yes   no      CdPA          no

ADAPTER  RSVDSLKTPS  MAXSLKTPS
m2pa     600        4000

TPSALM   LSUSEALM   SLKUSEALM
rsvdslktps 100%    100%

LOC  LINK  SLC  TYPE  ANAME
1303 A   0   IPSG  ipsgm2pa1
1303 A1  1   IPSG  ipsgm2pa2
1303 B1  2   IPSG  ipsgm2pa3
1303 A2  3   IPSG  ipsgm2pa4
1303 A3  4   IPSG  ipsgm2pa5
1307 A   5   IPSG  m2pa2

Link set table is (8 of 1024) 1% full.

```

```
rtrv-ls:lsn=ipsglsn2
```

This is an example of the possible output.

```

rlghncxa03w 10-07-19 21:16:37 GMT EAGLE5 42.0.0

LSN          APCA  (SS7)  SCRN  SET  SET  BEI  LST  LNKS  GWS  GWS  GWS
ipsglsn2     005-005-005  none  1   1   no  A   1   off  off  off  no  off

          SPCA          CLLI          TFATCABMLQ  MTPRSE  ASL8
          -----          -----          1          ---    no

RANDSLS
off

IPSG  IPGWAPC  GTTMODE          CGGTMOD
yes   no      CdPA          no

ADAPTER  RSVDSLKTPS  MAXSLKTPS
m2pa     600        4000

TPSALM   LSUSEALM   SLKUSEALM
rsvdslktps 100%    100%

LOC  LINK  SLC  TYPE  ANAME
1303 B3  0   IPSG  ipsgm2pa6

```

```
Link set table is (8 of 1024) 1% full.
```

Perform one or both of these actions as necessary.

- Perform the [Configuring an IPGWx Linkset](#) procedure to change the IPTPS value for any linksets shown in the `rtrv-ls` output whose IPGWAPC value is `yes`.
- Perform the [Changing an IPSG M2PA Linkset](#) procedure (for linkset whose IPSPG value is `yes` and ADAPTER value is M2PA) or the [Changing an IPSG M3UA Linkset](#) procedure (for linkset whose IPSPG value is `yes` and ADAPTER value is M3UA) to change the MAXSLKTPS value (and RSVDSLKTPS value if necessary) for any linksets shown in the `rtrv-ls` output.

Perform one or both of these actions to increase the available TPS if needed.

- An IPLIMx card that contains signaling links has to be removed. To perform this action, continue the procedure with [Step 5](#).
- Some ATM high-speed signaling links have to be removed. To perform this action, continue the procedure with [Step 4](#).

If you do not wish to perform other actions to increase the available TPS and the available TPS will allow the IPLIMx signaling link to be added, continue the procedure with [Step 8](#).

8. Display the current signaling link configuration using the `rtrv-slk` command.

This is an example of the possible output.

```
r1ghncxa03w 10-07-19 21:16:37 GMT EAGLE5 42.0.0
LOC LINK LSN          SLC TYPE          L2T          PCR PCR
1312 A  lsnds0           0  LIMDS0         1    56000    BASIC  ----  -----

LOC LINK LSN          SLC TYPE          LP           ATM          VCI  VPI  LL
1305 A  lsnds0           1  LIMATM         1    1.544M    LINE   5    0    0

LOC LINK LSN          SLC TYPE          LP           ATM          VCI  VPI  CRC4 SI SN
1306 A  lsniuatm        0  LIME1ATM       21   2.048M    LINE   5    0    ON  3  0

LOC LINK LSN          SLC TYPE          ANAME          SLKTPS
1303 A  ipsglsn         0  IPSPG         ipsgm2pa1     600
1303 A1 ipsglsn         1  IPSPG         ipsgm2pa2     600
1303 B1 ipsglsn         2  IPSPG         ipsgm2pa3     600
1303 A2 ipsglsn         3  IPSPG         ipsgm2pa4     600
1303 A3 ipsglsn         4  IPSPG         ipsgm2pa5     600
1303 B3 ipsglsn2        0  IPSPG         ipsgm2pa6     1000
1307 A  ipsglsn         5  IPSPG         m2pa2         600

LOC LINK LSN          SLC TYPE          IPLIML2
1301 A  lsniplim        0  IPLIM         M2PA
1301 A1 lsniplim        1  IPLIM         M2PA
1301 B1 lsniplim        2  IPLIM         M2PA
1317 A  lsniplimi       0  IPLIMI        M2PA

LOC LINK LSN          SLC TYPE
1201 A  ipgwx2          2  SS7IPGW
1202 A  ipgwx2          3  SS7IPGW
1203 A  ipgwx2          4  SS7IPGW
```

```

1204 A ipgwx2 5 SS7IPGW
1205 A ipgwx2 6 SS7IPGW
1206 A ipgwx2 7 SS7IPGW
1101 A ipgwx1 0 SS7IPGW
1102 A ipgwx1 1 SS7IPGW
1103 A ipgwx1 2 SS7IPGW
1104 A ipgwx1 3 SS7IPGW
1105 A ipgwx1 4 SS7IPGW
1106 A ipgwx1 5 SS7IPGW
1107 A ipgwx1 6 SS7IPGW
1108 A ipgwx1 7 SS7IPGW
1111 A ipgwx2 0 SS7IPGW
1112 A ipgwx2 1 SS7IPGW

```

SLK table is (30 of 1200) 2% full.

9. Display the current linkset configuration using the `rtrv-ls` command.

This is an example of the possible output.

```

rlghncxa03w 10-07-10 11:43:04 GMT EAGLE5 42.0.0

LSN          APCA  (SS7)  SCRN SET SET BEI LST LNKS ACT MES DIS SLSCI NIS
ipgwx1       001-001-002 none 1 1 no A 8 off off off no off
ipgwx2       001-001-003 none 1 1 no A 8 off off off no off
ipgwx3       001-001-004 none 1 1 no A 0 off off off no off
lsniplim     002-002-002 none 1 1 no A 3 off off off no off
ipsglsn      003-003-003 none 1 1 no A 6 off off off no off
ipsglsn2     005-005-005 none 1 1 no A 1 off off off no off
lsnds0       009-009-009 none 1 1 no A 2 off off off no off

LSN          APCI  (SS7)  SCRN SET SET BEI LST LNKS ACT MES DIS SLSCI NIS
lsnituatm    1-002-3 none 1 2 no A 1 off off off no off
atmitul      3-111-3 none 1 1 no A 0 off off off no off

LSN          APCN  (SS7)  SCRN SET SET BEI LST LNKS ACT MES DIS SLSCI NIS
lsipgw       2968 none 1 2 no A 1 off off off no off

Link set table is (10 of 1024) 1% full.

```

If the desired linkset is not in the database, perform one of these procedures to add the linkset to the database.

- “Adding an SS7 Linkset” in *Database Administration - SS7 User’s Guide*
- [Adding an IPSP M2PA Linkset](#)
- [Adding an IPSP M3UA Linkset](#)

After the new linkset has been added, continue the procedure with [Step 11](#).

If the signaling link will be assigned to the linkset shown in this step, continue the procedure with [Step 10](#).

10. Display the linkset that the signaling link is being assigned to using the `rtrv-ls` command, specifying the name of the linkset that the signaling link is being assigned to.

For this example, enter this command.

rtrv-ls:lsn=lsipgw

This is an example of the possible output.

```

rlghncxa03w 10-07-17 11:43:04 GMT EAGLE5 42.0.0

LSN          APCN   (SS7)   L3T SLT          GWS GWS GWS
lsipgw       2968          none 1  2  no  A  1  off off off no  off

          SPCN          CLLI          TFATCABMLQ MTPRSE ASL8
          -----          -----          1          ---  ---

SLSOCBIT SLSRSB RANDSLS MULTGC ITUTFR
none      1      off      no      off

IPSG IPGWAPC GTTMODE          CGGTMOD
no     no      CdPA          no

LOC LINK SLC TYPE      IPLIML2
1317 A  0  IPLIMI  M2PA

SAPCI
1-10-1

SAPCN
1234-aa
1235-bb
1200-zz

Link set table is (10 of 1024) 1% full.
    
```

The signaling link cannot be assigned to a linkset whose IPGWAPC value is yes. If the IPGWAPC value for the linkset is yes, repeat the procedure from [Step 9](#) and choose another linkset.

If the IPGWAPC value for the linkset is no, continue the procedure with [Step 11](#).

11. Add the signaling link to the database using the `ent-slk` command.

[Table 14: M2PA IPLIMx Signaling Link Parameter Combinations](#) shows the parameters and values that can be specified with the `ent-slk` command.

Table 14: M2PA IPLIMx Signaling Link Parameter Combinations

M2PA IPLIMx Signaling Link
Mandatory Parameters
:loc = location of the IP card with one of these applications: IPLIM or IPLIMI; and the DCM card type. (See Note 1)
:link = <see Note 2>
:lsn = linkset name (See Note 3)
:slc = 0 - 15 (See Note 4)
Optional Parameter
:ipliml2 = m2pa, default value = m2pa

M2PA IPLIMx Signaling Link
<p>Notes:</p> <ol style="list-style-type: none"> 1. If the <code>multgc=yes</code> parameter is assigned to the linkset, the card's application must be IPLIMI. 2. The range of link parameter values is dependent on the type of IPLIMx card that is being provisioned. <ul style="list-style-type: none"> Single-Slot EDCM - Link Parameter Values A - A3, B - B3 E5-ENET - Link Parameter Values A - A7, B - B7 3. If the card's application is IPLIMI, the linkset adjacent point code must be ITU. If the card's application is IPLIM, the linkset adjacent point code must be ANSI. The domain of the linkset adjacent point code must be SS7. 4. Signaling links provisioned in this procedure can be in a linkset that contains non-IPLIMx signaling links.

For this example, enter these commands.

```
ent-slk:loc=2204:link=b:lsn=lsnlp2:slc=0:ipliml2=m2pa
ent-slk:loc=2205:link=a:lsn=lsnlp1:slc=1:ipliml2=m2pa
ent-slk:loc=2213:link=a:lsn=lsnlp5:slc=1:ipliml2=m2pa
```

When each of these commands have successfully completed, this message should appear.

```
rlghncxa03w 06-10-07 08:29:03 GMT EAGLE5 36.0.0
ENT-SLK: MASP A - COMPLTD
```

Note: If adding the new signaling link will result in more than 700 signaling links in the database and the OAMHCMEAS value in the `rtrv-measopts` output is on, the scheduled UI measurement reports will be disabled.

12. Verify the changes using the `rtrv-slk` command with the card location and link parameter values specified in [Step 11](#). For this example, enter these commands.

```
rtrv-slk:loc=2204:link=b
```

This is an example of the possible output.

```
rlghncxa03w 06-10-19 21:16:37 GMT EAGLE5 36.0.0
LOC LINK LSN          SLC TYPE    IPLIML2
2204 B   lsnlp2        0  IPLIM     M2PA
```

```
rtrv-slk:loc=2205:link=a
```

This is an example of the possible output.

```
rlghncxa03w 06-10-19 21:16:37 GMT EAGLE5 36.0.0
LOC LINK LSN          SLC TYPE    IPLIML2
2205 A   lsnlp1         1  IPLIM     M2PA
```

```
rtrv-slk:loc=2213:link=a
```

This is an example of the possible output.

```
rlghncxa03w 06-10-19 21:16:37 GMT EAGLE5 36.0.0
LOC LINK LSN          SLC TYPE      IPLIML2
2213 A   lsnlp5        0  IPLIM       M2PA
```

Continue the procedure by performing one of these steps.

- If a new signaling link is the first signaling link on the IPLIMx card, continue the procedure with [Step 13](#).
- If all the signaling links that were added in this procedure were added to IPLIMx cards that contained other signaling links, continue the procedure with [Step 14](#).

13. Place the IPLIMx card containing the first signaling link on that card into service with the `rst-card` command, specifying the location of the card. For this example, enter these commands.

```
rst-card:loc=2204
```

```
rst-card:loc=2205
```

```
rst-card:loc=2213
```

When each of these commands have successfully completed, this message should appear.

```
rlghncxa03w 06-10-23 13:05:05 GMT EAGLE5 36.0.0
Card has been allowed.
```

14. Activate all signaling links on the cards using the `act-slk` command, specifying the card location and link parameter value of each signaling link. For this example, enter these commands.

```
act-slk:loc=2204:link=b
```

```
act-slk:loc=2205:link=a
```

```
act-slk:loc=2213:link=a
```

When each of these commands have successfully completed, this message should appear.

```
rlghncxa03w 06-10-07 08:31:24 GMT EAGLE5 36.0.0
Activate Link message sent to card
```

15. Check the status of the signaling links added in [Step 11](#) using the `rept-stat-slk` command with the card location and link parameter values specified in [Step 11](#). The state of each signaling link should be in service normal (IS-NR) after the link has completed alignment (shown in the PST field). For this example, enter these commands.

```
rept-stat-slk:loc=2204:link=b
```

This is an example of the possible output.

```
rlghncxa03w 07-05-23 13:06:25 GMT EAGLE5 37.0.0
SLK      LSN          CLLI          PST          SST          AST
2204,B   lsnlp2        -----      IS-NR        Avail        ----
ALARM STATUS      =
UNAVAIL REASON    =
```

```
rept-stat-slk:loc=2205:link=a
```

This is an example of the possible output.

```
rlghncxa03w 07-05-23 13:06:25 GMT EAGLE5 37.0.0
SLK      LSN      CLLI      PST      SST      AST
2205,A   lsnlp1   -----  IS-NR    Avail    ----
  ALARM STATUS      =
  UNAVAIL REASON    =
```

```
rept-stat-slk:loc=2213:link=a
```

This is an example of the possible output.

```
rlghncxa03w 07-05-23 13:06:25 GMT EAGLE5 37.0.0
SLK      LSN      CLLI      PST      SST      AST
2213,A   lsnlp5   -----  IS-NR    Avail    ----
  ALARM STATUS      =
  UNAVAIL REASON    =
```

16. Back up the new changes using the `chg-db:action=backup:dest=fixed` command. These messages should appear, the active Maintenance and Administration Subsystem Processor (MASP) appears first.

```
BACKUP (FIXED) : MASP A - Backup starts on active MASP.
BACKUP (FIXED) : MASP A - Backup on active MASP to fixed disk complete.
BACKUP (FIXED) : MASP A - Backup starts on standby MASP.
BACKUP (FIXED) : MASP A - Backup on standby MASP to fixed disk complete.
```

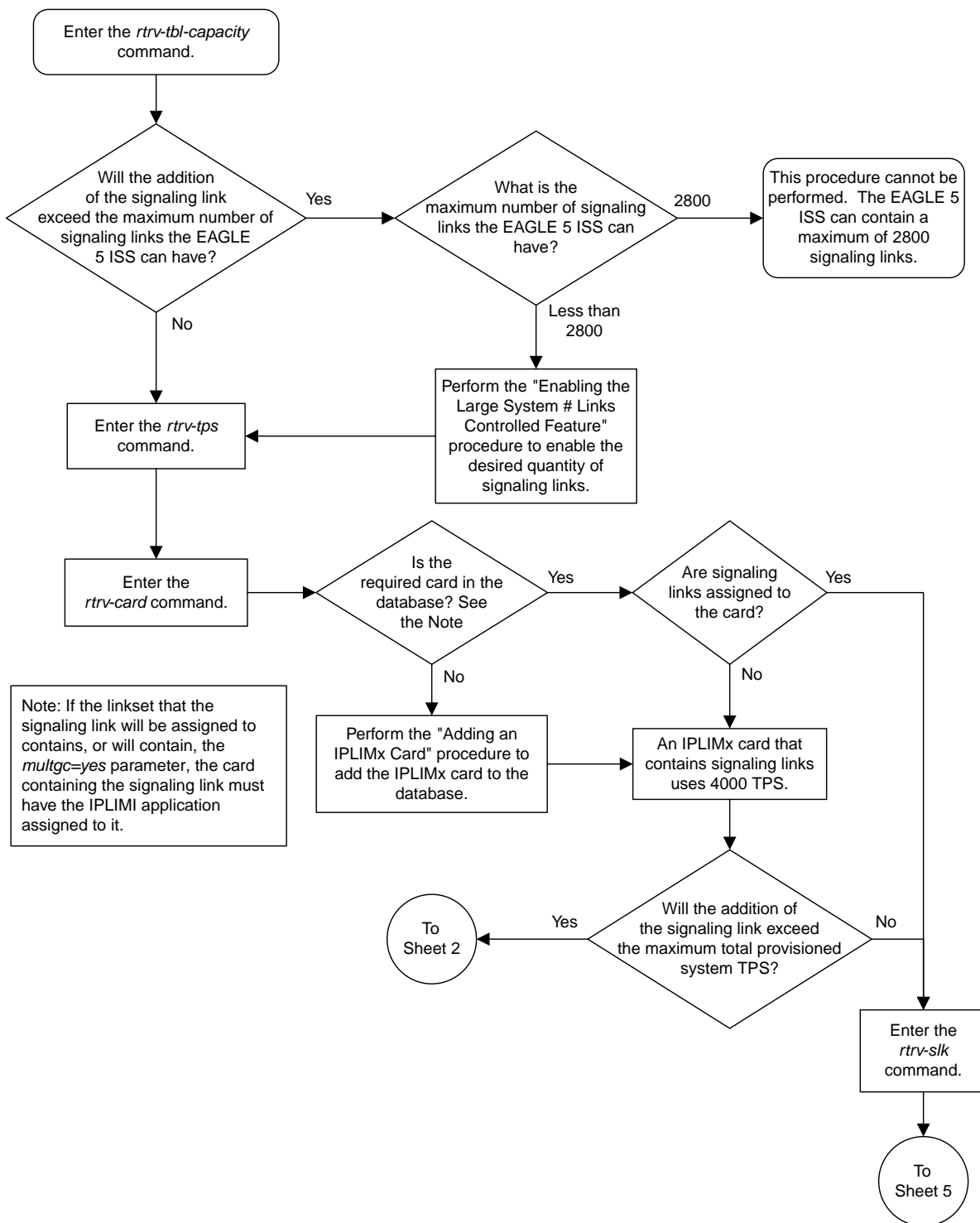

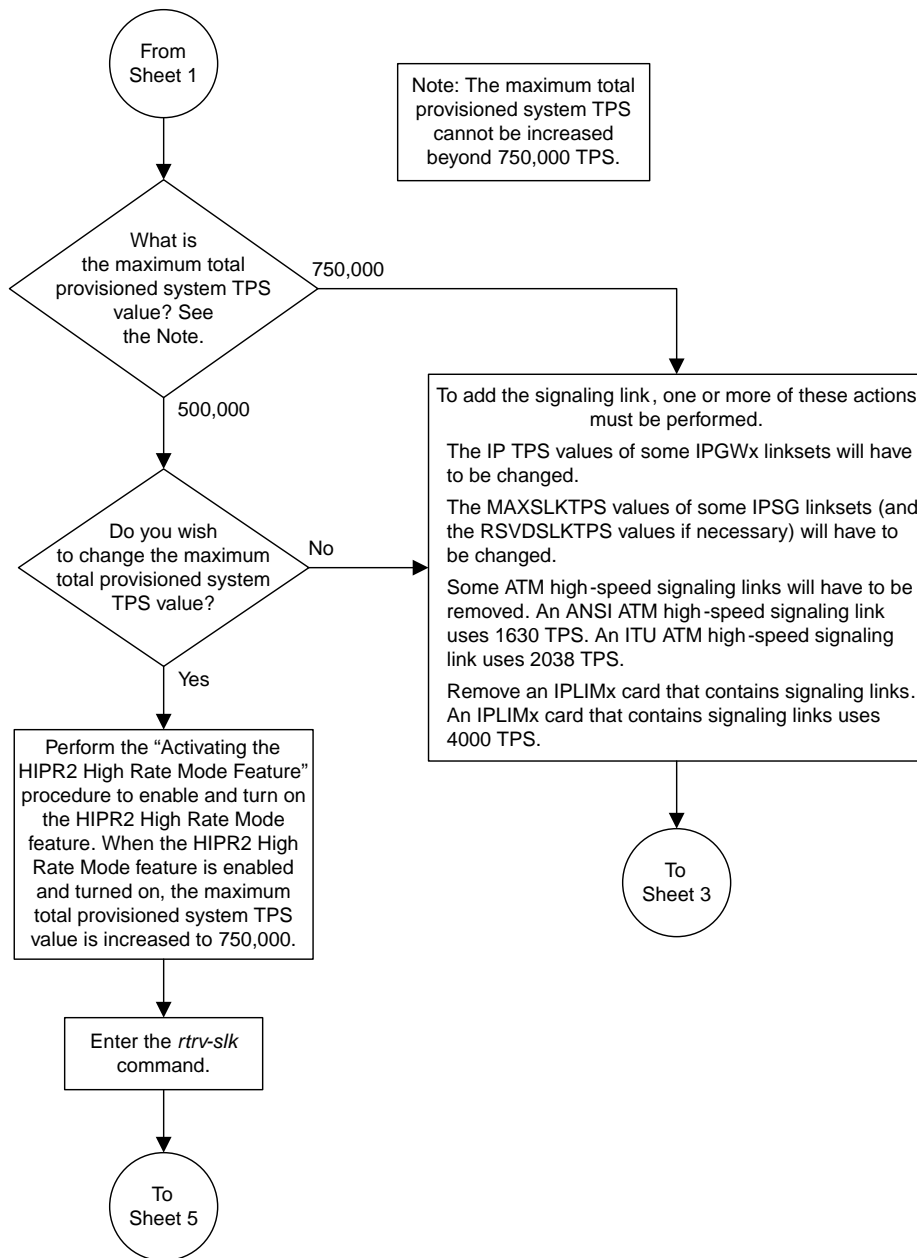

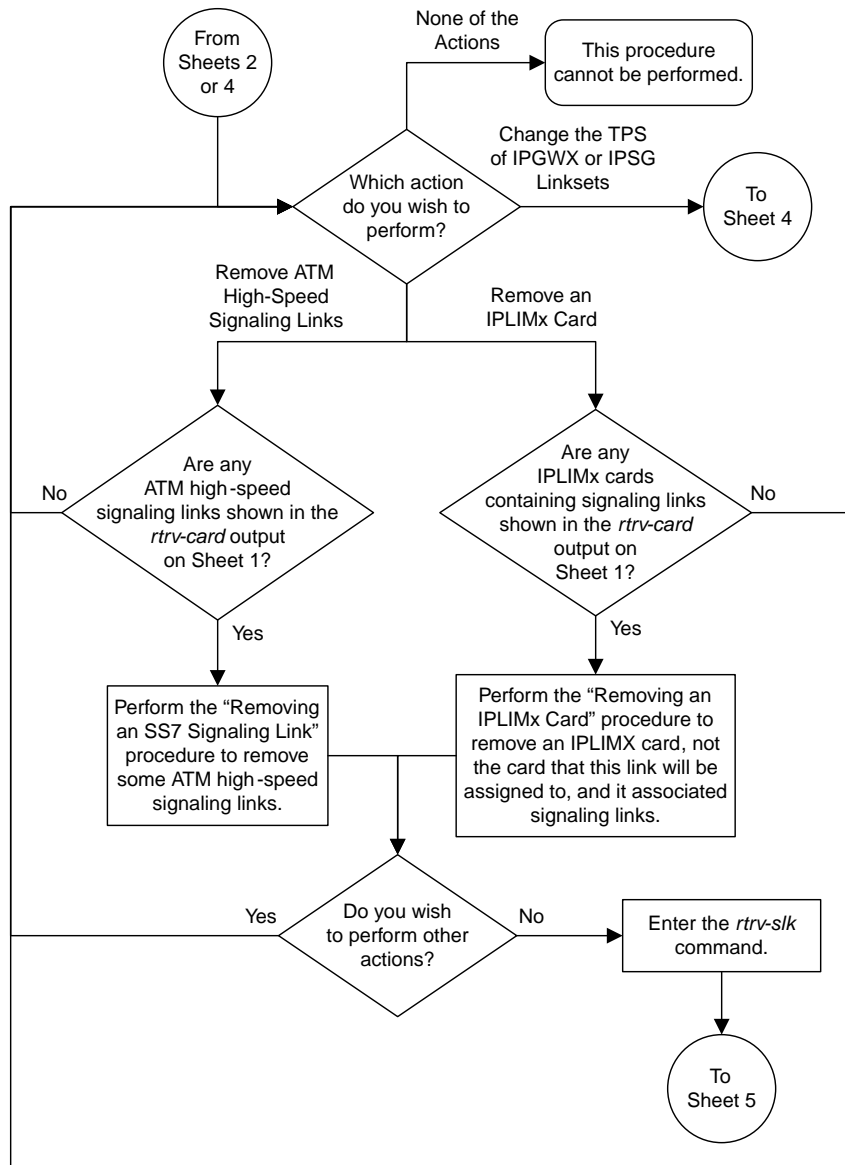

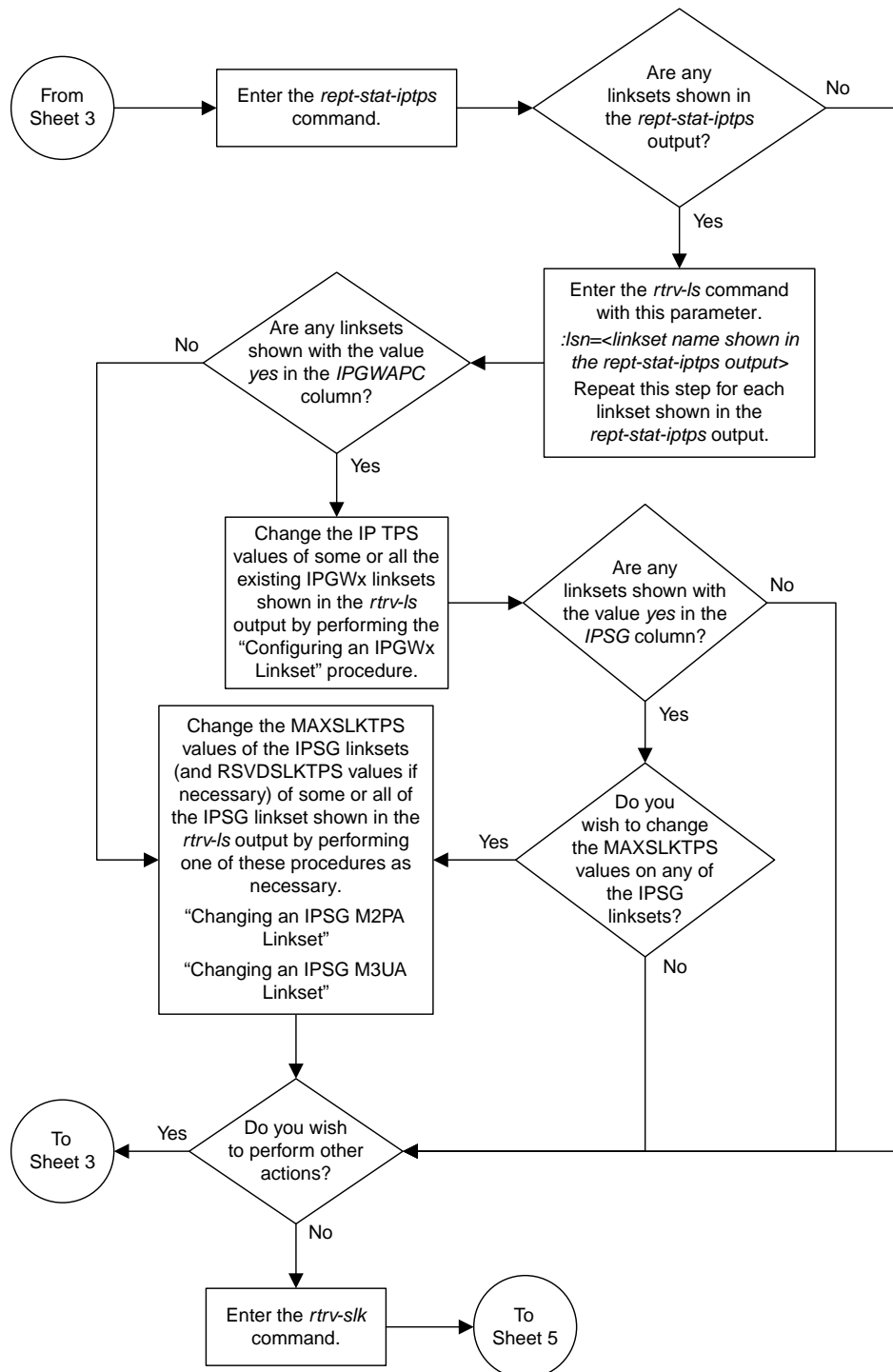

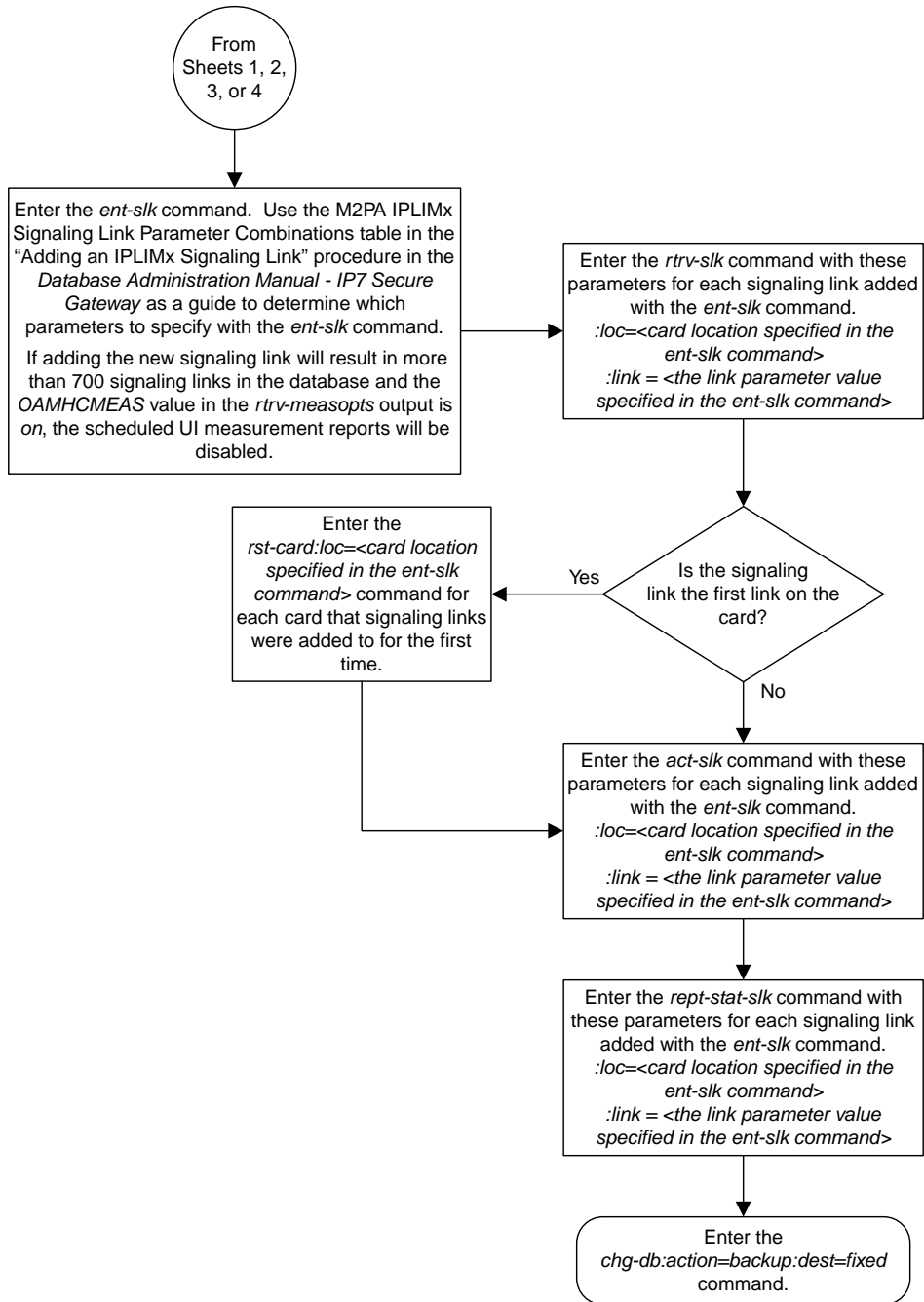

Sheet 5 of 5

Figure 21: Adding an IPLIMx Signaling Link

Configuring an IP Link

This procedure is used to configure the link parameters for IP cards using the `chg-ip-lnk` command. These link parameters are used to configure the Ethernet hardware.

The `chg-ip-lnk` command uses the following parameters.

- `:loc` – The card location of the IP card.
- `:port` – The Ethernet interface on the IP card, A or B.
- `:ipaddr` – IP address assigned to the Ethernet interface on the IP card. This is an IP address expressed in standard “dot notation.” IP addresses consist of the system’s network number and the machine’s unique host number.
- `:submask` – The subnet mask of the IP interface. A subnet mask is an IP address with a restricted range of values. The bits in the mask must be a string of one’s followed by a string of zero’s. There must be at least two one’s in the mask, and the mask cannot be all one’s. See [Table 15: Valid Subnet Mask Parameter Values](#) to assign the correct parameter values.
- `:auto` – Tells hardware whether to automatically detect the duplex and speed.
- `:duplex` – This is the mode of operation of the interface.
- `:speed` – This is the bandwidth in megabits per second of the interface.
- `:mactype` – This is the Media Access Control Type of the interface.
- `:mcast` – The multicast control flag. This parameter enables or disables multicast support for the interface.

The EAGLE can contain a maximum of 2048 IP links.

A zero `ipaddr` parameter value (0 . 0 . 0 . 0) indicates the IP card Ethernet interface to IP link association is disabled. The host to the original IP address must be removed before the `ipaddr=0 . 0 . 0 . 0` can be specified.

If the `defrouter` parameter of the `chg-ip-card` command contains an IP address for the card specified in this procedure, the network portion of one of the IP addresses assigned to the card in this procedure must match the network portion of the IP address specified by the `defrouter` parameter of the `chg-ip-card` command.

The network portion of the IP address is based on the class of the IP address (shown in [Table 15: Valid Subnet Mask Parameter Values](#)). If the IP address is a Class A IP address, the first field is the network portion of the IP address. If the IP address is a Class B IP address, the first two fields are the network portion of the IP address. If the IP address is a Class C IP address, the first three fields are the network portion of the IP address. For example, if the IP address is 193.5.207.150, a Class C IP address, the network portion of the IP address is 193.5.207.

If the `auto=yes` parameter is specified, then the `duplex` and `speed` parameters are not allowed.

The `loc` parameter value must be shown in the `rtvr-ip-card` output.

The IP card must be placed out of service.

If either the `ipaddr` or `submask` parameters are specified, then both parameters must be specified. If the `ipaddr` parameter value is zero (0.0.0.0), the `submask` parameter is not required.

The IP address and subnet mask values cannot be changed to an address representing a different network if:

- If the network interface specified by the `loc` and `port` parameters has a default router, `dnsc`, or `dsnb` parameter values assigned to it, as shown in the `rtrv-ip-card` output.
- Any IP routes, shown in the `rtrv-ip-rte` output, reference the IP address for the network interface specified by the `loc` and `port` parameters.

The IP link cannot be changed if open associations reference the IP link being changed.

The network portion of the IP addresses assigned to the IP links on an IP card must be unique. For example, if IP links are assigned to IP card 1103, the network portion of the IP address for Ethernet interface A (`port=a`) must be different from the IP address for Ethernet interface B (`port=b`).

The `submask` parameter value is based upon the `ipaddr` setting. See [Table 15: Valid Subnet Mask Parameter Values](#) for the valid input values for the `submask` and `ipaddr` parameter combinations.

Table 15: Valid Subnet Mask Parameter Values

Network Class	IP Network Address Range	Valid Subnet Mask Values
A	1.0.0.0 to 127.0.0.0	255.0.0.0 (the default value for a class A IP address) 255.192.0.0 255.224.0.0 255.240.0.0 255.248.0.0 255.252.0.0 255.254.0.0 255.255.128.1
A+B	128.0.0.0 to 191.255.0.0	255.255.0.0 (the default value for a class B IP address) 255.255.192.0 255.255.224.0 255.255.240.0 255.255.248.0 255.255.252.0 255.255.254.0 255.255.255.128
A+B+C	192.0.0.0 to 223.255.255.0	255.255.255.0 (the default value for a class C IP address) 255.255.255.192

Network Class	IP Network Address Range	Valid Subnet Mask Values
		255.255.255.224
		255.255.255.240
		255.255.255.248
		255.255.255.252

If a Class B IP address is specified for the `ipaddr` parameter of the `chg-ip-lnk` command, the subnet address that results from the `ipaddr` and `submask` parameter values cannot be the same as the subnet address that results from the `pvn` and `pvnmask`, `fcna` and `fcnamask`, or `fcnb` and `fcnbmask` parameter values of the `chg-netopts` command. The `pvn` and `pvnmask`, `fcna` and `fcnamask`, or `fcnb` and `fcnbmask` parameter values can be verified by entering the `rtrv-netopts` command. Choose `ipaddr` and `submask` parameter values for the IP link whose resulting subnet address is not be the same as the subnet address resulting from the `pvn` and `pvnmask`, `fcna` and `fcnamask`, or `fcnb` and `fcnbmask` parameter values of the `chg-netopts` command.

The IP address for the IP link cannot be shown as the `IPADDR` value in the `rtrv-ip-lnk`, `rtrv-ftp-serv`, or `rtrv-seas-config` outputs, or the `BPIPADDR` value in the `rtrv-ip-card` output.

Canceling the RTRV-ASSOC Command

Because the `rtrv-assoc` command used in this procedure can output information for a long period of time, the `rtrv-assoc` command can be canceled and the output to the terminal stopped. There are three ways that the `rtrv-assoc` command can be canceled.

- Press the F9 function key on the keyboard at the terminal where the `rtrv-assoc` command was entered.
- Enter the `canc-cmd` without the `trm` parameter at the terminal where the `rtrv-assoc` command was entered.
- Enter the `canc-cmd:trm=<xx>`, where `<xx>` is the terminal where the `rtrv-assoc` command was entered, from another terminal other than the terminal where the `rtrv-assoc` command was entered. To enter the `canc-cmd:trm=<xx>` command, the terminal must allow Security Administration commands to be entered from it and the user must be allowed to enter Security Administration commands. The terminal's permissions can be verified with the `rtrv-secu-trm` command. The user's permissions can be verified with the `rtrv-user` or `rtrv-secu-user` commands.

For more information about the `canc-cmd` command, go to *Commands User's Guide*.

1. Display the current link parameters associated with the IP card in the database by entering the `rtrv-ip-lnk` command.

The following is an example of the possible output.

```
rlghncxa03w 08-12-28 21:14:37 GMT EAGLE5 40.0.0
LOC  PORT  IPADDR          SUBMASK          DUPLEX  SPEED  MACTYPE  AUTO  MCAST
1201  A      192.1.1.10     255.255.255.128  HALF    10     802.3    NO    NO
1201  B      -----          -----          HALF    10     DIX      NO    NO
1203  A      192.1.1.12     255.255.255.0   ----    ---    DIX      YES   NO
1203  B      -----          -----          HALF    10     DIX      NO    NO
1205  A      192.1.1.14     255.255.255.0   FULL    100    DIX      NO    NO
1205  B      -----          -----          HALF    10     DIX      NO    NO
```

```

2101 A 192.1.1.20 255.255.255.0 FULL 100 DIX NO NO
2101 B ----- HALF 10 DIX NO NO
2103 A 192.1.1.22 255.255.255.0 FULL 100 DIX NO NO
2103 B ----- HALF 10 DIX NO NO
2105 A 192.1.1.24 255.255.255.0 FULL 100 DIX NO NO
2105 B ----- HALF 10 DIX NO NO
2205 A 192.1.1.30 255.255.255.0 FULL 100 DIX NO NO
2205 B ----- HALF 10 DIX NO NO
2207 A 192.1.1.32 255.255.255.0 FULL 100 DIX NO NO
2207 B ----- HALF 10 DIX NO NO
2213 A 192.1.1.50 255.255.255.0 FULL 100 DIX NO NO
2213 B ----- HALF 10 DIX NO NO
2301 A 192.1.1.52 255.255.255.0 FULL 100 DIX NO NO
2301 B ----- HALF 10 DIX NO NO

```

```
IP-LNK table is (20 of 2048) full.
```

Note: If the `ipaddr=0.0.0.0` is not being specified in this procedure, continue the procedure with [Step 3](#).

- If IP address information is being added or changed (not deleted) in the link parameters, verify that the IP address is present in the IP host table by using the `rtrv-ip-host:display=all` command.

The following is an example of the possible output.

```

rlghncxa03w 13-06-28 21:15:37 GMT EAGLE5 45.0.0

LOCAL IPADDR    LOCAL HOST
192.1.1.10      IPNODE1-1201
192.1.1.12      IPNODE1-1203
192.1.1.14      IPNODE1-1205
192.1.1.20      IPNODE2-1201
192.1.1.22      IPNODE2-1203
192.1.1.24      IPNODE2-1205
192.1.1.30      KC-HLR1
192.1.1.32      KC-HLR2
192.1.1.50      DN-MSC1
192.1.1.52      DN-MSC2

REMOTE IPADDR    REMOTE HOST
150.1.1.5        NCDEPTECONOMIC_DEVELOPMENT. SOUTHEASTERN_COORIDOR_ASHVL. GOV

IP Host table is (11 of 4096) 0.26% full

```

If the current IP address of the IP link is shown in the `rtrv-ip-host` output, remove the host assigned to the IP address by performing the [Removing an IP Host Assigned to an IPLIMx Card](#) procedure.

- To change IP link parameters, the signaling link to the IP card and the IP card have to be inhibited. Display the signaling link associated with the card shown in [Step 1](#) using the `rtrv-slk` command specifying the card location.

For this example, enter this command.

```
rtrv-slk:loc=1201
```

This is an example of the possible output.

```
rlghncxa03w 06-10-19 21:17:04 GMT EAGLE5 36.0.0
LOC LINK LSN          SLC TYPE   IPLIML2
1201 A    nc001        0 IPLIM    M2PA
```

- Retrieve the status of the signaling link assigned to the IP card to be changed using the `rept-stat-slk` command.

For example, enter this command.

```
rept-stat-slk:loc=1201:link=a
```

The output lists the signaling link assigned to this card:

```
rlghncxa03w 06-10-28 21:16:37 GMT EAGLE5 36.0.0
SLK LSN          CLLI      PST          SST          AST
1201,A nc001      ----- IS-NR
Command Completed.
```

If the signaling link is in service-normal (IS-NR), continue the procedure with [Step 5](#) to deactivate the signaling link. If the signaling link is out-of-service-maintenance disabled (OOS-MT-DSBLD), continue the procedure with [Step 7](#) to verify the IP card status.

- Deactivate the signaling link assigned to the IP card using the `dact-slk` command.

For example, enter this command.

```
dact-slk:loc=1201:link=a
```



CAUTION

Caution: This command impacts network performance and should only be used during periods of low traffic.

After this command has successfully completed, this message appears.

```
rlghncxa03w 06-10-12 09:12:36 GMT EAGLE5 36.0.0
Deactivate Link message sent to card.
```

- Verify the new link status using the `rept-stat-slk` command.

For example, enter this command.

```
rept-stat-slk:loc=1201:link=a
```

The output displays the link status as OOS-MT-DSBLD and gives off a minor alarm:

```
rlghncxa03w 06-10-27 17:00:36 GMT EAGLE5 36.0.0
SLK LSN          CLLI      PST          SST          AST
1201,A nc001      ----- OOS-MT-DSBLD AVAIL  ---
ALARM STATUS = * 0236 REPT-LKS:not aligned
UNAVAIL REASON = NA
Command Completed.
```

- Verify the status of the IP card to be inhibited using the `rept-stat-card` command.

For example, enter this command.

```
rept-stat-card:loc=1201
```

This is an example of the possible output.

```
rlghncxa03w 06-10-27 17:00:36 GMT EAGLE5 36.0.0
CARD VERSION      TYPE   GPL      PST      SST      AST
1201 114-000-000  DCM    IPLIM    IS-NR    Active   -----
  ALARM STATUS      = No Alarms.
  BPCM GPL          = 002-102-000
  IMT BUS A        = Conn
  IMT BUS B        = Conn
  SIGNALING LINK STATUS
    SLK   PST              LS           CLLI
    A     IS-NR            nc001        -----
Command Completed.
```

If the IP card to be inhibited is in service-normal (IS-NR), continue the procedure with [Step 8](#) to inhibit the card. If the IP card is out-of-service-maintenance disabled (OOS-MT-DSBLD), continue the procedure with [Step 10](#) to change the IP link parameters.

- Inhibit the IP card using the `inh-card` command.

For example, enter this command.

```
inh-card:loc=1201
```

This message should appear.

```
rlghncxa03w 06-10-28 21:18:37 GMT EAGLE5 36.0.0
Card has been inhibited.
```

- Display the status of the IP card to verify that it is out-of-service maintenance-disabled (OOS-MT-DSBLD).

Enter this command.

```
rept-stat-card:loc=1201
```

This is an example of the possible output.

```
rlghncxa03w 06-10-27 17:00:36 GMT EAGLE5 36.0.0
CARD VERSION      TYPE   GPL      PST      SST      AST
1201 114-000-000  DCM    IPLIM    IS-NR    Active   -----
  ALARM STATUS      = No Alarms.
  BPCM GPL          = 002-102-000
  IMT BUS A        = Conn
  IMT BUS B        = Conn
  SIGNALING LINK STATUS
    SLK   PST              LS           CLLI
    A     IS-NR            nc001        -----
Command Completed.
```

10. Display the attributes of the IP card assigned to the IP link being changed by entering the `rtrv-ip-card` command and specifying the card location of the IP link.

Note: If the `ipaddr` or `submask` parameter values are not being changed, continue the procedure with [Step 13](#).

For this example, enter this command.

```
rtrv-ip-card:loc=1201
```

This is an example of the possible output.

```
rlghncxa03w 08-08-28 21:17:37 GMT EAGLE5 39.0.0
  LOC 1201
    SRCHORDR  LOCAL
    DNSA      150.1.1.1
    DNSB      -----
    DEFROUTER -----
    DOMAIN    -----
    SCTPCSUM  crc32c
    BPIPADDR  -----
    BPSUBMASK -----
```

If the `rtrv-ip-card` output shows an IP address for the default router (DEFROUTER) whose network portion matches the network portion of the IP address being changed, go to the [Configuring an IP Card](#) procedure and change the IP address of the default router to 0.0.0.0.

11. Display any IP routes referencing the IP link being changed by entering the `rtrv-ip-rte` command and specifying the card location of the IP link.

For this example, enter this command.

```
rtrv-ip-rte:loc=1201
```

This is an example of the possible output.

```
rlghncxa03w 06-10-28 21:17:37 GMT EAGLE5 36.0.0
LOC  DEST          SUBMASK          GTWY
1201 128.252.10.5     255.255.255.255 140.188.13.33
1201 128.252.0.0      255.255.0.0     140.188.13.34
1201 150.10.1.1       255.255.255.255 140.190.15.3

IP Route table is (5 of 2048) 0.24% full
```

If the `rtrv-ip-rte` output shows that the card has IP routes assigned to it, go to the [Removing an IP Route](#) procedure and remove the IP routes from the database.

12. The subnet address that results from the `ipaddr` and `submask` parameter values of the `chg-ip-lnk` command cannot be the same as the subnet address that results from the `pvn` and `pvnmask`, `fcna` and `fcnamask`, or `fcnb` and `fcnbmask` parameter values of the `chg-netopts` command.

Note: If a Class A or CIP address (see [Table 15: Valid Subnet Mask Parameter Values](#)) will be specified for the `ipaddr` parameter in [Step 14](#), continue the procedure with [Step 13](#).

Display the `pvn`, `pvnmask`, `fcna`, `fcnamask`, `fcnb`, and `fcnbmask` parameter values of the `chg-netopts` command by entering the `rtrv-netopts` command.

If error message E3967 Cmd Rej: E5IS must be on is displayed after the `rtrv-netopts` command is executed, the `pvn`, `pvnmask`, `fcna`, `fcnamask`, `fcnb`, and `fcnbmask` parameters are not configured. Continue the procedure with [Step 13](#).

This is an example of the possible output if the E5IS feature is on.

```
rlghncxa03w 09-02-28 21:17:37 GMT EAGLE5 40.1.0
NETWORK OPTIONS
-----
PVN           = 128.20.30.40
PVNMASK       = 255.255.192.0
FCNA          = 170.120.50.0
FCNAMASK      = 255.255.240.0
FCNB          = 170.121.50.0
FCNBMASK      = 255.255.254.0
```

Choose `ipaddr` and `submask` parameter values for the IP link whose resulting subnet address is not be the same as the subnet address resulting from the `pvn` and `pvnmask`, `fcna` and `fcnamask`, or `fcnb` and `fcnbmask` parameter values of the `chg-netopts` command. Continue the procedure with [Step 13](#).

13. Display the associations referencing the local host name that is associated with the IP link being changed by entering the `rtrv-assoc` command and specifying the local host name shown in the `rtrv-ip-host` output in [Step 2](#).

For this example, enter this command.

```
rtrv-assoc: lhost="ipnode-1201"
```

This is an example of the possible output.

```
rlghncxa03w 06-10-28 09:12:36 GMT EAGLE5 36.0.0
CARD IPLNK
ANAME      LOC  PORT  LINK ADAPTER  LPORT  RPORT  OPEN  ALW
swbel32    1201 A    A    M2PA    1030    2345   YES   YES

IP Appl Sock/Assoc table is (3 of 4000) 1% full
Assoc Buffer Space Used (16 KB of 3200 KB) on LOC = 1201
```

If no associations are displayed in this step, continue the procedure with [Step 14](#).

If the `rtrv-assoc` output shows that the open parameter for any associations is yes, perform one of these procedures to change the value of the open parameter the associations to no.

- [Changing the Attributes of an M2PA Association](#)
- [Changing the Attributes of a M3UA or SUA Association](#)

14. Change the link parameters associated with the IP card in the database using the `chg-ip-lnk` command.

For this example, enter this command.

```
chg-ip-lnk: loc=1201: port=a: ipaddr=192.1.1.10: submask=255.255.255.0
: auto=yes: mactype=dix
```

When this command has successfully completed, the following message should appear.

```
rlghncxa03w 06-10-28 21:18:37 GMT EAGLE5 36.0.0
CHG-IP-LNK: MASP A - COMPLTD
```

15. Verify the new link parameters associated with the IP card that was changed in [Step 14](#) by entering the `rtrv-ip-lnk` command with the card location specified in [Step 14](#).

For this example, enter this command.

The following is an example of the possible output.

```
rlghncxa03w 07-05-28 21:14:37 GMT EAGLE5 37.0.0
LOC  PORT  IPADDR          SUBMASK          DUPLEX  SPEED  MACTYPE  AUTO  MCAST
1201  A      192.1.1.10          255.255.255.128  HALF    10     DIX      YES  NO
1201  B      -----             -----          HALF    10     DIX      NO   NO
```

16. Allow the IP card that was inhibited in [Step 8](#) by using by using the `alw-card` command.

Note: If [Step 8](#) was not performed, continue the procedure with [Step 18](#).

For example, enter this command.

```
alw-card:loc=1201
```

This message should appear.

```
rlghncxa03w 06-10-28 21:20:37 GMT EAGLE5 36.0.0
Card has been allowed.
```

17. Verify the in-service normal (IS-NR) status of the IP card using the `rept-stat-card` command.

For example, enter this command.

```
rept-stat-card:loc=1201
```

This is an example of the possible output.

```
rlghncxa03w 06-10-27 17:00:36 GMT EAGLE5 36.0.0
CARD  VERSION      TYPE      GPL      PST      SST      AST
1201  114-000-000    DCM      IPLIM    IS-NR    Active   -----
ALARM STATUS      = No Alarms.
BPDCM GPL         = 002-102-000
IMT BUS A         = Conn
IMT BUS B         = Conn
SIGNALING LINK STATUS
SLK   PST          LS          CLLI
A     IS-NR        nc001      -----
Command Completed.
```

18. Activate the signaling link from [Step 5](#) using the `act-slk` command.

Note: If [Step 5](#) was not performed, continue the procedure with [Step 20](#).

For example, enter this command.

```
act-slk:loc=1201:link=a
```

The link changes its state from OOS-MT-DSBLD (out-of-service maintenance-disabled) to IS-NR (in-service normal).

The output confirms the activation.

```
rlghncxa03w 06-10-07 11:11:28 GMT EAGLE5 36.0.0
Activate Link message sent to card
```

19. Verify the in-service normal (IS-NR) status of the signaling link using the `rept-stat-slk` command.

For example, enter this command.

```
rept-stat-slk:loc=1201:link=a
```

This message should appear.

```
rlghncxa03w 06-10-28 21:16:37 GMT EAGLE5 36.0.0
SLK      LSN      CLLI      PST      SST      AST
1201,A   nc001     -----  IS-NR
Command Completed.
```

20. Perform the [Configuring an IP Card](#) procedure and change the IP address of the default router to a non-zero value, where the network portion of the default router IP address matches the network portion of the IP link's new IP address.

Note: If the `ipaddr` or `submask` values were not changed, continue the procedure with [Step 22](#).

Note: If the IP address of the default router was not changed to 0.0.0.0 in [Step 10](#), continue the procedure with [Step 21](#).

21. Perform the [Adding an IP Route](#) procedure and add the IP routes back into the database.

Note: If IP routes were not removed in [Step 11](#), continue the procedure with [Step 22](#).

22. Perform one of these procedures as necessary and change the value of the `open` parameter of the association to `yes`.

Note: If the `open` parameter value for an association was not changed in [Step 13](#), continue the procedure with [Step 23](#).

- [Changing the Attributes of an M2PA Association](#)
- [Changing the Attributes of a M3UA or SUA Association](#)

23. Back up the new changes using the `chg-db:action=backup:dest=fixed` command.

These messages should appear, the active Maintenance and Administration Subsystem Processor (MASP) appears first.

```
BACKUP (FIXED) : MASP A - Backup starts on active MASP.
BACKUP (FIXED) : MASP A - Backup on active MASP to fixed disk complete.
BACKUP (FIXED) : MASP A - Backup starts on standby MASP.
BACKUP (FIXED) : MASP A - Backup on standby MASP to fixed disk complete.
```

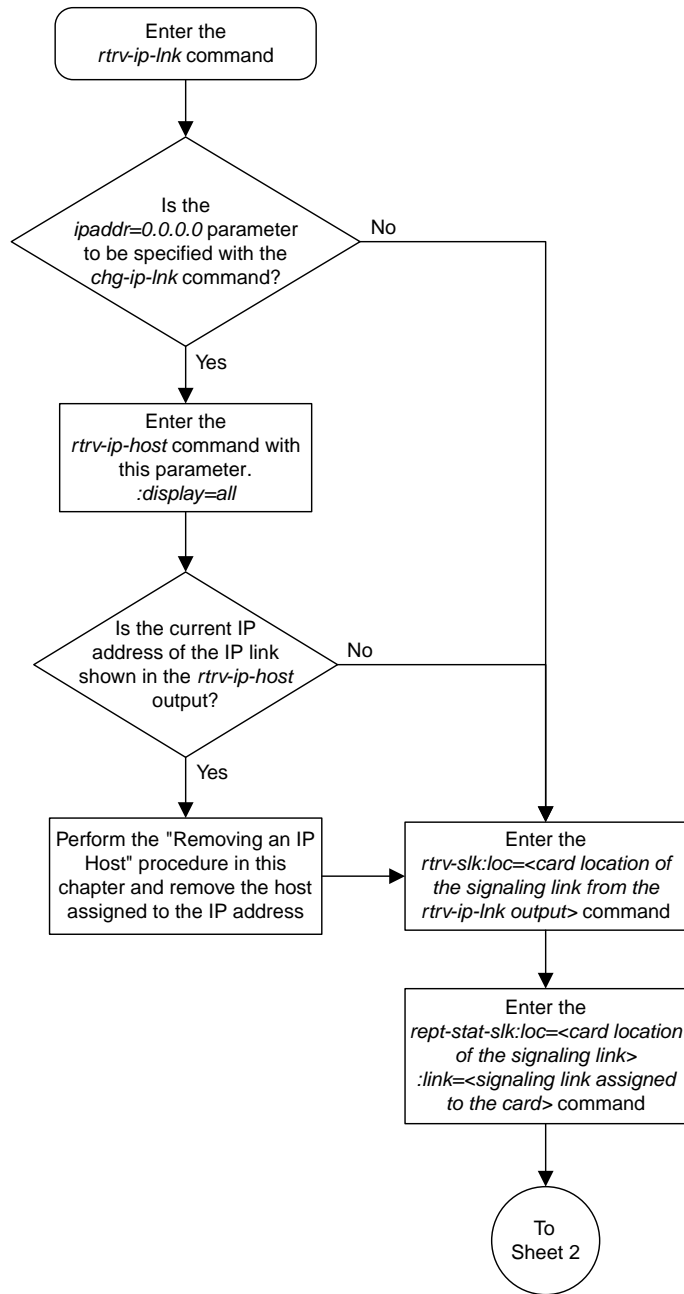

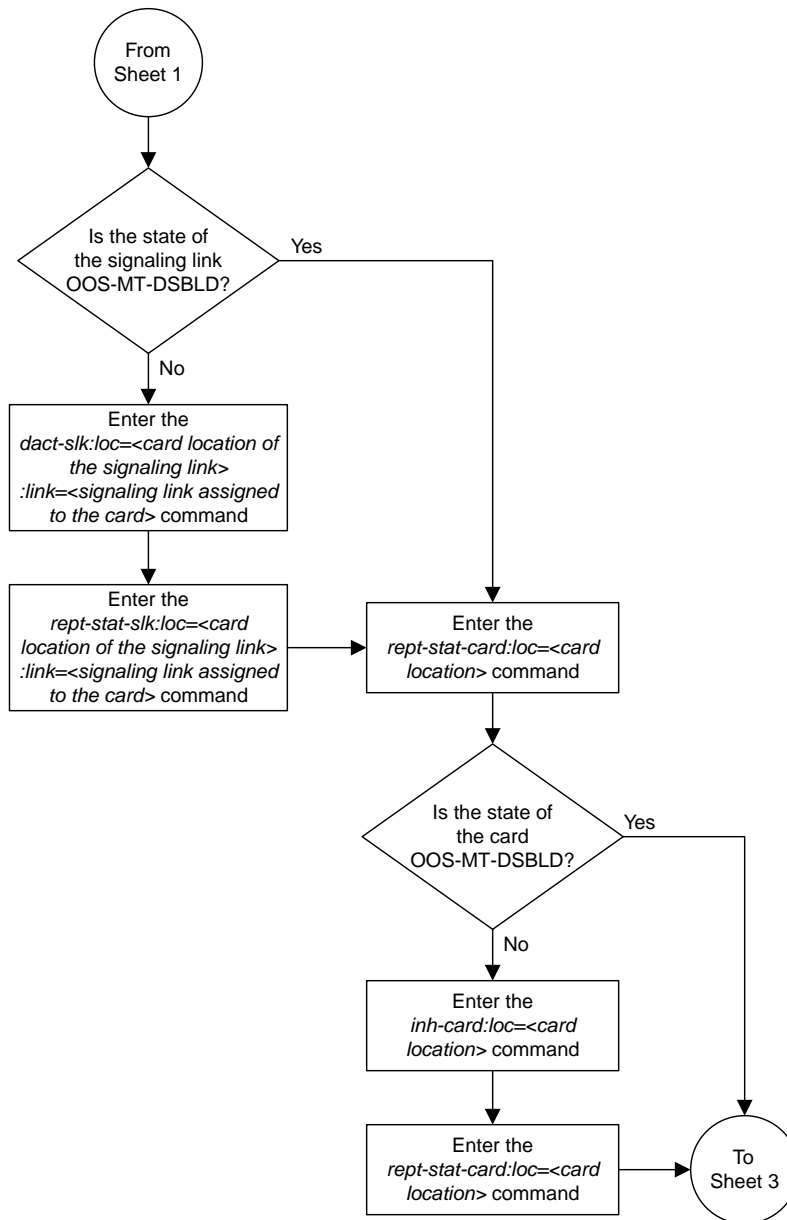

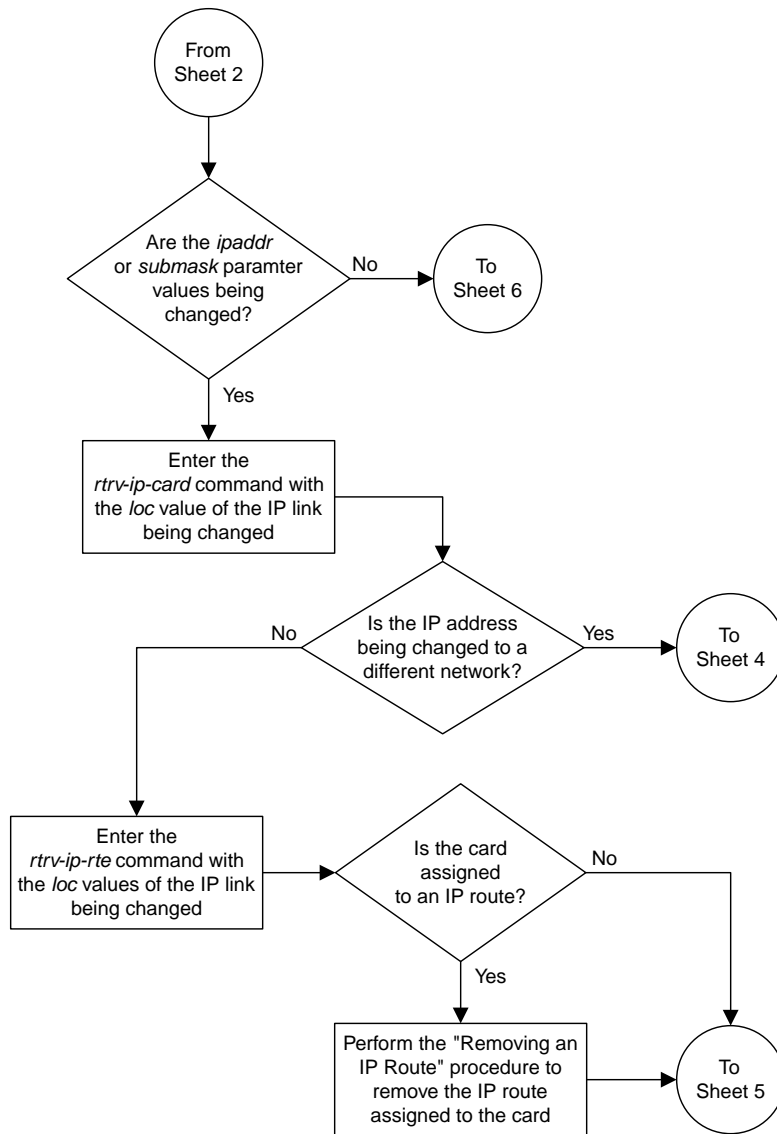

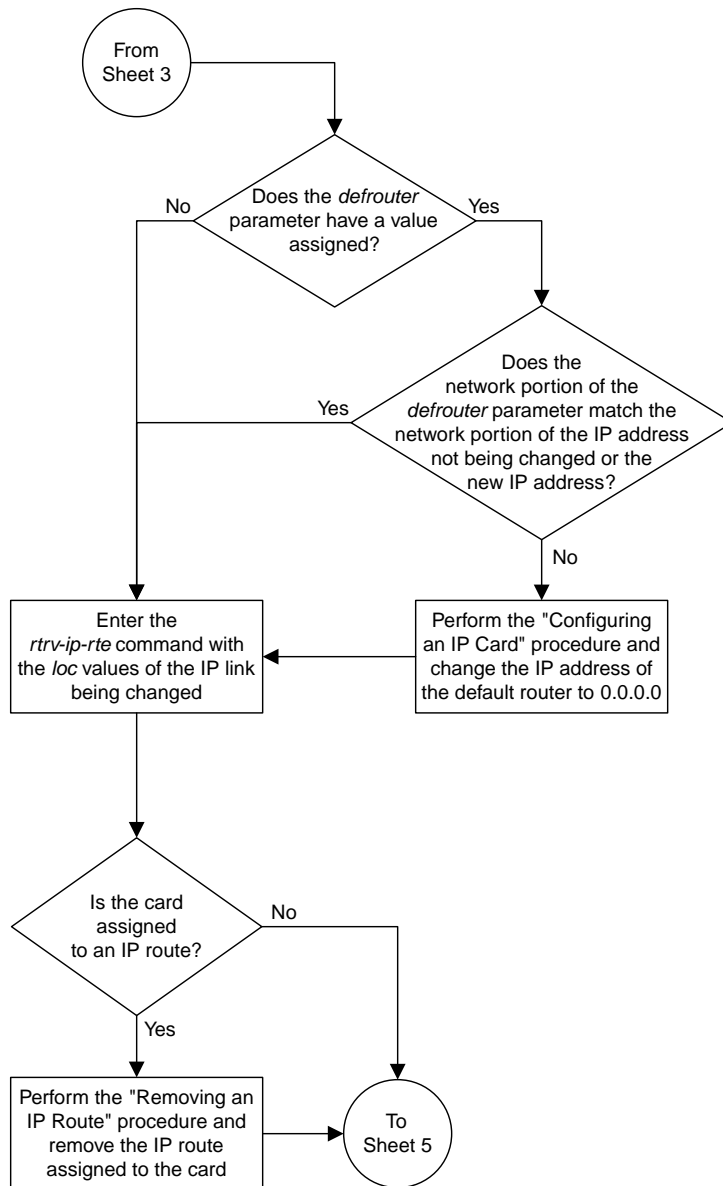

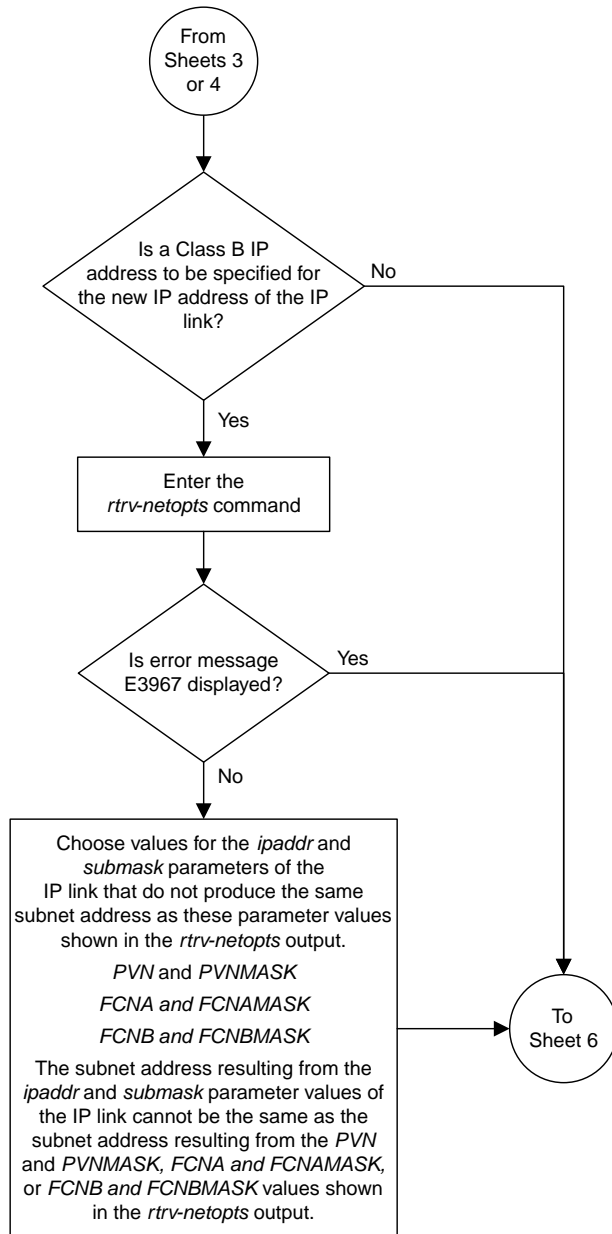

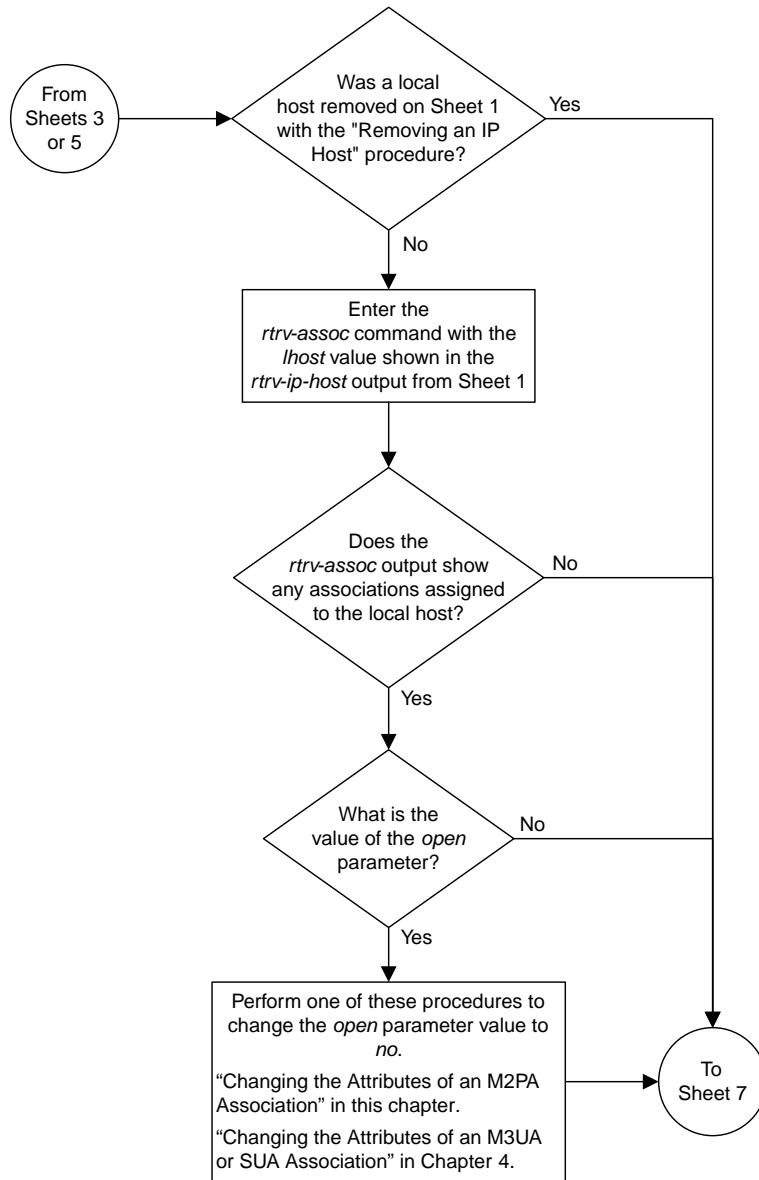

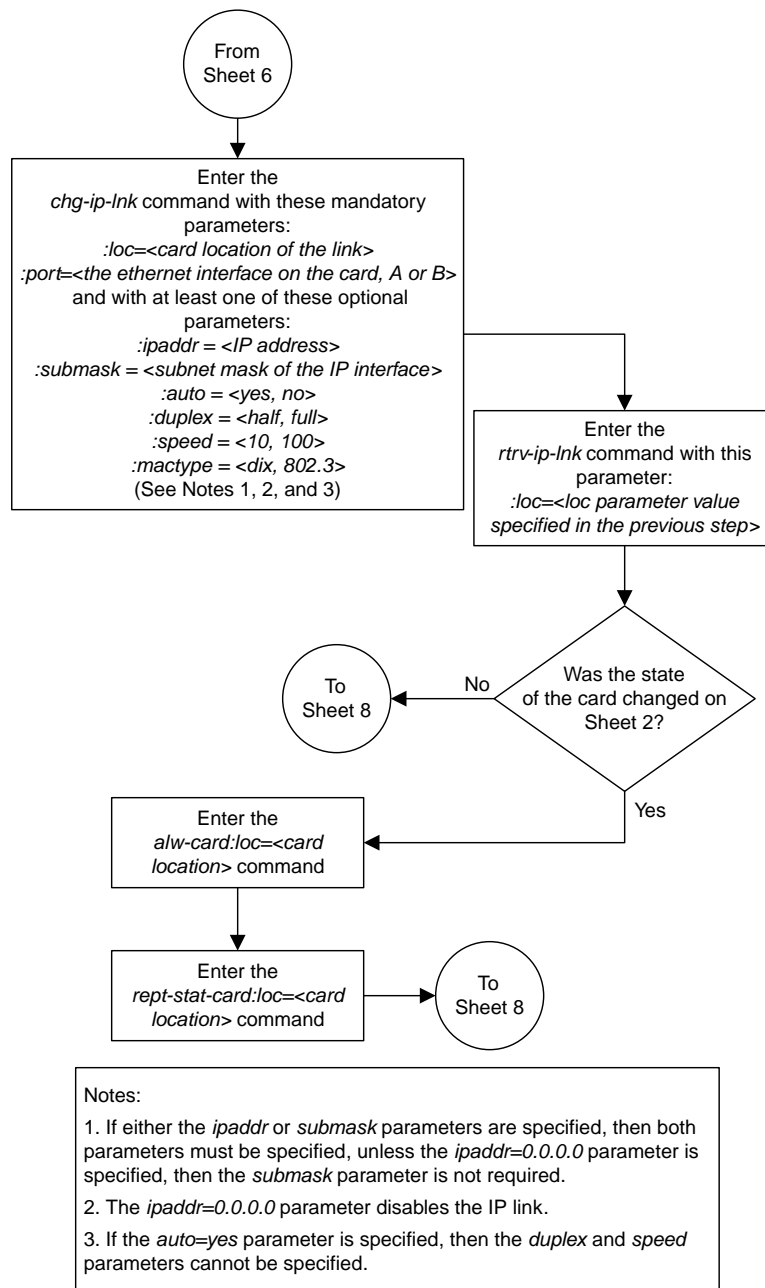

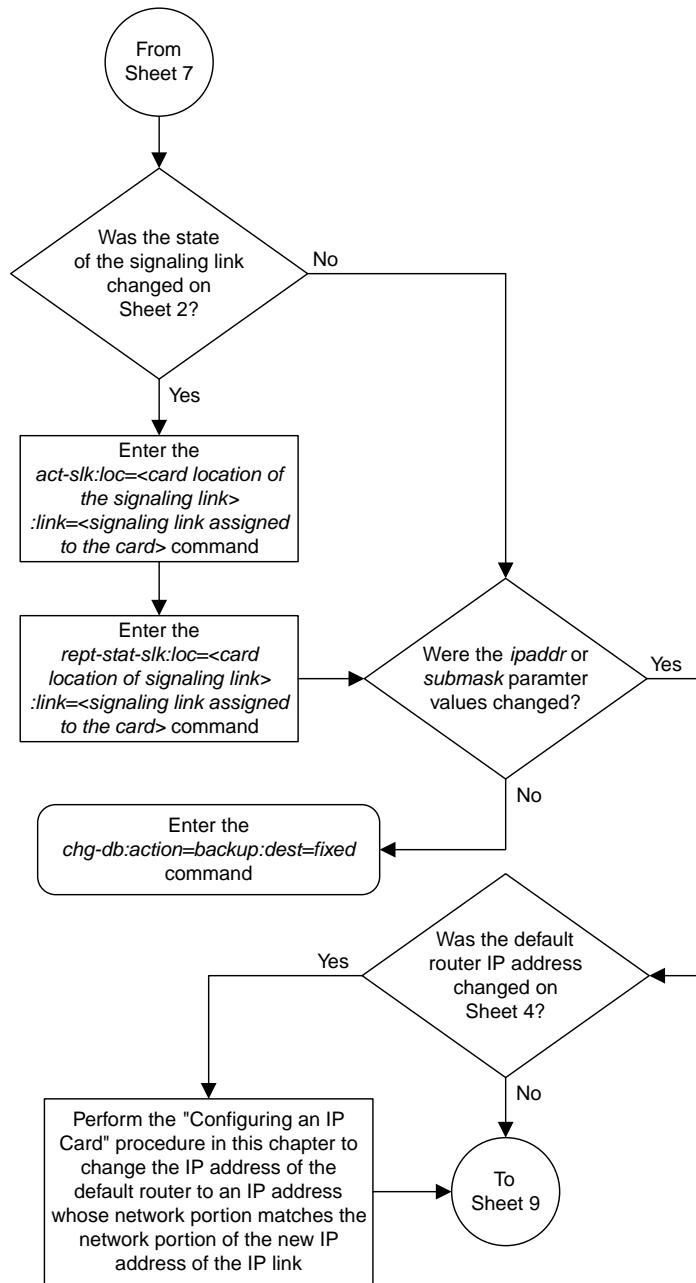

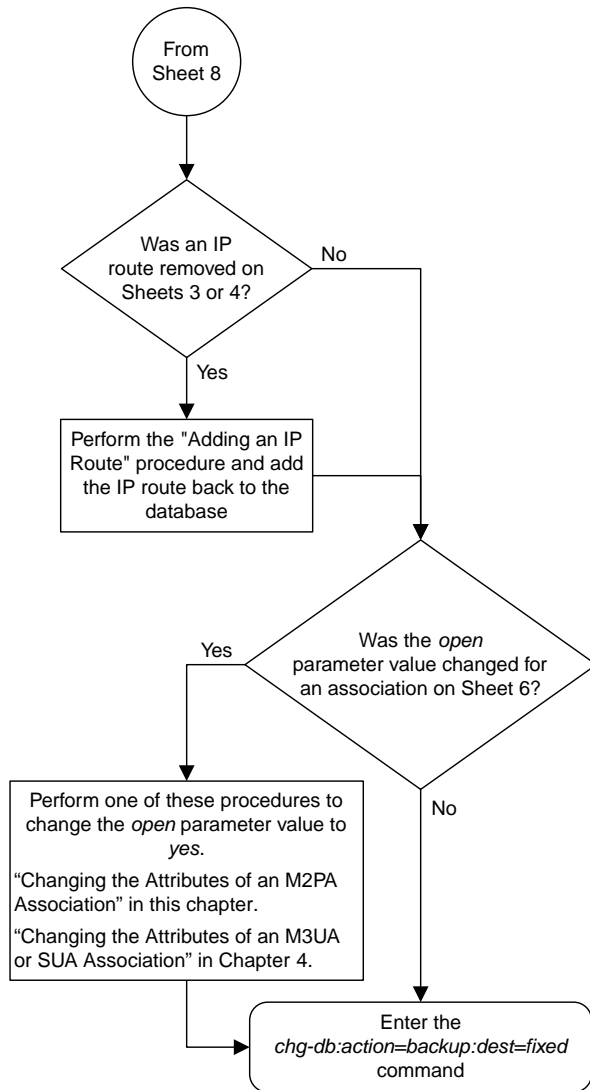

Sheet 9 of 9

Figure 22: Configuring an IP Link

Adding an IP Host

This procedure associates hostnames with IP addresses using the `ent-ip-host` command.

The `ent-ip-host` command uses the following parameters.

`:host` – The host name to be associated with the IP address. This parameter identifies the logical name assigned to the device with the IP address indicated. The host name can contain up to 60 characters (using only these characters: a-z, A-Z, 0-9, -, .) and is not case sensitive. The host name must begin with a letter. Host names containing a dash (-) must be enclosed in double quotes.

`:ipaddr` – The IP address to be associated with the hostname. The node's IP address. This is an IP address expressed in standard "dot notation." IP addresses consist of the system's network number and the machine's unique host number.

`:type` – Specifies if the host resides on the IP card on the EAGLE 5 (`type=local`, the default value), or if the host resides on equipment that is not in the EAGLE 5 (`type=remote`). This parameter is optional.

The EAGLE 5 can contain a maximum of 4096 IP hosts.

The IP address for a local host must be shown in the `rtrv-ip-lnk` output.

The IP address for a remote host must not be shown in the `rtrv-ip-lnk` output.

1. Display the current IP host information in the database by entering the `rtrv-ip-host:display=all` command.

The following is an example of the possible output.

```
rlghncxa03w 13-06-28 21:17:37 GMT EAGLE5 45.0.0
LOCAL IPADDR      LOCAL HOST
192.1.1.10       IPNODE1-1201
192.1.1.12       IPNODE1-1203
192.1.1.14       IPNODE1-1205
192.1.1.20       IPNODE2-1201
192.1.1.22       IPNODE2-1203
192.1.1.24       IPNODE2-1205
192.1.1.32       KC-HLR2
192.1.1.50       DN-MS1
192.1.1.52       DN-MS2

REMOTE IPADDR     REMOTE HOST
150.1.1.5        NCDEPTECONOMIC_DEVELOPMENT. SOUTHEASTERN_COORIDOR_ASHVL. GOV

IP Host table is (10 of 4096) .24% full
```

2. Verify that the IP address assigned to the IP links by entering the `rtrv-ip-lnk` command.

The following is an example of the possible output.

```

rlghncxa03w 08-12-28 21:14:37 GMT EAGLE5 40.0.0
LOC  PORT  IPADDR          SUBMASK          DUPLEX  SPEED  MACTYPE  AUTO  MCAST
1201  A    192.1.1.10     255.255.255.128 HALF      10    802.3   NO   NO
1201  B    -----          -----          HALF      10    DIX     NO   NO
1203  A    192.1.1.12     255.255.255.0   ---      ---    DIX     YES  NO
1203  B    -----          -----          HALF      10    DIX     NO   NO
1205  A    192.1.1.14     255.255.255.0   FULL     100    DIX     NO   NO
1205  B    -----          -----          HALF      10    DIX     NO   NO
2101  A    192.1.1.20     255.255.255.0   FULL     100    DIX     NO   NO
2101  B    -----          -----          HALF      10    DIX     NO   NO
2103  A    192.1.1.22     255.255.255.0   FULL     100    DIX     NO   NO
2103  B    -----          -----          HALF      10    DIX     NO   NO
2105  A    192.1.1.24     255.255.255.0   FULL     100    DIX     NO   NO
2105  B    -----          -----          HALF      10    DIX     NO   NO
2207  A    192.1.1.32     255.255.255.0   FULL     100    DIX     NO   NO
2207  B    -----          -----          HALF      10    DIX     NO   NO
2213  A    192.1.1.50     255.255.255.0   FULL     100    DIX     NO   NO
2213  B    -----          -----          HALF      10    DIX     NO   NO
2301  A    192.1.1.52     255.255.255.0   FULL     100    DIX     NO   NO
2301  B    -----          -----          HALF      10    DIX     NO   NO

IP-LNK  table is (20 of 2048) 1% full.

```

If a local host is being configured in this procedure, the IP address assigned to the local host must be shown in the `rtrv-ip-lnk` output. If the IP address is not shown in the `rtrv-ip-lnk` output, add the IP address by performing the [Configuring an IP Link](#) procedure.

If a remote host is being configured in this procedure, the IP address assigned to the remote host cannot be shown in the `rtrv-ip-lnk` output.

3. Add IP host information to the database by entering the `ent-ip-host` command.

If a local host is being configured, enter the `ent-ip-host` command with the IP address from [Step 2](#), and the `type=local` parameter or without the `type` parameter. If the `type` parameter is not specified with the `ent-ip-host` command, the `type` parameter value defaults to `local`.

If a remote host is being configured, enter the `ent-ip-host` command with the IP address that is not shown in [Step 2](#), and the `type=remote` parameter.

For example, enter this command.

```
ent-ip-host:host="kc-hlr1":ipaddr=192.1.1.30
```

When this command has successfully completed, the following message should appear.

```

rlghncxa03w 06-10-28 21:18:37 GMT EAGLE5 36.0.0
ENT-IP-HOST: MASP A - COMPLTD

```

4. Verify the new IP host information in the database by entering the `rtrv-ip-host` command with the `host` parameter value specified in [Step 3](#).

For this example, enter this command.

```
rtrv-ip-host:host="kc-hlr1"
```

The following is an example of the possible output.

```
rlghncxa03w 13-06-28 21:19:37 GMT EAGLE5 45.0.0
LOCAL IPADDR      LOCAL HOST
192.1.1.30        KC-HLR1

IP Host table is (11 of 4096) .26% full
```

5. Back up the new changes using the `chg-db:action=backup:dest=fixed` command.

These messages should appear, the active Maintenance and Administration Subsystem Processor (MASP) appears first.

```
BACKUP (FIXED) : MASP A - Backup starts on active MASP.
BACKUP (FIXED) : MASP A - Backup on active MASP to fixed disk complete.
BACKUP (FIXED) : MASP A - Backup starts on standby MASP.
BACKUP (FIXED) : MASP A - Backup on standby MASP to fixed disk complete.
```

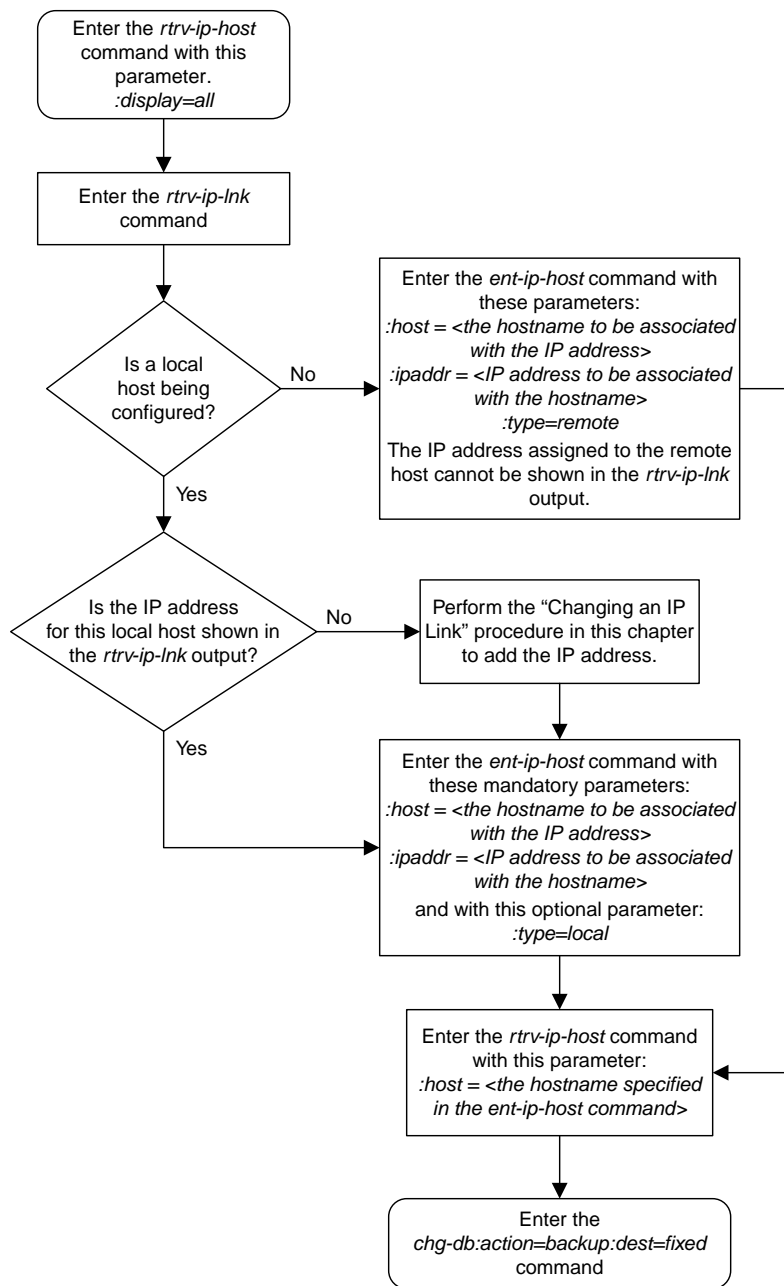

Figure 23: Adding an IP Host

Configuring an IP Card

This procedure is used to change the IP stack parameters associated with an IP card in the database using the `chg-ip-card` command.

The `chg-ip-card` command uses the following parameters.

`:loc` – The card location of the IP card

`:srchordr` – Host Table Search Order

`:dnrsa` – Domain name server A's IP address. This is an IP address expressed in standard "dot notation." IP addresses consist of the system's network number and the machine's unique host number.

`:dnspb` – Domain name server B's IP address. This is an IP address expressed in standard "dot notation." IP addresses consist of the system's network number and the machine's unique host number.

`:domain` – The domain name is used to construct a fully-qualified DNS name consisting of 120 characters or less. For example, a domain name can be `tekelec.com`, the hostname is `john.doe`. The fully-qualified DNS name would be `john.doe@tekelec.com`.

`:defrouter` – Default router IP address. This is an IP address expressed in standard "dot notation." IP addresses consist of the system's network number and the machine's unique host number.

`:rstdomain` – Reset Domain name. The parameter is used to reset the domain to a NULL value.

`:sctpchecksum` – The SCTP checksum algorithm that will be applied to the traffic on the IP card, either `adler32` or `crc32c`. The `sctpchecksum` parameter can be specified only if the `SCTPCSUM` value in the `rtrv-sg-opts` output is `percard`.

The `chg-ip-card` command contains other parameters that cannot be used in this procedure. Refer to *Commands User's Guide* for more information about these parameters.

The IP card must be placed out of service.

The `rstdomain` parameter cannot be specified if the `domain` parameter is specified.

There is only one default router (`defrouter` parameter) for each IP card. The default router is used as the primary route unless a static IP routes is defined for the destination IP address. Static IP routes are assigned using the `ent-ip-rte` command in the [Adding an IP Route](#) procedure.

The network portion of the IP address of the default router must match the network portion of one of the IP addresses assigned to the card.

The network portion of the IP address is based on the class of the IP address (shown in [Table 15: Valid Subnet Mask Parameter Values](#)). If the IP address is a Class A IP address, the first field is the network portion of the IP address. If the IP address is a Class B IP address, the first two fields are the network portion of the IP address. If the IP address is a Class C IP address, the first three fields are the network portion of the IP address. For example, if the IP address is 193.5.207.150, a Class C IP address, the network portion of the IP address is 193.5.207.

The default router can be associated with only one IP address assigned to the card if the `defrouter` parameter is specified. For example, the `dnrsa` value for card 1101 is 150.1.1.10. The `dnspb` value for card 1101 is 160.25.37.1. A default router is provisioned with the IP address 150.1.1.4. The default router is associated with the Ethernet A IP address (the `dnrsa` parameter value), but not the Ethernet B IP address (the `dnspb` parameter value).

If the default router is associated with one of the IP card's IP addresses, a second gateway router can be assigned to the other IP address on the IP card by provisioning a static IP route for the IP card using the `ent-ip-rte` command in the [Adding an IP Route](#) procedure. Static IP routes can provide gateway routers associated with the other IP address on the IP card. To provision the gateway router (the `gtwy` parameter of the `ent-ip-rte` command) for the other IP address assigned to the IP card, the network portion of the gateway router's IP address must match the network portion of the other IP address assigned to the IP card.

Specifying the IP address 0.0.0.0 for the `dnrsa` or `dnspb` parameters, removes the IP address for Ethernet A (`dnrsa`) or Ethernet B (`dnspb`).

When an IP card is entered into the database with the `ent-card` command, the IP stack parameters associated with this card are initially set with these default values:

- `:srchordr` – SRVR
- `:dnrsa` – No DNSA IP address is specified
- `:dnspb` – No DNSB IP address is specified
- `:domain` – No domain name is specified
- `:defrouter` – No default router IP address is specified
- `:rstdomain` – No
- `:sctpcsum` – CRC32C

The value of any optional parameter not specified with the `chg-ip-card` command is not changed.

1. Display the current IP parameters associated with card in the database by entering the `rtrv-ip-card` command.

The following is an example of the possible output.

```
rlghncxa03w 08-06-28 21:17:37 GMT EAGLE5 39.0.0
  LOC 1201
    SRCHORDR  SRVR
    DNSA      150.1.1.1
    DNSB      -----
    DEFROUTER -----
    DOMAIN    -----
    SCTPCSUM  crc32c
    BPIPADDR  -----
    BPSUBMASK -----
  LOC 1203
    SRCHORDR  LOCAL
    DNSA      192.1.1.40
    DNSB      -----
    DEFROUTER -----
    DOMAIN    NC. TEKELEC. COM
    SCTPCSUM  crc32c
    BPIPADDR  -----
    BPSUBMASK -----
  LOC 1205
    SRCHORDR  SRVROONLY
    DNSA      192.1.1.40
    DNSB      -----
    DEFROUTER -----
    DOMAIN    NC. TEKELEC. COM
    SCTPCSUM  crc32c
    BPIPADDR  -----
    BPSUBMASK -----
```

To change the parameters of an IP card, the signaling link to the card and the card have to be inhibited.

2. Display the signaling link associated with the card shown in [Step 1](#) using the `rtrv-slk` command specifying the card location.

For this example, enter this command.

```
rtrv-slk:loc=1201
```

This is an example of the possible output.

```
rlghncxa03w 06-10-28 21:17:37 GMT EAGLE5 36.0.0
LOC  LINK LSN          SLC TYPE  IPLIML2
1201 A    nc001          0  IPLIM  M2PA
```

3. Retrieve the status of the signaling link shown in [Step 2](#) using the `rept-stat-slk` command specifying the card location and signaling link.

For example, enter this command.

```
rept-stat-slk:loc=1201:link=a
```

The output lists the signaling link assigned to this card:

```
rlghncxa03w 06-10-28 21:16:37 GMT EAGLE5 36.0.0
SLK  LSN          CLLI          PST          SST          AST
1201,A  nc001      -----  IS-NR
          Avail      ----
Command Completed.
```

If the signaling link is in service-normal (IS-NR), continue the procedure with [Step 4](#) to deactivate the signaling link. If the signaling link is out-of-service-maintenance disabled (OOS-MT-DSBLD), continue the procedure with [Step 6](#) to verify the card status.

4. Deactivate the signaling link assigned to the IP card using the `rept-stat-slk` command.

For example, enter this command.

```
dact-slk:loc=1201:link=a
```



CAUTION

Caution: This command impacts network performance and should only be used during periods of low traffic.

After this command has successfully completed, this message appears.

```
rlghncxa03w 06-10-12 09:12:36 GMT EAGLE5 36.0.0
Deactivate Link message sent to card.
```

5. Verify the new link status using the `rept-stat-slk` command.

For example, enter this command.

```
rept-stat-slk:loc=1201:link=a
```

The output displays the link status as OOS-MT-DSBLD and gives off a minor alarm:

```
rlghncxa03w 06-10-27 17:00:36 GMT EAGLE5 36.0.0
SLK      LSN      CLLI      PST      SST      AST
1201,A   nc001      ----- OOS-MT-DSBLD AVAIL   ---
ALARM STATUS = * 0236 REPT-LKS:not aligned
UNAVAIL REASON = NA
Command Completed.
```

- Verify the status of the IP card to be inhibited using the `rept-stat-card` command.

For example, enter this command.

```
rept-stat-card:loc=1201
```

This is an example of the possible output.

```
rlghncxa03w 06-10-27 17:00:36 GMT EAGLE5 36.0.0
CARD VERSION      TYPE      GPL      PST      SST      AST
1201 114-000-000 DCM      IPLIM    IS-NR    Active   -----
ALARM STATUS      = No Alarms.
BPDCM GPL         = 002-102-000
IMT BUS A         = Conn
IMT BUS B         = Conn
SIGNALING LINK STATUS
SLK  PST          LS          CLLI
A    IS-NR        nc001      -----
Command Completed.
```

If the IP card to be inhibited is in service-normal (IS-NR), continue the procedure with [Step 7](#) to inhibit the card. If the IP card is out-of-service-maintenance disabled (OOS-MT-DSBLD), continue the procedure with [Step 9](#).

- Inhibit the IP card using the `inh-card` command.

For example, enter this command.

```
inh-card:loc=1201
```

This message should appear.

```
rlghncxa03w 06-10-28 21:18:37 GMT EAGLE5 36.0.0
Card has been inhibited.
```

- Display the status of the IP card to verify that it is out-of-service maintenance-disabled (OOS-MT-DSBLD).

Enter this command.

```
rept-stat-card:loc=1201
```

This is an example of the possible output.

```
rlghncxa03w 06-10-27 17:00:36 GMT EAGLE5 36.0.0
CARD VERSION      TYPE      GPL      PST      SST      AST
```

```

1201 114-000-000 DCM IPLIM IS-NR Active -----
ALARM STATUS = No Alarms.
BPDCM GPL = 002-102-000
IMT BUS A = Conn
IMT BUS B = Conn
SIGNALING LINK STATUS
SLK PST LS CLLI
A IS-NR nc001 -----
Command Completed.

```

If the `defrouter` parameter will be specified in [Step 11](#), continue the procedure with [Step 11](#).

If the `defrouter` parameter will not be specified in [Step 11](#), continue the procedure by performing one of these steps.

- If the `sctpcsum` parameter value for the card will not be changed, continue the procedure with [Step 11](#).
 - If the `sctpcsum` parameter value for the card will be changed, continue the procedure with [Step 10](#).
9. Verify that the IP address of either Ethernet A or B (the address whose network portion matches the network portion of the `defrouter` parameter value to be used in [Step 11](#)) is in the IP link table by entering the `rtrv-ip-lnk` command with the card location specified in this procedure.

For this example, enter this command.

```
rtrv-ip-lnk:loc=1201
```

The following is an example of the possible output.

```

rlghncxa03w 06-10-28 21:17:37 GMT EAGLE5 36.0.0
LOC PORT IPADDR SUBMASK DUPLEX SPEED MACTYPE AUTO MCAST
1201 A 192.1.1.10 255.255.255.0 ---- --- DIX YES NO
1201 B ----- ----- ---- --- DIX YES NO

```

If the network portion of the IP address specified by the `defrouter` value does not match the network portions of either IP address displayed in this step, perform one of these actions:

- Choose another value for the `defrouter` parameter, making sure that the network portion of the new IP address matches the network portion of one of the IP addresses displayed in this step.
- Perform the [Configuring an IP Link](#) procedure and change one of the IP addresses shown in this step so that the network portion of the new IP address changed in the [Configuring an IP Link](#) procedure matches the network portion of the IP address value for the `defrouter` parameter.

After this step has been completed, continue the procedure by performing one of these steps.

- If the `sctpcsum` parameter value for the card will not be changed, continue the procedure with [Step 11](#).
 - If the `sctpcsum` parameter value for the card will be changed, continue the procedure with [Step 10](#).
10. To change the `sctpcsum` parameter value for the IP card, the `sctpcsum` parameter value in the `rtrv-sg-opts` output must be `percard`. Verify the `sctpcsum` parameter value by entering the `rtrv-sg-opts` command.

The following is an example of the possible output.

```
rlghncxa03w 08-04-13 09:19:43 GMT EAGLE5 38.0.0
SRKQ:          1500
SNMPCONT:     tekelec
GETCOMM:      public
SETCOMM:      private
TRAPCOMM:     public
SCTPCSUM:     adler32
IPGWABATE:    NO
UAMEASUSEDFTAS: NO
```

If the `sctpcsum` parameter value in the `rtrv-sg-opts` output is `percard`, continue the procedure with [Step 11](#).

If the `sctpcsum` parameter value in the `rtrv-sg-opts` output is `adler 32` or `crc32c`, perform the [Changing the SCTP Checksum Algorithm Option for M2PA Associations](#) procedure to change the `sctpcsum` parameter value to `percard`. After the [Changing the SCTP Checksum Algorithm Option for M2PA Associations](#) procedure has been performed, continue the procedure with [Step 11](#).

11. Change the IP stack parameters associated with an IP card in the database using the `chg-ip-card` command.

For this example, enter this command.

```
chg-ip-card:loc=1201:srchordr=local:dnsa=192.1.1.40:domain=nc.tekelec.com
:sctpcsum=adler32
```

When this command has successfully completed, the following message should appear.

```
rlghncxa03w 06-10-28 21:20:37 GMT EAGLE5 36.0.0
CHG-IP-CARD: MASP A - COMPLTD
```

12. Verify the new IP parameters associated with the IP card that was changed in [Step 11](#) by entering the `rtrv-ip-card` command with the card location specified in [Step 11](#).

For this example, enter this command.

```
rtrv-ip-card:loc=1201
```

The following is an example of the possible output.

```
rlghncxa03w 08-06-28 21:17:37 GMT EAGLE5 39.0.0
LOC 1201
  SRCHORDR  LOCAL
  DNSA      192.1.1.40
  DNSB      -----
  DEFROUTER -----
  DOMAIN    NC. TEKELEC. COM
  SCTPCSUM  adler32
  BPIPADDR  -----
  BPSUBMASK -----
```

Note: If [Step 7](#) was not performed, continue the procedure with [Step 15](#).

13. Allow the IP card that was inhibited in [Step 7](#) by using the `alw-card` command.

For example, enter this command.

```
alw-card:loc=1201
```

This message should appear.

```
rlghncxa03w 06-10-28 21:22:37 GMT EAGLE5 36.0.0
Card has been allowed.
```

14. Verify the in-service normal (IS-NR) status of the IP card using the `rept-stat-card` command.

For example, enter this command.

```
rept-stat-card:loc=1201
```

This is an example of the possible output.

```
rlghncxa03w 06-10-27 17:00:36 GMT EAGLE5 36.0.0
CARD  VERSION      TYPE      GPL      PST      SST      AST
1201  114-000-000  DCM      IPLIM    IS-NR    Active   -----
  ALARM STATUS      = No Alarms.
  BPDCM GPL         = 002-102-000
  IMT BUS A         = Conn
  IMT BUS B         = Conn
  SIGNALING LINK STATUS
    SLK  PST          LS          CLLI
    A    IS-NR       nc001      -----
Command Completed.
```

15. Activate the signaling link from [Step 4](#) using the `act-slk` command.

Note: If [Step 4](#) was not performed, continue the procedure with [Step 17](#).

For example, enter this command.

```
act-slk:loc=1201:link=a
```

The link changes its state from OOS-MT-DSBLD (out-of-service maintenance-disabled) to IS-NR (in-service normal).

The output confirms the activation.

```
rlghncxa03w 06-10-07 11:11:28 GMT EAGLE5 36.0.0
Activate Link message sent to card
```

16. Verify the in-service normal (IS-NR) status of the signaling link using the `rept-stat-slk` command.

For example, enter this command.

```
rept-stat-slk:loc=1201:link=a
```

This message should appear.

```
rlghncxa03w 06-10-28 21:16:37 GMT EAGLE5 36.0.0
SLK      LSN      CLLI      PST      SST      AST
```

```
1201,A   nc001   -----   IS-NR
          Avail   -----
Command Completed.
```

17. Back up the new changes using the `chg-db:action=backup:dest=fixed` command.

These messages should appear, the active Maintenance and Administration Subsystem Processor (MASP) appears first.

```
BACKUP (FIXED) : MASP A - Backup starts on active MASP.
BACKUP (FIXED) : MASP A - Backup on active MASP to fixed disk complete.
BACKUP (FIXED) : MASP A - Backup starts on standby MASP.
BACKUP (FIXED) : MASP A - Backup on standby MASP to fixed disk complete.
```

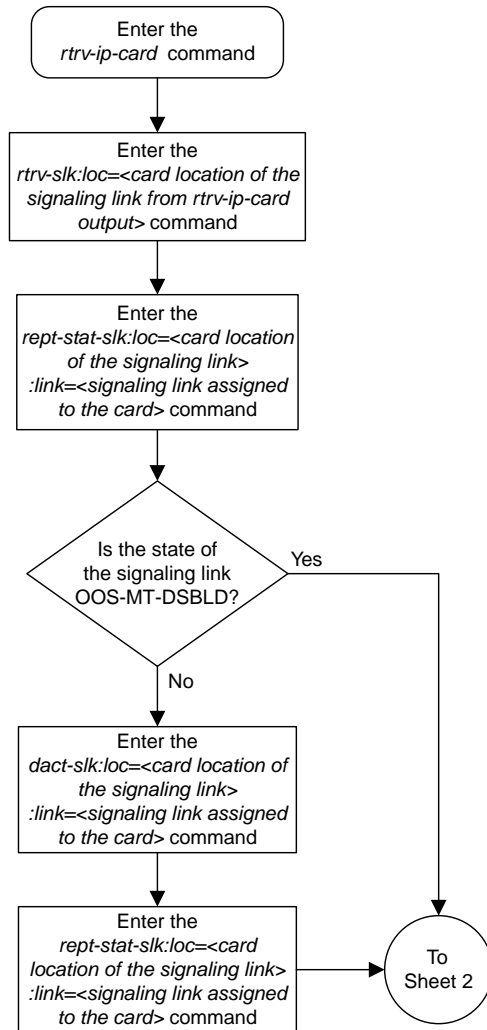

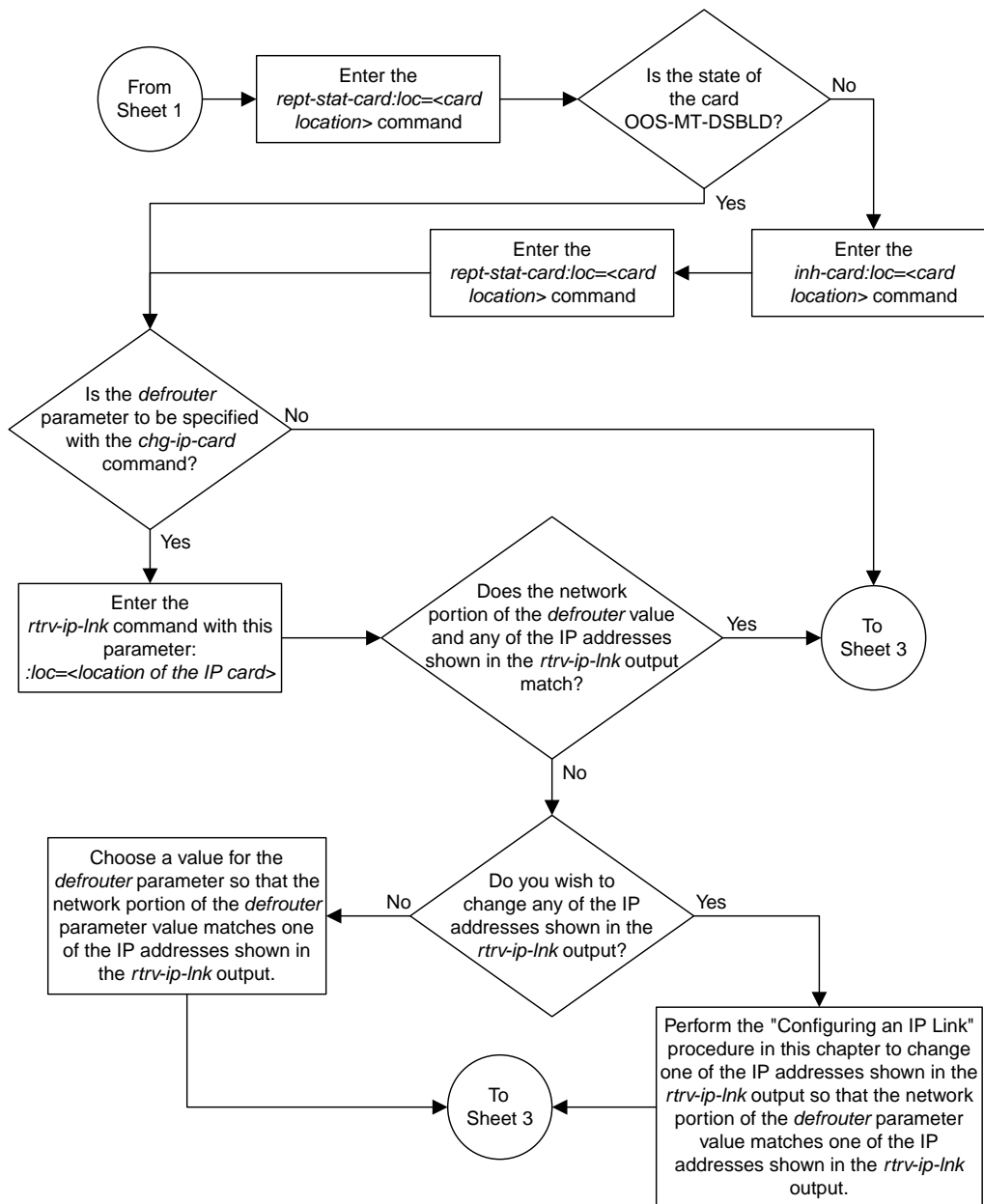

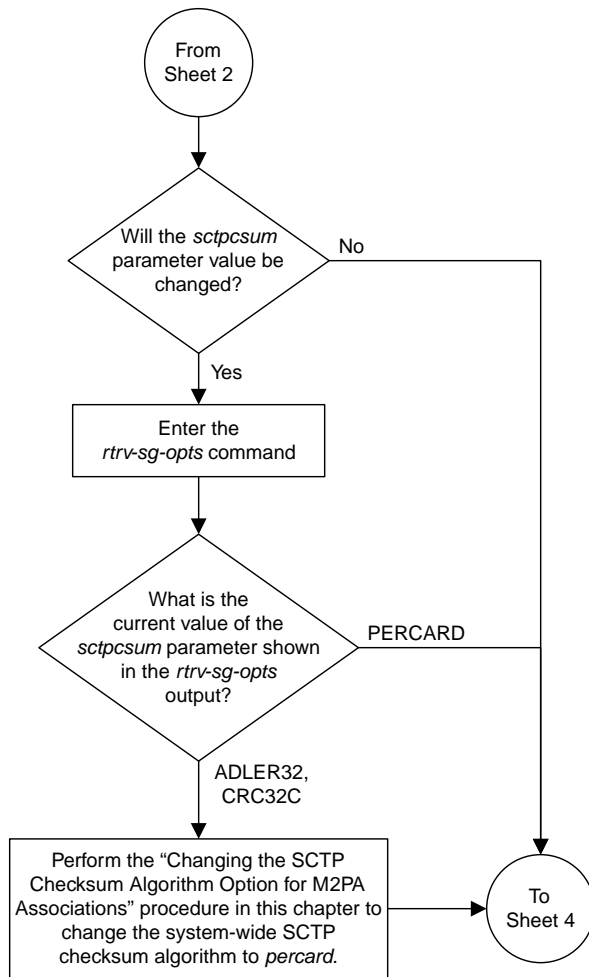

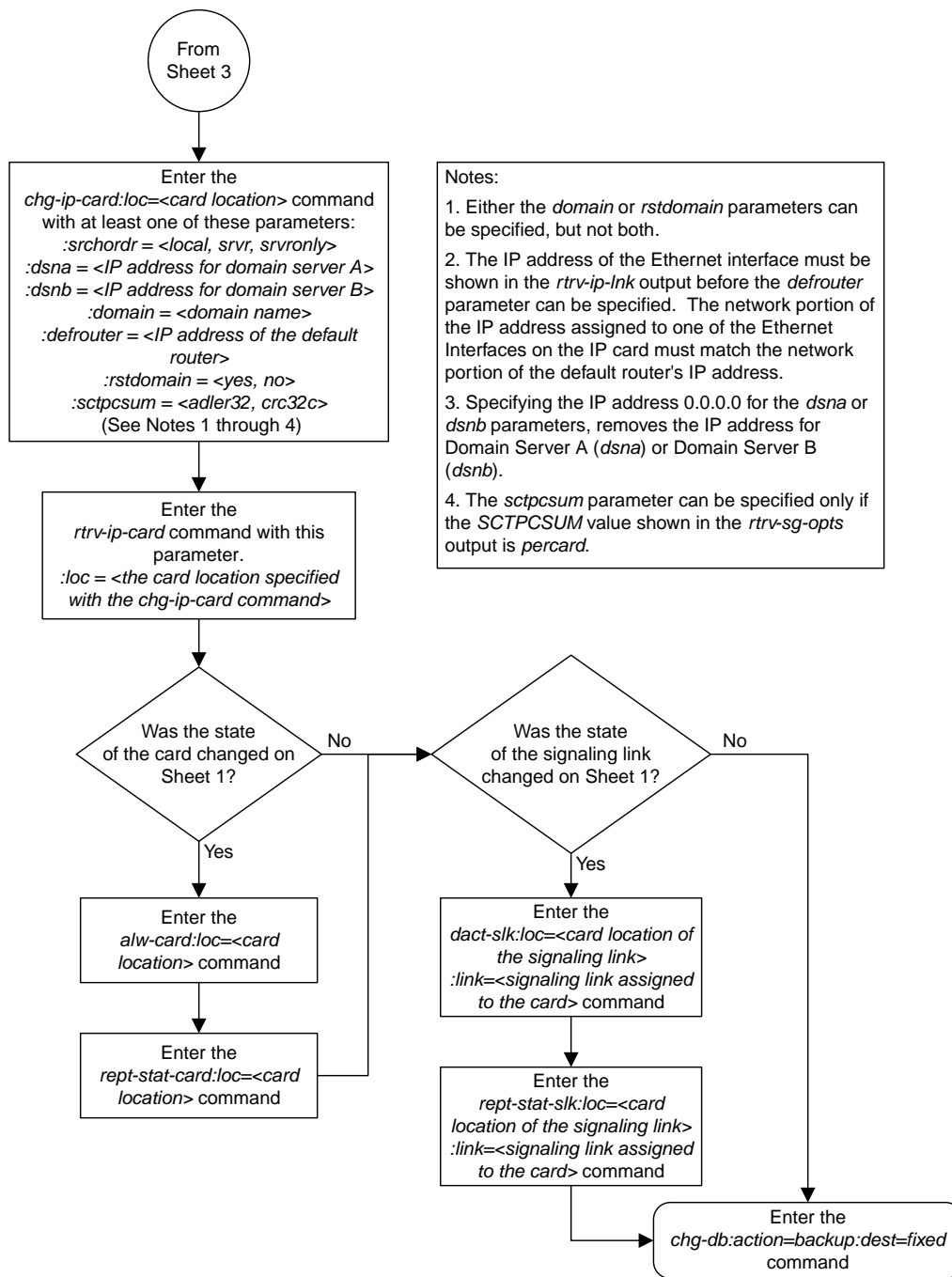

Sheet 4 of 4

Figure 24: Configuring an IP Card

Adding an IP Route

This procedure is used to add an IP route to the database using the `ent-ip-rte` command.

The `ent-ip-rte` command uses these parameters.

`:loc` – The location of the IP card that the IP route will be assigned to.

`:dest` – The IP address of the remote host or network.

`:submask` – The subnet mask of the destination IP address.

`:gtwy` – The IP address of the gateway or router that will send the IP data to its final destination.

There can be a maximum of 64 IP routes assigned to an IP card.

The EAGLE can contain a maximum of 1024 IP routes.

Ethernet Interfaces A and B on the IP card specified by the `loc` parameter can be used.

The network portion of the IP address value of the `gtwy` parameter must be the same as the network portion of the IP addresses shown for either the A or B interfaces in the `rtrv-ip-card` output.

The value of the `dest` and `gtwy` parameters cannot be 127.x.x.x (the loopback address), 0.0.0.0, or the IP addresses of the A or B interfaces on the IP card, and cannot be assigned to another IP card.

If the `dest` parameter value represents a host IP address, the value for the `submask` parameter must be 255.255.255.255. Otherwise, the `submask` parameter value identifies the network/host ID portions that must be entered when the `dest` parameter value represents a network address.

The submask is applied to the IP address which is being routed to see if it yields a route match. For example, if IP address 192.1.1.2 is being routed and the IP routing table contains these entries.

Table 16: Sample IP Routing Table

IP address	Submask	Gateway
191.1.0.0	255.255.0.0	192.168.110.250
192.0.0.0	255.0.0.0	192.168.110.251

IP routing occurs as follows:

1. The subnet mask of route 1 (255.255.0.0) is applied to the IP address being routed (192.1.1.2) with the resulting IP address of 192.1.0.0. IP address 192.1.0.0 does not match IP address 191.1.0.0 in the IP routing table, so the next route is chosen.
2. The subnet mask of route 2 (255.0.0.0) is applied to the IP address being routed (192.1.1.2) with the resulting IP address of 192.0.0.0 which matches the second route in the IP routing table, so this route is selected for routing this datagram.

See [Table 17: Valid Subnet Mask Parameter Values](#) for the valid input values for the `submask` and `dest` parameter combinations.

Table 17: Valid Subnet Mask Parameter Values

Network Class	IP Network Address Range	Valid Subnet Mask Values
A	1.0.0.0 to 127.0.0.0	255.0.0.0 (the default value for a class A IP address) 255.192.0.0 255.224.0.0 255.240.0.0 255.248.0.0 255.252.0.0 255.254.0.0 255.255.128.1
A+B	128.1.0.0 to 191.255.0.0	255.255.0.0 (the default value for a class B IP address) 255.255.192.0 255.255.224.0 255.255.240.0 255.255.248.0 255.255.252.0 255.255.254.0 255.255.255.128
A+B+C	192.0.0.0 to 223.255.255.0	255.255.255.0 (the default value for a class C IP address) 255.255.255.192 255.255.255.224 255.255.255.240 255.255.255.248 255.255.255.252

If a Class B IP address is specified for the `dest` parameter of the `ent-ip-rte` command, the subnet address that results from the `dest` and `submask` parameter values cannot be the same as the subnet address that results from the `pvn` and `pvnmask`, `fcna` and `fcnamask`, or `fcnb` and `fcnbmask` parameter values of the `chg-netopts` command. The `pvn` and `pvnmask`, `fcna` and `fcnamask`, or `fcnb` and `fcnbmask` parameter values can be verified by entering the `rtrv-netopts` command. Choose `dest` and `submask` parameter values for the IP route whose resulting subnet address is not

be the same as the subnet address resulting from the `pvn` and `pvnmask`, `fcna` and `fcnamask`, or `fcnb` and `fcnbmask` parameter values of the `chg-netopts` command.

1. Display the IP routes in the database with the `rtrv-ip-rte` command.

This is an example of the possible output.

```
rlghncxa03w 06-10-28 09:12:36 GMT EAGLE5 36.0.0
LOC  DEST          SUBMASK          GTWY
1301 128.252.10.5     255.255.255.255 140.188.13.33
1301 128.252.0.0      255.255.0.0     140.188.13.34
1301 150.10.1.1       255.255.255.255 140.190.15.3
1303 192.168.10.1     255.255.255.255 150.190.15.23
1303 192.168.0.0      255.255.255.0   150.190.15.24

IP Route table is (5 of 2048) 0.24% full
```

2. Display the IP cards in the database with the `rtrv-ip-card` command.

This is an example of the possible output.

```
rlghncxa03w 08-08-28 21:17:37 GMT EAGLE5 39.0.0
LOC 1212
  SRCHORDR  LOCAL
  DNSA      150.1.1.1
  DNSB      -----
  DEFROUTER 150.1.1.100
  DOMAIN    NC. TEKELEC. COM
  SCTPCSUM  crc32c
  BPIPADDR  -----
  BPSUBMASK -----
LOC 1301
  SRCHORDR  SRVROONLY
  DNSA      140.188.13.10
  DNSB      140.190.15.28
  DEFROUTER -----
  DOMAIN    NC. TEKELEC. COM
  SCTPCSUM  crc32c
  BPIPADDR  -----
  BPSUBMASK -----
LOC 1303
  SRCHORDR  LOCAL
  DNSA      150.190.15.1
  DNSB      -----
  DEFROUTER 150.190.15.25
  DOMAIN    NC. TEKELEC. COM
  SCTPCSUM  crc32c
  BPIPADDR  -----
  BPSUBMASK -----
```

If the required IP card is not shown in the `rtrv-ip-card` output, perform the [Adding an IPLIMx Card](#) procedure to add the card to the database.

Perform the [Configuring an IP Card](#) procedure and make sure that the network portion of the IP addresses assigned for the A or B interfaces of the IP card is the same as the network portion of the IP address that will be assigned to the `gtwy` parameter of the IP route

Note: If a Class A or CIP address (see [Table 17: Valid Subnet Mask Parameter Values](#)) will be specified for the `dest` parameter in [Step 4](#), continue the procedure with [Step 4](#).

- The subnet address that results from the `dest` and `submask` parameter values of the `ent-ip-rte` command cannot be the same as the subnet address that results from the `pvn` and `pvnmask`, `fcna` and `fcnamask`, or `fcnb` and `fcnbmask` parameter values of the `chg-netopts` command.

Display the `pvn`, `pvnmask`, `fcna`, `fcnamask`, `fcnb`, and `fcnbmask` parameter values of the `chg-netopts` command by entering the `rtrv-netopts` command.

If error message E3967 Cmd Rej: E5IS must be on is displayed after the `rtrv-netopts` command is executed, the `pvn`, `pvnmask`, `fcna`, `fcnamask`, `fcnb`, and `fcnbmask` parameters are not configured. Continue the procedure with [Step 4](#).

This is an example of the possible output if the E5IS feature is on.

```
rlghncxa03w 09-02-28 21:17:37 GMT EAGLE5 40.1.0
NETWORK OPTIONS
-----
PVN           = 128.20.30.40
PVNMASK       = 255.255.192.0
FCNA          = 170.120.50.0
FCNAMASK      = 255.255.240.0
FCNB          = 170.121.50.0
FCNBMASK      = 255.255.254.0
```

Choose `dest` and `submask` parameter values for the IP route whose resulting subnet address is not be the same as the subnet address resulting from the `pvn` and `pvnmask`, `fcna` and `fcnamask`, or `fcnb` and `fcnbmask` parameter values of the `chg-netopts` command. Continue the procedure with [Step 4](#).

- Add the IP route to the database using the `ent-ip-rte` command.

For this example, enter this command.

```
ent-ip-rte:loc=1212:dest=132.10.175.20:submask=255.255.255.255
:gtwy=150.1.1.50
```

When this command has successfully completed, this message should appear.

```
rlghncxa03w 06-10-12 09:12:36 GMT EAGLE5 36.0.0
ENT-IP-RTE: MASP A - COMPLTD
```

- Verify the changes using the `rtrv-ip-rte` command with the card location specified with the `ent-ip-rte` command in [Step 4](#).

For this example, enter these commands.

```
rtrv-ip-rte:loc=1212
```

This is an example of the possible output.

```
rlghncxa03w 06-10-28 09:12:36 GMT EAGLE5 36.0.0
LOC  DEST          SUBMASK          GTWY
1212 132.10.175.20    255.255.255.255 150.1.1.50
IP Route table is (6 of 2048) 0.29% full
```

- Back up the new changes using the `chg-db:action=backup:dest=fixed` command.

These messages should appear, the active Maintenance and Administration Subsystem Processor (MASP) appears first.

```
BACKUP (FIXED) : MASP A - Backup starts on active MASP.  
BACKUP (FIXED) : MASP A - Backup on active MASP to fixed disk complete.  
BACKUP (FIXED) : MASP A - Backup starts on standby MASP.  
BACKUP (FIXED) : MASP A - Backup on standby MASP to fixed disk complete.
```

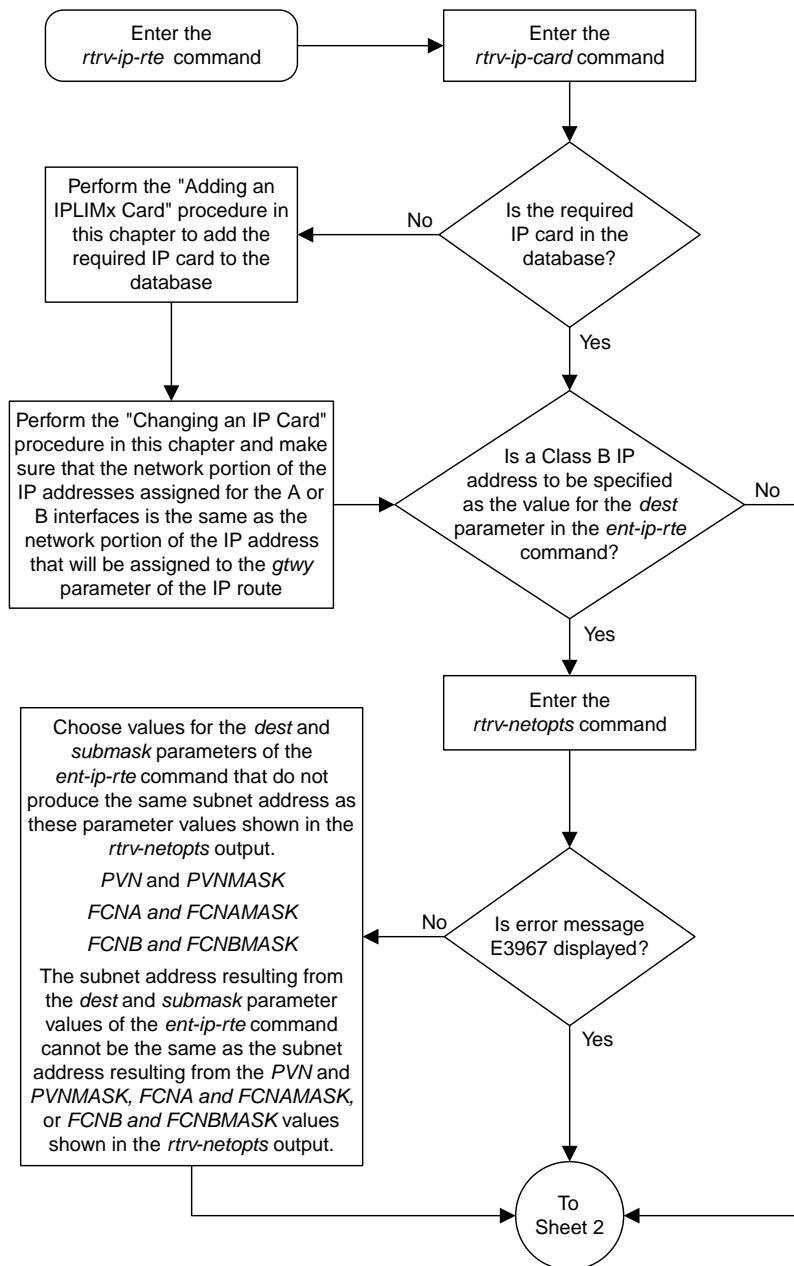

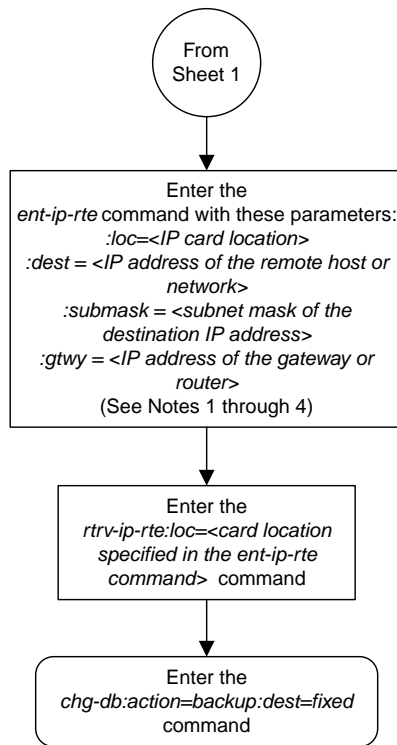
**Notes:**

1. The network portion of the IP address value of the *gtwy* parameter must be the same as the network portion of the IP addresses shown for either the A or B interfaces in the *rtrv-ip-card* output.
2. The value of the *dest* and *gtwy* parameters cannot be the 127.x.x.x (the loopback address), 0.0.0.0, or the IP addresses of the A or B interfaces on the IP card, and cannot be assigned to another IP card.
3. There can be a maximum of 64 IP routes assigned to an IP card.
4. The EAGLE 5 ISS can contain a maximum of 1024 IP routes.

Sheet 2 of 2

Figure 25: Adding an IP Route

Adding an M2PA Association

This procedure is used to configure M2PA associations using the `ent-assoc` command. The combination of a local host, local SCTP port, remote host and remote SCTP port defines an association. M2PA associations are assigned to cards running either the IPLIM or IPLIMI applications (IPLIMx cards).

The `ent-assoc` command uses these parameters:

`:aname` – The name assigned to the association. Valid association names can contain up to 15 alphanumeric characters where the first character is a letter and the remaining characters are alphanumeric characters. The `aname` parameter value is not case-sensitive.

`:lhost` – Local Hostname. The logical name assigned to the local host device.

`:lport` – The SCTP port number for the local host.

`:rhost` – Remote Hostname. The logical name assigned to the remote host device.

`:rport` – The SCTP port number for the remote host.

`:link` – The signaling link on the IP card. If a signaling link is not specified for a association when it is entered, the association defaults to signaling link A. If the card is an E5-ENET or E5-ENET-B card, the values for the `link` parameter can be `a`, `a1`, `a2`, `a3`, `a4`, `a5`, `a6`, `a7`, `b`, `b1`, `b2`, `b3`, `b4`, `b5`, `b6`, or `b7`.

Note: The `port` parameter can be used in place of the `link` parameter to specify the signaling link on the card.

`:adapter` – The adapter layer for this association, `m2pa`. The `adapter` parameter is optional. The default value for the `adapter` parameter is `m2pa`.

`:alhost` – The alternate local host name.

`:m2patset` – The M2PA timer set assigned to the association. The `m2patset` parameter can be specified only with the `adapter=m2pa` parameter. If the `adapter=m2pa` parameter is specified, and the `m2patset` parameter is not specified with the `ent-assoc` command, the default value for the `m2patset` parameter (1 - M2PA timer set 1) is assigned to the association.

Associations contain fields whose values are not assigned using the `ent-assoc` command. When an association is added to the database, these fields receive their default values. If a different value is desired, the `chg-assoc` command must be used. To change these values perform the [Changing the Attributes of an M2PA Association](#) procedure.

These fields and their default values are shown in [Table 18: M2PA Association Fields and Default Values](#).

Table 18: M2PA Association Fields and Default Values

<code>open=no</code>	<code>rmax=800</code>	<code>cwmin=3000</code>	<code>alw=no</code>	<code>uaps=10</code>
<code>istrms=2</code>	<code>rmode=lin</code>	<code>rtimes=10</code>	<code>ostrms=2</code>	<code>rmin=120</code>

ver=rfc	bufsize=200	rtxthr=0	rhostval=relaxed	
---------	-------------	----------	------------------	--

An M2PA association that is assigned to an IPLIMx signaling link can contain a UA parameter set value (the `uaps` parameter). The `uaps` parameter cannot be specified with the `ent-assoc` command. The default value for the `uaps` parameter is 10. While the `uaps` parameter value can be changed with the `chg-assoc` command, the `uaps` parameter value has no impact on the traffic carried by an M2PA association that is assigned to an IPLIMx signaling link. The `uaps` parameter value impacts M3UA or SUA associations that are assigned to IPGWx signaling links and M2PA and M3UA associations that are assigned to IPSPG cards. The `uaps` parameter value is shown in the `UAPS` field in the `rtrv-assoc` output for an M2PA associations that is assigned to an IPLIMx signaling link.

An M2PA association can contain an alternate remote host. The alternate remote host is provisioned with the `rhost` and `rhostype=alternate` parameters of the `chg-assoc` command. A primary remote host can be provisioned in this procedure by specifying the `rhost` parameter with the `ent-assoc` command. To provision an alternate remote host for an M2PA association, perform [Changing the Attributes of an M2PA Association](#).

The size of the buffers on the on the E5-ENET and E5-ENET-B cards are shown in the following list.

- E5-ENET Card and E5-ENET-B - 3200 KB

The size of the buffers assigned to each association that is assigned to the IP card cannot exceed the maximum buffer size for the IP card. When a new association is added, the default buffer size for the association is assigned to the association. If adding the new association causes the total buffer size for all the associations on the IP card to exceed the maximum buffer size for that IP card, the `ent-assoc` command will be rejected. If the you wish to add the association and the maximum buffer size for the IP card will be exceeded, the buffer size of the other associations assigned to the IP card must be decreased by performing the [Changing the Buffer Size of a M2PA Association](#) procedure. The available size of the buffers on the IP card can be verified by entering this command.

```
rtrv-assoc:lhost=<local host name assigned to the association being changed>
```

The `alhost` parameter can also be used with the `rtrv-assoc` command to display the available size of the buffers on the IP card.

The `aname` parameter can be used with the `rtrv-assoc` command to display the available size of the buffers on the IP card and the size of the buffer assigned to the association.

The value of the `lhost`, `rhost`, or `alhost` parameters is a text string of up to 60 characters, with the first character being a letter. The command line on the terminal can contain up to 150 characters. If the host names are too long to fit on the `ent-assoc` command line, perform the `chg-assoc` command with the parameters and values necessary to complete the entry of the M2PA association.

The EAGLE can contain a maximum of 4000 connections (association to application server assignments).

IPLIMx cards can contain one association for each signaling link on the card. The E5-ENET card can contain a maximum of 16 signaling links, resulting in a maximum of 16 associations for this card.

The B Ethernet interface of the IP card can be used on the E5-ENET card.

If the association is to be activated in this procedure, with the `chg-assoc` command, the association must contain values for the `lhost`, `lport`, `rhost`, `rport` parameters.

The `ipliml2` parameter value of the signaling link assigned to the association must be `m2pa`. The `adapter` parameter value of the association must be `m2pa`.

The signaling link being assigned to the association must be out of service. This state is shown in the `rept-stat-slk` output with the entries `OOS-MT` in the `PST` field and `Unavail` in the `SST` field.

If the association is being opened in this procedure with the `chg-assoc` command and the `open=yes` parameter, the signaling link assigned to the association must be in the database and the `iplink2` parameter value of the signaling link assigned to the association must be `m2pa`.

Uni-homed endpoints are associations configured with the `lhost` parameter only. The `lhost` parameter value represents an IP address that corresponds to either the A or B network interface of the IP card. Multi-homed endpoints are associations configured with both the `lhost` and `alhost` parameters. The `lhost` parameter value represents an IP address corresponding to one of the network interfaces (A or B) of the IP card while the `alhost` parameter value represents an IP address corresponding to the other network interface of the same IP card.

An alternate remote host can be configured for multi-homed associations using the `rhost` and `rhosttype` parameters of the `chg-assoc` command. The `rhost` parameter value with the `rhosttype=primary` parameter represents an IP address that corresponds to one of the network interfaces at the remote end while the `rhost` parameter value with the `rhosttype=alternate` parameter represents an IP address that corresponds to the other network interface at the remote end.

Canceling the RTRV-ASSOC Command

Because the `rtrv-assoc` command used in this procedure can output information for a long period of time, the `rtrv-assoc` command can be canceled and the output to the terminal stopped. There are three ways that the `rtrv-assoc` command can be canceled.

- Press the F9 function key on the keyboard at the terminal where the `rtrv-assoc` command was entered.
- Enter the `canc-cmd` without the `trm` parameter at the terminal where the `rtrv-assoc` command was entered.
- Enter the `canc-cmd:trm=<xx>`, where `<xx>` is the terminal where the `rtrv-assoc` command was entered, from another terminal other than the terminal where the `rtrv-assoc` command was entered. To enter the `canc-cmd:trm=<xx>` command, the terminal must allow Security Administration commands to be entered from it and the user must be allowed to enter Security Administration commands. The terminal's permissions can be verified with the `rtrv-secu-trm` command. The user's permissions can be verified with the `rtrv-user` or `rtrv-secu-user` commands.

For more information about the `canc-cmd` command, go to *Commands User's Guide*.

1. Display the associations in the database using the `rtrv-assoc` command. This is an example of possible output.

```
rlghncxa03w 08-04-28 09:12:36 GMT EAGLE5 38.0.0
CARD IPLNK
ANAME      LOC  PORT  LINK ADAPTER LPORT RPORT OPEN ALW
swbel32    1201 A     A    M3UA  1030  2345 YES  YES
a2         1305 A     A    SUA   1030  2345 YES  YES
a3         1307 A     A    SUA   1030  2346 YES  YES
assoc3     1203 A     A1   M2PA  2048  1030 NO   NO
```

Perform one of these actions.

- If the desired IP link (shown by the entries in the `CARD LOC` and `IPLINK PORT` columns for an association whose `ADAPTER` value is `M2PA`) is shown in the `rtrv-assoc` output, continue the procedure with [Step 2](#).

- If the desired IP link is not shown in the `rtrv-assoc` output, continue the procedure with [Step 3](#).
2. Display the signaling links assigned to the card that the new M2PA association will be assigned to by entering the `rtrv-slk` command with the card location displayed in [Step 1](#). For this example, enter this command.

```
rtrv-slk:loc=1203
```

The following is an example of the possible output.

```
rlghncxa03w 08-04-06 10:07:25 GMT EAGLE5 38.0.0
```

LOC	LINK	LSN	SLC	TYPE	IPLIML2
1203	A	e5e6a	0	IPLIM	M2PA
1203	A1	m2pa1	0	IPLIM	M2PA

If the value in the `TYPE` column is either `IPLIM` or `IPLIMI`, continue the procedure with [Step 6](#).

If the value in the `TYPE` column is `IPSG`, the links and host assigned to this card cannot be used in this procedure. If you wish to use this card to configure an M2PA association, perform the [Adding an IPSG M2PA Association](#) procedure.

If you do not wish to use this card to configure an M2PA association, perform one of these actions.

- Choose another card from the `rtrv-assoc` output in [Step 1](#) and repeat this step.
 - Continue the procedure with [Step 3](#) to choose another `IPLIMx` card and IP link for the new M2PA association.
3. Display the IP links in the database by entering the `rtrv-ip-lnk` command. The following is an example of the possible output.

```
rlghncxa03w 08-12-28 21:14:37 GMT EAGLE5 40.0.0
```

LOC	PORT	IPADDR	SUBMASK	DUPLEX	SPEED	MACTYPE	AUTO	MCAST
1201	A	192.1.1.10	255.255.255.128	HALF	10	802.3	NO	NO
1201	B	-----	-----	HALF	10	DIX	NO	NO
1203	A	192.1.1.12	255.255.255.0	----	---	DIX	YES	NO
1203	B	-----	-----	HALF	10	DIX	NO	NO
1205	A	192.1.1.14	255.255.255.0	FULL	100	DIX	NO	NO
1205	B	-----	-----	HALF	10	DIX	NO	NO
2101	A	192.1.1.20	255.255.255.0	FULL	100	DIX	NO	NO
2101	B	-----	-----	HALF	10	DIX	NO	NO
2103	A	192.1.1.22	255.255.255.0	FULL	100	DIX	NO	NO
2103	B	-----	-----	HALF	10	DIX	NO	NO
2105	A	192.1.1.24	255.255.255.0	FULL	100	DIX	NO	NO
2105	B	-----	-----	HALF	10	DIX	NO	NO
2205	A	192.1.1.30	255.255.255.0	FULL	100	DIX	NO	NO
2205	B	-----	-----	HALF	10	DIX	NO	NO
2207	A	192.1.1.32	255.255.255.0	FULL	100	DIX	NO	NO
2207	B	-----	-----	HALF	10	DIX	NO	NO
2213	A	192.1.1.50	255.255.255.0	FULL	100	DIX	NO	NO
2213	B	-----	-----	HALF	10	DIX	NO	NO
2301	A	192.1.1.52	255.255.255.0	FULL	100	DIX	NO	NO
2301	B	-----	-----	HALF	10	DIX	NO	NO

```
IP-LNK table is (20 of 2048) 1% full.
```

If the required IP link is not in the database, add the IP link using the [Configuring an IP Link](#) procedure.

- Verify that the local host name to be assigned to the association is in the database by using the `rtrv-ip-host:display=all` command. The following is an example of the possible output.

```
rlghncxa03w 13-06-28 21:15:37 GMT EAGLE5 45.0.0

LOCAL IPADDR      LOCAL HOST
192.1.1.10        IPNODE1-1201
192.1.1.12        IPNODE1-1203
192.1.1.14        IPNODE1-1205
192.1.1.20        IPNODE2-1201
192.1.1.22        IPNODE2-1203
192.1.1.24        IPNODE2-1205
192.1.1.30        KC-HLR1
192.1.1.32        KC-HLR2
192.1.1.50        DN-MS1
192.1.1.52        DN-MS2

REMOTE IPADDR     REMOTE HOST
150.1.1.5         NCDEPTECONOMIC_DEVELOPMENT. SOUTHEASTERN_COORIDOR_ASHVL. GOV

IP Host table is (11 of 4096) .26% full
```

The IP address of the IP link should be assigned to the local host name that will be assigned to the association.

The `ipliml2` parameter value of the signaling link must be `m2pa`.

The values of the `lhost` and `alhost` parameters must be in the LOCAL HOST column in the `rtrv-ip-host` output.

If the required hostname is not in the database, add the IP host name using the [Adding an IP Host](#) procedure.

- Display the signaling links assigned to the card that the new M2PA association will be assigned to by entering the `rtrv-slk` command with the card location displayed in [Step 3](#) or the card location of the IP link that was configured by performing the [Configuring an IP Link](#) procedure in [Step 3](#). For this example, enter this command.

```
rtrv-slk:loc=1203
```

The following is an example of the possible output.

```
rlghncxa03w 08-04-06 10:07:25 GMT EAGLE5 38.0.0

LOC  LINK  LSN          SLC  TYPE      IPLIML2
1203 A    e5e6a        0    IPLIM     M2PA
1203 A1   m2pa1        0    IPLIM     M2PA
```

If the signaling link that you wish to assign to the association is shown in the `rtrv-slk` output, continue the procedure with [Step 6](#).

If the signaling link that you wish to assign to the association is not shown in the `rtrv-slk` output, add the signaling link to the database with the `ipliml2=m2pa` parameter, and without activating the signaling link, by performing the [Adding an IPLIMx Signaling Link](#) procedure. After the signaling link has been added, continue the procedure with [Step 9](#).

- Display the status of the signaling link shown in [Step 5](#) using the `rept-stat-slk` command specifying the card location and signaling link. For example, enter this command.

```
rept-stat-slk:loc=1203:link=a
```

This is an example of the possible output.

```
rlghncxa03w 08-04-28 21:16:37 GMT EAGLE5 38.0.0
SLK      LSN      CLLI      PST      SST      AST
1203,A   e5e6a     -----  IS-NR    Avail    ----
Command Completed.
```

If the primary state (PST) of the signaling link is OOS-MT and the secondary state (SST) is Unavail, continue the procedure with [Step 9](#).

If the primary state (PST) of the signaling link not is OOS-MT and the secondary state (SST) is not Unavail, continue the procedure with [Step 7](#).

- Deactivate the signaling link from [Step 6](#) using the `dact-slk` command. For example, enter this command.

```
dact-slk:loc=1203:link=a
```

When this command has successfully completed, the following message should appear.

```
rlghncxa03w 08-04-07 11:11:28 GMT EAGLE5 38.0.0
Deactivate Link message sent to card
```

- Verify the status of the signaling link using the `rept-stat-slk` command. For example, enter this command.

```
rept-stat-slk:loc=1203:link=a
```

This is an example of the possible output.

```
rlghncxa03w 08-04-28 21:16:37 GMT EAGLE5 38.0.0
SLK      LSN      CLLI      PST      SST      AST
1203,A   e5e6a     -----  OOS-MT   Unavail  ----
Command Completed.
```

- Verify the values of the M2PA timer set you wish to assign to the association by entering the `rtrv-m2pa-tset` command with the `ver=rfc` parameter.

When an M2PA association is provisioned in this procedure, the RFC M2PA version is assigned to the M2PA association by default.

The M2PA version of the association determines the version of the M2PA timer set that is assigned to the association. For example, if M2PA timer set 3 is assigned to the M2PA association, and the association is an RFCM2PA association, the RFC version of M2PA timer set 3 is used with the association. If M2PA timer set 7 is assigned to the M2PA association, and the association is a Draft 6 M2PA association, the Draft 6 version of M2PA timer set 7 is used with the association.

If you wish to assign the Draft 6 M2PA version to this association and use the Draft 6 M2PA timer sets, perform the [Changing the Attributes of an M2PA Association](#) procedure after this procedure is completed to change the M2PA version of this association.

Note: If the `m2patset` parameter will not be specified with the `ent-assoc` command, the M2PA timer set 1 will be assigned to the association.

To display the M2PA Draft 6 timer values, enter this command.

```
rtrv-m2pa-tset:ver=d6
```

This is an example of the possible output.

```
rlghncxa03w 08-04-28 21:16:37 GMT EAGLE5 38.0.0

M2PA Draft 6 Timers (in msec, T16 in microsec)
TSET T1      T2      T3      T4N     T4E     T5      T6      T7      T16     T17     T18
1     6000    ----- 5000    20000  500    5000   4000  1000  100000  150    500
2     7500    ----- 1500    2000   500    9000   1250  300   150000  175    600
3     100000  ----- 2000    3000   500    4000   1500  500   170000  200    800
4     200000  ----- 20000   4000   500    6000   2000  700   480000  225    900
5     250000  ----- 30000   30000  500    100    2250  400   400000  400    8000
6     50000   ----- 50000   60000  500    500    4500  800   300000  300    7000
7     10000   ----- 10000   10000  500    1000   3000  1200  200000  250    1000
8     80000   ----- 1500    15000  500    8000   2750  1100  350000  350    5000
9     27500   ----- 3850    4859   450    5700   3750  1150  250    375    8750
10    90000   ----- 2500    50000  500    7500   5000  1750  440000  450    3000
11    20000   ----- 4500    5500   500    6500   5500  1600  250000  475    4500
12    30000   ----- 7500    7000   500    750    4250  1800  275000  275    3500
13    40000   ----- 35000   9000   500    1250   3500  1900  500    325    9000
14    70000   ----- 45000   11000  500    1500   1750  900   1000    125    6000
15    9000    ----- 25000   40000  500    2500   3250  600   5000    425    5500
16    75000   ----- 15000   25000  500    4500   1600  1400  6000    240    9500
17    350000  ----- 60000   70000  600    10000  6000  2000  500000  500    10000
18    150000  ----- 55000   35000  500    3500   5750  1500  125000  440    750
19    175000  ----- 12500   45000  500    1100   2600  1300  7000    340    850
20    1000    ----- 1000    1000   400    80     1000  200   100    100    100
```

To display the M2PARFC values, enter this command.

```
rtrv-m2pa-tset:ver=rfc
```

This is an example of the possible output.

```
rlghncxa03w 08-04-28 21:16:37 GMT EAGLE5 38.0.0

M2PA RFC Timers (in msec, T16 in microsec)
TSET T1      T2      T3      T4N     T4E     T5      T6      T7      T16     T17     T18
1     6000    75000  5000    20000  500    5000   4000  1000  100000  150    500
2     7500    8000   1500    2000   500    9000   1250  300   150000  175    600
3     100000  10000  2000    3000   500    4000   1500  500   170000  200    800
4     200000  6000   20000  4000   500    6000   2000  700   480000  225    900
5     250000  140000 30000  30000  500    100    2250  400   400000  400    8000
6     50000   100000 50000  60000  500    500    4500  800   300000  300    7000
7     300000  20000  2000    10000  500    1000   3000  1200  200000  250    1000
8     80000   130000 1500    15000  500    8000   2750  1100  350000  350    5000
9     27500   120000 3850    4859   450    5700   3750  1150  250    375    8750
10    90000   9000   2500    50000  500    7500   5000  1750  440000  450    3000
11    20000   60000  4500    5500   500    6500   5500  1600  250000  475    4500
12    30000   50000  7500    7000   500    750    4250  1800  275000  275    3500
13    40000   90000  35000  9000   500    1250   3500  1900  500    325    9000
14    70000   45000  45000  11000  500    1500   1750  900   1000    125    6000
15    9000    30000  25000  40000  500    2500   3250  600   5000    425    5500
16    75000   15000  15000  25000  500    4500   1600  1400  6000    240    9500
17    350000  150000 60000  70000  600    10000  6000  2000  500000  500    10000
18    150000  20000  55000  35000  500    3500   5750  1500  125000  440    750
```

```

19 175000 12500 12500 45000 500 1100 2600 1300 7000 340 850
20 1000 5000 1000 1000 400 80 1000 200 100 100 100

```

If the `ver` parameter is not specified when entering the `rtrv-m2pa-tset` command, both the Draft 6 and RFC values are displayed. This is an example of the possible output.

```

rlghncxa03w 08-04-28 21:16:37 GMT EAGLE5 38.0.0

M2PA Draft 6 Timers (in msec, T16 in microsec)
TSET T1      T2      T3      T4N     T4E     T5      T6      T7      T16     T17     T18
1     6000    ----- 5000    20000  500     5000    4000  1000    100000  150    500
2     7500    ----- 1500    2000   500     9000    1250  300     150000  175    600
3     100000  ----- 2000    3000   500     4000    1500  500     170000  200    800
4     200000  ----- 20000   4000   500     6000    2000  700     480000  225    900
5     250000  ----- 30000   30000  500     100     2250   400     400000  400    8000
6     50000   ----- 50000   60000  500     500     4500   800     300000  300    7000
7     10000   ----- 10000   10000  500     1000    3000   1200    200000  250    1000
8     80000   ----- 1500    15000  500     8000    2750   1100    350000  350    5000
9     27500   ----- 3850    4859   450     5700    3750   1150    250     375    8750
10    90000   ----- 2500    50000  500     7500    5000   1750    440000  450    3000
11    20000   ----- 4500    5500   500     6500    5500   1600    250000  475    4500
12    30000   ----- 7500    7000   500     750     4250   1800    275000  275    3500
13    40000   ----- 35000   9000   500     1250    3500   1900    500     325    9000
14    70000   ----- 45000   11000  500     1500    1750   900     1000    125    6000
15    9000     ----- 25000   40000  500     2500    3250   600     5000    425    5500
16    75000   ----- 15000   25000  500     4500    1600   1400    6000    240    9500
17    350000  ----- 60000   70000  600     10000   6000   2000    500000  500    10000
18    150000  ----- 55000   35000  500     3500    5750   1500    125000  440    750
19    175000  ----- 12500   45000  500     1100    2600   1300    7000    340    850
20    1000     ----- 1000    1000   400     80      1000   200     100     100    100

M2PA RFC Timers (in msec, T16 in microsec)

TSET T1      T2      T3      T4N     T4E     T5      T6      T7      T16     T17     T18
1     6000    75000  5000    20000  500     5000    4000  1000    100000  150    500
2     7500    8000   1500    2000   500     9000    1250  300     150000  175    600
3     100000  10000  2000    3000   500     4000    1500  500     170000  200    800
4     200000  6000   20000  4000   500     6000    2000  700     480000  225    900
5     250000  140000 30000   30000  500     100     2250   400     400000  400    8000
6     50000   100000 50000   60000  500     500     4500   800     300000  300    7000
7     300000  20000  2000   10000  500     1000    3000   1200    200000  250    1000
8     80000   130000 1500    15000  500     8000    2750   1100    350000  350    5000
9     27500   120000 3850    4859   450     5700    3750   1150    250     375    8750
10    90000   9000   2500    50000  500     7500    5000   1750    440000  450    3000
11    20000   60000  4500    5500   500     6500    5500   1600    250000  475    4500
12    30000   50000  7500    7000   500     750     4250   1800    275000  275    3500
13    40000   90000  35000   9000   500     1250    3500   1900    500     325    9000
14    70000   45000  45000  11000  500     1500    1750   900     1000    125    6000
15    9000     30000  25000  40000  500     2500    3250   600     5000    425    5500
16    75000   15000  15000  25000  500     4500    1600   1400    6000    240    9500
17    350000  150000 60000   70000  600     10000   6000   2000    500000  500    10000
18    150000  20000  55000  35000  500     3500    5750   1500    125000  440    750
19    175000  12500  12500  45000  500     1100    2600   1300    7000    340    850
20    1000     5000   1000    1000   400     80      1000   200     100     100    100

```

If the M2PA timer set you wish to assign to the association does not contain the desired values, go to the [Changing a M2PA Timer Set](#) procedure and changed the desired timer values.

**CAUTION**

Caution: Changing an M2PA timer set may affect the performance of any associations using the timer set being changed.

10. Verify the available buffer size for the IP card that will contain the association being added in this procedure by entering the `rtrv-assoc` command with the local host name assigned to the association being added. For this example, enter this command.

```
rtrv-assoc: lhost="IPNODE2-1203"
```

This is an example of the possible output.

```
rlghncxa03w 08-04-28 09:12:36 GMT EAGLE5 38.0.0
CARD IPLNK
ANAME          LOC  PORT  LINK ADAPTER LPORT RPORT OPEN ALW
assoc2         1203 A    A1  M2PA    2048  1030 NO  NO

IP Appl Sock/Assoc table is (8 of 4000) 1% full
Assoc Buffer Space Used (200 KB of 1600 KB) on LOC = 1203
```

If adding the new association causes the total buffer size for all the associations on the IP card to exceed the maximum buffer size for that IP card, the `ent-assoc` command will be rejected.

The default buffer value for an IPLIMx association is 200.

If the you wish to add the association and the maximum buffer size for the IP card will be exceeded, the buffer size of the other associations assigned to the IP card must be decreased by performing the [Changing the Buffer Size of a M2PA Association](#) procedure.

11. Add the associations using the `ent-assoc` command. For this example, enter this command.

```
ent-assoc:aname=assoc2:lhost=gw107.nc.tekelec.com:lport=2000:
rhost=gw100.nc.tekelec.com:rport=1030:adapter=m2pa:link=a
```

These are the rules that apply to adding M2PA associations that are assigned to IPLIMx signaling links.

- The B Ethernet interface can be used with E5-ENET cards.
- The EAGLE can contain a maximum of 4000 connections (association – application server assignments plus sockets).
- The `adapter` parameter value for the association must be `m2pa`. The value of the `ipliml2` parameter of the signaling link being assigned to this association must be `m2pa`. The default value for the `adapter` parameter is `m2pa`.
- IPLIMx cards can have only one connection for each signaling link assigned to the card. If the card is an E5-ENET card, the card may contain a maximum of 16 connections.
- The value of the `lhost`, `rhost`, or `alhost` parameters is a text string of up to 60 characters, with the first character being a letter. The command line on the terminal can contain up to 150 characters. If the host names are too long to fit on the `ent-assoc` command line, perform the `chg-assoc` command with the parameters and values necessary to complete the entry of the M2PA association.
- If the new association is to be activated in this procedure with the `chg-assoc` command, the association must contain values for the `lhost`, `rhost`, `lport`, and `rport` parameters.
- If the `lhost` and `alhost` parameters are specified, the `lhost` parameter value represents the IP address corresponding to one of the network interfaces (A or B) on the IP card while the

alhost parameter value represents the IP address corresponding to the other network interface of the same IP card.

- The m2patset parameter can be specified only with the adapter=m2pa parameter.
- The m2patset parameter value defaults to M2PA timer set 1 (m2patset=1) if the m2patset parameter is not specified.
- The port parameter can be used in place of the link parameter to specify the signaling link assigned to the association.
- When the adapter=m2pa parameter is specified, the RFC M2PA version is assigned to the M2PA association by default. If you wish to assign the Draft 6 M2PA version to this association, perform the [Changing the Attributes of an M2PA Association](#) procedure after this procedure is completed to change the M2PA version of this association.

When each of these commands have successfully completed, this message should appear.

```
rlghncxa03w 08-04-28 09:12:36 GMT EAGLE5 38.0.0
ENT-ASSOC: MASP A - COMPLTD
```

Note: If the association added in this step is not being activated in this procedure, continue the procedure with [Step 13](#).

12. Activate the association added in [Step 11](#) by entering the chg-assoc command with the association name specified in [Step 11](#) and the open=yes and alw=yes parameters. For example, enter this command.

```
chg-assoc:aname=assoc2:open=yes:alw=yes
```

When this command have successfully completed, this message should appear.

```
rlghncxa03w 08-04-28 21:15:37 GMT EAGLE5 38.0.0
CHG-ASSOC: MASP A - COMPLTD
```

13. Verify the changes using the rtrv-assoc command specifying the association name specified in [Step 11](#) and [Step 12](#). For this example, enter this command.

```
rtrv-assoc:aname=assoc2
```

This is an example of possible output.

```
rlghncxa03w 10-07-28 09:12:36 GMT EAGLE5 42.0.0
ANAME assoc2
LOC 1203 IPLNK PORT A LINK A
ADAPTER M2PA VER M2PA RFC
LHOST gw105.nc.tekelec.com
ALHOST ---
RHOST gw100.nc.tekelec.com
ARHOST ---
LPORT 1030 RPORT 1030
ISTRMS 2 OSTRMS 2 BUFSIZE 200
RMODE LIN RMIN 120 RMAX 800
RTIMES 10 CWMIN 3000 UAPS 10
OPEN NO ALW NO RTXTHR 0
RHOSTVAL RELAXED M2PATSET 1
```

```
IP Appl Sock table is (5 of 4000) 1% full
Assoc Buffer Space Used (400 KB of 1600 KB) on LOC = 1203
```

14. Activate the signaling link assigned to the association using the `act-slk` command.

For example, enter this command.

```
act-slk:loc=1203:link=a
```

When this command has successfully completed, the following message should appear.

```
rlghncxa03w 08-04-07 11:11:28 GMT EAGLE5 38.0.0
Activate Link message sent to card
```

15. Verify the status of the signaling link using the `rept-stat-slk` command. For example, enter this command.

```
rept-stat-slk:loc=1203:link=a
```

This is an example of the possible output.

```
rlghncxa03w 08-04-28 21:16:37 GMT EAGLE5 38.0.0
SLK      LSN      CLLI      PST      SST      AST
1203,A   e5e6a    -----  IS-NR    Avail    ----
Command Completed.
```

16. Back up the new changes, using the `chg-db:action=backup:dest=fixed` command. These messages should appear; the active Maintenance and Administration Subsystem Processor (MASP) appears first.

```
BACKUP (FIXED) : MASP A - Backup starts on active MASP.
BACKUP (FIXED) : MASP A - Backup on active MASP to fixed disk complete.
BACKUP (FIXED) : MASP A - Backup starts on standby MASP.
BACKUP (FIXED) : MASP A - Backup on standby MASP to fixed disk complete.
```

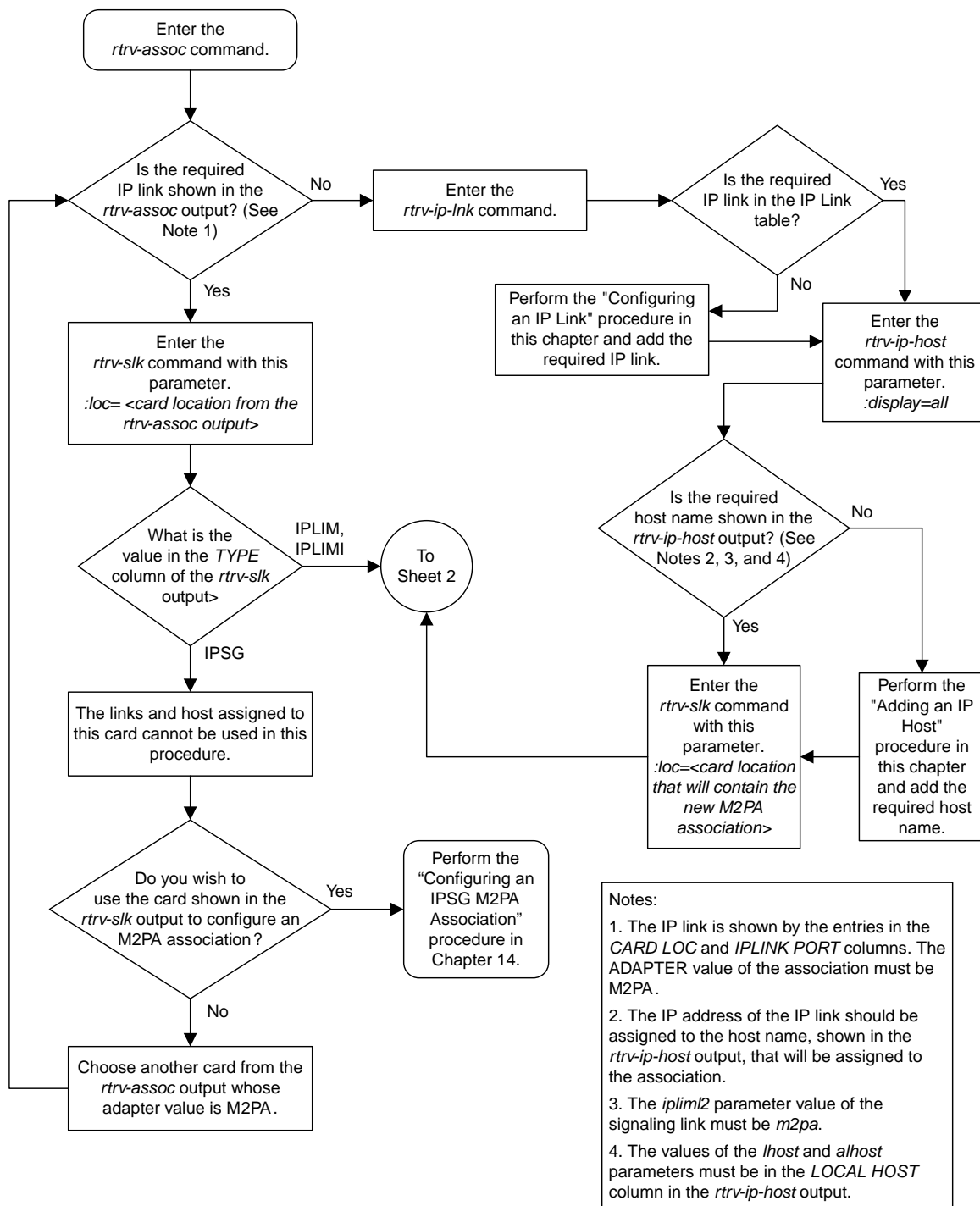

Notes:

1. The IP link is shown by the entries in the *CARD LOC* and *IPLINK PORT* columns. The *ADAPTER* value of the association must be *M2PA*.
2. The IP address of the IP link should be assigned to the host name, shown in the *rtrv-ip-host* output, that will be assigned to the association.
3. The *ipliml2* parameter value of the signaling link must be *m2pa*.
4. The values of the *lhost* and *alhost* parameters must be in the *LOCAL HOST* column in the *rtrv-ip-host* output.

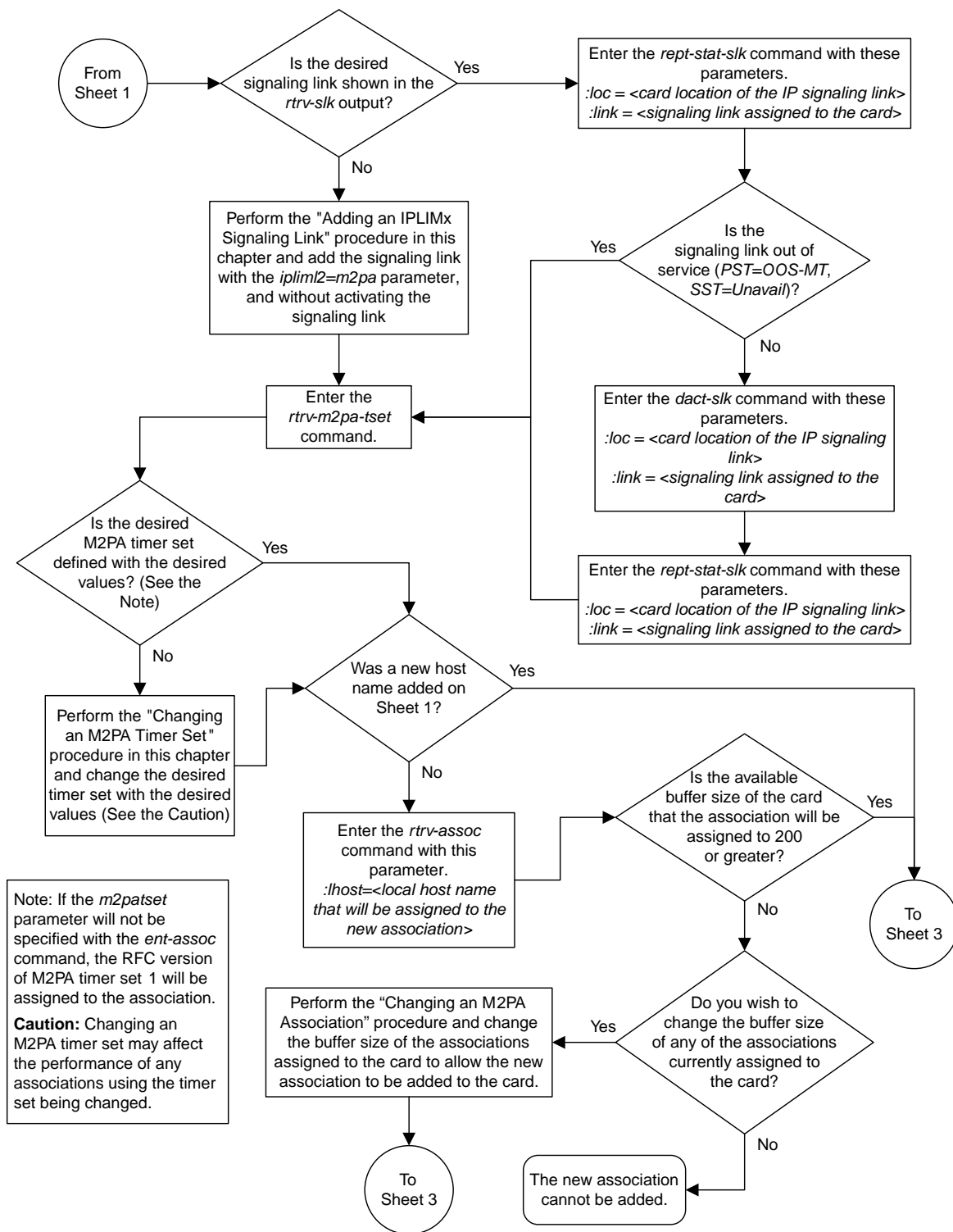

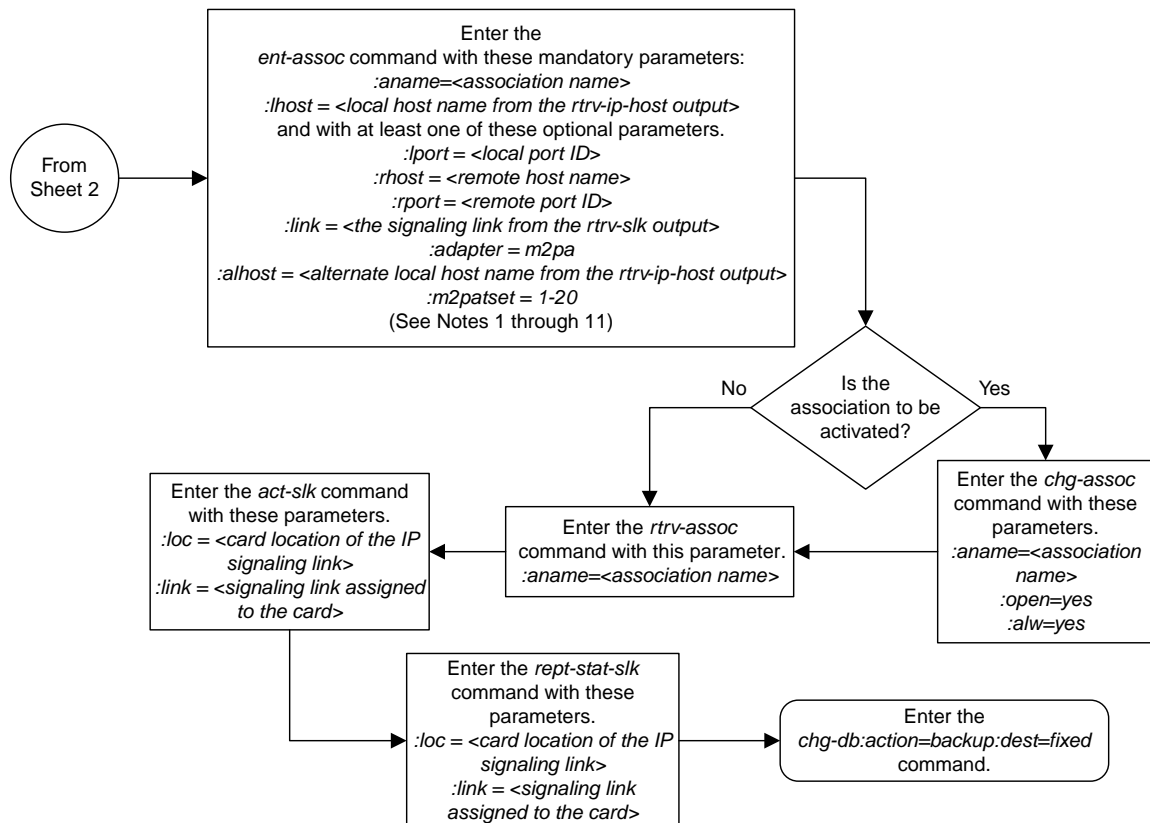

Notes:

1. The B Ethernet interface can be used with single-slot EDCMs or E5-ENET cards.
2. The EAGLE 5 ISS can contain a maximum of 4000 connections (association – application server assignments plus sockets).
3. The *adapter* parameter value for the association must be *m2pa*. The value of the *iplim2* parameter of the signaling link being assigned to this association must be *m2pa*. The default value for the adapter parameter is *m2pa*.
4. IPLIMx cards can have only one connection for each signaling link assigned to the card. If the card is a single-slot EDCM, the card may contain a maximum of eight connections. If the card is an E5-ENET card, the card may contain a maximum of 16 connections.
5. The value of the *lhost*, *rhost*, or *alhost* parameters is a text string of up to 60 characters, with the first character being a letter. The command line on the terminal can contain up to 150 characters. If the host names are too long to fit on the *ent-assoc* command line, perform the *chg-assoc* command with the parameters and values necessary to complete the entry of the M2PA association.
6. If the new association is to be activated in this procedure with the *chg-assoc* command, the association must contain values for the *lhost*, *rhost*, *lport*, and *rport* parameters.
7. If the *lhost* and *alhost* are specified, the *lhost* parameter value represents the IP address corresponding to one of the network interfaces (A or B) on the IP card while the *alhost* parameter value represents the IP address corresponding to the other network interface of the same IP card.
8. The *m2patset* parameter can be specified only with the *adapter=m2pa* parameter.
9. The *m2patset* parameter value defaults to M2PA timer set 1 (*m2patset=1*) if the *m2patset* parameter is not specified.
10. The *port* parameter can be used in place of the *link* parameter to specify the signaling link assigned to the association.
11. When the *adapter=m2pa* parameter is specified, the RFC M2PA version is assigned to the M2PA association by default. If you wish to assign the Draft 6 M2PA version to this association, perform the “Changing the Attributes of an M2PA Association” procedure in this chapter after this procedure is completed to change the M2PA version of this association.

Sheet 3 of 3

Figure 26: Adding an M2PA Association

Activating the Large MSU Support for IP Signaling Feature

This procedure is used to enable and turn on the Large MSU Support for IP Signaling feature using the feature's part number and a feature access key.

The feature access key for the Large MSU Support for IP Signaling feature is based on the feature's part number and the serial number of the EAGLE, making the feature access key site-specific.

The `enable-ctrl-feat` command enables the controlled feature by inputting the controlled feature's access key and the controlled feature's part number with these parameters:

Note: As of Release 46.3, the `fak` parameter is no longer required. This parameter is only used for backward compatibility.

`: fak` – The feature access key provided by Oracle. The feature access key contains 13 alphanumeric characters and is not case sensitive.

`: partnum` – The Oracle-issued part number of the Large MSU Support for IP Signaling feature, 893018401.

The `enable-ctrl-feat` command requires that the database contain a valid serial number for the EAGLE, and that this serial number is locked. This can be verified with the `rtrv-serial-num` command. The EAGLE is shipped with a serial number in the database, but the serial number is not locked. The serial number can be changed, if necessary, and locked once the EAGLE is on-site, by using the `ent-serial-num` command. The `ent-serial-num` command uses these parameters.

`: serial` – The serial number assigned to the EAGLE. The serial number is not case sensitive.

`: lock` – Specifies whether or not the serial number is locked. This parameter has only one value, `yes`, which locks the serial number. Once the serial number is locked, it cannot be changed.

Note: To enter and lock the EAGLE's serial number, the `ent-serial-num` command must be entered twice, once to add the correct serial number to the database with the `serial` parameter, then again with the `serial` and the `lock=yes` parameters to lock the serial number. You should verify that the serial number in the database is correct before locking the serial number. The serial number can be found on a label affixed to the control shelf (shelf 1100).

This feature cannot be temporarily enabled (with the temporary feature access key).

Once this feature has been enabled, the feature must be turned on with the `chg-ctrl-feat` command. The `chg-ctrl-feat` command uses these parameters:

`: partnum` – The Oracle-issued part number of the Large MSU Support for IP Signaling feature, 893018401.

`: status=on` – used to turn the Large MSU Support for IP Signaling feature on.

Once the Large MSU Support for IP Signaling feature has been turned on, it can be turned off. For more information about turning the Large MSU Support for IP Signaling feature off, go to the [Turning Off the Large MSU Support for IP Signaling Feature](#) procedure.

The status of the features in the EAGLE is shown with the `rtrv-ctrl-feat` command.

The Large MSU Support for IP Signaling feature allows the EAGLE to process messages with a service indicator value of 6 to 15 and with a service information field (SIF) that is larger than 272 bytes. The large messages are processed only on E5-ENET cards. There are certain software components that if enabled or provisioned, that will not process large messages even if the Large MSU Support for IP Signaling feature is enabled and turned on. UIMs are displayed when most of these circumstances occur. These UIMs are:

- UIM 1333 – Displayed when a large message is received on an M3UA association and the Large MSU Support for IP Signaling feature is not enabled or is enabled and turned off. The large message is discarded.
- UIM 1350 – Displayed when a M2PA IP connection receives message with an SIF greater than 272 bytes and the Large MSU Support for IP Signaling feature is not enabled or is enabled and turned off. The large message is discarded.
- UIM 1352 – Displayed when a message with an SIF greater than 272 bytes is received; the Large MSU Support for IP Signaling feature is enabled and turned on; there are routes available for the destination point code; but the selected outbound card does not support large messages.
- UIM 1353 – Displayed when a large message passes a gateway screening screenset that redirects messages for the Database Transport Access (DTA) feature. Large messages are not redirected for the DTA feature.
- UIM 1354 – Displayed when a large message passes a gateway screening screenset that copies messages for the STPLAN feature. Large messages are not copied for the STPLAN feature.

For more information on these UIMs, refer to the *Unsolicited Alarm and Information Messages Reference*.

Note: For STC style monitoring, large messages are not monitored by the EAGLE 5 Integrated Monitoring Support feature and are not sent to the IMF. A UIM is not generated. If Fast Copy is allowed, however, Fast Copy can copy large MSUs to IMF.

1. Display the status of the controlled features by entering the `rtrv-ctrl-feat` command.

The following is an example of the possible output.

```
rlghncxa03w 08-04-28 21:15:37 GMT EAGLE5 38.0.0
The following features have been permanently enabled:

Feature Name          Partnum    Status    Quantity
Command Class Management 893005801  on       ----
LNP Short Message Service 893006601  on       ----
Intermed GTT Load Sharing 893006901  on       ----
XGTT Table Expansion    893006101  on       400000
XMAP Table Expansion    893007710  off      ----
Large System # Links    893005910  on       2000
Routesets              893006401  on       6000
HC-MIM SLK Capacity    893012707  on       64

The following features have been temporarily enabled:

Feature Name          Partnum    Status    Quantity    Trial Period Left
Zero entries found.

The following features have expired temporary keys:

Feature Name          Partnum
Zero entries found.
```

If the Large MSU Support for IP Signaling feature is enabled and turned on, no further action is necessary. This procedure does not need to be performed.

If the Large MSU Support for IP Signaling feature is enabled and but not turned on, continue this procedure with [Step 7](#).

If the Large MSU Support for IP Signaling feature is not enabled, continue this procedure with [Step 2](#).

Note: If the `rtrv-ctrl-feat` output in [Step 1](#) shows any controlled features, continue this procedure with [Step 6](#). If the `rtrv-ctrl-feat` output shows only the HC-MIM SLK Capacity feature with a quantity of 64, [Step 2](#) through [Step 5](#) must be performed.

2. Display the serial number in the database with the `rtrv-serial-num` command.

This is an example of the possible output.

```
rlghncxa03w 06-10-28 21:15:37 GMT EAGLE5 36.0.0
System serial number = nt00001231

System serial number is not locked.

rlghncxa03w 06-10-28 21:15:37 GMT EAGLE5 36.0.0
Command Completed
```

Note: If the serial number is correct and locked, continue the procedure with [Step 6](#). If the serial number is correct but not locked, continue the procedure with [Step 5](#). If the serial number is not correct, but is locked, this feature cannot be enabled and the remainder of this procedure cannot be performed. Contact the Customer Care Center to get an incorrect and locked serial number changed. Refer to [My Oracle Support \(MOS\)](#) for the contact information. The serial number can be found on a label affixed to the control shelf (shelf 1100).

3. Enter the correct serial number into the database using the `ent-serial-num` command with the `serial` parameter.

For this example, enter this command.

```
ent-serial-num:serial=<EAGLE's correct serial number>
```

When this command has successfully completed, the following message should appear.

```
rlghncxa03w 06-10-28 21:15:37 GMT EAGLE5 36.0.0
ENT-SERIAL-NUM:  MASP A - COMPLTD
```

4. Verify that the serial number entered into [Step 3](#) was entered correctly using the `rtrv-serial-num` command.

This is an example of the possible output.

```
rlghncxa03w 06-10-28 21:15:37 GMT EAGLE5 36.0.0
System serial number = nt00001231

System serial number is not locked.

rlghncxa03w 06-10-28 21:15:37 GMT EAGLE5 36.0.0
Command Completed
```

If the serial number was not entered correctly, repeat [Step 3](#) and [Step 4](#) and re-enter the correct serial number.

5. Lock the serial number in the database by entering the `ent-serial-num` command with the serial number shown in [Step 2](#), if the serial number shown in [Step 2](#) is correct, or with the serial number shown in [Step 4](#), if the serial number was changed in [Step 3](#), and with the `lock=yes` parameter.

For this example, enter this command.

```
ent-serial-num:serial=<EAGLE's serial number>:lock=yes
```

When this command has successfully completed, the following message should appear.

```
rlghncxa03w 06-10-28 21:15:37 GMT EAGLE5 36.0.0
ENT-SERIAL-NUM: MASP A - COMPLTD
```

6. Enable the Large MSU Support for IP Signaling feature with the `enable-ctrl-feat` command specifying the part number for the Large MSU Support for IP Signaling feature and the feature access key. Enter this command.

```
enable-ctrl-feat:partnum=893018401:fak=<Large MSU Support for IP Signaling
feature access key>
```

Note: A temporary feature access key cannot be specified to enable this feature.

Note: The values for the feature access key (the `fak` parameter) are provided by Oracle. If you do not have the feature access key for the feature you wish to enable, contact your Sales Representative or Account Representative.

When the `enable-ctrl-feat` command has successfully completed, this message should appear.

```
rlghncxa03w 06-10-28 21:15:37 GMT EAGLE5 36.0.0
ENABLE-CTRL-FEAT: MASP B - COMPLTD
```

7. Turn the Large MSU Support for IP Signaling feature on with the `chg-ctrl-feat` command specifying the part number for the Large MSU Support for IP Signaling feature and the `status=on` parameter. Enter this command.

```
chg-ctrl-feat:partnum=893018401:status=on
```

When the `chg-ctrl-feat` command has successfully completed, this message should appear.

```
rlghncxa03w 07-05-28 21:15:37 GMT EAGLE5 37.0.0
CHG-CTRL-FEAT: MASP B - COMPLTD
```

8. Verify the changes by entering the `rtrv-ctrl-feat` command with the Large MSU Support for IP Signaling feature part number. Enter this command.

```
rtrv-ctrl-feat:partnum=893018401
```

The following is an example of the possible output.

```
rlghncxa03w 10-04-28 21:15:37 GMT EAGLE5 42.0.0
The following features have been permanently enabled:

Feature Name          Partnum   Status   Quantity
Large MSU for IP Sig  893018401 on       ----
```



```
The following features have been temporarily enabled:
```

```
Feature Name          Partnum   Status   Quantity   Trial Period Left
Zero entries found.
```

```
The following features have expired temporary keys:
```

```
Feature Name          Partnum
Zero entries found.
```

9. Back up the new changes using the `chg-db:action=backup:dest=fixed` command. These messages should appear, the active Maintenance and Administration Subsystem Processor (MASP) appears first.

```
BACKUP (FIXED) : MASP A - Backup starts on active MASP.
BACKUP (FIXED) : MASP A - Backup on active MASP to fixed disk complete.
BACKUP (FIXED) : MASP A - Backup starts on standby MASP.
BACKUP (FIXED) : MASP A - Backup on standby MASP to fixed disk complete.
```

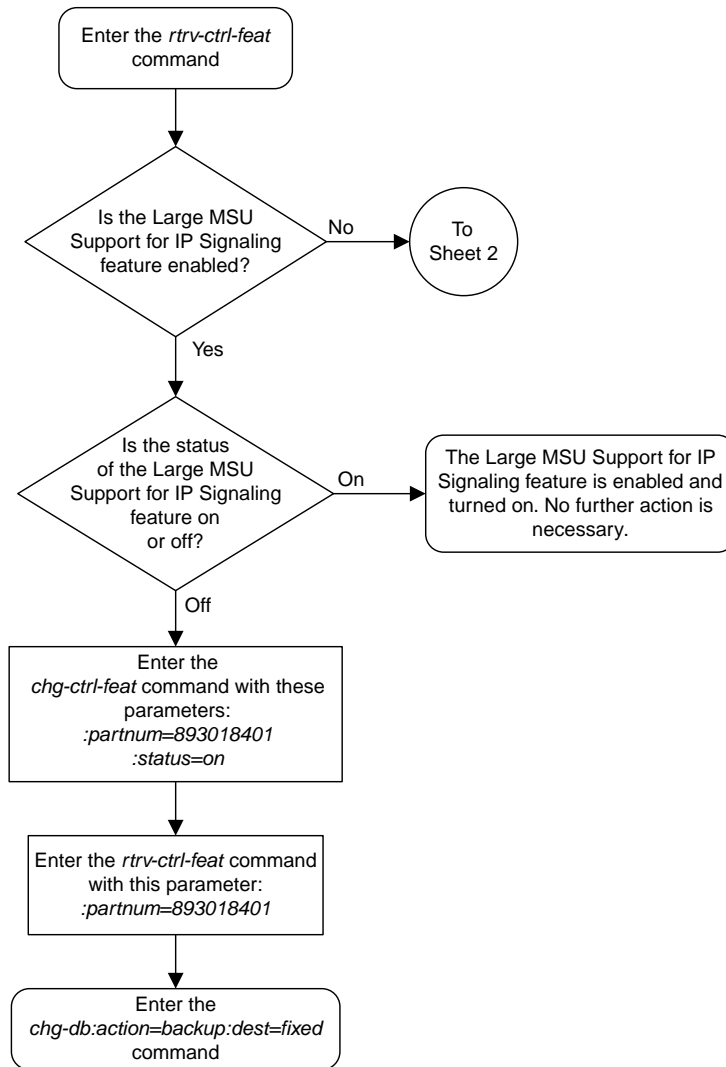

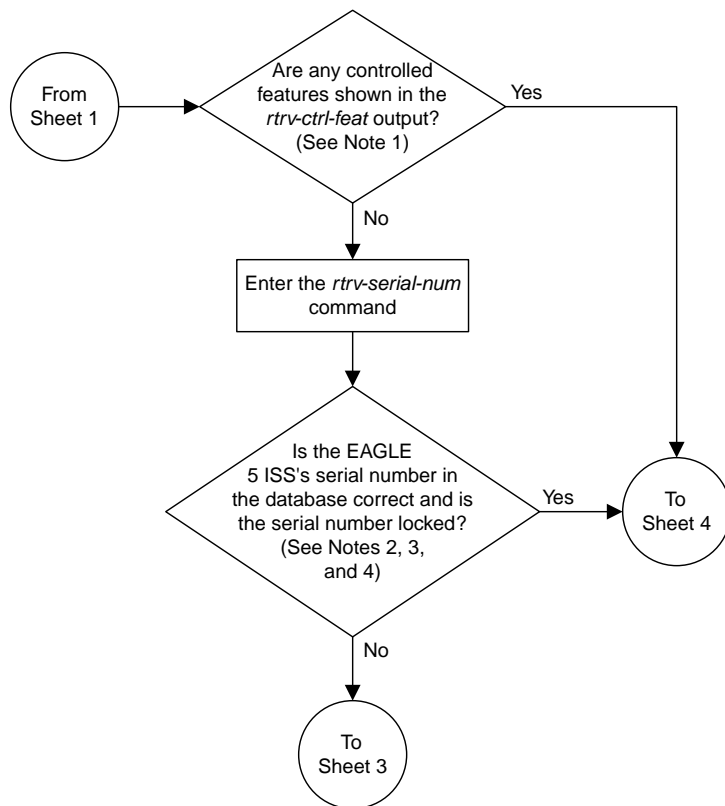

Notes:

1. If the *rtrv-ctrl-feat* output shows only the HC -MIM SLK Capacity feature with a quantity of 64, the answer to this question is no and the Eagle 5 ISS's serial number must be verified. This is the default entry for the *rtrv-ctrl-feat* output. This entry is shown whether or not the Eagle 5 ISS's serial number is in the database.
2. If the serial number is locked, it cannot be changed.
3. If the serial number is not locked, the controlled feature cannot be enabled.
4. The serial number can be found on a label affixed to the control shelf (shelf 1100).

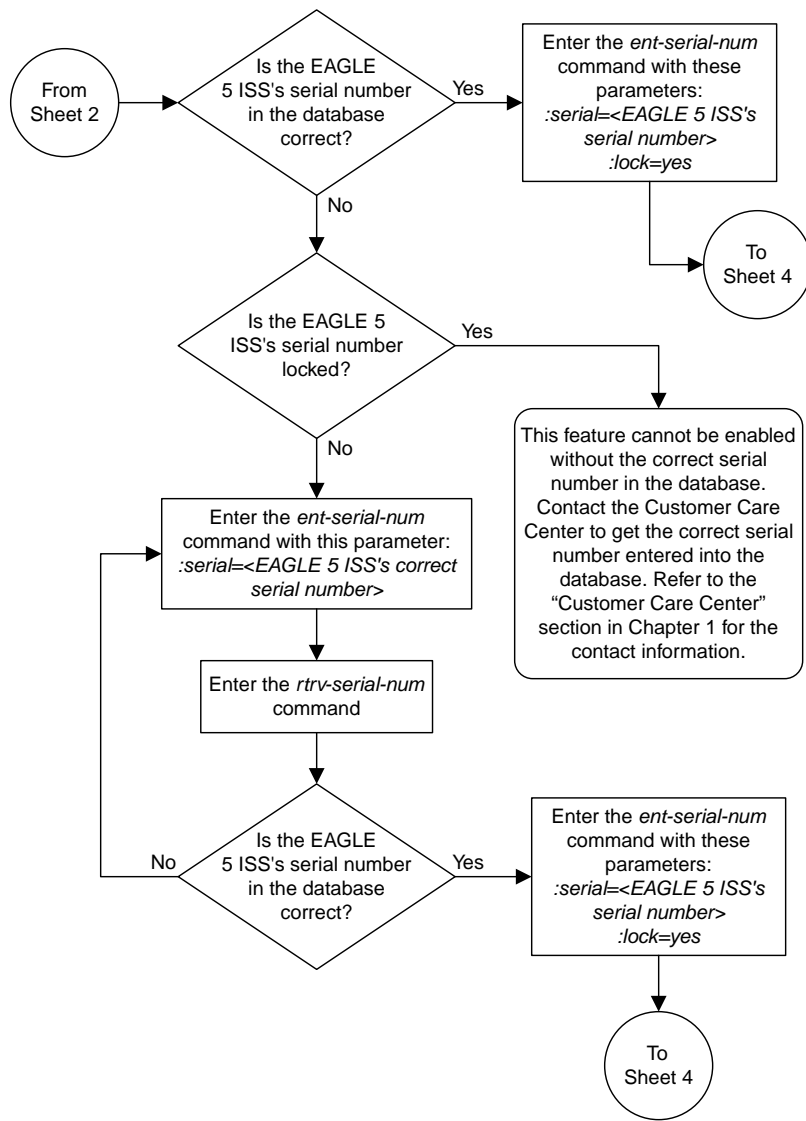

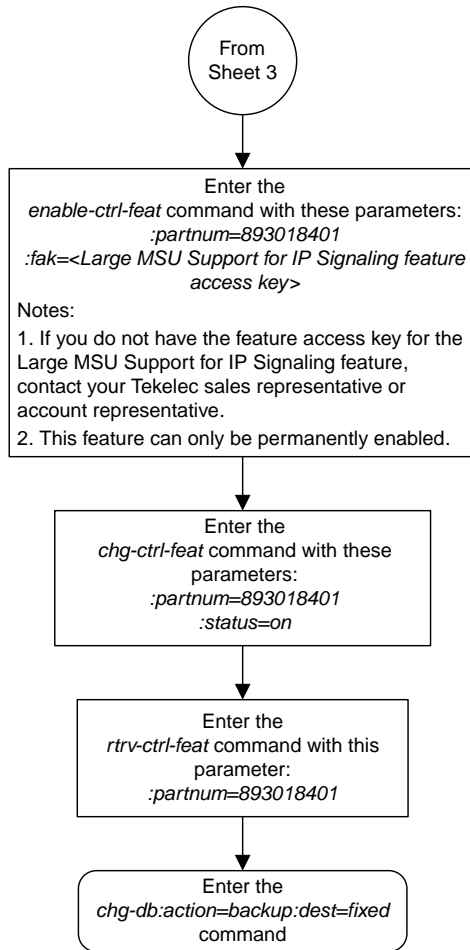

Sheet 4 of 4

Figure 27: Activating the Large MSU Support for IP Signaling Feature

Removing IETF M2PA Components

This section describes how to remove the following components from the database.

- An IPLIMx Card – Perform the [Removing an IPLIMx Card](#) procedure
- An IPLIMx Signaling Link – Perform the [Removing an IPLIMx Signaling Link](#) procedure
- An IP Host – Perform the [Removing an IP Host Assigned to an IPLIMx Card](#) procedure
- An IP Route – Perform the [Removing an IP Route](#) procedure
- An M2PA Association – Perform the [Removing an M2PA Association](#) procedure

Removing an IPLIMx Card

Use this procedure to remove an IPLIMx card, a card running the `iplim` or `iplimi` applications from the database using the `dlt-card` command.

The card cannot be removed if it does not exist in the database. Prior to removing the card from the database, the signaling links assigned to the card must be removed.



Caution: If the IPGWx card is the last IP card in service, removing this card from the database will cause traffic to be lost.

CAUTION

1. Display the cards in the database using the `rtrv-card` command.

This is an example of the possible output.

```
rlghncxa03w 13-06-15 16:34:56 GMT EAGLE5 45.0.0
CARD   TYPE      APPL      LSET NAME      LINK SLC LSET NAME      LINK SLC
1101   DSM        VSCCP
1102   TSM        GLS
1104   DCM        STPLAN
1113   E5MCAP     OAMHC
1114   E5TDM-A
1115   E5MCAP     OAMHC
1116   E5TDM-B
1117   E5MDAL
1201   LIMDS0     SS7ANSI    lsn1            A    0    lsn2            B    1
1203   LIMDS0     SS7ANSI    lsn2            A    0    lsn1            B    1
1204   LIMATM     ATMANSI    atmgwy          A    0
1205   DCM        IPLIM      ipnode1         A    0    ipnode3         B    1
1207   DCM        IPLIM      ipnode2         A    0
1303   DCM        IPLIM      ipnode1         A    0    ipnode3         B    1
1305   DCM        IPLIM      ipnode4         A    0
```

Select a card whose application is either `IPLIM` or `IPLIMI`.

Perform the [Removing an IPLIMx Signaling Link](#) procedure in this chapter to remove all the signaling links assigned to the card, shown in the `LINK` column of the `rtrv-card` output.

The card location is shown in the `CARD` field of the `rtrv-card` command output. No entries in the `LSET NAME`, `LINK`, and `SLC` columns mean that no signaling link is assigned to the card.

2. Remove the card from the database using the `dlt-card` command.

The `dlt-card` command has only one parameter, `loc`, which is the location of the card. For this example, enter these commands.

```
dlt-card:loc=1205
```

```
dlt-card:loc=1207
```

When these commands have successfully completed, this message appears.

```
rlghncxa03w 06-10-12 09:12:36 GMT EAGLE5 36.0.0
DLT-CARD: MASP A - COMPLTD
```

3. Verify the changes using the `rtrv-card` command and specifying the card that was removed in [Step 2](#).

For this example, enter these commands.

```
rtrv-card:loc=1205
```

```
rtrv-card:loc=1207
```

When these commands have successfully completed, this message appears.

```
E2144 Cmd Rej: Location invalid for hardware configuration
```

4. Back up the new changes using the `chg-db:action=backup:dest=fixed` command.

These messages appear, the active Maintenance and Administration Subsystem Processor (MASP) appears first.

```
BACKUP (FIXED) : MASP A - Backup starts on active MASP.
BACKUP (FIXED) : MASP A - Backup on active MASP to fixed disk complete.
BACKUP (FIXED) : MASP A - Backup starts on standby MASP.
BACKUP (FIXED) : MASP A - Backup on standby MASP to fixed disk complete.
```

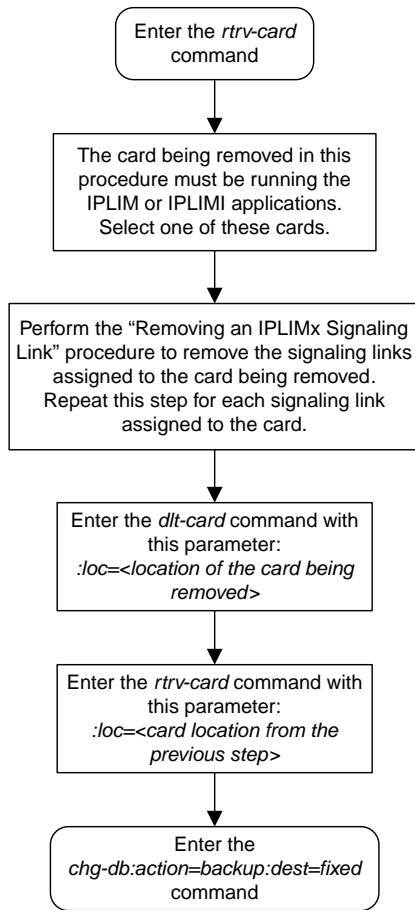

Figure 28: Removing an IPLIMx Card

Removing an IPLIMx Signaling Link

This procedure is used to remove an IPLIMx signaling link from the database using the `dlt-slk` command. The `dlt-slk` command uses these parameters.

`:loc` – The card location of the IPLIMx card that the IP signaling link is assigned to.

`:link` – The signaling link on the card specified in the `loc` parameter.

`:force` – This parameter must be used to remove the last link in a linkset without having to remove all of the routes that referenced the linkset.

The `tfatcabmlq` parameter (TFA/TCA Broadcast Minimum Link Quantity), assigned to linksets, shows the minimum number of links in the given linkset (or in the combined link set in which it resides) that must be available for traffic. When the number of signaling links in the specified linkset is equal to or greater than the value of the `tfatcabmlq` parameter, the status of the routes that use the specified linkset is set to allowed and can carry traffic. Otherwise, these routes are restricted. The value of the `tfatcabmlq` parameter cannot exceed the total number of signaling links contained in the linkset.

If the linkset type of the linkset that contains the signaling link that is being removed is either A, B, D, E, or PRX, the signaling link can be removed regardless of the `tfatcabmlq` parameter value of the linkset and regardless of the `LSRESTRICT` option value. When a signaling link in one of these types of linksets is removed, the `tfatcabmlq` parameter value of the linkset is decreased automatically.

If the linkset type of the linkset that contains the signaling link that is being removed is C, the signaling link can be removed only:

- If the `LSRESTRICT` option is off. The `LSRESTRICT` option value is shown in the `rtrv-ss7opts` output.
- If the `LSRESTRICT` option is on and the number of signaling links assigned to the linkset will be equal to or greater than the value of the `tfatcabmlq` parameter value of the linkset after the signaling link is removed.

The `tfatcabmlq` parameter value of the linkset is shown in the `TFATCABMLQ` column of the `rtrv-ls:lsn=<linkset name>` output. The `tfatcabmlq` parameter value can be a fixed value (1 to 16) or 0. If the `tfatcabmlq` parameter value of the linkset is a fixed value, the number of signaling links that are in the linkset after the signaling link is removed must be equal to or greater than the `tfatcabmlq` parameter value of the linkset.

If the `tfatcabmlq` parameter value is 0, the signaling link can be removed. When the `tfatcabmlq` parameter value is 0, the value displayed in the `TFATCABMLQ` column of the `rtrv-ls` output is 1/2 of the number of signaling links contained in the linkset. If the number of signaling links in the linkset is an odd number, the `tfatcabmlq` parameter value is rounded up to the next whole number. As the signaling links are removed, the `tfatcabmlq` parameter value of the linkset is decreased automatically.

Canceling the `RTRV-SLK` Command

Because the `rtrv-slk` command used in this procedure can output information for a long period of time, the `rtrv-slk` command can be canceled and the output to the terminal stopped. There are three ways that the `rtrv-slk` command can be canceled.

- Press the F9 function key on the keyboard at the terminal where the `rtrv-slk` command was entered.
- Enter the `canc-cmd` without the `trm` parameter at the terminal where the `rtrv-slk` command was entered.
- Enter the `canc-cmd:trm=<xx>`, where `<xx>` is the terminal where the `rtrv-slk` command was entered, from another terminal other than the terminal where the `rtrv-slk` command was entered. To enter the `canc-cmd:trm=<xx>` command, the terminal must allow Security Administration commands to be entered from it and the user must be allowed to enter Security Administration commands. The terminal's permissions can be verified with the `rtrv-secu-trm` command. The user's permissions can be verified with the `rtrv-user` or `rtrv-secu-user` commands.

For more information about the `canc-cmd` command, go to *Commands User's Guide*.

1. Display the current link configuration using the `rtrv-slk` command.

This is an example of the possible output.

```

rlghncxa03w 09-07-19 21:16:37 GMT EAGLE5 41.1.0

LOC LINK LSN          SLC TYPE          L2T          PCR PCR
      SET BPS      ECM N1  N2
1201 A  ls01          0 LIMDS0 1 56000 BASIC ---
1201 B  lsa1          0 LIMDS0 1 56000 BASIC ---
1203 A  ls03          0 LIMDS0 3 56000 BASIC ---
1203 B  lsa2          0 LIMDS0 1 56000 BASIC ---
1204 B  ls01          1 LIMDS0 1 56000 BASIC ---
1207 A  lsn1207a      0 LIMDS0 1 56000 BASIC ---
1207 B  lsn1207b      0 LIMDS0 1 56000 BASIC ---
1208 B  ls03          1 LIMDS0 3 56000 BASIC ---
1213 B  ls05          0 LIMDS0 5 56000 BASIC ---
1215 A  ls05          1 LIMDS0 5 56000 BASIC ---
1311 A  ls01          2 LIMDS0 1 56000 BASIC ---
1311 A1 ls05          2 LIMDS0 5 56000 BASIC ---
1311 B  ls03          2 LIMDS0 3 56000 BASIC ---
1311 B1 ls07          1 LIMDS0 7 56000 BASIC ---
1313 A  ls07          0 LIMDS0 7 56000 BASIC ---

LOC LINK LSN          SLC TYPE          LP          ATM
      SET BPS      TSEL VCI VPI LL
1302 A  atmansi0      0 LIMATM 3 1544000 EXTERNAL 35 15 0
1305 A  atmansi1      0 LIMATM 4 1544000 INTERNAL 100 20 2
1318 A  atmansi0      1 LIMATM 9 1544000 LINE 150 25 4

LOC LINK LSN          SLC TYPE          LP          ATM          E1ATM
      SET BPS      TSEL VCI VPI CRC4 SI SN
2101 A  atmitu1      0 LIM1ATM 5 2.048M LINE 150 2 ON 1 20
2105 A  atmitu1      1 LIM1ATM 5 2.048M LINE 35 15 ON 2 15

LOC LINK LSN          SLC TYPE          IPLIML2
2202 A  lsnlp1          0 IPLIM M2PA
2205 A  lsnip1          0 IPLIM M2PA
2204 B  lsnlp2          0 IPLIM M2PA
2213 A  lsnip5          0 IPLIMI M2PA
2215 A  lsnlp2          1 IPLIM M2PA

LOC LINK LSN          SLC TYPE
2207 A  lsnlp3          0 SS7IPGW
2211 A  lsnlp4          0 IPGWI

SLK table is (27 of 1200) 2% full

```

2. Display the linkset that contains the signaling link that is being removed by entering the `rtrv-ls` command with the name of the linkset shown in the LSN column of the `rtrv-slk` output.

For this example, enter these commands.

```
rtrv-ls:lsn=lsnlp1
```

This is an example of the possible output.

```
rlghncxa03w 10-07-17 11:43:04 GMT EAGLE5 42.0.0

LSN          APCA  (SS7)  L3T SLT          GWS GWS GWS
lsnlp1       002-009-003  scr2 1  1  no a  1  on off on no  off
           SPCA          CLLI          TFATCABMLQ MTPRSE ASL8
           -----
           1          no          no

RANDSLS
off

ISLSRSB RLS8
1      no

IPSG  IPGWAPC  GTTMODE          CGGTMOD
no    no      CdPA          no

LOC  LINK  SLC  TYPE          IPLIML2
2205 A    0   IPLIM    M2PA

Link set table is ( 20 of 1024)  2% full
```

```
rtrv-ls:lsn=lsnlp2
```

This is an example of the possible output.

```
rlghncxa03w 10-07-17 11:43:04 GMT EAGLE5 42.0.0

LSN          APCA  (SS7)  L3T SLT          GWS GWS GWS
lsnlp2       002-009-003  scr2 1  1  no a  2  on off on no  off
           SPCA          CLLI          TFATCABMLQ MTPRSE ASL8
           -----
           1          no          no

RANDSLS
off

ISLSRSB RLS8
1      no

IPSG  IPGWAPC  GTTMODE          CGGTMOD
no    no      CdPA          no

LOC  LINK  SLC  TYPE          IPLIML2
2204 B    0   IPLIM    M2PA
2215 A    1   IPLIM    M2PA

Link set table is ( 20 of 1024)  2% full
```

If the linkset type of the linkset is A, B, D, E, or PRX, continue the procedure with [Step 5](#).

If the linkset type of the linkset is C, continue the procedure with [Step 3](#).

3. Display the LSRESTRICT option value by entering the `rtrv-ss7opts` command.

This is an example of the possible output.

```
rlghncxa03w 10-07-30 15:09:00 GMT 42.0.0
SS7 OPTIONS
-----
LSRESTRICT      on
```

Note: The `rtrv-feat` command output contains other fields that are not used by this procedure. If you wish to see all the fields displayed by the `rtrv-feat` command, refer to the `rtrv-feat` command description in *Commands User's Guide*.

The signaling link cannot be removed, if the LSRESTRICT option is on and the number of signaling links assigned to the linkset will be less than the value of the `tfatcabmlq` parameter value of the linkset if the signaling link is removed.

If the LSRESTRICT option is on and the number of signaling links assigned to the linkset will be equal to or greater than the value of the `tfatcabmlq` parameter value of the linkset if the signaling link is removed, continue the procedure with [Step 5](#).

If the LSRESTRICT option is on and the number of signaling links assigned to the linkset will be less than the value of the `tfatcabmlq` parameter value of the linkset if the signaling link is removed, the signaling link cannot be removed unless the `tfatcabmlq` parameter value of the linkset is changed to 0. Continue the procedure with [Step 4](#).

If the LSRESTRICT value is off, continue the procedure with [Step 5](#).

4. Change the `tfatcabmlq` parameter value of the linkset to 0 by entering the `chg-ls` command with the name of the linkset that contains the signaling link that is being removed and the `tfatcabmlq` parameters. For this example, enter this command.

```
chg-ls:lsn=ls17:tfatcabmlq=0
```

When this command has successfully completed, this message should appear.

```
rlghncxa03w 10-07-07 08:41:12 GMT EAGLE5 42.0.0
Link set table is (20 of 1024) 2% full.
CHG-LS: MASP A - COMPLTD
```

5. Display the IP link associated with the card that the signaling link being removed the database is assigned to.

Enter the `rtrv-ip-lnk` command with the card location of the signaling link being removed shown in [Step 1](#). For this example, enter these commands.

```
rtrv-ip-lnk:loc=2205
```

The following is an example of the possible output.

```
rlghncxa03w 06-10-28 21:14:37 GMT EAGLE5 36.0.0
```

```

LOC   PORT  IPADDR          SUBMASK          DUPLEX  SPEED  MACTYPE  AUTO  MCAST
2205  A     192.3.1.10     255.255.255.128 HALF     10     802.3    NO   NO
2205  B     -----          -----          HALF     10     DIX      NO   NO

```

```
rtrv-ip-lnk:loc=2204
```

The following is an example of the possible output.

```

rlghncxa03w 06-10-28 21:14:37 GMT EAGLE5 36.0.0
LOC   PORT  IPADDR          SUBMASK          DUPLEX  SPEED  MACTYPE  AUTO  MCAST
2204  A     192.1.1.10     255.255.255.128 HALF     10     802.3    NO   NO
2204  B     -----          -----          HALF     10     DIX      NO   NO

```

6. Display the IP host information associated with the IP link by entering the `rtrv-ip-host` command with the IP address shown in [Step 5](#).

For this example, enter these commands.

```
rtrv-ip-host:ipaddr=192.001.001.010
```

The following is an example of the possible output.

```

rlghncxa03w 08-12-28 21:17:37 GMT EAGLE5 40.0.0

LOCAL IPADDR      LOCAL HOST
192.1.1.10       IPNODE1_2204

IP Host table is (11 of 4096) .26% full

```

```
rtrv-ip-host:ipaddr=192.003.001.010
```

The following is an example of the possible output.

```

rlghncxa03w 08-12-28 21:17:37 GMT EAGLE5 40.0.0

LOCAL IPADDR      LOCAL HOST
192.3.1.10       IPNODE1_2205

IP Host table is (11 of 4096) .26% full

```

7. Display the association associated with the local host name shown in [Step 6](#) by entering the `rtrv-assoc` command.

For this example, enter this command.

```
rtrv-assoc:lhost=ipnode1_2204
```

This is an example of possible output.

```

rlghncxa03w 06-10-28 09:12:36 GMT EAGLE5 36.0.0
CARD IPLNK
ANAME          LOC  PORT  LINK ADAPTER  LPORT  RPORT  OPEN  ALW
assoc1        2204 A     A     M2PA    1030   1030   YES   YES

IP Appl Sock/Assoc table is (4 of 4000) 1% full
Assoc Buffer Space Used (16 KB of 3200 KB) on LOC = 2204

```

```
rtrv-assoc: lhost=ipnode1_2205
```

This is an example of possible output.

```
rlghncxa03w 06-10-28 09:12:36 GMT EAGLE5 36.0.0
IP Appl Sock/Assoc table is (4 of 4000) 1% full
```

Note: If there are no associations assigned to the specified local host name, the `rtrv-assoc` output shows no association information as shown above.

- Change the value of the `open` and `alw` parameters to `no` by specifying the `chg-assoc` command with the `open=no` and `alw=no` parameters, as necessary.

Note: If there is no association shown in [Step 7](#), or the `open` and `alw` parameter values of the association shown in [Step 7](#) are `no`, continue the procedure with [Step 9](#).

For this example, enter this command.

```
chg-assoc: aname=assoc1: open=no: alw=no
```

When this command has successfully completed, this message should appear.

```
rlghncxa03w 06-10-28 09:12:36 GMT EAGLE5 36.0.0
CHG-ASSOC: MASP A - COMPLTD;
```

- Deactivate the link to be removed using the `dact-slk` command, using the output from [Step 1](#) to obtain the card location and `link` parameter value of the signaling link to be removed.

For this example, enter these commands.

```
dact-slk: loc=2205: link=a
```

```
dact-slk: loc=2204: link=a
```

When each of these command has successfully completed, this message should appear.

```
rlghncxa03w 06-10-07 08:41:12 GMT EAGLE5 36.0.0
Deactivate Link message sent to card
```

- Verify that the link is out of service - maintenance disabled (OOS-MT-DSBLD) using the `rept-stat-slk` command with the card location and `link` parameter values specified in [Step 9](#).

For this example, enter these commands.

```
rept-stat-slk: loc=2205: link=a
```

This is an example of the possible output.

```
rlghncxa03w 06-10-23 13:06:25 GMT EAGLE5 36.0.0
SLK      LSN      CLLI      PST      SST      AST
2205,A   ls05      ls05clli OOS-MT_DSBLD Unavail  ----
  ALARM STATUS      = *    0235 REPT-LNK-MGTINH: local inhibited
  UNAVAIL REASON    = LI
```

```
rept-stat-slk:loc=2204:link=a
```

This is an example of the possible output.

```
rlghncxa03w 06-10-23 13:06:25 GMT EAGLE5 36.0.0
SLK      LSN      CLLI      PST      SST      AST
2204,A   ls04      ls04clli  OOS-MT   Unavail  ----
  ALARM STATUS      = *    0235 REPT-LNK-MGTINH: local inhibited
  UNAVAIL REASON    = LI
```

- If the signaling link to be removed is the last signaling link on a card, the card must be inhibited before the signaling link is removed.

Note: If the signaling link being removed is not the last signaling link on the card, continue the procedure with [Step 13](#).

Before entering the `dlt-slk` command, enter the `rmv-card` command and specify the location of the card to be inhibited. The card location is shown in the output of `rept-stat-slk` command executed in [Step 10](#).

In the example used for this procedure, the signaling link is the last signaling link on the card and must be inhibited. Enter these commands.

```
rmv-card:loc=2205
```

```
rmv-card:loc=2204
```

When each of these command has successfully completed, this message should appear.

```
rlghncxa03w 06-10-07 08:41:12 GMT EAGLE5 36.0.0
Card has been inhibited.
```

- Verify that the card has been inhibited by entering the `rept-stat-card` command with the card location specified in [Step 11](#). For this example, enter these commands.

```
rept-stat-card:loc=2205
```

This is an example of the possible output.

```
rlghncxa03w 07-05-27 16:43:42 GMT EAGLE5 37.0.0
CARD  VERSION  TYPE  GPL  PST  SST  AST
2205  114-001-000 DCM   IPLIM  OOS-MT-DSBLD  Isolated  -----
  ALARM STATUS      = **  0013 Card is isolated from the system
  BPDCM GPL          = 002-102-000
  IMT BUS A          = Disc
  IMT BUS B          = Disc
  SIGNALING LINK STATUS
    SLK  PST          LS          CLLI          E5IS
    A    OOS-MT      lsnlp1     -----      INACTIVE
```

Command Completed.

```
rept-stat-card:loc=2204
```

This is an example of the possible output.

```
rlghncxa03w 07-05-27 16:43:42 GMT EAGLE5 37.0.0
CARD  VERSION  TYPE  GPL  PST  SST  AST
```

```

2204  114-001-000  DCM          IPLIM          OOS-MT-DSBLD  Isolated  -----
ALARM STATUS      = ** 0013 Card is isolated from the system
BPDCM GPL         = 002-102-000
IMT BUS A         = Disc
IMT BUS B         = Disc
SIGNALING LINK STATUS
SLK   PST          LS          CLLI          E5IS
A     OOS-MT       lsnlp2      -----      INACTIVE

Command Completed.

```

13. Remove the signaling link from the EAGLE using the `dlt-slk` command.

If there is only one signaling link in the linkset, the `force=yes` parameter must be specified to remove the signaling link.

In the example used in this procedure, the signaling link is the last signaling link in the linkset. Enter these commands.

```

dlt-slk:loc=2205:link=a:force=yes
dlt-slk:loc=2204:link=a:force=yes

```

When this command has successfully completed, this message should appear.

```

rlghncxa03w 06-10-07 08:41:17 GMT EAGLE5 36.0.0
DLT-SLK: MASP A - COMPLTD

```

Note: If removing the signaling link will result in 700 or less signaling links in the database and the OAMHCMEAS value in the `rtrv-measopts` output is on, the scheduled UI measurement reports will be enabled.

14. Verify the changes using the `rtrv-slk` command with the card location and link values specified in [Step 13](#). For this example, enter these commands.

```

rtrv-slk:loc=2205:link=a
rtrv-slk:loc=2204:link=a

```

When the `rtrv-slk` command has completed, the specified signaling link is not shown in the `rtrv-slk` output, as shown in this example.

```

rlghncxa03w 09-09-18 13:43:31 GMT EAGLE5 41.1.0
E2373 Cmd Rej: Link is unequipped in the database

```

15. Back up the new changes using the `chg-db:action=backup:dest=fixed` command. These messages should appear, the active Maintenance and Administration Subsystem Processor (MASP) appears first.

```

BACKUP (FIXED) : MASP A - Backup starts on active MASP.
BACKUP (FIXED) : MASP A - Backup on active MASP to fixed disk complete.
BACKUP (FIXED) : MASP A - Backup starts on standby MASP.
BACKUP (FIXED) : MASP A - Backup on standby MASP to fixed disk complete.

```

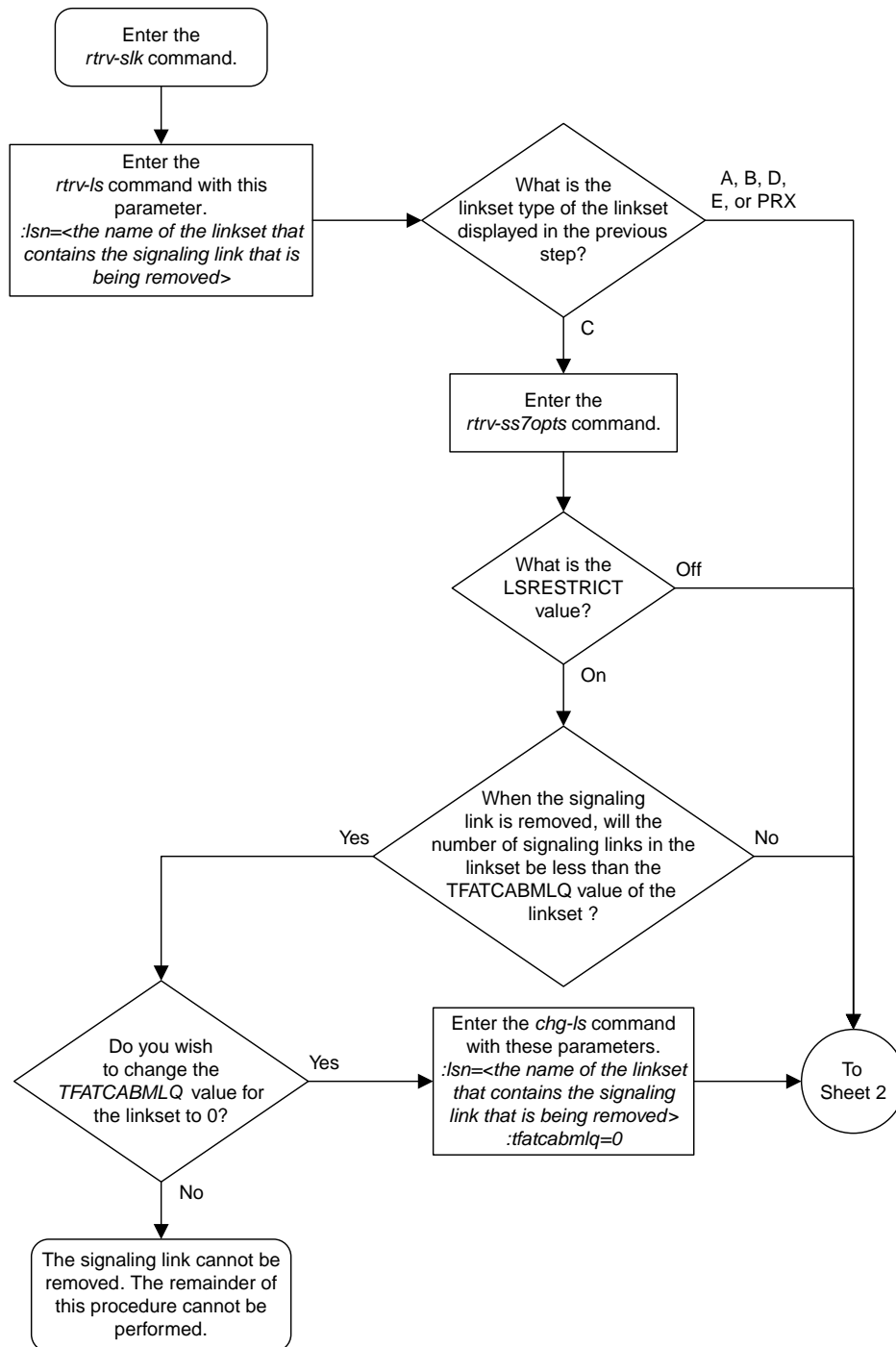

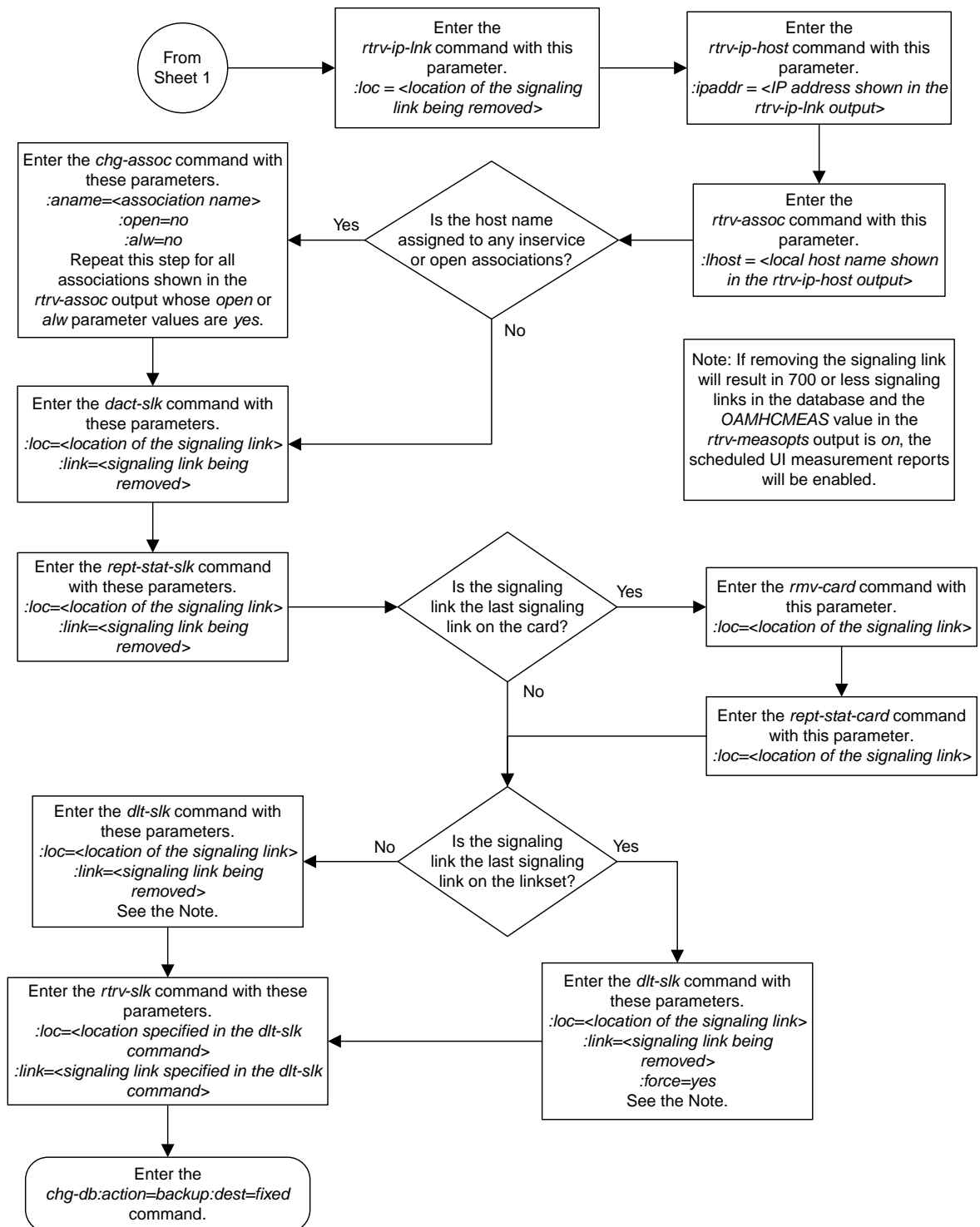
Sheet 2 of 2

Figure 29: Removing an IPLIMx Signaling Link**Removing an IP Host Assigned to an IPLIMx Card**

This procedure removes an IP host that is assigned to an IPLIMx card using the `dlt-ip-host` command.

The `dlt-ip-host` command uses the following parameter.

`:host-Hostname`. The hostname to be removed. This parameter identifies the logical name assigned to a device with an IP address.

No associations can reference the host name being removed in this procedure.

The associations referencing the host name can be removed by performing the [Removing an M2PA Association](#) procedure or the host name in these associations can be changed by performing the [Changing the Host Values of a M2PA Association](#) procedure. The host name assigned to associations is displayed in the `rtrv-assoc` outputs.

1. Display the current IP host information in the database by entering the `rtrv-ip-host:display=all` command.

The following is an example of the possible output.

```
rlghncxa03w 08-12-28 21:17:37 GMT EAGLE5 40.0.0

LOCAL IPADDR      LOCAL HOST
192.1.1.10        IPNODE1-1201
192.1.1.12        IPNODE1-1203
192.1.1.14        IPNODE1-1205
192.1.1.20        IPNODE2-1201
192.1.1.22        IPNODE2-1203
192.1.1.24        IPNODE2-1205
192.1.1.30        KC-HLR1
192.1.1.32        KC-HLR2
192.1.1.50        DN-MS1
192.1.1.52        DN-MS2
192.3.3.33        GW100. NC. TEKELEC. COM

REMOTE IPADDR     REMOTE HOST
150.1.1.5         NCDEPTECONOMIC_DEVELOPMENT. SOUTHEASTERN_COORIDOR_ASHVL. GOV

IP Host table is (12 of 4096) .29% full
```

If the IP host that is being removed is a remote host, continue the procedure with [Step 5](#).

If the IP host that is being removed is a local host, continue the procedure with [Step 2](#).

2. Display the current link parameters associated with the IP card in the database by entering the `rtrv-ip-lnk` command. The following is an example of the possible output.

```
rlghncxa03w 08-12-28 21:14:37 GMT EAGLE5 40.0.0
LOC  PORT IPADDR      SUBMASK          DUPLEX  SPEED MACTYPE AUTO MCAST
```

```

1303 A 192.1.1.10 255.255.255.128 HALF 10 802.3 NO NO
1303 B ----- HALF 10 DIX NO NO
1305 A 192.1.1.12 255.255.255.0 ---- DIX YES NO
1305 B ----- HALF 10 DIX NO NO
1313 A 192.1.1.14 255.255.255.0 FULL 100 DIX NO NO
1313 B ----- HALF 10 DIX NO NO
2101 A 192.1.1.20 255.255.255.0 FULL 100 DIX NO NO
2101 B ----- HALF 10 DIX NO NO
2103 A 192.1.1.22 255.255.255.0 FULL 100 DIX NO NO
2103 B ----- HALF 10 DIX NO NO
2105 A 192.1.1.24 255.255.255.0 FULL 100 DIX NO NO
2105 B ----- HALF 10 DIX NO NO
2205 A 192.1.1.30 255.255.255.0 FULL 100 DIX NO NO
2205 B ----- HALF 10 DIX NO NO
2207 A 192.1.1.32 255.255.255.0 FULL 100 DIX NO NO
2207 B ----- HALF 10 DIX NO NO
2213 A 192.1.1.50 255.255.255.0 FULL 100 DIX NO NO
2213 B ----- HALF 10 DIX NO NO
2301 A 192.1.1.52 255.255.255.0 FULL 100 DIX NO NO
2301 B ----- HALF 10 DIX NO NO
2305 A 192.3.3.33 255.255.255.0 FULL 100 DIX NO NO
2305 B ----- HALF 10 DIX NO NO

```

```
IP-LNK table is (22 of 2048) 1% full.
```

3. Display the cards in the database using the `rtrv-card` command. This is an example of the possible output.

```

rlghncxa03w 09-05-28 09:12:36 GMT EAGLE5 41.0.0
CARD TYPE APPL LSET NAME LINK SLC LSET NAME LINK SLC
1101 DSM VSCCP
1102 TSM GLS
1113 E5MCAP EOAM
1114 E5TDM-A
1115 E5MCAP EOAM
1116 E5TDM-B
1117 E5MDAL
1201 LIMDS0 SS7ANSI sp2 A 0 sp1 B 0
1203 LIMDS0 SS7ANSI sp3 A 0
1204 LIMDS0 SS7ANSI sp3 A 1
1206 LIMDS0 SS7ANSI nsp3 A 1 nsp4 B 1
1216 DCM STPLAN
1301 LIMDS0 SS7ANSI sp6 A 1 sp7 B 0
1302 LIMDS0 SS7ANSI sp7 A 1 sp5 B 1
1303 DCM IPLIM ipnode1 A 0 ipnode3 B 1
1305 DCM IPLIM ipnode4 A 0
1307 DCM STPLAN
1313 DCM SS7IPGW ipgtwy1 A 0
2101 DCM SS7IPGW ipgtwy2 A 0
2103 DCM SS7IPGW ipgtwy3 A 0
2105 DCM IPLIM ipnode1 A1 1 ipnode5 B 2
2205 DCM IPLIM ipnode3 A2 0 ipnode6 B1 2
2207 DCM IPLIM ipnode5 A 0 ipnode4 B3 1
2213 DCM IPLIM ipnode5 A3 1 ipnode3 B2 2
2301 DCM IPLIM ipnode6 A 0 ipnode1 B 2
2305 DCM IPLIM ipnode6 A1 1 ipnode1 B1 3

```

Select an IP host whose IP address is assigned to a card running the IPLIM or IPLIMI application.

4. Display the associations referencing the host name being removed in this procedure by entering the `rtrv-assoc` command with the local host name.

For this example, enter this command.

```
rtrv-assoc:host=gw100.nc.tekelec.com
```

The following is an example of the possible output.

```
rlghncxa03w 06-10-28 21:14:37 GMT EAGLE5 36.0.0
                CARD IPLNK
ANAME          LOC  PORT  LINK ADAPTER LPORT RPORT OPEN ALW
a2             2305 A    A    M2PA   7205  7001 NO   NO

IP Appl Sock/Assoc table is (4 of 4000) 1% full
Assoc Buffer Space Used (200 KB of 1600 KB) on LOC = 2305
```

If no associations referencing the host name being removed in this procedure are shown in this step, continue the procedure with [Step 5](#).

Any associations referencing the host name must either be removed or the host name assigned to the association must be changed.

To remove the associations, perform the [Removing an M2PA Association](#) procedure.

Continue the procedure with [Step 5](#) after the associations have been removed.

To change the host name assigned to the associations, perform the [Changing the Host Values of a M2PA Association](#) procedure.

Continue the procedure with [Step 5](#) after the host name assigned to the associations have been changed.

5. Delete IP host information from the database by entering the `dlt-ip-host` command.

For example, enter this command.

```
dlt-ip-host:host=gw100.nc.tekelec.com
```

When this command has successfully completed, the following message should appear.

```
rlghncxa03w 06-10-28 21:19:37 GMT EAGLE5 36.0.0
DLT-IP-HOST: MASP A - COMPLTD
```

6. Verify the changes by entering the `rtrv-ip-host` command with the host name specified in [Step 5](#).

For this example, enter this command.

```
rtrv-ip-host:host=gw100.nc.tekelec.com
```

The following is an example of the possible output.

```
rlghncxa03w 09-07-28 21:20:37 GMT EAGLE5 41.1.0
No matching entries found.
IP Host table is (10 of 4096) .24% full
```

7. Back up the new changes using the `chg-db:action=backup:dest=fixed` command.

These messages should appear, the active Maintenance and Administration Subsystem Processor (MASP) appears first.

```
BACKUP (FIXED) : MASP A - Backup starts on active MASP.  
BACKUP (FIXED) : MASP A - Backup on active MASP to fixed disk complete.  
BACKUP (FIXED) : MASP A - Backup starts on standby MASP.  
BACKUP (FIXED) : MASP A - Backup on standby MASP to fixed disk complete.
```

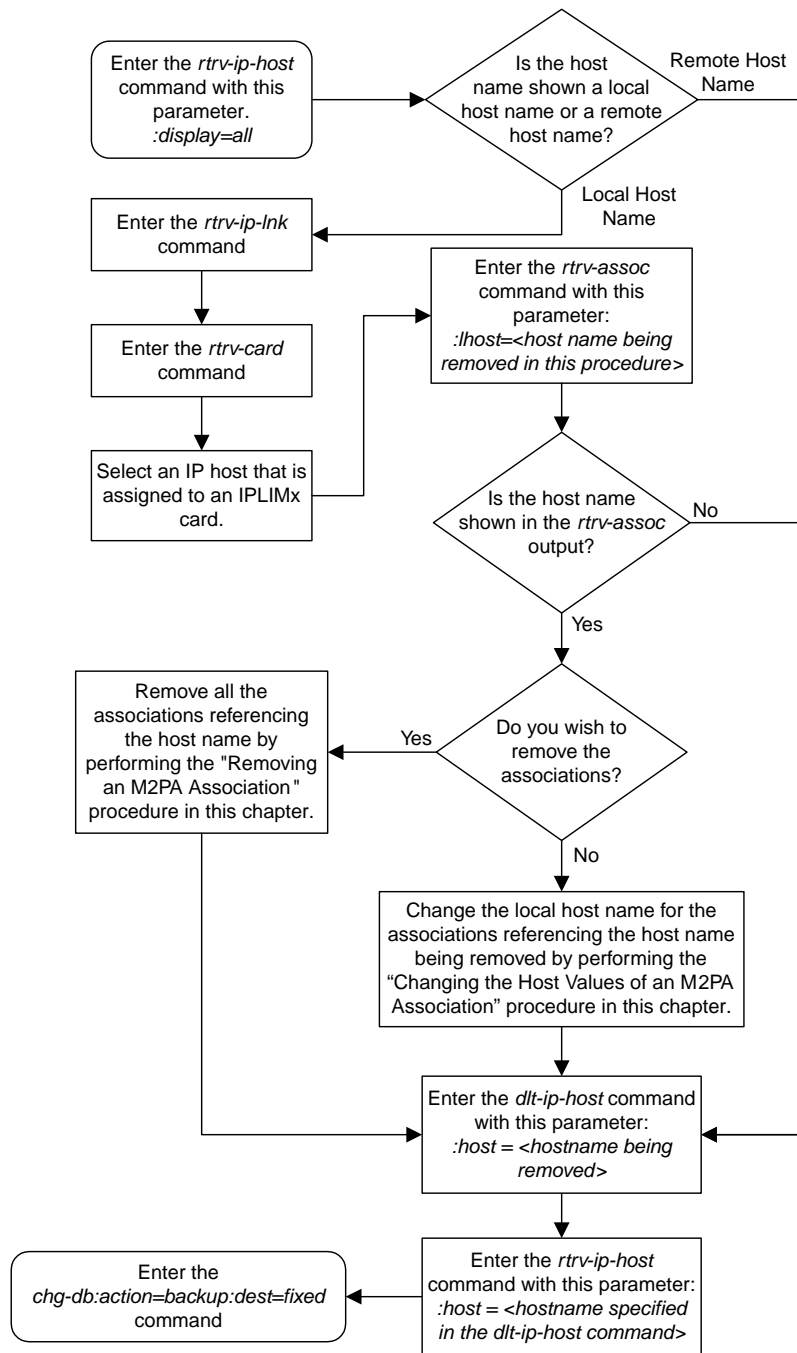

Figure 30: Removing an IP Host Assigned to an IPLIMx Card

Removing an IP Route

This procedure is used to remove an IP route from the database using the `dlt-ip-rte` command.

The `dlt-ip-rte` command uses these parameters.

`:loc` – The location of the IP card containing the IP route being removed.

`:dest` – The IP address of the remote host or network assigned to the IP route being removed.

`:force` – To remove the IP route, the IP card that the route is assigned to must be out of service, or the `force=yes` parameter must be specified with the `dlt-ip-rte` command. The `force=yes` parameter allows the IP route to be removed if the IP card is in service.



Caution: Removing an IP route while the IP card is still in service can result in losing the ability to route outbound IP traffic on the IP card. This can cause both TCP and SCTP sessions on the IP card to be lost.

1. Display the IP routes in the database with the `rtrv-ip-rte` command.

This is an example of the possible output.

```
rlghncxa03w 06-10-28 09:12:36 GMT EAGLE5 36.0.0
LOC  DEST          SUBMASK          GTWY
1212 132.10.175.20    255.255.0.0      150.1.1.50
1301 128.252.10.5     255.255.255.255 140.188.13.33
1301 128.252.0.0      255.255.0.0      140.188.13.34
1301 150.10.1.1       255.255.255.255 140.190.15.3
1303 192.168.10.1     255.255.255.255 150.190.15.23
1303 192.168.0.0      255.255.255.0    150.190.15.24
```

```
IP Route table is (6 of 2048) 0.29% full
```

2. Verify the state of the IP card containing the IP route being removed by entering the `rept-stat-card` command and specifying the card location of the IP card.

The IP card should be in the out-of-service maintenance-disabled (OOS-MT-DSBLD) in order to remove the IP route. If the IP card's state is out-of-service maintenance-disabled, the entry OOS-MT-DSBLD is shown in the `PST` column of the `rept-stat-card` output. For this example, enter this command.

```
rept-stat-card:loc=1301
```

This is an example of the possible output.

```
rlghncxa03w 06-10-27 17:00:36 GMT EAGLE5 36.0.0
CARD  VERSION  TYPE  GPL  PST  SST  AST
1301  114-000-000  DCM  IPLIM  IS-NR  Active  -----
ALARM STATUS          = No Alarms.
BPDCM GPL             = 002-102-000
IMT BUS A             = Conn
IMT BUS B             = Conn
SIGNALING LINK STATUS
  SLK  PST  LS  CLLI
  A    IS-NR  nc001  -----
```



```
Command Completed.
```

Note: If the output of [Step 2](#) shows that the IP card's state is not OOS-MT-DSBLD, and you do not wish to change the state of the IP card, continue the procedure with [Step 4](#).

3. Change the IP card's state to OOS-MT-DSBLD using the `inh-card` command and specifying the card location of the IP card.

For this example, enter these commands.

```
inh-card:loc=1301
```

When this command has successfully completed, this message appears.

```
rlghncxa03w 06-10-12 09:12:36 GMT EAGLE5 36.0.0
Card has been inhibited.
```

4. Remove the IP route from the database using the `dlt-ip-rte` command.

If the state of the IP card is not OOS-MT-DSBLD, the `force=yes` parameter must be specified with the `dlt-ip-rte` command. For this example, enter this command.

```
dlt-ip-rte:loc=1301:dest=128.252.0.0
```



CAUTION

Caution: Removing an IP route while the IP card is still in service can result in losing the ability to route outbound IP traffic on the IP card. This can cause both TCP and SCTP sessions on the IP card to be lost.

When this command has successfully completed, this message should appear.

```
rlghncxa03w 06-10-12 09:12:36 GMT EAGLE5 36.0.0
DLT-IP-RTE: MASP A - COMPLTD
```

5. Verify the changes using the `rtrv-ip-rte` command.

This is an example of the possible output.

```
rlghncxa03w 06-10-28 09:12:36 GMT EAGLE5 36.0.0
LOC  DEST          SUBMASK          GTWY
1212 132.10.175.20    255.255.0.0      150.1.1.50
1301 128.252.10.5     255.255.255.255  140.188.13.33
1301 150.10.1.1       255.255.255.255  140.190.15.3
1303 192.168.10.1     255.255.255.255  150.190.15.23
1303 192.168.0.0      255.255.0.0      150.190.15.24
```

```
IP Route table is (5 of 2048) 0.24% full
```

6. Place the IP card back into service by using the `alw-card` command.

Note: If the IP card containing the IP route that was removed from the database does not contain other IP routes, continue the procedure with [Step 7](#).

For example, enter this command.

```
alw-card:loc=1301
```

This message should appear.

```
rlghncxa03w 06-10-28 21:22:37 GMT EAGLE5 36.0.0  
Card has been allowed.
```

7. Back up the new changes using the `chg-db:action=backup:dest=fixed` command.
These messages should appear, the active Maintenance and Administration Subsystem Processor (MASP) appears first.

```
BACKUP (FIXED) : MASP A - Backup starts on active MASP.  
BACKUP (FIXED) : MASP A - Backup on active MASP to fixed disk complete.  
BACKUP (FIXED) : MASP A - Backup starts on standby MASP.  
BACKUP (FIXED) : MASP A - Backup on standby MASP to fixed disk complete.
```

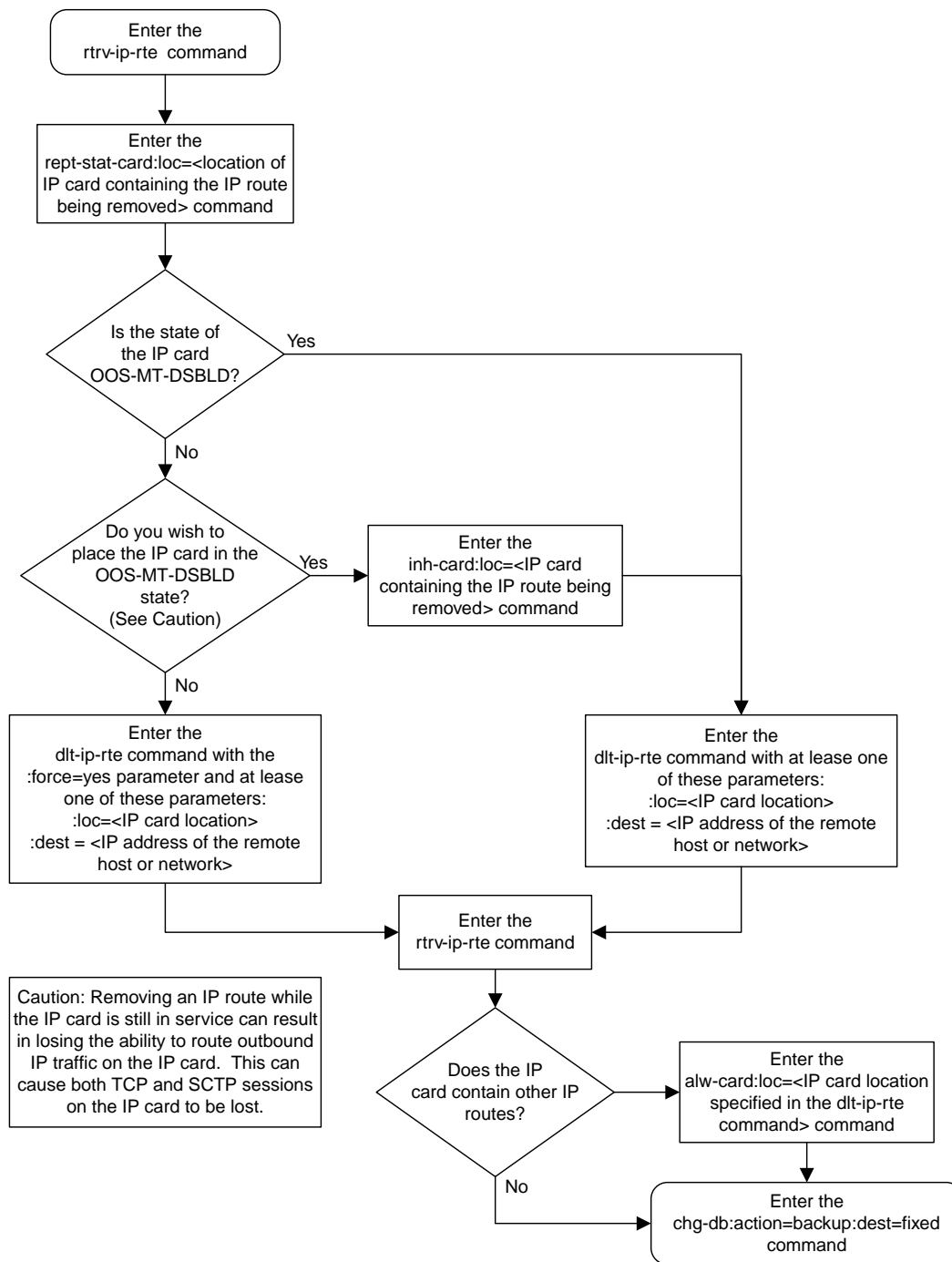

Figure 31: Removing an IP Route

Removing an M2PA Association

This procedure is used to remove an association from the database using the `dlt-assoc` command.

The `dlt-assoc` command uses one parameter, `aname`, the name of the association being removed from the database. The association being removed must be in the database.

The `open` parameter must be set to `no` before the association can be removed. Use the `chg-assoc` command to change the value of the `open` parameter.

The `adapter` value assigned to the association being removed in this procedure must be `m2pa`. The application assigned to the card that is hosting the M2PA association must be either `IPLIM` or `IPLIMI`. Perform the [Removing an IPSPG Association](#) procedure to remove an M2PA association assigned to an IPSPG card.

Canceling the RTRV-ASSOC Command

Because the `rtrv-assoc` command used in this procedure can output information for a long period of time, the `rtrv-assoc` command can be canceled and the output to the terminal stopped. There are three ways that the `rtrv-assoc` command can be canceled.

- Press the F9 function key on the keyboard at the terminal where the `rtrv-assoc` command was entered.
- Enter the `canc-cmd` without the `trm` parameter at the terminal where the `rtrv-assoc` command was entered.
- Enter the `canc-cmd:trm=<xx>`, where `<xx>` is the terminal where the `rtrv-assoc` command was entered, from another terminal other than the terminal where the `rtrv-assoc` command was entered. To enter the `canc-cmd:trm=<xx>` command, the terminal must allow Security Administration commands to be entered from it and the user must be allowed to enter Security Administration commands. The terminal's permissions can be verified with the `rtrv-secu-trm` command. The user's permissions can be verified with the `rtrv-user` or `rtrv-secu-user` commands.

For more information about the `canc-cmd` command, go to *Commands User's Guide*.

1. Display the associations in the database using the `rtrv-assoc` command.

This is an example of possible output.

```
rlghncxa03w 06-10-28 09:12:36 GMT EAGLE5 36.0.0

          CARD IPLNK
ANAME     LOC  PORT  LINK ADAPTER  LPORT  RPORT  OPEN  ALW
swbel32   1201 A     A    M3UA    1030    2345   YES   YES
a2        1305 A     A    SUA     1030    2345   YES   YES
a3        1307 A     A    SUA     1030    2346   YES   YES
assoc1    1203 A     A1   M2PA    2048    1030   NO    NO
```

2. Enter the `rtrv-card` command with the location of the card that is hosting the M2PA association that will be removed in this procedure. For this example, enter this command.

```
rtrv-card:loc=1203
```

This is an example of possible output.

```
rlghncxa03w 08-03-06 15:17:20 EST EAGLE5 38.0.0
CARD   TYPE      APPL      LSET NAME   LINK SLC LSET NAME   LINK SLC
1203   DCM          IPLIM     lsn1        A1      0
```

If the application assigned to the card is IPLIM or IPLIMI, shown in the APPL column, continue the procedure with [Step 3](#).

If the application assigned to the card is IPSPG, perform the [Removing an IPSPG Association](#) procedure.

3. Change the value of the open parameter to no by specifying the chg-assoc command with the open=no parameter.

Note: If the value of the open parameter for the association being removed from the database (shown in [Step 1](#)) is no, continue this procedure with [Step 4](#).

For this example, enter this command.

```
chg-assoc:aname=assoc1:open=no
```

When this command has successfully completed, this message should appear.

```
rlghncxa03w 06-10-28 09:12:36 GMT EAGLE5 36.0.0
CHG-ASSOC: MASP A - COMPLTD;
```

4. Remove the association from the database using the dlt-assoc command.

For this example, enter this command.

```
dlt-assoc:aname=assoc1
```

When this command has successfully completed, this message should appear.

```
rlghncxa03w 06-10-28 09:12:36 GMT EAGLE5 36.0.0
DLT-ASSOC: MASP A - COMPLTD
```

5. Verify the changes using the rtrv-assoc command with the name of the association specified in [Step 4](#).

For this example, enter this command.

```
rtrv-assoc:aname=assoc1
```

This is an example of possible output.

```
rlghncxa03w 06-10-28 09:12:36 GMT EAGLE5 36.0.0
No matching entries found
IP Appl Sock table is (3 of 4000) 1% full
```

6. Back up the new changes, using the `chg-db:action=backup:dest=fixed` command. These messages should appear; the active Maintenance and Administration Subsystem Processor (MASP) appears first.

```
BACKUP (FIXED) : MASP A - Backup starts on active MASP.  
BACKUP (FIXED) : MASP A - Backup on active MASP to fixed disk complete.  
BACKUP (FIXED) : MASP A - Backup starts on standby MASP.  
BACKUP (FIXED) : MASP A - Backup on standby MASP to fixed disk complete.
```

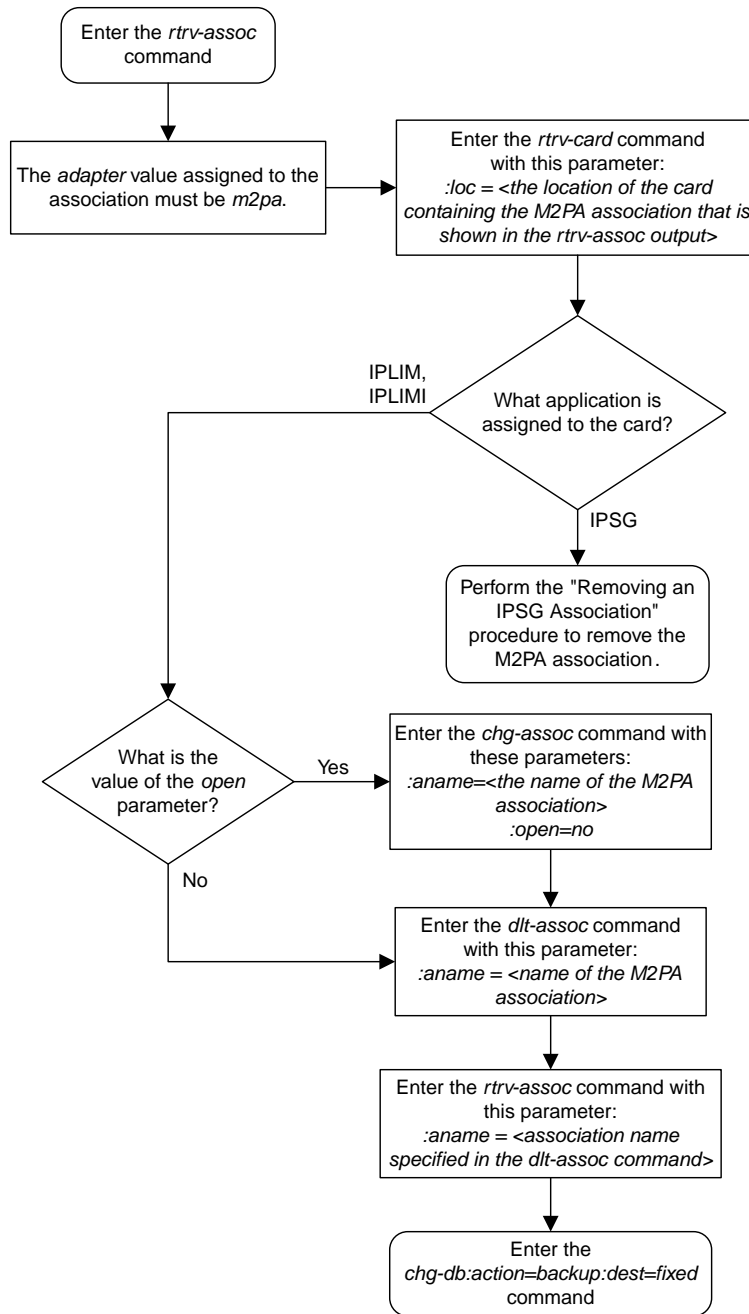

Figure 32: Removing an M2PA Association

Changing IETF M2PA Components

This section describes how to change the attributes of the following components in the database.

- An M2PA Association – Perform these procedures.
 - [Changing the Attributes of an M2PA Association](#)
 - [Changing the Buffer Size of a M2PA Association](#)
 - [Changing the Host Values of a M2PA Association](#)
 - [Changing the Link Value of a M2PA Association to another Link Value on the Same IPLIMx Card](#)
- The SCTP retransmission parameters – Perform the [Changing the SCTP Checksum Algorithm Option for M2PA Associations](#) procedure.
- A M2PA timer set – Perform the [Changing a M2PA Timer Set](#) procedure.
- The SCTP Checksum Algorithm – Perform the [Changing the SCTP Checksum Algorithm Option for M2PA Associations](#) procedure.
- Turn off the Large MSU Support for IP Signaling feature – Perform the [Turning Off the Large MSU Support for IP Signaling Feature](#) procedure.

Changing the Attributes of an M2PA Association

This procedure is used to change the values of the attributes of an M2PA association, assigned to cards that are running the IPLIM or IPLIMI applications, using the `chg-assoc` command and the following parameters.

Table 19: Change M2PA Association Parameters

aname	lport	rhost	rport	open	alw
rmode	rmin	rmax	rtimes	cwmin	istrms
ostrms	m2patset	ver	rtxthr	rhosttype	rhostval

An M2PA association that is assigned to an IPLIMx signaling link can contain a UA parameter set value (the `uaps` parameter). While the `uaps` parameter value can be changed with the `chg-assoc` command, the `uaps` parameter value has no impact on the traffic carried by an M2PA association that is assigned to an IPLIMx signaling link. The `uaps` parameter value impacts M3UA or SUA associations that are assigned to IPGWx signaling links and M2PA and M3UA associations that are assigned to IPSP cards. The `uaps` parameter value is shown in the `UAPS` field in the `rtv-assoc` output for an M2PA associations that is assigned to an IPLIMx signaling link.

If you wish to change the attributes of M2PA associations assigned to cards that are running the IPSP application, perform [Changing the Attributes of an IPSP Association](#).

The `chg-assoc` command contains other parameters that are not used in this procedure. To change these parameters, perform these procedures.

- `lhost` and `alhost` - [Changing the Host Values of a M2PA Association](#)
- `link` - [Changing the Link Value of a M2PA Association to another Link Value on the Same IPLIMx Card](#)

- `bufsize` - [Changing the Buffer Size of a M2PA Association](#)
- `:aname` – The name assigned to the association, shown in the `rtrv-assoc` output.
- `:lport` – The SCTP port number for the local host.
- `:rhost` – The host name for the remote host, `rhost` can be any string of characters starting with a letter and comprising these characters ['a'..'z', 'A'..'Z', '0'..'9', '-', '.']. Hostnames are not case-sensitive and can contain up to 60 characters. The default value of this optional parameter is empty (null string).
- `:rport` – The SCTP port number for the remote host.
- `:open` – The connection state for this association. Valid values are `yes` or `no`. When the `open=yes` parameter is specified, the connection manager opens the association if the association is operational. When the `open=no` parameter is specified, the connection manager will not open the association.
- `:alw` – The connection state for this association. Valid values are `yes` or `no`. When the `alw=yes` parameter is specified, the connection manager allows the association to carry SS7 traffic. When the `alw=no` parameter is specified, the connection manager prohibits the association from carrying SS7 traffic.
- `:rmode` – The retransmission policy used when packet loss is detected. The values are `rfc` or `lin`.
- `rfc` – Standard RFC 2960 algorithm in the retransmission delay doubles after each retransmission. The RFC 2960 standard for congestion control is also used.
 - `lin` – Oracle's linear retransmission policy where each retransmission timeout value is the same as the initial transmission timeout and only the slow start algorithm is used for congestion control.
- `:rmin` – The minimum value of the calculated retransmission timeout in milliseconds, from 10 - 1000.
- `:rmax` – The maximum value of the calculated retransmission timeout in milliseconds, from 10 - 1000.
- `:rtimes` – The number of times a data retransmission will occur before closing the association from 3 - 12.
- `:cwmn` – The minimum size in bytes of the association's congestion window and the initial size in bytes of the congestion window, from 1500 - 409600. The `cwmn` parameter value must be less than or equal to the size of the buffer used by the association, shown by the `bufsize` parameter value. If the buffer size for the association needs to be changed, perform [Changing the Buffer Size of a M2PA Association](#).
- The `rmode`, `rmin`, `rmax`, `rtimes`, and `cwmn` parameters are used to configure the SCTP retransmission controls for an association, in addition to other commands. Perform [Configuring SCTP Retransmission Control for a M2PA Association](#) to configure the SCTP retransmission controls for an association.
- `:istrms` – The number of inbound streams (1 or 2) advertised by the SCTP layer for the association.
- `:ostrms` – The number of outbound streams (1 or 2) advertised by the SCTP layer for the association.
- `:m2patset` – The M2PA timer set assigned to the association. The `m2patset` parameter can be specified only with the `adapter=m2pa` parameter, or if the association already has the `adapter=m2pa` parameter assigned and the `adapter` parameter value is not being changed. If the `adapter` parameter value is being changed to `m2pa`, and the `m2patset` parameter is not specified, the default value for the `m2patset` parameter (1 - M2PA timer set 1) is assigned to the association. If the `adapter` parameter value for the association is `m2pa`, is not being changed, and the `m2patset` parameter is not specified with the `chg-assoc` command, the `m2patset` parameter value is not changed.
- `:ver` – The M2PA version assigned to the M2PA association, either the RFC version (`ver=rfc`), or the Draft 6 version (`ver=d6`). The `ver` parameter can be specified only if, when this procedure is

completed, the `adapter` parameter value is `m2pa`. If the `adapter` parameter value is being changed to `m2pa`, and the `ver` parameter is not specified, the default M2PA version of RFC is assigned to the association. To change the `ver` parameter value, the `open` parameter value for the association must be `no`.

`:rtxthr` –The retransmission threshold for the association. The `RTXTHR` parameter value indicates the number of packet re-transmissions that can occur on the association (per monitoring time period of 2 seconds). Alarm "IP Connection Excess Retransmits" (UAM 536) will be raised if the number of packets re-transmitted is greater than the configured `RTXTHR` parameter value, during 5 such consecutive monitoring periods. Once alarm is raised, it may require up to 12 consecutive monitoring periods with the number of re-transmissions < `RTXTHR` to clear the alarm. The design allows the alarm to come on at low error rates, and not come for occasional errors.

The value of this parameter is 0 to 65,535. The value of this parameter is shown in the `RTXTHR` field of the `rtrv-assoc:aname=<association name>` output. The `rtxthr` parameter value can be changed if the `open` parameter value is either "yes" or "no". It is possible to configure the `RTXTHR` so that UAM 536 alarms if the error rate on association is above the recommended maximum packet loss of 0.025%. If the error rate is more than 0.025%, investigate to determine if this can be improved in the network.

`:rhosttype` – The type of remote host assigned to the association, `primary` or `alternate`. The primary remote host is shown in the `RHOST` field of the `rtrv-assoc:aname=<association name>` output. The alternate remote host is shown in the `ARHOST` field of the `rtrv-assoc:aname=<association name>` output.

An alternate remote host can be configured for multi-homed associations using the `rhost` and `rhosttype` parameters of the `chg-assoc` command. The `rhost` parameter value with the `rhosttype=primary` parameter represents an IP address that corresponds to one of the network interfaces at the remote end while the `rhost` parameter value with the `rhosttype=alternate` parameter represents an IP address that corresponds to the other network interface at the remote end.

`:rhostval` – The validation mode used for the association when an SCTP INIT/INIT-ACK message is received. The value of this parameter is shown in the `RHOSTVAL` field of the `rtrv-assoc:aname=<association name>` output. This parameter has two values.

- `relaxed` - accept the message if the IP address for the primary or alternate remote host matches the IP address, source IP address, or the host name in the message.
- `match` - accept the message if the message contains the primary remote host value and the alternate remote host value (if the alternate remote host is provisioned). If the alternate remote host is not provisioned, then accept the message if the message contains the primary remote host value. Reject the message if it contains any IP address other than that of the primary or alternate remote host.

Refer to the `chg-assoc` command description in *Commands User's Guide* for more information about this parameter.

If the value of the `open` parameter is `yes`, only the value of the `alw`, and `rtxthr` parameters can be changed. To change the values of other parameters, the value of the `open` parameter must be `no`.

To set the `open` parameter value to `yes`, the association specified by the `aname` parameter must contain values for the `lhost`, `lport`, `rhost`, and `rport` parameters. The `lhost` parameter value must have a signaling link assigned to it.

At least one optional parameter is required.

The command input is limited to 150 characters, including the hostnames.

The value of the `rmin` parameter must be less than or equal to the `rmax` parameter value.

The `ipliml2` parameter value of the signaling link assigned to the association must be `m2pa`. The `adapter` parameter value of the association must match the `ipliml2` parameter value.

The signaling link being assigned to the association must be out of service. This state is shown in the `rept-stat-slk` output with the entries `OOS-MT` in the `PST` field and `Unavail` in the `SST` field.

If the association is being opened in this procedure with the `chg-assoc` command and the `open=yes` parameter, the signaling link assigned to the association must be in the database and the `ipliml2` parameter value of the signaling link assigned to the association must be `m2pa`.

Canceling the `RTRV-ASSOC` Command

Because the `rtrv-assoc` command used in this procedure can output information for a long period of time, the `rtrv-assoc` command can be canceled and the output to the terminal stopped. There are three ways that the `rtrv-assoc` command can be canceled.

- Press the `F9` function key on the keyboard at the terminal where the `rtrv-assoc` command was entered.
- Enter the `canc-cmd` without the `trm` parameter at the terminal where the `rtrv-assoc` command was entered.
- Enter the `canc-cmd:trm=<xx>`, where `<xx>` is the terminal where the `rtrv-assoc` command was entered, from another terminal other than the terminal where the `rtrv-assoc` command was entered. To enter the `canc-cmd:trm=<xx>` command, the terminal must allow Security Administration commands to be entered from it and the user must be allowed to enter Security Administration commands. The terminal's permissions can be verified with the `rtrv-secu-trm` command. The user's permissions can be verified with the `rtrv-user` or `rtrv-secu-user` commands.

For more information about the `canc-cmd` command, go to *Commands User's Guide*.

1. Display the associations in the database using the `rtrv-assoc` command.

This is an example of possible output.

```
rlghncxa03w 06-10-28 09:12:36 GMT EAGLE5 36.0.0

          CARD IPLNK
ANAME      LOC  PORT  LINK ADAPTER  LPORT  RPORT  OPEN  ALW
swbel32    1201 A     A   M3UA    1030   2345   YES   YES
a2         1305 A     A   SUA     1030   2345   YES   YES
a3         1307 A     A   SUA     1030   2346   YES   YES
assoc1     1201 A     A   M3UA    2000   1030   YES   YES
assoc2     1205 A     A   M2PA    2048   2048   YES   YES
assoc3     1205 A     B2  M2PA    3000   3000   YES   YES
assoc5     1205 A     A3  M2PA    1500   3000   YES   YES
```

2. Enter the `rtrv-card` command with the location of the card that is hosting the M2PA association that will be changed in this procedure. For this example, enter this command.

```
rtrv-card:loc=1205
```

This is an example of possible output.

```
rlghncxa03w 08-04-06 15:17:20 EST EAGLE5 38.0.0
CARD  TYPE      APPL      LSET NAME  LINK SLC  LSET NAME  LINK SLC
1205  DCM         IPLIM     e5e6a     A   0   e5e6a     B2   1
          e5e6a     A3   2
```

If the application assigned to the card is IPLIM or IPLIMI, shown in the `APPL` column, and the values of any of these parameters are being changed: `lport`, `rhost`, `rport`, `rmode`, `rmin`, `rmax`, `rtimes`, `cwmin`, `istrms`, `ostrms`, `ver`, or `m2patset`, continue the procedure by performing one of these steps.

- If the `open` parameter value for the association is `yes`, continue the procedure with [Step 3](#).
- If the `open` parameter value for the association is `no`, continue the procedure with [Step 4](#).

If the application assigned to the card is IPLIM or IPLIMI, shown in the `APPL` column, and only the values of the `alw`, `open`, `rtxthr` parameters are being changed, continue the procedure by performing one of these steps.

- If only the values of the `alw` parameter is being changed, or the `open` parameter value is being changed to `no`, continue the procedure with [Step 9](#).
- If the value of the `rtxthr` parameter is being changed, continue the procedure with [Step 4](#).
- If the value of the `open` parameter value is being changed to `yes`, a signaling link must be assigned to the card shown in this step. If a signaling link is assigned to the card, entries are shown in the `LSET NAME` and `LINK` columns of the `rtrv-card` output. If a signaling link is assigned to the card, perform one of these actions.
 - If only the `alw` parameter is being specified with the `open=yes` parameter, continue the procedure with [Step 9](#).
 - If the value of the `rtxthr` parameter is being changed, continue the procedure with [Step 4](#).
- If the value of the `open` parameter value is being changed to `yes` and a signaling link is not assigned to the card, perform [Adding an IPLIMx Signaling Link](#) to assign an IPLIMx signaling link to the card. After the signaling link has been added, perform one of these actions.
 - If only the `alw` parameter is being specified with the `open=yes` parameter, continue the procedure with [Step 9](#).
 - If the value of the `rtxthr` parameter is being changed, continue the procedure with [Step 4](#).

If the application assigned to the card is IPSPG, perform [Changing the Attributes of an IPSPG Association](#).

3. Change the value of the `open` parameter to `no` by specifying the `chg-assoc` command with the `open=no` parameter.

For this example, enter this command.

```
chg-assoc : aname=assoc2 : open=no
```

When this command has successfully completed, this message should appear.

```
rlghncxa03w 06-10-28 09:12:36 GMT EAGLE5 36.0.0
CHG-ASSOC: MASP A - COMPLTD;
```

4. Display the association being changed by entering the `rtrv-assoc` command with the `aname` parameter specified in [Step 3](#) or selected in [Step 1](#).

For this example, enter this command.

```
rtrv-assoc : aname=assoc2
```

This is an example of the possible output.

```

rlghncxa03w 10-07-28 21:14:37 GMT EAGLE5 42.0.0
ANAME assoc2
  LOC      1205          IPLNK PORT  A          LINK  A
  ADAPTER  M2PA          VER          M2PA RFC
  LHOST    IPNODE2-1205
  ALHOST    ---
  RHOST    remotehost1
  ARHOST    ---
  LPORT    2048          RPORT      2048
  ISTRMS   2            OSTRMS     2          BUFSIZE  400
  RMODE    LIN          RMIN       120        RMAX     800
  RTIMES   10          CWMIN      3000      UAPS     10
  OPEN     NO           ALW        YES        RTXTHR   2000
  RHOSTVAL RELAXED     M2PATSET   1
IP Appl Sock/Assoc table is (8 of 4000) 1% full
Assoc Buffer Space Used (1600 KB of 1600 KB) on LOC = 1205

```

Continue the procedure by performing one of these actions.

- If the `cwmin` and `m2patset` parameters will not be specified in this procedure, continue the procedure with [Step 7](#).
 - If the `cwmin` parameter will be specified in this procedure, continue the procedure with [Step 5](#).
 - If the `m2patset` parameter will be specified in this procedure, but the `cwmin` parameter will not be specified in this procedure, continue the procedure with [Step 6](#).
5. To change the `cwmin` value, the new `cwmin` parameter value must be less than or equal to the `bufsize` parameter value.

The `cwmin` parameter is the number of bytes specified for the association's congestion window. The `bufsize` is the number of kilobytes specified for the size of the association's buffer. To determine whether or not the `cwmin` value is less than or equal to the `bufsize` value, perform one of these actions.

- Multiply the `bufsize` value by 1024.
- Divide the `cwmin` value by 1024.

Continue the procedure by performing one of these actions.

- If the new `cwmin` value is less than or equal to the `bufsize` value, and the `m2patset` parameter will be specified in this procedure, continue the procedure with [Step 6](#).
- If the new `cwmin` value is less than or equal to the `bufsize` value, and the `m2patset` parameter will not be specified in this procedure, continue the procedure with [Step 7](#).
- If the new `cwmin` value is not less than or equal to the `bufsize` value, either choose another value for the `cwmin` parameter that is less than or equal to the `bufsize` value, or perform to change the `bufsize` value so that the `bufsize` value is greater than or equal to the `cwmin` value. After the new `cwmin` value has been chosen or the `bufsize` value has been changed, continue the procedure by performing one of these actions.
 - If the `m2patset` parameter will be specified in this procedure, continue the procedure with [Step 6](#).
 - If the `m2patset` parameter will not be specified in this procedure, continue the procedure with [Step 7](#).

6. Verify the values of the M2PA timer set you wish to assign to the association by entering the `rtrv-m2pa-tset` command with the M2PA version (either `ver=rfc` to display the RFCM2PA timer values or `ver=d6` to display the Draft 6 M2PA timer values) of the timer set you wish to assign to the association.

If the `ver` parameter is not specified with the `rtrv-m2pa-tset` command, both the RFC and Draft 6 timer values are displayed.

To display the M2PA Draft 6 timer values, enter this command.

```
rtrv-m2pa-tset:ver=d6
```

This is an example of the possible output.

```
rlghncxa03w 06-10-28 21:16:37 GMT EAGLE5 36.0.0
M2PA Draft 6 Timers (in msec, T16 in microsec)
TSET T1      T2      T3      T4N     T4E     T5      T6      T7      T16     T17     T18
1     6000    ----- 5000    20000   500     5000    4000   1000    100000  150     500
2     7500    ----- 1500    2000    500     9000    1250   300     150000  175     600
3     100000  ----- 2000    3000    500     4000    1500   500     170000  200     800
4     200000  ----- 20000   4000    500     6000    2000   700     480000  225     900
5     250000  ----- 30000   30000   500     100     2250   400     400000  400     8000
6     50000    ----- 50000   60000   500     500     4500   800     300000  300     7000
7     10000    ----- 10000   10000   500     1000    3000   1200    200000  250     1000
8     80000    ----- 1500    15000   500     8000    2750   1100    350000  350     5000
9     27500    ----- 3850    4859    450     5700    3750   1150    250     375     8750
10    90000    ----- 2500    50000   500     7500    5000   1750    440000  450     3000
11    20000    ----- 4500    5500    500     6500    5500   1600    250000  475     4500
12    30000    ----- 7500    7000    500     750     4250   1800    275000  275     3500
13    40000    ----- 35000   9000    500     1250    3500   1900    500     325     9000
14    70000    ----- 45000   11000   500     1500    1750   900     1000    125     6000
15    9000     ----- 25000   40000   500     2500    3250   600     5000    425     5500
16    75000    ----- 15000   25000   500     4500    1600   1400    6000    240     9500
17    350000  ----- 60000   70000   600     10000   6000   2000    500000  500     10000
18    150000  ----- 55000   35000   500     3500    5750   1500    125000  440     750
19    175000  ----- 12500   45000   500     1100    2600   1300    7000    340     850
20    1000     ----- 1000    1000    400     80      1000   200     100     100     100
```

To display the M2PARFC values, enter this command.

```
rtrv-m2pa-tset:ver=rfc
```

This is an example of the possible output.

```
rlghncxa03w 06-10-28 21:16:37 GMT EAGLE5 36.0.0
M2PA RFC Timers (in msec, T16 in microsec)
TSET T1      T2      T3      T4N     T4E     T5      T6      T7      T16     T17     T18
1     6000    75000   5000    20000   500     5000    4000   1000    100000  150     500
2     7500    8000    1500    2000    500     9000    1250   300     150000  175     600
3     100000  10000   2000    3000    500     4000    1500   500     170000  200     800
4     200000  6000    20000   4000    500     6000    2000   700     480000  225     900
5     250000  140000  30000   30000   500     100     2250   400     400000  400     8000
6     50000    100000  50000   60000   500     500     4500   800     300000  300     7000
7     300000  20000   2000    10000   500     1000    3000   1200    200000  250     1000
8     80000    130000  1500    15000   500     8000    2750   1100    350000  350     5000
9     27500    120000  3850    4859    450     5700    3750   1150    250     375     8750
```

10	90000	9000	2500	50000	500	7500	5000	1750	440000	450	3000
11	20000	60000	4500	5500	500	6500	5500	1600	250000	475	4500
12	30000	50000	7500	7000	500	750	4250	1800	275000	275	3500
13	40000	90000	35000	9000	500	1250	3500	1900	500	325	9000
14	70000	45000	45000	11000	500	1500	1750	900	1000	125	6000
15	9000	30000	25000	40000	500	2500	3250	600	5000	425	5500
16	75000	15000	15000	25000	500	4500	1600	1400	6000	240	9500
17	350000	150000	60000	70000	600	10000	6000	2000	500000	500	10000
18	150000	20000	55000	35000	500	3500	5750	1500	125000	440	750
19	175000	12500	12500	45000	500	1100	2600	1300	7000	340	850
20	1000	5000	1000	1000	400	80	1000	200	100	100	100

If the `ver` parameter is not specified when entering the `rtrv-m2pa-tset` command, both the Draft 6 and RFC values are displayed. This is an example of the possible output.

```
rlghncxa03w 06-10-28 21:16:37 GMT EAGLE5 36.0.0
```

```
M2PA Draft 6 Timers (in msec, T16 in microsec)
```

TSET	T1	T2	T3	T4N	T4E	T5	T6	T7	T16	T17	T18
1	6000	-----	5000	20000	500	5000	4000	1000	100000	150	500
2	7500	-----	1500	2000	500	9000	1250	300	150000	175	600
3	100000	-----	2000	3000	500	4000	1500	500	170000	200	800
4	200000	-----	20000	4000	500	6000	2000	700	480000	225	900
5	250000	-----	30000	30000	500	100	2250	400	400000	400	8000
6	50000	-----	50000	60000	500	500	4500	800	300000	300	7000
7	10000	-----	10000	10000	500	1000	3000	1200	200000	250	1000
8	80000	-----	1500	15000	500	8000	2750	1100	350000	350	5000
9	27500	-----	3850	4859	450	5700	3750	1150	250	375	8750
10	90000	-----	2500	50000	500	7500	5000	1750	440000	450	3000
11	20000	-----	4500	5500	500	6500	5500	1600	250000	475	4500
12	30000	-----	7500	7000	500	750	4250	1800	275000	275	3500
13	40000	-----	35000	9000	500	1250	3500	1900	500	325	9000
14	70000	-----	45000	11000	500	1500	1750	900	1000	125	6000
15	9000	-----	25000	40000	500	2500	3250	600	5000	425	5500
16	75000	-----	15000	25000	500	4500	1600	1400	6000	240	9500
17	350000	-----	60000	70000	600	10000	6000	2000	500000	500	10000
18	150000	-----	55000	35000	500	3500	5750	1500	125000	440	750
19	175000	-----	12500	45000	500	1100	2600	1300	7000	340	850
20	1000	-----	1000	1000	400	80	1000	200	100	100	100

```
M2PA RFC Timers (in msec, T16 in microsec)
```

TSET	T1	T2	T3	T4N	T4E	T5	T6	T7	T16	T17	T18
1	6000	75000	5000	20000	500	5000	4000	1000	100000	150	500
2	7500	8000	1500	2000	500	9000	1250	300	150000	175	600
3	100000	10000	2000	3000	500	4000	1500	500	170000	200	800
4	200000	6000	20000	4000	500	6000	2000	700	480000	225	900
5	250000	140000	30000	30000	500	100	2250	400	400000	400	8000
6	50000	100000	50000	60000	500	500	4500	800	300000	300	7000
7	300000	20000	2000	10000	500	1000	3000	1200	200000	250	1000
8	80000	130000	1500	15000	500	8000	2750	1100	350000	350	5000
9	27500	120000	3850	4859	450	5700	3750	1150	250	375	8750
10	90000	9000	2500	50000	500	7500	5000	1750	440000	450	3000
11	20000	60000	4500	5500	500	6500	5500	1600	250000	475	4500
12	30000	50000	7500	7000	500	750	4250	1800	275000	275	3500
13	40000	90000	35000	9000	500	1250	3500	1900	500	325	9000
14	70000	45000	45000	11000	500	1500	1750	900	1000	125	6000
15	9000	30000	25000	40000	500	2500	3250	600	5000	425	5500
16	75000	15000	15000	25000	500	4500	1600	1400	6000	240	9500
17	350000	150000	60000	70000	600	10000	6000	2000	500000	500	10000

18	150000	20000	55000	35000	500	3500	5750	1500	125000	440	750
19	175000	12500	12500	45000	500	1100	2600	1300	7000	340	850
20	1000	5000	1000	1000	400	80	1000	200	100	100	100

If the M2PA timer set you wish to assign to the association does not contain the desired values, perform [Changing a M2PA Timer Set](#) to change the desired timer values.



CAUTION

Caution: Changing an M2PA timer set may affect the performance of any associations using the timer set being changed.

- The remote hosts assigned to the association can be changed by specifying the `rhost` and `rhosttype` parameters with the `chg-assoc` command.

If the primary and alternate remote hosts are not being changed in this procedure, or if only the primary remote host is being changed, continue the procedure with [Step 9](#).

To change the alternate remote host value for the association, the association must have a primary remote host assigned to it. If the association has a primary remote host, continue the procedure with [Step 9](#). If the association does not have a primary remote host, continue the procedure with [Step 8](#).

- Assign a primary remote host to the association by entering the `chg-assoc` command with the name of the association and the primary remote host name.

For this example, enter this command.

```
chg-assoc:aname=assoc2:rhost="gw200.nc-Oracle.com"
```

The `rhosttype=primary` parameter can be specified with the `chg-assoc` command, but is not necessary.

When this command has successfully completed, this message should appear.

```
rlghncxa03w 09-05-28 09:12:36 GMT EAGLE5 41.0.0
CHG-ASSOC: MASP A - COMPLTD;
```

- Change the association using the `chg-assoc` command.

For this example, enter this command.

```
chg-assoc:aname=assoc2:rhost="gw200.nc-Oracle.com":rport=3000
:rtxthr=10000:rhostval=match
```

If an alternate remote host is being specified for the association, for this example enter this command.

```
chg-assoc:aname=assoc2:rhost="gw210.nc-Oracle.com":rhosttype=alternate:rport=3000
:rtxthr=10000:rhostval=match
```

If only the `alw`, `open`, or `rtxthr` parameter values are being changed in this step, for this example, enter this command.

```
chg-assoc:aname=assoc2:alw=no:open=yes:rtxthr=10000
```

These are the rules that apply to changing the attributes of M2PA associations that are assigned to IPLIMx signaling links.

- If any optional parameters are not specified with the `chg-assoc` command, those values are not changed.
- The value of the `rhost` parameter is a text string of up to 60 characters, with the first character being a letter. The command input is limited to 150 characters, including the hostname.
- If the value of the `open` parameter is `yes`, only the values of the `alw` and `rtxthr` parameters can be changed. To change the values of the other parameters, the value of the `open` parameter must be `no`.
- The value of the `rmin` parameter must be less than or equal to the `rmax` parameter value.
- The M2PA version of the association determines the version of the M2PA timer set that is assigned to the association. For example, if M2PA timer set 3 is assigned to the M2PA association, and the association is an RFC M2PA association, the RFC version of M2PA timer set 3 is used with the association. If M2PA timer set 7 is assigned to the M2PA association, and the association is a Draft 6 M2PA association, the Draft 6 version of M2PA timer set 7 is used with the association.

When this command has successfully completed, this message should appear.

```
rlghncxa03w 06-10-28 09:12:36 GMT EAGLE5 36.0.0
CHG-ASSOC: MASP A - COMPLTD;
```

If the value of the `open` parameter was not changed in [Step 3](#), continue the procedure with [Step 11](#).

10. Change the value of the `open` parameter to `yes` by specifying the `chg-assoc` command with the `open=yes` parameter.

For this example, enter this command.

```
chg-assoc:aname=assoc2:open=yes
```

When this command has successfully completed, this message should appear.

```
rlghncxa03w 06-10-28 09:12:36 GMT EAGLE5 36.0.0
CHG-ASSOC: MASP A - COMPLTD;
```

11. Verify the changes using the `rtrv-assoc` command specifying the association name specified in [Step 9](#) and [Step 10](#).

For this example, enter this command.

```
rtrv-assoc:aname=assoc2
```

This is an example of possible output.

```
rlghncxa03w 10-07-28 21:14:37 GMT EAGLE5 42.0.0
ANAME assoc2
  LOC      1205          IPLNK PORT  A          LINK  A
  ADAPTER  M2PA          VER          M2PA RFC
  LHOST    IPNODE2-1205
  ALHOST    ---
  RHOST    gw200.nc-Oracle.com
  ARHOST    gw210.nc-Oracle.com
  LPORT    2048          RPORT      3000
  ISTRMS   2            OSTRMS     2          BUFSIZE  400
  RMODE    LIN          RMIN       120        RMAX     800
  RTIMES   10          CWMIN      3000       UAPS     10
  OPEN     YES          ALW        NO          RTXTHR  10000
```

```

RHOSTVAL MATCH          M2PATSET    1
IP Appl Sock/Assoc table is (8 of 4000) 1% full
Assoc Buffer Space Used (1600 KB of 1600 KB) on LOC = 1205

```

12. Back up the new changes, using the `chg-db:action=backup:dest=fixed` command.

These messages should appear; the active Maintenance and Administration Subsystem Processor (MASP) appears first.

```

BACKUP (FIXED) : MASP A - Backup starts on active MASP.
BACKUP (FIXED) : MASP A - Backup on active MASP to fixed disk complete.
BACKUP (FIXED) : MASP A - Backup starts on standby MASP.
BACKUP (FIXED) : MASP A - Backup on standby MASP to fixed disk complete.

```

If you wish to change the `lhost`, `alhost`, `bufsize`, or `link` values of the M2PA association, perform one of these procedures.

- `lhost` and `alhost` - [Changing the Host Values of a M2PA Association](#)
- `bufsize` - [Changing the Buffer Size of a M2PA Association](#)
- `link` - [Changing the Link Value of a M2PA Association to another Link Value on the Same IPLIMx Card](#)

If you do not wish to change the `lhost`, `alhost`, `bufsize`, or `link` values of the M2PA association, this procedure is finished.

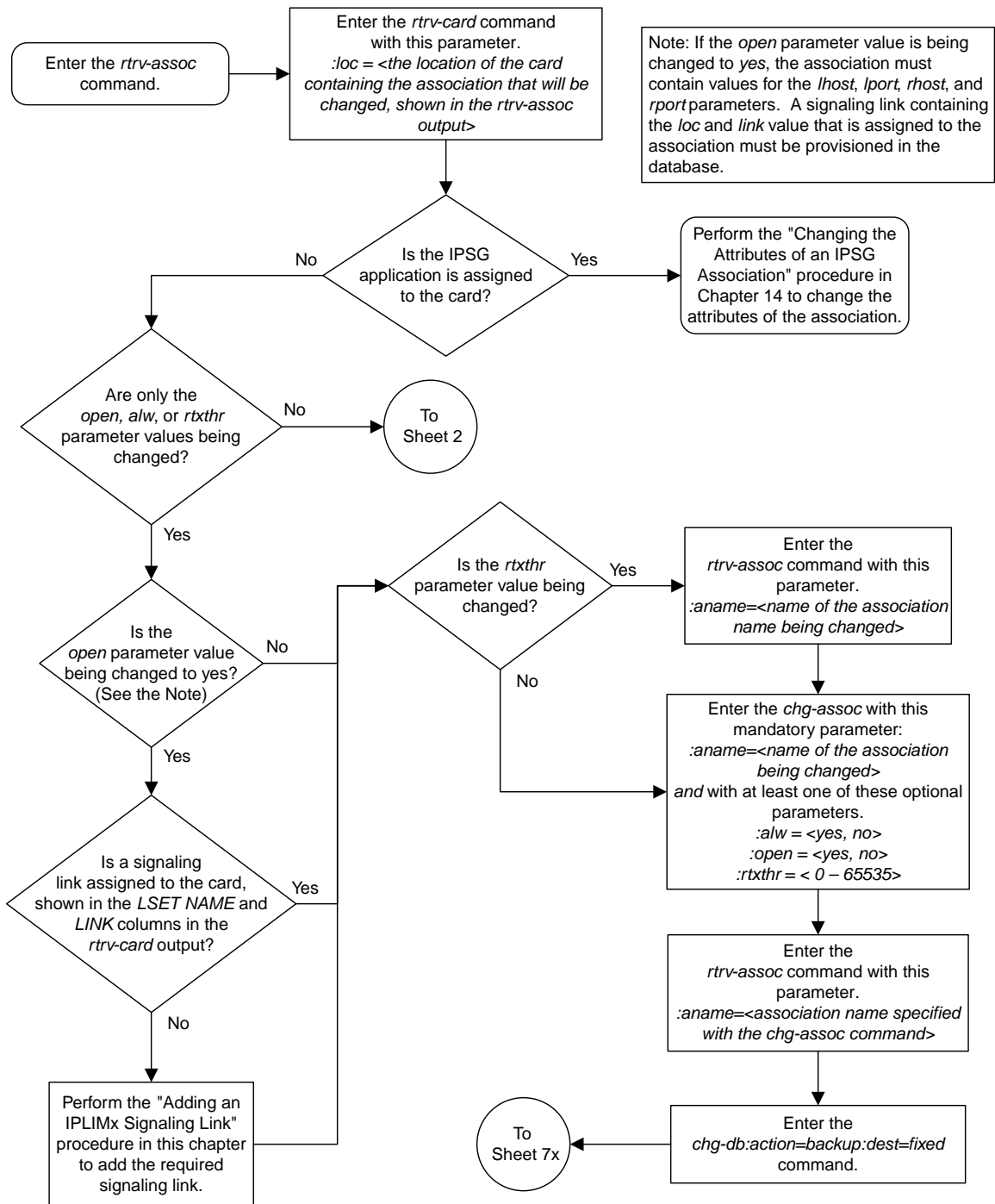

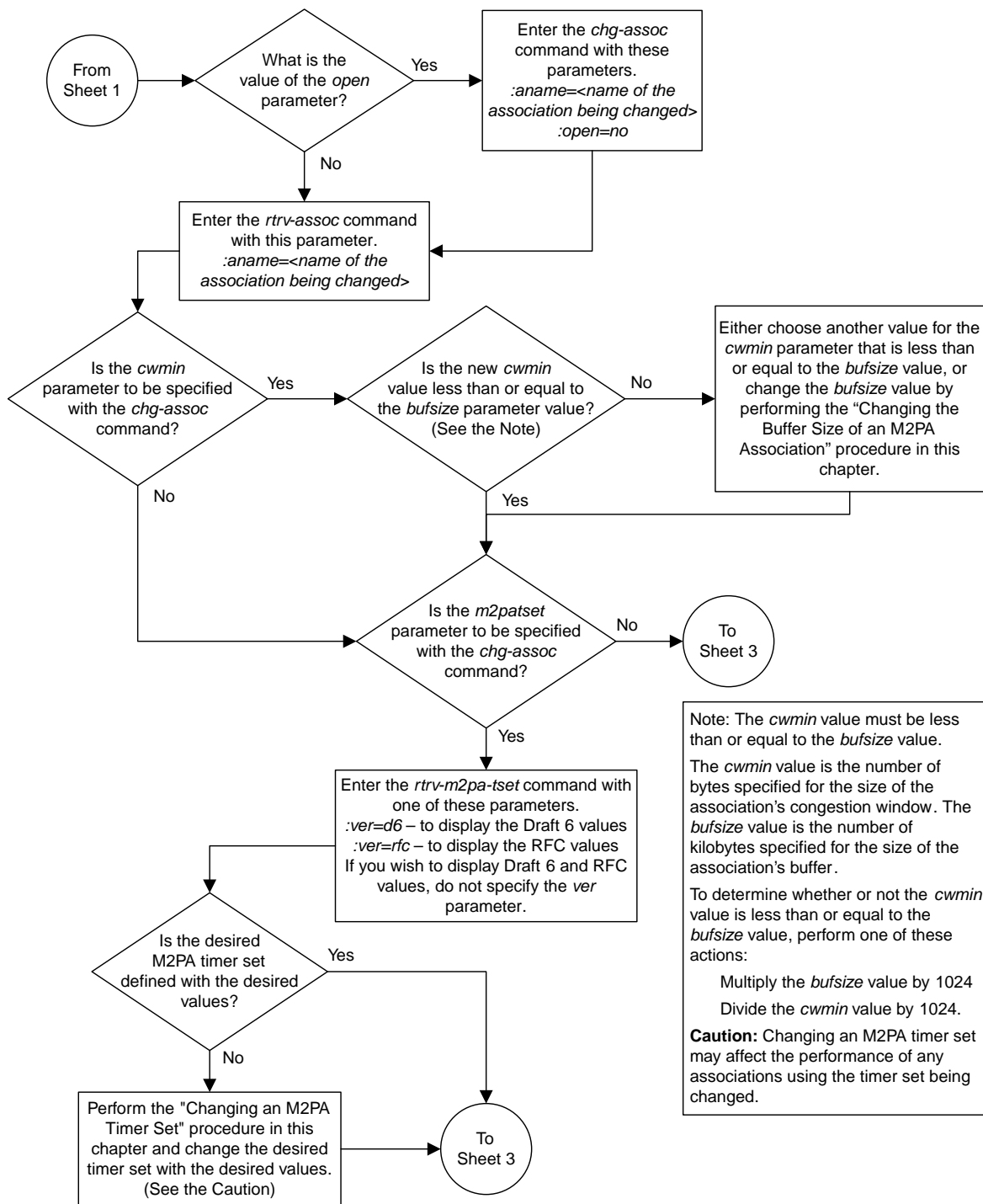

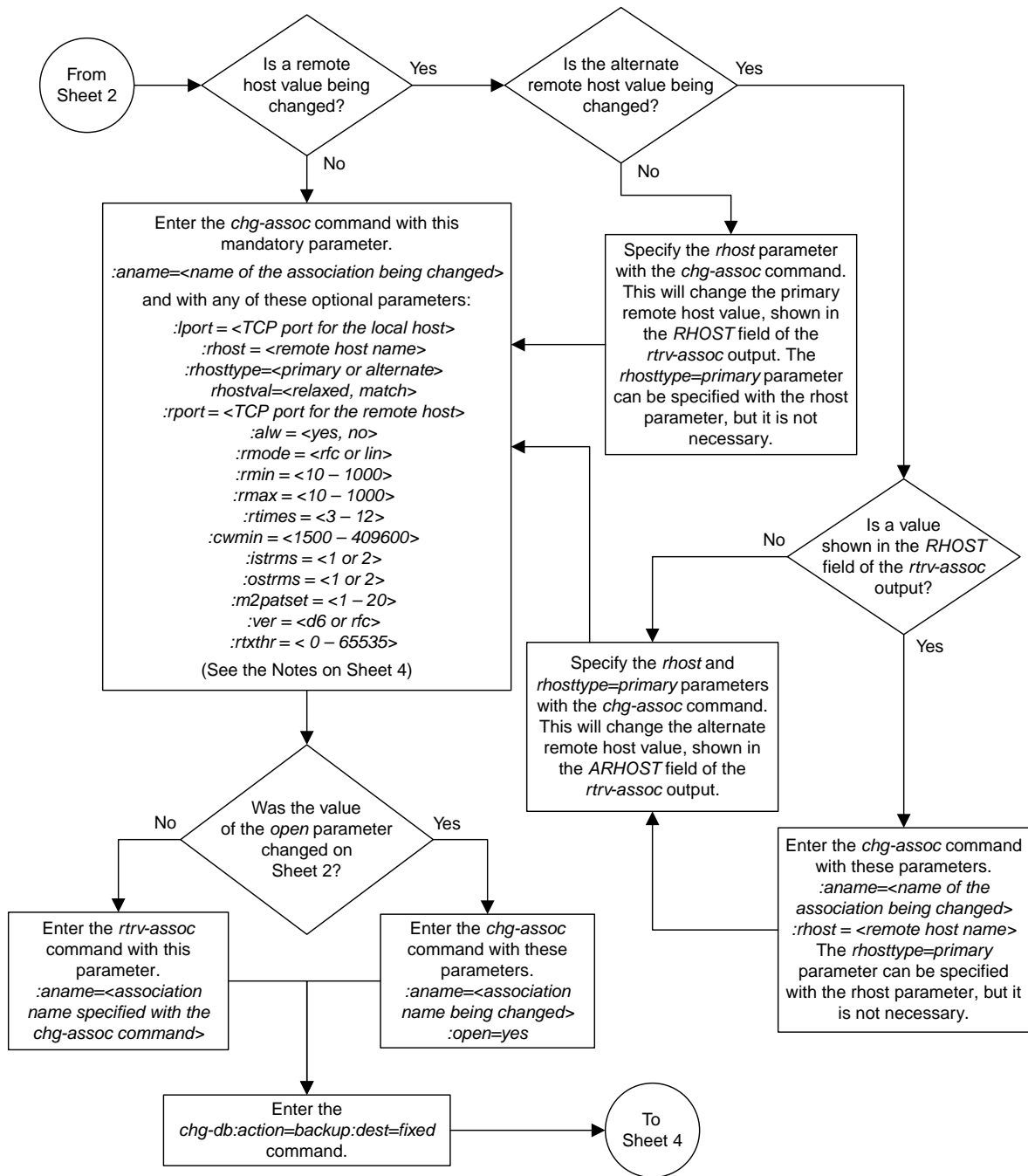

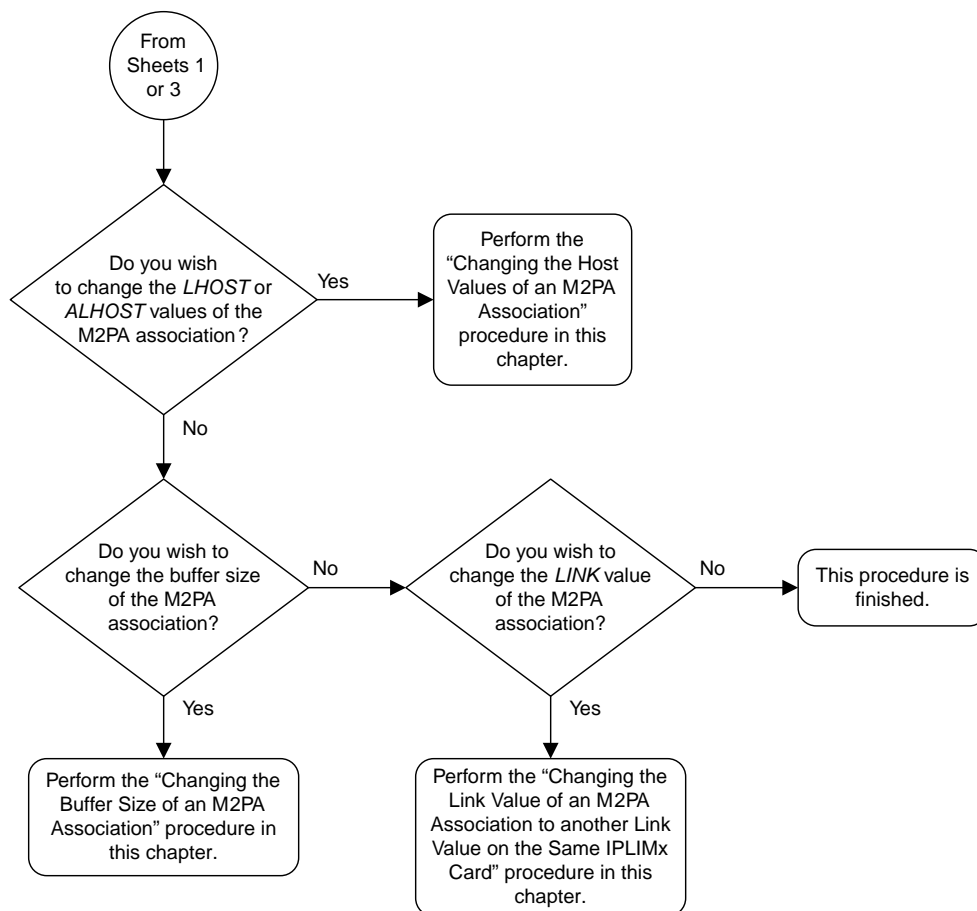

Notes:

1. If any optional parameters are not specified with the *chg-assoc* command, those values are not changed.
2. The value of the *rhost* parameter is a text string of up to 60 characters, with the first character being a letter. The command input is limited to 150 characters, including the hostname.
3. If the value of the *open* parameter is *yes*, only the values of the *alw* and *rtxthr* parameters can be changed. To change the values of the other parameters, the value of the *open* parameter must be *no*.
4. The value of the *rmin* parameter must be less than or equal to the *rmax* parameter value.
5. The M2PA version of the association determines the version of the M2PA timer set that is assigned to the association. For example, if M2PA timer set 3 is assigned to the M2PA association, and the association is an RFC M2PA association, the RFC version of M2PA timer set 3 is used with the association. If M2PA timer set 7 is assigned to the M2PA association, and the association is a Draft 6 M2PA association, the Draft 6 version of M2PA timer set 7 is used with the association.

Sheet 4 of 4

Figure 33: Changing the Attributes of an M2PA Association

Changing the Buffer Size of a M2PA Association

This procedure is used to change the buffer size of a M2PA association, assigned to cards that are running the IPLIM or IPLIMI applications, using the `chg-assoc` command. If you wish to change the buffer size of M2PA associations assigned to cards that are running the IPSPG application, perform the [Changing the Buffer Size of an IPSPG Association](#) procedure.

These parameters of the `chg-assoc` command are used in this procedure:

- :aname – The name assigned to the association, shown in the `rtrv-assoc` output.
- :open – The connection state for this association. Valid values are `yes` or `no`. When the `open=yes` parameter is specified, the connection manager opens the association if the association is operational. When the `open=no` parameter is specified, the connection manager will not open the association.
- :bufsize – The size, in kilobytes, of the buffer used by the association. The values for this parameter are 8 kilobytes to 400 kilobytes. The maximum size of the buffers on the E5-ENET cards are shown in the following list.

- E5-ENET Card - 3200 KB

The size of the buffers assigned to each association that is assigned to the IP card cannot exceed the maximum buffer size for that card. If the `bufsize` parameter value causes the total buffer size for all the associations on the IP card to exceed the maximum buffer size for that IP card, the `chg-assoc` command will be rejected. The available size of the buffers on the IP card can be verified by entering this command.

```
rtrv-assoc:lhost=<local host name assigned to the association being changed>
```

The `alhost` parameter can also be used with the `rtrv-assoc` command to display the available size of the buffers on the IP card.

The `aname` parameter can be used with the `rtrv-assoc` command to display the available size of the buffers on the IP card and the size of the buffer assigned to the association.

If you wish to increase the buffer size for this association to a value that is greater than available buffer size for the card, the buffer size of the other associations assigned to the card must be decreased.

The `chg-assoc` command contains other parameters that are not used this procedure. To change these parameters, perform these procedures.

- `lhost` and `alhost` - [Changing the Host Values of a M2PA Association](#)
- `link` - [Changing the Link Value of a M2PA Association to another Link Value on the Same IPLIMx Card](#)
- Other attributes of the M2PA Association - [Changing the Attributes of an M2PA Association](#)

Canceling the RTRV-ASSOC Command

Because the `rtrv-assoc` command used in this procedure can output information for a long period of time, the `rtrv-assoc` command can be canceled and the output to the terminal stopped. There are three ways that the `rtrv-assoc` command can be canceled.

- Press the F9 function key on the keyboard at the terminal where the `rtrv-assoc` command was entered.
- Enter the `canc-cmd` without the `trm` parameter at the terminal where the `rtrv-assoc` command was entered.
- Enter the `canc-cmd:trm=<xx>`, where `<xx>` is the terminal where the `rtrv-assoc` command was entered, from another terminal other than the terminal where the `rtrv-assoc` command was entered. To enter the `canc-cmd:trm=<xx>` command, the terminal must allow Security Administration commands to be entered from it and the user must be allowed to enter Security Administration commands. The terminal's permissions can be verified with the `rtrv-secu-trm` command. The user's permissions can be verified with the `rtrv-user` or `rtrv-secu-user` commands.

For more information about the `canc-cmd` command, go to *Commands User's Guide*.

1. Display the associations in the database using the `rtrv-assoc` command.

This is an example of possible output.

```
rlghncxa03w 06-10-28 09:12:36 GMT EAGLE5 36.0.0

          CARD IPLNK
ANAME      LOC  PORT  LINK ADAPTER LPORT RPORT OPEN ALW
swbel32    1201 A      A   M3UA   1030  2345  YES  YES
a2         1305 A      A   SUA    1030  2345  YES  YES
a3         1307 A      A   SUA    1030  2346  YES  YES
assoc1     1201 A      A   M3UA   2000  1030  YES  YES
assoc2     1205 A      A   M2PA   2048  2048  YES  YES
assoc3     1205 A      B2  M2PA   3000  3000  YES  YES
assoc5     1205 A      A3  M2PA   1500  3000  YES  YES
```

2. Enter the `rtrv-card` command with the location of the card that is hosting the M2PA association that will be changed in this procedure. For this example, enter this command.

```
rtrv-card:loc=1205
```

This is an example of possible output.

```
rlghncxa03w 08-04-06 15:17:20 EST EAGLE5 38.0.0
CARD  TYPE  APPL  LSET NAME  LINK SLC LSET NAME  LINK SLC
1205  DCM    IPLIM  e5e6a     A   0   e5e6a     B2   1
      e5e6a     A3   2
```

If the application assigned to the card is IPLIM or IPLIMI, shown in the APPL column, continue the procedure by performing one of these steps.

- If the open parameter value for the association being changed is yes, continue the procedure with [Step 3](#).
- If the open parameter value for the association being changed is no, continue the procedure with [Step 4](#).

If the application assigned to the card is IPSP, perform the [Changing the Buffer Size of an IPSP Association](#) procedure.

3. Change the value of the open parameter to no by specifying the `chg-assoc` command with the `open=no` parameter.

For this example, enter this command.

```
chg-assoc:aname=assoc2:open=no
```

When this command has successfully completed, this message should appear.

```
rlghncxa03w 06-10-28 09:12:36 GMT EAGLE5 36.0.0
CHG-ASSOC: MASP A - COMPLTD;
```

4. Display the association being changed by entering the `rtrv-assoc` command with the `aname` parameter specified in [Step 3](#) or the name of the association assigned to the card displayed in [Step 1](#).

For this example, enter this command.

```
rtrv-assoc:aname=assoc2
```

This is an example of the possible output.

```
rlghncxa03w 10-07-28 21:14:37 GMT EAGLE5 42.0.0
ANAME assoc2
  LOC      1205          IPLNK PORT  A          LINK  A
  ADAPTER  M2PA          VER          M2PA RFC
  LHOST    IPNODE2-1205
  ALHOST    ---
  RHOST    remotehost1
  ARHOST    ---
  LPORT    2048          RPORT      2048
  ISTRMS   2            OSTRMS     2          BUFSIZE  400
  RMODE    LIN          RMIN       120        RMAX     800
  RTIMES   10          CWMIN      3000       UAPS     10
  OPEN     NO           ALW        YES         RTXTHR  2000
  RHOSTVAL RELAXED     M2PATSET   1
```

```
IP Appl Sock/Assoc table is (8 of 4000) 1% full
Assoc Buffer Space Used (1600 KB of 1600 KB) on LOC = 1205
```

5. If the `bufsize` parameter value causes the total buffer size for all the associations on the IP card to exceed the maximum buffer size for that IP card, the `chg-assoc` command will be rejected.

If you wish to increase the buffer size for this association to a value that is greater than available buffer size for the card, the buffer size of the other associations assigned to the card must be decreased. Perform this step and [Step 6](#), [Step 7](#), and [Step 8](#).

If the buffers on the other associations assigned to the card do not need to be changed, continue the procedure with [Step 9](#).

Display the associations assigned to the IP card (and its corresponding local host) by entering the `rtrv-assoc` command with the local host name assigned to the association being changed. For this example, enter this command.

```
rtrv-assoc:lhost=IPNODE2-1205
```

This is an example of the possible output.

```
rlghncxa03w 06-10-28 21:14:37 GMT EAGLE5 36.0.0
CARD IPLNK
```

```

ANAME          LOC  PORT  LINK ADAPTER  LPORT  RPORT  OPEN  ALW
assoc2         1205 A      A   M2PA      2048   2048   YES   YES
assoc3         1205 A      B2  M2PA      3000   3000   YES   YES
assoc5         1205 A      A3  M2PA      1500   3000   YES   YES

```

```

IP Appl Sock/Assoc table is (8 of 4000) 1% full
Assoc Buffer Space Used (1600 KB of 1600 KB) on LOC = 1205

```

6. Display each association shown in [Step 5](#) by entering the `rtrv-assoc` command with the name of each association shown in [Step 5](#).

For this example, enter these commands.

```
rtrv-assoc:aname=assoc2
```

This is an example of the possible output.

```

rlghncxa03w 10-07-28 21:14:37 GMT EAGLE5 42.0.0
ANAME assoc2
  LOC      1205          IPLNK PORT  A          LINK  A
  ADAPTER  M2PA          VER          M2PA RFC
  LHOST    IPNODE2-1205
  ALHOST    ---
  RHOST    remotehost1
  ARHOST    ---
  LPORT    2048          RPORT        2048
  ISTRMS   2            OSTRMS        2          BUFSIZE  400
  RMODE    LIN          RMIN          120        RMAX      800
  RTIMES   10          CWMIN         3000       UAPS      10
  OPEN     NO           ALW           YES         RTXTHR   2000
  RHOSTVAL RELAXED      M2PATSET     1

```

```

IP Appl Sock/Assoc table is (8 of 4000) 1% full
Assoc Buffer Space Used (1600 KB of 1600 KB) on LOC = 1205

```

```
rtrv-assoc:aname=assoc3
```

This is an example of the possible output.

```

rlghncxa03w 10-07-28 21:14:37 GMT EAGLE5 42.0.0
ANAME assoc2
  LOC      1205          IPLNK PORT  A          LINK  B2
  ADAPTER  M2PA          VER          M2PA RFC
  LHOST    IPNODE2-1205
  ALHOST    ---
  RHOST    remotehost3
  ARHOST    ---
  LPORT    3000          RPORT        3000
  ISTRMS   2            OSTRMS        2          BUFSIZE  400
  RMODE    LIN          RMIN          120        RMAX      800
  RTIMES   10          CWMIN         3000       UAPS      10
  OPEN     YES          ALW           YES         RTXTHR   2000
  RHOSTVAL RELAXED      M2PATSET     1

```

```

IP Appl Sock/Assoc table is (8 of 4000) 1% full
Assoc Buffer Space Used (1600 KB of 1600 KB) on LOC = 1205

```

```
rtrv-assoc:aname=assoc5
```

This is an example of the possible output.

```
rlghncxa03w 10-07-28 21:14:37 GMT EAGLE5 42.0.0
ANAME assoc2
  LOC      1205          IPLNK PORT  A          LINK  A3
  ADAPTER  M2PA          VER          M2PA RFC
  LHOST    IPNODE2-1205
  ALHOST    ---
  RHOST    remotehost3
  ARHOST    ---
  LPORT    1500          RPORT      3000
  ISTRMS   2            OSTRMS     2          BUFSIZE  400
  RMODE    LIN          RMIN       120        RMAX     800
  RTIMES   10          CWMIN      3000      UAPS     10
  OPEN     YES          ALW        YES        RTXTHR   2000
  RHOSTVAL RELAXED     M2PATSET   1
```

IP Appl Sock/Assoc table is (8 of 4000) 1% full
 Assoc Buffer Space Used (1600 KB of 1600 KB) on LOC = 1205

- To change the `bufsize` value for the associations shown in [Step 6](#), the new `bufsize` parameter value must be greater than or equal to the `cwmin` parameter value.

The `cwmin` parameter is the number of bytes specified for the association's congestion window. The `bufsize` is the number of kilobytes specified for the size of the association's buffer. To determine whether or not the `cwmin` value is less than or equal to the `bufsize` value, perform one of these actions.

- Multiply the `bufsize` value by 1024.
- Divide the `cwmin` value by 1024.

Continue the procedure by performing one of these actions.

- If the new `bufsize` value is greater than or equal to the `cwmin` value, continue the procedure with [Step 8](#).
- If the new `bufsize` value is not greater than or equal to the `cwmin` value, either choose another value for the `bufsize` parameter that is greater than or equal to the `cwmin` value, or perform the [Changing the Attributes of an M2PA Association](#) procedure to change the `bufsize` value so that the `bufsize` value is greater than or equal to the `cwmin` value. After the new `bufsize` value has been chosen or the `cwmin` value has been changed, continue the procedure with [Step 8](#).

- Change the size of the buffers for one or more of the associations displayed in [Step 6](#) to allow the buffer of the association displayed in [Step 4](#) to be changed.

Enter the `chg-assoc` command with the `bufsize` parameter. For this example, enter this command.

```
chg-assoc:aname=assoc3:bufsize=400
```

When this command has successfully completed, this message should appear.

```
rlghncxa03w 06-10-28 09:12:36 GMT EAGLE5 36.0.0
CHG-ASSOC: MASP A - COMPLTD;
```

- To change the `bufsize` value for the association shown in [Step 4](#), the new `bufsize` parameter value must be greater than or equal to the `cwmin` parameter value.

The `cwmin` parameter is the number of bytes specified for the association's congestion window. The `bufsize` is the number of kilobytes specified for the size of the association's buffer. To determine whether or not the `cwmin` value is less than or equal to the `bufsize` value, perform one of these actions.

- Multiply the `bufsize` value by 1024.
- Divide the `cwmin` value by 1024.

Continue the procedure by performing one of these actions.

- If the new `bufsize` value is greater than or equal to the `cwmin` value, continue the procedure with [Step 10](#).
- If the new `bufsize` value is not greater than or equal to the `cwmin` value, either choose another value for the `bufsize` parameter that is greater than or equal to the `cwmin` value, or perform the [Changing the Attributes of an M2PA Association](#) procedure to change the `bufsize` value so that the `bufsize` value is greater than or equal to the `cwmin` value. After the new `bufsize` value has been chosen or the `cwmin` value has been changed, continue the procedure with [Step 10](#).

10. Change the association using the `chg-assoc` command.

For this example, enter this command.

```
chg-assoc:aname=assoc2:bufsize=500
```

When this command has successfully completed, this message should appear.

```
rlghncxa03w 06-10-28 09:12:36 GMT EAGLE5 36.0.0
CHG-ASSOC: MASP A - COMPLTD;
```

If the value of the `open` parameter was not changed in [Step 3](#), continue the procedure with [Step 12](#).

If the value of the `open` parameter was changed in [Step 3](#), continue the procedure with [Step 11](#).

11. Change the value of the `open` parameter to `yes` by specifying the `chg-assoc` command with the `open=yes` parameter.

For this example, enter this command.

```
chg-assoc:aname=assoc2:open=yes
```

When this command has successfully completed, this message should appear.

```
rlghncxa03w 06-10-28 09:12:36 GMT EAGLE5 36.0.0
CHG-ASSOC: MASP A - COMPLTD;
```

12. Verify the changes using the `rtrv-assoc` command specifying the association name specified in [Step 10](#) and [Step 11](#).

For this example, enter this command.

```
rtrv-assoc:aname=assoc2
```

This is an example of possible output.

```
rlghncxa03w 10-07-28 21:14:37 GMT EAGLE5 42.0.0
```

```

ANAME assoc2
LOC 1205 IPLNK PORT A LINK A
ADAPTER M2PA VER M2PA RFC
LHOST IPNODE2-1205
ALHOST ---
RHOST remotehost1
ARHOST ---
LPORT 2048 RPORT 2048
ISTRMS 2 OSTRMS 2 BUFSIZE 500
RMODE LIN RMIN 120 RMAX 800
RTIMES 10 CWMIN 3000 UAPS 10
OPEN YES ALW YES RTXTHR 2000
RHOSTVAL RELAXED M2PATSET 1

IP Appl Sock/Assoc table is (8 of 4000) 1% full
Assoc Buffer Space Used (1600 KB of 1600 KB) on LOC = 1205

```

13. Back up the new changes, using the `chg-db:action=backup:dest=fixed` command.

These messages should appear; the active Maintenance and Administration Subsystem Processor (MASP) appears first.

```

BACKUP (FIXED) : MASP A - Backup starts on active MASP.
BACKUP (FIXED) : MASP A - Backup on active MASP to fixed disk complete.
BACKUP (FIXED) : MASP A - Backup starts on standby MASP.
BACKUP (FIXED) : MASP A - Backup on standby MASP to fixed disk complete.

```

If you wish to change the other attributes of the M2PA association, perform one of these procedures.

- `lhost` and `alhost` - [Changing the Host Values of a M2PA Association](#)
- `link` - [Changing the Link Value of a M2PA Association to another Link Value on the Same IPLIMx Card](#)
- Other attributes of the M2PA Association - [Changing the Attributes of an M2PA Association](#)

If you do not wish to change the other attributes of the M2PA association, this procedure is finished.

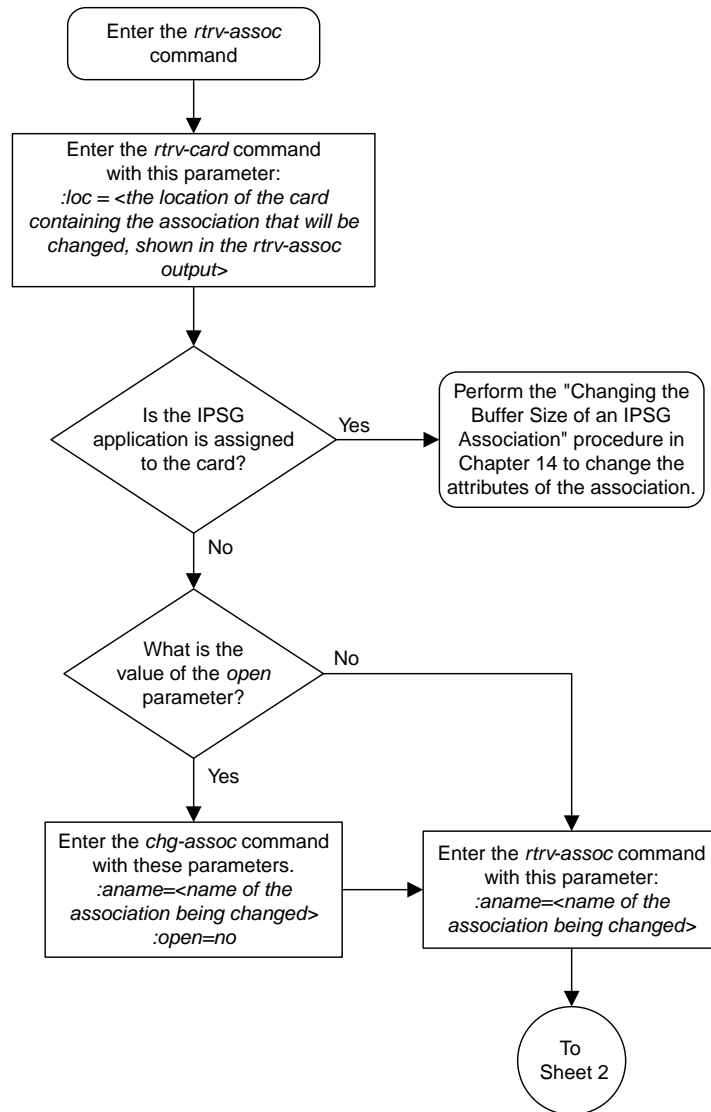

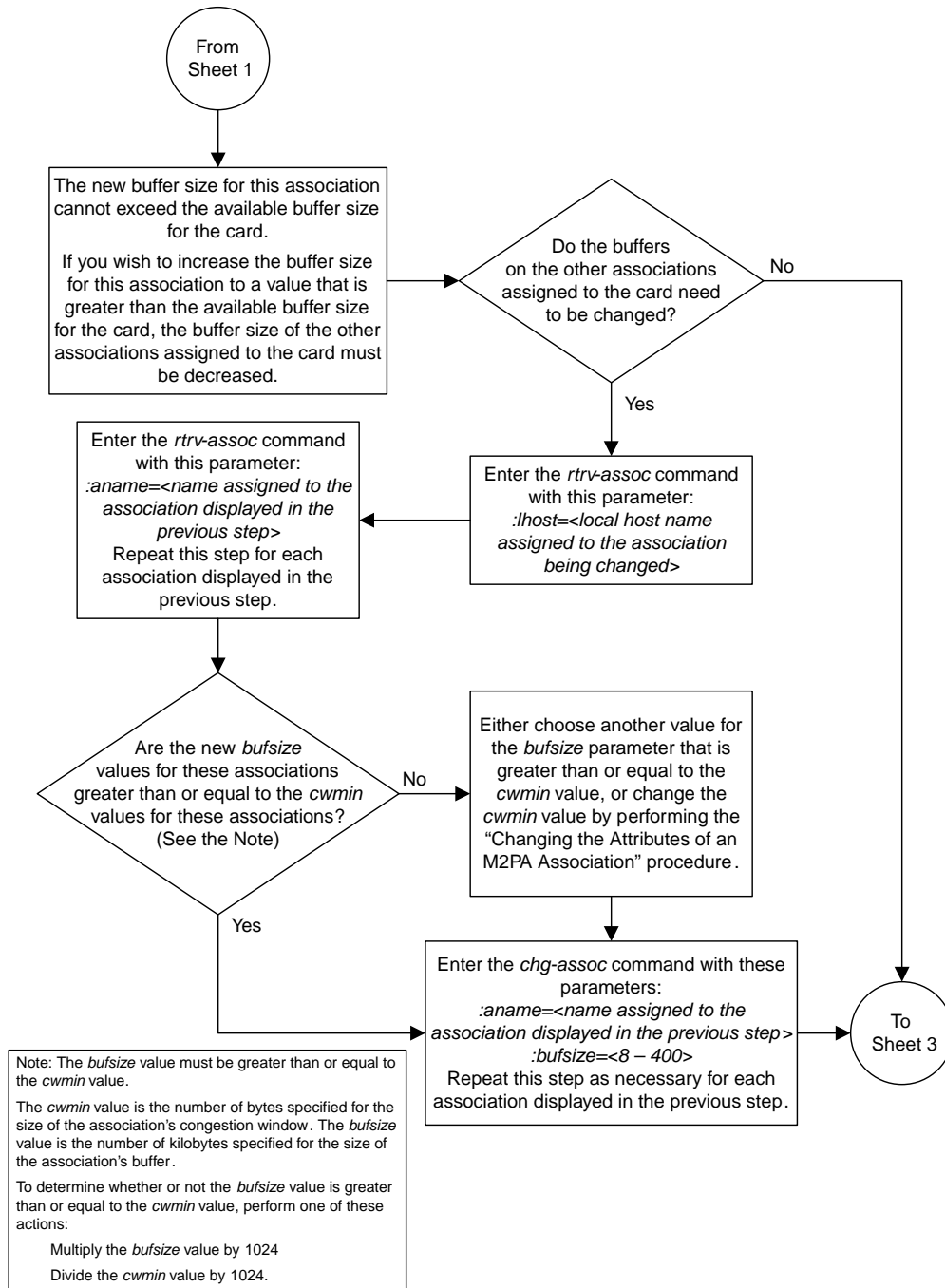

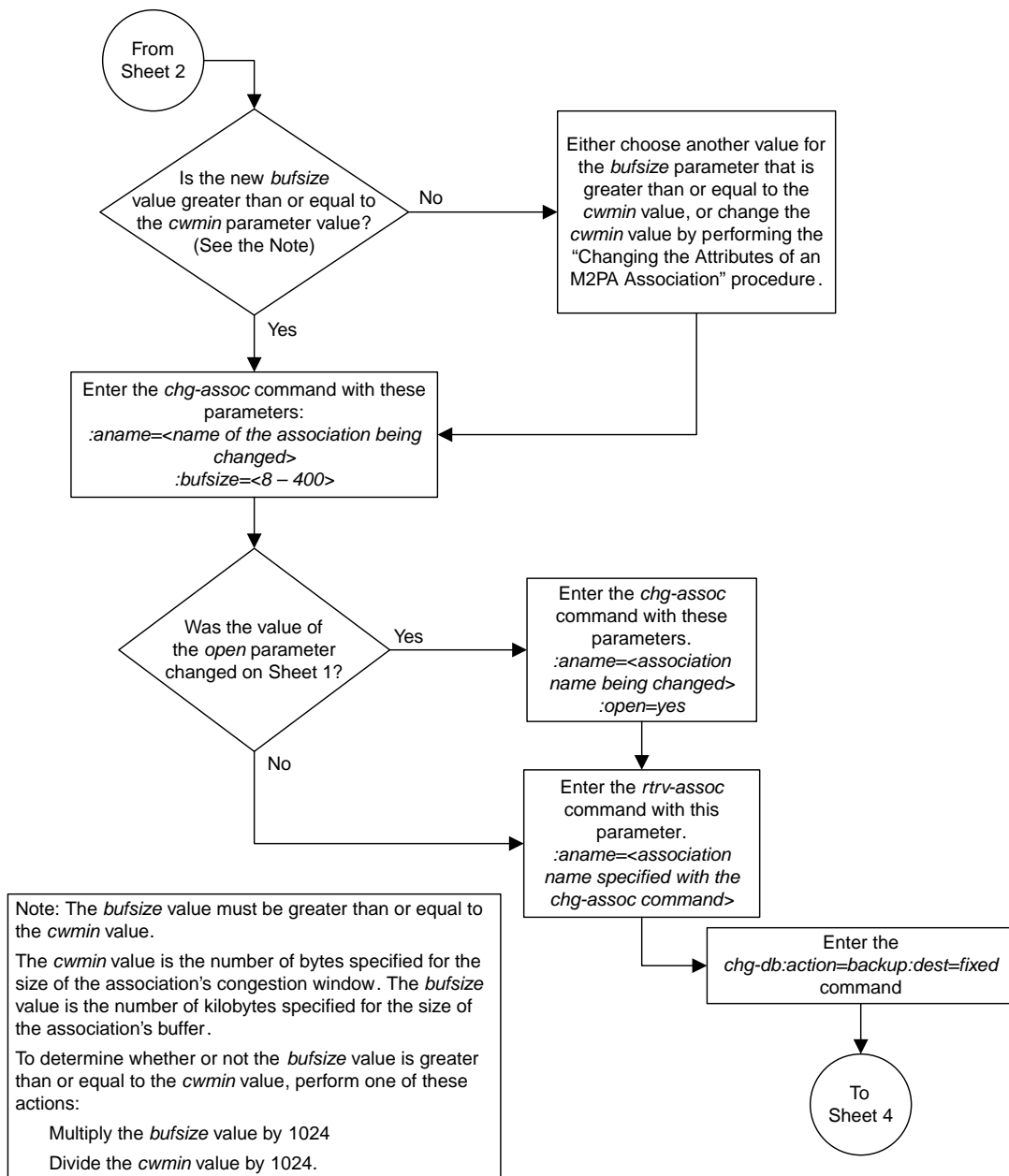

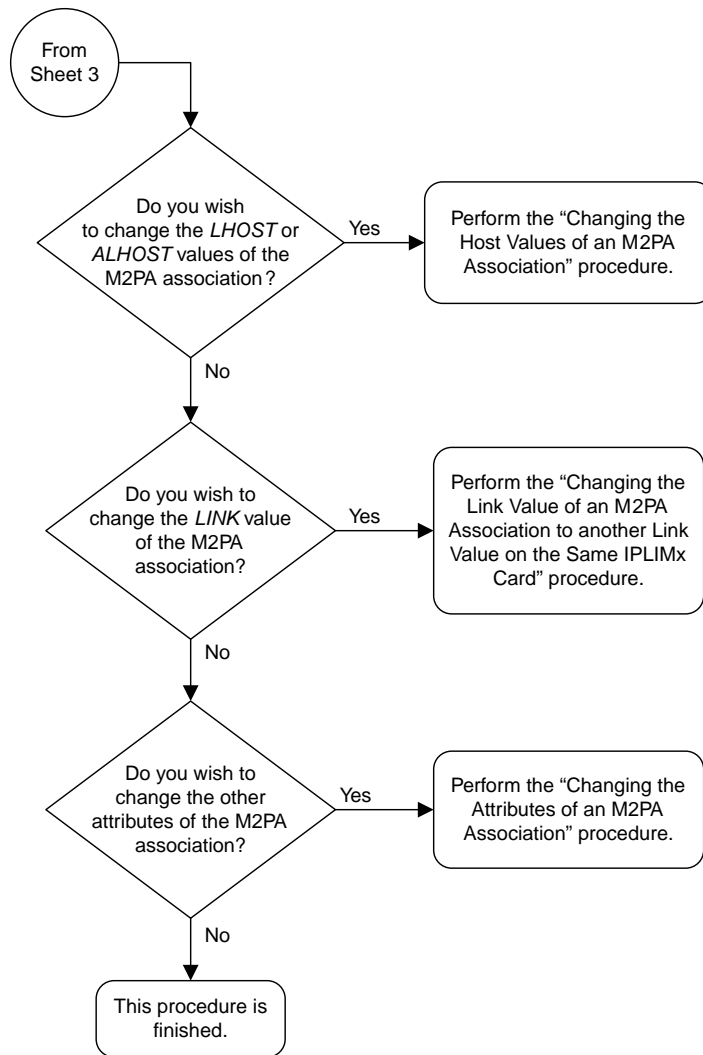

Sheet 4 of 4

Figure 34: Changing the Buffer Size of a M2PA Association

Changing the Host Values of a M2PA Association

This procedure is used to change the host values of a M2PA association, assigned to cards that are running the IPLIM or IPLIMI applications, using the `chg-assoc` command. If you wish to change the attributes of M2PA associations assigned to cards that are running the IPSPG application, perform the [Changing the Host Values of an IPSPG Association](#) procedure.

These parameters of the `chg-assoc` command are used in this procedure:

- `:aname` – The name assigned to the association, shown in the `rtrv-assoc` output.
 - `:lhost` – The host name for the local host, shown in the `rtrv-ip-host` output.
 - `:lport` – The SCTP port number for the local host.
 - `:rhost` – The host name for the remote host, `rhost` can be any string of characters starting with a letter and comprising these characters [a..'z', 'A..'Z', '0..'9', '-', '.']. Hostnames are not case-sensitive and can contain up to 60 characters. The default value of this optional parameter is empty (null string).
 - `:rport` – The SCTP port number for the remote host.
 - `:alhost` – The alternate local host name, shown in the `rtrv-ip-host` output.
 - `:link` – The signaling link on the IPLIMx card. If the card is a E5-ENET card, the values for the `link` parameter can be a, a1, a2, a3, a4, a5, a6, a7, b, b1, b2, b3, b4, b5, b6, or b7.
- Note:** The `port` parameter can be used in place of the `link` parameter to specify the signaling link on the card.
- `:adapter` – The adapter layer for this association, `m2pa`.
 - `:open` – The connection state for this association. Valid values are `yes` or `no`. When the `open=yes` parameter is specified, the connection manager opens the association if the association is operational. When the `open=no` parameter is specified, the connection manager will not open the association.
 - `:m2patset` – The M2PA timer set assigned to the association. The `m2patset` parameter can be specified only with the `adapter=m2pa` parameter, or if the association already has the `adapter=m2pa` parameter assigned and the `adapter` parameter value is not being changed. If the `adapter` parameter value is being changed to `m2pa`, and the `m2patset` parameter is not specified, the default value for the `m2patset` parameter (1 - M2PA timer set 1) is assigned to the association. If the `adapter` parameter value for the association is `m2pa`, is not being changed, and the `m2patset` parameter is not specified with the `chg-assoc` command, the `m2patset` parameter value is not changed.
 - `:ver` – The M2PA version assigned to the M2PA association, either the RFC version (`ver=rfc`), or the Draft 6 version (`ver=d6`). The `ver` parameter can be specified only if, when this procedure is completed, the `adapter` parameter value is `m2pa`. If the `adapter` parameter value is being changed to `m2pa`, and the `ver` parameter is not specified, the default M2PA version of RFC is assigned to the association. To change the `ver` parameter value, the `open` parameter value for the association must be `no`.

The `chg-assoc` command contains other parameters that are not used this procedure. To change these parameters, perform these procedures.

- `bufsize` - [Changing the Buffer Size of a M2PA Association](#)
- Other attributes of the M2PA Association - [Changing the Attributes of an M2PA Association](#)

At least one optional parameter is required.

The command input is limited to 150 characters, including the hostnames.

The EAGLE can contain a maximum of 4000 connections (association to application server assignments).

IPLIMx cards can have one association for each signaling link on the card. The E5-ENET card can contain a maximum of 16 signaling links, resulting in a maximum of 16 associations for this card.

The B Ethernet interface of the IP card can be used on E5-ENET cards.

The `ipliml2` parameter value of the signaling link assigned to the association must be `m2pa`. The `adapter` parameter value of the association must match the `ipliml2` parameter value.

The signaling link being assigned to the association must be out of service. This state is shown in the `rept-stat-slk` output with the entries `OOS-MT` in the `PST` field and `Unavail` in the `SST` field.

Uni-homed endpoints are associations configured with the `lhost` parameter only. The `lhost` parameter value represents an IP address that corresponds to either the A or B network interface of the IP card. Multi-homed endpoints are associations configured with both the `lhost` and `alhost` parameters. The `lhost` parameter value represents an IP address corresponding to one of the network interfaces (A or B) of the IP card while the `alhost` parameter value represents an IP address corresponding to the other network interface of the same IP card.

The `alhost=none` parameter removes the alternate local host from the specified association, which also removes the multi-homed endpoint capability.

Canceling the `RTRV-ASSOC` and `RTRV-AS` Commands

Because the `rtrv-assoc` and `rtrv-as` commands used in this procedure can output information for a long period of time, the `rtrv-assoc` and `rtrv-as` commands can be canceled and the output to the terminal stopped. There are three ways that the `rtrv-assoc` and `rtrv-as` commands can be canceled.

- Press the F9 function key on the keyboard at the terminal where the `rtrv-assoc` or `rtrv-as` commands were entered.
- Enter the `canc-cmd` without the `trm` parameter at the terminal where the `rtrv-assoc` or `rtrv-as` commands were entered.
- Enter the `canc-cmd:trm=<xx>`, where `<xx>` is the terminal where the `rtrv-assoc` or `rtrv-as` commands were entered, from another terminal other than the terminal where the `rtrv-assoc` or `rtrv-as` commands were entered. To enter the `canc-cmd:trm=<xx>` command, the terminal must allow Security Administration commands to be entered from it and the user must be allowed to enter Security Administration commands. The terminal's permissions can be verified with the `rtrv-secu-trm` command. The user's permissions can be verified with the `rtrv-user` or `rtrv-secu-user` commands.

For more information about the `canc-cmd` command, go to *Commands User's Guide*.

1. Display the associations in the database using the `rtrv-assoc` command.

This is an example of possible output.

```
rlghncxa03w 08-04-28 09:12:36 GMT EAGLE5 38.0.0
CARD IPLNK
```

ANAME	LOC	PORT	LINK	ADAPTER	LPORT	RPORT	OPEN	ALW
swbel32	1201	A	A	M3UA	1030	2345	YES	YES
a2	1305	A	A	SUA	1030	2345	YES	YES
a3	1307	A	A	SUA	1030	2346	YES	YES
assoc1	1201	A	A	M3UA	2000	1030	YES	YES
assoc2	2105	A	A	M2PA	2048	2048	YES	YES
assoc3	2105	A	B2	M2PA	3000	3000	YES	YES
assoc5	2105	A	A3	M2PA	1500	3000	YES	YES

2. Enter the `rtrv-card` command with the location of the card that is hosting the M2PA association that will be changed in this procedure. For this example, enter this command.

```
rtrv-card:loc=2105
```

This is an example of possible output.

```
rlghncxa03w 08-04-06 15:17:20 EST EAGLE5 38.0.0
CARD   TYPE      APPL      LSET NAME   LINK SLC LSET NAME   LINK SLC
2105   DCM        IPLIM     e5e6a      A    0    e5e6a      B2    1
                e5e6a      A3    2
```

If the application assigned to the card is IPLIM or IPLIMI, shown in the `APPL` column, continue the procedure by performing one of these steps.

- If the open parameter value for the association being changed is yes, continue the procedure with [Step 3](#).
- If the open parameter value for the association being changed is no, continue the procedure with [Step 4](#).

If the application assigned to the card is IPSP, perform the [Changing the Host Values of an IPSP Association](#) procedure.

3. Change the value of the open parameter to no by specifying the `chg-assoc` command with the `open=no` parameter.

For this example, enter this command.

```
chg-assoc:aname=assoc2:open=no
```

When this command has successfully completed, this message should appear.

```
rlghncxa03w 08-04-28 09:12:36 GMT EAGLE5 38.0.0
CHG-ASSOC: MASP A - COMPLTD;
```

4. Display the association being changed by entering the `rtrv-assoc` command with the `aname` parameter specified in [Step 3](#).

For this example, enter this command.

```
rtrv-assoc:aname=assoc2
```

This is an example of the possible output.

```
rlghncxa03w 10-07-28 21:14:37 GMT EAGLE5 42.0.0
ANAME assoc2
LOC      2105
IPLNK PORT A,B
LINK A
```

```

ADAPTER  M2PA          VER          M2PA RFC
LHOST    IPNODE2-1205
ALHOST   M2PA1
RHOST    remotehost1
ARHOST   ---
LPORT    2048          RPORT      2048
ISTRMS   2            OSTRMS     2          BUFSIZE   400
RMODE    LIN          RMIN       120         RMAX      800
RTIMES   10          CWMIN      3000        UAPS      10
OPEN     NO           ALW        YES         RTXTHR    2000
RHOSTVAL RELAXED     M2PATSET   1

```

```

IP Appl Sock/Assoc table is (8 of 4000) 1% full
Assoc Buffer Space Used (1600 KB of 1600 KB) on LOC = 2105

```

If the association shown in this step is not an M2PA association, continue the procedure with [Step 5](#).

If the association shown in this step is an M2PA association, perform one of these actions.

- If the association does not have an ALHOST value, continue the procedure with [Step 5](#).
- If the association does have an ALHOST value, and the ALHOST value will be removed along with changing the LHOST value of the association, continue the procedure with [Step 5](#).
- If the association does have an ALHOST value, and the only action that will be performed in this procedure is to remove the ALHOST value from the association, continue the procedure with [Step 15](#).

5. Verify that the local host name to be assigned to the association is in the database by entering the `rtrv-ip-host:display=all` command.

The following is an example of the possible output.

```

rlghncxa03w 08-12-28 21:15:37 GMT EAGLE5 40.0.0

LOCAL IPADDR    LOCAL HOST
192.1.1.10      IPNODE1-1201
192.1.1.12      GW105. NC. Oracle. COM
192.1.1.14      IPNODE1-1205
192.1.1.20      IPNODE2-1201
192.1.1.22      IPNODE2-1203
192.1.1.24      IPNODE2-1205
192.1.1.30      KC-HLR1
192.1.1.32      KC-HLR2
192.1.1.50      DN-MS1
192.1.1.52      DN-MS2
192.1.1.54      M2PA1

REMOTE IPADDR    REMOTE HOST
150.1.1.5        NCDEPTECONOMIC_DEVELOPMENT. SOUTHEASTERN_COORIDOR_ASHVL. GOV

IP Host table is (12 of 4096) .29% full

```

6. Display the IP links in the database by entering the `rtrv-ip-lnk` command.

The following is an example of the possible output.

```

rlghncxa03w 08-12-28 21:14:37 GMT EAGLE5 40.0.0

```

LOC	PORT	IPADDR	SUBMASK	DUPLEX	SPEED	MACTYPE	AUTO	MCAST
1303	A	192.1.1.10	255.255.255.128	HALF	10	802.3	NO	NO
1303	B	-----	-----	HALF	10	DIX	NO	NO
1305	A	192.1.1.12	255.255.255.0	----	---	DIX	YES	NO
1305	B	-----	-----	HALF	10	DIX	NO	NO
1313	A	192.1.1.14	255.255.255.0	FULL	100	DIX	NO	NO
1313	B	-----	-----	HALF	10	DIX	NO	NO
2101	A	192.1.1.20	255.255.255.0	FULL	100	DIX	NO	NO
2101	B	-----	-----	HALF	10	DIX	NO	NO
2103	A	192.1.1.22	255.255.255.0	FULL	100	DIX	NO	NO
2103	B	-----	-----	HALF	10	DIX	NO	NO
2105	A	192.1.1.24	255.255.255.0	FULL	100	DIX	NO	NO
2105	B	192.1.1.54	255.255.255.0	FULL	100	DIX	NO	NO
2205	A	192.1.1.30	255.255.255.0	FULL	100	DIX	NO	NO
2205	B	-----	-----	HALF	10	DIX	NO	NO
2207	A	192.1.1.32	255.255.255.0	FULL	100	DIX	NO	NO
2207	B	-----	-----	HALF	10	DIX	NO	NO
2213	A	192.1.1.50	255.255.255.0	FULL	100	DIX	NO	NO
2213	B	-----	-----	HALF	10	DIX	NO	NO
2301	A	192.1.1.52	255.255.255.0	FULL	100	DIX	NO	NO
2301	B	-----	-----	HALF	10	DIX	NO	NO

IP-LNK table is (20 of 2048) 1% full.

If the required IP link, one that contains the desired IP address, is not shown in the `rtrv-ip-lnk` output, add the IP link using the [Configuring an IP Link](#) procedure. After the IP link has been added, assign the IP address of the IP link to the IP host name using the [Adding an IP Host](#) procedure. Then continue the procedure with [Step 11](#).

If the required IP link is shown in the `rtrv-ip-lnk` output, but the IP host is not shown in the `rtrv-ip-host` output in [Step 5](#), assign the IP address of the IP link to the IP host name using the [Adding an IP Host](#) procedure. Then continue the procedure with [Step 11](#).

If the required IP host was shown in [Step 5](#), the required IP link is shown in the `rtrv-ip-lnk` output in this step. Perform [Step 7](#) to verify the application running on the card whose IP address is assigned to the IP host.

Note: The `rtrv-ip-host` output must contain a host name for the association's `slhost` parameter and a host name for the association's `alhost` parameter, if the `alhost` parameter will be specified for the association. The IP address of the IP link should be assigned to the host name, shown in the `rtrv-ip-host` output, that will be used as the association's `slhost` parameter value. If the `alhost` parameter will be specified for the association, the IP address of the IP link must be assigned to the host name that will be used as the `alhost` parameter value. The IP links associated with the association's `slhost` and `alhost` values must be assigned to the same card.

7. Display the application running on the IP card shown in [Step 6](#) whose IP address is assigned to the IP host using the `rept-stat-card` command specifying the location of the IP card.

For this example, enter this command.

```
rept-stat-card:loc=1205
```

This is an example of the possible output.

```
rlghncxa03w 08-04-27 17:00:36 GMT EAGLE5 38.0.0
CARD  VERSION      TYPE      GPL      PST      SST      AST
1205  114-000-000    DCM      IPLIM    IS-NR    Active   -----
      ALARM STATUS      = No Alarms.
```

```

BPCDM GPL          = 002-102-000
IMT BUS A          = Conn
IMT BUS B          = Conn
SIGNALING LINK STATUS
  SLK   PST              LS           CLLI
  A     IS-NR           e5e6a       -----
  A3    IS-NR           e5e6a       -----
  B2    IS-NR           e5e6a       -----

```

Command Completed.

8. Display the signaling link associated with the association being changed using the `rtrv-slk` command and specifying the card location shown in [Step 7](#), and the new link parameter value of the association for the link parameter value. The card location should reference the local host assigned to the association. The `rtrv-ip-lnk` output shows the card location associated with the IP address that is associated with the local host in [Step 7](#). If the `rtrv-ip-lnk` command was not executed in [Step 6](#), execute it now to get the card location and the IP address. To display the signaling link for this example, enter this command.

Note: If the link parameter value is not being changed, continue the procedure with [Step 9](#).

```
rtrv-slk:loc=1205:link=a
```

The following is an example of the possible output.

```

rlghncxa03w 08-04-19 21:17:04 GMT EAGLE5 38.0.0
LOC  LINK LSN          SLC TYPE  IPLIML2
1205 A    e5e6a         0  IPLIM  M2PA

```

If the required signaling link is not in the database, add the signaling link using the [Adding an IPLIMx Signaling Link](#) procedure without activating the signaling link. If the application of the card containing the signaling link is IPLIM or IPLIMI, the `ipliml2=m2pa` parameter must be specified for the signaling link and the `adapter=m2pa` parameter value must be specified for the association.

9. Display the application servers referencing the association being changed using the `rtrv-as` command with the name of the association being changed in this procedure.

Note: If the `adapter` parameter value is not being changed from M3UA or SUA to M2PA, continue the procedure with [Step 10](#).

For this example, enter this command.

```
rtrv-as:aname=assoc2
```

This is an example of possible output.

```

rlghncxa03w 08-04-28 21:14:37 GMT EAGLE5 38.0.0
AS Name      Mode      Tr ms   Association Names
as1          LOADSHARE 2000    assoc2
as4          LOADSHARE 2000    assoc2
as6          LOADSHARE 2000    assoc2
AS Table is (6 of 250) 1% full

```

If the association is not assigned to any application servers, continue the procedure with [Step 10](#)

If the association is assigned to any application servers, go to the [Removing an Association from an Application Server](#) procedure and remove the association from the application servers. After the association has been removed from the application servers, continue the procedure with [Step 10](#)

10. Display the application running on the IP card shown in [Step 6](#) using the `rept-stat-card` command specifying the location of the IP card.

Note: If the `rept-stat-card` command was performed in [Step 7](#), continue the procedure with [Step 11](#).

For this example, enter this command.

```
rept-stat-card:loc=2105
```

This is an example of the possible output.

```
rlghncxa03w 08-04-27 17:00:36 GMT EAGLE5 38.0.0
CARD  VERSION      TYPE      GPL      PST      SST      AST
2105  114-000-000    DCM      IPLIM    IS-NR    Active   -----
ALARM STATUS      = No Alarms.
BPDCM GPL          = 002-102-000
IMT BUS A         = Conn
IMT BUS B         = Conn
SIGNALING LINK STATUS
SLK   PST          LS          CLLI
A     IS-NR        e5e6a      -----
A3    IS-NR        e5e6a      -----
B2    IS-NR        e5e6a      -----
Command Completed.
```

11. Display the signaling link that will be assigned to the association by entering the `rtrv-slk` command and specifying the card location and signaling link.

Note: If a new signaling link was added in [Step 8](#), continue the procedure with [Step 15](#).

For this example, enter this command.

```
rtrv-slk:loc=1203:link=a
```

This is an example of the possible output.

```
rlghncxa03w 08-04-19 21:17:04 GMT EAGLE5 38.0.0
LOC  LINK LSN          SLC TYPE    IPLIML2
1203 A     e5e6a          1  IPLIM    M2PA
```

When the IP card's application is either IPLIM or IPLIMI, the `ipliml2` parameter value for the signaling link assigned to the association must be `m2pa`. If the `ipliml2` parameter is not `m2pa`, remove the signaling link using the [Removing an IPLIMx Signaling Link](#) procedure. Add the signaling link back into the database with the `ipliml2=m2pa` parameter, and without activating the signaling link, using the [Adding an IPLIMx Signaling Link](#) procedure.

12. Display the status of the signaling link shown in [Step 11](#) using the `rept-stat-slk` command specifying the card location and signaling link.

Note: If the [Adding an IPLIMx Signaling Link](#) procedure was not performed in [Step 11](#), continue the procedure with [Step 15](#).

For example, enter this command.

```
rept-stat-slk:loc=1203:link=a
```

This is an example of the possible output.

```
rlghncxa03w 08-04-28 21:16:37 GMT EAGLE5 38.0.0
SLK      LSN      CLLI      PST      SST      AST
1203,A   e5e6a     -----  IS-NR    Avail    ----
Command Completed.
```

Note: If the primary state (PST) of the signaling link is OOS-MT and the secondary state (SST) is Unavail, continue the procedure with [Step 15](#).

- Deactivate the signaling link from [Step 12](#) using the `dact-slk` command.

For example, enter this command.

```
dact-slk:loc=1203:link=a
```

When this command has successfully completed, the following message should appear.

```
rlghncxa03w 08-04-07 11:11:28 GMT EAGLE5 38.0.0
Deactivate Link message sent to card
```

- Verify the status of the signaling link using the `rept-stat-slk` command.

For example, enter this command.

```
rept-stat-slk:loc=1203:link=a
```

This is an example of the possible output.

```
rlghncxa03w 08-04-28 21:16:37 GMT EAGLE5 38.0.0
SLK      LSN      CLLI      PST      SST      AST
1203,A   e5e6a     -----  OOS-MT   Unavail  ----
Command Completed.
```

- Change the association using the `chg-assoc` command.

For this example, enter this command.

```
chg-assoc:aname=assoc2:lhost=m2pa2:alhost=m2pa3:rhost="gw200.nc-Oracle.com"
```

These are the rules that apply to changing the host value of M2PA associations that are assigned to IPLIMx signaling links.

- If any optional parameters are not specified with the `chg-assoc` command, those values are not changed.
- The B Ethernet interface can be used with E5-ENET cards.
- The EAGLE can contain a maximum of 4000 connections.
- IPLIMx cards can have only one connection for each signaling link assigned to the card. If the card is an E5-ENET card, the card may contain a maximum of 16 connections.
- The value of the `lhost` and `rhost` parameters is a text string of up to 60 characters, with the first character being a letter. The command input is limited to 150 characters, including the hostnames.

- The `adapter` parameter value for the association must be `m2pa` and the `iplim12=m2pa` parameter must be assigned to the signaling link on the `iplim` or `iplimi` card.
- Specifying the `lhost` parameter only creates a uni-homed endpoint. The network portion of the endpoint's IP address must be the same as the network portion of the IP address assigned to either the A or B network interface of the IP card.
- Specifying the `lhost` and `alhost` parameters creates a multi-homed endpoint. The network portion of the IP address associated with the `lhost` parameter must be the same as the network portion of the IP address assigned to one of the network interfaces (A or B) of the IP card, and the network portion of the IP address associated with the `alhost` parameter must be the same as the network portion of the IP address assigned to the other network interface on the IP card.
- The `alhost=none` parameter removes the alternate local host from the specified association, which also removes the multi-homed endpoint capability.
- If the `mp2atset` parameter is not specified with the `chg-assoc` command, and the `adapter` parameter value is being changed to `m2pa`, the `m2patset` parameter value defaults to M2PA timer set 1 (`m2patset=1`).
- The `port` parameter can be used in place of the `link` parameter to specify the signaling link assigned to the association.
- The M2PA version of the association determines the version of the M2PA timer set that is assigned to the association. For example, if M2PA timer set 3 is assigned to the M2PA association, and the association is an RFC M2PA association, the RFC version of M2PA timer set 3 is used with the association. If M2PA timer set 7 is assigned to the M2PA association, and the association is a Draft 6 M2PA association, the Draft 6 version of M2PA timer set 7 is used with the association.
- If the `adapter` parameter value of the association is changed to `m2pa` in this procedure and the `ver` parameter is not specified, the version of the association will be RFC. To make this association a M2PA Draft 6 association, the `ver=d6` parameter must be specified for this association.

When this command has successfully completed, this message should appear.

```
rlghncxa03w 08-04-28 09:12:36 GMT EAGLE5 38.0.0
CHG-ASSOC: MASP A - COMPLTD;
```

Note: If the value of the `open` parameter was not changed in [Step 3](#), continue the procedure with [Step 17](#).

16. Change the value of the `open` parameter to `yes` by specifying the `chg-assoc` command with the `open=yes` parameter.

For this example, enter this command.

```
chg-assoc:aname=assoc2:open=yes
```

When this command has successfully completed, this message should appear.

```
rlghncxa03w 08-04-28 09:12:36 GMT EAGLE5 38.0.0
CHG-ASSOC: MASP A - COMPLTD;
```

17. Verify the changes using the `rtrv-assoc` command specifying the association name specified in [Step 15](#) and [Step 16](#).

For this example, enter this command.

```
rtrv-assoc:aname=assoc2
```

This is an example of possible output.

```
rlghncxa03w 10-07-28 21:14:37 GMT EAGLE5 42.0.0
  ANAME assoc2
    LOC      1203          IPLNK PORT  A,B          LINK  A
    ADAPTER  M2PA          VER        M2PA RFC
    LHOST    M2PA2
    ALHOST    M2PA3
    RHOST    gw200.nc-tekelec.com
    ARHOST    ---
    LPORT    2048          RPORT      3000
    ISTRMS   2             OSTRMS     2             BUFSIZE  500
    RMODE    LIN           RMIN       120           RMAX     800
    RTIMES   10           CWMIN      3000         UAPS     10
    OPEN     YES           ALW        YES           RTXTHR   10000
    RHOSTVAL RELAXED      M2PATSET   1
```

IP Appl Sock/Assoc table is (8 of 4000) 1% full
 Assoc Buffer Space Used (1300 KB of 1600 KB) on LOC = 1203

18. Activate the signaling link assigned to the association using the `act-slk` command.

For example, enter this command.

```
act-slk:loc=1203:link=a
```

When this command has successfully completed, the following message should appear.

```
rlghncxa03w 08-04-07 11:11:28 GMT EAGLE5 38.0.0
Activate Link message sent to card
```

19. Verify the status of the signaling link using the `rept-stat-slk` command.

For example, enter this command.

```
rept-stat-slk:loc=1203:link=a
```

This is an example of the possible output.

```
rlghncxa03w 08-04-28 21:16:37 GMT EAGLE5 38.0.0
SLK      LSN      CLLI      PST      SST      AST
1203,A   e5e6a      -----  IS-NR    Avail    ----
Command Completed.
```

20. Back up the new changes, using the `chg-db:action=backup:dest=fixed` command.

These messages should appear; the active Maintenance and Administration Subsystem Processor (MASP) appears first.

```
BACKUP (FIXED) : MASP A - Backup starts on active MASP.
BACKUP (FIXED) : MASP A - Backup on active MASP to fixed disk complete.
BACKUP (FIXED) : MASP A - Backup starts on standby MASP.
BACKUP (FIXED) : MASP A - Backup on standby MASP to fixed disk complete.
```

If you wish to change the other attributes of the M2PA association, perform one of these procedures.

- bufsize - *Changing the Buffer Size of a M2PA Association*
- Other attributes of the M2PA Association - *Changing the Attributes of an M2PA Association*

If you do not wish to change the other attributes of the M2PA association, this procedure is finished.

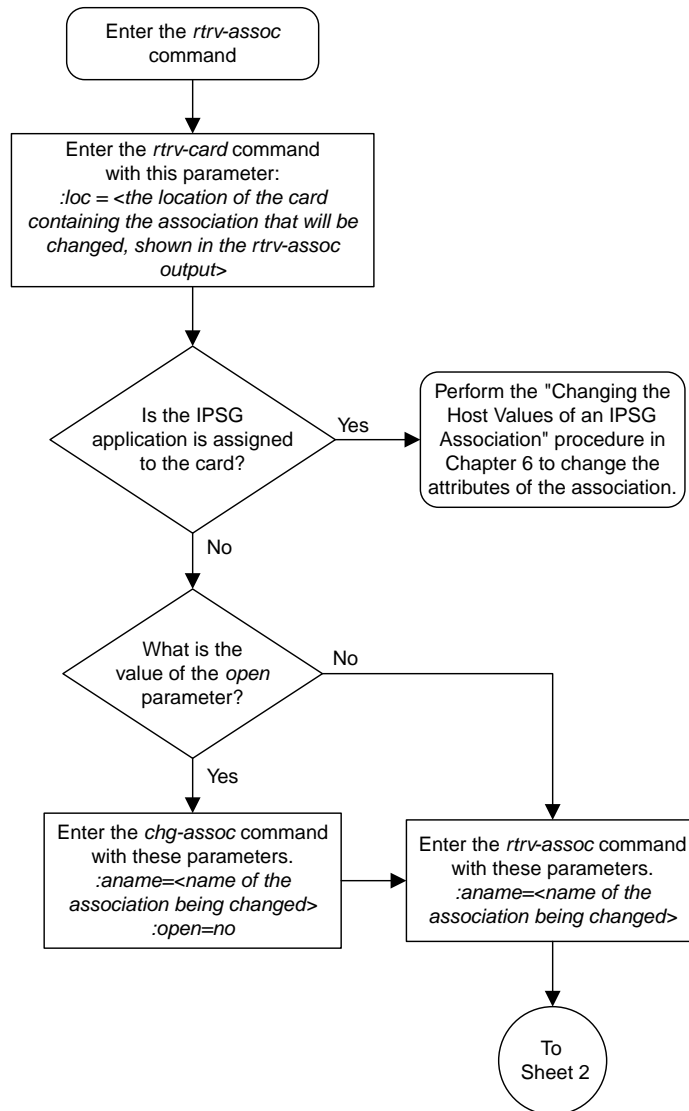

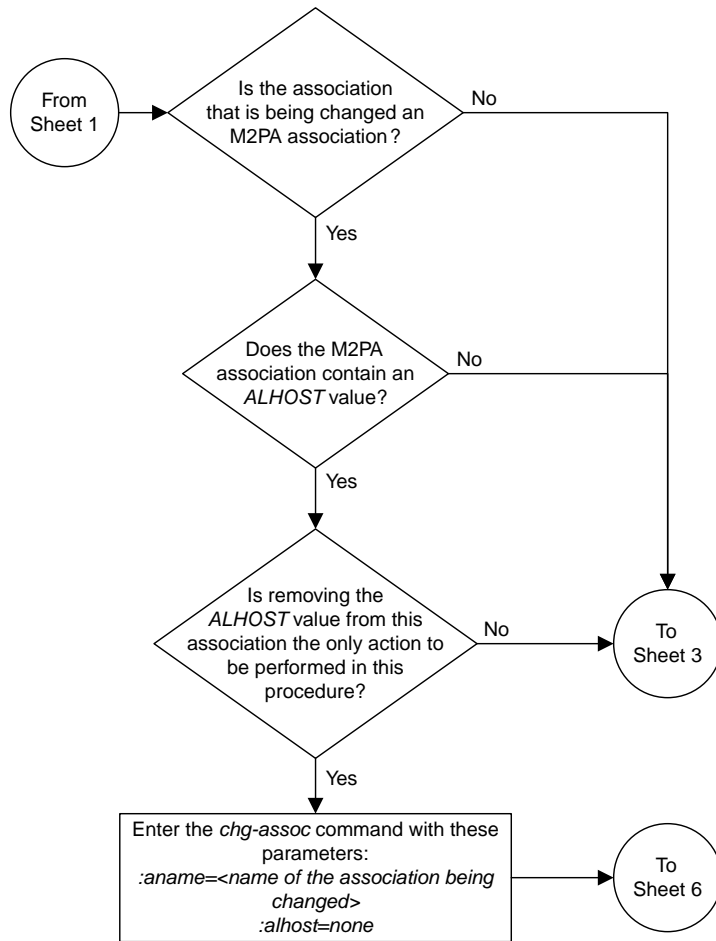

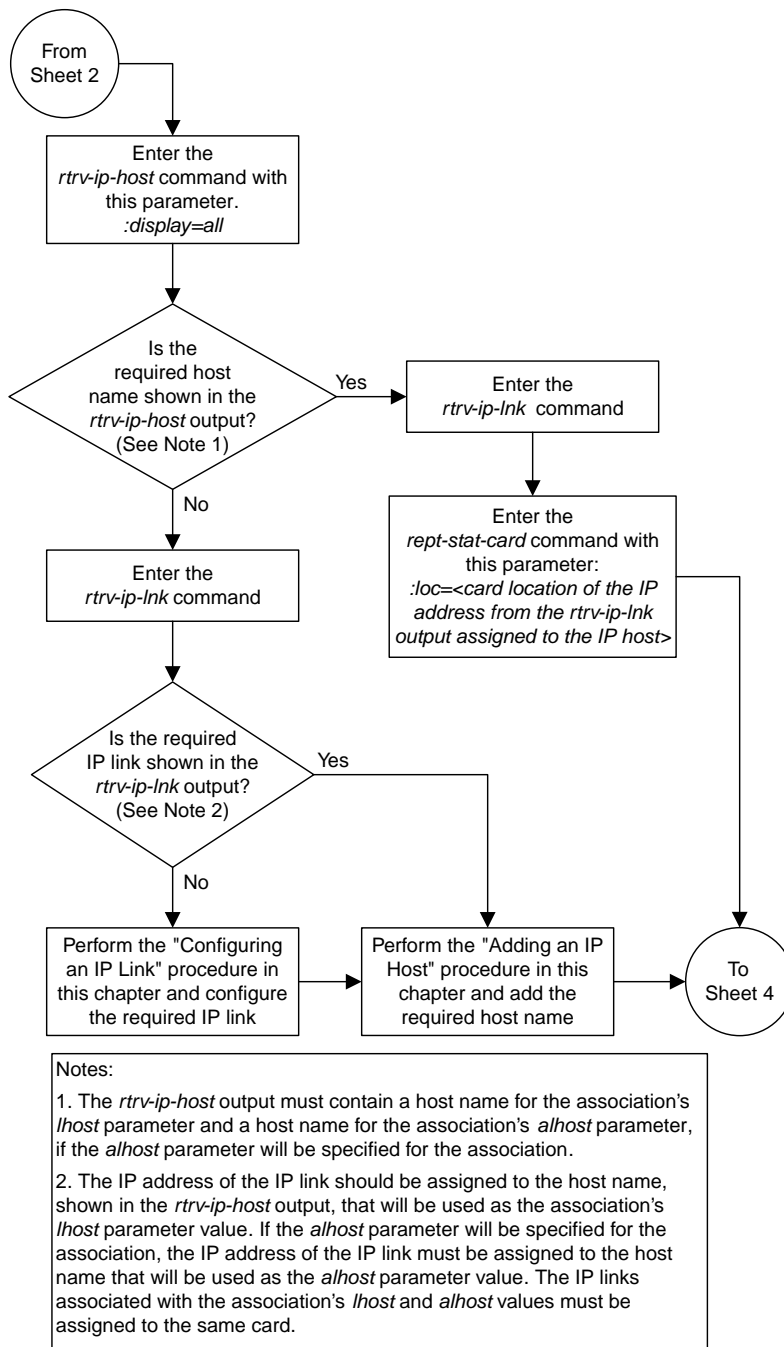

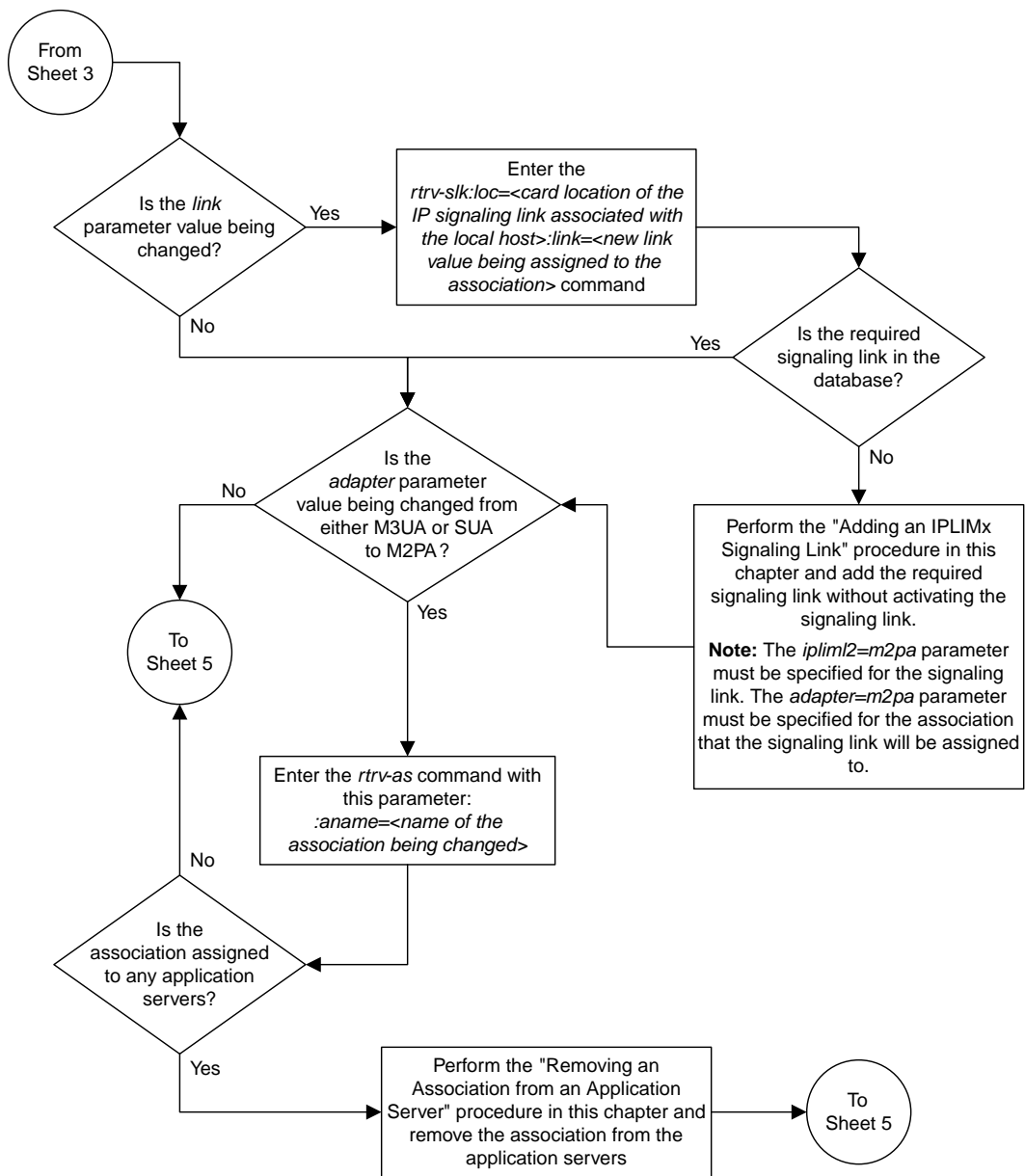

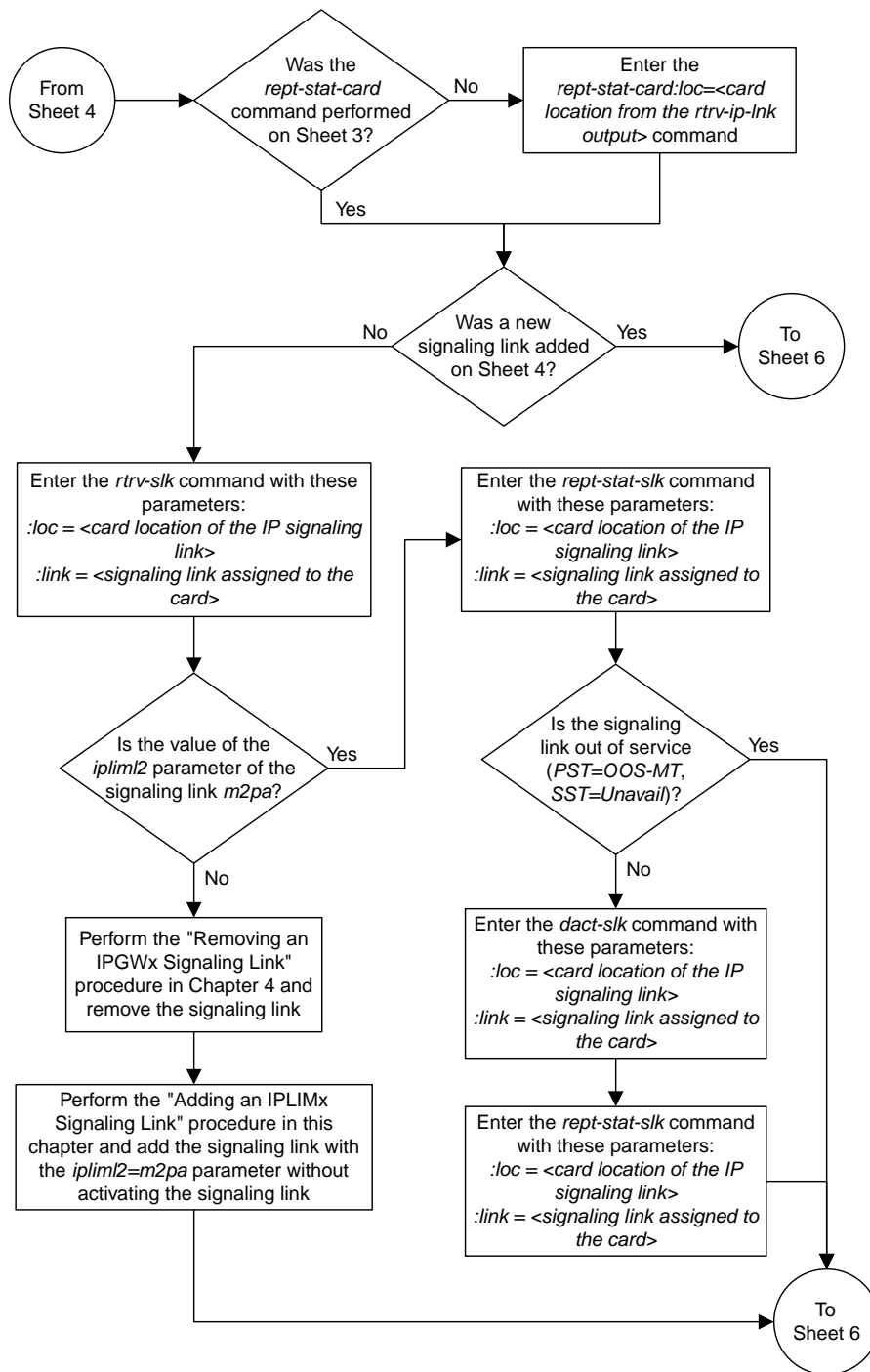

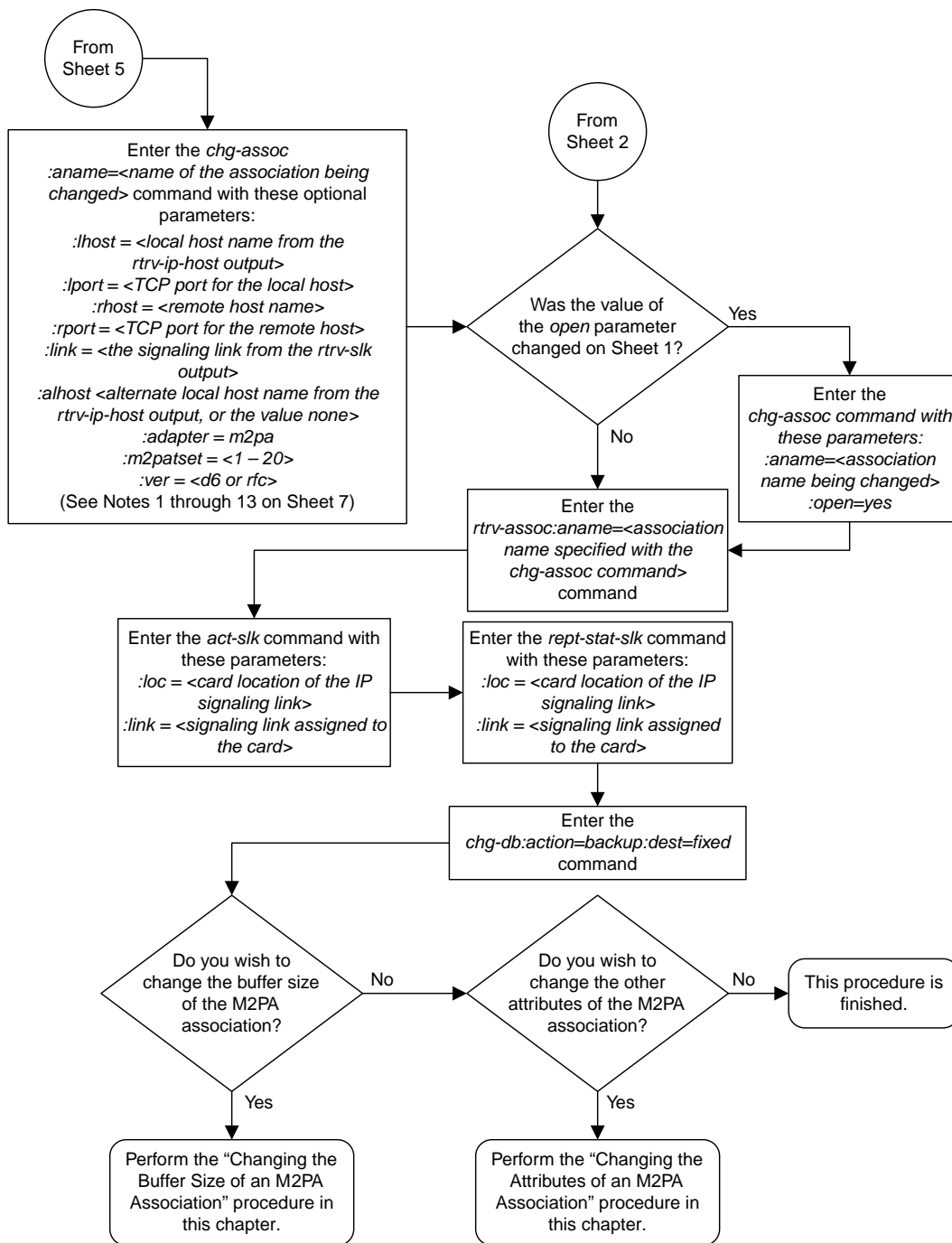

Notes:

1. If any optional parameters are not specified with the *chg-assoc* command, those values are not changed.
2. The B Ethernet interface can be used with single-slot EDCMs or E5-ENET cards.
3. The EAGLE 5 ISS can contain a maximum of 4000 connections.
4. IPLIMx cards can have only one connection for each signaling link assigned to the card. If the card is a single-slot EDCM, the card may contain a maximum of eight connections. If the card is an E5-ENET card, the card may contain a maximum of 16 connections.
5. The value of the *lhost* and *rhost* parameters is a text string of up to 60 characters, with the first character being a letter. The command input is limited to 150 characters, including the hostnames
6. The *adapter* parameter value for the association must be *m2pa* and the *ipliml2=m2pa* parameter must be assigned to the signaling link on the *iplim* or *iplimi* card.
7. Specifying the *lhost* parameter only creates a uni-homed endpoint. The network portion of the endpoint's IP address must be the same as the network portion of the IP address assigned to either the A or B network interface of the IP card.
8. Specifying the *lhost* and *alhost* parameters creates a multi-homed endpoint. The network portion of the IP address associated with the *lhost* parameter must be the same as the network portion of the IP address assigned to one of the network interfaces (A or B) of the IP card, and the network portion of the IP address associated with the *alhost* parameter must be the same as the network portion of the IP address assigned to the other network interface on the IP card .
9. The *alhost=none* parameter removes the alternate local host from the specified association, which also removes the multi-homed endpoint capability.
10. If the *mp2atset* parameter is not specified with the *chg-assoc* command, and the *adapter* parameter value is being changed to *m2pa*, the *m2patset* parameter value defaults to M2PA timer set 1 (*m2patset=1*).
11. The *port* parameter can be used in place of the *link* parameter to specify the signaling link assigned to the association.
12. The M2PA version of the association determines the version of the M2PA timer set that is assigned to the association. For example, if M2PA timer set 3 is assigned to the M2PA association, and the association is an RFC M2PA association, the RFC version of M2PA timer set 3 is used with the association. If M2PA timer set 7 is assigned to the M2PA association, and the association is a Draft 6 M2PA association, the Draft 6 version of M2PA timer set 7 is used with the association.
13. If the *adapter* parameter value of the association is changed to *m2pa* in this procedure and the *ver* parameter is not specified, the version of the association will be RFC. To make this association a M2PA Draft 6 association, the *ver=d6* parameter must be specified for this association.

Sheet 7 of 7

Figure 35: Changing the Host Values of a M2PA Association

Changing the Link Value of a M2PA Association to another Link Value on the Same IPLIMx Card

This procedure is used to change the `link` value of an M2PA association, assigned to cards that are running the IPLIM or IPLIMI applications (IPLIMx cards), to another `link` value that is assigned to the same IPLIMx card that is hosting the M2PA association. The `chg-assoc` command is used to change the `link` value for the association. If you wish to change the attributes of M2PA associations assigned to cards that are running the IPSP application, perform the [Changing the Attributes of an IPSP Association](#) procedure.

These parameters of the `chg-assoc` command are used in this procedure:

`:aname` – The name assigned to the association, shown in the `rtrv-assoc` output.

`:link` – The signaling link on the IPLIMx card. If the card is a single-slot EDCM, the values for the `link` parameter can be `a`, `a1`, `a2`, `a3`, `b`, `b1`, `b2`, or `b3`.

If the card is a E5-ENET card, the values for the `link` parameter can be `a`, `a1`, `a2`, `a3`, `a4`, `a5`, `a6`, `a7`, `b`, `b1`, `b2`, `b3`, `b4`, `b5`, `b6`, or `b7`.

Note: The `port` parameter can be used in place of the `link` parameter to specify the signaling link on the card.

`:open` – The connection state for this association. Valid values are `yes` or `no`. When the `open=yes` parameter is specified, the connection manager opens the association if the association is operational. When the `open=no` parameter is specified, the connection manager will not open the association.

IPLIMx cards can have one association for each signaling link on the card. The single-slot EDCM can contain a maximum of eight signaling links, resulting in a maximum of eight associations for this card. The E5-ENET card can contain a maximum of 16 signaling links, resulting in a maximum of 16 associations for this card.

The signaling link being assigned to the association must be out of service. This state is shown in the `rept-stat-slk` output with the entries `OOS-MT` in the `PST` field and `Unavail` in the `SST` field.

If you wish to change the `lhost`, `alhost`, `bufsize`, or `link` values of the M2PA association, perform one of these procedures.

- `lhost` and `alhost` - [Changing the Host Values of a M2PA Association](#)
- `bufsize` - [Changing the Buffer Size of a M2PA Association](#)
- Other attributes of the M2PA Association - [Changing the Attributes of an M2PA Association](#)

If you do not wish to change the `lhost`, `alhost`, `bufsize`, or `link` values of the M2PA association, this procedure is finished.

Canceling the RTRV-ASSOC Command

Because the `rtrv-assoc` command used in this procedure can output information for a long period of time, the `rtrv-assoc` command can be canceled and the output to the terminal stopped. There are three ways that the `rtrv-assoc` command can be canceled.

- Press the F9 function key on the keyboard at the terminal where the `rtrv-assoc` command was entered.
- Enter the `canc-cmd` without the `trm` parameter at the terminal where the `rtrv-assoc` command was entered.
- Enter the `canc-cmd:trm=<xx>`, where `<xx>` is the terminal where the `rtrv-assoc` command was entered, from another terminal other than the terminal where the `rtrv-assoc` command was entered. To enter the `canc-cmd:trm=<xx>` command, the terminal must allow Security Administration commands to be entered from it and the user must be allowed to enter Security Administration commands. The terminal's permissions can be verified with the `rtrv-secu-trm` command. The user's permissions can be verified with the `rtrv-user` or `rtrv-secu-user` commands.

For more information about the `canc-cmd` command, go to *Commands User's Guide*.

1. Display the associations in the database using the `rtrv-assoc` command.

This is an example of possible output.

```
rlghncxa03w 06-10-28 09:12:36 GMT EAGLE5 36.0.0

          CARD IPLNK
ANAME      LOC  PORT  LINK ADAPTER LPORT RPORT OPEN ALW
swbel32    1201 A      A   M3UA   1030  2345  YES  YES
a2         1305 A      A   SUA    1030  2345  YES  YES
a3         1307 A      A   SUA    1030  2346  YES  YES
assoc1     1201 A      A   M3UA   2000  1030  YES  YES
assoc2     1205 A      A   M2PA   2048  2048  YES  YES
assoc3     1205 A      B2  M2PA   3000  3000  YES  YES
```

2. Enter the `rtrv-card` command with the location of the card that is hosting the M2PA association that will be changed in this procedure. For this example, enter this command.

```
rtrv-card:loc=1205
```

This is an example of possible output.

```
rlghncxa03w 08-04-06 15:17:20 EST EAGLE5 38.0.0
CARD  TYPE      APPL      LSET NAME  LINK SLC LSET NAME  LINK SLC
1205  DCM        IPLIM     e5e6a      A    0    e5e6a      B2    1
                   e5e6a      A3    2
```

If the application assigned to the card is IPLIM or IPLIMI, shown in the `APPL` column, continue the procedure by performing one of these steps.

- If the open parameter value for the association being changed is `yes`, continue the procedure with [Step 3](#).
- If the open parameter value for the association being changed is `no`, continue the procedure with [Step 4](#).

If the application assigned to the card is IPSP, perform the [Changing the Attributes of an IPSP Association](#) procedure.

3. Change the value of the open parameter to `no` by specifying the `chg-assoc` command with the `open=no` parameter.

For this example, enter this command.

```
chg-assoc:aname=assoc2:open=no
```

When this command has successfully completed, this message should appear.

```
rlghncxa03w 06-10-28 09:12:36 GMT EAGLE5 36.0.0
CHG-ASSOC: MASP A - COMPLTD;
```

4. Perform one of these actions.

- If the new link value is not shown in the `rtrv-card` output in [Step 2](#), perform the [Adding an IPLIMx Signaling Link](#) procedure to provision the signaling link with the card location specified in [Step 2](#) and the new link value. After the new signaling link has been provisioned, continue the procedure with [Step 8](#).
- If the new link value is shown in the `rtrv-card` output in [Step 2](#) and in the `rtrv-assoc` output in [Step 1](#), this link value cannot be used. Perform the [Adding an IPLIMx Signaling Link](#) procedure to provision the signaling link with the card location specified in [Step 2](#) and the new link value. After the new signaling link has been provisioned, continue the procedure with [Step 8](#).
- If the new link value is shown in the `rtrv-card` output in [Step 2](#) but not in the `rtrv-assoc` output in [Step 1](#), continue the procedure with [Step 5](#).

5. Display the status of the signaling link that will be the new link value for the association shown in [Step 2](#) (using the values in the LOC and LINK columns in the `rtrv-card` output) by entering the `rept-stat-slk` command specifying the card location and signaling link.

For example, enter this command.

```
rept-stat-slk:loc=1205:link=a3
```

This is an example of the possible output.

```
rlghncxa03w 06-10-28 21:16:37 GMT EAGLE5 36.0.0
SLK      LSN      CLLI      PST      SST      AST
1205,A3  e5e6a    -----  IS-NR    Avail    ----
Command Completed.
```

If the primary state (PST) of the signaling link not is OOS-MT and the secondary state (SST) is Unavail, continue the procedure with [Step 6](#).

If the primary state (PST) of the signaling link is OOS-MT and the secondary state (SST) is Unavail, continue the procedure with [Step 8](#).

6. Deactivate the signaling link shown in [Step 5](#) using the `dact-slk` command.

For example, enter this command.

```
dact-slk:loc=1205:link=a3
```

When this command has successfully completed, the following message should appear.

```
rlghncxa03w 06-10-07 11:11:28 GMT EAGLE5 36.0.0
Deactivate Link message sent to card
```

7. Verify the status of the signaling link using the `rept-stat-slk` command.

For example, enter this command.

```
rept-stat-slk:loc=1205:link=a3
```

This is an example of the possible output.

```
rlghncxa03w 06-10-28 21:16:37 GMT EAGLE5 36.0.0
SLK      LSN      CLLI      PST      SST      AST
1205,A3  e5e6a    -----  OOS-MT   Unavail  ----
Command Completed.
```

8. Change the association using the `chg-assoc` command.

For this example, enter this command.

```
chg-assoc:aname=assoc2:link=a3
```

When this command has successfully completed, this message should appear.

```
rlghncxa03w 06-10-28 09:12:36 GMT EAGLE5 36.0.0
CHG-ASSOC: MASP A - COMPLTD;
```

If the value of the `open` parameter was not changed in [Step 3](#), continue the procedure with [Step 10](#).

If the value of the `open` parameter was changed in [Step 3](#), continue the procedure with [Step 9](#).

9. Change the value of the `open` parameter to `yes` by specifying the `chg-assoc` command with the `open=yes` parameter.

For this example, enter this command.

```
chg-assoc:aname=assoc2:open=yes
```

When this command has successfully completed, this message should appear.

```
rlghncxa03w 06-10-28 09:12:36 GMT EAGLE5 36.0.0
CHG-ASSOC: MASP A - COMPLTD;
```

10. Verify the changes using the `rtrv-assoc` command specifying the association name specified in [Step 8](#) and [Step 9](#).

For this example, enter this command.

```
rtrv-assoc:aname=assoc2
```

This is an example of possible output.

```
rlghncxa03w 10-07-28 21:14:37 GMT EAGLE5 42.0.0
ANAME  assoc2
      LOC      1205      IPLNK PORT  A      LINK  A
      ADAPTER  M2PA      VER      M2PA RFC
      LHOST    IPNODE2-1205
      ALHOST    ---
      RHOST    gw200.nc-tekelec.com
      ARHOST    ---
      LPORT    2048      RPORT      3000
      ISTRMS   2      OSTRMS     2      BUFSIZE  500
```

```

RMODE      LIN          RMIN      120          RMAX      800
RTIMES     10           CWMIN     3000        UAPS      10
OPEN       YES          ALW       NO           RTXTHR   10000
RHOSTVAL   MATCH       M2PATSET  1

```

```

IP Appl Sock/Assoc table is (8 of 4000) 1% full
Assoc Buffer Space Used (1300 KB of 1600 KB) on LOC = 1205

```

If the state of the signaling link was changed in [Step 6](#), continue the procedure with [Step 11](#).

If the state of the signaling link was not changed in [Step 6](#), continue the procedure with [Step 13](#).

11. Activate the signaling link assigned to the association using the `act-slk` command.

For example, enter this command.

```
act-slk:loc=1205:link=a3
```

When this command has successfully completed, the following message should appear.

```

rlghncxa03w 06-10-07 11:11:28 GMT EAGLE5 36.0.0
Activate Link message sent to card

```

12. Verify the status of the signaling link using the `rept-stat-slk` command.

For example, enter this command.

```
rept-stat-slk:loc=1205:link=a3
```

This is an example of the possible output.

```

rlghncxa03w 06-10-28 21:16:37 GMT EAGLE5 36.0.0
SLK      LSN          CLLI          PST          SST          AST
1205,A3  e5e6a         ----- IS-NR          Avail        ----
Command Completed.

```

13. Back up the new changes, using the `chg-db:action=backup:dest=fixed` command.

These messages should appear; the active Maintenance and Administration Subsystem Processor (MASP) appears first.

```

BACKUP (FIXED) : MASP A - Backup starts on active MASP.
BACKUP (FIXED) : MASP A - Backup on active MASP to fixed disk complete.
BACKUP (FIXED) : MASP A - Backup starts on standby MASP.
BACKUP (FIXED) : MASP A - Backup on standby MASP to fixed disk complete.

```

If you wish to change the other attributes of the M2PA association, perform one of these procedures.

- `lhost` and `alhost` - [Changing the Host Values of a M2PA Association](#)
- `bufsize` - [Changing the Buffer Size of a M2PA Association](#)
- Other attributes of the M2PA Association - [Changing the Attributes of an M2PA Association](#)

If you do not wish to change the other attributes of the M2PA association, this procedure is finished.

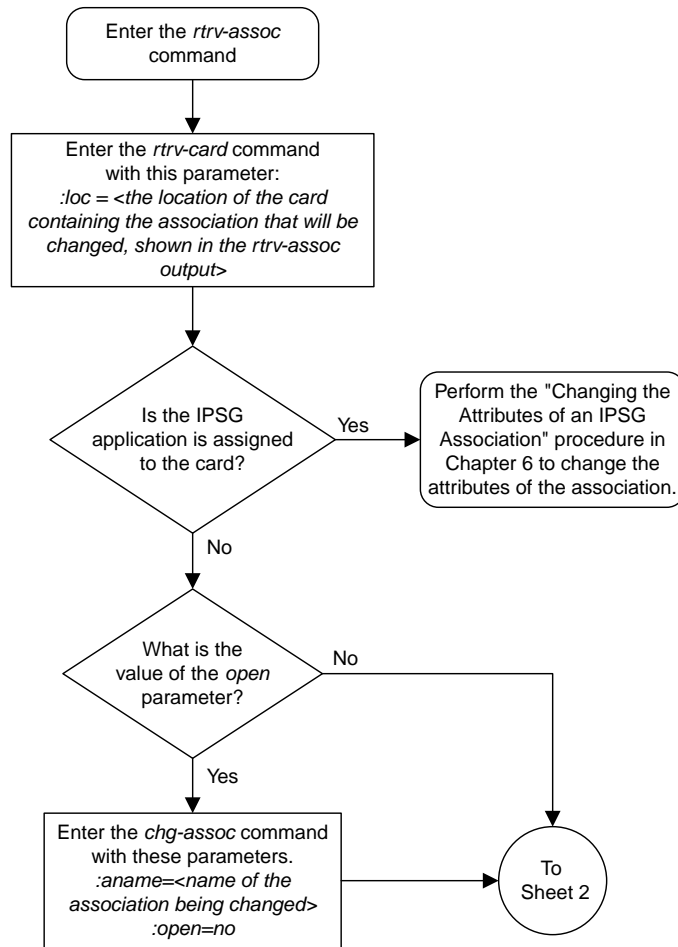

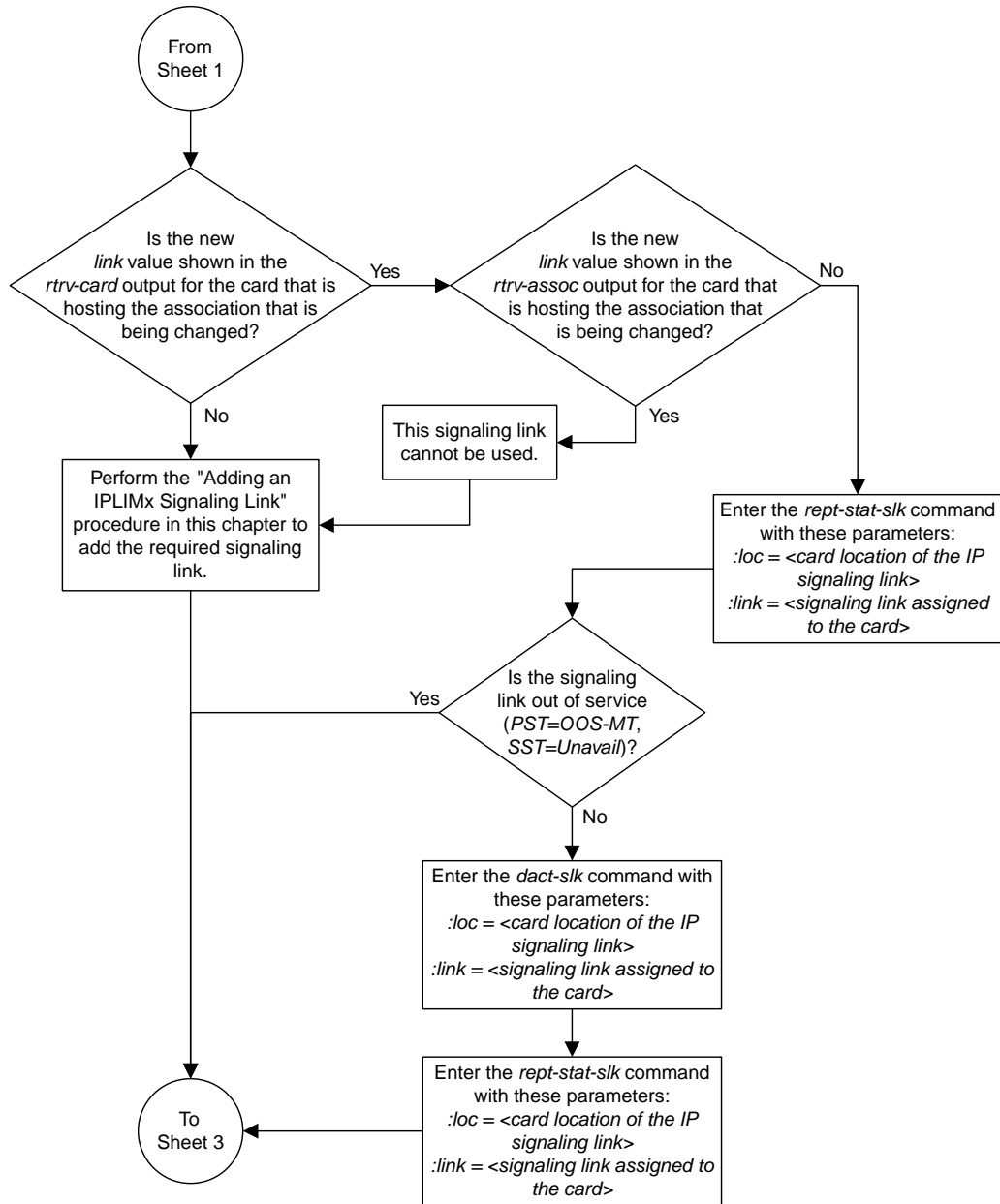

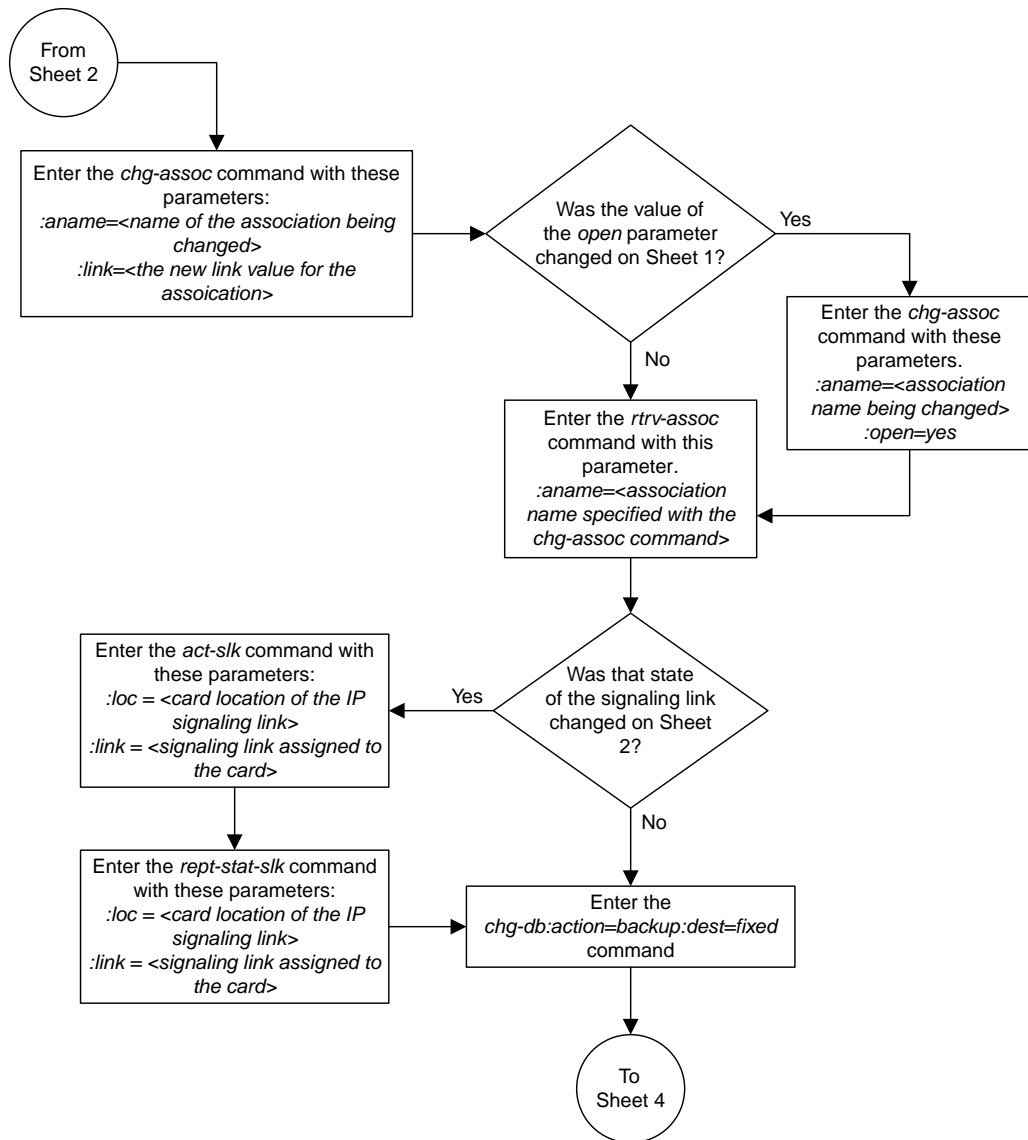

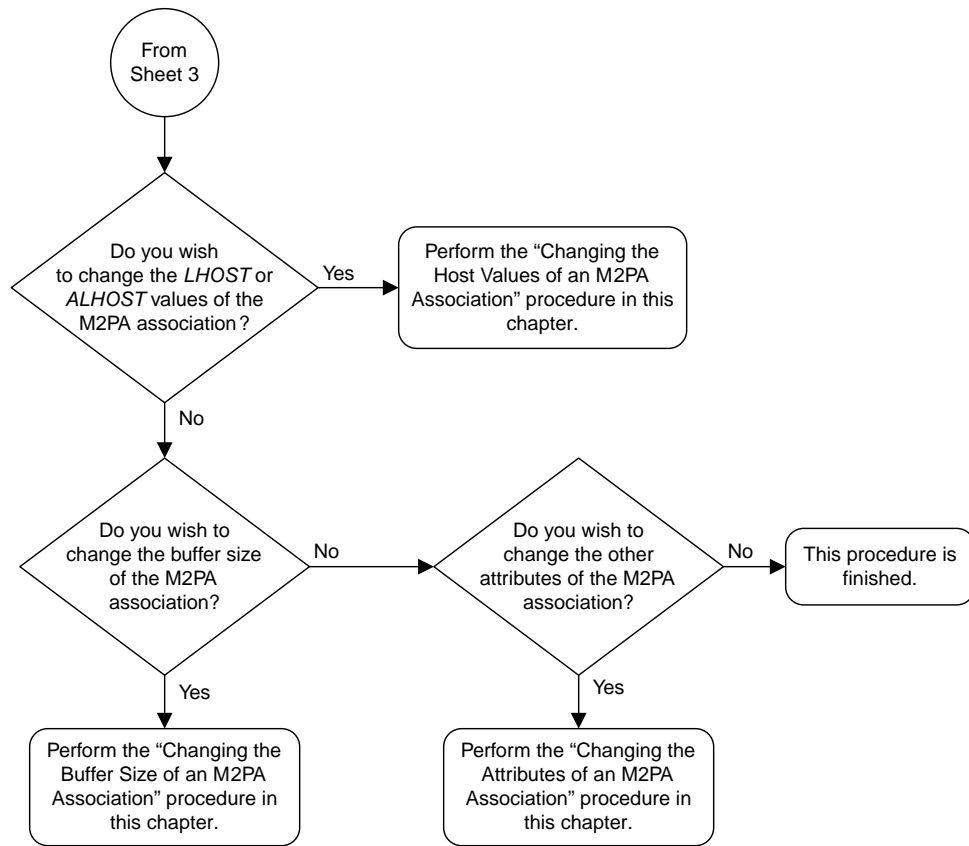

Sheet 4 of 4

Figure 36: Changing the Link Value of a M2PA Association to another Link Value on the Same IPLIMx Card

Configuring SCTP Retransmission Control for a M2PA Association

This procedure is used to gather the information required to configure the retransmission parameters for M2PA associations assigned to cards running either the IPLIM or IPLIMI applications. Perform the [Configuring an IPSG Association for SCTP Retransmission Control](#) procedure to configure the retransmission parameters for M2PA associations assigned to IPSG cards. If any assistance is needed to configure the retransmission parameters for associations, contact [My Oracle Support \(MOS\)](#).

The retransmission parameters are configured using the `rmode`, `rmin`, `rmax`, `rtimes`, and `cwmin` parameters of the `chg-assoc` command.

`:rmode` – The retransmission mode used when packet loss is detected. The values are `rfc` or `lin`.

- `rfc` – Standard RFC 2960 algorithm in the retransmission delay doubles after each retransmission. The RFC 2960 standard for congestion control is also used.
- `lin` – Oracle's linear retransmission mode where each retransmission timeout value is the same as the initial transmission timeout and only the slow start algorithm is used for congestion control.

`:rmin` – The minimum value of the calculated retransmission timeout in milliseconds.

`:rmax` – The maximum value of the calculated retransmission timeout in milliseconds.

Note: The `rmin` and `rmax` parameter values form a range of retransmission values. The value of the `rmin` parameter must be less than or equal to the `rmax` parameter value.

`:rtimes` – The number of times a data retransmission occurs before closing the association.

`:cwmin` – The minimum size in bytes of the association's congestion window and the initial size in bytes of the congestion window.

The [Changing the Attributes of an M2PA Association](#) procedure is used to change the values of these parameters. In addition to using the [Changing the Attributes of an M2PA Association](#) procedure, these `pass` commands are also used in this procedure.

- `ping` – tests for the presence of hosts on the network.
- `assocrtt` – displays the SCTP round trip times for a specified association. Minimum, maximum, and average times are kept for each open association. The Retransmission Mode (RFC or LIN) and the configured Minimum and Maximum Retransmission Timeout limits are also displayed.
- `sctp` – provides a summary list of all SCTP instances.
- `sctp -a <association name>` – displays the measurements and information for a specific association.

Note: The values for the minimum and maximum retransmission times in the output from this command are shown in microseconds.

For more information on the `pass` commands, see *Commands User's Guide*.

The `chg-assoc` command contains other optional parameters that can be used to configure an association. These parameters are not shown here because they are not necessary for configuring the SCTP retransmission parameters. These parameters are explained in more detail in the [Changing the](#)

[Attributes of an M2PA Association](#) procedure, or in the `and chg-assoc` command description in *Commands User's Guide*.

Canceling the RTRV-ASSOC Command

Because the `rtrv-assoc` command used in this procedure can output information for a long period of time, the `rtrv-assoc` command can be canceled and the output to the terminal stopped. There are three ways that the `rtrv-assoc` command can be canceled.

- Press the F9 function key on the keyboard at the terminal where the `rtrv-assoc` command was entered.
- Enter the `canc-cmd` without the `trm` parameter at the terminal where the `rtrv-assoc` command was entered.
- Enter the `canc-cmd:trm=<xx>`, where `<xx>` is the terminal where the `rtrv-assoc` command was entered, from another terminal other than the terminal where the `rtrv-assoc` command was entered. To enter the `canc-cmd:trm=<xx>` command, the terminal must allow Security Administration commands to be entered from it and the user must be allowed to enter Security Administration commands. The terminal's permissions can be verified with the `rtrv-secu-trm` command. The user's permissions can be verified with the `rtrv-user` or `rtrv-secu-user` commands.

For more information about the `canc-cmd` command, go to *Commands User's Guide*.

1. Display the associations in the database using the `rtrv-assoc` command.

This is an example of possible output.

```
rlghncxa03w 06-10-28 09:12:36 GMT EAGLE5 36.0.0
          CARD IPLNK
ANAME      LOC  PORT  LINK ADAPTER LPORT RPORT OPEN ALW
swbel32    1201 A     A   M3UA   1030  2345 YES  YES
a2         1305 A     A   SUA    1030  2345 YES  YES
a3         1307 A     A   SUA    1030  2346 YES  YES
assoc1     1201 A     A   M2PA   2000  1030 YES  YES
```

2. Enter the `rtrv-card` command with the location of the card that is hosting the M2PA association that will be changed in this procedure. For this example, enter this command.

```
rtrv-card:loc=1201
```

This is an example of possible output.

```
rlghncxa03w 08-03-06 15:17:20 EST EAGLE5 38.0.0
CARD  TYPE  APPL  LSET NAME  LINK SLC LSET NAME  LINK SLC
1201  DCM    IPLIM  lsn1      A    0
```

If the application assigned to the card is IPLIM or IPLIMI, shown in the APPL column, continue the procedure with [Step 3](#).

If the application assigned to the card is IPSG, perform the [Configuring an IPSG Association for SCTP Retransmission Control](#) procedure.

3. Display the association that will be changed by entering the `rtrv-assoc` command with the name of the association. For this example, enter this command.

```
rtrv-assoc:aname=assoc1
```

This is an example of the possible output.

```
rlghncxa03w 10-07-28 21:14:37 GMT EAGLE5 42.0.0
  ANAME assoc1
    LOC      1201          IPLNK PORT  A          LINK  A
    ADAPTER  M2PA          VER      M2PA RFC
    LHOST    IPNODE2-1205
    ALHOST   ---
    RHOST    gw100.nc-tekelec.com
    ARHOST   ---
    LPORT    2000          RPORT    1030
    ISTRMS   2            OSTRMS   2          BUFSIZE  400
    RMODE    LIN          RMIN     120        RMAX     800
    RTIMES   10          CWMIN    3000     UAPS     10
    OPEN     YES          ALW      NO         RTXTHR   2000
    RHOSTVAL MATCH      M2PATSET  1
```

IP Appl Sock/Assoc table is (8 of 4000) 1% full
 Assoc Buffer Space Used (1600 KB of 1600 KB) on LOC = 1201

4. Enter the ping pass command specifying the card location of the local host, shown in [Step 3](#) , and the name of the remote host assigned to the association being changed, shown in [Step 3](#) .

This command is entered several times to obtain the average round trip time. For this example, enter this command.

```
pass:loc=1201:cmd="ping gw100.nc.tekelec.com"
```

The following is an example of the possible output

```
rlghncxa03w 06-10-28 21:15:37 GMT EAGLE5 36.0.0
PASS: Command sent to card

rlghncxa03w 06-10-28 21:15:37 GMT EAGLE5 36.0.0
PING command in progress

rlghncxa03w 06-10-28 21:15:37 GMT EAGLE5 36.0.0
PING GW100. NC. TEKELEC. COM (192.1.1.30): 56 data bytes
64 bytes from tekral.nc.tekelec.com (192.1.1.30): icmp_seq=0. time=5. ms
64 bytes from tekral.nc.tekelec.com (192.1.1.30): icmp_seq=1. time=9. ms
64 bytes from tekral.nc.tekelec.com (192.1.1.30): icmp_seq=2. time=14. ms
----tekral PING Statistics----
3 packets transmitted, 3 packets received, 0% packet loss
round-trip (ms)  min/avg/max = 5/9/14

PING command complete
```

If the SCTP retransmission parameters do not need to be changed, do not perform [Step 5](#) through [Step 8](#). This procedure is finished.

5. Perform the [Changing the Attributes of an M2PA Association](#) procedure to change the retransmission parameters of the association based on the results of pinging the remote host.
6. Enter the `assocrtt` pass command to display the round trip time data collected after an association is established when an SCTP INIT message is sent and an acknowledgment is received.

The `assocrtt` command is entered with the card location from [Step 4](#) (the card location assigned to the association being changed), and the name of the association being changed. This association must contain the host name used in [Step 4](#). For this example, enter this command.

```
pass:loc=1201:cmd="assocrtt assoc1"
```

The following is an example of the possible output

```
rlghncxa03w 06-10-28 21:15:37 GMT EAGLE5 36.0.0
PASS: Command sent to card

rlghncxa03w 06-10-28 21:15:37 GMT EAGLE5 36.0.0

ASSOCRTT: Association round-trip time report (in milliseconds)

Retransmission Configuration
  Retransmission Mode           : LIN
  Minimum RTO: 120
  Maximum RTO: 800

Traffic Round-Trip Times
  Minimum round-trip time       : 5
  Maximum round-trip time       : 120
  Weighted Average round-trip time : 10
  Last recorded round-trip time  : 10

Measured Congested Traffic Round-Trip Times
  Minimum round-trip time       : 0
  Maximum round-trip time       : 0
  Weighted Average round-trip time : 0
  Last recorded round-trip time  : 0
;
rlghncxa03w 06-10-28 21:15:37 GMT EAGLE5 36.0.0
ASSOCRTT command complete
```

7. Enter the `sctp -a <association name> pass` command to determine if retransmissions have occurred.

The association name is the association name specified in [Step 6](#). Specify the card location used in [Step 6](#). For this example, enter this command.

```
pass:loc=1201:cmd="sctp -a assoc1"
```

The following is an example of the possible output

```
rlghncxa03w 10-12-28 21:15:37 GMT EAGLE5 43.0.0

Aname           Local           Local Remote      Remote
                IP Address     Port  Address     Port
Assoc1          192.168.110.12 2222  192.168.112.4 5555
                192.168.112.12

                Configuration                               State
                Retransmission Mode = LIN                State = OPEN
Min. Retransmission Timeout = 10000                    ULP association id = 18
Max. Retransmission Timeout = 800000                   Number of nets = 2
                Max. Number of Retries = 10              Inbound Streams = 1
                Min. Congestion Window = 3000            Outbound Streams = 2
```



```

    Inbound Streams = 2
    Outbound Streams = 2
    Checksum Algorithm = crc32c
    Send/Rcv Buffer Size = 204800

```

Nets Data

IP Address	192.168.112.4	State	Reachable
Port	7777	Primary	YES
MTU	1500	cwnd	16384
ssthresh	16384	RTO	120
IP Address	192.168.113.5	State	Reachable
Port	7777	Primary	NO
MTU	1500	cwnd	16384
ssthresh	16384	RTO	120

```

    Last Net Sent To = 192.168.112.4
    Last Net Rcvd From = 192.168.112.4
    Over All Error Count = 0
        Peers Rwnd = 13880
        My Rwnd = 16384
        Max Window = 16384
    Initial Seq Number = 24130
    Next Sending Seq Number = 124686
    Last Acked Seq Number = 124669
    Maximum Outbound Char Count = 16384
    Current Outbound Char Count = 2112
    Number Unsent Char Count = 0
    Outbound Data Chunk Count = 16
        Number Unsent = 0
    Number To Retransmit = 0

    ip datagrams rcvd = 155402
ip datagrams with data chunks rcvd = 120844
    data chunks rcvd = 367908
    data chunks read = 367900
    dup tsns rcvd = 8
    sacks rcvd = 38734
    gap ack blocks rcvd = 3
    heartbeat requests rcvd = 135
    heartbeat acks rcvd = 52
    heartbeat requests sent = 52
    ip datagrams sent = 129254
ip datagrams with data chunks sent = 73084
    data chunks sent = 396330
    retransmit data chunks sent = 135
    sacks sent = 64872
    send failed = 0
    retransmit timer count = 0
    consecutive retransmit timeouts = 0
RTT between RMIN and RMAX inclusive = 6
    RTT greater than RMAX = 0
    fast retransmit count = 135
    recv timer count = 0
    heartbeat timer count = 244
    none left tosend = 0
    none left rwnd gate = 5
    none left cwnd gate = 8

;

rlghncxa03w 10-12-28 21:15:37 GMT EAGLE5 43.0.0

```

SCTP command complete

rlghncxa03w 06-10-28 21:15:37 GMT EAGLE5 36.0.0

Aname	Local IP Address	Local Port	Remote Address	Remote Port
Assoc1	192.168.110.12	2222	192.168.112.4	5555
	192.168.112.12			

Configuration	State
Retransmission Mode = LIN	State = OPEN
Min. Retransmission Timeout = 10	ULP association id = 18
Max. Retransmission Timeout = 800	Number of nets = 2
Max. Number of Retries = 10	Inbound Streams = 1
Min. Congestion Window = 3000	Outbound Streams = 2
Inbound Streams = 2	
Outbound Streams = 2	

Nets Data

IP Address	Port	State	Reachable
192.168.112.4	7777	Primary	YES
	MTU 1500	cwnd	16384
	ssthresh 16384	RTO	120
192.168.113.5	7777	Primary	NO
	MTU 1500	cwnd	16384
	ssthresh 16384	RTO	120

```

Last Net Sent To = 192.168.112.4
Last Net Rcvd From = 192.168.112.4
Over All Error Count = 0
Peers Rwnd = 13880
My Rwnd = 16384
Max Window = 16384
Initial Seq Number = 24130
Next Sending Seq Number = 124686
Last Acked Seq Number = 124669
Maximum Outbound Char Count = 16384
Current Outbound Char Count = 2112
Number Unsent Char Count = 0
Outbound Data Chunk Count = 16
Number Unsent = 0
Number To Retransmit = 0

ip datagrams rcvd = 155402
ip datagrams with data chunks rcvd = 120844
data chunks rcvd = 367908
data chunks read = 367900
dup tsns rcvd = 8
sacks rcvd = 38734
gap ack blocks rcvd = 3
heartbeat requests rcvd = 135
heartbeat acks rcvd = 52
heartbeat requests sent = 52
ip datagrams sent = 129254
ip datagrams with data chunks sent = 73084
data chunks sent = 396330
retransmit data chunks sent = 135
sacks sent = 64872

```

```
                send failed = 0
                retransmit timer count = 0
consecutive retransmit timeouts = 0
RTT between RMIN and RMAX inclusive = 6
                RTT greater than RMAX = 0
                fast retransmit count = 135
                recv timer count = 0
                heartbeat timer count = 244
                none left tosend = 0
                none left rwnd gate = 5
                none left cwnd gate = 8

SCTP command complete
```

8. Perform the *Changing the Attributes of an M2PA Association* procedure to change the retransmission parameters of the association based on the results of the outputs of [Step 6](#) and [Step 7](#).

The Weighted Average round-trip time shown in the `assocrtt pass` command output in [Step 6](#), and the data retransmission counts shown in the `sctp -a` pass command output in [Step 7](#) are used as a guide to determine the appropriate values for the `rmode`, `rmin`, `rmax`, and `rtimes` parameters. If the retransmission parameters do not have to be adjusted, do not perform this step. This procedure is finished.

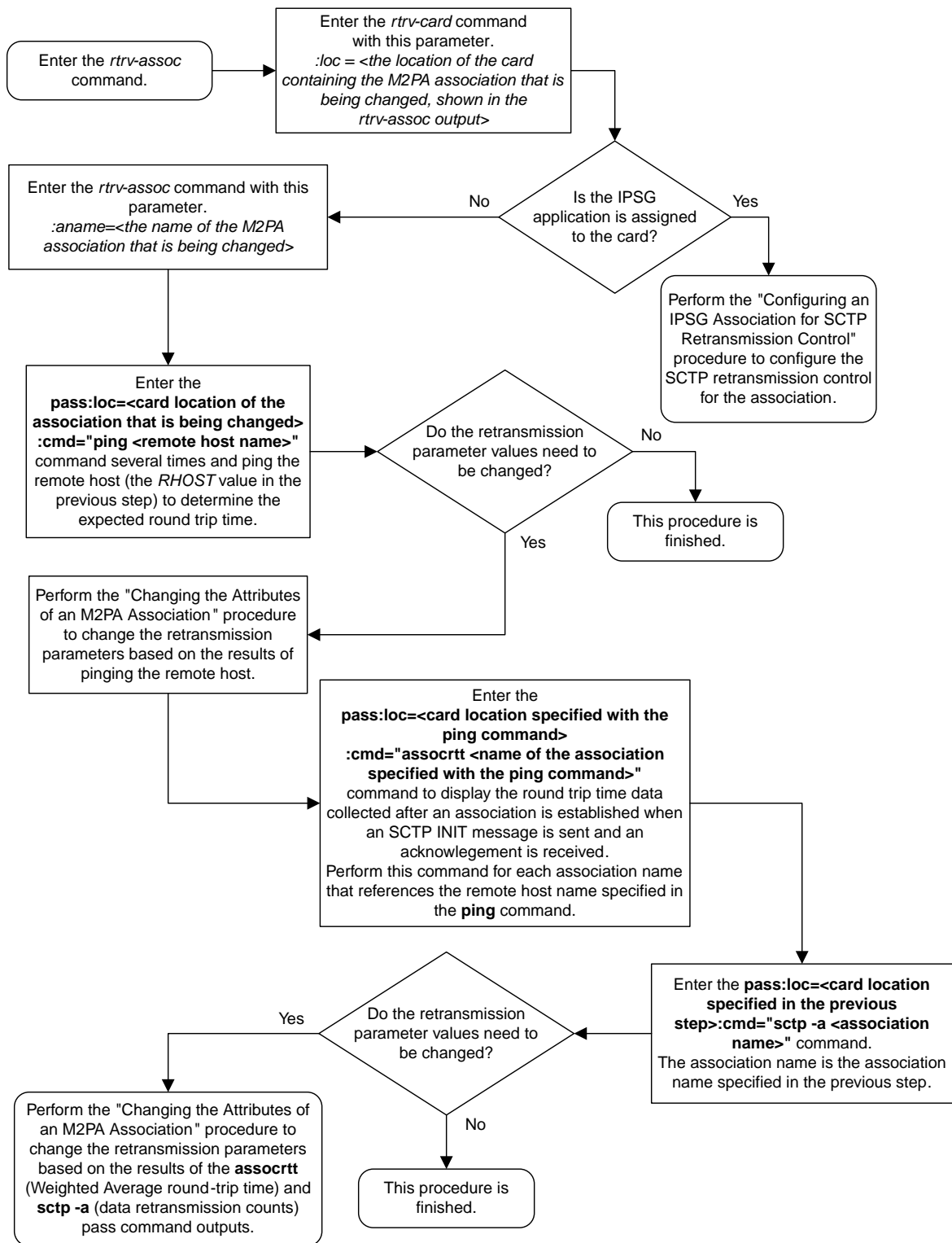

Figure 37: Configuring the SCTP Retransmission Control for a M2PA Association

Changing a M2PA Timer Set

This procedure is used to change the values of the M2PA timers in a M2PA timer set using the `chg-m2pa-tset` command. The M2PA timers are used to control the behavior of the signaling link assigned to an M2PA association (an association containing the M2PA adapter layer - `adapter=m2pa`) during signaling link alignment and proving, and during times of transmit congestion.

The EAGLE contains 20 M2PA timer sets. One of these timer sets is assigned to an M2PA association using the `m2patset` parameter of either the `ent-assoc` or `chg-assoc` command. If the `m2patset` parameter is not specified with the `ent-assoc` command, or with the `chg-assoc` command if the adapter layer for that association is being changed to M2PA, timer set 1 is automatically assigned to the association.



CAUTION

Caution: Changing an M2PA timer set may affect the performance of any associations using the timer set being changed.

The `chg-m2pa-tset` command uses these parameters.

`:tset` – The M2PA timer set being changed, 1 - 20.

`:srctset` – The timer values in an existing M2PA timer set can be copied to another M2PA timer set, specified by the `tset` parameter. The `srctset` parameter specifies the timer set that is to be copied. If the `srctset` parameter is specified, no other timer values can be specified, The `srctset` parameter value cannot be the timer set specified by the `tset` parameter.

`:ver` – The M2PA version, either Draft 6 (`ver=d6`) or RFC (`ver=rfc`).

Note: The definitions of timers T1 and T3 for the Draft 6 version are different from the RFC version. The T2 timer applies only to the RFC version. The definitions of timers T4N, T4E, T5, T6, T7, T16, T17 and T18 for are the same for the Draft 6 version and the RFC version.

The timer parameter descriptions and values are shown in [Table 20: M2PA Timers](#).

Table 20: M2PA Timers

Timer	Draft 6 Timer Name	RFC Timer Name	Definition	Value (in msec)	DRAFT 6 System Default Value (in msec)	RFC System Default Value (in msec)
<code>:t1</code>	N/A	Ready Timer	The amount of time after proving the M2PA adapter layer waits to receive a Link Status Ready message from the peer.	1000 - 350000	N/A	300000
<code>:t1</code>	Alignment Timer	N/A	The amount of time the M2PA adapter layer waits to receive a Link Status Alignment message from the peer.	1000 - 350000	10000	N/A

Timer	Draft 6 Timer Name	RFC Timer Name	Definition	Value (in msec)	DRAFT 6 System Default Value (in msec)	RFC System Default Value (in msec)
:t2 *	N/A	Not Aligned Timer	The the amount of time the M2PA adapter layer waits to receive a Link Status Alignment/Link Status Proving message after sending a Link Status Alignment message. Timer T2 is not used in M2PA Draft 6 timer sets.	5000 - 150000	N/A	20000
:t3	N/A	Alignment Timer	The amount of time the M2PA layer waits to receive a Link Status Alignment message from the peer.	1000 - 60000	N/A	2000
	Ready Timer	N/A	The amount of time after proving the M2PA adapter layer waits to receive a Link Status Ready message from the peer.	1000 - 60000	10000	N/A
:t4n	Proving Timer (Normal)		The amount of time the M2PA adapter layer generates Link Status Proving messages during normal proving.	1000 - 70000	10000	30000
:t4e	Proving Timer (Emergency)		The amount of time the M2PA adapter layer generates Link Status Proving messages during emergency proving.	400 - 5000	500	500
:t5	Busy Rate Timer		The amount of time between sending Link Status Busy messages while the link is in-service.	80 - 10000	1000	100
:t6	Remote Congestion Timer		The amount of time that a congested link will remain in service.	1000 - 6000	3000	3000
:t7	Excess Delay in Acknowledgement Timer		The maximum amount of time that may pass between when a user data message is transmitted and an acknowledgement for that message is received from the	200 - 2000	1200	1200

Timer	Draft 6 Timer Name	RFC Timer Name	Definition	Value (in msec)	DRAFT 6 System Default Value (in msec)	RFC System Default Value (in msec)
			peer. If this timer expires, the link is taken out of service.			
:t16	Proving Rate Timer		The amount of time between sending Link Status Proving messages while the T4N or T4E timer is running.	100 - 500000 **	200000 **	200000 **
:t17	Ready Rate Timer		The amount of time between sending Link Status Ready messages while the T3 timer is running.	100 - 500	250	250
:t18	Processor Outage Rate Timer		The amount of time between sending Link Status Processor Outage messages while the link is in-service.	100 - 10000	1000	1000
msecs - milliseconds						
* The T2 Timer can be specified only for the M2PA RFC version.						
** The value of the T16 Timer is in microseconds.						

The value of any timer parameter not specified with the `chg-m2pa-tset` command is not changed.

1. Display the M2PA timer sets in the database by entering the `rtrv-m2pa-tset` command with the version of the M2PA timer sets you wish to change with the `ver` parameter.

To display the M2PA Draft 6 timer values, enter this command.

```
rtrv-m2pa-tset:ver=d6
```

```
rlghncxa03w 06-10-28 21:16:37 GMT EAGLE5 36.0.0
```

```
M2PA Draft 6 Timers (in msec, T16 in microsec)
```

```
TSET T1    T2    T3    T4N  T4E  T5    T6    T7    T16  T17  T18
1     6000  ----- 5000  20000 500  5000  3000 1000  200000 250 1000
2     10000 ----- 10000 10000 500  1000  3000 1200  200000 250 1000
3     10000 ----- 10000 10000 500  1000  3000 1200  200000 250 1000
4     10000 ----- 10000 10000 500  1000  3000 1200  200000 250 1000
5     10000 ----- 10000 10000 500  1000  3000 1200  200000 250 1000
6     10000 ----- 10000 10000 500  1000  3000 1200  200000 250 1000
7     10000 ----- 10000 10000 500  1000  3000 1200  200000 250 1000
8     10000 ----- 10000 10000 500  1000  3000 1200  200000 250 1000
9     27500 ----- 3850  4859  450  5700  3750 1150  250   375  8750
10    10000 ----- 10000 10000 500  1000  3000 1200  200000 250 1000
11    10000 ----- 10000 10000 500  1000  3000 1200  200000 250 1000
12    10000 ----- 10000 10000 500  1000  3000 1200  200000 250 1000
```

```

13 10000 ----- 10000 10000 500 1000 3000 1200 200000 250 1000
14 10000 ----- 10000 10000 500 1000 3000 1200 200000 250 1000
15 10000 ----- 10000 10000 500 1000 3000 1200 200000 250 1000
16 10000 ----- 10000 10000 500 1000 3000 1200 200000 250 1000
17 10000 ----- 10000 10000 500 1000 3000 1200 200000 250 1000
18 10000 ----- 10000 10000 500 1000 3000 1200 200000 250 1000
19 10000 ----- 10000 10000 500 1000 3000 1200 200000 250 1000
20 10000 ----- 10000 10000 500 1000 3000 1200 200000 250 1000

```

To display the M2PARFC timer values, enter this command.

```
rtrv-m2pa-tset:ver=rfc
```

```
rlghncxa03w 06-10-28 21:16:37 GMT EAGLE5 36.0.0
```

```
M2PA RFC Timers (in msec, T16 in microsec)
```

TSET	T1	T2	T3	T4N	T4E	T5	T6	T7	T16	T17	T18
1	6000	20000	5000	20000	500	5000	3000	1000	200000	250	1000
1	300000	20000	2000	30000	500	100	3000	1200	200000	250	1000
2	300000	20000	2000	30000	500	100	3000	1200	200000	250	1000
3	300000	20000	2000	30000	500	100	3000	1200	200000	250	1000
4	300000	20000	2000	30000	500	100	3000	1200	200000	250	1000
5	300000	20000	2000	30000	500	100	3000	1200	200000	250	1000
6	300000	20000	2000	30000	500	100	3000	1200	200000	250	1000
7	300000	20000	2000	30000	500	100	3000	1200	200000	250	1000
8	300000	20000	2000	30000	500	100	3000	1200	200000	250	1000
9	27500	10000	3850	4859	450	5700	3750	1150	250	375	8750
10	300000	20000	2000	30000	500	100	3000	1200	200000	250	1000
11	300000	20000	2000	30000	500	100	3000	1200	200000	250	1000
12	300000	20000	2000	30000	500	100	3000	1200	200000	250	1000
13	300000	20000	2000	30000	500	100	3000	1200	200000	250	1000
14	300000	20000	2000	30000	500	100	3000	1200	200000	250	1000
15	300000	20000	2000	30000	500	100	3000	1200	200000	250	1000
16	300000	20000	2000	30000	500	100	3000	1200	200000	250	1000
17	300000	20000	2000	30000	500	100	3000	1200	200000	250	1000
18	300000	20000	2000	30000	500	100	3000	1200	200000	250	1000
19	300000	20000	2000	30000	500	100	3000	1200	200000	250	1000
20	300000	20000	2000	30000	500	100	3000	1200	200000	250	1000

If the ver parameter is not specified when entering the rtrv-m2pa-tset command, both the Draft 6 and RFC values are displayed. This is an example of the possible output.

```
rlghncxa03w 06-10-28 21:16:37 GMT EAGLE5 36.0.0
```

```
M2PA Draft 6 Timers (in msec, T16 in microsec)
```

TSET	T1	T2	T3	T4N	T4E	T5	T6	T7	T16	T17	T18
1	6000	-----	5000	20000	500	5000	3000	1000	200000	250	1000
2	10000	-----	10000	10000	500	1000	3000	1200	200000	250	1000
3	10000	-----	10000	10000	500	1000	3000	1200	200000	250	1000
4	10000	-----	10000	10000	500	1000	3000	1200	200000	250	1000
5	10000	-----	10000	10000	500	1000	3000	1200	200000	250	1000
6	10000	-----	10000	10000	500	1000	3000	1200	200000	250	1000
7	10000	-----	10000	10000	500	1000	3000	1200	200000	250	1000
8	10000	-----	10000	10000	500	1000	3000	1200	200000	250	1000
9	27500	-----	3850	4859	450	5700	3750	1150	250	375	8750
10	10000	-----	10000	10000	500	1000	3000	1200	200000	250	1000
11	10000	-----	10000	10000	500	1000	3000	1200	200000	250	1000
12	10000	-----	10000	10000	500	1000	3000	1200	200000	250	1000

13	10000	-----	10000	10000	500	1000	3000	1200	200000	250	1000
14	10000	-----	10000	10000	500	1000	3000	1200	200000	250	1000
15	10000	-----	10000	10000	500	1000	3000	1200	200000	250	1000
16	10000	-----	10000	10000	500	1000	3000	1200	200000	250	1000
17	10000	-----	10000	10000	500	1000	3000	1200	200000	250	1000
18	10000	-----	10000	10000	500	1000	3000	1200	200000	250	1000
19	10000	-----	10000	10000	500	1000	3000	1200	200000	250	1000
20	10000	-----	10000	10000	500	1000	3000	1200	200000	250	1000

M2PA RFC Timers (in msec, T16 in microsec)

TSET	T1	T2	T3	T4N	T4E	T5	T6	T7	T16	T17	T18
1	6000	20000	5000	20000	500	5000	3000	1000	200000	250	1000
2	300000	20000	2000	30000	500	100	3000	1200	200000	250	1000
3	300000	20000	2000	30000	500	100	3000	1200	200000	250	1000
4	300000	20000	2000	30000	500	100	3000	1200	200000	250	1000
5	300000	20000	2000	30000	500	100	3000	1200	200000	250	1000
6	300000	20000	2000	30000	500	100	3000	1200	200000	250	1000
7	300000	20000	2000	30000	500	100	3000	1200	200000	250	1000
8	300000	20000	2000	30000	500	100	3000	1200	200000	250	1000
9	27500	10000	3850	4859	450	5700	3750	1150	250	375	8750
10	300000	20000	2000	30000	500	100	3000	1200	200000	250	1000
11	300000	20000	2000	30000	500	100	3000	1200	200000	250	1000
12	300000	20000	2000	30000	500	100	3000	1200	200000	250	1000
13	300000	20000	2000	30000	500	100	3000	1200	200000	250	1000
14	300000	20000	2000	30000	500	100	3000	1200	200000	250	1000
15	300000	20000	2000	30000	500	100	3000	1200	200000	250	1000
16	300000	20000	2000	30000	500	100	3000	1200	200000	250	1000
17	300000	20000	2000	30000	500	100	3000	1200	200000	250	1000
18	300000	20000	2000	30000	500	100	3000	1200	200000	250	1000
19	300000	20000	2000	30000	500	100	3000	1200	200000	250	1000
20	300000	20000	2000	30000	500	100	3000	1200	200000	250	1000

2. Change the desired timer set with the `chg-m2pa-tset` command. To change a specific timer set, enter the `chg-m2pa-tset` command with the `tset` and `ver` parameters and the timer parameters you wish to change. For this example, to change the values of the RFC version of timer set 1, enter this command.

```
chg-m2pa-tset:tset=1:t1=27500:t2=10000:t3=3850:t4e=450:t4n=45000:t5=5700
:t6=3750:t7=1150:t16=250000:t17=375:t18=8750:ver=rfc
```

To change the values of the Draft 6 version of timer set 1, enter this command.

```
chg-m2pa-tset:tset=1:t1=27500:t3=3850:t4e=450:t4n=45000:t5=5700
:t6=3750:t7=1150:t16=250000:t17=375:t18=8750:ver=d6
```

Note: The values for the M2PA timers are shown in [Table 20: M2PA Timers](#).

To copy an M2PA timer set to another timer set, enter the `chg-m2pa-tset` command with the `tset`, `ver`, and `srctset` parameters. For this example, to copy the RFC version of timer set 9 to timer set 1, enter this command.

```
chg-m2pa-tset:tset=1:srctset=9:ver=rfc
```

To copy the Draft 6 version of timer set 9 to timer set 1, enter this command.

```
chg-m2pa-tset:tset=1:srctset=9:ver=d6
```

Note: The `ver` parameter is optional and does not have to be specified to change the M2PA RFC timer values. The default value for the `ver` parameter is `rfc`. If you wish to change the M2PA Draft 6 timer values, the `ver=d6` parameter must be specified with the `chg-m2pa-tset` command.

When the `chg-m2pa-tset` command has successfully completed, the following message should appear.

```
rlghncxa03w 06-10-28 21:16:37 GMT EAGLE5 36.0.0
CHG-M2PA-TSET: MASP A - COMPLTD
```

3. Verify the changes by entering the `rtrv-m2pa-tset` command specifying the timer set and version parameter values specified in [Step 2](#). For this example, enter one of these commands.

```
rtrv-m2pa-tset:tset=1:ver=rfc
```

```
rlghncxa03w 06-10-28 21:16:37 GMT EAGLE5 36.0.0
M2PA RFC Timers (in msec, T16 in microsec)
TSET T1      T2      T3      T4N    T4E    T5      T6      T7      T16     T17    T18
1     27500   10000   3850   45000  450    5700   3750   1150   250000  375    8750
```

```
rtrv-m2pa-tset:tset=1:ver=d6
```

```
rlghncxa03w 06-10-28 21:16:37 GMT EAGLE5 36.0.0
M2PA Draft 6 Timers (in msec, T16 in microsec)
TSET T1      T2      T3      T4N    T4E    T5      T6      T7      T16     T17    T18
1     27500   ----- 3850   45000  450    5700   3750   1150   250000  375    8750
```

```
rtrv-m2pa-tset:tset=9:ver=rfc
```

```
rlghncxa03w 06-10-28 21:16:37 GMT EAGLE5 36.0.0
M2PA RFC Timers (in msec, T16 in microsec)
TSET T1      T2      T3      T4N    T4E    T5      T6      T7      T16     T17    T18
9     27500   10000   3850   45000  450    5700   3750   1150   250000  375    8750
```

```
rtrv-m2pa-tset:tset=9:ver=d6
```

```
rlghncxa03w 06-10-28 21:16:37 GMT EAGLE5 36.0.0
M2PA Draft 6 Timers (in msec, T16 in microsec)
TSET T1      T2      T3      T4N    T4E    T5      T6      T7      T16     T17    T18
9     27500   ----- 3850   45000  450    5700   3750   1150   250000  375    8750
```

4. Back up the new changes, using the `chg-db:action=backup:dest=fixed` command. These messages should appear; the active Maintenance and Administration Subsystem Processor (MASP) appears first.

```
BACKUP (FIXED) : MASP A - Backup starts on active MASP.
BACKUP (FIXED) : MASP A - Backup on active MASP to fixed disk complete.
```

```
BACKUP (FIXED) : MASP A - Backup starts on standby MASP.  
BACKUP (FIXED) : MASP A - Backup on standby MASP to fixed disk complete.
```

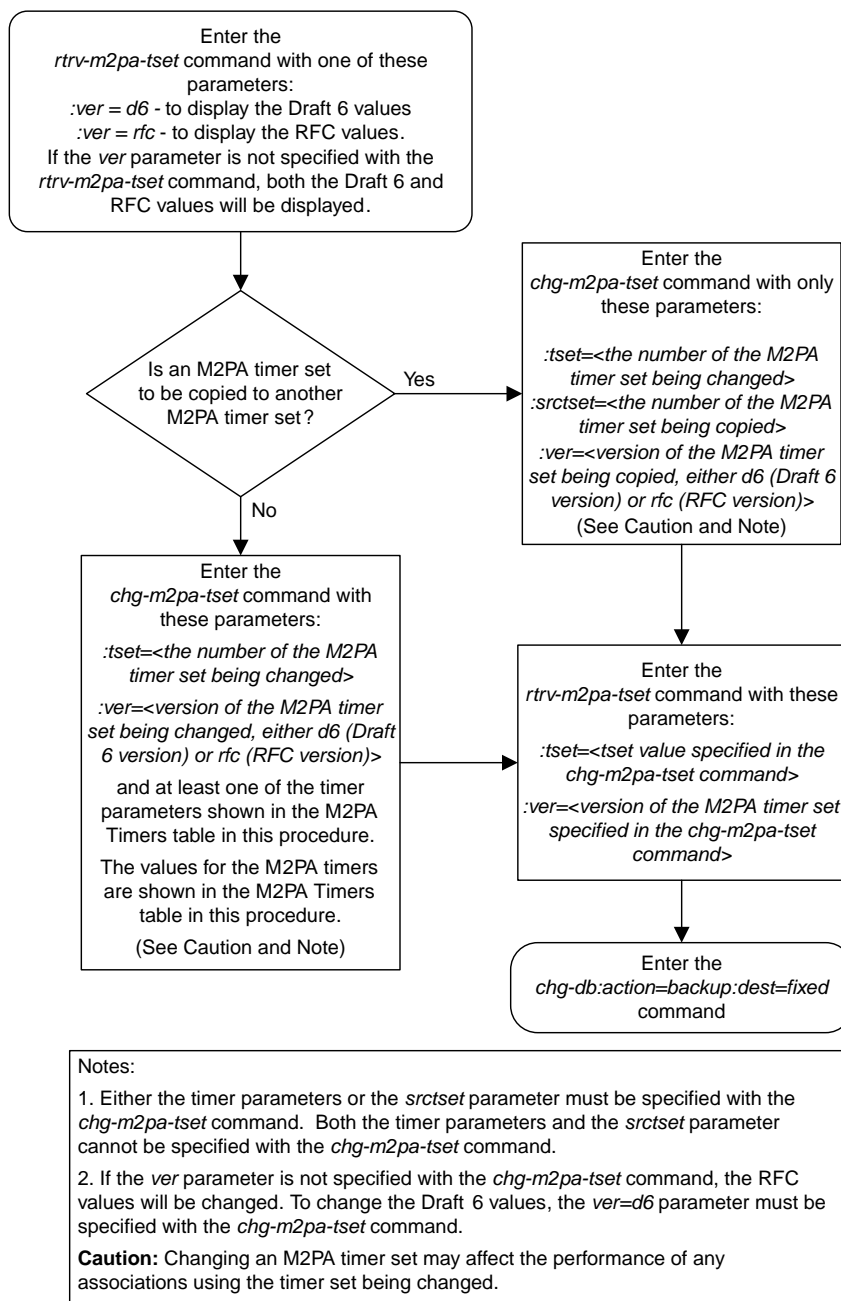

Figure 38: Changing an M2PA Timer Set

Changing the SCTP Checksum Algorithm Option for M2PA Associations

Use this procedure to change the SCTP checksum algorithm, either Adler-32 or CRC-32c, applied to traffic on SCTP associations. The `sctpchecksum` parameter of the `chg-sg-opts` command is used to change this option. The Adler-32 and CRC-32c checksum algorithms specified in this procedure applies to all the associations that are assigned to all the IP cards running the IPLIM or IPLIMI applications. This option is a system-wide option. To apply this option to associations assigned to cards running the SS7IPGW, IPGWI, or IPSG applications, perform these procedures.

- [Changing the SCTP Checksum Algorithm Option for IPSG M2PA Associations](#)
- [Changing the SCTP Checksum Algorithm Option for IPSG M3UA Associations](#)
- [Changing the SCTP Checksum Algorithm Option for M3UA and SUA Associations](#)

The `sctpchecksum` parameter contains another value, `percard`, that allows either the Adler-32 or CRC-32c SCTP checksum algorithm to be specified for the all the associations assigned to a specific card. With this option specified, the Adler-32 checksum algorithm can be specified for the associations on one card and the CRC-32c checksum algorithm can be specified for the associations on another card. Setting the `sctpchecksum` parameter to `percard` changes the SCTP checksum algorithm for the associations assigned to a card to the SCTP checksum algorithm value for that card. The checksum algorithm for individual cards is provisioned by performing the [Configuring an IP Card](#) procedure.

Once the SCTP checksum option has been changed, the associations on each IP card need to be reset by changing the `open` parameter value for each association to `no`, then back to `yes`. This ensures that the associations on the IP card are using the new SCTP checksum algorithm.

Canceling the RTRV-ASSOC Command

Because the `rtrv-assoc` command used in this procedure can output information for a long period of time, the `rtrv-assoc` command can be canceled and the output to the terminal stopped. There are three ways that the `rtrv-assoc` command can be canceled.

- Press the F9 function key on the keyboard at the terminal where the `rtrv-assoc` command was entered.
- Enter the `canc-cmd` without the `trm` parameter at the terminal where the `rtrv-assoc` command was entered.
- Enter the `canc-cmd:trm=<xx>`, where `<xx>` is the terminal where the `rtrv-assoc` command was entered, from another terminal other than the terminal where the `rtrv-assoc` command was entered. To enter the `canc-cmd:trm=<xx>` command, the terminal must allow Security Administration commands to be entered from it and the user must be allowed to enter Security Administration commands. The terminal's permissions can be verified with the `rtrv-secu-trm` command. The user's permissions can be verified with the `rtrv-user` or `rtrv-secu-user` commands.

For more information about the `canc-cmd` command, go to *Commands User's Guide*.

1. Display the current IP options in the database by entering the `rtrv-sg-opts` command. The following is an example of the possible output.

```
rlghncxa03w 06-10-28 21:16:37 GMT EAGLE5 36.0.0
SCTPCSUM:      adler32
```

The `rtrv-sg-opts` command output contains other fields that are not used by this procedure. If you wish to see all the fields displayed by the `rtrv-sg-opts` command, see the `rtrv-sg-opts` command description in *Commands User's Guide*.

2. Display the cards in the EAGLE by entering the `rtrv-card` command. This is an example of the possible output.

```
rlghncxa03w 13-05-28 09:12:36 GMT EAGLE5 45.0.0
CARD   TYPE      APPL      LSET NAME      LINK SLC LSET NAME      LINK SLC
1101   DSM        VSCCP
1102   TSM        GLS
1113   E5MCAP     EOAM
1114   E5TDM-A
1115   E5MCAP     EOAM
1116   E5TDM-B
1117   E5MDAL
1201   LIMDS0     SS7ANSI    sp2            A    0    sp1            B    0
1203   LIMDS0     SS7ANSI    sp3            A    0
1204   LIMDS0     SS7ANSI    sp3            A    1
1206   LIMDS0     SS7ANSI    nsp3           A    1    nsp4           B    1
1216   DCM        STPLAN
1301   LIMDS0     SS7ANSI    sp6            A    1    sp7            B    0
1302   LIMDS0     SS7ANSI    sp7            A    1    sp5            B    1
1303   DCM        IPLIM      ipnode1        A    0    ipnode3        B    1
1305   DCM        IPLIM      ipnode4        A    0
1307   DCM        STPLAN
1313   DCM        SS7IPGW    ipgtwy1        A    0
2101   DCM        SS7IPGW    ipgtwy2        A    0
2103   DCM        SS7IPGW    ipgtwy3        A    0
2105   DCM        IPLIM      ipnode1        A1   1    ipnode5        B    2
2205   DCM        IPLIM      ipnode3        A2   0    ipnode6        B1   2
2207   DCM        IPLIM      ipnode5        A    0    ipnode4        B3   1
2213   DCM        IPLIM      ipnode5        A3   1    ipnode3        B2   2
2301   DCM        IPLIM      ipnode6        A    0    ipnode1        B    2
2305   DCM        IPLIM      ipnode6        A1   1    ipnode1        B1   3
```

Record the card location, shown in the `LOC` column, and signaling link, shown in the `LINK` column, information for all cards running the `IPLIM` or `IPLIMI` applications.

3. Change the SCTP checksum option in the database using the `chg-sg-opts` command. For this example, enter this command.

```
chg-sg-opts:sctpcsum=crc32c
```

When this command has successfully completed, the following message should appear.

```
rlghncxa03w 06-10-28 21:19:37 GMT EAGLE5 36.0.0
CHG-SG-OPTS: MASP A - COMPLTD
```

Continue the procedure by performing one of these actions.

- If the `sctpcsum` parameter value was changed to either `adler32` or `crc32c`, continue the procedure with [Step 4](#).
- If the `sctpcsum` parameter value was changed to `percard`, perform the [Configuring an IP Card](#) procedure to assign an `sctpcsum` parameter value to all the cards running the `IPLIM` or `IPLIMI` applications. After the [Configuring an IP Card](#) procedure has been performed, continue the procedure with [Step 5](#).

- Verify that the SCTP checksum algorithm was changed using the `rtrv-sg-opts` command. The SCTP checksum algorithm option value is shown in the `SCTPCSUM` parameter. The following is an example of the possible output.

```
rlghncxa03w 06-10-28 21:16:37 GMT EAGLE5 36.0.0
SCTPCSUM:      crc32c
```

The `rtrv-sg-opts` command output contains other fields that are not used by this procedure. If you wish to see all the fields displayed by the `rtrv-sg-opts` command, see the `rtrv-sg-opts` command description in *Commands User's Guide*.

- Select one of the IP cards shown in the `rtrv-card` output in [Step 2](#) running the `IPLIM` or `IPLIMI` applications. Place the signaling links on this card out of service using the `dact-slk` command. For this example, enter these commands.

```
dact-slk:loc=1308:link=a1
dact-slk:loc=1308:link=b
dact-slk:loc=1308:link=b2
```

When these commands have successfully completed, this message appears.

```
rlghncxa03w 06-10-12 09:12:36 GMT EAGLE5 36.0.0
Deactivate Link message sent to card
```

- Display the IP addresses of the IP links in the database by entering the `rtrv-ip-lnk` command. The following is an example of the possible output.

```
rlghncxa03w 08-12-28 21:17:37 GMT EAGLE5 40.0.0
LOC  PORT  IPADDR          SUBMASK          DUPLEX  SPEED  MACTYPE  AUTO  MCAST
1202  A      192.1.1.10      255.255.255.0    HALF    10     DIX      NO    NO
1202  B      -----
1205  A      192.1.1.12      255.255.255.0    HALF    10     DIX      NO    NO
1205  B      -----
1207  A      192.1.1.14      255.255.255.0    HALF    10     DIX      NO    NO
1207  B      -----
1303  A      192.1.1.20      255.255.255.0    HALF    10     DIX      NO    NO
1303  B      -----
1305  A      192.1.1.22      255.255.255.0    HALF    10     DIX      NO    NO
1305  B      -----
1308  A      192.1.1.24      255.255.255.0    HALF    10     DIX      NO    NO
1308  B      -----
1315  A      192.1.1.50      255.255.255.0    HALF    10     DIX      NO    NO
1315  B      -----
1317  A      192.1.1.52      255.255.255.0    HALF    10     DIX      NO    NO
1317  B      -----
IP-LNK  table is (16 of 2048) 1% full.
```

- Display the current IP host information in the database by entering the `rtrv-ip-host:display=all` command. The following is an example of the possible output.

```
rlghncxa03w 08-12-28 21:17:37 GMT EAGLE5 40.0.0
LOCAL IPADDR      LOCAL HOST
```

```

192.1.1.10      IPNODE1-1201
192.1.1.12      IPNODE1-1203
192.1.1.14      IPNODE1-1205
192.1.1.20      IPNODE2-1201
192.1.1.22      IPNODE2-1203
192.1.1.24      IPNODE2-1205
192.1.1.32      KC-HLR2
192.1.1.50      DN-MS1
192.1.1.52      DN-MS2

REMOTE IPADDR  REMOTE HOST
150.1.1.5      NCDEPTECONOMIC_DEVELOPMENT. SOUTHEASTERN_COORIDOR_ASHVL. GOV

IP Host table is (10 of 4096) .24% full

```

8. Display the associations assigned to the IP card specified in [Step 5](#), using the `rtrv-assoc` command with the local host name of the associations assigned to the IP card. To find the local host name of the association, the card location of the IP card is assigned to an IP address in the IP link table (`rtrv-ip-lnk` output). The IP address is assigned to a hostname in the IP host table (`rtrv-ip-host` output).

For this example, the local host name of associations assigned to the IP card 1308 (the card specified in [Step 5](#)) is IPNODE2-1205. Enter this command.

```
rtrv-assoc:lhost=ipnode2-1205
```

The following is an example of the possible output.

```

rlghncxa03w 06-10-28 09:12:36 GMT EAGLE5 36.0.0
CARD IPLNK
ANAME          LOC  PORT  LINK ADAPTER  LPORT  RPORT  OPEN  ALW
assoc2         1308 A     A1   M2PA     2187   1025   YES   YES
assoc4         1308 A     B    M2PA     3290   1025   YES   YES
assoc5         1308 A     B2   M2PA     1057   1025   YES   YES

IP Appl Sock/Assoc table is (9 of 4000) 1% full
Assoc Buffer Space Used (600 KB of 3200 KB) on LOC = 1308

```

9. Change the value of the open parameter of the associations shown in [Step 8](#) to no by specifying the `chg-assoc` command with the `open=no` parameter. For this example, enter this command.

```
chg-assoc:aname=assoc2:open=no
```

```
chg-assoc:aname=assoc4:open=no
```

```
chg-assoc:aname=assoc5:open=no
```

When this command has successfully completed, this message should appear.

```

rlghncxa03w 06-10-28 09:12:36 GMT EAGLE5 36.0.0
CHG-ASSOC: MASP A - COMPLTD;

```

10. Change the value of the open parameter of the associations changed in [Step 9](#) to yes by specifying the `chg-assoc` command with the `open=yes` parameter. For this example, enter this command.

```
chg-assoc:aname=assoc2:open=yes
```

```
chg-assoc:aname=assoc4:open=yes
```



```
chg-assoc:aname=assoc5:open=yes
```

When this command has successfully completed, this message should appear.

```
rlghncxa03w 06-10-28 09:12:36 GMT EAGLE5 36.0.0
CHG-ASSOC: MASP A - COMPLTD;
```

11. Verify the checksum algorithm that is assigned to the associations shown in [Step 10](#) by entering the `sctp -a` pass command with the card location of the IP card specified in [Step 5](#) and the name of the associations specified in [Step 10](#). For this example, enter this command.

```
pass:loc=1308:cmd="sctp -a assoc2 "
```

The following is an example of the possible output.

```
rlghncxa03w 10-12-28 21:16:37 GMT EAGLE5 43.0.0
Aname          Local          Local Primary          Remote
              IP Address    Port   Address           Port
assoc2         192.1.1.24     2187   192.168.112.4    1025
              192.1.1.24
```

```

Configuration                               State
Retransmission Mode = LIN                    State = OPEN
Min. Retransmission Timeout = 10000          ULP association id = 18
Max. Retransmission Timeout = 800000        Number of nets = 2
Max. Number of Retries = 10                 Inbound Streams = 1
Min. Congestion Window = 3000               Outbound Streams = 2
      Inbound Streams = 2
      Outbound Streams = 2
Checksum Algorithm = crc32c
Send/Rcv Buffer Size = 204800
```

Nets Data

```
IP Address    192.168.112.4      State    Reachable
Port          1025                Primary  YES
MTU           1500                cwnd    16384
ssthresh      16384               RTO     120

IP Address    192.168.112.5      State    Reachable
Port          7777                Primary  NO
MTU           1500                cwnd    16384
ssthresh      16384               RTO     120
```

```

Last Net Sent To = 192.168.112.4
Last Net Rcvd From = 192.168.112.4
Over All Error Count = 0
Peers Rwnd = 13880
My Rwnd = 16384
Max Window = 16384
Initial Seq Number = 24130
Next Sending Seq Number = 124686
Last Acked Seq Number = 124669
Maximum Outbound Char Count = 16384
Current Outbound Char Count = 2112
Number Unsent Char Count = 0
Outbound Data Chunk Count = 16
Number Unsent = 0
Number To Retransmit = 0
```

```

        ip datagrams rcvd = 155402
ip datagrams with data chunks rcvd = 120844
        data chunks rcvd = 367908
        data chunks read = 367900
        dup tsns rcvd = 8
        sacks rcvd = 38734
        gap ack blocks rcvd = 3
        heartbeat requests rcvd = 135
        heartbeat acks rcvd = 52
        heartbeat requests sent = 52
        ip datagrams sent = 129254
ip datagrams with data chunks sent = 73084
        data chunks sent = 396330
        retransmit data chunks sent = 135
        sacks sent = 64872
        send failed = 0
        retransmit timer count = 0
        consecutive retransmit timeouts = 0
RTT between RMIN and RMAX inclusive = 6
        RTT greater than RMAX = 0
        fast retransmit count = 135
        rcv timer count = 0
        heartbeat timer count = 244
        none left tosend = 0
        none left rwnd gate = 5
        none left cwnd gate = 8

;

rlghncxa03w 10-12-28 21:16:37 GMT EAGLE5 43.0.0

SCTP command complete

```

```

rlghncxa03w 08-04-28 21:16:37 GMT EAGLE5 38.0.0
Aname          Local          Local   Primary      Remote
                IP Address      Port    Address      Port
assoc2         192.1.1.24      2187    192.168.112.4 1025
                192.1.1.24

Configuration                                     State
Retransmission Mode = LIN                          State = OPEN
Min. Retransmission Timeout = 10                   ULP association id = 18
Max. Retransmission Timeout = 800                  Number of nets = 2
Max. Number of Retries = 10                         Inbound Streams = 1
Min. Congestion Window = 3000                       Outbound Streams = 2
    Inbound Streams = 2
    Outbound Streams = 2
Checksum Algorithm = crc32c

Nets Data

IP Address      192.168.112.4      State      Reachable
Port            1025                Primary    YES
MTU             1500                cwnd      16384
ssthresh        16384                RTO       120

IP Address      192.168.112.5      State      Reachable
Port            7777                Primary    NO
MTU             1500                cwnd      16384
ssthresh        16384                RTO       120

```

```

        Last Net Sent To = 192.168.112.4
        Last Net Rcvd From = 192.168.112.4
    Over All Error Count = 0
        Peers Rwnd = 13880
        My Rwnd = 16384
        Max Window = 16384
        Initial Seq Number = 24130
    Next Sending Seq Number = 124686
        Last Acked Seq Number = 124669
    Maximum Outbound Char Count = 16384
    Current Outbound Char Count = 2112
        Number Unsent Char Count = 0
    Outbound Data Chunk Count = 16
        Number Unsent = 0
        Number To Retransmit = 0

    ip datagrams rcvd = 155402
ip datagrams with data chunks rcvd = 120844
    data chunks rcvd = 367908
    data chunks read = 367900
    dup tsns rcvd = 8
    sacks rcvd = 38734
    gap ack blocks rcvd = 3
    heartbeat requests rcvd = 135
    heartbeat acks rcvd = 52
    heartbeat requests sent = 52
    ip datagrams sent = 129254
ip datagrams with data chunks sent = 73084
    data chunks sent = 396330
    retransmit data chunks sent = 135
    sacks sent = 64872
    send failed = 0
    retransmit timer count = 0
    consecutive retransmit timeouts = 0
    RTT between RMIN and RMAX inclusive = 6
    RTT greater than RMAX = 0
    fast retransmit count = 135
    rcv timer count = 0
    heartbeat timer count = 244
    none left tosend = 0
    none left rwnd gate = 5
    none left cwnd gate = 8

;

    rlghncxa03w 08-04-28 21:16:37 GMT EAGLE5 38.0.0

    SCTP command complete

```

```
pass:loc=1308:cmd="sctp -a assoc4 "
```

The following is an example of the possible output.

```

    rlghncxa03w 10-12-28 21:16:37 GMT EAGLE5 43.0.0
    Aname          Local          Local   Primary      Remote
                   IP Address      Port    Address      Port
    assoc4         192.1.1.24    3290   192.168.112.4 1025
                   192.1.1.24

```

Configuration State

```

Retransmission Mode = LIN                State = OPEN
Min. Retransmission Timeout = 10000      ULP association id = 18
Max. Retransmission Timeout = 800000     Number of nets = 2
Max. Number of Retries = 10              Inbound Streams = 1
Min. Congestion Window = 3000            Outbound Streams = 2
Inbound Streams = 2
Outbound Streams = 2
Checksum Algorithm = crc32c
Send/Rcv Buffer Size = 204800

```

Nets Data

IP Address	192.168.112.4	State	Reachable
Port	1025	Primary	YES
MTU	1500	cwnd	16384
ssthresh	16384	RTO	120
IP Address	192.168.112.5	State	Reachable
Port	7777	Primary	NO
MTU	1500	cwnd	16384
ssthresh	16384	RTO	120

```

Last Net Sent To = 192.168.112.4
Last Net Rcvd From = 192.168.112.4
Over All Error Count = 0
Peers Rwnd = 13880
My Rwnd = 16384
Max Window = 16384
Initial Seq Number = 24130
Next Sending Seq Number = 124686
Last Acked Seq Number = 124669
Maximum Outbound Char Count = 16384
Current Outbound Char Count = 2112
Number Unsent Char Count = 0
Outbound Data Chunk Count = 16
Number Unsent = 0
Number To Retransmit = 0

ip datagrams rcvd = 155402
ip datagrams with data chunks rcvd = 120844
data chunks rcvd = 367908
data chunks read = 367900
dup tsns rcvd = 8
sacks rcvd = 38734
gap ack blocks rcvd = 3
heartbeat requests rcvd = 135
heartbeat acks rcvd = 52
heartbeat requests sent = 52
ip datagrams sent = 129254
ip datagrams with data chunks sent = 73084
data chunks sent = 396330
retransmit data chunks sent = 135
sacks sent = 64872
send failed = 0
retransmit timer count = 0
consecutive retransmit timeouts = 0
RTT between RMIN and RMAX inclusive = 6
RTT greater than RMAX = 0
fast retransmit count = 135
recv timer count = 0
heartbeat timer count = 244
none left tosend = 0

```

```

        none left rwnd gate = 5
        none left cwnd gate = 8

;

rlghncxa03w 10-12-28 21:16:37 GMT EAGLE5 43.0.0

SCTP command complete

rlghncxa03w 08-04-28 21:16:37 GMT EAGLE5 38.0.0
Aname           Local           Local Primary           Remote
                IP Address      Port   Address            Port
assoc4          192.1.1.24      3290   192.168.112.4     1025
                192.1.1.24

Configuration                                     State
Retransmission Mode = LIN                         State = OPEN
Min. Retransmission Timeout = 10                   ULP association id = 18
Max. Retransmission Timeout = 800                 Number of nets = 2
Max. Number of Retries = 10                       Inbound Streams = 1
Min. Congestion Window = 3000                     Outbound Streams = 2
    Inbound Streams = 2
    Outbound Streams = 2
Checksum Algorithm = crc32c

Nets Data

IP Address      192.168.112.4      State      Reachable
Port            1025               Primary    YES
MTU             1500               cwnd       16384
ssthresh        16384              RTO        120

IP Address      192.168.112.5      State      Reachable
Port            7777               Primary    NO
MTU             1500               cwnd       16384
ssthresh        16384              RTO        120

Last Net Sent To = 192.168.112.4
Last Net Rcvd From = 192.168.112.4
Over All Error Count = 0
    Peers Rwnd = 13880
    My Rwnd = 16384
    Max Window = 16384
    Initial Seq Number = 24130
    Next Sending Seq Number = 124686
    Last Acked Seq Number = 124669
Maximum Outbound Char Count = 16384
Current Outbound Char Count = 2112
Number Unsent Char Count = 0
Outbound Data Chunk Count = 16
    Number Unsent = 0
    Number To Retransmit = 0

ip datagrams rcvd = 155402
ip datagrams with data chunks rcvd = 120844
    data chunks rcvd = 367908
    data chunks read = 367900
    dup tsns rcvd = 8
    sacks rcvd = 38734
gap ack blocks rcvd = 3

```

```

        heartbeat requests rcvd = 135
          heartbeat acks rcvd = 52
        heartbeat requests sent = 52
          ip datagrams sent = 129254
    ip datagrams with data chunks sent = 73084
          data chunks sent = 396330
        retransmit data chunks sent = 135
          sacks sent = 64872
          send failed = 0
        retransmit timer count = 0
        consecutive retransmit timeouts = 0
    RTT between RMIN and RMAX inclusive = 6
        RTT greater than RMAX = 0
        fast retransmit count = 135
          rcv timer count = 0
        heartbeat timer count = 244
          none left tosend = 0
          none left rwnd gate = 5
          none left cwnd gate = 8
;

    rlghncxa03w 08-04-28 21:16:37 GMT EAGLE5 38.0.0

    SCTP command complete

```

```
pass:loc=1308:cmd="sctp -a assoc5 "
```

The following is an example of the possible output.

```

    rlghncxa03w 10-12-28 21:16:37 GMT EAGLE5 43.0.0
    Aname          Local          Local   Primary      Remote
                   IP Address      Port    Address      Port
    assoc5         192.1.1.24      1057    192.168.112.4 1025
                   192.1.1.24

```

Configuration		State	
Retransmission Mode =	LIN	State =	OPEN
Min. Retransmission Timeout =	10000	ULP association id =	18
Max. Retransmission Timeout =	800000	Number of nets =	2
Max. Number of Retries =	10	Inbound Streams =	1
Min. Congestion Window =	3000	Outbound Streams =	2
Inbound Streams =	2		
Outbound Streams =	2		
Checksum Algorithm =	crc32c		
Send/Rcv Buffer Size =	204800		

Nets Data			
IP Address	192.168.112.4	State	Reachable
Port	1025	Primary	YES
MTU	1500	cwnd	16384
ssthresh	16384	RTO	120
IP Address	192.168.112.5	State	Reachable
Port	7777	Primary	NO
MTU	1500	cwnd	16384
ssthresh	16384	RTO	120

```

        Last Net Sent To = 192.168.112.4
        Last Net Rcvd From = 192.168.112.4

```

```

Over All Eror Count = 0
    Peers Rwnd = 13880
        My Rwnd = 16384
        Max Window = 16384
    Initial Seq Number = 24130
    Next Sending Seq Number = 124686
    Last Acked Seq Number = 124669
Maximum Outbound Char Count = 16384
Current Outbound Char Count = 2112
    Number Unsent Char Count = 0
Outbound Data Chunk Count = 16
    Number Unsent = 0
    Number To Retransmit = 0

ip datagrams rcvd = 155402
ip datagrams with data chunks rcvd = 120844
    data chunks rcvd = 367908
    data chunks read = 367900
    dup tsns rcvd = 8
    sacks rcvd = 38734
    gap ack blocks rcvd = 3
    heartbeat requests rcvd = 135
    heartbeat acks rcvd = 52
    heartbeat requests sent = 52
    ip datagrams sent = 129254
ip datagrams with data chunks sent = 73084
    data chunks sent = 396330
    retransmit data chunks sent = 135
        sacks sent = 64872
        send failed = 0
    retransmit timer count = 0
    consecutive retransmit timeouts = 0
RTT between RMIN and RMAX inclusive = 6
    RTT greater than RMAX = 0
    fast retransmit count = 135
    rcv timer count = 0
    heartbeat timer count = 244
    none left tosend = 0
    none left rwnd gate = 5
    none left cwnd gate = 8

;

rlghncxa03w 10-12-28 21:16:37 GMT EAGLE5 43.0.0

SCTP command complete

rlghncxa03w 08-04-28 21:16:37 GMT EAGLE5 38.0.0
Aname          Local          Local Primary      Remote
              IP Address    Port   Address      Port
assoc5         192.1.1.24    1057   192.168.112.4 1025
              192.1.1.24

Configuration                                     State
Retransmission Mode = LIN                          State = OPEN
Min. Retransmission Timeout = 10                    ULP association id = 18
Max. Retransmission Timeout = 800                   Number of nets = 2
Max. Number of Retries = 10                          Inbound Streams = 1
Min. Congestion Window = 3000                        Outbound Streams = 2
    Inbound Streams = 2
    Outbound Streams = 2

```

```

Checksum Algorithm = crc32c

                                Nets Data

IP Address      192.168.112.4      State      Reachable
  Port          1025                Primary    YES
  MTU           1500                cwnd      16384
  ssthresh      16384                RTO       120

IP Address      192.168.112.5      State      Reachable
  Port          7777                Primary    NO
  MTU           1500                cwnd      16384
  ssthresh      16384                RTO       120

      Last Net Sent To = 192.168.112.4
      Last Net Rcvd From = 192.168.112.4
      Over All Eror Count = 0
          Peers Rwnd = 13880
          My Rwnd = 16384
          Max Window = 16384
          Initial Seq Number = 24130
          Next Sending Seq Number = 124686
          Last Acked Seq Number = 124669
      Maximum Outbound Char Count = 16384
      Current Outbound Char Count = 2112
          Number Unsent Char Count = 0
          Outbound Data Chunk Count = 16
              Number Unsent = 0
          Number To Retransmit = 0

      ip datagrams rcvd = 155402
ip datagrams with data chunks rcvd = 120844
      data chunks rcvd = 367908
      data chunks read = 367900
          dup tsns rcvd = 8
          sacks rcvd = 38734
      gap ack blocks rcvd = 3
      heartbeat requests rcvd = 135
      heartbeat acks rcvd = 52
      heartbeat requests sent = 52
          ip datagrams sent = 129254
ip datagrams with data chunks sent = 73084
      data chunks sent = 396330
      retransmit data chunks sent = 135
          sacks sent = 64872
          send failed = 0
      retransmit timer count = 0
      consecutive retransmit timeouts = 0
      RTT between RMIN and RMAX inclusive = 6
          RTT greater than RMAX = 0
      fast retransmit count = 135
          rcv timer count = 0
      heartbeat timer count = 244
          none left tosend = 0
          none left rwnd gate = 5
          none left cwnd gate = 8

;

rlghncxa03w 08-04-28 21:16:37 GMT EAGLE5 38.0.0

```



```
SCTP command complete
```

If the checksum algorithm shown in any of the associations displayed in this step do not match the checksum algorithm specified in [Step 3](#), contact the Customer Care Center. Refer to [My Oracle Support \(MOS\)](#) for the contact information.

If the checksum algorithm shown in all of the associations displayed in this step match the checksum algorithm specified in [Step 3](#), continue the procedure with [Step 12](#).

12. Put the signaling links that were placed out of service in [Step 5](#) back into service using the `act-slk` command. For example, enter this command.

```
act-slk:loc=1308:link=a1
```

```
act-slk:loc=1308:link=b
```

```
act-slk:loc=1308:link=b2
```

When these commands have successfully completed, this message appears.

```
rlghncxa03w 06-10-07 11:11:28 GMT EAGLE5 36.0.0
Activate Link message sent to card
```

13. Verify the in-service normal (IS-NR) status of the signaling link by using the `rept-stat-slk` command and specifying the card location and link values specified in [Step 12](#).

For example, enter these commands.

```
rept-stat-slk:loc=1308:link=a1
```

This message should appear.

```
rlghncxa03w 06-10-28 21:16:37 GMT EAGLE5 36.0.0
SLK      LSN      CLLI      PST      SST      AST
1308,A1  ipnode1  -----  IS-NR    Avail    ----
Command Completed.
```

```
rept-stat-slk:loc=1308:link=b
```

This message should appear.

```
rlghncxa03w 06-10-28 21:16:37 GMT EAGLE5 36.0.0
SLK      LSN      CLLI      PST      SST      AST
1308,B   ipnode3  -----  IS-NR    Avail    ----
Command Completed.
```

```
rept-stat-slk:loc=1308:link=b2
```

This message should appear.

```
rlghncxa03w 06-10-28 21:16:37 GMT EAGLE5 36.0.0
SLK      LSN      CLLI      PST      SST      AST
1308,B2  ipnode4  -----  IS-NR    Avail    ----
Command Completed.
```

14. Enter the `netstat -p sctp` pass command with the card location of the IP card to determine if any errors have occurred. For this example, enter this command.

```
pass:loc=1308:cmd="netstat -p sctp"
```

The following is an example of the possible output.

```
rlghncxa03w 08-04-28 21:16:37 GMT EAGLE5 38.0.0
ip packets sent..... 1474882
  ip packets sent with data chunk..... 306354
  control chunks (excluding retransmissions)..... 1172759
  ordered data chunks (excluding retransmissions).. 1534350
  unordered data chunks (excluding retransmissions) 0
  user messages fragmented due to MTU..... 0
  retransmit data chunks sent..... 4
  sacks sent..... 496302
  send failed..... 0
ip packets received..... 1816035
  ip packets received with data chunk..... 989957
  control chunks (excluding duplicates)..... 833141
  ordered data chunks (excluding duplicates)..... 989968
  unordered data chunks (excluding duplicates).... 0
  user messages reassembled..... 0
  data chunks read..... 988601
  duplicate tsns received..... 0
  sacks received..... 153763
  gap ack blocks received..... 0
  out of the blue..... 4
  with invalid checksum..... 0
connections established..... 2954
  by upper layer..... 0
  by remote endpoint..... 2958
connections terminated..... 4
  ungracefully..... 2952
  gracefully..... 0
associations dropped due to retransmits..... 0
consecutive retransmit timeouts..... 4
retransmit timer count..... 6
fast retransmit count..... 0
heartbeat requests received..... 330275
heartbeat acks received..... 340239
heartbeat requests sent..... 340258
associations supported..... 50
milliseconds cookie life at 4-way start-up handshake. 5000
retransmission attempts allowed at start-up phase.... 8

;

rlghncxa03w 08-04-28 21:16:37 GMT EAGLE5 38.0.0

NETSTAT command complete
```

If errors are shown in the pass command output, contact the Customer Care Center. Refer to [My Oracle Support \(MOS\)](#) for the contact information.

15. Repeat [Step 5](#) through [Step 14](#) to update the other IP cards in the EAGLE running the IPLIM and IPLIMI applications with the new SCTP checksum algorithm.

If the `rtrv-card` output in [Step 2](#) shows cards running the SS7IPGW, IPGWI, or IPGS applications, continue the procedure with [Step 17](#).

16. Back up the database by entering the `chg-db:action=backup:dest=fixed` command. These messages should appear, the active Maintenance and Administration Subsystem Processor (MASP) appears first.

```
BACKUP (FIXED) : MASP A - Backup starts on active MASP.  
BACKUP (FIXED) : MASP A - Backup on active MASP to fixed disk complete.  
BACKUP (FIXED) : MASP A - Backup starts on standby MASP.  
BACKUP (FIXED) : MASP A - Backup on standby MASP to fixed disk complete.
```

17. If the `rtrv-card` output in [Step 2](#) shows cards running the SS7IPGW or IPGWI applications, perform the [Changing the SCTP Checksum Algorithm Option for M3UA and SUA Associations](#) procedure.

If the `rtrv-card` output in [Step 2](#) shows cards running the IPSP application, perform these procedures.

- [Changing the SCTP Checksum Algorithm Option for IPSP M3UA Associations](#)
- [Changing the SCTP Checksum Algorithm Option for IPSP M2PA Associations](#)

If the `rtrv-card` output in [Step 2](#) shows that there are no cards running the SS7IPGW, IPGWI, or IPSP applications, this procedure is finished.

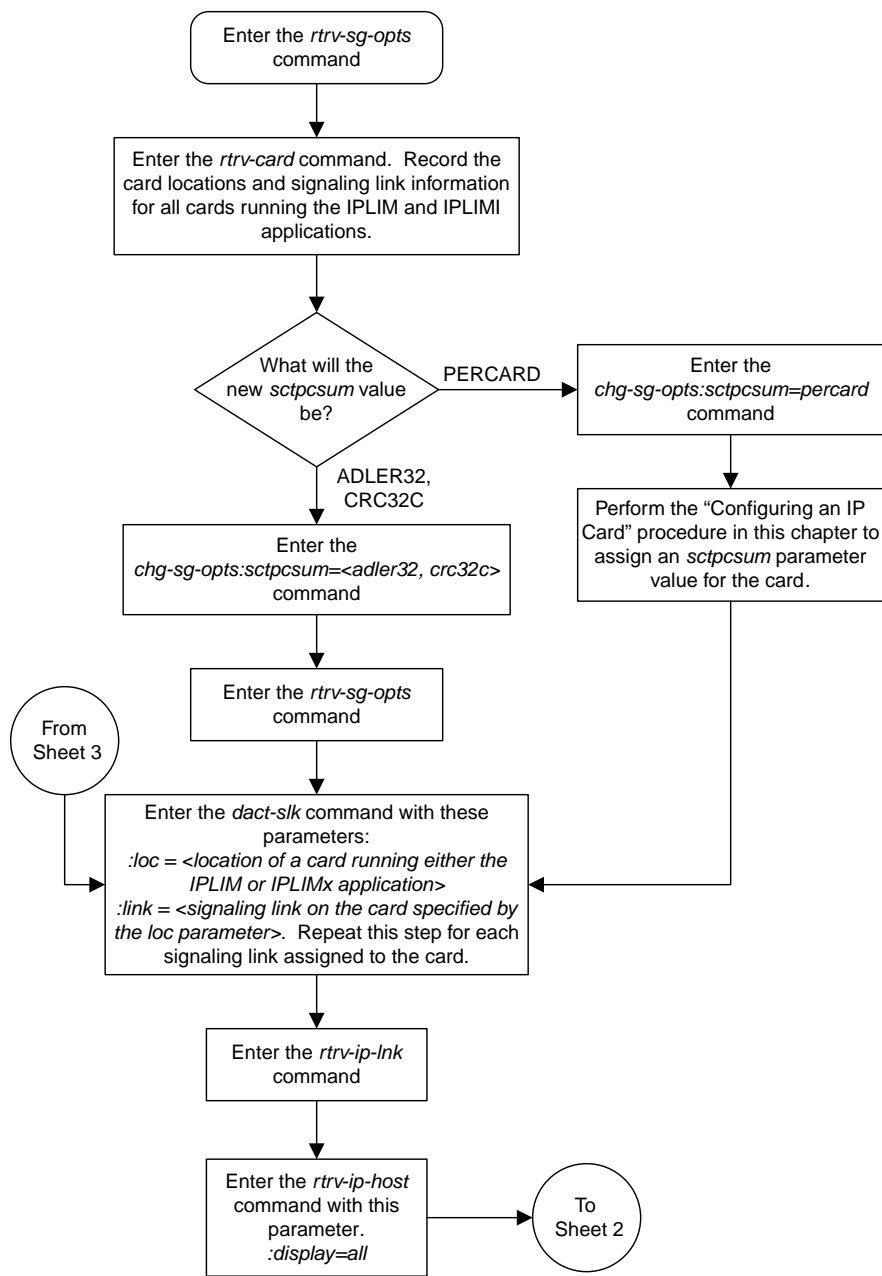

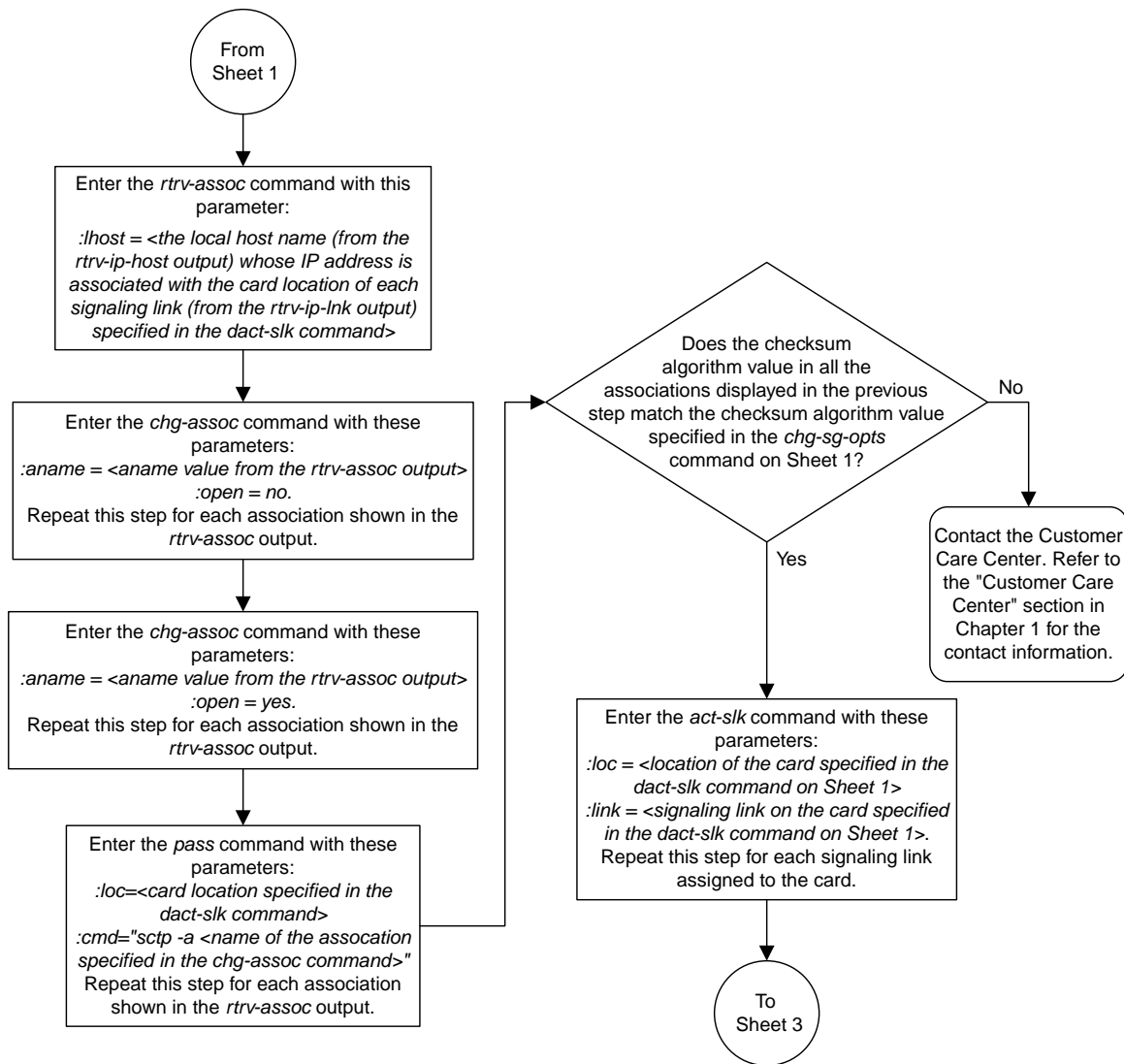

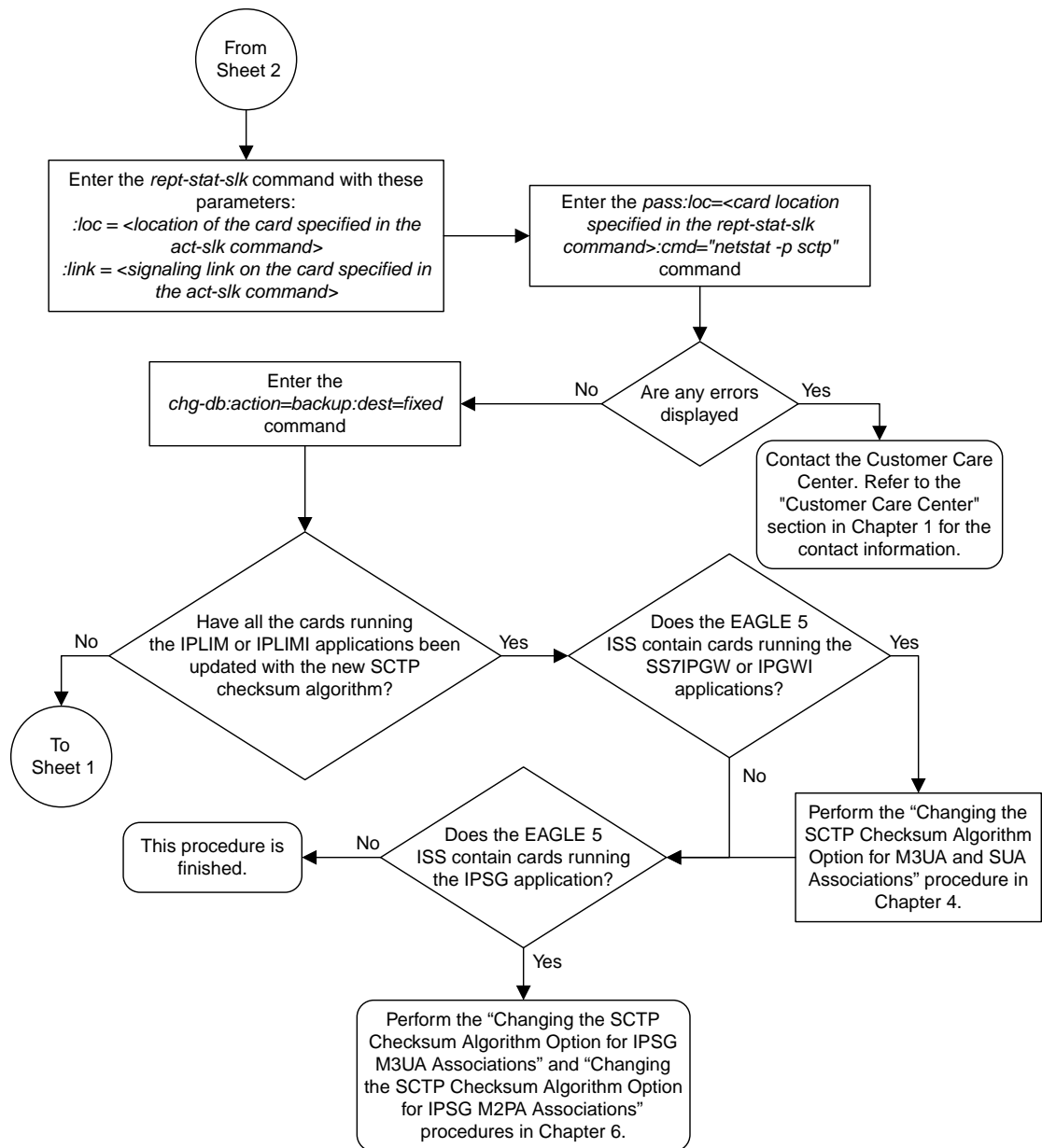

Sheet 3 of 3

Figure 39: Changing the SCTP Checksum Algorithm Option for M2PA Associations

Turning Off the Large MSU Support for IP Signaling Feature

This procedure is used to turn off the Large MSU Support for IP Signaling feature, using the `chg-ctrl-feat` command.

The `chg-ctrl-feat` command uses these parameters:

`:partnum` – The part number of the Large MSU Support for IP Signaling feature, 893018401.

`:status=off` – used to turn off the Large MSU Support for IP Signaling feature.

The status of the Large MSU Support for IP Signaling feature must be on and is shown with the `rtrv-ctrl-feat` command.



Caution: If the Large MSU Support for IP Signaling feature is turned off, the EAGLE will not process messages with a signaling information field (SIF) that is larger than 272 bytes.

1. Display the status of the Large MSU Support for IP Signaling feature by entering the `rtrv-ctrl-feat:partnum=893018401` command. The following is an example of the possible output.

```
rlghncxa03w 10-04-28 21:15:37 GMT EAGLE5 42.0.0
The following features have been permanently enabled:

Feature Name          Partnum    Status    Quantity
Large MSU for IP Sig  893018401  on       ----

The following features have been temporarily enabled:

Feature Name          Partnum    Status    Quantity    Trial Period Left
Zero entries found.

The following features have expired temporary keys:

Feature Name          Partnum
Zero entries found.
```

If the status of the Large MSU Support for IP Signaling feature is off, or if the Large MSU Support for IP Signaling feature is not enabled, this procedure cannot be performed.

2. Turn off the Large MSU Support for IP Signaling feature by entering the `chg-ctrl-feat` command with the `status=off` parameter. For example, enter this command.

```
chg-ctrl-feat:partnum=893018401:status=off
```

When this command has successfully completed, the following message should appear.

```
rlghncxa03w 06-10-28 21:15:37 GMT EAGLE5 36.0.0
CHG-CTRL-FEAT: MASP B - COMPLTD
```

3. Verify that the Large MSU Support for IP Signaling feature has been turned off by using the `rtrv-ctrl-feat:partnum=893018401` command. The following is an example of the possible output.

```
rlghncxa03w 10-04-28 21:15:37 GMT EAGLE5 42.0.0
The following features have been permanently enabled:

Feature Name           Partnum   Status   Quantity
Large MSU for IP Sig   893018401 off      ----

The following features have been temporarily enabled:

Feature Name           Partnum   Status   Quantity   Trial Period Left
Zero entries found.

The following features have expired temporary keys:

Feature Name           Partnum
Zero entries found.
```

4. Back up the new changes using the `chg-db:action=backup:dest=fixed` command. These messages should appear, the active Maintenance and Administration Subsystem Processor (MASP) appears first.

```
BACKUP (FIXED) : MASP A - Backup starts on active MASP.
BACKUP (FIXED) : MASP A - Backup on active MASP to fixed disk complete.
BACKUP (FIXED) : MASP A - Backup starts on standby MASP.
BACKUP (FIXED) : MASP A - Backup on standby MASP to fixed disk complete.
```

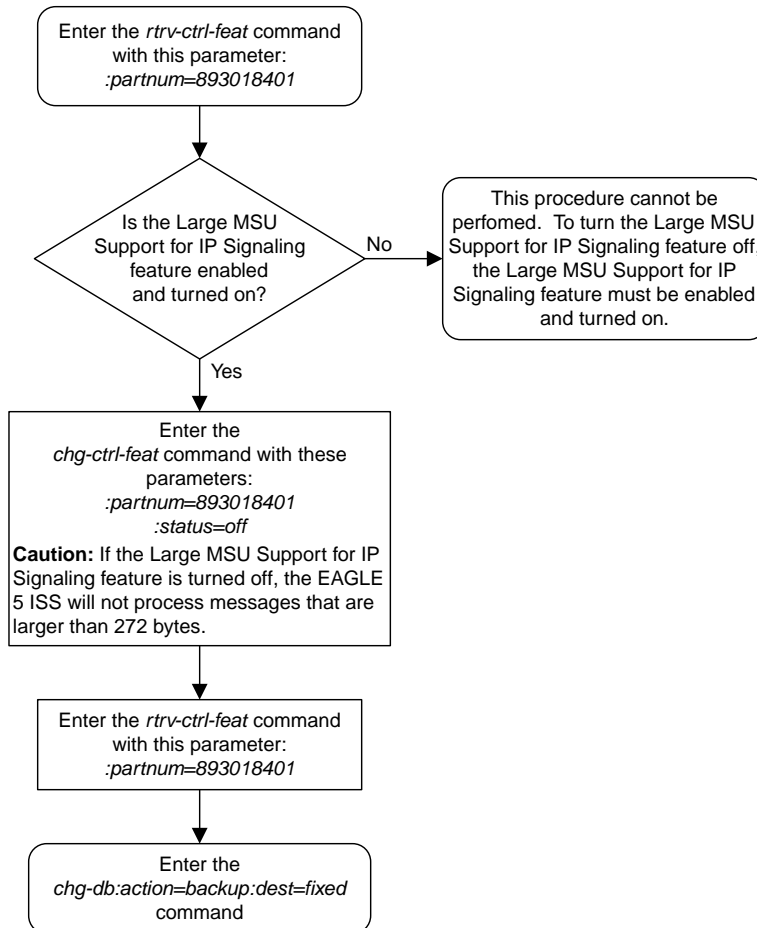



Figure 40: Turning Off the Large MSU Support for IP Signaling Feature

Chapter 4

IETF M3UA and SUA Configuration Procedures

Topics:

- [Adding IETF M3UA and SUA Components...276](#)
- [Adding an IPGWx Card.....277](#)
- [Configuring an IPGWx Linkset.....286](#)
- [Adding a Mate IPGWx Linkset to another IPGWx Linkset.....315](#)
- [Adding an IPGWx Signaling Link.....329](#)
- [Configuring an IP Link.....343](#)
- [Adding an IP Host.....362](#)
- [Configuring an IP Card.....366](#)
- [Adding an IP Route.....378](#)
- [Adding an M3UA or SUA Association.....385](#)
- [Adding a New Association to a New Application Server.....396](#)
- [Adding an Existing Association to a New Application Server.....405](#)
- [Adding a New Association to an Existing Application Server.....416](#)
- [Adding an Existing Association to an Existing Application Server.....428](#)
- [Adding a Routing Key Containing an Application Server.....440](#)
- [Adding a Network Appearance.....460](#)
- [Activating the Large MSU Support for IP Signaling Feature.....467](#)
- [Removing IETF M3UA and SUA Components.....476](#)
- [Removing an IPGWx Card.....476](#)
- [Removing an IPGWx Signaling Link.....479](#)
- [Removing a Mate IPGWx Linkset from another IPGWx Linkset.....488](#)
- [Removing an IP Host Assigned to an IPGWx Card.....500](#)

Chapter 4, IETF M3UA and SUA Configuration Procedures, describes the procedures necessary to configure the components necessary to establish IP connections using M3UA or SUA associations on IPGWx signaling links.

- *Removing an IP Route.....505*
- *Removing a M3UA or SUA Association.....509*
- *Removing an Association from an Application Server.....513*
- *Removing a Routing Key Containing an Application Server.....519*
- *Removing a Network Appearance.....528*
- *Changing IETF M3UA and SUA Components.....531*
- *Changing IP Options.....531*
- *Changing the Attributes of a M3UA or SUA Association.....535*
- *Changing the Buffer Size of a M3UA or SUA Association.....553*
- *Changing the Host Values of a M3UA or SUA Association.....564*
- *Configuring SCTP Retransmission Control for a M3UA or SUA Association.....580*
- *Changing an Application Server.....589*
- *Changing the CIC Values in an Existing Routing Key Containing an Application Server.....595*
- *Changing the Routing Context Value in an Existing Routing Key.....605*
- *Changing the SCTP Checksum Algorithm Option for M3UA and SUA Associations.....612*
- *Changing a UA Parameter Set.....633*
- *Turning Off the Large MSU Support for IP Signaling Feature.....645*

Adding IETF M3UA and SUA Components

This section describes how to configure the components necessary to establish IP connections using M3UA or SUA associations on IPGWx signaling links. IPGWx signaling links are signaling links assigned to cards running either the SS7IPGW or IPGWI applications. The SS7IPGW application supports point-to-multipoint connectivity for ANSI networks. The IPGWI application supports point-to-multipoint connectivity for ITU networks.

The configuration of these IP connections consists of these items.

1. Configure the IPGWx card with the [Adding an IPGWx Card](#) procedure. Turn the ISUP-over-IP (`ipisup`) feature with the `chg-feat` command.

Note: Before turning on the ISUP-over-IP feature (`ipisup`) feature, make sure you have purchased these features. If you are not sure whether you have purchased the ISUP-over-IP feature, contact your Oracle Sales Representative or Account Representative. Once a feature has been turned on with the `chg-feat` command, the feature cannot be turned off.

2. Configure the required destination point codes - see Chapter 2, "Configuring Destination Tables," in *Database Administration - SS7 User's Guide*.
3. Configure the required IPGWx linksets with the [Configuring an IPGWx Linkset](#) procedure. If you wish to add a mate IPGWx linkset to another IPGWx linkset, perform the [Adding a Mate IPGWx Linkset to another IPGWx Linkset](#) procedure.
4. Configure the IPGWx signaling links with the [Adding an IPGWx Signaling Link](#) procedure. If the addition of these signaling links will exceed the current number of signaling links the EAGLE is allowed to have, the [Enabling the Large System # Links Controlled Feature](#) procedure will have to be performed to increase the quantity of signaling links.
5. Configure the required routes - see Chapter 3, "SS7 Configuration," in *Database Administration - SS7 User's Guide*.
6. IP addresses must be assigned to the IPGWx card configured in step 1 by performing the [Configuring an IP Link](#) procedure. There are other IP link parameters that are assigned to the IPGWx card when the IPGWx card is configured. Default values are assigned to these parameters when the IPGWx card is configured. These values can be displayed by the `rtrv-ip-lnk` command. These values can be changed by performing the [Configuring an IP Link](#) procedure.
7. Local IP hosts, assigned to the IP addresses assigned to step 6, must be configured in the database by performing the [Adding an IP Host](#) procedure. Verify the hosts with the `rtrv-ip-host` command. This establishes a relationship between the IP card related information and the connection related information.
8. When the IP cards are added to the database in step 1, there are IP parameters that control the IP stack that are assigned default values. These parameter values can be displayed by the `rtrv-ip-card` command. These values can be changed by performing the [Configuring an IP Card](#) procedure.
9. Static IP routes provide more flexibility in selecting the path to the remote destination and reduces the dependence on default routers. Static IP routes are provisioned by performing the [Adding an IP Route](#) procedure.
10. Associations specify a connection between a local host/TCP port and a remote host/TCP port. Three types of associations can be provisioned: M2PA, M3UA, and SUA. Associations that are assigned to IPGWx signaling links must be either M3UA or SUA associations. The M3UA and SUA associations are configured by performing the [Adding an M3UA or SUA Association](#) procedure. M2PA associations that are assigned to IPLIMx signaling links are provisioned with the [Adding an](#)

M2PA Association procedure in *IETF M2PA Configuration Procedures*. Associations can be assigned to IPSP signaling links also. These associations are configured by performing the *Adding an IPSP M2PA Association* or *Adding an IPSP M3UA Association* procedures. A number of fields in the association cannot be configured with the *Adding an M3UA or SUA Association* procedure and are set to default values. The values of these fields can be displayed using the `rtrv-assoc` command after the *Adding an M3UA or SUA Association* procedure is performed. These values can be changed by performing these procedures: *Changing the Attributes of a M3UA or SUA Association*, *Changing the Buffer Size of a M3UA or SUA Association*. Only one signaling link can be assigned to an IPGWx card. A maximum of 50 IP connections can be assigned to an IPGWx card.

11. When an M3UA or SUA association is added to the database, UA parameter set 10 is assigned to the association. There are 10 UA parameter sets that can be assigned to an association, but the UA parameter set assignment can be changed, using the *Changing the Attributes of a M3UA or SUA Association* procedure. The values assigned to each UA parameter set can be changed, except for UA parameter set 10, using the *Changing a UA Parameter Set* procedure.
12. The application server contains a set of one to 16 associations, of which one or more is normally actively processing traffic. Application servers are configured by performing one of these procedures:
 - *Adding a New Association to a New Application Server*
 - *Adding an Existing Association to a New Application Server*
 - *Adding a New Association to an Existing Application Server*
 - *Adding an Existing Association to an Existing Application Server*

If the associations assigned to application server are M3UA associations, and the `open` parameter value for these associations is `yes`, then the same UA parameter set must be assigned to all of the associations in the application server.

13. Routing keys specify MSU filters for the IP connection. Configure the routing keys with the *Adding a Routing Key Containing an Application Server* procedure.
14. An internal point code can be provisioned to provide routing to an IP end office node. Configure the internal point codes by performing the *Adding an End Node Internal Point Code* procedure.
15. The network appearance field identifies the SS7 network context for the message, for the purpose of logically separating the signaling traffic between the SGP (signaling gateway process) and the application server over a common SCTP (stream control transmission protocol) association. This field is contained in the DATA, DUNA, DAVA, DRST, DAUD, SCON, and DUPU messages. Network appearances are configured by performing the *Adding a Network Appearance* procedure.
16. The EAGLE processes messages with a service information field (SIF) that is 272 bytes or smaller. The Large MSU Support for IP Signaling feature allows the EAGLE to process messages with a service indicator value of 6 to 15 and with a SIF that is larger than 272 bytes. Perform the *Activating the Large MSU Support for IP Signaling Feature* procedure to enable and turn on the Large MSU Support for IP Signaling feature.

Adding an IPGWx Card

This procedure is used to add an IPGWx card to the database using the `ent-card` command. An IPGWx card is a card that is running either the SS7IPGW or IPGWI applications. *Table 21: IPGWx Card Types* shows the cards that can be provisioned in this procedure.

Table 21: IPGWx Card Types

Card Type	Part Number
E5-ENET	870-2212-xx
E5-ENET-B	870-2971-xx

The EAGLE can support a combination of E5-ENET and E5-ENET-B cards.

The `ent-card` command uses these parameters.

`:loc` – The location of the card being added to the database.

`:type` – The type of card being added to the database. For this procedure, the value of this parameter is `dcm`.

`:appl` – The application software that is assigned to the card. For this procedure, the value of this parameter is `ss7ipgw` for ANSI IP network connections or `ipgwi` for ITU IP network connections.

`:force` – If the global title translation feature is on, the `force=yes` parameter allows the LIM to be added to the database even if the current SCCP transactions-per-second threshold is unable to support the additional SCCP transaction-per-second capacity created by adding the IP card. This parameter is obsolete and is no longer used.

If you have purchased the ISUP-over-IP (`ipisup`) feature, verify that the ISUP-over-IP feature is turned on (`ipisup=on`) using the `rtrv-feat` command. If the appropriate feature is off, turn it on with the `chg-feat` command. For more information on the ISUP-over-IP feature, refer to section [Understanding Routing for SS7IPGW and IPGWI Applications](#).

Note: Before turning on the ISUP-over-IP feature (`ipisup`), make sure you have purchased this feature. If you are not sure whether you have purchased the ISUP-over-IP feature, contact your Oracle Sales Representative or Account Representative. Once a feature has been turned on with the `chg-feat` command, the feature cannot be turned off.

Card Slot Selection

The E5-ENET card can be inserted into any card slot, except for card slots that must remain empty to accommodate dual-slot cards, slots 09 and 10 in each shelf, and slots 1113 through 1118.

To provision a E5-ENET card, the shelf containing the E5-ENET card must have HIPR2 cards installed in slots 9 and 10 in that shelf. If HIPR2 cards are not installed in the shelf that the E5-ENET card will occupy, the E5-ENET card will be auto-inhibited when the E5-ENET card is inserted into the shelf.

Enter the `rept-stat-gpl:gpl=hipr2` command to verify whether or not HIPR2 cards are installed in the same shelf as the E5-ENET card being provisioned in this procedure.

1. Display the cards in the database using the `rtrv-card` command.

This is an example of the possible output. Cards should be distributed throughout the EAGLE for proper power distribution. Refer to *Installation Guide* for the shelf power distribution.

```
rlghncxa03w 09-03-05 08:12:53 GMT 41.0.0
CARD  TYPE      APPL      LSET NAME      LINK SLC LSET NAME      LINK SLC
1101  DSM          VSCCP
1102  TSM          GLS
1113  GSPM         EOAM
1114  TDM-A
1115  GSPM         EOAM
```

```

1116 TDM-B
1117 MDAL
1201 LIMDS0 SS7ANSI sp2 A 0 sp1 B 0
1203 LIMDS0 SS7ANSI sp3 A 0
1204 LIMDS0 SS7ANSI sp3 A 1
1206 LIMDS0 SS7ANSI nsp3 A 1 nsp4 B 1
1216 DCM STPLAN
1301 LIMDS0 SS7ANSI sp6 A 1 sp7 B 0
1302 LIMDS0 SS7ANSI sp7 A 1 sp5 B 1
1303 DCM IPLIM ipnode1 A 0 ipnode3 B 1
1305 DCM IPLIM ipnode4 A 0
1307 DCM STPLAN
2101 ENET IPSE
2103 ENET IPSE
2105 ENET IPSE
2107 ENET IPSE
2201 DCM IPLIM
2203 DCM IPLIM
2207 DCM IPLIM
2211 DCM SS7IPGW
2213 DCM SS7IPGW
2215 DCM IPGWI
2217 DCM IPGWI
2301 DCM SS7IPGW
2303 DCM SS7IPGW
2305 DCM IPGWI
2307 DCM IPGWI
2311 DCM IPLIMI
2313 DCM IPLIMI

```

If the required unprovisioned card slots (see the [Card Slot Selection](#) section) are shown in the `rtrv-card` output, continue the procedure with [Step 4](#).

If the required unprovisioned card slots are not shown in the `rtrv-card` output, [Step 2](#) must be performed.

2. Display the shelves in the database by entering the `rtrv-shlf` command. This is an example of the possible output.

```

rlghncxa03w 08-03-05 08:12:53 GMT 38.0.0
SHELF DISPLAY
FRAME SHELF TYPE
1 1 CONTROL
1 2 EXTENSION
1 3 EXTENSION
2 1 EXTENSION
2 2 EXTENSION
2 3 EXTENSION

```

If all the shelves are provisioned in the database, this procedure cannot be performed. There are no available card slots for the new IPGWx card.

If all the shelves have not been provisioned in the database, continue the procedure with [Step 3](#).

3. Add the required shelf using the `ent-shlf` command with the location of the shelf and the `type=ext` parameter. The shelf location values are 1200, 1300, 2100, 2200, 2300, 3100, 3200, 3300, 4100, 4200, 4300, 5100, 5200, 5300, and 6100. For this example, enter this command.

```
ent-shlf:loc=3100:type=ext
```

When this command has successfully completed, this message should appear.

```
r1ghncxa03w 07-05-01 09:12:36 GMT EAGLE5 37.0.0
ENT-SHLF: MASP A - COMPLTD
```

4. Verify that the card to be entered has been physically installed into the proper location (see the [Card Slot Selection](#) section). If the card has not been installed, insert the card into the desired card location following the rules described in the [Card Slot Selection](#) section.



Caution: If the versions of the flash GPLs on the IP card do not match the flash GPL versions in the database when the IP card is inserted into the card slot, UAM 0002 is generated indicating that these GPL versions do not match. If UAM 0002 has been generated, perform the alarm clearing procedure for UAM 0002 in *Unsolicted Alarm and Information Messages* before proceeding with this procedure.

If the ISUP-over-IP feature will be used, continue the procedure with [Step 5](#).

If the ISUP-over-IP feature will not be used, continue the procedure with one of these actions.

- If the card being added in this procedure is not an E5-ENET card, continue the procedure with [Step 12](#).
 - If the card being added in this procedure is an E5-ENET card, continue the procedure with [Step 7](#).
5. Verify that the ISUP-over-IP feature is on by entering the `rtrv-feat` command.

If the ISUP-over-IP feature is on, the `ipisup` field is set to `on`.

Note: The `rtrv-feat` command output contains other fields that are not used by this procedure. If you wish to see all the fields displayed by the `rtrv-feat` command, see the `rtrv-feat` command description in the *Commands User's Guide*.

If the ISUP-over-IP feature is on, continue the procedure with one of these actions.

- If the card being added in this procedure is not an E5-ENET card, continue the procedure with [Step 12](#).
- If the card being added in this procedure is an E5-ENET card, continue the procedure with [Step 7](#).

If the ISUP-over-IP feature is not on, continue the procedure with [Step 6](#).

6. Turn the ISUP-over-IP feature on by entering this command.

To enable the ISUP-over-IP feature, enter this command.

```
chg-feat: ipisup=on
```

Note: Once the ISUP-over-IP feature is turned on with the `chg-feat` command, it cannot be turned off.

Note: The ISUP-over-IP feature must be purchased before turning them on. If you are not sure whether you have purchased the ISUP-over-IP feature, contact your Sales Representative or Account Representative.

When this command has successfully completed, this message should appear.

```
rlghncxa03w 06-10-12 09:12:36 GMT EAGLE5 36.0.0
CHG-FEAT: MASP A - COMPLTD
```

After the ISUP-over-IP feature is turned on, continue the procedure with one of these actions.

- If the card being added in this procedure is not an E5-ENET card, continue the procedure with [Step 12](#).
 - If the card being added in this procedure is an E5-ENET card, continue the procedure with [Step 7](#).
7. Verify that HIPR2 cards are installed in card locations 9 and 10 in the shelf containing the E5-ENET card being added in this procedure. Enter this command.

```
rept-stat-gpl:gpl=hipr2
```

This is an example of the possible output.

```
rlghncxa03w 09-07-05 08:12:53 GMT 41.1.0
GPL          CARD          RUNNING          APPROVED          TRIAL
HIPR2        1109          132-002-000     132-002-000     132-003-000
HIPR2        1110          132-002-000     132-002-000     132-003-000
HIPR2        1209          132-002-000     132-002-000     132-003-000
HIPR2        1210          132-002-000     132-002-000     132-003-000
HIPR2        1309          132-002-000     132-002-000     132-003-000
HIPR2        1310          132-002-000     132-002-000     132-003-000
HIPR2        2109          132-002-000     132-002-000     132-003-000
HIPR2        2110          132-002-000     132-002-000     132-003-000
HIPR2        2209          132-002-000     132-002-000     132-003-000
HIPR2        2210          132-002-000     132-002-000     132-003-000
HIPR2        2309          132-002-000     132-002-000     132-003-000
HIPR2        2310          132-002-000     132-002-000     132-003-000
Command Completed
```

If HIPR2 cards are installed in the shelf containing the E5-ENET card, continue the procedure with [Step 12](#).

If HIPR2 cards are not installed on the shelf containing the E5-ENET card, go to *Installation Guide* and install the HIPR2 cards. Once the HIPR2 cards have been installed, continue the procedure with [Step 12](#).

8. Enter the `rtrv-stpopts` command to verify whether or not the MFC option is on.

This is an example of the possible output.

```
rlghncxa03w 11-10-17 16:02:05 GMT EAGLE5 44.0.0
STP OPTIONS
-----
MFC                off
```

The `rtrv-stpopts` command output contains other fields that are not used by this procedure. To see all fields displayed by the `rtrv-stpopts` command, see the `rtrv-stpopts` command description in the *Commands User's Guide*.

If the MFC option is off, perform the Configuring the MFC Option procedure in *Database Administration - System Management User's Guide* to turn on the MFC option.

If the MFC option is on or the Configuring the MFC Option procedure in *Database Administration - System Management User's Guide* was performed in this step, continue the procedure with [Step 9](#).

9. The Fan feature must be turned on. If the `rtrv-feat` command in [Step 5](#) was not performed, enter the `rtrv-feat` command to verify that the Fan feature is on.

If the Fan feature is on, shown in either the `rtrv-feat` output in this step or in [Step 6](#) If [Step 13](#) was performed, the FAN field should be set to on.

The `rtrv-feat` command output contains other fields that are not used by this procedure. To see all fields displayed by the `rtrv-feat` command, see the `rtrv-feat` command description in *Commands User's Guide*.

If the Fan feature is on, continue the procedure with [Step 11](#).

If the Fan feature is off, continue the procedure with [Step 10](#).

10. Turn the Fan feature on by entering this command.

```
chg-feat:fan=on
```

Note: Once the Fan feature is turned on with the `chg-feat` command, it cannot be turned off.

When the `chg-feat` has successfully completed, this message appears.

```
rlghncxa03w 11-10-28 11:43:04 GMT EAGLE5 44.0.0
CHG-FEAT: MASP A - COMPLTD
```

11. The shelf containing the E5-ENET-B card that is being added in this procedure must have fans installed. Verify whether or not fans are installed on the shelf.

If the fans are installed, continue the procedure with [Step 12](#).

If the fans are not installed on the shelf containing the E5-ENET-B card, go to *Installation User's Guide* and install the fans. After the fans have been installed and tested, continue the procedure with [Step 12](#).

12. Add the card using the `ent-card` command.

For this example, enter these commands.

```
ent-card:loc=1315:type=dcm:appl=ss7ipgw
```

```
ent-card:loc=1317:type=dcm:appl=ipgwi
```

When each of these commands have successfully completed, this message should appear.

```
rlghncxa03w 06-10-12 09:12:36 GMT EAGLE5 36.0.0
ENT-CARD: MASP A - COMPLTD
```

13. Verify the changes using the `rtrv-card` command with the card location specified in [Step 12](#).

For this example, enter these commands.

```
rtrv-card:loc=1315
```

This is an example of the possible output.

```
rlghncxa03w 06-10-28 09:12:36 GMT EAGLE5 36.0.0
CARD   TYPE      APPL      LSET NAME      LINK SLC LSET NAME      LINK SLC
1315   DCM          SS7IPGW
```

```
rtrv-card:loc=1317
```

This is an example of the possible output.

```
rlghncxa03w 06-10-28 09:12:36 GMT EAGLE5 36.0.0
CARD   TYPE      APPL      LSET NAME      LINK SLC LSET NAME      LINK SLC
1317   DCM          IPGWI
```

14. Back up the new changes using the `chg-db:action=backup:dest=fixed` command.

These messages should appear, the active Maintenance and Administration Subsystem Processor (MASP) appears first.

```
BACKUP (FIXED) : MASP A - Backup starts on active MASP.
BACKUP (FIXED) : MASP A - Backup on active MASP to fixed disk complete.
BACKUP (FIXED) : MASP A - Backup starts on standby MASP.
BACKUP (FIXED) : MASP A - Backup on standby MASP to fixed disk complete.
```

15. If you wish to change the quantity of static routing keys in the database, perform the [Changing IP Options](#) procedure.

Otherwise, this procedure is finished.

Note: Before executing this procedure, make sure you have purchased the ISUP-over-IP feature. If you are not sure whether you have purchased the ISUP-over-IP feature, contact your Sales Representative or Account Representative.

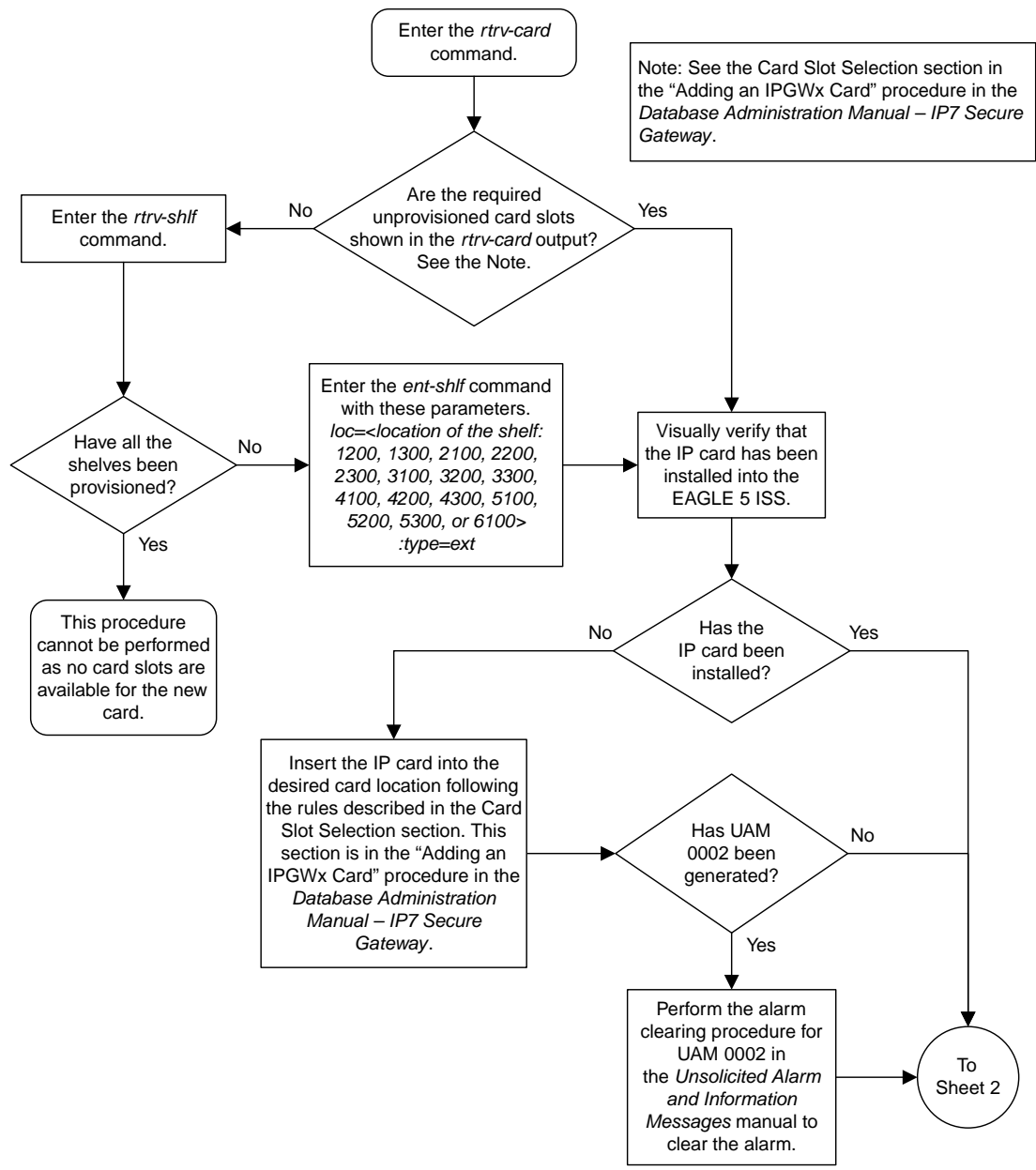

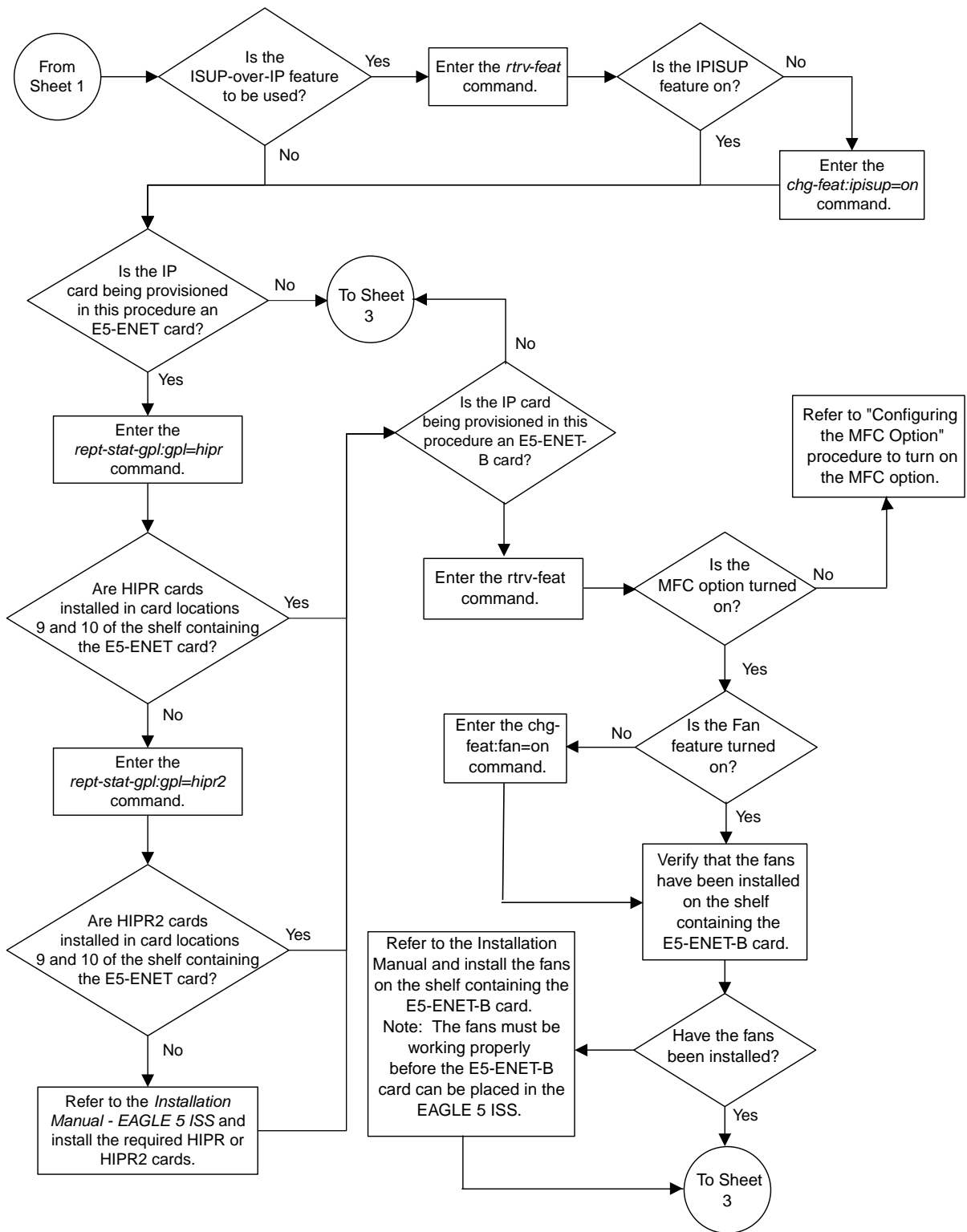

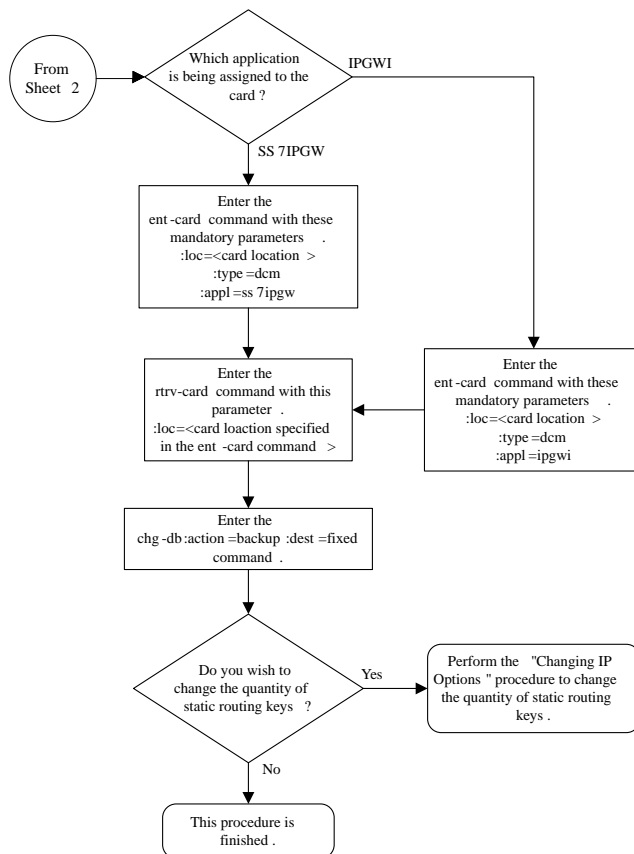

Sheet 3 of 3

Figure 41: Adding an IPGWx Card

Configuring an IPGWx Linkset

This procedure is used to configure IPGWx linksets in the EAGLE using the `ent-ls` or `chg-ls` commands with these parameters. An IPGWx linkset is a linkset that contains signaling links running either the SS7IPGW or IPGWI applications.

Note: This procedure is not used to configure a mate IPGWx linkset, with the `mateIsn` and `action` parameters. To configure a mate IPGWx linkset, perform procedure.

`:lsn` – The name of the linkset. The linkset name can contain up to 10 characters, with the first character being a letter. However, the SEAS interface supports only eight characters. If this linkset is displayed on the SEAS interface and the linkset name contains more than eight characters, only the first eight characters in the linkset name are shown. If this linkset name contains more than eight characters, and is specified with the linkset commands on the SEAS interface, only the first eight characters can be specified.

`:apc/apca/apci/apcn/apcn24` – Adjacent point code – the point code identifying the node that is next to the EAGLE. The adjacent point code can be one of the following types of point codes:

`:apc/apca` – ANSI point code, ANSI private point code

`:apci` – ITU-I point code, ITU-I spare point code, ITU-I private point code, ITU-I private spare point code.

`:apcn` – 14-bit ITU-N point code, 14-bit ITU-N spare point code, 14-bit ITU-N private point code, 14-bit ITU-N private spare point code.

`:apcn24` – 24-bit ITU-N point code, 24-bit ITU-N private point code.

Note: See the “Point Code Formats” section in *Database Administration - SS7 User's Guide* for a definition of the point code types that are used on the EAGLE and for a definition of the different formats that can be used for ITU national point codes.

Note: The `apc/apca/apci/apcn/apcn24` parameter must be specified with the `ent-ls` command. Specifying this parameter with the `chg-ls` command is required only if the adjacent point code of the linkset is being changed.

`:lst` – The linkset type of the specified linkset - The `lst` parameter must be specified with the `ent-ls` command. Specifying this parameter with the `chg-ls` command is required only if the linkset type of the linkset is being changed.

`:ipgwapc` – IP Gateway Adjacent Point Code indicator. Specify the `ipgwapc=yes` parameter to provide SS7 linkset definition compatibility for gateway connections to IP-SCPs. This parameter can be specified only for, and must be specified for, linksets containing signaling links assigned to either the SS7IPGW or IPGWI applications. The default is `ipgwapc=no`.

Note: The `ipgwapc` parameter can be specified only with the `ent-ls` command.

To provision ISUP-CIC routing keys, the `ipgwapc=yes` parameter and the IP Gateway ISUP routing feature must be turned on. Verify this with the `rtrv-feat` command. If the IP Gateway ISUP routing feature is turned on, the `ipisup` field should be set to `on`. If the IP Gateway ISUP routing feature is not turned on, enter the `chg-feat:ipisup=on` command.

Note: Once the IP Gateway ISUP routing feature is turned on with the `chg-feat` command, it cannot be turned off.

Note: The IP Gateway ISUP routing feature must be purchased before you turn the feature on with the `chg-feat` command. If you are not sure if you have purchased the IP Gateway ISUP routing feature, contact your Oracle Sales Representative or Account Representative.

`:iptps` – The quantity of IP TPS (transactions per second) that is assigned to the IPGWx linkset, from 100 to 32,000. The total amount of the IP TPS for all IPGWx linksets cannot exceed the total provisioned system TPS value in the `rtrv-tps` output..

`:lsusealm` – The linkset’s IPTPS alarm threshold, from 10 to 100 percent of the linkset’s IPTPS. When this threshold is reached, a major alarm (UAM 0115) is generated. When the linkset’s IPTPS falls below this threshold, UAM 0115 is automatically cleared and UAM 0118 is generated.

`:slkusealm` – The signaling link IPTPS alarm threshold, from 10 to 100 percent of the signaling link’s fair share of the linkset’s IPTPS or from 10 to 100 percent of the IPGWx card’s capacity (4000 TPS). This threshold is reached when the signaling link’s actual usage exceeds the percentage of the signaling link’s fair share of the linkset’s IPTPS or the percentage of the IPGWx card’s capacity.

A signaling link’s fair share of linkset’s IPTPS is the linkset’s IPTPS divided by the number of in-service links in the linkset. For example, if the linkset IPTPS is 4000 and there are 4 signaling links in the linkset, all in-service, then the signaling link’s fair-share would be 1000 IPTPS ($4000/4=1000$). [Table 22: Signaling Link Fair Share Example](#) shows this calculation for a linkset with 1, 2, 3 and 4 in-service signaling links.

Table 22: Signaling Link Fair Share Example

Number of In-Service Signaling Links	Linkset IPTPS	Signaling Link Fair Share of the Linkset IPTPS
4	4000	1000
3	4000	1333
2	4000	2000
1	4000	4000

When this threshold is exceeded, a minor alarm (UAM 0116) is generated. When the amount of traffic on the signaling link falls below this threshold, UAM 0116 is automatically cleared and UAM 0119 is generated.

The signaling link IPTPS alarm shows that the linkset IPTPS is set too low for the linkset or that the IPGWx card’s capacity has been exceeded. Setting the signaling link IPTPS alarm threshold lower than the linkset IPTPS alarm threshold can give the user an earlier indication that the linkset IPTPS is inadequate or that traffic is not balanced across the links in the linkset.

`:multgc` – specifies whether multiple group codes (for 14-bit ITU-N point codes) are supported for the linkset. When this parameter value is `yes`, secondary adjacent point codes whose group codes are different from the adjacent point code of the linkset can be assigned to the linkset. If the parameter value is `no`, the group code of the secondary adjacent point code must be the same as the group code of the linkset’s adjacent point code. For more information on secondary adjacent point codes, go to the “Configuring an ITU Linkset with a Secondary Adjacent Point Code (SAPC)” procedure in the *Database Administration - SS7 User’s Guide*.

This parameter only applies to linksets whose adjacent point codes are either ITU international point codes or ITU national point codes. All the signaling links in this linkset must be assigned to cards running the IPGWI application. For more information on assigning signaling links to cards running the IPGWI application, go to the [Adding an IPGWx Signaling Link](#) procedure.

The ITU duplicate point code feature must be on before this parameter can be specified. Verify this with the `rtvr-feat` command. If the ITU duplicate point code feature is turned on, the `ituduppc` field should be set to `on`. If the ITU duplicate point code feature is not turned on, enter the `chg-feat:ituduppc=on` command.

Note: Once the ITU duplicate point code feature is turned on with the `chg-feat` command, it cannot be turned off.

The ITU duplicate point code feature must be purchased before you turn the feature on with the `chg-feat` command. If you are not sure if you have purchased the ITU duplicate point code feature, contact your Oracle Sales Representative or Account Representative.

Adding the IPGWx linkset cannot exceed the maximum total provisioned system TPS shown in the `rtrv-tps` output. An IPGWx linkset uses 4000 TPS.

If adding the IPGWx linkset will exceed the maximum total provisioned system TPS, and the maximum total provisioned system TPS is 500,000, perform the "Activating the HIPR2 High Rate Mode" feature in *Database Administration - System Management User's Guide* to enable and turn on the HIPR2 High Rate Mode feature. When the HIPR2 High Rate Mode feature is enabled and turned on, the maximum total provisioned system TPS is increased to 1,000,000 (1M). If the maximum total provisioned system TPS is 1M, or the maximum total provisioned system TPS is 500,000 and will not be increased, and adding the IPGWx linkset will exceed the maximum total provisioned system TPS, the IPGWx linkset cannot be added unless the amount of available TPS is reduced enough to allow the IPGWx linkset to be added. The available TPS can be reduced by performing one or more of these actions.

- The IP TPS values of some IPGWx linksets have to be changed.
- The MAXSLKTPS values of some IPGW linksets (and the RSVDSLKTPS values if necessary) have to be changed.
- Some ATM high-speed signaling links have to be removed.
- An IPLIMx card that contains signaling links has to be removed.

The adjacent point code (APC) for the linkset must be defined in the database, must be in the SS7 domain and cannot match the point code or capability point code of the EAGLE. The domain of the point code is shown in the `DMN` field in the output of the `rtrv-dstn` command. The point code of the EAGLE is shown in the `PCA`, `PCN`, `PCN24`, or `PCI` fields and the capability point code of the EAGLE are shown in the `CPCA`, `CPCN`, `CPCN24`, or `CPCI` fields in the output of the `rtrv-sid` command. An ANSI adjacent point code must be a full point code and cannot be a cluster point code or a network routing point code. The adjacent point code of the linkset cannot be a proxy point code, cannot have a proxy point code assigned to it, and cannot be assigned to another linkset.

If the APC is not in the destination point code table, go to the "Adding a Destination Point Code" procedure in *Database Administration - SS7 User's Guide* and add the APC to the destination point code table.

For IPGWx linksets, more than one device may be attached to the LAN and have IP connections to the IP card running either the SS7IPGW or IPGWI application. Thus each IPGWx linkset is adjacent to all devices on the LAN (or adjacent to no device on the LAN, depending on your point of view). To provide a scheme allowing this point-to-multipoint connection and maintain consistent SS7 linkset definition rules, a virtual APC is required. This virtual APC is a real SS7 point code that is not used anywhere else in the SS7 network. Virtual APCs assigned to SS7IPGW linksets are ANSI point codes. Virtual APCs assigned to IPGWI linksets are either ITU-I or ITU-N point codes (either 14-bit or 24-bit ITU-N point codes). Virtual point codes can be reused on more than one switch. For example, a mated set of switches, each with two related links, could share two virtual point codes instead of requiring four. DPCs and linksets related to the virtual APC must be defined with the `ipgwapc` parameter set to `yes`.

For provisioning of ISUP-CIC routing keys, the `ipgwapc=yes` parameter and the IP Gateway ISUP routing feature must be turned on. Verify this with the `rtrv-feat` command. If the IP Gateway ISUP routing feature is turned on, the `ipisup` field should be set to `on`. If the IP Gateway ISUP routing feature is not turned on, enter the `chg-feat:ipisup=on` command.

Note: Once the IP Gateway ISUP routing feature is turned on with the `chg-feat` command, it cannot be turned off.

The IP Gateway ISUP routing feature must be purchased before you turn the feature on with the `chg-feat` command. If you are not sure if you have purchased the IP Gateway ISUP routing feature, contact your Oracle Sales Representative or Account Representative.

Other Optional Parameters

There are other optional parameters that can be used to configure an IPGWx linkset. These parameters are not required for configuring an IPGWx linkset. These parameters are discussed in more detail in *Commands User's Guide* or in these sections.

- These procedures in this manual:
 - [Adding a Mate IPGWx Linkset to another IPGWx Linkset](#)
 - [Removing a Mate IPGWx Linkset from another IPGWx Linkset](#)
 - [Adding an IPSP M2PA Linkset](#)
 - [Adding an IPSP M3UA Linkset](#)
 - [Changing an IPSP M2PA Linkset](#)
 - [Changing an IPSP M3UA Linkset](#)
- These procedures in *Database Administration - SS7 User's Guide*
 - Adding an SS7 Linkset
 - Changing an SS7 Linkset
 - Configuring an ITU Linkset with a Secondary Adjacent Point Code (SAPC)
- The "Configuring a Linkset for the GSM MAP Screening Feature" procedure in *Database Administration - Features User's Guide*.

Note: The `mtprse`, `spc/spca/spci/spcn/spcn24`, and `ppc/ppca/ppci/ppcn/ppcn24` parameters cannot be specified for an IPGWx linkset.

Canceling the RTRV-LS and RTRV-DSTN Commands

Because the `rtrv-ls` and `rtrv-dstn` commands used in this procedure can output information for a long period of time, the `rtrv-ls` and `rtrv-dstn` commands can be canceled and the output to the terminal stopped. There are three ways that the `rtrv-ls` and `rtrv-dstn` commands can be canceled.

- Press the F9 function key on the keyboard at the terminal where the `rtrv-ls` or `rtrv-dstn` commands were entered.
- Enter the `canc-cmd` without the `trm` parameter at the terminal where the `rtrv-ls` or `rtrv-dstn` commands were entered.
- Enter the `canc-cmd:trm=<xx>`, where `<xx>` is the terminal where the `rtrv-ls` or `rtrv-dstn` commands were entered, from another terminal other than the terminal where the `rtrv-ls` or `rtrv-dstn` commands were entered. To enter the `canc-cmd:trm=<xx>` command, the terminal must allow Security Administration commands to be entered from it and the user must be allowed to enter Security Administration commands. The terminal's permissions can be verified with the `rtrv-secu-trm` command. The user's permissions can be verified with the `rtrv-user` or `rtrv-secu-user` commands.

For more information about the `canc-cmd` command, go to *Commands User's Guide*.

1. Display the total provisioned system TPS by entering the `rtrv-tps` command.

This is an example of the possible output.

```
rlghncxa03w 10-07-10 16:20:46 GMT EAGLE 42.0.0

CARD      NUM      NUM      RSVD      MAX
TYPE     CARDS   LINKS    TPS       TPS
-----
IPGW      17      16      48000     80000
IPSG       3       7       4200      8000
IPLIM     2       4       8000      8000
ATM       2       2       3668      3668

Total provisioned System TPS (99668 of 500000) 20%

Command Completed.
```

An IPGWx linkset uses 4000 TPS. If configuring the linkset will not exceed the maximum total provisioned system TPS, continue the procedure with [Step 7](#).

If configuring the IPGWx linkset will exceed the maximum total provisioned system TPS, continue the procedure by performing one of these actions.

- If the maximum total provisioned system TPS is 500,000 and you wish to change and the maximum total provisioned system TPS to 1M, perform the "Activating the HIPR2 High Rate Mode" feature in *Database Administration - System Management User's Guide* to enable and turn on the HIPR2 High Rate Mode feature. When the HIPR2 High Rate Mode feature is enabled and turned on, the maximum total provisioned system TPS is increased to 1M. After the HIPR2 High Rate Mode feature has been enabled and turned on, continue the procedure with [Step 7](#).
- If the maximum total provisioned system TPS is 1M, or the maximum total provisioned system TPS is 500,000 and will not be increased, and adding the IPGWx linkset will exceed the maximum total provisioned system TPS, the IPGWx linkset cannot be added unless the amount of available TPS is reduced enough to allow the IPGWx linkset to be added. The available TPS can be increased by performing one or more of these actions.
 - The IP TPS values of some IPGWx linksets have to be changed. To perform this action, continue the procedure with [Step 4](#).
 - The MAXSLKTPS values of some IPSG linksets (and the RSVDSLKTPS values if necessary) have to be changed. To perform this action, continue the procedure with [Step 4](#).
 - Some ATM high-speed signaling links have to be removed. To perform this action, continue the procedure with [Step 2](#).
 - An IPLIMx card that contains signaling links has to be removed. To perform this action, continue the procedure with [Step 3](#).

2. Display the ATM high-speed signaling links by entering this command.

```
rtrv-slk:type=saal
```

This is an example of the possible output.

```
rlghncxa03w 10-07-19 21:16:37 GMT EAGLE5 42.0.0

LOC  LINK  LSN          SLC  TYPE      LP      ATM
      A    lsnds0      1    LIMATM    SET  BPS    TSEL   VCI  VPI  LL
1303  A     lsnds0      1    LIMATM    1    1.544M LINE  5    0    0
```

```

LOC LINK LSN          SLC TYPE      LP          ATM          E1ATM
1306 A   lsnituatm    0  LIME1ATM  21  2.048M  LINE      VCI  VPI  CRC4 SI SN
                                           5    0    ON    3  0

SLK table is (30 of 1200) 2% full.

```

If ATM high-speed signaling links are shown in the `rtrv-slk` output, perform the "Removing an SS7 Signaling Link" procedure in *Database Administration - SS7 User's Guide* to remove some of the ATM high-speed signaling links.

If ATM high-speed signaling links are not displayed in the `rtrv-slk` output, perform one or more of these actions to increase the available TPS.

Note: If one or more of these actions are not performed to increase the available TPS and the available TPS will not allow the IPGWx linkset to be added, the IPGWx linkset cannot be added and the remainder of this procedure cannot be performed.

- The IP TPS values of some IPGWx linksets have to be changed. To perform this action, continue the procedure with [Step 4](#).
- The MAXSLKTPS values of some IPGWx linksets (and the RSVDSLKTPS values if necessary) have to be changed. To perform this action, continue the procedure with [Step 4](#).
- An IPLIMx card that contains signaling links has to be removed. To perform this action, continue the procedure with [Step 3](#).

If you do not wish to perform other actions to increase the available TPS and the available TPS will allow the IPGWx linkset to be added, continue the procedure with [Step 7](#).

3. Display the signaling links that are assigned to IPLIMx cards by entering this command.

```
rtrv-slk:type=iplim
```

This is an example of the possible output.

```

rlghncxa03w 10-07-19 21:16:37 GMT EAGLE5 42.0.0

LOC LINK LSN          SLC TYPE      ANAME          SLKTPS
1301 A   lsniplim    0  IPLIM    M2PA
1301 A1  lsniplim    1  IPLIM    M2PA
1301 B1  lsniplim    2  IPLIM    M2PA
1317 A   lsniplimi   0  IPLIMI   M2PA

SLK table is (30 of 1200) 2% full.

```

If IPLIMx cards containing signaling links are shown in the `rtrv-slk` output, perform the [Removing an IPLIMx Card](#) procedure to remove an IPLIMx card and its associated signaling links.

If IPLIMx cards containing signaling links are not displayed in the `rtrv-slk` output, perform one or more of these actions to increase the available TPS.

Note: If one or more of these actions are not performed to increase the available TPS and the available TPS will not allow the IPGWx linkset to be added, the IPGWx linkset cannot be added and the remainder of this procedure cannot be performed.

- The IP TPS values of some IPGWx linksets have to be changed. To perform this action, continue the procedure with [Step 4](#).
- The MAXSLKTPS values of some IPGWx linksets (and the RSVDSLKTPS values if necessary) have to be changed. To perform this action, continue the procedure with [Step 4](#).

- Some ATM high-speed signaling links have to be removed. To perform this action, continue the procedure with [Step 2](#).

If you do not wish to perform other actions to increase the available TPS and the available TPS will allow the IPGWx linkset to be added, continue the procedure with [Step 7](#).

4. Display the IPGWx and IPSG linksets by entering this command.

```
rept-stat-iptps
```

This is an example of the possible output.

```
rlghncxa03w 10-07-19 21:16:37 GMT EAGLE5 42.0.0
IP TPS USAGE REPORT
```

	THRESH	CONFIG/ RSVD	CONFIG/ MAX		TPS	PEAK	PEAKTIMESTAMP

LSN							
ipgwx1105	70%	----	10000	TX:	3700	4000	10-07-19 09:49:19
				RCV:	3650	4000	10-07-19 09:49:19
ipgwx1	100%	----	32000	TX:	3700	4000	10-07-19 09:49:19
				RCV:	3650	4000	10-07-19 09:49:19
ipgwx2	100%	----	16000	TX:	4800	5000	10-07-19 09:49:09
				RCV:	4850	5000	10-07-19 09:49:09
ipgwx3	100%	----	32000	TX:	427	550	10-07-19 09:49:19
				RCV:	312	450	10-07-19 09:49:19
ipsglsn	100%	600	24000	TX:	4800	5000	10-07-19 09:49:19
				RCV:	4800	5000	10-07-19 09:49:19
ipsglsn2	100%	600	4000	TX:	427	550	10-07-19 09:49:19
				RCV:	312	450	10-07-19 09:49:19

Command Completed.							

If linksets are displayed in the `rept-stat-iptps` output, continue the procedure with [Step 5](#).

If linksets are not displayed in the `rept-stat-iptps` output, perform one or more of these actions to increase the available TPS.

Note: If one or more of these actions are not performed to increase the available TPS and the available TPS will not allow the IPGWx linkset to be added, the IPGWx linkset cannot be added and the remainder of this procedure cannot be performed.

- An IPLIMx card that contains signaling links has to be removed. To perform this action, continue the procedure with [Step 3](#).
- Some ATM high-speed signaling links have to be removed. To perform this action, continue the procedure with [Step 2](#).

If you do not wish to perform other actions to increase the available TPS and the available TPS will allow the IPGWx linkset to be added, continue the procedure with [Step 7](#).

5. Display the attributes of the linksets shown in [Step 4](#) by entering the `rtrv-ls` command with the name of the linkset shown in [Step 4](#). If an existing IPGWx linkset is being changed in [Step 20](#), that linkset does not need to be displayed in this step.

For this example enter these commands.

```
rtrv-ls:lsn=ipgwx1
```

This is an example of the possible output.

```
rlghncxa03w 10-07-19 21:16:37 GMT EAGLE5 42.0.0

LSN          APCA  (SS7)  SCRN SET SET  BEI LST LNKS  ACT MES DIS SLSCI NIS
ipgwx1      001-001-002  none 1  1  no  A  8  off off off no  off

          SPCA          CLLI          TFATCABMLQ MTPRSE ASL8
          -----          -----          4          ---  no

RANDSLS
off

IPSG  IPGWAPC  GTTMODE          CGGTMOD
no    yes    CdPA          no

MATELSN  IPTPS  LSUSEALM  SLKUSEALM
-----  32000  100%    80%

LOC  LINK  SLC  TYPE
1101 A  0  SS7IPGW
1102 A  1  SS7IPGW
1103 A  2  SS7IPGW
1104 A  3  SS7IPGW
1105 A  4  SS7IPGW
1106 A  5  SS7IPGW
1107 A  6  SS7IPGW
1108 A  7  SS7IPGW
```

Link set table is (11 of 1024) 1% full.

```
rtrv-ls:lsn=ipgwx2
```

This is an example of the possible output.

```
rlghncxa03w 10-07-19 21:16:37 GMT EAGLE5 42.0.0

LSN          APCA  (SS7)  SCRN SET SET  BEI LST LNKS  ACT MES DIS SLSCI NIS
ipgwx2      001-001-003  none 1  1  no  A  8  off off off no  off

          SPCA          CLLI          TFATCABMLQ MTPRSE ASL8
          -----          -----          4          ---  no

RANDSLS
off

IPSG  IPGWAPC  GTTMODE          CGGTMOD
no    yes    CdPA          no

MATELSN  IPTPS  LSUSEALM  SLKUSEALM
-----  16000  100%    80%

LOC  LINK  SLC  TYPE
1111 A  0  SS7IPGW
1112 A  1  SS7IPGW
1201 A  2  SS7IPGW
1202 A  3  SS7IPGW
1203 A  4  SS7IPGW
```

```

1204 A    5    SS7IPGW
1205 A    6    SS7IPGW
1206 A    7    SS7IPGW
    
```

Link set table is (11 of 1024) 1% full.

```
rtrv-ls:lsn=ipgwx3
```

This is an example of the possible output.

```

rlghncxa03w 10-07-19 21:16:37 GMT EAGLE5 42.0.0

LSN              APCA  (SS7)  SCRN  SET  SET  BEI  LST  LNKS  GWS  GWS  GWS
ipgwx3          001-001-004  none  1    1    no  A    0    off  off  off  SLSCI  NIS
                                     TFATCABMLQ  MTPRSE  ASL8
-----
                                     1          ---    no

RANDSLS
off

IPSG  IPGWAPC  GTTMODE          CGGTMOD
no    yes     CdPA              no

MATELSN  IPTPS  LSUSEALM  SLKUSEALM
-----  32000  100%     80%
    
```

Link set table is (11 of 1024) 1% full.

```
rtrv-ls:lsn=ipsglsn
```

This is an example of the possible output.

```

rlghncxa03w 10-07-19 21:16:37 GMT EAGLE5 42.0.0

LSN              APCA  (SS7)  SCRN  SET  SET  BEI  LST  LNKS  GWS  GWS  GWS
ipsglsn          003-003-003  none  1    1    no  A    6    off  off  off  SLSCI  NIS
                                     TFATCABMLQ  MTPRSE  ASL8
-----
                                     3          ---    no

RANDSLS
off

IPSG  IPGWAPC  GTTMODE          CGGTMOD
yes   no      CdPA              no

ADAPTER  RSVDSLKTPS  MAXSLKTPS
m2pa     600        4000

TPSALM  LSUSEALM  SLKUSEALM
rsvdsltktps 100%     100%

LOC  LINK  SLC  TYPE  ANAME
1303 A    0    IPSG  ipsgm2pa1
1303 A1   1    IPSG  ipsgm2pa2
    
```

```

1303 B1 2 IPSP ipsgm2pa3
1303 A2 3 IPSP ipsgm2pa4
1303 A3 4 IPSP ipsgm2pa5
1307 A 5 IPSP m2pa2

```

Link set table is (11 of 1024) 1% full.

```
rtrv-ls:lsn=ipsglsn2
```

This is an example of the possible output.

```

rlghncxa03w 10-07-19 21:16:37 GMT EAGLE5 42.0.0

LSN              APCA  (SS7)  SCRN SET SET BEI LST LNKS ACT MES DIS SLSCI NIS
ipsglsn2         005-005-005 none 1 1 no A 1 off off off no off

              SPCA              CLLI              TFATCABMLQ MTPRSE ASL8
              -----              -----              ---
              1              --- no

RANDSLS
off

IPSP  IPGWAPC  GTTMODE              CGGTMOD
yes   no      CdPA              no

ADAPTER  RSVDSLKTPS  MAXSLKTPS
m2pa     600        4000

TPSALM  LSUSEALM  SLKUSEALM
rsvdsltktps 100%    100%

LOC  LINK  SLC  TYPE  ANAME
1303 B3 0 IPSP ipsgm2pa6

```

Link set table is (11 of 1024) 1% full.

Perform one or both of these actions as necessary.

- To change the IPTPS value for any linksets shown in the `rtrv-ls` output whose IPGWAPC value is yes, continue the procedure with [Step 6](#).
- To change the MAXSLKTPS value (and RSVDSLKTPS value if necessary) for any linksets shown in the `rtrv-ls` output, perform the [Changing an IPSP M2PA Linkset](#) procedure (for linkset whose IPSP value is yes and ADAPTER value is M2PA) or the [Changing an IPSP M3UA Linkset](#) procedure (for linkset whose IPSP value is yes and ADAPTER value is M3UA).

Perform one or both of these actions to increase the available TPS if needed.

- An IPLIMx card that contains signaling links has to be removed. To perform this action, continue the procedure with [Step 3](#).
- Some ATM high-speed signaling links have to be removed. To perform this action, continue the procedure with [Step 2](#).

If you do not wish to perform other actions to increase the available TPS and the available TPS will allow the IPGWx linkset to be added, continue the procedure with [Step 7](#).

6. Reduce the IPTPS values of some or all the IPGWx linksets by entering the `chg-ls` command with the name of each linkset being changed, shown in [Step 5](#), and the new IPTPS value. For this example, enter these commands.

```
chg-ls:lsn=ipgwx1:iptps=28000
```

```
chg-ls:lsn=ipgwx3:iptps=28000
```

When the `chg-ls` command has successfully completed, this message should appear.

```
rlghncxa03w 10-07-17 16:23:21 GMT EAGLE5 42.0.0
Link set table is ( 11 of 1024) 1% full
CHG-LS: MASP A - COMPLTD
```

If no IPSP linksets are shown in [Step 5](#), continue the procedure with [Step 7](#).

If IPSP linksets are shown in [Step 5](#), continue the procedure with one of these steps.

- To change the MAXSLKTPS value (and RSVDSLKTPS value if necessary) for any linksets shown in the `rtrv-ls` output, perform the [Changing an IPSP M2PA Linkset](#) procedure (for linkset whose IPSP value is yes and ADAPTER value is M2PA) or the [Changing an IPSP M3UA Linkset](#) procedure (for linkset whose IPSP value is yes and ADAPTER value is M3UA).
- If you do not wish to change any IPSP linksets, continue the procedure by performing these actions as required.
 - To remove some IPLIMx cards that contains signaling links, continue the procedure with [Step 3](#).
 - To remove some ATM high-speed signaling links, continue the procedure with [Step 2](#).
 - If you do not wish to perform other actions to increase the available TPS and the available TPS will allow the IPGWx linkset to be added, continue the procedure with [Step 7](#).

7. Display the current linksets in the database using the `rtrv-ls` command.

This is an example of the possible output.

```
rlghncxa03w 10-07-10 11:43:04 GMT EAGLE5 42.0.0

LSN          APCA  (SS7)  SCRN SET SET BEI LST LNKS ACT MES DIS SLSCI NIS
ipgwx1       001-001-002 none 1 1 no A 8 off off off no off
ipgwx2       001-001-003 none 1 1 no A 8 off off off no off
ipgwx3       001-001-004 none 1 1 no A 0 off off off no off
lsniplim     002-002-002 none 1 1 no A 3 off off off no off
ipsglsn      003-003-003 none 1 1 no A 6 off off off no off
ipsglsn2     005-005-005 none 1 1 no A 1 off off off no off
lsgw1105     009-002-003 none 1 1 no A 1 off off off no off
lsnds0       009-009-009 none 1 1 no A 2 off off off no off

LSN          APCI  (SS7)  SCRN SET SET BEI LST LNKS ACT MES DIS SLSCI NIS
lsnituatm    1-002-3 none 1 2 no A 1 off off off no off
atmitul      3-111-3 none 1 1 no A 0 off off off no off

LSN          APCN  (SS7)  SCRN SET SET BEI LST LNKS ACT MES DIS SLSCI NIS
lsipgw       2968 none 1 2 no A 1 off off off no off
```

```
Link set table is (11 of 1024) 1% full.
```

Continue the procedure by performing one of these steps.

- If the `multgc=yes` parameter is not being specified for the linkset, continue the procedure by performing one of these steps.
 - If a new linkset is being added, continue the procedure with [Step 12](#).
 - If an existing linkset is being changed and the APC of the linkset is being changed, continue the procedure with [Step 12](#).
 - If an existing linkset is being changed and the APC of the linkset is not being changed, continue the procedure with [Step 20](#).
 - If the `multgc=yes` parameter will be specified for the linkset and a new linkset is being added, continue the procedure by performing one of these steps. The `multgc=yes` parameter can be specified only for IPGWx linksets that contain signaling links that are assigned to cards that are running the IPGWI application.
 - If linksets containing ITU-N adjacent point codes with group codes are shown in the `rtrv-ls` output, continue the procedure with [Step 12](#).
 - If linksets containing ITU-N adjacent point codes with group codes are not shown in the `rtrv-ls` output, continue the procedure with [Step 8](#).
 - If the `multgc` parameter value for an existing linkset will be changed, continue the procedure by performing one of these steps.
 - If the `multgc` parameter value is being changed to `no`, continue the procedure with [Step 10](#).
 - If the `multgc` parameter value is being changed to `yes`, continue the procedure with [Step 8](#). The `multgc=yes` parameter can be specified only for IPGWx linksets that contain signaling links that are assigned to cards that are running the IPGWI application.
8. To specify the `multgc=yes` parameter with the `ent-ls` or `chg-ls` commands, the ITU Duplicate Point Code feature must be on. For the ITU Duplicate Point Code feature to be on, the Multiple Point Code feature must be on. Enter the `rtrv-feat` command to verify that either of these features are on.

The entry `MPC = on` in the `rtrv-feat` command output shows that the Multiple Point Code feature is on. The entry `ITUDUPPC = on` in the `rtrv-feat` command output shows that the ITU Duplicate Point Code feature is on.

Note: The `rtrv-feat` command output contains other fields that are not used by this procedure. If you wish to see all the fields displayed by the `rtrv-feat` command, see the `rtrv-feat` command description in *Commands User's Guide*.

Continue the procedure by performing one of these steps.

- If the ITU Duplicate Point Code feature is on (`ITUDUPPC = on`), continue the procedure with [Step 10](#).
 - If the ITU Duplicate Point Code feature is off (`ITUDUPPC = off`), continue the procedure with [Step 9](#).
9. Turn the ITU Duplicate Point Code feature on, and the Multiple Point Code feature if necessary, by entering one of these commands.

To turn the ITU Duplicate Point Code feature on only.

```
chg-feat:ituduppc=on
```

To turn both the ITU Duplicate Point Code and Multiple Point Code features on.

```
chg-feat:mpc=on:ituduppc=on
```

Note: Once the ITU Duplicate Point Code and Multiple Point Code features are turned on with the `chg-feat` command, they cannot be turned off.

The ITU Duplicate Point Code and Multiple Point Code features must be purchased before you turn either of these features on with the `chg-feat` command. If you are not sure if you have purchased these features, contact your Oracle Sales Representative or Account Representative.

When this command has successfully completed, this message should appear.

```
rlghncxa03w 06-10-10 11:43:04 GMT EAGLE5 37.5.0
CHG-FEAT: MASP A - COMPLTD
```

Continue the procedure by performing one of these steps.

- If a new linkset is being added, continue the procedure with [Step 12](#).
 - If an existing linkset is being changed and the APC of the linkset is being changed, continue the procedure with [Step 12](#).
 - If an existing linkset is being changed and the APC of the linkset is not being changed, continue the procedure with [Step 20](#).
10. If the `multgc` parameter value is changed to `no`, the linkset can contain only one secondary adjacent point code. An ITU international linkset can contain only one 14-bit ITU national secondary adjacent point code. If the ITU international linkset contains more than one 14-bit ITU national secondary adjacent point code, all but one of these 14-bit ITU national secondary adjacent point codes must be removed from the linkset. An ITU national linkset can contain only one ITU international secondary adjacent point code. All 14-bit ITU-N secondary adjacent point codes must be removed from the linkset. All routes to these secondary adjacent point codes must be removed from the database before the secondary adjacent point codes can be removed.

Display the routes using the secondary adjacent point code being removed from the linkset with the `rtrv-rte` command, specifying the secondary adjacent point code being removed as the value of the `dpc` parameter.

For this example, enter these commands.

```
rtrv-rte:dpcn=11213-de
```

This is an example of the possible output.

```
rlghncxa03w 06-10-07 11:43:04 GMT EAGLE5 37.5.0
DPCN          ALIASA          ALIASI  LSN          RC          APC
11213-de     -----          -----  lsn3         10         11213-de
                                     RTX:No  CLLI=-----
```

```
rtrv-rte:dpcn=12114-fr
```

This is an example of the possible output.

```
rlghncxa03w 06-10-07 11:43:04 GMT EAGLE5 37.5.0
```

```

DPCN          ALIASA          ALIASI  LSN          RC          APC
12114-fr      -----
                                lsn3         10          12114-fr
                                RTX:No      CLLI=-----

```

```
rtrv-rte:dpcn=12115-uk
```

This is an example of the possible output.

```

rlghncxa03w 06-10-07 11:43:04 GMT EAGLE5 37.5.0
DPCN          ALIASA          ALIASI  LSN          RC          APC
12115-uk      -----
                                lsn3         10          12115-uk
                                RTX:No      CLLI=-----

```

If the secondary adjacent point code is assigned to a route, that route must be removed from the database. Perform the “Removing a Route” procedure in the *Database Administration - SS7 User’s Guide* to remove the route from the database.

11. Remove the secondary adjacent point codes specified in [Step 10](#) from the linkset with the `chg-ls` command with the `sapcn` and the `action=delete` parameters. For this example, enter these commands.

```
chg-ls:lsn=lsn3:sapcn=11213-de:action=delete
```

```
chg-ls:lsn=lsn3:sapcn=12114-fr:action=delete
```

```
chg-ls:lsn=lsn3:sapcn=12115-uk:action=delete
```

When the `chg-ls` command has successfully completed, this message should appear.

```

rlghncxa03w 06-10-17 16:23:21 GMT EAGLE5 37.5.0
Link set table is ( 13 of 255) 5% full
CHG-LS: MASP A - COMPLTD

```

Continue the procedure by performing one of these steps.

- If a new linkset is being added, continue the procedure with [Step 12](#).
- If an existing linkset is being changed and the APC of the linkset is being changed, continue the procedure with [Step 12](#).
- If an existing linkset is being changed and the APC of the linkset is not being changed, continue the procedure with [Step 20](#).

12. Display the point code and capability point code of the EAGLE by using the `rtrv-sid` command.

This is an example of the possible output.

```

rlghncxa03w 06-10-10 11:43:04 GMT EAGLE5 37.5.0
PCA          PCI          PCN          CLLI          PCTYPE
001-001-001  1-200-6          13482        rlghncxa03w  OTHER

CPCA
002-002-002  002-002-003      002-002-004  002-002-005
002-002-006  002-002-007      002-002-008  002-002-009
004-002-001  004-003-003      144-212-003

CPCA (LNP)
005-005-002  005-005-004      005-005-005

```

CPCI				
1-001-1	1-001-2	1-001-3	1-001-4	
CPCN				
02091	02092	02094	02097	
02191	02192	11177		

13. Display the destination point codes in the database by entering the `rtrv-dstn` command. This is an example of the possible output.

```

rlghncxa03w 10-12-10 11:43:04 GMT EAGLE5 43.0.0
Extended Processing Time may be Required

  DPCA          CLLI          BEI  ELEI    ALIASI          ALIASN/N24    DMN
  001-207-000  ----- no  --- -----  -----  SS7
  001-001-001  ----- no  --- -----  -----  SS7
  001-001-002  ----- no  --- -----  -----  SS7
  001-005-000  ----- no  --- -----  -----  SS7
  001-007-000  ----- no  --- -----  -----  SS7
  008-012-003  ----- no  --- -----  -----  SS7
  003-002-004  ----- no  --- -----  -----  SS7
  009-002-003  ----- no  --- -----  -----  SS7
  010-020-005  ----- no  --- -----  -----  SS7

  DPCI          CLLI          BEI  ELEI    ALIASA          ALIASN/N24    DMN
  1-207-0       ----- no  --- -----  -----  SS7
  0-015-0       ----- no  --- -----  -----  SS7
  0-017-0       ----- no  --- -----  -----  SS7
  1-011-1       ----- no  --- -----  -----  SS7
  1-011-2       ----- no  --- -----  -----  SS7

Destination table is (14 of 2000) 1% full
Alias table is (0 of 12000) 0% full

```

If the new adjacent point code is not shown in the `rtrv-dstn` output, perform the "Adding a Destination Point Code" procedure in *Database Administration - SS7 User's Guide* to add the required point code. This point code cannot be a proxy point code (the `prx=yes` value assigned to the point code) and a proxy point code (a point code value is shown in the `PPC` column) cannot be assigned to the point code. After the point code has been added, continue the procedure by performing one of these steps.

- If a new linkset is being added, continue the procedure by performing one of these steps.
 - If you do not wish to use the IP Gateway ISUP routing feature, continue the procedure with [Step 19](#).
 - If you wish to use the IP Gateway ISUP routing feature, continue the procedure with [Step 17](#).
- If an existing linkset is being changed, continue the procedure with [Step 20](#).

If the new adjacent point code is shown in the `rtrv-dstn` output, continue the procedure with [Step 14](#).

14. Display the adjacent point code of the new linkset in the destination point code table by using the `rtrv-dstn` command and specifying the point code. For this example, enter this command.

```
rtrv-dstn:dpca=010-020-005
```

This is an example of the possible output.

```
rlghncxa03w 10-12-10 11:43:04 GMT EAGLE5 43.0.0

  DPCA          CLLI          BEI  ELEI    ALIASI          ALIASN/N24    DMN
  010-020-005  -----  no   ---  -----  -----  SS7

  SPCA          NCAI          RCAUSE NPRST SPLITIAM HMSMSC HMSCP SCCPMSGCNV
  -----  ----          none   off   none     no     no     none

Destination table is (14 of 2000) 1% full
Alias table is (0 of 12000) 0% full
```

This point code cannot be a proxy point code (the `prx=yes` value assigned to the point code) and a proxy point code (a point code value is shown in the PPC column) cannot be assigned to the point code. If a proxy point code is shown in this step, or if the point code is a proxy point code, choose another point code and repeat this procedure from [Step 12](#).

- The APC of the linkset cannot be the DPC of any exception route. Verify that the adjacent point code of the linkset is not the DPC of any exception route by entering the `rtrv-rtx` command with the `dpc/dpca/dpci/dpcn/dpcn24` parameter. The `dpc/dpca/dpci/dpcn/dpcn24` parameter value is the adjacent point code value that will be specified for the linkset.

For this example, enter this command.

```
rtrv-rtx:dpca=010-020-005
```

This is an example of the possible output.

```
rlghncxa03w 06-10-10 11:43:04 GMT EAGLE5 37.5.0
  DPCA          RTX-CRITERIA          LSN          RC    APC
  010-020-005  OPCA
                   007-008-009          1s1305      20    001-005-000
                   008-008-008          1s1307      40    001-007-000

DESTINATION ENTRIES ALLOCATED:    2000
  FULL DPC(s):                    13
  EXCEPTION DPC(s):                5
  NETWORK DPC(s):                  0
  CLUSTER DPC(s):                  1
  TOTAL DPC(s):                    19
  CAPACITY (% FULL):               1%
ALIASES ALLOCATED:                12000
  ALIASES USED:                    0
  CAPACITY (% FULL):               0%
X-LIST ENTRIES ALLOCATED:         500
```

If the adjacent point code of the linkset is not the DPC of a route exception table entry, no entries are displayed in the `rtrv-rtx` output, but a summary of the point code quantities is displayed, as shown in the following output example.

```
rlghncxa03w 06-10-10 11:43:04 GMT EAGLE5 37.5.0

  DESTINATION ENTRIES ALLOCATED:    2000
  FULL DPC(s):                    15
  EXCEPTION DPC(s):                5
```

```

NETWORK DPC(s):           0
CLUSTER DPC(s):          1
TOTAL DPC(s):            21
CAPACITY (% FULL):       1%
ALIASES ALLOCATED:       12000
ALIASES USED:            0
CAPACITY (% FULL):       0%
X-LIST ENTRIES ALLOCATED: 500

```

If the point code specified in this step is shown in the DPCA/DPCI/DPCN/ DPCN24 columns in this step, the point code value cannot be used as an adjacent point code unless one of two actions are taken:

- Choose another adjacent point code value and repeat [Step 12](#) through [Step 15](#).
- Remove all the entries displayed in this step by performing the “Removing a Route Exception Entry” procedure in *Database Administration - SS7 User’s Guide*.

16. Display any entries in the route table whose DPC value is also the adjacent point code of the new linkset being added in this procedure, or the new adjacent point code of the existing linkset being changed in this procedure. Enter the `rtrv-rte` command with the `dpc/dpca/dpci/dpcn/dpcn24` parameter. The `dpc/dpca/dpci/dpcn/dpcn24` parameter value is the adjacent point code value that will be specified for the linkset. For this example, enter this command.

```
rtrv-rte:dpca=010-020-005
```

This is an example of the possible output.

```

rlghncxa03w 06-10-10 11:43:04 GMT EAGLE5 37.5.0

DPCA          ALIASI          ALIASN/N24      LSN           RC           APCA
010-020-005  -----
                                lsn1          1             003-003-003
                                lsn2          2             003-003-004
                                RTX:No       CLLI=-----

```

If the adjacent point code of the linkset is not the DPC of a route, the point code entry is displayed in the `rtrv-rte` output, but the LSN, RC, and APC columns contain dashes, as shown in the following output example.

```

rlghncxa03w 06-10-10 11:43:04 GMT EAGLE5 37.5.0

DPCA          ALIASI          ALIASN/N24      LSN           RC           APCA
002-002-002  -----
                                -----
                                RTX:No       CLLI=-----

```

If the point code specified in this step is shown in the DPCA/DPCI/DPCN/ DPCN24 columns in this step, the point code value cannot be used as an adjacent point code unless one of two actions are taken:

- Choose another adjacent point code value and repeat [Step 12](#) through [Step 16](#).
- Remove all the entries displayed in this step by performing the “Removing a Route” procedure in *Database Administration - SS7 User’s Guide*.

After this step has been performed, continue the procedure by performing one of these steps.

- If a new linkset is being added, continue the procedure by performing one of these steps.

- If you do not wish to use the IP Gateway ISUP routing feature, continue the procedure with [Step 19](#).
 - If you wish to use the IP Gateway ISUP routing feature, continue the procedure with [Step 17](#).
 - If an existing linkset is being changed, continue the procedure with [Step 20](#).
17. Verify that the IP Gateway ISUP routing feature is on by entering the `rtrv-feat` command. The entry `IPISUP = on` in the `rtrv-feat` command output shows that the IP Gateway ISUP routing feature is on.

Note: The `rtrv-feat` command output contains other fields that are not used by this procedure. If you wish to see all the fields displayed by the `rtrv-feat` command, see the `rtrv-feat` command description in *Commands User's Guide*.

- If the IP Gateway ISUP routing feature is on, continue the procedure with [Step 19](#).
 - If the IP Gateway ISUP routing feature, continue the procedure with [Step 18](#).
18. Turn the IP Gateway ISUP routing feature on by entering this command.

Note: If the IP Gateway ISUP routing feature is on (`IPISUP = on`), continue the procedure with [Step 19](#).

```
chg-feat:ipisup=on
```

Note: Once the IP Gateway ISUP routing feature is turned on with the `chg-feat` command, it cannot be turned off.

The IP Gateway ISUP routing feature must be purchased before you turn the feature on with the `chg-feat` command. If you are not sure if you have purchased the IP Gateway ISUP routing feature, contact your Oracle Sales Representative or Account Representative.

When this command has successfully completed, this message should appear.

```
rlghncxa03w 06-10-10 11:43:04 GMT EAGLE5 37.5.0
CHG-FEAT: MASP A - COMPLTD
```

19. Add the new linkset to the database using the `ent-ls` command. The new linkset must meet these conditions.

The name of this linkset, the `lsn` parameter value, cannot be used by another linkset – the linkset configuration is shown in the output of [Step 7](#).

The APC of the new linkset must be in the destination point code table, but cannot be either the EAGLE's point code or the EAGLE's capability point code – shown in the outputs of [Step 12](#), [Step 13](#), and [Step 14](#). The adjacent point code can be one of the following types of point codes:

:apc/apca – ANSI point code, ANSI private point code

:apci – ITU-I point code, ITU-I spare point code, ITU-I private point code, ITU-I private spare point code.

:apcn – 14-bit ITU-N point code, 14-bit ITU-N spare point code, 14-bit ITU-N private point code, 14-bit ITU-N private spare point code.

:apcn24 – 24-bit ITU-N point code, 24-bit ITU-N private point code.

These parameters and values must also be specified for the IPGWx linkset:

- `ipgwapc=yes`
- `lst=<a,b,c,d,e>`
- `iptps=<100-32000>`

Note: The `iptps` parameter value must be divisible by 10. The sum of all the linkset IP TPS values, including the value for this linkset, cannot exceed the maximum total provisioned system TPS value shown in the `trv-tps` output in [Step 1](#), or the increased value if the "Activating the HIPR2 High Rate Mode Feature" procedure was performed.

- The optional parameters `lsusealm` (the linkset's IP TPS alarm threshold) and `slkusealm` (the signaling link IP TPS alarm threshold) can be specified with the `ent-ls` command. The default value for the `lsusealm` parameter is 100%, and the default value for the `slkusealm` parameters is 80%.
- The `multgc=yes` parameter can be specified only for IPGWx linksets that will contain signaling links that are assigned to cards that are running the IPGWI application.

Note: There are other optional parameters that can be specified with the `ent-ls` command, but are not required for an IPGWx linkset. See the [Other Optional Parameters](#) section for the procedures that discuss these parameters and their usage.

For this example, enter this command.

```
ent-ls:lsn=lsqw1107:apca=010-020-005:lst=a:ipgwapc=yes:iptps=4000
:lsusealm=70:slkusealm=70
```

When this command has successfully completed, this message should appear.

```
rlghncxa03w 06-10-17 16:23:21 GMT EAGLE5 37.5.0
Link set table is ( 14 of 1024) 1% full
ENT-LS: MASP A - COMPLTD
```

Continue the procedure with [Step 21](#).

20. Change the existing linkset by entering the `chg-ls` command.

The name of the linkset that is being changed, specified with the `lsn` parameter, must be specified. The name of the linkset is shown in the `rept-stat-iptps` output in [Step 4](#).

One of these optional parameters must be specified.

- The new adjacent point code of the linkset, specified with the `apc/apca/apci/apcn/apcn24`, if the current adjacent point code of the linkset is being changed.
- `iptps=<100-32000>`

Note: The `iptps` parameter value must be divisible by 10. The sum of all the linkset IP TPS values, including the value for this linkset, cannot exceed the maximum total provisioned system TPS value shown in the `trv-tps` output in [Step 1](#), or the increased value if the "Activating the HIPR2 High Rate Mode Feature" procedure was performed. .

- The optional parameters `lsusealm` (the linkset's IP TPS alarm threshold) and `slkusealm` (the signaling link IPTPS alarm threshold) can be specified with the `chg-ls` command.
- The `multgc=yes` parameter can be specified only for IPGWx linksets that contain signaling links that are assigned to cards that are running the IPGWI application.

Note: There are other optional parameters that can be specified with the `ent-ls` command, but are not required for an IPGWx linkset. See the [Other Optional Parameters](#) section for the procedures that discuss these parameters and their usage.

For this example, enter this command.

```
chg-ls:lsn=lsgw1105:iptps=14000:lsusealm=70:slkusealm=70
```

When this command has successfully completed, this message should appear.

```
rlghncxa03w 06-10-17 16:23:21 GMT EAGLE5 37.5.0
Link set table is ( 14 of 1024) 1% full
CHG-LS: MASP A - COMPLTD
```

21. Verify the changes using the `rtrv-ls` command specifying the linkset name specified in either [Step 19](#) or [Step 20](#) with the `lsn` parameter. For this example, enter these commands.

```
rtrv-ls:lsn=lsgw1105
```

This is an example of the possible output.

```
rlghncxa03w 08-04-17 11:43:04 GMT EAGLE5 38.0.0

LSN          APCA  (SS7)  SCRN  L3T  SLT          GWS  GWS  GWS
lsgw1105     009-002-003  none  1    1    no  A    1    off off off no  off

          CLLI          TFATCABMLQ  MTPRSE  ASL8
          -----  1          no      no

          IPGWAPC  MATELSN      IPTPS  LSUSEALM  SLKUSEALM  GTTMODE
          yes      -----  14000  70      % 70      % CdPA

          LOC  LINK  SLC  TYPE
          1105  A    0    SS7IPGW

Link set table is ( 14 of 1024) 1% full
```

```
rtrv-ls:lsn=lsgw1107
```

This is an example of the possible output.

```
rlghncxa03w 08-04-17 11:43:04 GMT EAGLE5 38.0.0

LSN          APCA  (SS7)  SCRN  L3T  SLT          GWS  GWS  GWS
lsgw1107     010-020-005  none  1    1    no  A    0    off off off no  off

          CLLI          TFATCABMLQ  MTPRSE  ASL8
          -----  1          no      no

          IPGWAPC  MATELSN      IPTPS  LSUSEALM  SLKUSEALM  GTTMODE
          yes      -----  4000  70      % 70      % CdPA

Link set table is ( 14 of 1024) 1% full
```

22. Back up the new changes using the `chg-db:action=backup:dest=fixed` command. These messages should appear, the active Maintenance and Administration Subsystem Processor (MASP) appears first.

```
BACKUP (FIXED) : MASP A - Backup starts on active MASP.  
BACKUP (FIXED) : MASP A - Backup on active MASP to fixed disk complete.  
BACKUP (FIXED) : MASP A - Backup starts on standby MASP.  
BACKUP (FIXED) : MASP A - Backup on standby MASP to fixed disk complete.
```

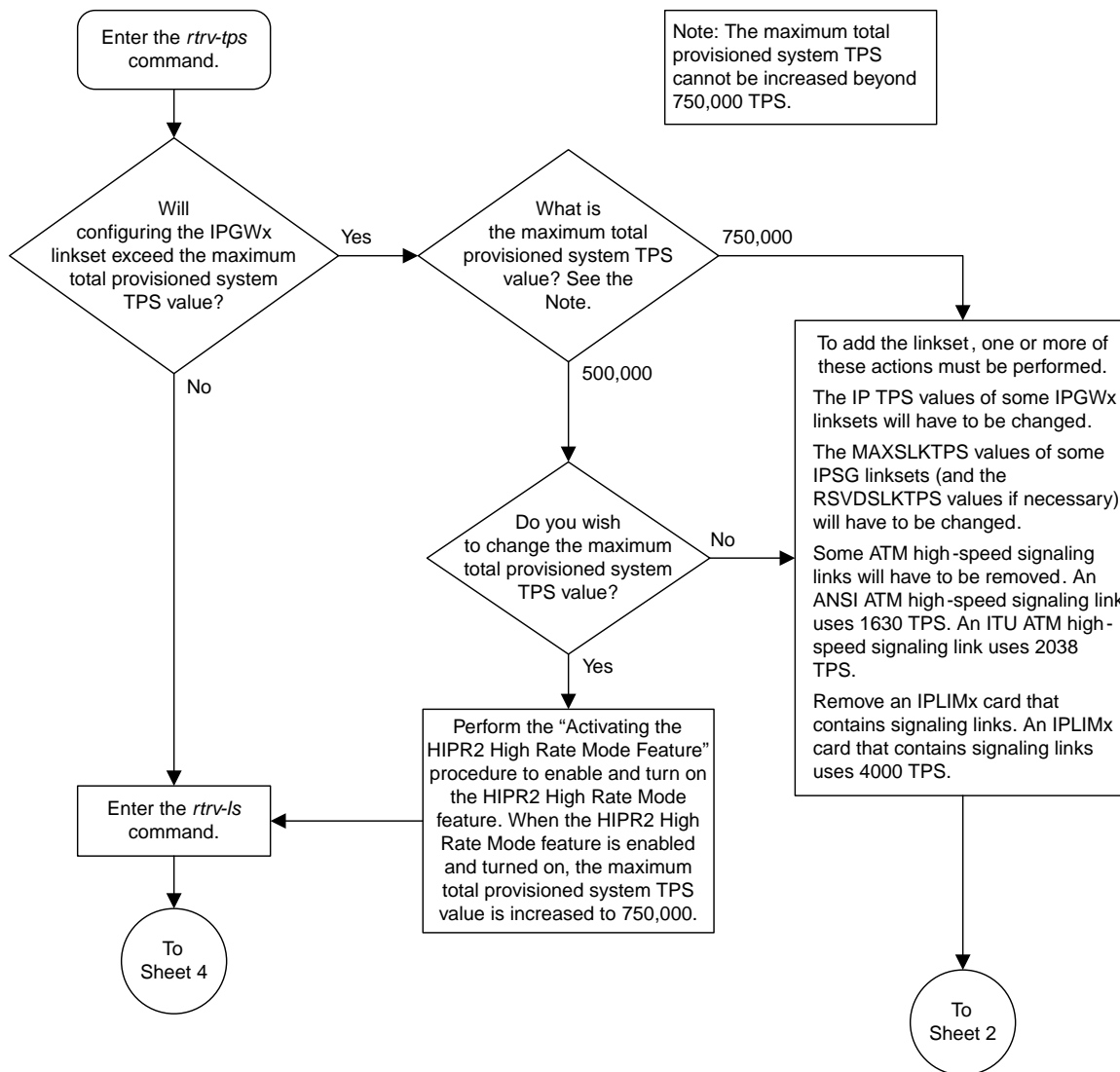

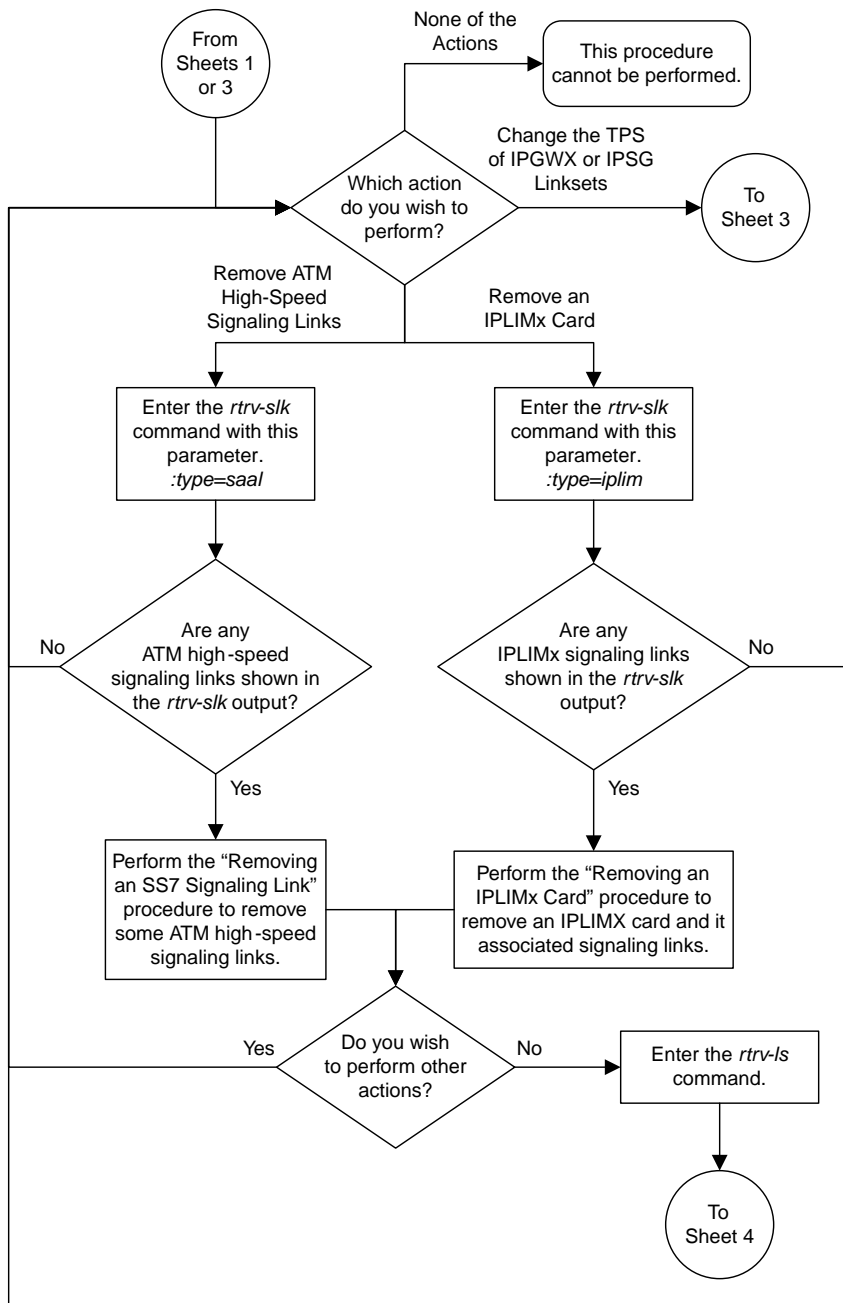

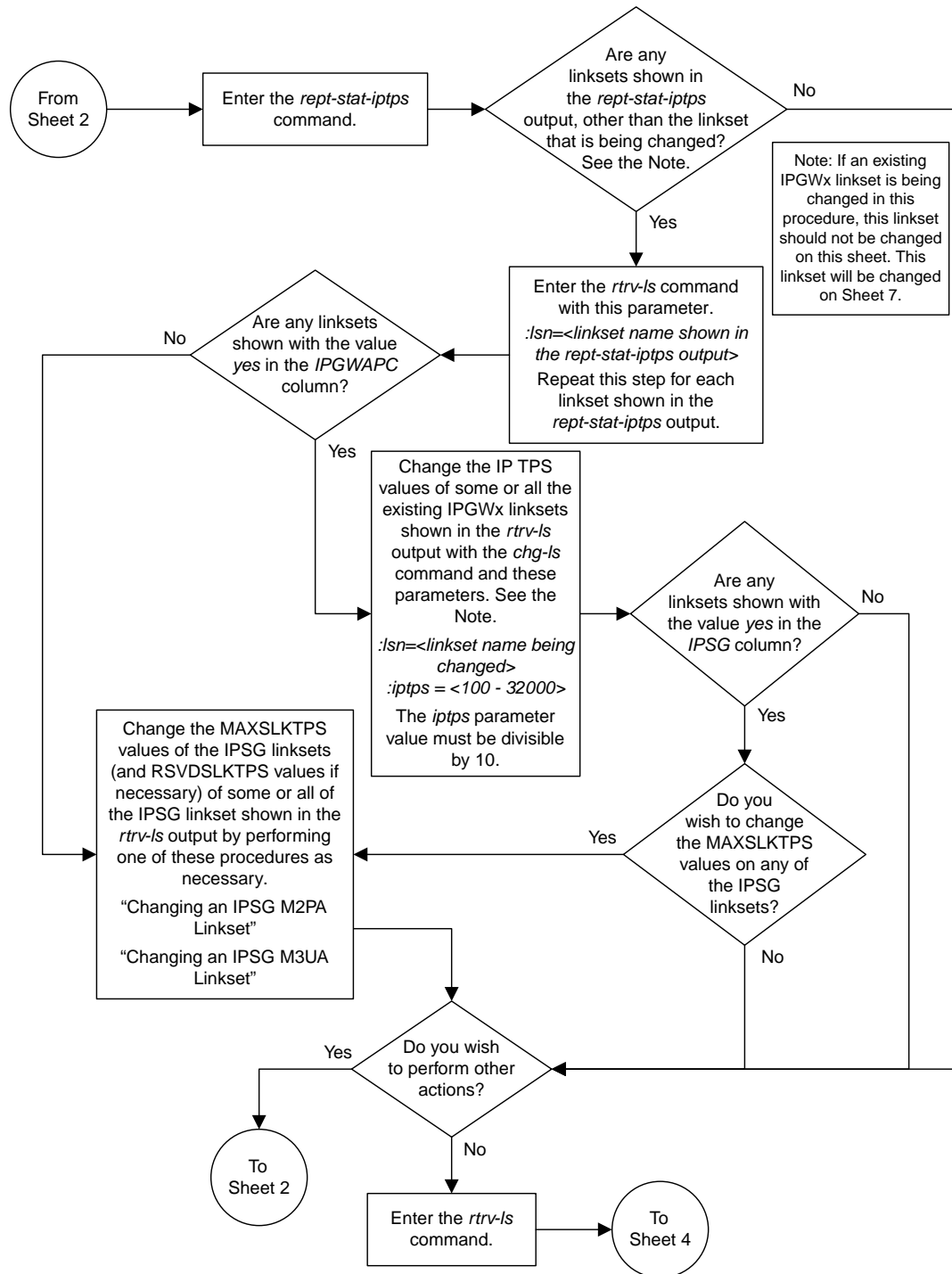

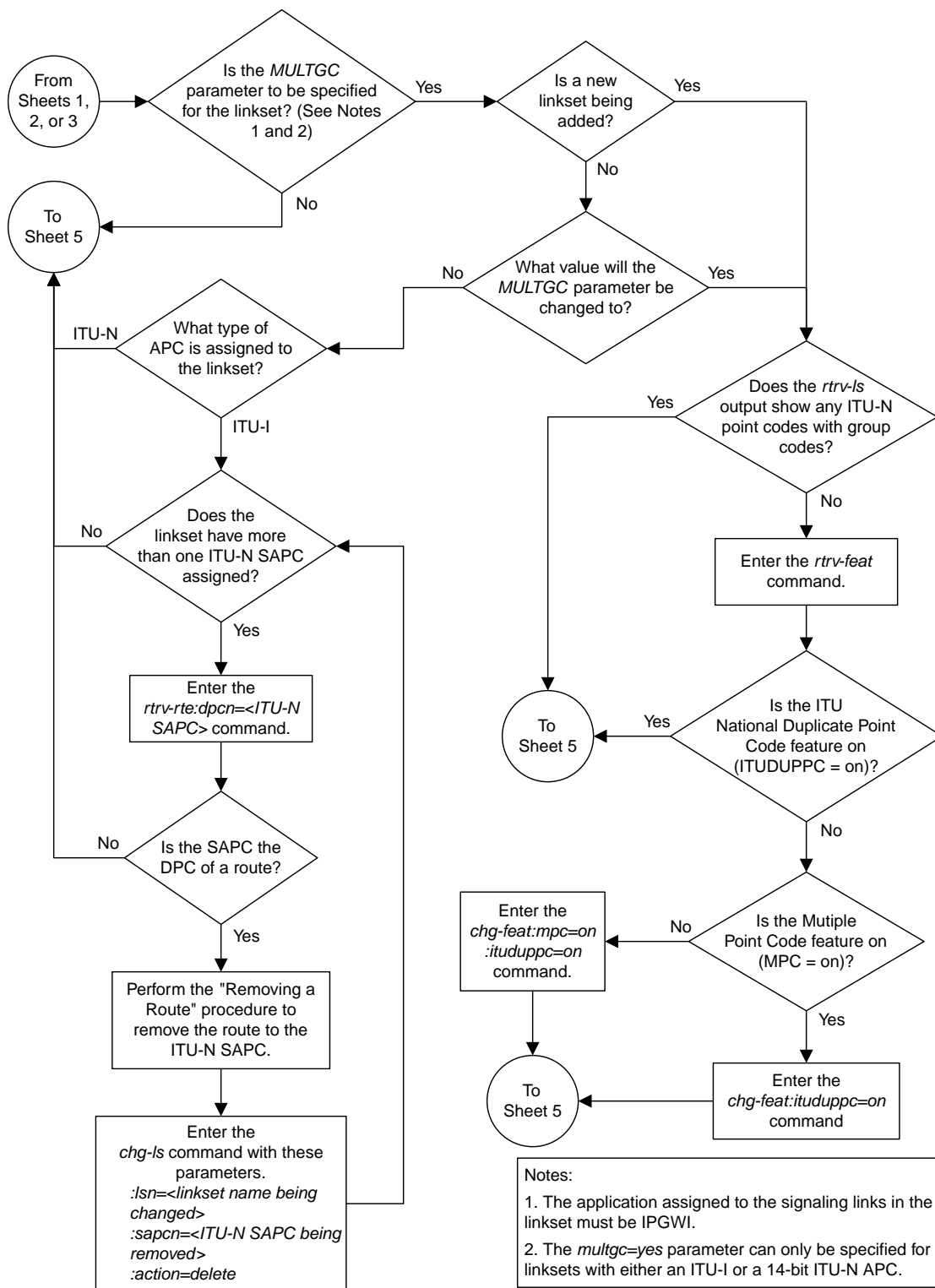

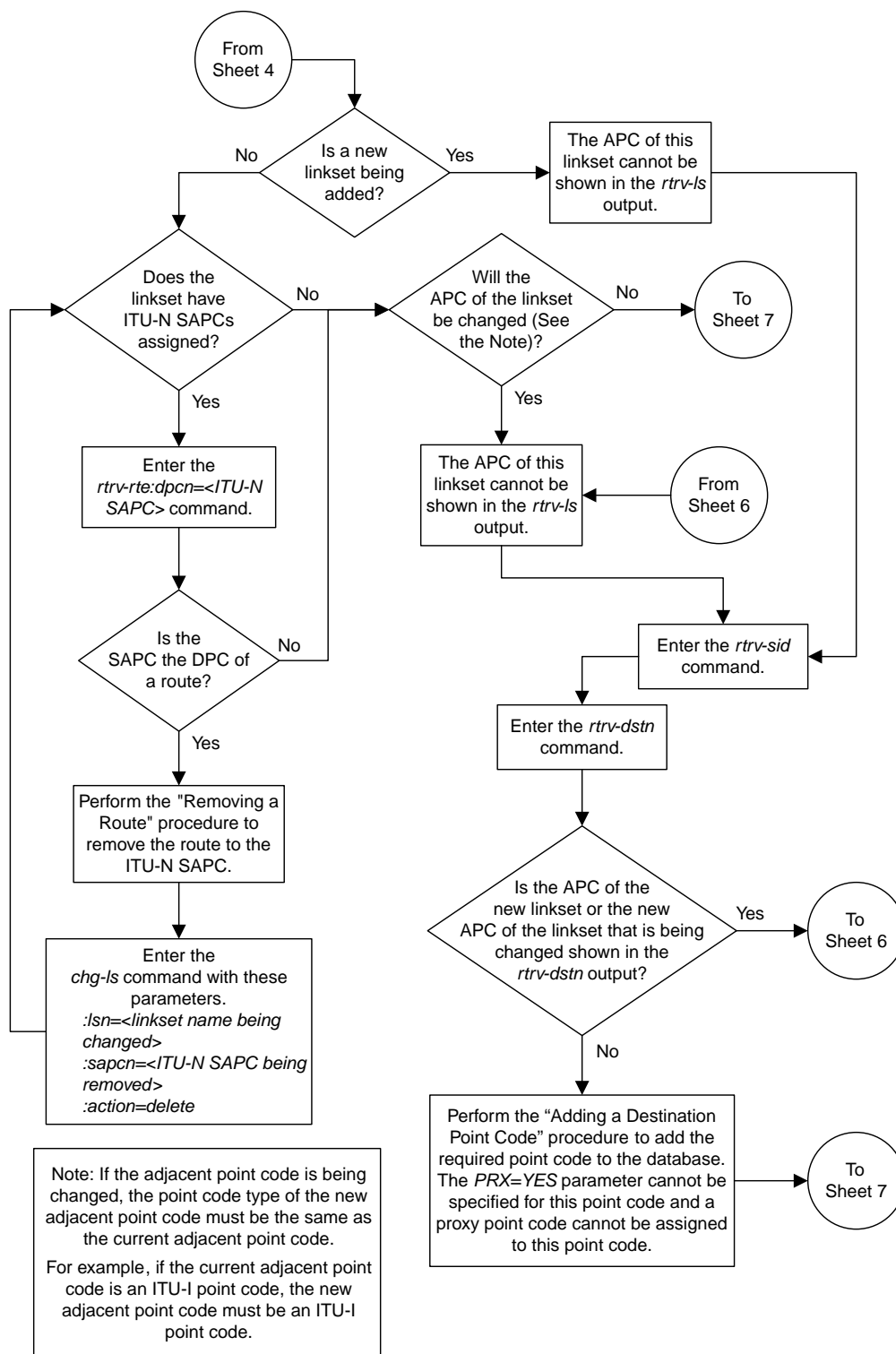

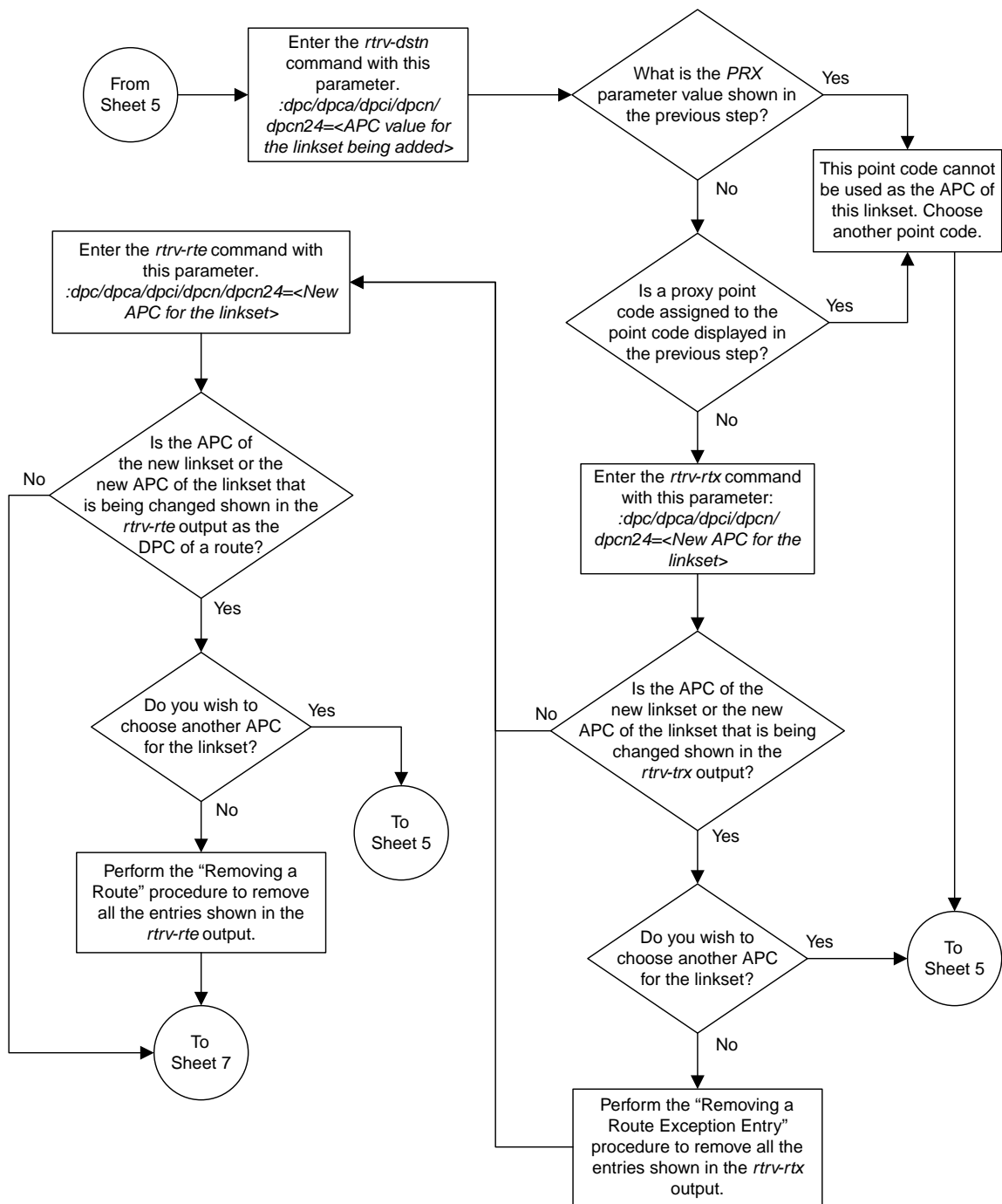

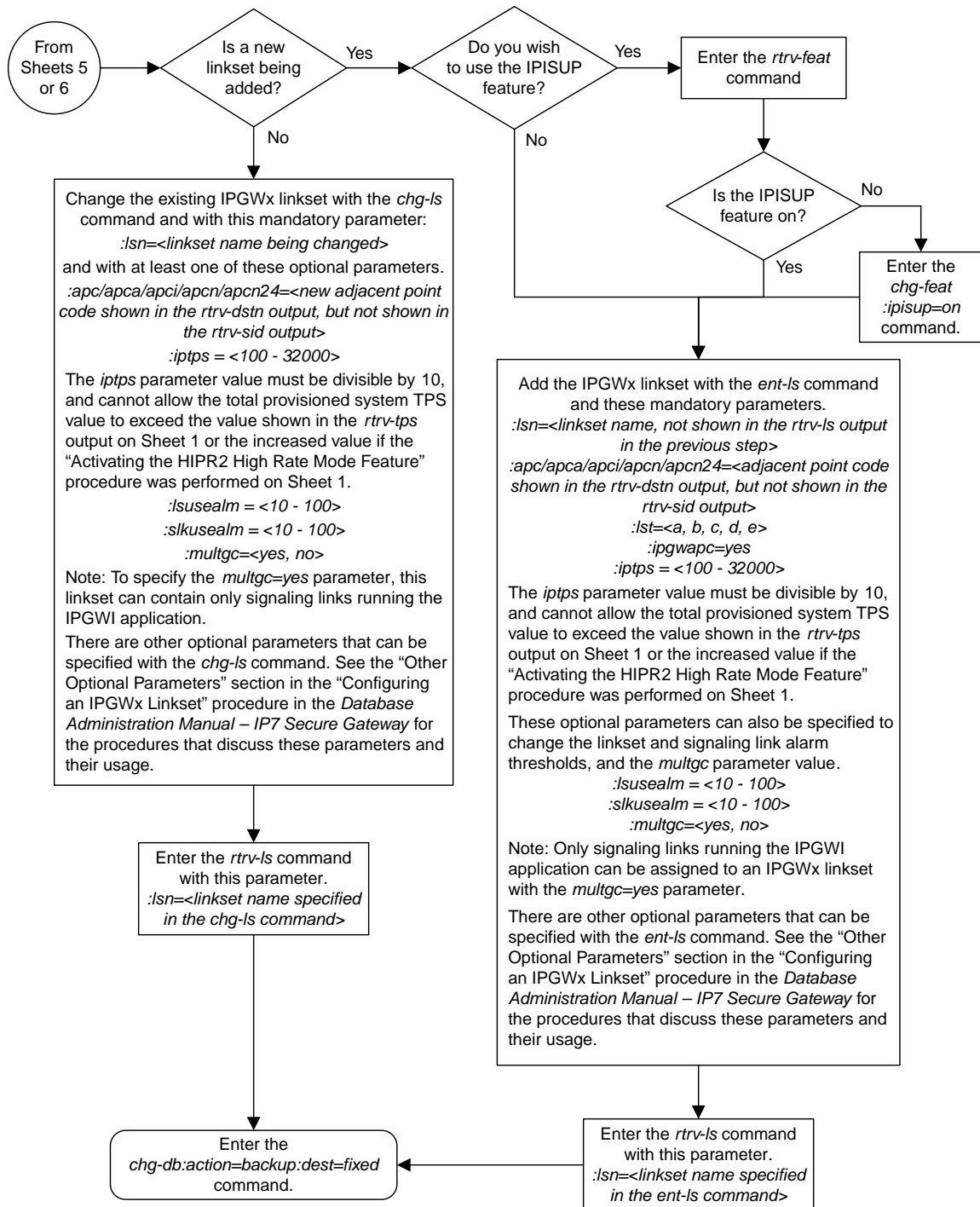

Sheet 7 of 7

Figure 42: Configuring an IPGWx Linkset

Adding a Mate IPGWx Linkset to another IPGWx Linkset

This procedure is used to add a mate IPGWx linkset to an existing IPGWx linkset `chg-ls` command with these parameters.

`:lsn` – The name of the IPGWx linkset that will contain the mate IPGWx linkset that is being added shown in the `rept-stat-iptps` or `rtrv-ls` command outputs. is being added.

`:matelsn` – The name of the mate IPGWx linkset that is being added.

`:action=add` – adds the mate IPGWx linkset to the IPGWx linkset specified by the `lsn` parameter.

An IPGWx linkset is a linkset that contains signaling links assigned to IPGWx cards. IPGWx cards are cards running either the SS7IPGW or IPGWI applications.

The EAGLE allows an IPGWx linkset to contain up to 8 IPGWx signaling links, and as a result, 8 IPGWx cards. This increases the amount of traffic that can be delivered to a single IP node compared to the two-card combined IPGWx linkset deployments used in previous releases. An IPGWx linkset containing up to 8 IPGWx signaling links is the preferred method of configuring IPGWx linksets (see the [Configuring an IPGWx Linkset](#) procedure). This method is required if more than two IPGWx signaling links are to be used in the linkset.

To provide backward compatibility with pre-existing two-card combined IPGWx linkset deployments, the EAGLE also provides for a mate IPGWx linkset. A mate IPGWx linkset consists of one IPGWx linkset assigned to another IPGWx linkset using the `matelsn` parameter of the `chg-ls` command. To assign a mate IPGWx linkset to another IPGWx linkset, both linksets can contain no more than one signaling link. While mate IPGWx linksets can be configured using this procedure, the preferred method of configuring two-card IPGWx deployments is to configure a two-link non-mated linkset using the [Configuring an IPGWx Linkset](#) procedure.

Each linkset in the mated pair must either contain no mate linksets, or can reference the other linkset in the mated pair. For example, to assign linkset `LSN2` to IPGWx linkset `LSN1` as a mate linkset, linkset `LSN1` cannot contain any mate linksets. Linkset `LSN2` can have linkset `LSN1` as a mate, otherwise linkset `LSN2` cannot have any mate linksets assigned to it.

The mate linkset name is displayed in the `rtrv-ls:lsn=<linkset name>` command output. If either linkset contains more than one signaling link, all but one of the signaling links must be removed from these linksets or other linksets must be chosen. Perform the [Removing an IPGWx Signaling Link](#) procedure to remove any signaling links from the linkset. If new linksets must be configured for this procedure, perform the [Configuring an IPGWx Linkset](#) procedure.

Before a mate IPGWx linkset can be added to an IPGWx linkset, the card containing the IPGWx signaling link assigned to the linkset being changed, and the signaling link assigned to that card must be placed out of service.

The network type of the adjacent point code of the mate IPGWx linkset must be the same type as the linkset the mate is assigned to. For example, if a mate IPGWx linkset is assigned to an IPGWx linkset with an ITU-I adjacent point code, the mate IPGWx linkset must have an ITU-I adjacent point code.

Other Optional Parameters

There are other optional parameters that can be used to configure a linkset. These parameters are not required for configuring an IPGWx linkset. These parameters are discussed in more detail in *Commands User's Guide* or in these sections.

- These procedures in this manual:
 - [Configuring an IPGWx Linkset](#)
 - [Removing a Mate IPGWx Linkset from another IPGWx Linkset](#)
 - [Adding an IPSP M3UA Linkset](#)
 - [Adding an IPSP M2PA Linkset](#)
 - [Changing an IPSP M3UA Linkset](#)
 - [Changing an IPSP M2PA Linkset](#)
 - These procedures in *Database Administration - SS7 User's Guide*
 - Adding an SS7 Linkset
 - Changing an SS7 Linkset
 - Configuring an ITU Linkset with a Secondary Adjacent Point Code (SAPC)
 - The "Configuring a Linkset for the GSM MAP Screening Feature" procedure in *Database Administration - Features User's Guide*.
1. Display the system-wide IP TPS usage report, and the IPGWx linksets, by entering the `rept-stat-iptps` command. This is an example of the possible output.

```
rlghncxa03w 10-07-19 21:16:37 GMT EAGLE5 42.0.0
IP TPS USAGE REPORT
```

	THRESH	CONFIG/ RSVD	CONFIG/ MAX		TPS	PEAK	PEAKTIMESTAMP
LSN							
lsgw1101	80%	----	6000	TX:	5100	5500	05-02-10 11:40:04
				RCV:	5100	5500	05-02-10 11:40:04
lsgw1103	80%	----	6000	TX:	5200	5500	05-02-10 11:40:04
				RCV:	5200	5500	05-02-10 11:40:04
lsgw1105	80%	----	14000	TX:	7300	7450	05-02-10 11:40:04
				RCV:	7300	7450	05-02-10 11:40:04
lsgw1107	70%	----	4000	TX:	3200	3500	05-02-10 11:40:04
				RCV:	3200	3500	05-02-10 11:40:04

```
-----
Command Completed.
```

If linksets are displayed in this step, continue the procedure [Step 2](#).

If no linksets are displayed in this step, perform the [Configuring an IPGWx Linkset](#) to create two IPGWx linksets. After the IPGWx linksets have been created, continue the procedure with [Step 14](#).

2. Display the linkset that is being changed by entering the `rtrv-ls` command with a linkset name shown in the `rept-stat-iptps` output in [Step 1](#). For this example, enter this command.

```
rtrv-ls:lsn=lsgw1103
```

This is an example of the possible output.

```
rlghncxa03w 08-04-17 11:43:04 GMT EAGLE5 38.0.0
```

```

LSN              APCA  (SS7)  SCRNR  L3T  SLT          GWS  GWS  GWS
lsgw1103         003-002-004  none  1    1    no  A    1    off off off no  off

                CLLI          TFATCABMLQ  MTPRSE  ASL8
                -----  1          no      no

                IPGWAPC  MATELSN      IPTPS  LSUSEALM  SLKUSEALM  GTTMODE
                yes      -----  10000  70      % 70      % CdPA

                LOC  LINK  SLC  TYPE
                1103 A    0    SS7IPGW

Link set table is ( 14 of 1024)  1% full

```

To assign a mate IPGWx linkset to this linkset, this linkset cannot contain more than one signaling link.

If this linkset does not contain more than one signaling link, and the linkset that will be the mate IPGWx linkset is shown in the `rept-stat-iptps` output in [Step 1](#), continue the procedure with [Step 3](#).

If this linkset does not contain more than one signaling link, and the linkset that will be the mate IPGWx linkset is not shown in the `rept-stat-iptps` output in [Step 1](#), continue the procedure with [Step 5](#).

If this linkset contains more than one signaling link, and you wish to add the mate IPGWx linkset to this linkset, perform the [Removing an IPGWx Signaling Link](#) procedure to remove all but one of the signaling links in the linkset. After the signaling links have been removed, perform one of these actions.

- If the linkset that will be the mate IPGWx linkset is shown in the `rept-stat-iptps` output in [Step 1](#), continue the procedure with [Step 3](#).
- If the linkset that will be the mate IPGWx linkset is not shown in the `rept-stat-iptps` output in [Step 1](#), perform the [Configuring an IPGWx Linkset](#) procedure to add the linkset that will be the mate IPGWx linkset. After the linkset has been added, continue the procedure with [Step 5](#).

If this linkset contains more than one signaling link, and you do not wish to add the mate IPGWx linkset to this linkset, perform one of these actions.

- If wish to use another linkset shown in the `rept-stat-iptps` output in [Step 1](#), repeat this step with a linkset shown in the `rept-stat-iptps` output in [Step 1](#).
- Perform the [Configuring an IPGWx Linkset](#) procedure to add the new IPGWx linkset that the mate IPGWx linkset will be assigned to. After the linkset has been added, if the linkset that will be the mate IPGWx linkset is shown in the `rept-stat-iptps` output in [Step 1](#), continue the procedure with [Step 3](#). If the linkset that will be the mate IPGWx linkset is not shown in the `rept-stat-iptps` output in [Step 1](#), perform the [Configuring an IPGWx Linkset](#) procedure to add the new IPGWx linkset that will be the mate IPGWx linkset. After the mate IPGWx linkset has been added, continue the procedure with [Step 14](#)

3. Display the mate linkset from the IPGWx linksets shown in the `rept-stat-iptps` output in [Step 1](#).

For this example, enter this command.

```
rtrv-ls:lsn=lsgw1107
```

This is an example of the possible output.

```

rlghncxa03w 08-04-17 11:43:04 GMT EAGLE5 38.0.0

LSN          APCA  (SS7)  SCRNR  L3T  SLT          GWS  GWS  GWS
lsgw1107     003-002-004  none  1    1    no  A    1    off off off no  off

          CLLI          TFATCABMLQ  MTPRSE  ASL8
          -----  1          no      no

          IPGWAPC  MATELSN      IPTPS  LSUSEALM  SLKUSEALM  GTTMODE
          yes      -----  10000  70      % 70      % CdPA

          LOC  LINK  SLC  TYPE
          1107 A    0    SS7IPGW

Link set table is ( 14 of 1024)  1% full

```

- To use the linkset shown in [Step 3](#) as a mate, the network type of the adjacent point code of the linkset shown in [Step 3](#) must be the same as the network type of the linkset shown in [Step 2](#). The linkset shown in [Step 3](#) must not have more than one signaling link assigned to it.

If the linkset contains more than one signaling link, all but one of these signaling links must be removed from the linkset. Perform the [Removing an IPGWx Signaling Link](#) procedure to remove these signaling links.

If you do not wish to change this linkset, or if the network type of the adjacent point codes of both linksets are not the same, either choose another linkset from the `rept-stat-iptps` output in [Step 1](#), and repeat [Step 3](#), and [Step 4](#) if necessary, or perform the [Configuring an IPGWx Linkset](#) procedure and add a new linkset. Continue the procedure with [Step 5](#).

If the network types of the adjacent point codes of both linksets are the same, and the mate linkset contains no more than one signaling link, do not perform the actions in this step. Continue the procedure with [Step 5](#).

- Display the status of the card containing the signaling link assigned to the linkset being changed by entering the `rept-stat-card` command with the card location shown in the LOC field in the `rtrv-ls` output in [Step 2](#). For this example, enter this command.

Note: If the linkset that the mate linkset is being added to has no signaling links (see the `rtrv-ls` output in [Step 2](#)), continue the procedure with [Step 14](#).

```
rept-stat-card:loc=1103
```

This is an example of the possible output.

```

rlghncxa03w 08-04-27 17:00:36 GMT EAGLE5 38.0.0
CARD  VERSION  TYPE  GPL  PST  SST  AST
1103  114-000-000  DCM  SS7IPGW  IS-NR  Active  -----
ALARM STATUS      = No Alarms.
BPDCM GPL         = 002-102-000
IMT BUS A         = Conn
IMT BUS B         = Conn
SIGNALING LINK STATUS
SLK  PST  LS  CLLI
A    IS-NR  lsgw1103  -----
Command Completed.

```

6. Display the status of the signaling link assigned to the card shown in [Step 5](#) by entering the `rept-stat-slk` command with the card location used in [Step 5](#) and the `link=a` parameter. For this example, enter this command.

Note: If the status of the card shown in `PST` field in the `rept-stat-card` output in [Step 5](#) is `OOS-MT-DSBLD`, continue the procedure with [Step 14](#).

```
rept-stat-slk:loc=1103:link=a
```

This is an example of the possible output.

```
rlghncxa03w 08-04-27 17:00:36 GMT EAGLE5 38.0.0
SLK      LSN      CLLI      PST      SST      AST
1103,A   lsgw1103   -----  IS-NR    Avail    -----
  ALARM STATUS      = No Alarms.
  UNAVAIL REASON    = NA
Command Completed.
```

If the status of the signaling link is out-of-service maintenance disabled (OOS-MT-DSBLD), continue the procedure with [Step 14](#).

If the status of the signaling link is not out-of-service maintenance disabled (OOS-MT-DSBLD), any in-service IP connections on the signaling link must be placed out of service. Continue the procedure by performing one of these steps.

- The recommended method is to have the far end node place these IP connections out of service. Have the far-end node for the signaling link shown in this step place the M3UA or SUA associations in either the `ASP-INACTIVE` or `ASP-DOWN` state. After the IP connections have been placed out of service, continue the procedure with [Step 12](#).
- If you do not wish to have the far end node place these IP connections out of service, continue the procedure with [Step 7](#).

7. Display the IP link associated with the card that the signaling link shown in [Step 6](#) is assigned to by entering the `rtrv-ip-lnk` command with the card location shown in [Step 6](#). For this example, enter this command.

```
rtrv-ip-lnk:loc=1103
```

The following is an example of the possible output.

```
rlghncxa03w 08-04-28 21:14:37 GMT EAGLE5 38.0.0
LOC  PORT  IPADDR      SUBMASK      DUPLEX  SPEED  MACTYPE  AUTO  MCAST
1103  A    192.1.1.10  255.255.255.128  HALF    10    802.3    NO    NO
1103  B    -----    -----    HALF    10    DIX      NO    NO
```

8. Display the IP host information associated with the IP link by entering the `rtrv-ip-host` command with the IP address shown in [Step 7](#). For this example, enter this command.

```
rtrv-ip-host:ipaddr=192.001.001.010
```

The following is an example of the possible output.

```
rlghncxa03w 08-12-28 21:17:37 GMT EAGLE5 40.0.0
LOCAL IPADDR      LOCAL HOST
```

```
192.1.1.10      IPNODE1_1103
IP Host table is (11 of 4096) .26% full
```

9. Display the association associated with the local host name shown in [Step 8](#) by entering the `rtrv-assoc` command.

For this example, enter this command.

```
rtrv-assoc:lhost=ipnode1_1103
```

The following is an example of the possible output.

```
rlghncxa03w 08-04-28 09:12:36 GMT EAGLE5 38.0.0
                CARD IPLNK
ANAME          LOC  PORT  LINK ADAPTER  LPORT  RPORT  OPEN  ALW
assoc2         1103  A     A    M3UA     1030   1030   YES   YES

IP Appl Sock/Assoc table is (4 of 4000) 1% full
Assoc Buffer Space Used (16 KB of 3200 KB) on LOC = 1103
```

10. Change the `alw` parameter values in the association shown in [Step 9](#) using the `chg-assoc` command with the `alw=no` parameters, as necessary.

Note: If the `open` and `alw` parameter values of the association shown in [Step 9](#) are `no`, continue the procedure with [Step 11](#).

```
chg-assoc:aname=assoc2:alw=no
```



CAUTION

Caution: This command impacts network performance and should only be used during periods of low traffic.

When this command has successfully completed, this message should appear.

```
rlghncxa03w 08-04-28 09:12:36 GMT EAGLE5 38.0.0
CHG-ASSOC: MASP A - COMPLTD
```

Repeat this step for all associations shown in [Step 9](#).

11. Change the `open` parameter values in the association shown in [Step 9](#) using the `chg-assoc` command with the `open=no` parameters, as necessary.

```
chg-assoc:aname=assoc2:open=no
```

When this command has successfully completed, this message should appear.

```
rlghncxa03w 08-04-28 09:12:36 GMT EAGLE5 38.0.0
CHG-ASSOC: MASP A - COMPLTD
```

Repeat this step for all associations shown in [Step 9](#).

12. Deactivate the signaling link assigned to the IP card using the `dact-slk` command. For example, enter this command.

```
dact-slk:loc=1103:link=a
```

**CAUTION**

Caution: This command impacts network performance and should only be used during periods of low traffic.

After this command has successfully completed, this message appears.

```
rlghncxa03w 08-04-12 09:12:36 GMT EAGLE5 38.0.0
Deactivate Link message sent to card.
```

13. Inhibit the IP card using the `inh-card` command. For example, enter this command.

```
inh-card:loc=1103
```

This message should appear.

```
rlghncxa03w 08-04-28 21:18:37 GMT EAGLE5 38.0.0
Card has been inhibited.
```

14. Change the linkset shown in [Step 2](#) by entering the `chg-ls` command with the `matelsn` and `action=add` parameters.

For this example, enter this command.

```
chg-ls:lsn=lsgw1103:matelsn=lsgw1107:action=add
```

When the `chg-ls` command has successfully completed, this message should appear.

```
rlghncxa03w 08-04-17 16:23:21 GMT EAGLE5 38.0.0
Link set table is ( 14 of 1024) 1% full
CHG-LS: MASP A - COMPLTD
```

15. Verify the changes using the `rtrv-ls` command specifying the linkset name specified in [Step 14](#) with the `lsn` parameter. For this example, enter this command.

```
rtrv-ls:lsn=lsgw1103
```

This is an example of the possible output.

```
rlghncxa03w 08-04-17 11:43:04 GMT EAGLE5 38.0.0

LSN          APCA  (SS7)  SCRN  SET  SET  BEI  LST  LNKS  ACT  MES  DIS  SLSCI  NIS
lsgw1103     003-002-004  none  1   1   no  A   1   off  off  off  no   off

          CLLI          TFATCABMLQ  MTPRSE  ASL8
          -----  1           no      no

          IPGWAPC  MATELSN    IPTPS  LSUSEALM  SLKUSEALM  GTTMODE
          yes      lsgw1107  10000  70       % 70       % CdPA

          LOC  LINK  SLC  TYPE
          1103 A   0   SS7IPGW

Link set table is ( 14 of 1024) 1% full
```

If the linkset shown in this step does not have a signaling link assigned to it, or if the `dact-slk` command in [Step 12](#) was not performed, continue the procedure with [Step 20](#).

16. Allow the IP card that was inhibited in [Step 13](#) using the `alw-card` command. For example, enter this command.

```
alw-card:loc=1103
```

This message should appear.

```
rlghncxa03w 08-04-28 21:21:37 GMT EAGLE5 38.0.0
Card has been allowed.
```

17. Activate the signaling link from [Step 12](#) using the `act-slk` command. For example, enter this command.

```
act-slk:loc=1103:link=a
```

The output confirms the activation.

```
rlghncxa03w 08-04-07 11:11:28 GMT EAGLE5 38.0.0
Activate Link message sent to card
```

If [Step 10](#) and [Step 11](#) were not performed, continue the procedure with [Step 19](#).

18. Change the `open` and `alw` parameter values for all the associations changed in [Step 10](#) or [Step 11](#) using the `chg-assoc` command with the `open=yes` and `alw=yes` parameters.

```
chg-assoc:aname=assoc1:open=yes:alw=yes
```

When this command has successfully completed, this message should appear.

```
rlghncxa03w 08-04-28 09:12:36 GMT EAGLE5 38.0.0
CHG-ASSOC: MASP A - COMPLTD
```

19. Have the far-end node for the signaling link shown in [Step 15](#) place the IP connections on the signaling link into service by placing the M3UA or SUA associations in the ASP-ACTIVE state.
20. Back up the new changes using the `chg-db:action=backup:dest=fixed` command. These messages should appear, the active Maintenance and Administration Subsystem Processor (MASP) appears first.

```
.
BACKUP (FIXED) : MASP A - Backup starts on active MASP.
BACKUP (FIXED) : MASP A - Backup on active MASP to fixed disk complete.
BACKUP (FIXED) : MASP A - Backup starts on standby MASP.
BACKUP (FIXED) : MASP A - Backup on standby MASP to fixed disk complete.
```

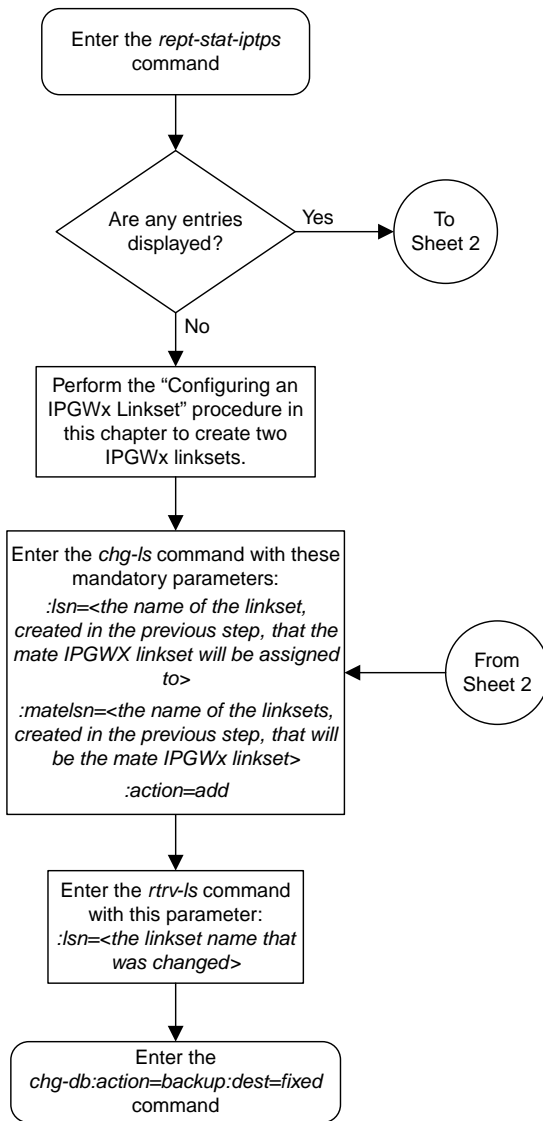

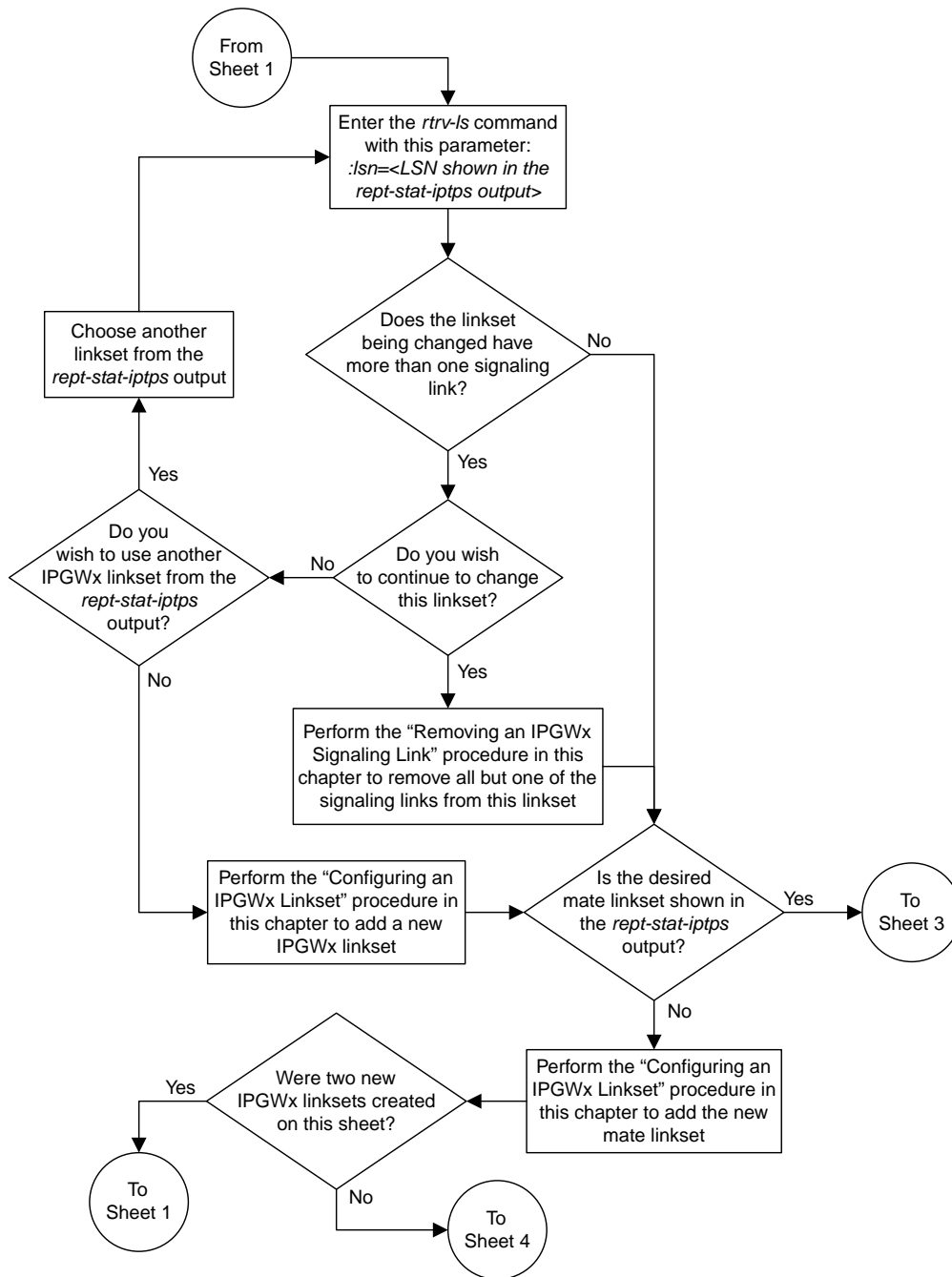

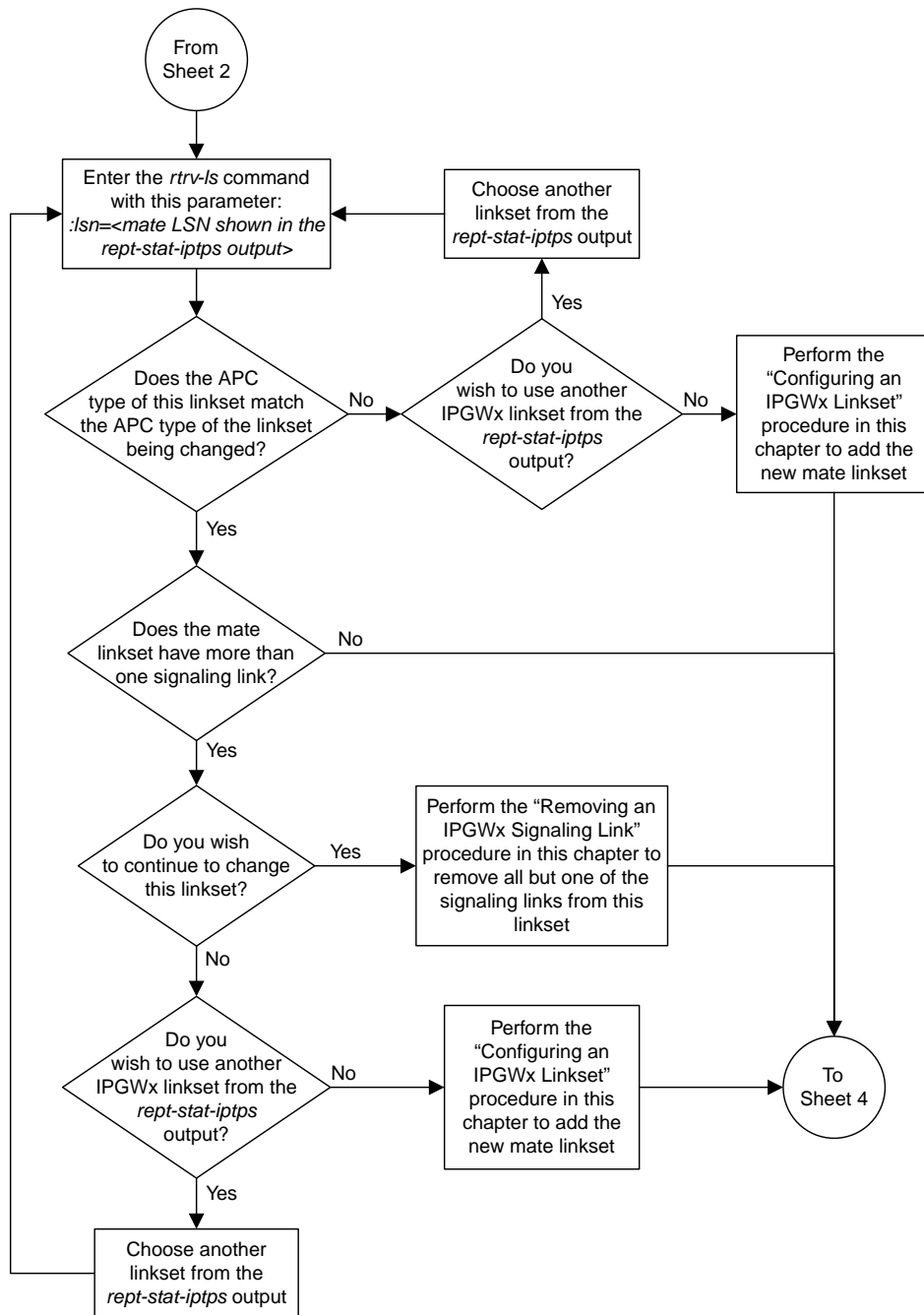

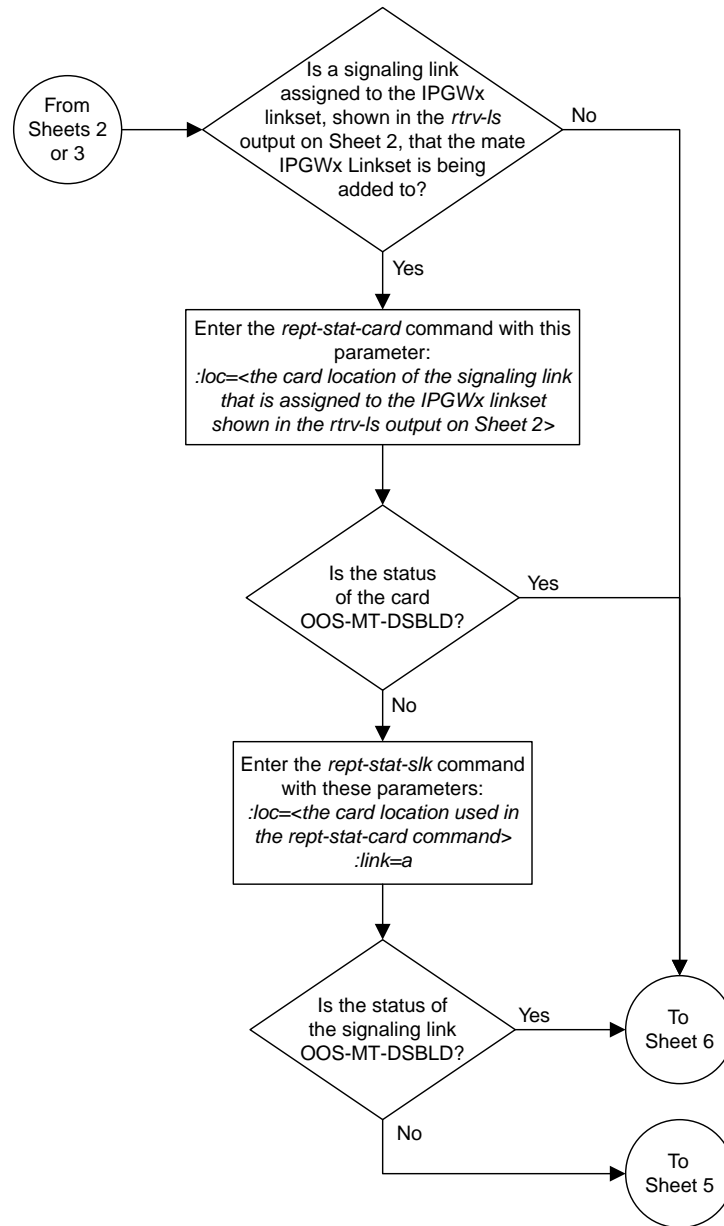

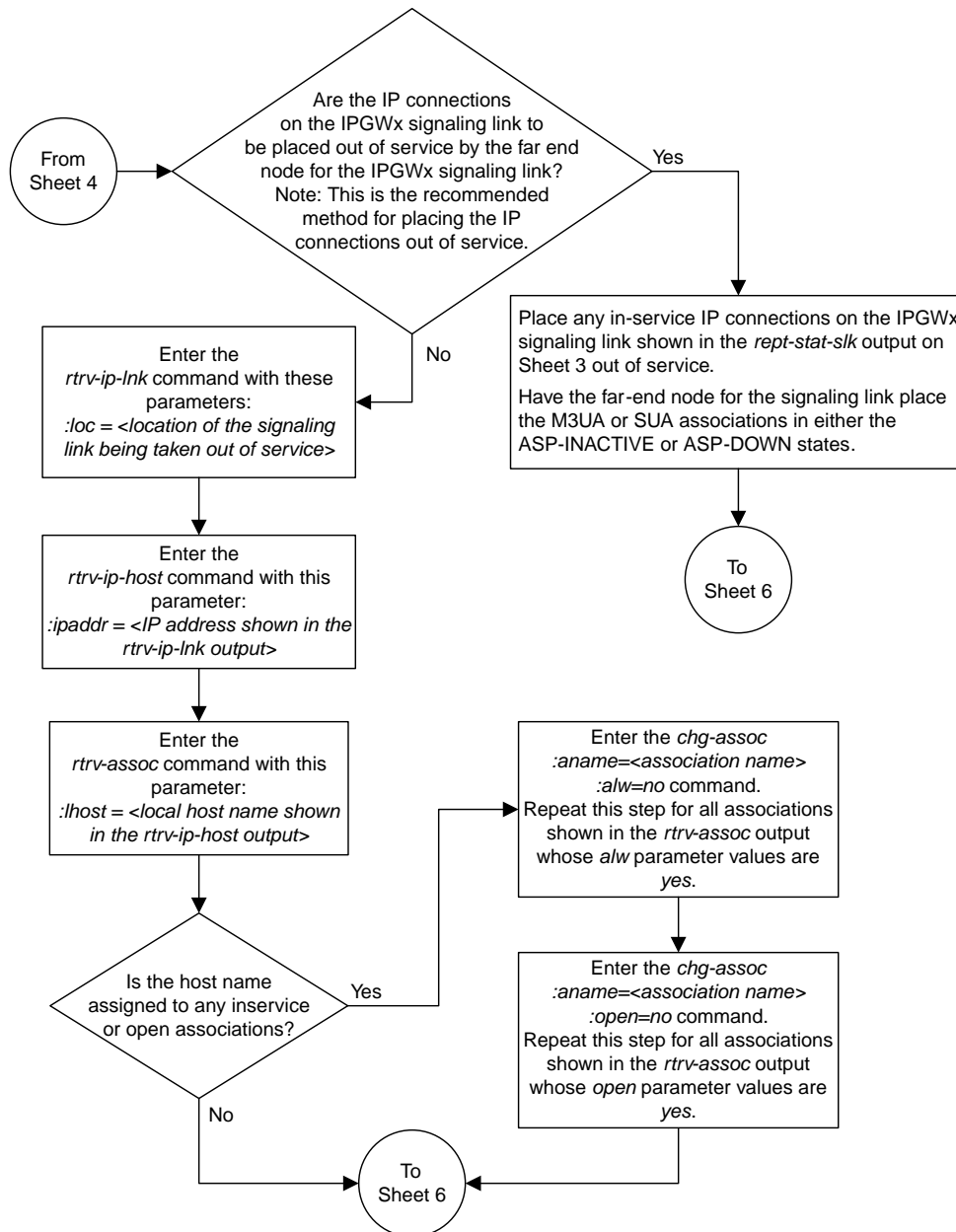

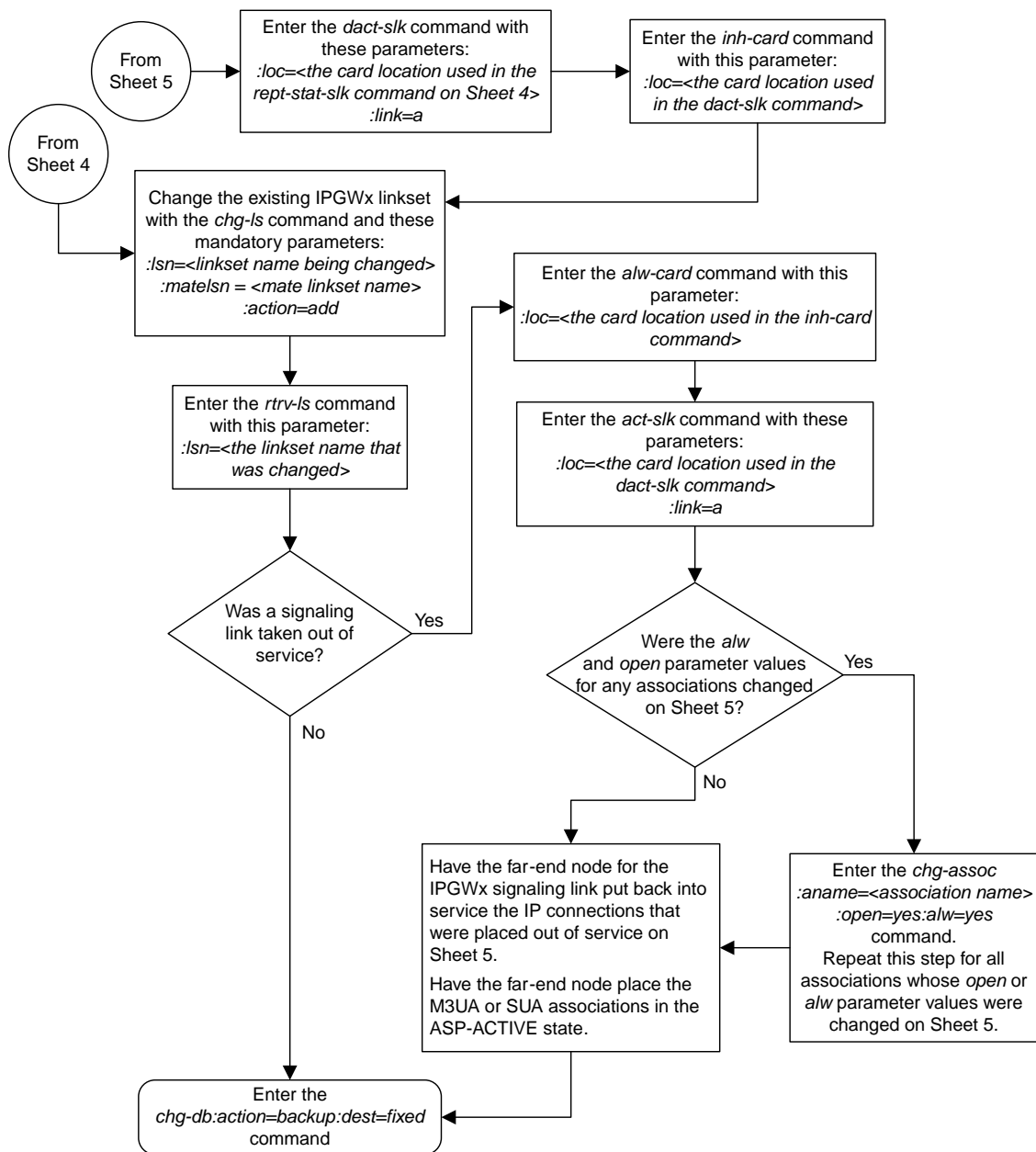

Sheet 6 of 6

Figure 43: Adding a Mate IPGWx Linkset to another IPGWx Linkset

Adding an IPGWx Signaling Link

This procedure is used to add an IPGWx signaling link to the database using the `ent-slk` command with these parameters:

`:loc` – The card location of the IP card that the IP signaling link will be assigned to. The cards specified by this parameter are IP cards running the SS7IPGW or IPGWI applications.

`:link` – The signaling link on the card specified in the `loc` parameter.

`:lsn` – The name of the linkset that will contain the signaling link.

`:slc` – The signaling link code. The SLC must be unique within the linkset. It must be the same at both the EAGLE location and the distant node.

The `ent-slk` command contains other optional parameters that are not used to configure an IPGWx signaling link. These parameters are discussed in more detail in *Commands User's Guide* or in these sections.

- These procedures in this manual:
 - [Adding an IPLIMx Signaling Link](#)
 - [Adding an IPSC M3UA Signaling Link](#)
 - [Adding an IPSC M2PA Linkset](#)
- These procedures in *Database Administration - SS7 User's Guide*
 - Adding an SS7 Signaling Link
 - Adding an E1 Signaling Link
 - Adding a T1 Signaling Link
 - Adding an ATM High-Speed Signaling Link

These items must be configured in the database before an IP signaling link can be added:

- Shelf – see "Adding a Shelf" in the *Database Administration - System Management User's Guide*.
- Card – see [Adding an IPGWx Card](#)
- Destination Point Code – see "Adding a Destination Point Code" in the *Database Administration - SS7 User's Guide*.
- Linkset – see [Configuring an IPGWx Linkset](#).

Verify that the link has been physically installed (all cable connections have been made).

To configure the EAGLE to perform circular routing detection test on the signaling links, "Configuring Circular Route Detection" procedure in *Database Administration - SS7 User's Guide*.

Note: Circular route detection is not supported in ITU networks.

To provision a EAGLE with more than 1200 signaling links, the EAGLE must have certain levels of hardware installed. See the [Requirements for EAGLEs Containing more than 1200 Signaling Links](#) section for more information on these hardware requirements.

The EAGLE can contain a mixture of low-speed, E1, T1, ATM high-speed, and IP signaling links. The [Determining the Number of High-Speed and Low-Speed Signaling Links](#) section describes how to determine the quantities of the different types of signaling links the EAGLE can have.

Canceling the REPT-STAT-SLK, RTRV-LS, and RTRV-SLK Commands

Because the `rept-stat-slk`, `rtrv-ls`, and `rtrv-slk` commands used in this procedure can output information for a long period of time, the `rept-stat-slk`, `rtrv-ls`, and `rtrv-slk` commands can be canceled and the output to the terminal stopped. There are three ways that the `rept-stat-slk`, `rtrv-ls`, and `rtrv-slk` commands can be canceled.

- Press the F9 function key on the keyboard at the terminal where the `rept-stat-slk`, `rtrv-ls`, or `rtrv-slk` commands were entered.
- Enter the `canc-cmd` without the `trm` parameter at the terminal where the `rept-stat-slk`, `rtrv-ls`, or `rtrv-slk` commands were entered.
- Enter the `canc-cmd:trm=<xx>`, where `<xx>` is the terminal where the `rept-stat-slk`, `rtrv-ls`, or `rtrv-slk` commands were entered, from another terminal other than the terminal where the `rept-stat-slk`, `rtrv-ls`, or `rtrv-slk` commands were entered. To enter the `canc-cmd:trm=<xx>` command, the terminal must allow Security Administration commands to be entered from it and the user must be allowed to enter Security Administration commands. The terminal's permissions can be verified with the `rtrv-secu-trm` command. The user's permissions can be verified with the `rtrv-user` or `rtrv-secu-user` commands.

For more information about the `canc-cmd` command, go to *Commands User's Guide*.

1. Display the maximum number of signaling links the EAGLE can have and the number of signaling links that are currently provisioned by entering the `rtrv-tbl-capacity` command.

This is an example of the possible output.

```
rlghncxa03w 09-07-19 21:16:37 GMT EAGLE5 41.1.0
SLK      table is (          7 of      1200)   1% full
```

Note: The `rtrv-tbl-capacity` command output contains other fields that are not used by this procedure. If you wish to see all the fields displayed by the `rtrv-tbl-capacity` command, refer to the `rtrv-tbl-capacity` command description in *Commands User's Guide*.

If the addition of the new signaling link will not exceed the maximum number of signaling links the EAGLE can have, continue the procedure with [Step 2](#).

If the addition of the new signaling link will exceed the maximum number of signaling links the EAGLE can have, and the maximum number of signaling links is less than 2800, perform the [Enabling the Large System # Links Controlled Feature](#) procedure to enable the desired quantity of signaling links. After the new quantity of signaling links has been enabled, continue the procedure with [Step 2](#).

If the addition of the new signaling link will exceed the maximum number of signaling links the EAGLE can have (in this example, the maximum number of signaling links is 1200), and the maximum number of signaling links is 2800, this procedure cannot be performed. The EAGLE cannot contain more than 2800 signaling links.

2. Display the current signaling link configuration using the `rtrv-slk` command.

```
rlghncxa03w 09-07-19 21:16:37 GMT EAGLE5 41.1.0
```

```

LOC LINK LSN          SLC TYPE          L2T          PCR PCR
1201 B lsa1           0 LIMDS0        1 56000 BASIC --- -----
1203 B lsa2           0 LIMDS0        1 56000 BASIC --- -----
1207 A lsn1207a       0 LIMDS0        1 56000 BASIC --- -----
1207 B lsn1207b       0 LIMDS0        1 56000 BASIC --- -----

```

SLK table is (4 of 1200) 1% full.

3. Display the current linkset configuration using the `rtrv-ls` command.

This is an example of the possible output.

```

rlghncxa03w 08-04-10 11:43:04 GMT EAGLE5 38.0.0

LSN          APCA  (SS7)  SCRNRN  L3T SLT          GWS GWS GWS
ele2         001-207-000 none 1 1 no B 6 off off off no off
ls1305       000-005-000 none 1 1 no A 1 off off off no off
ls1307       000-007-000 none 1 1 no A 1 off off off no off
elm1s1       001-001-001 none 1 1 no A 7 off off off no off
elm1s2       001-001-002 none 1 1 no A 7 off off off no off

LSN          APCI  (SS7)  SCRNRN  L3T SLT          GWS GWS GWS
ele2i        1-207-0 none 1 1 no B 4 off off off --- on
ls1315       0-015-0 none 1 1 no A 1 off off off --- off
ls1317       0-017-0 none 1 1 no A 1 off off off --- on
elm2s1       1-011-1 none 1 1 no A 7 off off off --- off
elm2s2       1-011-2 none 1 1 no A 7 off off off --- off

```

Link set table is (10 of 1024) 1% full.

If the required linkset is not in the database, perform the [Configuring an IPGWx Linkset](#) to add the linkset to the database.

If you plan to use a linkset shown in this step, continue the procedure with [Step 4](#).

If a new linkset is being added in this step, continue the procedure with [Step 5](#).

4. Display the linkset that the signaling link is being assigned to using the `rtrv-ls` command, specifying the name of the linkset that the signaling link is being assigned to.

For this example, enter this command.

```
rtrv-ls:lsn=lsnipgw
```

This is an example of the possible output.

```

rlghncxa03w 08-04-17 11:43:04 GMT EAGLE5 38.0.0

LSN          APCI  (SS7)  SCRNRN  L3T SLT          GWS GWS GWS
lsnipgw      2968          none 1 1 no A 1 off off off --- off

          CLLI          TFATCABMLQ  MTPRSE  ASL8  SLRSRB  MULTGC  ITUTFR
          ----- 1          no      --- 1          yes      off

          IPGWAPC MATELSN          IPTPS LSUSEALM SLKUSEALM GTTMODE

```

```

yes      ----- 10000 70      % 70      % CdPA

LOC LINK SLC TYPE
1317 A      0  IPGWI

SAPCI
1-10-1

SAPCN
1234-aa
1235-bb
1200-zz

Link set table is (13 of 1024) 1% full.

```

Linksets containing IPGWx signaling links can contain only IPGWx signaling links.

5. Display the cards in the database using the `rtrv-card` command.

This is an example of the possible output.

```

rlghncxa03w 09-10-28 09:12:36 GMT EAGLE5 41.0.0
CARD  TYPE      APPL      LSET NAME      LINK SLC LSET NAME      LINK SLC
1102  TSM          GLS
1103  DCM          STPLAN
1113  GSPM         EOAM
1114  TDM-A
1115  GSPM         EOAM
1116  TDM-B
1117  MDAL
1201  LIMDS0      SS7ANSI      lsa1           B      0
1202  LIMDS0      SS7ANSI
1203  LIMDS0      SS7ANSI      lsa2           B      0
1204  LIMDS0      SS7ANSI
1205  LIMDS0      SS7ANSI      lsa3           A      0
1206  LIMDS0      SS7ANSI
1207  LIMDS0      SS7ANSI      lsn1207a       A      0      lsn1207b       B      0
1208  LIMDS0      SS7ANSI
1212  LIMDS0      SS7ANSI
1213  LIMDS0      SS7ANSI
1214  LIMDS0      SS7ANSI      lsn1214a       A      0      lsa3           B      1
1215  LIMDS0      SS7ANSI
1301  LIMDS0      ATMANSI
1302  LIMATM      ATMANSI
1304  LIMDS0      SS7ANSI
1305  LIMATM      ATMANSI
1308  LIMDS0      SS7ANSI
1311  LIMDS0      SS7ANSI
1313  LIMDS0      SS7ANSI
1318  LIMATM      ATMANSI

```

If the required card is not in the database, perform the [Adding an IPGWx Card](#) procedure and add the IP card to the database.

Note: If the linkset that the signaling link will be added to contains the `multgic=yes` parameter, the application assigned to the card must be IPGWI.

Note: If the IPGWx linkset contains any IPGWx signaling links, continue the procedure with [Step 7](#).

6. If you wish to assign an IPGWx signaling link to a linkset contains no signaling links, but the IPGWAPC value is no, perform the “Removing a Linkset Containing SS7 Signaling Links” procedure in the *Database Administration - SS7 User’s Guide* and remove the linkset, then perform the [Configuring an IPGWx Linkset](#) procedure and re-enter the new linkset with the `ipgwapc=yes` parameter. Continue the procedure with [Step 10](#).

7. If the desired linkset, shown in the `rtrv-ls` output in [Step 4](#), has a mate IPGWx linkset assigned, or is the mate to another IPGWx linkset, the desired linkset can contain only one signaling link.

If the desired linkset does not have a mate IPGWx linkset assigned, or is not the mate of another IPGWx linkset, the desired linkset can contain up to 8 IPGWx signaling links. No other signaling link types can be in an IPGWx linkset.

If you wish to assign more than one IPGWx signaling link to an IPGWx linkset that has a mate linkset assigned, the mate to this linkset must be removed. Perform the [Removing a Mate IPGWx Linkset from another IPGWx Linkset](#) procedure and remove the mate linkset from the linkset you wish to assign the IPGWx signaling link to. If you do not wish to use this linkset, perform the [Configuring an IPGWx Linkset](#) procedure and add a new IPGWx linkset.

If the desired IPGWx linkset does not have a mate assigned, continue the procedure with [Step 9](#).

If the desired linkset has a mate linkset assigned, and contains an IPGWx signaling link, perform the [Configuring an IPGWx Linkset](#) procedure and add a new IPGWx linkset. Continue the procedure with [Step 10](#).

8. If you wish to assign more than one IPGWx signaling link to an IPGWx linkset that is a mate to another IPGWx linkset, this linkset must be removed from the other linkset as a mate.

To verify if the linkset you wish to use is the mate of another IPGWx linkset, enter the `rept-stat-iptps` command to display the names of all the IPGWx linksets. This is an example of the possible output.

```
rlghncxa03w 10-07-19 21:16:37 GMT EAGLE5 42.0.0
IP TPS USAGE REPORT
```

	THRESH	CONFIG/ RSVD	CONFIG/ MAX		TPS	PEAK	PEAKTIMESTAMP
LSN							
lsgw1101	80%	----	6000	TX:	5100	5500	05-02-10 11:40:04
				RCV:	5100	5500	05-02-10 11:40:04
lsgw1103	80%	----	6000	TX:	5200	5500	05-02-10 11:40:04
				RCV:	5200	5500	05-02-10 11:40:04
lsgw1105	80%	----	14000	TX:	7300	7450	05-02-10 11:40:04
				RCV:	7300	7450	05-02-10 11:40:04
lsgw1107	70%	----	4000	TX:	3200	3500	05-02-10 11:40:04
				RCV:	3200	3500	05-02-10 11:40:04

```
-----
Command Completed.
```

9. Enter the `rtrv-ls:lsn=<IPGWx linkset name from the rept-stat-iptps output>` to verify if the desired linkset is the mate of another IPGWx linkset.

For this example, enter this command.

```
rtrv-ls:lsn=lsgw1103
```

This is an example of the possible output.

```

rlghncxa03w 08-04-17 11:43:04 GMT EAGLE5 38.0.0

LSN          APCA  (SS7)  SCRN  L3T  SLT          GWS  GWS  GWS
lsgw1103     003-002-004  none  1    1    no  A    1    off off off no  off

          CLLI          TFATCABMLQ  MTPRSE  ASL8
          -----  1          no      no

          IPGWAPC  MATELSN      IPTPS  LSUSEALM  SLKUSEALM  GTTMODE
          yes      lsgw1107    10000  70      % 70      % CdPA

          LOC  LINK  SLC  TYPE
          1103 A    0    SS7IPGW

Link set table is ( 14 of 1024) 1% full

```

If the name of the linkset you wish to use is not shown in the MATELSN field of the `rtrv-ls` output, repeat this step until all the IPGWx linksets have been displayed, or until a linkset has been found that has the linkset you wish to use assigned as a mate. If the linkset you wish to use is not the mate of another IPGWx linkset, continue the procedure with [Step 10](#).

If the name of the linkset you wish to use is shown in the MATELSN field of the `rtrv-ls` output, perform the [Removing a Mate IPGWx Linkset from another IPGWx Linkset](#) procedure to remove this linkset from the other linkset as a mate. Then continue the procedure with [Step 10](#).

If the desired linkset is the mate of another IPGWx linkset, and you do not wish to use this linkset, perform the [Configuring an IPGWx Linkset](#) procedure and add a new IPGWx linkset. Then continue the procedure with [Step 10](#).

10. Add the signaling link to the database using the `ent-slk` command [Table 23: IPGWx Signaling Link Parameter Combinations](#) shows the parameters and values that can be specified with the `ent-slk` command.

Table 23: IPGWx Signaling Link Parameter Combinations

IPGWx Signaling Link
:loc = location of the IP card with one of these applications: SS7IPGW or IPGWI; and the DCM card type. (See Note 6)
:link = A
:lsn = linkset name (See Notes 1, 2, 3, 4, and 5)
:slc = 0 - 15 (See Notes 4 and 5)
Notes:
1. If the <code>multgc=yes</code> parameter is assigned to the linkset, the card's application must be IPGWI.
2. The <code>ipgwapc=yes</code> parameter must be assigned to the linkset.
3. If the card's application is IPGWI, the linkset adjacent point code must be ITU. If the card's application is SS7IPGW, the linkset adjacent point code must be ANSI. The domain of the linkset adjacent point code must be SS7.

IPGWx Signaling Link

- | |
|--|
| <p>4. A linkset can contain only one signaling link assigned to the SS7IPGW or IPGWI applications if the linkset contains a mate IPGWx linkset, or is the mate of an IPGWx linkset.</p> <p>5. If the linkset does not have a mate IPGWx linkset assigned to it, or is not the mate of an IPGWx linkset, the linkset can contain up to 8 signaling links assigned to the SS7IPGW or IPGWI applications.</p> |
|--|

For this example, enter these commands.

```
ent-slk:loc=2207:link=a:lsn=lsnlp3:slc=0
```

```
ent-slk:loc=2211:link=a:lsn=lsnlp4:slc=0
```

When each of these commands have successfully completed, this message should appear.

```
rlghncxa03w 06-10-07 08:29:03 GMT EAGLE5 36.0.0
ENT-SLK: MASP A - COMPLTD
```

Note: If adding the new signaling link will result in more than 700 signaling links in the database and the OAMHCMEAS value in the `rtrv-measopts` output is on, the scheduled UI measurement reports will be disabled.

11. Verify the changes using the `rtrv-slk` command with the card location and link parameter values specified in [Step 10](#).

```
rtrv-slk:loc=2207:link=a
```

This is an example of the possible output.

```
rlghncxa03w 07-05-19 21:17:04 GMT EAGLE5 37.0.0
LOC LINK LSN          SLC TYPE
2207 A   lsnlp3       0   SS7IPGW
```

```
rtrv-slk:loc=2211:link=a
```

This is an example of the possible output.

```
rlghncxa03w 07-05-19 21:17:04 GMT EAGLE5 37.0.0
LOC LINK LSN          SLC TYPE
2211 A   lsnlp4       0   IPGWI
```

12. If any cards contain the first signaling link on a card, those cards must be brought into service with the `rst-card` command, specifying the location of the card.

For this example, enter these commands.

```
rst-card:loc=2207
```

```
rst-card:loc=2211
```

When each of these commands have successfully completed, this message should appear.

```
rlghncxa03w 06-10-23 13:05:05 GMT EAGLE5 36.0.0
Card has been allowed.
```

13. Activate all signaling links on the cards using the `act-slk` command, specifying the card location and link parameter value of each signaling link.

For this example, enter these commands.

```
act-slk:loc=2207:link=a
```

```
act-slk:loc=2211:link=a
```

When each of these commands have successfully completed, this message should appear.

```
rlghncxa03w 06-10-07 08:31:24 GMT EAGLE5 36.0.0
Activate Link message sent to card
```

14. Check the status of the signaling links added in [Step 10](#) using the `rept-stat-slk` command with the card location and link parameter values specified in [Step 10](#). The state of each signaling link should be in service normal (IS-NR) after the link has completed alignment (shown in the PST field). For this example, enter these commands.

```
rept-stat-slk:loc=2207:link=a
```

This is an example of the possible output.

```
rlghncxa03w 07-05-23 13:06:25 GMT EAGLE5 37.0.0
SLK      LSN      CLLI      PST      SST      AST
2207,A   lsnlp3   -----  IS-NR    Avail    ----
  ALARM STATUS      =
  UNAVAIL REASON    =
```

```
rept-stat-slk:loc=2211:link=a
```

This is an example of the possible output.

```
rlghncxa03w 07-05-23 13:06:25 GMT EAGLE5 37.0.0
SLK      LSN      CLLI      PST      SST      AST
2211,A   lsnlp4   -----  IS-NR    Avail    ----
  ALARM STATUS      =
  UNAVAIL REASON    =
```

15. Back up the new changes using the `chg-db:action=backup:dest=fixed` command.

These messages should appear, the active Maintenance and Administration Subsystem Processor (MASP) appears first.

```
BACKUP (FIXED) : MASP A - Backup starts on active MASP.
BACKUP (FIXED) : MASP A - Backup on active MASP to fixed disk complete.
BACKUP (FIXED) : MASP A - Backup starts on standby MASP.
BACKUP (FIXED) : MASP A - Backup on standby MASP to fixed disk complete.
```

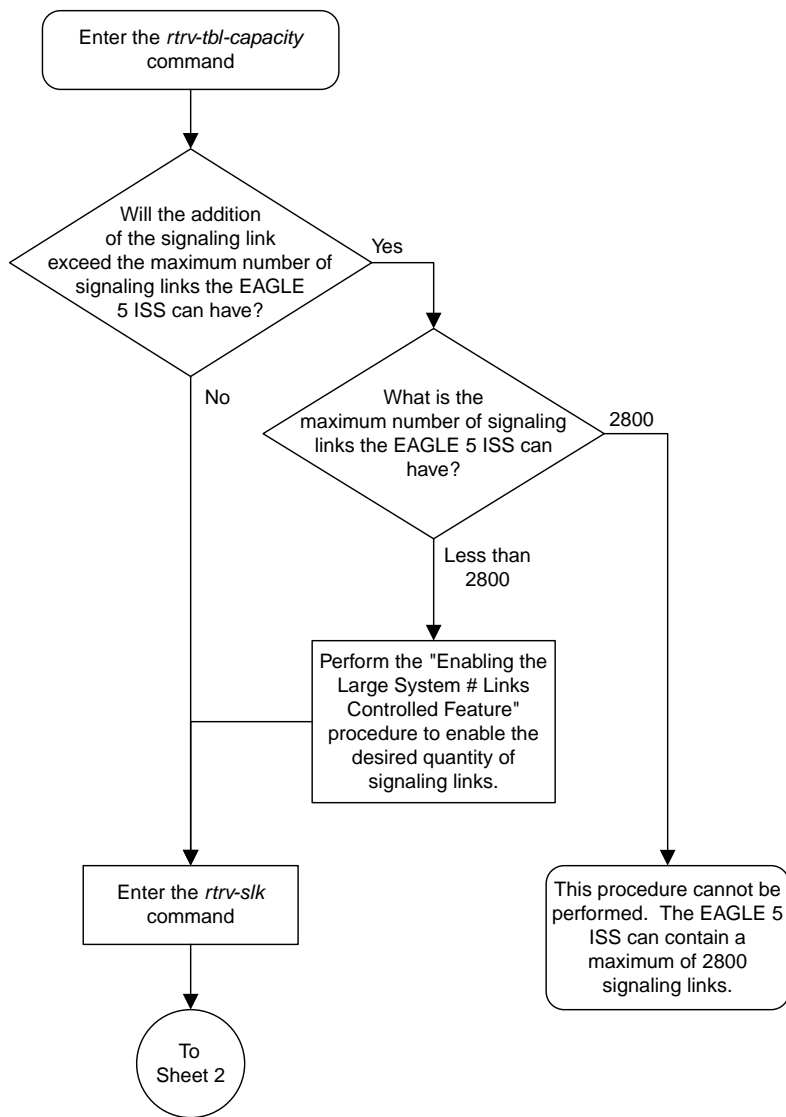

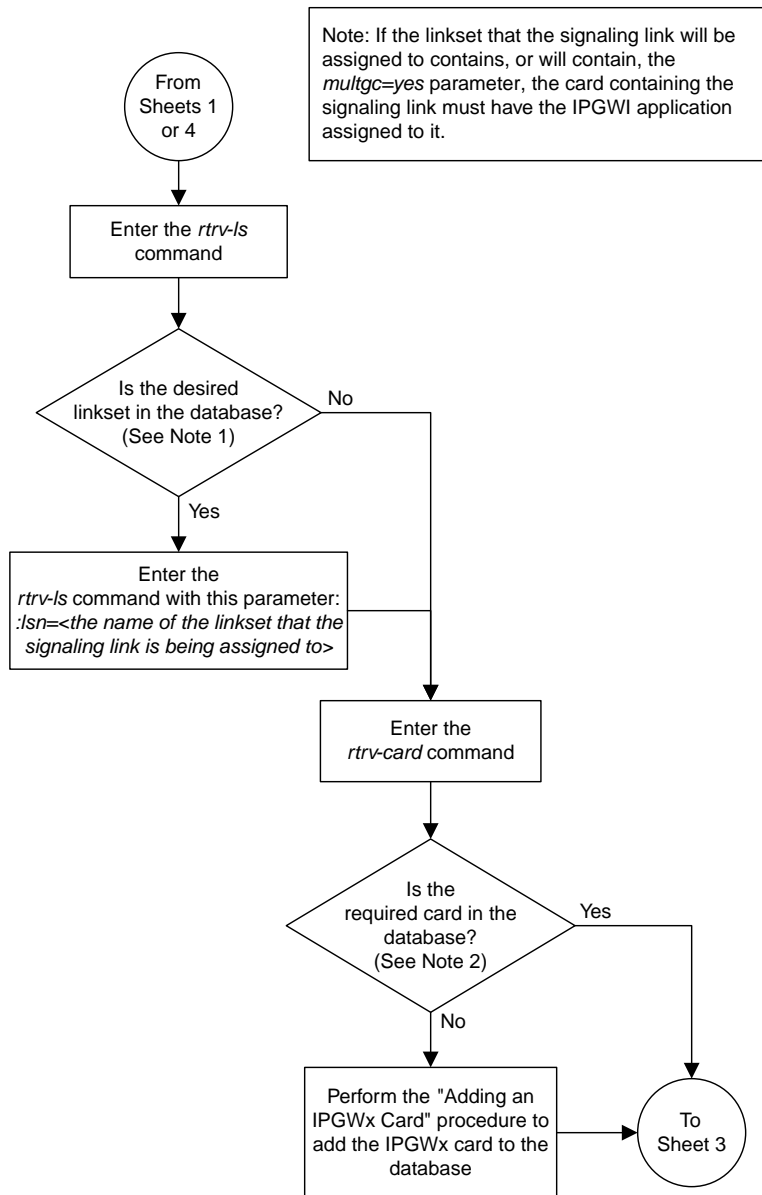

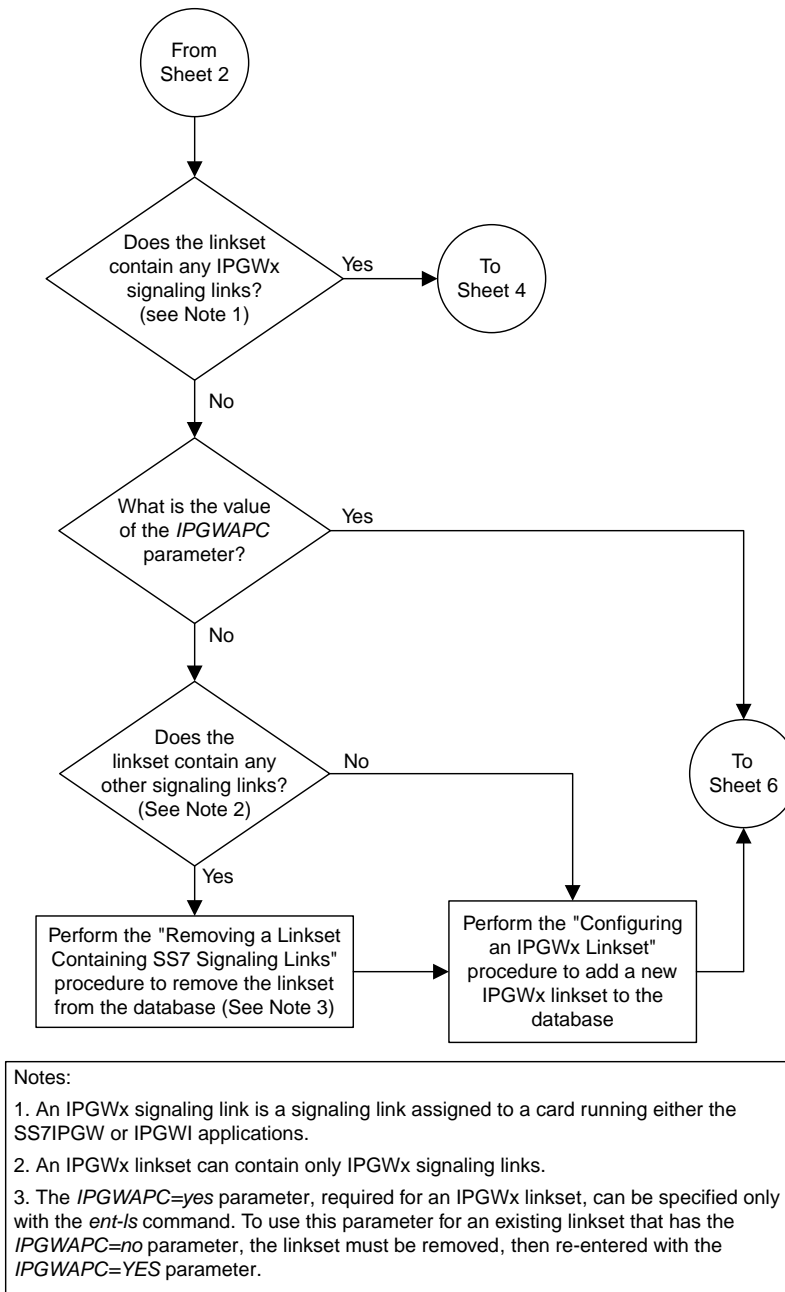

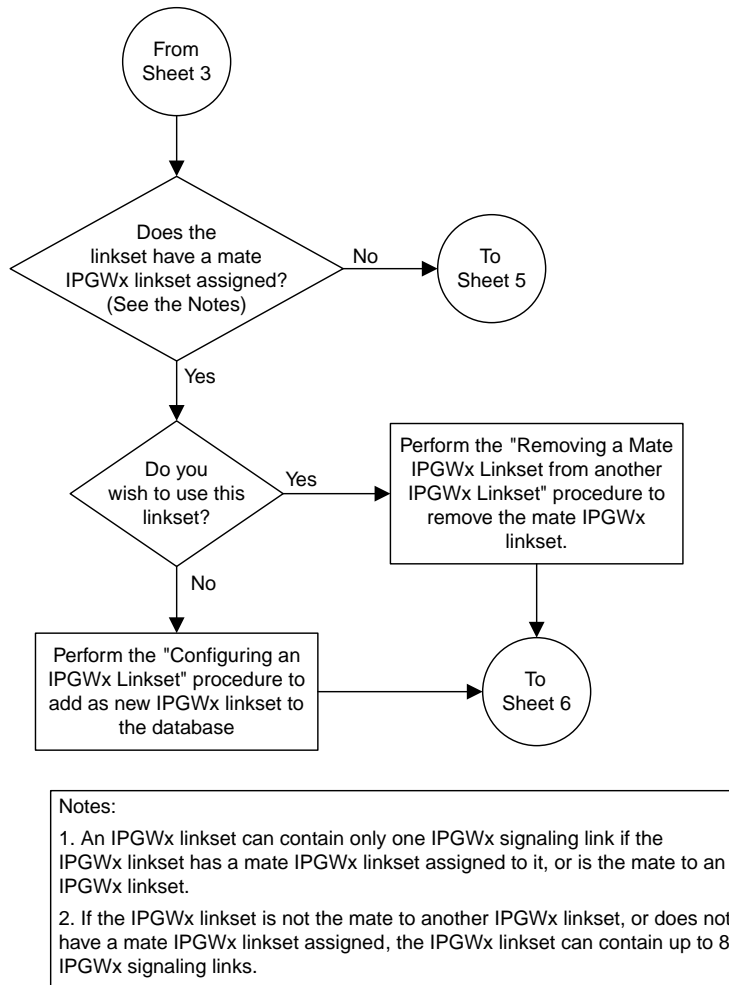

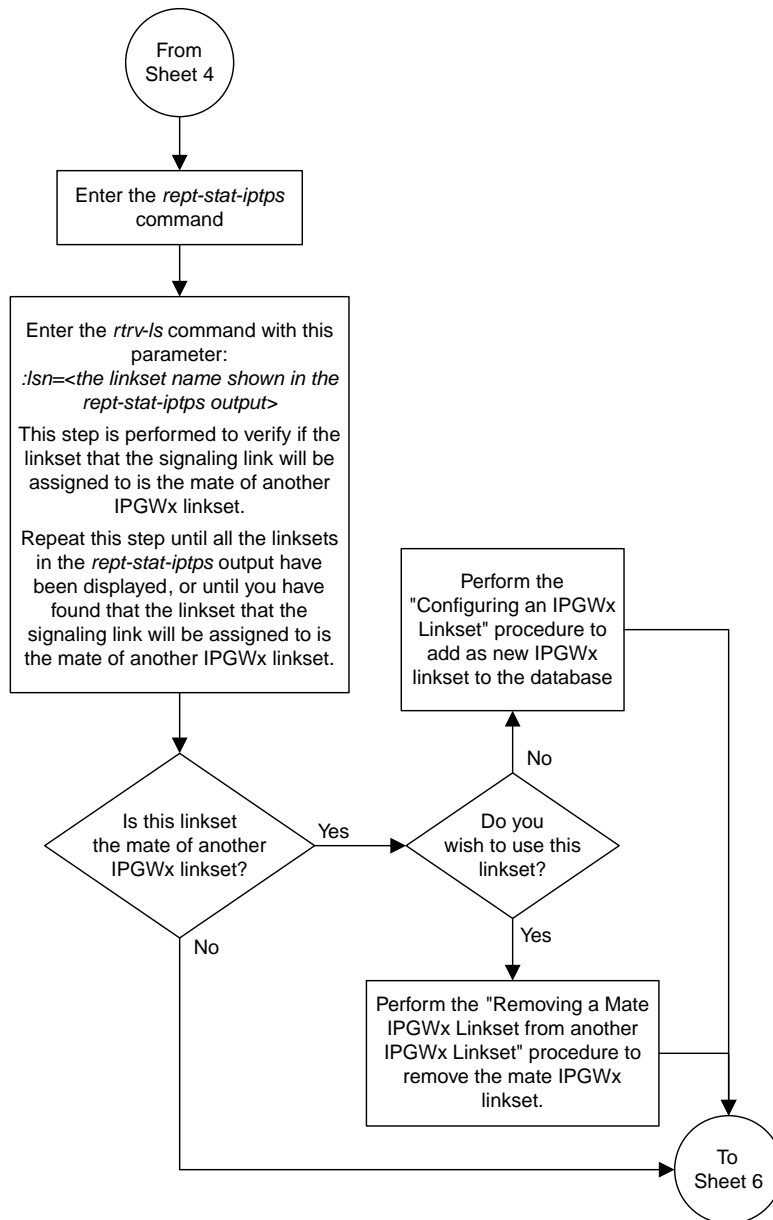

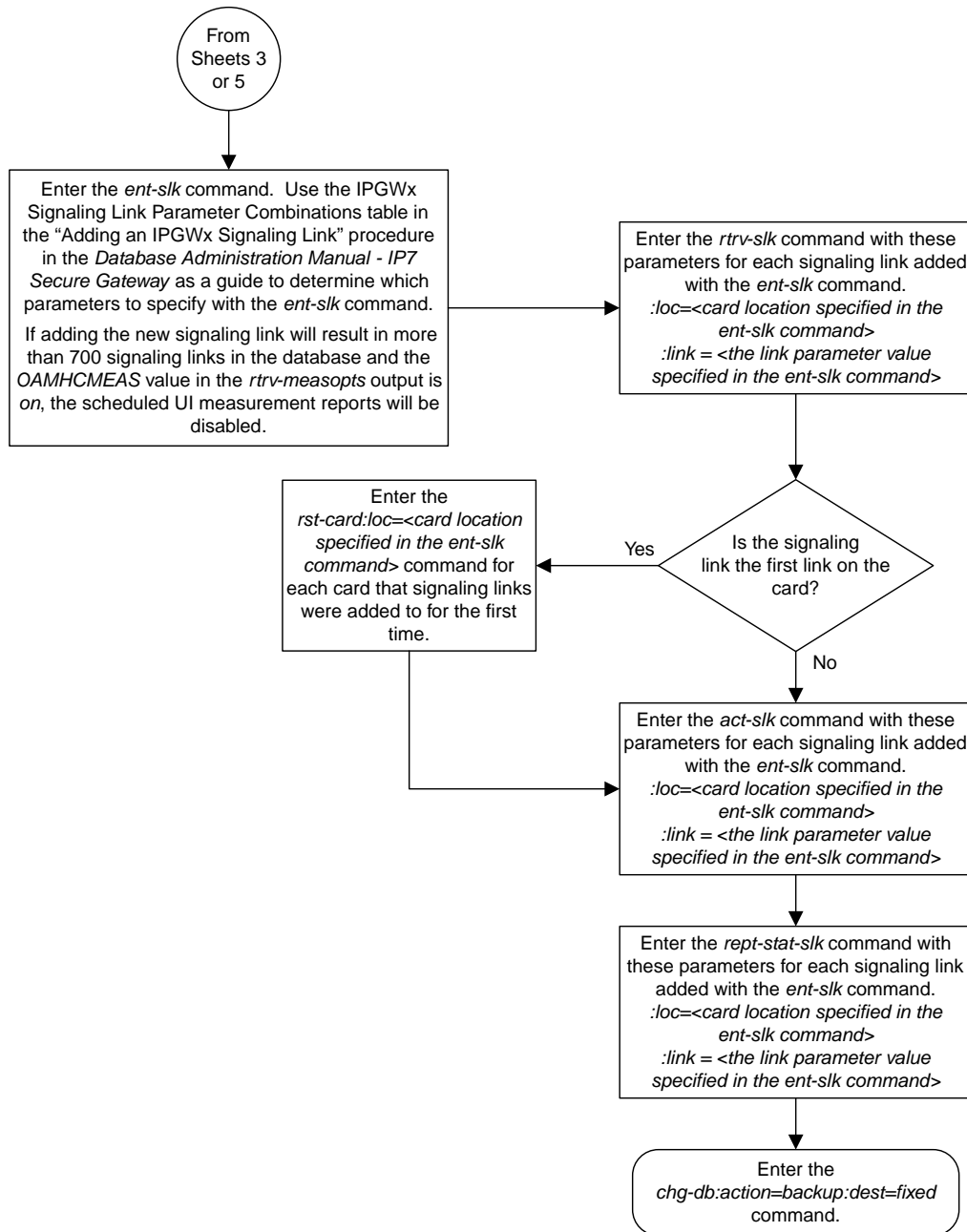



Sheet 6 of 6

Figure 44: Adding an IPGWx Signaling Link

Configuring an IP Link

This procedure is used to configure the link parameters for IP cards using the `chg-ip-lnk` command. These link parameters are used to configure the Ethernet hardware.

The `chg-ip-lnk` command uses the following parameters.

`:loc` – The card location of the IP card.

`:port` – The Ethernet interface on the IP card, A or B.

`:ipaddr` – IP address assigned to the Ethernet interface on the IP card. This is an IP address expressed in standard “dot notation.” IP addresses consist of the system’s network number and the machine’s unique host number.

`:submask` – The subnet mask of the IP interface. A subnet mask is an IP address with a restricted range of values. The bits in the mask must be a string of one’s followed by a string of zero’s. There must be at least two one’s in the mask, and the mask cannot be all one’s. See [Table 24: Valid Subnet Mask Parameter Values](#) to assign the correct parameter values.

`:auto` – Tells hardware whether to automatically detect the duplex and speed.

`:duplex` – This is the mode of operation of the interface.

`:speed` – This is the bandwidth in megabits per second of the interface.

`:mactype` – This is the Media Access Control Type of the interface.

`:mcast` – The multicast control flag. This parameter enables or disables multicast support for the interface.

The EAGLE can contain a maximum of 2048 IP links.

A zero `ipaddr` parameter value (0 . 0 . 0 . 0) indicates the IP card Ethernet interface to IP link association is disabled. The host to the original IP address must be removed before the `ipaddr=0 . 0 . 0 . 0` can be specified.

If the `defrouter` parameter of the `chg-ip-card` command contains an IP address for the card specified in this procedure, the network portion of one of the IP addresses assigned to the card in this procedure must match the network portion of the IP address specified by the `defrouter` parameter of the `chg-ip-card` command.

The network portion of the IP address is based on the class of the IP address (shown in [Table 24: Valid Subnet Mask Parameter Values](#)). If the IP address is a Class A IP address, the first field is the network portion of the IP address. If the IP address is a Class B IP address, the first two fields are the network portion of the IP address. If the IP address is a Class C IP address, the first three fields are the network portion of the IP address. For example, if the IP address is 193.5.207.150, a Class C IP address, the network portion of the IP address is 193.5.207.

If the `auto=yes` parameter is specified, then the `duplex` and `speed` parameters are not allowed.

The `loc` parameter value must be shown in the `rtvr-ip-card` output.

The IP card must be placed out of service.

If either the `ipaddr` or `submask` parameters are specified, then both parameters must be specified. If the `ipaddr` parameter value is zero (0.0.0.0), the `submask` parameter is not required.

The IP address and subnet mask values cannot be changed to an address representing a different network if:

- If the network interface specified by the `loc` and `port` parameters has a default router, `dnas`, or `dsnb` parameter values assigned to it, as shown in the `rtrv-ip-card` output.
- Any IP routes, shown in the `rtrv-ip-rte` output, reference the IP address for the network interface specified by the `loc` and `port` parameters.

The IP link cannot be changed if open associations reference the IP link being changed.

The network portion of the IP addresses assigned to the IP links on an IP card must be unique. For example, if IP links are assigned to IP card 1103, the network portion of the IP address for Ethernet interface A (`port=a`) must be different from the IP address for Ethernet interface B (`port=b`).

The `submask` parameter value is based upon the `ipaddr` setting. See [Table 24: Valid Subnet Mask Parameter Values](#) for the valid input values for the `submask` and `ipaddr` parameter combinations.

Table 24: Valid Subnet Mask Parameter Values

Network Class	IP Network Address Range	Valid Subnet Mask Values
A	1.0.0.0 to 127.0.0.0	255.0.0.0 (the default value for a class A IP address) 255.192.0.0 255.224.0.0 255.240.0.0 255.248.0.0 255.252.0.0 255.254.0.0 255.255.128.1
A+B	128.0.0.0 to 191.255.0.0	255.255.0.0 (the default value for a class B IP address) 255.255.192.0 255.255.224.0 255.255.240.0 255.255.248.0 255.255.252.0 255.255.254.0 255.255.255.128
A+B+C	192.0.0.0 to 223.255.255.0	255.255.255.0 (the default value for a class C IP address) 255.255.255.192

Network Class	IP Network Address Range	Valid Subnet Mask Values
		255.255.255.224
		255.255.255.240
		255.255.255.248
		255.255.255.252

If a Class B IP address is specified for the `ipaddr` parameter of the `chg-ip-lnk` command, the subnet address that results from the `ipaddr` and `submask` parameter values cannot be the same as the subnet address that results from the `pvn` and `pvnmask`, `fcna` and `fcnamask`, or `fcnb` and `fcnbmask` parameter values of the `chg-netopts` command. The `pvn` and `pvnmask`, `fcna` and `fcnamask`, or `fcnb` and `fcnbmask` parameter values can be verified by entering the `rtrv-netopts` command. Choose `ipaddr` and `submask` parameter values for the IP link whose resulting subnet address is not be the same as the subnet address resulting from the `pvn` and `pvnmask`, `fcna` and `fcnamask`, or `fcnb` and `fcnbmask` parameter values of the `chg-netopts` command.

Canceling the RTRV-ASSOC Command

Because the `rtrv-assoc` command used in this procedure can output information for a long period of time, the `rtrv-assoc` command can be canceled and the output to the terminal stopped. There are three ways that the `rtrv-assoc` command can be canceled.

- Press the F9 function key on the keyboard at the terminal where the `rtrv-assoc` command was entered.
- Enter the `canc-cmd` without the `trm` parameter at the terminal where the `rtrv-assoc` command was entered.
- Enter the `canc-cmd:trm=<xx>`, where `<xx>` is the terminal where the `rtrv-assoc` command was entered, from another terminal other than the terminal where the `rtrv-assoc` command was entered. To enter the `canc-cmd:trm=<xx>` command, the terminal must allow Security Administration commands to be entered from it and the user must be allowed to enter Security Administration commands. The terminal's permissions can be verified with the `rtrv-secu-trm` command. The user's permissions can be verified with the `rtrv-user` or `rtrv-secu-user` commands.

For more information about the `canc-cmd` command, go to *Commands User's Guide*.

1. Display the current link parameters associated with the IP card in the database by entering the `rtrv-ip-lnk` command.

The following is an example of the possible output.

```

rlghncxa03w 08-12-28 21:14:37 GMT EAGLE5 40.0.0
LOC  PORT  IPADDR          SUBMASK          DUPLEX  SPEED  MACTYPE  AUTO  MCAST
1201  A     192.1.1.10     255.255.255.128  HALF    10     802.3    NO   NO
1201  B     -----        -----        HALF    10     DIX      NO   NO
1203  A     192.1.1.12     255.255.255.0   ----    ---    DIX      YES  NO
1203  B     -----        -----        HALF    10     DIX      NO   NO
1205  A     192.1.1.14     255.255.255.0   FULL    100    DIX      NO   NO
1205  B     -----        -----        HALF    10     DIX      NO   NO
2101  A     192.1.1.20     255.255.255.0   FULL    100    DIX      NO   NO
2101  B     -----        -----        HALF    10     DIX      NO   NO
2103  A     192.1.1.22     255.255.255.0   FULL    100    DIX      NO   NO
2103  B     -----        -----        HALF    10     DIX      NO   NO
2105  A     192.1.1.24     255.255.255.0   FULL    100    DIX      NO   NO

```

```

2105 B -----
2205 A 192.1.1.30 255.255.255.0 FULL 100 DIX NO NO
2205 B -----
2207 A 192.1.1.32 255.255.255.0 FULL 100 DIX NO NO
2207 B -----
2213 A 192.1.1.50 255.255.255.0 FULL 100 DIX NO NO
2213 B -----
2301 A 192.1.1.52 255.255.255.0 FULL 100 DIX NO NO
2301 B -----

```

```
IP-LNK table is (20 of 2048) 1% full.
```

Note: If the `ipaddr=0.0.0.0` is not being specified in this procedure, continue the procedure with [Step 3](#).

- If IP address information is being added or changed (not deleted) in the link parameters, verify that the IP address is present in the IP host table by using the `rtrv-ip-host:display=all` command.

The following is an example of the possible output.

```

rlghncxa03w 13-06-28 21:15:37 GMT EAGLE5 45.0.0

LOCAL IPADDR    LOCAL HOST
192.1.1.10     IPNODE1-1201
192.1.1.12     IPNODE1-1203
192.1.1.14     IPNODE1-1205
192.1.1.20     IPNODE2-1201
192.1.1.22     IPNODE2-1203
192.1.1.24     IPNODE2-1205
192.1.1.30     KC-HLR1
192.1.1.32     KC-HLR2
192.1.1.50     DN-MSC1
192.1.1.52     DN-MSC2

REMOTE IPADDR   REMOTE HOST
150.1.1.5      NCDEPTECONOMIC_DEVELOPMENT. SOUTHEASTERN_COORIDOR_ASHVL. GOV

IP Host table is (11 of 4096) 0.26% full

```

If the current IP address of the IP link is shown in the `rtrv-ip-host` output, remove the host assigned to the IP address by performing the [Removing an IP Host Assigned to an IPGWx Card](#) procedure.

- To change IP link parameters, the signaling link to the IP card and the IP card have to be inhibited. Display the signaling link associated with the card shown in [Step 1](#) using the `rtrv-slk` command specifying the card location.

For this example, enter this command.

```
rtrv-slk:loc=1201
```

This is an example of the possible output.

```

rlghncxa03w 06-10-19 21:17:04 GMT EAGLE5 36.0.0
LOC  LINK LSN          SLC TYPE
1201 A   nc001             0  SS7IPGW

```

- Retrieve the status of the signaling link assigned to the IP card to be changed using the `rept-stat-slk` command.

For example, enter this command.

```
rept-stat-slk:loc=1201:link=a
```

The output lists the signaling link assigned to this card:

```
rlghncxa03w 06-10-28 21:16:37 GMT EAGLE5 36.0.0
SLK      LSN      CLLI      PST      SST      AST
1201,A   nc001      ----- IS-NR
Command Completed.
```

If the signaling link is in service-normal (IS-NR), continue the procedure with [Step 5](#) to deactivate the signaling link. If the signaling link is out-of-service-maintenance disabled (OOS-MT-DSBLD), continue the procedure with [Step 7](#) to verify the IP card status.

- Deactivate the signaling link assigned to the IP card using the `dact-slk` command.

For example, enter this command.

```
dact-slk:loc=1201:link=a
```



CAUTION

Caution: This command impacts network performance and should only be used during periods of low traffic.

After this command has successfully completed, this message appears.

```
rlghncxa03w 06-10-12 09:12:36 GMT EAGLE5 36.0.0
Deactivate Link message sent to card.
```

- Verify the new link status using the `rept-stat-slk` command.

For example, enter this command.

```
rept-stat-slk:loc=1201:link=a
```

The output displays the link status as OOS-MT-DSBLD and gives off a minor alarm:

```
rlghncxa03w 06-10-27 17:00:36 GMT EAGLE5 36.0.0
SLK      LSN      CLLI      PST      SST      AST
1201,A   nc001      ----- OOS-MT-DSBLD AVAIL  ---
ALARM STATUS = * 0236 REPT-LKS:not aligned
UNAVAIL REASON = NA
Command Completed.
```

- Verify the status of the IP card to be inhibited using the `rept-stat-card` command.

For example, enter this command.

```
rept-stat-card:loc=1201
```

This is an example of the possible output.

```

rlghncxa03w 06-10-27 17:00:36 GMT EAGLE5 36.0.0
CARD VERSION      TYPE      GPL      PST      SST      AST
1201 114-000-000 DCM      SS7IPGW IS-NR      Active   -----
  ALARM STATUS    = No Alarms.
  BPDCM GPL       = 002-102-000
  IMT BUS A       = Conn
  IMT BUS B       = Conn
  SIGNALING LINK STATUS
    SLK  PST      LS      CLLI
    A    IS-NR    nc001   -----
Command Completed.

```

If the IP card to be inhibited is in service-normal (IS-NR), continue the procedure with [Step 8](#) to inhibit the card. If the IP card is out-of-service-maintenance disabled (OOS-MT-DSBLD), continue the procedure with [Step 10](#) to change the IP link parameters.

8. Inhibit the IP card using the `inh-card` command.

For example, enter this command.

```
inh-card:loc=1201
```

This message should appear.

```

rlghncxa03w 06-10-28 21:18:37 GMT EAGLE5 36.0.0
Card has been inhibited.

```

9. Display the status of the IP card to verify that it is out-of-service maintenance-disabled (OOS-MT-DSBLD).

Enter this command.

```
rept-stat-card:loc=1201
```

This is an example of the possible output.

```

rlghncxa03w 06-10-27 17:00:36 GMT EAGLE5 36.0.0
CARD VERSION      TYPE      GPL      PST      SST      AST
1201 114-000-000 DCM      SS7IPGW IS-NR      Active   -----
  ALARM STATUS    = No Alarms.
  BPDCM GPL       = 002-102-000
  IMT BUS A       = Conn
  IMT BUS B       = Conn
  SIGNALING LINK STATUS
    SLK  PST      LS      CLLI
    A    IS-NR    nc001   -----
Command Completed.

```

10. Display the attributes of the IP card assigned to the IP link being changed by entering the `rtrv-ip-card` command and specifying the card location of the IP link.

Note: If the `ipaddr` or `submask` parameter values are not being changed, continue the procedure with [Step 13](#).

For this example, enter this command.

```
rtrv-ip-card:loc=1201
```

This is an example of the possible output.

```
rlghncxa03w 08-06-28 21:17:37 GMT EAGLE5 39.0.0
  LOC 1201
    SRCHORDR LOCAL
    DNSA      150.1.1.1
    DNSB      -----
    DEFROUTER -----
    DOMAIN    -----
    SCTPCSUM  crc32c
    BPIPADDR  -----
    BPSUBMASK -----
```

If the `rtrv-ip-card` output shows an IP address for the default router (DEFROUTER) whose network portion matches the network portion of the IP address being changed, go to the [Configuring an IP Card](#) procedure and change the IP address of the default router to 0.0.0.0.

11. Display any IP routes referencing the IP link being changed by entering the `rtrv-ip-rte` command and specifying the card location of the IP link.

For this example, enter this command.

```
rtrv-ip-rte:loc=1201
```

This is an example of the possible output.

```
rlghncxa03w 06-10-28 21:17:37 GMT EAGLE5 36.0.0
LOC  DEST          SUBMASK          GTWY
1201 128.252.10.5     255.255.255.255 140.188.13.33
1201 128.252.0.0      255.255.0.0     140.188.13.34
1201 150.10.1.1       255.255.255.255 140.190.15.3

IP Route table is (5 of 2048) 0.24% full
```

If the `rtrv-ip-rte` output shows that the card has IP routes assigned to it, go to the [Removing an IP Route](#) procedure and remove the IP routes from the database.

12. The subnet address that results from the `ipaddr` and `submask` parameter values of the `chg-ip-lnk` command cannot be the same as the subnet address that results from the `pvn` and `pvnmask`, `fcna` and `fcnamask`, or `fcnb` and `fcnbmask` parameter values of the `chg-netopts` command.

Note: If a Class A or CIP address (see [Table 24: Valid Subnet Mask Parameter Values](#)) will be specified for the `ipaddr` parameter in [Step 14](#), continue the procedure with [Step 13](#).

Display the `pvn`, `pvnmask`, `fcna`, `fcnamask`, `fcnb`, and `fcnbmask` parameter values of the `chg-netopts` command by entering the `rtrv-netopts` command.

If error message E3967 Cmd Rej: E5IS must be on is displayed after the `rtrv-netopts` command is executed, the `pvn`, `pvnmask`, `fcna`, `fcnamask`, `fcnb`, and `fcnbmask` parameters are not configured. Continue the procedure with [Step 13](#).

This is an example of the possible output if the E5IS feature is on.

```
rlghncxa03w 09-02-28 21:17:37 GMT EAGLE5 40.1.0
NETWORK OPTIONS
-----
PVN          = 128.20.30.40
PVNMASK      = 255.255.192.0
FCNA         = 170.120.50.0
FCNAMASK     = 255.255.240.0
FCNB         = 170.121.50.0
FCNBMASK     = 255.255.254.0
```

Choose `ipaddr` and `submask` parameter values for the IP link whose resulting subnet address is not be the same as the subnet address resulting from the `pvn` and `pvnmask`, `fcna` and `fcnamask`, or `fcnb` and `fcnbmask` parameter values of the `chg-netopts` command. Continue the procedure with [Step 13](#).

13. Display the associations referencing the local host name that is associated with the IP link being changed by entering the `rtrv-assoc` command and specifying the local host name shown in the `rtrv-ip-host` output in [Step 2](#).

For this example, enter this command.

```
rtrv-assoc: lhost="ipnode-1201"
```

This is an example of the possible output.

```
rlghncxa03w 06-10-28 09:12:36 GMT EAGLE5 36.0.0
CARD IPLNK
ANAME      LOC  PORT  LINK ADAPTER  LPORT  RPORT  OPEN ALW
swbel32    1201 A     A     M3UA     1030   2345   YES  YES

IP Appl Sock/Assoc table is (3 of 4000) 1% full
Assoc Buffer Space Used (16 KB of 3200 KB) on LOC = 1201
```

If no associations are displayed in this step, continue the procedure with [Step 14](#).

If the `rtrv-assoc` output shows that the open parameter for any associations is yes, perform one of these procedures to change the value of the open parameter the associations to no.

- [Changing the Attributes of an M2PA Association](#)
- [Changing the Attributes of a M3UA or SUA Association](#)

14. Change the link parameters associated with the IP card in the database using the `chg-ip-lnk` command.

For this example, enter this command.

```
chg-ip-lnk: loc=1201:port=a:ipaddr=192.1.1.10:submask=255.255.255.0
:auto=yes:mactype=dix
```

When this command has successfully completed, the following message should appear.

```
rlghncxa03w 06-10-28 21:18:37 GMT EAGLE5 36.0.0
CHG-IP-LNK: MASP A - COMPLTD
```

15. Verify the new link parameters associated with the IP card that was changed in [Step 14](#) by entering the `rtrv-ip-lnk` command with the card location specified in [Step 14](#).

For this example, enter this command.

The following is an example of the possible output.

```
rlghncxa03w 07-05-28 21:14:37 GMT EAGLE5 37.0.0
LOC  PORT  IPADDR          SUBMASK          DUPLEX  SPEED  MACTYPE  AUTO  MCAST
1201 A    192.1.1.10          255.255.255.128 HALF     10     DIX      YES  NO
1201 B    -----             -----             HALF     10     DIX      NO   NO
```

16. Allow the IP card that was inhibited in [Step 8](#) by using by using the `alw-card` command.

Note: If [Step 8](#) was not performed, continue the procedure with [Step 18](#).

For example, enter this command.

```
alw-card:loc=1201
```

This message should appear.

```
rlghncxa03w 06-10-28 21:20:37 GMT EAGLE5 36.0.0
Card has been allowed.
```

17. Verify the in-service normal (IS-NR) status of the IP card using the `rept-stat-card` command.

For example, enter this command.

```
rept-stat-card:loc=1201
```

This is an example of the possible output.

```
rlghncxa03w 06-10-27 17:00:36 GMT EAGLE5 36.0.0
CARD  VERSION  TYPE      GPL      PST      SST      AST
1201  114-000-000 DCM       SS7IPGW  IS-NR    Active   -----
ALARM STATUS      = No Alarms.
BPDCM GPL         = 002-102-000
IMT BUS A         = Conn
IMT BUS B         = Conn
SIGNALING LINK STATUS
SLK   PST      LS      CLLI
A     IS-NR   nc001   -----
Command Completed.
```

18. Activate the signaling link from [Step 5](#) using the `act-slk` command.

Note: If [Step 5](#) was not performed, continue the procedure with [Step 20](#).

For example, enter this command.

```
act-slk:loc=1201:link=a
```

The link changes its state from OOS-MT-DSBLD (out-of-service maintenance-disabled) to IS-NR (in-service normal).

The output confirms the activation.

```
rlghncxa03w 06-10-07 11:11:28 GMT EAGLE5 36.0.0
Activate Link message sent to card
```

19. Verify the in-service normal (IS-NR) status of the signaling link using the `rept-stat-slk` command.

For example, enter this command.

```
rept-stat-slk:loc=1201:link=a
```

This message should appear.

```
rlghncxa03w 06-10-28 21:16:37 GMT EAGLE5 36.0.0
SLK      LSN      CLLI      PST      SST      AST
1201,A   nc001      -----  IS-NR
Command Completed.
```

20. Perform the [Configuring an IP Card](#) procedure and change the IP address of the default router to a non-zero value, where the network portion of the default router IP address matches the network portion of the IP link's new IP address.

Note: If the `ipaddr` or `submask` values were not changed, continue the procedure with [Step 22](#).

Note: If the IP address of the default router was not changed to 0.0.0.0 in [Step 10](#), continue the procedure with [Step 21](#).

21. Perform the [Adding an IP Route](#) procedure and add the IP routes back into the database.

Note: If IP routes were not removed in [Step 11](#), continue the procedure with [Step 22](#).

22. Perform one of these procedures as necessary and change the value of the `open` parameter of the association to `yes`.

Note: If the `open` parameter value for an association was not changed in [Step 13](#), continue the procedure with [Step 23](#).

- [Changing the Attributes of an M2PA Association](#)
- [Changing the Attributes of a M3UA or SUA Association](#)

23. Back up the new changes using the `chg-db:action=backup:dest=fixed` command.

These messages should appear, the active Maintenance and Administration Subsystem Processor (MASP) appears first.

```
BACKUP (FIXED) : MASP A - Backup starts on active MASP.
BACKUP (FIXED) : MASP A - Backup on active MASP to fixed disk complete.
BACKUP (FIXED) : MASP A - Backup starts on standby MASP.
BACKUP (FIXED) : MASP A - Backup on standby MASP to fixed disk complete.
```

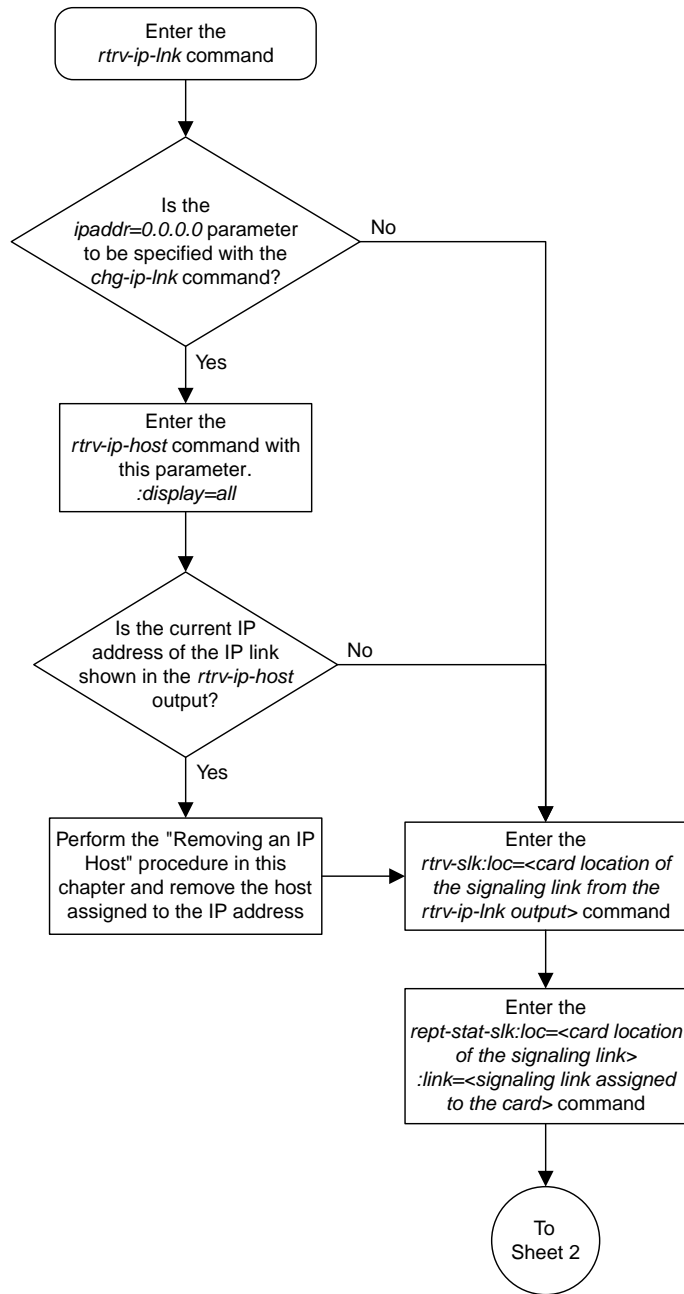

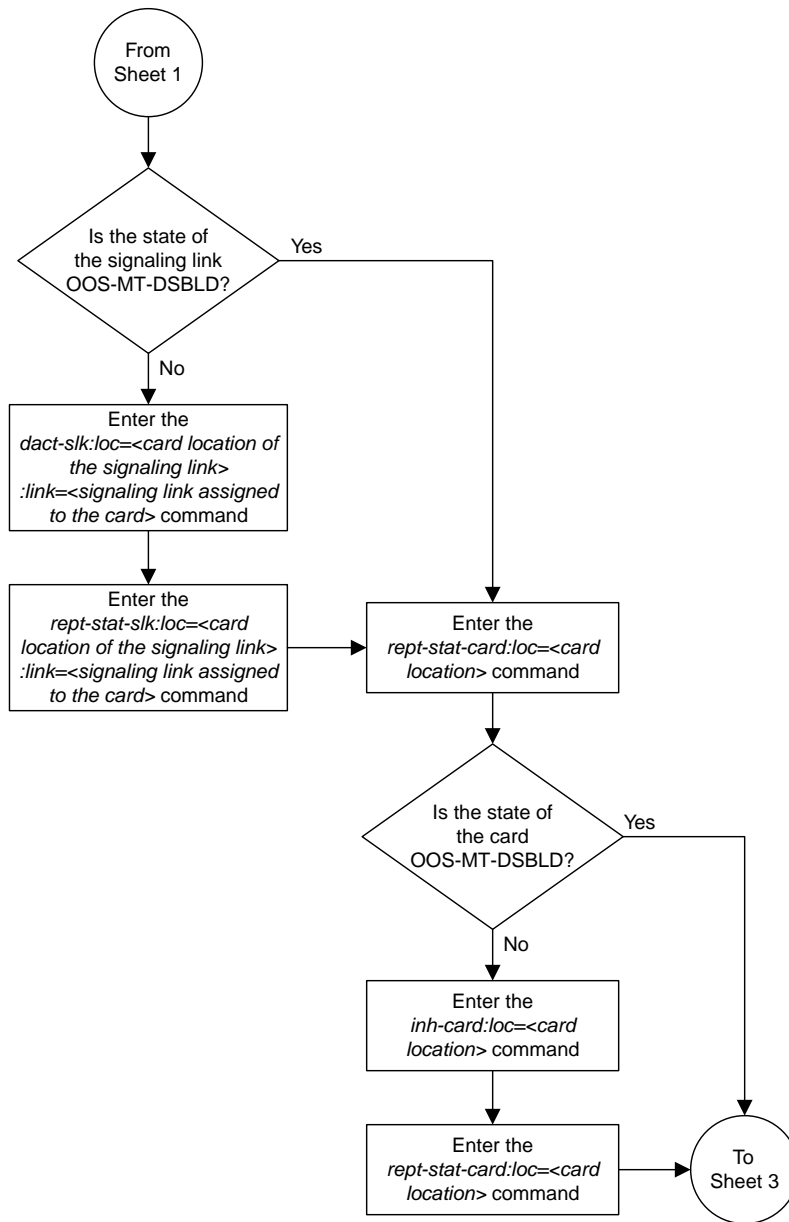

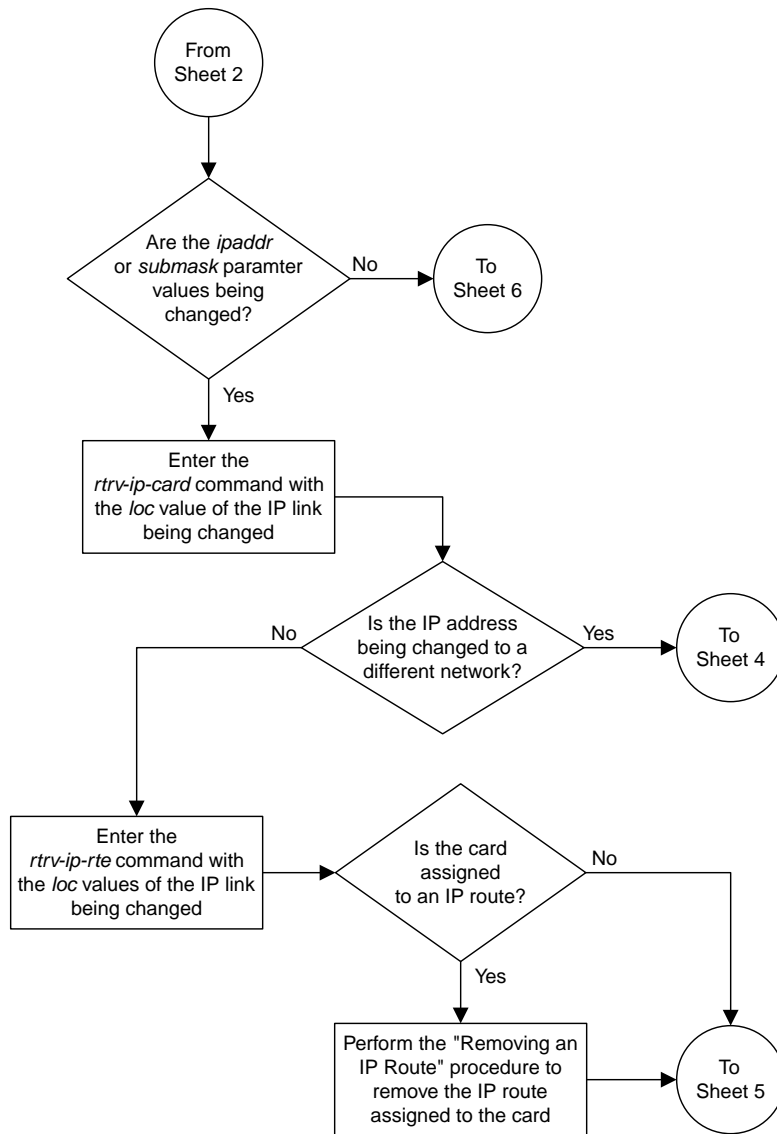

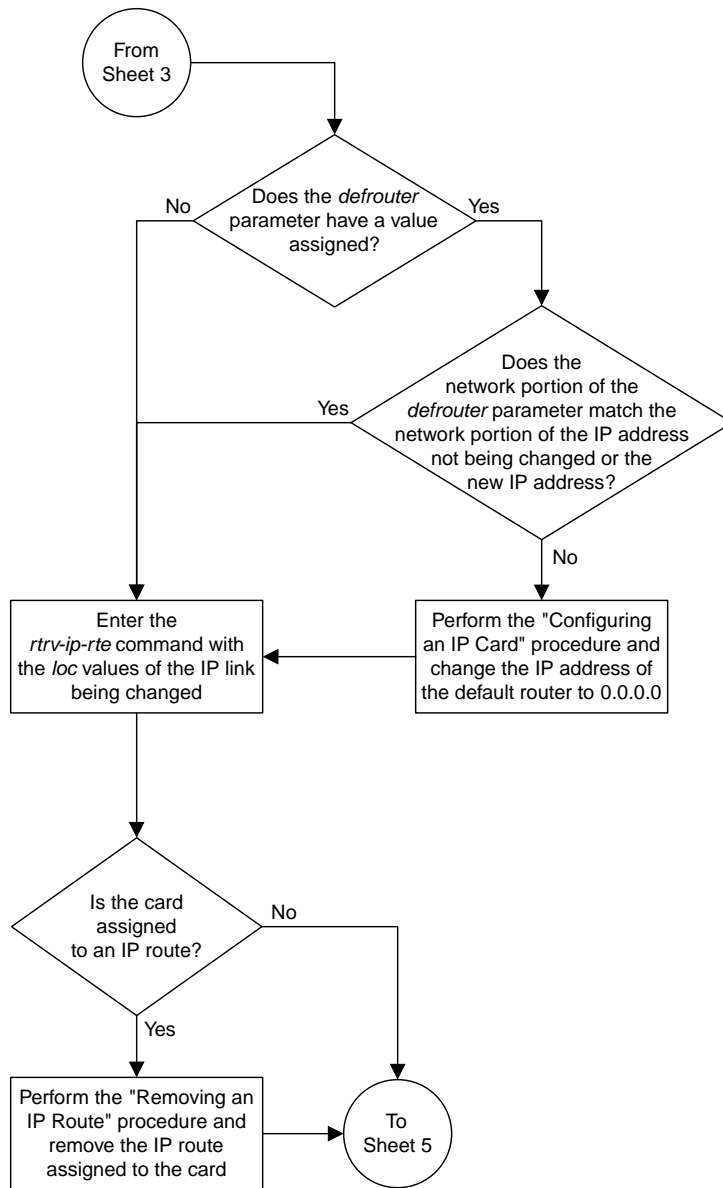

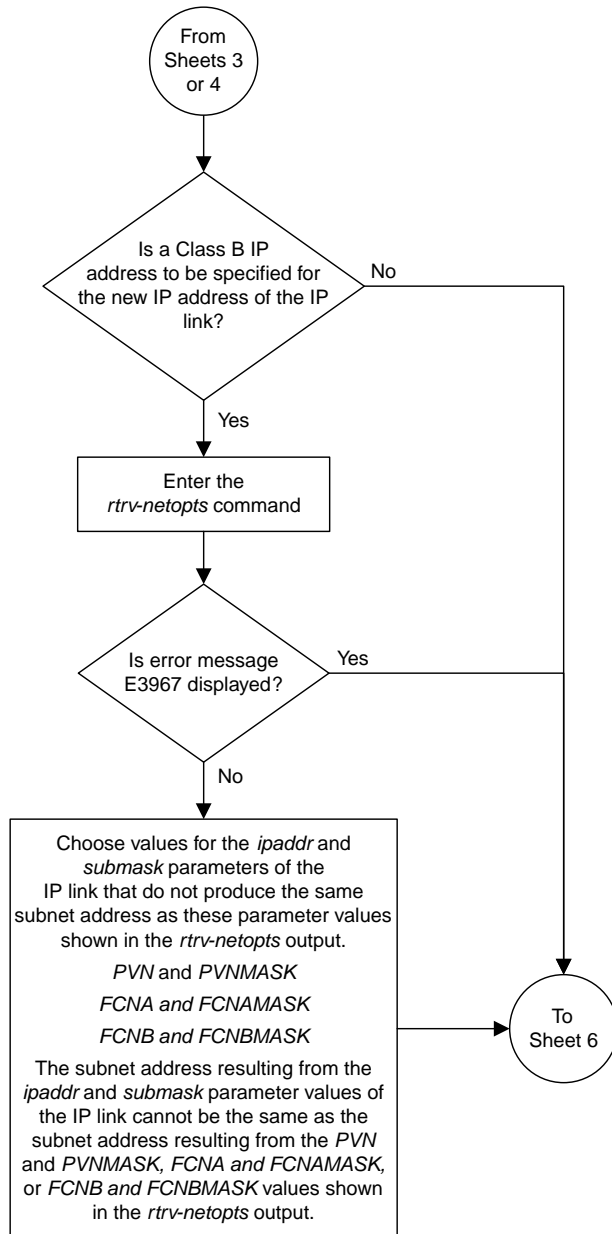

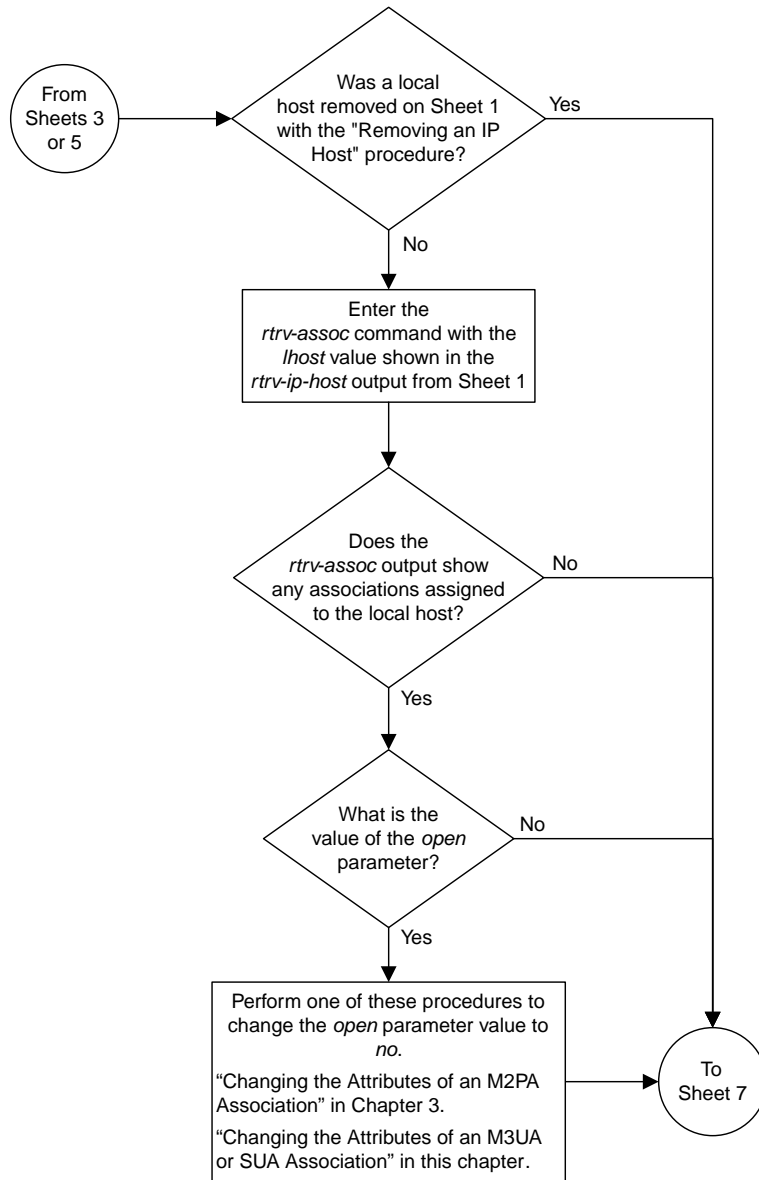



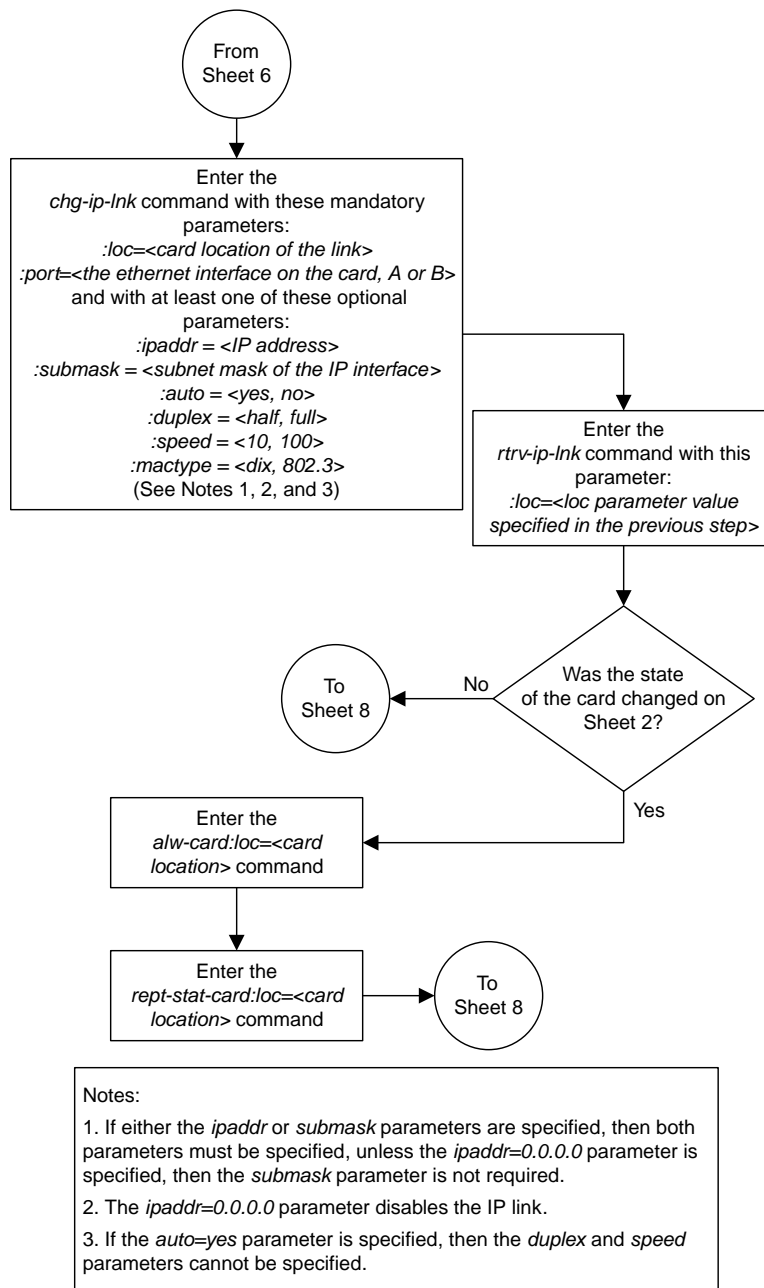

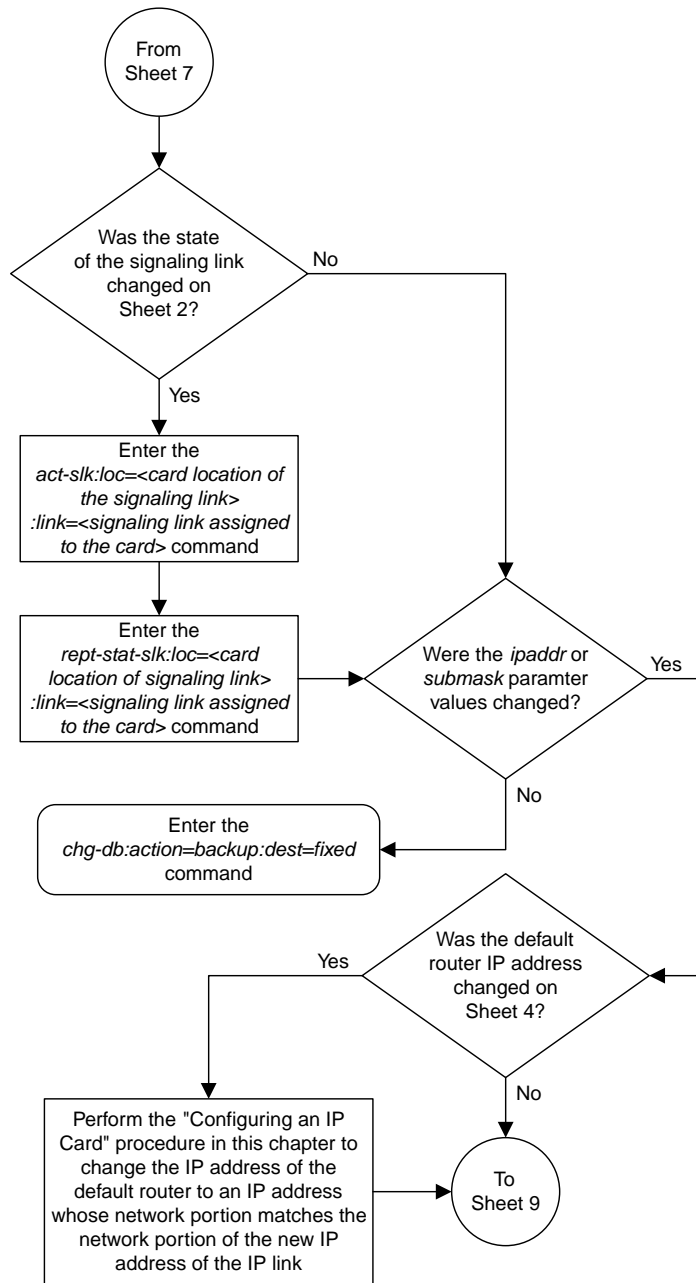

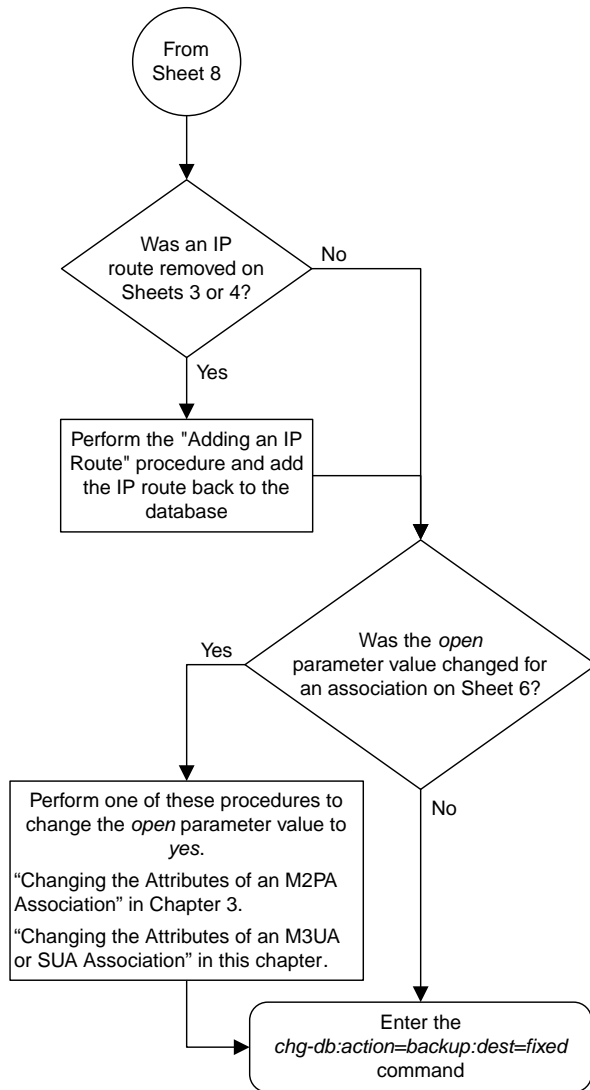

Sheet 9 of 9

Figure 45: Configuring an IP Link

Adding an IP Host

This procedure associates hostnames with IP addresses using the `ent-ip-host` command.

The `ent-ip-host` command uses the following parameters.

`:host` – The host name to be associated with the IP address. This parameter identifies the logical name assigned to the device with the IP address indicated. The host name can contain up to 60 characters (using only these characters: a-z, A-Z, 0-9, -, .) and is not case sensitive. The host name must begin with a letter. Host names containing a dash (-) must be enclosed in double quotes.

`:ipaddr` – The IP address to be associated with the hostname. The node's IP address. This is an IP address expressed in standard "dot notation." IP addresses consist of the system's network number and the machine's unique host number.

`:type` – Specifies if the host resides on the IP card on the EAGLE 5 (`type=local`, the default value), or if the host resides on equipment that is not in the EAGLE 5 (`type=remote`). This parameter is optional.

The EAGLE 5 can contain a maximum of 4096 IP hosts.

The IP address for a local host must be shown in the `rtrv-ip-lnk` output.

The IP address for a remote host must not be shown in the `rtrv-ip-lnk` output.

1. Display the current IP host information in the database by entering the `rtrv-ip-host:display=all` command.

The following is an example of the possible output.

```
rlghncxa03w 13-06-28 21:17:37 GMT EAGLE5 45.0.0
LOCAL IPADDR      LOCAL HOST
192.1.1.10        IPNODE1-1201
192.1.1.12        IPNODE1-1203
192.1.1.14        IPNODE1-1205
192.1.1.20        IPNODE2-1201
192.1.1.22        IPNODE2-1203
192.1.1.24        IPNODE2-1205
192.1.1.32        KC-HLR2
192.1.1.50        DN-MS1
192.1.1.52        DN-MS2

REMOTE IPADDR     REMOTE HOST
150.1.1.5         NCDEPTECONOMIC_DEVELOPMENT. SOUTHEASTERN_COORIDOR_ASHVL. GOV

IP Host table is (10 of 4096) .24% full
```

2. Verify that the IP address assigned to the IP links by entering the `rtrv-ip-lnk` command.

The following is an example of the possible output.

```

rlghncxa03w 08-12-28 21:14:37 GMT EAGLE5 40.0.0
LOC  PORT  IPADDR          SUBMASK          DUPLEX  SPEED  MACTYPE  AUTO  MCAST
1201  A    192.1.1.10     255.255.255.128 HALF      10    802.3    NO   NO
1201  B    -----          -----          HALF      10    DIX      NO   NO
1203  A    192.1.1.12     255.255.255.0   ---      DIX    YES    NO
1203  B    -----          -----          HALF      10    DIX      NO   NO
1205  A    192.1.1.14     255.255.255.0   FULL     100    DIX      NO   NO
1205  B    -----          -----          HALF      10    DIX      NO   NO
2101  A    192.1.1.20     255.255.255.0   FULL     100    DIX      NO   NO
2101  B    -----          -----          HALF      10    DIX      NO   NO
2103  A    192.1.1.22     255.255.255.0   FULL     100    DIX      NO   NO
2103  B    -----          -----          HALF      10    DIX      NO   NO
2105  A    192.1.1.24     255.255.255.0   FULL     100    DIX      NO   NO
2105  B    -----          -----          HALF      10    DIX      NO   NO
2207  A    192.1.1.32     255.255.255.0   FULL     100    DIX      NO   NO
2207  B    -----          -----          HALF      10    DIX      NO   NO
2213  A    192.1.1.50     255.255.255.0   FULL     100    DIX      NO   NO
2213  B    -----          -----          HALF      10    DIX      NO   NO
2301  A    192.1.1.52     255.255.255.0   FULL     100    DIX      NO   NO
2301  B    -----          -----          HALF      10    DIX      NO   NO

IP-LNK table is (20 of 2048) 1% full.

```

If a local host is being configured in this procedure, the IP address assigned to the local host must be shown in the `rtrv-ip-lnk` output. If the IP address is not shown in the `rtrv-ip-lnk` output, add the IP address by performing the [Configuring an IP Link](#) procedure.

If a remote host is being configured in this procedure, the IP address assigned to the remote host cannot be shown in the `rtrv-ip-lnk` output.

3. Add IP host information to the database by entering the `ent-ip-host` command.

If a local host is being configured, enter the `ent-ip-host` command with the IP address from [Step 2](#), and the `type=local` parameter or without the `type` parameter. If the `type` parameter is not specified with the `ent-ip-host` command, the `type` parameter value defaults to `local`.

If a remote host is being configured, enter the `ent-ip-host` command with the IP address that is not shown in [Step 2](#), and the `type=remote` parameter.

For example, enter this command.

```
ent-ip-host:host="kc-hlr1":ipaddr=192.1.1.30
```

When this command has successfully completed, the following message should appear.

```

rlghncxa03w 06-10-28 21:18:37 GMT EAGLE5 36.0.0
ENT-IP-HOST: MASP A - COMPLTD

```

4. Verify the new IP host information in the database by entering the `rtrv-ip-host` command with the `host` parameter value specified in [Step 3](#).

For this example, enter this command.

```
rtrv-ip-host:host="kc-hlr1"
```

The following is an example of the possible output.

```
rlghncxa03w 13-06-28 21:19:37 GMT EAGLE5 45.0.0
LOCAL IPADDR      LOCAL HOST
192.1.1.30        KC-HLR1

IP Host table is (11 of 4096) .26% full
```

5. Back up the new changes using the `chg-db:action=backup:dest=fixed` command.

These messages should appear, the active Maintenance and Administration Subsystem Processor (MASP) appears first.

```
BACKUP (FIXED) : MASP A - Backup starts on active MASP.
BACKUP (FIXED) : MASP A - Backup on active MASP to fixed disk complete.
BACKUP (FIXED) : MASP A - Backup starts on standby MASP.
BACKUP (FIXED) : MASP A - Backup on standby MASP to fixed disk complete.
```

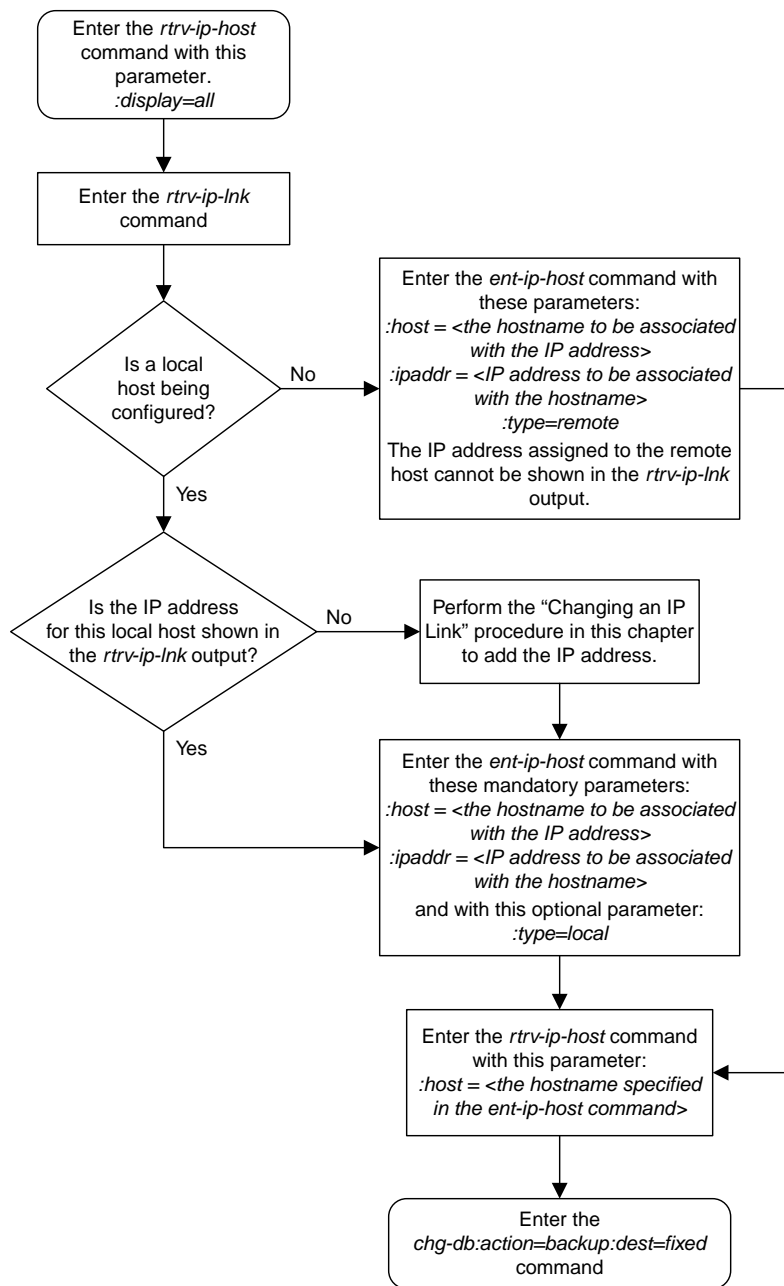

Figure 46: Adding an IP Host

Configuring an IP Card

This procedure is used to change the IP stack parameters associated with an IP card in the database using the `chg-ip-card` command.

The `chg-ip-card` command uses the following parameters.

`:loc` – The card location of the IP card

`:srchordr` – Host Table Search Order

`:dnrsa` – Domain name server A's IP address. This is an IP address expressed in standard "dot notation." IP addresses consist of the system's network number and the machine's unique host number.

`:dnspb` – Domain name server B's IP address. This is an IP address expressed in standard "dot notation." IP addresses consist of the system's network number and the machine's unique host number.

`:domain` – The domain name is used to construct a fully-qualified DNS name consisting of 120 characters or less. For example, a domain name can be `tekelec.com`, the hostname is `john.doe`. The fully-qualified DNS name would be `john.doe@tekelec.com`.

`:defrouter` – Default router IP address. This is an IP address expressed in standard "dot notation." IP addresses consist of the system's network number and the machine's unique host number.

`:rstdomain` – Reset Domain name. The parameter is used to reset the domain to a NULL value.

`:sctpchecksum` – The SCTP checksum algorithm that will be applied to the traffic on the IP card, either `adler32` or `crc32c`. The `sctpchecksum` parameter can be specified only if the `SCTPCSUM` value in the `rtrv-sg-opts` output is `percard`.

The `chg-ip-card` command contains other parameters that cannot be used in this procedure. Refer to *Commands User's Guide* for more information about these parameters.

The IP card must be placed out of service.

The `rstdomain` parameter cannot be specified if the `domain` parameter is specified.

There is only one default router (`defrouter` parameter) for each IP card. The default router is used as the primary route unless a static IP routes is defined for the destination IP address. Static IP routes are assigned using the `ent-ip-rte` command in the [Adding an IP Route](#) procedure.

The network portion of the IP address of the default router must match the network portion of one of the IP addresses assigned to the card.

The network portion of the IP address is based on the class of the IP address (shown in [Table 24: Valid Subnet Mask Parameter Values](#)). If the IP address is a Class A IP address, the first field is the network portion of the IP address. If the IP address is a Class B IP address, the first two fields are the network portion of the IP address. If the IP address is a Class C IP address, the first three fields are the network portion of the IP address. For example, if the IP address is 193.5.207.150, a Class C IP address, the network portion of the IP address is 193.5.207.

The default router can be associated with only one IP address assigned to the card if the `defrouter` parameter is specified. For example, the `dnrsa` value for card 1101 is 150.1.1.10. The `dnspb` value for card 1101 is 160.25.37.1. A default router is provisioned with the IP address 150.1.1.4. The default router is associated with the Ethernet A IP address (the `dnrsa` parameter value), but not the Ethernet B IP address (the `dnspb` parameter value).

If the default router is associated with one of the IP card's IP addresses, a second gateway router can be assigned to the other IP address on the IP card by provisioning a static IP route for the IP card using the `ent-ip-rte` command in the [Adding an IP Route](#) procedure. Static IP routes can provide gateway routers associated with the other IP address on the IP card. To provision the gateway router (the `gtwy` parameter of the `ent-ip-rte` command) for the other IP address assigned to the IP card, the network portion of the gateway router's IP address must match the network portion of the other IP address assigned to the IP card.

Specifying the IP address 0.0.0.0 for the `dnrsa` or `dnspb` parameters, removes the IP address for Ethernet A (`dnrsa`) or Ethernet B (`dnspb`).

When an IP card is entered into the database with the `ent-card` command, the IP stack parameters associated with this card are initially set with these default values:

- `:srchordr` – SRVR
- `:dnrsa` – No DNSA IP address is specified
- `:dnspb` – No DNSB IP address is specified
- `:domain` – No domain name is specified
- `:defrouter` – No default router IP address is specified
- `:rstdomain` – No
- `:sctpcsum` – `crc32c`

The value of any optional parameter not specified with the `chg-ip-card` command is not changed.

1. Display the current IP parameters associated with card in the database by entering the `rtrv-ip-card` command.

The following is an example of the possible output.

```
rlghncxa03w 08-06-28 21:17:37 GMT EAGLE5 39.0.0
  LOC 1201
    SRCHORDR  SRVR
    DNSA      150.1.1.1
    DNSB      -----
    DEFROUTER -----
    DOMAIN    -----
    SCTPCSUM  crc32c
    BPIPADDR  -----
    BPSUBMASK -----
  LOC 1203
    SRCHORDR  LOCAL
    DNSA      192.1.1.40
    DNSB      -----
    DEFROUTER -----
    DOMAIN    NC. TEKELEC. COM
    SCTPCSUM  crc32c
    BPIPADDR  -----
    BPSUBMASK -----
  LOC 1205
    SRCHORDR  SRVROnLY
    DNSA      192.1.1.40
    DNSB      -----
    DEFROUTER -----
    DOMAIN    NC. TEKELEC. COM
    SCTPCSUM  crc32c
    BPIPADDR  -----
    BPSUBMASK -----
```

To change the parameters of an IP card, the signaling link to the card and the card have to be inhibited.

2. Display the signaling link associated with the card shown in [Step 1](#) using the `rtrv-slk` command specifying the card location.

For this example, enter this command.

```
rtrv-slk:loc=1201
```

This is an example of the possible output.

```
rlghncxa03w 06-10-28 21:17:37 GMT EAGLE5 36.0.0
LOC  LINK LSN          SLC TYPE
1201 A    nc001          0  SS7IPGW
```

3. Retrieve the status of the signaling link shown in [Step 2](#) using the `rept-stat-slk` command specifying the card location and signaling link.

For example, enter this command.

```
rept-stat-slk:loc=1201:link=a
```

The output lists the signaling link assigned to this card:

```
rlghncxa03w 06-10-28 21:16:37 GMT EAGLE5 36.0.0
SLK  LSN          CLLI          PST          SST          AST
1201,A  nc001          -----      IS-NR
          Avail          ----
Command Completed.
```

If the signaling link is in service-normal (IS-NR), go to [Step 4](#) to deactivate the signaling link. If the signaling link is out-of-service-maintenance disabled (OOS-MT-DSBLD), continue the procedure with [Step 6](#) to verify the card status.

4. Deactivate the signaling link assigned to the IP card using the `rept-stat-slk` command.

For example, enter this command.

```
dact-slk:loc=1201:link=a
```



CAUTION

Caution: This command impacts network performance and should only be used during periods of low traffic.

After this command has successfully completed, this message appears.

```
rlghncxa03w 06-10-12 09:12:36 GMT EAGLE5 36.0.0
Deactivate Link message sent to card.
```

5. Verify the new link status using the `rept-stat-slk` command.

For example, enter this command.

```
rept-stat-slk:loc=1201:link=a
```

The output displays the link status as OOS-MT-DSBLD and gives off a minor alarm:

```
rlghncxa03w 06-10-27 17:00:36 GMT EAGLE5 36.0.0
SLK      LSN      CLLI      PST      SST      AST
1201,A   nc001      ----- OOS-MT-DSBLD AVAIL   ---
ALARM STATUS = * 0236 REPT-LKS:not aligned
UNAVAIL REASON = NA
Command Completed.
```

6. Verify the status of the IP card to be inhibited using the `rept-stat-card` command.

For example, enter this command.

```
rept-stat-card:loc=1201
```

This is an example of the possible output.

```
rlghncxa03w 06-10-27 17:00:36 GMT EAGLE5 36.0.0
CARD VERSION      TYPE      GPL      PST      SST      AST
1201 114-000-000 DCM      SS7IPGW  IS-NR      Active   -----
ALARM STATUS      = No Alarms.
BPDCM GPL         = 002-102-000
IMT BUS A         = Conn
IMT BUS B         = Conn
SIGNALING LINK STATUS
SLK  PST          LS          CLLI
A    IS-NR        nc001      -----
Command Completed.
```

If the IP card to be inhibited is in service-normal (IS-NR), go to [Step 7](#) to inhibit the card. If the IP card is out-of-service-maintenance disabled (OOS-MT-DSBLD), continue the procedure with [Step 9](#).

7. Inhibit the IP card using the `inh-card` command.

For example, enter this command.

```
inh-card:loc=1201
```

This message should appear.

```
rlghncxa03w 06-10-28 21:18:37 GMT EAGLE5 36.0.0
Card has been inhibited.
```

8. Display the status of the IP card to verify that it is out-of-service maintenance-disabled (OOS-MT-DSBLD).

Enter this command.

```
rept-stat-card:loc=1201
```

This is an example of the possible output.

```
rlghncxa03w 06-10-27 17:00:36 GMT EAGLE5 36.0.0
CARD VERSION      TYPE      GPL      PST      SST      AST
```

```

1201 114-000-000 DCM      SS7IPGW  IS-NR      Active     -----
ALARM STATUS      = No Alarms.
BPDCM GPL         = 002-102-000
IMT BUS A         = Conn
IMT BUS B         = Conn
SIGNALING LINK STATUS
  SLK   PST              LS           CLLI
  A     IS-NR            nc001       -----
Command Completed.

```

If the `defrouter` parameter will be specified in [Step 11](#), continue the procedure with [Step 11](#).

If the `defrouter` parameter will not be specified in [Step 11](#), continue the procedure by performing one of these steps.

- If the `sctpcsum` parameter value for the card will not be changed, continue the procedure with [Step 11](#).
 - If the `sctpcsum` parameter value for the card will be changed, continue the procedure with [Step 10](#).
9. Verify that the IP address of either Ethernet A or B (the address whose network portion matches the network portion of the `defrouter` parameter value to be used in [Step 11](#)) is in the IP link table by entering the `rtrv-ip-lnk` command with the card location specified in this procedure.

For this example, enter this command.

```
rtrv-ip-lnk:loc=1201
```

The following is an example of the possible output.

```

rlghncxa03w 06-10-28 21:17:37 GMT EAGLE5 36.0.0
LOC  PORT  IPADDR          SUBMASK          DUPLEX  SPEED  MACTYPE  AUTO  MCAST
1201  A     192.1.1.10     255.255.255.0   -----  ---   DIX      YES  NO
1201  B     -----        -----          -----  ---   DIX      YES  NO

```

If the network portion of the IP address specified by the `defrouter` value does not match the network portions of either IP address displayed in this step, perform one of these actions:

- Choose another value for the `defrouter` parameter, making sure that the network portion of the new IP address matches the network portion of one of the IP addresses displayed in this step.
- Perform the [Configuring an IP Link](#) procedure and change one of the IP addresses shown in this step so that the network portion of the new IP address changed in the [Configuring an IP Link](#) procedure matches the network portion of the IP address value for the `defrouter` parameter.

After this step has been completed, continue the procedure by performing one of these steps.

- If the `sctpcsum` parameter value for the card will not be changed, continue the procedure with [Step 11](#).
 - If the `sctpcsum` parameter value for the card will be changed, continue the procedure with [Step 10](#).
10. To change the `sctpcsum` parameter value for the IP card, the `sctpcsum` parameter value in the `rtrv-sg-opts` output must be `percard`. Verify the `sctpcsum` parameter value by entering the `rtrv-sg-opts` command.

The following is an example of the possible output.

```
rlghncxa03w 08-04-13 09:19:43 GMT EAGLE5 38.0.0
SRKQ:          1500
SNMPCONT:     tekelec
GETCOMM:      public
SETCOMM:      private
TRAPCOMM:     public
SCTPCSUM:     adler32
IPGWABATE:    NO
UAMEASUSEDFTAS: NO
```

If the `sctpcsum` parameter value in the `rtrv-sg-opts` output is `percard`, continue the procedure with [Step 11](#).

If the `sctpcsum` parameter value in the `rtrv-sg-opts` output is `adler 32` or `crc32c`, perform the [Changing the SCTP Checksum Algorithm Option for M3UA and SUA Associations](#) procedure to change the `sctpcsum` parameter value to `percard`. After the [Changing the SCTP Checksum Algorithm Option for M3UA and SUA Associations](#) procedure has been performed, continue the procedure with [Step 11](#).

11. Change the IP stack parameters associated with an IP card in the database using the `chg-ip-card` command.

For this example, enter this command.

```
chg-ip-card:loc=1201:srchordr=local:dnsa=192.1.1.40:domain=nc.tekelec.com
:sctpcsum=adler32
```

When this command has successfully completed, the following message should appear.

```
rlghncxa03w 06-10-28 21:20:37 GMT EAGLE5 36.0.0
CHG-IP-CARD: MASP A - COMPLTD
```

12. Verify the new IP parameters associated with the IP card that was changed in [Step 11](#) by entering the `rtrv-ip-card` command. with the card location specified in [Step 11](#)

For this example, enter this command.

```
rtrv-ip-card:loc=1201
```

The following is an example of the possible output.

```
rlghncxa03w 08-06-28 21:17:37 GMT EAGLE5 39.0.0
LOC 1201
  SRCHORDR  LOCAL
  DNSA      192.1.1.40
  DNSB      -----
  DEFROUTER -----
  DOMAIN    NC. TEKELEC. COM
  SCTPCSUM  adler32
  BPIPADDR  -----
  BPSUBMASK -----
```

Note: If [Step 7](#) was not performed, continue the procedure with [Step 15](#).

13. Allow the IP card that was inhibited in [Step 7](#) by using the `alw-card` command.

For example, enter this command.

```
alw-card:loc=1201
```

This message should appear.

```
rlghncxa03w 06-10-28 21:22:37 GMT EAGLE5 36.0.0
Card has been allowed.
```

14. Verify the in-service normal (IS-NR) status of the IP card using the `rept-stat-card` command.

For example, enter this command.

```
rept-stat-card:loc=1201
```

This is an example of the possible output.

```
rlghncxa03w 06-10-27 17:00:36 GMT EAGLE5 36.0.0
CARD  VERSION      TYPE      GPL      PST      SST      AST
1201  114-000-000    DCM      SS7IPGW  IS-NR    Active   -----
ALARM STATUS      = No Alarms.
BPDCM GPL         = 002-102-000
IMT BUS A         = Conn
IMT BUS B         = Conn
SIGNALING LINK STATUS
  SLK  PST          LS          CLLI
  A    IS-NR       nc001      -----
Command Completed.
```

15. Activate the signaling link from [Step 4](#) using the `act-slk` command.

Note: If [Step 4](#) was not performed, continue the procedure with [Step 17](#).

For example, enter this command.

```
act-slk:loc=1201:link=a
```

The link changes its state from OOS-MT-DSBLD (out-of-service maintenance-disabled) to IS-NR (in-service normal).

The output confirms the activation.

```
rlghncxa03w 06-10-07 11:11:28 GMT EAGLE5 36.0.0
Activate Link message sent to card
```

16. Verify the in-service normal (IS-NR) status of the signaling link using the `rept-stat-slk` command.

For example, enter this command.

```
rept-stat-slk:loc=1201:link=a
```

This message should appear.

```
rlghncxa03w 06-10-28 21:16:37 GMT EAGLE5 36.0.0
SLK      LSN      CLLI      PST      SST      AST
```

```
1201,A  nc001      -----  IS-NR
        Avail      -----
Command Completed.
```

17. Back up the new changes using the `chg-db:action=backup:dest=fixed` command.

These messages should appear, the active Maintenance and Administration Subsystem Processor (MASP) appears first.

```
BACKUP (FIXED) : MASP A - Backup starts on active MASP.
BACKUP (FIXED) : MASP A - Backup on active MASP to fixed disk complete.
BACKUP (FIXED) : MASP A - Backup starts on standby MASP.
BACKUP (FIXED) : MASP A - Backup on standby MASP to fixed disk complete.
```

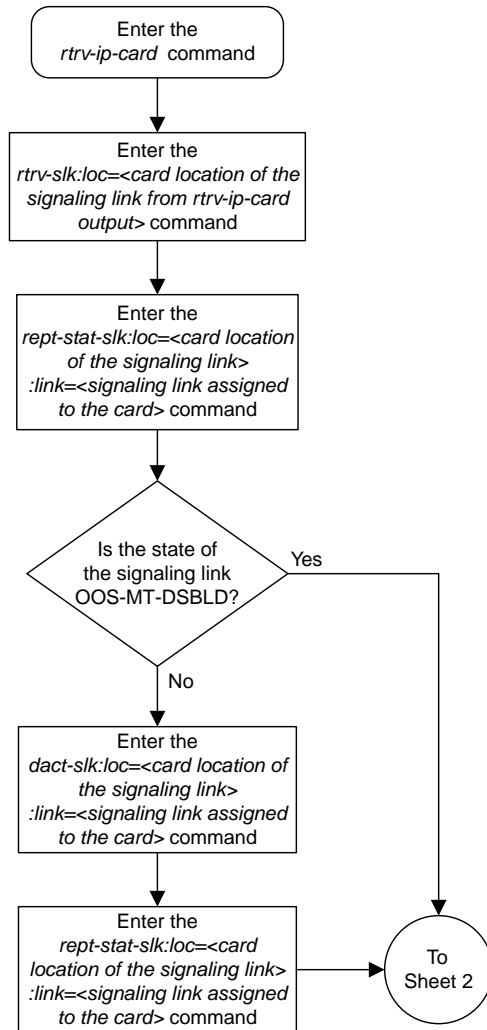

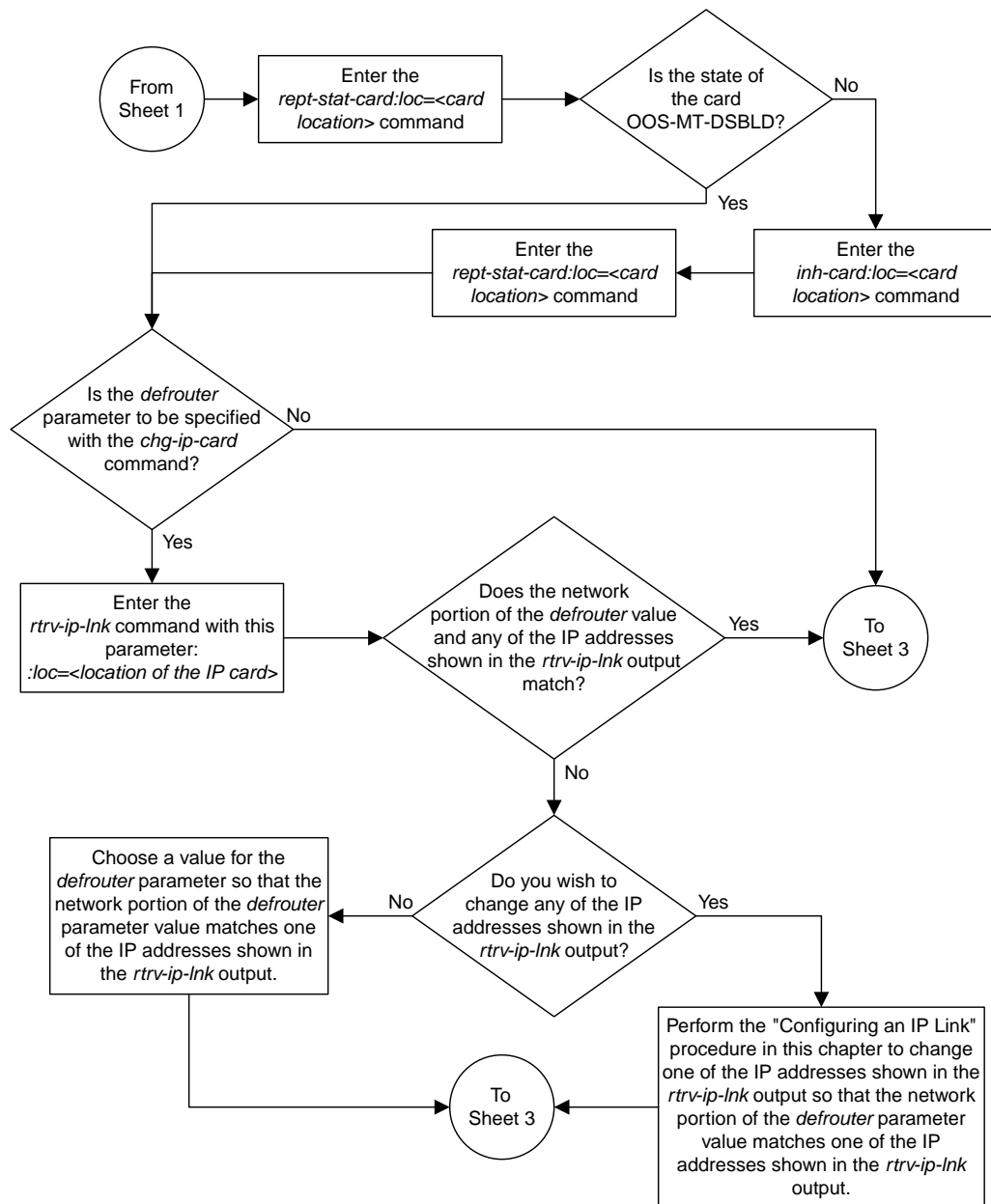

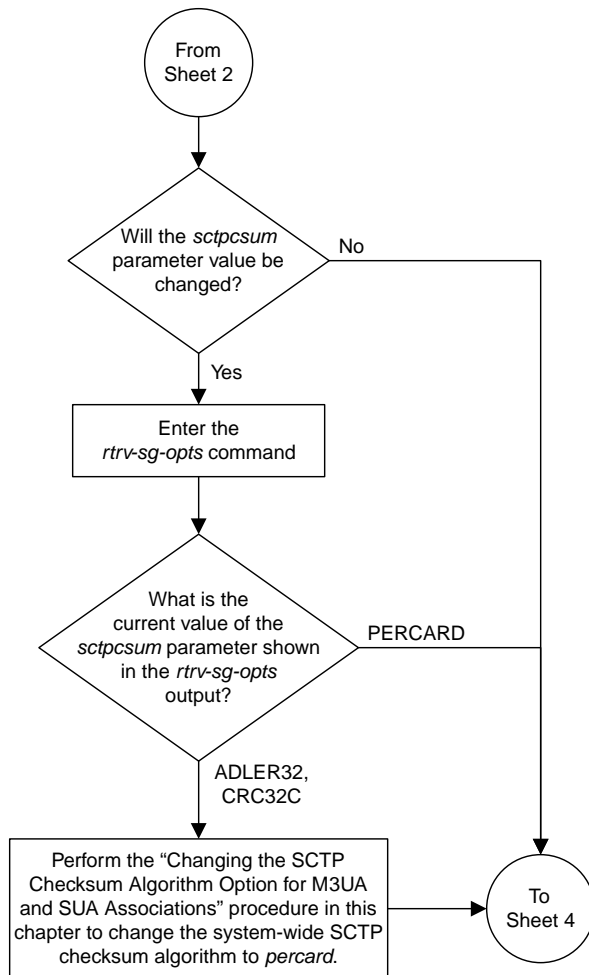

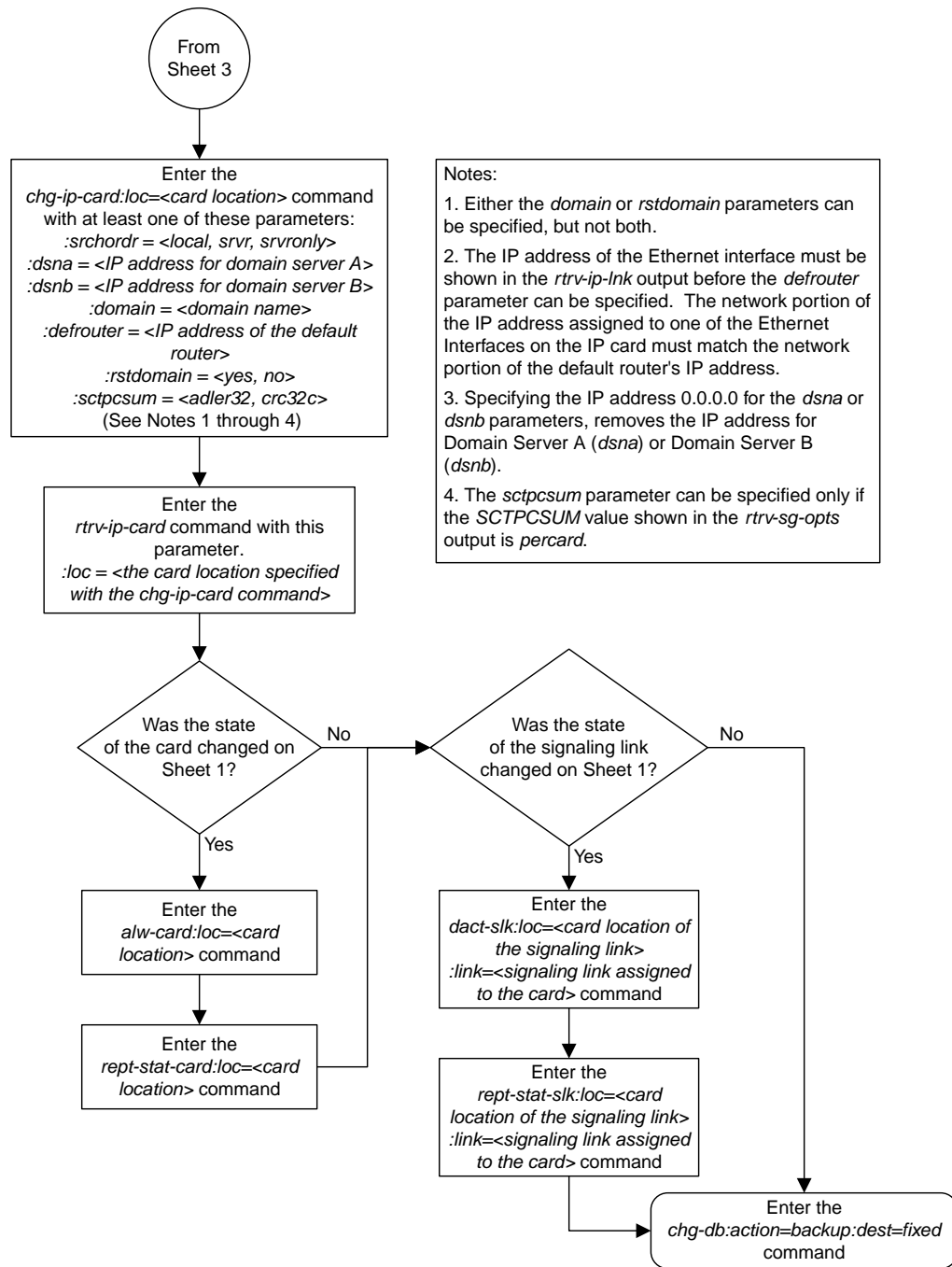

Sheet 4 of 4

Figure 47: Configuring an IP Card

Adding an IP Route

This procedure is used to add an IP route to the database using the `ent-ip-rte` command.

The `ent-ip-rte` command uses these parameters.

`:loc` – The location of the IP card that the IP route will be assigned to.

`:dest` – The IP address of the remote host or network.

`:submask` – The subnet mask of the destination IP address.

`:gtwy` – The IP address of the gateway or router that will send the IP data to its final destination.

There can be a maximum of 64 IP routes assigned to an IP card.

The EAGLE can contain a maximum of 2048 IP routes.

Ethernet Interfaces A and B on the IP card specified by the `loc` parameter can be used.

The network portion of the IP address value of the `gtwy` parameter must be the same as the network portion of the IP addresses shown for either the A or B interfaces in the `rtrv-ip-card` output.

The value of the `dest` and `gtwy` parameters cannot be 127.x.x.x (the loopback address), 0.0.0.0, or the IP addresses of the A or B interfaces on the IP card, and cannot be assigned to another IP card.

If the `dest` parameter value represents a host IP address, the value for the `submask` parameter must be 255.255.255.255. Otherwise, the `submask` parameter value identifies the network/host ID portions that must be entered when the `dest` parameter value represents a network address.

The submask is applied to the IP address which is being routed to see if it yields a route match. For example, if IP address 192.1.1.2 is being routed and the IP routing table contains these entries.

Table 25: Sample IP Routing Table

IP address	Submask	Gateway
191.1.0.0	255.255.0.0	192.168.110.250
192.0.0.0	255.0.0.0	192.168.110.251

IP routing occurs as follows:

1. The subnet mask of route 1 (255.255.0.0) is applied to the IP address being routed (192.1.1.2) with the resulting IP address of 192.1.0.0. IP address 192.1.0.0 does not match IP address 191.1.0.0 in the IP routing table, so the next route is chosen.
2. The subnet mask of route 2 (255.0.0.0) is applied to the IP address being routed (192.1.1.2) with the resulting IP address of 192.0.0.0 which matches the second route in the IP routing table, so this route is selected for routing this datagram.

See [Table 26: Valid Subnet Mask Parameter Values](#) for the valid input values for the `submask` and `dest` parameter combinations.

Table 26: Valid Subnet Mask Parameter Values

Network Class	IP Network Address Range	Valid Subnet Mask Values
A	1.0.0.0 to 127.0.0.0	255.0.0.0 (the default value for a class A IP address) 255.192.0.0 255.224.0.0 255.240.0.0 255.248.0.0 255.252.0.0 255.254.0.0 255.255.128.1
A+B	128.1.0.0 to 191.255.0.0	255.255.0.0 (the default value for a class B IP address) 255.255.192.0 255.255.224.0 255.255.240.0 255.255.248.0 255.255.252.0 255.255.254.0 255.255.255.128
A+B+C	192.0.0.0 to 223.255.255.0	255.255.255.0 (the default value for a class C IP address) 255.255.255.192 255.255.255.224 255.255.255.240 255.255.255.248 255.255.255.252

If a Class B IP address is specified for the `dest` parameter of the `ent-ip-rte` command, the subnet address that results from the `dest` and `submask` parameter values cannot be the same as the subnet address that results from the `pvn` and `pvnmask`, `fcna` and `fcnamask`, or `fcnb` and `fcnbmask` parameter values of the `chg-netopts` command. The `pvn` and `pvnmask`, `fcna` and `fcnamask`, or `fcnb` and `fcnbmask` parameter values can be verified by entering the `rtrv-netopts` command. Choose `dest` and `submask` parameter values for the IP route whose resulting subnet address is not

be the same as the subnet address resulting from the `pvn` and `pvnmask` parameter values of the `chg-netopts` command.

1. Display the IP routes in the database with the `rtrv-ip-rte` command.

This is an example of the possible output.

```
rlghncxa03w 06-10-28 09:12:36 GMT EAGLE5 36.0.0
LOC  DEST          SUBMASK          GTWY
1301 128.252.10.5     255.255.255.255 140.188.13.33
1301 128.252.0.0      255.255.0.0     140.188.13.34
1301 150.10.1.1       255.255.255.255 140.190.15.3
1303 192.168.10.1     255.255.255.255 150.190.15.23
1303 192.168.0.0      255.255.255.0   150.190.15.24

IP Route table is (5 of 2048) 0.24% full
```

2. Display the IP cards in the database with the `rtrv-ip-card` command.

This is an example of the possible output.

```
rlghncxa03w 08-08-28 21:17:37 GMT EAGLE5 39.0.0
LOC 1212
  SRCHORDR  LOCAL
  DNSA      150.1.1.1
  DNSB      -----
  DEFROUTER 150.1.1.100
  DOMAIN    NC. TEKELEC. COM
  SCTPCSUM  crc32c
  BPIPADDR  -----
  BPSUBMASK -----
LOC 1301
  SRCHORDR  SRVROONLY
  DNSA      140.188.13.10
  DNSB      140.190.15.28
  DEFROUTER -----
  DOMAIN    NC. TEKELEC. COM
  SCTPCSUM  crc32c
  BPIPADDR  -----
  BPSUBMASK -----
LOC 1303
  SRCHORDR  LOCAL
  DNSA      150.190.15.1
  DNSB      -----
  DEFROUTER 150.190.15.25
  DOMAIN    NC. TEKELEC. COM
  SCTPCSUM  crc32c
  BPIPADDR  -----
  BPSUBMASK -----
```

If the required IP card is not shown in the `rtrv-ip-card` output, perform the [Adding an IPGWx Card](#) to add the card to the database.

Perform the [Configuring an IP Card](#) and make sure that the network portion of the IP addresses assigned for the A or B interfaces of the IP card is the same as the network portion of the IP address that will be assigned to the `gtwy` parameter of the IP route

Note: If a Class A or CIP address (see [Table 26: Valid Subnet Mask Parameter Values](#)) will be specified for the `dest` parameter in [Step 4](#), continue the procedure with [Step 4](#).

- The subnet address that results from the `dest` and `submask` parameter values of the `ent-ip-rte` command cannot be the same as the subnet address that results from the `pvn` and `pvnmask`, `fcna` and `fcnamask`, or `fcnb` and `fcnbmask` parameter values of the `chg-netopts` command.

Display the `pvn`, `pvnmask`, `fcna`, `fcnamask`, `fcnb`, and `fcnbmask` parameter values of the `chg-netopts` command by entering the `rtrv-netopts` command.

If error message E3967 Cmd Rej: E5IS must be on is displayed after the `rtrv-netopts` command is executed, the `pvn`, `pvnmask`, `fcna`, `fcnamask`, `fcnb`, and `fcnbmask` parameters are not configured. Continue the procedure with [Step 4](#).

This is an example of the possible output if the E5IS feature is on.

```
rlghncxa03w 09-02-28 21:17:37 GMT EAGLE5 40.1.0
NETWORK OPTIONS
-----
PVN           = 128.20.30.40
PVNMASK       = 255.255.192.0
FCNA         = 170.120.50.0
FCNAMASK     = 255.255.240.0
FCNB         = 170.121.50.0
FCNBMASK     = 255.255.254.0
```

Choose `dest` and `submask` parameter values for the IP route whose resulting subnet address is not be the same as the subnet address resulting from the `pvn` and `pvnmask`, `fcna` and `fcnamask`, or `fcnb` and `fcnbmask` parameter values of the `chg-netopts` command. Continue the procedure with [Step 4](#).

- Add the IP route to the database using the `ent-ip-rte` command.

For this example, enter this command.

```
ent-ip-rte:loc=1212:dest=132.10.175.20:submask=255.255.255.255
:gtwy=150.1.1.50
```

When this command has successfully completed, this message should appear.

```
rlghncxa03w 06-10-12 09:12:36 GMT EAGLE5 36.0.0
ENT-IP-RTE: MASP A - COMPLTD
```

- Verify the changes using the `rtrv-ip-rte` command with the card location specified with the `ent-ip-rte` command in [Step 4](#).

For this example, enter these commands.

```
rtrv-ip-rte:loc=1212
```

This is an example of the possible output.

```
rlghncxa03w 06-10-28 09:12:36 GMT EAGLE5 36.0.0
LOC  DEST          SUBMASK          GTWY
1212 132.10.175.20    255.255.255.255 150.1.1.50
IP Route table is (6 of 2048) 0.29% full
```

- Back up the new changes using the `chg-db:action=backup:dest=fixed` command.

These messages should appear, the active Maintenance and Administration Subsystem Processor (MASP) appears first.

```
BACKUP (FIXED) : MASP A - Backup starts on active MASP.  
BACKUP (FIXED) : MASP A - Backup on active MASP to fixed disk complete.  
BACKUP (FIXED) : MASP A - Backup starts on standby MASP.  
BACKUP (FIXED) : MASP A - Backup on standby MASP to fixed disk complete.
```

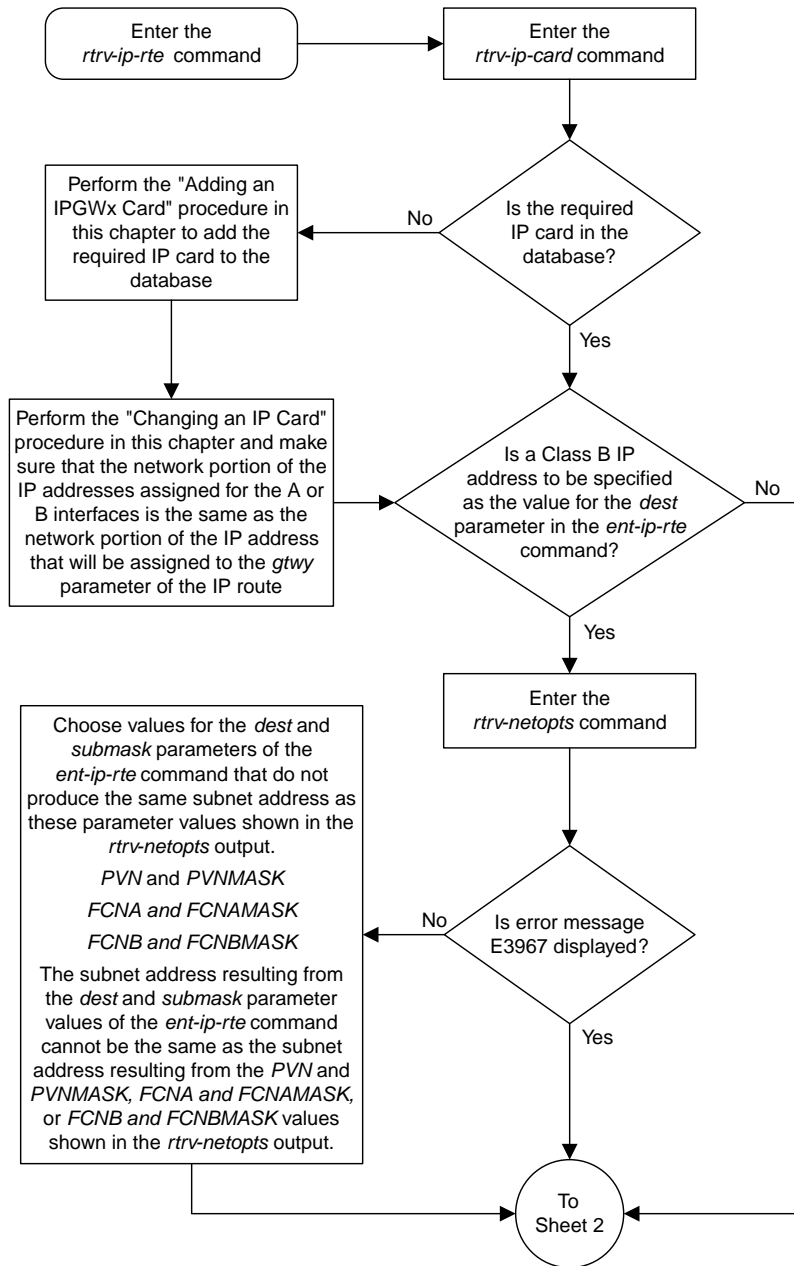

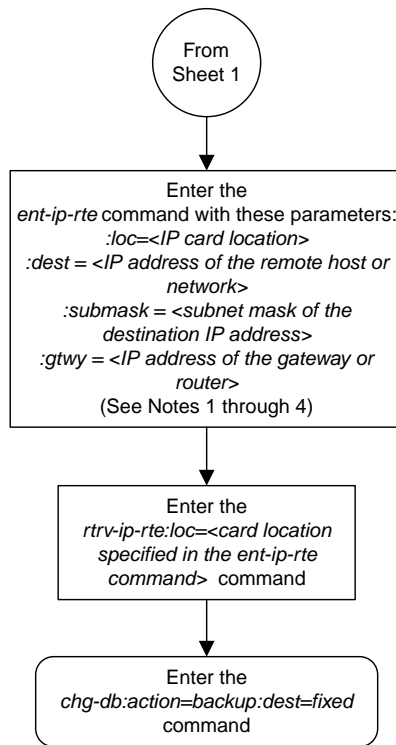
**Notes:**

1. The network portion of the IP address value of the *gtwy* parameter must be the same as the network portion of the IP addresses shown for either the A or B interfaces in the *rtrv-ip-card* output.
2. The value of the *dest* and *gtwy* parameters cannot be the 127.x.x.x (the loopback address), 0.0.0.0, or the IP addresses of the A or B interfaces on the IP card, and cannot be assigned to another IP card.
3. There can be a maximum of 64 IP routes assigned to an IP card.
4. The EAGLE 5 ISS can contain a maximum of 1024 IP routes.

Sheet 2 of 2

Figure 48: Adding an IP Route**Adding an M3UA or SUA Association**

This procedure is used to configure M3UA or SUA associations using the `ent-assoc` command. The combination of a local host, local SCTP port, remote host and remote SCTP port defines an association. M3UA and SUA associations are assigned to cards running either the SS7IPGW or IPGWI applications (IPGWx cards).

The `ent-assoc` command uses these parameters:

`:aname` – The name assigned to the association. Valid association names can contain up to 15 alphanumeric characters where the first character is a letter and the remaining characters are alphanumeric characters. The `aname` parameter value is not case-sensitive.

`:lhost` – Local Hostname. The logical name assigned to the local host device.

`:lport` – The SCTP port number for the local host.

`:rhost` – Remote Hostname. The logical name assigned to the remote host device.

`:rport` – The SCTP port number for the remote host.

`:link` – The signaling link on the IP card. The value for the link parameter for M3UA or SUA associations is A.

Note: The `port` parameter can be used in place of the `link` parameter to specify the signaling link on the card.

`:adapter` – The adapter layer for this association, either `m3ua` or `sua`. The `adapter` parameter is optional. The default value for the `adapter` parameter is `m3ua`.

`:alhost` – The alternate local host name.

The `adapter=m2pa` and `m2patset` parameters can be used only when configuring M2PA associations. Perform the [Adding an M2PA Association](#) or [Adding an IPSG M2PA Association](#) procedures to configure M2PA associations.

Associations contain fields whose values are not assigned using the `ent-assoc` command. When an association is added to the database, these fields receive their default values. If a different value is desired, the `chg-assoc` command must be used. To change these values perform the [Changing the Attributes of a M3UA or SUA Association](#) procedure.

These fields and their default values are shown in [Table 27: M3UA and SUA Association Fields and Default Values](#).

Table 27: M3UA and SUA Association Fields and Default Values

<code>open=no</code>	<code>rmax=800</code>	<code>cwmin=3000</code>	<code>alw=no</code>	<code>uaps=10</code>
<code>istrms=2</code>	<code>rmode=lin</code>	<code>rtimes=10</code>	<code>ostrms=2</code>	<code>rmin=120</code>
<code>bufsize=16</code>	<code>rtxthr=0</code>	<code>rhostval=relaxed</code>		

An M3UA or SUA association can contain an alternate remote host. The alternate remote host is provisioned with the `rhost` and `rhostype=alternate` parameters of the `chg-assoc` command. A primary remote host can be provisioned on this procedure by specifying the `rhost` parameter with the `ent-assoc` command. To provision an alternate remote host for an M3UA or SUA association, perform [Changing the Attributes of a M3UA or SUA Association](#).

The size of the buffers on the E5-ENET card is shown in the following list.

- E5-ENET Card - 3200 KB

The size of the buffers assigned to each association that is assigned to the IP card cannot exceed the maximum buffer size for the IP card. When a new association is added, the default buffer size for the association is assigned to the association. If adding the new association causes the total buffer size for all the associations on the IP card to exceed the maximum buffer size for that IP card, the `ent-assoc` command will be rejected. If you wish to add the association and the maximum buffer size for the IP card will be exceeded, the buffer size of the other associations assigned to the IP card must be decreased by performing the [Changing the Buffer Size of a M3UA or SUA Association](#) procedure. The available size of the buffers on the IP card can be verified by entering this command.

```
rtrv-assoc:lhost=<local host name assigned to the association being changed>
```

The `alhost` parameter can also be used with the `rtrv-assoc` command to display the available size of the buffers on the IP card.

The `aname` parameter can be used with the `rtrv-assoc` command to display the available size of the buffers on the IP card and the size of the buffer assigned to the association.

The value of the `lhost`, `rhost`, or `alhost` parameters is a text string of up to 60 characters, with the first character being a letter. The command line on the terminal can contain up to 150 characters. If the host names are too long to fit on the `ent-assoc` command line, perform the `chg-assoc` command with the parameters and values necessary to complete the entry of the M3UA or SUA association.

The EAGLE can contain a maximum of 4000 connections (association to application server assignments).

The B Ethernet interface of the IP card can be used on the E5-ENET card.

If the association is to be activated in this procedure, with the `chg-assoc` command, the association must contain values for the `lhost`, `lport`, `rhost`, and `rport` parameters.

The signaling link being assigned to the association must be in service. This state is shown in the `rept-stat-slk` output with the entries `IS-NR` in the `PST` field and `Avail` in the `SST` field.

Uni-homed endpoints are associations configured with the `lhost` parameter only. The `lhost` parameter value represents an IP address that corresponds to either the A or B network interface of the IP card. Multi-homed endpoints are associations configured with both the `lhost` and `alhost` parameters. The `lhost` parameter value represents an IP address corresponding to one of the network interfaces (A or B) of the IP card while the `alhost` parameter value represents an IP address corresponding to the other network interface of the same IP card.

An alternate remote host can be configured for multi-homed associations using the `rhost` and `rhostype` parameters of the `chg-assoc` command. The `rhost` parameter value with the `rhostype=primary` parameter represents an IP address that corresponds to one of the network interfaces at the remote end while the `rhost` parameter value with the `rhostype=alternate` parameter represents an IP address that corresponds to the other network interface at the remote end.

Canceling the RTRV-ASSOC Command

Because the `rtrv-assoc` command used in this procedure can output information for a long period of time, the `rtrv-assoc` command can be canceled and the output to the terminal stopped. There are three ways that the `rtrv-assoc` command can be canceled.

- Press the F9 function key on the keyboard at the terminal where the `rtrv-assoc` command was entered.
- Enter the `canc-cmd` without the `trm` parameter at the terminal where the `rtrv-assoc` command was entered.
- Enter the `canc-cmd:trm=<xx>`, where `<xx>` is the terminal where the `rtrv-assoc` command was entered, from another terminal other than the terminal where the `rtrv-assoc` command was entered. To enter the `canc-cmd:trm=<xx>` command, the terminal must allow Security Administration commands to be entered from it and the user must be allowed to enter Security Administration commands. The terminal's permissions can be verified with the `rtrv-secu-trm` command. The user's permissions can be verified with the `rtrv-user` or `rtrv-secu-user` commands.

For more information about the `canc-cmd` command, go to *Commands User's Guide*.

1. Display the associations in the database using the `rtrv-assoc` command. This is an example of possible output.

```
rlghncxa03w 06-10-28 09:12:36 GMT EAGLE5 36.0.0
CARD IPLNK
ANAME      LOC  PORT  LINK ADAPTER  LPORT  RPORT  OPEN  ALW
swbel32    1201 A     A    M3UA    1030    2345   YES   YES
a2         1305 A     A     SUA     1030    2345   YES   YES
a3         1307 A     A     SUA     1030    2346   YES   YES
assoc3     1203 A     A1    M2PA    2048    1030   NO    NO
```

Perform one of these actions.

- If SUA associations are assigned to the desired IP link (shown by the entries in the `CARD LOC` and `IPLNK PORT` columns for an association whose `ADAPTER` value is `SUA` in the `rtrv-assoc` output), continue the procedure with [Step 5](#).
 - If M3UA associations are assigned to the desired IP link (shown by the entries in the `CARD LOC` and `IPLNK PORT` columns for an association whose `ADAPTER` value is `M3UA` in the `rtrv-assoc` output), continue the procedure with [Step 2](#).
 - If the desired IP link is not shown in the `rtrv-assoc` output, continue the procedure with [Step 3](#).
2. Display the signaling links assigned to the card that the new M3UA association will be assigned to by entering the `rtrv-slk` command with the card location displayed in [Step 1](#). For this example, enter this command.

```
rtrv-slk:loc=1201
```

The following is an example of the possible output.

```
rlghncxa03w 08-04-06 10:07:25 GMT EAGLE5 38.0.0
LOC  LINK  LSN          SLC  TYPE
1201 A    lsn1         0    SS7IPGW
```

If the value in the `TYPE` column is either `SS7IPGW` or `IPGWI`, continue the procedure with [Step 5](#).

If the value in the TYPE column is IPSEG, the links and host assigned to this card cannot be used in this procedure. If you wish to use this card to configure an M3UA association, perform the [Adding an IPSEG M3UA Association](#) procedure.

If you do not wish to use this card to configure an M3UA association, perform one of these actions.

- Choose another card from the `rtrv-assoc` output in [Step 1](#) and repeat this step.
 - Continue the procedure with [Step 3](#) to choose another IPGWx card and IP link for the new association.
3. Display the IP links in the database by entering the `rtrv-ip-lnk` command. The following is an example of the possible output.

```
rlghncxa03w 08-12-28 21:14:37 GMT EAGLE5 40.0.0
LOC  PORT  IPADDR          SUBMASK          DUPLEX  SPEED  MACTYPE  AUTO  MCAST
1201  A      192.1.1.10     255.255.255.128  HALF    10     802.3    NO    NO
1201  B      -----
1203  A      192.1.1.12     255.255.255.0   ----    ---    DIX      YES   NO
1203  B      -----
1205  A      192.1.1.14     255.255.255.0   FULL    100    DIX      NO    NO
1205  B      -----
2101  A      192.1.1.20     255.255.255.0   FULL    100    DIX      NO    NO
2101  B      -----
2103  A      192.1.1.22     255.255.255.0   FULL    100    DIX      NO    NO
2103  B      -----
2105  A      192.1.1.24     255.255.255.0   FULL    100    DIX      NO    NO
2105  B      -----
2205  A      192.1.1.30     255.255.255.0   FULL    100    DIX      NO    NO
2205  B      -----
2207  A      192.1.1.32     255.255.255.0   FULL    100    DIX      NO    NO
2207  B      -----
2213  A      192.1.1.50     255.255.255.0   FULL    100    DIX      NO    NO
2213  B      -----
2301  A      192.1.1.52     255.255.255.0   FULL    100    DIX      NO    NO
2301  B      -----
IP-LNK  table is (20 of 2048) 1% full.
```

If the required IP link is not in the database, add the IP link using the [Configuring an IP Link](#) procedure.

4. Verify that the local host name to be assigned to the association is in the database by using the `rtrv-ip-host:display=all` command. The following is an example of the possible output.

```
rlghncxa03w 13-06-28 21:15:37 GMT EAGLE5 45.0.0

LOCAL IPADDR      LOCAL HOST
192.1.1.10        IPNODE1-1201
192.1.1.12        IPNODE1-1203
192.1.1.14        IPNODE1-1205
192.1.1.20        IPNODE2-1201
192.1.1.22        IPNODE2-1203
192.1.1.24        IPNODE2-1205
192.1.1.30        KC-HLR1
192.1.1.32        KC-HLR2
192.1.1.50        DN-MS1
192.1.1.52        DN-MS2

REMOTE IPADDR      REMOTE HOST
```

```
150.1.1.5          NCDEPTECONOMIC_DEVELOPMENT. SOUTHEASTERN_COORIDOR_ASHVL. GOV
IP Host table is (11 of 4096) .26% full
```

The IP address of the IP link should be assigned to the local host name that will be assigned to the association.

The values of the `lhost` and `alhost` parameters must be in the LOCAL HOST column in the `rtrv-ip-host` output.

If the required hostname is not in the database, add the IP host name using the [Adding an IP Host](#) procedure.

- Verify the available buffer size for the IP card that will contain the association being added in this procedure by entering the `rtrv-assoc` command with the local host name assigned to the association being added. For this example, enter this command.

Note: If a new IP host was added in [Step 4](#), continue the procedure with [Step 6](#).

```
rtrv-assoc:lhost="IPNODE2-1305"
```

This is an example of the possible output.

```
rlghncxa03w 06-10-28 09:12:36 GMT EAGLE5 36.0.0
CARD IPLNK
ANAME          LOC  PORT  LINK ADAPTER LPORT RPORT OPEN ALW
a2             1305 A    A    SUA      1030 2345 YES YES
IP Appl Sock/Assoc table is (8 of 4000) 1% full
Assoc Buffer Space Used (16 KB of 800 KB) on LOC = 1305
```

If adding the new association causes the total buffer size for all the associations on the IP card to exceed the maximum buffer size for that IP card, the `ent-assoc` command will be rejected.

The default buffer value for an M3UA or SUA association is 16.

If you wish to add the association and the maximum buffer size for the IP card will be exceeded, the buffer size of the other associations assigned to the IP card must be decreased by performing the [Changing the Buffer Size of a M3UA or SUA Association](#) procedure.

- Add the associations using the `ent-assoc` command. For this example, enter these commands.

```
ent-assoc:aname=assoc1:lhost=gw105.nc.tekelec.com:lport=1030:
rhost=gw100.nc.tekelec.com:rport=1030:adapter=m3ua:link=a
```

These are the rules that apply to adding M3UA or SUA associations that are assigned to IPGWx signaling links.

- The B Ethernet interface can be used with E5-ENET cards.
- Each local host on an IPGWx card can contain a maximum of 50 connections (association – application server assignments).
- The EAGLE can contain a maximum of 4000 connections (association – application server assignments).
- The value of the `lhost`, `rhost`, or `alhost` parameters is a text string of up to 60 characters, with the first character being a letter. The command line on the terminal can contain up to 150 characters. If the host names are too long to fit on the `ent-assoc` command line, perform the

chg-assoc command with the parameters and values necessary to complete the entry of the M3UA or SUA association.

- If the new association is to be activated in this procedure with the chg-assoc command, the association must contain values for the lhost, rhost, lport, and rport parameters.
- If the lhost and alhost are specified, the lhost parameter value represents the IP address corresponding to one of the network interfaces (A or B) on the IP card while the alhost parameter value represents the IP address corresponding to the other network interface of the same IP card.
- The default value for the adapter parameter is m3ua.
- The port parameter can be used in place of the link parameter to specify the signaling link assigned to the association.

When each of these commands have successfully completed, this message should appear.

```
rlghncxa03w 06-10-28 09:12:36 GMT EAGLE5 36.0.0
ENT-ASSOC: MASP A - COMPLTD
```

Note: If the association added in step 6 is not being activated in this procedure, skip step 7 and go to step 8.

7. Activate the association added in [Step 6](#) by entering the chg-assoc command with the association name specified in [Step 6](#) and the open=yes and alw=yes parameters. For example, enter this command.

```
chg-assoc:aname=assoc1:open=yes:alw=yes
```

When this command has successfully completed, this message should appear.

```
rlghncxa03w 06-10-28 21:15:37 GMT EAGLE5 36.0.0
CHG-ASSOC: MASP A - COMPLTD
```

8. Verify the changes using the rtrv-assoc command specifying the association name specified in [Step 6](#) and [Step 7](#). For this example, enter these commands.

```
rtrv-assoc:aname=assoc1
```

This is an example of possible output.

```
rlghncxa03w 09-05-28 09:12:36 GMT EAGLE5 41.0.0
ANAME assoc1
  LOC      1305          IPLNK PORT  A          LINK  A
  ADAPTER  M3UA          VER          M3UA RFC
  LHOST    gw105.nc.tekelec.com
  ALHOST    ---
  RHOST    gw100.nc.tekelec.com
  ARHOST    ---
  LPORT    1030          RPORT      1030
  ISTRMS   2            OSTRMS     2          BUFSIZE  16
  RMODE    LIN          RMIN       120        RMAX     800
  RTIMES   10          CWMIN      3000       UAPS     10
  OPEN     YES          ALW        YES         RTXTHR   0
  RHOSTVAL RELAXED

IP Appl Sock table is (5 of 4000) 1% full
Assoc Buffer Space Used (16 KB of 800 KB) on LOC = 1305
```

9. Back up the new changes, using the `chg-db:action=backup:dest=fixed` command. These messages should appear; the active Maintenance and Administration Subsystem Processor (MASP) appears first.

```
BACKUP (FIXED) : MASP A - Backup starts on active MASP.  
BACKUP (FIXED) : MASP A - Backup on active MASP to fixed disk complete.  
BACKUP (FIXED) : MASP A - Backup starts on standby MASP.  
BACKUP (FIXED) : MASP A - Backup on standby MASP to fixed disk complete.
```

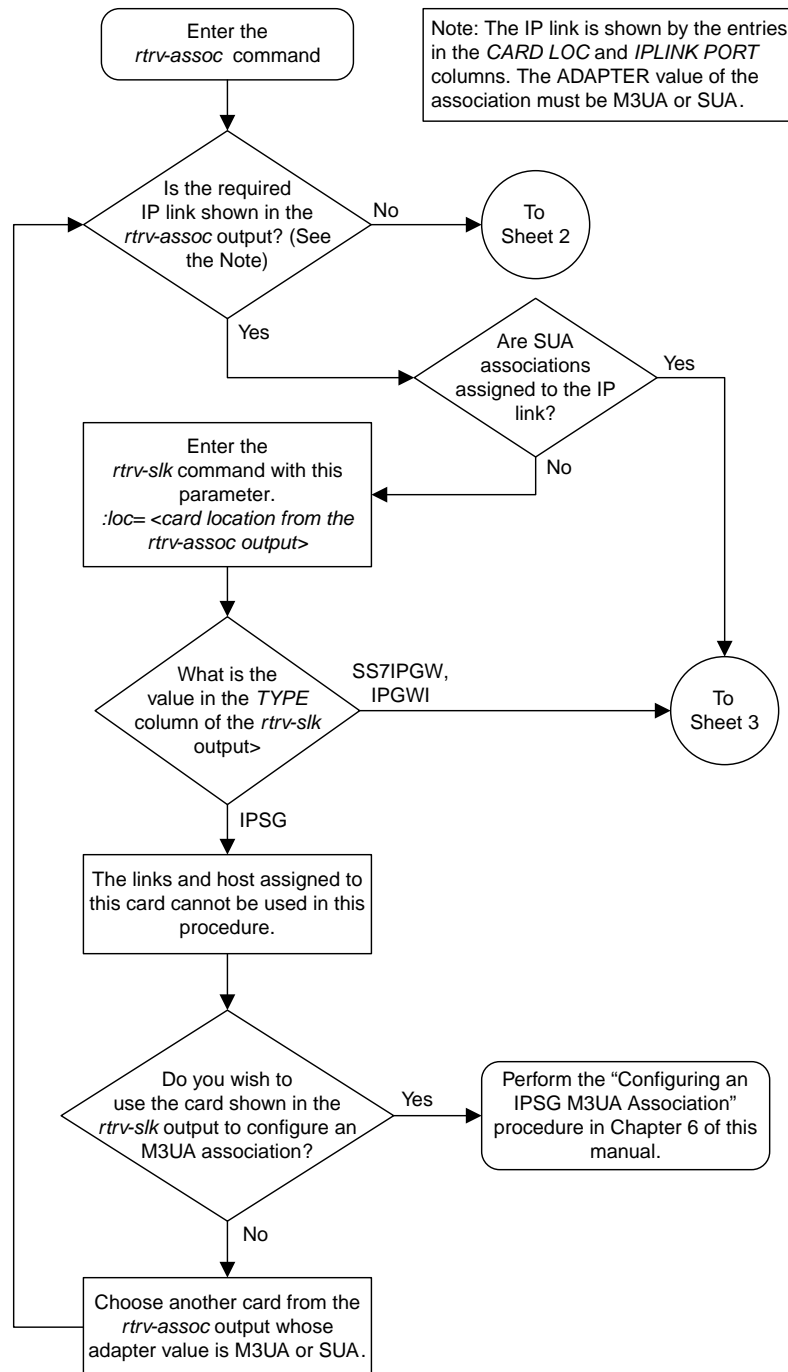

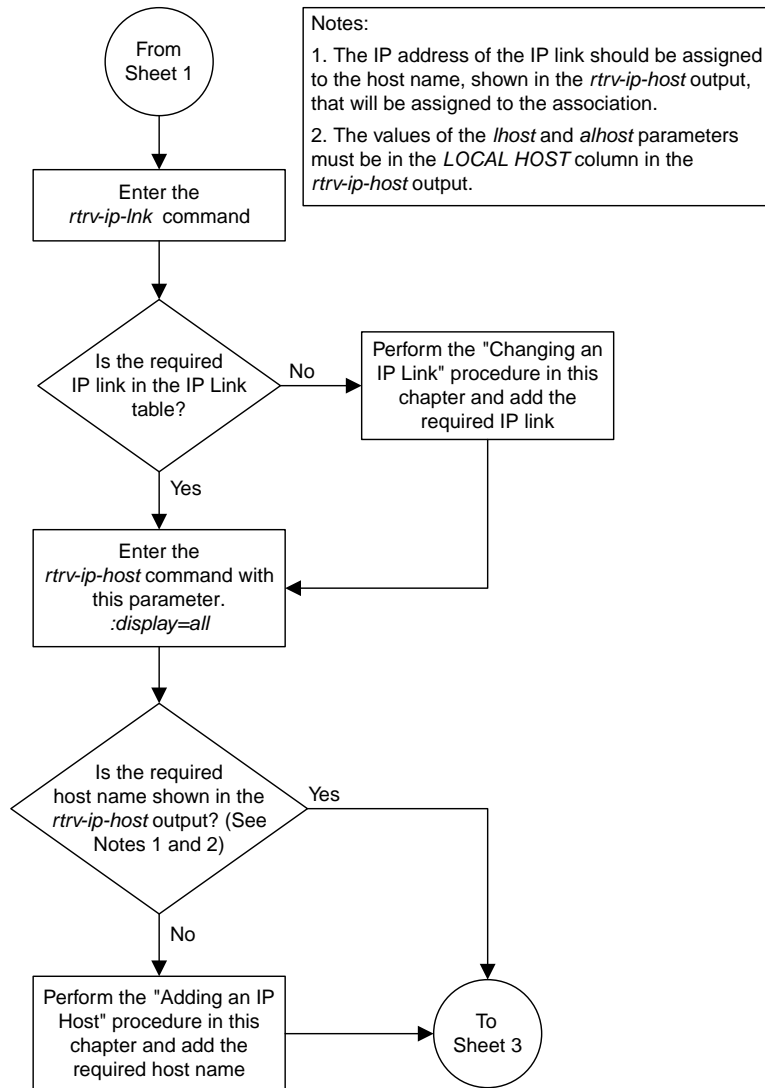

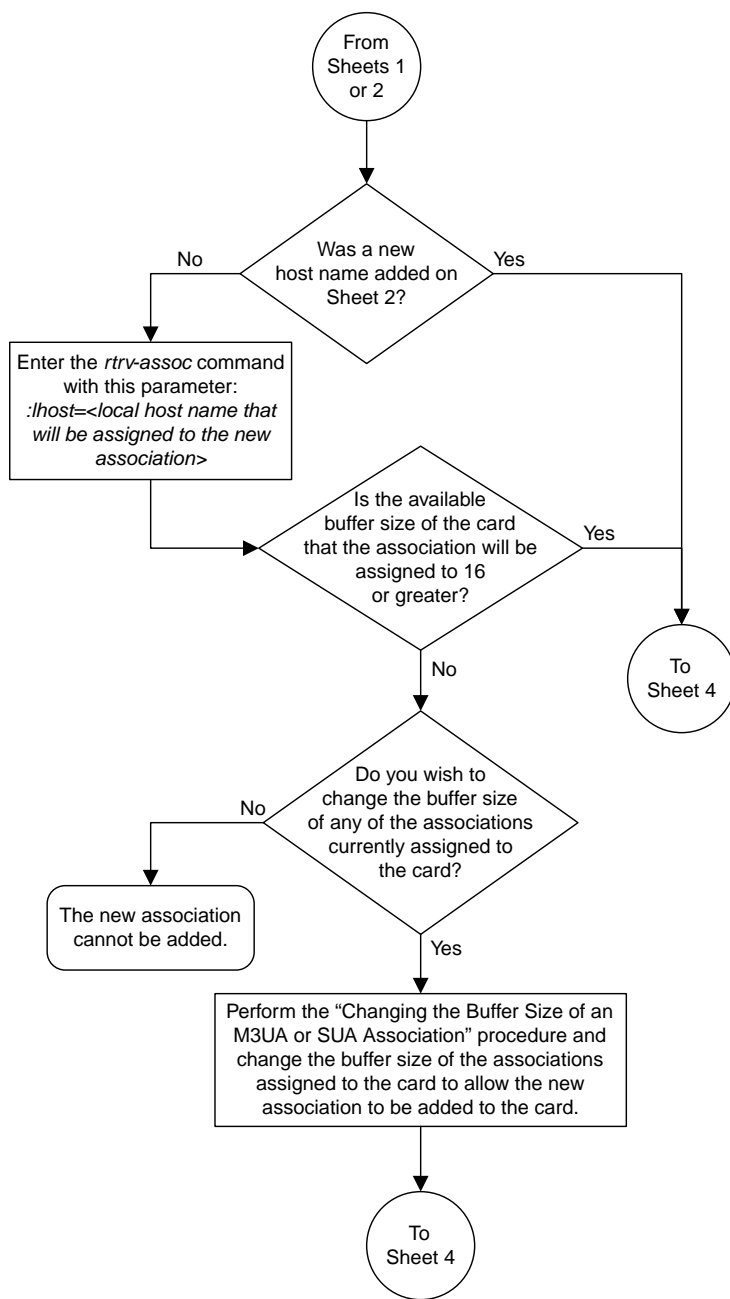

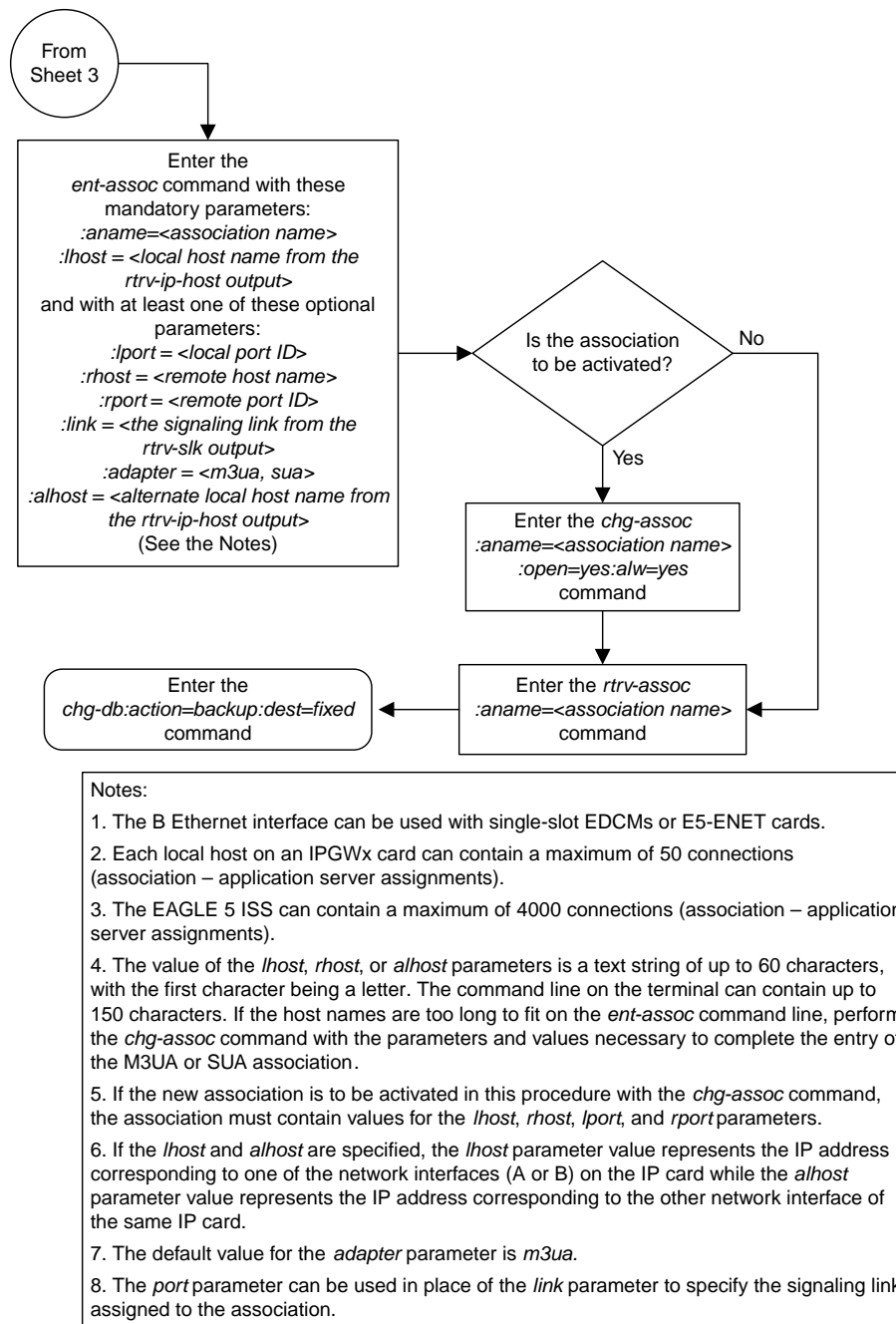

Sheet 4 of 4

Figure 49: Adding an IPGWx M3UA or SUA Association

Adding a New Association to a New Application Server

This procedure is used create a new application server and assign a new association to the application server using the `ent-as` command.

The `ent-as` command uses these parameters:

`:asname` – The name of the new application server. The name of the application server can contain up to 15 alphanumeric characters, with the first character being an alphabetic character. Application server names are not case sensitive.

`:aname` – The name of the association being assigned to the application server.

The maximum number SCTP association to application server assignments that can be hosted by an IPGWx card (referenced by the `lhost` parameter of the association) is 50. For example, the IPGWx card currently contains 38 SCTP association to application server assignments. The SCTP association to application server assignments could be one SCTP association assigned to 38 application servers, two SCTP associations assigned to 19 application servers, or any combination of SCTP associations assigned to application servers that add up to 38. The SCTP association to application server assignments can be verified with the `rtrv-assoc:lhost=<local host name>` and `rtrv-as:aname=<association name>` commands.

Table 28: Examples of IPGWx Card Provisioning Limits

Number of Associations hosted by the IPGWx card	Number of Application Servers each Association is Assigned to *	Total Association - Application Server Assignments maintained by the IPGWx card
1	50	50
50	1	50
25	1	50
25	2	50
0	0	50
38	1	38
19	2	38
* The EAGLE can contain a maximum of 250 application servers.		

The `open` parameter of the association must be set to `no` before the association can be assigned to the application server. This can be verified with the `rtrv-assoc` command.

M2PA associations (`adapter=m2pa`) cannot be assigned to application servers. Only M3UA (`adapter=m3ua`) and SUA (`adapter=sua`) associations can be assigned to application servers. This can be verified in the `ADAPTER` field in the `rtrv-assoc` output.

The application server recovery timer (the `tr` parameter of the `chg-as` command) for the application server is set by default to 10 milliseconds when an application server is added. The traffic mode (the `mode` parameter of the `chg-as` command) for the application server is set by default to `LOADSHARE` when an application server is added. Perform the [Changing an Application Server](#) procedure to change these parameter values.

Canceling the RTRV-AS and RTRV-ASSOC Commands

Because the `rtrv-as` and `rtrv-assoc` commands used in this procedure can output information for a long period of time, the `rtrv-as` and `rtrv-assoc` commands can be canceled and the output to the terminal stopped. There are three ways that the `rtrv-as` and `rtrv-assoc` commands can be canceled.

- Press the `F9` function key on the keyboard at the terminal where the `rtrv-as` or `rtrv-assoc` commands were entered.
- Enter the `canc-cmd` without the `trm` parameter at the terminal where the `rtrv-as` or `rtrv-assoc` commands were entered.
- Enter the `canc-cmd:trm=<xx>`, where `<xx>` is the terminal where the `rtrv-as` or `rtrv-assoc` commands were entered, from another terminal other than the terminal where the `rtrv-as` or `rtrv-assoc` commands were entered. To enter the `canc-cmd:trm=<xx>` command, the terminal must allow Security Administration commands to be entered from it and the user must be allowed to enter Security Administration commands. The terminal's permissions can be verified with the `rtrv-secu-trm` command. The user's permissions can be verified with the `rtrv-user` or `rtrv-secu-user` commands.

For more information about the `canc-cmd` command, go to *Commands User's Guide*.

1. Display the application servers in the database using the `rtrv-as` command. This is an example of possible output.

```
rlghncxa03w 06-10-28 09:12:36 GMT EAGLE5 36.0.0

AS Name           Mode           Tr ms      Association Names
as1                LOADSHARE      10         a2
                  a3
                  assoc1

as2                OVERRIDE       10         assoc7
as3                OVERRIDE       10         swbel32

AS table is (3 of 250) 1% full.
```

2. Display the associations in the database using the `rtrv-assoc` command. This is an example of possible output.

```
rlghncxa03w 06-10-28 09:12:36 GMT EAGLE5 36.0.0

CARD IPLNK
ANAME      LOC  PORT  LINK ADAPTER  LPORT  RPORT  OPEN  ALW
swbel32    1201 A     A    M3UA    1030    2345   YES   YES
a2         1305 A     A    SUA     2000    2345   YES   YES
a3         1307 A     A    SUA     3000    3000   YES   YES
```

assoc1	1305	A	A	SUA	4000	1030	YES	YES
assoc7	1311	A	A	SUA	2500	2000	YES	YES

3. Display the IP host names in the database by using the `rtrv-ip-host:display=all` command. The following is an example of the possible output.

```
rlghncxa03w 13-06-28 21:15:37 GMT EAGLE5 45.0.0

LOCAL IPADDR      LOCAL HOST
192.1.1.10        IPNODE1-1201
192.1.1.12        GW105. NC. TEKELEC. COM
192.1.1.14        IPNODE1-1205
192.1.1.20        IPNODE2-1201
192.1.1.22        IPNODE2-1203
192.1.1.24        IPNODE2-1205
192.1.1.30        KC-HLR1
192.1.1.32        KC-HLR2
192.1.1.50        DN-MSC1
192.1.1.52        DN-MSC2

REMOTE IPADDR     REMOTE HOST
150.1.1.5         NCDEPTECONOMIC_DEVELOPMENT. SOUTHEASTERN_COORIDOR_ASHVL. GOV

IP Host table is (11 of 4096) .26% full
```

If the IP host name for the new association is not shown in the LOCAL HOST column of the `rtrv-ip-host` output, add the IP host name by performing the [Adding an IP Host](#) procedure. After the IP host has been added, continue the procedure with [Step 7](#).

If the IP host name for the new association is shown in the LOCAL HOST column of the `rtrv-ip-host` output, continue the procedure with [Step 4](#).

4. Display the IP links in the database by entering the `rtrv-ip-lnk` command.

The following is an example of the possible output.

```
rlghncxa03w 08-12-28 21:14:37 GMT EAGLE5 40.0.0
LOC  PORT  IPADDR      SUBMASK          DUPLEX  SPEED  MACTYPE  AUTO  MCAST
1201  A     192.1.1.10  255.255.255.128 HALF     10     802.3    NO    NO
1201  B     -----    -----          HALF     10     DIX      NO    NO
1203  A     192.1.1.12  255.255.255.0   ----    ---    DIX      YES   NO
1203  B     -----    -----          HALF     10     DIX      NO    NO
1205  A     192.1.1.14  255.255.255.0   FULL    100    DIX      NO    NO
1205  B     -----    -----          HALF     10     DIX      NO    NO
2101  A     192.1.1.20  255.255.255.0   FULL    100    DIX      NO    NO
2101  B     -----    -----          HALF     10     DIX      NO    NO
2103  A     192.1.1.22  255.255.255.0   FULL    100    DIX      NO    NO
2103  B     -----    -----          HALF     10     DIX      NO    NO
2105  A     192.1.1.24  255.255.255.0   FULL    100    DIX      NO    NO
2105  B     -----    -----          HALF     10     DIX      NO    NO
2205  A     192.1.1.30  255.255.255.0   FULL    100    DIX      NO    NO
2205  B     -----    -----          HALF     10     DIX      NO    NO
2207  A     192.1.1.32  255.255.255.0   FULL    100    DIX      NO    NO
2207  B     -----    -----          HALF     10     DIX      NO    NO
2213  A     192.1.1.50  255.255.255.0   FULL    100    DIX      NO    NO
2213  B     -----    -----          HALF     10     DIX      NO    NO
2301  A     192.1.1.52  255.255.255.0   FULL    100    DIX      NO    NO
2301  B     -----    -----          HALF     10     DIX      NO    NO
```

```
IP-LNK table is (20 of 2048) 1% full.
```

5. Enter the `rtrv-card` command with the location of the card, from the `rtrv-ip-lnk` output in [Step 4](#), that will host the association that will be assigned to the application server. For this example, enter this command.

```
rtrv-card:loc=1205
```

This is an example of possible output.

```
rlghncxa03w 08-03-06 15:17:20 EST EAGLE5 38.0.0
CARD TYPE APPL LSET NAME LINK SLC LSET NAME LINK SLC
1205 DCM SS7IPGW lsn1 A 0
```

If the application assigned to the card is SS7IPGW or IPGWI, shown in the APPL column, continue the procedure with [Step 6](#).

If the application assigned to the card is IPSG, the host assigned to this card cannot be used for the association that will be assigned to the application server. Repeat this procedure from [Step 3](#) and choose another IP host.

6. Display the associations assigned to the local host value that will be assigned to the association being configured in this procedure by entering the `rtrv-assoc` command with the `lhost` parameter. For this example, enter this command.

```
rtrv-assoc:lhost="IPNODE2-1205"
```

This is an example of the possible output.

```
rlghncxa03w 06-10-28 21:14:37 GMT EAGLE5 36.0.0
CARD IPLNK
ANAME LOC PORT LINK ADAPTER LPORT RPORT OPEN ALW
a2 1205 A A SUA 2000 2048 YES YES
a3 1205 A A SUA 3000 3000 YES YES

IP Appl Sock/Assoc table is (8 of 4000) 1% full
Assoc Buffer Space Used (32 KB of 3200 KB) on LOC = 1205
```

7. Display the application servers that the associations shown in [Step 6](#) are assigned to by entering `rtrv-as` command with the names of the associations shown in [Step 6](#). For this example, enter these commands.

```
rtrv-as:aname=a2
```

This is an example of the possible output.

```
rlghncxa03w 06-10-28 21:14:37 GMT EAGLE5 36.0.0
AS Name Mode Tr ms Association Names
as1 LOADSHARE 2000 a2
AS Table is (3 of 250) 1% full
```

```
rtrv-as:aname=a3
```

This is an example of the possible output.

```
rlghncxa03w 06-10-28 21:14:37 GMT EAGLE5 36.0.0
AS Name           Mode           Tr ms      Association Names
as2                LOADSHARE     2000      a3
AS Table is (3 of 250) 2% full
```

The maximum number of SCTP association to application server assignments that can be hosted by an IPGWx card (referenced by the `lhost` parameter of the association) is 50.

If the number of SCTP association to application server assignments is less than 50, continue the procedure with [Step 8](#).

If the number of SCTP association to application server assignments is 50, the local host value cannot be used in this procedure.

Repeat this procedure from [Step 3](#) and select another local IP host from the `rtrv-ip-host` output or perform the [Adding an IP Host](#) procedure to add a new local IP host. After the new local IP host name as been added, continue the procedure with [Step 8](#).

8. Add the new association by performing the [Adding an M3UA or SUA Association](#) procedure.

The `open` parameter value for this association must be set to `no`.

These are the rules that apply to the association and the application server.

1. M2PA associations cannot be assigned to an application server.
2. If the application server is being added in this procedure will be assigned to a routing key containing an `rcontext` parameter value, the `adapter` parameter value for the association assigned to this application server can be either M3UA or SUA.
3. If the application server is being added in this procedure will be assigned to a routing key that does not contain an `rcontext` parameter value, the `adapter` parameter value for the association assigned to this application server must be M3UA.
4. SUA associations and their corresponding application server, can be assigned to only these types of routing keys.
 - Full routing key – DPC/SI=3/SSN
 - Partial routing key – DPC/SI=3
 - Partial routing key – DPC only
 - Partial routing key – SI=3 only
 - Default routing key.
 - The routing key containing the application server with the SUA associations must have an `rcontext` value assigned to it. If the new application server will not be assigned to one of these types of routing keys, the `adapter` parameter value of the associations assigned to the application server must be M3UA.
5. The application of the card containing the signaling link assigned to the association is either SS7IPGW or IPGWI.
9. Assign the new association to the new application server and add the new application server to the database using the `ent-as` command. For this example, enter this command

```
ent-as:asname=as4:aname=assoc10
```

When this command has successfully completed, this message should appear.

```
rlghncxa03w 06-10-28 09:12:36 GMT EAGLE5 36.0.0
ENT-AS: MASP A - COMPLTD;
```

10. Verify the changes using the `rtrv-as` command with the application server name and association name specified in [Step 9](#). For this example, enter this command.

```
rtrv-as:asname=as4:aname=assoc10
```

This is an example of possible output.

```
rlghncxa03w 06-10-28 09:12:36 GMT EAGLE5 36.0.0
AS Name           Mode           Tr ms   Association Names
as4                LOADSHARE     10      assoc10
AS table is (4 of 250) 1% full.
```

Note: If you do not wish to change the `open` parameter value of the association specified in [Step 9](#), continue the procedure with [Step 12](#).

11. Change the value of the `open` parameter to `yes` by specifying the `chg-assoc` command with the `open=yes` parameter. For this example, enter this command.

```
chg-assoc:aname=assoc10:open=yes
```

When this command has successfully completed, this message should appear.

```
rlghncxa03w 06-10-28 09:12:36 GMT EAGLE5 36.0.0
CHG-ASSOC: MASP A - COMPLTD;
```

12. Back up the new changes, using the `chg-db:action=backup:dest=fixed` command.

These messages should appear; the active Maintenance and Administration Subsystem Processor (MASP) appears first.

```
BACKUP (FIXED) : MASP A - Backup starts on active MASP.
BACKUP (FIXED) : MASP A - Backup on active MASP to fixed disk complete.
BACKUP (FIXED) : MASP A - Backup starts on standby MASP.
BACKUP (FIXED) : MASP A - Backup on standby MASP to fixed disk complete.
```

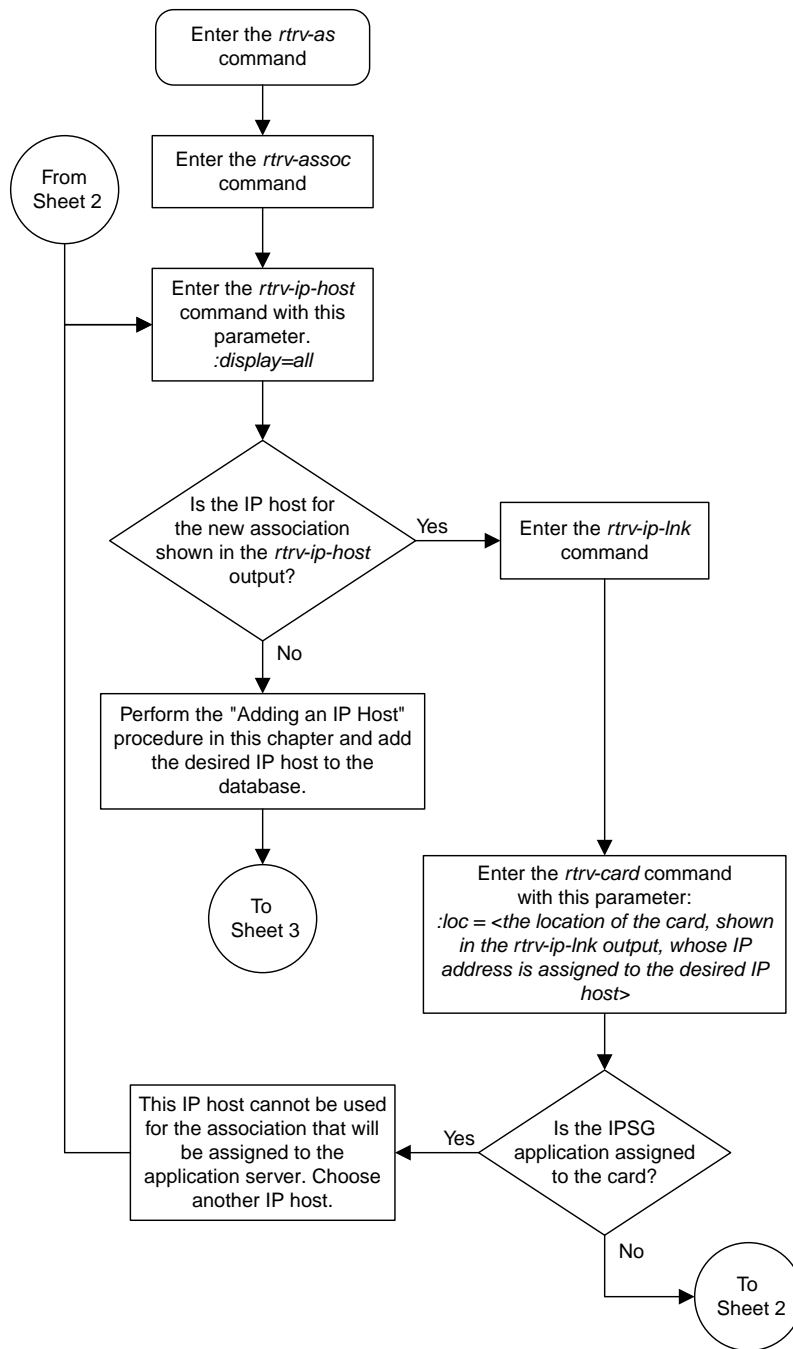

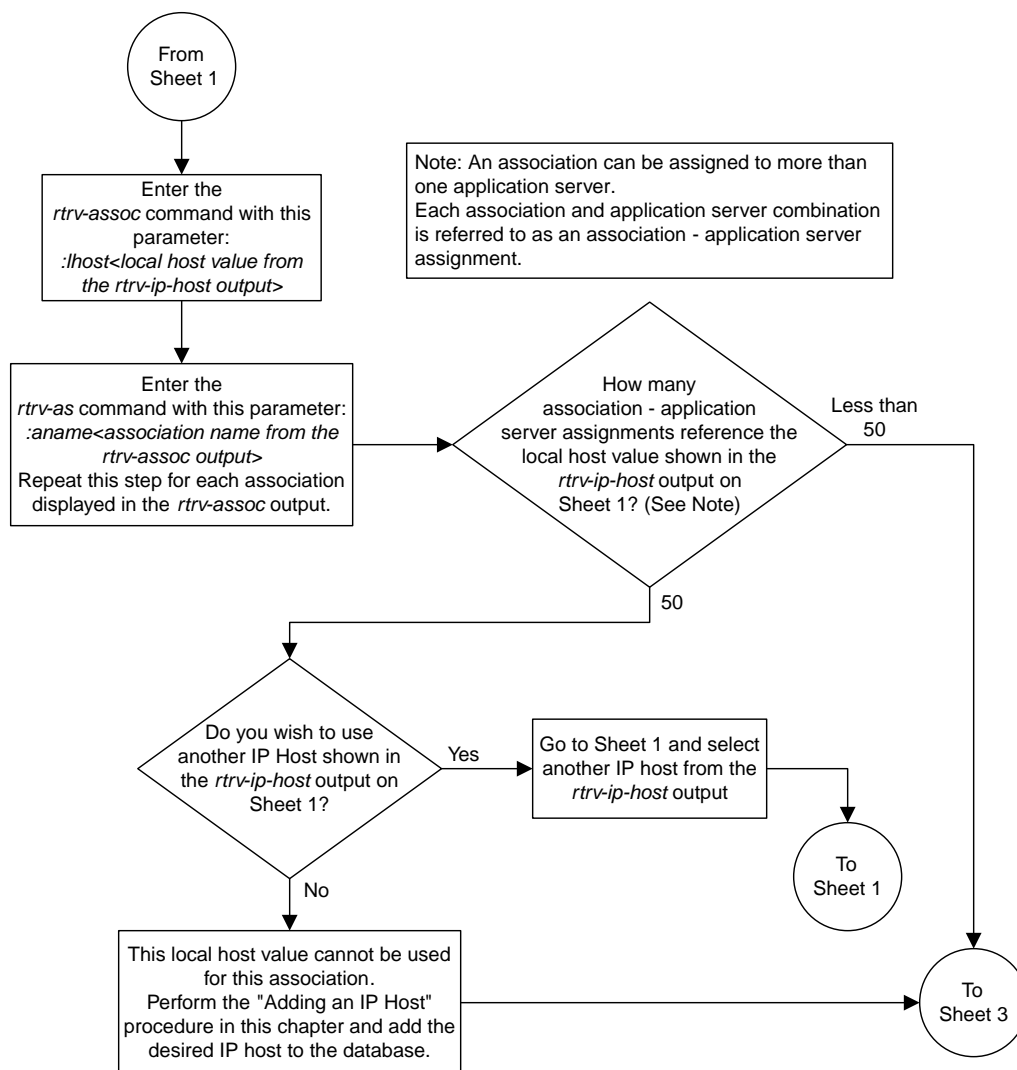

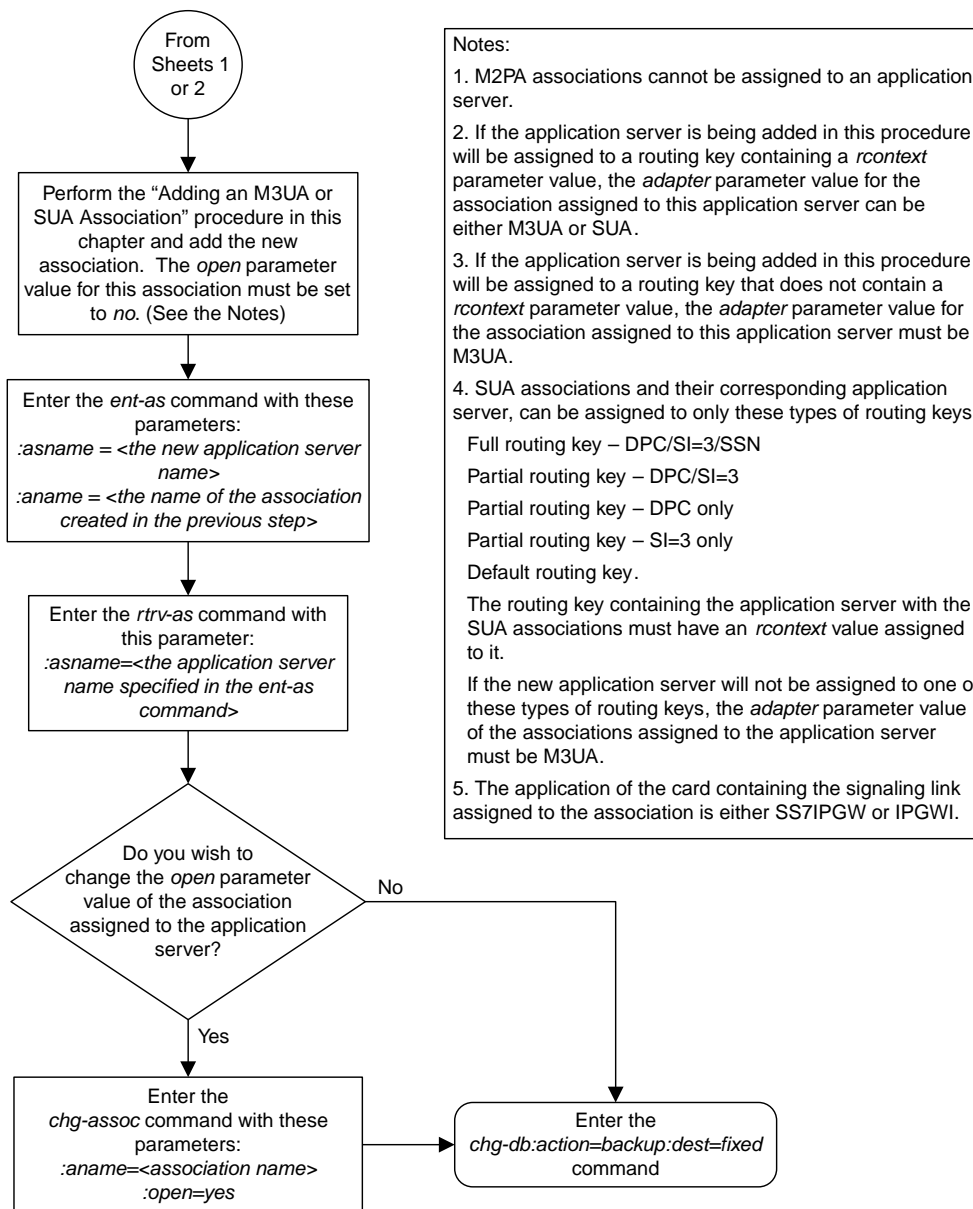

Sheet 3 of 3

Figure 50: Adding a New Association to a New Application Server

Adding an Existing Association to a New Application Server

This procedure is used create a new application server and assign an existing association to the application server using the `ent-as` command.

The `ent-as` command uses these parameters:

`:asname` – The name of the new application server. The name of the application server can contain up to 15 alphanumeric characters, with the first character being an alphabetic character. Application server names are not case sensitive.

`:aname` – The name of the association being assigned to the application server.

The maximum number SCTP association to application server assignments that can be hosted by an IPGWx card (referenced by the `lhost` parameter of the association) is 50. For example, the IPGWx card currently contains 38 SCTP association to application server assignments. The SCTP association to application server assignments could be one SCTP association assigned to 38 application servers, two SCTP associations assigned to 19 application servers, or any combination of SCTP associations assigned to application servers that add up to 38. The SCTP association to application server assignments can be verified with the `rtrv-assoc:lhost=<local host name>` and `rtrv-as:aname=<association name>` commands.

Table 29: Examples of IPGWx Card Provisioning Limits

Number of Associations hosted by the IPGWx card	Number of Application Servers each Association is Assigned to *	Total Association - Application Server Assignments maintained by the IPGWx card
1	50	50
50	1	50
25	1	50
25	2	50
0	0	50
38	1	38
19	2	38
* The EAGLE can contain a maximum of 250 application servers.		

The `open` parameter of the association must be set to `no` before the association can be assigned to the application server. This can be verified with the `rtrv-assoc` command.

M2PA associations (`adapter=m2pa`) cannot be assigned to application servers. Only M3UA (`adapter=m3ua`) and SUA (`adapter=sua`) associations can be assigned to application servers. This can be verified in the `ADAPTER` field in the `rtrv-assoc` output.

The application server recovery timer (the `tr` parameter of the `chg-as` command) for the application server is set by default to 10 milliseconds when an application server is added. The traffic mode (the `mode` parameter of the `chg-as` command) for the application server is set by default to `LOADSHARE` when an application server is added. Perform the [Changing an Application Server](#) procedure to change these parameter values.

Canceling the RTRV-AS and RTRV-ASSOC Commands

Because the `rtrv-as` and `rtrv-assoc` commands used in this procedure can output information for a long period of time, the `rtrv-as` and `rtrv-assoc` commands can be canceled and the output to the terminal stopped. There are three ways that the `rtrv-as` and `rtrv-assoc` commands can be canceled.

- Press the F9 function key on the keyboard at the terminal where the `rtrv-as` or `rtrv-assoc` commands were entered.
- Enter the `canc-cmd` without the `trm` parameter at the terminal where the `rtrv-as` or `rtrv-assoc` commands were entered.
- Enter the `canc-cmd:trm=<xx>`, where `<xx>` is the terminal where the `rtrv-as` or `rtrv-assoc` commands were entered, from another terminal other than the terminal where the `rtrv-as` or `rtrv-assoc` commands were entered. To enter the `canc-cmd:trm=<xx>` command, the terminal must allow Security Administration commands to be entered from it and the user must be allowed to enter Security Administration commands. The terminal's permissions can be verified with the `rtrv-secu-trm` command. The user's permissions can be verified with the `rtrv-user` or `rtrv-secu-user` commands.

For more information about the `canc-cmd` command, go to *Commands User's Guide*.

1. Display the application servers in the database using the `rtrv-as` command.

This is an example of possible output.

```
rlghncxa03w 06-10-28 09:12:36 GMT EAGLE5 36.0.0

AS Name           Mode           Tr ms          Association Names
as1                LOADSHARE      10             a2
                  a3
                  assoc1

as2                OVERRIDE       10             assoc7
as3                OVERRIDE       10             swbel32

AS table is (3 of 250) 1% full.
```

Note: If the association being added to the application server is not shown in the `rtrv-as` output in [Step 1](#), continue the procedure with [Step 3](#).

2. Display the associations in the database using the `rtrv-assoc` command and specifying the association name shown in the `rtrv-as` output in [Step 1](#).

For this example, enter this command.

```
rtrv-assoc:aname=assoc1
```

This is an example of possible output.

```

rlghncxa03w 09-05-28 09:12:36 GMT EAGLE5 41.0.0
ANAME assoc1
  LOC      1305          IPLNK PORT  A          LINK  A
  ADAPTER  SUA          VER          SUA RFC
  LHOST    gw102.nc.tekelec.com
  ALHOST   ---
  RHOST    gw100.nc.tekelec.com
  ARHOST   ---
  LPORT    4000          RPORT      1030
  ISTRMS   2            OSTRMS     2          BUFSIZE  16
  RMODE    LIN          RMIN       120        RMAX     800
  RTIMES   10          CWMIN      3000      UAPS     10
  OPEN     YES          ALW        YES        RTXTHR  10000
  RHOSTVAL RELAXED

  ASNAMES
  as1

IP Appl Sock table is (6 of 4000) 1% full
Assoc Buffer Space Used (16 KB of 800 KB) on LOC = 1305

```

If the association does not meet the requirements shown in [Step 8](#), repeat this step with another association shown in [Step 1](#), or continue the procedure with [Step 3](#).

If the association does meet the requirements shown in [Step 8](#), continue the procedure with [Step 5](#).

3. Display the associations in the database using the `rtrv-assoc` command with the `display=all` parameter.

This is an example of possible output.

```

rlghncxa03w 09-05-28 09:12:36 GMT EAGLE5 41.0.0
ANAME swbel32
  LOC      1201          IPLNK PORT  A          LINK  A
  ADAPTER  M3UA          VER          M3UA RFC
  LHOST    gw101.nc.tekelec.com
  ALHOST   ---
  RHOST    gw100.ncd-economic-development.southeastern-corridor-ash.gov
  ARHOST   ---
  LPORT    1030          RPORT      2345
  ISTRMS   2            OSTRMS     2          BUFSIZE  16
  RMODE    LIN          RMIN       120        RMAX     800
  RTIMES   10          CWMIN      3000      UAPS     10
  OPEN     YES          ALW        YES        RTXTHR  10000
  RHOSTVAL RELAXED

  ASNAMES
  as3

IP Appl Sock table is (6 of 4000) 1% full
Assoc Buffer Space Used (16 KB of 800 KB) on LOC = 1201

ANAME a2
  LOC      1305          IPLNK PORT  A          LINK  A
  ADAPTER  SUA          VER          SUA RFC
  LHOST    gw102.nc.tekelec.com

```

```

ALHOST    ---
RHOST     gw100.nc.tekelec.com
ARHOST    ---
LPORT     2000           RPORT      2345
ISTRMS    2             OSTRMS     2           BUFSIZE   16
RMODE     LIN           RMIN       120          RMAX      800
RTIMES    10           CWMIN      3000         UAPS      10
OPEN      YES          ALW        YES           RTXTHR   10000
RHOSTVAL  RELAXED

```

```

ASNAMES
as1

```

```

IP Appl Sock table is (6 of 4000) 1% full
Assoc Buffer Space Used (16 KB of 800 KB) on LOC = 1305

```

```

ANAME a3
LOC      1307           IPLNK PORT  A           LINK  A
ADAPTER  SUA           VER        SUA RFC
LHOST    gw103.nc.tekelec.com
ALHOST   ---
RHOST    gw106.nc.tekelec.com
ARHOST   ---
LPORT    3000           RPORT      2346
ISTRMS    2             OSTRMS     2           BUFSIZE   16
RMODE     LIN           RMIN       120          RMAX      800
RTIMES    10           CWMIN      3000         UAPS      10
OPEN      YES          ALW        YES           RTXTHR   10000
RHOSTVAL  RELAXED

```

```

ASNAMES
as1

```

```

IP Appl Sock table is (6 of 4000) 1% full
Assoc Buffer Space Used (16 KB of 800 KB) on LOC = 1307

```

```

ANAME assoc1
LOC      1305           IPLNK PORT  A           LINK  A
ADAPTER  SUA           VER        SUA RFC
LHOST    gw102.nc.tekelec.com
ALHOST   ---
RHOST    gw100.nc.tekelec.com
ARHOST   ---
LPORT    4000           RPORT      1030
ISTRMS    2             OSTRMS     2           BUFSIZE   16
RMODE     LIN           RMIN       120          RMAX      800
RTIMES    10           CWMIN      3000         UAPS      10
OPEN      YES          ALW        YES           RTXTHR   10000
RHOSTVAL  RELAXED

```

```

ASNAMES
as1

```

```

IP Appl Sock table is (6 of 4000) 1% full
Assoc Buffer Space Used (16 KB of 800 KB) on LOC = 1305

```

```

ANAME assoc7
LOC      1311           IPLNK PORT  A           LINK  A
ADAPTER  SUA           VER        SUA RFC
LHOST    gw105.nc.tekelec.com
ALHOST   ---
RHOST    gw100.nc.tekelec.com
ARHOST   ---

```



```

LPORT      2500          RPORT      2000
ISTRMS     2            OSTRMS     2          BUFSIZE    16
RMODE      LIN          RMIN       120         RMAX       800
RTIMES     10          CWMIN      3000        UAPS       10
OPEN       YES          ALW        YES         RTXTHR     10000
RHOSTVAL   RELAXED

```

```

ASNAMES
as2

```

```

IP Appl Sock table is (6 of 4000) 1% full
Assoc Buffer Space Used (16 KB of 800 KB) on LOC = 1311

```

If the desired association is shown in the `rtrv-assoc` output, see [Step 8](#) for the rules that apply to the association and the new application server, continue the procedure with [Step 4](#).

If the desired association is not shown in the `rtrv-assoc` output, perform the [Adding a New Association to a New Application Server](#) procedure to add a new association to a new application server.

4. Enter the `rtrv-card` command with the location of the card, from the `rtrv-assoc` output in [Step 3](#), that contains the association that will be assigned to the application server. For this example, enter this command.

```
rtrv-card:loc=1201
```

This is an example of possible output.

```

rlghncxa03w 08-03-06 15:17:20 EST EAGLE5 38.0.0
CARD  TYPE      APPL      LSET NAME  LINK SLC LSET NAME  LINK SLC
1201  DCM          SS7IPGW  lsn1      A      0

```

If the application assigned to the card is `SS7IPGW` or `IPGWI`, shown in the `APPL` column, continue the procedure with [Step 5](#).

If the application assigned to the card is `IPSG`, the association assigned to this card cannot be assigned to the application server. Repeat this procedure from [Step 3](#) and choose another association.

5. Display the associations assigned to the local IP host value specified in [Step 2](#) or [Step 3](#) by entering the `rtrv-assoc` command with the `lhost` parameter.

For this example, enter this command.

```
rtrv-assoc:lhost=gw102.nc.tekelec.com
```

This is an example of the possible output.

```

rlghncxa03w 06-10-28 21:14:37 GMT EAGLE5 36.0.0
CARD IPLNK
ANAME      LOC PORT  LINK ADAPTER LPORT RPORT OPEN ALW
assoc1     1305 A    A    SUA      4000 1030 YES YES

```

```

IP Appl Sock/Assoc table is (5 of 4000) 1% full
Assoc Buffer Space Used (16 KB of 3200 KB) on LOC = 1305

```

6. Display the application servers that the associations shown in [Step 5](#) are assigned to by entering `rtrv-as` command with the names of the associations shown in [Step 5](#).

For this example, enter this command.

```
rtrv-as:aname=assoc1
```

This is an example of the possible output.

```
rlghncxa03w 06-10-28 21:14:37 GMT EAGLE5 36.0.0
AS Name           Mode           Tr ms   Association Names
asl               LOADSHARE     10      assoc1
AS Table is (3 of 250) 1% full
```

The maximum number of SCTP association to application server assignments that can be hosted by an IPGWx card (referenced by the `lhost` parameter of the association) is 50.

If the number of SCTP association to application server assignments is less than 50, continue the procedure with [Step 7](#).

If the number of SCTP association to application server assignments is 50, the association shown in either [Step 2](#) or [Step 3](#) cannot be used in this procedure. Go back to [Step 1](#) and choose another association to assign to the new application server.

Note: If the value of the `open` parameter of the association being assigned to the application server in [Step 5](#) is `no`, continue the procedure with [Step 8](#).

- Change the value of the `open` parameter to `no` by specifying the `chg-assoc` command with the `open=no` parameter.

For this example, enter this command.

```
chg-assoc:aname=assoc1:open=no
```

When this command has successfully completed, this message should appear.

```
rlghncxa03w 06-10-28 09:12:36 GMT EAGLE5 36.0.0
CHG-ASSOC: MASP A - COMPLTD;
```

- Add the application server to the database with the name of the association shown in either [Step 2](#) or [Step 3](#) using the `ent-as` command.

These are the rules that apply to the association and the application server.

- M2PA associations cannot be assigned to an application server.
- If the application server is being added in this procedure will be assigned to a routing key containing an `rcontext` parameter value, the `adapter` parameter value for the association assigned to this application server can be either M3UA or SUA.
- If the application server is being added in this procedure will be assigned to a routing key that does not contain an `rcontext` parameter value, the `adapter` parameter value for the association assigned to this application server must be M3UA.
- SUA associations and their corresponding application server, can be assigned to only these types of routing keys.
 - Full routing key – DPC/SI=3/SSN
 - Partial routing key – DPC/SI=3
 - Partial routing key – DPC only
 - Partial routing key – SI=3 only

- Default routing key.
- The routing key containing the application server with the SUA associations must have an `rcontext` value assigned to it. If the new application server will not be assigned to one of these types of routing keys, the `adapter` parameter value of the associations assigned to the application server must be M3UA.

For this example, enter this command.

```
ent-as:asname=as4:aname=assoc1
```

This is an example of the possible outputs.

```
rlghncxa03w 06-10-28 09:12:36 GMT EAGLE5 36.0.0
ENT-AS: MASP A - COMPLTD;
```

9. Verify the changes using the `rtrv-as` command with the application server name specified in [Step 8](#).

For this example, enter this command.

```
rtrv-as:asname=as4
```

This is an example of the possible output.

```
rlghncxa03w 06-10-28 09:12:36 GMT EAGLE5 36.0.0

AS Name           Mode           Tr ms   Association Names
as4                LOADSHARE     10      assoc1

AS table is (4 of 250) 1% full.
```

Note: If you do not wish to change the `open` parameter value of the association specified in [Step 8](#), continue the procedure with [Step 11](#).

10. Change the value of the `open` parameter to `yes` by specifying the `chg-assoc` command with the `open=yes` parameter.

For this example, enter this command.

```
chg-assoc:aname=assoc1:open=yes
```

When this command has successfully completed, this message should appear.

```
rlghncxa03w 06-10-28 09:12:36 GMT EAGLE5 36.0.0
CHG-ASSOC: MASP A - COMPLTD;
```

11. Back up the new changes, using the `chg-db:action=backup:dest=fixed` command.

These messages should appear; the active Maintenance and Administration Subsystem Processor (MASP) appears first.

```
BACKUP (FIXED) : MASP A - Backup starts on active MASP.
BACKUP (FIXED) : MASP A - Backup on active MASP to fixed disk complete.
BACKUP (FIXED) : MASP A - Backup starts on standby MASP.
BACKUP (FIXED) : MASP A - Backup on standby MASP to fixed disk complete.
```

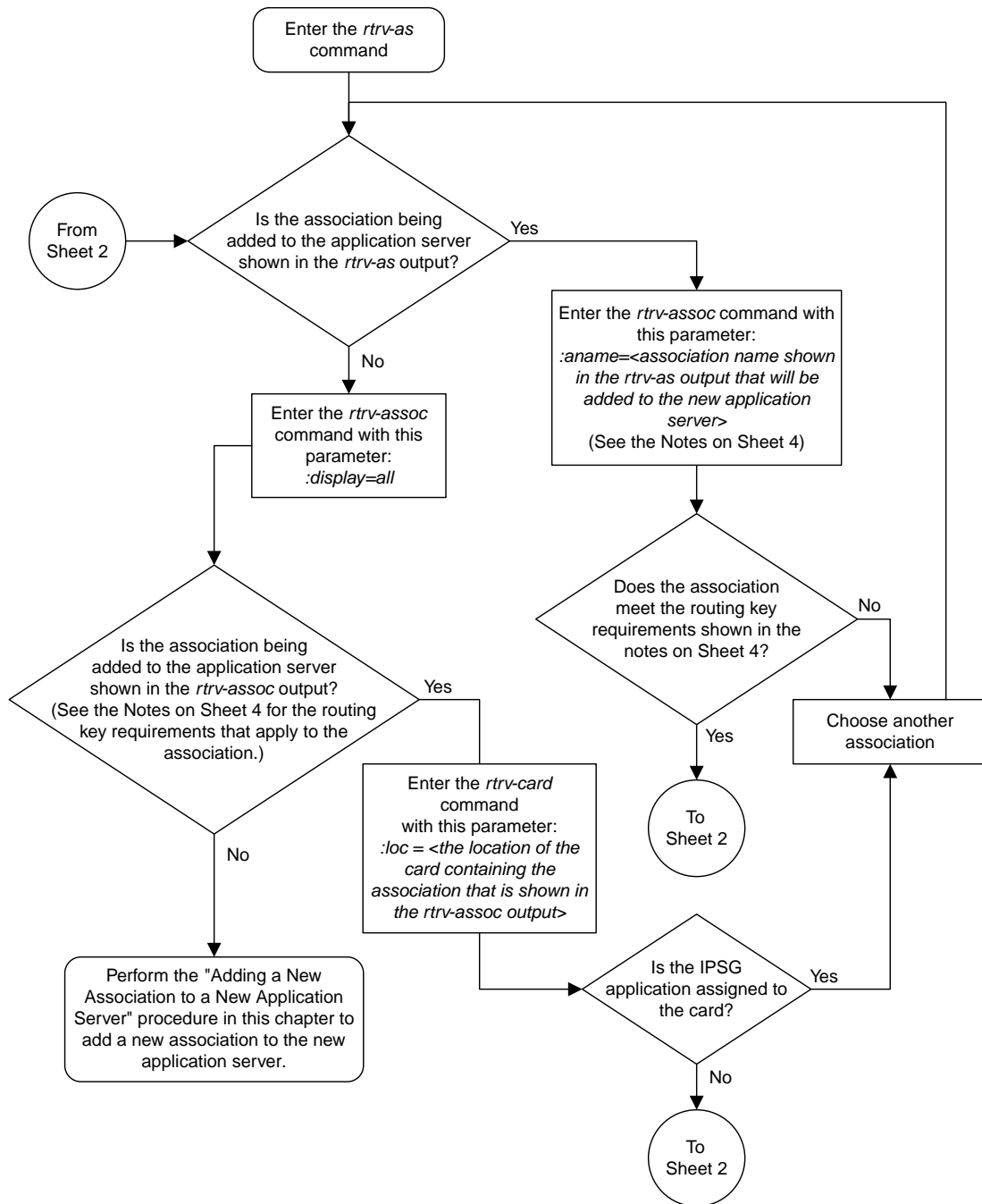

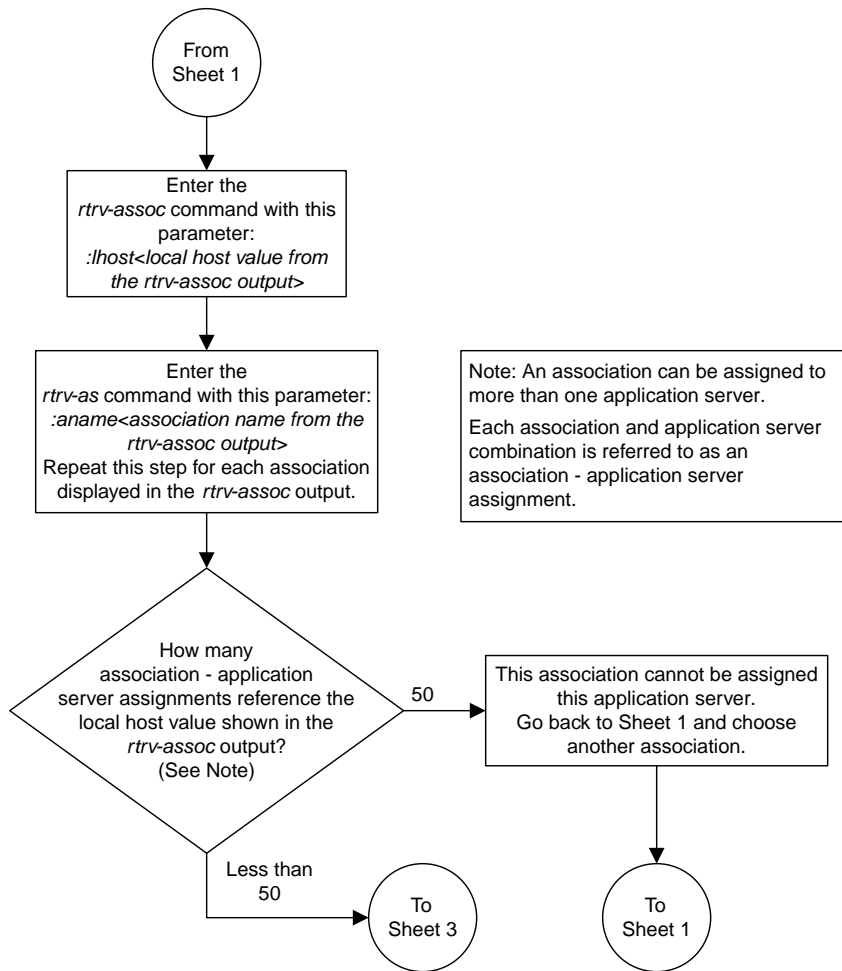

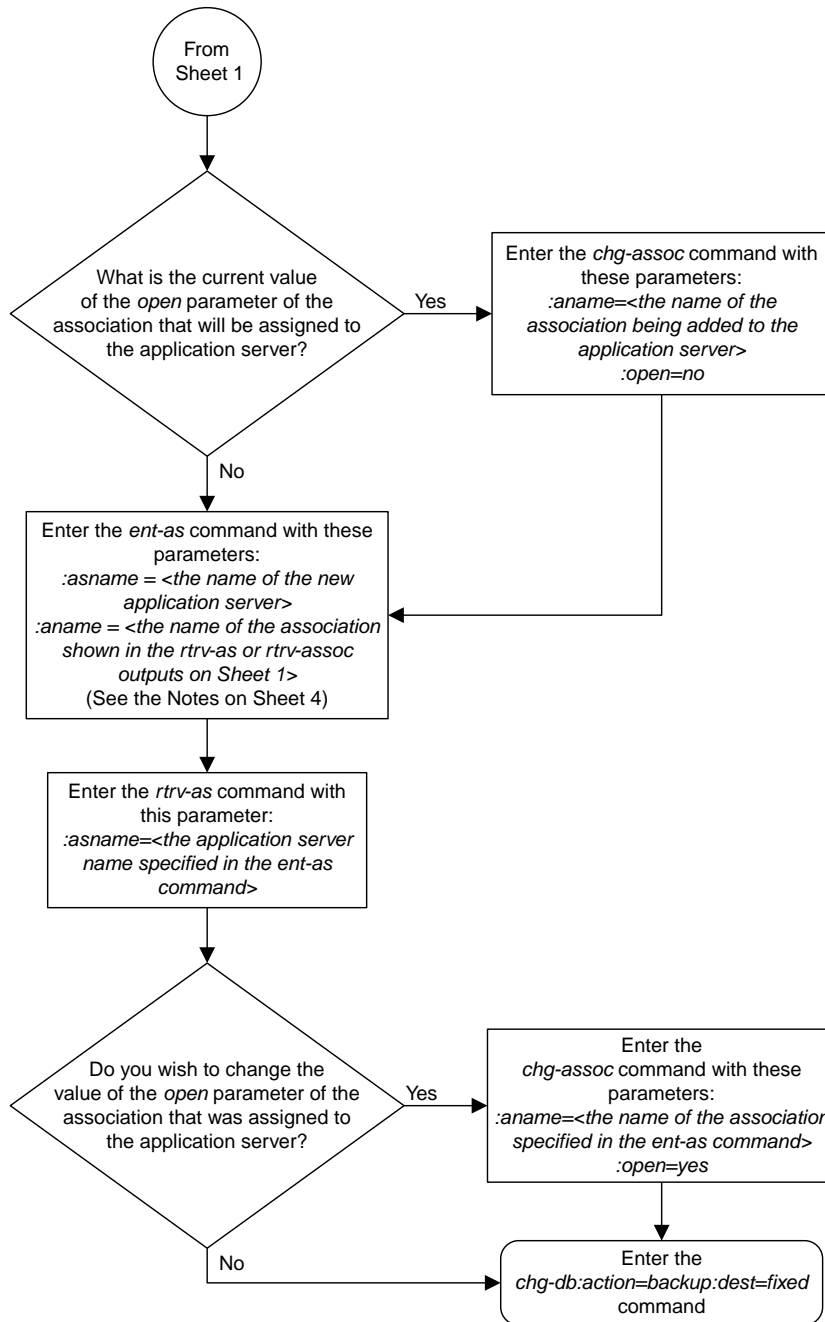

Notes:

1. If the application server is being added in this procedure will be assigned to a routing key containing a *rcontext* parameter value, the *adapter* parameter value for the association assigned to this application server can be either M3UA or SUA.
2. If the application server is being added in this procedure will be assigned to a routing key that does not contain a *rcontext* parameter value, the *adapter* parameter value for the association assigned to this application server must be M3UA.
3. SUA associations and their corresponding application server, can be assigned to only these types of routing keys:
 - Full routing key – DPC/SI=3/SSN
 - Partial routing key – DPC/SI=3
 - Partial routing key – DPC only
 - Partial routing key – SI=3 only
 - Default routing key.The routing key containing the application server with the SUA associations must have an *rcontext* value assigned to it.
If the new application server will not be assigned to one of these types of routing keys, the *adapter* parameter value of the associations assigned to the application server must be M3UA.
4. M2PA associations cannot be assigned to application servers.

Sheet 4 of 4

Figure 51: Adding an Existing Association to a New Application Server

Adding a New Association to an Existing Application Server

This procedure is used assign a new association to an existing application server using the `ent-as` command.

The `ent-as` command uses these parameters:

:`asname` – The name of the new application server.

:`aname` – The name of the association being assigned to the application server.

The maximum number SCTP association to application server assignments that can be hosted by an IPGWx card (referenced by the `lhost` parameter of the association) is 50. For example, the IPGWx card currently contains 38 SCTP association to application server assignments. The SCTP association to application server assignments could be one SCTP association assigned to 38 application servers, two SCTP associations assigned to 19 application servers, or any combination of SCTP associations assigned to application servers that add up to 38. The SCTP association to application server assignments can be verified with the `rtrv-assoc:lhost=<local host name>` and `rtrv-as:aname=<association name>` commands.

Table 30: Examples of IPGWx Card Provisioning Limits

Number of Associations hosted by the IPGWx card	Number of Application Servers each Association is Assigned to *	Total Association - Application Server Assignments maintained by the IPGWx card
1	50	50
50	1	50
25	1	50
25	2	50
0	0	50
38	1	38
19	2	38
* The EAGLE can contain a maximum of 250 application servers.		

A maximum of 16 associations can be assigned to an application server.

The `open` parameter of the association must be set to `no` before the association can be assigned to the application server. This can be verified with the `rtrv-assoc` command.

M2PA associations (`adapter=m2pa`) cannot be assigned to application servers. Only M3UA (`adapter=m3ua`) and SUA (`adapter=sua`) associations can be assigned to application servers. This can be verified in the `ADAPTER` field in the `rtrv-assoc` output.

The application running on the card hosting the association that will be assigned to the application server must be the same as the application running on the cards hosting the other associations assigned to the application server.

Canceling the RTRV-AS and RTRV-ASSOC Commands

Because the `rtrv-as` and `rtrv-assoc` commands used in this procedure can output information for a long period of time, the `rtrv-as` and `rtrv-assoc` commands can be canceled and the output to the terminal stopped. There are three ways that the `rtrv-as` and `rtrv-assoc` commands can be canceled.

- Press the F9 function key on the keyboard at the terminal where the `rtrv-as` or `rtrv-assoc` commands were entered.
- Enter the `canc-cmd` without the `trm` parameter at the terminal where the `rtrv-as` or `rtrv-assoc` commands were entered.
- Enter the `canc-cmd:trm=<xx>`, where `<xx>` is the terminal where the `rtrv-as` or `rtrv-assoc` commands were entered, from another terminal other than the terminal where the `rtrv-as` or `rtrv-assoc` commands were entered. To enter the `canc-cmd:trm=<xx>` command, the terminal must allow Security Administration commands to be entered from it and the user must be allowed to enter Security Administration commands. The terminal's permissions can be verified with the `rtrv-secu-trm` command. The user's permissions can be verified with the `rtrv-user` or `rtrv-secu-user` commands.

For more information about the `canc-cmd` command, go to *Commands User's Guide*.

1. Display the application servers in the database using the `rtrv-as` command.

This is an example of possible output.

```
rlghncxa03w 06-10-28 09:12:36 GMT EAGLE5 36.0.0
AS Name      Mode      Tr ms     Association Names
as1          LOADSHARE 10        assoc1
              assoc2
              assoc3
              assoc5
              assoc6

as2          OVERRIDE 10        assoc7

AS table is (2 of 250) 1% full.
```

2. Display the application server that the new association will be added to by entering the `rtrv-as` command with the name of the application server.

For this example, enter this command.

```
rtrv-as:asname=as2
```

This is an example of possible output.

```
rlghncxa03w 06-10-28 09:12:36 GMT EAGLE5 36.0.0
AS Name      Mode      Tr ms     Association Names
```

```
as2          OVERRIDE    10      assoc7
AS table is (2 of 250) 1% full.
```

A maximum of 16 associations can be assigned to an application server. If the application server displayed in this step contains less than 16 associations, continue the procedure with [Step 3](#).

If the application server displayed in this step contains 16 associations, either select another application server to use in this procedure and repeat this step, or perform the [Adding a New Association to a New Application Server](#) procedure to add the new association to a new application server.

3. Display the one of the associations assigned to the application server shown in [Step 2](#) using the `rtrv-assoc` command and specifying the association name shown in the `rtrv-as` output from [Step 2](#). For this example, enter this command.

```
rtrv-assoc:aname=assoc7
```

This is an example of possible output.

```
rlghncxa03w 09-05-28 09:12:36 GMT EAGLE5 41.0.0
ANAME assoc7
  LOC      1203          IPLNK PORT  A          LINK  A
  ADAPTER  SUA          VER          SUA RFC
  LHOST    gw105.nc.tekelec.com
  ALHOST    ---
  RHOST    gw100.nc.tekelec.com
  ARHOST    ---
  LPORT    1030          RPORT      1030
  ISTRMS   2            OSTRMS     2          BUFSIZE  16
  RMODE    LIN          RMIN       120        RMAX     800
  RTIMES   10          CWMIN      3000       UAPS     10
  OPEN     YES          ALW        YES        RTXTHR   10000
  RHOSTVAL RELAXED

  ASNAMES
  as2

IP Appl Sock table is (7 of 4000) 1% full
Assoc Buffer Space Used (16 KB of 800 KB) on LOC = 1203
```

The adapter parameter value of all the associations assigned to an application server must be the same. This step identifies the adapter value of the associations assigned to the application server. The application running on the card hosting the new association must be the same as the application on the cards hosting the associations assigned to the application server.

4. Display the signaling link assigned to the card, shown in [Step 3](#) by entering the `rtrv-slk` command with the card location of the signaling link shown in [Step 3](#). For this example, enter this command.

```
rtrv-slk:loc=1203
```

The following is an example of the possible output.

```
rlghncxa03w 06-10-28 21:19:37 GMT EAGLE5 36.0.0
LOC LINK LSN          SLC TYPE
1203 A   lsn5          1  SS7IPGW
```

The application running on the card is shown in the TYPE column of the `rtrv-slk` output.

For this example, the new association must be assigned to a card running the SS7IPGW application.

If the local host value shown in [Step 3](#) will be assigned to the new association, continue the procedure with [Step 8](#).

If another local host value will be assigned to the new association, perform [Step 5](#).

5. Display the IP host names in the database by using the `rtrv-ip-host:display=all` command. The following is an example of the possible output.

```
rlghncxa03w 13-06-28 21:15:37 GMT EAGLE5 44.0.0

LOCAL IPADDR      LOCAL HOST
192.1.1.10        IPNODE1-1201
192.1.1.12        GW105. NC. TEKELEC. COM
192.1.1.14        IPNODE1-1205
192.1.1.20        IPNODE2-1201
192.1.1.22        IPNODE2-1203
192.1.1.24        IPNODE2-1205
192.1.1.30        KC-HLR1
192.1.1.32        KC-HLR2
192.1.1.50        DN-MSC1
192.1.1.52        DN-MSC2

REMOTE IPADDR     REMOTE HOST
150.1.1.5         NCDEPTECONOMIC_DEVELOPMENT. SOUTHEASTERN_COORIDOR_ASHVL. GOV

IP Host table is (11 of 4096) .26% full
```

If the local IP host name for the new association is not shown in the LOCAL HOST column of the `rtrv-ip-host` output, add the new IP host name by performing the [Adding an IP Host](#) procedure. The new local IP host must be assigned to a card running the application shown in [Step 4](#).

After the new local IP host has been added, continue the procedure with [Step 9](#).

If the local IP host name for the new association is shown in the LOCAL HOST column of the `rtrv-ip-host` output, continue the procedure with [Step 8](#).

6. Display the IP links in the database by entering the `rtrv-ip-lnk` command. The following is an example of the possible output.

```
rlghncxa03w 08-12-28 21:14:37 GMT EAGLE5 40.0.0
LOC  PORT  IPADDR      SUBMASK          DUPLEX  SPEED  MACTYPE  AUTO  MCAST
1201  A     192.1.1.10  255.255.255.128 HALF     10     802.3    NO   NO
1201  B     -----    -----          HALF     10     DIX      NO   NO
1203  A     192.1.1.12  255.255.255.0   ---     ---     DIX      YES  NO
1203  B     -----    -----          HALF     10     DIX      NO   NO
1205  A     192.1.1.14  255.255.255.0   FULL    100    DIX      NO   NO
1205  B     -----    -----          HALF     10     DIX      NO   NO
2101  A     192.1.1.20  255.255.255.0   FULL    100    DIX      NO   NO
2101  B     -----    -----          HALF     10     DIX      NO   NO
2103  A     192.1.1.22  255.255.255.0   FULL    100    DIX      NO   NO
2103  B     -----    -----          HALF     10     DIX      NO   NO
2105  A     192.1.1.24  255.255.255.0   FULL    100    DIX      NO   NO
2105  B     -----    -----          HALF     10     DIX      NO   NO
2205  A     192.1.1.30  255.255.255.0   FULL    100    DIX      NO   NO
2205  B     -----    -----          HALF     10     DIX      NO   NO
2207  A     192.1.1.32  255.255.255.0   FULL    100    DIX      NO   NO
```

```

2207 B -----
2213 A 192.1.1.50 255.255.255.0 FULL 100 DIX NO NO
2213 B -----
2301 A 192.1.1.52 255.255.255.0 FULL 100 DIX NO NO
2301 B -----

```

```
IP-LNK table is (20 of 2048) 1% full.
```

7. Display the signaling link assigned to the card, shown in [Step 6](#), whose IP address is assigned to the local host shown in [Step 5](#) by entering the `rtrv-slk` command with the card location of the signaling link. For this example, enter this command.

```
rtrv-slk:loc=1205
```

The following is an example of the possible output.

```
rlghncxa03w 06-10-28 21:19:37 GMT EAGLE5 36.0.0
```

```

LOC LINK LSN          SLC TYPE
1205 A  lsn5          1  SS7IPGW

```

The application running on the card is shown in the `TYPE` column of the `rtrv-slk` output.

For this example, the new association must be assigned to a card running the `SS7IPGW` application.

If the card's application shown in this step and in [Step 4](#) are the same, continue the procedure with [Step 8](#).

If the card's application shown in this step and in [Step 4](#) are not the same, either repeat this procedure from [Step 5](#) with another local IP host, or add the new local IP host name by performing the [Adding an IP Host](#) procedure. The new local IP host must be assigned to a card running the application shown in [Step 4](#). After the new local IP host has been added, continue the procedure with [Step 9](#).

8. Display the associations assigned to the local IP host value specified in [Step 3](#) or [Step 5](#) by entering the `rtrv-assoc` command with the `lhost` parameter. For this example, enter this command.

```
rtrv-assoc:lhost="IPNODE-1205"
```

This is an example of the possible output.

```
rlghncxa03w 06-10-28 21:14:37 GMT EAGLE5 36.0.0
```

```

CARD IPLNK
ANAME          LOC PORT LINK ADAPTER LPORT RPORT OPEN ALW
assoc1         1205 A  A    M3UA    1030  1030  YES  YES

```

```

IP Appl Sock/Assoc table is (7 of 4000) 1% full
Assoc Buffer Space Used (16 KB of 3200 KB) on LOC = 1205

```

9. Display the application servers that the associations shown in [Step 8](#) are assigned to by entering the `rtrv-as` command with the names of the associations shown in [Step 8](#). For this example, enter this command.

```
rtrv-as:aname=assoc1
```

This is an example of the possible output.

```
rlghncxa03w 06-10-28 21:14:37 GMT EAGLE5 36.0.0
```

```
AS Name           Mode           Tr ms   Association Names
as1               LOADSHARE     10      assoc1
AS Table is (2 of 250) 1% full
```

The maximum number of SCTP association to application server assignments that can be hosted by an IPGWx card (referenced by the `lhost` parameter of the association) is 50.

If the number of SCTP association to application server assignments is less than 50, continue the procedure with [Step 10](#).

If the number of SCTP association to application server assignments is 50, either repeat this procedure from [Step 5](#) with another local IP host, or add the new local IP host name by performing the [Adding an IP Host](#) procedure. The new local IP host must be assigned to a card running the application shown in [Step 4](#) and [Step 7](#). After the new local IP host has been added, continue the procedure with [Step 10](#).

10. Add the new association by performing the [Adding an M3UA or SUA Association](#) procedure.

The `open` parameter value for this association must be set to `no`. The `adapter` value for this association must be the same as the `adapter` value shown in [Step 3](#).

These are the rules that apply to the association and the application server.

- M2PA associations cannot be assigned to an application server.
- If the application server is being added in this procedure will be assigned to a routing key containing an `rcontext` parameter value, the `adapter` parameter value for the association assigned to this application server can be either M3UA or SUA.
- If the application server is being added in this procedure will be assigned to a routing key that does not contain an `rcontext` parameter value, the `adapter` parameter value for the association assigned to this application server must be M3UA.
- SUA associations and their corresponding application server, can be assigned to only these types of routing keys.
 - Full routing key – DPC/SI=3/SSN
 - Partial routing key – DPC/SI=3
 - Partial routing key – DPC only
 - Partial routing key – SI=3 only
 - Default routing key.
 - The routing key containing the application server with the SUA associations must have an `rcontext` value assigned to it. If the new application server will not be assigned to one of these types of routing keys, the `adapter` parameter value of the associations assigned to the application server must be M3UA.
- The application of the card containing the signaling link assigned to the association is either SS7IPGW or IPGWI.

11. Add the association to the application server using the `ent-as` command with the name of the application server specified in [Step 2](#) and the name of the new association. For this example, enter this command.

```
ent-as:aname=as2:aname=assoc10
```

This is an example of possible output.

```
rlghncxa03w 06-10-28 09:12:36 GMT EAGLE5 36.0.0
ENT-AS: MASP A - COMPLTD;
```

12. Verify the changes using the `rtrv-as` command with the name of the application server specified in [Step 11](#). For this example, enter this command.

```
rtrv-as:asname=as2
```

This is an example of possible output.

```
rlghncxa03w 06-10-28 09:12:36 GMT EAGLE5 36.0.0
AS Name           Mode           Tr ms  Association Names
as2                OVERRIDE       10     assoc7
                  assoc10

AS table is (2 of 250) 1% full.
```

Note: If you do not wish to change the `open` parameter value of the association specified in [Step 11](#), continue the procedure with [Step 14](#).

13. Change the value of the `open` parameter to `yes` by specifying the `chg-assoc` command with the `open=yes` parameter. For this example, enter this command.

```
chg-assoc:aname=assoc10:open=yes
```

When this command has successfully completed, this message should appear.

```
rlghncxa03w 06-10-28 09:12:36 GMT EAGLE5 36.0.0
CHG-ASSOC: MASP A - COMPLTD;
```

14. Back up the new changes, using the `chg-db:action=backup:dest=fixed` command. These messages should appear; the active Maintenance and Administration Subsystem Processor (MASP) appears first.

```
BACKUP (FIXED) : MASP A - Backup starts on active MASP.
BACKUP (FIXED) : MASP A - Backup on active MASP to fixed disk complete.
BACKUP (FIXED) : MASP A - Backup starts on standby MASP.
BACKUP (FIXED) : MASP A - Backup on standby MASP to fixed disk complete.
```

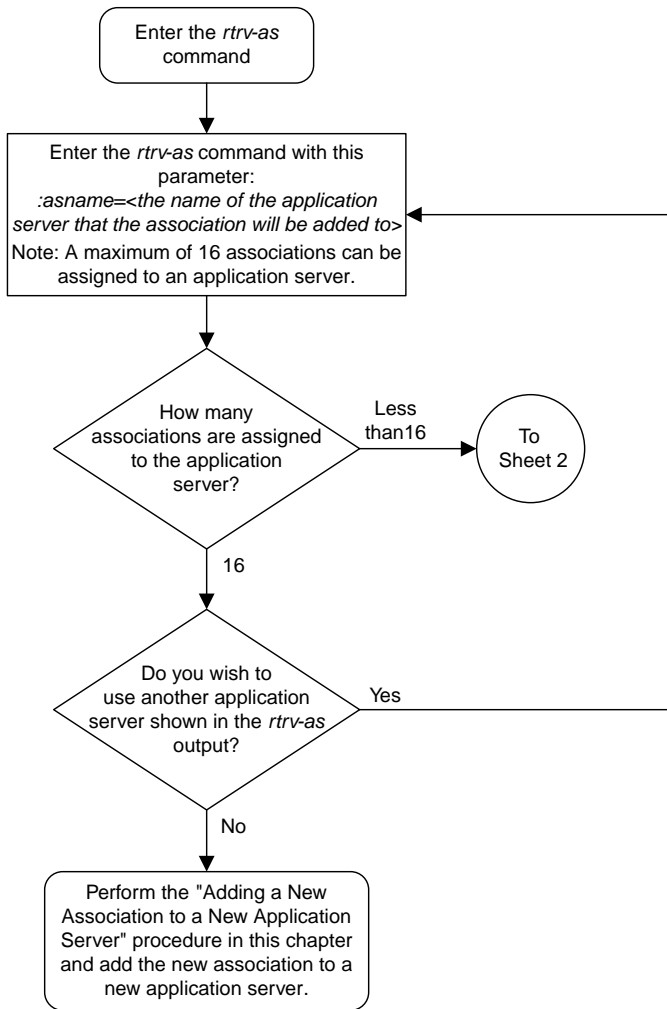

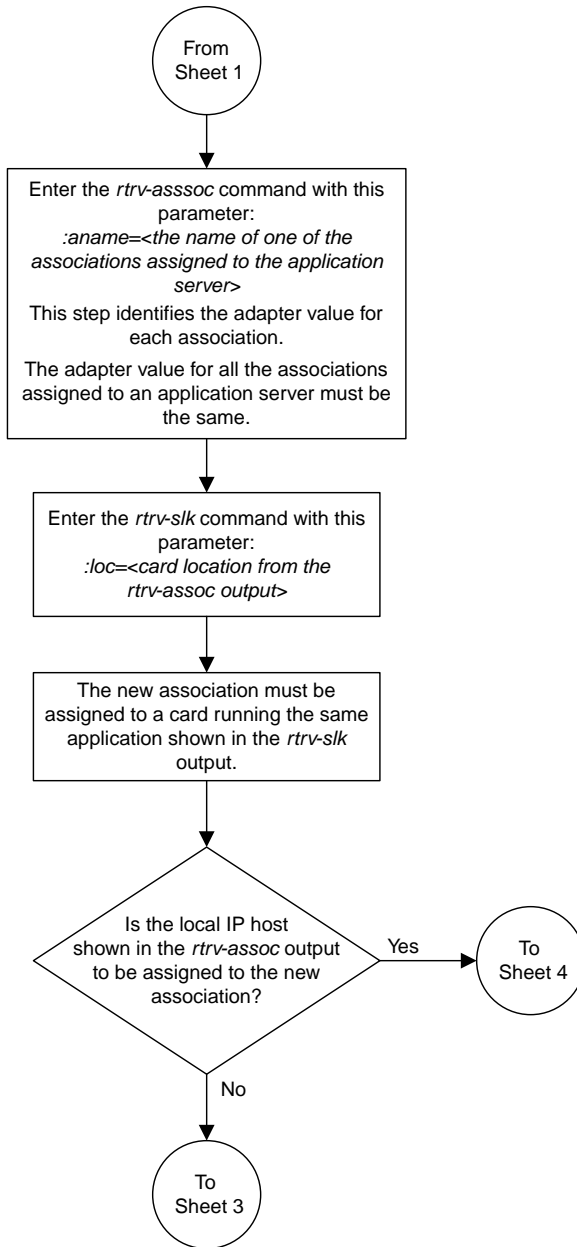

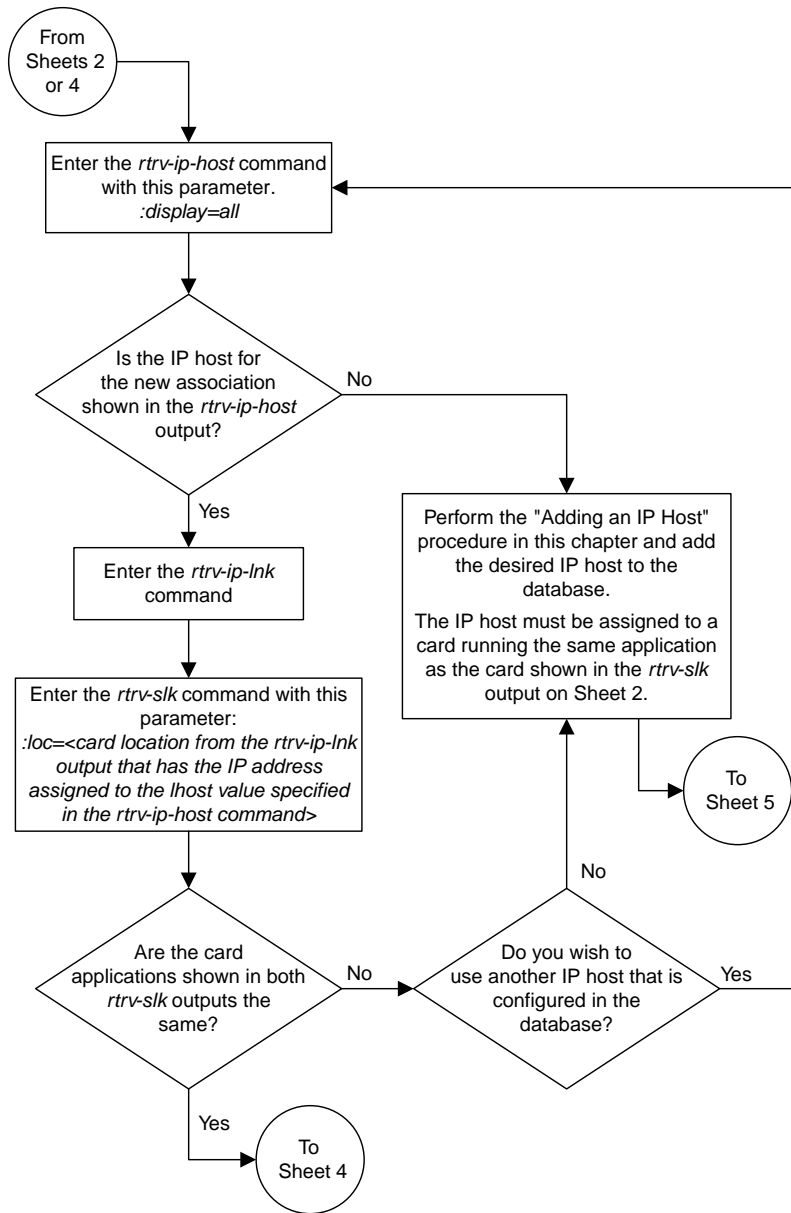

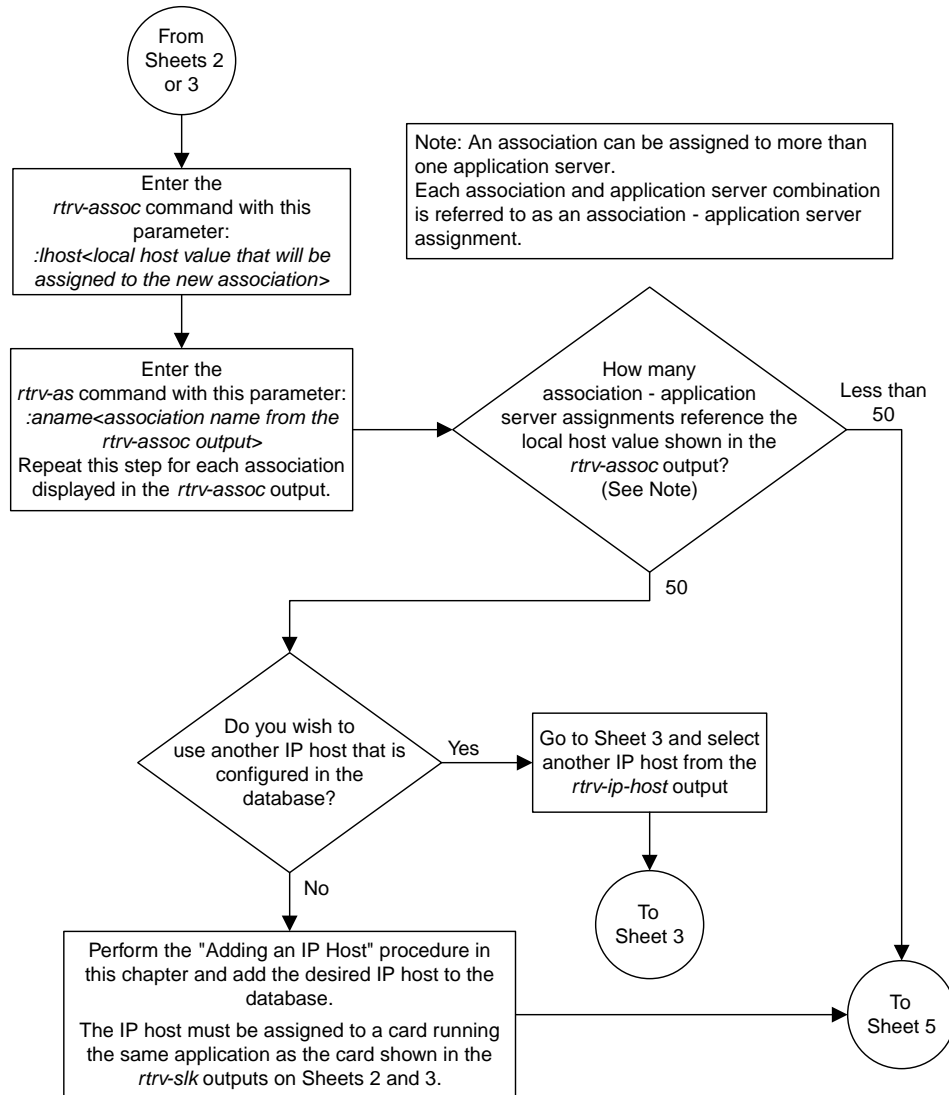

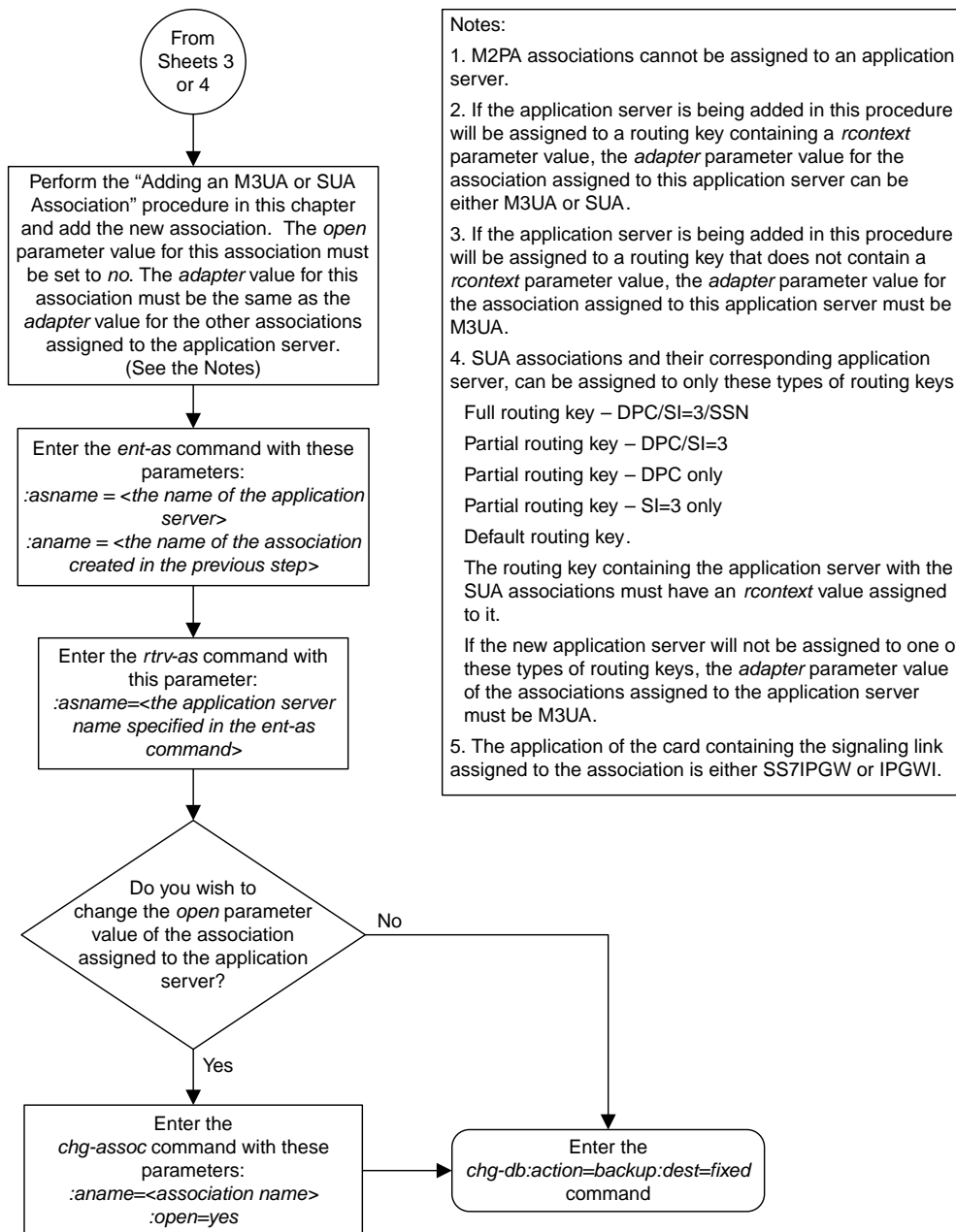

Sheet 5 of 5

Figure 52: Adding a New Association to an Existing Application Server

Adding an Existing Association to an Existing Application Server

This procedure is used assign an existing association to an existing application server using the `ent-as` command.

The `ent-as` command uses these parameters:

`:asname` – The name of the application server.

`:aname` – The name of the association being assigned to the application server.

The maximum number SCTP association to application server assignments that can be hosted by an IPGWx card (referenced by the `lhost` parameter of the association) is 50. For example, the IPGWx card currently contains 38 SCTP association to application server assignments. The SCTP association to application server assignments could be one SCTP association assigned to 38 application servers, two SCTP associations assigned to 19 application servers, or any combination of SCTP associations assigned to application servers that add up to 38. The SCTP association to application server assignments can be verified with the `rtrv-assoc:lhost=<local host name>` and `rtrv-as:aname=<association name>` commands.

Table 31: Examples of IPGWx Card Provisioning Limits

Number of Associations hosted by the IPGWx card	Number of Application Servers each Association is Assigned to *	Total Association - Application Server Assignments maintained by the IPGWx card
1	50	50
50	1	50
25	1	50
25	2	50
0	0	50
38	1	38
19	2	38
* The EAGLE can contain a maximum of 250 application servers.		

A maximum of 16 associations can be assigned to an application server.

The `open` parameter of the association must be set to `no` before the association can be assigned to the application server. This can be verified with the `rtrv-assoc` command.

M2PA associations (`adapter=m2pa`) cannot be assigned to application servers. Only M3UA (`adapter=m3ua`) and SUA (`adapter=sua`) associations can be assigned to application servers. This can be verified in the `ADAPTER` field in the `rtrv-assoc` output.

The application running on the card hosting the association that will be assigned to the application server must be the same as the application running on the cards hosting the other associations assigned to the application server.

Canceling the `RTRV-AS` and `RTRV-ASSOC` Commands

Because the `rtrv-as` and `rtrv-assoc` commands used in this procedure can output information for a long period of time, the `rtrv-as` and `rtrv-assoc` commands can be canceled and the output to the terminal stopped. There are three ways that the `rtrv-as` and `rtrv-assoc` commands can be canceled.

- Press the `F9` function key on the keyboard at the terminal where the `rtrv-as` or `rtrv-assoc` commands were entered.
- Enter the `canc-cmd` without the `trm` parameter at the terminal where the `rtrv-as` or `rtrv-assoc` commands were entered.
- Enter the `canc-cmd:trm=<xx>`, where `<xx>` is the terminal where the `rtrv-as` or `rtrv-assoc` commands were entered, from another terminal other than the terminal where the `rtrv-as` or `rtrv-assoc` commands were entered. To enter the `canc-cmd:trm=<xx>` command, the terminal must allow Security Administration commands to be entered from it and the user must be allowed to enter Security Administration commands. The terminal's permissions can be verified with the `rtrv-secu-trm` command. The user's permissions can be verified with the `rtrv-user` or `rtrv-secu-user` commands.

For more information about the `canc-cmd` command, go to *Commands User's Guide*.

1. Display the application servers in the database using the `rtrv-as` command.

This is an example of possible output.

```
rlghncxa03w 06-10-28 09:12:36 GMT EAGLE5 36.0.0

AS Name           Mode           Tr ms   Association Names
as1                LOADSHARE      10      a2
                  a3
                  assoc1

as2                OVERRIDE       10      assoc7
as3                OVERRIDE       10      swbel32

AS table is (3 of 250) 1% full.
```

2. Display the application server that the new association will be added to by entering the `rtrv-as` command with the name of the application server.

For this example, enter this command.

```
rtrv-as:asname=as2
```

This is an example of possible output.

```
rlghncxa03w 06-10-28 09:12:36 GMT EAGLE5 36.0.0

AS Name           Mode           Tr ms   Association Names
```

```
as2          OVERRIDE    10      assoc7
AS table is (3 of 250) 1% full.
```

A maximum of 16 associations can be assigned to an application server. If the application server displayed in this step contains less than 16 associations, continue the procedure with [Step 3](#).

If the application server displayed in this step contains 16 associations, either select another application server to use in this procedure and repeat this step, or perform the [Adding an Existing Association to a New Application Server](#) procedure to add the association to a new application server.

Note: If the association being added to the application server is shown in the `rtrv-as` output in [Step 1](#), continue the procedure with [Step 4](#).

3. Display the associations in the database using the `rtrv-assoc` command.

This is an example of possible output.

```
rlghncxa03w 06-10-28 09:12:36 GMT EAGLE5 36.0.0

          CARD IPLNK
ANAME     LOC  PORT  LINK ADAPTER LPORT RPORT OPEN ALW
swbel32   1201 A      A    M3UA   1030  2345  YES  YES
a2        1305 A      A    SUA    2000  2345  YES  YES
a3        1307 A      A    SUA    3000  2346  YES  YES
assoc1    1305 A      A    SUA    4000  1030  YES  YES
assoc7    1305 A      A    SUA    4500  1030  YES  YES
```

If the association being added to the application server is shown in this step, continue the procedure with [Step 4](#).

If the association being added to the application server is not shown in this step, perform the [Adding a New Association to an Existing Application Server](#) procedure to add a new association to the application server.

4. Display one of the associations assigned to the application server shown in [Step 2](#) using the `rtrv-assoc` command and specifying the association name shown in the `rtrv-as` output from [Step 2](#) or in the `rtrv-assoc` output in [Step 3](#).

For this example, enter this command.

```
rtrv-assoc:aname=assoc7
```

This is an example of possible output.

```
rlghncxa03w 09-05-28 09:12:36 GMT EAGLE5 41.0.0
ANAME assoc7
      LOC 1203          IPLNK PORT  A          LINK  A
ADAPTER SUA          VER   SUA RFC
LHOST  gw105.nc.tekelec.com
ALHOST ---
RHOST  gw100.nc.tekelec.com
ARHOST ---
LPORT  4500          RPORT 1030
ISTRMS 2          OSTRMS 2          BUFSIZE 16
RMODE  LIN          RMIN 120          RMAX 800
RTIMES 10          CWMIN 3000         UAPS 10
OPEN   YES          ALW   YES          RTXTHR 10000
```

```

RHOSTVAL RELAXED

ASNAMES
as2

IP Appl Sock table is (6 of 4000) 1% full
Assoc Buffer Space Used (16 KB of 800 KB) on LOC = 1203

```

The adapter parameter value of all the associations assigned to an application server must be the same. This step identifies the adapter value of the associations assigned to the application server.

The application running on the card hosting the new association must be the same as the application on the cards hosting the associations assigned to the application server.

5. Display the signaling link assigned to the card, shown in [Step 4](#) by entering the `rtrv-slk` command with the card location of the signaling link.

For this example, enter this command.

```
rtrv-slk:loc=1205
```

The following is an example of the possible output.

```

rlghncxa03w 06-10-28 21:19:37 GMT EAGLE5 36.0.0

LOC LINK LSN          SLC TYPE
1205 A   lsn5          1  SS7IPGW

```

The application running on the card is shown in the `TYPE` column of the `rtrv-slk` output.

For this example, the new association must be assigned to a card running the `SS7IPGW` application.

6. Display the association being added to the application server using the `rtrv-assoc` command and specifying the name of the association being added.

For this example, enter this command.

```
rtrv-assoc:aname=assoc1
```

This is an example of possible output.

```

rlghncxa03w 09-05-28 09:12:36 GMT EAGLE5 41.0.0
ANAME assoc1
  LOC      1203          IPLNK PORT  A          LINK  A
  ADAPTER  SUA          VER          SUA RFC
  LHOST    gw101.nc.tekelec.com
  ALHOST    ---
  RHOST    gw100.nc.tekelec.com
  ARHOST    ---
  LPORT    4000          RPORT      1030
  ISTRMS   2            OSTRMS     2          BUFSIZE  16
  RMODE    LIN          RMIN       120        RMAX     800
  RTIMES   10          CWMIN      3000       UAPS     10
  OPEN     YES          ALW        YES        RTXTHR   10000
  RHOSTVAL RELAXED

ASNAMES
as1

```

```
IP Appl Sock table is (6 of 4000) 1% full
Assoc Buffer Space Used (16 KB of 800 KB) on LOC = 1203
```

If the local host and adapter values shown in this step are the same as the local host and adapter values shown in [Step 4](#), continue the procedure with [Step 8](#).

If the adapter value shown in this step is not the same as the adapter value shown in [Step 4](#), repeat this procedure from [Step 3](#).

If the local host value shown in this step is not the same as the local host value shown in [Step 4](#), but the adapter value shown in this step is the same as the adapter values shown in [Step 4](#), continue the procedure with [Step 7](#).

7. Display the signaling link assigned to the card, shown in [Step 6](#) by entering the `rtrv-slk` command with the card location of the signaling link.

For this example, enter this command.

```
rtrv-slk:loc=1201
```

The following is an example of the possible output.

```
rlghncxa03w 06-10-28 21:19:37 GMT EAGLE5 36.0.0
LOC LINK LSN          SLC TYPE
1201 A   lsn1         0  SS7IPGW
```

The application running on the card is shown in the `TYPE` column of the `rtrv-slk` output.

For this example, the association being added to the application server must be assigned to a card running the `SS7IPGW` application.

If the card applications shown in this step and in [Step 5](#) are the same, continue the procedure with [Step 8](#).

If the card applications shown in this step and in [Step 5](#) are not the same, repeat this procedure from [Step 3](#).

8. Display the associations assigned to the local IP host value specified in by entering the `rtrv-assoc` command with the `lhost` parameter.

For this example, enter this command.

```
rtrv-assoc:lhost=gw101.nc.tekelec.com
```

This is an example of the possible output.

```
rlghncxa03w 06-10-28 21:14:37 GMT EAGLE5 36.0.0
CARD IPLNK
ANAME          LOC PORT LINK ADAPTER LPORT RPORT OPEN ALW
assoc1         1203 A   A   SUA      4000  1030 YES  YES
IP Appl Sock/Assoc table is (6 of 4000) 1% full
Assoc Buffer Space Used (16 KB of 3200 KB) on LOC = 1203
```

9. Display the application servers that the associations shown in [Step 8](#) are assigned to by entering `rtrv-as` command with the names of the associations shown in [Step 8](#).

For this example, enter this command.

```
rtrv-as:aname=assoc1
```

This is an example of the possible output.

```
rlghncxa03w 06-10-28 21:14:37 GMT EAGLE5 36.0.0
AS Name           Mode           Tr ms   Association Names
as1                LOADSHARE     10     assoc1
AS Table is (3 of 250) 1% full
```

The maximum number of SCTP association to application server assignments that can be hosted by an IPGWx card (referenced by the lhost parameter of the association) is 50.

If the number of SCTP association to application server assignments is less than 50, continue the procedure with [Step 10](#).

If the number of SCTP association to application server assignments is 50, either repeat this procedure from [Step 3](#), or perform the [Adding a New Association to an Existing Application Server](#) procedure to add a new association to this application server.

Note: If the value of the open parameter shown in [Step 6](#) is no, continue the procedure with [Step 11](#).

10. Change the value of the open parameter to no by specifying the chg-assoc command with the open=no parameter.

For this example, enter this command.

```
chg-assoc:aname=assoc1:open=no
```

When this command has successfully completed, this message should appear.

```
rlghncxa03w 06-10-28 09:12:36 GMT EAGLE5 36.0.0
CHG-ASSOC: MASP A - COMPLTD;
```

11. Add the association to the application server using the ent-as command.

For this example, enter this command

```
ent-as:asname=as2:aname=assoc1
```

This is an example of possible output.

```
rlghncxa03w 06-10-28 09:12:36 GMT EAGLE5 36.0.0
ENT-AS: MASP A - COMPLTD;
```

12. Verify the changes using the rtrv-as command with the application server name specified in [Step 11](#).

For this example, enter this command.

```
rtrv-as:asname=as2
```

This is an example of possible output.

```
rlghncxa03w 06-10-28 09:12:36 GMT EAGLE5 36.0.0
AS Name           Mode           Tr ms   Association Names
as2                OVERRIDE      10     assoc1
```

```
AS table is (3 of 250) 1% full.          assoc7
```

Note: If you do not wish to change the `open` parameter value of the association specified in [Step 11](#), continue the procedure with [Step 14](#).

13. Change the value of the `open` parameter to `yes` by specifying the `chg-assoc` command with the `open=yes` parameter.

For this example, enter this command.

```
chg-assoc:aname=assoc1:open=yes
```

When this command has successfully completed, this message should appear.

```
rlghncxa03w 06-10-28 09:12:36 GMT EAGLE5 36.0.0  
CHG-ASSOC: MASP A - COMPLTD;
```

14. Back up the new changes, using the `chg-db:action=backup:dest=fixed` command.

These messages should appear; the active Maintenance and Administration Subsystem Processor (MASP) appears first.

```
BACKUP (FIXED) : MASP A - Backup starts on active MASP.  
BACKUP (FIXED) : MASP A - Backup on active MASP to fixed disk complete.  
BACKUP (FIXED) : MASP A - Backup starts on standby MASP.  
BACKUP (FIXED) : MASP A - Backup on standby MASP to fixed disk complete.
```

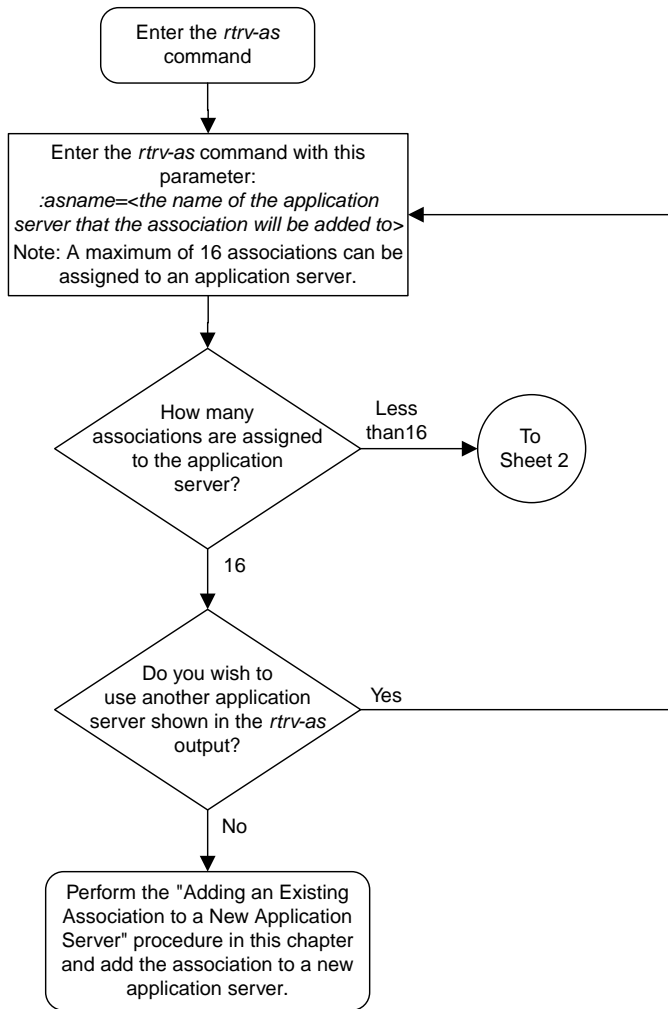

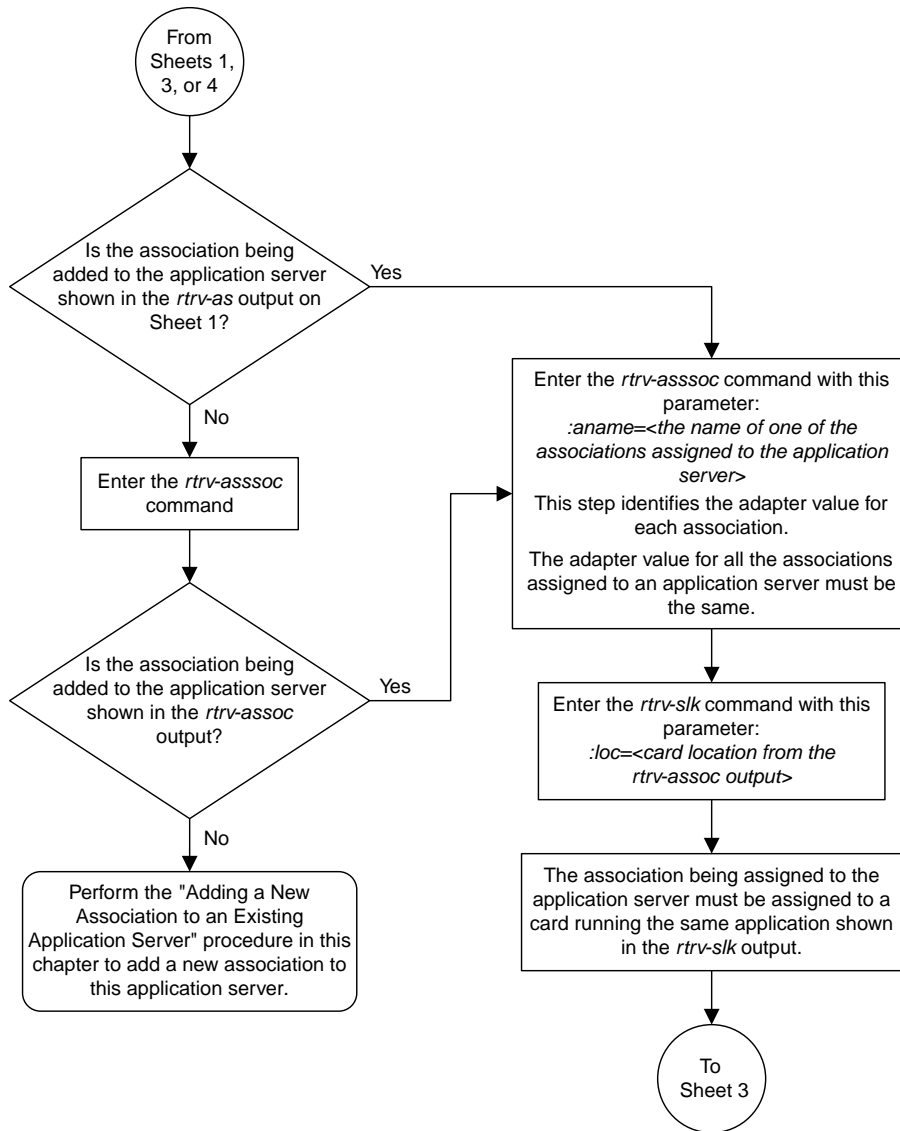

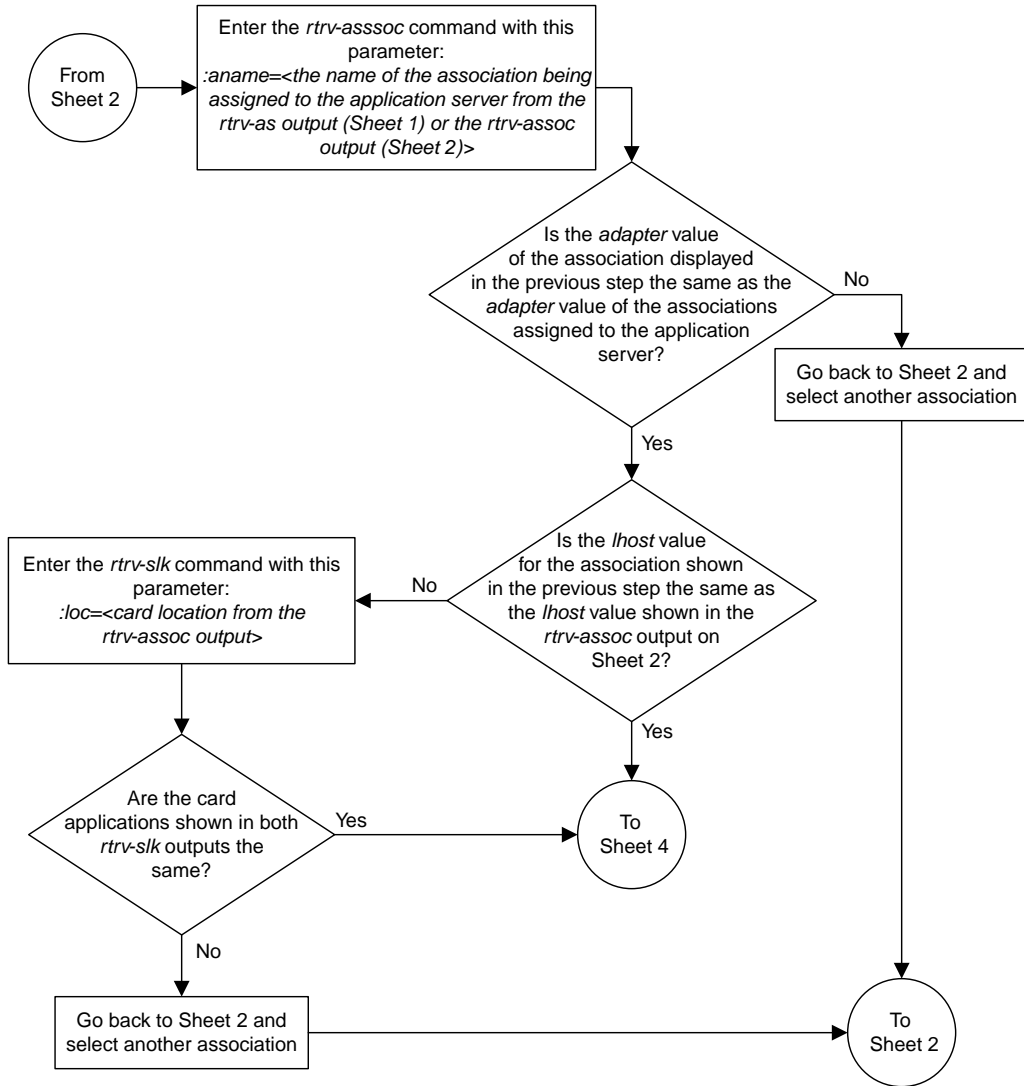

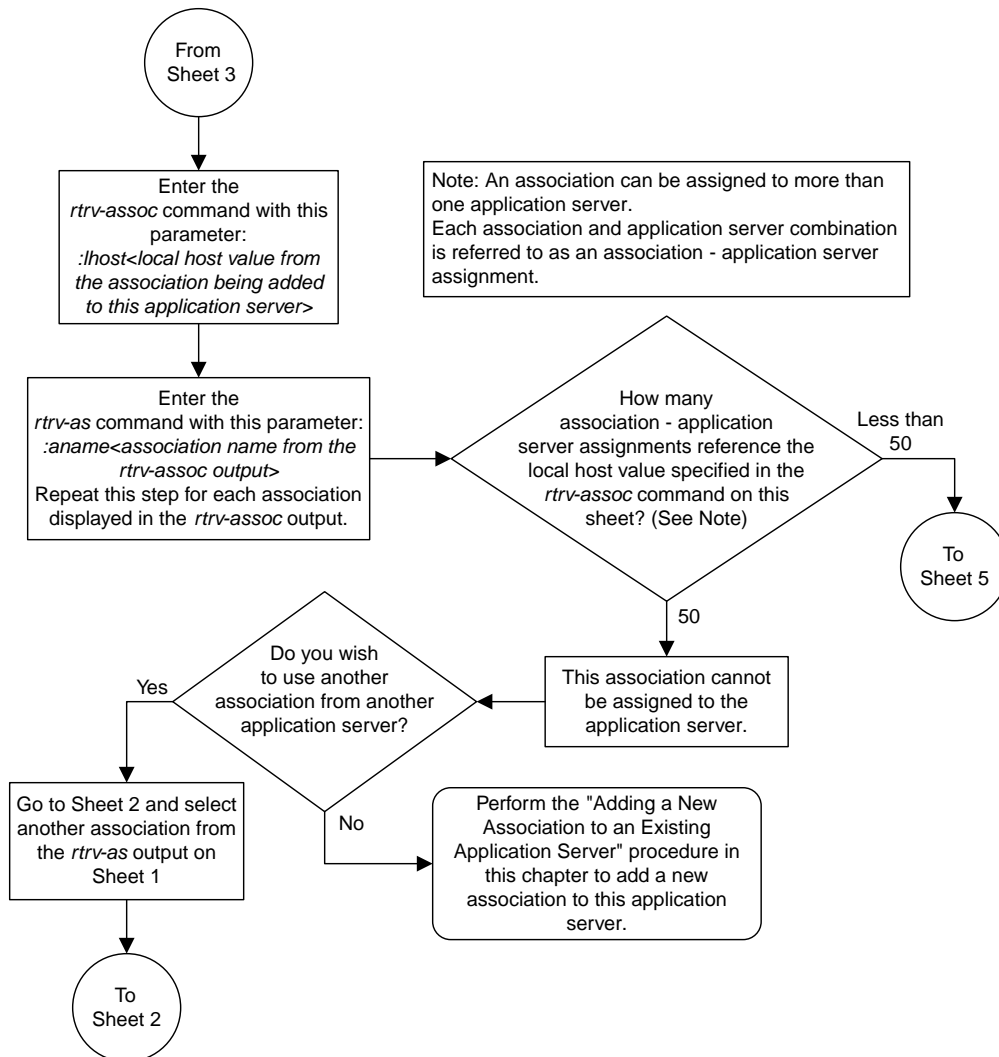

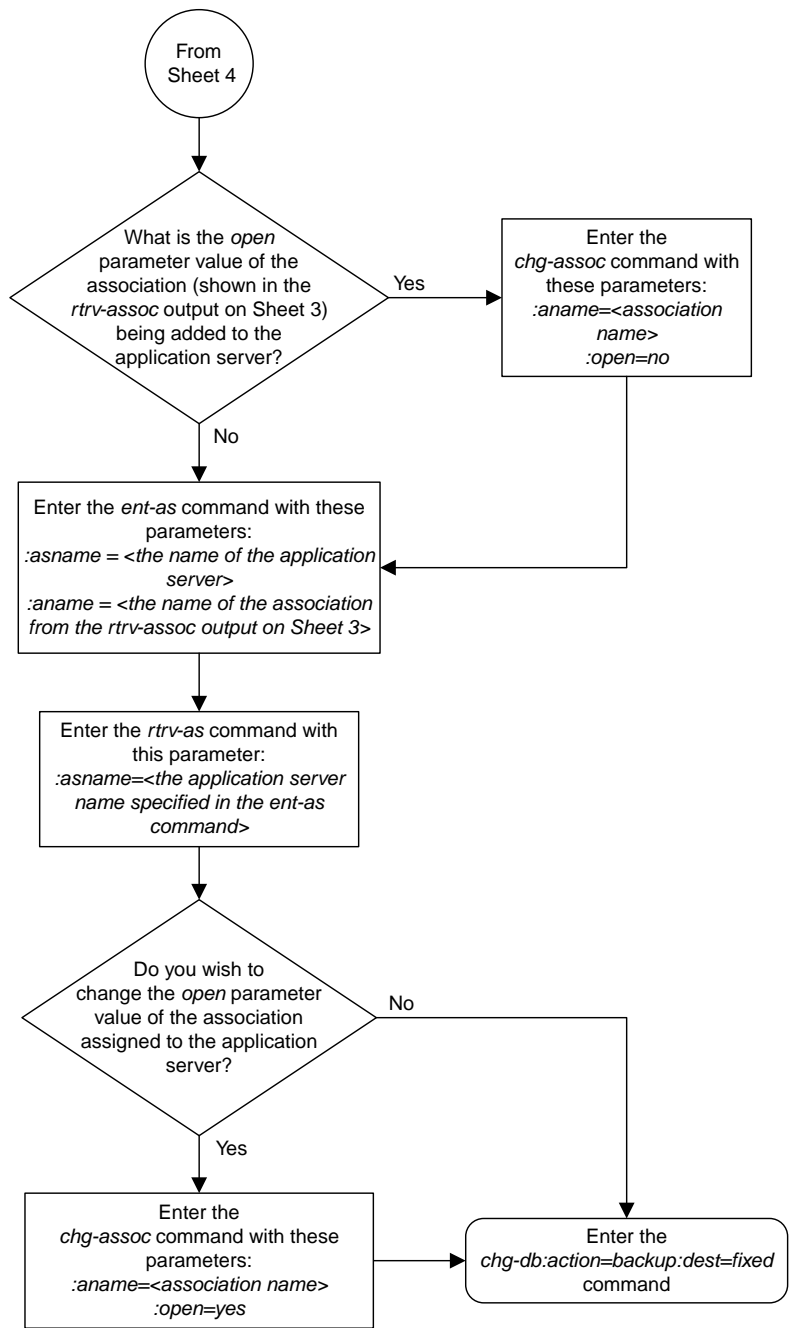

Sheet 5 of 5

Figure 53: Adding an Existing Application to an Existing Application Server

Adding a Routing Key Containing an Application Server

This procedure is used to add a routing key containing an application server to the database using the `ent-appl-rtkey` command.

A routing key defines a filter that checks the specified values in an incoming SS7 MSU to determine which, if any, association receives the MSU. For more information about static routing keys, see [Understanding Routing for SS7IPGW and IPGWI Applications](#).

The `ent-appl-rtkey` command uses these parameters.

`:dpc/dpca/dpci/dpcn/dpcn24` – The destination point code value that is used to filter incoming MSUs. This parameter must not specify a cluster route. The destination point code of the routing key cannot be the APC of an IPGWx linkset or the SAPC assigned to an IPGWx linkset.

`:opc/opca/opci/opcn/opcn24` – The originating point code value that is used to filter incoming MSUs. This parameter must not specify a cluster route. This parameter is valid only when the `si` parameter value is set to 4, 5, or 13. This parameter is required if `si=4, 5, or 13` and `type=full`.

Note: See the “Point Code Formats” section in *Database Administration - SS7 User’s Guide* for a definition of the point code types that are used on the EAGLE and for a definition of the different formats that can be used for ITU national point codes.

`:si` – The service indicator value that is used to filter incoming MSUs. The range of values for the service indicator parameter (`si`) can be a numerical value from 0 to 15, or for selected service indicator values, a text string can be used instead of numbers. [Table 32: Service Indicator Text String Values](#) shows the text strings that can be used in place of numbers for the service indicator values.

Table 32: Service Indicator Text String Values

Service Indicator Value	Text String
0	snm
1	regtest
2	spltst
3	sccp
4	tup
5	isup
13	qbicc

`:ssn` – The subsystem value that is used to filter incoming MSUs. The `ssn` parameter is only valid when the `si` parameter value is set to 3 or `sccp`.

`:cics` – The starting circuit identification code that is used to filter incoming MSUs. When specified with `cice`, `cics` identifies the start of the range of circuit identification codes. The `cics` parameter is valid only when the `si` parameter value is set to 4, 5, or 13. The `cics` is required if `si=4, 5, or 13` and `type=full`.

`:cice` – The ending circuit identification code that is used to filter incoming MSUs. When specified with `cics`, `cice` identifies the end of the range of circuit identification codes. The `cice` parameter is valid only when the `si` parameter value is set to 4, 5, or 13. The `cice` is required if `si=4, 5, or 13` and `type=full`.

`:type` – The routing key type – Identifies the type of routing key that is being entered and used to route message signaling units (MSUs). One of three values, `full/partial/default`, can be specified for the `type` parameter (see [Table 33: Routing Key Parameter Combinations for Adding a Routing Key Containing an Application Server](#)). If `type` is not explicitly specified, `type=full` is assumed.

`:asname` – Application server (AS) name.

`:rcontext` – The routing context parameter, which has two functions:

- Provides an index of the application server traffic that the sending application server is configured or registered to receive.
- Identifies the SS7 network context for the message. The routing context parameter implicitly defines the SS7 point code format used, the SS7 network indicator value, and the SCCP protocol type/variant/version used.

Application server names are shown in the `rtrv-as` output.

Only one application server can be assigned to a routing key. There is a maximum of 2500 routing keys allowed per EAGLE. The application server names in each routing key must be unique.

The number of static routing keys is limited by the `srkq` parameter that was specified on the `chg-sg-opts` command.

Routing keys are associated only with the `ss7ipgw` or `ipgwi` application.

Group codes are required for 14-bit ITU-N point codes (DPCN/OPCN) when the Duplicate Point Code feature is enabled.

The starting circuit identification code must be less than or equal to the ending circuit identification code.

The ISUP routing over IP feature must be on in order to enter a routing key with these parameters: `dpc`, `si`, `opc`, `cics`, and `cice`. The `IPISUP` field in the `rtrv-feat` command output shows whether or not this feature is on.

The parameter combinations used by the `ent-appl-rtkey` command are based on the type of routing key and the service indicator value in the routing key. The parameter combinations are shown in [Table 33: Routing Key Parameter Combinations for Adding a Routing Key Containing an Application Server](#).

Table 33: Routing Key Parameter Combinations for Adding a Routing Key Containing an Application Server

Full Routing Key - SI = 3 (SCCP)	Partial Routing Key - SI = 3 (SCCP)	Full Routing Key - SI=4 (TUP), 5 (ISUP), 13 (QBICC)	Partial Routing Key - SI=4 (TUP), 5 (ISUP), 13 (QBICC)	Full Routing Key - Other SI Values	Partial Routing Key - Other SI Values	Default Routing Key
dpc (See Notes 1, 2, and 11)	type=partial	dpc (See Notes 1 and 2)	type=partial	dpc (See Notes 1 and 2)	type=partial	type=default
si=3 (See Notes 4 and 11)	dpc (See Notes 1, 2, and 3)	si=4, 5, 13 (See Note 4)	dpc (See Notes 1, 2, and 3)	si=value other than 3, 4, 5, 13 (See Note 4)	dpc (See Notes 1, 2, and 3)	asname (See Note 10)
ssn (See Note 11)	si=3 (See Notes 3 and 4)	opc (See Notes 1 and 2)	si=4, 5, 13 (See Notes 3, 4, and 10)	type=full	si=value other than 3, 4, 5, 13 (See Notes 3, 4, and 10)	rcontext (See Note 10)
type=full	asname (See Note 10)	cics (See Notes 5, 6, 7, 8, and 9)	opc (See Notes 1, 2, and 3)	asname (See Note 10)	asname (See Note 10)	
asname (See Note 10)	rcontext (See Note 10)	cice (See Notes 5, 6, 7, 8, and 9)	asname (See Note 10)	rcontext (See Note 10)	rcontext (See Note 10)	
rcontext (See Note 10)		type=full	rcontext (See Note 10)			
		asname (See Note 10)				
		rcontext (See Note 10)				

Notes:

1. The `dpc` and `opc` parameters can be either an ANSI point code (`dpca`, `opca`), ITU-I point code or ITU-I spare point code (`dpci`, `opci`), 14-bit ITU-N point code or 14-bit ITU-N spare point code (`dpcn`, `opcn`), or 24-bit ITU-N point code (`dpcn24`, `opcn24`). If the `dpc` and `opc` parameters are specified, the `dpc` and `opc` must be the same type of point code. For example, if the `dpca` parameter is specified, the OPC is specified with the `opca` parameter. If either point code value is a spare point code, the other point code value must be a spare point code on the same type. For example, if the `dpc` value is an ITU-I spare point code, the `opc` value must be an ITU-I spare point code.

2. If the ITU National Duplicate Point Code feature is on, the values for the `dpcn` and `opcn` parameters must have group codes assigned to them. The field `ITUDUPPC` in the `rt rv-feat` command output

Full Routing Key - SI = 3 (SCCP)	Partial Routing Key - SI = 3 (SCCP)	Full Routing Key - SI=4 (TUP), 5 (ISUP), 13 (QBICC)	Partial Routing Key - SI=4 (TUP), 5 (ISUP), 13 (QBICC)	Full Routing Key - Other SI Values	Partial Routing Key - Other SI Values	Default Routing Key
<p>shows whether or not the ITU National Duplicate Point Code feature is on. If group codes are specified for ITU-N DPC and OPC, the groups codes must be the same.</p> <p>3. These parameters are optional for partial routing keys, but at least one these parameters must be specified with the <code>ent-appl-rtkey</code> command.</p> <p>4. Text strings can be used in place of some numerical service indicator values. See Table 32: Service Indicator Text String Values for a list of these text strings.</p> <p>5. When the service indicator parameter value equals 4 and an ANSI <code>dpc</code> is specified, the <code>opc</code>, <code>cics</code>, and <code>cice</code> parameters cannot be used. If the service indicator parameter value equals 4 and an ITU <code>dpc</code> is specified, the <code>opc</code>, <code>cics</code>, and <code>cice</code> parameters are required.</p> <p>6. If the service indicator parameter (<code>si</code>) value is 4, the values of the <code>cics</code> and <code>cice</code> parameters is from 0 to 4095.</p> <p>7. If the service indicator parameter (<code>si</code>) value is 5 and the point code in the routing key is either an ITU-I, 14-bit ITU-N, or 24-bit ITU-N point code, the values of the <code>cics</code> and <code>cice</code> parameters is from 0 to 4095. If the point code in the routing key is an ANSI point code, the values of the <code>cics</code> and <code>cice</code> parameters is from 0 to 16383.</p> <p>8. If the service indicator parameter value is 13, the values of the <code>cics</code> and <code>cice</code> parameters is from 0 to 4294967295.</p> <p>9. The CIC range, defined by the <code>cics</code> and <code>cice</code> parameters, cannot overlap the CIC range in an existing routing key.</p> <p>10. The following rules apply to using the <code>rcontext</code> parameter.</p> <ul style="list-style-type: none"> The value of the <code>rcontext</code> parameter is from 0 to 4294967295. The <code>rcontext</code> parameter is required for a routing key containing an SUA application server. The <code>rcontext</code> parameter is optional for a routing key containing an M3UA application server. The <code>rcontext</code> parameter value must be unique in the database. Multiple routing keys cannot have the same <code>rcontext</code> value assigned. An application server can be assigned to only one routing key containing a routing context value. If the application server being assigned to the new routing key is assigned to other routing keys that do not contain <code>rcontext</code> parameter values, the <code>rcontext</code> parameter cannot be specified for the new routing key. An application server can be assigned to multiple routing keys if those routing keys do not contain a routing context value. An application server can be assigned to either a routing key containing a routing context value, or to routing keys that do not contain a routing context value, but the application server cannot be assigned to both types of routing keys. In order for an M3UA or SUA association to be assigned to multiple routing keys with a routing context value, the M3UA or SUA association must be assigned to multiple application servers and then each application server must be assigned to a routing key containing a routing context value. 						

Full Routing Key - SI = 3 (SCCP)	Partial Routing Key - SI = 3 (SCCP)	Full Routing Key - SI=4 (TUP), 5 (ISUP), 13 (QBICC)	Partial Routing Key - SI=4 (TUP), 5 (ISUP), 13 (QBICC)	Full Routing Key - Other SI Values	Partial Routing Key - Other SI Values	Default Routing Key
11. To communicate the status changes of remote IP subsystems (defined by the DPC and SSN specified in a full SCCP routing key), the DPC and SSN specified for a full SCCP routing key must be provisioned in the mated application table. Perform one of the mated application procedures in <i>Database Administration - GTT User's Guide</i> to provision a mated application with the DPC and SSN specified for a full SCCP routing key.						

Canceling the RTRV-AS and RTRV-APPL-RTKEY Commands

Because the `rtrv-as` and `rtrv-appl-rtkey` commands used in this procedure can output information for a long period of time, the `rtrv-as` and `rtrv-appl-rtkey` commands can be canceled and the output to the terminal stopped. There are three ways that the `rtrv-as` and `rtrv-appl-rtkey` commands can be canceled.

- Press the F9 function key on the keyboard at the terminal where the `rtrv-as` or `rtrv-appl-rtkey` commands were entered.
- Enter the `canc-cmd` without the `trm` parameter at the terminal where the `rtrv-as` or `rtrv-appl-rtkey` commands were entered.
- Enter the `canc-cmd:trm=<xx>`, where `<xx>` is the terminal where the `rtrv-as` and `rtrv-appl-rtkey` commands were entered, from another terminal other than the terminal where the `rtrv-as` or `rtrv-appl-rtkey` commands were entered. To enter the `canc-cmd:trm=<xx>` command, the terminal must allow Security Administration commands to be entered from it and the user must be allowed to enter Security Administration commands. The terminal's permissions can be verified with the `rtrv-secu-trm` command. The user's permissions can be verified with the `rtrv-user` or `rtrv-secu-user` commands.

For more information about the `canc-cmd` command, go to *Commands User's Guide*.

1. Display the current routing key information in the database by entering the `rtrv-appl-rtkey` command.

The following is an example of the possible output.

```
rlghncxa03w 08-04-28 21:15:37 GMT EAGLE5 38.0.0

RCONTEXT      DPC          SI  ADPTR  ASNAME      TYPE
-----
123-234-123    5  M3UA   as12        FULL
005-005-001    5  M3UA   as9          FULL
005-005-001    5  M3UA   as9          FULL
2500           006-006-001  5  SUA     as10        FULL

RCONTEXT      DPCI         SI  ADPTR  ASNAME      TYPE
-----
2-100-7        6  M3UA   as4          FULL
100            3-137-6      6  SUA     as1          FULL
225            4-035-7      5  SUA     as7          FULL
6-006-6        5  M3UA   as2          FULL
6-006-7        5  M3UA   as8          FULL
6-006-6        5  M3UA   as2          FULL
6-006-6        5  M3UA   as2          FULL
6-006-8        3  M3UA   as3          FULL
6-006-8        5  M3UA   as5          FULL
```

```

-----      6-024-7      5  M3UA  as4          FULL
-----      6-024-7      5  M3UA  as4          FULL
300          7-008-7      6  SUA   as6          FULL

RCONTEXT    DPC          SI  ADPTR  ASNAME      TYPE
-----      *****      ** M3UA  as11       DEFAULT

STATIC Route Key table is (17 of 2000) 1% full
STATIC Route Key Socket Association table is (17 of 32000) 1% full

```

The database can contain only one default routing key. If the `rtrv-appl-rtkey` output contains a default routing key, a default routing key cannot be added in this procedure. Continue the procedure with [Step 2](#) to add either a full or partial routing key with the desired application server.

2. Display the current application server information in the database by entering the `rtrv-as` command.

The following is an example of the possible output.

```

rlghncxa03w 06-10-28 09:12:36 GMT EAGLE5 36.0.0

AS Name      Mode          Tr ms   Association Names
as1          LOADSHARE    10      assoc1
            LOADSHARE    10      assoc2
            LOADSHARE    10      assoc3
            LOADSHARE    10      assoc5
            LOADSHARE    10      assoc6

as2          OVERRIDE     10      assoc7

as3          LOADSHARE    10      assoc8
            LOADSHARE    10      assoc9

as4          LOADSHARE    10      assoc10
            LOADSHARE    10      assoc11

as5          LOADSHARE    10      assoc12
            LOADSHARE    10      assoc13

as6          LOADSHARE    10      assoc14
            LOADSHARE    10      assoc15

as7          LOADSHARE    10      assoc16
            LOADSHARE    10      assoc17

as8          LOADSHARE    10      assoc18
            LOADSHARE    10      assoc19

as9          LOADSHARE    10      assoc20
            LOADSHARE    10      assoc21

as10         LOADSHARE    10      assoc22
            LOADSHARE    10      assoc23

as12         LOADSHARE    10      assoc24
            LOADSHARE    10      assoc25

AS Table is (11 of 250) 4% full

```

If the required application server is not in the database, perform one of these procedures to add the application server:

- *Adding a New Association to a New Application Server*
- *Adding an Existing Association to a New Application Server*
- *Adding a New Association to an Existing Application Server*
- *Adding an Existing Association to an Existing Application Server.*

If the `rcontext` parameter will not be specified for the routing key, make sure that the `adapter` parameter value for the associations assigned to the new application server is M3UA.

If the `rcontext` parameter will be specified for the routing key, make sure that the `open` parameter value of the associations is set to `no`. The `adapter` parameter value of these associations can be either SUA or M3UA.

SUA associations, and their corresponding application server, can be assigned to only these types of routing keys:

- Full routing key – DPC/SI=3/SSN
- Partial routing key – DPC/SI=3
- Partial routing key – DPC only
- Partial routing key – SI=3 only
- Default routing key.

After the new application server is added to the database, continue the procedure with [Step 4](#).

3. Display the routing keys containing the application server being used in this procedure by entering the `rtrv-appl-rtkey` command with the application server name and the `display=all` parameter.

For this example, enter these commands.

```
rtrv-appl-rtkey:asname=as4:display=all
```

The following is an example of the possible output.

```
rlghncxa03w 08-04-28 09:12:36 GMT EAGLE5 38.0.0

RCONTEXT  DPCI          SI SSN OPCI          CICS          CICE
-----
          6-024-7      5 --- 1-057-4      150           175

      ADPTR  TYPE      ASNAME
      M3UA   FULL      as4

      ANAMES
      assoc11          assoc12

RCONTEXT  DPCI          SI SSN OPCI          CICS          CICE          LOC
-----
          2-100-7      6 --- -----
          -----
          -----

      ADPTR  TYPE      ASNAME
      M3UA   FULL      as4

      ANAMES
      assoc11          assoc12

STATIC Route Key table is (17 of 2000) 1% full
STATIC Route Key Socket Association table is (17 of 32000) 1% full
```

```
rtrv-appl-rtkey:asname=as5:display=all
```

The following is an example of the possible output.

```
rlghncxa03w 08-04-28 09:12:36 GMT EAGLE5 38.0.0
RCONTEXT  DPCI          SI SSN OPCI          CICS  CICE
225       4-035-7      5 --- 3-200-4      200   300

  ADPTR  TYPE      ASNAME
  M3UA   FULL    as5

  ANAMES
  assoc15          assoc16

STATIC Route Key table is (17 of 2000) 1% full
STATIC Route Key Socket Association table is (17 of 32000) 1% full
```

If the application server is not assigned to any routing keys, the `rcontext` parameter can be specified for the new routing key using this application server. Continue the procedure with [Step 4](#).

An application server can be assigned to only one routing key containing a routing context value. If the application server is assigned to other routing keys, the `rcontext` parameter cannot be specified for the new routing key being added in this procedure. If you wish to use the `rcontext` parameter for the new routing key, perform one of these procedures to add the application server:

- [Adding a New Association to a New Application Server](#)
- [Adding an Existing Association to a New Application Server](#)
- [Adding a New Association to an Existing Application Server](#)
- [Adding an Existing Association to an Existing Application Server](#).

After the new application server is added, continue the procedure with [Step 6](#).

If the application server is assigned to other routing keys, and these routing keys do not contain `rcontext` parameter values, the application server can be assigned to the new routing key in this procedure, but the `rcontext` parameter cannot be specified for the new routing key.

If you do not wish to use the `rcontext` parameter for the new routing key, continue the procedure with [Step 6](#).

4. Display the associations assigned to the application server displayed in [Step 3](#), to verify the open parameter value of the association, using the `rtrv-assoc` command with the association names shown in [Step 2](#).

For this example, enter these commands.

```
rtrv-assoc:aname=assoc11
```

This is an example of possible output.

```
rlghncxa03w 06-10-28 09:12:36 GMT EAGLE5 36.0.0
ANAME assoc11
  LOC      1203          IPLNK PORT  A          LINK  A
  ADAPTER  M3UA          VER        M3UA RFC
  LHOST    gw110.nc.tekelec.com
  ALHOST   ---
  RHOST    gw100.nc.tekelec.com
  LPORT    1030          RPORT      1030
```

```

ISTRMS  2          OSTRMS  2          BUFSIZE 16
RMODE   LIN        RMIN    120         RMAX    800
RTIMES  10         CWMIN   3000        UAPS    10
OPEN    YES        ALW     YES          RTXTHR 10000

```

```

ASNAMES
as4

```

```

IP Appl Sock table is (10 of 4000) 1% full
Assoc Buffer Space Used (16 KB of 800 KB) on LOC = 1203

```

```
rtrv-assoc:aname=assoc12
```

This is an example of possible output.

```

rlghncxa03w 06-10-28 09:12:36 GMT EAGLE5 36.0.0
ANAME assoc12
  LOC      1204          IPLNK PORT  A          LINK  A
  ADAPTER  M3UA          VER        M3UA RFC
  LHOST    gw200.nc.tekelec.com
  ALHOST   ---
  RHOST    gw100.nc.tekelec.com
  LPORT    2564          RPORT      1030
  ISTRMS   2            OSTRMS     2          BUFSIZE 16
  RMODE    LIN          RMIN       120         RMAX    800
  RTIMES   10          CWMIN      3000        UAPS    10
  OPEN     YES          ALW        YES          RTXTHR 10000

```

```

ASNAMES
as4

```

```

IP Appl Sock table is (10 of 4000) 1% full
Assoc Buffer Space Used (16 KB of 800 KB) on LOC = 1204

```

```
rtrv-assoc:aname=assoc15
```

This is an example of possible output.

```

rlghncxa03w 06-10-28 09:12:36 GMT EAGLE5 36.0.0
ANAME assoc15
  LOC      1207          IPLNK PORT  A          LINK  A
  ADAPTER  SUA           VER        SUA RFC
  LHOST    gw150.nc.tekelec.com
  ALHOST   ---
  RHOST    gw100.nc.tekelec.com
  LPORT    1500          RPORT      1030
  ISTRMS   2            OSTRMS     2          BUFSIZE 16
  RMODE    LIN          RMIN       120         RMAX    800
  RTIMES   10          CWMIN      3000        UAPS    10
  OPEN     YES          ALW        YES          RTXTHR 10000

```

```

ASNAMES
as5

```

```

IP Appl Sock table is (4 of 4000) 1% full
Assoc Buffer Space Used (16 KB of 800 KB) on LOC = 1207

```

```
rtrv-assoc:aname=assoc16
```

This is an example of possible output.

```

rlghncxa03w 06-10-28 09:12:36 GMT EAGLE5 36.0.0
ANAME assoc16
  LOC      1211          IPLNK PORT  A          LINK  A
  ADAPTER  SUA          VER          SUA RFC
  LHOST    gw160.nc.tekelec.com
  ALHOST    ---
  RHOST    gw100.nc.tekelec.com
  LPORT    3571          RPORT      1030
  ISTRMS   2            OSTRMS     2          BUFSIZE  16
  RMODE    LIN          RMIN       120        RMAX     800
  RTIMES   10          CWMIN      3000      UAPS     10
  OPEN     YES          ALW        YES        RTXTHR   10000

ASNAMES
as5

IP Appl Sock table is (4 of 4000) 1% full
Assoc Buffer Space Used (16 KB of 800 KB) on LOC = 1211

```

Repeat this step for each association name displayed in [Step 3](#) to verify the open parameter of each association assigned to the application server.

If a new application server was added in [Step 2](#), continue the procedure with [Step 6](#).

If the rcontext parameter is not being specified in this procedure, continue the procedure with [Step 6](#).

If the open parameter value for all the associations assigned to the application server is no (shown in this step), continue the procedure with [Step 6](#).

5. Change the value of the open parameter to no by specifying the chg-assoc command with the open=no parameter.

For this example, enter this command.

```

chg-assoc:aname=assoc11:open=no
chg-assoc:aname=assoc12:open=no
chg-assoc:aname=assoc15:open=no
chg-assoc:aname=assoc16:open=no
chg-assoc:aname=assoc20:open=no

```

When each of these commands have successfully completed, this message should appear.

```

rlghncxa03w 06-10-28 09:12:36 GMT EAGLE5 36.0.0
CHG-ASSOC: MASP A - COMPLTD

```



CAUTION

Caution: The IP connections using the associations specified in this step will not be able to carry any traffic when the open parameter is changed to no.

Repeat this step for all the associations assigned to the application server that have the open=yes parameter value.

If a default routing key with an application server name is being added in this procedure, continue the procedure with [Step 11](#).

If ITU-I or 14-bit ITU-N spare point codes are not being assigned to the routing key, or if ITU-I or 14-bit ITU-N spare point codes are shown in any routing keys shown in the `rtrv-app-rtkey` output in [Step 1](#), continue the procedure with [Step 7](#).

6. Display the status of the ITU National and International Spare Point Code Support feature by entering the `rtrv-ctrl-feat` command with the ITU National and International Spare Point Code Support feature part number.

Enter this command.

```
rtrv-ctrl-feat:partnum=893013601
```

The following is an example of the possible output.

```
rlghncxa03w 06-10-28 21:15:37 GMT EAGLE5 36.0.0
The following features have been permanently enabled:

Feature Name          Partnum    Status    Quantity
Spare Point Code Support 893013601 on        ----

The following features have been temporarily enabled:

Feature Name          Partnum    Status    Quantity    Trial Period Left
Zero entries found.

The following features have expired temporary keys:
Feature Name          Partnum
Zero entries found.
```

If the ITU National and International Spare Point Code Support feature is not enabled, perform the “Activating the ITU National and International Spare Point Code Support feature” procedure in *Database Administration - SS7 User’s Guide* and enable and turn on the ITU National and International Spare Point Code Support feature.

7. The DPC of the routing key cannot be the APC of an IPGWx linkset or an SAPC assigned to an IPGWx linkset.

Display the names of the IPGWx linksets by entering the `rept-stat-iptps` command. This is an example of the possible output.

```
rlghncxa03w 10-07-19 21:16:37 GMT EAGLE5 42.0.0
IP TPS USAGE REPORT
```

	THRESH	CONFIG/ RSVD	CONFIG/ MAX		TPS	PEAK	PEAKTIMESTAMP

LSN							
lsgw1201	80%	----	10000	TX:	7200	7600	05-02-10 11:40:04
				RCV:	7200	7600	05-02-10 11:40:04
lsgw1204	80%	----	10000	TX:	6700	7600	05-02-10 11:40:04
				RCV:	6500	7600	05-02-10 11:40:04
lsgw1207	80%	----	10000	TX:	7300	7450	05-02-10 11:40:04
				RCV:	7300	7450	05-02-10 11:40:04
lsgw1211	80%	----	10000	TX:	7400	7450	05-02-10 11:40:04
				RCV:	7400	7450	05-02-10 11:40:04

```
Command Completed.
```

8. Display the IPGWx linksets shown in the `rept-stat-iptps` output in [Step 7](#) using the `rtrv-ls` command and specifying the name of the linkset shown in [Step 7](#).

For this example, enter these commands.

```
rtrv-ls:lsn=lsgw1201
```

This is an example of the possible output.

```
rlghncxa03w 08-04-28 16:31:35 GMT EAGLE5 38.0.0

LSN          APCA  (SS7)  SCRN  L3T SLT          GWS GWS GWS
lsgw1201     240-020-000  scr1  1   1   yes A   1   off off off yes  off

          IPGWAPC MATELSN      IPTPS LSUSEALM SLKUSEALM GTTMODE
          yes      ----- 10000 70      % 70      % CdPA

          LOC  LINK SLC TYPE          IPLIML2

          LOC  LINK SLC TYPE
          1201 A   0   SS7IPGW

Link set table is (14 of 1024) 1% full
```

```
rtrv-ls:lsn=lsgw1204
```

This is an example of the possible output.

```
rlghncxa03w 08-04-17 11:43:04 GMT EAGLE5 38.0.0

LSN          APCN  (SS7)  SCRN  L3T SLT          GWS GWS GWS
lsgw1204     2968          none  1   1   no  A   1   off off off ---  off

          CLLI          TFATCABMLQ  MTPRSE  ASL8  SLRSRB  MULTGC  ITUTFR
          ----- 1          ---      ---      1          no          off

          IPGWAPC MATELSN      IPTPS LSUSEALM SLKUSEALM GTTMODE
          yes      ----- 10000 70      % 70      % CdPA

          LOC  LINK SLC TYPE          IPGWI

          SAPI
          1-010-1

Link set table is (14 of 1024) 1% full.
```

```
rtrv-ls:lsn=lsgw1207
```

This is an example of the possible output.

```
rlghncxa03w 08-04-17 11:43:04 GMT EAGLE5 38.0.0
```

```

LSN          APCI  (SS7)  SCRNL3T SLT          GWS GWS GWS
lsgw1207     2-154-0  none  1  1  no  A  1  off off off --- off

          CLLI          TFATCABMLQ  MTPRSE  ASL8  SLRSRB  MULTGC  ITUTFR
          -----  1          ---    ---    1          no          off

          IPGWAPC MATELSN      IPTPS LSUSEALM  SLKUSEALM  GTTMODE
          yes      -----  10000 70      % 70      % CdPA

          LOC  LINK  SLC  TYPE
          1207 A    0    IPGWI

          SAPCN
          5823

Link set table is (14 of 1024) 1% full.

```

```
rtrv-ls:lsn=lsgw1211
```

This is an example of the possible output.

```

rlghncxa03w 08-04-28 16:31:35 GMT EAGLE5 38.0.0
LSN          APCA  (SS7)  SCRNL3T SLT          GWS GWS GWS
lsgw1211     010-130-057  scr1  1  1  yes  A  1  off off off yes  off

          IPGWAPC MATELSN      IPTPS LSUSEALM  SLKUSEALM  GTTMODE
          yes      -----  10000 70      % 70      % CdPA

          LOC  LINK  SLC  TYPE
          1211 A    0    SS7IPGW

Link set table is (14 of 1024) 1% full

```

If the DPC of the routing key is shown in the `rtrv-ls` outputs in this step, choose another DPC value for the routing key that is not shown in the `rtrv-ls` outputs in this step.

Note: If the SI value of the routing key being added is a value other than 4, 5, or 13, continue the procedure with [Step 11](#).

9. Verify that the ISUP Routing over IP feature is on, by entering the `rtrv-feat` command.

If the ISUP Routing over IP feature is on, the `IPISUP` field should be set to on. For this example, the ISUP Routing over IP feature is off.

Note: The `rtrv-feat` command output contains other fields that are not used by this procedure. If you wish to see all the fields displayed by the `rtrv-feat` command, see the `rtrv-feat` command description in the *Commands Manual*.

If the ISUP Routing over IP feature is on, continue the procedure with [Step 11](#).

10. Turn the ISUP Routing over IP feature on by entering this command.

```
chg-feat:ipisup=on
```

Note: Once the ISUP Routing over IP feature is turned on with the `chg-feat` command, it cannot be turned off.

The ISUP Routing over IP feature must be purchased before you turn this feature on with the `chg-feat` command. If you are not sure if you have purchased the ISUP Routing over IP feature, contact your Oracle Sales Representative or Account Representative.

When the `chg-feat` has successfully completed, this message should appear.

```
rlghncxa03w 06-10-28 11:43:04 GMT EAGLE5 36.0.0
CHG-FEAT: MASP A - COMPLTD
```

11. Add a routing key entry to the database by entering the `ent-appl-rtkey` command.

The parameters required for the `ent-appl-rtkey` command are determined by the type of routing key being added and the service indicator value in the routing key. See [Table 33: Routing Key Parameter Combinations for Adding a Routing Key Containing an Application Server](#) for the parameter combinations that can be used for the type of routing key being added to the database. For this example, enter these commands.

```
ent-appl-rtkey:dpci=3-009-3:si=5:opci=4-100-3:cics=100
:cice=500:asname=as3:type=full
```

```
ent-appl-rtkey:dpci=1-050-2:si=5:opci=6-077-7:cics=200
:cice=300:asname=as20:type=full:rcontext=2000
```

Note: A routing key cannot be added with the application server `as4`, displayed in [Step 3](#), because application server `as4` is assigned to a routing key containing a routing context value. Only one application server can be assigned to a routing key containing a routing context value.

When each of these commands have successfully completed, the following message should appear.

```
rlghncxa03w 06-10-28 21:15:37 GMT EAGLE5 36.0.0
ENT-APPL-RTKEY: MASP A - COMPLTD
```

12. Verify the new routing key information in the database by entering the `rtrv-appl-rtkey` command with the routing key parameters specified in [Step 11](#) (`dpc`, `si`, `opc`, `cics`, `cice`, `ssn`, `asname`, `type`, and `rcontext`, as applicable) with the `display=all` parameter.

For this example, enter these commands.

```
rtrv-appl-rtkey:dpci=3-009-3:si=5:opci=4-100-3:cics=100
:cice=500:asname=as3:type=full:display=all
```

The following is an example of the possible output.

```
rlghncxa03w 08-04-28 21:16:37 GMT EAGLE5 38.0.0

RCONTEXT  DPCI          SI SSN OPCI          CICS          CICE
-----
          3-009-3      5 ---   4-100-3      100           500

      ADPTR  TYPE          ASNAME
      M3UA   FULL         as3

      ANAMES
      assoc11          assoc12

STATIC Route Key table is (19 of 2000) 1% full
STATIC Route Key Socket Association table is (19 of 32000) 1% full
```

```
rtrv-appl-rtkey:dpci=1-050-2:si=5:opci=6-077-7:cics=200
:cice=300:asname=as20:type=full:rcontext=2000:display=all
```

The following is an example of the possible output.

```
rlghncxa03w 08-04-28 21:16:37 GMT EAGLE5 38.0.0

RCONTEXT  DPCI          SI SSN  OPCI          CICS      CICE
2000      1-050-2        5 ---   6-077-7      200       300

  ADPTR  TYPE      ASNAME
  SUA    FULL    as20

  ANAMES
  assoc20

STATIC Route Key table is (19 of 2000) 1% full
STATIC Route Key Socket Association table is (19 of 32000) 1% full
```

Note: If the open parameter value of the associations assigned to the routing key added in this procedure was not changed ([Step 5](#) was not performed), continue the procedure with [Step 14](#).

13. Change the value of the open parameter of the associations that were changed in [Step 5](#) to yes by specifying the chg-assoc command with the open=yes parameter.

For this example, enter these commands.

```
chg-assoc:aname=assoc11:open=yes
chg-assoc:aname=assoc12:open=yes
chg-assoc:aname=assoc15:open=yes
chg-assoc:aname=assoc16:open=yes
chg-assoc:aname=assoc20:open=yes
```

When each of these commands have successfully completed, this message should appear.

```
rlghncxa03w 06-10-28 09:12:36 GMT EAGLE5 36.0.0
CHG-ASSOC: MASP A - COMPLTD;
```

Repeat this step for all the associations that were changed in [Step 5](#).

14. Back up the new changes using the chg-db:action=backup:dest=fixed command. These messages should appear, the active Maintenance and Administration Subsystem Processor (MASP) appears first.

```
BACKUP (FIXED) : MASP A - Backup starts on active MASP.
BACKUP (FIXED) : MASP A - Backup on active MASP to fixed disk complete.
BACKUP (FIXED) : MASP A - Backup starts on standby MASP.
BACKUP (FIXED) : MASP A - Backup on standby MASP to fixed disk complete.
```

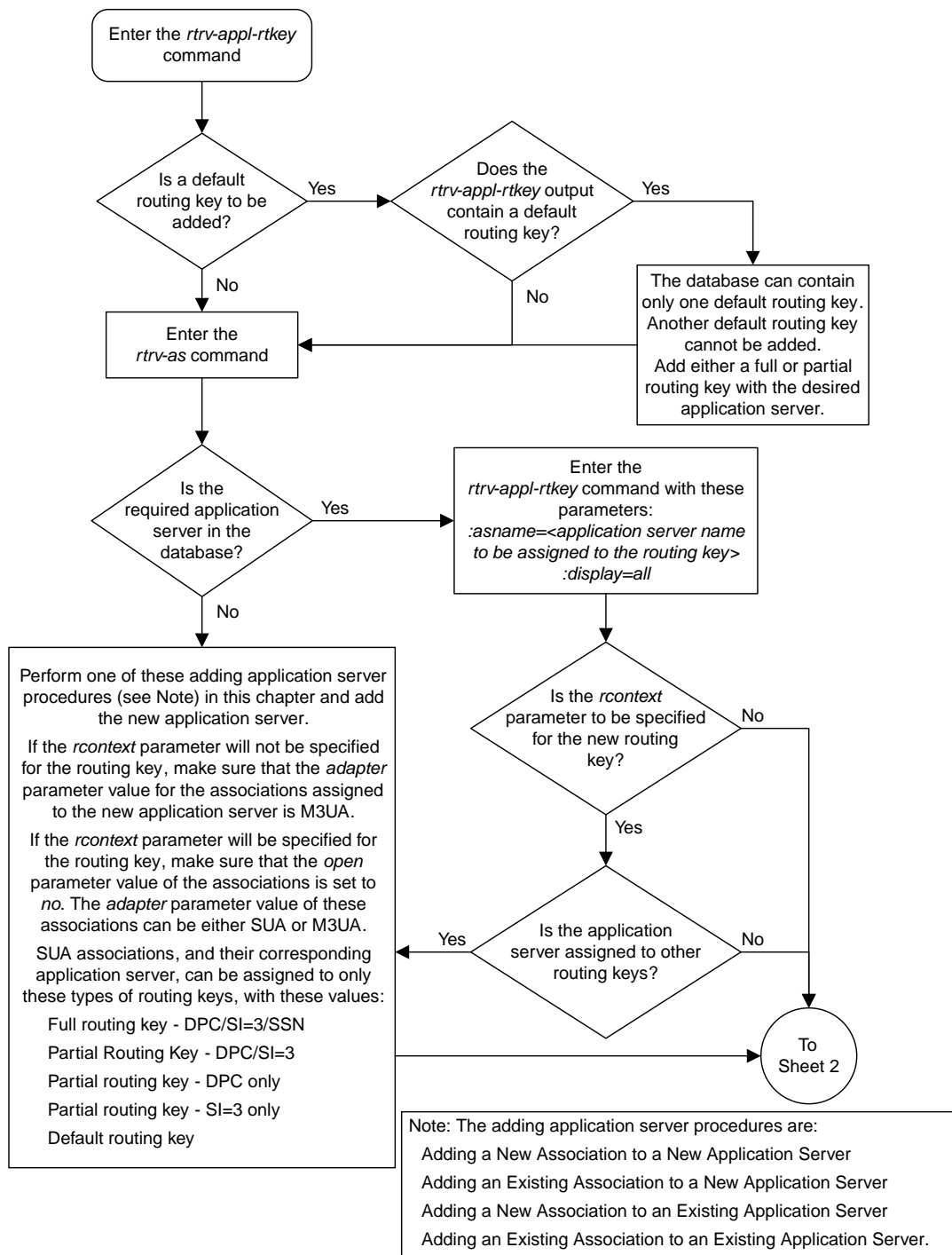

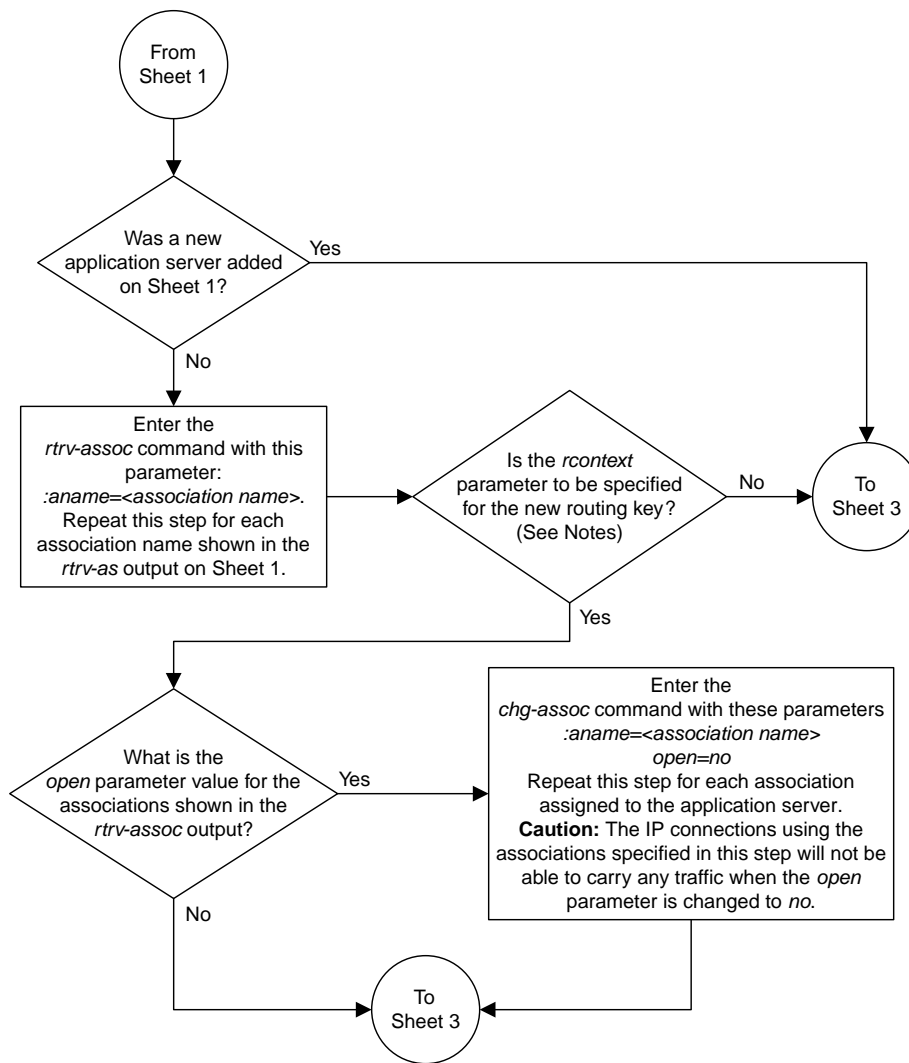

Notes:

1. If the *adapter* parameter value for the application server is SUA, and a new application server is specified for the routing key, the *rcontext* parameter is required.
2. If the *adapter* parameter value for the application server is M3UA, and a new application server is specified for the routing key, the *rcontext* parameter is optional.
3. If the application server is assigned to other routing keys, the *rcontext* parameter cannot be specified for this routing key. An application server can be assigned to only one routing key that contains an *rcontext* parameter value.

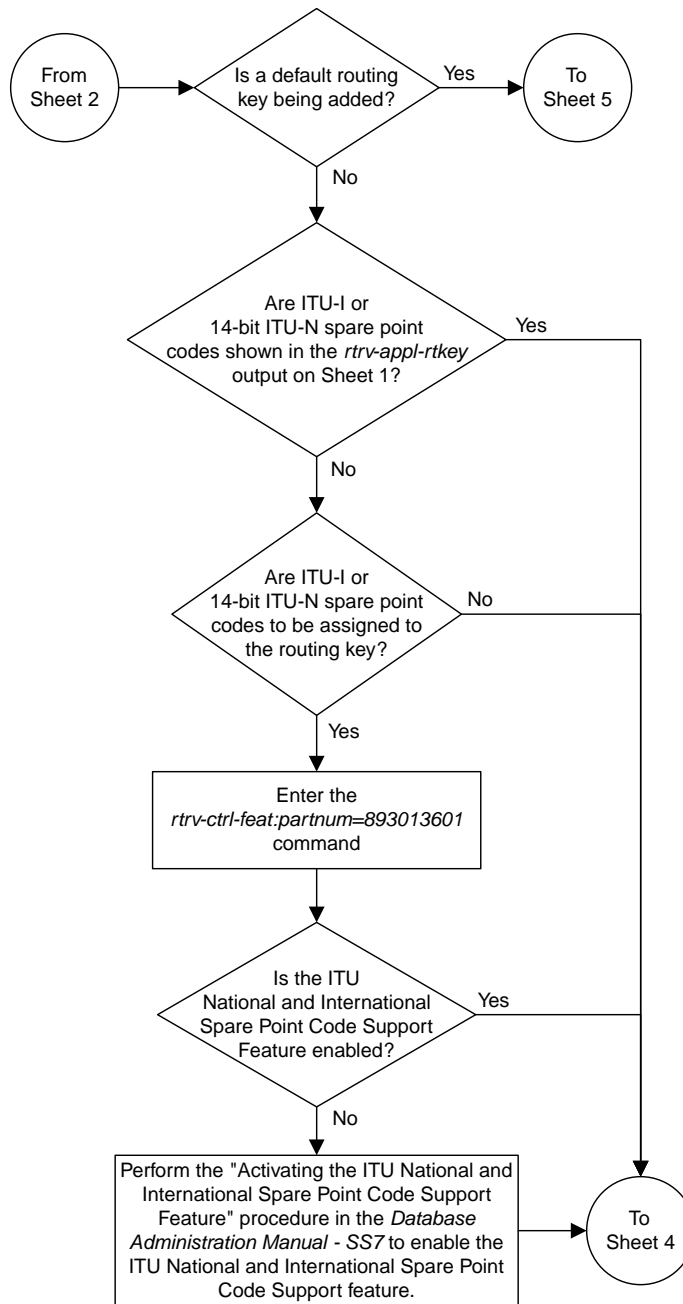

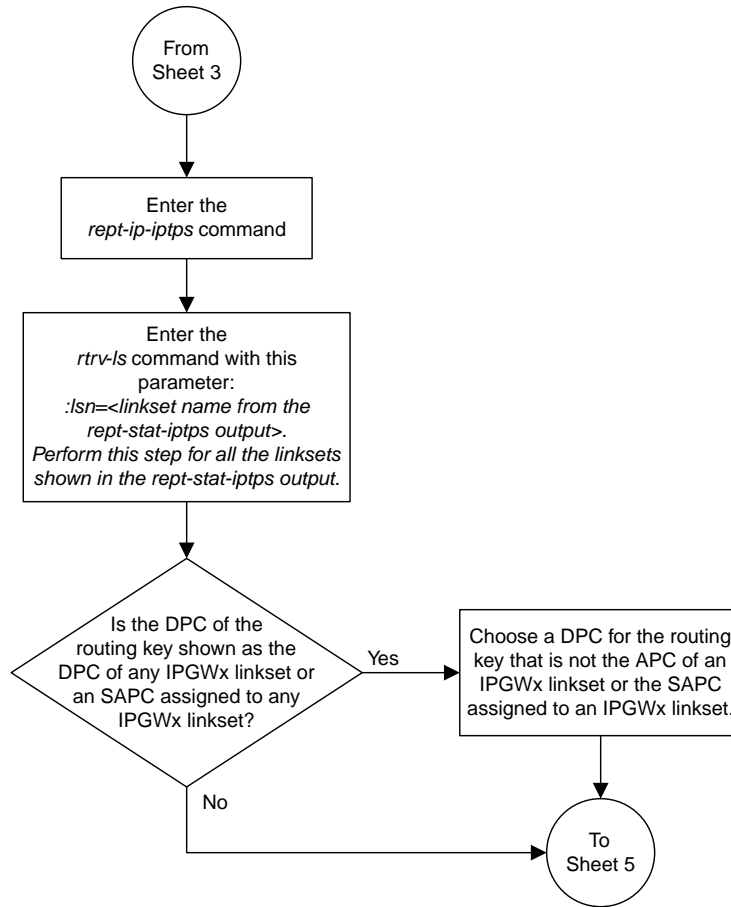

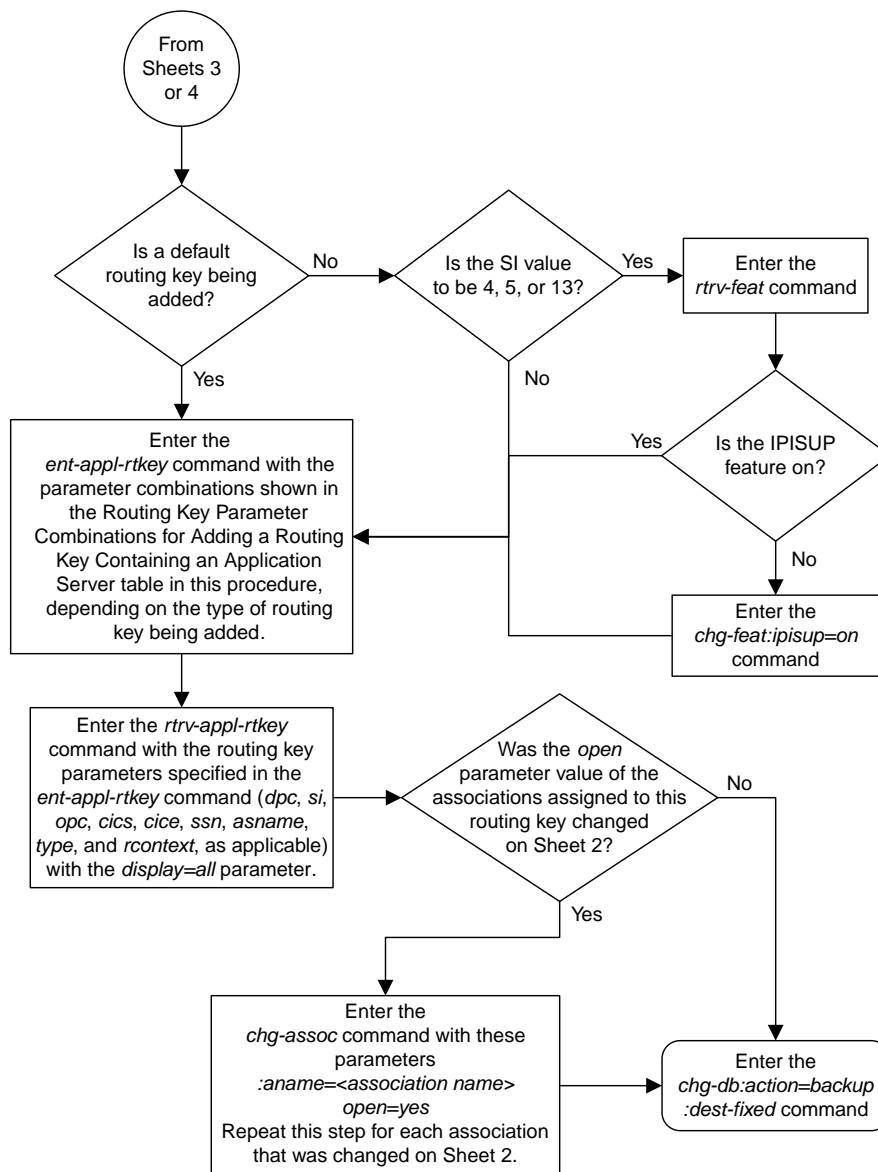

Sheet 5 of 5

Figure 54: Adding a Routing Key Containing an Application Server

Adding a Network Appearance

The network appearance field identifies the SS7 network context for the message, for the purpose of logically separating the signaling traffic between the SGP (signaling gateway process) and the ASP (application server process) over a common SCTP (stream control transmission protocol) association. This field is contained in the DATA, DUNA, DAVA, DRST, DAUD, SCON, and DUPU messages.

The network appearance is provisioned in the database using the `ent-na` command with these parameters.

`:na` – the 32-bit value of the network appearance, from 0 to 4294967295.

`:type` – the network type of the network appearance, `ansi` (ANSI), `itui` (ITU-I), `itun` (14-bit ITU-N), `itun24` (24-bit ITU-N), `ituis` (ITU-I Spare), `ituns` (14-bit ITU-N Spare).

`:gc` – the specific ITU-N group code associated with the network appearance.

The `gc` parameter can be specified only with the `type=itun` or `type=ituns` parameters.

The `gc` parameter must be specified with the `type=itun` or `type=ituns` parameters if the ITU Duplicate Point Code feature is on. If the ITU Duplicate Point Code feature is off, the `gc` parameter cannot be specified.

The `gc` parameter value must be shown in the `rtrv-spc` or `rtrv-sid` outputs.

The `ituis` or `ituns` parameters can be specified only if the ITU National and International Spare Point Code Support feature is enabled.

1. Display the network appearances in the database with the `rtrv-na` command. This is an example of the possible output.

```
rlghncxa03w 06-10-28 09:12:36 GMT EAGLE5 36.0.0
TYPE  GC      NA
ANSI  --      100
ITUN  FR      4000000000
ITUN  GE      1000000000
```

Note: If the `gc` parameter is not being specified in this procedure, continue the procedure with [Step 4](#).

2. Display the self-identification of the EAGLE using the `rtrv-sid` command. This is an example of the possible output.

```
rlghncxa03w 06-10-28 09:12:36 GMT EAGLE5 36.0.0
PCA          PCI          PCN          CLLI          PCTYPE
001-001-001  1-200-6          13482        rlghncxa03w  OTHER

CPCA
002-002-002      002-002-003      002-002-004      002-002-005
002-002-006      002-002-007      002-002-008      002-002-009
004-002-001      004-003-003      144-212-003
```

```

CPCA (LNP)
005-005-002      005-005-004      005-005-005

CPCI
1-001-1          1-001-2          1-001-3          1-001-4

CPCN
02091           02092           02094           02097
02191           02192           11177

```

If the desired group code is shown in the `rtrv-sid` output, continue the procedure with [Step 4](#).

3. Display the secondary point codes in the database with the `rtrv-spc` command. This is an example of the possible output.

```

rlghncxa03w 06-10-28 09:12:36 GMT EAGLE5 36.0.0
SPC (Secondary Point Codes)

SPCA
001-010-010
002-010-010
003-010-010

SPC-I
1-253-5
2-254-6
3-255-7

SPC-N
10-01-11-1-fr
13-02-12-0-ge
13-02-12-0-uk

SPC-N24
none

Secondary Point Code table is (9 of 40) 23% full

```

If the desired group code is not shown in the `rtrv-spc` or `rtrv-sid` outputs, go to the “Adding a Secondary Point Code” procedure in *Database Administration - SS7 User’s Guide* to turn the ITU Duplicate Point Code feature on, and add a secondary point code to the database with the desired group code value.

If the `ituis` or `ituns` parameters will not be specified in this procedure, continue the procedure with [Step 5](#).

If the `ituis` or `ituns` parameters will be specified in this procedure, and ITU-I spare or 14-bit ITU-N spare network appearances are shown in the `rtrv-na` output in [Step 1](#), or ITU-I spare or 14-bit ITU-N spare point codes are shown in the `rtrv-sid` output in [Step 2](#), continue the procedure with [Step 5](#).

4. Display the status of the ITU National and International Spare Point Code Support feature by entering the `rtrv-ctrl-feat` command with the ITU National and International Spare Point Code Support feature part number. Enter this command.

```
rtrv-ctrl-feat:partnum=893013601
```

The following is an example of the possible output.

```
rlghncxa03w 06-10-28 21:15:37 GMT EAGLE5 36.0.0
The following features have been permanently enabled:

Feature Name          Partnum   Status   Quantity
Spare Point Code Support 893013601 on      ----

The following features have been temporarily enabled:

Feature Name          Partnum   Status   Quantity   Trial Period Left
Zero entries found.

The following features have expired temporary keys:

Feature Name          Partnum
Zero entries found.
```

If the ITU National and International Spare Point Code Support feature is not enabled, perform the “Activating the ITU National and International Spare Point Code Support feature” procedure in *Database Administration - SS7 User’s Guide* and enable and turn on the ITU National and International Spare Point Code Support feature.

5. Add the network appearance to the database with the `ent-na` command.

If the `gc` parameter is specified with the `ent-na` command, the `gc` parameter value must be shown in the `rtrv-sid` output in [Step 2](#), or assigned to an ITU-N point code (SPC-N) shown in the `rtrv-spc` output in [Step 3](#). For this example, enter these commands.

```
ent-na:na=1000:type=itui
ent-na:na=3:type=itun24
ent-na:na=150000:type=itun:gc=uk
ent-na:na=2000:type=ituis
ent-na:na=5000:type=ituns:gc=sp
```

When each of these commands have successfully completed, this message should appear.

```
rlghncxa03w 06-10-28 09:12:36 GMT EAGLE5 36.0.0
ENT-NA:  MASP A - COMPLTD
```

6. Verify the changes using the `rtrv-na` command. This is an example of the possible output.

```
rlghncxa03w 06-10-28 09:12:36 GMT EAGLE5 36.0.0
TYPE      GC      NA
ANSI      --      100
ITUI      --      1000
ITUN      uk      150000
ITUN      fr      4000000000
ITUN      ge      1000000000
ITUN24    --      3
ITUIS     --      2000
ITUNS     sp      5000
```

7. Back up the new changes, using the `chg-db:action=backup:dest=fixed` command.

These messages should appear; the active Maintenance and Administration Subsystem Processor (MASP) appears first.

```
BACKUP (FIXED) : MASP A - Backup starts on active MASP.  
BACKUP (FIXED) : MASP A - Backup on active MASP to fixed disk complete.  
BACKUP (FIXED) : MASP A - Backup starts on standby MASP.  
BACKUP (FIXED) : MASP A - Backup on standby MASP to fixed disk complete.
```

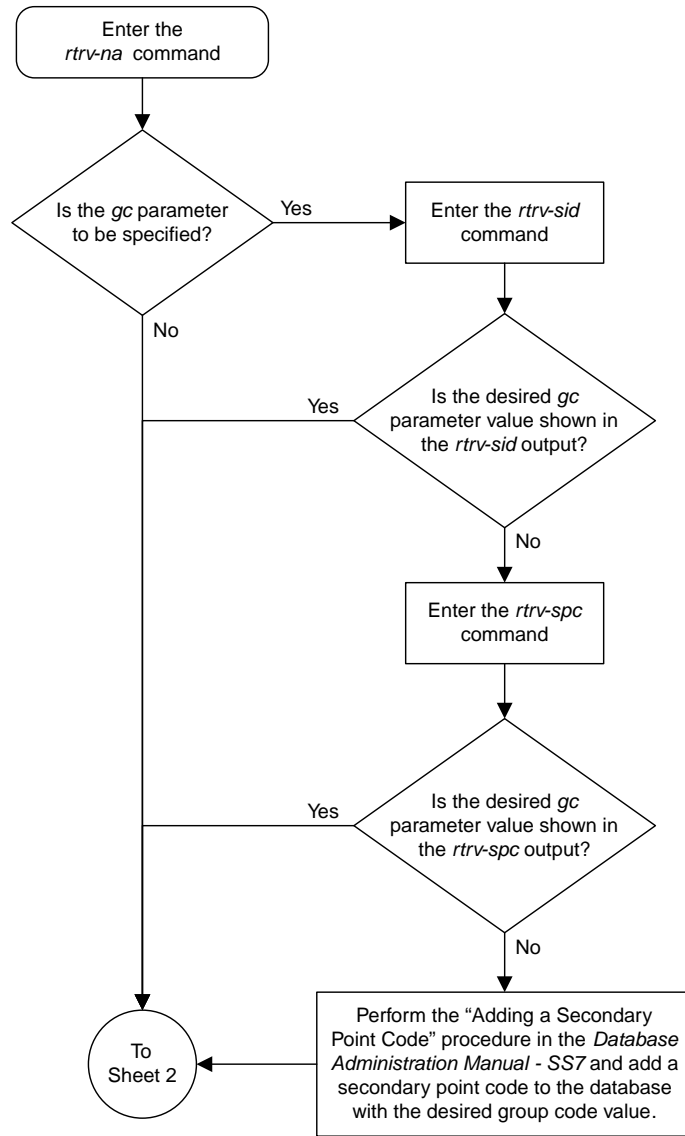

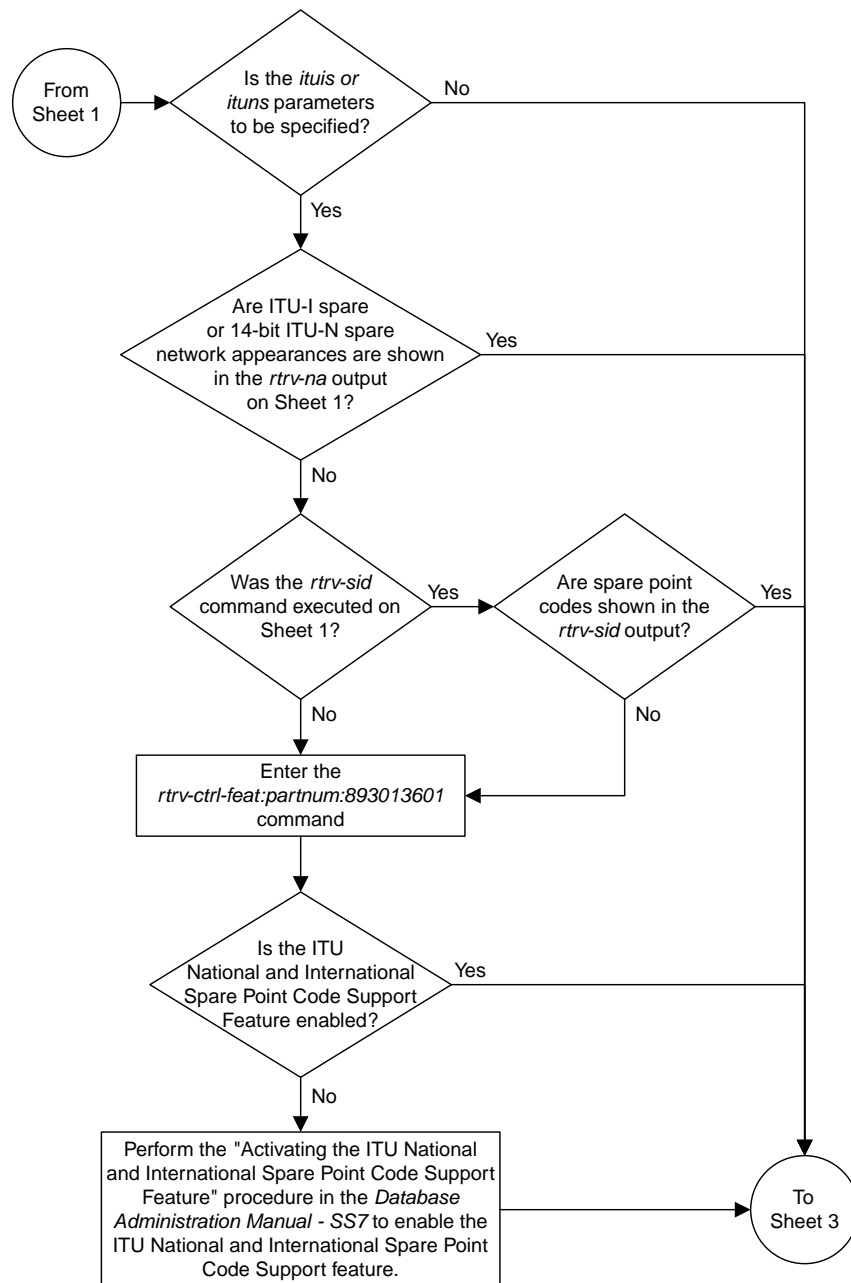

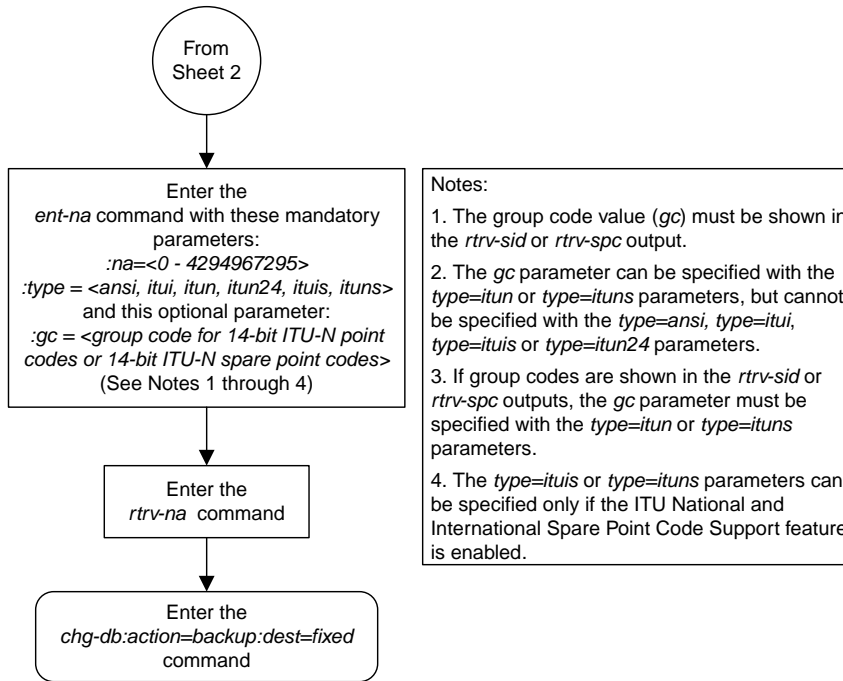

Sheet 3 of 3

Figure 55: Adding a Network Appearance

Activating the Large MSU Support for IP Signaling Feature

This procedure is used to enable and turn on the Large MSU Support for IP Signaling feature using the feature's part number and a feature access key.

The feature access key for the Large MSU Support for IP Signaling feature is based on the feature's part number and the serial number of the EAGLE, making the feature access key site-specific.

The `enable-ctrl-feat` command enables the controlled feature by inputting the controlled feature's access key and the controlled feature's part number with these parameters:

Note: As of Release 46.3, the `fak` parameter is no longer required. This parameter is only used for backward compatibility.

`: fak` – The feature access key provided by Oracle. The feature access key contains 13 alphanumeric characters and is not case sensitive.

`: partnum` – The Oracle-issued part number of the Large MSU Support for IP Signaling feature, 893018401.

The `enable-ctrl-feat` command requires that the database contain a valid serial number for the EAGLE, and that this serial number is locked. This can be verified with the `rtrv-serial-num` command. The EAGLE is shipped with a serial number in the database, but the serial number is not locked. The serial number can be changed, if necessary, and locked once the EAGLE is on-site, by using the `ent-serial-num` command. The `ent-serial-num` command uses these parameters.

`: serial` – The serial number assigned to the EAGLE. The serial number is not case sensitive.

`: lock` – Specifies whether or not the serial number is locked. This parameter has only one value, `yes`, which locks the serial number. Once the serial number is locked, it cannot be changed.

Note: To enter and lock the EAGLE's serial number, the `ent-serial-num` command must be entered twice, once to add the correct serial number to the database with the `serial` parameter, then again with the `serial` and the `lock=yes` parameters to lock the serial number. You should verify that the serial number in the database is correct before locking the serial number. The serial number can be found on a label affixed to the control shelf (shelf 1100).

This feature cannot be temporarily enabled (with the temporary feature access key).

Once this feature has been enabled, the feature must be turned on with the `chg-ctrl-feat` command. The `chg-ctrl-feat` command uses these parameters:

`: partnum` – The Oracle-issued part number of the Large MSU Support for IP Signaling feature, 893018401.

`: status=on` – used to turn the Large MSU Support for IP Signaling feature on.

Once the Large MSU Support for IP Signaling feature has been turned on, it can be turned off. For more information about turning the Large MSU Support for IP Signaling feature off, go to the [Turning Off the Large MSU Support for IP Signaling Feature](#) procedure.

The status of the features in the EAGLE is shown with the `rtrv-ctrl-feat` command.

The Large MSU Support for IP Signaling feature allows the EAGLE to process messages with a service indicator value of 6 to 15 and with a service information field (SIF) that is larger than 272 bytes. The large messages are processed only on E5-ENET cards. There are certain software components that if enabled or provisioned, that will not process large messages even if the Large MSU Support for IP Signaling feature is enabled and turned on. UIMs are displayed when most of these circumstances occur. These UIMs are:

- UIM 1333 – Displayed when a large message is received on an M3UA association and the Large MSU Support for IP Signaling feature is not enabled or is enabled and turned off. The large message is discarded.
- UIM 1350 – Displayed when a M2PA IP connection receives message with an SIF greater than 272 bytes and the Large MSU Support for IP Signaling feature is not enabled or is enabled and turned off. The large message is discarded.
- UIM 1352 – Displayed when a message with an SIF greater than 272 bytes is received; the Large MSU Support for IP Signaling feature is enabled and turned on; there are routes available for the destination point code; but the selected outbound card does not support large messages.
- UIM 1353 – Displayed when a large message passes a gateway screening screenset that redirects messages for the Database Transport Access (DTA) feature. Large messages are not redirected for the DTA feature.
- UIM 1354 – Displayed when a large message passes a gateway screening screenset that copies messages for the STPLAN feature. Large messages are not copied for the STPLAN feature.

For more information on these UIMs, refer to the *Unsolicited Alarm and Information Messages Reference*.

Note: Large messages are not monitored by the EAGLE 5 Integrated Monitoring Support feature and are not sent to the IMF. A UIM is not generated.

1. Display the status of the controlled features by entering the `rtrv-ctrl-feat` command.

The following is an example of the possible output.

```
rlghncxa03w 08-04-28 21:15:37 GMT EAGLE5 38.0.0
The following features have been permanently enabled:

Feature Name           Partnum   Status   Quantity
Command Class Management 893005801 on       ----
LNP Short Message Service 893006601 on       ----
Intermed GTT Load Sharing 893006901 on       ----
XGTT Table Expansion     893006101 on       400000
XMAP Table Expansion     893007710 off      ----
Large System # Links     893005910 on       2000
Routesets                893006401 on       6000
HC-MIM SLK Capacity      893012707 on       64

The following features have been temporarily enabled:

Feature Name           Partnum   Status   Quantity   Trial Period Left
Zero entries found.

The following features have expired temporary keys:

Feature Name           Partnum
Zero entries found.
```

If the Large MSU Support for IP Signaling feature is enabled and turned on, no further action is necessary. This procedure does not need to be performed.

If the Large MSU Support for IP Signaling feature is enabled and but not turned on, continue the procedure with [Step 7](#).

If the Large MSU Support for IP Signaling feature is not enabled, continue the procedure with [Step 2](#).

Note: If the `trv-ctrl-feat` output in [Step 1](#) shows any controlled features, continue this procedure with [Step 6](#). If the `trv-ctrl-feat` output shows only the HC-MIM SLK Capacity feature with a quantity of 64, [Step 2](#) through [Step 5](#) must be performed.

2. Display the serial number in the database with the `rtrv-serial-num` command.

This is an example of the possible output.

```
rlghncxa03w 06-10-28 21:15:37 GMT EAGLE5 36.0.0
System serial number = nt00001231

System serial number is not locked.

rlghncxa03w 06-10-28 21:15:37 GMT EAGLE5 36.0.0
Command Completed
```

Note: If the serial number is correct and locked, continue the procedure with [Step 6](#). If the serial number is correct but not locked, continue the procedure with [Step 5](#). If the serial number is not correct, but is locked, this feature cannot be enabled and the remainder of this procedure cannot be performed. Contact the Customer Care Center to get an incorrect and locked serial number changed. Refer to [My Oracle Support \(MOS\)](#) for the contact information. The serial number can be found on a label affixed to the control shelf (shelf 1100).

3. Enter the correct serial number into the database using the `ent-serial-num` command with the `serial` parameter.

For this example, enter this command.

```
ent-serial-num:serial=<EAGLE's correct serial number>
```

When this command has successfully completed, the following message should appear.

```
rlghncxa03w 06-10-28 21:15:37 GMT EAGLE5 36.0.0
ENT-SERIAL-NUM:  MASP A - COMPLTD
```

4. Verify that the serial number entered into [Step 3](#) was entered correctly using the `rtrv-serial-num` command.

This is an example of the possible output.

```
rlghncxa03w 06-10-28 21:15:37 GMT EAGLE5 36.0.0
System serial number = nt00001231

System serial number is not locked.

rlghncxa03w 06-10-28 21:15:37 GMT EAGLE5 36.0.0
Command Completed
```

If the serial number was not entered correctly, repeat [Step 3](#) and [Step 4](#) and re-enter the correct serial number.

5. Lock the serial number in the database by entering the `ent-serial-num` command with the serial number shown in [Step 2](#), if the serial number shown in [Step 2](#) is correct, or with the serial number shown in [Step 4](#), if the serial number was changed in [Step 3](#), and with the `lock=yes` parameter.

For this example, enter this command.

```
ent-serial-num:serial=<EAGLE's serial number>:lock=yes
```

When this command has successfully completed, the following message should appear.

```
rlghncxa03w 06-10-28 21:15:37 GMT EAGLE5 36.0.0
ENT-SERIAL-NUM: MASP A - COMPLTD
```

6. Enable the Large MSU Support for IP Signaling feature with the `enable-ctrl-feat` command specifying the part number for the Large MSU Support for IP Signaling feature and the feature access key. Enter this command.

```
enable-ctrl-feat:partnum=893018401:fak=<Large MSU Support for IP Signaling
feature access key>
```

Note: A temporary feature access key cannot be specified to enable this feature.

Note: The values for the feature access key (the `fak` parameter) are provided by Oracle. If you do not have the feature access key for the feature you wish to enable, contact your Sales Representative or Account Representative.

When the `enable-ctrl-feat` command has successfully completed, this message should appear.

```
rlghncxa03w 06-10-28 21:15:37 GMT EAGLE5 36.0.0
ENABLE-CTRL-FEAT: MASP B - COMPLTD
```

7. Turn the Large MSU Support for IP Signaling feature on with the `chg-ctrl-feat` command specifying the part number for the Large MSU Support for IP Signaling feature and the `status=on` parameter. Enter this command.

```
chg-ctrl-feat:partnum=893018401:status=on
```

When the `chg-ctrl-feat` command has successfully completed, this message should appear.

```
rlghncxa03w 07-05-28 21:15:37 GMT EAGLE5 37.0.0
CHG-CTRL-FEAT: MASP B - COMPLTD
```

8. Verify the changes by entering the `rtrv-ctrl-feat` command with the Large MSU Support for IP Signaling feature part number. Enter this command.

```
rtrv-ctrl-feat:partnum=893018401
```

The following is an example of the possible output.

```
rlghncxa03w 10-04-28 21:15:37 GMT EAGLE5 42.0.0
The following features have been permanently enabled:
```

Feature Name	Partnum	Status	Quantity
Large MSU for IP Sig	893018401	on	----

```
The following features have been temporarily enabled:
```

```
Feature Name          Partnum   Status   Quantity   Trial Period Left
Zero entries found.
```

```
The following features have expired temporary keys:
```

```
Feature Name          Partnum
Zero entries found.
```

9. Back up the new changes using the `chg-db:action=backup:dest=fixed` command. These messages should appear, the active Maintenance and Administration Subsystem Processor (MASP) appears first.

```
BACKUP (FIXED) : MASP A - Backup starts on active MASP.
BACKUP (FIXED) : MASP A - Backup on active MASP to fixed disk complete.
BACKUP (FIXED) : MASP A - Backup starts on standby MASP.
BACKUP (FIXED) : MASP A - Backup on standby MASP to fixed disk complete.
```

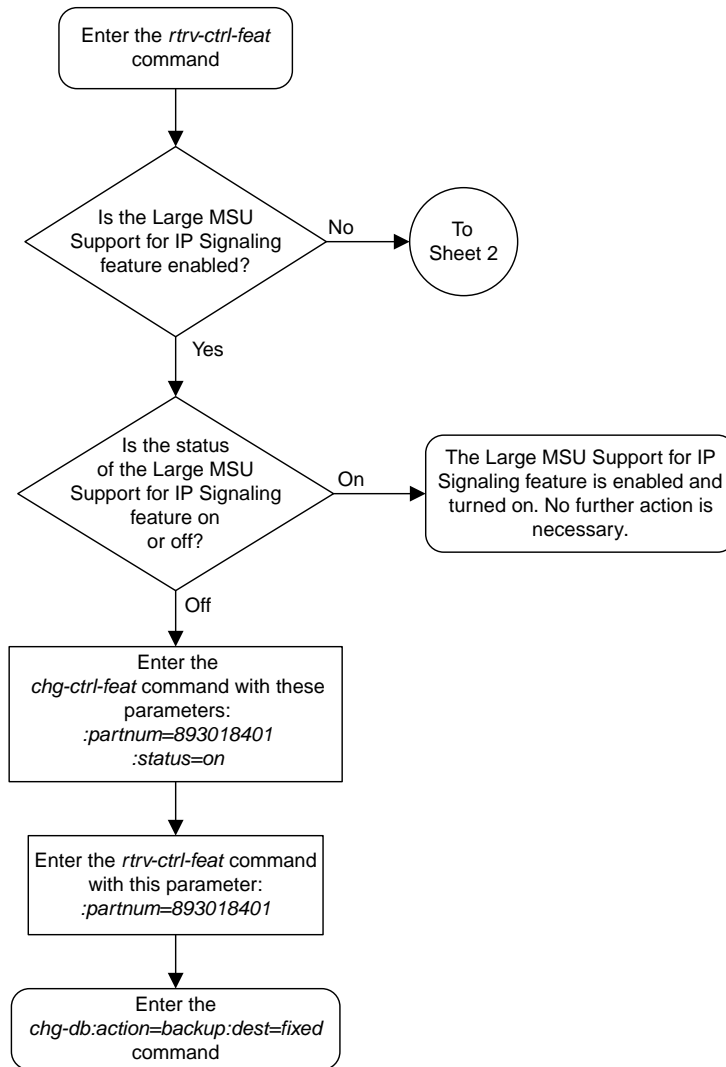

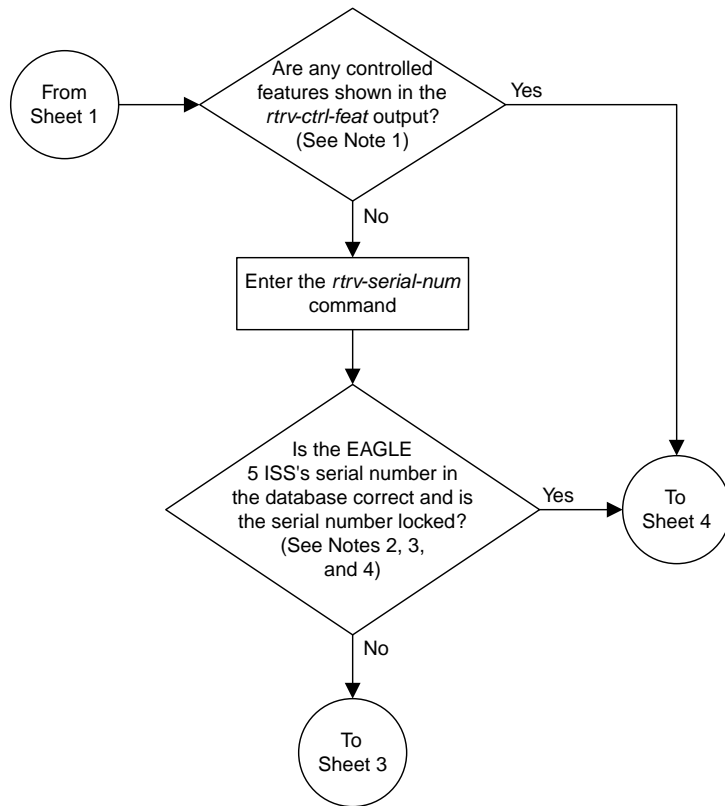

Notes:

1. If the *rtrv-ctrl-feat* output shows only the HC -MIM SLK Capacity feature with a quantity of 64, the answer to this question is no and the Eagle 5 ISS's serial number must be verified. This is the default entry for the *rtrv-ctrl-feat* output. This entry is shown whether or not the Eagle 5 ISS's serial number is in the database.
2. If the serial number is locked, it cannot be changed.
3. If the serial number is not locked, the controlled feature cannot be enabled.
4. The serial number can be found on a label affixed to the control shelf (shelf 1100).

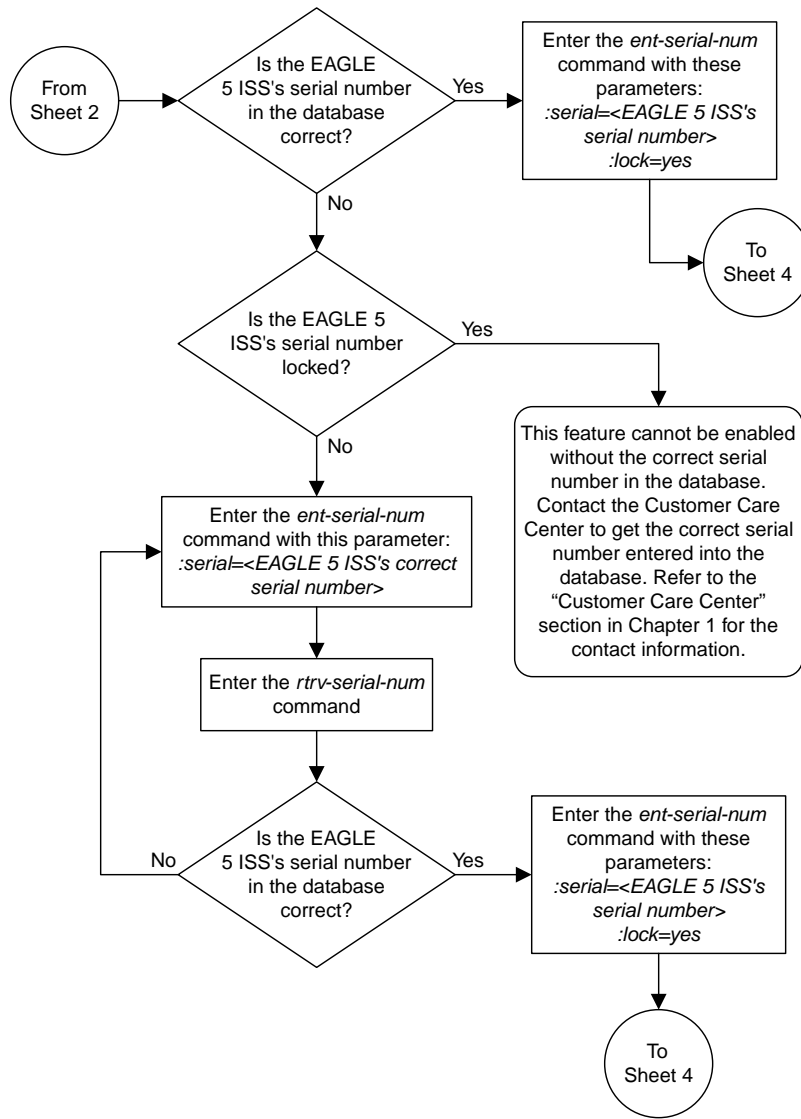

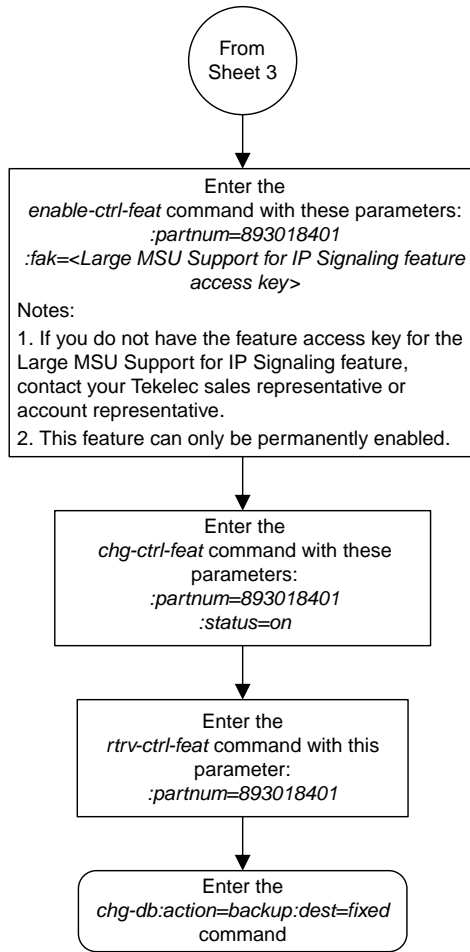

Sheet 4 of 4

Figure 56: Activating the Large MSU Support for IP Signaling Feature

Removing IETF M3UA and SUA Components

This section describes how to remove the following components from the database.

- An IPGWx Card – Perform the *Removing an IPGWx Card* procedure
- A mate IPGWx linkset from another IPGWx linkset – Perform the *Removing a Mate IPGWx Linkset from another IPGWx Linkset* procedure
- An IPGWx Signaling Link – Perform the *Removing an IPGWx Signaling Link* procedure
- An IP Host – Perform the *Removing an IP Host Assigned to an IPGWx Card* procedure
- An IP Route – Perform the *Removing an IP Route* procedure
- An M3UA or SUA Association – Perform the *Removing a M3UA or SUA Association* procedure
- An Association from an Application Server – Perform the *Removing an Association from an Application Server* procedure
- A Routing Key – Perform the *Removing a Routing Key Containing an Application Server* procedure
- A Network Appearance – Perform the *Removing a Network Appearance* procedure

Removing an IPGWx Card

Use this procedure to remove an IP card, a card running one of these applications: `ss7ipgw` or `ipgwi`, from the database using the `dlc-card` command.

The card cannot be removed if it does not exist in the database. Prior to removing the card from the database, the signaling links assigned to the card must be removed.



CAUTION

Caution: If the IPGWx card is the last IP card in service, removing this card from the database will cause traffic to be lost.

1. Display the cards in the database using the `rtrv-card` command.

This is an example of the possible output.

```

rlghncxa03w 09-10-15 16:34:56 GMT EAGLE5 41.0.0
CARD   TYPE      APPL      LSET NAME      LINK SLC LSET NAME      LINK SLC
1101   DSM        VSCCP
1102   TSM        GLS
1104   DCM        STPLAN
1113   GSPM      EOAM
1114   TDM-A
1115   GSPM      EOAM
1116   TDM-B
1117   MDAL
1201   LIMDS0    SS7ANSI    lsn1           A      0      lsn2           B      1
1203   LIMDS0    SS7ANSI    lsn2           A      0      lsn1           B      1
1204   LIMATM    ATMANSI    atmgwy        A      0

```

1205	DCM	IPLIM	ipnode1	A	0	ipnode3	B	1
1207	DCM	IPLIM	ipnode2	A	0			
1303	DCM	IPLIM	ipnode1	A	0	ipnode3	B	1
1305	DCM	IPLIM	ipnode4	A	0			

Select a card whose application is either SS7IPGW or IPGWI.

Perform the [Removing an IPGWx Signaling Link](#) procedure to remove all the signaling links assigned to the card, shown in the LINK column of the rtrv-card output.

The card location is shown in the CARD field of the rtrv-card command output. No entries in the LSET NAME, LINK, and SLC columns mean that no signaling link is assigned to the card.

- Remove the card from the database using the dlt-card command.

The dlt-card command has only one parameter, loc, which is the location of the card. For this example, enter these commands.

```
dlt-card:loc=1205
```

```
dlt-card:loc=1207
```

When these commands have successfully completed, this message appears.

```
rlghncxa03w 06-10-12 09:12:36 GMT EAGLE5 36.0.0
DLT-CARD: MASP A - COMPLTD
```

- Verify the changes using the rtrv-card command and specifying the card that was removed in [Step 2](#).

For this example, enter these commands.

```
rtrv-card:loc=1205
```

```
rtrv-card:loc=1207
```

When these commands have successfully completed, this message appears.

```
E2144 Cmd Rej: Location invalid for hardware configuration
```

- Back up the new changes using the chg-db:action=backup:dest=fixed command.

These messages appear, the active Maintenance and Administration Subsystem Processor (MASP) appears first.

```
BACKUP (FIXED) : MASP A - Backup starts on active MASP.
BACKUP (FIXED) : MASP A - Backup on active MASP to fixed disk complete.
BACKUP (FIXED) : MASP A - Backup starts on standby MASP.
BACKUP (FIXED) : MASP A - Backup on standby MASP to fixed disk complete.
```

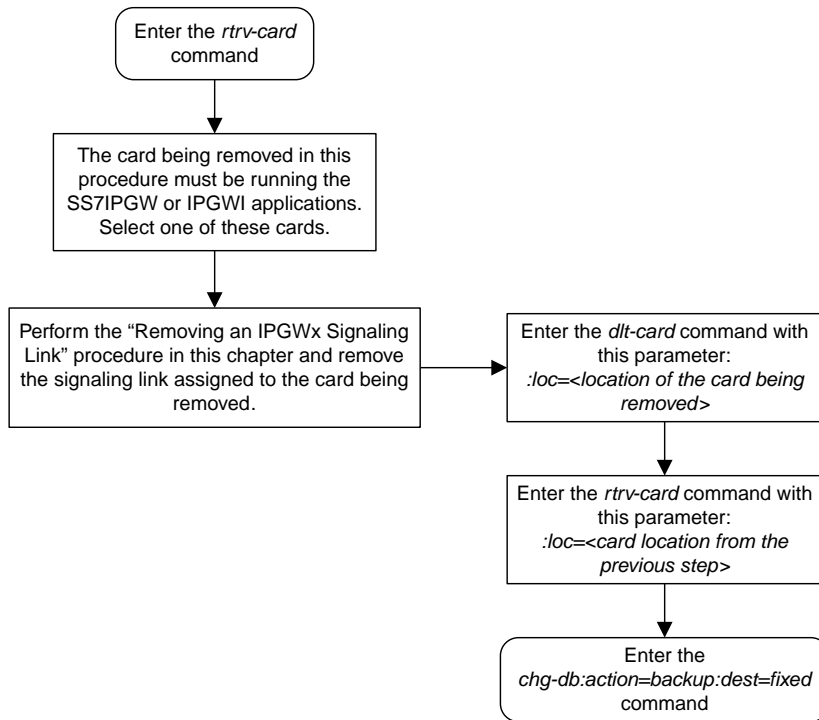

Figure 57: Removing an IPGWx Card

Removing an IPGWx Signaling Link

This procedure is used to remove an IPGWx signaling link from the database using the `dlt-slk` command. The `dlt-slk` command uses these parameters.

`:loc` – The card location of the IP card that the IP signaling link is assigned to.

`:link` – The signaling link on the card specified in the `loc` parameter.

`:force` – This parameter must be used to remove the last link in a linkset without having to remove all of the routes that referenced the linkset.

The `tfatcabmlq` parameter (TFA/TCA Broadcast Minimum Link Quantity), assigned to linksets, shows the minimum number of links in the given linkset (or in the combined link set in which it resides) that must be available for traffic. When the number of signaling links in the specified linkset is equal to or greater than the value of the `tfatcabmlq` parameter, the status of the routes that use the specified linkset is set to allowed and can carry traffic. Otherwise, these routes are restricted. The value of the `tfatcabmlq` parameter cannot exceed the total number of signaling links contained in the linkset.

If the linkset type of the linkset that contains the signaling link that is being removed is either A, B, D, E, or PRX, the signaling link can be removed regardless of the `tfatcabmlq` parameter value of the linkset and regardless of the `LSRESTRICT` option value. When a signaling link in one of these types of linksets is removed, the `tfatcabmlq` parameter value of the linkset is decreased automatically.

If the linkset type of the linkset that contains the signaling link that is being removed is C, the signaling link can be removed only:

- If the `LSRESTRICT` option is off. The `LSRESTRICT` option value is shown in the `rtrv-ss7opts` output.
- If the `LSRESTRICT` option is on and the number of signaling links assigned to the linkset will be equal to or greater than the value of the `tfatcabmlq` parameter value of the linkset after the signaling link is removed.

The `tfatcabmlq` parameter value of the linkset is shown in the `TFATCABMLQ` column of the `rtrv-ls:lsn=<linkset name>` output. The `tfatcabmlq` parameter value can be a fixed value (1 to 16) or 0. If the `tfatcabmlq` parameter value of the linkset is a fixed value, the number of signaling links that are in the linkset after the signaling link is removed must be equal to or greater than the `tfatcabmlq` parameter value of the linkset.

If the `tfatcabmlq` parameter value is 0, the signaling link can be removed. When the `tfatcabmlq` parameter value is 0, the value displayed in the `TFATCABMLQ` column of the `rtrv-ls` output is 1/2 of the number of signaling links contained in the linkset. If the number of signaling links in the linkset is an odd number, the `tfatcabmlq` parameter value is rounded up to the next whole number. As the signaling links are removed, the `tfatcabmlq` parameter value of the linkset is decreased automatically.

Canceling the `RTRV-SLK` Command

Because the `rtrv-slk` command used in this procedure can output information for a long period of time, the `rtrv-slk` command can be canceled and the output to the terminal stopped. There are three ways that the `rtrv-slk` command can be canceled.

- Press the F9 function key on the keyboard at the terminal where the `rtrv-slk` command was entered.
- Enter the `canc-cmd` without the `trm` parameter at the terminal where the `rtrv-slk` command was entered.
- Enter the `canc-cmd:trm=<xx>`, where `<xx>` is the terminal where the `rtrv-slk` command was entered, from another terminal other than the terminal where the `rtrv-slk` command was entered. To enter the `canc-cmd:trm=<xx>` command, the terminal must allow Security Administration commands to be entered from it and the user must be allowed to enter Security Administration commands. The terminal's permissions can be verified with the `rtrv-secu-trm` command. The user's permissions can be verified with the `rtrv-user` or `rtrv-secu-user` commands.

For more information about the `canc-cmd` command, go to *Commands User's Guide*.

1. Display the current link configuration using the `rtrv-slk` command.

This is an example of the possible output.

```

rlghncxa03w 09-07-19 21:16:37 GMT EAGLE5 41.1.0

LOC  LINK  LSN          SLC  TYPE      L2T          SET  BPS      ECM  PCR  PCR
1201  A      ls01           0    LIMDS0    1           56000  BASIC ---  -----
1201  B      lsa1           0    LIMDS0    1           56000  BASIC ---  -----
1203  A      ls03           0    LIMDS0    3           56000  BASIC ---  -----
1203  B      lsa2           0    LIMDS0    1           56000  BASIC ---  -----
1204  B      ls01           1    LIMDS0    1           56000  BASIC ---  -----
1207  A      lsn1207a      0    LIMDS0    1           56000  BASIC ---  -----
1207  B      lsn1207b     0    LIMDS0    1           56000  BASIC ---  -----
1208  B      ls03           1    LIMDS0    3           56000  BASIC ---  -----
1213  B      ls05           0    LIMDS0    5           56000  BASIC ---  -----
1215  A      ls05           1    LIMDS0    5           56000  BASIC ---  -----
1311  A      ls01           2    LIMDS0    1           56000  BASIC ---  -----
1311  A1     ls05           2    LIMDS0    5           56000  BASIC ---  -----
1311  B      ls03           2    LIMDS0    3           56000  BASIC ---  -----
1311  B1     ls07           1    LIMDS0    7           56000  BASIC ---  -----
1313  A      ls07           0    LIMDS0    7           56000  BASIC ---  -----

LOC  LINK  LSN          SLC  TYPE      LP           SET  BPS      ATM  TSEL  VCI  VPI  LL
1302  A      atmansi0      0    LIMATM    3           1544000  EXTERNAL 35  15  0
1305  A      atmansi1      0    LIMATM    4           1544000  INTERNAL 100 20  2
1318  A      atmansi0      1    LIMATM    9           1544000  LINE     150 25  4

LOC  LINK  LSN          SLC  TYPE      LP           SET  BPS      ATM  TSEL  VCI  VPI  CRC4  SI  SN
2101  A      atmitu1      0    LIMELATM  5           2.048M  LINE     150  2  ON  1  20
2105  A      atmitu1      1    LIMELATM  5           2.048M  LINE     35  15  ON  2  15

LOC  LINK  LSN          SLC  TYPE      IPLIML2
2202  A      lsnlp1       0    IPLIM    SAALTALI
2205  A      lsnip1       1    IPLIM    M2PA
2204  B      lsnlp2       0    IPLIM    M2PA
2213  A      lsnip5       0    IPLIMI   M2PA
2215  A      lsnlp2       1    IPLIM    SAALTALI

LOC  LINK  LSN          SLC  TYPE
2207  A      lsnlp3       0    SS7IPGW
2211  A      lsnlp4       0    IPGWI

SLK table is (27 of 1200) 2% full

```

2. Display the linkset that contains the signaling link that is being removed by entering the `rtrv-ls` command with the name of the linkset shown in the LSN column of the `rtrv-slk` output.

For this example, enter these commands.

```
rtrv-ls:lsn=lsnlp3
```

This is an example of the possible output.

```
rlghncxa03w 10-07-17 11:43:04 GMT EAGLE5 42.0.0

LSN          APCA  (SS7)  L3T SLT          GWS GWS GWS
lsnlp3      002-009-003  scr2 1  1  no a  1  on off on no  off
          SPCA          CLLI          TFATCABMLQ MTPRSE ASL8
          -----
          1          no          no

RANDSLS
off

IPSG  IPGWAPC  GTTMODE          CGGTMOD
no    yes    CdPA          no

MATELSN  IPTPS  LSUSEALM  SLKUSEALM
-----  32000  100%     80%

LOC  LINK  SLC  TYPE
1201 A  0  SS7IPGW

Link set table is ( 20 of 1024)  2% full
```

If the linkset type of the linkset is A, B, D, E, or PRX, continue the procedure with [Step 5](#).

If the linkset type of the linkset is C, continue the procedure with [Step 3](#).

3. Display the LSRESTRICT option value by entering the `rtrv-ss7opts` command.

This is an example of the possible output.

```
rlghncxa03w 10-07-30 15:09:00 GMT 42.0.0

SS7 OPTIONS
-----
LSRESTRICT      on
```

Note: The `rtrv-feat` command output contains other fields that are not used by this procedure. If you wish to see all the fields displayed by the `rtrv-feat` command, refer to the `rtrv-feat` command description in *Commands User's Guide*.

The signaling link cannot be removed, if the LSRESTRICT option is on and the number of signaling links assigned to the linkset will be less than the value of the `tfatcabmlq` parameter value of the linkset if the signaling link is removed.

If the LSRESTRICT option is on and the number of signaling links assigned to the linkset will be equal to or greater than the value of the `tfatcabmlq` parameter value of the linkset if the signaling link is removed, continue the procedure with [Step 5](#).

If the LSRESTRICT option is on and the number of signaling links assigned to the linkset will be less than the value of the `tfatcabmlq` parameter value of the linkset if the signaling link is removed, the signaling link cannot be removed unless the `tfatcabmlq` parameter value of the linkset is changed to 0. Continue the procedure with [Step 4](#).

If the LSRESTRICT value is `off`, continue the procedure with [Step 5](#).

4. Change the `tfatcabmlq` parameter value of the linkset to 0 by entering the `chg-ls` command with the name of the linkset that contains the signaling link that is being removed and the `tfatcabmlq` parameters. For this example, enter this command.

```
chg-ls:lsn=ls17:tfatcabmlq=0
```

When this command has successfully completed, this message should appear.

```
rlghncxa03w 10-07-07 08:41:12 GMT EAGLE5 42.0.0
Link set table is (20 of 1024) 2% full.
CHG-LS: MASP A - COMPLTD
```

5. Any in-service IP connections on the signaling link being removed in this procedure must be placed out of service.

Have the far-end node for the signaling link being removed place the M3UA or SUA associations in either the ASP-INACTIVE or ASP-DOWN state.

6. Display the IP link associated with the card that the signaling link being removed the database is assigned to. Enter the `rtrv-ip-lnk` command with the card location of the signaling link being removed shown in [Step 1](#). For this example, enter this command.

```
rtrv-ip-lnk:loc=2207
```

The following is an example of the possible output.

```
rlghncxa03w 06-10-28 21:14:37 GMT EAGLE5 36.0.0
LOC  PORT  IPADDR          SUBMASK          DUPLEX  SPEED  MACTYPE  AUTO  MCAST
2207  A      192.1.1.10      255.255.255.128  HALF    10     802.3    NO    NO
2207  B      -----          -----          HALF    10     DIX      NO    NO
```

7. Display the IP host information associated with the IP link by entering the `rtrv-ip-host` command with the IP address shown in [Step 6](#). For this example, enter these commands.

```
rtrv-ip-host:ipaddr=192.001.001.010
```

The following is an example of the possible output.

```
rlghncxa03w 08-12-28 21:17:37 GMT EAGLE5 40.0.0
LOCAL IPADDR      LOCAL HOST
192.1.1.10        IPNODE1_2207
IP Host table is (11 of 4096) .26% full
```

8. Display the associations associated with the local host name shown in [Step 7](#) by entering the `rtrv-assoc` command. For this example, enter this command.

```
rtrv-assoc: lhost=ipnode1_2207
```

This is an example of possible output.

```
rlghncxa03w 06-10-28 09:12:36 GMT EAGLE5 36.0.0
                CARD IPLNK
ANAME          LOC  PORT  LINK ADAPTER  LPORT  RPORT  OPEN  ALW
assoc1        2207  A     A    M3UA     1030   1030   YES   YES

IP Appl Sock/Assoc table is (4 of 4000) 1% full
Assoc Buffer Space Used (16 KB of 3200 KB) on LOC = 2207
```

9. Change the value of the `open` and `alw` parameters to `no` by specifying the `chg-assoc` command with the `open=no` and `alw=no` parameters, as necessary. For this example, enter this command.

Note: If there is no association shown in [Step 7](#), or the `open` and `alw` parameter values of the association shown in [Step 7](#) are `no`, continue the procedure with [Step 10](#).

```
chg-assoc: aname=assoc1: open=no: alw=no
```

When this command has successfully completed, this message should appear.

```
rlghncxa03w 06-10-28 09:12:36 GMT EAGLE5 36.0.0
CHG-ASSOC: MASP A - COMPLTD;
```

10. Deactivate the link to be removed using the `dact-slk` command, using the output from [Step 1](#) to obtain the card location and link parameter value of the signaling link to be removed. For this example, enter these commands.

```
dact-slk: loc=2207: link=a
```

When each of these command has successfully completed, this message should appear.

```
rlghncxa03w 06-10-07 08:41:12 GMT EAGLE5 36.0.0
Deactivate Link message sent to card
```

11. Verify that the link is out of service - maintenance disabled (OOS-MT-DSBLD) using the `rept-stat-slk` command with the card location and link parameter values specified in [Step 10](#). For this example, enter these commands.

```
rept-stat-slk: loc=2207: link=a
```

This is an example of the possible output.

```
rlghncxa03w 06-10-23 13:06:25 GMT EAGLE5 36.0.0
SLK      LSN      CLLI      PST      SST      AST
2207,A   ls04      ls04clli OOS-MT   Unavail  ----
ALARM STATUS = *      0235 REPT-LNK-MGTINH: local inhibited
UNAVAIL REASON = LI
```

12. Place the card that contains the signaling link shown in [Step 11](#) out of service by entering the `rmv-card` command specifying the card location shown in [Step 11](#). For this example, enter this command.

```
rmv-card:loc=2207
```

When this command has successfully completed, this message should appear.

```
rlghncxa03w 06-10-07 08:41:12 GMT EAGLE5 36.0.0
Card has been inhibited.
```

13. Verify that the card has been inhibited by entering the `rept-stat-card` command with the card location specified in [Step 12](#). For this example, enter this command.

```
rept-stat-card:loc=2207
```

This is an example of the possible output.

```
rlghncxa03w 07-05-27 16:43:42 GMT EAGLE5 37.0.0
CARD   VERSION      TYPE      GPL      PST      SST      AST
2207   114-001-000  DCM      SS7IPGW  OOS-MT-DSBLD  Isolated  -----
  ALARM STATUS      = ** 0013 Card is isolated from the system
  BPDCM GPL         = 002-102-000
  IMT BUS A         = Disc
  IMT BUS B         = Disc
  SIGNALING LINK STATUS
    SLK   PST      LS      CLLI      E5IS
    A     OOS-MT  lsnlp1  -----  INACTIVE

Command Completed.
```

14. Remove the signaling link from the EAGLE using the `dlt-slk` command. If there is only one signaling link in the linkset, the `force=yes` parameter must be specified to remove the signaling link.

In the example used in this procedure, the signaling link is the last signaling link in the linkset. Enter this command.

```
dlt-slk:loc=2207:link=a:force=yes
```

When this command has successfully completed, this message should appear.

```
rlghncxa03w 06-10-07 08:41:17 GMT EAGLE5 36.0.0
DLT-SLK: MASP A - COMPLTD
```

Note: If removing the signaling link will result in 700 or less signaling links in the database and the `OAMHCMEAS` value in the `rtrv-measopts` output is on, the scheduled UI measurement reports will be enabled.

15. Verify the changes using the `rtrv-slk` command, with the card location and link values specified in [Step 14](#). For this example, enter this command.

```
rtrv-slk:loc=2207:link=a
```

When the `rtrv-slk` command has completed, no entry is displayed showing that the signaling link has been removed.

```
rlghncxa03w 09-09-18 13:43:31 GMT EAGLE5 41.1.0
E2373 Cmd Rej: Link is unequipped in the database
```

16. Back up the new changes using the `chg-db:action=backup:dest=fixed` command. These messages should appear, the active Maintenance and Administration Subsystem Processor (MASP) appears first.

```
BACKUP (FIXED) : MASP A - Backup starts on active MASP.
BACKUP (FIXED) : MASP A - Backup on active MASP to fixed disk complete.
BACKUP (FIXED) : MASP A - Backup starts on standby MASP.
BACKUP (FIXED) : MASP A - Backup on standby MASP to fixed disk complete.
```

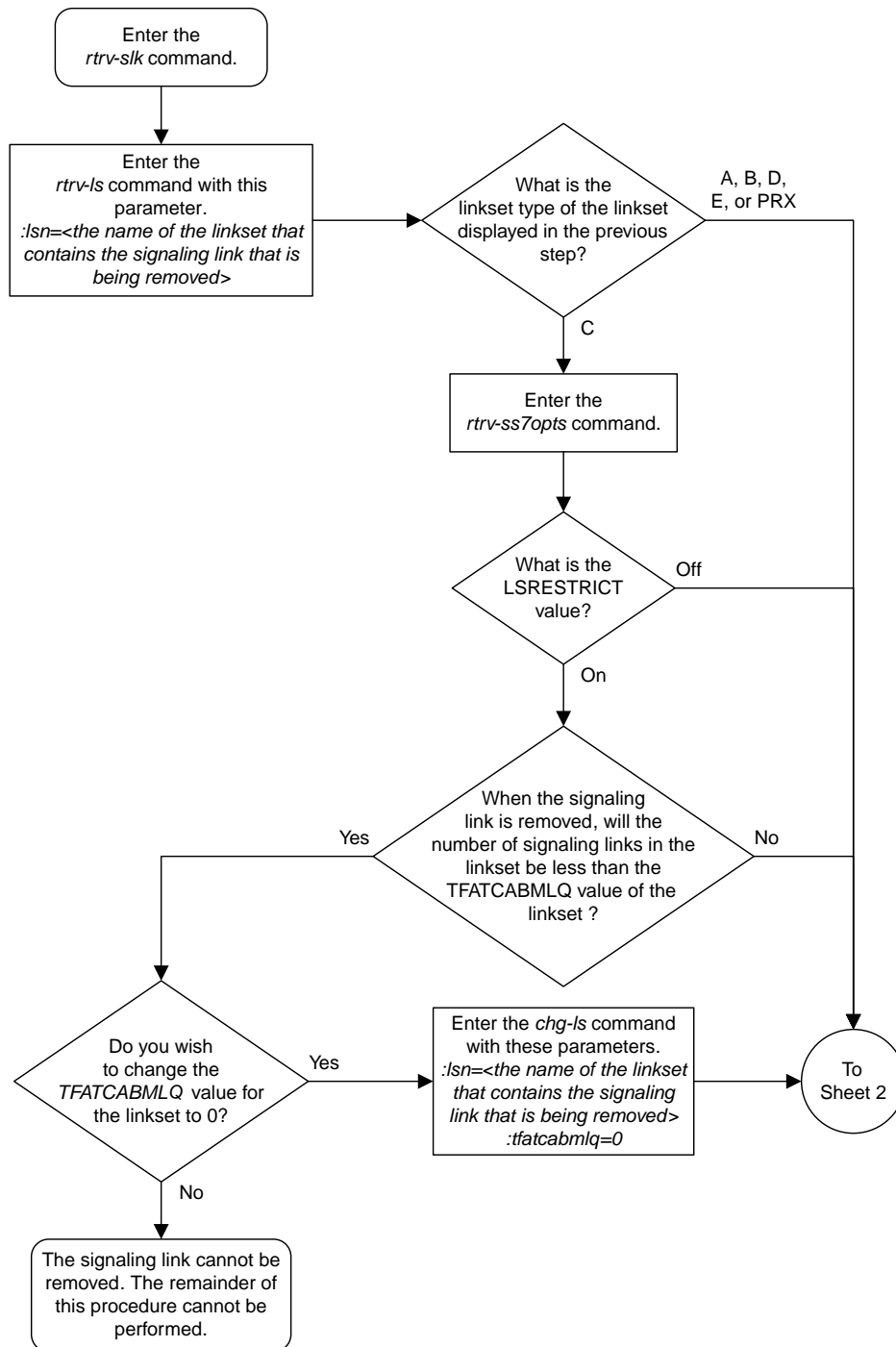

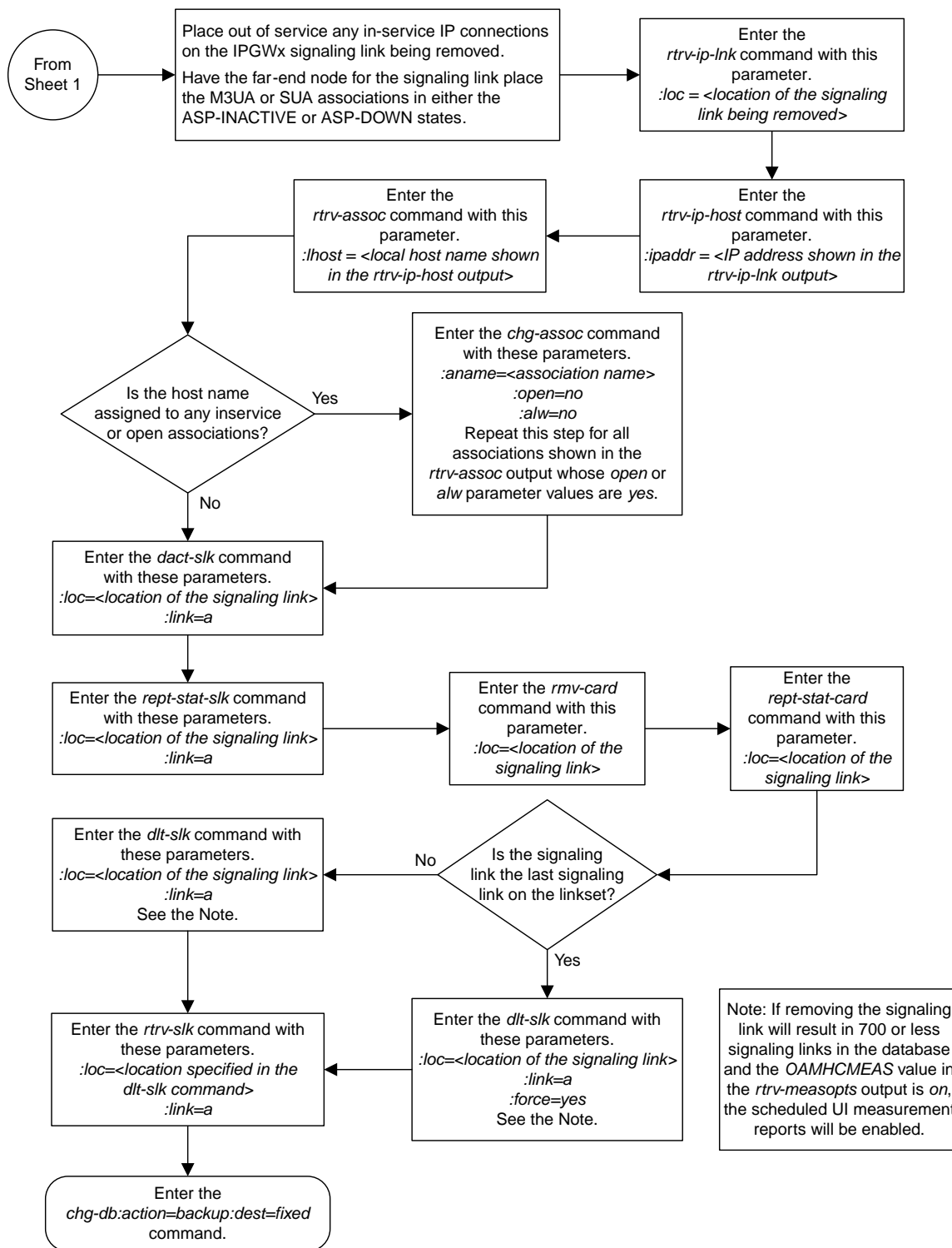

Sheet 2 of 2

Figure 58: Removing an IPGWx Signaling Link

Removing a Mate IPGWx Linkset from another IPGWx Linkset

This procedure is used to remove a mate IPGWx linkset from an existing IPGWx linkset `chg-ls` command with these parameters.

`:lsn` – The name of the IPGWx linkset that contains the mate IPGWx Linkset that is being removed, shown in the `rept-stat-iptps` or `rtrv-ls` command outputs.

`:matelsn` – The name of the mate IPGWx linkset that is being removed.

`:action=delete` – removes the mate IPGWx linkset from the IPGWx linkset specified by the `lsn` parameter.

An IPGWx linkset is a linkset that contains signaling links assigned to IPGWx cards. IPGWx cards are cards running either the SS7IPGW or IPGWI applications.

The mate linkset name is displayed in the `rtrv-ls:lsn=<linkset name>` command output.

Before a mate IPGWx linkset can be removed from an IPGWx linkset, the card containing the IPGWx signaling link assigned to the mate linkset, and the signaling link assigned to that card must be placed out of service.

Other Optional Parameters

There are other optional parameters that can be used to configure a linkset. These parameters are not required for configuring an IPGWx linkset. These parameters are discussed in more detail in *Commands User's Guide* or in these sections.

- These procedures in this manual:
 - [Configuring an IPGWx Linkset](#)
 - [Adding a Mate IPGWx Linkset to another IPGWx Linkset](#)
 - [Adding an IPSP M3UA Linkset](#)
 - [Adding an IPSP M2PA Linkset](#)
 - [Changing an IPSP M3UA Linkset](#)
 - [Changing an IPSP M2PA Linkset](#)
 - These procedures in the *Database Administration - SS7 User's Guide*
 - Adding an SS7 Linkset
 - Changing an SS7 Linkset
 - Configuring an ITU Linkset with a Secondary Adjacent Point Code (SAPC)
 - The "Configuring a Linkset for the GSM MAP Screening Feature" procedure in *Database Administration - Features User's Guide*.
1. Display the system-wide IP TPS usage report, and the IPGWx linksets, by entering the `rept-stat-iptps` command. This is an example of the possible output.

```
rlghncxa03w 10-07-19 21:16:37 GMT EAGLE5 42.0.0
```



```

IP TPS USAGE REPORT
-----
          THRESH  CONFIG/  CONFIG/          TPS  PEAK          PEAKTIMESTAMP
          RSVD    RSV D    MAX
-----
LSN
lsgw1101    80%    ----    6000 TX:    5100    5500  05-02-10 11:40:04
          RCV:    5100    5500  05-02-10 11:40:04
lsgw1103    80%    ----    6000 TX:    5200    5500  05-02-10 11:40:04
          RCV:    5200    5500  05-02-10 11:40:04
lsgw1105    80%    ----    14000 TX:    7300    7450  05-02-10 11:40:04
          RCV:    7300    7450  05-02-10 11:40:04
lsgw1107    70%    ----    4000 TX:    3200    3500  05-02-10 11:40:04
          RCV:    3200    3500  05-02-10 11:40:04
-----
Command Completed.

```

If no entries are displayed in the `rept-stat-iptps` output, there are no IPGWx linksets in the database. This procedure cannot be performed.

If entries are displayed in the `rept-stat-iptps` output, continue the procedure with [Step 2](#).

2. Display the attributes of all the linksets shown in the `rept-stat-iptps` output in [Step 1](#) by entering the `rtrv-ls` command with the name of each linkset shown in the `rept-stat-iptps` output in [Step 1](#). For this example, enter these commands.

```
rtrv-ls:lsn=lsgw1101
```

This is an example of the possible output.

```

rlghncxa03w 08-04-17 11:43:04 GMT EAGLE5 38.0.0

          L3T SLT          GWS GWS GWS
LSN      APCA  (SS7)  SCR N SET SET BEI LST LNKS ACT MES DIS SLSCI NIS
lsgw1101 008-012-003 none 1  1  no  A  1  off off off no  off

          CLI          TFATCABMLQ MTPRSE ASL8
          -----      1          no    no

          IPGWAPC MATELSN      IPTPS LSUSEALM SLKUSEALM GTTMODE
          yes      ----- 10000 70      % 70      % CdPA

          LOC LINK SLC TYPE
          1101 A  0  SS7IPGW

Link set table is ( 14 of 1024) 1% full

```

```
rtrv-ls:lsn=lsgw1103
```

This is an example of the possible output.

```

rlghncxa03w 08-04-17 11:43:04 GMT EAGLE5 38.0.0

          L3T SLT          GWS GWS GWS
LSN      APCA  (SS7)  SCR N SET SET BEI LST LNKS ACT MES DIS SLSCI NIS
lsgw1103 003-002-004 none 1  1  no  A  1  off off off no  off

          CLI          TFATCABMLQ MTPRSE ASL8

```

```

----- 1          no    no

IPGWAPC  MATELSN      IPTPS  LSUSEALM  SLKUSEALM  GTTMODE
yes      lsgw1107      10000  70        % 70        % CdPA

LOC  LINK  SLC  TYPE
1103 A    0    SS7IPGW

Link set table is ( 14 of 1024)  1% full

```

```
rtrv-ls:lsn=lsgw1105
```

This is an example of the possible output.

```

rlghncxa03w 08-04-17 11:43:04 GMT EAGLE5 38.0.0

LSN          APCA  (SS7)  SCRN  L3T  SLT          GWS  GWS  GWS
lsgw1105     009-002-003  none  1    1    no  A    1    off off off no  off

CLLI          TFATCABMLQ  MTPRSE  ASL8
----- 1          no    no

IPGWAPC  MATELSN      IPTPS  LSUSEALM  SLKUSEALM  GTTMODE
yes      ----- 10000  70        % 70        % CdPA

LOC  LINK  SLC  TYPE
1105 A    0    SS7IPGW

Link set table is ( 14 of 1024)  1% full

```

```
rtrv-ls:lsn=lsgw1107
```

This is an example of the possible output.

```

rlghncxa03w 08-04-17 11:43:04 GMT EAGLE5 38.0.0

LSN          APCA  (SS7)  SCRN  L3T  SLT          GWS  GWS  GWS
lsgw1107     010-020-005  none  1    1    no  A    1    off off off no  off

CLLI          TFATCABMLQ  MTPRSE  ASL8
----- 1          no    no

IPGWAPC  MATELSN      IPTPS  LSUSEALM  SLKUSEALM  GTTMODE
yes      ----- 10000  70        % 70        % CdPA

LOC  LINK  SLC  TYPE
1107 A    0    SS7IPGW

Link set table is ( 14 of 1024)  1% full

```

If none of the linksets displayed in this step contain a mate IPGWx linkset, shown in the MATELSN column, this procedure cannot be performed.

If any of the linksets displayed in this step contain a mate IPGWx linkset, shown in the MATELSN column, continue this procedure with one of these steps.

- If a signaling link is assigned to the mate linkset, continue the procedure with [Step 3](#).

- If a signaling link is not assigned to the mate linkset, continue the procedure with [Step 12](#).
3. Display the status of the card containing the signaling link that is assigned to the mate IPGWx linkset that is being removed by entering the `rept-stat-card` command with the card location shown in the `LOC` column for the mate IPGWx linkset shown in [Step 2](#). For this example, enter this command.

```
rept-stat-card:loc=1107
```

This is an example of the possible output.

```
rlghncxa03w 08-04-27 17:00:36 GMT EAGLE5 38.0.0
CARD  VERSION      TYPE      GPL      PST      SST      AST
1107  114-000-000    EDCM     SS7IPGW  IS-NR     Active   -----
ALARM STATUS      = No Alarms.
BPDCM GPL         = 002-102-000
IMT BUS A         = Conn
IMT BUS B         = Conn
SIGNALING LINK STATUS
  SLK  PST          LS          CLLI
  A    IS-NR       lsgw1107   -----
Command Completed.
```

If the status of the card is out-of-service maintenance disabled (OOS-MT-DSBLD), continue the procedure with [Step 12](#).

If the status of the card is not out-of-service maintenance disabled (OOS-MT-DSBLD), continue the procedure with [Step 4](#).

4. Display the status of the signaling link assigned to the card shown in [Step 3](#) by entering the `rept-stat-slk` command with the card location used in [Step 3](#) and the `link=a` parameter. For this example, enter this command.

```
rept-stat-slk:loc=1107:link=a
```

This is an example of the possible output.

```
rlghncxa03w 08-04-27 17:00:36 GMT EAGLE5 38.0.0
SLK  LSN          CLLI          PST      SST      AST
1107,A  lsgw1107     ----- IS-NR     Avail   -----
ALARM STATUS      = No Alarms.
UNAVAIL REASON    = NA
Command Completed.
```

If the status of the signaling link is out-of-service maintenance disabled (OOS-MT-DSBLD), continue the procedure with [Step 12](#).

If the status of the signaling link is not out-of-service maintenance disabled (OOS-MT-DSBLD), any in-service IP connections on the signaling link must be placed out of service. Continue the procedure by performing one of these steps.

- The recommended method is to have the far end node place these IP connections out of service. Have the far-end node for the signaling link shown in [Step 4](#) place the M3UA or SUA associations in either the ASP-INACTIVE or ASP-DOWN state. After the IP connections have been placed out of service, continue the procedure with [Step 10](#).
- If you do not wish to have the far end node place these IP connections out of service, continue the procedure with [Step 5](#).

5. Display the IP link associated with the card that the signaling link shown in [Step 4](#) is assigned to by entering the `rtrv-ip-lnk` command with the card location shown in [Step 4](#). For this example, enter this command.

```
rtrv-ip-lnk:loc=1107
```

The following is an example of the possible output.

```
rlghncxa03w 08-04-28 21:14:37 GMT EAGLE5 38.0.0
LOC  PORT  IPADDR          SUBMASK          DUPLEX  SPEED  MACTYPE  AUTO  MCAST
1107  A      192.3.1.10      255.255.255.128  HALF    10     802.3    NO    NO
1107  B      -----          -----          HALF    10     DIX      NO    NO
```

6. Display the IP host information associated with the IP link by entering the `rtrv-ip-host` command with the IP address shown in [Step 5](#). For this example, enter this command.

```
rtrv-ip-host:ipaddr=192.003.001.010
```

The following is an example of the possible output.

```
rlghncxa03w 13-06-28 21:17:37 GMT EAGLE5 45.0.0

LOCAL IPADDR      LOCAL HOST
192.3.1.10      IPNODE1_1107

IP Host table is (11 of 4096) .26% full
```

7. Display the association associated with the local host name shown in [Step 6](#) by entering the `rtrv-assoc` command.

For this example, enter this command.

```
rtrv-assoc:lhost=ipnode1_1107
```

This is an example of possible output.

```
rlghncxa03w 08-04-28 09:12:36 GMT EAGLE5 38.0.0
CARD IPLNK
ANAME          LOC  PORT  LINK  ADAPTER  LPORT  RPORT  OPEN  ALW
assoc1         1107 A    A     M3UA    1030   1030   YES   YES

IP Appl Sock/Assoc table is (4 of 4000) 1% full
Assoc Buffer Space Used (16 KB of 3200 KB) on LOC = 1107
```

8. Change the `alw` parameter values in the association shown in [Step 7](#) using the `chg-assoc` command with the `alw=no` parameters, as necessary.

Note: If the `open` and `alw` parameter values of the association shown in [Step 7](#) are `no`, continue the procedure with [Step 10](#).

```
chg-assoc:aname=assoc1:alw=no
```



Caution: This command impacts network performance and should only be used during periods of low traffic.

When this command has successfully completed, this message should appear.

```
rlghncxa03w 08-04-28 09:12:36 GMT EAGLE5 38.0.0
CHG-ASSOC: MASP A - COMPLTD
```

Repeat this step for all associations shown in [Step 7](#).

- Change the open parameter values in the association shown in [Step 7](#) using the `chg-assoc` command with the `open=no` parameters, as necessary.

```
chg-assoc:aname=assoc1:open=no
```

When this command has successfully completed, this message should appear.

```
rlghncxa03w 08-04-28 09:12:36 GMT EAGLE5 38.0.0
CHG-ASSOC: MASP A - COMPLTD
```

Repeat this step for all associations shown in [Step 7](#).

- Deactivate the signaling link assigned to the IP card using the `dact-slk` command. For example, enter this command.

```
dact-slk:loc=1107:link=a (for the removing a mate linkset example)
```



CAUTION

Caution: This command impacts network performance and should only be used during periods of low traffic.

After this command has successfully completed, this message appears.

```
rlghncxa03w 08-04-12 09:12:36 GMT EAGLE5 38.0.0
Deactivate Link message sent to card.
```

- Inhibit the IP card using the `inh-card` command. For example, enter this command.

```
inh-card:loc=1107 (for the removing a mate linkset example)
```

This message should appear.

```
rlghncxa03w 08-04-28 21:18:37 GMT EAGLE5 38.0.0
Card has been inhibited.
```

- Change the linkset shown in [Step 2](#) by entering the `chg-ls` command with the `matelsn` and `action=delete` parameter.

For this example, enter this command.

```
chg-ls:lsn=lsgw1103:matelsn=lsgw1107:action=delete
```

When the `chg-ls` command has successfully completed, this message should appear.

```
rlghncxa03w 08-04-17 16:23:21 GMT EAGLE5 38.0.0
Link set table is ( 14 of 1024) 1% full
CHG-LS: MASP A - COMPLTD
```

13. Verify the changes using the `rtrv-ls` command specifying the linkset name specified in [Step 12](#) with the `lsn` parameter. For this example, enter this command.

```
rtrv-ls:lsn=lsgw1103
```

This is an example of the possible output.

```
rlghncxa03w 08-04-17 11:43:04 GMT EAGLE5 38.0.0

LSN          APCA  (SS7)  SCRN  L3T  SLT          GWS  GWS  GWS
lsgw1103     003-002-004  none  1    1    no  A    1    off off off no  off

          CLLI          TFATCABMLQ  MTPRSE  ASL8
          -----  1          no      no

IPGWAPC  MATELSN      IPTPS  LSUSEALM  SLKUSEALM  GTTMODE
yes      -----  10000  70      % 70      % CdPA

LOC  LINK  SLC  TYPE
1103 A    0   SS7IPGW

Link set table is ( 14 of 1024)  1% full
```

If the linkset shown in this step does not have a signaling link assigned to it, continue the procedure with [Step 18](#).

If the linkset shown in this step has a signaling link assigned to it, continue the procedure with [Step 14](#).

14. Allow the IP card that was inhibited in [Step 11](#) using the `alw-card` command. For example, enter this command.

```
alw-card:loc=1107
```

This message should appear.

```
rlghncxa03w 08-04-28 21:21:37 GMT EAGLE5 38.0.0
Card has been allowed.
```

15. Activate the signaling link from [Step 10](#) using the `act-slk` command. For example, enter one of these commands.

```
act-slk:loc=1107:link=a
```

The output confirms the activation.

```
rlghncxa03w 08-04-07 11:11:28 GMT EAGLE5 38.0.0
Activate Link message sent to card
```

16. Change the `open` and `alw` parameter values for all the associations changed in [Step 8](#) or [Step 9](#) using the `chg-assoc` command with the `open=yes` and `alw=yes` parameters.

Note: If [Step 8](#) and [Step 9](#) were not performed, continue the procedure with [Step 17](#).

```
chg-assoc:aname=assoc1:open=yes:alw=yes
```

When this command has successfully completed, this message should appear.

```
rlghncxa03w 08-04-28 09:12:36 GMT EAGLE5 38.0.0  
CHG-ASSOC: MASP A - COMPLTD
```

17. Have the far-end node for the signaling link shown in [Step 13](#) place the M3UA or SUA associations in the ASP-ACTIVE state to place the IP connections on the signaling link into service.
18. Back up the new changes using the `chg-db:action=backup:dest=fixed` command. These messages should appear, the active Maintenance and Administration Subsystem Processor (MASP) appears first.

```
.  
BACKUP (FIXED) : MASP A - Backup starts on active MASP.  
BACKUP (FIXED) : MASP A - Backup on active MASP to fixed disk complete.  
BACKUP (FIXED) : MASP A - Backup starts on standby MASP.  
BACKUP (FIXED) : MASP A - Backup on standby MASP to fixed disk complete.
```

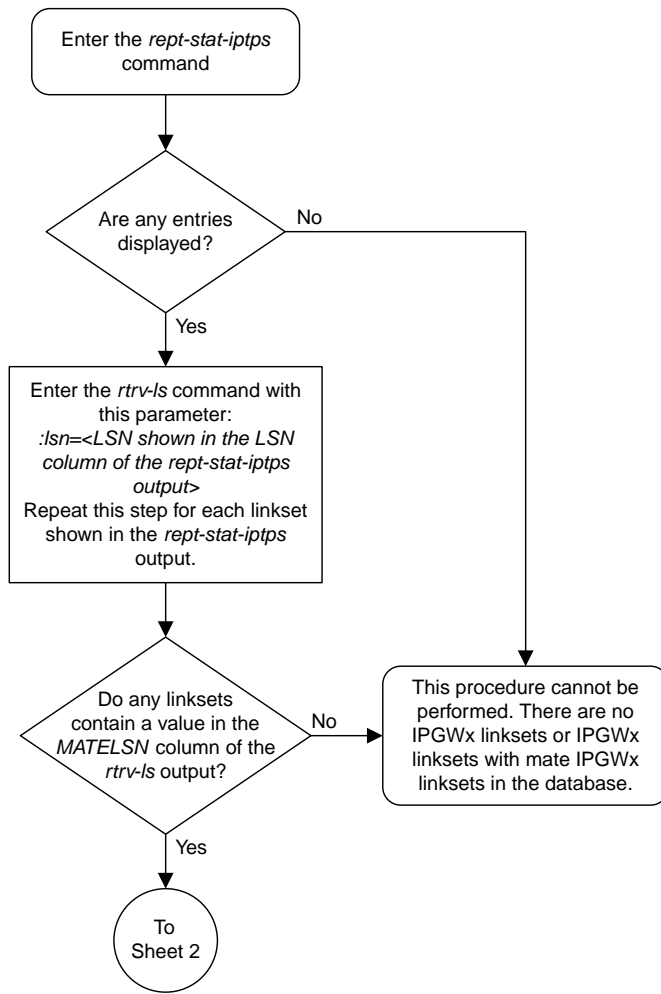

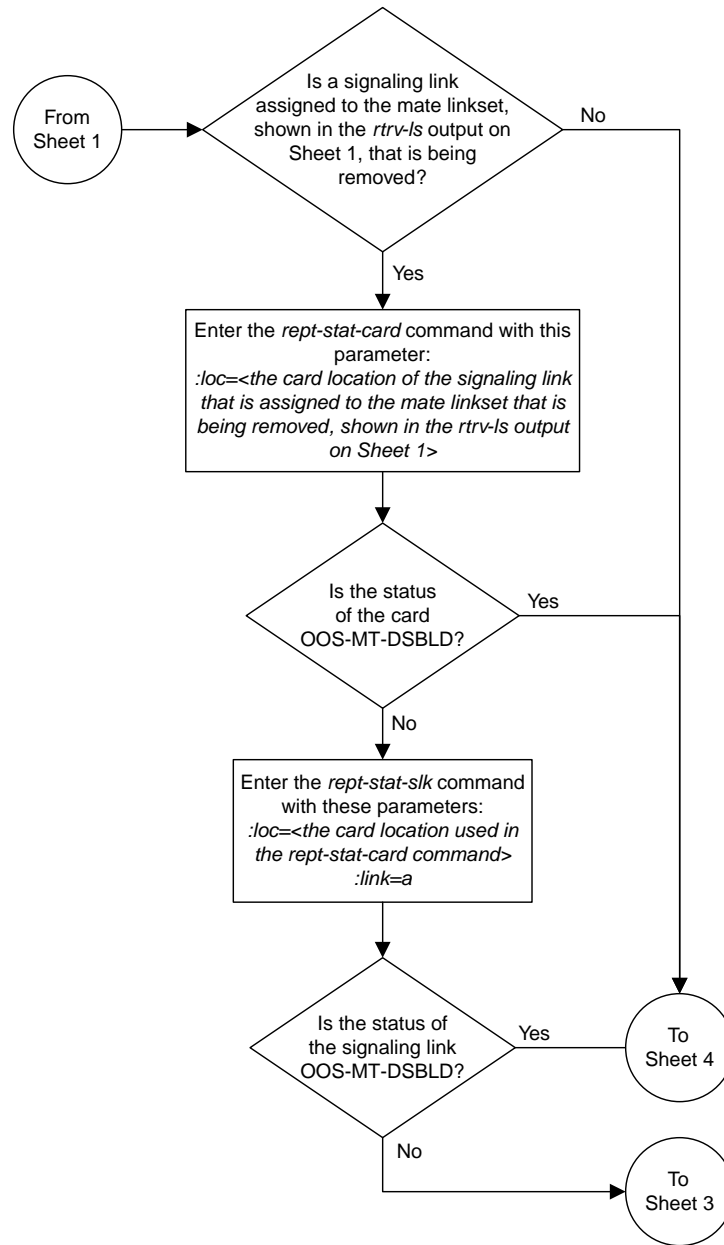

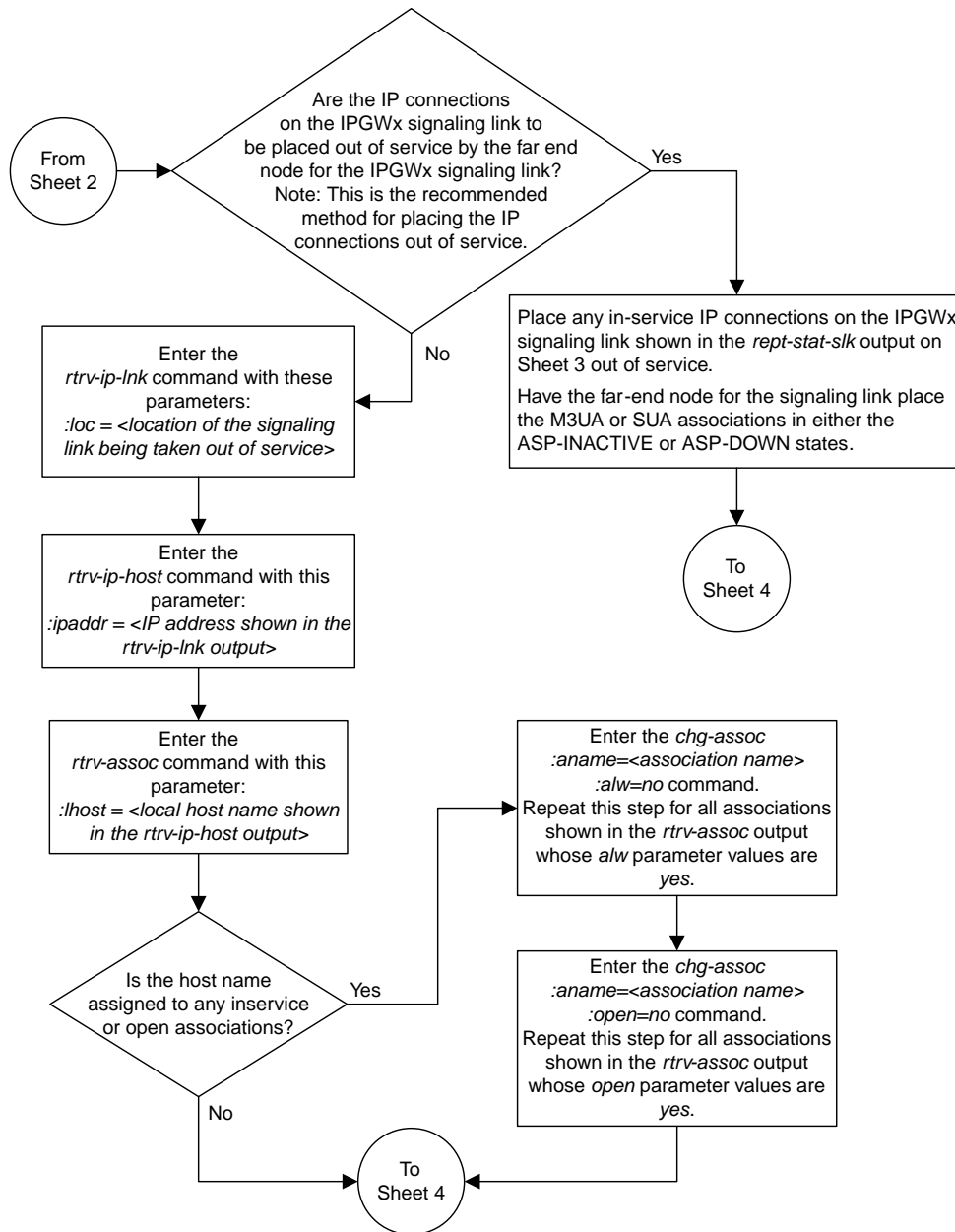

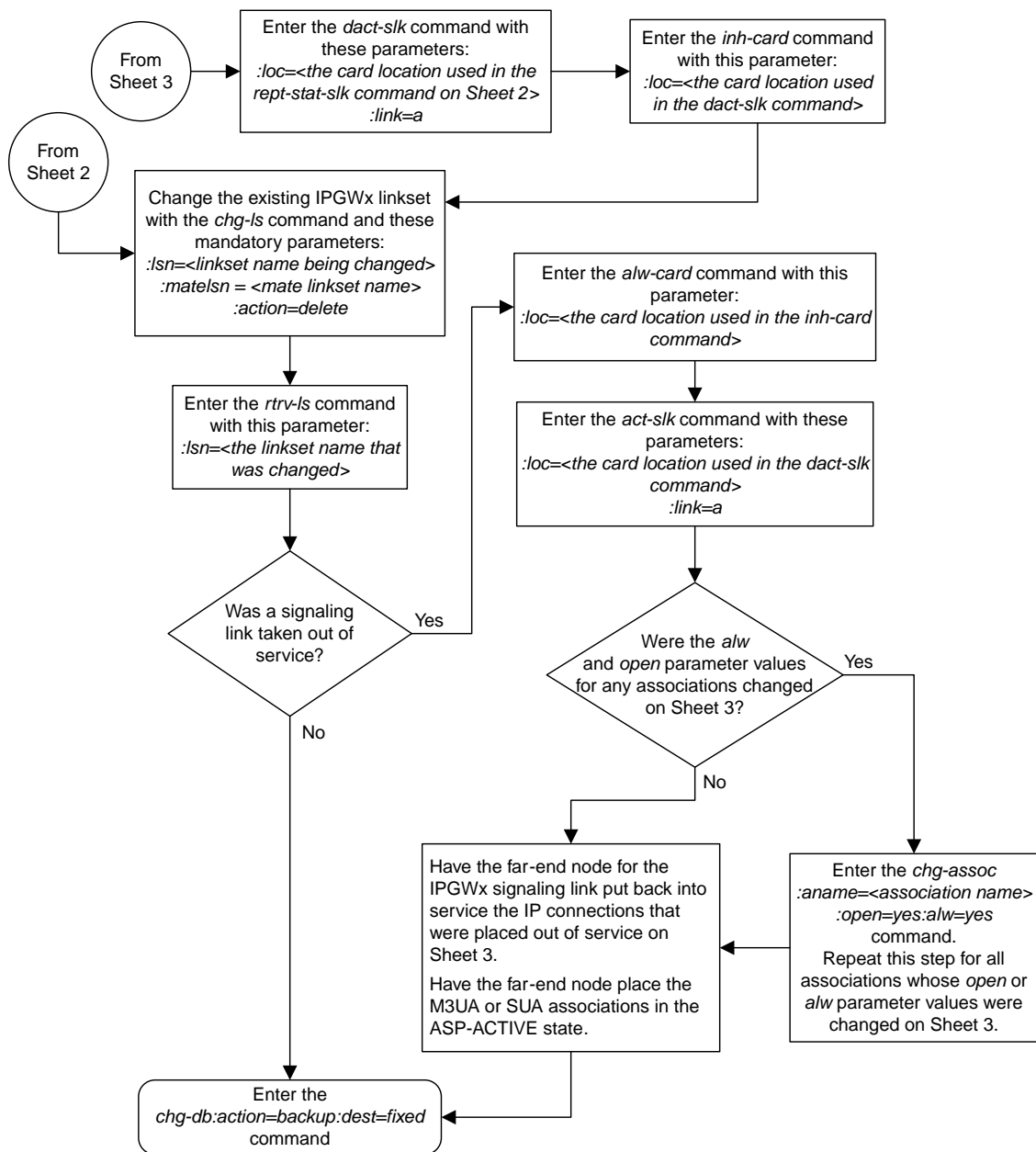

Sheet 4 of 4

Figure 59: Removing a Mate IPGWx Linkset from another IPGWx Linkset

Removing an IP Host Assigned to an IPGWx Card

This procedure removes an IP host that is assigned to an IPGWx card using the `dlt-ip-host` command.

The `dlt-ip-host` command uses the following parameter.

`:host-Hostname`. The hostname to be removed. This parameter identifies the logical name assigned to a device with an IP address.

No associations can reference the host name being removed in this procedure.

The associations referencing the host name can be removed by performing the [Removing a M3UA or SUA Association](#) procedure or the host name in these associations can be changed by performing the [Changing the Host Values of a M3UA or SUA Association](#) procedure. The host name assigned to associations is displayed in the `rtrv-assoc` outputs.

1. Display the current IP host information in the database by entering the `rtrv-ip-host:display=all` command.

The following is an example of the possible output.

```
rlghncxa03w 08-12-28 21:17:37 GMT EAGLE5 40.0.0
LOCAL IPADDR      LOCAL HOST
192.1.1.10        IPNODE1-1201
192.1.1.12        IPNODE1-1203
192.1.1.14        IPNODE1-1205
192.1.1.20        IPNODE2-1201
192.1.1.22        IPNODE2-1203
192.1.1.24        IPNODE2-1205
192.1.1.30        KC-HLR1
192.1.1.32        KC-HLR2
192.1.1.50        DN-MSC1
192.1.1.52        DN-MSC2
192.3.3.33        GW100. NC. TEKELEC. COM

REMOTE IPADDR     REMOTE HOST
150.1.1.5         NCDEPTECONOMIC_DEVELOPMENT. SOUTHEASTERN_COORIDOR_ASHVL. GOV

IP Host table is (12 of 4096) 0.29% full
```

If the IP host that is being removed is a remote host, continue the procedure with [Step 5](#).

If the IP host that is being removed is a local host, continue the procedure with [Step 2](#).

2. Display the current link parameters associated with the IP card in the database by entering the `rtrv-ip-lnk` command. The following is an example of the possible output.

```
rlghncxa03w 08-12-28 21:14:37 GMT EAGLE5 40.0.0
LOC   PORT IPADDR      SUBMASK      DUPLEX  SPEED MACTYPE AUTO MCAST
```

```

1303 A 192.1.1.10 255.255.255.128 HALF 10 802.3 NO NO
1303 B ----- HALF 10 DIX NO NO
1305 A 192.1.1.12 255.255.255.0 ---- DIX YES NO
1305 B ----- HALF 10 DIX NO NO
1313 A 192.1.1.14 255.255.255.0 FULL 100 DIX NO NO
1313 B ----- HALF 10 DIX NO NO
2101 A 192.1.1.20 255.255.255.0 FULL 100 DIX NO NO
2101 B ----- HALF 10 DIX NO NO
2103 A 192.1.1.22 255.255.255.0 FULL 100 DIX NO NO
2103 B ----- HALF 10 DIX NO NO
2105 A 192.1.1.24 255.255.255.0 FULL 100 DIX NO NO
2105 B ----- HALF 10 DIX NO NO
2205 A 192.1.1.30 255.255.255.0 FULL 100 DIX NO NO
2205 B ----- HALF 10 DIX NO NO
2207 A 192.1.1.32 255.255.255.0 FULL 100 DIX NO NO
2207 B ----- HALF 10 DIX NO NO
2213 A 192.1.1.50 255.255.255.0 FULL 100 DIX NO NO
2213 B ----- HALF 10 DIX NO NO
2301 A 192.1.1.52 255.255.255.0 FULL 100 DIX NO NO
2301 B ----- HALF 10 DIX NO NO
2305 A 192.3.3.33 255.255.255.0 FULL 100 DIX NO NO
2305 B ----- HALF 10 DIX NO NO

```

```
IP-LNK table is (22 of 2048) 1% full.
```

3. Display the cards in the database using the `rtrv-card` command. This is an example of the possible output.

```

rlghncxa03w 09-05-28 09:12:36 GMT EAGLE5 41.0.0
CARD TYPE APPL LSET NAME LINK SLC LSET NAME LINK SLC
1101 DSM VSCCP
1102 TSM GLS
1113 E5MCAP EOAM
1114 E5TDM-A
1115 E5MCAP EOAM
1116 E5TDM-B
1117 E5MDAL
1201 LIMDS0 SS7ANSI sp2 A 0 sp1 B 0
1203 LIMDS0 SS7ANSI sp3 A 0
1204 LIMDS0 SS7ANSI sp3 A 1
1206 LIMDS0 SS7ANSI nsp3 A 1 nsp4 B 1
1216 DCM STPLAN
1301 LIMDS0 SS7ANSI sp6 A 1 sp7 B 0
1302 LIMDS0 SS7ANSI sp7 A 1 sp5 B 1
1303 DCM IPLIM ipnode1 A 0 ipnode3 B 1
1305 DCM IPLIM ipnode4 A 0
1307 DCM STPLAN
1313 DCM SS7IPGW ipgtwy1 A 0
2101 DCM SS7IPGW ipgtwy2 A 0
2103 DCM SS7IPGW ipgtwy3 A 0
2105 DCM IPLIM ipnode1 A1 1 ipnode5 B 2
2205 DCM IPLIM ipnode3 A2 0 ipnode6 B1 2
2207 DCM IPLIM ipnode5 A 0 ipnode4 B3 1
2213 DCM IPLIM ipnode5 A3 1 ipnode3 B2 2
2301 DCM IPLIM ipnode6 A 0 ipnode1 B 2
2305 DCM IPLIM ipnode6 A1 1 ipnode1 B1 3

```

Select an IP host whose IP address is assigned to a card running the SS7IPGW or IPGWI application.

4. Display the associations referencing the host name being removed in this procedure by entering the `rtrv-assoc` command with the local host name.

For this example, enter this command.

```
rtrv-assoc:lhost="IPNODE1-1205"
```

The following is an example of the possible output.

```
rlghncxa03w 06-10-28 21:14:37 GMT EAGLE5 36.0.0
                CARD IPLNK
ANAME          LOC  PORT  LINK ADAPTER LPORT RPORT OPEN ALW
a2             1313 A    A    M3UA   7205  7001 NO   NO

IP Appl Sock/Assoc table is (4 of 4000) 1% full
Assoc Buffer Space Used (16 KB of 3200 KB) on LOC = 1203
```

If no associations referencing the host name being removed in this procedure are shown in this step, continue the procedure with [Step 5](#).

Any associations referencing the host name must either be removed or the host name assigned to the association must be changed.

To remove the associations, perform the [Removing a M3UA or SUA Association](#) procedure.

Continue the procedure with [Step 5](#) after the associations have been removed.

To change the host name assigned to the associations, perform the [Changing the Host Values of a M3UA or SUA Association](#) procedure.

Continue the procedure with [Step 5](#) after the host name assigned to the associations have been changed.

5. Delete IP host information from the database by entering the `dlt-ip-host` command.

For example, enter this command.

```
dlt-ip-host:host="IPNODE1-1205"
```

When this command has successfully completed, the following message should appear.

```
rlghncxa03w 06-10-28 21:19:37 GMT EAGLE5 36.0.0
DLT-IP-HOST: MASP A - COMPLTD
```

6. Verify the changes by entering the `rtrv-ip-host` command with the host name specified in [Step 5](#).

For this example, enter this command.

```
rtrv-ip-host:host="IPNODE1-1205"
```

The following is an example of the possible output.

```
rlghncxa03w 09-07-28 21:20:37 GMT EAGLE5 41.1.0
No matching entries found.
IP Host table is (10 of 4096) 0.24% full
```

7. Back up the new changes using the `chg-db:action=backup:dest=fixed` command.

These messages should appear, the active Maintenance and Administration Subsystem Processor (MASP) appears first.

```
BACKUP (FIXED) : MASP A - Backup starts on active MASP.  
BACKUP (FIXED) : MASP A - Backup on active MASP to fixed disk complete.  
BACKUP (FIXED) : MASP A - Backup starts on standby MASP.  
BACKUP (FIXED) : MASP A - Backup on standby MASP to fixed disk complete.
```

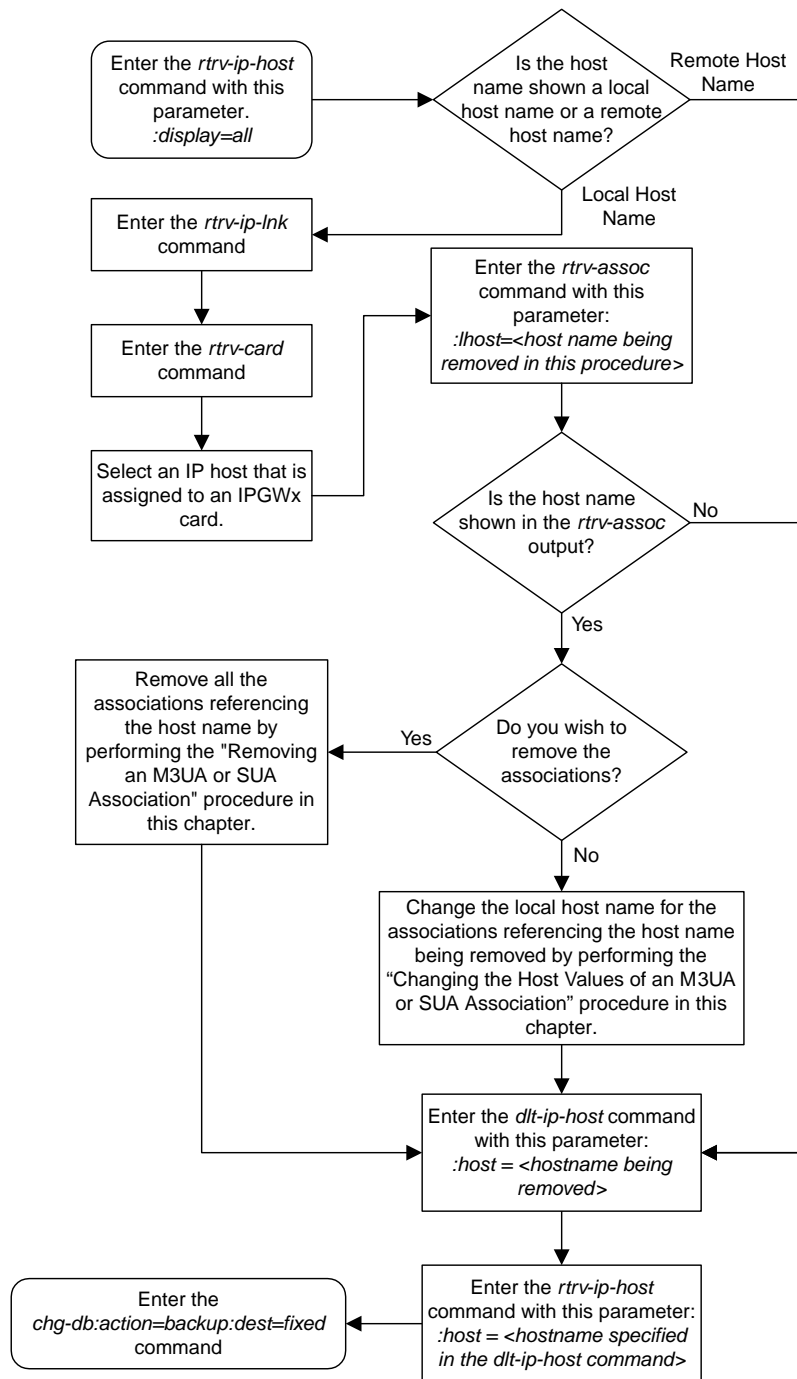

Figure 60: Removing an IP Host Assigned to an IPGWx Card

Removing an IP Route

This procedure is used to remove an IP route from the database using the `dlt-ip-rte` command.

The `dlt-ip-rte` command uses these parameters.

`:loc` – The location of the IP card containing the IP route being removed.

`:dest` – The IP address of the remote host or network assigned to the IP route being removed.

`:force` – To remove the IP route, the IP card that the route is assigned to must be out of service, or the `force=yes` parameter must be specified with the `dlt-ip-rte` command. The `force=yes` parameter allows the IP route to be removed if the IP card is in service.



Caution: Removing an IP route while the IP card is still in service can result in losing the ability to route outbound IP traffic on the IP card. This can cause both TCP and SCTP sessions on the IP card to be lost.

1. Display the IP routes in the database with the `rtrv-ip-rte` command.

This is an example of the possible output.

```
rlghncxa03w 06-10-28 09:12:36 GMT EAGLE5 36.0.0
LOC  DEST          SUBMASK          GTWY
1212 132.10.175.20    255.255.0.0      150.1.1.50
1301 128.252.10.5     255.255.255.255 140.188.13.33
1301 128.252.0.0      255.255.0.0      140.188.13.34
1301 150.10.1.1       255.255.255.255 140.190.15.3
1303 192.168.10.1     255.255.255.255 150.190.15.23
1303 192.168.0.0      255.255.255.0    150.190.15.24
```

```
IP Route table is (6 of 2048) 0.29% full
```

2. Verify the state of the IP card containing the IP route being removed by entering the `rept-stat-card` command and specifying the card location of the IP card.

The IP card should be in the out-of-service maintenance-disabled (OOS-MT-DSBLD) in order to remove the IP route. If the IP card's state is out-of-service maintenance-disabled, the entry OOS-MT-DSBLD is shown in the `PST` column of the `rept-stat-card` output. For this example, enter this command.

```
rept-stat-card:loc=1301
```

This is an example of the possible output.

```
rlghncxa03w 06-10-27 17:00:36 GMT EAGLE5 36.0.0
CARD  VERSION  TYPE    GPL    PST    SST    AST
1301  114-000-000  DCM    SS7IPGW  IS-NR  Active  -----
ALARM STATUS          = No Alarms.
BPDCM GPL             = 002-102-000
IMT BUS A             = Conn
IMT BUS B             = Conn
SIGNALING LINK STATUS
SLK   PST           LS           CLLI
A     IS-NR         nc001       -----
```

```
Command Completed.
```

Note: If the output of [Step 2](#) shows that the IP card's state is not OOS-MT-DSBLD, and you do not wish to change the state of the IP card, continue the procedure with [Step 4](#).

3. Change the IP card's state to OOS-MT-DSBLD using the `inh-card` command and specifying the card location of the IP card.

For this example, enter these commands.

```
inh-card:loc=1301
```

When this command has successfully completed, this message appears.

```
rlghncxa03w 06-10-12 09:12:36 GMT EAGLE5 36.0.0
Card has been inhibited.
```

4. Remove the IP route from the database using the `dlt-ip-rte` command.

If the state of the IP card is not OOS-MT-DSBLD, the `force=yes` parameter must be specified with the `dlt-ip-rte` command. For this example, enter this command.

```
dlt-ip-rte:loc=1301:dest=128.252.0.0
```



CAUTION

Caution: Removing an IP route while the IP card is still in service can result in losing the ability to route outbound IP traffic on the IP card. This can cause both TCP and SCTP sessions on the IP card to be lost.

When this command has successfully completed, this message should appear.

```
rlghncxa03w 06-10-12 09:12:36 GMT EAGLE5 36.0.0
DLT-IP-RTE: MASP A - COMPLTD
```

5. Verify the changes using the `rtrv-ip-rte` command.

This is an example of the possible output.

```
rlghncxa03w 06-10-28 09:12:36 GMT EAGLE5 36.0.0
LOC  DEST          SUBMASK          GTWY
1212 132.10.175.20    255.255.0.0      150.1.1.50
1301 128.252.10.5     255.255.255.255 140.188.13.33
1301 150.10.1.1       255.255.255.255 140.190.15.3
1303 192.168.10.1    255.255.255.255 150.190.15.23
1303 192.168.0.0     255.255.0.0      150.190.15.24

IP Route table is (5 of 2048) 0.24% full
```

6. Place the IP card back into service by using the `alw-card` command.

Note: If the IP card containing the IP route that was removed from the database does not contain other IP routes, continue the procedure with [Step 7](#).

For example, enter this command.

```
alw-card:loc=1301
```

This message should appear.

```
rlghncxa03w 06-10-28 21:22:37 GMT EAGLE5 36.0.0  
Card has been allowed.
```

7. Back up the new changes using the `chg-db:action=backup:dest=fixed` command.
These messages should appear, the active Maintenance and Administration Subsystem Processor (MASP) appears first.

```
BACKUP (FIXED) : MASP A - Backup starts on active MASP.  
BACKUP (FIXED) : MASP A - Backup on active MASP to fixed disk complete.  
BACKUP (FIXED) : MASP A - Backup starts on standby MASP.  
BACKUP (FIXED) : MASP A - Backup on standby MASP to fixed disk complete.
```

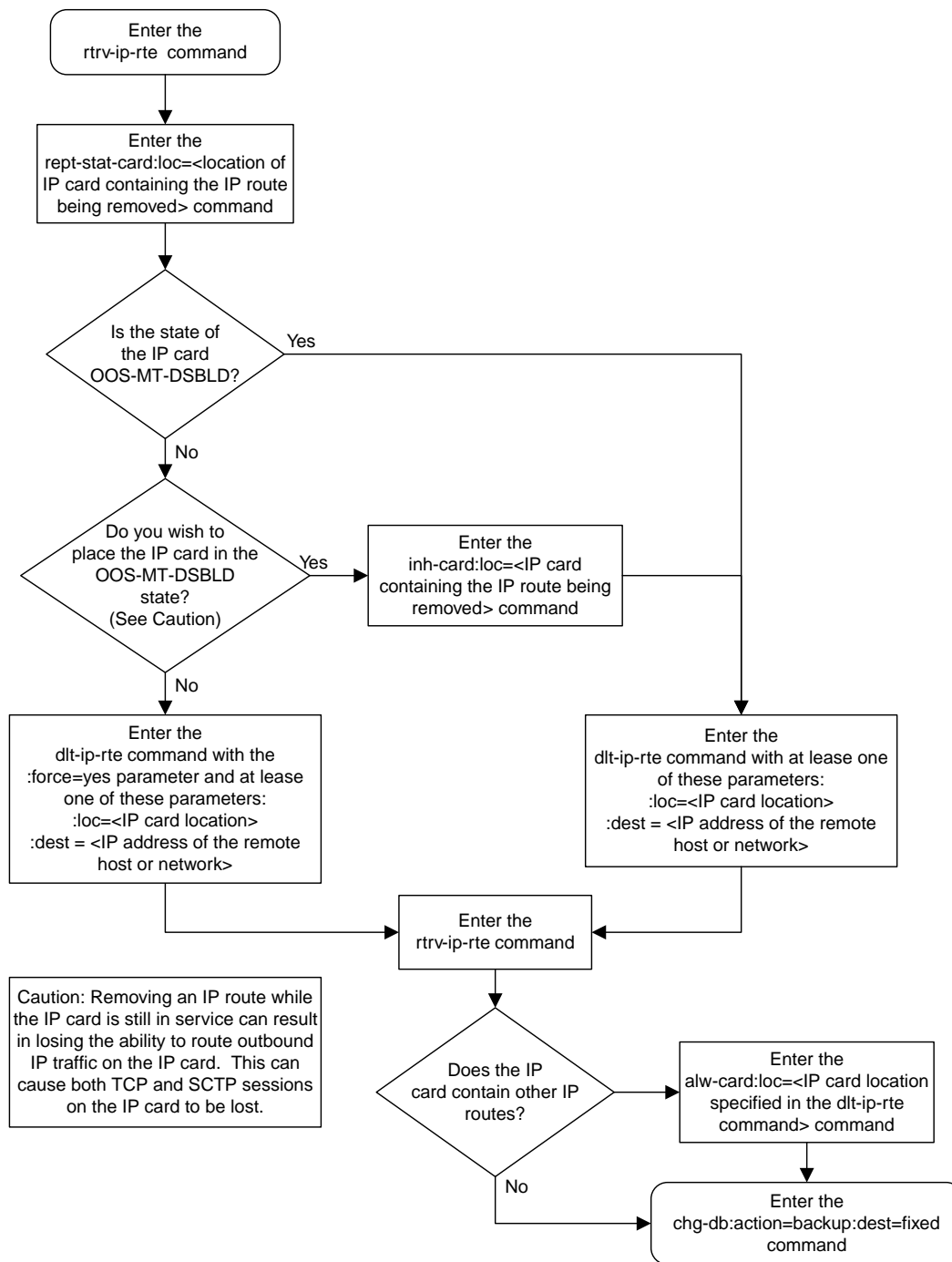

Figure 61: Removing an IP Route

Removing a M3UA or SUA Association

This procedure is used to remove a SUA association from the database or to remove a M3UA association that is assigned to a card running either the SS7IPGW or IPGWI applications. Perform the [Removing an IPSP Association](#) procedure to remove a M3UA association that is assigned to a card running the IPSP application.

The `dlt-assoc` command uses one parameter, `aname`, the name of the association being removed from the database. The association being removed must be in the database.

The `open` parameter must be set to `no` before the association can be removed. Use the `chg-assoc` command to change the value of the `open` parameter.

The association being removed from the database cannot be assigned to an application server. This can be verified with the `rtrv-as` command. If the association is assigned to any application servers, go to the [Removing an Association from an Application Server](#) procedure and remove the association from the application servers.

Canceling the RTRV-ASSOC and RTRV-AS Commands

Because the `rtrv-assoc` and `rtrv-as` commands used in this procedure can output information for a long period of time, the `rtrv-assoc` and `rtrv-as` commands can be canceled and the output to the terminal stopped. There are three ways that the `rtrv-assoc` and `rtrv-as` commands can be canceled.

- Press the F9 function key on the keyboard at the terminal where the `rtrv-assoc` or `rtrv-as` commands were entered.
- Enter the `canc-cmd` without the `trm` parameter at the terminal where the `rtrv-assoc` or `rtrv-as` commands were entered.
- Enter the `canc-cmd:trm=<xx>`, where `<xx>` is the terminal where the `rtrv-assoc` or `rtrv-as` commands were entered, from another terminal other than the terminal where the `rtrv-assoc` or `rtrv-as` commands were entered. To enter the `canc-cmd:trm=<xx>` command, the terminal must allow Security Administration commands to be entered from it and the user must be allowed to enter Security Administration commands. The terminal's permissions can be verified with the `rtrv-secu-trm` command. The user's permissions can be verified with the `rtrv-user` or `rtrv-secu-user` commands.

For more information about the `canc-cmd` command, go to *Commands User's Guide*.

1. Display the associations in the database using the `rtrv-assoc` command.

This is an example of possible output.

```
rlghncxa03w 06-10-28 09:12:36 GMT EAGLE5 36.0.0

          CARD IPLNK
ANAME     LOC  PORT  LINK ADAPTER  LPORT  RPORT  OPEN  ALW
swbel32   1201 A      A    M3UA   1030   2345   YES   YES
a2        1305 A      A    SUA    1030   2345   YES   YES
a3        1307 A      A    SUA    1030   2346   YES   YES
assoc1    1203 A      A1   M2PA   2048   1030   NO    NO
```

If the association that is being removed in this procedure is an SUA association, continue the procedure with [Step 3](#).

If the association that is being removed in this procedure is an M3UA association, continue the procedure with [Step 2](#).

2. Enter the `rtrv-card` command with the location of the card that is hosting the M3UA association that will be removed in this procedure. For this example, enter this command.

```
rtrv-card:loc=1201
```

This is an example of possible output.

```
rlghncxa03w 08-03-06 15:17:20 EST EAGLE5 38.0.0
CARD   TYPE      APPL      LSET NAME  LINK SLC LSET NAME  LINK SLC
1201   DCM          SS7IPGW  lsn1       A     0
```

If the application assigned to the card is SS7IPGW or IPGWI, shown in the APPL column, continue the procedure with [Step 3](#).

If the application assigned to the card is IPSG, perform the [Removing an IPSG Association](#) procedure.

3. Display the application servers referencing the association being removed from the database using the `rtrv-as` command with the name of the association being removed in this procedure.

For this example, enter this command.

```
rtrv-as:aname=swbel32
```

This is an example of possible output.

```
rlghncxa03w 06-10-28 09:12:36 GMT EAGLE5 36.0.0
AS Name      Mode          Tr ms  Association Names
as1          LOADSHARE    2000   swbel32
as2          OVERRIDE     10     swbel32
AS Table is (2 of 250) 1% full
```

If the association is assigned to any application servers, go to the [Removing an Association from an Application Server](#) procedure and remove the association from the application servers.

4. Change the value of the `open` parameter to `no` by specifying the `chg-assoc` command with the `open=no` parameter.

Note: If the value of the `open` parameter for the association being removed from the database (shown in [Step 1](#)) is `no`, continue this procedure with [Step 5](#).

For this example, enter this command.

```
chg-assoc:aname=swbel32:open=no
```

When this command has successfully completed, this message should appear.

```
rlghncxa03w 06-10-28 09:12:36 GMT EAGLE5 36.0.0
CHG-ASSOC: MASP A - COMPLTD;
```

5. Remove the association from the database using the `dlt-assoc` command.

For this example, enter this command.

```
dlt-assoc:aname=swbel32
```

When this command has successfully completed, this message should appear.

```
rlghncxa03w 06-10-28 09:12:36 GMT EAGLE5 36.0.0
DLT-ASSOC: MASP A - COMPLTD
```

6. Verify the changes using the `rtrv-assoc` command with the name of the association specified in [Step 5](#).

For this example, enter this command.

```
rtrv-assoc:aname=swbel32
```

This is an example of possible output.

```
rlghncxa03w 06-10-28 09:12:36 GMT EAGLE5 36.0.0
No matching entries found
IP Appl Sock table is (3 of 4000) 1% full
```

7. Back up the new changes, using the `chg-db:action=backup:dest=fixed` command. These messages should appear; the active Maintenance and Administration Subsystem Processor (MASP) appears first.

```
BACKUP (FIXED) : MASP A - Backup starts on active MASP.
BACKUP (FIXED) : MASP A - Backup on active MASP to fixed disk complete.
BACKUP (FIXED) : MASP A - Backup starts on standby MASP.
BACKUP (FIXED) : MASP A - Backup on standby MASP to fixed disk complete.
```

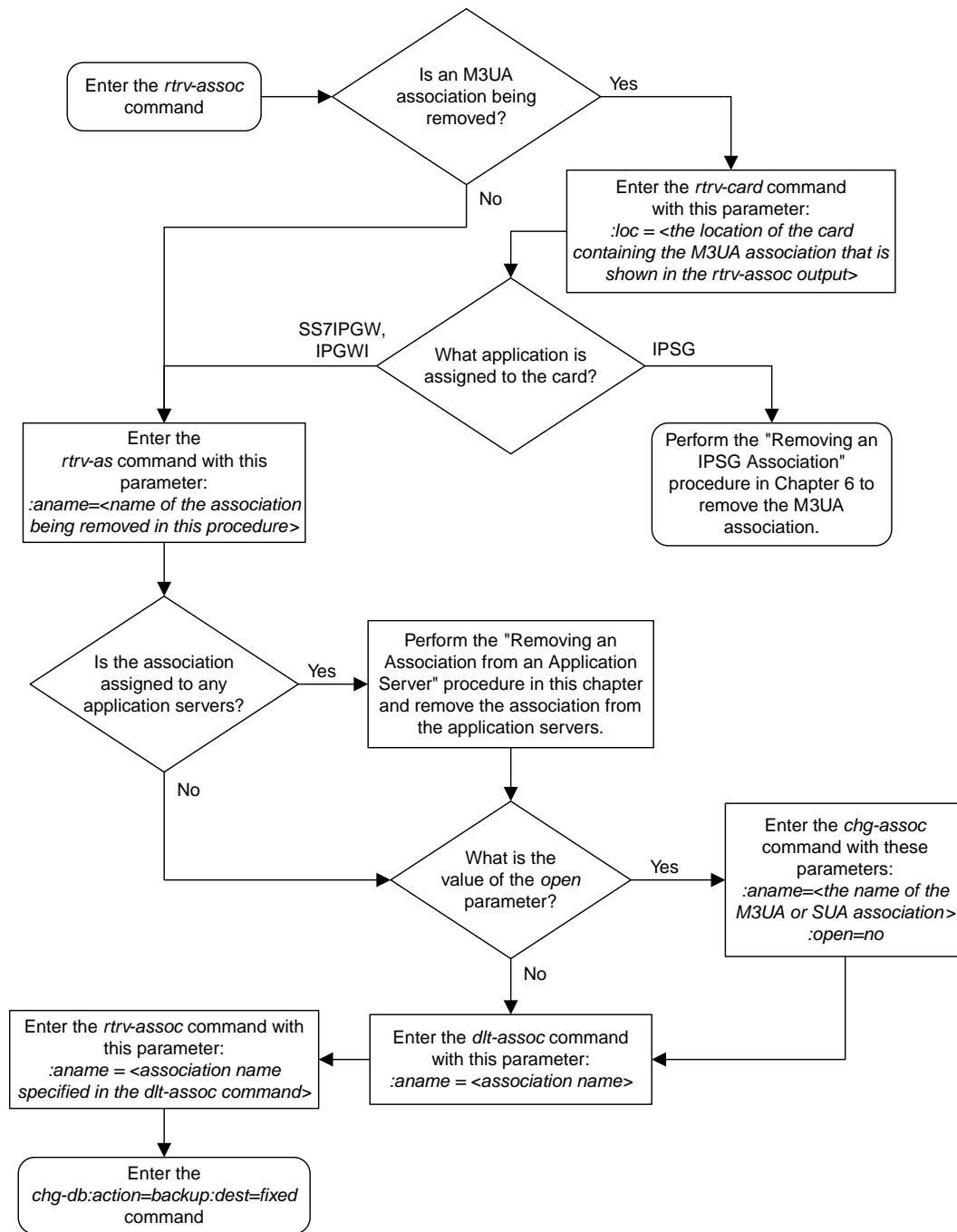

Figure 62: Removing a M3UA or SUA Association

Removing an Association from an Application Server

This procedure is used to remove an association from an application server using the `dlt-as` command.

The `dlt-as` command uses these parameters:

- :asname – The application server name containing the association being removed in this procedure.
- :aname – The name of the association being removed from the application server.

The association name and application server name combination must be in the database.

The open parameter value in the association assigned to the application server specified in the `dlt-as` command must be `no`. This can be verified with the `rtrv-assoc` command. Use the `chg-assoc` command to change the value of the open parameter.

If the association is the only association assigned to the application server, the application server is removed from the database. The application server cannot be removed from the database if it is assigned to a routing key. This can be verified with the `rtrv-appl-rtkey` command.

Canceling the RTRV-AS, RTRV-ASSOC, and RTRV-APPL-RTKEY Commands

Because the `rtrv-as`, `rtrv-assoc`, and `rtrv-appl-rtkey` commands used in this procedure can output information for a long period of time, the `rtrv-as`, `rtrv-assoc`, and `rtrv-appl-rtkey` commands can be canceled and the output to the terminal stopped. There are three ways that the `rtrv-as`, `rtrv-assoc`, and `rtrv-appl-rtkey` commands can be canceled.

- Press the F9 function key on the keyboard at the terminal where the `rtrv-as`, `rtrv-assoc`, or `rtrv-appl-rtkey` commands were entered.
- Enter the `canc-cmd` without the `trm` parameter at the terminal where the `rtrv-as`, `rtrv-assoc`, or `rtrv-appl-rtkey` commands were entered.
- Enter the `canc-cmd:trm=<xx>`, where `<xx>` is the terminal where the `rtrv-as`, `rtrv-assoc`, or `rtrv-appl-rtkey` commands were entered, from another terminal other than the terminal where the `rtrv-as`, `rtrv-assoc`, or `rtrv-appl-rtkey` commands were entered. To enter the `canc-cmd:trm=<xx>` command, the terminal must allow Security Administration commands to be entered from it and the user must be allowed to enter Security Administration commands. The terminal's permissions can be verified with the `rtrv-secu-trm` command. The user's permissions can be verified with the `rtrv-user` or `rtrv-secu-user` commands.

For more information about the `canc-cmd` command, go to *Commands Manual User's Guide*.

1. Display the application servers in the database using the `rtrv-as` command.

This is an example of possible output.

```
rlghncxa03w 06-10-28 09:12:36 GMT EAGLE5 36.0.0

AS Name           Mode           Tr ms      Association Names
as1                LOADSHARE     10         assoc1
                  assoc2
                  assoc3
                  assoc5
                  assoc6

as2                OVERRIDE      10         assoc7
as3                LOADSHARE     10         assoc4
```

```
AS table is (3 of 250) 1% full.
```

2. Display the associations to be removed from the application server using the `rtrv-assoc` command and specifying the association name shown in the `rtrv-as` output in [Step 1](#).

For this example, enter this command.

```
rtrv-assoc:aname=assoc1
```

This is an example of possible output.

```
rlghncxa03w 09-05-28 09:12:36 GMT EAGLE5 41.0.0
ANAME assoc1
  LOC      1203          IPLNK PORT  A          LINK  A
ADAPTER  M3UA          VER          M3UA RFC
LHOST    gw105.nc.tekelec.com
ALHOST   ---
RHOST    gw100.nc.tekelec.com
ARHOST   ---
LPOR     1030          RPORT      1030
ISTRMS   2              OSTRMS     2          BUFSIZE  16
RMODE    LIN          RMIN       120        RMAX     800
RTIMES   10          CWMIN      3000      UAPS     10
OPEN     YES          ALW        YES        RTXTHR   10000
RHOSTVAL RELAXED

ASNAMES
as1

IP Appl Sock table is (4 of 4000) 1% full
Assoc Buffer Space Used (16 KB of 800 KB) on LOC = 1203
```

3. Change the value of the open parameter to no by specifying the `chg-assoc` command with the `open=no` parameter.

Note: If the value of the `open` parameter shown in [Step 2](#) is no, continue the procedure with [Step 4](#).

For this example, enter this command.

```
chg-assoc:aname=assoc1:open=no
```

When this command has successfully completed, this message should appear.

```
rlghncxa03w 06-10-28 09:12:36 GMT EAGLE5 36.0.0
CHG-ASSOC: MASP A - COMPLTD;
```

4. If the association is the only association assigned to the application server, the application server is removed from the database.

Note: If the application server specified in this procedure contains more than one association, continue this procedure with [Step 5](#).

The application server cannot be removed from the database if it is assigned to a routing key. Verify the routing keys that the application server is assigned to by entering the `rtrv-appl-rtkey` command with the application server name that will be specified in [Step 5](#) and the `display=all` parameter. For this example, enter this command.

```
rtrv-appl-rtkey:asname=as1:display=all
```

```
rlghncxa03w 06-10-28 09:12:36 GMT EAGLE5 36.0.0

RCONTEXT  DPCI          SI SSN OPCI          CICS          CICE          LOC
-----  -
          6-024-7      5 --- 1-057-4      150           175           STATIC

      ADPTR  TYPE          ASNAME
      M3UA   FULL        as1

      ANAMES
      assoc1
      assoc6

          assoc2          assoc3          assoc5

RCONTEXT  DPCI          SI SSN OPCI          CICS          CICE          LOC
-----  -
          2-100-7      6 --- -----  -----  -----  STATIC

      ADPTR  TYPE          ASNAME
      M3UA   FULL        as1

      ANAMES
      assoc1
      assoc6

          assoc2          assoc3          assoc5

STATIC Route Key table is (7 of 2000) 1% full
STATIC Route Key Socket Association table is (7 of 32000) 1% full
```

If the application server is assigned to any routing keys, remove the routing keys referencing the application server by performing the [Removing a Routing Key Containing an Application Server](#) procedure.

- Remove the association from the application server from the database using the `dlt-as` command. For this example, enter this command.

```
dlt-as:asname=as1:aname=assoc1
```

Note: If the association being removed from the application server is the only association assigned to the application server, the application server is removed from the database.

This is an example of possible inputs and outputs:

```
rlghncxa03w 06-10-28 09:12:36 GMT EAGLE5 36.0.0
DLT-AS: MASP A - COMPLTD;
```

- Verify the changes using the `rtrv-as` command with the application server name specified in [Step 5](#).

For this example, enter this command.

```
rtrv-as:asname=as1
```

This is an example of possible output.

```
rlghncxa03w 06-10-28 09:12:36 GMT EAGLE5 36.0.0

AS Name          Mode          Tr ms          Association Names
as1              LOADSHARE     10             assoc2
```

```
assoc3
assoc5
assoc6

AS table is (3 of 250) 1% full.
```

7. Change the value of the open parameter to yes by specifying the chg-`assoc` command with the `open=yes` parameter.

Note: If the value of the open parameter was not changed in [Step 3](#), continue this procedure with [Step 8](#).

For this example, enter this command.

```
chg-assoc:aname=assoc1:open=yes
```

When this command has successfully completed, this message should appear.

```
rlghncxa03w 06-10-28 09:12:36 GMT EAGLE5 36.0.0
CHG-ASSOC: MASP A - COMPLTD;
```

8. Back up the new changes, using the `chg-db:action=backup:dest=fixed` command. These messages should appear; the active Maintenance and Administration Subsystem Processor (MASP) appears first.

```
BACKUP (FIXED) : MASP A - Backup starts on active MASP.
BACKUP (FIXED) : MASP A - Backup on active MASP to fixed disk complete.
BACKUP (FIXED) : MASP A - Backup starts on standby MASP.
BACKUP (FIXED) : MASP A - Backup on standby MASP to fixed disk complete.
```

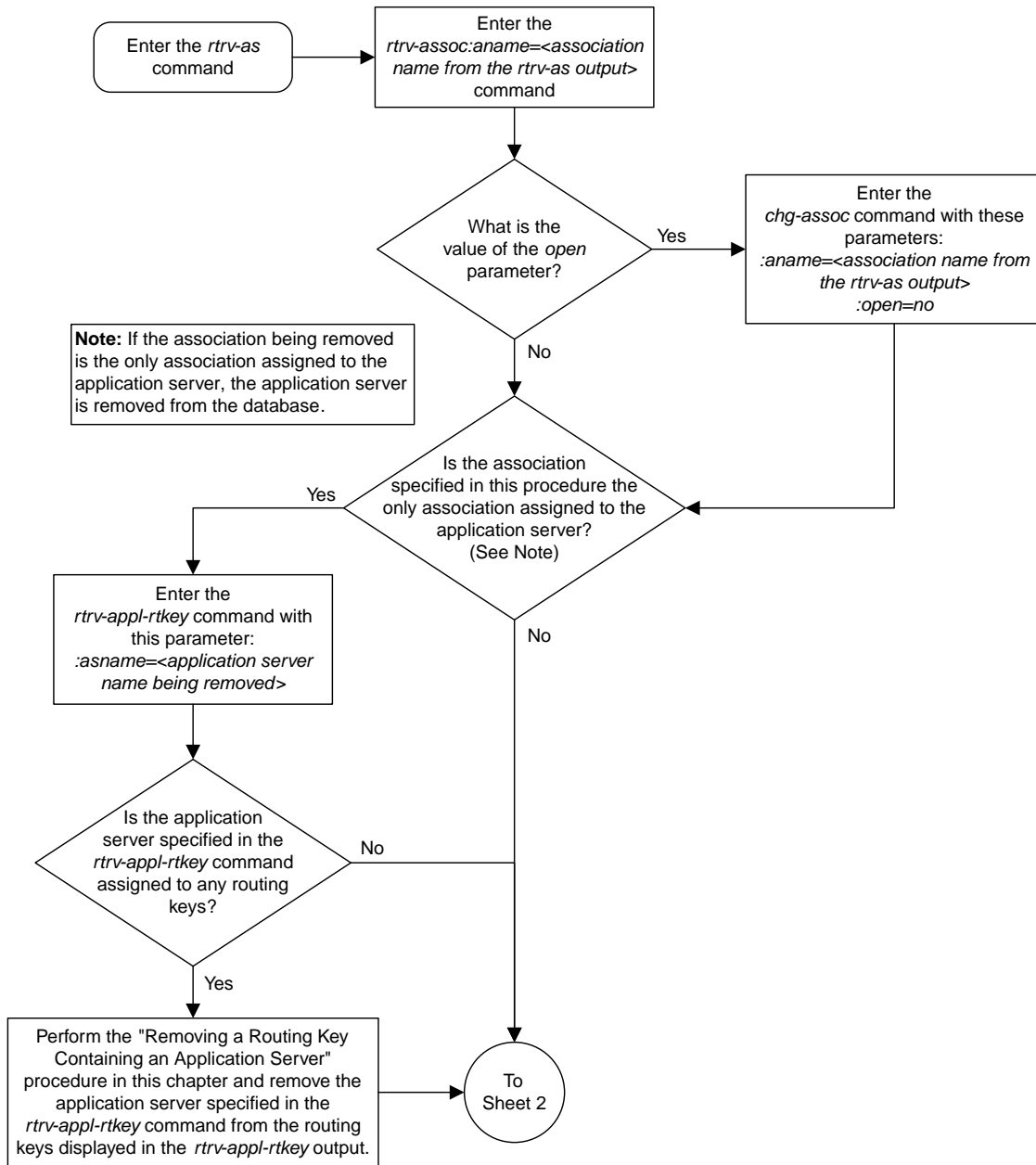

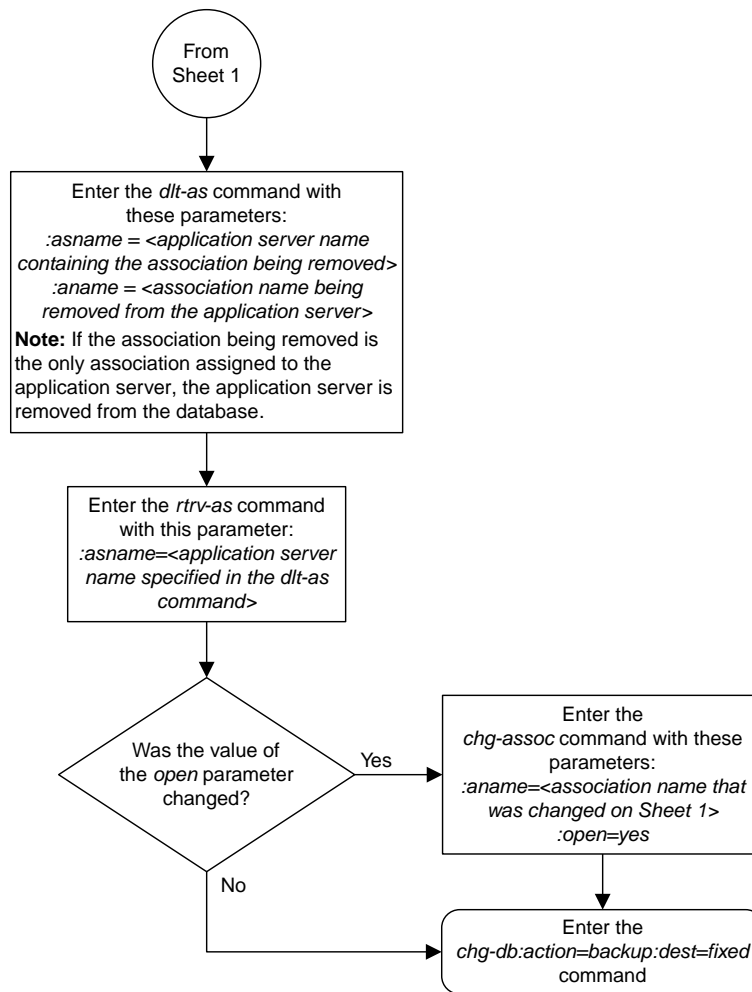

Sheet 2 of 2

Figure 63: Removing an Association from an Application Server

Removing a Routing Key Containing an Application Server

This procedure is used to remove a static key from the database using the `dlt-appl-rtkey` command. For more information about static and dynamic routing keys, see [Understanding Routing for SS7IPGW and IPGWI Applications](#).

The `dlt-appl-rtkey` command uses these parameters.

`:dpc/dpca/dpci/dpcn/dpca24` – The destination point code value that is used to filter incoming MSUs.

`:opc/opca/opci/opcn/opcn24` – The originating point code value that is used to filter incoming MSUs. This parameter must not specify a cluster route. This parameter must not specify a cluster route. This parameter is only valid when the `si` parameter value is set to 4, 5, or 13. This parameter is required if `si=4, 5, or 13` and `type=full`.

Note: See the “Point Code Formats” section in *Database Administration - SS7 User’s Guide* for a definition of the point code types that are used on the EAGLE and for a definition of the different formats that can be used for ITU national point codes.

`:si` – The service indicator value that is used to filter incoming MSUs. The range of values for the service indicator parameter (`si`) can be a numerical value from 0 to 15, or for selected service indicator values, a text string can be used instead of numbers. [Table 34: Service Indicator Text String Values](#) shows the text strings that can be used in place of numbers for the service indicator values.

Table 34: Service Indicator Text String Values

Service Indicator Value	Text String	Service Indicator Value	Text String
0	snm	4	tup
1	regtest	5	isup
2	spltst	13	qbicc
3	sccp		

`:ssn` – The subsystem value that is used to filter incoming MSUs. The `ssn` parameter is only valid when the `si` parameter value is set to 3 or `sccp`.

`:cics` – The starting circuit identification code that is used to filter incoming MSUs. Specify with `cice` to delete routing keys with the circuit identification code or range of circuit identification codes. The `cics` parameter is only valid when the `si` parameter value is set to 4, 5, or 13. The `cics` is required if `si=4, 5, or 13` and `type=full`.

`:cice` – The ending circuit identification code that is used to filter incoming MSUs. Specify with `cics` to delete routing keys with the circuit identification code or range of circuit identification codes. The `cice` parameter is only valid when the `si` parameter value is set to 4, 5, or 13. The `cics` is required if `si=4, 5, or 13` and `type=full`.

:type - Identifies the type of routing key that is being deleted. One of three values, type = full/partial/default. If type is not explicitly specified, type = full is assumed.

:asname - Application server (AS) name.

:rcontext - The routing context parameter value assigned to the routing key.

The parameter combinations used by the `dlt-appl-rtkey` command are based on the type of routing key and the service indicator value in the routing key. The parameter combinations are shown in [Table 35: Routing Key Parameter Combinations for Removing Routing Keys](#).

Table 35: Routing Key Parameter Combinations for Removing Routing Keys

Full Routing Key SI=3 (SCCP) (See Notes 1, 3, and 4)	Partial Routing Key SI=3 (SCCP) (See Notes 1, 3, and 4)	Full Routing Key SI=4 (TUP), 5 (ISUP), 13 (QBICC) (See Notes 1, 3, and 4)	Partial Routing Key SI=4 (TUP), 5 (ISUP), 13 (QBICC) (See Notes 1, 3, and 4)	Full Routing Key Other SI Values (See Notes 1, 3, and 4)	Partial Routing Key Other SI Values (See Notes 1, 3, and 4)	Default Routing Key (See Notes 1, 3, and 4)
dpc	type=partial	dpc	type=partial	dpc	type=partial	type=default
si=3 (See Note 1)	dpc (See Note 2)	si=4, 5, 13 (See Note 1)	dpc (See Note 2)	si=value other than 3, 4, 5, 13 (See Note 1)	dpc (See Note 2)	asname
ssn	si=3 (See Notes 1 and 2)	opc	si=4, 5, 13 (See Notes 1 and 2)	type=full	si=value other than 3, 4, 5, 13 (See Notes 1 and 2)	rcontext (See Notes 3 and 4)
type=full	asname	cics	opc (See Note 2)	asname	asname	
asname	rcontext (See Notes 3 and 4)	cice	asname	rcontext (See Notes 3 and 4)	rcontext (See Notes 3 and 4)	
rcontext (See Notes 3 and 4)		type=full	rcontext (See Notes 3 and 4)			
		asname				
		rcontext (See Notes 3 and 4)				

Notes:

1. The values for these parameters must be entered exactly as shown in the `rtrv-appl-rtkey` command output for the routing key being removed. However, text strings can be used in place of

Full Routing Key SI=3 (SCCP) (See Notes 1, 3, and 4)	Partial Routing Key SI=3 (SCCP) (See Notes 1, 3, and 4)	Full Routing Key SI=4 (TUP), 5 (ISUP), 13 (QBICC) (See Notes 1, 3, and 4)	Partial Routing Key SI=4 (TUP), 5 (ISUP), 13 (QBICC) (See Notes 1, 3, and 4)	Full Routing Key Other SI Values (See Notes 1, 3, and 4)	Partial Routing Key Other SI Values (See Notes 1, 3, and 4)	Default Routing Key (See Notes 1, 3, and 4)
some numerical service indicator values. See Table 34: Service Indicator Text String Values for a list of these text strings.						
2. These parameters are optional for partial routing keys, but at least one these parameters must be specified with the <code>dlt-appl-rtkey</code> command.						
3. If the routing key contains a numerical value in the RCONTEXT column in the <code>rtrv-appl-rtkey</code> output, the <code>dlt-appl-rtkey</code> command can be specified with only the <code>rcontext</code> parameter and value instead of the <code>dpc</code> , <code>si</code> , <code>ssn</code> , <code>opc</code> , <code>cics</code> , <code>cice</code> , or <code>type</code> parameters and values to remove the routing key.						
4. If the routing key contains dashes in the RCONTEXT column in the <code>rtrv-appl-rtkey</code> output, the <code>dpc</code> , <code>si</code> , <code>ssn</code> , <code>opc</code> , <code>cics</code> , <code>cice</code> , or <code>type</code> parameters and values must be used with the <code>dlt-appl-rtkey</code> command to remove the routing key.						

Canceling the RTRV-APPL-RTKEY Command

Because the `rtrv-appl-rtkey` command used in this procedure can output information for a long period of time, the `rtrv-appl-rtkey` command can be canceled and the output to the terminal stopped. There are three ways that the `rtrv-appl-rtkey` command can be canceled.

- Press the F9 function key on the keyboard at the terminal where the `rtrv-appl-rtkey` command was entered.
- Enter the `canc-cmd` without the `trm` parameter at the terminal where the `rtrv-appl-rtkey` command was entered.
- Enter the `canc-cmd:trm=<xx>`, where `<xx>` is the terminal where the `rtrv-appl-rtkey` commands were entered, from another terminal other than the terminal where the `rtrv-appl-rtkey` command was entered. To enter the `canc-cmd:trm=<xx>` command, the terminal must allow Security Administration commands to be entered from it and the user must be allowed to enter Security Administration commands. The terminal's permissions can be verified with the `rtrv-secu-trm` command. The user's permissions can be verified with the `rtrv-user` or `rtrv-secu-user` commands.

For more information about the `canc-cmd` command, go to *Commands User's Guide*.

1. Display the current routing key information in the database by entering the `rtrv-appl-rtkey` command.

The following is an example of the possible output.

```
rlghncxa03w 08-04-28 21:15:37 GMT EAGLE5 38.0.0

RCONTEXT      DPC          SI  ADPTR  ASNAME      TYPE
-----
-----  123-234-123  5   M3UA   as9         FULL
-----  123-234-123  5   M3UA   as9         FULL
1000         005-005-001  5   SUA    as10        FULL
```

```

2000      005-005-001   5  SUA   as10      FULL
-----      006-006-001   5  M3UA  as11      FULL
-----      006-006-001   5  M3UA  as11      FULL

RCONTEXT   DPCI           SI  ADPTR  ASNAME     TYPE
-----
100        2-100-7        6  M3UA  as4        FULL
225        3-137-6        6  SUA   as1        FULL
          4-035-7        5  M3UA  as7        FULL
          6-006-6        5  M3UA  as2        FULL
          6-006-7        5  M3UA  as8        FULL
          6-006-6        5  M3UA  as2        FULL
          6-006-6        5  M3UA  as2        FULL
          6-006-8        3  M3UA  as3        FULL
          6-006-8        5  M3UA  as5        FULL
          6-024-7        5  M3UA  as4        FULL
          6-024-7        5  M3UA  as4        FULL
300        7-008-7        6  SUA   as6        FULL

RCONTEXT   DPC           SI  ADPTR  ASNAME     TYPE
-----
          *****  **  M3UA  as123      DEFAULT

STATIC Route Key table is (15 of 2000) 1% full
STATIC Route Key Socket Association table is (15 of 32000) 1% full

```

If a routing context value is not assigned to the the routing key being removed in this procedure, continue the procedure with [Step 3](#).

2. Display the specific routing key information for the routing key being removed from the database by entering the `rtrv-appl-rtkey` command with the `display=all` parameter and the `RCONTEXT` values shown in the `rtrv-appl-rtkey` output in [Step 1](#) for the routing key being removed.

For this example, enter this command.

```
rtrv-appl-rtkey:rcontext=225
```

This is an example of the possible output.

```

rlghncxa03w 08-04-28 21:16:37 GMT EAGLE5 38.0.0

RCONTEXT   DPCI           SI  SSN  OPCI           CICS     CICE
225        4-035-7        5  ---  2-007-3        2000     3000

      ADPTR  TYPE       ASNAME
      M3UA   FULL      as7

      ANAMES
      assoc15

STATIC Route Key table is (15 of 2000) 1% full
STATIC Route Key Socket Association table is (15 of 32000) 1% full

```

After this step is performed, continue the procedure with [Step 4](#).

3. Display the specific routing key information for the routing key being removed from the database by entering the `rtrv-appl-rtkey` command with the `display=all` parameter and the `DPC`, `SI`, and `TYPE` values shown in the `rtrv-appl-rtkey` output in [Step 1](#) for the routing key being removed. For this example, enter this command.

```
rtrv-appl-rtkey:dpci=6-006-6:si=3:display=all:type=full
```

This is an example of the possible output.

```
rlghncxa03w 08-04-28 09:12:36 GMT EAGLE5 38.0.0

RCONTEXT  DPCI          SI SSN OPCI          CICS          CICE
-----  -
          6-006-6          3 170 -----  -----

      ADPTR  TYPE          ASNAME
      M3UA  FULL          as2

      ANAMES
      assoc1

STATIC Route Key table is (15 of 2000) 1% full
STATIC Route Key Socket Association table is (15 of 32000) 1% full
```

4. Display the associations assigned to the routing key by entering the `rtrv-assoc` parameter with the association name shown in either [Step 2](#) or [Step 3](#). For this example, enter these commands.

```
rtrv-assoc:aname=assoc1
```

This is an example of possible output.

```
rlghncxa03w 09-05-28 09:12:36 GMT EAGLE5 41.0.0
ANAME assoc1
      LOC      1203          IPLNK PORT  A          LINK  A
      ADAPTER  M3UA          VER          M3UA RFC
      LHOST    gw105.nc.tekelec.com
      ALHOST    ---
      RHOST    gw100.nc.tekelec.com
      ARHOST    ---
      LPORT    1030          RPORT          1030
      ISTRMS   2          OSTRMS          2          BUFSIZE  16
      RMODE    LIN          RMIN            120          RMAX      800
      RTIMES   10          CWMIN           3000          UAPS       10
      OPEN     YES          ALW             YES          RTXTHR    10000
      RHOSTVAL RELAXED

      ASNAMES
      as2

IP Appl Sock table is (8 of 4000) 1% full
Assoc Buffer Space Used (16 KB of 800 KB) on LOC = 1203
```

```
rtrv-assoc:aname=assoc15
```

This is an example of possible output.

```
rlghncxa03w 09-05-28 09:12:36 GMT EAGLE5 41.0.0
ANAME assoc15
      LOC      1205          IPLNK PORT  A          LINK  A
      ADAPTER  M3UA          VER          M3UA RFC
      LHOST    gw115.nc.tekelec.com
      ALHOST    ---
      RHOST    gw100.nc.tekelec.com
      ARHOST    ---
      LPORT    2000          RPORT          2000
      ISTRMS   2          OSTRMS          2          BUFSIZE  16
      RMODE    LIN          RMIN            120          RMAX      800
```

```

RTIMES    10          CWMIN    3000    UAPS    10
OPEN     YES          ALW     YES     RTXTHR  10000
RHOSTVAL RELAXED

ASNAMES
as7

IP Appl Sock table is (8 of 4000) 1% full
Assoc Buffer Space Used (16 KB of 800 KB) on LOC = 1203

```

Repeat this step for all the associations shown in [Step 2](#) or [Step 3](#).

- Change the open parameter value of the association to no by using the `chg-assoc` command.

Note: If the open parameter value of all the associations shown in [Step 4](#) is no, continue the procedure with [Step 6](#).

For example, enter these commands.

```

chg-assoc:aname=assoc1:open=no
chg-assoc:aname=assoc15:open=no

```

When this command has successfully completed, the following message should appear.

```

rlghncxa03w 06-10-28 21:18:37 GMT EAGLE5 36.0.0
CHG-ASSOC: MASP A - COMPLTD

```



CAUTION

Caution: The IP connections using the associations specified in this step will not be able to carry any traffic when the open parameter is changed to no.

Repeat this step for all the associations shown in [Step 4](#) that contain the open=yes parameter value.

- Remove the routing key information from the database by entering the `dlt-appl-rtkey` command. The parameters required for the `dlt-appl-rtkey` command are determined by the type of routing key being added and the service indicator value in the routing key. See [Table 35: Routing Key Parameter Combinations for Removing Routing Keys](#) for the parameter combinations that can be used for the type of routing key being added to the database. For example, enter these commands.

```

dlt-appl-rtkey:dpci=6-006-6:si=3:ssn=170:asname=as2
dlt-appl-rtkey:rcontext=225

```

When each of these commands have successfully completed, the following message should appear.

```

rlghncxa03w 06-10-28 21:16:37 GMT EAGLE5 36.0.0
DLT-APPL-RTKEY: MASP A - COMPLTD

```

- Verify the changes by entering the `rtrv-appl-rtkey` command with the routing key parameters specified in [Step 6](#) (dpc, si, opc, cics, cice, ssn, asname, and type, and loc, as applicable). For this example, enter these commands.

```

rtrv-appl-rtkey:dpci=6-006-6:si=3:ssn=170:asname=as2

```

The following is an example of the possible output.

```
rlghncxa03w 08-04-28 21:15:37 GMT EAGLE5 38.0.0
No matching entries found
STATIC Route Key table is (12 of 2000) 1% full
STATIC Route Key Socket Association table is (6 of 32000) 1% full
```

```
rtrv-appl-rtkey:rcontext=225
```

The following is an example of the possible output.

```
rlghncxa03w 08-04-28 21:15:37 GMT EAGLE5 38.0.0
No matching entries found
STATIC Route Key table is (12 of 2000) 1% full
STATIC Route Key Socket Association table is (6 of 32000) 1% full
```

Note: If [Step 5](#) was not performed, continue the procedure with [Step 9](#).

8. Change the open parameter value of the associations that were changed in [Step 5](#) to yes by using the `chg-assoc` command.

For example, enter these commands.

```
chg-assoc:aname=assoc1:open=yes
chg-assoc:aname=assoc15:open=yes
```

When this command has successfully completed, the following message should appear.

```
rlghncxa03w 06-10-28 21:18:37 GMT EAGLE5 36.0.0
CHG-ASSOC: MASP A - COMPLTD
```

Repeat this step for all the associations that were changed in [Step 9](#).

9. Back up the new changes using the `chg-db:action=backup:dest=fixed` command. These messages should appear, the active Maintenance and Administration Subsystem Processor (MASP) appears first.

```
BACKUP (FIXED) : MASP A - Backup starts on active MASP.
BACKUP (FIXED) : MASP A - Backup on active MASP to fixed disk complete.
BACKUP (FIXED) : MASP A - Backup starts on standby MASP.
BACKUP (FIXED) : MASP A - Backup on standby MASP to fixed disk complete.
```

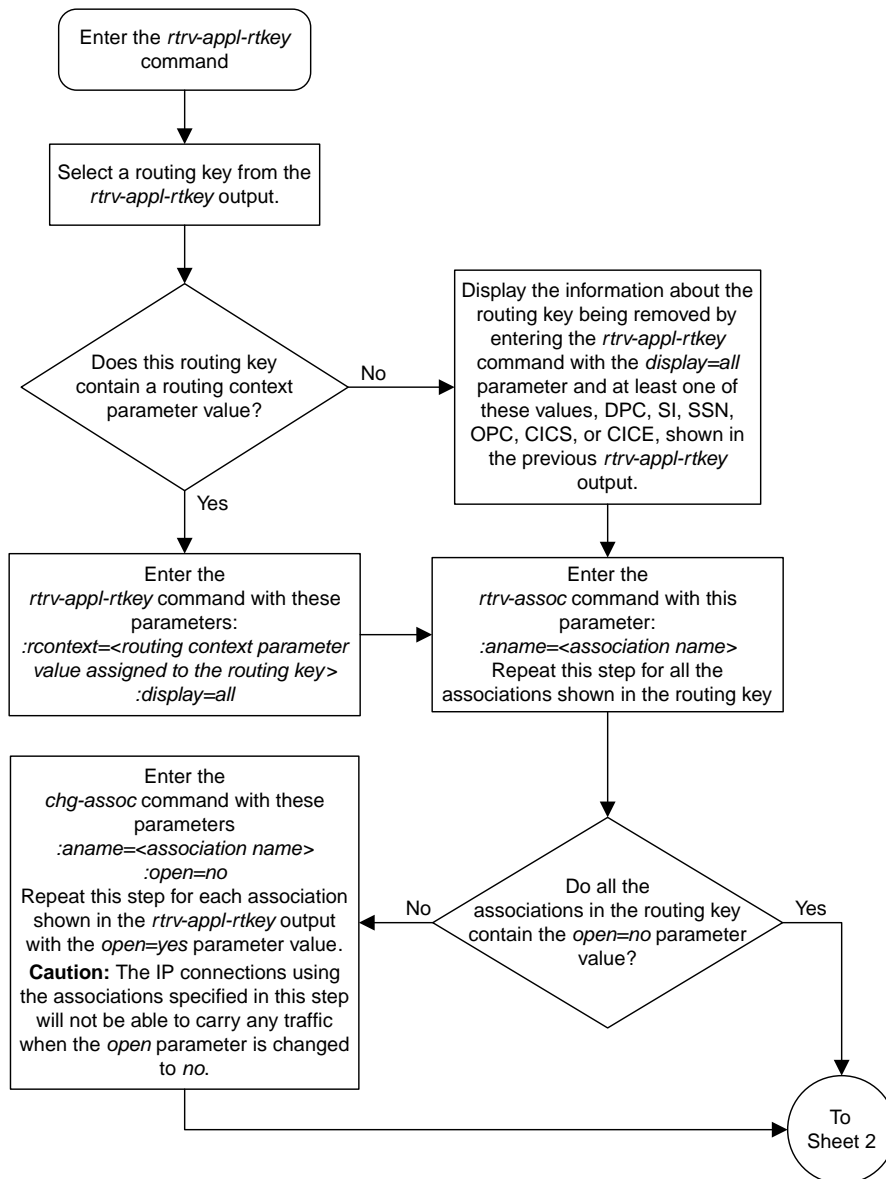

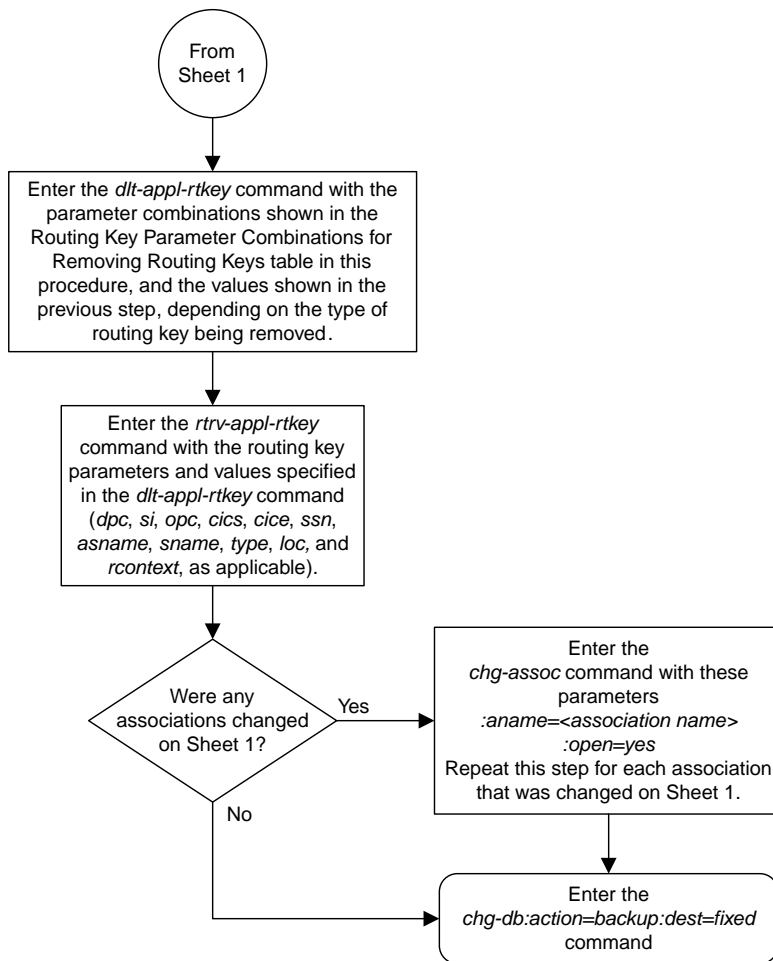

Sheet 2 of 2

Figure 64: Removing a Routing Key Containing an Application Server

Removing a Network Appearance

This procedure removes the network appearance from the database using the `dlt-na` command with these parameters.

`:na` – the 32-bit value of the network appearance, from 0 to 4294967295.

`:type` – the network type of the network appearance, `ansi` (ANSI), `itui` (ITU-I), `itun` (14-bit ITU-N), `itun24` (24-bit ITU-N), `ituis` (ITU-I Spare), `ituns` (14-bit ITU-N Spare).

`:gc` – the specific ITU-N group code associated with the network appearance.

Specifying the `gc` parameter removes the specific network appearance containing the `na` and `gc` parameter values.

Specifying the `type=itun` or `type=ituns` parameter without the `gc` parameter removes all 14-bit ITU-N or 14-bit ITU-N spare network appearances containing the specified `na` parameter value.

1. Display the network appearances in the database with the `rtrv-na` command.

This is an example of the possible output.

```
rlghncxa03w 06-10-28 09:12:36 GMT EAGLE5 36.0.0
TYPE      GC          NA
ANSI      --          100
ITUI      --          1000
ITUN      uk          150000
ITUN      fr          4000000000
ITUN      ge          1000000000
ITUN24    --           3
ITUIS     --          2000
ITUNS     sp          5000
```

2. Remove the network appearance from the database with the `dlt-na` command.

For this example, enter these commands.

```
dlt-na:na=100:type=ansi
```

```
dlt-na:na=4000000000:type=itun:gc=fr
```

When each of these commands have successfully completed, this message should appear.

```
rlghncxa03w 06-10-28 09:12:36 GMT EAGLE5 36.0.0
DLT-NA:  MASP A - COMPLTD
```

3. Verify the changes using the `rtrv-na` command.

This is an example of possible output.

```
rlghncxa03w 06-10-28 09:12:36 GMT EAGLE5 36.0.0
TYPE      GC          NA
```



```
ITUI    --      1000
ITUN    uk      150000
ITUN    ge     1000000000
ITUN24  --        3
ITUIS   --      2000
ITUNS   sp      5000
```

4. Back up the new changes, using the `chg-db:action=backup:dest=fixed` command.

These messages should appear; the active Maintenance and Administration Subsystem Processor (MASP) appears first.

```
BACKUP (FIXED) : MASP A - Backup starts on active MASP.
BACKUP (FIXED) : MASP A - Backup on active MASP to fixed disk complete.
BACKUP (FIXED) : MASP A - Backup starts on standby MASP.
BACKUP (FIXED) : MASP A - Backup on standby MASP to fixed disk complete.
```

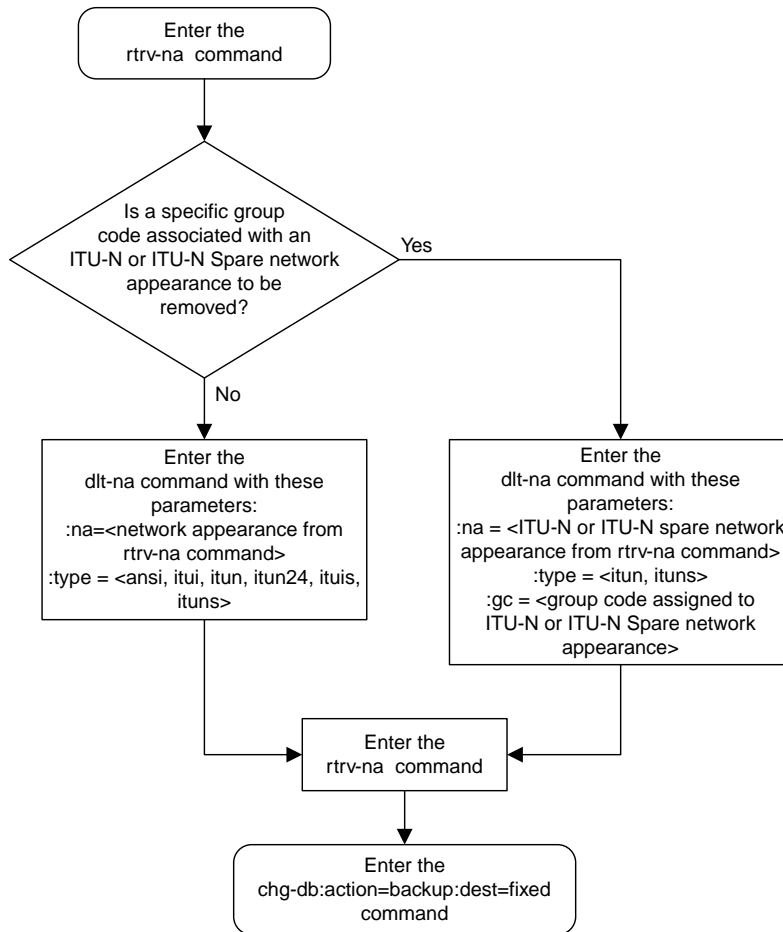

Figure 65: Removing a Network Appearance

Changing IETF M3UA and SUA Components

This section describes how to change the attributes of the following components in the database.

- IP Options – Perform the *Changing IP Options* procedure.
- An M3UA or SUA Association – Perform these procedures.
 - *Changing the Attributes of a M3UA or SUA Association*
 - *Changing the Buffer Size of a M3UA or SUA Association*
 - *Changing the Host Values of a M3UA or SUA Association*
- The SCTP Retransmission Parameters – Perform the *Changing the SCTP Checksum Algorithm Option for M3UA and SUA Associations* procedure.
- An Application Server – Perform the *Changing an Application Server* procedure.
- CIC Values in a Routing Key – Perform the *Changing the CIC Values in an Existing Routing Key Containing an Application Server* procedure.
- Routing Context Values in a Routing Key – Perform the *Changing the Routing Context Value in an Existing Routing Key* procedure.
- The SCTP Checksum Algorithm – Perform the *Changing the SCTP Checksum Algorithm Option for M3UA and SUA Associations* procedure.
- A UA Parameter Set – Perform the *Changing a UA Parameter Set* procedure.
- Turn off the Large MSU Support for IP Signaling feature – Perform the *Turning Off the Large MSU Support for IP Signaling Feature* procedure.

Changing IP Options

Use this procedure to change the IP options defined by these parameters: `getcomm`, `setcomm`, `snmpcont`, `srkq`, `trapcomm`, `ipgwabate`, and `uameasusedftas`.

The `chg-sg-opts` command also contains the `sctpcsum` parameter. Perform the one of these procedures to change the `sctpcsum` parameter value.

- *Changing the SCTP Checksum Algorithm Option for M3UA and SUA Associations*
- *Changing the SCTP Checksum Algorithm Option for M2PA Associations*
- *Changing the SCTP Checksum Algorithm Option for IPSG M2PA Associations*
- *Changing the SCTP Checksum Algorithm Option for IPSG M3UA Associations*

`:getcomm` – The community name used to validate SNMP *Get* and *GetNext* requests. This value applies to each IP card SNMP agent.

`:setcomm` – The community name used to validate SNMP *Set* requests. This value applies to each IP card SNMP agent.

`:snmpcont` – The system contact information for each IP card SNMP agent, used to define the *sysContact* object in the SNMP MIB II System Group.

`:srkq` – The static routing key quantity used to specify the maximum number of static routing key entries in the Routing Key table of each `ss7ipgw` and `ipgwi` card.

:trapcomm – The community name used when sending SNMP traps. This value applies to each IP card SNMP agent.

:ipgwabate – enables (ipgwabate=yes) or disables (ipgwabate=no) SS7 congestion abatement procedures for IPGWx signaling links (signaling links assigned to cards running the ss7ipgw or ipgwi applications). The default value for this parameter is no.

:uameasusedftas - specifies whether UA measurements are pegged against the default application server or against the application server shown by the routing context. The values for this parameter are yes and no. The system default value for this parameter is yes.

- yes - UA measurement registers are pegged against the default application server.
- no - UA measurements are pegged against the application server shown by the routing context.

The maximum value of the srkq parameter is 2500.

The value specified for the srkq parameter cannot be less than the current number of provisioned routing keys. The number of routing keys that are currently provisioned is shown in the rtrv-appl-rtkey or rtrv-tbl-capacity command outputs.

The values of the snmpcont, getcomm, setcomm, and trapcomm parameters are a string of up to 32 characters that is not case sensitive. If the character string contains characters other than alphanumeric characters, the character string must be enclosed in single quotes.

1. Display the current IP options in the database by entering the rtrv-sg-opts command.

The following is an example of the possible output.

```
rlghncxa03w 08-04-28 21:17:37 GMT EAGLE5 38.0.0
SRKQ:                250
SNMPCONT:            john doe 555-123-4567
GETCOMM:             public
SETCOMM:             private
TRAPCOMM:            public
SCTPCSUM:            crc32c
IPGWABATE:           NO
UAMEASUSEDFTAS      YES
```

If the srkq parameter value will not be changed, continue the procedure with [Step 3](#).

If the srkq parameter value will be changed, verify the number of routing keys that are currently provisioned by performing [Step 2](#).

2. Enter the rtrv-tbl-capacity command to verify the number of routing keys that are currently provisioned.

The following is an example of the possible output.

```
rlghncxa03w 08-04-28 21:17:37 GMT EAGLE5 38.0.0
RTEKEY table is (      53 of      2500)  2% full
```

Note: The rtrv-tbl-capacity command output contains other fields that are not used by this procedure. If you wish to see all the fields displayed by the rtrv-tbl-capacity command, see the rtrv-tbl-capacity command description in *Commands User's Guide*.

The number of routing keys that are currently provisioned is shown in the RTEKEY row of the `rtrv-tbl-capacity` output. In this example, there are 53 routing keys provisioned in the database. The new `srkq` parameter value cannot be less than 53.

3. Change the IP options in the database using the `chg-sg-opts` command.

For this example, enter this command.

```
chg-sg-opts:srkq=200:ipgwabate=yes:uameasusedftas=no
```

When this command has successfully completed, the following message should appear.

```
rlghncxa03w 08-04-28 21:18:37 GMT EAGLE5 38.0.0
CHG-SG-OPTS: MASP A - COMPLTD
```

4. Verify the new IP options in the database by entering the `rtrv-sg-opts` command.

The following is an example of the possible output.

```
rlghncxa03w 08-04-28 21:19:37 GMT EAGLE5 38.0.0
SRKQ:                200
SNMPCONT:            john doe 555-123-4567
GETCOMM:             public
SETCOMM:             private
TRAPCOMM:            public
SCTPCSUM:            crc32c
IPGWABATE:           YES
UAMEASUSEDFTAS      NO
```

5. Back up the new changes using the `chg-db:action=backup:dest=fixed` command. These messages should appear, the active Maintenance and Administration Subsystem Processor (MASP) appears first.

```
BACKUP (FIXED) : MASP A - Backup starts on active MASP.
BACKUP (FIXED) : MASP A - Backup on active MASP to fixed disk complete.
BACKUP (FIXED) : MASP A - Backup starts on standby MASP.
BACKUP (FIXED) : MASP A - Backup on standby MASP to fixed disk complete.
```

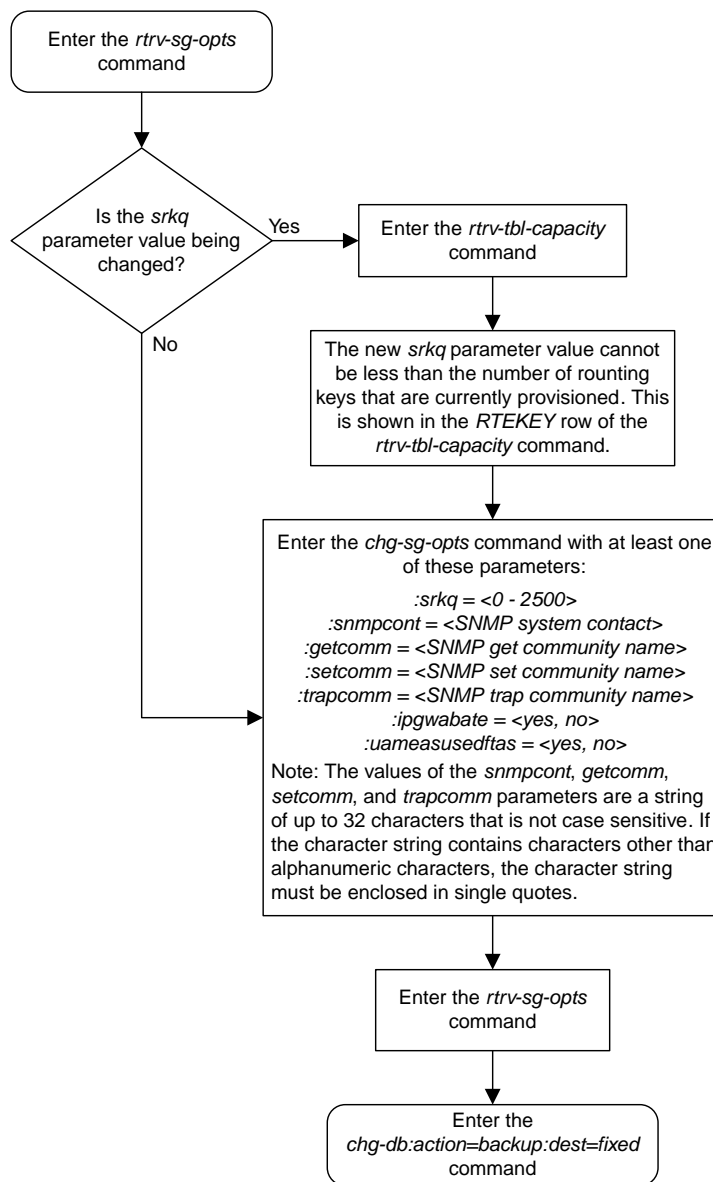

Figure 66: Changing IP Options

Changing the Attributes of a M3UA or SUA Association

This procedure is used to change the values of the attributes of a M3UA or SUA association, assigned to cards that are running the SS7IPGW or IPGWI applications, using the `chg-assoc` command and the following parameters.

Table 36: Change M3UA and SUA Association Parameters

aname	lport	rhost	rport	open	alw
rmode	rmin	rmax	rtimes	cwmin	istrms
ostrms	uaps	rtxthr	rhosttype	rhostval	

If you wish to change the attributes of M3UA associations assigned to cards that are running the IPGS application, perform.

The `chg-assoc` command contains other parameters that are not used in this procedure. To change these parameters, perform these procedures.

- `lhost` and `alhost` - [Changing the Host Values of a M3UA or SUA Association](#)
- `bufsize` - [Changing the Buffer Size of a M3UA or SUA Association](#)

`:aname` – The name assigned to the association, shown in the `rtrv-assoc` output.

`:lport` – The SCTP port number for the local host.

`:rhost` – The host name for the remote host, `rhost` can be any string of characters starting with a letter and comprising these characters [a..'z', 'A..'Z', '0..'9', '-', '.']. Hostnames are not case-sensitive and can contain up to 60 characters. The default value of this optional parameter is empty (null string).

`:rport` – The SCTP port number for the remote host.

`:adapter` – The adapter layer for this association, either `m3ua` or `sua`. The `adapter` parameter is optional. The default value for the `adapter` parameter in this procedure is `m3ua`.

`:open` – The connection state for this association. Valid values are `yes` or `no`. When the `open=yes` parameter is specified, the connection manager opens the association if the association is operational. When the `open=no` parameter is specified, the connection manager will not open the association.

`:alw` – The connection state for this association. Valid values are `yes` or `no`. When the `alw=yes` parameter is specified, the connection manager allows the association to carry SS7 traffic. When the `alw=no` parameter is specified, the connection manager prohibits the association from carrying SS7 traffic.

`:rmode` – The retransmission policy used when packet loss is detected. The values are `rfc` or `lin`.

- `rfc` – Standard RFC 2960 algorithm in the retransmission delay doubles after each retransmission. The RFC 2960 standard for congestion control is also used.
- `lin` – Oracle's linear retransmission policy where each retransmission timeout value is the same as the initial transmission timeout and only the slow start algorithm is used for congestion control.

`:rmin` – The minimum value of the calculated retransmission timeout in milliseconds, from 10 - 1000.

`:rmax` – The maximum value of the calculated retransmission timeout in milliseconds, from 10 - 1000.

: *rtimes* – The number of times a data retransmission will occur before closing the association, from 3 - 12.

: *cwmin* – The minimum size in bytes of the association's congestion window and the initial size in bytes of the congestion window, from 1500 - 409600. The *cwmin* parameter value must be less than or equal to the size of the buffer used by the association, shown by the *bufsize* parameter value. If the buffer size for the association needs to be changed, perform [Changing the Buffer Size of a M3UA or SUA Association](#).

The *rmode*, *rmin*, *rmax*, *rtimes*, and *cwmin* parameters are used to configure the SCTP retransmission controls for an association, in addition to other commands. Perform [Configuring SCTP Retransmission Control for a M3UA or SUA Association](#) to configure the SCTP retransmission controls for an association.

: *istrms* – The number of inbound streams (1 or 2) advertised by the SCTP layer for the association.

: *ostrms* – The number of outbound streams (1 or 2) advertised by the SCTP layer for the association.

: *uaps* – The UA parameter set value being assigned to either an M3UA or SUA association.

: *rtxthr* – The retransmission threshold for the association. The *rtxthr* parameter value indicates the number of retransmissions that can occur on the association that when exceeded will generate UAM 0537, Ethernet Error Threshold Exceeded. The value of this parameter is 0 to 65,535. The value of this parameter is shown in the *RTXTHR* field of the *rtrv-assoc:aname=<association name>* output. The *rtxthr* parameter value can be changed if the *open* parameter value is either *yes* or *no*.

: *rhosttype* – The type of remote host assigned to the association, *primary* or *alternate*. The primary remote host is shown in the *RHOST* field of the *rtrv-assoc:aname=<association name>* output. The alternate remote host is shown in the *ARHOST* field of the *rtrv-assoc:aname=<association name>* output.

An alternate remote host can be configured for multi-homed associations using the *rhost* and *rhosttype* parameters of the *chg-assoc* command. The *rhost* parameter value with the *rhosttype=primary* parameter represents an IP address that corresponds to one of the network interfaces at the remote end while the *rhost* parameter value with the *rhosttype=alternate* parameter represents an IP address that corresponds to the other network interface at the remote end.

: *rhostval* – The validation mode used for the association when an SCTP INIT/INIT-ACK message is received. The value of this parameter is shown in the *RHOSTVAL* field of the *rtrv-assoc:aname=<association name>* output. This parameter has two values.

- *relaxed* - accept the message if the IP address for the primary or alternate remote host matches the IP address, source IP address, or the host name in the message.
- *match* - accept the message if the message contains the primary remote host value and the alternate remote host value (if the alternate remote host is provisioned). If the alternate remote host is not provisioned, then accept the message if the message contains the primary remote host value. Reject the message if it contains any IP address other than that of the primary or alternate remote host.

Refer to the *chg-assoc* command description in *Commands User's Guide* for more information about this parameter.

If the value of the *open* parameter is *yes*, only the value of the *alw*, and *rtxthr* parameters can be changed. To change the values of other parameters, the value of the *open* parameter must be *no*.

To set the *open* parameter value to *yes*, the association specified by the *aname* parameter must contain values for the *lhost*, *lport*, *rhost*, and *rport* parameters. The *lhost* parameter value must have a signaling link assigned to it.

At least one optional parameter is required.

The command input is limited to 150 characters, including the hostnames.

The `adapter` parameter value cannot be changed if the association is assigned to an application server. This can be verified with the `rtrv-as` command. If the association is assigned to any application servers, perform [Removing an Association from an Application Server](#) to remove the association from the application servers.

The value of the `rmin` parameter must be less than or equal to the `rmax` parameter value.

If the card's application is either SS7IPGW or IPGWI, the signaling link being assigned to the association must be in service. This state is shown in the `rept-stat-slk` output with the entries IS-NR in the PST field and Avail in the SST field.

Canceling the RTRV-ASSOC and RTRV-AS Commands

Because the `rtrv-assoc` and `rtrv-as` commands used in this procedure can output information for a long period of time, the `rtrv-assoc` and `rtrv-as` commands can be canceled and the output to the terminal stopped. There are three ways that the `rtrv-assoc` and `rtrv-as` commands can be canceled.

- Press the F9 function key on the keyboard at the terminal where the `rtrv-assoc` or `rtrv-as` commands were entered.
- Enter the `canc-cmd` without the `trm` parameter at the terminal where the `rtrv-assoc` or `rtrv-as` commands were entered.
- Enter the `canc-cmd:trm=<xx>`, where `<xx>` is the terminal where the `rtrv-assoc` or `rtrv-as` commands were entered, from another terminal other than the terminal where the `rtrv-assoc` or `rtrv-as` commands were entered. To enter the `canc-cmd:trm=<xx>` command, the terminal must allow Security Administration commands to be entered from it and the user must be allowed to enter Security Administration commands. The terminal's permissions can be verified with the `rtrv-secu-trm` command. The user's permissions can be verified with the `rtrv-user` or `rtrv-secu-user` commands.

For more information about the `canc-cmd` command, go to *Commands User's Guide*.

1. Display the associations in the database using the `rtrv-assoc` command.

This is an example of possible output.

```
rlghncxa03w 08-04-28 09:12:36 GMT EAGLE5 38.0.0

          CARD IPLNK
ANAME     LOC  PORT  LINK ADAPTER  LPORT  RPORT  OPEN  ALW
swbel32   1201 A    A    M3UA   1030   2345   YES   YES
a2        1305 A    A    SUA    1030   2345   YES   YES
a3        1307 A    A    SUA    1030   2346   YES   YES
assoc1    1201 A    A    M3UA   2000   1030   YES   YES
assoc2    1205 A    A    M3UA   2048   2048   YES   YES
assoc3    1205 A    A    M3UA   3000   3000   YES   YES
assoc5    1205 A    A    M3UA   1500   3000   YES   YES
```

Select an association whose adapter value is M3UA or SUA. If the card shown in the `CARD LOC` column contains any SUA associations, continue the procedure with [Step 3](#). If the card contains only M3UA associations, continue the procedure with [Step 2](#).

2. Enter the `rtrv-card` command with the location of the card that is hosting the M3UA association that will be changed in this procedure. For this example, enter this command.

```
rtrv-card:loc=1205
```

This is an example of possible output.

```
rlghncxa03w 08-04-06 15:17:20 EST EAGLE5 38.0.0
CARD   TYPE      APPL      LSET NAME  LINK SLC LSET NAME  LINK SLC
1205   DCM          SS7IPGW   e5e6a      A      0
```

If the application assigned to the card is IPSP, perform [Changing the Attributes of an IPSP Association](#).

If the application assigned to the card is SS7IPGW or IPGWI, continue the procedure with [Step 3](#).

3. Continue the procedure by performing one of these actions.

If the application assigned to the card is SS7IPGW or IPGWI, shown in the APPL column, and the values of any of these parameters are being changed: `lport`, `rhost`, `rport`, `adapter`, `rmode`, `rmin`, `rmax`, `rtimes`, `cwmin`, `istrms`, `ostrms`, or `uaps`, continue the procedure by performing one of these actions.

- If the open parameter value for the association is `yes`, continue the procedure with [Step 5](#).
- If the open parameter value for the association is `no`, continue the procedure with [Step 6](#).

If the application assigned to the card is SS7IPGW or IPGWI, shown in the APPL column, and only the values of the `alw`, `open`, or `rtxthr` parameters are being changed, continue the procedure by performing one of these actions.

- If only the values of the `alw` parameter is being changed, or the open parameter value is being changed to `no`, continue the procedure with [Step 12](#).
- If the value of the `rtxthr` parameter is being changed, continue the procedure with [Step 6](#).
- If the value of the open parameter value is being changed to `yes`, a signaling link must be assigned to the card shown in this step. If [Step 2](#) was performed, perform one of these actions.
 - If a signaling links is assigned to the card, entries area shown in the LSET NAME and LINK columns of the `rtrv-card` output in [Step 2](#). If a signaling link is assigned to the card, perform one of these actions.
 - If only the `alw` parameter is being specified with the `open=yes` parameter, continue the procedure with [Step 12](#).
 - If the value of the `rtxthr` parameter is being changed, continue the procedure with [Step 6](#).
 - If the value of the open parameter value is being changed to `yes` and a signaling link is not assigned to the card, perform [Adding an IPGWx Signaling Link](#) to assign an IPGWx signaling link to the card. After the signaling link has been added, perform one of these actions.
 - If only the `alw` parameter is being specified with the `open=yes` parameter, continue the procedure with [Step 12](#).
 - If the value of the `rtxthr` parameter is being changed, continue the procedure with [Step 6](#).
- If the value of the open parameter value is being changed to `yes`, and [Step 2](#) was not performed, continue the procedure with [Step 4](#).

4. Display the signaling link that is assigned to the card containing the association that is being changed by entering the `rtrv-slk` command with the location of the card. For this example, enter this command.

```
rtrv-slk:loc=1205
```

This is an example of possible output.

```
rlghncxa03w 08-04-25 14:02:39 EST 38.0.0
rtrv-slk:loc=1101
Command entered at terminal #4.
```

LOC	LINK	LSN	SLC	TYPE
1205	A	e5e6a	0	SS7IPGW

If a signaling link is shown in this step, perform one of these actions.

- If only the `alw` parameter is being specified with the `open=yes` parameter, continue the procedure with [Step 12](#).
- If the value of the `rtxtthr` parameter is being changed, continue the procedure with [Step 6](#).

If a signaling link is not shown in this step, perform [Adding an IPGWx Signaling Link](#) to assign an IPGWx signaling link to the card. After the signaling link has been added, perform one of these actions.

- If only the `alw` parameter is being specified with the `open=yes` parameter, continue the procedure with [Step 12](#).
 - If the value of the `rtxtthr` parameter is being changed, continue the procedure with [Step 6](#).
5. Change the value of the `open` parameter to `no` by specifying the `chg-assoc` command with the `open=no` parameter.

For this example, enter this command.

```
chg-assoc:aname=assoc2:open=no
```

When this command has successfully completed, this message should appear.

```
rlghncxa03w 08-04-28 09:12:36 GMT EAGLE5 38.0.0
CHG-ASSOC: MASP A - COMPLTD;
```

6. Display the association being changed by entering the `rtrv-assoc` command with the `aname` parameter specified in [Step 5](#) or selected in [Step 1](#).

For this example, enter this command.

```
rtrv-assoc:aname=assoc2
```

This is an example of the possible output.

```
rlghncxa03w 09-05-28 21:14:37 GMT EAGLE5 41.0.0
ANAME assoc2
LOC 1205 IPLNK PORT A LINK A
ADAPTER M3UA VER M3UA RFC
LHOST IPNODE2-1205
ALHOST ---
RHOST remotehost1
ARHOST ---
LPORT 2048 RPORT 2048
ISTRMS 2 OSTRMS 2 BUFSIZE 200
RMODE LIN RMIN 120 RMAX 800
RTIMES 10 CWMIN 3000 UAPS 10
OPEN No ALW YES RTXTHR 2000
RHOSTVAL RELAXED
```

```

ASNAMES
as1          as4          as6

IP Appl Sock/Assoc table is (8 of 4000) 1% full
Assoc Buffer Space Used (800 KB of 800 KB) on LOC = 1205

```

Continue the procedure by performing one of these steps.

- If only the `rtxthr` parameter value is being changed, continue the procedure with [Step 12](#).
 - If the `adapter`, `uaps`, or `cwmin` parameter values are not being changed, continue the procedure with [Step 10](#).
 - If the `adapter` parameter value is being changed, continue the procedure with [Step 7](#).
 - If the `uaps` parameter value is being changed, but the `adapter` parameter value is not being changed, continue the procedure with [Step 8](#).
 - If the `cwmin` parameter value is being changed, but the `adapter` and `uaps` parameter values are not being changed, continue the procedure with [Step 9](#).
7. Display the application servers referencing the association being changed using the `rtrv-as` command with the name of the association being changed in this procedure.

For this example, enter this command.

```
rtrv-as:aname=assoc2
```

This is an example of possible output.

```

rlghncxa03w 08-04-28 21:14:37 GMT EAGLE5 38.0.0
AS Name      Mode      Tr ms     Association Names
as1          LOADSHARE 2000      assoc2
as4          LOADSHARE 2000      assoc2
as6          LOADSHARE 2000      assoc2
AS Table is (6 of 250) 1% full

```

If the association is assigned to any application servers, perform [Removing an Association from an Application Server](#) to remove the association from the application servers.

Continue the procedure by performing one of these steps.

- If the `uaps` or `cwmin` parameter values are not being changed, continue the procedure with [Step 10](#).
 - If the `uaps` parameter value is being changed, continue the procedure with [Step 8](#).
 - If the `cwmin` parameter value is being changed, but the `uaps` parameter value is not being changed, continue the procedure with [Step 9](#).
8. Verify the values of the UA parameter set you wish to assign to the association by entering the `rtrv-uaps` command with the desired parameter set.

Note: If the `uaps` parameter will not be specified with the `chg-assoc` command, and the `adapter` parameter value is being changed to either `m3ua` or `sua`, the UA parameter set 10 will be assigned to the association.

For this example, enter this command.

```
rtrv-uaps:set=3
```

This is an example of possible output.

```
rlghncxa03w 10-07-28 09:12:36 GMT EAGLE5 42.0.0
SET  TIMER      TVALUE  PARM      PVALUE
3     1           10       1          3
3     2           3000    2          0
3     3           10000   3          1
3     4           5000    4          0
3     5           0       5          0
3     6           0       6          0
3     7           0       7          0
3     8           0       8          0
3     9           0       9          0
3    10          0       10         0

TIMER 2: False IP Connection Congestion Timer, max time an
         association can be congested before failing due to false
         congestion. SS7IPGW and IPGWI applications enforce
         0-30000(ms). Not supported on IPSP application.
TVALUE : Valid range = 32-bits

TIMER 3: UA HeartBeat Period Timer T(beat), time (ms) between sending
         of BEAT msgs by NE. IPSP, SS7IPGW and IPGWI applications
         enforce 100(ms)-60000(ms).
TVALUE : Valid range = 32-bits

TIMER 4: UA HeartBeat Received Timer T(beat ack), timeout period for
         response BEAT ACK msgs by NE. IPSP, SS7IPGW and IPGWI
         applications enforce 100(ms)-10000(ms).
TVALUE : Valid range = 32-bits

PARM  1: ASP SNM options. Each bit is used as an enabled/disabled
         flag for a particular ASP SNM option. Not supported on IPSP
         application.
PVALUE : Valid range = 32-bits
        BIT                               BIT VALUE
        0=Broadcast                        0=Disabled , 1=Enabled
        1=Response Method                  0=Disabled , 1=Enabled
        2-5=Reserved
        6=Broadcast Congestion Status Change 0=Disabled , 1=Enabled
        7-31=Reserved

PARM  2: ASP/AS Notification options. Each bit is used as an
         enabled/disabled flag for a particular ASP/AS
         Notification option. Not supported on IPSP application.
PVALUE : Valid range = 32-bits
        BIT                               BIT VALUE
        0=ASP Active Notifications         0=Disabled , 1=Enabled
        1=ASP Inactive Notifications      0=Disabled , 1=Enabled
        2=ASP AS State Query              0=Disabled , 1=Enabled
        3-31=Reserved

PARM  3: UA Serviceability Options. Each bit is used as an
         enabled/disabled flag for a particular UA Serviceability
         option. Supported on IPSP, SS7IPGW, and IPGWI applications.
         UA Graceful Shutdown supported on IPSP for M3UA only.
PVALUE : Valid range = 32-bits
        BIT                               BIT VALUE
        0=UA Heartbeats                   0=Disabled , 1=Enabled
        1=UA Graceful Shutdown            0=Disabled , 1=Enabled
        2-31=Reserved
```

```

PARM 4: SCTP Payload Protocol Indicator byte order option. Bit indicates
PPI value is RCV/TX in Big Endian or Little Endian byte format.
Supported on IPSP-M2PA associations only.
PVALUE : Valid range = 32-bits
        BIT                               BIT VALUE
        0=Payload Protocol Indicator       0=Big Endian , 1=Little Endian
        1-31=Reserved

```

If the UA parameter set you wish to assign to the association does not contain the desired values, perform [Changing a UA Parameter Set](#) to change the desired parameter set values.



CAUTION

Caution: Changing a UA parameter set may affect the performance of any associations using the parameter set being changed.

Continue the procedure by performing one of these steps.

- If the `cwmin` parameter value is not being changed, continue the procedure with [Step 10](#).
 - If the `cwmin` parameter value is being changed, continue the procedure with [Step 9](#).
9. To change the `cwmin` value, the new `cwmin` parameter value must be less than or equal to the `bufsize` parameter value.

The `cwmin` parameter is the number of bytes specified for the association's congestion window. The `bufsize` is the number of kilobytes specified for the size of the association's buffer. To determine whether or not the `cwmin` value is less than or equal to the `bufsize` value, perform one of these actions.

- Multiply the `bufsize` value by 1024.
- Divide the `cwmin` value by 1024.

Continue the procedure by performing one of these actions.

- If the new `cwmin` value is less than or equal to the `bufsize` value, continue the procedure with [Step 10](#).
- If the new `cwmin` value is not less than or equal to the `bufsize` value, either choose another value for the `cwmin` parameter that is less than or equal to the `bufsize` value, or perform [Changing the Buffer Size of a M3UA or SUA Association](#) to change the `bufsize` value so that the `bufsize` value is greater than or equal to the `cwmin` value. After the new `cwmin` value has been chosen or the `bufsize` value has been changed, continue the procedure with [Step 10](#).

10. The remote hosts assigned to the association can be changed by specifying the `rhost` and `rhosttype` parameters with the `chg-assoc` command.

If the primary and alternate remote hosts are not being changed in this procedure, or if only the primary remote host is being changed, continue the procedure with [Step 12](#).

To change the alternate remote host value for the association, the association must have a primary remote host assigned to it. If the association has a primary remote host, continue the procedure with [Step 12](#). If the association does not have a primary remote host, continue the procedure with [Step 10](#).

11. Assign a primary remote host to the association by entering the `chg-assoc` command with the name of the association and the primary remote host name.

For this example, enter this command.

```
chg-assoc:aname=assoc2:rhost="gw200.nc-Oracle.com"
```

The `rhosttype=primary` parameter can be specified with the `chg-assoc` command, but is not necessary.

When this command has successfully completed, this message should appear.

```
rlghncxa03w 09-05-28 09:12:36 GMT EAGLE5 41.0.0
CHG-ASSOC: MASP A - COMPLTD;
```

12. Change the association using the `chg-assoc` command.

For this example, enter this command.

```
chg-assoc:aname=assoc2:rhost="gw200.nc-Oracle.com":rport=3000
:rtxthr=10000:rhostval=match
```

If an alternate remote host is being specified for the association, for this example enter this command.

```
chg-assoc:aname=assoc2:rhost="gw210.nc-Oracle.com":rhosttype=alternate:rport=3000
:rtxthr=10000:rhostval=match
```

If only the `alw`, `open`, or `rtxthr` parameter values are being changed in this step, for this example, enter this command.

```
chg-assoc:aname=assoc2:alw=no:open=yes:rtxthr=10000
```

These are the rules that apply to the `chg-assoc` command.

1. If any optional parameters are not specified with the `chg-assoc` command, those values are not changed.
2. The value of the `rmin` parameter must be less than or equal to the `rmax` parameter value.
3. The value of the `rhost` parameter is a text string of up to 60 characters, with the first character being a letter. The command input is limited to 150 characters, including the hostname.
4. If the value of the `open` parameter is `yes`, only the values of the `alw` and `rtxthr` parameters can be changed. To change the values of the other parameters, the value of the `open` parameter must be `no`.

When this command has successfully completed, this message should appear.

```
rlghncxa03w 08-04-28 09:12:36 GMT EAGLE5 38.0.0
CHG-ASSOC: MASP A - COMPLTD;
```

Note: If the value of the `open` parameter was not changed in [Step 3](#), continue the procedure with [Step 14](#).

13. Change the value of the `open` parameter to `yes` by specifying the `chg-assoc` command with the `open=yes` parameter.

For this example, enter this command.

```
chg-assoc:aname=assoc2:open=yes
```

When this command has successfully completed, this message should appear.

```
rlghncxa03w 08-04-28 09:12:36 GMT EAGLE5 38.0.0  
CHG-ASSOC: MASP A - COMPLTD;
```

14. Verify the changes using the `rtrv-assoc` command specifying the association name specified in [Step 12](#) and [Step 13](#).

For this example, enter this command.

```
rtrv-assoc:aname=assoc2
```

This is an example of possible output.

Note: If the [Removing an Association from an Application Server](#) procedure in [Step 7](#) was not performed, continue the procedure with [Step 16](#).

15. Assign the association changed in [Step 12](#) to all applicable application servers by performing one of these procedures:
 - [Adding an Existing Association to a New Application Server](#)
 - [Adding an Existing Association to an Existing Application Server](#)
16. Back up the new changes, using the `chg-db:action=backup:dest=fixed` command. These messages should appear; the active Maintenance and Administration Subsystem Processor (MASP) appears first.

```
BACKUP (FIXED) : MASP A - Backup starts on active MASP.  
BACKUP (FIXED) : MASP A - Backup on active MASP to fixed disk complete.  
BACKUP (FIXED) : MASP A - Backup starts on standby MASP.  
BACKUP (FIXED) : MASP A - Backup on standby MASP to fixed disk complete.
```

If you wish to change the `lhost`, `alhost`, or `bufsize` values of the M3UA or SUA association, perform one of these procedures.

- `lhost` and `alhost` - [Changing the Host Values of a M3UA or SUA Association](#)
- `bufsize` - [Changing the Buffer Size of a M3UA or SUA Association](#)

If you do not wish to change the `lhost`, `alhost`, or `bufsize` values of the M3UA or SUA association, this procedure is finished.

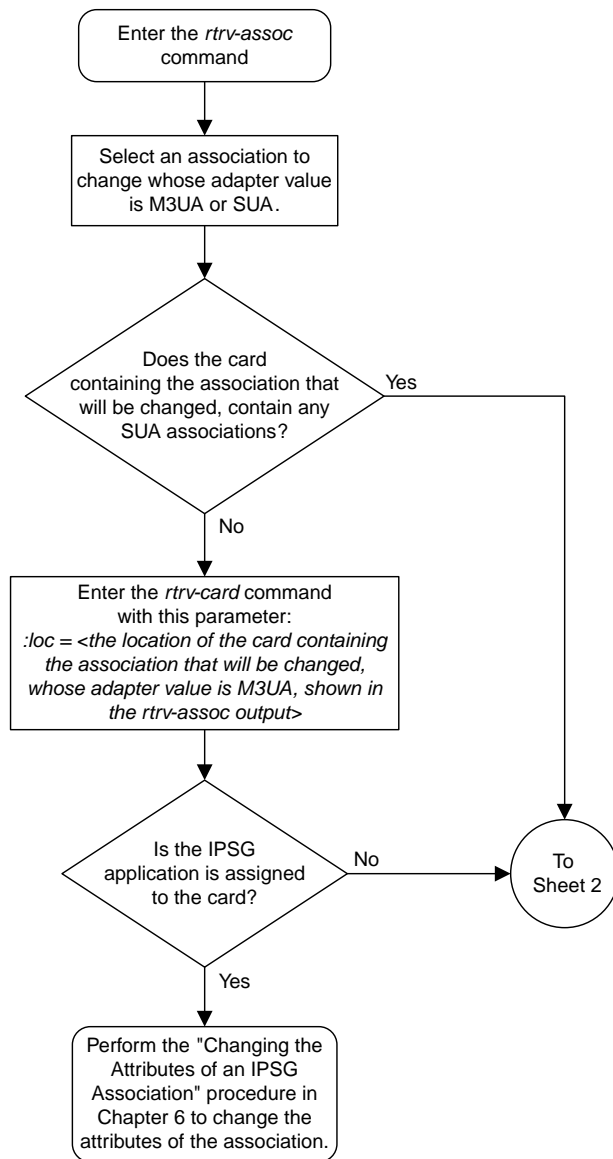

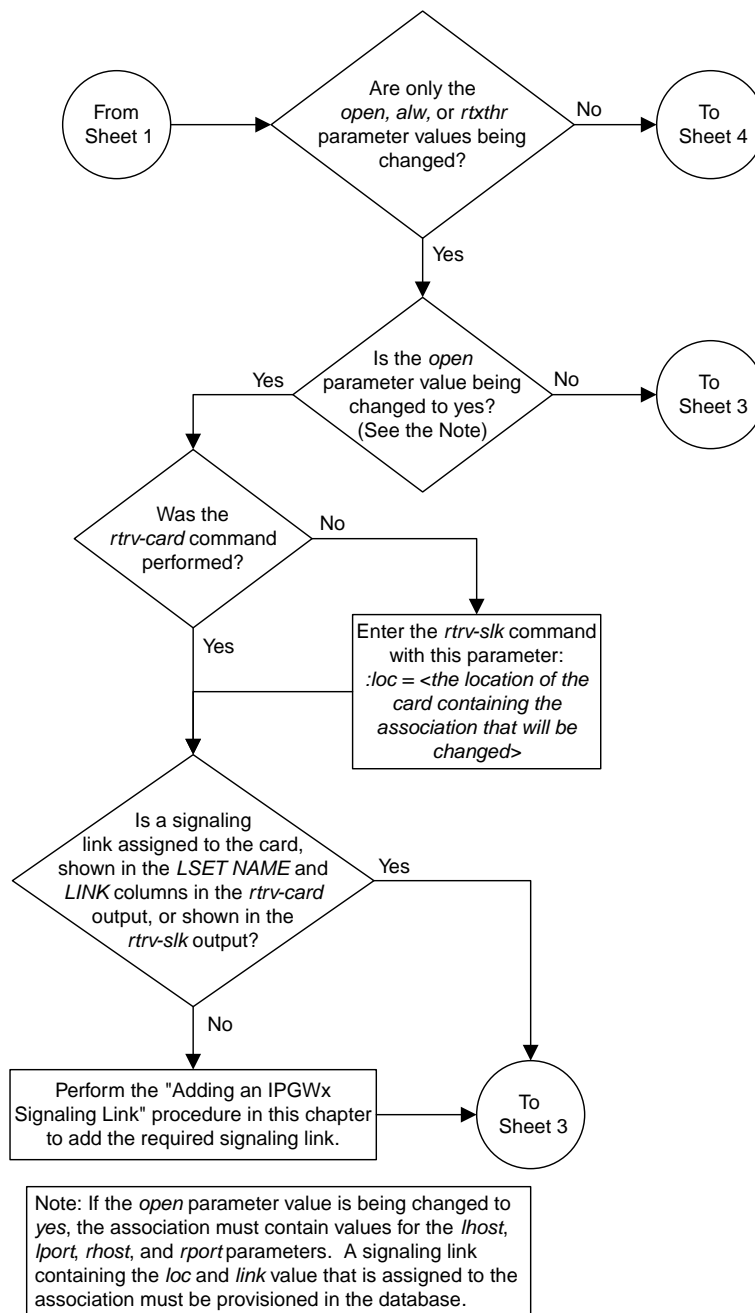

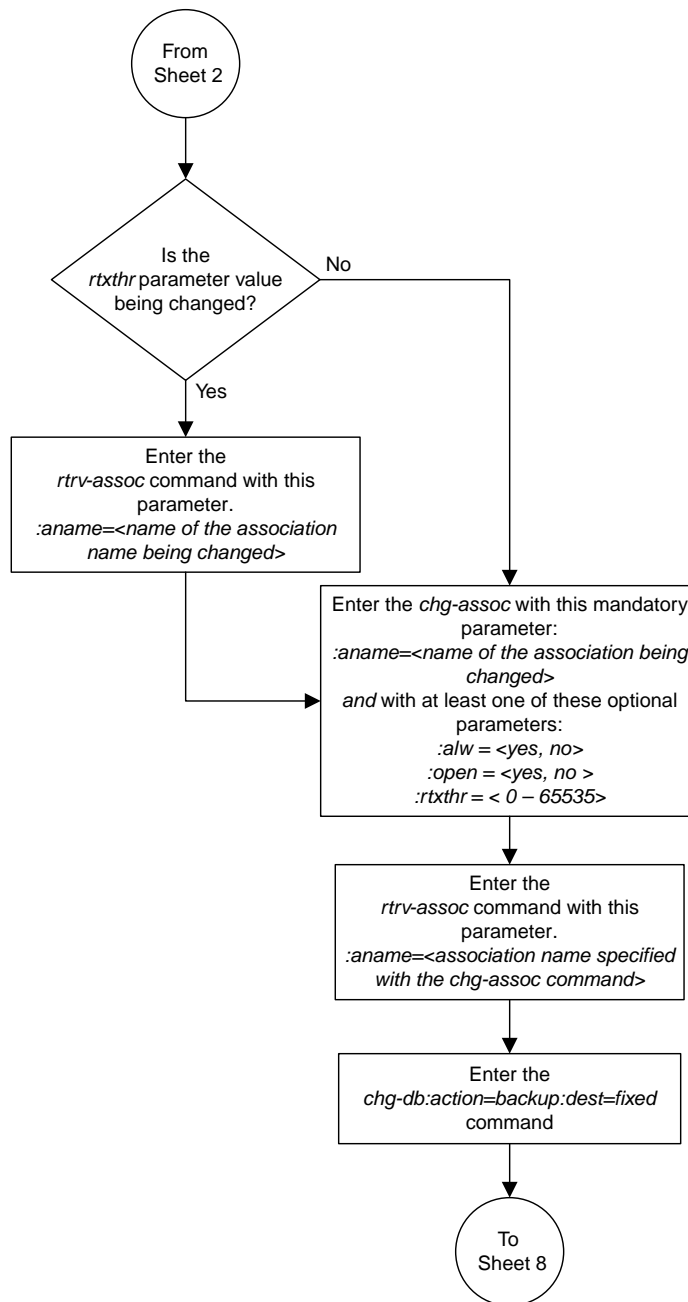

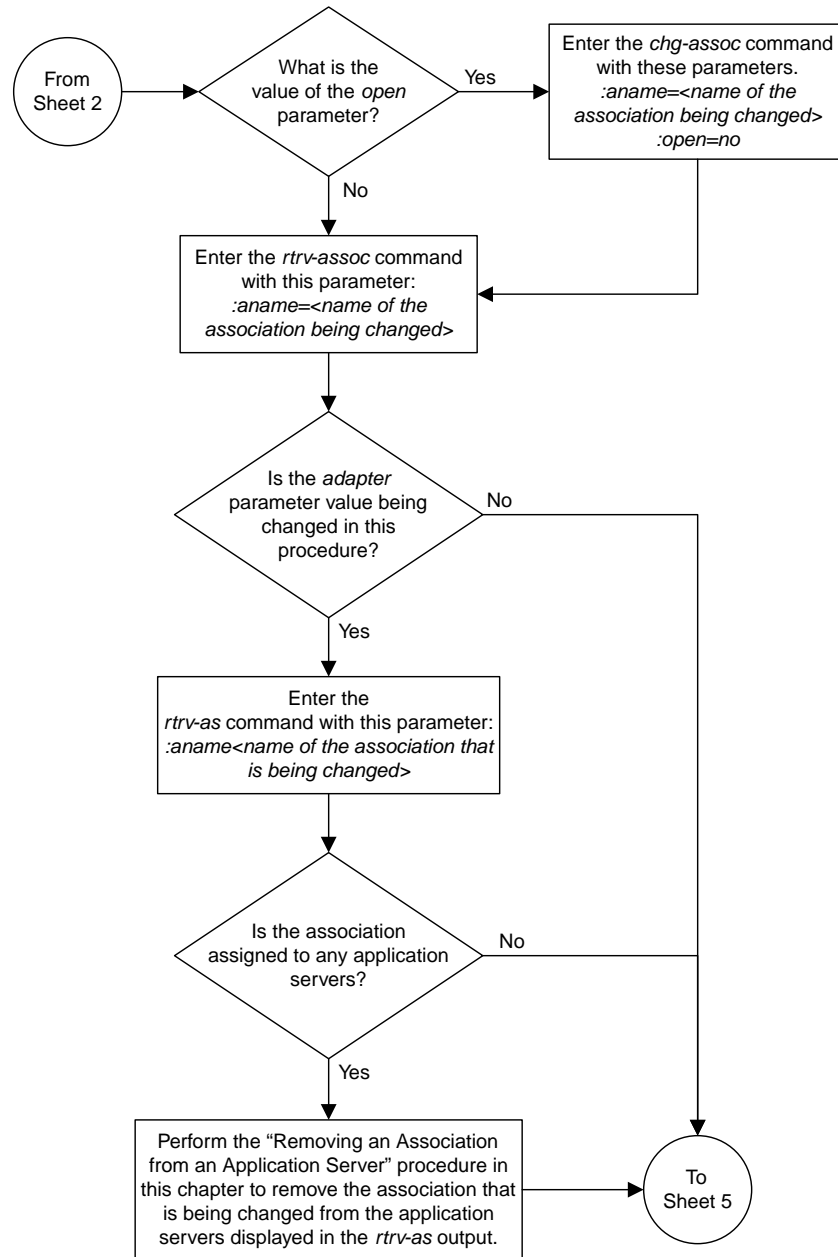

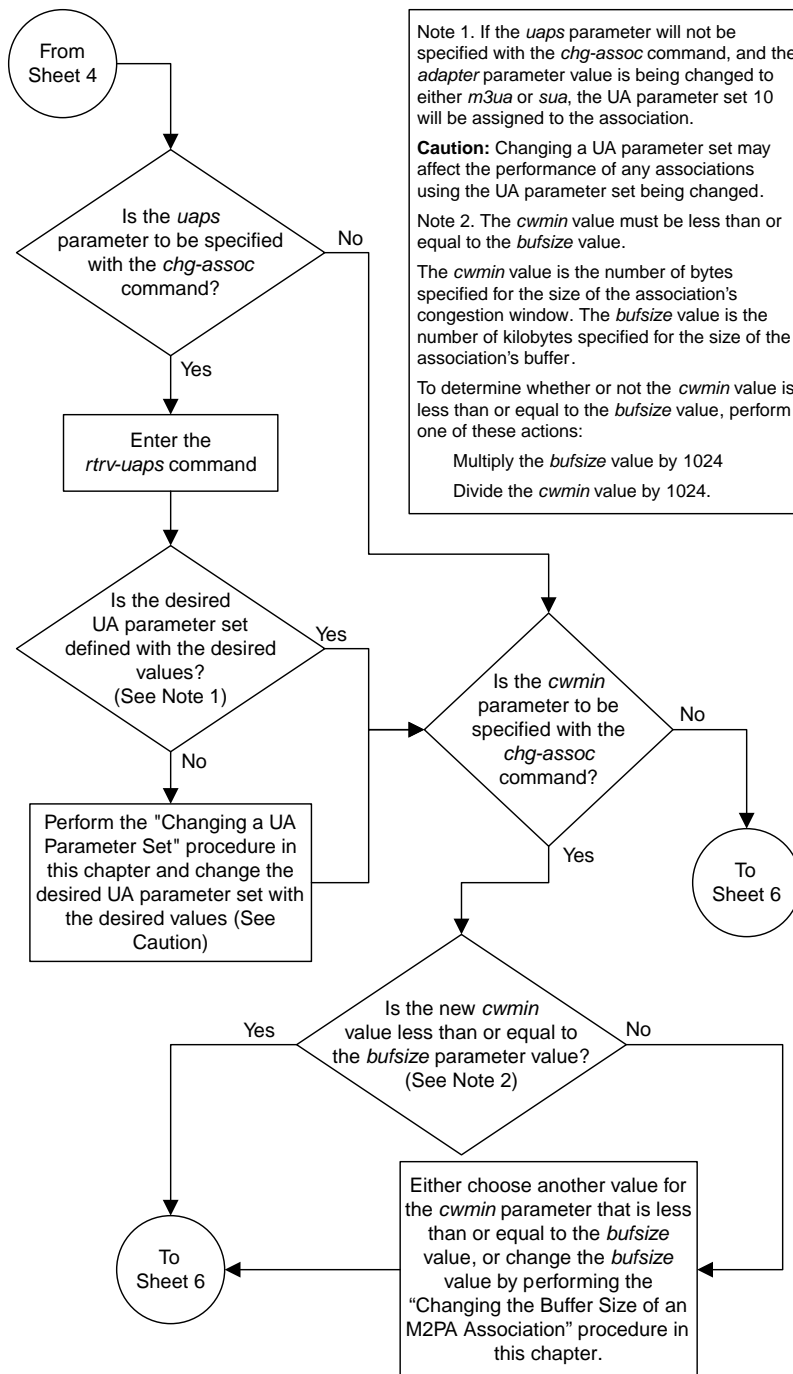

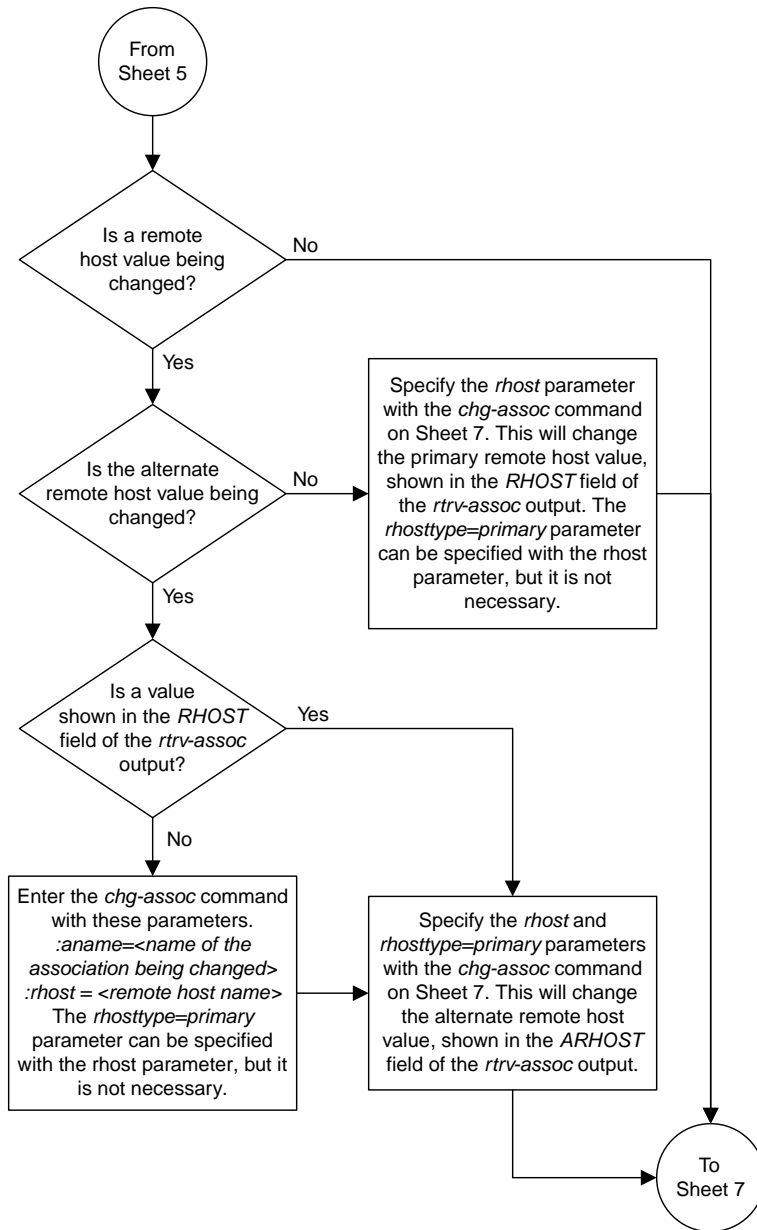

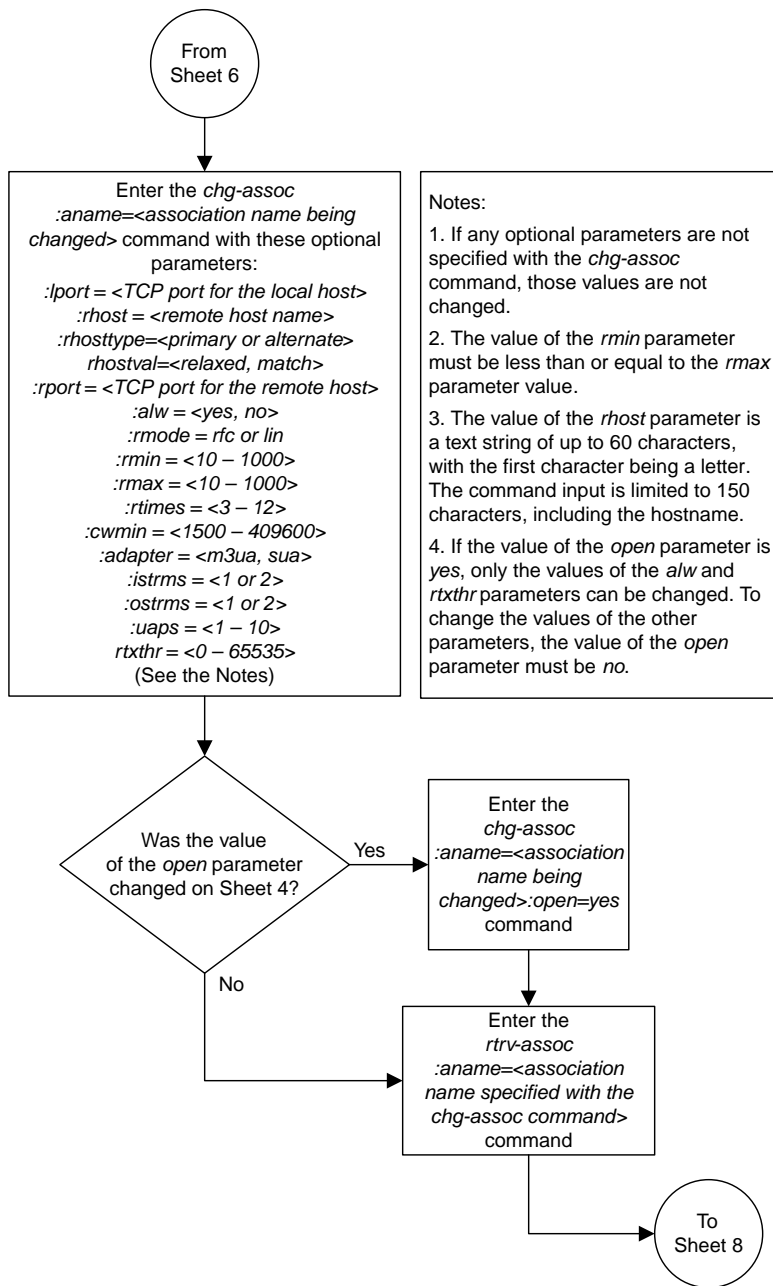

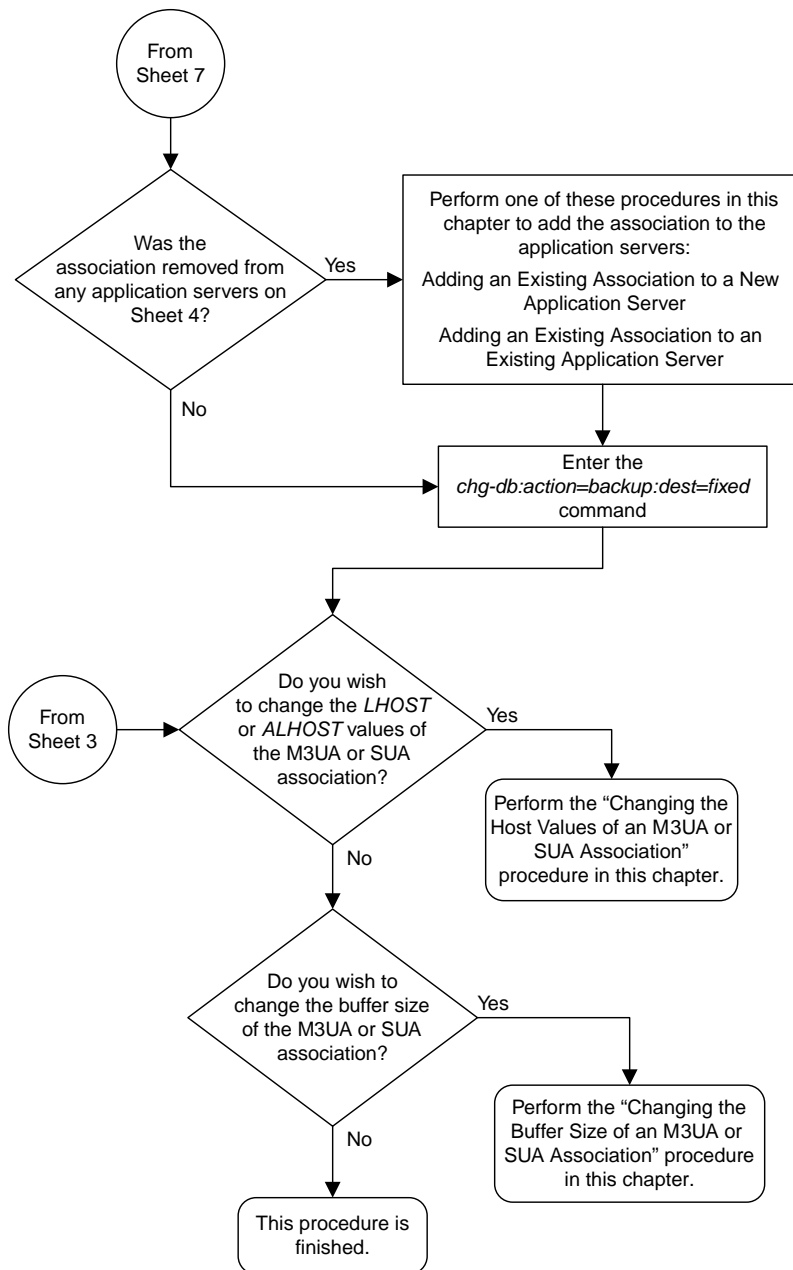

Sheet 8 of 8

Figure 67: Changing the Attributes of a M3UA or SUA Association

Changing the Buffer Size of a M3UA or SUA Association

This procedure is used to change the buffer size of a M3UA or a SUA association, assigned to cards that are running the SS7IPGW or IPGWI applications, using the `chg-assoc` command. If you wish to change the attributes of M3UA associations assigned to cards that are running the IPSP application, perform the [Changing the Buffer Size of an IPSP Association](#) procedure.

These parameters of the `chg-assoc` command are used in this procedure:

- :aname – The name assigned to the association, shown in the `rtrv-assoc` output.
- :open – The connection state for this association. Valid values are `yes` or `no`. When the `open=yes` parameter is specified, the connection manager opens the association if the association is operational. When the `open=no` parameter is specified, the connection manager will not open the association.
- :bufsize – The size, in kilobytes, of the buffer used by the association. The values for this parameter are 8 kilobytes to 400 kilobytes. The maximum size of the buffers on the IP cards are shown in the following list:

- E5-ENET Card - 3200 KB.

The size of the buffers assigned to each association that is assigned to the IP card cannot exceed the maximum buffer size for that card. If the `bufsize` parameter value causes the total buffer size for all the associations on the IP card to exceed the maximum buffer size for that IP card, the `chg-assoc` command will be rejected. The available size of the buffers on the IP card can be verified by entering this command.

```
rtrv-assoc:lhost=<local host name assigned to the association being changed>
```

The `alhost` parameter can also be used with the `rtrv-assoc` command to display the available size of the buffers on the IP card.

The `aname` parameter can be used with the `rtrv-assoc` command to display the available size of the buffers on the IP card and the size of the buffer assigned to the association.

If you wish to increase the buffer size for this association to a value that is greater than available buffer size for the card, the buffer size of the other associations assigned to the card must be decreased.

The `chg-assoc` command contains other parameters that are not used this procedure. To change these parameters, perform these procedures.

- `lhost` and `alhost` - [Changing the Host Values of a M3UA or SUA Association](#)
- Other attributes of the M3UA or SUA Association - [Changing the Attributes of a M3UA or SUA Association](#)

Canceling the RTRV-ASSOC Command

Because the `rtrv-assoc` command used in this procedure can output information for a long period of time, the `rtrv-assoc` command can be canceled and the output to the terminal stopped. There are three ways that the `rtrv-assoc` command can be canceled.

- Press the F9 function key on the keyboard at the terminal where the `rtrv-assoc` command was entered.
- Enter the `canc-cmd` without the `trm` parameter at the terminal where the `rtrv-assoc` command was entered.
- Enter the `canc-cmd:trm=<xx>`, where `<xx>` is the terminal where the `rtrv-assoc` command was entered, from another terminal other than the terminal where the `rtrv-assoc` command was entered. To enter the `canc-cmd:trm=<xx>` command, the terminal must allow Security Administration commands to be entered from it and the user must be allowed to enter Security Administration commands. The terminal's permissions can be verified with the `rtrv-secu-trm` command. The user's permissions can be verified with the `rtrv-user` or `rtrv-secu-user` commands.

For more information about the `canc-cmd` command, go to *Commands User's Guide*.

1. Display the associations in the database using the `rtrv-assoc` command.

This is an example of possible output.

```
rlghncxa03w 08-04-28 09:12:36 GMT EAGLE5 38.0.0

          CARD IPLNK
ANAME     LOC  PORT  LINK ADAPTER LPORT RPORT OPEN ALW
swbel32   1201 A     A   M3UA   1030  2345  YES  YES
a2        1305 A     A   SUA    1030  2345  YES  YES
a3        1307 A     A   SUA    1030  2346  YES  YES
assoc1    1201 A     A   M3UA   2000  1030  YES  YES
assoc2    1205 A     A   M3UA   2048  2048  YES  YES
assoc3    1205 A     A   M3UA   3000  3000  YES  YES
assoc5    1205 A     A   M3UA   1500  3000  YES  YES
```

Select an association whose adapter value is M3UA or SUA. If the card shown in the `CARD LOC` column contains any SUA associations, and the `open` parameter value of the association is `no`, continue the procedure with [Step 4](#). If the `open` parameter value of the association is `yes`, continue the procedure with [Step 3](#).

If the card contains only M3UA associations, continue the procedure with [Step 2](#).

2. Enter the `rtrv-card` command with the location of the card that is hosting the M3UA association that will be changed in this procedure. For this example, enter this command.

```
rtrv-card:loc=1205
```

This is an example of possible output.

```
rlghncxa03w 08-04-06 15:17:20 EST EAGLE5 38.0.0
CARD  TYPE      APPL      LSET NAME  LINK SLC LSET NAME  LINK SLC
1205  DCM        SS7IPGW  e5e6a     A     0
```

If the application assigned to the card is SS7IPGW or IPGWI, shown in the `APPL` column, continue the procedure by performing one of these steps.

- If the `open` parameter value for the association being changed is `yes`, continue the procedure with [Step 3](#).
- If the `open` parameter value for the association being changed is `no`, continue the procedure with [Step 4](#).

If the application assigned to the card is IP7, perform the [Changing the Buffer Size of an IP7 Association](#) procedure.

3. Change the value of the open parameter to no by specifying the `chg-assoc` command with the `open=no` parameter.

For this example, enter this command.

```
chg-assoc:aname=assoc2:open=no
```

When this command has successfully completed, this message should appear.

```
rlghncxa03w 08-04-28 09:12:36 GMT EAGLE5 38.0.0
CHG-ASSOC: MASP A - COMPLTD;
```

4. Display the association being changed by entering the `rtrv-assoc` command with the `aname` parameter specified in [Step 3](#) or the association selected in [Step 1](#).

For this example, enter this command.

```
rtrv-assoc:aname=assoc2
```

This is an example of the possible output.

```
rlghncxa03w 09-05-28 21:14:37 GMT EAGLE5 41.0.0
ANAME assoc2
  LOC      1205          IPLNK PORT  A          LINK  A
  ADAPTER  M3UA          VER          M3UA RFC
  LHOST    IPNODE2-1205
  ALHOST    ---
  RHOST     remotehost1
  ARHOST    ---
  LPORT    2048          RPORT       2048
  ISTRMS   2            OSTRMS      2          BUFSIZE  200
  RMODE    LIN          RMIN        120        RMAX     800
  RTIMES   10          CWMIN       3000       UAPS     10
  OPEN     No           ALW         YES        RTXTHR   2000
  RHOSTVAL RELAXED

ASNAMES
as1          as4          as6

IP Appl Sock/Assoc table is (8 of 4000) 1% full
Assoc Buffer Space Used (800 KB of 800 KB) on LOC = 1205
```

5. If the `bufsize` parameter value causes the total buffer size for all the associations on the IP card to exceed the maximum buffer size for that IP card, the `chg-assoc` command will be rejected. If you wish to increase the buffer size for this association to a value that is greater than available buffer size for the card, the buffer size of the other associations assigned to the card must be decreased. Perform this step and [Step 6](#), [Step 7](#), and [Step 8](#).

If the buffers on the other associations assigned to the card do not need to be changed, continue the procedure with [Step 9](#).

Display the associations assigned to the IP card (and its corresponding local host) by entering the `rtrv-assoc` command with the local host name assigned to the association being changed. For this example, enter this command.

```
rtrv-assoc:lhost="IPNODE2-1205"
```

This is an example of the possible output.

```
rlghncxa03w 08-04-28 21:14:37 GMT EAGLE5 38.0.0
CARD IPLNK
ANAME      LOC  PORT  LINK ADAPTER  LPORT  RPORT  OPEN  ALW
assoc2     1205 A    A    M3UA   2048   2048   YES   YES
assoc3     1205 A    A    M3UA   3000   3000   YES   YES
assoc5     1205 A    A    M3UA   1500   3000   YES   YES

IP Appl Sock/Assoc table is (8 of 4000) 1% full
Assoc Buffer Space Used (800 KB of 3200 KB) on LOC = 1205
```

6. Display each association shown in [Step 5](#) by entering the `rtrv-assoc` command with the name of each association shown in [Step 5](#).

For this example, enter these commands.

```
rtrv-assoc:aname=assoc2
```

This is an example of the possible output.

```
ANAME assoc2
LOC      1205          IPLNK PORT  A          LINK  A
ADAPTER  M3UA            VER          M3UA RFC
LHOST    IPNODE2-1205
ALHOST   ---
RHOST    remotehost1
ARHOST   ---
LPORT    2048          RPORT      2048
ISTRMS   2              OSTRMS     2          BUFSIZE  200
RMODE    LIN          RMIN       120        RMAX     800
RTIMES   10           CWMIN      3000      UAPS     10
OPEN     YES          ALW        YES        RTXTHR   2000
RHOSTVAL RELAXED

ASNAMES
as1              as4              as6

IP Appl Sock/Assoc table is (8 of 4000) 1% full
Assoc Buffer Space Used (800 KB of 800 KB) on LOC = 1205
```

```
rtrv-assoc:aname=assoc3
```

This is an example of the possible output.

```
ANAME assoc3
LOC      1205          IPLNK PORT  A          LINK  A
ADAPTER  M3UA            VER          M3UA RFC
LHOST    IPNODE2-1205
ALHOST   ---
RHOST    remotehost3
ARHOST   ---
LPORT    3000          RPORT      3000
ISTRMS   2              OSTRMS     2          BUFSIZE  400
RMODE    LIN          RMIN       120        RMAX     800
RTIMES   10           CWMIN      3000      UAPS     10
OPEN     YES          ALW        YES        RTXTHR   10000
RHOSTVAL RELAXED
```

```

ASNAMES
as2          as3          as5

IP Appl Sock/Assoc table is (8 of 4000) 1% full
Assoc Buffer Space Used (800 KB of 800 KB) on LOC = 1205

```

```
rtrv-assoc:aname=assoc5
```

This is an example of the possible output.

```

ANAME assoc5
LOC      1205          IPLNK PORT  A          LINK  A
ADAPTER M3UA           VER          M3UA RFC
LHOST    IPNODE2-1205
ALHOST    ---
RHOST    remotehost3
ARHOST    ---
LPORT    1500          RPORT      3000
ISTRMS   2             OSTRMS     2          BUFSIZE  200
RMODE    LIN          RMIN       120        RMAX     800
RTIMES   10           CWMIN      3000      UAPS     10
OPEN     YES          ALW        YES        RTXTHR   10000
RHOSTVAL RELAXED

ASNAMES
as2          as3          as5

IP Appl Sock/Assoc table is (8 of 4000) 1% full
Assoc Buffer Space Used (800 KB of 800 KB) on LOC = 1205

```

- To change the `bufsize` value for the associations shown in [Step 6](#), the new `bufsize` parameter value must be greater than or equal to the `cwmin` parameter value.

The `cwmin` parameter is the number of bytes specified for the association's congestion window. The `bufsize` is the number of kilobytes specified for the size of the association's buffer. To determine whether or not the `cwmin` value is less than or equal to the `bufsize` value, perform one of these actions.

- Multiply the `bufsize` value by 1024.
- Divide the `cwmin` value by 1024.

Continue the procedure by performing one of these actions.

- If the new `bufsize` value is greater than or equal to the `cwmin` value, continue the procedure with [Step 8](#).
- If the new `bufsize` value is not greater than or equal to the `cwmin` value, either choose another value for the `bufsize` parameter that is greater than or equal to the `cwmin` value, or perform the [Changing the Attributes of a M3UA or SUA Association](#) procedure to change the `bufsize` value so that the `bufsize` value is greater than or equal to the `cwmin` value. After the new `bufsize` value has been chosen or the `cwmin` value has been changed, continue the procedure with [Step 8](#).

- Change the size of the buffers for one or more of the associations displayed in [Step 6](#) to allow the buffer of the association displayed in [Step 4](#) to be changed.

Enter the `chg-assoc` command with the `bufsize` parameter. For this example, enter this command.

```
chg-assoc:aname=assoc3:bufsize=200
```

When this command has successfully completed, this message should appear.

```
rlghncxa03w 08-04-28 09:12:36 GMT EAGLE5 38.0.0
CHG-ASSOC: MASP A - COMPLTD;
```

9. To change the `bufsize` value for the association shown in [Step 4](#), the new `bufsize` parameter value must be greater than or equal to the `cwmin` parameter value.

The `cwmin` parameter is the number of bytes specified for the association's congestion window. The `bufsize` is the number of kilobytes specified for the size of the association's buffer. To determine whether or not the `cwmin` value is less than or equal to the `bufsize` value, perform one of these actions.

- Multiply the `bufsize` value by 1024.
- Divide the `cwmin` value by 1024.

Continue the procedure by performing one of these actions.

- If the new `bufsize` value is greater than or equal to the `cwmin` value, continue the procedure with [Step 10](#).
- If the new `bufsize` value is not greater than or equal to the `cwmin` value, either choose another value for the `bufsize` parameter that is greater than or equal to the `cwmin` value, or perform the [Changing the Attributes of a M3UA or SUA Association](#) procedure to change the `bufsize` value so that the `bufsize` value is greater than or equal to the `cwmin` value. After the new `bufsize` value has been chosen or the `cwmin` value has been changed, continue the procedure with [Step 10](#).

10. Change the association using the `chg-assoc` command.

For this example, enter this command.

```
chg-assoc:aname=assoc2:bufsize=250
```

When this command has successfully completed, this message should appear.

```
rlghncxa03w 08-04-28 09:12:36 GMT EAGLE5 38.0.0
CHG-ASSOC: MASP A - COMPLTD;
```

If the value of the `open` parameter was not changed in [Step 3](#), continue the procedure with [Step 12](#).

If the value of the `open` parameter was changed in [Step 3](#), continue the procedure with [Step 11](#).

11. Change the value of the `open` parameter to `yes` by specifying the `chg-assoc` command with the `open=yes` parameter.

For this example, enter this command.

```
chg-assoc:aname=assoc2:open=yes
```

When this command has successfully completed, this message should appear.

```
rlghncxa03w 08-04-28 09:12:36 GMT EAGLE5 38.0.0
CHG-ASSOC: MASP A - COMPLTD;
```

12. Verify the changes using the `rtrv-assoc` command specifying the association name specified in [Step 10](#) and [Step 11](#).

For this example, enter this command.

```
rtrv-assoc:aname=assoc2
```

This is an example of possible output.

```
rlghncxa03w 09-05-28 09:12:36 GMT EAGLE5 41.0.0
ANAME assoc2
  LOC      1205          IPLNK PORT  A          LINK  A
  ADAPTER  M3UA          VER        M3UA RFC
  LHOST    IPNODE2-1205
  ALHOST    ---
  RHOST    gw200.nc-tekelec.com
  ARHOST    ---
  LPORT    2048          RPORT      3000
  ISTRMS   2            OSTRMS     2          BUFSIZE  250
  RMODE    LIN          RMIN       120        RMAX     800
  RTIMES   10          CWMIN      3000      UAPS     10
  OPEN     YES          ALW        YES        RTXTHR   10000
  RHOSTVAL RELAXED

ASNAMES
as1          as4          as6

IP Appl Sock table is (8 of 4000) 1% full
Assoc Buffer Space Used (650 KB of 800 KB) on LOC = 1205
```

13. Back up the new changes, using the `chg-db:action=backup:dest=fixed` command. These messages should appear; the active Maintenance and Administration Subsystem Processor (MASP) appears first.

```
BACKUP (FIXED) : MASP A - Backup starts on active MASP.
BACKUP (FIXED) : MASP A - Backup on active MASP to fixed disk complete.
BACKUP (FIXED) : MASP A - Backup starts on standby MASP.
BACKUP (FIXED) : MASP A - Backup on standby MASP to fixed disk complete.
```

If you wish to change other attributes of the M3UA or SUA association, perform one of these procedures.

- `lhost` and `alhost` - [Changing the Host Values of a M3UA or SUA Association](#)
- Other attributes of the M3UA or SUA Association - [Changing the Attributes of a M3UA or SUA Association](#)

If you do not wish to change other attributes of the M3UA or SUA association, this procedure is finished.

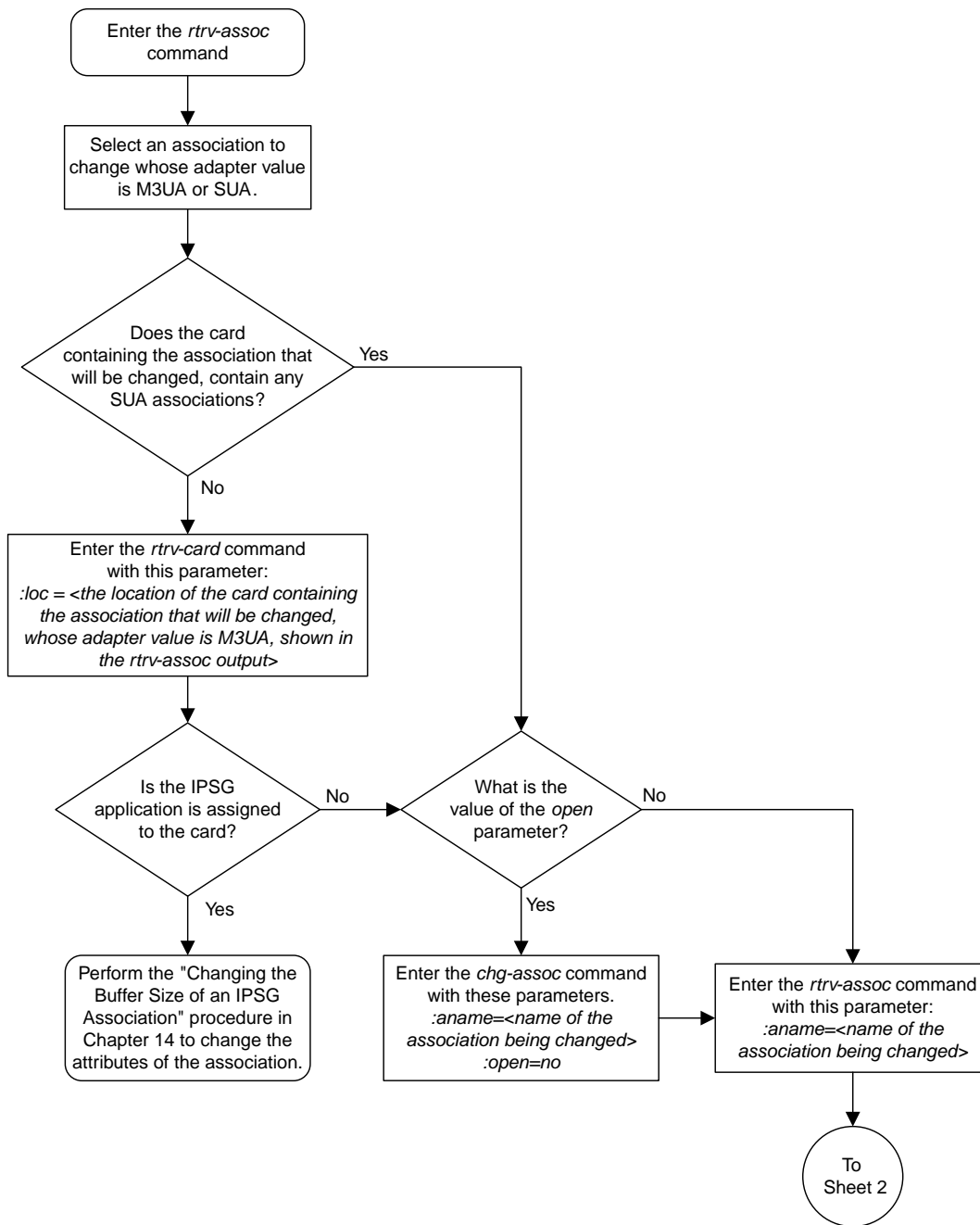

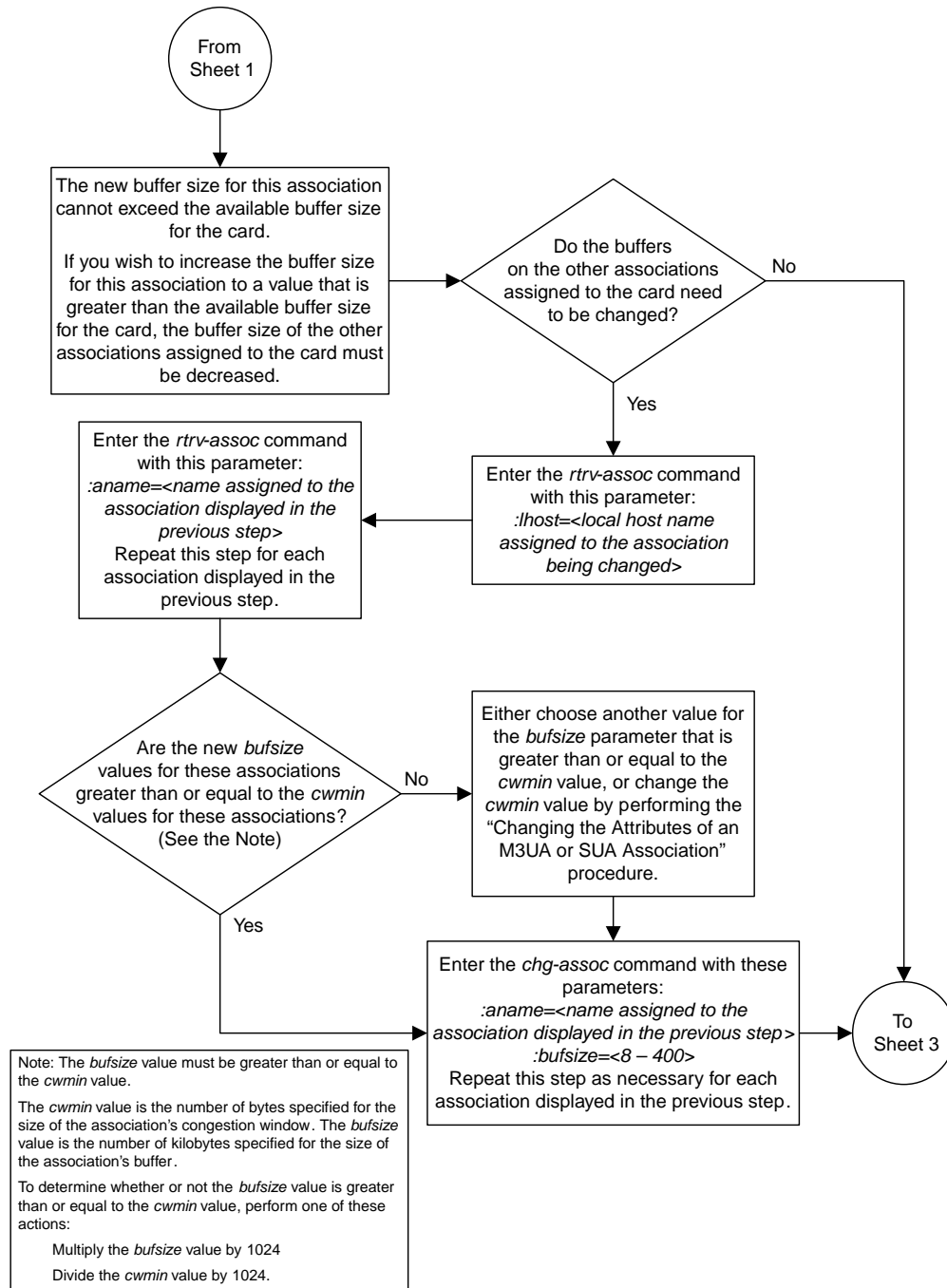

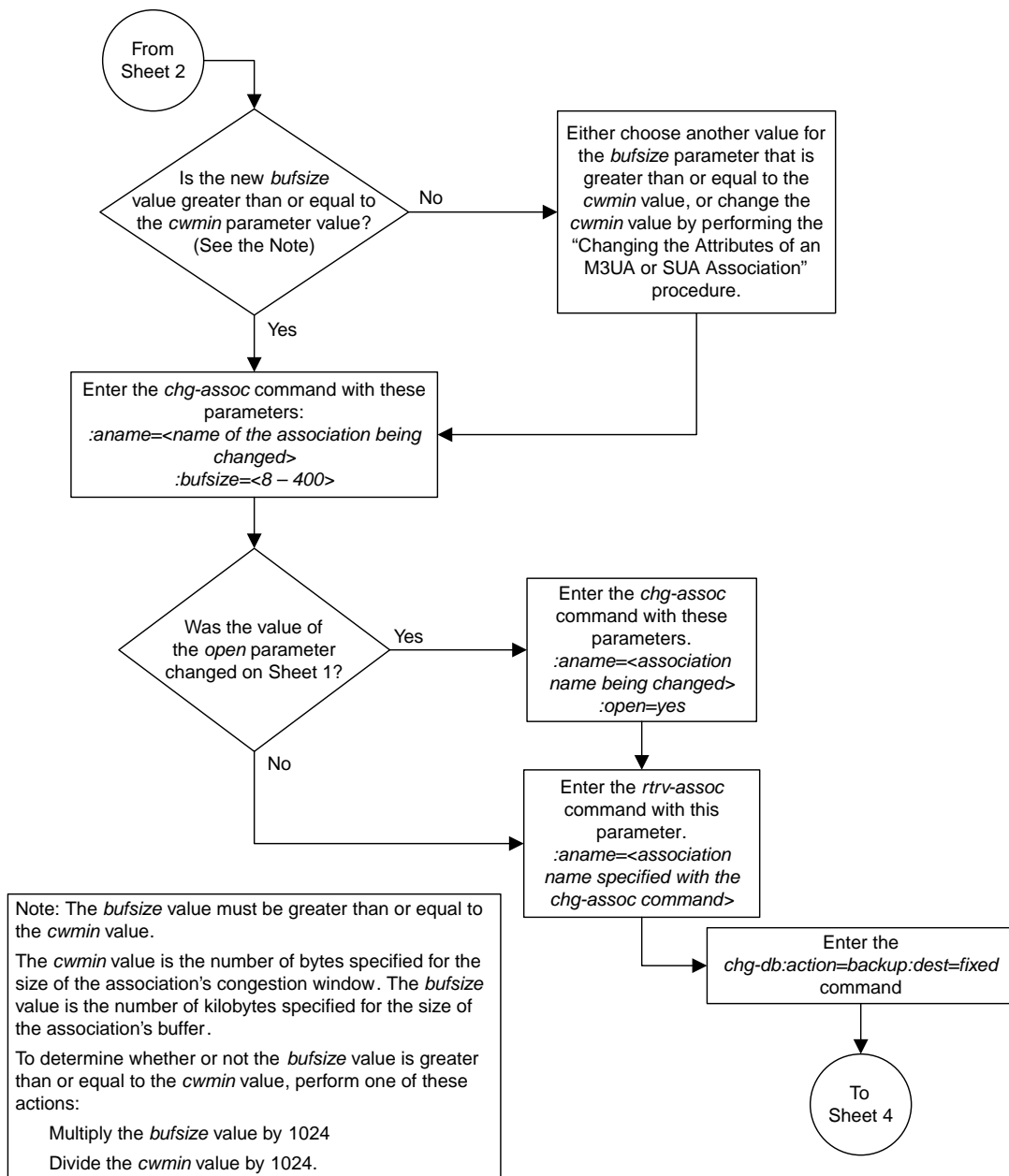

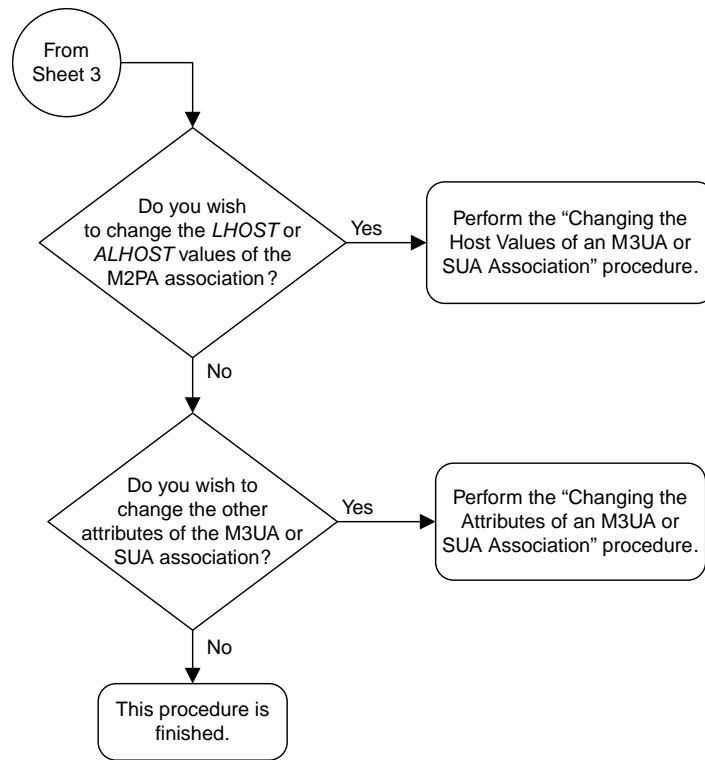

Sheet 4 of 4

Figure 68: Changing the Buffer Size of an M3UA or SUA Association

Changing the Host Values of a M3UA or SUA Association

This procedure is used to change the host values of a M3UA or SUA association, assigned to cards that are running the SS7IPGW or IPGWI applications, using the `chg-assoc` command. If you wish to change the attributes of M3UA associations assigned to cards that are running the IPSP application, perform the [Changing the Host Values of an IPSP Association](#) procedure.

These parameters of the `chg-assoc` command are used in this procedure:

- `:aname` – The name assigned to the association, shown in the `rtrv-assoc` output.
 - `:lhost` – The host name for the local host, shown in the `rtrv-ip-host` output.
 - `:lport` – The SCTP port number for the local host.
 - `:rhost` – The host name for the remote host, `rhost` can be any string of characters starting with a letter and comprising these characters [‘a’..‘z’, ‘A’..‘Z’, ‘0’..‘9’, ‘-’, ‘.']. Hostnames are not case-sensitive and can contain up to 60 characters. The default value of this optional parameter is empty (null string).
 - `:rport` – The SCTP port number for the remote host.
 - `:link` – The signaling link on the IPGWx card. The value for the `link` parameter for M3UA or SUA associations is A.
- Note:** The `port` parameter can be used in place of the `link` parameter to specify the signaling link on the card.
- `:adapter` – The adapter layer for this association, either `m3ua` or `sua`. The `adapter` parameter is optional. The default value for the `adapter` parameter in this procedure is `m3ua`.
 - `:alhost` – The alternate local host name, shown in the `rtrv-ip-host` output.
 - `:open` – The connection state for this association. Valid values are `yes` or `no`. When the `open=yes` parameter is specified, the connection manager opens the association if the association is operational. When the `open=no` parameter is specified, the connection manager will not open the association.
 - `:uaps` – The UA parameter set value being assigned to either an M3UA or SUA association.

At least one optional parameter is required.

The command input is limited to 150 characters, including the hostnames.

The maximum number SCTP association to application server assignments that can be hosted by an IPGWx card (referenced by the `lhost` parameter of the association) is 50. For example, the IPGWx card currently contains 38 SCTP association to application server assignments. The SCTP association to application server assignments could be one SCTP association assigned to 38 application servers, two SCTP associations assigned to 19 application servers, or any combination of SCTP associations assigned to application servers that add up to 38. The SCTP association to application server assignments can be verified with the `rtrv-assoc:lhost=<local host name>` and `rtrv-as:aname=<association name>` commands.

Table 37: Examples of IPGWx Card Provisioning Limits

Number of Associations hosted by the IPGWx card	Number of Application Servers each Association is Assigned to *	Total Association - Application Server Assignments maintained by the IPGWx card
1	50	50
50	1	50
25	1	50
25	2	50
0	0	50
38	1	38
19	2	38

* The EAGLE can contain a maximum of 250 application servers.

The EAGLE can contain a maximum of 4000 connections.

The B Ethernet interface of the IP card can be used on the E5-ENET cards.

If the card's application is either SS7IPGW or IPGWI, the signaling link being assigned to the association must be in service. This state is shown in the `rept-stat-slk` output with the entries IS-NR in the PST field and Avail in the SST field.

Uni-homed endpoints are associations configured with the `lhost` parameter only. The `lhost` parameter value represents an IP address that corresponds to either the A or B network interface of the IP card. Multi-homed endpoints are associations configured with both the `lhost` and `alhost` parameters. The `lhost` parameter value represents an IP address corresponding to one of the network interfaces (A or B) of the IP card while the `alhost` parameter value represents an IP address corresponding to the other network interface of the same IP card.

The `alhost=none` parameter removes the alternate local host from the specified association, which also removes the multi-homed endpoint capability.

Canceling the RTRV-ASSOC and RTRV-AS Commands

Because the `rtrv-assoc` and `rtrv-as` commands used in this procedure can output information for a long period of time, the `rtrv-assoc` and `rtrv-as` commands can be canceled and the output to the terminal stopped. There are three ways that the `rtrv-assoc` and `rtrv-as` commands can be canceled.

- Press the F9 function key on the keyboard at the terminal where the `rtrv-assoc` or `rtrv-as` commands were entered.
- Enter the `canc-cmd` without the `trm` parameter at the terminal where the `rtrv-assoc` or `rtrv-as` commands were entered.
- Enter the `canc-cmd:trm=<xx>`, where `<xx>` is the terminal where the `rtrv-assoc` or `rtrv-as` commands were entered, from another terminal other than the terminal where the `rtrv-assoc` or `rtrv-as` commands were entered. To enter the `canc-cmd:trm=<xx>` command, the terminal must allow Security Administration commands to be entered from it and the user must be allowed

to enter Security Administration commands. The terminal's permissions can be verified with the `rtrv-secu-trm` command. The user's permissions can be verified with the `rtrv-user` or `rtrv-secu-user` commands.

For more information about the `canc-cmd` command, go to *Commands User's Guide*.

1. Display the associations in the database using the `rtrv-assoc` command.

This is an example of possible output.

```
rlghncxa03w 08-04-28 09:12:36 GMT EAGLE5 38.0.0

          CARD IPLNK
ANAME     LOC  PORT  LINK ADAPTER  LPORT  RPORT  OPEN  ALW
swbel32   1201 A     A   M3UA    1030   2345   YES   YES
a2        1305 A     A   SUA     1030   2345   YES   YES
a3        1307 A     A   SUA     1030   2346   YES   YES
assoc1    1201 A     A   M3UA    2000   1030   YES   YES
assoc2    1205 A     A   M3UA    2048   2048   YES   YES
assoc3    1205 A     A   M3UA    3000   3000   YES   YES
assoc5    1205 A     A   M3UA    1500   3000   YES   YES
```

Select an association whose adapter value is M3UA or SUA. If the card shown in the `CARD LOC` column contains any SUA associations, continue the procedure by performing one of these steps.

- If the open parameter value for the association being changed is yes, continue the procedure with [Step 3](#).
- If the open parameter value for the association being changed is no, continue the procedure with [Step 4](#).

If the card contains only M3UA associations, continue the procedure with [Step 2](#).

2. Enter the `rtrv-card` command with the location of the card that is hosting the M3UA association that will be changed in this procedure. For this example, enter this command.

```
rtrv-card:loc=1205
```

This is an example of possible output.

```
rlghncxa03w 08-04-06 15:17:20 EST EAGLE5 38.0.0
CARD  TYPE      APPL      LSET NAME  LINK SLC  LSET NAME  LINK SLC
1205  DCM         SS7IPGW   e5e6a      A     0
```

If the application assigned to the card is IPSP, perform the [Changing the Host Values of an IPSP Association](#) procedure.

If the application assigned to the card is SS7IPGW or IPGWI, continue the procedure by performing one of these steps.

- If the open parameter value for the association being changed is yes, continue the procedure with [Step 3](#).
- If the open parameter value for the association being changed is no, continue the procedure with [Step 4](#).

3. Change the value of the open parameter to no by specifying the `chg-assoc` command with the `open=no` parameter.

For this example, enter this command.

```
chg-assoc:aname=assoc2:open=no
```

When this command has successfully completed, this message should appear.

```
rlghncxa03w 08-04-28 09:12:36 GMT EAGLE5 38.0.0
CHG-ASSOC: MASP A - COMPLTD;
```

4. Display the association being changed by entering the `rtrv-assoc` command with the `aname` parameter specified in [Step 3](#) or the association selected in [Step 1](#).

For this example, enter this command.

```
rtrv-assoc:aname=assoc2
```

This is an example of the possible output.

```
rlghncxa03w 09-05-28 21:14:37 GMT EAGLE5 41.0.0
ANAME assoc2
  LOC          1205          IPLNK PORT  A          LINK  A
  ADAPTER      M3UA          VER          M3UA RFC
  LHOST        IPNODE2-1205
  ALHOST       ---
  RHOST        remotehost1
  ARHOST       ---
  LPORT        2048          RPORT          2048
  ISTRMS       2          OSTRMS       2          BUFSIZE  200
  RMODE        LIN          RMIN          120         RMAX      800
  RTIMES       10          CWMIN         3000        UAPS      10
  OPEN         No          ALW           YES          RTXTHR   2000
  RHOSTVAL     RELAXED

  ASNAMES
  as1          as4          as6

IP Appl Sock/Assoc table is (8 of 4000) 1% full
Assoc Buffer Space Used (800 KB of 800 KB) on LOC = 1205
```

If the association shown in this step is an M2PA association, continue the procedure with [Step 5](#).

If the association shown in this step is an M3UA or SUA association, perform one of these actions.

- If the association does not have an ALHOST value, continue the procedure with [Step 5](#).
- If the association does have an ALHOST value, and the ALHOST value will be removed along with changing the LHOST value of the association, continue the procedure with [Step 5](#).
- If the association does have an ALHOST value, and the only action that will be performed in this procedure is to remove the ALHOST value from the association, continue the procedure with [Step 12](#).

5. Verify that the local host name to be assigned to the association is in the database by using the `rtrv-ip-host:display=all` command.

The following is an example of the possible output.

```
rlghncxa03w 08-12-28 21:15:37 GMT EAGLE5 40.0.0

LOCAL IPADDR    LOCAL HOST
192.1.1.10      IPNODE1-1201
```

```

192.1.1.12      GW105. NC. Oracle. COM
192.1.1.14      IPNODE1-1205
192.1.1.20      IPNODE2-1201
192.1.1.22      IPNODE2-1203
192.1.1.24      IPNODE2-1205
192.1.1.30      KC-HLR1
192.1.1.32      KC-HLR2
192.1.1.50      DN-MS1
192.1.1.52      DN-MS2

REMOTE IPADDR  REMOTE HOST
150.1.1.5      NCDEPTECONOMIC_DEVELOPMENT. SOUTHEASTERN_COORIDOR_ASHVL. GOV

IP Host table is (11 of 4096) .26% full

```

6. Display the IP links in the database by entering the `rtrv-ip-lnk` command.

The following is an example of the possible output.

```

rlghncxa03w 07-05-28 21:14:37 GMT EAGLE5 37.0.0
LOC  PORT  IPADDR          SUBMASK          DUPLEX  SPEED  MACTYPE  AUTO  MCAST
1303  A      192.1.1.10      255.255.255.128  HALF    10     802.3    NO    NO
1303  B      -----          -----          HALF    10     DIX      NO    NO
1305  A      192.1.1.12      255.255.255.0    ----    ---    DIX      YES   NO
1305  B      -----          -----          HALF    10     DIX      NO    NO
1313  A      192.1.1.14      255.255.255.0    FULL    100    DIX      NO    NO
1313  B      -----          -----          HALF    10     DIX      NO    NO
2101  A      192.1.1.20      255.255.255.0    FULL    100    DIX      NO    NO
2101  B      -----          -----          HALF    10     DIX      NO    NO
2103  A      192.1.1.22      255.255.255.0    FULL    100    DIX      NO    NO
2103  B      -----          -----          HALF    10     DIX      NO    NO
2105  A      192.1.1.24      255.255.255.0    FULL    100    DIX      NO    NO
2105  B      -----          -----          HALF    10     DIX      NO    NO
2205  A      192.1.1.30      255.255.255.0    FULL    100    DIX      NO    NO
2205  B      -----          -----          HALF    10     DIX      NO    NO
2207  A      192.1.1.32      255.255.255.0    FULL    100    DIX      NO    NO
2207  B      -----          -----          HALF    10     DIX      NO    NO
2213  A      192.1.1.50      255.255.255.0    FULL    100    DIX      NO    NO
2213  B      -----          -----          HALF    10     DIX      NO    NO
2301  A      192.1.1.52      255.255.255.0    FULL    100    DIX      NO    NO
2301  B      -----          -----          HALF    10     DIX      NO    NO
2305  A      192.3.3.33      255.255.255.0    FULL    100    DIX      NO    NO
2305  B      -----          -----          HALF    10     DIX      NO    NO

IP-LNK  table is (22 of 2048) 1% full.

```

If the required IP link, one that contains the desired IP address, is not shown in the `rtrv-ip-lnk` output, add the IP link using the [Configuring an IP Link](#) procedure. After the IP link has been added, assign the IP address of the IP link to the IP host name using the [Adding an IP Host](#) procedure, then continue the procedure with [Step 11](#).

If the required IP link is shown in the `rtrv-ip-lnk` output, but the IP host is not shown in the `rtrv-ip-host` output in [Step 5](#), assign the IP address of the IP link to the IP host name using the [Adding an IP Host](#) procedure, then continue the procedure with [Step 11](#).

If the required IP host was shown in [Step 5](#), the required IP link is shown in the `rtrv-ip-lnk` output in this step. Perform [Step 7](#) to verify the application running on the card whose IP address is assigned to the IP host.

Note: Thertrv-ip-host output must contain a host name for the association'slhost parameter and a host name for the association'salhost parameter, if thealhost parameter will be specified for the association. The IP address of the IP link should be assigned to the host name, shown in thertrv-ip-host output, that will be used as the association'slhost parameter value. If thealhost parameter will be specified for the association, the IP address of the IP link must be assigned to the host name that will be used as thealhost parameter value. The IP links associated with the association'slhost andalhost values must be assigned to the same card.

7. Display the application running on the IP card shown in [Step 6](#) whose IP address is assigned to the IP host using the rept-stat-card command specifying the location of the IP card.

For this example, enter this command.

```
rept-stat-card:loc=1205
```

This is an example of the possible output.

```
rlghncxa03w 08-04-27 17:00:36 GMT EAGLE5 38.0.0
CARD  VERSION      TYPE      GPL      PST      SST      AST
1205  114-000-000    DCM      SS7IPGW  IS-NR    Active   -----
ALARM STATUS      = No Alarms.
BPDCM GPL         = 002-102-000
IMT BUS A         = Conn
IMT BUS B         = Conn
SIGNALING LINK STATUS
SLK   PST          LS      CLLI
A     IS-NR        nc001   -----
Command Completed.
```

8. Display the associations assigned to the local host that will be assigned to the association being configured in this procedure by entering the rtrv-assoc command with the lhost parameter.

For this example, enter this command.

```
rtrv-assoc:lhost="IPNODE2-1205"
```

This is an example of the possible output.

```
rlghncxa03w 08-04-28 21:14:37 GMT EAGLE5 38.0.0

CARD IPLNK
ANAME  LOC  PORT  LINK ADAPTER  LPORT  RPORT  OPEN  ALW
assoc2 1205 A    A    M3UA   2048  2048  YES  YES
assoc3 1205 A    A    M3UA   3000  3000  YES  YES
assoc5 1205 A    A    M3UA   1500  3000  YES  YES

IP Appl Sock/Assoc table is (8 of 4000) 1% full
Assoc Buffer Space Used (600 KB of 3200 KB) on LOC = 1205
```

9. Display the application servers that the associations shown in [Step 8](#) are assigned to by entering rtrv-as command with the names of the associations shown in [Step 8](#).

For this example, enter these commands.

```
rtrv-as:aname=assoc2
```

This is an example of the possible output.

```
rlghncxa03w 08-04-28 21:14:37 GMT EAGLE5 38.0.0
AS Name      Mode      Tr ms     Association Names
as1          LOADSHARE 2000      assoc2

as4          LOADSHARE 2000      assoc2

as6          LOADSHARE 2000      assoc2

AS Table is (6 of 250) 1% full
```

```
rtrv-as:aname=assoc3
```

This is an example of the possible output.

```
rlghncxa03w 08-04-28 21:14:37 GMT EAGLE5 38.0.0
AS Name      Mode      Tr ms     Association Names
as2          LOADSHARE 2000      assoc3

as3          LOADSHARE 2000      assoc3

as5          LOADSHARE 2000      assoc3

AS Table is (6 of 250) 2% full
```

```
rtrv-as:aname=assoc5
```

This is an example of the possible output.

```
rlghncxa03w 08-04-28 21:14:37 GMT EAGLE5 38.0.0
AS Name      Mode      Tr ms     Association Names
as2          LOADSHARE 2000      assoc5

as3          LOADSHARE 2000      assoc5

as5          LOADSHARE 2000      assoc5

AS Table is (6 of 250) 2% full
```

The maximum number of SCTP association to application server assignments that can be hosted by an IPGWx card (referenced by the lhost parameter of the association) is 50.

If the number of SCTP association to application server assignments (shown in this step) is less than 50, continue the procedure by performing one of these steps.

- If the rept-stat-card command was not performed in [Step 7](#), continue the procedure with [Step 10](#).
- If the rept-stat-card command was performed in [Step 7](#), and the link value will not be changed, continue the procedure with [Step 12](#).
- If the rept-stat-card command was performed in [Step 7](#), and the link value will be changed, continue the procedure with [Step 11](#).

If the number of SCTP association to application server assignments (shown in this step) is 50, the local host value cannot be used in this procedure. Repeat [Step 5](#) and [Step 6](#) and select another IP link and IP.

10. Display the application running on the IP card shown in [Step 6](#) using the `rept-stat-card` command specifying the location of the IP card.

For this example, enter this command.

```
rept-stat-card:loc=1205
```

This is an example of the possible output.

```
rlghncxa03w 08-04-27 17:00:36 GMT EAGLE5 38.0.0
CARD VERSION TYPE GPL PST SST AST
1205 114-000-000 DCM SS7IPGW IS-NR Active -----
ALARM STATUS = No Alarms.
BPDCM GPL = 002-102-000
IMT BUS A = Conn
IMT BUS B = Conn
SIGNALING LINK STATUS
SLK PST LS CLLI
A IS-NR nc001 -----
Command Completed.
```

- If the link value will not be changed, continue the procedure with [Step 12](#).
- If the link value will be changed, continue the procedure with [Step 11](#).

11. Display the signaling link that will be assigned to the association by entering the `rtrv-slk` command and specifying the card location and signaling link.

For this example, enter this command.

```
rtrv-slk:loc=1203
```

This is an example of the possible output.

```
rlghncxa03w 08-04-19 21:17:04 GMT EAGLE5 38.0.0
LOC LINK LSN SLC TYPE
1203 A e5e6a 1 SS7IPGW
```

If the required IPGWx signaling is shown in this step, continue the procedure with [Step 12](#).

If the required IPGWx signaling is not shown in this step, perform the [Adding an IPGWx Signaling Link](#) to add the required IPGWx signaling link. After the signaling link has been added, continue the procedure with [Step 12](#).

12. Change the association using the `chg-assoc` command.

For this example, enter this command.

```
chg-assoc:aname=assoc2:lhost=m3ua1:alhost=m3ua2:rhost="gw200.nc-Oracle.com"
```

These are the rules that apply to the `chg-assoc` command.

- If any optional parameters are not specified with the `chg-assoc` command, those values are not changed.
- E5-ENET cards can use the B Ethernet interface.
- The number of association – application server assignments on an IPGWx card cannot exceed 50.
- The EAGLE can contain a maximum of 4000 connections.

- The value of the `lhost` and `rhost` parameters is a text string of up to 60 characters, with the first character being a letter. The command input is limited to 150 characters, including the hostnames.
- Specifying the `lhost` parameter only creates a uni-homed endpoint. The network portion of the endpoint's IP address must be the same as the network portion of the IP address assigned to either the A or B network interface of the IP card.
- Specifying the `lhost` and `alhost` parameters creates a multi-homed endpoint. The network portion of the IP address associated with the `lhost` parameter must be the same as the network portion of the IP address assigned to one of the network interfaces (A or B) of the IP card, and the network portion of the IP address associated with the `alhost` parameter must be the same as the network portion of the IP address assigned to the other network interface on the IP card.
- The `alhost=none` parameter removes the alternate local host from the specified association, which also removes the multi-homed endpoint capability.
- If the `uaps` parameter is not specified with the `chg-assoc` command, and the `adapter` parameter value is being changed to either `m3ua` or `sua`, the `uaps` parameter value defaults to UA parameter set 10 (`uaps=10`).
- The `port` parameter can be used in place of the `link` parameter to specify the signaling link assigned to the association.

When this command has successfully completed, this message should appear.

```
rlghncxa03w 08-04-28 09:12:36 GMT EAGLE5 38.0.0
CHG-ASSOC: MASP A - COMPLTD;
```

Note: If the value of the `open` parameter was not changed in [Step 3](#), continue the procedure with [Step 14](#).

13. Change the value of the `open` parameter to `yes` by specifying the `chg-assoc` command with the `open=yes` parameter.

For this example, enter this command.

```
chg-assoc:aname=assoc2:open=yes
```

When this command has successfully completed, this message should appear.

```
rlghncxa03w 08-04-28 09:12:36 GMT EAGLE5 38.0.0
CHG-ASSOC: MASP A - COMPLTD;
```

14. Verify the changes using the `rtrv-assoc` command specifying the association name specified in [Step 12](#) and [Step 13](#).

For this example, enter this command.

```
rtrv-assoc:aname=assoc2
```

This is an example of possible output.

```
rlghncxa03w 09-05-28 09:12:36 GMT EAGLE5 41.0.0
ANAME assoc2
      LOC      1205          IPLNK PORT  A          LINK  A
      ADAPTER  M3UA          VER          M3UA RFC
      LHOST    m3ua1
```

```

ALHOST    m3ua2
RHOST     gw200.nc-tekelec.com
ARHOST    ---
LPORT     2048           RPORT      3000
ISTRMS    2             OSTRMS     2           BUFSIZE    250
RMODE     LIN           RMIN       120          RMAX       800
RTIMES    10           CWMIN      3000         UAPS       10
OPEN      YES          ALW        YES          RTXTHR     10000
RHOSTVAL  RELAXED

ASNAMES
as1              as4              as6

IP Appl Sock table is (8 of 4000) 1% full
Assoc Buffer Space Used (650 KB of 800 KB) on LOC = 1205

```

15. Back up the new changes, using the `chg-db:action=backup:dest=fixed` command. These messages should appear; the active Maintenance and Administration Subsystem Processor (MASP) appears first.

```

BACKUP (FIXED) : MASP A - Backup starts on active MASP.
BACKUP (FIXED) : MASP A - Backup on active MASP to fixed disk complete.
BACKUP (FIXED) : MASP A - Backup starts on standby MASP.
BACKUP (FIXED) : MASP A - Backup on standby MASP to fixed disk complete.

```

If you wish to change other attributes the of the M3UA or SUA association, perform one of these procedures.

- `bufsize` - [Changing the Buffer Size of a M3UA or SUA Association](#)
- Other attributes of the M3UA or SUA association - [Changing the Attributes of a M3UA or SUA Association](#)

If you do not wish to change the other attributes of the M3UA or SUA association, this procedure is finished.

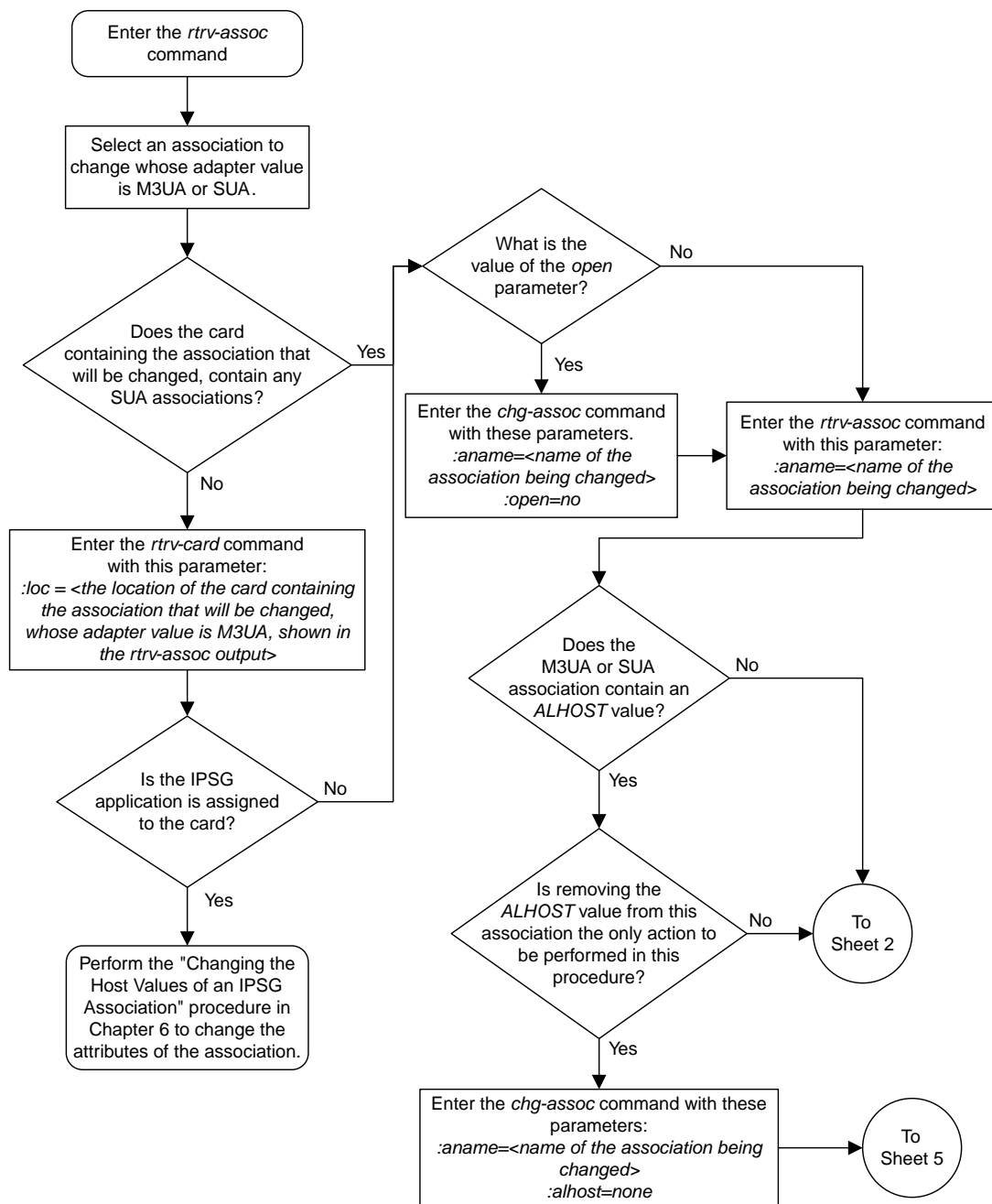

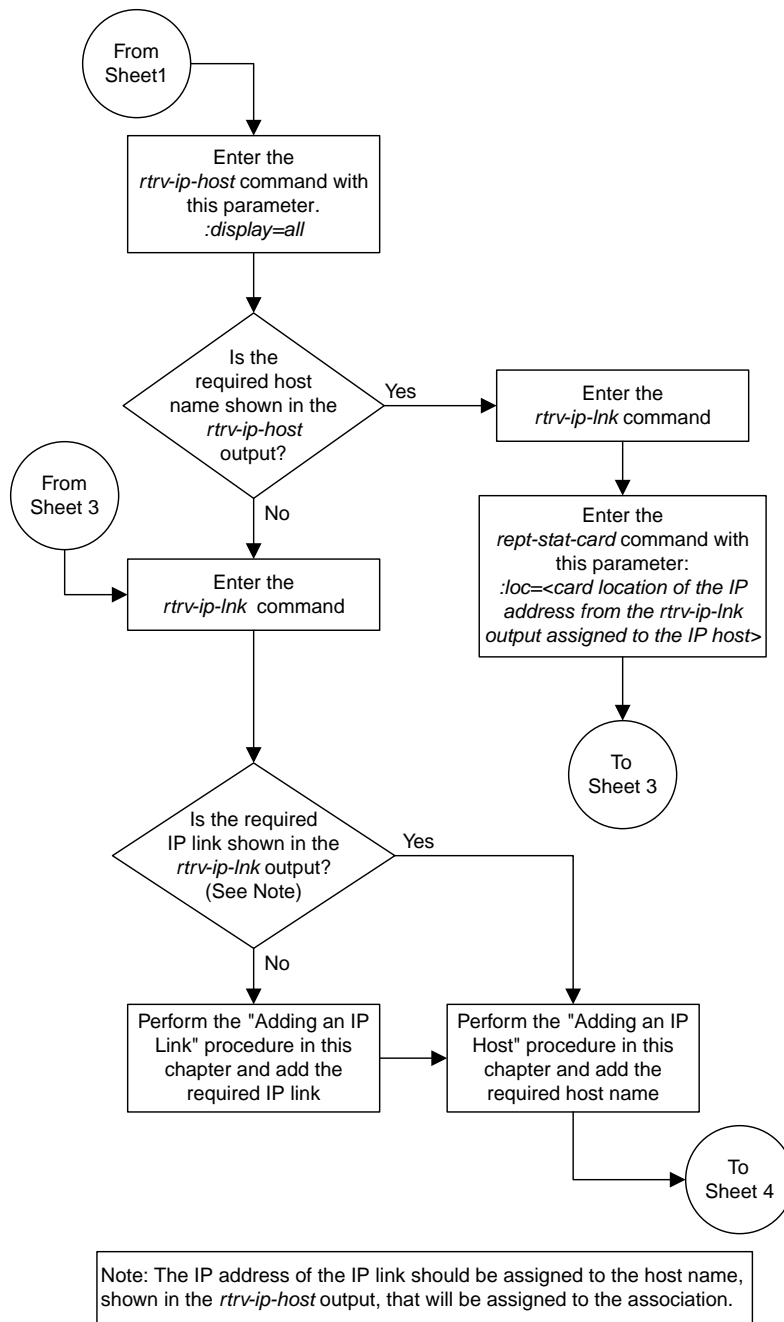

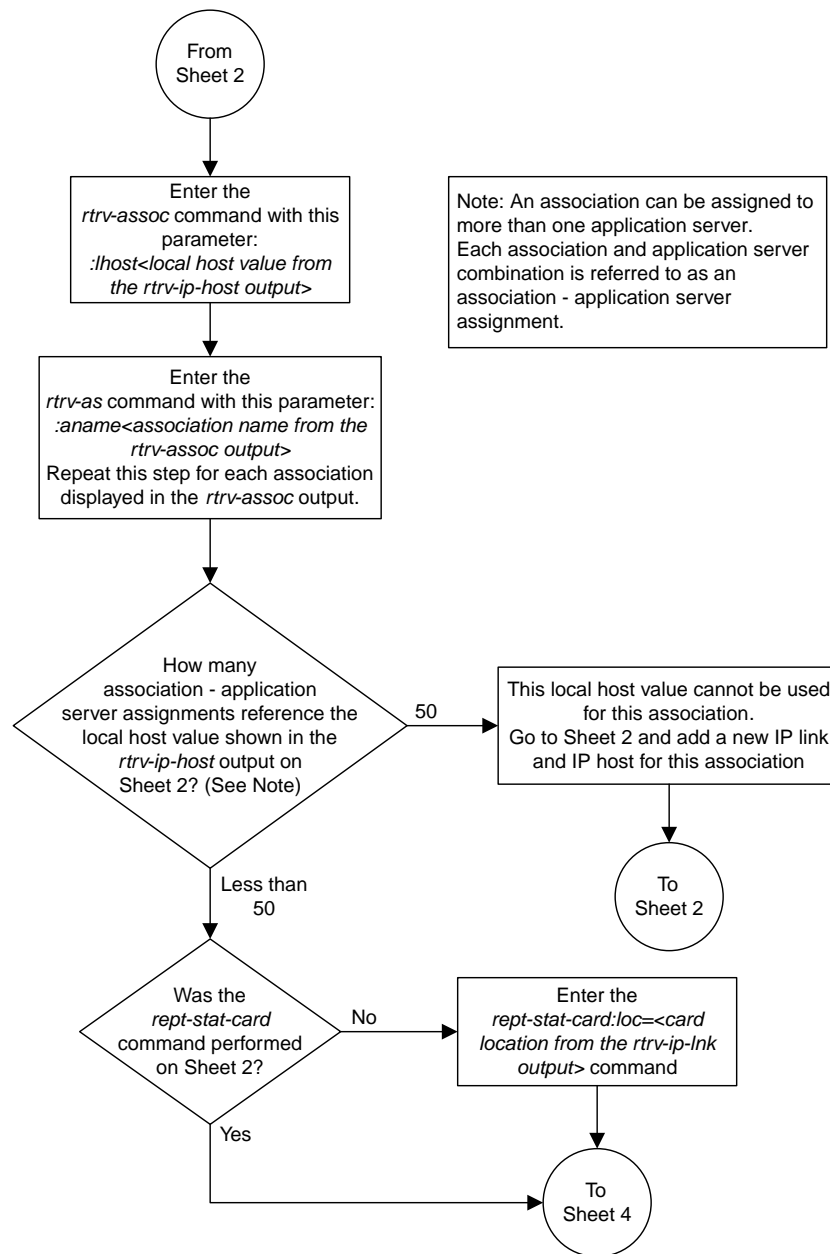

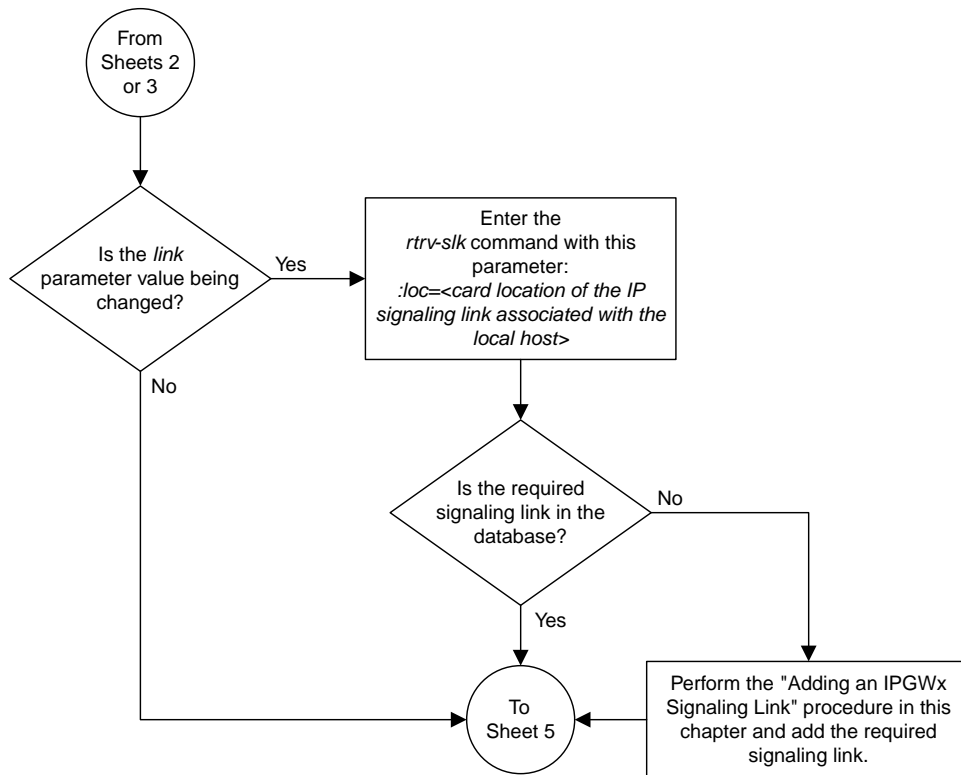

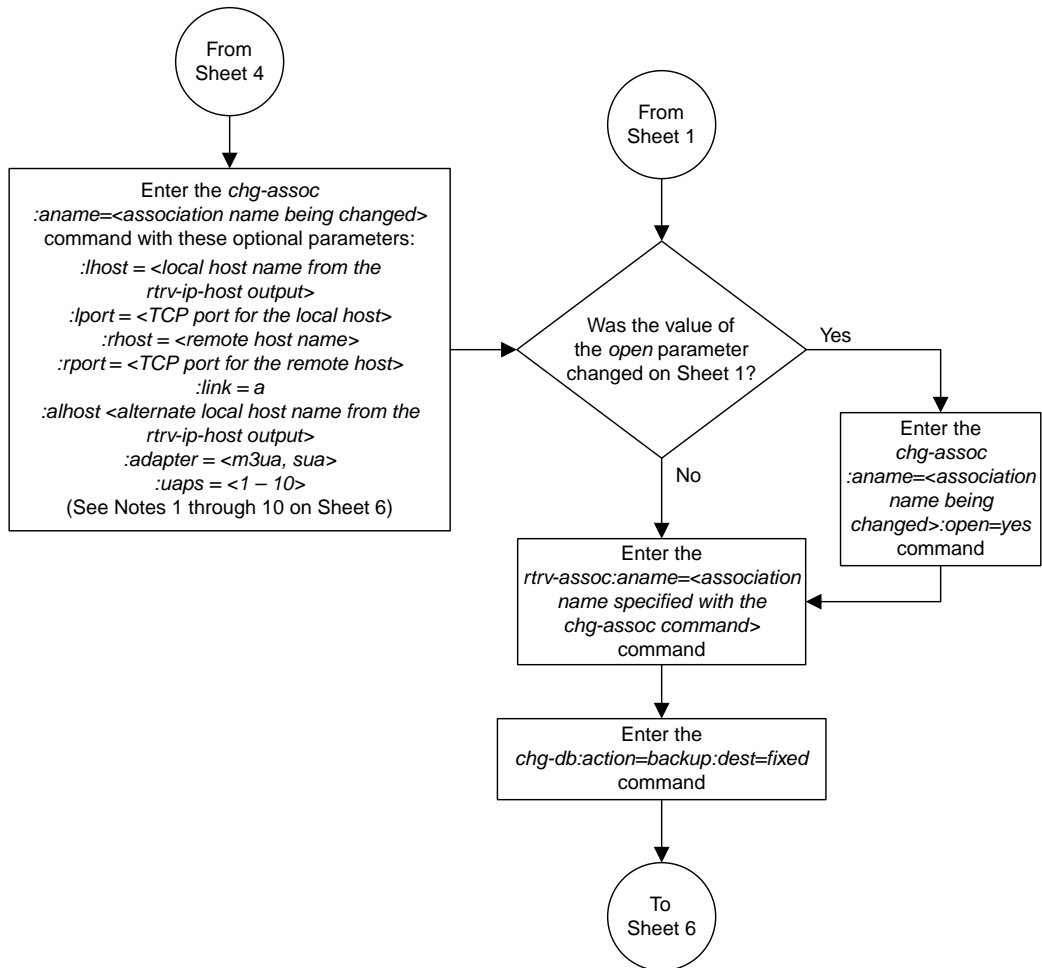

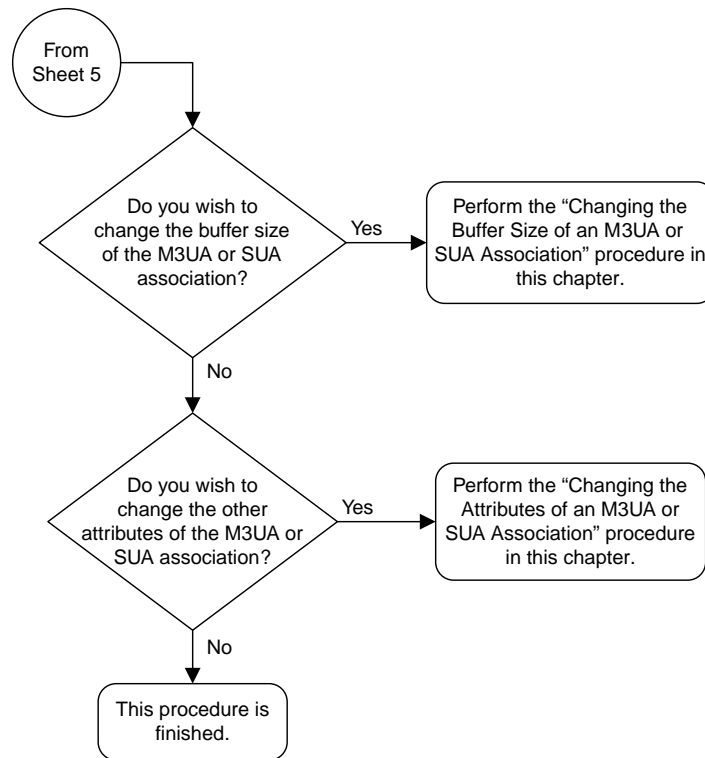

Notes:

1. If any optional parameters are not specified with the *chg-assoc* command, those values are not changed.
2. Single-slot EDCMs or E5-ENET cards can use the B Ethernet interface.
3. The number of association – application server assignments on an IPGWx card cannot exceed 50.
4. The EAGLE 5 ISS can contain a maximum of 4000 connections.
5. The value of the *lhost* and *rhost* parameters is a text string of up to 60 characters, with the first character being a letter. The command input is limited to 150 characters, including the hostnames
6. Specifying the *lhost* parameter only creates a uni-homed endpoint. The network portion of the endpoint's IP address must be the same as the network portion of the IP address assigned to either the A or B network interface of the IP card.
7. Specifying the *lhost* and *alhost* parameters creates a multi-homed endpoint. The network portion of the IP address associated with the *lhost* parameter must be the same as the network portion of the IP address assigned to one of the network interfaces (A or B) of the IP card, and the network portion of the IP address associated with the *alhost* parameter must be the same as the network portion of the IP address assigned to the other network interface on the IP card .
8. The *alhost=none* parameter removes the alternate local host from the specified association, which also removes the multi-homed endpoint capability.
9. If the *uaps* parameter is not specified with the *chg-assoc* command, and the *adapter* parameter value is being changed to either *m3ua* or *sua*, the *uaps* parameter value defaults to UA parameter set 10 (*uaps=10*).
10. The *port* parameter can be used in place of the *link* parameter to specify the signaling link assigned to the association.

Sheet 6 of 6

Figure 69: Changing the Host Values of a M3UA or SUA Association

Configuring SCTP Retransmission Control for a M3UA or SUA Association

This procedure is used to gather the information required to configure the retransmission parameters for SUA associations and M3UA associations that are assigned to cards running either the SS7IPGW or IPGWI applications. Perform the [Configuring an IPSP Association for SCTP Retransmission Control](#) procedure to configure the retransmission parameters for M3UA associations assigned to IPSP cards. If any assistance is needed to configure the retransmission parameters for associations, contact the Customer Care Center. Refer to [My Oracle Support \(MOS\)](#) for the contact information.

The retransmission parameters are configured using the `rmode`, `rmin`, `rmax`, `rtimes`, and `cwmin` parameters of the `chg-assoc` command.

`:rmode` – The retransmission mode used when packet loss is detected. The values are `rfc` or `lin`.

- `rfc` – Standard RFC 2960 algorithm in the retransmission delay doubles after each retransmission. The RFC 2960 standard for congestion control is also used.
- `lin` – Oracle's linear retransmission mode where each retransmission timeout value is the same as the initial transmission timeout and only the slow start algorithm is used for congestion control.

`:rmin` – The minimum value of the calculated retransmission timeout in milliseconds.

`:rmax` – The maximum value of the calculated retransmission timeout in milliseconds.

Note: The `rmin` and `rmax` parameter values form a range of retransmission values. The value of the `rmin` parameter must be less than or equal to the `rmax` parameter value.

`:rtimes` – The number of times a data retransmission occurs before closing the association.

`:cwmin` – The minimum size in bytes of the association's congestion window and the initial size in bytes of the congestion window.

For associations assigned to the `ss7ipgw` or `ipgwi` applications, the value of the `cwmin` parameter must be less than or equal to 16384.

The [Changing the Attributes of a M3UA or SUA Association](#) procedure is used to change the values of these parameters. In addition to using the [Changing the Attributes of a M3UA or SUA Association](#) procedure, these pass commands are also used in this procedure.

- `ping` – tests for the presence of hosts on the network.
- `assocrtt` – displays the SCTP round trip times for a specified association. Minimum, maximum, and average times are kept for each open association. The Retransmission Mode (RFC or LIN) and the configured Minimum and Maximum Retransmission Timeout limits are also displayed.
- `sctp` – provides a summary list of all SCTP instances.
- `sctp -a <association name>` – displays the measurements and information for a specific association.

Note: The values for the minimum and maximum retransmission times in the output from this command are shown in microseconds.

For more information on the pass commands, see *Commands User's Guide*.

The `chg-assoc` command contains other optional parameters that can be used to configure an association. These parameters are not shown here because they are not necessary for configuring the SCTP retransmission parameters. These parameters are explained in more detail in the [Changing the Attributes of a M3UA or SUA Association](#) procedure, or in the `chg-assoc` command description in *Commands User's Guide*.

Canceling the RTRV-ASSOC Command

Because the `rtrv-assoc` command used in this procedure can output information for a long period of time, the `rtrv-assoc` command can be canceled and the output to the terminal stopped. There are three ways that the `rtrv-assoc` command can be canceled.

- Press the F9 function key on the keyboard at the terminal where the `rtrv-assoc` command was entered.
- Enter the `canc-cmd` without the `trm` parameter at the terminal where the `rtrv-assoc` command was entered.
- Enter the `canc-cmd:trm=<xx>`, where `<xx>` is the terminal where the `rtrv-assoc` command was entered, from another terminal other than the terminal where the `rtrv-assoc` command was entered. To enter the `canc-cmd:trm=<xx>` command, the terminal must allow Security Administration commands to be entered from it and the user must be allowed to enter Security Administration commands. The terminal's permissions can be verified with the `rtrv-secu-trm` command. The user's permissions can be verified with the `rtrv-user` or `rtrv-secu-user` commands.

For more information about the `canc-cmd` command, go to *Commands User's Guide*.

1. Display the associations in the database using the `rtrv-assoc` command.

This is an example of possible output.

```
rlghncxa03w 06-10-28 09:12:36 GMT EAGLE5 36.0.0

          CARD IPLNK
ANAME     LOC  PORT  LINK ADAPTER  LPORT  RPORT  OPEN  ALW
swbel32   1201 A     A   M3UA    1030   2345   YES   YES
a2        1305 A     A   SUA     1030   2345   YES   YES
a3        1307 A     A   SUA     1030   2346   YES   YES
assoc1    1201 A     A   M3UA    2000   1030   YES   YES
```

If the association that is being removed in this procedure is an SUA association, continue the procedure with [Step 3](#).

If the association that is being removed in this procedure is an M3UA association, continue the procedure with [Step 2](#).

2. Enter the `rtrv-card` command with the location of the card that is hosting the M3UA association that will be changed in this procedure. For this example, enter this command.

```
rtrv-card:loc=1201
```

This is an example of possible output.

```
rlghncxa03w 08-03-06 15:17:20 EST EAGLE5 38.0.0
CARD  TYPE      APPL      LSET NAME  LINK SLC LSET NAME  LINK SLC
1201  DCM        SS7IPGW  lsn1      A    0
```

If the application assigned to the card is SS7IPGW or IPGWI, shown in the APPL column, continue the procedure with [Step 3](#).

If the application assigned to the card is IPSPG, perform the [Configuring an IPSPG Association for SCTP Retransmission Control](#) procedure.

3. Display the association that will be changed by entering the `rtrv-assoc` command with the name of the association. For this example, enter this command.

```
rtrv-assoc:aname=assoc1
```

This is an example of the possible output.

```
rlghncxa03w 09-05-28 21:14:37 GMT EAGLE5 41.0.0
ANAME assoc1
  LOC      1201          IPLNK PORT  A          LINK  A
  ADAPTER  M3UA          VER          M3UA RFC
  LHOST    IPNODE2-1205
  ALHOST    ---
  RHOST    gw100.nc.tekelec.com
  ARHOST    ---
  LPORT    2000          RPORT        1030
  ISTRMS   2            OSTRMS       2          BUFSIZE  200
  RMODE    LIN          RMIN         120        RMAX     800
  RTIMES   10          CWMIN        3000       UAPS     10
  OPEN     YES          ALW          YES        RTXTHR   2000
  RHOSTVAL RELAXED

ASNAMES
as1          as4          as6

IP Appl Sock/Assoc table is (8 of 4000) 1% full
Assoc Buffer Space Used (800 KB of 800 KB) on LOC = 1201
```

4. Enter the `ping pass` command specifying the card location of the local host, shown in [Step 3](#), and the name of the remote host assigned to the association being changed, shown in [Step 3](#).

This command is entered several times to obtain the average round trip time. For this example, enter this command.

```
pass:loc=1201:cmd="ping gw100.nc.tekelec.com"
```

The following is an example of the possible output

```
rlghncxa03w 06-10-28 21:15:37 GMT EAGLE5 36.0.0
PASS: Command sent to card

rlghncxa03w 06-10-28 21:15:37 GMT EAGLE5 36.0.0
PING command in progress

rlghncxa03w 06-10-28 21:15:37 GMT EAGLE5 36.0.0
PING GW100. NC. TEKELEC. COM (192.1.1.30): 56 data bytes
64 bytes from tekral.nc.tekelec.com (192.1.1.30): icmp_seq=0. time=5. ms
64 bytes from tekral.nc.tekelec.com (192.1.1.30): icmp_seq=1. time=9. ms
64 bytes from tekral.nc.tekelec.com (192.1.1.30): icmp_seq=2. time=14. ms
---tekral PING Statistics---
3 packets transmitted, 3 packets received, 0% packet loss
round-trip (ms)  min/avg/max = 5/9/14

PING command complete
```

If the SCTP retransmission parameters are not to be changed, do not perform [Step 5](#) through [Step 8](#). This procedure is finished.

5. Perform the [Changing the Attributes of a M3UA or SUA Association](#) procedure to change the retransmission parameters of the association based on the results of pinging the remote host.
6. Enter the `assocrtt` pass command to display the round trip time data collected after an association is established when an SCTP INIT message is sent and an acknowledgment is received.

The `assocrtt` command is entered with the card location from [Step 4](#) (the card location assigned to the association being changed), and the name of the association being changed. This association must contain the local host name used in [Step 4](#). For this example, enter this command.

```
pass:loc=1201:cmd="assocrtt assoc1"
```

The following is an example of the possible output

```
rlghncxa03w 06-10-28 21:15:37 GMT EAGLE5 36.0.0
PASS: Command sent to card

rlghncxa03w 06-10-28 21:15:37 GMT EAGLE5 36.0.0

ASSOCRTT: Association round-trip time report (in milliseconds)

Retransmission Configuration
  Retransmission Mode           : LIN
  Minimum RTO: 120
  Maximum RTO: 800

Traffic Round-Trip Times

  Minimum round-trip time       : 5
  Maximum round-trip time       : 120
  Weighted Average round-trip time : 10
  Last recorded round-trip time  : 10

Measured Congested Traffic Round-Trip Times

  Minimum round-trip time       : 0
  Maximum round-trip time       : 0
  Weighted Average round-trip time : 0
  Last recorded round-trip time  : 0
;
rlghncxa03w 06-10-28 21:15:37 GMT EAGLE5 36.0.0
ASSOCRTT command complete
```

7. Enter the `sctp -a <association name>` pass command to determine if retransmissions have occurred.

The association name is the association name specified in [Step 6](#). Specify the card location used in [Step 6](#). For this example, enter this command.

```
pass:loc=1201:cmd="sctp -a assoc1"
```

The following is an example of the possible output

```
rlghncxa03w 10-12-28 21:15:37 GMT EAGLE5 43.0.0

Aname          Local          Local Remote          Remote
```

```

Assoc1          IP Address      Port   Address      Port
                192.168.110.12  2222   192.168.112.4  5555
                192.168.112.12

Configuration                                     State
Retransmission Mode = LIN                          State = OPEN
Min. Retransmission Timeout = 10000                ULP association id = 18
Max. Retransmission Timeout = 800000              Number of nets = 2
Max. Number of Retries = 10                       Inbound Streams = 1
Min. Congestion Window = 3000                     Outbound Streams = 2
Inbound Streams = 2
Outbound Streams = 2
Checksum Algorithm = crc32c
Send/Rcv Buffer Size = 204800

Nets Data

IP Address      192.168.112.4      State      Reachable
Port            7777                  Primary    YES
MTU             1500                  cwnd      16384
ssthresh       16384                  RTO       120

IP Address      192.168.113.5      State      Reachable
Port            7777                  Primary    NO
MTU             1500                  cwnd      16384
ssthresh       16384                  RTO       120

Last Net Sent To = 192.168.112.4
Last Net Rcvd From = 192.168.112.4
Over All Error Count = 0
Peers Rwnd = 13880
My Rwnd = 16384
Max Window = 16384
Initial Seq Number = 24130
Next Sending Seq Number = 124686
Last Acked Seq Number = 124669
Maximum Outbound Char Count = 16384
Current Outbound Char Count = 2112
Number Unsent Char Count = 0
Outbound Data Chunk Count = 16
Number Unsent = 0
Number To Retransmit = 0

ip datagrams rcvd = 155402
ip datagrams with data chunks rcvd = 120844
data chunks rcvd = 367908
data chunks read = 367900
dup tsns rcvd = 8
sacks rcvd = 38734
gap ack blocks rcvd = 3
heartbeat requests rcvd = 135
heartbeat acks rcvd = 52
heartbeat requests sent = 52
ip datagrams sent = 129254
ip datagrams with data chunks sent = 73084
data chunks sent = 396330
retransmit data chunks sent = 135
sacks sent = 64872
send failed = 0
retransmit timer count = 0
consecutive retransmit timeouts = 0
RTT between RMIN and RMAX inclusive = 6
RTT greater than RMAX = 0
fast retransmit count = 135

```



```

    recv timer count = 0
    heartbeat timer count = 244
    none left tosend = 0
    none left rwnd gate = 5
    none left cwnd gate = 8
;
rlghncxa03w 10-12-28 21:15:37 GMT EAGLE5 43.0.0
SCTP command complete

```

```
rlghncxa03w 06-10-28 21:15:37 GMT EAGLE5 36.0.0
```

Aname	Local	Local	Remote	Remote
	IP Address	Port	Address	Port
Assoc1	192.168.110.12	2222	192.168.112.4	5555
	192.168.112.12			

Configuration	State
Retransmission Mode = LIN	State = OPEN
Min. Retransmission Timeout = 10	ULP association id = 18
Max. Retransmission Timeout = 800	Number of nets = 2
Max. Number of Retries = 10	Inbound Streams = 1
Min. Congestion Window = 3000	Outbound Streams = 2
Inbound Streams = 2	
Outbound Streams = 2	

Nets Data

IP Address	192.168.112.4	State	Reachable
Port	7777	Primary	YES
MTU	1500	cwnd	16384
ssthresh	16384	RTO	120
IP Address	192.168.113.5	State	Reachable
Port	7777	Primary	NO
MTU	1500	cwnd	16384
ssthresh	16384	RTO	120

```

    Last Net Sent To = 192.168.112.4
    Last Net Rcvd From = 192.168.112.4
    Over All Error Count = 0
    Peers Rwnd = 13880
    My Rwnd = 16384
    Max Window = 16384
    Initial Seq Number = 24130
    Next Sending Seq Number = 124686
    Last Acked Seq Number = 124669
    Maximum Outbound Char Count = 16384
    Current Outbound Char Count = 2112
    Number Unsent Char Count = 0
    Outbound Data Chunk Count = 16
    Number Unsent = 0
    Number To Retransmit = 0

```

```

    ip datagrams rcvd = 155402
ip datagrams with data chunks rcvd = 120844
    data chunks rcvd = 367908
    data chunks read = 367900
    dup tsns rcvd = 8
    sacks rcvd = 38734
    gap ack blocks rcvd = 3

```

```
      heartbeat requests rcvd = 135
      heartbeat acks rcvd = 52
      heartbeat requests sent = 52
      ip datagrams sent = 129254
ip datagrams with data chunks sent = 73084
      data chunks sent = 396330
      retransmit data chunks sent = 135
      sacks sent = 64872
      send failed = 0
      retransmit timer count = 0
      consecutive retransmit timeouts = 0
RTT between RMIN and RMAX inclusive = 6
      RTT greater than RMAX = 0
      fast retransmit count = 135
      recv timer count = 0
      heartbeat timer count = 244
      none left tosend = 0
      none left rwnd gate = 5
      none left cwnd gate = 8

SCTP command complete
```

8. Perform the *Changing the Attributes of a M3UA or SUA Association* procedure to change the retransmission parameters of the association based on the results of the outputs of [Step 6](#) and [Step 7](#).

The Weighted Average round-trip time shown in the `assocrtt pass` command output in [Step 5](#), and the data retransmission counts shown in the `sctp -a` pass command output in [Step 6](#) are used as a guide to determine the appropriate values for the `rmode`, `rmin`, `rmax`, and `rtimes` parameters. If the retransmission parameters do not have to be adjusted, do not perform this step. This procedure is finished.

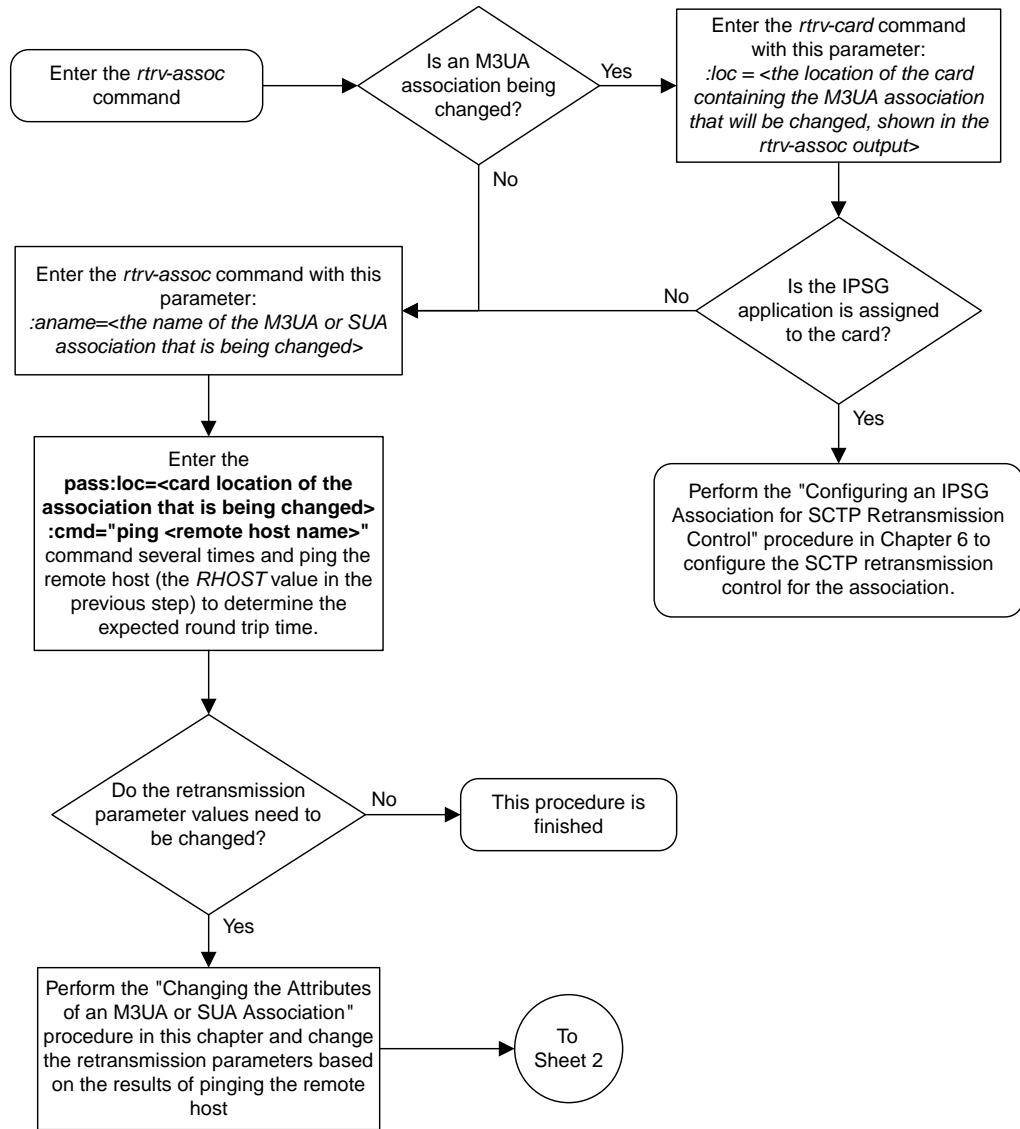

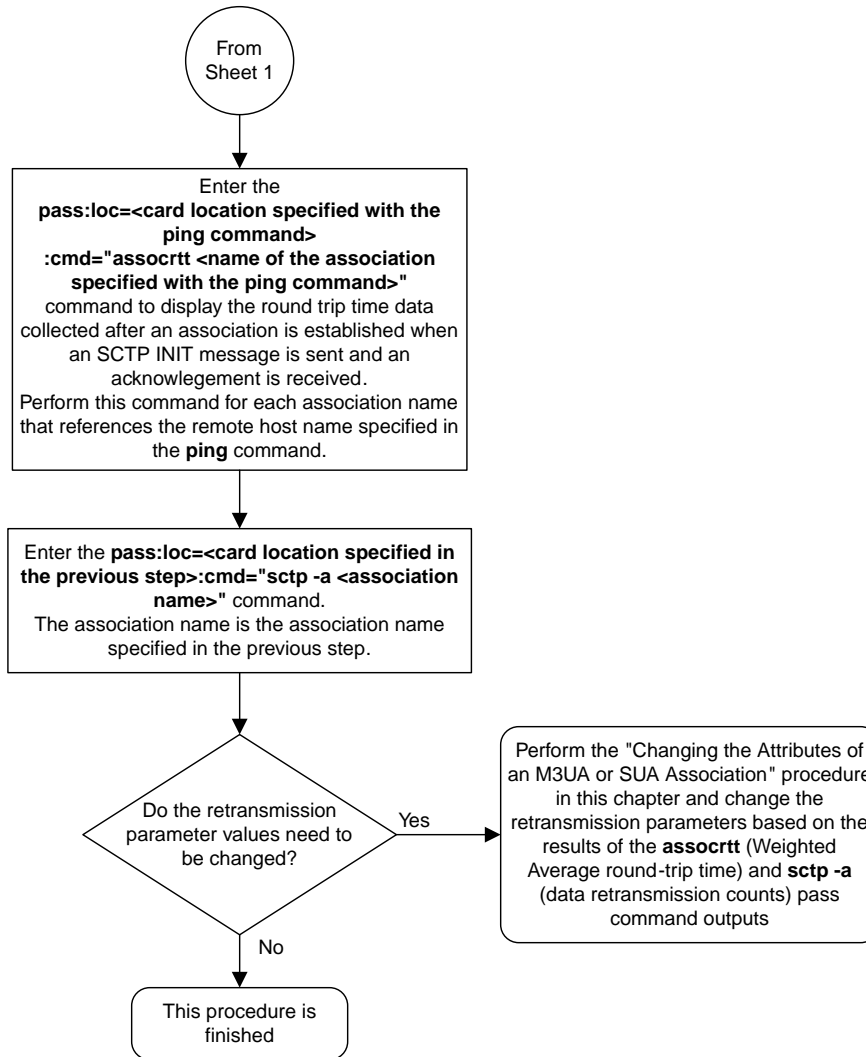

Sheet 2 of 2

Figure 70: Configuring SCTP Retransmission Control for a M3UA or SUA Association

Changing an Application Server

This procedure is used to change the characteristics of an existing application server using the `chg-as` command.

The `chg-as` command uses these parameters:

- `:asname` – The name of the application server being changed.
- `:mode` – The traffic mode assigned to the application server, either `loadshare` or `override`.
- `:tr` – The application server recovery timer, 10 - 2000 milliseconds.

The `mode` parameter value cannot be changed unless the `open` parameter value of all the associations assigned to the application server is set to `no`. This can be verified with the `rtrv-assoc` command.

The association assignments for an application server cannot be changed with this procedure. To change an association assignment for an application server, go to the [Removing an Association from an Application Server](#) procedure and remove the association from the application server, then perform one of these procedures to add another association to the application server:

- [Adding a New Association to an Existing Application Server](#)
- [Adding an Existing Association to an Existing Application Server.](#)

Canceling the RTRV-AS and RTRV-ASSOC Commands

Because the `rtrv-as` and `rtrv-assoc` commands used in this procedure can output information for a long period of time, the `rtrv-as` and `rtrv-assoc` commands can be canceled and the output to the terminal stopped. There are three ways that the `rtrv-as` and `rtrv-assoc` commands can be canceled.

- Press the F9 function key on the keyboard at the terminal where the `rtrv-as` or `rtrv-assoc` commands were entered.
- Enter the `canc-cmd` without the `trm` parameter at the terminal where the `rtrv-as` or `rtrv-assoc` commands were entered.
- Enter the `canc-cmd:trm=<xx>`, where `<xx>` is the terminal where the `rtrv-as` or `rtrv-assoc` commands were entered, from another terminal other than the terminal where the `rtrv-as` or `rtrv-assoc` commands were entered. To enter the `canc-cmd:trm=<xx>` command, the terminal must allow Security Administration commands to be entered from it and the user must be allowed to enter Security Administration commands. The terminal's permissions can be verified with the `rtrv-secu-trm` command. The user's permissions can be verified with the `rtrv-user` or `rtrv-secu-user` commands.

For more information about the `canc-cmd` command, go to *Commands User's Guide*.

1. Display the application servers in the database using the `rtrv-as` command.

This is an example of possible output.

```
rlghncxa03w 06-10-28 09:12:36 GMT EAGLE5 36.0.0
```

```

AS Name      Mode      Tr ms      Association Names
as1          LOADSHARE 10         assoc1
              assoc2
              assoc3
              assoc5
              assoc6

as2          OVERRIDE 10         assoc7
as3          LOADSHARE 10         assoc4

AS table is (2 of 250) 1% full.

```

Note: If the `mode` parameter will not be specified with the `chg-as` command in [Step 5](#), continue the procedure with [Step 5](#).

2. Display one of the associations assigned to the application server shown in [Step 1](#) using the `rtrv-assoc` command and specifying the association name shown in the `rtrv-as` output in [Step 1](#).

For this example, enter this command.

```
rtrv-assoc:aname=assoc1
```

This is an example of possible output.

```

rlghncxa03w 09-05-28 09:12:36 GMT EAGLE5 41.0.0
ANAME assoc1
  LOC      1203          IPLNK PORT  A          LINK  A
  ADAPTER  M3UA          VER          M3UA RFC
  LHOST    gw105.nc.tekelec.com
  ALHOST   ---
  RHOST    gw100.ncd-economic-development.southeastern-corridor-ash.gov
  ARHOST   ---
  LPORT    1030          RPORT      2345
  ISTRMS   2            OSTRMS     2            BUFSIZE  16
  RMODE    LIN          RMIN       120          RMAX     800
  RTIMES   10          CWMIN      3000         UAPS     10
  OPEN     YES          ALW        YES          RTXTHR   10000
  RHOSTVAL RELAXED

  ASNAMES
  as1

IP Appl Sock table is (4 of 4000) 1% full
Assoc Buffer Space Used (16 KB of 800 KB) on LOC = 1203

```

Note: If the value of the `open` parameter shown in this step is `no`, continue the procedure with [Step 5](#).

3. Change the value of the `open` parameter to `no` by specifying the `chg-assoc` command with the `open=no` parameter.

For this example, enter this command.

```
chg-assoc:aname=assoc1:open=no
```

When this command has successfully completed, this message should appear.

```
rlghncxa03w 06-10-28 09:12:36 GMT EAGLE5 36.0.0
CHG-ASSOC: MASP A - COMPLTD
```

Note: If all the associations assigned to the application server been displayed, continue the procedure with [Step 5](#).

4. Repeat [Step 2](#) and [Step 3](#) for all associations assigned to the application server being changed.
5. Change the application server in the database using the `chg-as` command.

For this example, enter this command

```
chg-as:asname=as1:mode=override:tr=1000
```

This is an example of possible inputs and outputs:

```
rlghncxa03w 06-10-28 09:12:36 GMT EAGLE5 36.0.0
CHG-AS: MASP A - COMPLTD;
```

6. Verify the changes using the `rtrv-as` command.

This is an example of possible output.

```
rlghncxa03w 06-10-28 09:12:36 GMT EAGLE5 36.0.0

AS Name           Mode           Tr ms   Association Names
as1                OVERRIDE       1000    assoc1
                  assoc2
                  assoc3
                  assoc5
                  assoc6

as2                OVERRIDE       10      assoc7
as3                LOADSHARE      10      assoc4

AS table is (2 of 250) 1% full
```

Note: If the value of the `open` parameter was not changed in [Step 3](#), continue the procedure with [Step 8](#).

7. Change the value of the `open` parameter to `yes` by specifying the `chg-assoc` command with the `open=yes` parameter.

For this example, enter this command.

```
chg-assoc:aname=assoc1:open=yes
```

When this command has successfully completed, this message should appear.

```
rlghncxa03w 06-10-28 09:12:36 GMT EAGLE5 36.0.0
CHG-ASSOC: MASP A - COMPLTD
```

Repeat this step for all associations that were changed in [Step 3](#).

8. Back up the new changes, using the `chg-db:action=backup:dest=fixed` command.

These messages should appear; the active Maintenance and Administration Subsystem Processor (MASP) appears first.

```
BACKUP (FIXED) : MASP A - Backup starts on active MASP.  
BACKUP (FIXED) : MASP A - Backup on active MASP to fixed disk complete.  
BACKUP (FIXED) : MASP A - Backup starts on standby MASP.  
BACKUP (FIXED) : MASP A - Backup on standby MASP to fixed disk complete.
```

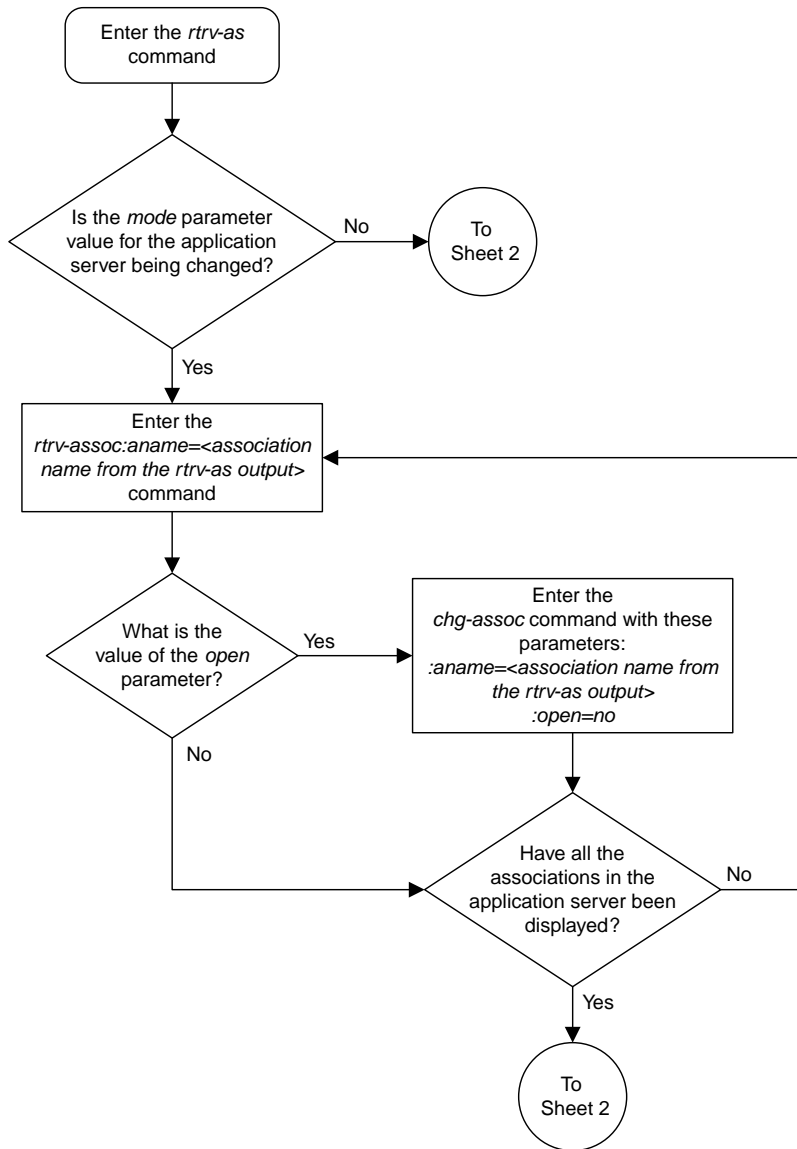

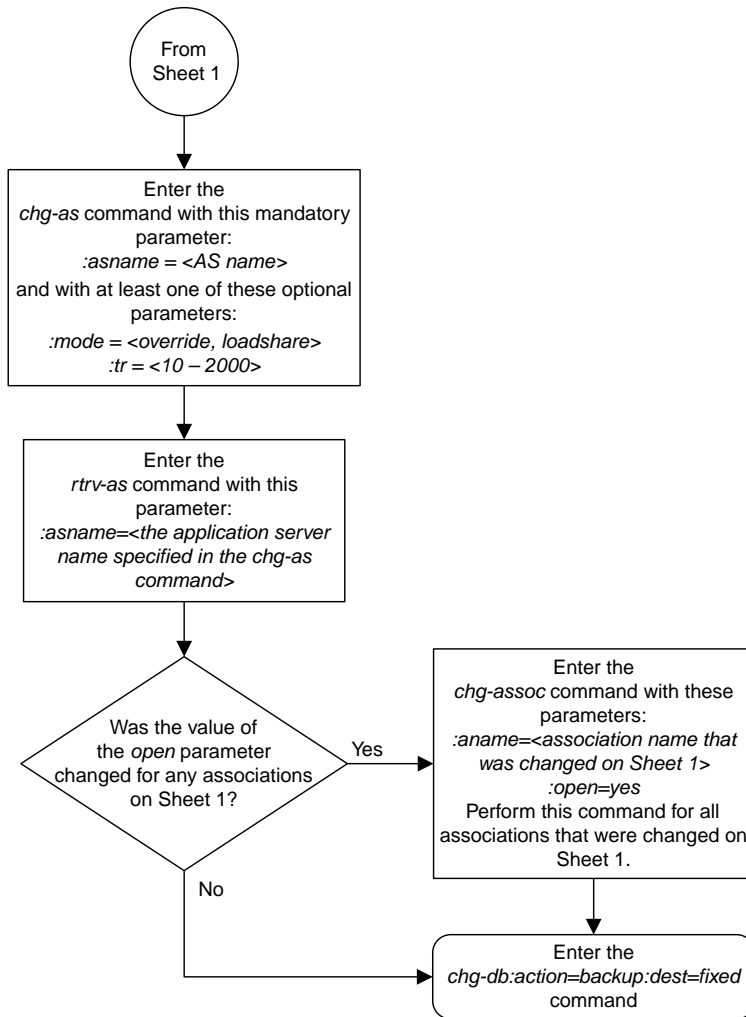
Sheet 2 of 2

Figure 71: Changing an Application Server

Changing the CIC Values in an Existing Routing Key Containing an Application Server

This procedure is used to change the CIC values in an existing routing key using the `chg-appl-rtkey` command. These parameters are used in this procedure.

`:dpc/dpca/dpci/dpcn/dpcn24` – Destination point code value that is used to filter incoming MSUs.

`:opc/opca/opci/opcn/opcn24` - The originating point code value that is used to filter incoming MSUs. This value must not specify a cluster route.

Note: See the “Point Code Formats” section in the *Database Administration - SS7 User’s Guide* for a definition of the point code types that are used on the EAGLE and for a definition of the different formats that can be used for ITU national point codes.

`:si` – The service indicator value that is used to filter incoming MSUs. The range of values for the service indicator parameter (`si`) can be a numerical value either 4, 5, or 13, or for selected service indicator values, a text string can be used instead of numbers. [Table 38: Service Indicator Text String Values](#) shows the text strings that can be used in place of numbers for the service indicator values.

Table 38: Service Indicator Text String Values

Service Indicator Value	Text String
4	tup
5	isup
13	qbicc

`:cics` - Starting circuit identification code that is used to filter incoming MSUs. Specify with `cice` to identify the routing key to be changed.

`:cice` - Ending circuit identification code that is used to filter incoming MSUs. Specify with `cics` to identify the routing key to be changed.

`:ncics` - New starting circuit identification code that is used to filter incoming MSUs. Specify the `ncics` parameter and/or the `ncice` parameter to change the range of circuit identification codes assigned to the routing key.

`:ncice` - New ending circuit identification code that is used to filter incoming MSUs. Specify the `ncice` parameter and/or the `ncics` parameter to change the range of circuit identification codes assigned to the routing key.

`:split` - The circuit identification code value where the specified range of CIC values for the routing key specified by the `cics` and `cice` values is to be split into two routing keys. The CIC values in one routing key ranges from the `cics` value of the original routing key to a value equal to one less than the `split` value. The CIC values in the other routing key ranges from the `split` value to the `cice` value of the original routing key. All other parameters in both routing keys remain the same as in the

original routing key. The range of CIC values cannot be split if the routing key contains a routing context parameter value.

:type - Key type. Identifies the type of routing key that will be changed. One of three values, type=full/partial/default. If type is not explicitly specified, type=full is assumed. Only the type=full parameter can be used in this procedure.

:rcontext - The routing context parameter value assigned to the routing key.

The chg-appl-rtkey command contains other parameters that are not used in this procedure.

:ssn - The subsystem number value that is used to filter incoming MSUs. See the [Adding a Routing Key Containing an Application Server](#) procedure for more information on using the ssn parameter with a routing key.

:nrcontext - The new routing context parameter value.

See the [Changing the Routing Context Value in an Existing Routing Key](#) procedure for changing the routing context parameter value in an existing routing key.

Rules for Changing the Range of CIC Values in an Existing Routing Key

The parameter combinations used by the chg-appl-rtkey command to change the range of CIC values in the routing key are shown in [Table 39: Routing Key Parameter Combinations for Changing the Range of CIC Values in an Existing Routing Key](#).

Table 39: Routing Key Parameter Combinations for Changing the Range of CIC Values in an Existing Routing Key

SI=4 (TUP)	SI=5 (ISUP)		SI=13 (QBICC)
dpci/dpcn/dpcn24=<the DPC assigned to the routing key> (See Note 1)	dpc/dpca=<the DPC assigned to the routing key> (See Note 1)	dpci/dpcn/dpcn24=<the DPC assigned to the routing key> (See Note 1)	dpc/dpca/dpci/dpcn/dpcn24=<the DPC assigned to the routing key> (See Note 1)
si=4 (See Note 1)	si=5 (See Note 1)	si=5 (See Note 1)	si=13 (See Note 1)
opci/opcn/opcn24=<the OPC assigned to the routing key> (See Note 1)	opc/opca=<the OPC assigned to the routing key> (See Note 1)	opci/opcn/opcn24=<the OPC assigned to the routing key> (See Note 1)	opc/opca/opci/opcn/opcn24=<the OPC assigned to the routing key> (See Note 1)
cics=<the CICS value assigned to the routing key> (See Notes 1 and 2)	cics=<the CICS value assigned to the routing key>	cics=<the CICS value assigned to the routing key> (See Notes 1 and 2)	cics=<the CICS value assigned to the routing key> (See Notes 1 and 2)
cice=<the CICE value assigned to the routing key> (See Notes 1 and 2)	cice=<the CICE value assigned to the routing key> (See Notes 1 and 2)	cice=<the CICE value assigned to the routing key> (See Notes 1 and 2)	cice=<the CICE value assigned to the routing key> (See Notes 1 and 2)

SI=4 (TUP)	SI=5 (ISUP)		SI=13 (QBICC)
type=full	type=full	type=full	type=full
ncics=<0 to 4095> (See Notes 2 and 3)	ncics=<0 to 16383> (See Notes 2 and 3)	ncics=<0 to 4095> (See Notes 2 and 3)	ncics=<0 to 4294967295> (See Notes 2 and 3)
ncice=<0 to 4095> (See Notes 2 and 3)	ncice=<0 to 16383> (See Notes 2 and 3)	ncice=<0 to 4095> (See Notes 2 and 3)	ncice=<0 to 4294967295> (See Notes 2 and 3)
rcontext=<the current routing context value assigned to the routing key> (See Notes 4 and 5)	rcontext=<the current routing context value assigned to the routing key> (See Notes 4 and 5)	rcontext=<the current routing context value assigned to the routing key> (See Notes 4 and 5)	rcontext=<the current routing context value assigned to the routing key> (See Notes 4 and 5)

1. The values for these parameters must be entered exactly as shown in the `rtrv-appl-rtkey` command output for the routing key being changed. However, text strings can be used in place of some numerical service indicator values. See [Table 38: Service Indicator Text String Values](#) for a list of these text strings. The text string must correspond to the numerical value shown in the routing key being changed.
2. The `cics` and `cice` parameters must be specified and either the `ncics` or `ncice` parameters, or both, must be specified. If both the `ncics` and `ncice` parameters are specified, the value of the `ncics` parameter must be less than the value of the `ncice` parameter. If the `ncics` parameter is not specified, the value of the `ncice` parameter must be greater than or equal to the `cics` parameter value. If the `ncice` parameter is not specified, the value of the `ncics` parameter must be less than or equal to the `cice` parameter value.
3. The new CIC range cannot overlap the CIC range in an existing routing key.
4. If the routing key contains a numerical value in the `RCONTEXT` column in the `rtrv-appl-rtkey` output, the `rcontext` parameter and value can be used in place of the `dpc`, `si`, `opc`, `cics`, `cice`, or `type=full` parameters and values to identify the routing that is being changed with the `chg-appl-rtkey` command. However, if only the `rcontext` parameter is used to identify the routing key being changed, only one of these parameters, `ncics` or `ncice` can be specified with the `chg-appl-rtkey` parameter. If you wish to specify the `ncics` and `ncice` parameters with the `chg-appl-rtkey` parameter, the `dpc`, `si`, `opc`, `cics`, `cice`, or `type=full` parameters and values must be specified with the `chg-appl-rtkey` command.
5. If the routing key contains dashes in the `RCONTEXT` column in the `rtrv-appl-rtkey` output, the `dpc`, `si`, `opc`, `cics`, `cice`, or `type` parameters and values must be used with the `chg-appl-rtkey` command to identify the routing key being changed.

Rules for Splitting the Range of CIC Values in an Existing Routing Key

The parameter combinations used by the `chg-appl-rtkey` command to split the range of CIC values in the routing key are shown in [Table 40: Routing Key Parameter Combinations for Splitting the Range of CIC Values in an Existing Routing Key](#).

Splitting the range of CIC values creates two routing keys. The CIC values in one routing key ranges from the `cics` value of the original routing key to a value equal to one less than the `split` value. The CIC values in the other routing key ranges from the `split` value to the `cice` value of the original

routing key. All other parameters in both routing keys remain the same as in the original routing key. The range of CIC values cannot be split if the routing key contains a routing context parameter value.

Table 40: Routing Key Parameter Combinations for Splitting the Range of CIC Values in an Existing Routing Key

SI=4 (TUP)	SI=5 (ISUP)		SI=13 (QBICC)
dpci/dpcn/dpcn24=<the DPC assigned to the routing key> (See Note 1)	dpc/dpca=<the DPC assigned to the routing key> (See Note 1)	dpci/dpcn/dpcn24=<the DPC assigned to the routing key> (See Note 1)	dpc/dpca/dpci/dpcn/dpcn24=<the DPC assigned to the routing key> (See Note 1)
si=4 (See Note 1)	si=5 (See Note 1)	si=5 (See Note 1)	si=13 (See Note 1)
opci/opcn/opcn24=<the OPC assigned to the routing key> (See Note 1)	opc/opca=<the OPC assigned to the routing key> (See Note 1)	opci/opcn/opcn24=<the OPC assigned to the routing key> (See Note 1)	opc/opca/opci/opcn/opcn24=<the OPC assigned to the routing key> (See Note 1)
cics=<the CICS value assigned to the routing key> (See Note 1)	cics=<the CICS value assigned to the routing key> (See Note 1)	cics=<the CICS value assigned to the routing key> (See Note 1)	cics=<the CICS value assigned to the routing key> (See Note 1)
cice=<the CICE value assigned to the routing key> (See Note 1)	cice=<the CICE value assigned to the routing key> (See Note 1)	cice=<the CICE value assigned to the routing key> (See Note 1)	cice=<the CICE value assigned to the routing key> (See Note 1)
type=full	type=full	type=full	type=full
split=<0 to 4095> (See Note 2)	split=<0 to 16383> (See Note 2)	split=<0 to 4095> (See Note 2)	split=<0 to 4294967295> (See Note 2)
<p>1. The values for these parameters must be entered exactly as shown in the <code>rtrv-appl-rtkey</code> command output for the routing key being changed. However, text strings can be used in place of some numerical service indicator values. See Table 38: Service Indicator Text String Values for a list of these text strings. The text string must correspond to the numerical value shown in the routing key being changed.</p> <p>2. The <code>split</code> parameter value must be greater than the <code>cics</code> parameter value and less than the <code>cice</code> parameter value.</p>			

Canceling the RTRV-APPL-RTKEY Command

Because the `rtrv-appl-rtkey` command used in this procedure can output information for a long period of time, the `rtrv-appl-rtkey` command can be canceled and the output to the terminal stopped. There are three ways that the `rtrv-appl-rtkey` command can be canceled.

- Press the F9 function key on the keyboard at the terminal where the `rtrv-appl-rtkey` command was entered.

- Enter the `canc-cmd` without the `trm` parameter at the terminal where the `rtrv-appl-rtkey` command was entered.
- Enter the `canc-cmd:trm=<xx>`, where `<xx>` is the terminal where the `rtrv-appl-rtkey` command was entered, from another terminal other than the terminal where the `rtrv-appl-rtkey` command was entered. To enter the `canc-cmd:trm=<xx>` command, the terminal must allow Security Administration commands to be entered from it and the user must be allowed to enter Security Administration commands. The terminal's permissions can be verified with the `rtrv-secu-trm` command. The user's permissions can be verified with the `rtrv-user` or `rtrv-secu-user` commands.

For more information about the `canc-cmd` command, go to *Commands User's Guide*.

1. Display the current routing key information in the database by entering the `rtrv-appl-rtkey` command.

The following is an example of the possible output.

```
rlghncxa03w 08-04-28 21:15:37 GMT EAGLE5 38.0.0

RCONTEXT      DPC          SI  ADPTR  ASNAME          TYPE
-----
----- 123-234-123  5  M3UA   as12            FULL
----- 005-005-001  5  M3UA   as9             FULL
----- 005-005-001  5  M3UA   as9             FULL
2500         006-006-001  5  SUA    as10            FULL

RCONTEXT      DPCI         SI  ADPTR  ASNAME          TYPE
-----
----- 2-100-7      6  M3UA   as4             FULL
100          3-137-6      6  SUA    as1             FULL
225          4-035-7      5  SUA    as7             FULL
----- 6-006-6      5  M3UA   as2             FULL
----- 6-006-7      5  M3UA   as8             FULL
----- 6-006-6      5  M3UA   as2             FULL
----- 6-006-6      5  M3UA   as2             FULL
----- 6-006-8      3  M3UA   as3             FULL
----- 6-006-8      5  M3UA   as5             FULL
----- 6-024-7      5  M3UA   as4             FULL
----- 6-024-7      5  M3UA   as4             FULL
300          7-008-7      6  SUA    as6             FULL

RCONTEXT      DPC          SI  ADPTR  ASNAME          TYPE
-----
----- *****  **  M3UA   as11            DEFAULT

STATIC Route Key table is (17 of 2000) 1% full
STATIC Route Key Socket Association table is (17 of 32000) 1% full
```

2. Display the specific routing key information for the routing key being changed by entering the `rtrv-appl-rtkey` command with the `display=all` parameter.

If the routing key being changed contains a routing context value, specify the `rcontext` parameter and value shown in the `rtrv-appl-rtkey` output in [Step 1](#) for the routing key being changed.

If the routing key being changed does not contain a routing context value, specify the `DPC`, `SI`, and `TYPE` values shown in the `rtrv-appl-rtkey` output in [Step 1](#) for the routing key being changed. The service indicator value for the routing key to be used in this procedure is either 4, 5, or 13.

For this example, enter these commands.

```
rtrv-appl-rtkey:dpc=123-234-123:si=5:type=full:display=all
```

This is an example of the possible output.

```
rlghncxa03w 08-04-28 21:16:37 GMT EAGLE5 38.0.0
RCONTEXT  DPC          SI SSN OPC          CICS      CICE
-----  123-234-123    5 --- 122-124-125    1         1000

  ADPTR  TYPE      ASNAME
  M3UA   FULL     as12

  ANAMES
  assoc20

STATIC Route Key table is (17 of 2000) 1% full
STATIC Route Key Socket Association table is (17 of 32000) 1% full
```

```
rtrv-appl-rtkey:rcontext=225:display=all
```

This is an example of the possible output.

```
rlghncxa03w 06-10-28 21:16:37 GMT EAGLE5 36.0.0
RCONTEXT  DPCI          SI SSN OPC          CICS      CICE
225       4-035-7       5 --- 2-007-3       2000     3000

  ADPTR  TYPE      ASNAME
  M3UA   FULL     as7

  ANAMES
  assoc15

STATIC Route Key table is (17 of 2000) 1% full
STATIC Route Key Socket Association table is (17 of 32000) 1% full
```

3. Change the CIC values of the routing key by entering the `chg-appl-rtkey` command.

The parameters required for the `chg-appl-rtkey` command are determined by the type of change being made to the routing key. Go to one of these sections to determine the required parameter combination.

- [Rules for Changing the Range of CIC Values in an Existing Routing Key](#)
- [Rules for Splitting the Range of CIC Values in an Existing Routing Key](#)

To change the range of CIC values for this example, enter these commands.

```
chg-appl-rtkey:dpca=123-234-123:si=5:opca=122-124-125:cics=1:cice=1000:ncice=2000
```

```
chg-appl-rtkey:dpci=4-035-7:si=5:opci=2-007-3:cics=2000:cice=3000:ncice=4000
```

If a routing context value is assigned to the routing key, the `rcontext` parameter and value assigned to the routing key can be used to identify the routing key being changed instead of the `dpc`, `si`, `opc`, `cics`, and `cice` parameters. If the `rcontext` parameter is specified only one of these parameters, `ncics` or `ncice`, can be specified with the `chg-appl-rtkey` parameter.

For this example, enter this command.

```
chg-appl-rtkey:rcontext=225:ncice=4000
```

To split the range of CIC values for this example, enter this command.

```
chg-appl-rtkey:dpca=123-234-123:si=5:opca=122-124-125:cics=1:cice=1000:split=500
```

When this command has successfully completed, the following message should appear.

```
rlghncxa03w 06-10-28 21:16:37 GMT EAGLE5 36.0.0
CHG-APPL-RTKEY: MASP A - COMPLTD
```

4. Display the new routing key information in the database by entering the `rtrv-appl-rtkey` command with the `display=all` parameter.

If the routing key being changed contains a routing context value, specify the `rcontext` parameter and value specified in the `chg-appl-rtkey` command in [Step 3](#). The `DPC`, `SI`, `CICS`, and `CICE` parameters and values used in [Step 3](#) can be specified in the `rtrv-appl-rtkey` command for routing keys containing routing context values.

If the routing key being changed does not contain a routing context value, specify the `DPC`, `SI`, `CICS`, and `CICE` parameters and values specified in the `chg-appl-rtkey` command in [Step 3](#). If the `ncics` or `ncice` parameters were specified in [Step 3](#), the `NCICS` or `NCICE` values specified in [Step 3](#) must be specified for the `cics` or `cice` parameters in this step.

For this example, enter these commands.

```
rtrv-appl-rtkey:dpca=123-234-123:si=5:cics=1:cice=2000:display=all
```

```
rlghncxa03w 08-04-28 21:16:37 GMT EAGLE5 38.0.0

RCONTEXT  DPC          SI SSN OPC          CICS    CICE
-----  123-234-123    5 --- 122-124-125    1       2000

      ADPTR  TYPE      ASNAME
      M3UA   FULL     as12

      ANAMES
      assoc20

STATIC Route Key table is (17 of 2000) 1% full
STATIC Route Key Socket Association table is (17 of 32000) 1% full
```

```
rtrv-appl-rtkey:dpci=4-035-7:si=5:cics=2000:cice=4000 :display=all
```

or

```
rtrv-appl-rtkey:rcontext=225:display=all
```

This is an example of the possible output.

```
rlghncxa03w 08-04-28 21:16:37 GMT EAGLE5 38.0.0
RCONTEXT  DPCI          SI SSN OPC          CICS    CICE
-----  4-035-7      5 --- 2-007-3      2000    4000

      ADPTR  TYPE      ASNAME
      SUA   FULL     as7

      ANAMES
      assoc15

STATIC Route Key table is (17 of 2000) 1% full
STATIC Route Key Socket Association table is (17 of 32000) 1% full
```

```
rtrv-appl-rtkey:dpca=123-234-123:si=5:cics=1:cice=1000 :display=all
```

```
rlghncxa03w 08-04-28 21:16:37 GMT EAGLE5 38.0.0
RCONTEXT  DPC          SI SSN OPC          CICS      CICE
-----  123-234-123    5 --- 100-100-100    1         499

  ADPTR  TYPE      ASNAME
  M3UA   FULL    as12

  ANAMES
  assoc20

RCONTEXT  DPC          SI SSN OPC          CICS      CICE
-----  123-234-123    5 --- 122-124-125    500      1000

  ADPTR  TYPE      ASNAME
  M3UA   FULL    as12

  ANAMES
  assoc20
```

```
STATIC Route Key table is (18 of 2000) 1% full
STATIC Route Key Socket Association table is (18 of 32000) 1% full
```

5. Back up the new changes using the `chg-db:action=backup:dest=fixed` command. These messages should appear, the active Maintenance and Administration Subsystem Processor (MASP) appears first.

```
BACKUP (FIXED) : MASP A - Backup starts on active MASP.
BACKUP (FIXED) : MASP A - Backup on active MASP to fixed disk complete.
BACKUP (FIXED) : MASP A - Backup starts on standby MASP.
BACKUP (FIXED) : MASP A - Backup on standby MASP to fixed disk complete.
```

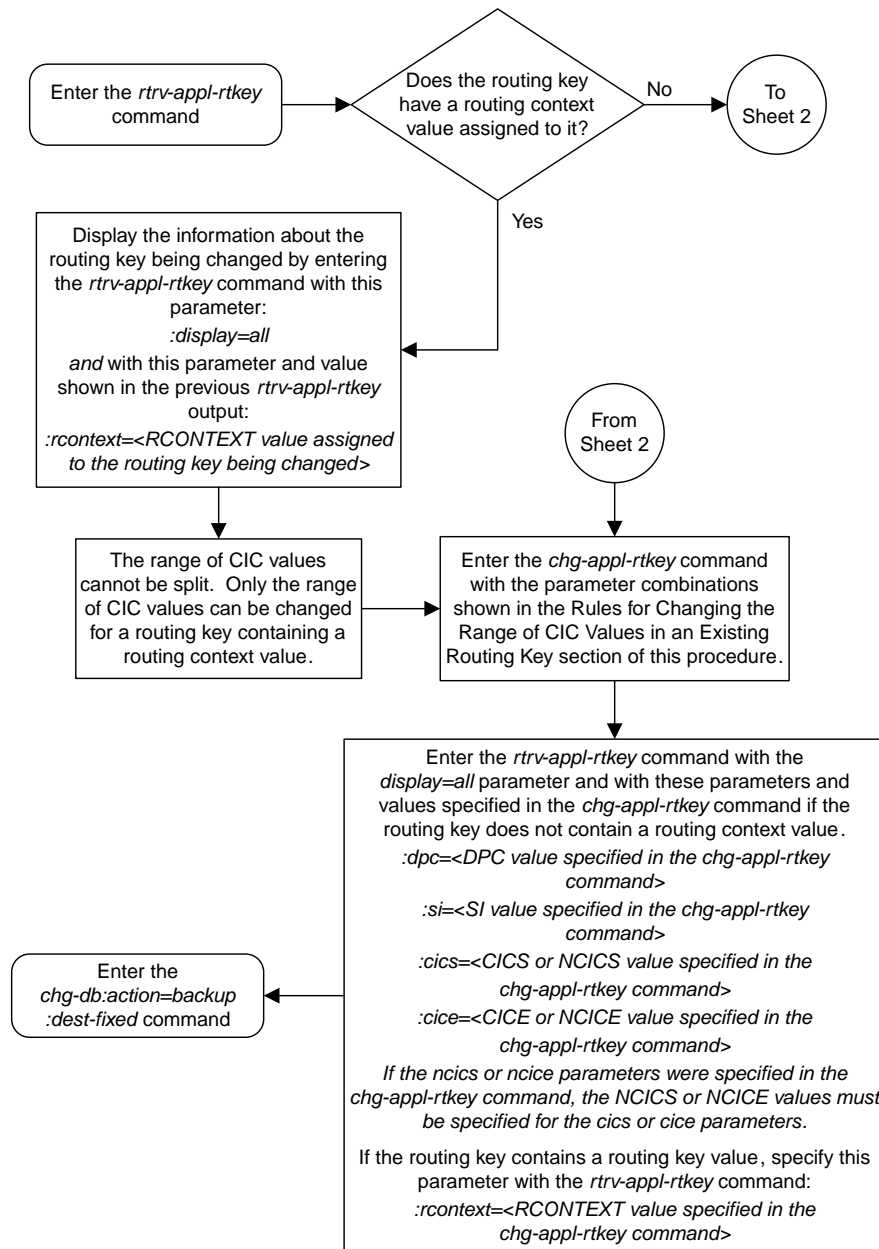

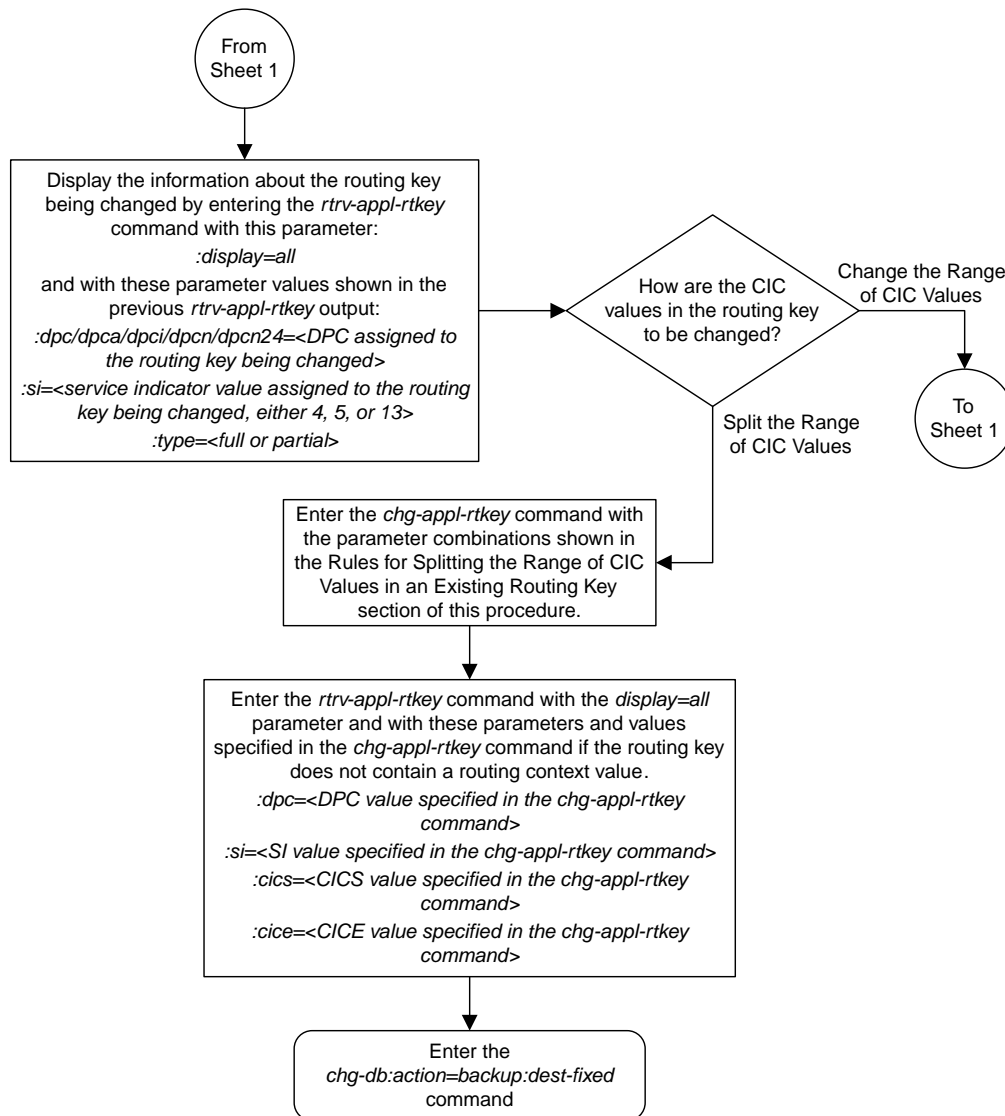

Sheet 2 of 2

Figure 72: Changing the CIC Values in an Existing Routing Key Containing an Application Server

Changing the Routing Context Value in an Existing Routing Key

This procedure is used to change the routing context value in an existing routing key using the `chg-appl-rtkey` command.

The routing key being changed in this procedure must contain a number for the routing context value. If the routing context value shown for the routing key contains dashes (-), this routing key cannot be used in this procedure. The dashes shows that the routing key does not have a routing context assigned to it.

To assign a routing context value to an existing M3UA routing key, the routing key must be removed by performing the [Removing a Routing Key Containing an Application Server](#) procedure, then re-enter the routing key with the routing context value by performing the [Adding a Routing Key Containing an Application Server](#) procedure. A routing context value must always be assigned to an SUA routing key.

These parameters are used in this procedure.

`:rcontext` – The current routing context parameter value, which has two functions:

- Provides an index of the application server traffic that the sending ASP is configured or registered to receive.
- Identifies the SS7 network context for the message. The routing context parameter implicitly defines the SS7 point code format used, the SS7 network indicator value, and the SCCP protocol type/variant/version used.

`:nrcontext` – The new routing context parameter value, from 0 to 4294967295. The new routing context value cannot be assigned to other routing keys.

The `chg-appl-rtkey` command contains other parameters that are not used in this procedure.

`:dpc/dpca/dpci/dpcn/dpcn24` – Destination point code value that is used to filter incoming MSUs.

`:opc/opca/opci/opcn/opcn24` - The originating point code value that is used to filter incoming MSUs. This value must not specify a cluster route.

`:si` – The service indicator value that is used to filter incoming MSUs. The range of values for the service indicator parameter (`si`) can be a numerical value from 0 to 15, or for selected service indicator values, a text string can be used instead of numbers. [Table 41: Service Indicator Text String Values](#) shows the text strings that can be used in place of numbers for the service indicator values.

Table 41: Service Indicator Text String Values

Service Indicator Value	Text String	Service Indicator Value	Text String
0	snm	4	tup
1	regtest	5	isup
2	spltst	13	qbicc

Service Indicator Value	Text String	Service Indicator Value	Text String
3	sccp		

:ssn – The subsystem number value that is used to filter incoming MSUs.

:cics - Starting circuit identification code that is used to filter incoming MSUs.

:cice - Ending circuit identification code that is used to filter incoming MSUs.

:type - Key type. Identifies the type of routing key that will be changed. One of three values, type =full/partial/default. If type is not explicitly specified, type = full is assumed.

:ncics - New starting circuit identification code that is used to filter incoming MSUs.

:ncice - New ending circuit identification code that is used to filter incoming MSUs.

:split - The circuit identification code value where the specified range of the routing key specified by the cics and cice values is to be split into two entries.

See the [Changing the CIC Values in an Existing Routing Key Containing an Application Server](#) procedure for changing a routing key using the ncics, ncice, and split parameters.

Canceling the RTRV-APPL-RTKEY Command

Because the rtrv-appl-rtkey command used in this procedure can output information for a long period of time, the rtrv-appl-rtkey command can be canceled and the output to the terminal stopped. There are three ways that the rtrv-appl-rtkey command can be canceled.

- Press the F9 function key on the keyboard at the terminal where the rtrv-appl-rtkey command was entered.
- Enter the `canc-cmd` without the `trm` parameter at the terminal where the rtrv-appl-rtkey command was entered.
- Enter the `canc-cmd:trm=<xx>`, where `<xx>` is the terminal where the rtrv-appl-rtkey command was entered, from another terminal other than the terminal where the rtrv-appl-rtkey command was entered. To enter the `canc-cmd:trm=<xx>` command, the terminal must allow Security Administration commands to be entered from it and the user must be allowed to enter Security Administration commands. The terminal's permissions can be verified with the `rtrv-secu-trm` command. The user's permissions can be verified with the `rtrv-user` or `rtrv-secu-user` commands.

For more information about the `canc-cmd` command, go to *Commands User's Guide*.

1. Display the current routing key information in the database by entering the `rtrv-appl-rtkey` command. The following is an example of the possible output.

```
rlghncxa03w 08-04-28 21:15:37 GMT EAGLE5 38.0.0

RCONTEXT      DPC          SI  ADPTR  ASNAME      TYPE
-----
123-234-123    5  M3UA   as12        FULL
005-005-001    5  M3UA   as9          FULL
005-005-001    5  M3UA   as9          FULL
2500           006-006-001  5  SUA     as10        FULL

RCONTEXT      DPCI         SI  ADPTR  ASNAME      TYPE
-----
2-100-7        6  M3UA   as4          FULL
100            3-137-6      6  SUA     as1          FULL
```

```

225          4-035-7      5  M3UA  as7          FULL
310          6-006-6      5  SUA   as2          FULL
-----
6-006-7      5  M3UA  as8          FULL
1000         6-006-6      5  SUA   as2          FULL
500          6-006-6      5  SUA   as2          FULL
-----
6-006-8      3  M3UA  as3          FULL
-----
6-006-8      5  M3UA  as5          FULL
-----
6-024-7      5  M3UA  as4          FULL
-----
6-024-7      5  M3UA  as4          FULL
300          7-008-7      6  SUA   as6          FULL

RCONTEXT    DPC          SI  ADPTR  ASNAME      TYPE
-----
*****      **  M3UA  as11       DEFAULT

STATIC Route Key table is (17 of 2000) 1% full
STATIC Route Key Socket Association table is (17 of 32000) 1% full

```

2. Display the specific routing key information for the routing key being changed by entering the `rtrv-appl-rtkey` command with the `display=all` parameter and the RCONTEXT value shown in the `rtrv-appl-rtkey` output in [Step 1](#) for the routing key being changed. For this example, enter this command.

```
rtrv-appl-rtkey:rcontext=310:display=all
```

This is an example of the possible output.

```

rlghncxa03w 08-04-28 21:16:37 GMT EAGLE5 38.0.0

RCONTEXT    DPCI          SI  SSN  OPCI          CICS      CICE
310          6-006-6      5  ---  1-002-3      75        100
  ADPTR    TYPE          ASNAME
  SUA      FULL          as2

  ANAMES
  assoc1

STATIC Route Key table is (17 of 2000) 1% full
STATIC Route Key Socket Association table is (17 of 32000) 1% full

```

If the routing context value shown for the routing key is dashes (-), this routing key cannot be used in this procedure. The dashes show that the routing key does not have a routing context assigned to it.

To assign a routing context value to a M3UA routing key that does not have a routing context value, the routing key must be removed by performing the [Removing a Routing Key Containing an Application Server](#) procedure. Re-enter the routing key with the routing context value by performing the [Adding a Routing Key Containing an Application Server](#) procedure. If you do not wish to assign a routing context value to this routing key, but you wish to change the routing context value in another routing key, repeat this step with another routing key shown in [Step 1](#). If you do not wish to assign a routing context value to this routing key, and do not wish to change the routing context value in another routing key, this procedure cannot be performed.

If the routing key contains a routing context value, continue the procedure with [Step 3](#).

3. Display the association displayed in the `rtrv-appl-rtkey` output in [Step 2](#), using the `rtrv-assoc` command with the association name shown in [Step 2](#).

```
rtrv-assoc:aname=assoc1
```

This is an example of possible output.

```

rlghncxa03w 09-05-28 09:12:36 GMT EAGLE5 41.0.0
ANAME assoc1
  LOC      1203          IPLNK PORT  A          LINK  A
  ADAPTER  SUA          VER        SUA RFC
  LHOST    gw105.nc.tekelec.com
  ALHOST    ---
  RHOST    gw100.nc.tekelec.com
  ARHOST    ---
  LPORT    1030          RPORT      1030
  ISTRMS   2            OSTRMS     2          BUFSIZE  16
  RMODE    LIN          RMIN       120        RMAX     800
  RTIMES   10          CWMIN      3000       UAPS     10
  OPEN     YES          ALW        YES        RTXTHR   10000
  RHOSTVAL RELAXED

ASNAMES
as2

IP Appl Sock table is (4 of 4000) 1% full
Assoc Buffer Space Used (16 KB of 800 KB) on LOC = 1203

```

Repeat this step for each association name displayed in [Step 2](#).

Note: If the `open` parameter value for all the associations assigned to the application server is `no` (shown in [Step 3](#)), continue the procedure with [Step 5](#).

4. Change the value of the `open` parameter to `no` by specifying the `chg-assoc` command with the `open=no` parameter. For this example, enter this command.

```
chg-assoc:aname=assoc1:open=no
```

When this command has successfully completed, this message should appear.

```

rlghncxa03w 06-10-28 09:12:36 GMT EAGLE5 36.0.0
CHG-ASSOC: MASP A - COMPLTD;

```



CAUTION

Caution: The IP connections using the associations specified in this step will not be able to carry any traffic when the `open` parameter is changed to `no`.

Repeat this step for all the associations assigned to the application server that have the `open=yes` parameter value.

5. Change the routing key information to the database by entering the `chg-appl-rtkey` command with the current and new routing context values. For this example, enter this command.

```
chg-appl-rtkey:nrcontext=5280:rcontext=310
```

When this command has successfully completed, the following message should appear.

```

rlghncxa03w 06-10-28 21:16:37 GMT EAGLE5 36.0.0
CHG-APPL-RTKEY: MASP A - COMPLTD

```

6. Display the new routing key information in the database by entering the `rtrv-appl-rtkey` command with the new routing context value specified in [Step 5](#) and the `display=all` parameter. For this example, enter this command.

```
rtrv-appl-rtkey:rcontext=5280:display=all
```

This is an example of the possible output.

```
rlghncxa03w 08-04-28 21:15:37 GMT EAGLE5 38.0.0
RCONTEXT  DPCI          SI SSN OPCI          CICS          CICE
5280      6-006-6          5 ---  1-002-3        75           100
  ADPTR  TYPE          ASNAME
  SUA    FULL          as2

ANAMES
assoc1

STATIC Route Key table is (17 of 2000) 1% full
STATIC Route Key Socket Association table is (17 of 32000) 1% full
```

Note: If [Step 4](#) was not performed in this procedure, continue the procedure with [Step 8](#).

7. Change the value of the open parameter of the associations that were changed in [Step 4](#) to yes by specifying the `chg-assoc` command with the `open=yes` parameter. For this example, enter this command.

```
chg-assoc:aname=assoc1:open=yes
```

When this command has successfully completed, this message should appear.

```
rlghncxa03w 06-10-28 09:12:36 GMT EAGLE5 36.0.0
CHG-ASSOC: MASP A - COMPLTD;
```

Repeat this step for all the associations that were changed in [Step 4](#).

8. Back up the new changes using the `chg-db:action=backup:dest=fixed` command. These messages should appear, the active Maintenance and Administration Subsystem Processor (MASP) appears first.

```
BACKUP (FIXED) : MASP A - Backup starts on active MASP.
BACKUP (FIXED) : MASP A - Backup on active MASP to fixed disk complete.
BACKUP (FIXED) : MASP A - Backup starts on standby MASP.
BACKUP (FIXED) : MASP A - Backup on standby MASP to fixed disk complete.
```

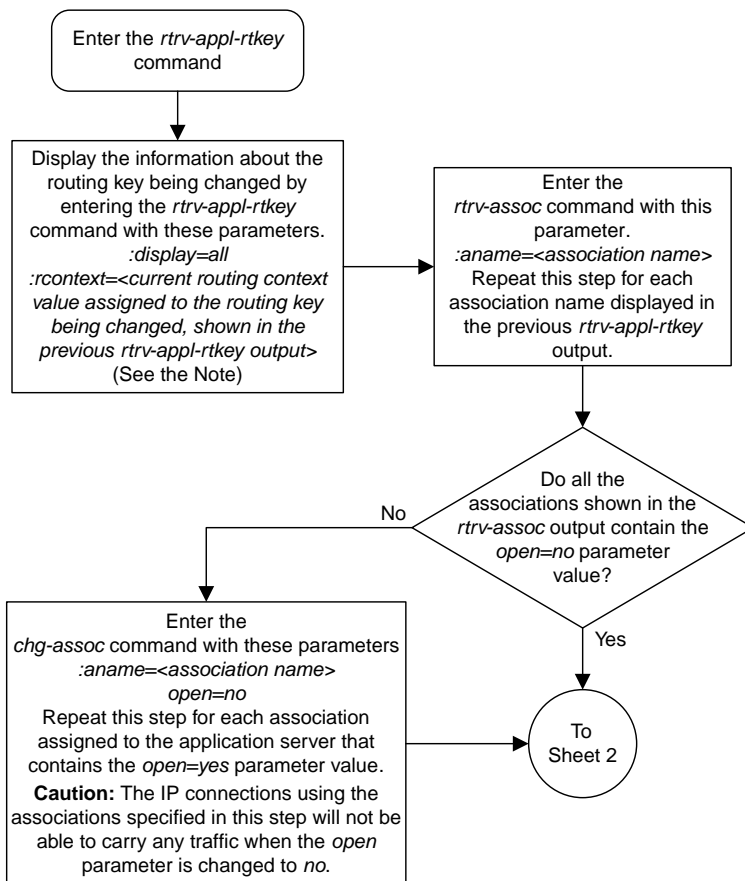

Note: If the *rcontext* field of the *rtv-appl-rtkey* output contains dashes (-), the routing key does not contain a routing context value.

To add a routing context value to an existing M3UA routing key that currently does not have a routing context value, perform the following procedures.

Remove the routing key by performing the "Removing an Application Routing Key" procedure. Record the routing key information before removing the routing key.

Add the routing key with the information recorded in the previous step and the routing context value by performing the "Adding an Application Routing Key Containing an Application Server" procedure.

A routing context value must always be assigned to an SUA routing key.

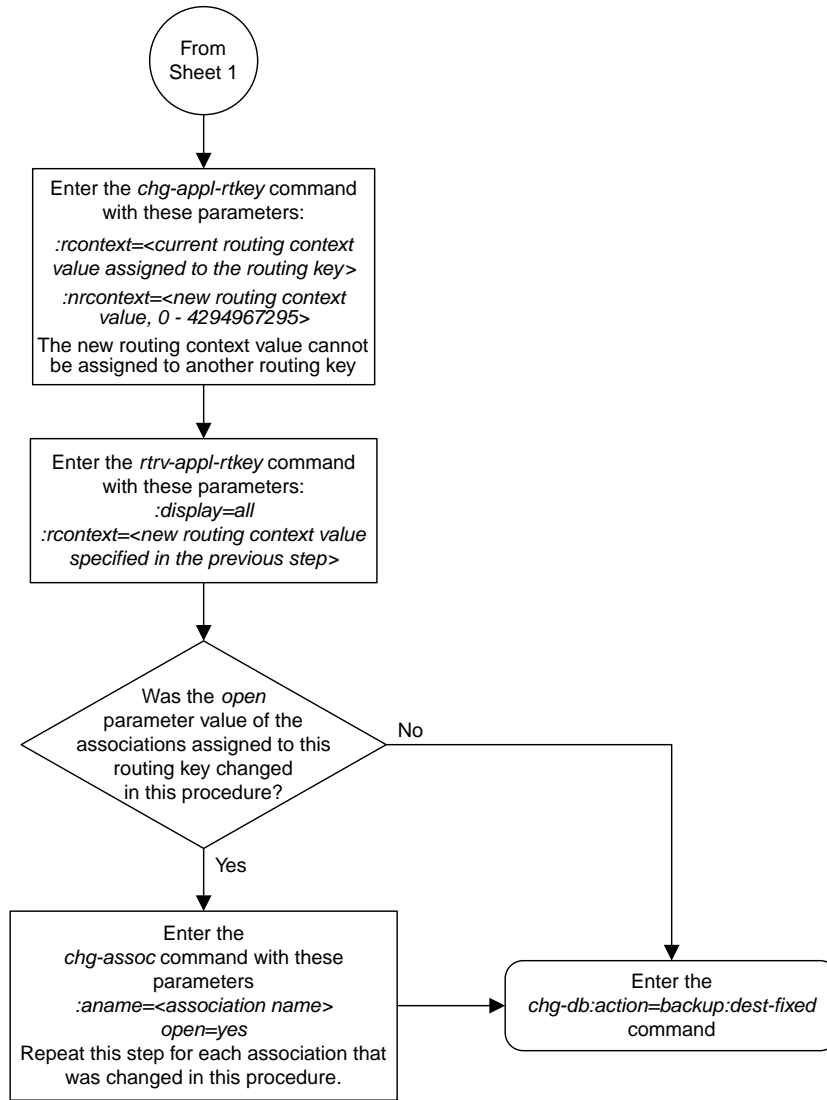

Sheet 2 of 2

Figure 73: Changing the Routing Context Value in an Existing Routing Key

Changing the SCTP Checksum Algorithm Option for M3UA and SUA Associations

Use this procedure to change the SCTP checksum algorithm, either Adler-32 or CRC-32c, applied to traffic on SCTP associations. The `sctpchecksum` parameter of the `chg-sg-opts` command is used to change this option. The Adler-32 and CRC-32c checksum algorithms specified in this procedure applies to all the associations that are assigned to all the IP cards running the SS7IPGW or IPGWI applications. This option is a system-wide option. To apply this option to associations assigned to cards running the IPLIM, IPLIMI, or IPSG applications, perform these procedures.

- [Changing the SCTP Checksum Algorithm Option for IPSG M2PA Associations](#)
- [Changing the SCTP Checksum Algorithm Option for IPSG M3UA Associations](#)
- [Changing the SCTP Checksum Algorithm Option for M2PA Associations](#)

The `sctpchecksum` parameter contains another value, `percard`, that allows either the Adler-32 or CRC-32c SCTP checksum algorithm to be specified for the all the associations assigned to a specific card. With this option specified, the Adler-32 checksum algorithm can be specified for the associations on one card and the CRC-32c checksum algorithm can be specified for the associations on another card. Setting the `sctpchecksum` parameter to `percard` changes the SCTP checksum algorithm for the associations assigned to a card to the SCTP checksum algorithm value for that card. The checksum algorithm for individual cards is provisioned by performing the [Configuring an IP Card](#) procedure.

Once the SCTP checksum option has been changed, the associations on each IP card need to be reset by changing the `open` parameter value for each association to `no`, then back to `yes`. This ensures that the associations on the IP card are using the new SCTP checksum algorithm.

Canceling the `RTRV-ASSOC` Command

Because the `rtrv-assoc` command used in this procedure can output information for a long period of time, the `rtrv-assoc` command can be canceled and the output to the terminal stopped. There are three ways that the `rtrv-assoc` command can be canceled.

- Press the F9 function key on the keyboard at the terminal where the `rtrv-assoc` command was entered.
- Enter the `canc-cmd` without the `trm` parameter at the terminal where the `rtrv-assoc` command was entered.
- Enter the `canc-cmd:trm=<xx>`, where `<xx>` is the terminal where the `rtrv-assoc` command was entered, from another terminal other than the terminal where the `rtrv-assoc` command was entered. To enter the `canc-cmd:trm=<xx>` command, the terminal must allow Security Administration commands to be entered from it and the user must be allowed to enter Security Administration commands. The terminal's permissions can be verified with the `rtrv-secu-trm` command. The user's permissions can be verified with the `rtrv-user` or `rtrv-secu-user` commands.

For more information about the `canc-cmd` command, go to *Commands User's Guide*.

1. Display the current IP options in the database by entering the `rtrv-sg-opts` command. The following is an example of the possible output.

```
rlghncxa03w 06-10-28 21:16:37 GMT EAGLE5 36.0.0
SCTPCSUM:      adler32
```

The `rtrv-sg-opts` command output contains other fields that are not used by this procedure. If you wish to see all the fields displayed by the `rtrv-sg-opts` command, see the `rtrv-sg-opts` command description in *Commands User's Guide*.

2. Display the cards in the EAGLE by entering the `rtrv-card` command. This is an example of the possible output.

```
rlghncxa03w 13-06-15 16:34:56 GMT EAGLE5 45.0.0
CARD   TYPE      APPL      LSET NAME      LINK SLC  LSET NAME      LINK SLC
1101   DSM        VSCCP
1102   TSM        GLS
1104   DCM        STPLAN
1113   E5MCAP     EOAM
1114   E5TDM-A
1115   E5MCAP     EOAM
1116   E5TDM-B
1117   E5MDAL
1201   LIMDS0     SS7ANSI    lsn1           A      0      lsn2           B      1
1202   DCM        IPLIM     ipnode2        A      1
1203   LIMDS0     SS7ANSI    lsn2           A      0      lsn1           B      1
1204   LIMATM     ATMANSI    atmgwy         A      0
1205   DCM        IPLIM     ipnode1        A      0      ipnode3        B      1
1207   DCM        IPLIM     ipnode2        A      0
1303   DCM        IPLIM     ipnode3        A      0      ipnode1        B      1
1305   DCM        IPLIM     ipnode4        A      0
1308   DCM        IPLIM     ipnode3        B      2
        ipnode1        A1     2      ipnode4        B2     1
1315   DCM        SS7IPGW    ipgtwy1        A
1317   DCM        IPGWI     ipgtwy2        A
```

Record the card location, shown in the `LOC` column, and signaling link, shown in the `LINK` column, information for all cards running the `SS7IPGW` and `IPGWI` applications.

3. At the IP near end node, stop all traffic to one of the IP cards running the `SS7IPGW` or `IPGWI` applications on the EAGLE.
4. At the EAGLE, enter the `msucount -1` pass command with the card location of the IP card selected in [Step 3](#). For this example, enter this command.

```
pass:loc=1315:cmd="msucount -1"
```

The following is an example of the possible output.

```
rlghncxa03w 06-10-28 21:16:37 GMT EAGLE5 36.0.0
PASS: Command sent to card

rlghncxa03w 06-10-28 21:16:37 GMT EAGLE5 36.0.0
MSUCOUNT: Command In Progress

rlghncxa03w 06-10-28 21:16:37 GMT EAGLE5 36.0.0
MSUCOUNT: MSU Count Report
```

```

-----
Link Measurements (Link A)
-----
Transmit Counts                                Receive Counts
-----
rate  msus          bytes                                rate  msus          bytes
-----
2000  4294967295    4294967295                                2000  4294967295    4294967295
MTP Primitive (MTPP) counts                    Reroute Counts
-----
sent pdus   rcvd pdus   dscrd pdus   sent msus   rcvd msus
-----
4294967295  4294967295   4294967295   4294967295  4294967295
-----
END of Report

```

5. Display the IP addresses of the IP links in the database by entering the `rtrv-ip-lnk` command. The following is an example of the possible output.

```

rlghncxa03w 08-12-28 21:17:37 GMT EAGLE5 40.0.0
LOC  PORT  IPADDR          SUBMASK          DUPLEX  SPEED  MACTYPE  AUTO  MCAST
1202 A    192.1.1.10      255.255.255.0    HALF    10     DIX      NO   NO
1202 B    -----          -----          HALF    10     DIX      NO   NO
1205 A    192.1.1.12      255.255.255.0    HALF    10     DIX      NO   NO
1205 B    -----          -----          HALF    10     DIX      NO   NO
1207 A    192.1.1.14      255.255.255.0    HALF    10     DIX      NO   NO
1207 B    -----          -----          HALF    10     DIX      NO   NO
1303 A    192.1.1.20      255.255.255.0    HALF    10     DIX      NO   NO
1303 B    -----          -----          HALF    10     DIX      NO   NO
1305 A    192.1.1.22      255.255.255.0    HALF    10     DIX      NO   NO
1305 B    -----          -----          HALF    10     DIX      NO   NO
1308 A    192.1.1.24      255.255.255.0    HALF    10     DIX      NO   NO
1308 B    -----          -----          HALF    10     DIX      NO   NO
1315 A    192.1.1.50      255.255.255.0    HALF    10     DIX      NO   NO
1315 B    -----          -----          HALF    10     DIX      NO   NO
1317 A    192.1.1.52      255.255.255.0    HALF    10     DIX      NO   NO
1317 B    -----          -----          HALF    10     DIX      NO   NO

IP-LNK  table is (16 of 2048) 1% full.

```

6. Display the current IP host information in the database by entering the `rtrv-ip-host:display=all` command. The following is an example of the possible output.

```

rlghncxa03w 08-12-28 21:17:37 GMT EAGLE5 40.0.0
LOCAL IPADDR    LOCAL HOST
192.1.1.10      IPNODE1-1201
192.1.1.12      IPNODE1-1203
192.1.1.14      IPNODE1-1205
192.1.1.20      IPNODE2-1201
192.1.1.22      IPNODE2-1203
192.1.1.24      IPNODE2-1205
192.1.1.32      KC-HLR2
192.1.1.50      DN-MS1
192.1.1.52      DN-MS2
REMOTE IPADDR    REMOTE HOST
150.1.1.5       NCDEPTECONOMIC_DEVELOPMENT. SOUTHEASTERN_COORIDOR_ASHVL. GOV

IP Host table is (10 of 4096) .24% full

```

7. Display the associations assigned to the IP card specified in [Step 4](#), using the `rtrv-assoc` command with the local host name of the associations assigned to the IP card. To find the local host name of the association, the card location of the IP card is assigned to an IP address in the IP link table (`rtrv-ip-lnk` output). The IP address is assigned to a hostname in the IP host table (`rtrv-ip-host` output).

For this example, the local host name of associations assigned to the IP card 1315 (the card specified in [Step 4](#)) is DN-MSCL. Enter this command.

```
rtrv-assoc:lhost=dn-mscl
```

The following is an example of the possible output.

```
rlghncxa03w 06-10-28 21:17:37 GMT EAGLE5 36.0.0
CARD IPLNK
ANAME          LOC  PORT  LINK ADAPTER LPORT RPORT OPEN ALW
assoc3         1315 A    A   SUA     2345  1025 YES  YES
assoc6         1315 A    A   SUA     4156  1025 YES  YES

IP Appl Sock/Assoc table is (9 of 4000) 1% full
Assoc Buffer Space Used (32 KB of 3200 KB) on LOC = 1315
```

8. At the EAGLE, enter the `msucount -a` pass command with the card location specified in [Step 4](#) and the association names shown in [Step 7](#). For this example, enter this command.

```
pass:loc=1315:cmd="msucount -a assoc3"
```

The following is an example of the possible output.

```
rlghncxa03w 06-10-28 21:17:37 GMT EAGLE5 36.0.0
PASS: Command sent to card

rlghncxa03w 06-10-28 21:17:37 GMT EAGLE5 36.0.0
MSUCOUNT: Command In Progress

rlghncxa03w 06-10-28 21:17:37 GMT EAGLE5 36.0.0
MSUCOUNT: MSU Count Report

-----
IP Connection Measurements
-----
Receive Counts                               Transmit Counts
-----
msus          bytes                               msus          bytes
-----
4294967295    4294967295                               4294967295    4294967295
Receive Discard Counts                       Transmit Discard Counts
-----
reason          count                               reason          count
-----
link state      4294967295                          sccp msg type   4294967295
sccp msg type   4294967295                          sccp class      4294967295
sccp class      4294967295                          normalization error 4294967295
sccp called party 4294967295                          invalid traffic type 4294967295
sccp calling party 4294967295                          M3UA conversion error 4294967295
isup sio        4294967295                          SUA conversion error 4294967295
normalization error 4294967295
error in XSRV packet 4294967295
M3UA PDU error  4294967295
```

```

SUA PDU error          4294967295
invalid rcontext      4294967295
Stored Transmit Discard Data
-----
no stored transmit discard data
Stored Receive Discard Data
-----
53 41 53 49 69 73 6f 74 11 00 87 0a 01 03 01 05
05 00 01 02 03 04 05 06 07 08 09 00 00 00 00 00

END of Report

```

```
pass:loc=1315:cmd="msucount -a assoc6"
```

The following is an example of the possible output.

```

rlghncxa03w 06-10-28 21:17:37 GMT EAGLE5 36.0.0
PASS: Command sent to card

rlghncxa03w 06-10-28 21:17:37 GMT EAGLE5 36.0.0
MSUCOUNT: Command In Progress

rlghncxa03w 06-10-28 21:17:37 GMT EAGLE5 36.0.0
MSUCOUNT: MSU Count Report

-----
IP Connection Measurements
-----
Receive Counts                                Transmit Counts
-----
msus                bytes                msus                bytes
-----
4294967295          4294967295          4294967295          4294967295
Receive Discard Counts                        Transmit Discard Counts
-----
reason                count                reason                count
-----
link state            4294967295          sccp msg type        4294967295
sccp msg type        4294967295          sccp class           4294967295
sccp class           4294967295          normalization error  4294967295
sccp called party    4294967295          invalid traffic type  4294967295
sccp calling party   4294967295          M3UA conversion error 4294967295
isup sio             4294967295          SUA conversion error  4294967295
normalization error  4294967295
error in XSRV packet 4294967295
M3UA PDU error       4294967295
SUA PDU error        4294967295
invalid rcontext     4294967295
Stored Transmit Discard Data
-----
no stored transmit discard data
Stored Receive Discard Data
-----
53 41 53 49 69 73 6f 74 11 00 87 0a 01 03 01 05
05 00 01 02 03 04 05 06 07 08 09 00 00 00 00 00

END of Report

```

9. At the IP near end node, disconnect all the associations attached to the IP card specified in [Step 8](#).
10. At the EAGLE, place the signaling link on this IP card out of service using the `dact -s1k` command. For this example, enter this command.

```
dact-slk:loc=1315:link=a
```

When this command has successfully completed, this message appears.

```
rlghncxa03w 06-10-12 09:12:36 GMT EAGLE5 36.0.0
Deactivate Link message sent to card
```

11. Change the SCTP checksum option in the database using the `chg-sg-opts` command. For this example, enter this command.

```
chg-sg-opts:sctpcsum=crc32c
```

When this command has successfully completed, the following message should appear.

```
rlghncxa03w 06-10-28 21:19:37 GMT EAGLE5 36.0.0
CHG-SG-OPTS: MASP A - COMPLTD
```

Continue the procedure by performing one of these actions.

- If the `sctpcsum` parameter value was changed to either `adler32` or `crc32c`, continue the procedure with [Step 12](#).
 - If the `sctpcsum` parameter value was changed to `percard`, perform the [Configuring an IP Card](#) procedure to assign an `sctpcsum` parameter value to all the cards running the IPLIM or IPLIMI applications. After the [Configuring an IP Card](#) procedure has been performed, continue the procedure with [Step 13](#).
12. Verify that the SCTP checksum algorithm was changed using the `rtrv-sg-opts` command. The SCTP checksum algorithm option value is shown in the `SCTPCSUM` parameter. The following is an example of the possible output.

```
rlghncxa03w 06-10-28 21:16:37 GMT EAGLE5 36.0.0
SCTPCSUM:      crc32c
```

The `rtrv-sg-opts` command output contains other fields that are not used by this procedure. If you wish to see all the fields displayed by the `rtrv-sg-opts` command, see the `rtrv-sg-opts` command description in *Commands User's Guide*.

13. Change the value of the `open` parameter of the associations shown in [Step 7](#) to `no` by specifying the `chg-assoc` command with the `open=no` parameter. For this example, enter this command.

```
chg-assoc:aname=assoc3:open=no
```

```
chg-assoc:aname=assoc6:open=no
```

When this command has successfully completed, this message should appear.

```
rlghncxa03w 06-10-28 09:12:36 GMT EAGLE5 36.0.0
CHG-ASSOC: MASP A - COMPLTD;
```

14. Change the value of the `open` parameter of the associations changed in [Step 13](#) to `yes` by specifying the `chg-assoc` command with the `open=yes` parameter. For this example, enter this command.

```
chg-assoc:aname=assoc3:open=yes
```

```
chg-assoc:aname=assoc6:open=yes
```

When this command has successfully completed, this message should appear.

```
rlghncxa03w 06-10-28 09:12:36 GMT EAGLE5 36.0.0
CHG-ASSOC: MASP A - COMPLTD;
```

15. Verify the checksum algorithm that is assigned to the associations shown in [Step 14](#) by entering the `sctp -a` pass command with the card location of the IP card specified in [Step 10](#) and the name of the associations specified in [Step 14](#). For this example, enter this command.

```
pass:loc=1315:cmd="sctp -a assoc3 "
```

The following is an example of the possible output.

```
rlghncxa03w 10-12-28 21:16:37 GMT EAGLE5 43.0.0
Aname          Local          Local Primary      Remote
                IP Address      Port   Address      Port
assoc3         192.1.1.50     2345   192.168.112.4 1025
                192.1.1.50
```

```

Configuration                               State
Retransmission Mode = LIN                   State = OPEN
Min. Retransmission Timeout = 10000         ULP association id = 18
Max. Retransmission Timeout = 800000       Number of nets = 2
Max. Number of Retries = 10                Inbound Streams = 1
Min. Congestion Window = 3000              Outbound Streams = 2
Inbound Streams = 2
Outbound Streams = 2
Checksum Algorithm = crc32c
Send/Rcv Buffer Size = 204800
```

Nets Data

```
IP Address      192.168.112.4      State      Reachable
Port            1025               Primary    YES
MTU             1500               cwnd      16384
ssthresh        16384              RTO       120

IP Address      192.168.112.5      State      Reachable
Port            7777               Primary    NO
MTU             1500               cwnd      16384
ssthresh        16384              RTO       120
```

```
Last Net Sent To = 192.168.112.4
Last Net Rcvd From = 192.168.112.4
Over All Error Count = 0
Peers Rwnd = 13880
My Rwnd = 16384
Max Window = 16384
Initial Seq Number = 24130
Next Sending Seq Number = 124686
Last Acked Seq Number = 124669
Maximum Outbound Char Count = 16384
Current Outbound Char Count = 2112
Number Unsent Char Count = 0
Outbound Data Chunk Count = 16
Number Unsent = 0
Number To Retransmit = 0
```

```
ip datagrams rcvd = 155402
```

```

ip datagrams with data chunks rcvd = 120844
    data chunks rcvd = 367908
    data chunks read = 367900
        dup tsns rcvd = 8
            sacks rcvd = 38734
        gap ack blocks rcvd = 3
    heartbeat requests rcvd = 135
        heartbeat acks rcvd = 52
    heartbeat requests sent = 52
        ip datagrams sent = 129254
ip datagrams with data chunks sent = 73084
    data chunks sent = 396330
    retransmit data chunks sent = 135
        sacks sent = 64872
        send failed = 0
    retransmit timer count = 0
    consecutive retransmit timeouts = 0
RTT between RMIN and RMAX inclusive = 6
    RTT greater than RMAX = 0
    fast retransmit count = 135
    recv timer count = 0
    heartbeat timer count = 244
    none left tosend = 0
    none left rwnd gate = 5
    none left cwnd gate = 8

;

rlghncxa03w 10-12-28 21:16:37 GMT EAGLE5 43.0.0

SCTP command complete
    
```

```

rlghncxa03w 08-04-28 21:16:37 GMT EAGLE5 38.0.0
Aname          Local          Local   Primary      Remote
              IP Address      Port    Address      Port
assoc3         192.1.1.50      2345    192.168.112.4 1025
              192.1.1.50

Configuration                                     State
Retransmission Mode = LIN                          State = OPEN
Min. Retransmission Timeout = 10                   ULP association id = 18
Max. Retransmission Timeout = 800                  Number of nets = 2
Max. Number of Retries = 10                        Inbound Streams = 1
Min. Congestion Window = 3000                      Outbound Streams = 2
Inbound Streams = 2
Outbound Streams = 2
Checksum Algorithm = crc32c

Nets Data

IP Address      192.168.112.4      State   Reachable
Port            1025                Primary YES
MTU             1500                cwnd   16384
ssthresh        16384                RTO    120

IP Address      192.168.112.5      State   Reachable
Port            7777                Primary NO
MTU             1500                cwnd   16384
ssthresh        16384                RTO    120

Last Net Sent To = 192.168.112.4
    
```

```

        Last Net Rcvd From = 192.168.112.4
    Over All Eror Count = 0
        Peers Rwnd = 13880
            My Rwnd = 16384
            Max Window = 16384
        Initial Seq Number = 24130
    Next Sending Seq Number = 124686
    Last Acked Seq Number = 124669
    Maximum Outbound Char Count = 16384
    Current Outbound Char Count = 2112
    Number Unsent Char Count = 0
    Outbound Data Chunk Count = 16
        Number Unsent = 0
    Number To Retransmit = 0

    ip datagrams rcvd = 155402
ip datagrams with data chunks rcvd = 120844
    data chunks rcvd = 367908
    data chunks read = 367900
    dup tsns rcvd = 8
        sacks rcvd = 38734
    gap ack blocks rcvd = 3
    heartbeat requests rcvd = 135
    heartbeat acks rcvd = 52
    heartbeat requests sent = 52
        ip datagrams sent = 129254
ip datagrams with data chunks sent = 73084
    data chunks sent = 396330
    retransmit data chunks sent = 135
        sacks sent = 64872
        send failed = 0
    retransmit timer count = 0
    consecutive retransmit timeouts = 0
    RTT between RMIN and RMAX inclusive = 6
    RTT greater than RMAX = 0
    fast retransmit count = 135
        recv timer count = 0
    heartbeat timer count = 244
        none left tosend = 0
        none left rwnd gate = 5
        none left cwnd gate = 8

;

    rlghncxa03w 08-04-28 21:16:37 GMT EAGLE5 38.0.0

    SCTP command complete

```

```
pass:loc=1315:cmd="sctp -a assoc6 "
```

The following is an example of the possible output.

```

rlghncxa03w 10-12-28 21:16:37 GMT EAGLE5 43.0.0
Aname          Local          Local   Primary      Remote
                IP Address      Port    Address      Port
assoc6         192.1.1.50     4156   192.168.112.4 1025
                192.1.1.50

                Configuration          State
                Retransmission Mode = LIN          State = OPEN
                Min. Retransmission Timeout = 10000          ULP association id = 18

```

```

Max. Retransmission Timeout = 800000      Number of nets = 2
Max. Number of Retries = 10              Inbound Streams = 1
Min. Congestion Window = 3000            Outbound Streams = 2
      Inbound Streams = 2
      Outbound Streams = 2
Checksum Algorithm = crc32c
Send/Rcv Buffer Size = 204800

```

Nets Data

IP Address	192.168.112.4	State	Reachable
Port	1025	Primary	YES
MTU	1500	cwnd	16384
ssthresh	16384	RTO	120
IP Address	192.168.112.5	State	Reachable
Port	7777	Primary	NO
MTU	1500	cwnd	16384
ssthresh	16384	RTO	120

```

      Last Net Sent To = 192.168.112.4
      Last Net Rcvd From = 192.168.112.4
      Over All Error Count = 0
          Peers Rwnd = 13880
          My Rwnd = 16384
          Max Window = 16384
      Initial Seq Number = 24130
      Next Sending Seq Number = 124686
      Last Acked Seq Number = 124669
      Maximum Outbound Char Count = 16384
      Current Outbound Char Count = 2112
      Number Unsent Char Count = 0
      Outbound Data Chunk Count = 16
          Number Unsent = 0
      Number To Retransmit = 0

      ip datagrams rcvd = 155402
ip datagrams with data chunks rcvd = 120844
      data chunks rcvd = 367908
      data chunks read = 367900
      dup tsns rcvd = 8
      sacks rcvd = 38734
      gap ack blocks rcvd = 3
      heartbeat requests rcvd = 135
      heartbeat acks rcvd = 52
      heartbeat requests sent = 52
      ip datagrams sent = 129254
ip datagrams with data chunks sent = 73084
      data chunks sent = 396330
      retransmit data chunks sent = 135
      sacks sent = 64872
      send failed = 0
      retransmit timer count = 0
      consecutive retransmit timeouts = 0
      RTT between RMIN and RMAX inclusive = 6
      RTT greater than RMAX = 0
      fast retransmit count = 135
      recv timer count = 0
      heartbeat timer count = 244
      none left tosend = 0
      none left rwnd gate = 5
      none left cwnd gate = 8

```

;

rlghncxa03w 10-12-28 21:16:37 GMT EAGLE5 43.0.0

SCTP command complete

rlghncxa03w 08-04-28 21:16:37 GMT EAGLE5 38.0.0

Aname	Local	Local	Primary	Remote
	IP Address	Port	Address	Port
assoc6	192.1.1.50	4156	192.168.112.4	1025
	192.1.1.50			

Configuration	State
Retransmission Mode = LIN	State = OPEN
Min. Retransmission Timeout = 10	ULP association id = 18
Max. Retransmission Timeout = 800	Number of nets = 2
Max. Number of Retries = 10	Inbound Streams = 1
Min. Congestion Window = 3000	Outbound Streams = 2
Inbound Streams = 2	
Outbound Streams = 2	
Checksum Algorithm = crc32c	

Nets Data

IP Address	192.168.112.4	State	Reachable
Port	1025	Primary	YES
MTU	1500	cwnd	16384
ssthresh	16384	RTO	120
IP Address	192.168.112.5	State	Reachable
Port	7777	Primary	NO
MTU	1500	cwnd	16384
ssthresh	16384	RTO	120

```

Last Net Sent To = 192.168.112.4
Last Net Rcvd From = 192.168.112.4
Over All Error Count = 0
Peers Rwnd = 13880
My Rwnd = 16384
Max Window = 16384
Initial Seq Number = 24130
Next Sending Seq Number = 124686
Last Acked Seq Number = 124669
Maximum Outbound Char Count = 16384
Current Outbound Char Count = 2112
Number Unsent Char Count = 0
Outbound Data Chunk Count = 16
Number Unsent = 0
Number To Retransmit = 0

```

```

ip datagrams rcvd = 155402
ip datagrams with data chunks rcvd = 120844
data chunks rcvd = 367908
data chunks read = 367900
dup tsns rcvd = 8
sacks rcvd = 38734
gap ack blocks rcvd = 3
heartbeat requests rcvd = 135
heartbeat acks rcvd = 52

```

```

        heartbeat requests sent = 52
          ip datagrams sent = 129254
    ip datagrams with data chunks sent = 73084
      data chunks sent = 396330
    retransmit data chunks sent = 135
      sacks sent = 64872
      send failed = 0
    retransmit timer count = 0
    consecutive retransmit timeouts = 0
    RTT between RMIN and RMAX inclusive = 6
      RTT greater than RMAX = 0
    fast retransmit count = 135
      rcv timer count = 0
    heartbeat timer count = 244
      none left tosend = 0
      none left rwnd gate = 5
      none left cwnd gate = 8
;

rlghncxa03w 08-04-28 21:16:37 GMT EAGLE5 38.0.0

SCTP command complete

```

If the checksum algorithm shown in any of the associations displayed in this step do not match the checksum algorithm specified in [Step 11](#), contact the Customer Care Center. Refer to [My Oracle Support \(MOS\)](#) for the contact information.

If the checksum algorithm shown in all of the associations displayed in this step match the checksum algorithm specified in [Step 11](#), continue the procedure with [Step 16](#).

16. At the IP near end node, configure all the associations attached to the IP card specified in [Step 14](#) to use the SCTP checksum algorithm.
17. Put the signaling link that was placed out of service in [Step 9](#) back into service using the `act-slk` command. For example, enter this command.

```
act-slk:loc=1315:link=a
```

When this command has successfully completed, this message appears.

```
rlghncxa03w 06-10-07 11:11:28 GMT EAGLE5 36.0.0
Activate Link message sent to card
```

18. Verify the in-service normal (IS-NR) status of the signaling link by using the `rept-stat-slk` command and specifying the card location and link value specified in [Step 17](#). For example, enter this command.

```
rept-stat-slk:loc=1315:link=a
```

The following is an example of the possible output.

```
rlghncxa03w 06-10-28 21:16:37 GMT EAGLE5 36.0.0
SLK      LSN      CLLI      PST      SST      AST
1315,A  ipgtwy1  -----  IS-NR    Avail    ----
Command Completed.
```

19. At the IP near end node, connect one of the associations attached to the IP card specified in [Step 13](#).
20. At the EAGLE, enter the `rept-stat-assoc` command specifying the association names specified with the `chg-assoc` command in [Step 13](#) and [Step 14](#) to verify that the association is established with the IP near end node. For this example, enter this command.

```
rept-stat-assoc:aname=assoc3
```

The following is an example of the possible output.

```
rlghncxa03w 06-10-28 21:16:37 GMT EAGLE5 36.0.0

          CARD  IPLNK
ANAME     LOC  PORT  LINK  PST          SST          ASPID
as1       1315 A    A    IS-NR      ESTABLISHED  4294967295

ASNAME    ANAME          ASP-STATE
assoc3    as1              ASP-ACTIVE

Command Completed.
```

```
rept-stat-assoc:aname=assoc6
```

The following is an example of the possible output.

```
rlghncxa03w 06-10-28 21:16:37 GMT EAGLE5 36.0.0

          CARD  IPLNK
ANAME     LOC  PORT  LINK  PST          SST          ASPID
as6       1315 A    A    IS-NR      ESTABLISHED  4294967295

ASNAME    ANAME          ASP-STATE
assoc6    as6              ASP-ACTIVE

Command Completed.
```

21. Enter the `netstat -p sctp` pass command with the card location of the IP card to determine if any errors have occurred. For this example, enter this command. For this example, enter this command.

```
pass:loc=1315:cmd="netstat -p sctp"
```

The following is an example of the possible output.

```
rlghncxa03w 08-04-28 21:16:37 GMT EAGLE5 38.0.0
ip packets sent..... 1474882
  ip packets sent with data chunk..... 306354
  control chunks (excluding retransmissions)..... 1172759
  ordered data chunks (excluding retransmissions).. 1534350
  unordered data chunks (excluding retransmissions) 0
  user messages fragmented due to MTU..... 0
  retransmit data chunks sent..... 4
  sacks sent..... 496302
  send failed..... 0
ip packets received..... 1816035
  ip packets received with data chunk..... 989957
  control chunks (excluding duplicates)..... 833141
  ordered data chunks (excluding duplicates)..... 989968
```



```

unordered data chunks (excluding duplicates)..... 0
user messages reassembled..... 0
data chunks read..... 988601
duplicate tsns received..... 0
sacks received..... 153763
gap ack blocks received..... 0
out of the blue..... 4
with invalid checksum..... 0
connections established..... 2954
  by upper layer..... 0
  by remote endpoint..... 2958
connections terminated..... 4
  ungracefully..... 2952
  gracefully..... 0
associations dropped due to retransmits..... 0
consecutive retransmit timeouts..... 4
retransmit timer count..... 6
fast retransmit count..... 0
heartbeat requests received..... 330275
heartbeat acks received..... 340239
heartbeat requests sent..... 340258
associations supported..... 50
milliseconds cookie life at 4-way start-up handshake. 5000
retransmission attempts allowed at start-up phase.... 8

;

rlghncxa03w 08-04-28 21:16:37 GMT EAGLE5 38.0.0

NETSTAT command complete

```

If errors are shown in the pass command output, contact the Customer Care Center. Refer to [My Oracle Support \(MOS\)](#) for the contact information.

22. At the IP near end node, connect all the other associations attached to the IP card specified in [Step 21](#).
23. At the IP near end node, activate one of the associations attached to the IP card specified in [Step 21](#).
24. At the EAGLE, enter the `msucount -1` pass command with the card location of the IP card specified in [Step 21](#). For this example, enter this command.

```
pass:loc=1315:cmd="msucount -1"
```

The following is an example of the possible output.

```

rlghncxa03w 06-10-28 21:16:37 GMT EAGLE5 36.0.0
PASS: Command sent to card

rlghncxa03w 06-10-28 21:16:37 GMT EAGLE5 36.0.0
MSUCOUNT: Command In Progress

rlghncxa03w 06-10-28 21:16:37 GMT EAGLE5 36.0.0
MSUCOUNT: MSU Count Report

-----
Link Measurements (Link A)
-----

Transmit Counts                                Receive Counts
-----

```

```

rate      msus          bytes          rate      msus          bytes
-----
2000      4294967295      4294967295    2000      4294967295    4294967295

MTP Primitive (MTPP) counts          Reroute Counts
-----
sent pdus   rcvd pdus   dscrd pdus   sent msus   rcvd msus
-----
4294967295  4294967295  4294967295   4294967295  4294967295

END of Report

```

25. At the EAGLE, enter the `msucount -a` pass command with the card location specified in [Step 24](#) and the association names specified in [Step 20](#). For this example, enter this command.

```
pass:loc=1315:cmd="msucount -a assoc3"
```

The following is an example of the possible output.

```

rlghncxa03w 06-10-28 21:17:37 GMT EAGLE5 36.0.0
PASS: Command sent to card

rlghncxa03w 06-10-28 21:17:37 GMT EAGLE5 36.0.0
MSUCOUNT: Command In Progress

rlghncxa03w 06-10-28 21:17:37 GMT EAGLE5 36.0.0
MSUCOUNT: MSU Count Report

-----
IP Connection Measurements
-----

Receive Counts                          Transmit Counts
-----
msus          bytes          msus          bytes
-----
4294967295    4294967295    4294967295    4294967295
Receive Discard Counts                  Transmit Discard Counts
-----
reason          count          reason          count
-----
link state      4294967295    sccp msg type   4294967295
sccp msg type   4294967295    sccp class      4294967295
sccp class      4294967295    normalization error 4294967295
sccp called party 4294967295    invalid traffic type 4294967295
sccp calling party 4294967295    M3UA conversion error 4294967295
isup sio        4294967295    SUA conversion error 4294967295
normalization error 4294967295
error in XSRV packet 4294967295
M3UA PDU error  4294967295
SUA PDU error   4294967295
invalid rcontext 4294967295

Stored Transmit Discard Data
-----
no stored transmit discard data
Stored Receive Discard Data
-----
53 41 53 49 69 73 6f 74 11 00 87 0a 01 03 01 05
05 00 01 02 03 04 05 06 07 08 09 00 00 00 00 00

```

```
END of Report
```

```
pass:loc=1315:cmd="msucount -a assoc6"
```

The following is an example of the possible output.

```
rlghncxa03w 06-10-28 21:17:37 GMT EAGLE5 36.0.0
PASS: Command sent to card

rlghncxa03w 06-10-28 21:17:37 GMT EAGLE5 36.0.0
MSUCOUNT: Command In Progress

rlghncxa03w 06-10-28 21:17:37 GMT EAGLE5 36.0.0
MSUCOUNT: MSU Count Report

-----
IP Connection Measurements
-----
Receive Counts                               Transmit Counts
-----
msus                bytes                msus                bytes
-----
4294967295          4294967295          4294967295          4294967295
Receive Discard Counts                       Transmit Discard Counts
-----
reason                count                reason                count
-----
link state            4294967295          sccp msg type         4294967295
sccp msg type        4294967295          sccp class            4294967295
sccp class           4294967295          normalization error   4294967295
sccp called party    4294967295          invalid traffic type   4294967295
sccp calling party   4294967295          M3UA conversion error 4294967295
isup sio             4294967295          SUA conversion error   4294967295
normalization error  4294967295
error in XSRV packet 4294967295
M3UA PDU error       4294967295
SUA PDU error        4294967295
invalid rcontext     4294967295
Stored Transmit Discard Data
-----
no stored transmit discard data
Stored Receive Discard Data
-----
53 41 53 49 69 73 6f 74 11 00 87 0a 01 03 01 05
05 00 01 02 03 04 05 06 07 08 09 00 00 00 00 00

END of Report
```

If the outputs of the pass commands in [Step 24](#) and [Step 25](#) show that traffic is not flowing over the association, contact the Customer Care Center. Refer to [My Oracle Support \(MOS\)](#) for the contact information.

26. At the IP near end node, activate all the other associations attached to the IP card specified in [Step 25](#).
27. Repeat [Step 3](#) through [Step 26](#) to update the other IP cards in the EAGLE running the SS7IPGW and IPGWI applications with the new SCTP checksum algorithm.

28. Back up the new changes using the `chg-db:action=backup:dest=fixed` command. These messages should appear, the active Maintenance and Administration Subsystem Processor (MASP) appears first.

```
BACKUP (FIXED) : MASP A - Backup starts on active MASP.  
BACKUP (FIXED) : MASP A - Backup on active MASP to fixed disk complete.  
BACKUP (FIXED) : MASP A - Backup starts on standby MASP.  
BACKUP (FIXED) : MASP A - Backup on standby MASP to fixed disk complete.
```

29. If the `rtrv-card` output in [Step 2](#) shows cards running the IPLIM or IPLIMI applications, perform the [Changing the SCTP Checksum Algorithm Option for M2PA Associations](#) procedure.

If the `rtrv-card` output in [Step 2](#) shows cards running the IPSP application, perform these procedures.

- [Changing the SCTP Checksum Algorithm Option for IPSP M3UA Associations](#)
- [Changing the SCTP Checksum Algorithm Option for IPSP M2PA Associations](#)

If the `rtrv-card` output in [Step 2](#) shows that there are no cards running the IPLIM, IPLIMI, or IPSP applications, this procedure is finished.

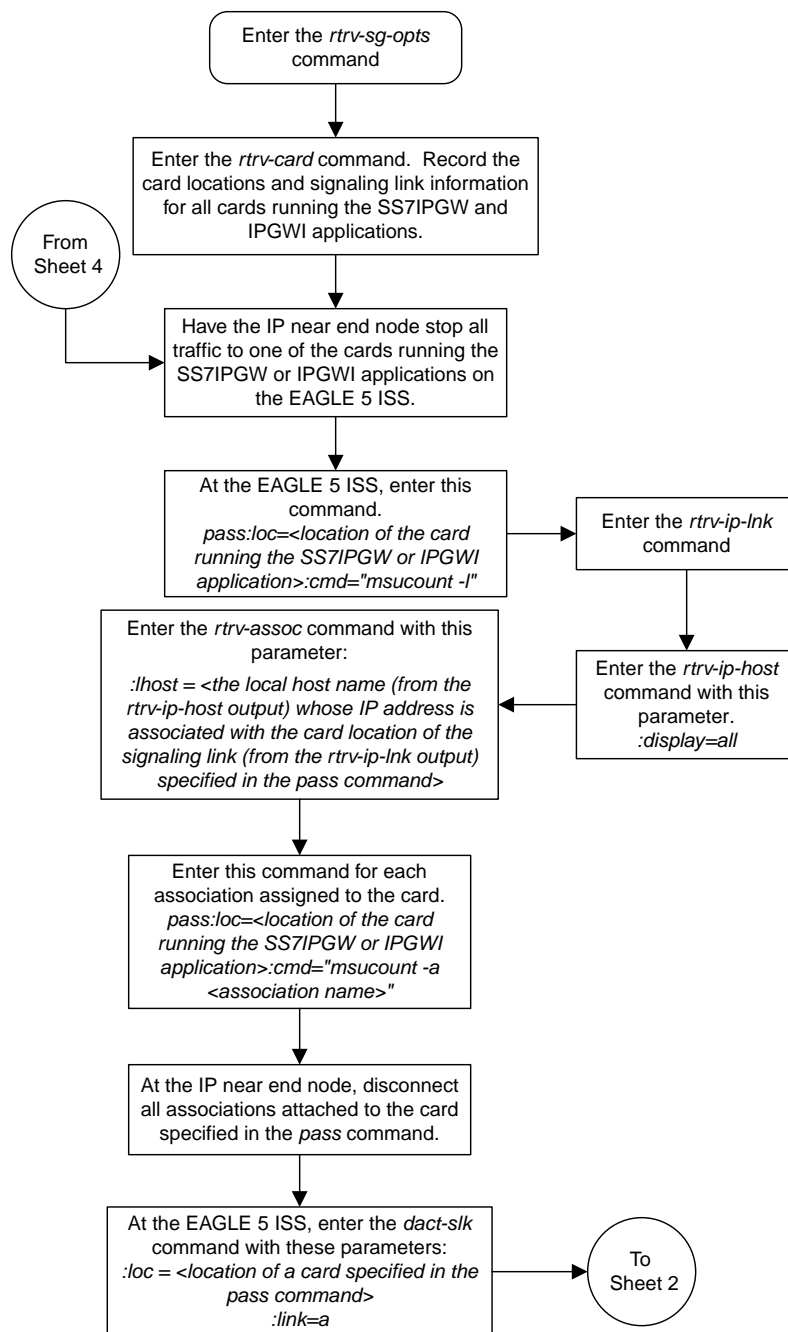

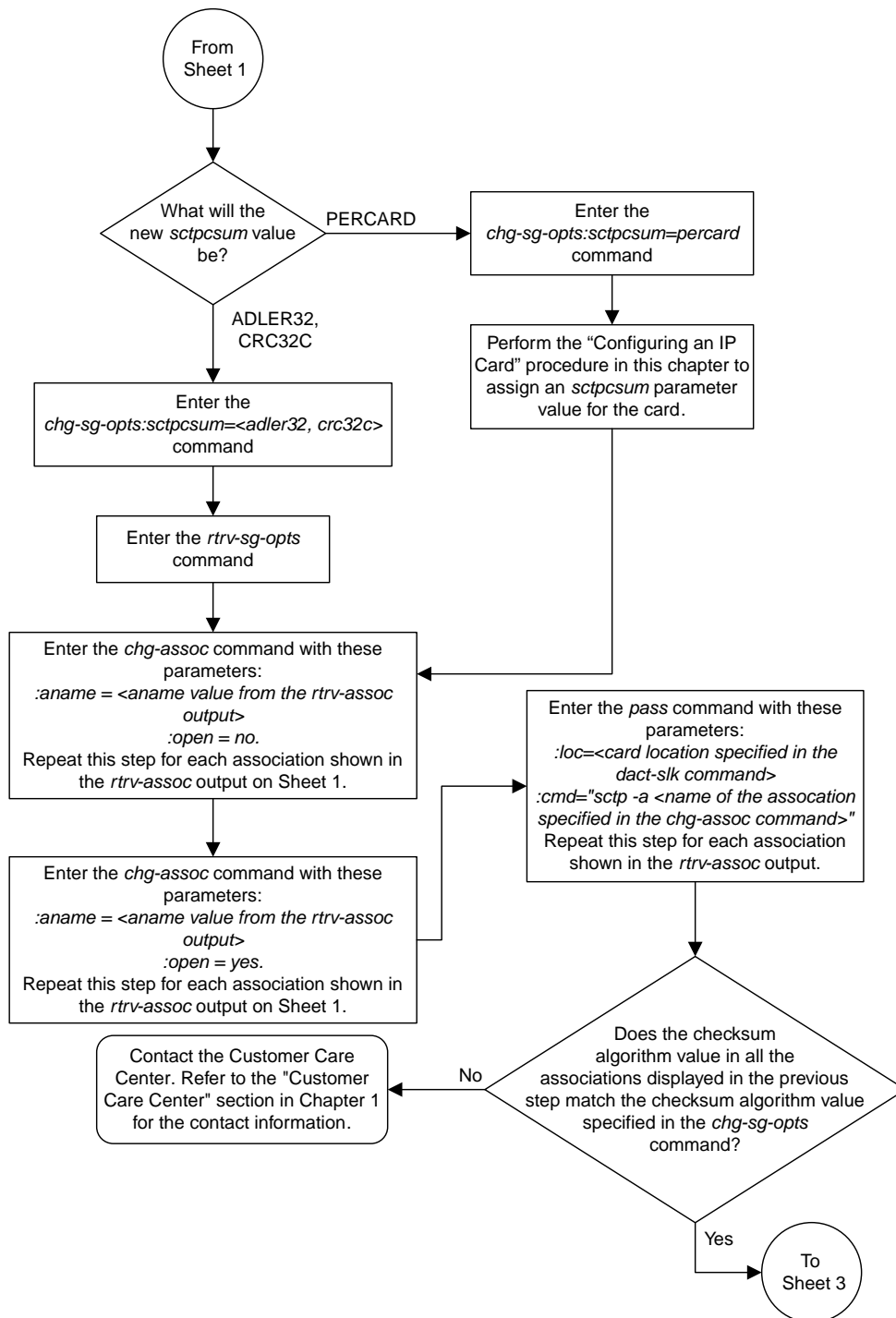

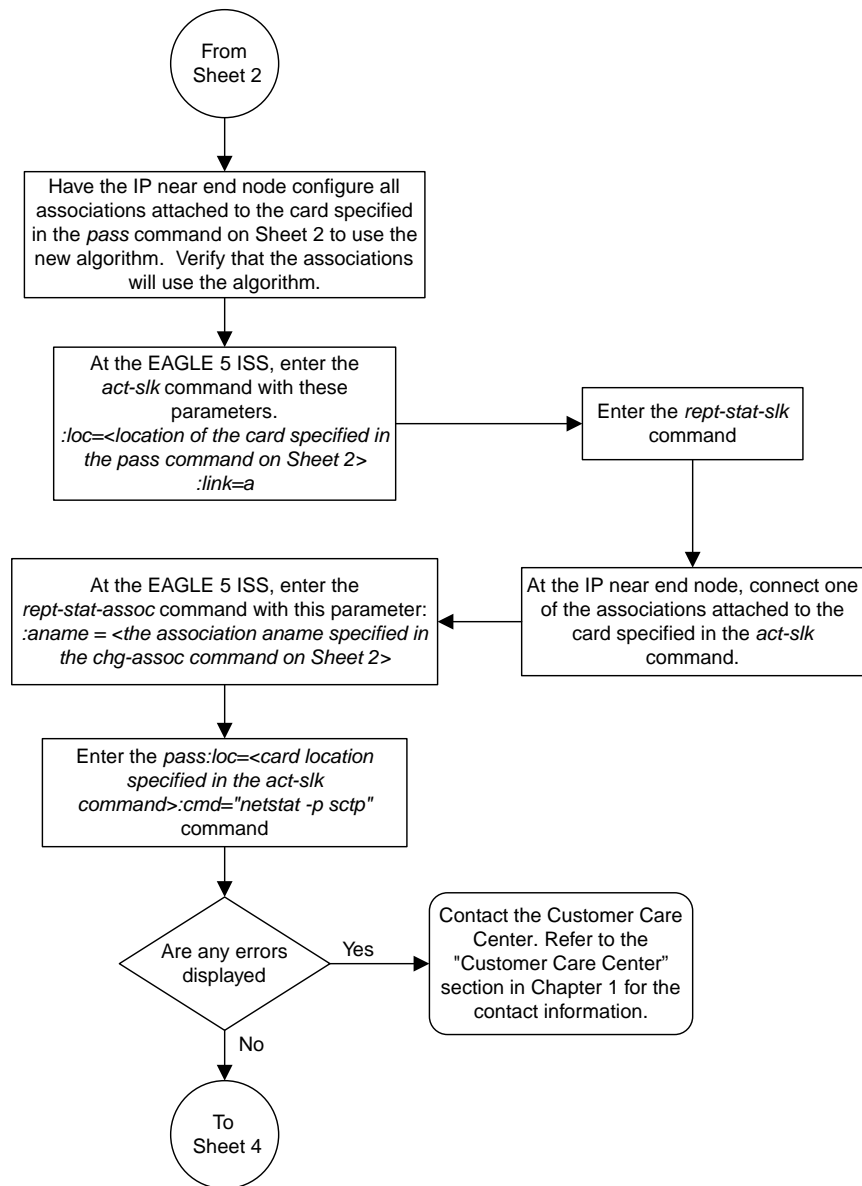

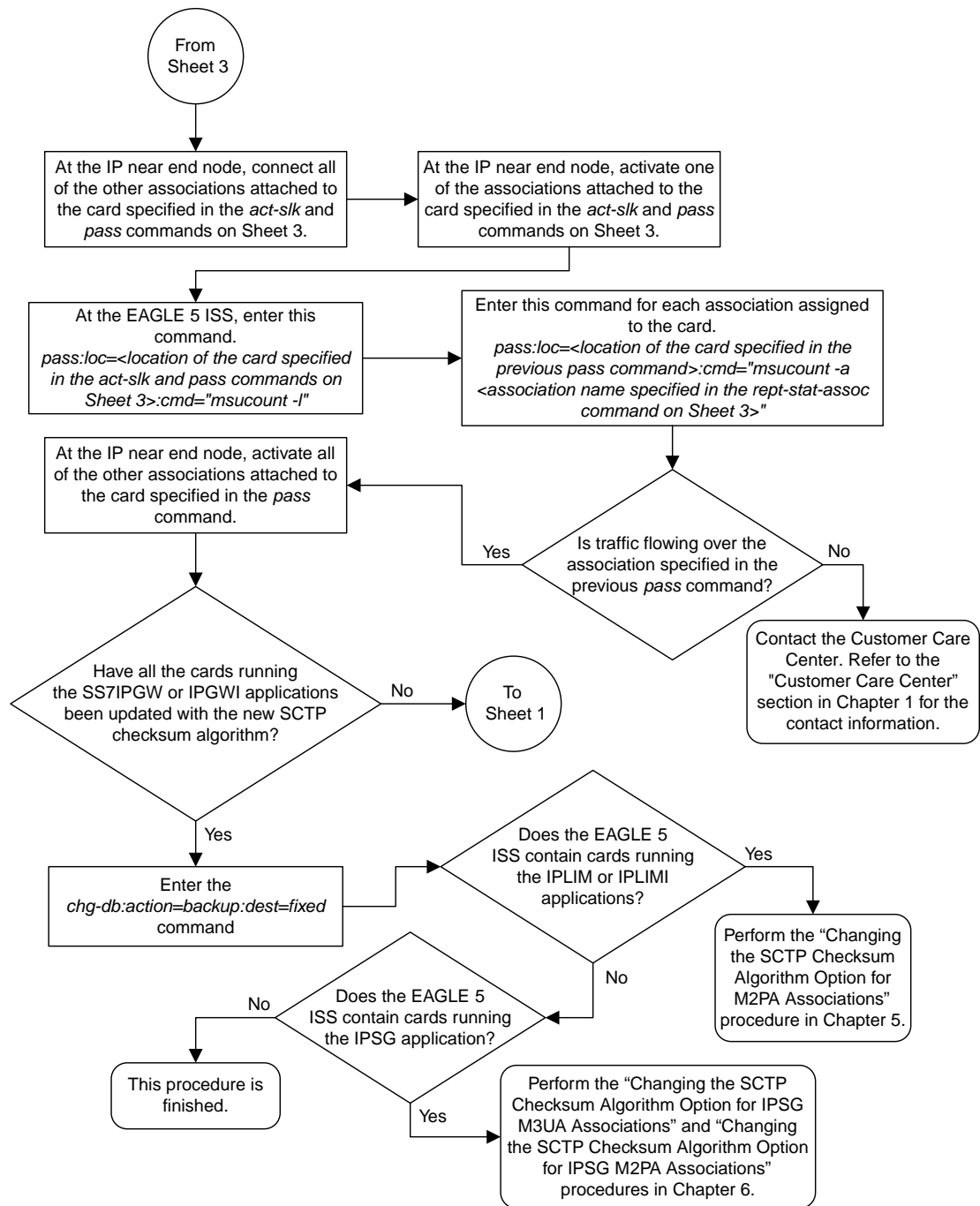

Sheet 4 of 4

Figure 74: Changing the SCTP Checksum Algorithm Option for M3UA and SUA Associations

Changing a UA Parameter Set

Use this procedure to change the values in a UA (user adapter) parameter set using the `chg-uaps` command. The `chg-uaps` command uses these parameters.

`:set` – the UA parameter set being changed, from 1 - 9

`:scrset` – the source UA parameter set used to copy the values from one UA parameter set to another, from 1 to 10.

`:timer` – the timer being changed, from 1 to 10. Currently, there are only three timers defined:

- Timer 2 – The False IP Connection Congestion Timer – the maximum amount of time (in milliseconds) that an association is allowed to remain congested before failing due to false connection congestion.
- Timer 3 – The UA Heartbeat Period Timer – The frequency, in milliseconds, that heartbeat messages are transmitted.
- Timer 4 – The UA Heartbeat Received Timer – The amount of time, in milliseconds, that the EAGLE waits for a response to the heartbeat message that was transmitted. If a response to the heartbeat message is not received in the amount of time defined by Timer 4, the association is torn down

`:tvalue` – The value of the timer specified by the `timer` parameter.

- The value of timer 2 is from 10 to 30,000 milliseconds. The system default value is 3,000 milliseconds.
- The value of timer 3 is from 100 to 60,000 milliseconds. The system default value is 10,000 milliseconds.
- The value of timer 4 is from 100 to 10,000 milliseconds. The system default value is 5,000 milliseconds.

`:parm` – the UA parameters, from 1 to 10. Currently, only four UA parameters are defined.

- 1 – Controlling ASPSNM Behavior
- 2 – Controlling ASP/Application Server State Notification Behavior
- 3 – UA Serviceability Options
- 4 – SCTP Payload Protocol Indicator Option

`:pvalue` – the value of the UA parameters, which is dependent on the `parm` parameter value. The value of the `pvalue` parameter is a bit-mapped value, requiring a 0 in the specific bit position to disable the item, or a 1 in the specific bit position to enabled the item. The value of the `pvalue` parameter is a 32-bit number. Any bits not specified in the following lists are not used.

- If the `parm` value is 1, the bits used by the `pvalue` parameter are:
 - 1 – Response Method – controls the sending of an SNM TFC/UPU as a reply to a message received on an association for an unavailable destination. The SNM TFC/UPU is replicated to all associations that have this capability and meet the Response SNM Criteria. The default is to allow the response to be sent.
 - 1 – Response Method – controls the sending of an SNM TFC/UPU as a reply to a message received on an association for an unavailable destination. The SNM TFC/UPU is replicated to

all associations that have this capability and meet the Response SNM Criteria. The default is to allow the response to be sent.

- 6 – Broadcast Congestion Status Change – controls the sending of unsolicited congestion status changes by an ASP. Unsolicited congestion status messages (TFCs generated when a destination's congestion status changes) are replicated to all ASPs who have this capability and meet the Multicast SNM Criteria. The default is to generate no unsolicited congestion status changes.

Table 42: Valid PVALUE Parameter Values if PARM=1 shows the values can be entered for the `pvalue` parameter if the `parm` value is 1. The `pvalue` parameter value can be entered as a hexadecimal or a decimal number.

Table 42: Valid PVALUE Parameter Values if PARM=1

Bits Enabled	Bits Disabled	Hexadecimal Value	Decimal Value
None	Bit 0 - Broadcast Bit 1 - Response Method Bit 6 - Broadcast Congestion Status Change	h'0	0
Bit 0 - Broadcast	Bit 1 - Response Method Bit 6 - Broadcast Congestion Status Change	h'1	1
Bit 1 - Response Method	Bit 0 - Broadcast Bit 6 - Broadcast Congestion Status Change	h'2	2
Bit 0 - Broadcast Bit 1 - Response Method	Bit 6 - Broadcast Congestion Status Change	h'3*	3*
Bit 6 - Broadcast Congestion Status Change	Bit 0 - Broadcast Bit 1 - Response Method	h'40	64
Bit 6 - Broadcast Congestion Status Change Bit 0 - Broadcast	Bit 1 - Response Method	h'41	65
Bit 6 - Broadcast Congestion Status Change Bit 1 - Response Method	Bit 0 - Broadcast	h'42	66
Bit 0 - Broadcast Bit 1 - Response Method Bit 6 - Broadcast Congestion Status Change	None	h'43	67

Bits Enabled	Bits Disabled	Hexadecimal Value	Decimal Value
* The system default value			

- If the `parm` value is 2, the bits used by the `pvalue` parameter are:
 - 0 – ASP Active Notifications – controls the sending of ASP-Active notifications. If this value is specified, an ASP-Default notification is sent when an ASP transitions to the ASP-ACTIVE state. The default is not to send ASP-Active notifications.
 - 1 – ASP Inactive Notifications – controls the sending of ASP-Inactive notifications. If this value is specified, an ASP-Inactive notification is sent when an ASP transitions to the ASP-INACTIVE state. The default is not to send ASP-Inactive notifications.

Note: To see the ASP activations and inactivations, bits 0 and 1 of the `pvalue` parameter value need to be enabled. See [Table 43: Valid PVALUE Parameter Values if PARM=2](#).

- 2 – ASPAS State Query – controls the sending of ASP/AS State notifications on request by an ASP. If this value is specified, the EAGLE responds with ASP and AS state notifications if the remote ASP sends ASP-UP or ASP-INACTIVE, while the local ASP is in the ASP-INACTIVE state, or the remote ASP sends an ASP-ACTIVE notification while the local ASP is in the ASP-ACTIVE state. The default is not to send ASP/AS state notifications.

[Table 43: Valid PVALUE Parameter Values if PARM=2](#) shows the values can be entered for the `pvalue` parameter if the `parm` value is 2. The `pvalue` parameter value can be entered as a hexadecimal or a decimal number.

Table 43: Valid PVALUE Parameter Values if PARM=2

Bits Enabled	Bits Disabled	Hexadecimal Value	Decimal Value
None	Bit 0 - ASP Activate Notifications Bit 1 - ASP Inactivate Notifications Bit 2 - ASP AS State Query	h'0*	0*
Bit 0 - ASP Activate Notifications	Bit 1 - ASP Inactivate Notifications Bit 2 - ASP AS State Query	h'1	1
Bit 1 - ASP Inactivate Notifications	Bit 0 - ASP Activate Notifications Bit 2 - ASP AS State Query	h'2	2
Bit 0 - ASP Activate Notifications Bit 1 - ASP Inactivate Notifications	Bit 2 - ASP AS State Query	h'3	3
Bit 2 - ASP AS State Query	Bit 0 - ASP Activate Notifications	h'4	4

Bits Enabled	Bits Disabled	Hexadecimal Value	Decimal Value
	Bit 1 - ASP Inactivate Notifications		
Bit 0 - ASP Activate Notifications Bit 2 - ASP AS State Query	Bit 1 - ASP Inactivate Notifications	h'5	5
Bit 1 - ASP Inactivate Notifications Bit 2 - ASP AS State Query	Bit 0 - ASP Activate Notifications	h'6	6
Bit 0 - ASP Activate Notifications Bit 1 - ASP Inactivate Notifications Bit 2 - ASP AS State Query	None	h'7	7
* The system default value			

- If the parm value is 3, the bits used by the pvalue parameter are:
 - 0 – UA Heartbeats – heartbeat messages are sent on connections from the EAGLE to the far-end node that are in the ASP-Down, ASP-Active, and ASP-Inactive states if the bit is enabled.
 - 1 – UA Graceful Shutdown – enables the graceful shutdown of IPSG M3UA connections if the bit is enabled.

Table 44: Valid PVALUE Parameter Values if PARM=3 shows the values can be entered for the pvalue parameter if the parm value is 3. The pvalue parameter value can be entered as a hexadecimal or a decimal number.

Table 44: Valid PVALUE Parameter Values if PARM=3

Bits Enabled	Bits Disabled	Hexadecimal Value	Decimal Value
None	Bit 0 - UA Heartbeats Bit 1 - UA Graceful Shutdown	h'0*	0*
Bit 0 - UA Heartbeats	Bit 1 - UA Graceful Shutdown	h'1	1
Bit 1 - UA Graceful Shutdown	Bit 0 - UA Heartbeats	h'2	2
Bit 0 - UA Heartbeats Bit 1 - UA Graceful Shutdown	None	h'3	3
* The system default value			

- If the `parm` value is 4, the bit 0, the SCTP Payload Protocol Indicator byte order option, is used by the `pvalue` parameter. This bit indicates whether the SCTP Payload Protocol Indicator (PPI) in the received or transmitted message should be in the Big Endian and Little Endian byte format.

Table 45: Valid PVALUE Parameter Values if PARM=4 shows the values can be entered for the `pvalue` parameter if the `parm` value is 4. The `pvalue` parameter value can be entered as a hexadecimal or a decimal number.

Table 45: Valid PVALUE Parameter Values if PARM=4

SCTP Payload Protocol Indicator Byte Order Option - Bit 0	Hexadecimal Value	Decimal Value
Big Endian Byte Format	h'0*	0*
Little Endian Byte Format	h'1	1
* The system default value		

UA parameter set 10 contains the default values for the UA parameter sets and cannot be changed.

The `set` and `scrset` parameter values cannot be the same.

If the `scrset` parameter is specified, no other optional parameter may be specified.

The `timer` and `tvalue` parameters must be specified together. If one is specified, the other must be specified.

The `parm` and `pvalue` parameters must be specified together. If one is specified, the other must be specified.

Canceling the RTRV-UAPS Command

Because the `rtrv-uaps` command used in this procedure can output information for a long period of time, the `rtrv-uaps` command can be canceled and the output to the terminal stopped. There are three ways that the `rtrv-uaps` command can be canceled.

- Press the F9 function key on the keyboard at the terminal where the `rtrv-uaps` command was entered.
- Enter the `canc-cmd` without the `trm` parameter at the terminal where the `rtrv-uaps` command was entered.
- Enter the `canc-cmd:trm=<xx>`, where `<xx>` is the terminal where the `rtrv-uaps` command was entered, from another terminal other than the terminal where the `rtrv-uaps` command was entered. To enter the `canc-cmd:trm=<xx>` command, the terminal must allow Security Administration commands to be entered from it and the user must be allowed to enter Security Administration commands. The terminal's permissions can be verified with the `rtrv-secu-trm` command. The user's permissions can be verified with the `rtrv-user` or `rtrv-secu-user` commands.

For more information about the `canc-cmd` command, go to *Commands User's Guide*.

1. Display the values in the UA parameter set being changed by entering the `rtrv-uaps` command and specifying the desired UA parameter set number, from 1 to 9. For this example, enter this command.

```
rtrv-uaps:set=3
```

This is an example of possible output.

```

rlghncxa03w 10-07-28 09:12:36 GMT EAGLE5 42.0.0
  SET  TIMER      TVALUE  PARM      PVALUE
    3    1          0        1          3
    3    2         3000       2          0
    3    3        10000       3          0
    3    4          5000       4          0
    3    5          0         5          0
    3    6          0         6          0
    3    7          0         7          0
    3    8          0         8          0
    3    9          0         9          0
    3   10          0        10          0

TIMER 2: False IP Connection Congestion Timer, max time an
association can be congested before failing due to false
congestion. SS7IPGW and IPGWI applications enforce
0-30000(ms). Not supported on IPSP application.
TVALUE : Valid range = 32-bits

TIMER 3: UA HeartBeat Period Timer T(beat), time (ms) between sending
of BEAT msgs by NE. IPSP, SS7IPGW and IPGWI applications
enforce 100(ms)-60000(ms).
TVALUE : Valid range = 32-bits

TIMER 4: UA HeartBeat Received Timer T(beat ack), timeout period for
response BEAT ACK msgs by NE. IPSP, SS7IPGW and IPGWI
applications enforce 100(ms)-10000(ms).
TVALUE : Valid range = 32-bits

PARM 1: ASP SNM options. Each bit is used as an enabled/disabled
flag for a particular ASP SNM option. Not supported on IPSP
application.
PVALUE : Valid range = 32-bits
  BIT                                BIT VALUE
  0=Broadcast                        0=Disabled , 1=Enabled
  1=Response Method                  0=Disabled , 1=Enabled
  2-5=Reserved
  6=Broadcast Congestion Status Change 0=Disabled , 1=Enabled
  7-31=Reserved

PARM 2: ASP/AS Notification options. Each bit is used as an
enabled/disabled flag for a particular ASP/AS
Notification option. Not supported on IPSP application.
PVALUE : Valid range = 32-bits
  BIT                                BIT VALUE
  0=ASP Active Notifications          0=Disabled , 1=Enabled
  1=ASP Inactive Notifications        0=Disabled , 1=Enabled
  2=ASP AS State Query                0=Disabled , 1=Enabled
  3-31=Reserved

PARM 3: UA Serviceability Options. Each bit is used as an
enabled/disabled flag for a particular UA Serviceability
option. Supported on IPSP, SS7IPGW, and IPGWI applications.
UA Graceful Shutdown supported on IPSP for M3UA only.
PVALUE : Valid range = 32-bits
  BIT                                BIT VALUE
  0=UA Heartbeats                    0=Disabled , 1=Enabled
  1=UA Graceful Shutdown              0=Disabled , 1=Enabled
  2-31=Reserved

PARM 4: SCTP Payload Protocol Indicator byte order option. Bit indicates

```

```

PPI value is RCV/TX in Big Endian or Little Endian byte format.
Supported on IPSPG-M2PA associations only.
PVALUE : Valid range = 32-bits
          BIT                               BIT VALUE
          0=Payload Protocol Indicator      0=Big Endian , 1=Little Endian
          1-31=Reserved

```

If the new values of the UA parameter set are being copied from another UA parameter set, continue the procedure with [Step 2](#).

If the new values of the UA parameter set are not being copied from another UA parameter set, continue the procedure with [Step 3](#).

2. Display the values in the UA parameter set that will be copied to the UA parameter set displayed in [Step 1](#) by entering the `rtrv-uaps` command and specifying the desired UA parameter set number, from 1 to 10. For this example, enter this command.

```
rtrv-uaps:set=10
```

This is an example of possible output.

```

rlghncxa03w 10-07-28 09:12:36 GMT EAGLE5 42.0.0
  SET  TIMER      TVALUE  PARM      PVALUE
   10    1           0       1          3
   10    2          3000     2          0
   10    3         10000    3          0
   10    4           5000    4          0
   10    5            0       5          0
   10    6            0       6          0
   10    7            0       7          0
   10    8            0       8          0
   10    9            0       9          0
   10   10            0      10          0

```

TIMER 2: False IP Connection Congestion Timer, max time an association can be congested before failing due to false congestion. SS7IPGW and IPGWI applications enforce 0-30000(ms). Not supported on IPSPG application.

TVALUE : Valid range = 32-bits

TIMER 3: UA HeartBeat Period Timer T(beat), time (ms) between sending of BEAT msgs by NE. IPSPG, SS7IPGW and IPGWI applications enforce 100(ms)-60000(ms).

TVALUE : Valid range = 32-bits

TIMER 4: UA HeartBeat Received Timer T(beat ack), timeout period for response BEAT ACK msgs by NE. IPSPG, SS7IPGW and IPGWI applications enforce 100(ms)-10000(ms).

TVALUE : Valid range = 32-bits

PARM 1: ASP SNM options. Each bit is used as an enabled/disabled flag for a particular ASP SNM option. Not supported on IPSPG application.

PVALUE : Valid range = 32-bits

```

          BIT                               BIT VALUE
          0=Broadcast                       0=Disabled , 1=Enabled
          1=Response Method                 0=Disabled , 1=Enabled
          2-5=Reserved
          6=Broadcast Congestion Status Change 0=Disabled , 1=Enabled
          7-31=Reserved

```

```

PARM 2: ASP/AS Notification options. Each bit is used as an
        enabled/disabled flag for a particular ASP/AS
        Notification option. Not supported on IPSG application.
PVALUE : Valid range = 32-bits
        BIT                               BIT VALUE
        0=ASP Active Notifications         0=Disabled , 1=Enabled
        1=ASP Inactive Notifications      0=Disabled , 1=Enabled
        2=ASP AS State Query              0=Disabled , 1=Enabled
        3-31=Reserved

PARM 3: UA Serviceability Options. Each bit is used as an
        enabled/disabled flag for a particular UA Serviceability
        option. Supported on IPSG, SS7IPGW, and IPGWI applications.
        UA Graceful Shutdown supported on IPSG for M3UA only.
PVALUE : Valid range = 32-bits
        BIT                               BIT VALUE
        0=UA Heartbeats                    0=Disabled , 1=Enabled
        1=UA Graceful Shutdown             0=Disabled , 1=Enabled
        2-31=Reserved

PARM 4: SCTP Payload Protocol Indicator byte order option. Bit indicates
        PPI value is RCV/TX in Big Endian or Little Endian byte format.
        Supported on IPSG-M2PA associations only.
PVALUE : Valid range = 32-bits
        BIT                               BIT VALUE
        0=Payload Protocol Indicator       0=Big Endian , 1=Little Endian
        1-31=Reserved

```

3. Change the UA parameter set values using the `chg-uaps` command with the UA parameter set value used in [Step 1](#). If the `parm` and `pvalue` parameters are being specified, see these tables for the valid values of the `pvalue` parameter.

- [Table 42: Valid PVALUE Parameter Values if PARM=1](#)
- [Table 43: Valid PVALUE Parameter Values if PARM=2](#)
- [Table 44: Valid PVALUE Parameter Values if PARM=3](#)
- [Table 45: Valid PVALUE Parameter Values if PARM=4](#)

For this example, enter this command.

```
chg-uaps:set=3:timer=2:tvalue=2000:parm=2:pvalue=1:parm=3:pvalue=3
```

The value of the `pvalue` parameter can be entered as either a decimal value or a hexadecimal value. This example shows the `pvalue` parameter value of the `chg-uaps` command being entered as a decimal value. If the decimal value of the `pvalue` parameter is 3, specify the `pvalue=h'3` parameter to specify the hexadecimal value for the `pvalue` parameter.

```
chg-uaps:set=3:timer=2:tvalue=2000:parm=2:pvalue=h'1:parm=3:pvalue=h'3
```

If the values from one UA parameter set are being copied to another UA parameter set, only the `set` and `scrset` parameters can be specified with the `chg-uaps` command. For example, to copy the values from UA parameter set 10 to UA parameter set 5, enter this command.

```
chg-uaps:set=5:scrset=10
```

When this command has successfully completed, this message should appear.

```
rlghncxa03w 06-10-28 09:12:36 GMT EAGLE5 36.0.0
CHG-UAPS: MASP A - COMPLTD
```

4. Verify the changes using the `rtrv-uaps` command with the UA parameter set name used in [Step 3](#). For this example, enter this command.

```
rtrv-uaps:set=3
```

This is an example of possible output.

```
rlghncxa03w 10-07-28 09:12:36 GMT EAGLE5 42.0.0
SET  TIMER      TVALUE  PARM      PVALUE
3     1           0        1          3
3     2          2000    2          1
3     3         10000   3          3
3     4           5000    4          0
3     5           0        5          0
3     6           0        6          0
3     7           0        7          0
3     8           0        8          0
3     9           0        9          0
3    10           0        10         0

TIMER 2: False IP Connection Congestion Timer, max time an
         association can be congested before failing due to false
         congestion. SS7IPGW and IPGWI applications enforce
         0-30000(ms). Not supported on IPSP application.
TVALUE : Valid range = 32-bits

TIMER 3: UA HeartBeat Period Timer T(beat), time (ms) between sending
         of BEAT msgs by NE. IPSP, SS7IPGW and IPGWI applications
         enforce 100(ms)-60000(ms).
TVALUE : Valid range = 32-bits

TIMER 4: UA HeartBeat Received Timer T(beat ack), timeout period for
         response BEAT ACK msgs by NE. IPSP, SS7IPGW and IPGWI
         applications enforce 100(ms)-10000(ms).
TVALUE : Valid range = 32-bits

PARM  1: ASP SNM options. Each bit is used as an enabled/disabled
         flag for a particular ASP SNM option. Not supported on IPSP
         application.
PVALUE : Valid range = 32-bits
        BIT                               BIT VALUE
        0=Broadcast                       0=Disabled , 1=Enabled
        1=Response Method                 0=Disabled , 1=Enabled
        2-5=Reserved
        6=Broadcast Congestion Status Change 0=Disabled , 1=Enabled
        7-31=Reserved

PARM  2: ASP/AS Notification options. Each bit is used as an
         enabled/disabled flag for a particular ASP/AS
         Notification option. Not supported on IPSP application.
PVALUE : Valid range = 32-bits
        BIT                               BIT VALUE
        0=ASP Active Notifications        0=Disabled , 1=Enabled
        1=ASP Inactive Notifications      0=Disabled , 1=Enabled
        2=ASP AS State Query              0=Disabled , 1=Enabled
        3-31=Reserved
```

```

PARM 3: UA Serviceability Options. Each bit is used as an
        enabled/disabled flag for a particular UA Serviceability
        option. Supported on IPSP, SS7IPGW, and IPGWI applications.
        UA Graceful Shutdown supported on IPSP for M3UA only.
PVALUE : Valid range = 32-bits
        BIT                                BIT VALUE
        0=UA Heartbeats                    0=Disabled , 1=Enabled
        1=UA Graceful Shutdown            0=Disabled , 1=Enabled
        2-31=Reserved

PARM 4: SCTP Payload Protocol Indicator byte order option. Bit indicates
        PPI value is RCV/TX in Big Endian or Little Endian byte format.
        Supported on IPSP-M2PA associations only.
PVALUE : Valid range = 32-bits
        BIT                                BIT VALUE
        0=Payload Protocol Indicator      0=Big Endian , 1=Little Endian
        1-31=Reserved

```

If [Step 2](#) was performed, for this example, enter this command.

```
rtrv-uaps:set=5
```

This is an example of possible output.

```

rlghncxa03w 10-07-28 09:12:36 GMT EAGLE5 42.0.0
SET  TIMER      TVALUE  PARM      PVALUE
 5     1           0       1         3
 5     2          3000     2         0
 5     3         10000     3         0
 5     4           5000     4         0
 5     5           0        5         0
 5     6           0        6         0
 5     7           0        7         0
 5     8           0        8         0
 5     9           0        9         0
 5    10           0       10         0

TIMER 2: False IP Connection Congestion Timer, max time an
        association can be congested before failing due to false
        congestion. SS7IPGW and IPGWI applications enforce
        0-30000(ms). Not supported on IPSP application.
TVALUE : Valid range = 32-bits

TIMER 3: UA HeartBeat Period Timer T(beat), time (ms) between sending
        of BEAT msgs by NE. IPSP, SS7IPGW and IPGWI applications
        enforce 100(ms)-60000(ms).
TVALUE : Valid range = 32-bits

TIMER 4: UA HeartBeat Received Timer T(beat ack), timeout period for
        response BEAT ACK msgs by NE. IPSP, SS7IPGW and IPGWI
        applications enforce 100(ms)-10000(ms).
TVALUE : Valid range = 32-bits

PARM 1: ASP SNM options. Each bit is used as an enabled/disabled
        flag for a particular ASP SNM option. Not supported on IPSP
        application.
PVALUE : Valid range = 32-bits
        BIT                                BIT VALUE
        0=Broadcast                        0=Disabled , 1=Enabled
        1=Response Method                  0=Disabled , 1=Enabled

```

```

        2-5=Reserved
        6=Broadcast Congestion Status Change 0=Disabled , 1=Enabled
        7-31=Reserved

PARM  2: ASP/AS Notification options.  Each bit is used as an
        enabled/disabled flag for a particular ASP/AS
        Notification option.  Not supported on IPSP application.
PVALUE : Valid range = 32-bits
        BIT                               BIT VALUE
        0=ASP Active Notifications         0=Disabled , 1=Enabled
        1=ASP Inactive Notifications       0=Disabled , 1=Enabled
        2=ASP AS State Query               0=Disabled , 1=Enabled
        3-31=Reserved

PARM  3: UA Serviceability Options.  Each bit is used as an
        enabled/disabled flag for a particular UA Serviceability
        option.  Supported on IPSP, SS7IPGW, and IPGWI applications.
        UA Graceful Shutdown supported on IPSP for M3UA only.
PVALUE : Valid range = 32-bits
        BIT                               BIT VALUE
        0=UA Heartbeats                    0=Disabled , 1=Enabled
        1=UA Graceful Shutdown              0=Disabled , 1=Enabled
        2-31=Reserved

PARM  4: SCTP Payload Protocol Indicator byte order option.  Bit indicates
        PPI value is RCV/TX in Big Endian or Little Endian byte format.
        Supported on IPSP-M2PA associations only.
PVALUE : Valid range = 32-bits
        BIT                               BIT VALUE
        0=Payload Protocol Indicator       0=Big Endian , 1=Little Endian
        1-31=Reserved

```

5. Back up the new changes, using the `chg-db:action=backup:dest=fixed` command. These messages should appear; the active Maintenance and Administration Subsystem Processor (MASP) appears first.

```

BACKUP (FIXED) : MASP A - Backup starts on active MASP.
BACKUP (FIXED) : MASP A - Backup on active MASP to fixed disk complete.
BACKUP (FIXED) : MASP A - Backup starts on standby MASP.
BACKUP (FIXED) : MASP A - Backup on standby MASP to fixed disk complete.

```

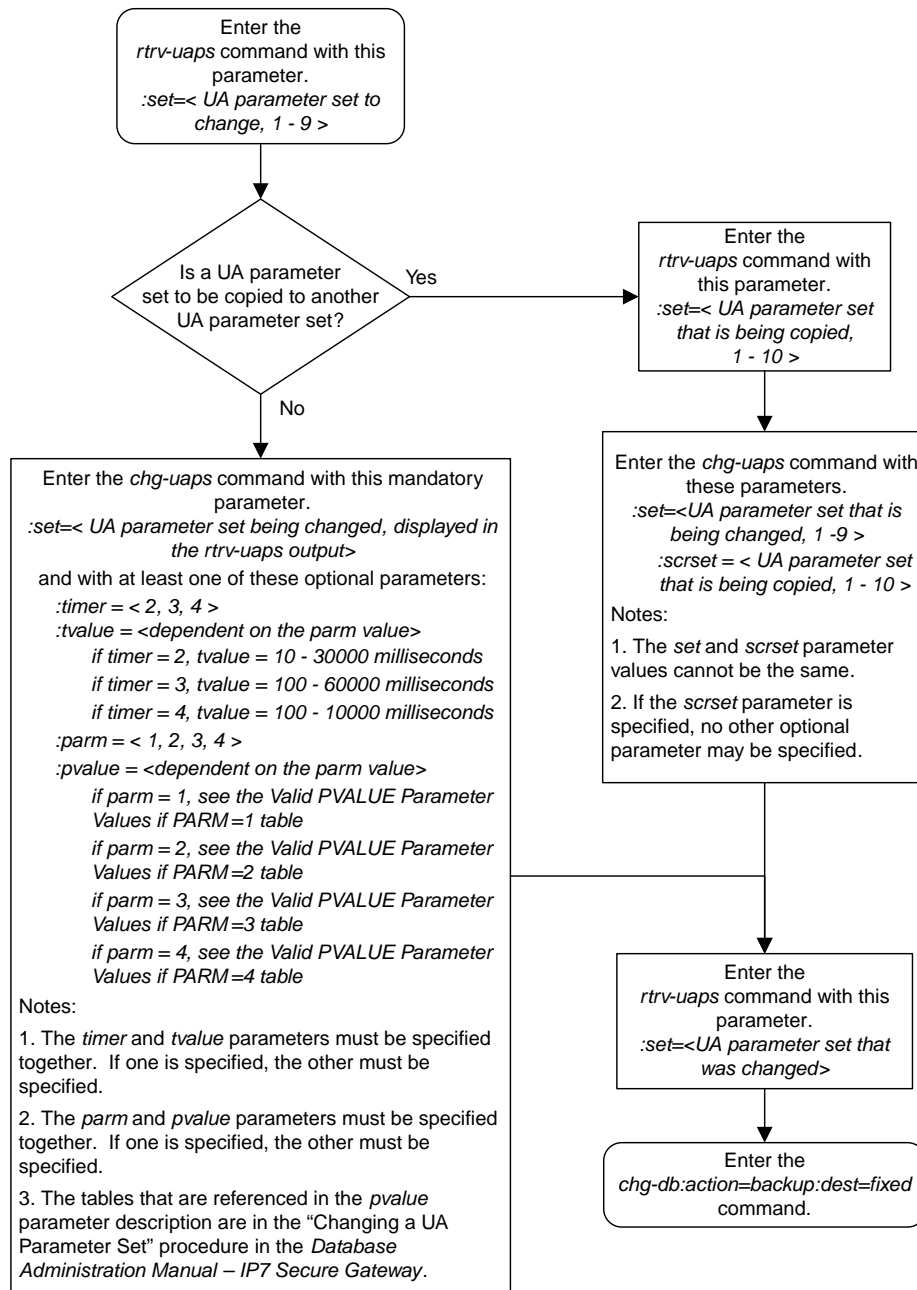

Figure 75: Changing a UA Parameter Set

Turning Off the Large MSU Support for IP Signaling Feature

This procedure is used to turn off the Large MSU Support for IP Signaling feature, using the `chg-ctrl-feat` command.

The `chg-ctrl-feat` command uses these parameters:

`:partnum` – The part number of the Large MSU Support for IP Signaling feature, 893018401.

`:status=off` – used to turn off the Large MSU Support for IP Signaling feature.

The status of the Large MSU Support for IP Signaling feature must be on and is shown with the `rtrv-ctrl-feat` command.



Caution: If the Large MSU Support for IP Signaling feature is turned off, the EAGLE will not process messages with a signaling information field (SIF) that is larger than 272 bytes.

1. Display the status of the Large MSU Support for IP Signaling feature by entering the `rtrv-ctrl-feat:partnum=893018401` command. The following is an example of the possible output.

```
rlghncxa03w 10-04-28 21:15:37 GMT EAGLE5 42.0.0
The following features have been permanently enabled:

Feature Name          Partnum   Status   Quantity
Large MSU for IP Sig  893018401 on       ----

The following features have been temporarily enabled:

Feature Name          Partnum   Status   Quantity   Trial Period Left
Zero entries found.

The following features have expired temporary keys:

Feature Name          Partnum
Zero entries found.
```

If the status of the Large MSU Support for IP Signaling feature is off, or if the Large MSU Support for IP Signaling feature is not enabled, this procedure cannot be performed.

2. Turn off the Large MSU Support for IP Signaling feature by entering the `chg-ctrl-feat` command with the `status=off` parameter. For example, enter this command.

```
chg-ctrl-feat:partnum=893018401:status=off
```

When this command has successfully completed, the following message should appear.

```
rlghncxa03w 06-10-28 21:15:37 GMT EAGLE5 36.0.0
CHG-CTRL-FEAT: MASP B - COMPLTD
```

3. Verify that the Large MSU Support for IP Signaling feature has been turned off by using the `rtrv-ctrl-feat:partnum=893018401` command. The following is an example of the possible output.

```
rlghncxa03w 10-04-28 21:15:37 GMT EAGLE5 42.0.0
The following features have been permanently enabled:

Feature Name           Partnum   Status   Quantity
Large MSU for IP Sig   893018401 off      ----

The following features have been temporarily enabled:

Feature Name           Partnum   Status   Quantity   Trial Period Left
Zero entries found.

The following features have expired temporary keys:

Feature Name           Partnum
Zero entries found.
```

4. Back up the new changes using the `chg-db:action=backup:dest=fixed` command. These messages should appear, the active Maintenance and Administration Subsystem Processor (MASP) appears first.

```
BACKUP (FIXED) : MASP A - Backup starts on active MASP.
BACKUP (FIXED) : MASP A - Backup on active MASP to fixed disk complete.
BACKUP (FIXED) : MASP A - Backup starts on standby MASP.
BACKUP (FIXED) : MASP A - Backup on standby MASP to fixed disk complete.
```

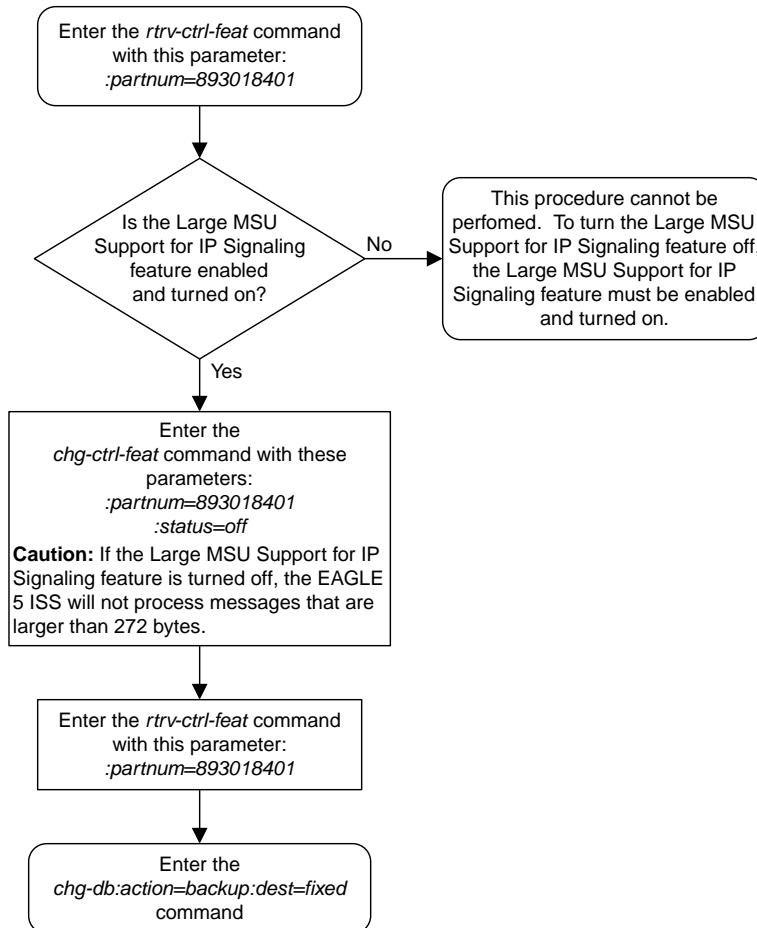

Figure 76: Turning the Large MSU Support for IP Signaling Feature Off

Chapter 5

End Office Support

Topics:

- [Overview.....649](#)
- [End Office Support Configuration.....658](#)
- [Adding an End Node Internal Point Code.....659](#)
- [Removing an End Node Internal Point Code...663](#)

Chapter 5, End Office Support, describes the procedures necessary to allow the EAGLE to share its true point code (TPC) with an IP-based node without the need for a separate point code for the IP node.

Overview

End Office Support enables the EAGLE to share its true point code (TPC) with an IP-based node without the need for a separate point code for the IP node. When the End Office Support feature is in use, the EAGLE shares a point code for up to three network types with attached IP network elements.

The EAGLE lets you take advantage of next generation network technology by migrating existing signaling end points from the PSTN to the IP network. The fact that the EAGLE is a signaling transfer point and has its own point code, however, can present a significant network management issue. This feature provides the means to perform the migration without obtaining a new point code or reconfiguring the network to interface with both the EAGLE and an IP end office node.

Characteristics of this feature include:

- The EAGLE allows a set of IP network elements to share its true point code.
- The EAGLE allows messages destined to its true point code and having SI>=3 to be forwarded to an IP network element.
- The EAGLE enables IP networks elements sharing its true point code to participate in network management.
- The EAGLE supports ANSI, ITU national and international end office nodes.
- The EAGLE implements the MTP procedures required for an end office node.
- The End Office Support feature does not reduce the rated TPS of any EAGLE application.

The Remote Application Table contains fields for assigning each user part to an end office node. The default value is 'not assigned'.

New Remote Application Table commands provide for adding, deleting, and retrieving user-part assignments:

- `ent-rmt-appl`
- `dlt-rmt-appl`
- `rtrv-rmt-appl`

The user parts SI=0, SI=1, and SI=2 cannot be assigned to an end office node. The SNM case is a special case in that UPU's may be forwarded, even though SI=0 cannot be assigned to a remote application. All other SNMs are processed as destined to the EAGLE rather than the end office node. This often results in a multicast throughout the EAGLE that updates the routing tables on all cards. An end office node can receive these messages via replication performed by MTPP.

Each SS7-based application that receives a message destined to a TSPC checks the user-part assignment within the Remote Application Table. If the user-part is assigned and the SI is greater than or equal to 3, then the message is forwarded to the appropriate application, otherwise it is processed as though destined to the EAGLE.

To assign a remote application for the SCCP (SI=3) user part, you must also specify a subsystem number. The Remote Application Table maintains a record of assignments for all possible subsystems (256). Subsystems are either assigned or not assigned.

Note: SSN=0 is normally an invalid value. This feature makes use of SSN=0 for the purpose of forwarding certain MSUs to the end office node.

- Received SCCP Messages that indicate route-on-global-title are treated as having SSN=0 for remote application assignment. If a remote application is assigned to SSN=0, then the message is forwarded, otherwise it is distributed to the local SCCP application. In previous releases, this would occur

only for mis-configured networks. Messages indicating route-on-global-title and intended for the EAGLE, not the end office node, should be sent to the EAGLE's capability point code.

- Received SCCP Messages that lack a Called Party SS are treated as having SSN=0 for remote application assignment. If a remote application is assigned to SSN=0, then the message is forwarded, otherwise it is distributed to the local SCCP application.
- Received SCCP Messages having a Called Party SS equal to SCMG (SSN=1) are processed and terminated by the EAGLE, and if SSN=1 has a remote application assigned, the MSU is also replicated and forwarded to the end office node.
- Received SCCP Messages having a Called Party SSN not equal to 0 or SCMG (1) and for which a remote application is assigned are forwarded to the end office node. Messages received for unassigned subsystems are distributed to the local SCCP application.
- The end office node cannot share SCCP subsystems (other than SCMG) with the EAGLE. If the end office node assigns a given subsystem, such as LNP, then the subsystem local to the EAGLE cannot receive messages. Remote applications take priority over local applications.

Internal Point Code

To route SS7 messages to the IP address without adding another external point code, the End Office feature uses an internal point code (IPC). This point code is private to the EAGLE, and the PSTN has no awareness of it. Its sole purpose is to allow messages destined to the End Office Node to be routed from the inbound LIM to the IPGWx card (a card running either the SS7IPGW or IPGWI applications). An IPC must be entered as a destination and must be assigned for each network type having an end office node. This point code is also used internally by the EAGLE in order to route inbound messages to the outbound IPGWx card. The EAGLE can have up to three IPCs, one for ANSI, one for ITU International, and one for ITU National networks.

Table 46: Sample IPC Values displays a sample Remote Application Table. The Network Type and SI are used to index into the table, rather than being stored in the table.

Table 46: Sample IPC Values

IPC	Assigned to End Office Node	Assigned SSNs	Network Type	User-Part (SI)	Action taken when MSU is received for the TPC
p-0-1-0	FALSE	n/a	ANSI	0	No application can be assigned for SI=0. Note that TFCs are processed, replicated and sent to an end office node, if an application is assigned to any other user part. UPUs are forwarded if the application specified by the affected SI is assigned.
	FALSE	n/a		1	No application can be assigned for SI=1.
	FALSE	n/a		2	No application can be assigned for SI=2.

IPC	Assigned to End Office Node	Assigned SSNs	Network Type	User-Part (SI)	Action taken when MSU is received for the TPC
	TRUE	3, 7, 100		3	SCCP messages destined to the TSPC and with SSN assigned are forwarded to an end office node. SCCP messages destined to a TSPC and SSN not assigned are distributed to subsystems local to the EAGLE (e.g. LNP).
	FALSE	n/a		4	Terminate with UPU.
	TRUE	n/a		5	ISUP messages destined to a TSPC are forwarded to the end office node.
	FALSE	n/a		6 - 15	Terminate with UPU.
110	FALSE	n/a	ITU-N	0	No application can be assigned for SI=0. TFCs are processed, replicated and sent to an end office node, if an application is assigned to any other user part. UPUs are forwarded if the application specified by the affected SI is assigned.
	FALSE	n/a		1	No application can be assigned for SI=1.
	FALSE	n/a		2	No application can be assigned for SI=2.
	FALSE	NULL		3	Distribute to local SCCP.
	TRUE	n/a		4	TUP messages destined to the TSPC are forwarded to the end office node.
	FALSE	n/a		5 - 12	Terminate with UPU.
	TRUE	n/a		13	QBICC messages destined to the TSPC are forwarded to the end office node.
	FALSE	n/a		14, 15	Terminate with UPU.
0-10-1	FALSE	n/a	ITU-I	0	No application can be assigned for SI=0. TFCs are processed, replicated and sent to an end office node, if an application is

IPC	Assigned to End Office Node	Assigned SSNs	Network Type	User-Part (SI)	Action taken when MSU is received for the TPC
					assigned to any other user part. UPUs are forwarded if the application specified by the affected SI is assigned.
	FALSE	n/a		1	No application can be assigned for SI=1.
	FALSE	n/a		2	No application can be assigned for SI=2.
	FALSE	NULL		3	Distribute to local SCCP.
	TRUE	n/a		4	TUP messages destined to the TSPC are forwarded to the end office node.
	FALSE	n/a		5 - 15	Terminate with UPU.

New Installation of VXI Behind a EAGLE with End Office Support

Figure 77: An EAGLE with End Office Support and VXI Node depicts a network in which a VXI node is deployed behind a EAGLE with End Office Support. Note that the VXI node resides in the IP network and shares the EAGLE's true point code. The PSTN views the EAGLE and VXI as one network element (one point code).

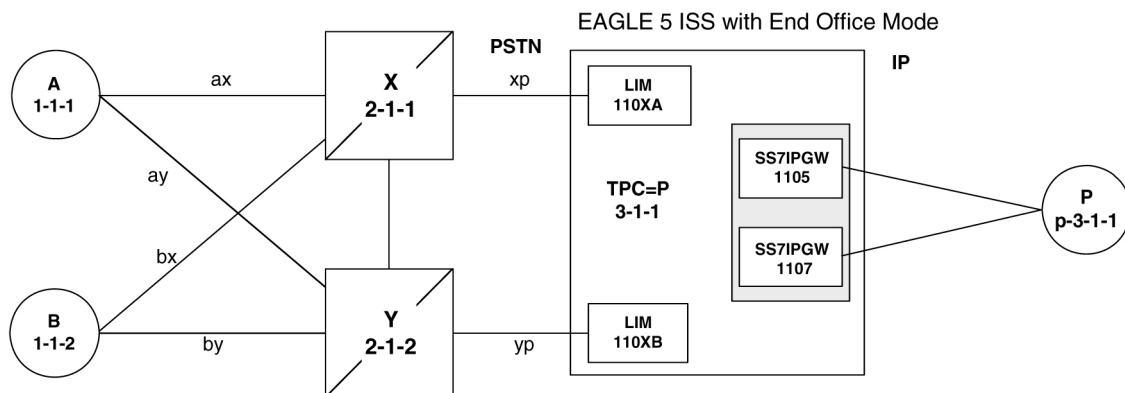

Figure 77: An EAGLE with End Office Support and VXI Node

One Node Migrates from PSTN to IP

Figure 78: Network Before an EAGLE with End Office, Node P is to Migrate and *Figure 79: Network After an EAGLE with End Office, Node P has Migrated* depict the migration of a signaling end point from the PSTN to an IP network using the EAGLE with the End Office Support feature.

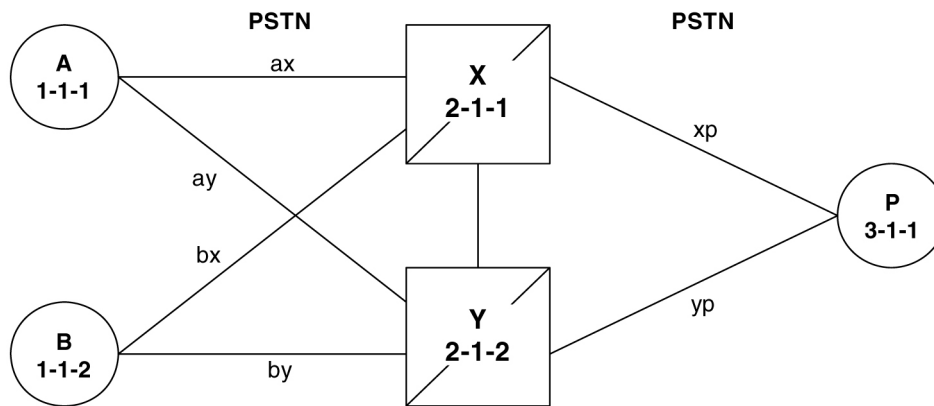

Figure 78: Network Before an EAGLE with End Office, Node P is to Migrate

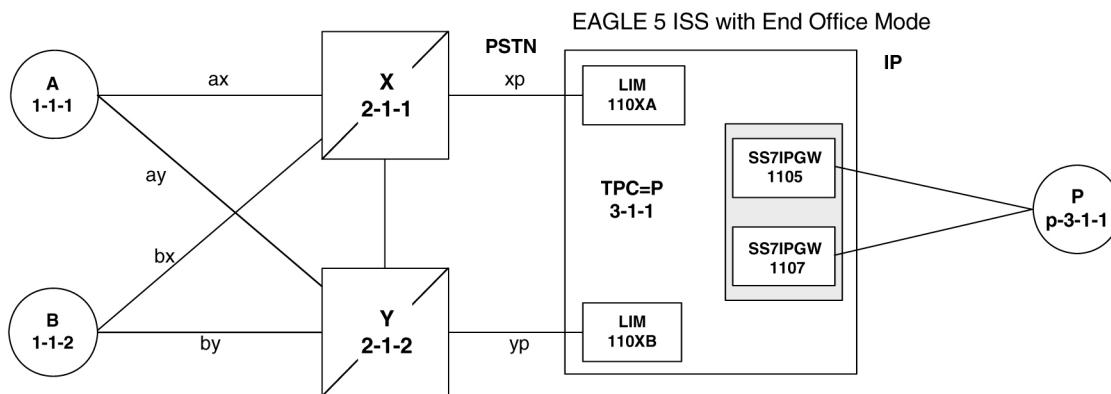

Figure 79: Network After an EAGLE with End Office, Node P has Migrated

In [Figure 79: Network After an EAGLE with End Office, Node P has Migrated](#) the EAGLE no longer acts like a signaling transfer point, but rather acts like a signaling end point that has an IP-attached application user-part. The EAGLE and the IP network element share the point code P. All messages received by the EAGLE should be destined to P and all messages sent to the PSTN from the EAGLE have an OPC of P.

A Signaling End Point is Added to a Deployed EAGLE Using End Office

Another possible scenario for the End Office feature is that a customer has a deployed EAGLE with attached IP nodes, and wants to make use of the End Office feature to add a new IP node. Consider the following network diagrams, [Figure 80: Original Network with Deployed EAGLE](#) and [Figure 81: New Network with an EAGLE Using End Office and End Node R](#).

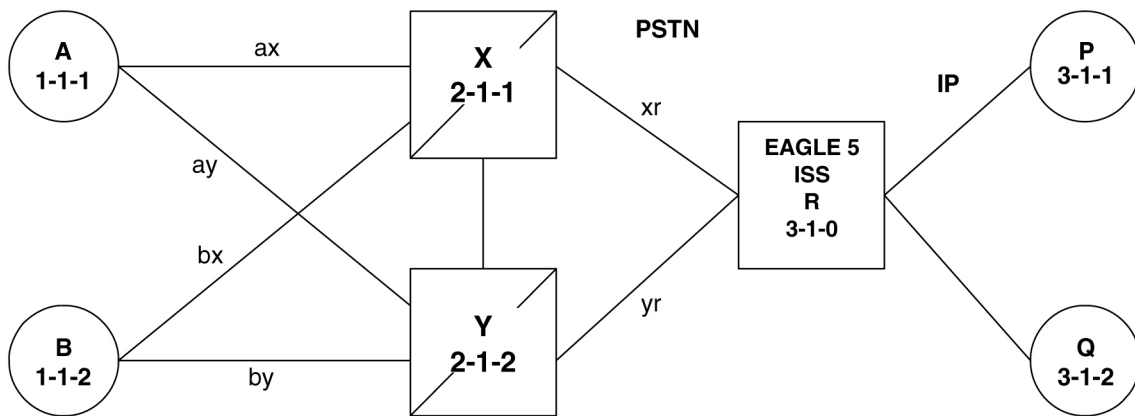

Figure 80: Original Network with Deployed EAGLE

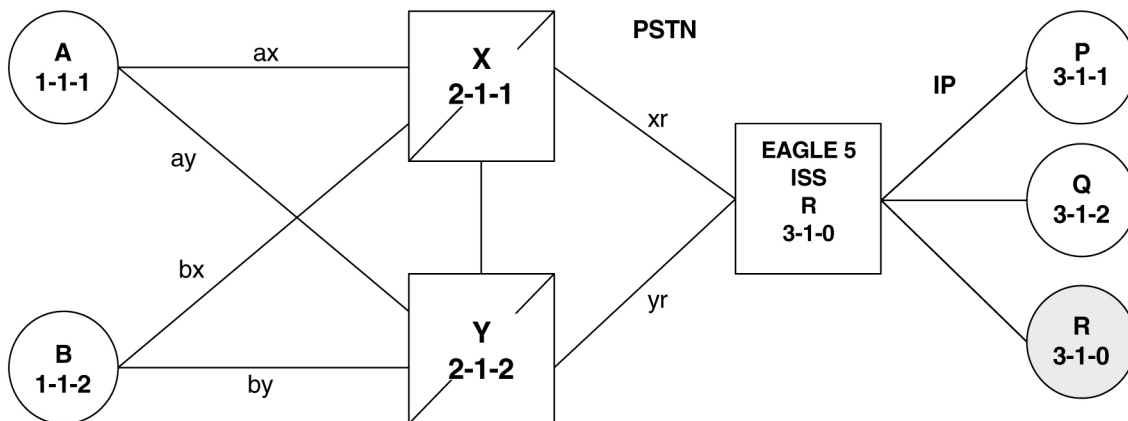

Figure 81: New Network with an EAGLE Using End Office and End Node R

In *Figure 81: New Network with an EAGLE Using End Office and End Node R* the customer saves a point code by using the End Office feature and making the new IP network element an end office node. No change is required in the PSTN or at P or Q. Non-network-management and non-test messages destined to R are now forwarded to an IP network element, rather than terminated by the EAGLE.

Two Signaling End Points Move from PSTN to IP Using End Office

A more complex scenario arises when multiple signaling end points are to migrate from the PSTN to an IP network using the End Office feature. Consider *Figure 82: Network before Two Signaling End Points Migrate from PSTN to IP* and *Figure 83: Network after Two Signaling End Points Migrate from PSTN to IP*.

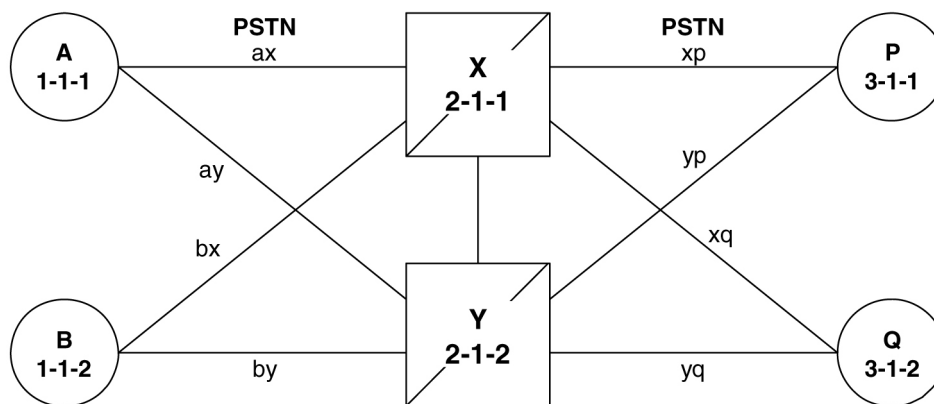

Figure 82: Network before Two Signaling End Points Migrate from PSTN to IP

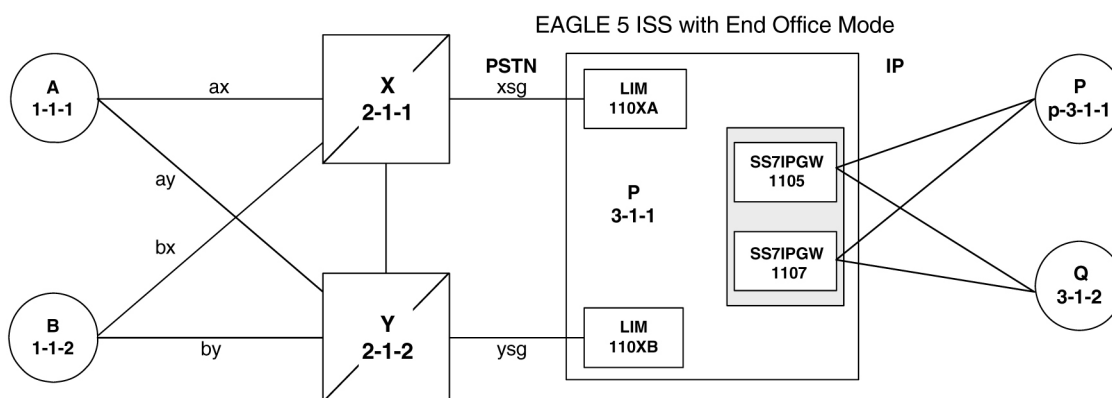

Figure 83: Network after Two Signaling End Points Migrate from PSTN to IP

In *Figure 83: Network after Two Signaling End Points Migrate from PSTN to IP*, P is an end office node, and so P serves as the adjacent point code for nodes X and Y. The following are key points about this figure:

- Q is not an end office node, and so the EAGLE behaves as an STP for messages originated by and destined to Q.
- Reprovisioning is required in the PSTN, since the Q is now behind P. One example of this is that the linksets between X and Q and between Y and Q must change.
- Traffic between P and Q are no longer routed through X/Y, but are routed within the EAGLE .

The EAGLE Simultaneously Acts as STP and End Office

Figure 84: The EAGLE Simultaneously Acts as STP and End Office depicts the EAGLE supporting three IP network elements, only one of which use the End Office feature, and two PSTN network elements. In addition, a capability point code is provisioned on the EAGLE, thereby allowing the use of GTT.

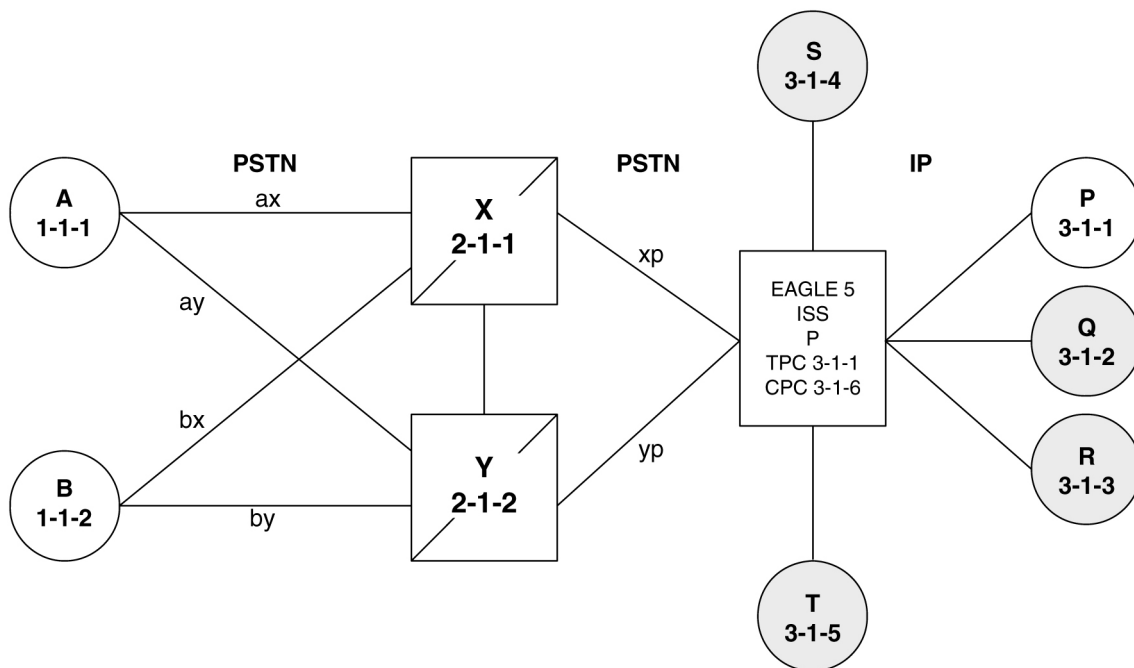

Figure 84: The EAGLE Simultaneously Acts as STP and End Office

Notes regarding [Figure 84: The EAGLE Simultaneously Acts as STP and End Office](#):

- P is the end office node, and so the EAGLETPC=P.
- Assume that end node P has an application assignment for SCCP.
- SCCP traffic destined to P is forwarded to the IP node via the SS7IPGW application.
- SCCP traffic destined to the CPC is distributed to the EAGLE's local SCCP application (e.g. GTT).
- Network elements Q, R, S, and T are not end office nodes, and so the EAGLE generates TFX network management concerning them.
- IP Network element P is an end office node, and so the EAGLE generates only UPU/SSP concerning it.

The EAGLE Supports Multiple Network Types and Multiple Hosts as an End Node

In [Figure 85: Three Multiple-Element End Office Nodes](#) the EAGLE supports an end office node for each of the three network types. Each end office node comprises multiple IP network elements. The IP network elements are distinguished by the remote host and remote port values of the IP network elements (IP address parameters).

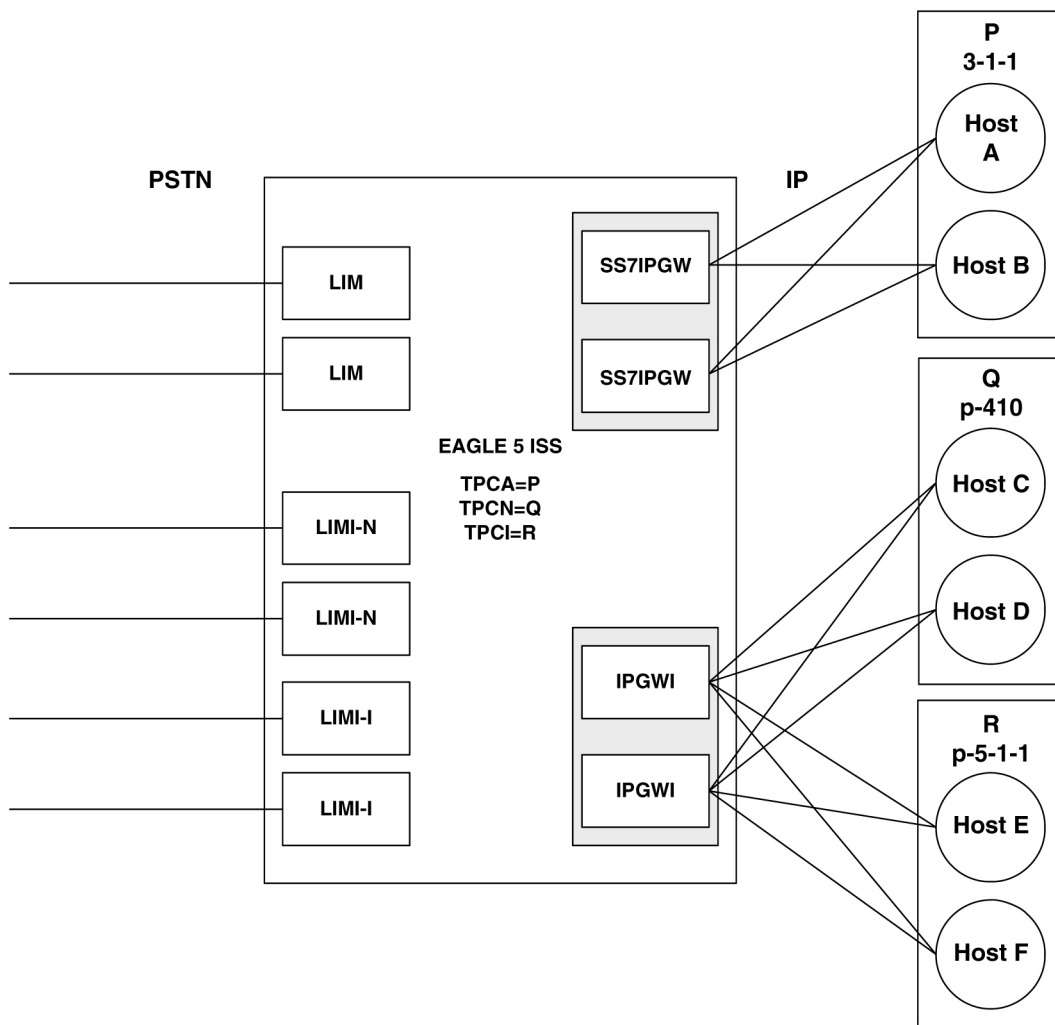

Figure 85: Three Multiple-Element End Office Nodes

Mated Pair Supports Two End Office Nodes

Figure 86: Mated Pair Supports Two End Office Nodes depicts a mated pair of EAGLEs with each EAGLE supporting an End Office Node. Note that EAGLE P lacks IP links to IPNE-Q and EAGLE Q lacks IP links to IPNE-P, since such links would conflict with the C-links of linkset pq.

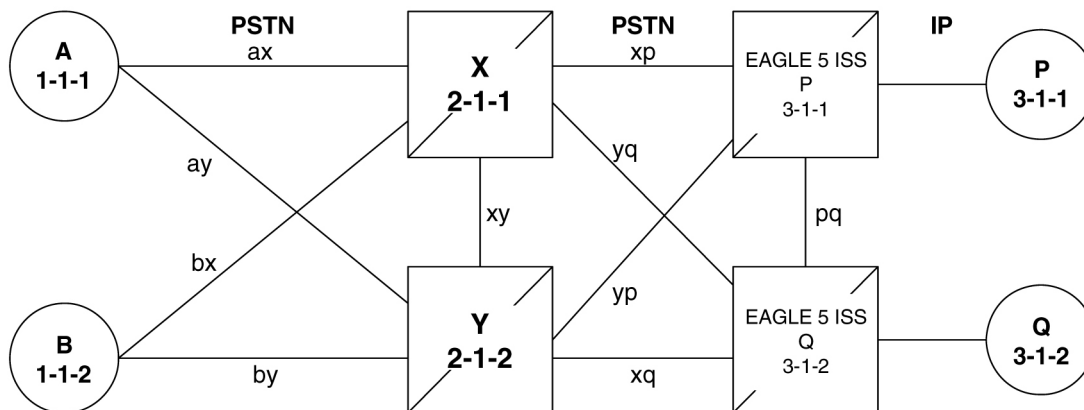

Figure 86: Mated Pair Supports Two End Office Nodes

Figure 86: Mated Pair Supports Two End Office Nodes shows that a mated pair of EAGLEs cannot share an End Office Node. Each EAGLE requires its own unique point code and so any attached End Office Nodes share those point codes. It would be possible for a single IP network element to act as both P and Q (have IP connections to both EAGLE P and EAGLE Q). This configuration, however, would not provide true redundancy. Messages destined to P are terminated either at EAGLE P or IPNE-P, and message destined to Q are terminated either at EAGLE Q or IPNE-Q. Should the IP link between EAGLE P and IPNE-P fail, this feature provides no way for EAGLE P to forward messages to the End Office Node using the linkset **pq** (the linkset between systems P and Q).

End Office Support Configuration

In addition to the internal point code provisioned in the database with the [Adding an End Node Internal Point Code](#) procedure, other entities must be configured in the database to support the End Office feature.

For IPGWx entities, these entities must be configured in the database.

- The internal point code must be in the destination point code table - go to the “Adding a Destination Point Code” procedure in *Database Administration - SS7 User’s Guide*.
- An SS7 route to the internal point code - go to either the “Adding a Route containing an SS7DPC” or “Adding a Route Containing an IPGWx Linkset” procedure in the *Database Administration - SS7 User’s Guide*.
- Signaling links assigned to the cards running either the SS7IPGW or IPGWI applications - [Adding an IPGWx Signaling Link](#) in *End Office Support*
- IPGWx associations (with the corresponding application servers):
 - [Adding an M3UA or SUA Association](#) procedure in *IETF M3UA and SUA Configuration Procedures*
 - [Adding a New Association to a New Application Server](#) procedure in *IETF M3UA and SUA Configuration Procedures*
 - [Adding an Existing Association to a New Application Server](#) procedure in *IETF M3UA and SUA Configuration Procedures*
 - [Adding a New Association to an Existing Application Server](#) procedure in *IETF M3UA and SUA Configuration Procedures*

- [Adding an Existing Association to an Existing Application Server](#) procedure in *IETF M3UA and SUA Configuration Procedures*
- Routing key matching the user part specified in the [Adding an End Node Internal Point Code](#) procedure and with the DPC of the routing key equal to the true point code of the EAGLE (shown in the `rtrv-sid` output) - See the [Adding a Routing Key Containing an Application Server](#) procedure in *IETF M3UA and SUA Configuration Procedures*.

For IPSPG entities, these entities must be configured in the database.

- The internal point code must be in the destination point code table - perform the “Adding a Destination Point Code” procedure in *Database Administration - SS7 User’s Guide*.
- An SS7 route to the internal point code - perform the “Adding a Route containing an SS7DPC” procedure in *Database Administration - SS7 User’s Guide*.
- M3UA Linksets - [Adding an IPSPG M3UA Linkset](#) procedure in *IPSPG M2PA and M3UA Configuration Procedures*
- M3UA associations - [Adding an IPSPG M3UA Association](#) procedure in *IPSPG M2PA and M3UA Configuration Procedures*
- Signaling links assigned to the IPSPG cards - [Adding an IPSPG M3UA Signaling Link](#) procedure in *IPSPG M2PA and M3UA Configuration Procedures*

Adding an End Node Internal Point Code

This procedure is used to assign user parts to an internal point code (IPC), and thereby to an end office node using the `ent-rmt-appl` command. An internal point code is assigned to remote applications.

Only one IPC value for each network type can be configured. If you are adding an IPC value of the same network type as an existing IPC (for example, adding an ANSI IPC when the `rtrv-rmt-appl` output contains an ANSI IPC), the IPC value must be the same as the existing IPC value.

The `ent-rmt-appl` command uses these parameters:

`:ipc/ipca/ipci/ipcn/ipcn24` – The end node's internal point code can be an ANSI (`ipc/ipca`), ITU-I or ITU-I spare (`ipci`), 14-bit ITU-N or 14-bit ITU-N spare (`ipcn`), or 24-bit ITU-N (`ipcn24`) point code.

Note: The point code value can also be either a private (p-) or a private spare (ps-) point code, but does not have to be a private or private spare point code. Any point code can be a private point code. Only ITU-I or 14-bit ITU-N point codes can be private spare point codes. The point code value must be shown in the `rtrv-dstn` command output.

Note: The EAGLE can contain 14-bit ITU-N point codes or 24-bit ITU-N point codes, but not both at the same time.

`:si` – The service indicator value designates which MSU user part is being assigned to a remote application. Valid values range from 3 to 15.

`:ssn` – The SCCP subsystem number parameter. This parameter is required if the `si=3` parameter is specified and is not valid for any other `si` value. If the `ssne` parameter is also specified, then the `ssn` parameter serves as the starting value of a range. Valid values range from 0 to 255.

`:ssne` – The SCCP subsystem number range end parameter. The `ssne` value can be specified only if the `si=3` parameter is specified and is not valid for any other `si` value. This parameter serves as an

end of a range, and so must be greater than the `ssn` parameter value. Valid values range from 1 to 255.

The specified assignment cannot be an existing assignment, including SSN subsets.

1. Display a report listing the remote application assignments using the `rtrv-rmt-appl` command.

This is an example of possible output:

```
rlghncxa03w 06-10-28 09:12:36 GMT EAGLE5 36.0.0
  IPCA                SI SSN
  003-003-003        3 100, 110-119, 200
                    5

  IPCI                SI SSN
  p-3-003-3          3 5, 50-100, 250
                    5

  IPCN                SI SSN

  IPCN24             SI SSN
```

2. Display the current destination point codes, using the `rtrv-dstn` command.

This is an example of the possible output.

```
rlghncxa03w 10-12-10 11:43:04 GMT EAGLE5 43.0.0
Extended Processing Time may be Required

  DPCA                CLLI          BEI  ELEI    ALIASI                ALIASN/N24    DMN
  003-003-003        ----- yes --- -----
  030-045-*          rlghncbb010 yes yes -----
  111-011-*          rlghncbb000 yes yes -----
  240-012-004        rlghncbb001 yes --- 1-111-1            2500          SS7
  240-012-005        rlghncbb002 yes --- 1-112-2            1357          SS7
  240-012-006        rlghncbb003 yes --- 1-112-3            4257          SS7
  240-012-008        ----- yes --- 1-113-5            6939          SS7
  p-003-003-003      ----- yes --- -----
                                     -----

  DPCI                CLLI          BEI  ELEI    ALIASA                ALIASN/N24    DMN
  2-131-1            rlghncbb023 no --- 222-210-000        10789         SS7
  2-131-2            ----- no --- 222-211-001        1138          SS7
  2-131-3            ----- no --- 222-211-002        1298          SS7
  p-3-003-3          ----- no --- -----
                                     -----

  DPCN                CLLI          BEI  ELEI    ALIASA                ALIASI         DMN
  7701               rlghncbb013 no --- 222-200-200        2-121-1       SS7
  11038              rlghncbb013 no --- 222-200-201        2-121-2       SS7
  p-16380            ----- no --- -----
                                     -----

DESTINATION ENTRIES ALLOCATED:    2000
  FULL DPC(s):                    12
  EXCEPTION DPC(s):                0
  NETWORK DPC(s):                  0
  CLUSTER DPC(s):                  2
  TOTAL DPC(s):                    14
  CAPACITY (% FULL):               1%
ALIASES ALLOCATED:                12000
```

```

ALIASES USED:                18
CAPACITY (% FULL):          1%
X-LIST ENTRIES ALLOCATED:    500

```

If the IPC being added to the database is not shown in the `rtrv-dstn` output, go to the “Adding a Destination Point Code” procedure in *Database Administration - SS7 User’s Guide* and add the IPC to the DPC table.

3. Add the remote application assignments using the `ent-rmt-appl` command.

For this example, enter these commands.

```

ent-rmt-appl:ipcn=p-16380:si=3:ssn=250
ent-rmt-appl:ipcn=p-16380:si=5
ent-rmt-appl:ipca=003-003-003:si=13
ent-rmt-appl:ipca=003-003-003:si=3:ssn=50:ssne=75

```

When each of these commands have successfully completed, the following message should appear.

```

rlghncxa03w 06-10-28 09:12:36 GMT EAGLE5 36.0.0
ENT-RMT-APPL: MASP A - COMPLTD;

```

4. Verify the changes using the `rtrv-rmt-appl` command.

This is an example of possible output:

```

rlghncxa03w 06-10-28 09:12:36 GMT EAGLE5 36.0.0
  IPCA                SI SSN
  003-003-003         3 50-75, 100, 110-119, 200
                      5
                      13

  IPCI                SI SSN
  p-3-003-3           3 5, 50-100, 250
                      5

  IPCN                SI SSN
  p-16380             3 250
                      5

  IPCN24              SI SSN

```

5. Back up the new changes, using the `chg-db:action=backup:dest=fixed` command.

These messages should appear; the active Maintenance and Administration Subsystem Processor (MASP) appears first.

```

BACKUP (FIXED) : MASP A - Backup starts on active MASP.
BACKUP (FIXED) : MASP A - Backup on active MASP to fixed disk complete.
BACKUP (FIXED) : MASP A - Backup starts on standby MASP.
BACKUP (FIXED) : MASP A - Backup on standby MASP to fixed disk complete.

```

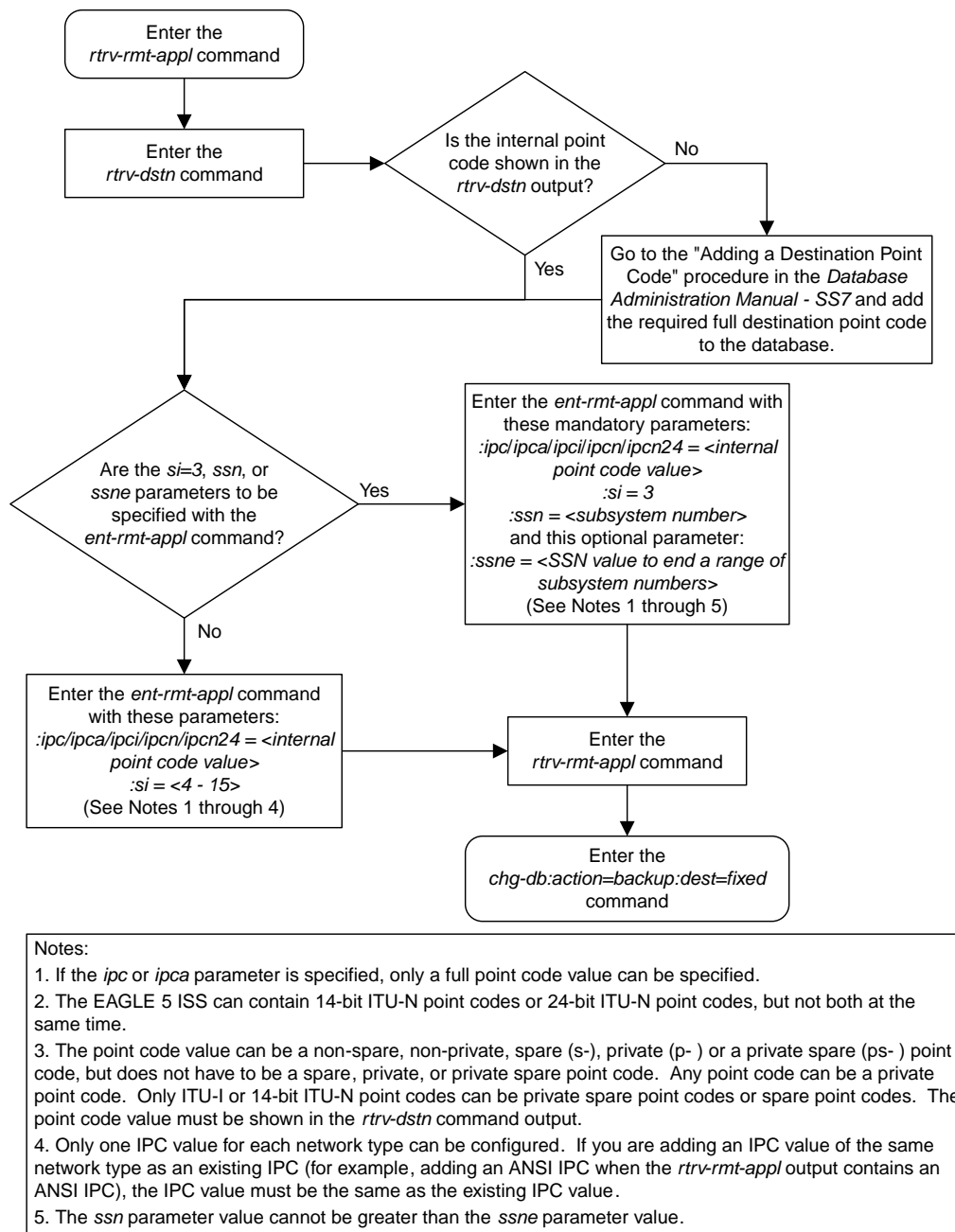

Figure 87: Adding an End Node Internal Point Code

Removing an End Node Internal Point Code

The `dlt-rmt-appl` command is used to remove remote application assignments from the database.

The `dlt-rmt-appl` command uses these parameters:

`:ipc/ipca/ipci/ipcn/ipcn24` – The end node's internal point code can be an ANSI, ANSI private (`ipc/ipca`), ITU-I, ITU-I spare, ITU-I private spare (`ipci`), 14-bit ITU-N, 14-bit ITU-N spare, 14-bit ITU-N private spare (`ipcn`), or 24-bit ITU-N, or 24-bit ITU-N private (`ipcn24`) point code.

`:si` – The service indicator value designates which MSU user part is being assigned to a remote application. Valid values range from 3 to 15.

`:ssn` – The SCCP subsystem number parameter. This parameter is required if the `si=3` parameter is specified and is not valid for any other `si` value. If the `ssne` parameter is also specified, then the `ssn` parameter serves as the starting value of a range. Valid values range from 0 to 255.

`:ssne` – The SCCP subsystem number range end parameter. The `ssne` value can be specified only if the `si=3` parameter is specified and is not valid for any other `si` value. This parameter serves as an end of a range, and so must be greater than the `ssn` parameter value. Valid values range from 1 to 255.

1. Display a report listing the remote application assignments using the `rtrv-rmt-appl` command.

This is an example of possible output:

```
rlghncxa03w 06-10-28 09:12:36 GMT EAGLE5 36.0.0
  IPCA          SI  SSN
  003-003-003   3  50-75, 100, 110-119, 200
                5
                13

  IPCI          SI  SSN
  p-3-003-3     3  5, 50-100, 250
                5

  IPCN          SI  SSN
  p-16380       3  250
                5

  IPCN24        SI  SSN
```

2. Delete remote application assignments using the `dlt-rmt-appl` command.

For this example, enter these commands.

```
dlt-rmt-appl:ipca=003-003-003:si=3:ssn=100
```

```
dlt-rmt-appl:ipca=003-003-003:si=13
```

When each of these commands have successfully completed, the following message should appear.

```
rlghncxa03w 06-10-28 09:12:36 GMT EAGLE5 36.0.0
DLT-RMT-APPL:  MASP A - COMPLTD;
```

3. Verify the changes using the `rtrv-rmt-appl` command.

This is an example of possible output:

```
rlghncxa03w 06-10-28 09:12:36 GMT EAGLE5 36.0.0
  IPCA          SI SSN
  003-003-003   3 50-75, 110-119, 200
                5

  IPCI          SI SSN
  p-3-003-3     3 5, 50-100, 250
                5

  IPCN          SI SSN
  p-16380       3 250
                5

  IPCN24        SI SSN
```

4. Back up the new changes, using the `chg-db:action=backup:dest=fixed` command.

These messages should appear; the active Maintenance and Administration Subsystem Processor (MASP) appears first.

```
BACKUP (FIXED) : MASP A - Backup starts on active MASP.
BACKUP (FIXED) : MASP A - Backup on active MASP to fixed disk complete.
BACKUP (FIXED) : MASP A - Backup starts on standby MASP.
BACKUP (FIXED) : MASP A - Backup on standby MASP to fixed disk complete.
```

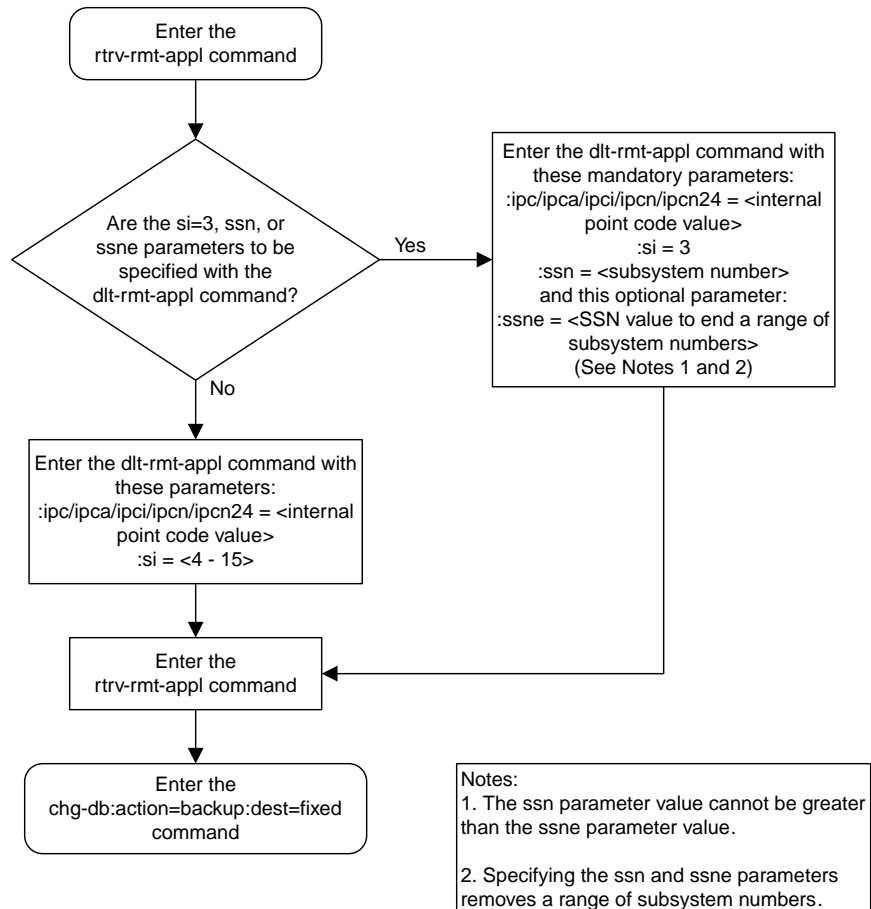



Figure 88: Removing an End Node Internal Point Code

Chapter 6

IPSG M2PA and M3UA Configuration Procedures

Topics:

- [Adding IPSG Components.....668](#)
- [Adding an IPSG Card.....669](#)
- [Adding an IPSG M2PA Linkset.....676](#)
- [Adding an IPSG M3UA Linkset.....696](#)
- [Configuring an IP Link.....716](#)
- [Adding an IP Host.....735](#)
- [Configuring an IP Card.....739](#)
- [Adding an IP Route.....751](#)
- [Adding an IPSG M2PA Association.....758](#)
- [Adding an IPSG M3UA Association.....771](#)
- [Adding an IPSG M2PA Signaling Link.....779](#)
- [Adding an IPSG M3UA Signaling Link.....800](#)
- [Adding a Network Appearance.....825](#)
- [Activating the Large MSU Support for IP Signaling Feature.....832](#)
- [Removing IPSG Components.....841](#)
- [Removing an IPSG Card.....841](#)
- [Removing an IPSG Linkset.....845](#)
- [Removing an IP Host Assigned to an IPSG Card.....858](#)
- [Removing an IP Route.....864](#)
- [Removing an IPSG Association.....868](#)
- [Removing an IPSG M2PA Signaling Link.....873](#)
- [Removing an IPSG M3UA Signaling Link.....882](#)
- [Removing a Network Appearance.....890](#)
- [Changing IPSG Components.....893](#)
- [Changing an IPLIMx Card to an IPSG Card...893](#)
- [Configuring IP Options.....906](#)
- [Configuring IPSG M3UA Linkset Options.....910](#)
- [Changing an IPSG M2PA Linkset.....915](#)
- [Changing an IPSG M3UA Linkset.....933](#)

Chapter 6, IPSG M2PA and M3UA Configuration Procedures, describes the procedures necessary to configure the components necessary to establish IP connections using M2PA or M3UA associations on IPSG signaling links.

- *Changing the Attributes of an IPSG Association.....958*
- *Changing the Buffer Size of an IPSG Association.....977*
- *Changing the Host Values of an IPSG Association.....991*
- *Configuring an IPSG Association for SCTP Retransmission Control.....1010*
- *Changing the SCTP Checksum Algorithm Option for IPSG M2PA Associations.....1019*
- *Changing the SCTP Checksum Algorithm Option for IPSG M3UA Associations.....1036*
- *Changing an M2PA Timer Set.....1052*
- *Changing a UA Parameter Set.....1060*
- *Turning Off the Large MSU Support for IP Signaling Feature1072*

Adding IPSG Components

This section describes how to configure the components necessary to establish connections using IPSG M2PA associations on IPSG signaling links, and IPSG M3UA associations on IPSG signaling links.

The configuration of these connections consists of these items.

1. Configure the IPSG card with the [Adding an IPSG Card](#) procedure.
2. Configure the required destination point codes - see Chapter 2, "Configuring Destination Tables," in *Database Administration - SS7 User's Guide*.
3. Configure the required IPSG linksets - perform the [Adding an IPSG M2PA Linkset](#) or the [Adding an IPSG M3UA Linkset](#) procedures.
4. IP addresses must be assigned to the IPSG card configured in step 1 by performing the [Configuring an IP Link](#) procedure. There are other IP link parameters that are assigned to the IPSG card when the IPSG card is configured. Default values are assigned to these parameters when the IPSG card is configured. These values can be displayed by the `rtrv-ip-lnk` command. These values can be changed by performing the [Configuring an IP Link](#) procedure.
5. Local IP hosts, assigned to the IP addresses assigned to step 4, must be configured in the database by performing the [Adding an IP Host](#) procedure. Verify the hosts with the `rtrv-ip-host` command. This establishes a relationship between the IPSG card related information and the association related information.
6. When the IPSG cards are added to the database in step 1, there are IP parameters that control the IP stack that are assigned default values. These parameter values can be displayed by the `rtrv-ip-card` command. These values can be changed by performing the [Configuring an IP Card](#) procedure.
7. Static IP routes provide more flexibility in selecting the path to the remote destination and reduces the dependence on default routers. Static IP routes are provisioned by performing the [Adding an IP Route](#) procedure.
8. IPSG Associations specify a connection between a local host/TCP port and a remote host/TCP port. Two types of IPSG associations can be provisioned: M2PA and M3UA. Associations that are assigned to IPSG M2PA signaling links must be IPSG M2PA associations. Associations that are assigned to IPSG M3UA signaling links must be IPSG M3UA associations. The IPSG M2PA association is configured by performing the [Adding an IPSG M2PA Association](#) procedure. The IPSG M3UA association is configured by performing the [Adding an IPSG M3UA Association](#) procedure. Associations can be assigned to IPLIMx or IPGWx signaling links also. These associations are configured by performing the [Adding an M2PA Association](#) or [Adding an M3UA or SUA Association](#) procedures. A number of fields in the association cannot be configured with the [Adding an IPSG M2PA Association](#) or [Adding an IPSG M3UA Association](#) procedures and are set to default values. The values of these fields can be displayed using the `rtrv-assoc` command after the [Adding an IPSG M2PA Association](#) or [Adding an IPSG M3UA Association](#) procedures are performed. These values can be changed by performing the [Changing the Attributes of an IPSG Association](#) procedure.
9. There are two versions of IPSG M2PA associations, RFC and Draft 6, that can be configured in the database. When an IPSG M2PA association is added to the database with the [Adding an IPSG M2PA Association](#) procedure, the association is configured as an RFCM2PA association. The RFC version of M2PA timer set 1 is also assigned to the association when the IPSG M2PA association is added to the database.

There are two different versions, RFC and Draft 6, of M2PA timer sets that can be assigned to IPSG M2PA associations. Each version of the M2PA timer sets contains 20 timer sets. The values of these timer sets can be changed with the [Changing an M2PA Timer Set](#) procedure.

The version of the IPSG M2PA association and the M2PA timer set assigned to the association can be changed with [Changing the Attributes of an IPSG Association](#) procedure. The M2PA version of the association determines the version of the M2PA timer set that is assigned to the association. For example, if M2PA timer set 3 is assigned to the IPSG M2PA association, and the association is an RFC M2PA association, the RFC version of M2PA timer set 3 is used with the association. If M2PA timer set 7 is assigned to the IPSG M2PA association, and the association is a Draft 6 M2PA association, the Draft 6 version of M2PA timer set 7 is used with the association.

10. When an IPSG M3UA association is added to the database, UA parameter set 10 is assigned to the association. There are 10 UA parameter sets that can be assigned to an association, but the UA parameter set assignment can be changed, using the [Changing the Attributes of an IPSG Association](#) procedure. The values assigned to each UA parameter set can be changed, except for UA parameter set 10, using the [Changing a UA Parameter Set](#) procedure.
11. Configure the IPSG signaling links with either the [Adding an IPSG M2PA Linkset](#) or [Adding an IPSG M3UA Signaling Link](#) procedures. If the addition of these signaling links will exceed the current number of signaling links the EAGLE is allowed to have, the [Enabling the Large System # Links Controlled Feature](#) procedure will have to be performed to increase the quantity of signaling links.
12. Configure the required routes - see Chapter 3, "SS7 Configuration," in *Database Administration - SS7 User's Guide*.
13. An internal point code can be provisioned to provide routing to an IP end office node. Configure the internal point codes by performing the [Adding an End Node Internal Point Code](#) procedure.
14. The network appearance field identifies the SS7 network context for the message, for the purpose of logically separating the signaling traffic between the SGP (signaling gateway process) and the application server over a common SCTP (stream control transmission protocol) association. This field is contained in the DATA, DUNA, DAVA, DRST, DAUD, SCON, and DUPU messages. Network appearances are configured by performing the [Adding a Network Appearance](#) procedure.
15. The EAGLE processes messages with a service information field (SIF) that is 272 bytes or smaller. The Large MSU Support for IP Signaling feature allows the EAGLE to process messages with a service indicator value of 6 to 15 and with a SIF that is larger than 272 bytes. Perform the [Activating the Large MSU Support for IP Signaling Feature](#) procedure to enable and turn on the Large MSU Support for IP Signaling feature.

Adding an IPSG Card

This procedure is used to add an IPSG card to the database using the `ent-card` command. An IPSG card is an E5-ENET card, part number 870-2212-xx, or the SLIC, part number 7094646, that is running the IPSG application.

The `ent-card` command uses these parameters.

`:loc` – The location of the card being added to the database.

`:type` – The type of card being added to the database. For this procedure, the value of this parameter is `enet` for an E5-ENET card and `enet b` for E5-ENET-B. When provisioning the SLIC, the card type will be `enet b`, but will be displayed as `slic` when plugged in.

: `appl` – The application software that is assigned to the card. For this procedure, the value of this parameter is `ipsg`.

: `force` – If the global title translation feature is on, the `force=yes` parameter allows the IPSG card to be added to the database even if the current SCCP transactions-per-second threshold is unable to support the additional SCCP transaction-per-second capacity created by adding the IP card. This parameter is obsolete and is no longer used.

Card Slot Selection

The E5-ENET card can be inserted into any card slot, except for card slots that must remain empty to accommodate dual-slot cards, slots 09 and 10 in each shelf, and slots 1113 through 1118.

To provision a E5-ENET card, the shelf containing the E5-ENET card must have HIPR2 cards installed in slots 9 and 10 in that shelf. If HIPR2 cards are not installed in the shelf that the E5-ENET card will occupy, the E5-ENET card will be auto-inhibited when the E5-ENET card is inserted into the shelf. Enter the `rept-stat-gpl:gpl=hipr2` command to verify whether or not HIPR2 cards are installed in the same shelf as the E5-ENET card being provisioned in this procedure.

1. Display the total provisioned system TPS by entering the `rtrv-tps` command.

This is an example of the possible output.

```
rlghncxa03w 10-07-30 16:20:46 GMT EAGLE 42.0.0
Total provisioned IPGW      TPS = 30000
Total provisioned IPGS      TPS = 400000
Total provisioned IPLIM     TPS = 20000
Total provisioned ATM       TPS = 3668

Total provisioned System TPS (453668 of 500000) 91%
Command Completed.
```

See [Maximum Card Capacity for Different Card Types](#) for MaxTPS values. If adding the new IPSG card will not exceed the maximum total provisioned system TPS, continue the procedure with [Step 2](#).

If adding the new IPSG card will exceed the maximum total provisioned system TPS, and the maximum total provisioned system TPS is 500,000, perform the "Activating the HIPR2 High Rate Mode" feature in *Database Administration - System Management User's Guide* to enable and turn on the HIPR2 High Rate Mode feature. When the HIPR2 High Rate Mode feature is enabled and turned on, the maximum total provisioned system TPS is increased to 1,000,000 (1M). After the HIPR2 High Rate Mode feature has been enabled and turned on, continue the procedure with [Step 2](#).

If adding the new IPSG card will exceed the maximum total provisioned system TPS, and the maximum total provisioned system TPS is 1M, This procedure cannot be performed. The maximum total provisioned system TPS the EAGLE can have is 1M,

2. Display the cards in the database using the `rtrv-card` command.

This is an example of the possible output. Cards should be distributed throughout the EAGLE for proper power distribution. Refer to *Installation Guide* for the shelf power distribution.

```
rlghncxa03w 13-06-05 08:12:53 GMT 45.0.0
CARD  TYPE      APPL      LSET NAME      LINK SLC LSET NAME      LINK SLC
1101  DSM          VSCCP
```

1102	TSM	GLS						
1113	E5MCAP	EOAM						
1114	E5TDM-A							
1115	E5MCAP	EOAM						
1116	E5TDM-B							
1117	E5MDAL							
1201	LIMDS0	SS7ANSI	sp2	A	0	sp1	B	0
1203	LIMDS0	SS7ANSI	sp3	A	0			
1204	LIMDS0	SS7ANSI	sp3	A	1			
1206	LIMDS0	SS7ANSI	nsp3	A	1	nsp4	B	1
1216	DCM	STPLAN						
1301	LIMDS0	SS7ANSI	sp6	A	1	sp7	B	0
1302	LIMDS0	SS7ANSI	sp7	A	1	sp5	B	1
1303	DCM	IPLIM	ipnode1	A	0	ipnode3	B	1
1305	DCM	IPLIM	ipnode4	A	0			
1307	DCM	STPLAN						
2101	ENET	IPSG						
2103	ENET	IPSG						
2105	ENET	IPSG						
2107	ENET	IPSG						
2201	DCM	IPLIM						
2203	DCM	IPLIM						
2207	DCM	IPLIM						
2211	DCM	SS7IPGW						
2213	DCM	SS7IPGW						
2215	DCM	IPGWI						
2217	DCM	IPGWI						
2301	DCM	SS7IPGW						
2303	DCM	SS7IPGW						
2305	DCM	IPGWI						
2307	DCM	IPGWI						
2311	DCM	IPLIMI						
2313	DCM	ILIMI						

Continue the procedure by performing one of these actions.

- If the required unprovisioned card slots (see the Card Slot Selection section) are shown in the `rtrv-card` output, continue the procedure with [Step 5](#).
 - If the required unprovisioned card slots are not shown in the `rtrv-card` output, [Step 3](#) must be performed.
3. Display the shelves in the database by entering the `rtrv-shlf` command. This is an example of the possible output.

```
rlghncxa03w 08-03-05 08:12:53 GMT 38.0.0
SHELF DISPLAY
FRAME SHELF TYPE
1 1 CONTROL
1 2 EXTENSION
1 3 EXTENSION
2 1 EXTENSION
2 2 EXTENSION
2 3 EXTENSION
```

If all the shelves are provisioned in the database, then the remainder of this procedure cannot be performed. There are no available card slots for the new IPSG card.

If all the shelves have not been provisioned in the database, continue the procedure with [Step 4](#).

4. Add the required shelf using the `ent-shlf` command with the location of the shelf and the `type=ext` parameter. The shelf location values are 1200, 1300, 2100, 2200, 2300, 3100, 3200, 3300, 4100, 4200, 4300, 5100, 5200, 5300, and 6100. For this example, enter this command.

```
ent-shlf:loc=3100:type=ext
```

When this command has successfully completed, this message should appear.

```
rlghncxa03w 07-05-01 09:12:36 GMT EAGLE5 37.0.0
ENT-SHLF: MASP A - COMPLTD
```

5. Verify that the card to be entered has been physically installed into the proper location (see the [Card Slot Selection](#) section). If the card has not been installed, insert the card into the desired card location following the rules described in the [Card Slot Selection](#) section.



Caution: If the versions of the flash GPLs on the IPSG card do not match the flash GPL versions in the database when the IPSG card is inserted into the card slot, UAM 0002 is generated indicating that these GPL versions do not match. If UAM 0002 has been generated, perform the alarm clearing procedure for UAM 0002 in *Unsolicted Alarm and Information Messages Reference* before proceeding with this procedure.

6. Verify that HIPR2 cards are installed in card locations 9 and 10 in the shelf containing the E5-ENET card being added in this procedure. Enter this command.

```
rept-stat-gpl:gpl=hipr2
```

This is an example of the possible output.

```
rlghncxa03w 09-07-05 08:12:53 GMT 41.1.0
GPL      CARD      RUNNING      APPROVED      TRIAL
HIPR2    1109    132-002-000  132-002-000  132-003-000
HIPR2    1110    132-002-000  132-002-000  132-003-000
HIPR2    1209    132-002-000  132-002-000  132-003-000
HIPR2    1210    132-002-000  132-002-000  132-003-000
HIPR2    1309    132-002-000  132-002-000  132-003-000
HIPR2    1310    132-002-000  132-002-000  132-003-000
HIPR2    2109    132-002-000  132-002-000  132-003-000
HIPR2    2110    132-002-000  132-002-000  132-003-000
HIPR2    2209    132-002-000  132-002-000  132-003-000
HIPR2    2210    132-002-000  132-002-000  132-003-000
HIPR2    2309    132-002-000  132-002-000  132-003-000
HIPR2    2310    132-002-000  132-002-000  132-003-000
Command Completed
```

If HIPR2 cards are installed in the shelf containing the E5-ENET card, continue the procedure with [Step 11](#).

If HIPR or HIPR2 cards are not installed on the shelf containing the E5-ENET card, go to *Installation Guide* and install the HIPR or HIPR2 cards. Once the HIPR or HIPR2 cards have been installed, continue the procedure with [Step 11](#).

7. Enter the `rtrv-stpopts` command to verify whether or not the MFC option is on.

This is an example of the possible output.

```
rlghncxa03w 11-10-17 16:02:05 GMT EAGLE5 44.0.0
STP OPTIONS
-----
MFC                               off
```

The `rtrv-stpopts` command output contains other fields that are not used by this procedure. To see all fields displayed by the `rtrv-stpopts` command, see the `rtrv-stpopts` command description in *Commands User's Guide*.

If the MFC option is off, perform the Configuring the MFC Option procedure in *Database Administration - System Management User's Guide* to turn on the MFC option.

If the MFC option is on or the Configuring the MFC Option procedure in *Database Administration - System Management User's Guide* was performed in this step, continue the procedure with [Step 8](#).

Note: The Fan feature must be purchased before you turn this feature on with the `chg-feat` command. If you are not sure if you have purchased the Fan feature, contact your Sales Representative or Account Representative.

8. Enter the `rtrv-feat` command to verify that the Fan feature is on.

If the Fan feature is on, shown in the `rtrv-feat` output, the `FAN` field should be set to on.

The `rtrv-feat` command output contains other fields that are not used by this procedure. To see all fields displayed by the `rtrv-feat` command, see the `rtrv-feat` command description in *Commands User's Guide*.

If the Fan feature is on, continue the procedure with [Step 10](#).

If the Fan feature is off, continue the procedure with [Step 8](#).

9. Turn the Fan feature on by entering this command.

```
chg-feat:fan=on
```

Note: Once the Fan feature is turned on with the `chg-feat` command, it cannot be turned off.

When the `chg-feat` has successfully completed, this message appears.

```
rlghncxa03w 11-10-28 11:43:04 GMT EAGLE5 44.0.0
CHG-FEAT: MASP A - COMPLTD
```

10. The shelf containing the E5-ENET-B card that is being added in this procedure must have fans installed. Verify whether or not fans are installed on the shelf.

If the fans are installed, continue the procedure with [Step 11](#).

If the fans are not installed on the shelf containing the E5-ENET-B card, go to *Installation Guide* and install the fans. After the fans have been installed and tested, continue the procedure with [Step 11](#).

11. Add the card using the `ent-card` command. For this example, enter these commands.

```
ent-card:loc=1311:type=enet:appl=ipsg
```

```
ent-card:loc=1313:type=enet:appl=ipsg
```

When each of these commands have successfully completed, this message should appear.

```
rlghncxa03w 06-10-12 09:12:36 GMT EAGLE5 36.0.0
ENT-CARD: MASP A - COMPLTD
```

12. Verify the changes using the `rtrv-card` command with the card location specified in [Step 11](#). For this example, enter these commands.

```
rtrv-card:loc=1311
```

This is an example of the possible output.

```
rlghncxa03w 06-10-28 09:12:36 GMT EAGLE5 36.0.0
CARD   TYPE      APPL      LSET NAME      LINK SLC LSET NAME      LINK SLC
1311   ENET        IPSG
```

```
rtrv-card:loc=1313
```

This is an example of the possible output.

```
rlghncxa03w 06-10-28 09:12:36 GMT EAGLE5 36.0.0
CARD   TYPE      APPL      LSET NAME      LINK SLC LSET NAME      LINK SLC
1313   ENET        IPSG
```

13. Back up the new changes using the `chg-db:action=backup:dest=fixed` command. These messages should appear, the active Maintenance and Administration Subsystem Processor (MASP) appears first.

```
BACKUP (FIXED) : MASP A - Backup starts on active MASP.
BACKUP (FIXED) : MASP A - Backup on active MASP to fixed disk complete.
BACKUP (FIXED) : MASP A - Backup starts on standby MASP.
BACKUP (FIXED) : MASP A - Backup on standby MASP to fixed disk complete.
```

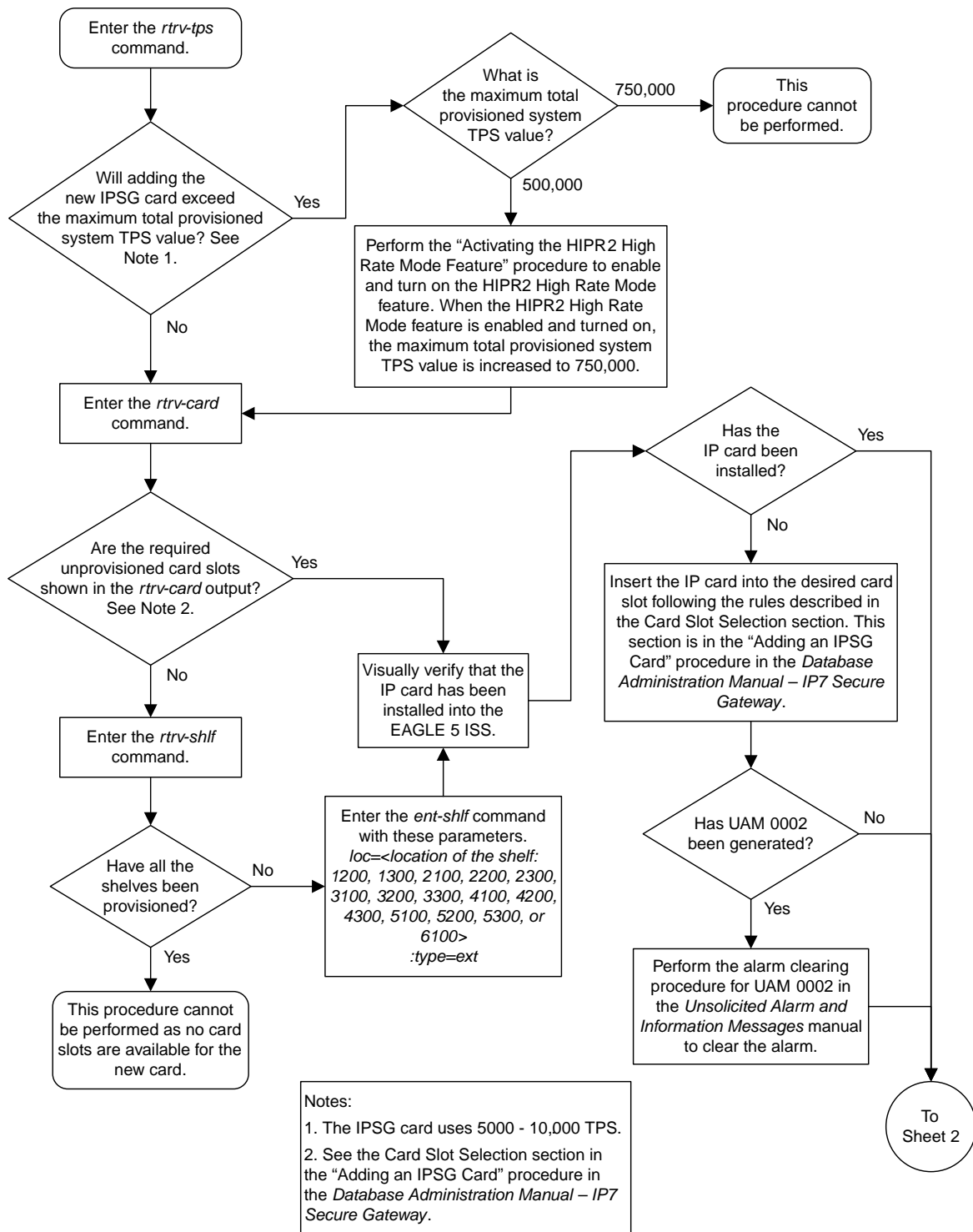

Sheet 2 of 2

Figure 89: Adding an IPSG Card

Adding an IPSG M2PA Linkset

This procedure is used to configure IPSG M2PA linksets in the EAGLE using the `ent-1s` commands with these parameters.

`:lsn` – The name of the linkset. The linkset name can contain up to 10 characters, with the first character being a letter. However, the SEAS interface supports only eight characters. If this linkset is displayed on the SEAS interface and the linkset name contains more than eight characters, only the first eight characters in the linkset name are shown. If this linkset name contains more than eight characters, and is specified with the linkset commands on the SEAS interface, only the first eight characters can be specified.

`:apc/apca/apci/apcn/apcn24` – Adjacent point code – the point code identifying the node that is next to the EAGLE. The adjacent point code can be one of the following types of point codes:

`:apc/apca` – ANSI point code, ANSI private point code

`:apci` – ITU-I point code, ITU-I spare point code, ITU-I private point code, ITU-I private spare point code.

`:apcn` – 14-bit ITU-N point code, 14-bit ITU-N spare point code, 14-bit ITU-N private point code, 14-bit ITU-N private spare point code.

`:apcn24` – 24-bit ITU-N point code, 24-bit ITU-N private point code.

Note: See the “Point Code Formats” section in *Database Administration - SS7 User’s Guide* for a definition of the point code types that are used on the EAGLE and for a definition of the different formats that can be used for ITU national point codes.

`:lst` – The linkset type of the specified linkset, a, b, c, d, e. The linkset type `prx` can also be specified for an IPSG M2PA linkset. For more information on using the `prx` linkset type, refer to the “Adding an SS7 Linkset” procedure in *Database Administration - SS7 User’s Guide*.

`:ipsg` – This parameter specifies whether or not the linkset is an IPSG linkset. This parameter has two values, `yes` (if the linkset is an IPSG linkset) or `no` (if the linkset is not an IPSG linkset). For this procedure, the `ipsg` parameter value must be `yes`.

`:maxslktps` – The maximum number of transactions per second (TPS) for all signaling links that are assigned to the IPSG M2PA linkset. See [Maximum Card Capacity for Different Card Types](#) for MaxTPS values.

`:rsvdslktps` – The number of transactions per second (TPS) that is assigned to each IPSG signaling link that will be in the linkset. See [Maximum Card Capacity for Different Card Types](#) for MaxTPS values. The `slktps` parameter can be used in place of the `rsvdslktps` parameter.

`:tpsalmtype` – The TPS threshold that will generate alarms. This parameter has two values.

- `rsvdslktps` - The RSVDSLKTPS threshold generates alarms.
- `maxslktps` - The MAXSLKTPS threshold generates alarms.

`:lsusealm` – The linkset’s TPS alarm threshold, from 10 to 100 percent of the linkset’s IPTPS. When this threshold is reached, a major alarm (UAM 0115) is generated. When the linkset’s IPTPS falls below this threshold, UAM 0115 is automatically cleared and UAM 0118 is generated.

`:slkusealm` – The signaling link TPS alarm threshold, from 10 to 100 percent of the signaling link’s fair share of the linkset’s TPS from 10 to 100 percent of the IPSG card’s capacity. See [Maximum Card Capacity for Different Card Types](#) for MaxTPS values. This threshold is reached when the signaling link’s actual usage exceeds the percentage of the signaling link’s fair share of the linkset’s TPS or the percentage of the IPGWx card’s capacity.

A signaling link’s fair share of linkset’s TPS is the linkset’s TPS divided by the number of in-service links in the linkset. For example, if the linkset TPS is 4000 and there are 4 signaling links in the linkset, all in-service, then the signaling link’s fair-share would be 1000 TPS ($4000/4=1000$). [Table 47: Signaling Link Fair Share Example](#) shows this calculation for a linkset with 1, 2, 3 and 4 in-service signaling links.

Table 47: Signaling Link Fair Share Example

Number of In-Service Signaling Links	Linkset TPS	Signaling Link Fair Share of the Linkset TPS
4	4000	1000
3	4000	1333
2	4000	2000
1	4000	4000

When this threshold is exceeded, a minor alarm (UAM 0116) is generated. When the amount of traffic on the signaling link falls below this threshold, UAM 0116 is automatically cleared and UAM 0119 is generated.

The signaling link TPS alarm shows that the linkset TPS is set too low for the linkset or that the IPSG card’s capacity has been exceeded. Setting the signaling link TPS alarm threshold lower than the linkset TPS alarm threshold can give the user an earlier indication that the linkset TPS is inadequate or that traffic is not balanced across the links in the linkset.

`:adapter` - This parameter specifies the adapter layer for the signaling links that will be assigned to the IPSG M2PA linkset. This parameter has two values, `m2pa` and `m3ua`. For an IPSG M2PA linkset, the `adapter` parameter value must be `m2pa`.

The adjacent point code (APC) for the linkset must be defined in the database, must be in the SS7 domain and cannot match the point code or capability point code of the EAGLE. The domain of the point code is shown in the `DMN` field in the output of the `rtrv-dstn` command. The point code of the EAGLE is shown in the `PCA`, `PCN`, `PCN24`, or `PCI` fields and the capability point code of the EAGLE are shown in the `CPCA`, `CPCN`, `CPCN24`, or `CPCI` fields in the output of the `rtrv-sid` command. An ANSI adjacent point code must be a full point code and cannot be a cluster point code or a network routing point code.

If the APC is not in the destination point code table, go to the “Adding a Destination Point Code” procedure in *Database Administration - SS7 User’s Guide* and add the APC to the destination point code table.

Adding the IPSG M2PA linkset cannot exceed the maximum total provisioned system TPS shown in the `rtrv-tps` output. An IPSG M2PA linkset uses from 100 to MaxTPS (see [Maximum Card Capacity for Different Card Types](#) for MaxTPS values, as provisioned by the `maxslktps` parameter.

If adding the IPSG M2PA linkset will exceed the maximum total provisioned system TPS, and the maximum total provisioned system TPS is 500,000, perform the "Activating the HIPR2 High Rate Mode" feature in *Database Administration - System Management User's Guide* to enable and turn on the HIPR2 High Rate Mode feature. When the HIPR2 High Rate Mode feature is enabled and turned on, the maximum total provisioned system TPS is increased to 1,000,000 (1M). If the maximum total provisioned system TPS is 1M, or the maximum total provisioned system TPS is 500,000 and will not be increased, and adding the IPSG M2PA linkset will exceed the maximum total provisioned system TPS, the IPSG M2PA linkset cannot be added unless the amount of available TPS is reduced enough to allow the IPSG M2PA linkset to be added. The available TPS can be reduced by performing one or more of these actions.

- The IP TPS values of some IPGWx linksets have to be changed.
- The MAXSLKTPS values of some IPSG linksets (and the RSVDSLKTPS values if necessary) have to be changed.
- Some ATM high-speed signaling links have to be removed.
- An IPLIMx card that contains signaling links has to be removed.

Other Optional Parameters

There are other optional parameters that can be used to configure an IPSG M2PA linkset. These parameters are not required for configuring an IPSG M2PA linkset. These parameters are discussed in more detail in *Commands User's Guide* or in these sections.

- These procedures in this manual:
 - [Adding a Mate IPGWx Linkset to another IPGWx Linkset](#)
 - [Removing a Mate IPGWx Linkset from another IPGWx Linkset](#)
 - [Configuring an IPGWx Linkset](#)
- These procedures in *Database Administration - SS7 User's Guide*
 - Adding an SS7 Linkset
 - Changing an SS7 Linkset
 - Configuring an ITU Linkset with a Secondary Adjacent Point Code (SAPC)
- The "Configuring a Linkset for the GSM MAP Screening Feature" procedure in *Database Administration - Features User's Guide*.

Canceling the RTRV-LS and RTRV-DSTN Commands

Because the `rtrv-ls` and `rtrv-dstn` commands used in this procedure can output information for a long period of time, the `rtrv-ls` and `rtrv-dstn` commands can be canceled and the output to the terminal stopped. There are three ways that the `rtrv-ls` and `rtrv-dstn` commands can be canceled.

- Press the F9 function key on the keyboard at the terminal where the `rtrv-ls` or `rtrv-dstn` commands were entered.
- Enter the `canc-cmd` without the `trm` parameter at the terminal where the `rtrv-ls` or `rtrv-dstn` commands were entered.
- Enter the `canc-cmd:trm=<xx>`, where `<xx>` is the terminal where the `rtrv-ls` or `rtrv-dstn` commands were entered, from another terminal other than the terminal where the `rtrv-ls` or `rtrv-dstn` commands were entered. To enter the `canc-cmd:trm=<xx>` command, the terminal

must allow Security Administration commands to be entered from it and the user must be allowed to enter Security Administration commands. The terminal's permissions can be verified with the `rtrv-secu-trm` command. The user's permissions can be verified with the `rtrv-user` or `rtrv-secu-user` commands.

For more information about the `canc-cmd` command, go to *Commands User's Guide*.

1. Display the current linksets in the database using the `rtrv-ls` command.

This is an example of the possible output.

```

rlghncxa03w 10-07-10 11:43:04 GMT EAGLE5 42.0.0

LSN          APCA   (SS7)   SCRN  SET  SET  BEI  LST  LNKS  GWS  GWS  GWS
ipgwx1      001-001-002  none  1   1   no  A   8   off off off no  off
ipgwx2      001-001-003  none  1   1   no  A   8   off off off no  off
ipgwx3      001-001-004  none  1   1   no  A   0   off off off no  off
ls1305      001-005-000  none  1   1   no  A   1   off off off no  off
ls1307      001-007-000  none  1   1   no  A   1   off off off no  off
lsniplim    002-002-002  none  1   1   no  A   3   off off off no  off
ipsglsn     003-003-003  none  1   1   no  A   6   off off off no  off
lsn2        003-003-004  none  1   1   no  A   1   off off off no  off
lsn1        003-003-005  none  1   1   no  A   1   off off off no  off
ipsglsn2    005-005-005  none  1   1   no  A   1   off off off no  off
lsnds0      009-009-009  none  1   1   no  A   2   off off off no  off

LSN          APCI   (SS7)   SCRN  SET  SET  BEI  LST  LNKS  GWS  GWS  GWS
lsnituatm   1-002-3      none  1   2   no  A   1   off off off no  off

Link set table is (12 of 1024) 1% full.

```

2. Display the point code and capability point code of the EAGLE by using the `rtrv-sid` command.

This is an example of the possible output.

```

rlghncxa03w 10-07-10 11:43:04 GMT EAGLE5 42.0.0
PCA          PCI          PCN          CLLI          PCTYPE
001-001-001  1-200-6        13482        rlghncxa03w   OTHER

CPCA
002-002-001  002-002-003   002-002-004   002-002-005
002-002-006  002-002-007   002-002-008   002-002-009
004-002-001  004-003-003   144-212-003

CPCA (LNP)
005-005-002  005-005-004   005-005-006

CPCI
1-001-1      1-001-2        1-001-3        1-001-4

CPCN
02091        02092          02094          02097
02191        02192          11177

```

3. Display the destination point codes in the database by entering the `rtrv-dstn` command. This is an example of the possible output.

```

rlghncxa03w 10-12-10 11:43:04 GMT EAGLE5 43.0.0
Extended Processing Time may be Required

  DPCA          CLLI          BEI  ELEI    ALIASI          ALIASN/N24    DMN
001-207-000    ----- no   --- -----          -----          SS7
001-001-002    ----- no   --- -----          -----          SS7
001-001-003    ----- no   --- -----          -----          SS7
001-001-004    ----- no   --- -----          -----          SS7
001-005-000    ----- no   --- -----          -----          SS7
001-007-000    ----- no   --- -----          -----          SS7
002-002-002    ----- no   --- -----          -----          SS7
003-002-004    ----- no   --- -----          -----          SS7
003-003-003    ----- no   --- -----          -----          SS7
003-003-004    ----- no   --- -----          -----          SS7
003-003-005    ----- no   --- -----          -----          SS7
005-005-005    ----- no   --- -----          -----          SS7
008-012-003    ----- no   --- -----          -----          SS7
009-002-003    ----- no   --- -----          -----          SS7
009-009-009    ----- no   --- -----          -----          SS7
010-020-005    ----- no   --- -----          -----          SS7

  DPCI          CLLI          BEI  ELEI    ALIASA          ALIASN/N24    DMN
1-002-3        ----- no   --- -----          -----          SS7
1-207-0        ----- no   --- -----          -----          SS7
0-015-0        ----- no   --- -----          -----          SS7
0-017-0        ----- no   --- -----          -----          SS7
1-011-1        ----- no   --- -----          -----          SS7
1-011-2        ----- no   --- -----          -----          SS7

Destination table is (22 of 2000) 2% full
Alias table is (0 of 12000) 0% full

```

If the new adjacent point code is not shown in the `rtrv-dstn` output, perform the "Adding a Destination Point Code" procedure in *Database Administration - SS7 User's Guide* to add the required point code. After the new adjacent point code has been added, continue the procedure with [Step 7](#).

If the new adjacent point code is shown in the `rtrv-dstn` output, continue the procedure with [Step 4](#).

4. Display the adjacent point code of the new linkset in the destination point code table by using the `rtrv-dstn` command and specifying the point code. For this example, enter this command.

```
rtrv-dstn:dpca=010-020-005
```

This is an example of the possible output.

```

rlghncxa03w 10-12-10 11:43:04 GMT EAGLE5 43.0.0

  DPCA          CLLI          BEI  ELEI    ALIASI          ALIASN/N24    DMN
010-020-005    ----- no   --- -----          -----          SS7

  SPCA          NCAI          RCAUSE NPRST  SPLITIAM  HMSMSC  HMSCP  SCCPMSGCNV
-----      -----
none         off      none      no      no      none

```



```
Destination table is (14 of 2000) 1% full
Alias table is (0 of 12000) 0% full
```

- The APC of the linkset cannot be the DPC of any exception route. Verify that the adjacent point code of the linkset is not the DPC of any exception route by entering the `rtrv-rtx` command with the `dpc/dpca/dpci/dpcn/dpcn24` parameter. The `dpc/dpca/dpci/dpcn/dpcn24` parameter value is the adjacent point code value that will be specified for the linkset.

For this example, enter this command.

```
rtrv-rtx:dpca=010-020-005
```

This is an example of the possible output.

```
rlghncxa03w 06-10-10 11:43:04 GMT EAGLE5 37.5.0
  DPCA          RTX-CRITERIA          LSN          RC          APC
  010-020-005   OPCA
                   007-008-009                   1s1305       20       001-005-000
                   008-008-008                   1s1307       40       001-007-000

DESTINATION ENTRIES ALLOCATED:    2000
  FULL DPC(s):                      13
  EXCEPTION DPC(s):                  5
  NETWORK DPC(s):                     0
  CLUSTER DPC(s):                     1
  TOTAL DPC(s):                       19
  CAPACITY (% FULL):                  1%
ALIASES ALLOCATED:                  12000
  ALIASES USED:                        0
  CAPACITY (% FULL):                   0%
X-LIST ENTRIES ALLOCATED:           500
```

If the adjacent point code of the linkset is not the DPC of a route exception table entry, no entries are displayed in the `rtrv-rtx` output, but a summary of the point code quantities is displayed, as shown in the following output example.

```
rlghncxa03w 06-10-10 11:43:04 GMT EAGLE5 37.5.0

DESTINATION ENTRIES ALLOCATED:    2000
  FULL DPC(s):                      15
  EXCEPTION DPC(s):                  5
  NETWORK DPC(s):                     0
  CLUSTER DPC(s):                     1
  TOTAL DPC(s):                       21
  CAPACITY (% FULL):                  1%
ALIASES ALLOCATED:                  12000
  ALIASES USED:                        0
  CAPACITY (% FULL):                   0%
X-LIST ENTRIES ALLOCATED:           500
```

If the point code specified in this step is shown in the `DPCA/DPCI/DPCN/ DPCN24` columns in this step, the point code value cannot be used as an adjacent point code unless one of two actions are taken:

- Choose another adjacent point code value and repeat the procedure from [Step 2](#).

- Remove all the entries displayed in this step by performing the “Removing a Route Exception Entry” procedure in *Database Administration - SS7 User’s Guide*. After the entries have been removed, continue the procedure with [Step 6](#).

If the adjacent point code of the linkset is not the DPC of a route exception table entry, continue the procedure with [Step 6](#).

- Display any entries in the route table whose DPC value is also the adjacent point code of the new linkset being added in this procedure, or the new adjacent point code of the existing linkset being changed in this procedure. Enter the `rtrv-rte` command with the `dpc/dpca/dpci/dpcn/dpcn24` parameter. The `dpc/dpca/dpci/dpcn/dpcn24` parameter value is the adjacent point code value that will be specified for the linkset. For this example, enter this command.

```
rtrv-rte:dpca=010-020-005
```

This is an example of the possible output.

```
rlghncxa03w 10-07-10 11:43:04 GMT EAGLE5 42.0.0

  DPCA          ALIASI          ALIASN/N24          LSN          RC          APCA
  010-020-005  -----
                                lsn1           1           003-003-005
                                lsn2           2           003-003-004
                                RTX:No      CLLI=-----
```

If the adjacent point code of the linkset is not the DPC of a route, the point code entry is displayed in the `rtrv-rte` output, but the LSN, RC, and APC columns contain dashes, as shown in the following output example.

```
rlghncxa03w 10-07-10 11:43:04 GMT EAGLE5 42.0.0

  DPCA          ALIASI          ALIASN/N24          LSN          RC          APCA
  010-020-005  -----
                                -----
                                RTX:No      CLLI=-----
```

If the point code specified in this step is shown in the DPCA/DPCI/DPCN/ DPCN24 columns in this step, the point code value cannot be used as an adjacent point code unless one of two actions are taken:

- Choose another adjacent point code value and repeat the procedure with [Step 2](#).
- Remove all the entries displayed in this step by performing the “Removing a Route” procedure in *Database Administration - SS7 User’s Guide*. After the entries have been removed, continue the procedure with [Step 12](#)

If the adjacent point code of the linkset is not the DPC of a route, continue the procedure with [Step 7](#).

- Display the total provisioned system TPS by entering the `rtrv-tps` command. This is an example of the possible output.

```
rlghncxa03w 10-07-10 16:20:46 GMT EAGLE 42.0.0

CARD    NUM    NUM    RSVD    MAX
TYPE   CARDS  LINKS  TPS     TPS
-----
IPGW    17     16     48000   80000
```

```

IPSG      3      7      4200      8000
IPLIM     2      4      8000      8000
ATM       2      2      3668      3668

Total provisioned System TPS (99668 of 500000) 20%

Command Completed.

```

An IPSG M2PA linkset uses 100 to MaxTPS (see [Maximum Card Capacity for Different Card Types](#) for MaxTPS values), as provisioned by the `maxslktps` parameter. If adding the new IPSG M2PA linkset will not exceed the maximum total provisioned system TPS, continue the procedure with [Step 12](#).

If adding the new IPSG M2PA linkset will exceed the maximum total provisioned system TPS, and the maximum total provisioned system TPS is 500,000 shown, perform the "Activating the HIPR2 High Rate Mode Feature" procedure in *Database Administration - System Management User's Guide* to enable and turn on the HIPR2 High Rate Mode feature. When the HIPR2 High Rate Mode feature is enabled and turned on, the maximum total provisioned system TPS is increased to 1M. After the HIPR2 High Rate Mode feature has been enabled and turned on, continue the procedure with [Step 12](#).

If the maximum total provisioned system TPS is 1M, or the maximum total provisioned system TPS is 500,000 and will not be increased, and adding the IPSG M2PA linkset will exceed the maximum total provisioned system TPS, the IPSG M2PA linkset cannot be added unless the amount of available TPS is reduced enough to allow the IPSG M2PA linkset to be added. The available TPS can be increased by performing one or more of these actions.

- The IP TPS values of some IPGWx linksets have to be changed. To perform this action, continue the procedure with [Step 10](#).
- The MAXSLKTPS values of some IPSG linksets (and the RSVDSLKTPS values if necessary) have to be changed. To perform this action, continue the procedure with [Step 10](#).
- Some ATM high-speed signaling links have to be removed. To perform this action, continue the procedure with [Step 8](#).
- An IPLIMx card that contains signaling links has to be removed. To perform this action, continue the procedure with [Step 9](#).

8. Display the ATM high-speed signaling links by entering this command.

```
rtrv-slk:type=saal
```

This is an example of the possible output.

```

rlghncxa03w 10-07-19 21:16:37 GMT EAGLE5 42.0.0

LOC LINK LSN          SLC TYPE          LP          ATM
1303 A  lsnds0          1  LIMATM          1  1.544M LINE      5  0  0

LOC LINK LSN          SLC TYPE          LP          ATM          E1ATM
1306 A  lsniuatm        0  LIME1ATM        21  2.048M LINE      5  0  ON  3  0

SLK table is (30 of 1200) 2% full.

```

If ATM high-speed signaling links are shown in the `rtrv-slk` output, perform the "Removing an SS7 Signaling Link" procedure in *Database Administration - SS7 User's Guide* to remove some of the ATM high-speed signaling links.

If ATM high-speed signaling links are not displayed in the `rtrv-slk` output, perform one or more of these actions to increase the available TPS.

Note: If one or more of these actions are not performed to increase the available TPS and the available TPS will not allow the IPSG M2PA linkset to be added, the IPSG M2PA linkset cannot be added and the remainder of this procedure cannot be performed.

- The IP TPS values of some IPGWx linksets have to be changed. To perform this action, continue the procedure with [Step 10](#).
- The MAXSLKTPS values of some IPSG linksets (and the RSVDSLKTPS values if necessary) have to be changed. To perform this action, continue the procedure with [Step 10](#).
- An IPLIMx card that contains signaling links has to be removed. To perform this action, continue the procedure with [Step 9](#).

If you do not wish to perform other actions to increase the available TPS and the available TPS will allow the IPSG M2PA linkset to be added, continue the procedure with [Step 12](#).

9. Display the signaling links that are assigned to IPLIMx cards by entering this command.

```
rtrv-slk:type=iplim
```

This is an example of the possible output.

```
rlghncxa03w 10-07-19 21:16:37 GMT EAGLE5 42.0.0

LOC LINK LSN          SLC TYPE      ANAME          SLKTPS
1301 A  lsniplim      0  IPLIM      M2PA
1301 A1 lsniplim      1  IPLIM      M2PA
1301 B1 lsniplim      2  IPLIM      M2PA
1317 A  lsniplimi     0  IPLIMI     M2PA

SLK table is (30 of 1200) 2% full.
```

If IPLIMx cards containing signaling links are shown in the `rtrv-slk` output, perform the [Removing an IPLIMx Card](#) procedure to remove an IPLIMx card and its associated signaling links.

If IPLIMx cards containing signaling links are not displayed in the `rtrv-slk` output, perform one or more of these actions to increase the available TPS.

Note: If one or more of these actions are not performed to increase the available TPS and the available TPS will not allow the IPSG M2PA linkset to be added, the IPSG M2PA linkset cannot be added and the remainder of this procedure cannot be performed.

- The IP TPS values of some IPGWx linksets have to be changed. To perform this action, continue the procedure with [Step 10](#).
- The MAXSLKTPS values of some IPSG linksets (and the RSVDSLKTPS values if necessary) have to be changed. To perform this action, continue the procedure with [Step 10](#).
- Some ATM high-speed signaling links have to be removed. To perform this action, continue the procedure with [Step 8](#).

If you do not wish to perform other actions to increase the available TPS and the available TPS will allow the IPSG M2PA linkset to be added, continue the procedure with [Step 12](#).

10. Display the IPGWx and IPSG linksets by entering this command.

```
rept-stat-iptps
```

This is an example of the possible output.

```
rlghncxa03w 10-07-19 21:16:37 GMT EAGLE5 42.0.0
IP TPS USAGE REPORT
```

	THRESH	CONFIG/ RSVD	CONFIG/ MAX		TPS	PEAK	PEAKTIMESTAMP
LSN							
ipgwx1	100%	----	32000	TX:	3700	4000	10-07-19 09:49:19
				RCV:	3650	4000	10-07-19 09:49:19
ipgwx2	100%	----	16000	TX:	4800	5000	10-07-19 09:49:09
				RCV:	4850	5000	10-07-19 09:49:09
ipgwx3	100%	----	32000	TX:	427	550	10-07-19 09:49:19
				RCV:	312	450	10-07-19 09:49:19
ipsglsn	100%	600	24000	TX:	4800	5000	10-07-19 09:49:19
				RCV:	4800	5000	10-07-19 09:49:19
ipsglsn2	100%	600	4000	TX:	427	550	10-07-19 09:49:19
				RCV:	312	450	10-07-19 09:49:19

Command Completed.

If linksets are displayed in the `rept-stat-iptps` output, continue the procedure with [Step 11](#).

If linksets are not displayed in the `rept-stat-iptps` output, perform one or more of these actions to increase the available TPS.

Note: If one or more of these actions are not performed to increase the available TPS and the available TPS will not allow the IPSG M2PA linkset to be added, the IPSG M2PA linkset cannot be added and the remainder of this procedure cannot be performed.

- An IPLIMx card that contains signaling links has to be removed. To perform this action, continue the procedure with [Step 9](#).
- Some ATM high-speed signaling links have to be removed. To perform this action, continue the procedure with [Step 8](#).

If you do not wish to perform other actions to increase the available TPS and the available TPS will allow the IPSG M2PA linkset to be added, continue the procedure with [Step 12](#).

11. Display the attributes of the linksets shown in [Step 10](#) by entering the `rtrv-ls` command with the name of the linkset shown in [Step 10](#).

For this example enter these commands.

```
rtrv-ls:lsn=ipgwx1
```

This is an example of the possible output.

```
rlghncxa03w 10-07-19 21:16:37 GMT EAGLE5 42.0.0
```

LSN	APCA	(SS7)	SCRN	L3T	SLT	SET	BEI	LST	LNKS	ACT	MES	GWS	DIS	SLSCI	NIS
ipgwx1	001-001-002		none	1	1	no	A	8	off	off	off	off	no	off	off

```

          SPCA          CLLI          TFATCABMLQ MTPRSE ASL8
          -----          -
          4              ---         no

RANDSLS
off

IPSG  IPGWAPC  GTTMODE          CGGTMOD
no    yes     CdPA              no

MATELSN      IPTPS      LSUSEALM  SLKUSEALM
-----      -         -         -
          32000      100%         80%

LOC  LINK  SLC  TYPE
1101 A    0   SS7IPGW
1102 A    1   SS7IPGW
1103 A    2   SS7IPGW
1104 A    3   SS7IPGW
1105 A    4   SS7IPGW
1106 A    5   SS7IPGW
1107 A    6   SS7IPGW
1108 A    7   SS7IPGW

Link set table is (8 of 1024) 1% full.

```

rtrv-ls:lsn=ipgwx2

This is an example of the possible output.

```

rlghncxa03w 10-07-19 21:16:37 GMT EAGLE5 42.0.0

LSN          APCA  (SS7)  L3T  SLT          GWS  GWS  GWS
ipgwx2      001-001-003  none  1    1    no  A    8    off off off no  off

          SPCA          CLLI          TFATCABMLQ MTPRSE ASL8
          -----          -
          4              ---         no

RANDSLS
off

IPSG  IPGWAPC  GTTMODE          CGGTMOD
no    yes     CdPA              no

MATELSN      IPTPS      LSUSEALM  SLKUSEALM
-----      -         -         -
          16000      100%         80%

LOC  LINK  SLC  TYPE
1111 A    0   SS7IPGW
1112 A    1   SS7IPGW
1201 A    2   SS7IPGW
1202 A    3   SS7IPGW
1203 A    4   SS7IPGW
1204 A    5   SS7IPGW
1205 A    6   SS7IPGW
1206 A    7   SS7IPGW

Link set table is (8 of 1024) 1% full.

```

rtrv-ls:lsn=ipgwx3

This is an example of the possible output.

```

rlghncxa03w 10-07-19 21:16:37 GMT EAGLE5 42.0.0

LSN              APCA  (SS7)  SCRN  SET  SET  BEI  LST  LNKS  ACT  MES  DIS  SLSCI  NIS
ipgwx3           001-001-004  none  1   1   no  A   0   off  off  off  no   off

              SPCA              CLLI              TFATCABMLQ  MTPRSE  ASL8
              -----  -----  1           ---    no

RANDSLS
off

IPSG  IPGWAPC  GTTMODE              CGGTMOD
no    yes     CdPA              no

MATELSN  IPTPS  LSUSEALM  SLKUSEALM
-----  32000  100%     80%

Link set table is (8 of 1024) 1% full.

```

```
rtrv-ls:lsn=ipsglsn
```

This is an example of the possible output.

```

rlghncxa03w 10-07-19 21:16:37 GMT EAGLE5 42.0.0

LSN              APCA  (SS7)  SCRN  SET  SET  BEI  LST  LNKS  ACT  MES  DIS  SLSCI  NIS
ipsglsn          003-003-003  none  1   1   no  A   6   off  off  off  no   off

              SPCA              CLLI              TFATCABMLQ  MTPRSE  ASL8
              -----  -----  3           ---    no

RANDSLS
off

IPSG  IPGWAPC  GTTMODE              CGGTMOD
yes   no     CdPA              no

ADAPTER  RSVDSLKTPS  MAXSLKTPS
m2pa     600      4000

TPSALM  LSUSEALM  SLKUSEALM
rsvdsltks 100%   100%

LOC  LINK  SLC  TYPE  ANAME
1303 A   0   IPGS  ipsgm2pa1
1303 A1  1   IPGS  ipsgm2pa2
1303 B1  2   IPGS  ipsgm2pa3
1303 A2  3   IPGS  ipsgm2pa4
1303 A3  4   IPGS  ipsgm2pa5
1307 A   5   IPGS  m2pa2

Link set table is (8 of 1024) 1% full.

```

```
rtrv-ls:lsn=ipsglsn2
```

This is an example of the possible output.

```

rlghncxa03w 10-07-19 21:16:37 GMT EAGLE5 42.0.0

LSN          APCA  (SS7)  SCRN  L3T  SLT          GWS  GWS  GWS
ipsglsn2    005-005-005  none  1    1    no  A    1    off off off no  off

          SPCA          CLLI          TFATCABMLQ  MTPRSE  ASL8
          -----          -----          1          ---    no

RANDSLS
off

IPSG  IPGWAPC  GTTMODE          CGGTMOD
yes   no      CdPA          no

ADAPTER  RSVDSLKTPS  MAXSLKTPS
m2pa     600        4000

TPSALM   LSUSEALM   SLKUSEALM
rsvdslktps 100%    100%

LOC  LINK  SLC  TYPE  ANAME
1303 B3   0    IPSG  ipsgm2pa6

Link set table is (8 of 1024) 1% full.

```

Perform one or both of these actions as necessary.

- Perform the [Configuring an IPGWx Linkset](#) procedure to change the IPTPS value for any linksets shown in the `rtrv-ls` output whose IPGWAPC value is `yes`.
- Perform the [Changing an IPSG M2PA Linkset](#) procedure (for linkset whose IPSG value is `yes` and ADAPTER value is M2PA) or the [Changing an IPSG M3UA Linkset](#) procedure (for linkset whose IPSG value is `yes` and ADAPTER value is M3UA) to change the MAXSLKTPS value (and RSVDSLKTPS value if necessary) for any linksets shown in the `rtrv-ls` output.

Perform one or both of these actions to increase the available TPS if needed.

- An IPLIMx card that contains signaling links has to be removed. To perform this action, continue the procedure with [Step 9](#).
- Some ATM high-speed signaling links have to be removed. To perform this action, continue the procedure with [Step 8](#).

If you do not wish to perform other actions to increase the available TPS and the available TPS will allow the IPSG M2PA linkset to be added, continue the procedure with [Step 12](#).

12. Add the new linkset to the database using the `ent-ls` command. The new linkset must meet these conditions.

The name of this linkset cannot be used by another linkset – the linkset configuration is shown in the output of [Step 1](#).

The APC of the new linkset must be in the destination point code table, but cannot be either the EAGLE's point code or the EAGLE's capability point code – shown in the outputs of [Step 2](#), [Step 3](#), and [Step 4](#). The adjacent point code can be one of the following types of point codes:

:apc/apca – ANSI point code, ANSI private point code

:apci – ITU-I point code, ITU-I spare point code, ITU-I private point code, ITU-I private spare point code.

:apcn – 14-bit ITU-N point code, 14-bit ITU-N spare point code, 14-bit ITU-N private point code, 14-bit ITU-N private spare point code.

:apcn24 – 24-bit ITU-N point code, 24-bit ITU-N private point code.

These parameters and values must also be specified for the IPSG M2PA linkset:

- ipsg=yes
- adapter=m2pa
- lst=<a,b,c,d,e>
- maxslktps=<100 - > see [Maximum Card Capacity for Different Card Types](#).
- rsvdsktps=<0 - > see [Maximum Card Capacity for Different Card Types](#).

Note: The maxslktps parameter value must be greater than or equal to the rsvdsktps parameter value. The slktps parameter can be used in place of the rsvdsktps parameter.

- The ipgwpc, iptps, rcontext, and asnotif parameters cannot be specified for an IPSG M2PA linkset.
- These optional parameters can be specified with the ent-ls command.
 - lsusealm - the linkset's IP TPS alarm threshold. The default value for the lsusealm parameter is 100.
 - slkusealm - the signaling link IP TPS alarm threshold. The default value for the slkusealm parameter is 80.
 - tpsalmtpe - The TPS threshold that will generate alarms, either rsvdsktps or maxslktps. The default value for the tpsalmtpe parameter is rsvdsktps.

For this example, enter this command.

```
ent-ls:lsn=lsgw1107:apca=010-020-005:lst=a:ipsg=yes:rsvdsktps=200:maxslktps=1000
:lsusealm=70:slkusealm=70:adapter=m2pa
```

When this command has successfully completed, this message should appear.

```
rlghncxa03w 06-10-17 16:23:21 GMT EAGLE5 37.5.0
Link set table is ( 14 of 1024) 1% full
ENT-LS: MASP A - COMPLTD
```

13. Verify the changes using the rtrv-ls command specifying the linkset name specified in [Step 12](#) with the lsn parameter. For this example, enter these commands.

```
rtrv-ls:lsn=lsgw1107
```

This is an example of the possible output.

```
rlghncxa03w 10-07-17 11:43:04 GMT EAGLE5 42.0.0

LSN          APCA   (SS7)  SCRNL3T  SLT          GWS  GWS  GWS
lsgw1107     010-020-005  none  1    1    no  A    0    off off off no  off
              SPCA          CLLI          TFATCABMLQ MTPRSE ASL8
```

```

----- 1 --- no
RANDSLS
off
IPSG IPGWAPC GTTMODE CGGTMOD
yes no CdPA no
ADAPTER RSVDSLKTPS MAXSLKTPS
m2pa 200 1000
TPSALM LSUSEALM SLKUSEALM
rsvdslktps 70% 70%
Link set table is ( 14 of 1024) 1% full

```

14. Back up the new changes using the `chg-db:action=backup:dest=fixed` command. These messages should appear, the active Maintenance and Administration Subsystem Processor (MASP) appears first.

```

BACKUP (FIXED) : MASP A - Backup starts on active MASP.
BACKUP (FIXED) : MASP A - Backup on active MASP to fixed disk complete.
BACKUP (FIXED) : MASP A - Backup starts on standby MASP.
BACKUP (FIXED) : MASP A - Backup on standby MASP to fixed disk complete.

```

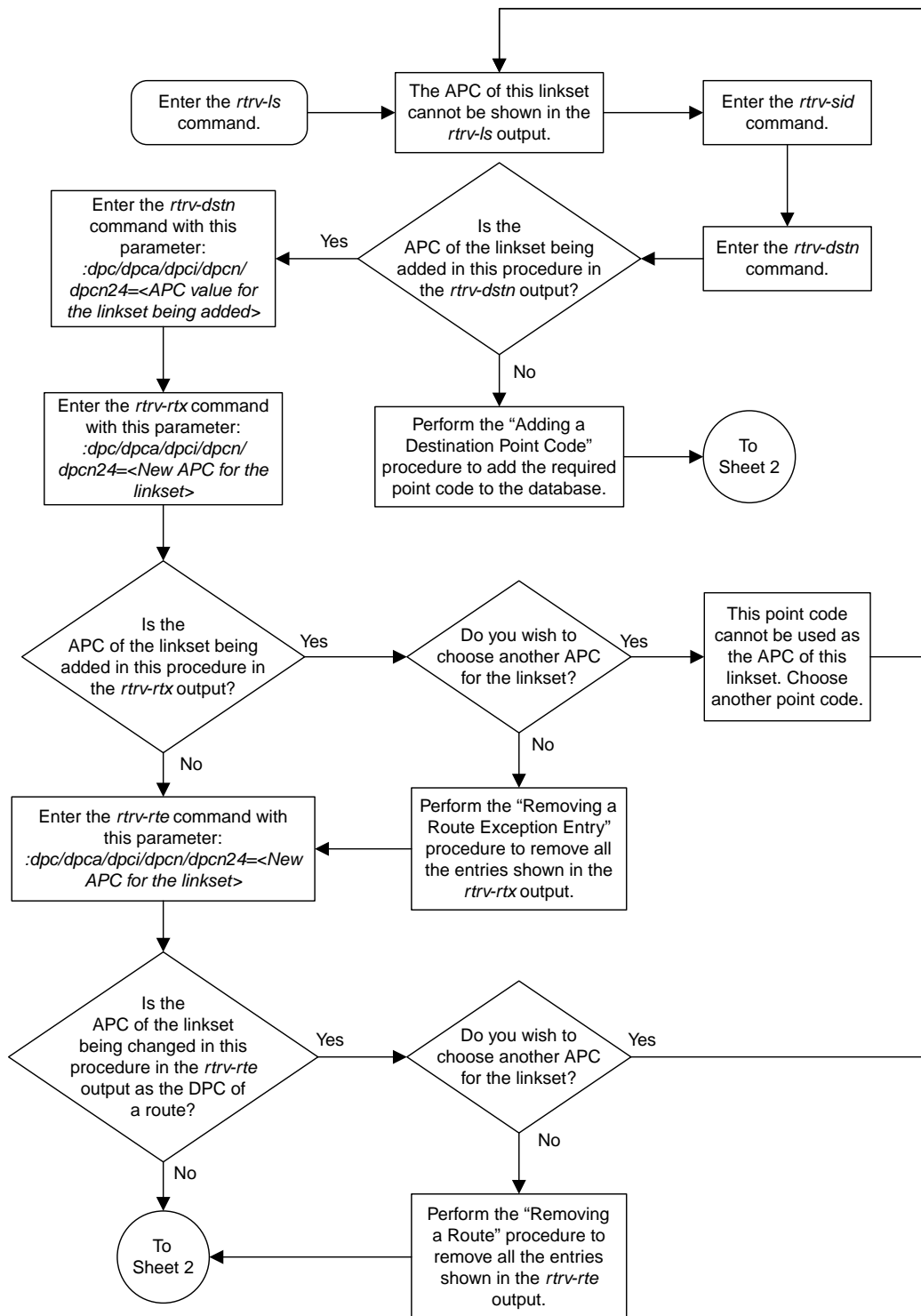

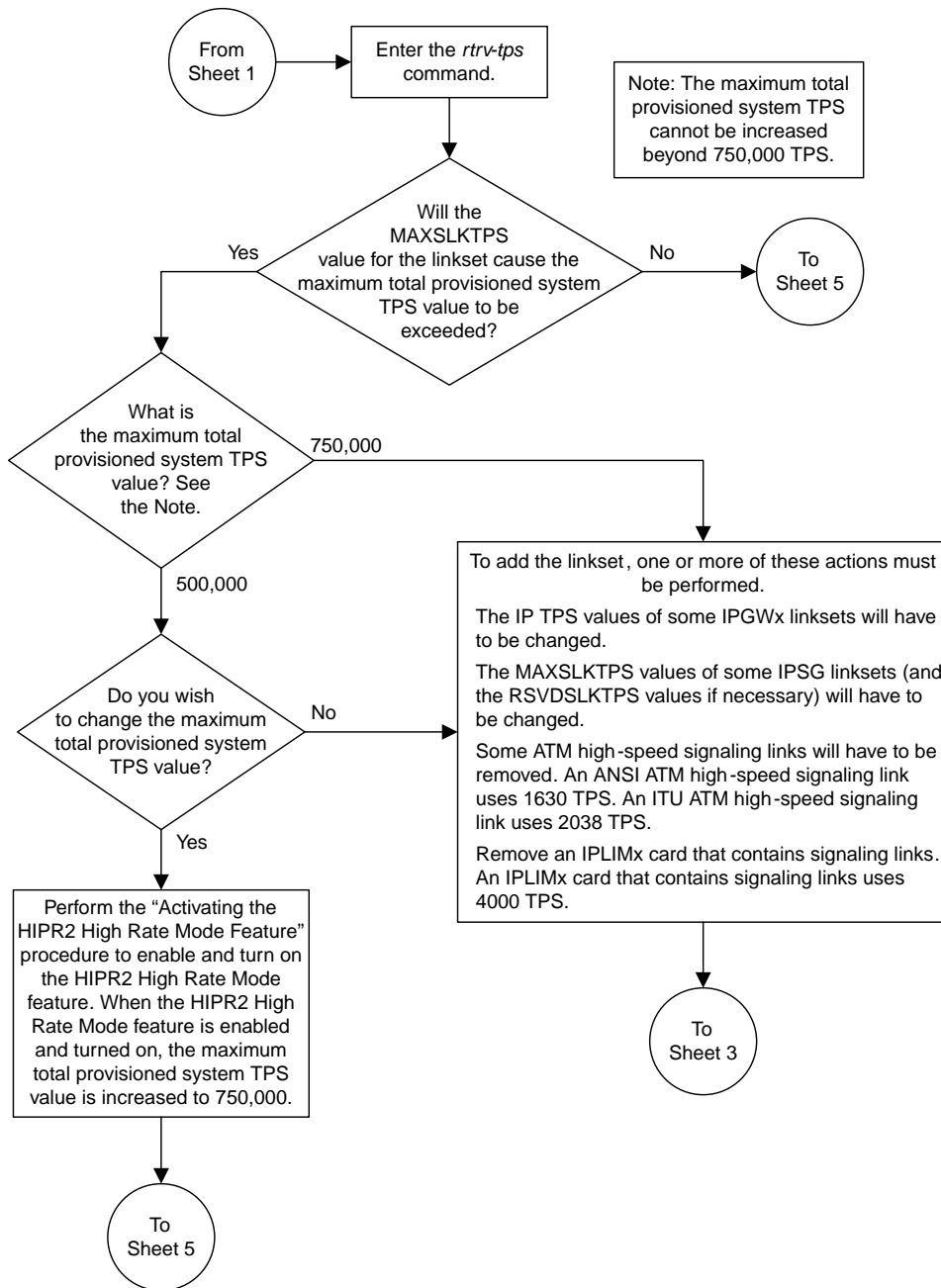

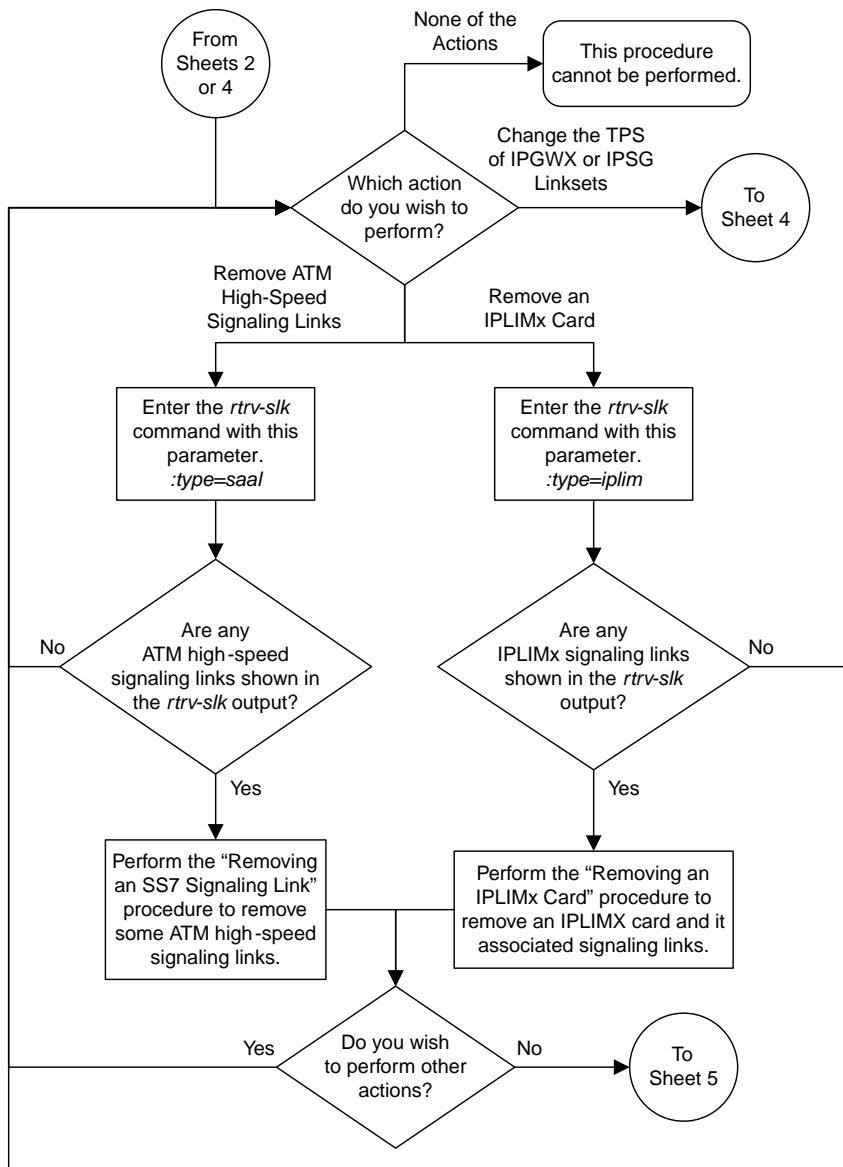

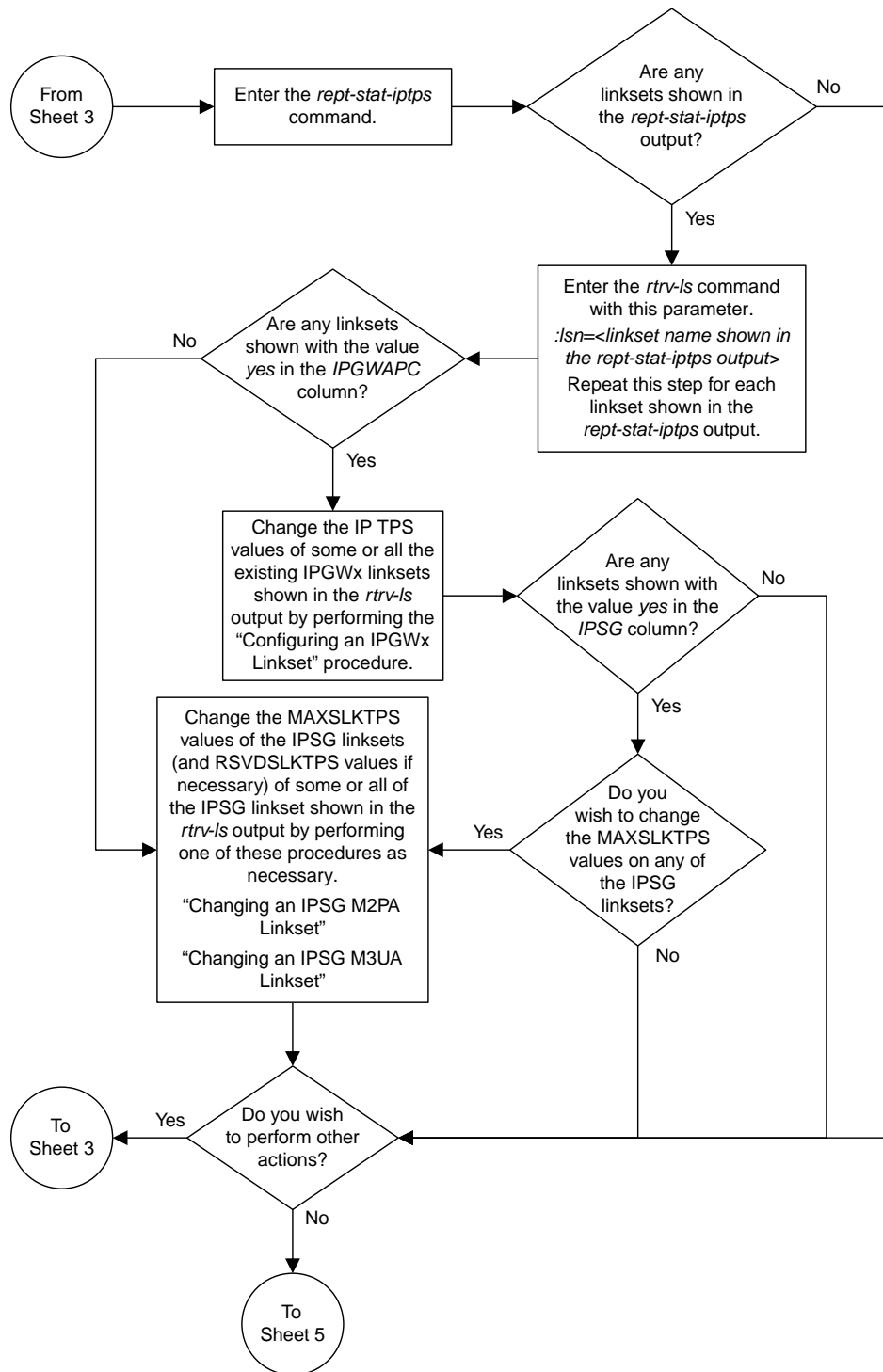

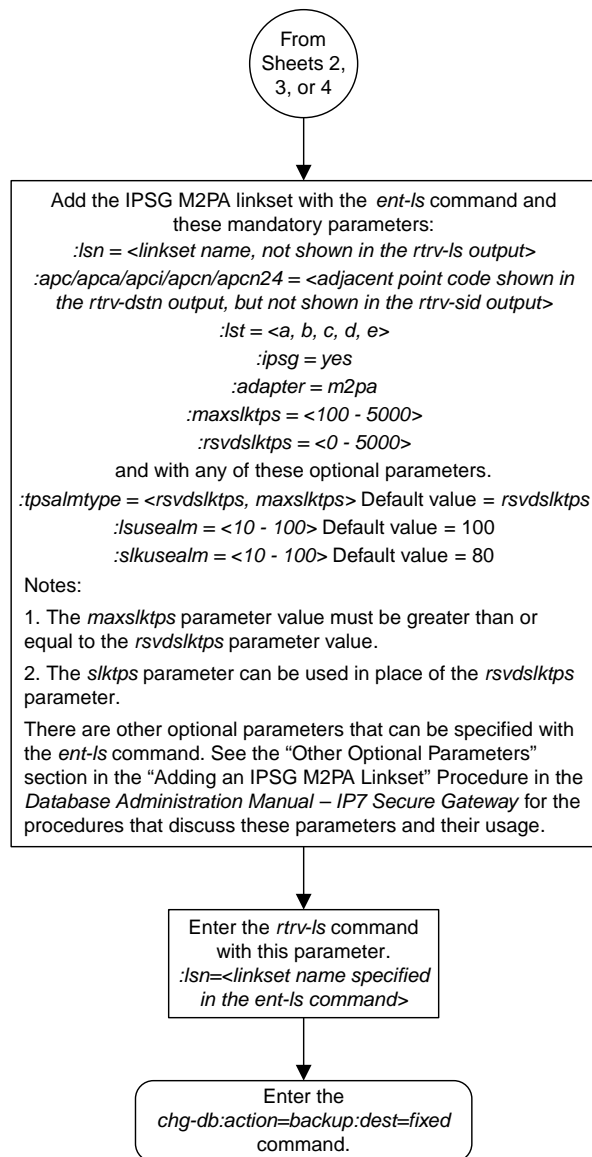

Sheet 5 of 5

Figure 90: Adding an IPSG M2PA Linkset

Adding an IPSG M3UA Linkset

This procedure is used to configure IPSG M3UA linksets in the EAGLE using the `ent-ls` command with these parameters.

`:lsn` – The name of the linkset. The linkset name can contain up to 10 characters, with the first character being a letter. However, the SEAS interface supports only eight characters. If this linkset is displayed on the SEAS interface and the linkset name contains more than eight characters, only the first eight characters in the linkset name are shown. If this linkset name contains more than eight characters, and is specified with the linkset commands on the SEAS interface, only the first eight characters can be specified.

`:apc/apca/apci/apcn/apcn24` – Adjacent point code – the point code identifying the node that is next to the EAGLE. The adjacent point code can be one of the following types of point codes:

`:apc/apca` – ANSI point code, ANSI private point code

`:apci` – ITU-I point code, ITU-I spare point code, ITU-I private point code, ITU-I private spare point code.

`:apcn` – 14-bit ITU-N point code, 14-bit ITU-N spare point code, 14-bit ITU-N private point code, 14-bit ITU-N private spare point code.

`:apcn24` – 24-bit ITU-N point code, 24-bit ITU-N private point code.

Note: See the “Point Code Formats” section in *Database Administration - SS7 User’s Guide* for a definition of the point code types that are used on the EAGLE and for a definition of the different formats that can be used for ITU national point codes.

`:lst` – The linkset type of the linkset. For an IPSG M3UA linkset, only one value can be specified, A.

`:ipsg` – This parameter specifies whether or not the linkset is an IPSG linkset. This parameter has two values, `yes` (if the linkset is an IPSG linkset) or `no` (if the linkset is not an IPSG linkset). For this procedure, the `ipsg` parameter value must be `yes`.

`:maxslktps` – The maximum number of transactions per second (TPS) for all signaling links that are assigned to the IPSG M3UA linkset. See [Maximum Card Capacity for Different Card Types](#) for MaxTPS values.

`:rsvdslktps` – The number of transactions per second (TPS) that is assigned to each IPSG signaling link that will be in the linkset. See [Maximum Card Capacity for Different Card Types](#) for MaxTPS values. The `slktps` parameter can be used in place of the `rsvdslktps` parameter.

`:tpsalmtype` – The TPS threshold that will generate alarms. This parameter has two values.

- `rsvdslktps` - The RSVDSLKTPS threshold generates alarms.
- `maxslktps` - The MAXSLKTPS threshold generates alarms.

`:lsusealm` – The linkset’s TPS alarm threshold, from 10 to 100 percent of the linkset’s TPS. When this threshold is reached, a major alarm (UAM 0115) is generated. When the linkset’s TPS falls below this threshold, UAM 0115 is automatically cleared and UAM 0118 is generated.

`:slkusealm` – The signaling link TPS alarm threshold, from 10 to 100 percent of the signaling link's fair share of the linkset's TPS from 10 to 100 percent of the IPSG card's capacity (5000 TPS). This threshold is reached when the signaling link's actual usage exceeds the percentage of the signaling link's fair share of the linkset's TPS or the percentage of the IPSG card's capacity.

A signaling link's fair share of linkset's TPS is the linkset's TPS divided by the number of in-service links in the linkset. For example, if the linkset TPS is 4000 and there are 4 signaling links in the linkset, all in-service, then the signaling link's fair-share would be 1000 TPS ($4000/4=1000$). [Table 48: Signaling Link Fair Share Example](#) shows this calculation for a linkset with 1, 2, 3 and 4 in-service signaling links.

Table 48: Signaling Link Fair Share Example

Number of In-Service Signaling Links	Linkset TPS	Signaling Link Fair Share of the Linkset TPS
4	4000	1000
3	4000	1333
2	4000	2000
1	4000	4000

When this threshold is exceeded, a minor alarm (UAM 0116) is generated. When the amount of traffic on the signaling link falls below this threshold, UAM 0116 is automatically cleared and UAM 0119 is generated.

The signaling link TPS alarm shows that the linkset TPS is set too low for the linkset or that the IPSG card's capacity has been exceeded. Setting the signaling link TPS alarm threshold lower than the linkset TPS alarm threshold can give the user an earlier indication that the linkset TPS is inadequate or that traffic is not balanced across the links in the linkset.

`:adapter` - This parameter specifies the adapter layer for the signaling links that will be assigned to the IPSG M3UA linkset. This parameter has two values, `m2pa` and `m3ua`. For an IPSG M3UA linkset, the `adapter` parameter value must be `m3ua`.

`:rcontext` - This parameter specifies the routing context value that is assigned to the IPSG M3UA linkset. The value for this parameter is from 0 to 4294967295. The default value for this parameter is none, no value is specified.

`:asnotif` - This parameter specifies whether or not AS notifications will be sent for the IPSG M3UA linkset. This parameter has two values, `yes`, AS notifications will be sent for the linkset, and `no`, AS notifications will not be sent for the linkset. The default value for this parameter is `yes`.

The adjacent point code (APC) for the linkset must be defined in the database, must be in the SS7 domain, and cannot match the point code or capability point code of the EAGLE. The domain of the point code is shown in the `DMN` field in the output of the `rtrv-dstn` command. The point code of the EAGLE is shown in the `PCA`, `PCN`, `PCN24`, or `PCI` fields and the capability point code of the EAGLE are shown in the `CPCA`, `CPCN`, `CPCN24`, or `CPCI` fields in the output of the `rtrv-sid` command. An ANSI adjacent point code must be a full point code and cannot be a cluster point code or a network routing point code. The adjacent point code of the linkset cannot be a proxy point code, cannot have a proxy point code assigned to it, and cannot be assigned to another linkset.

If the APC is not in the destination point code table, go to the "Adding a Destination Point Code" procedure in *Database Administration - SS7 User's Guide* and add the APC to the destination point code table.

Adding the IPSG M3UA linkset cannot exceed the maximum total provisioned system TPS shown in the `rtrv-tps` output. An IPSG M3UA linkset uses from 100 to 5000 TPS, as provisioned by the `maxslktps` parameter.

If adding the IPSG M3UA linkset will exceed the maximum total provisioned system TPS, and the maximum total provisioned system TPS is 500,000, perform the "Activating the HIPR2 High Rate Mode" feature in the *Database Administration - System Management User's Guide* to enable and turn on the HIPR2 High Rate Mode feature. When the HIPR2 High Rate Mode feature is enabled and turned on, the maximum total provisioned system TPS is increased to 1,000,000 (1M). If the maximum total provisioned system TPS is 1M, or the maximum total provisioned system TPS is 500,000 and will not be increased, and adding the IPSG M3UA linkset will exceed the maximum total provisioned system TPS, the IPSG M3UA linkset cannot be added unless the amount of available TPS is reduced enough to allow the IPSG M3UA linkset to be added. The available TPS can be reduced by performing one or more of these actions.

- The IP TPS values of some IPGWx linksets have to be changed.
- The MAXSLKTPS values of some IPSG linksets (and the RSVDSLKTPS values if necessary) have to be changed.
- Some ATM high-speed signaling links have to be removed.
- An IPLIMx card that contains signaling links has to be removed.

Other Optional Parameters

There are other optional parameters that can be used to configure an IPSG M3UA linkset. These parameters are not required for configuring an IPSG M3UA linkset. These parameters are discussed in more detail in *Commands User's Guide* or in these sections.

- These procedures in this manual:
 - [Adding a Mate IPGWx Linkset to another IPGWx Linkset](#)
 - [Removing a Mate IPGWx Linkset from another IPGWx Linkset](#)
 - [Configuring an IPGWx Linkset](#)
- These procedures in *Database Administration - SS7 User's Guide*
 - Adding an SS7 Linkset
 - Changing an SS7 Linkset
 - Configuring an ITU Linkset with a Secondary Adjacent Point Code (SAPC)
- The "Configuring a Linkset for the GSM MAP Screening Feature" procedure in *Database Administration - Features User's Guide*.

Note: The `mtpmse`, `spc/spca/spci/spcn/spcn24`, and `ppc/ppca/ppci/ppcn/ppcn24` parameters cannot be specified for an IPSG M3UA linkset.

Canceling the RTRV-LS and RTRV-DSTN Commands

Because the `rtrv-ls` and `rtrv-dstn` commands used in this procedure can output information for a long period of time, the `rtrv-ls` and `rtrv-dstn` commands can be canceled and the output to the terminal stopped. There are three ways that the `rtrv-ls` and `rtrv-dstn` commands can be canceled.

- Press the F9 function key on the keyboard at the terminal where the `rtrv-ls` or `rtrv-dstn` commands were entered.
- Enter the `canc-cmd` without the `trm` parameter at the terminal where the `rtrv-ls` or `rtrv-dstn` commands were entered.
- Enter the `canc-cmd:trm=<xx>`, where `<xx>` is the terminal where the `rtrv-ls` or `rtrv-dstn` commands were entered, from another terminal other than the terminal where the `rtrv-ls` or `rtrv-dstn` commands were entered. To enter the `canc-cmd:trm=<xx>` command, the terminal must allow Security Administration commands to be entered from it and the user must be allowed to enter Security Administration commands. The terminal's permissions can be verified with the `rtrv-secu-trm` command. The user's permissions can be verified with the `rtrv-user` or `rtrv-secu-user` commands.

For more information about the `canc-cmd` command, go to *Commands User's Guide*.

1. Display the current linksets in the database using the `rtrv-ls` command.

This is an example of the possible output.

```
rlghncxa03w 10-07-10 11:43:04 GMT EAGLE5 42.0.0

                L3T SLT
LSN            APCA   (SS7)  SCRN SET SET BEI LST LNKS  GWS GWS GWS
ipgwx1         001-001-002 none 1  1  no  A   8   off off off no  off
ipgwx2         001-001-003 none 1  1  no  A   8   off off off no  off
ipgwx3         001-001-004 none 1  1  no  A   0   off off off no  off
ls1305         001-005-000 none 1  1  no  A   1   off off off no  off
ls1307         001-007-000 none 1  1  no  A   1   off off off no  off
lsniplim       002-002-002 none 1  1  no  A   3   off off off no  off
ipsglsn        003-003-003 none 1  1  no  A   6   off off off no  off
lsn2           003-003-004 none 1  1  no  A   1   off off off no  off
lsn1           003-003-005 none 1  1  no  A   1   off off off no  off
ipsglsn2       005-005-005 none 1  1  no  A   1   off off off no  off
lsnds0         009-009-009 none 1  1  no  A   2   off off off no  off

                L3T SLT
LSN            APCI   (SS7)  SCRN SET SET BEI LST LNKS  GWS GWS GWS
lsnituatm      1-002-3   none 1  2  no  A   1   off off off no  off

Link set table is (12 of 1024) 1% full.
```

2. Display the point code and capability point code of the EAGLE by using the `rtrv-sid` command.

This is an example of the possible output.

```
rlghncxa03w 10-07-10 11:43:04 GMT EAGLE5 42.0.0
PCA          PCI          PCN          CLLI          PCTYPE
001-001-001  1-200-6           13482        rlghncxa03w   OTHER

CPCA
002-002-001      002-002-003      002-002-004      002-002-005
002-002-006      002-002-007      002-002-008      002-002-009
004-002-001      004-003-003      144-212-003

CPCA (LNP)
005-005-002      005-005-004      005-005-006

CPCI
```

1-001-1	1-001-2	1-001-3	1-001-4
CPCN			
02091	02092	02094	02097
02191	02192	11177	

3. Display the destination point codes in the database by entering the `rtrv-dstn` command. This is an example of the possible output.

```
rlghncxa03w 10-12-10 11:43:04 GMT EAGLE5 43.0.0
Extended Processing Time may be Required

  DPCA          CLLI          BEI  ELEI    ALIASI          ALIASN/N24    DMN
  001-207-000  ----- no  ---  -----  -----  SS7
  001-001-002  ----- no  ---  -----  -----  SS7
  001-001-003  ----- no  ---  -----  -----  SS7
  001-001-004  ----- no  ---  -----  -----  SS7
  001-005-000  ----- no  ---  -----  -----  SS7
  001-007-000  ----- no  ---  -----  -----  SS7
  002-002-002  ----- no  ---  -----  -----  SS7
  003-002-004  ----- no  ---  -----  -----  SS7
  003-003-003  ----- no  ---  -----  -----  SS7
  003-003-004  ----- no  ---  -----  -----  SS7
  003-003-005  ----- no  ---  -----  -----  SS7
  005-005-005  ----- no  ---  -----  -----  SS7
  008-012-003  ----- no  ---  -----  -----  SS7
  009-002-003  ----- no  ---  -----  -----  SS7
  009-009-009  ----- no  ---  -----  -----  SS7
  010-020-005  ----- no  ---  -----  -----  SS7

  DPCI          CLLI          BEI  ELEI    ALIASA          ALIASN/N24    DMN
  1-002-3      ----- no  ---  -----  -----  SS7
  1-207-0      ----- no  ---  -----  -----  SS7
  0-015-0      ----- no  ---  -----  -----  SS7
  0-017-0      ----- no  ---  -----  -----  SS7
  1-011-1      ----- no  ---  -----  -----  SS7
  1-011-2      ----- no  ---  -----  -----  SS7

Destination table is (22 of 2000) 2% full
Alias table is (0 of 12000) 0% full
```

If the adjacent point code is not shown in the `rtrv-dstn` output, perform the "Adding a Destination Point Code" procedure in *Database Administration - SS7 User's Guide* to add the required point code. This point code cannot be a proxy point code (the `prx=yes` value assigned to the point code) and a proxy point code (a point code value is shown in the `PPC` column) cannot be assigned to the point code. After the adjacent point code has been added, continue the procedure with [Step 7](#).

If the adjacent point code is shown in the `rtrv-dstn` output, continue the procedure with [Step 4](#).

4. Display the adjacent point code of the new linkset in the destination point code table by using the `rtrv-dstn` command and specifying the point code. For this example, enter this command.

```
rtrv-dstn:dpca=010-020-005
```

This is an example of the possible output.

```
rlghncxa03w 10-12-10 11:43:04 GMT EAGLE5 43.0.0
```

```

DPCA          CLLI          BEI ELEI  ALIASI          ALIASN/N24    DMN
010-020-005  ----- no  --- -----
                                     -----

SPCA          NCAI          RCAUSE NPRST SPLITIAM HMSMSC HMSCP SCCPMSGCNV
-----      ----
                                     none  off  none      no      no      none

Destination table is (14 of 2000) 1% full
Alias table is (0 of 12000) 0% full

```

This point code cannot be a proxy point code (the `prx=yes` value assigned to the point code) and a proxy point code (a point code value is shown in the `PPC` column) cannot be assigned to the point code. If a proxy point code is shown in this step, or if the point code is a proxy point code, choose another point code and repeat this procedure from [Step 2](#).

If a proxy point code is not shown in this step, or if the point code is not a proxy point code, continue this procedure with [Step 5](#).

- The APC of the linkset cannot be the DPC of any exception route. Verify that the adjacent point code of the linkset is not the DPC of any exception route by entering the `rtrv-rtx` command with the `dpc/dpca/dpci/dpcn/dpcn24` parameter. The `dpc/dpca/dpci/dpcn/dpcn24` parameter value is the adjacent point code value that will be specified for the linkset.

For this example, enter this command.

```
rtrv-rtx:dpca=010-020-005
```

This is an example of the possible output.

```

rlghncxa03w 06-10-10 11:43:04 GMT EAGLE5 37.5.0
  DPCA          RTX-CRITERIA          LSN          RC          APC
  010-020-005  OPCA
                   007-008-009          ls1305      20      001-005-000
                   008-008-008          ls1307      40      001-007-000

DESTINATION ENTRIES ALLOCATED:    2000
  FULL DPC(s):                    13
  EXCEPTION DPC(s):                5
  NETWORK DPC(s):                  0
  CLUSTER DPC(s):                  1
  TOTAL DPC(s):                    19
  CAPACITY (% FULL):               1%
ALIASES ALLOCATED:                12000
  ALIASES USED:                    0
  CAPACITY (% FULL):               0%
X-LIST ENTRIES ALLOCATED:         500

```

If the adjacent point code of the linkset is not the DPC of a route exception table entry, no entries are displayed in the `rtrv-rtx` output, but a summary of the point code quantities is displayed, as shown in the following output example.

```

rlghncxa03w 06-10-10 11:43:04 GMT EAGLE5 37.5.0

DESTINATION ENTRIES ALLOCATED:    2000
  FULL DPC(s):                    15
  EXCEPTION DPC(s):                5
  NETWORK DPC(s):                  0

```

```

CLUSTER DPC(s) :           1
TOTAL DPC(s) :           21
CAPACITY (% FULL) :       1%
ALIASES ALLOCATED:       12000
ALIASES USED:             0
CAPACITY (% FULL) :       0%
X-LIST ENTRIES ALLOCATED: 500

```

If the point code specified in this step is shown in the DPCA/DPCI/DPCN/ DPCN24 columns in this step, the point code value cannot be used as an adjacent point code unless one of two actions are taken:

- Choose another adjacent point code value and repeat the procedure from [Step 2](#).
- Remove all the entries displayed in this step by performing the “Removing a Route Exception Entry” procedure in the *Database Administration - SS7 User’s Guide*. After the entries have been removed, continue the procedure with [Step 6](#).

If the point code specified in this step is not shown in the DPCA/DPCI/DPCN/ DPCN24 columns in this step, continue this procedure with [Step 6](#).

6. Display any entries in the route table whose DPC value is also the adjacent point code of the new linkset being added in this procedure, or the new adjacent point code of the existing linkset being changed in this procedure. Enter the `rtrv-rte` command with the `dpc/dpca/dpci/dpcn/dpcn24` parameter. The `dpc/dpca/dpci/dpcn/dpcn24` parameter value is the adjacent point code value that will be specified for the linkset. For this example, enter this command.

```
rtrv-rte:dpca=010-020-005
```

This is an example of the possible output.

```

rlghncxa03w 10-07-10 11:43:04 GMT EAGLE5 42.0.0

DPCA          ALIASI          ALIASN/N24      LSN           RC           APCA
010-020-005  -----
                                lsn1          1             003-003-005
                                lsn2          2             003-003-004
                                RTX:No       CLLI=-----

```

If the adjacent point code of the linkset is not the DPC of a route, the point code entry is displayed in the `rtrv-rte` output, but the LSN, RC, and APC columns contain dashes, as shown in the following output example.

```

rlghncxa03w 10-07-10 11:43:04 GMT EAGLE5 42.0.0

DPCA          ALIASI          ALIASN/N24      LSN           RC           APCA
010-020-005  -----
                                lsn1          1             003-003-005
                                lsn2          2             003-003-004
                                RTX:No       CLLI=-----

```

If the point code specified in this step is shown in the DPCA/DPCI/DPCN/ DPCN24 columns in this step, the point code value cannot be used as an adjacent point code unless one of two actions are taken:

- Choose another adjacent point code value and repeat and repeat the procedure from [Step 2](#).

- Remove all the entries displayed in this step by performing the "Removing a Route" procedure in *Database Administration - SS7 User's Guide*. After the entries have been removed, continue the procedure with [Step 7](#).

If the point code specified in this step is not shown in the DPCA/DPCI/DPCN/ DPCN24 columns in this step, continue this procedure with [Step 7](#).

7. Display the total provisioned system TPS by entering the `rtrv-tps` command. This is an example of the possible output.

```
rlghncxa03w 10-07-10 16:20:46 GMT EAGLE 42.0.0

CARD      NUM      NUM      RSVD      MAX
TYPE     CARDS   LINKS    TPS       TPS
-----
IPGW      17       16      48000     80000
IPSG       3         7       4200      8000
IPLIM     2         4       8000      8000
ATM       2         2       3668      3668

Total provisioned System TPS (99668 of 500000) 20%

Command Completed.
```

An IPSG M3UA linkset uses 100 to MaxTPS (see [Maximum Card Capacity for Different Card Types](#) for MaxTPS values), as provisioned by the `maxslktps` parameter. If adding the new IPSG M3UA linkset will not exceed the maximum total provisioned system TPS, continue the procedure with [Step 12](#).

If adding the new IPSG M3UA linkset will exceed the maximum total provisioned system TPS, and the maximum total provisioned system TPS is 500,000 shown, perform the "Activating the HIPR2 High Rate Mode Feature" procedure in *Database Administration - System Management User's Guide* to enable and turn on the HIPR2 High Rate Mode feature. When the HIPR2 High Rate Mode feature is enabled and turned on, the maximum total provisioned system TPS is increased to 1M. After the HIPR2 High Rate Mode feature has been enabled and turned on, continue the procedure with [Step 12](#).

If the maximum total provisioned system TPS is 1M, or the maximum total provisioned system TPS is 500,000 and will not be increased, and adding the IPSG M3UA linkset will exceed the maximum total provisioned system TPS, the IPSG M3UA linkset cannot be added unless the amount of available TPS is reduced enough to allow the IPSG M3UA linkset to be added. The available TPS can be increased by performing one or more of these actions.

- The IP TPS values of some IPGWx linksets have to be changed. To perform this action, continue the procedure with [Step 10](#).
- The MAXSLKTPS values of some IPSG linksets (and the RSVDSLKTPS values if necessary) have to be changed. To perform this action, continue the procedure with [Step 10](#).
- Some ATM high-speed signaling links have to be removed. To perform this action, continue the procedure with [Step 8](#).
- An IPLIMx card that contains signaling links has to be removed. To perform this action, continue the procedure with [Step 9](#).

8. Display the ATM high-speed signaling links by entering this command.

```
rtrv-slk:type=saal
```

This is an example of the possible output.

```
rlghncxa03w 10-07-19 21:16:37 GMT EAGLE5 42.0.0

LOC LINK LSN          SLC TYPE          LP          ATM
1303 A  lsnds0          1  LIMATM        1  1.544M LINE    5  0  0

LOC LINK LSN          SLC TYPE          LP          ATM          E1ATM
1306 A  lsnituatm      0  LIME1ATM     21  2.048M LINE    5  0  ON  3  0

SLK table is (30 of 1200) 2% full.
```

If ATM high-speed signaling links are shown in the `rtrv-slkl` output, perform the "Removing an SS7 Signaling Link" procedure in the *Database Administration - SS7 User's Guide* to remove some of the ATM high-speed signaling links.

If ATM high-speed signaling links are not displayed in the `rtrv-slkl` output, perform one or more of these actions to increase the available TPS.

Note: If one or more of these actions are not performed to increase the available TPS and the available TPS will not allow the IPSG M3UA linkset to be added, the IPSG M3UA linkset cannot be added and the remainder of this procedure cannot be performed.

- The IP TPS values of some IPGWx linksets have to be changed. To perform this action, continue the procedure with [Step 10](#).
- The MAXSLKTPS values of some IPSG linksets (and the RSVDSLKTPS values if necessary) have to be changed. To perform this action, continue the procedure with [Step 10](#).
- An IPLIMx card that contains signaling links has to be removed. To perform this action, continue the procedure with [Step 9](#).

If you do not wish to perform other actions to increase the available TPS and the available TPS will allow the IPSG M3UA linkset to be added, continue the procedure with [Step 12](#).

9. Display the signaling links that are assigned to IPLIMx cards by entering this command.

```
rtrv-slkl:type=iplim
```

This is an example of the possible output.

```
rlghncxa03w 10-07-19 21:16:37 GMT EAGLE5 42.0.0

LOC LINK LSN          SLC TYPE          ANAME          SLKTPS
1301 A  lsniplim        0  IPLIM        M2PA
1301 A1 lsniplim        1  IPLIM        M2PA
1301 B1 lsniplim        2  IPLIM        M2PA
1317 A  lsniplimi       0  IPLIMI       M2PA

SLK table is (30 of 1200) 2% full.
```

If IPLIMx cards containing signaling links are shown in the `rtrv-slkl` output, perform the [Removing an IPLIMx Card](#) procedure to remove an IPLIMx card and its associated signaling links.

If IPLIMx cards containing signaling links are not displayed in the `rtrv-slkl` output, perform one or more of these actions to increase the available TPS.

Note: If one or more of these actions are not performed to increase the available TPS and the available TPS will not allow the IPSG M3UA linkset to be added, the IPSG M3UA linkset cannot be added and the remainder of this procedure cannot be performed.

- The IP TPS values of some IPGWx linksets have to be changed. To perform this action, continue the procedure with [Step 10](#).
- The MAXSLKTPS values of some IPSG linksets (and the RSVDSLKTPS values if necessary) have to be changed. To perform this action, continue the procedure with [Step 10](#).
- Some ATM high-speed signaling links have to be removed. To perform this action, continue the procedure with [Step 8](#).

If you do not wish to perform other actions to increase the available TPS and the available TPS will allow the IPSG M3UA linkset to be added, continue the procedure with [Step 12](#).

10. Display the IPGWx and IPSG linksets by entering this command.

```
rept-stat-iptps
```

This is an example of the possible output.

```
rlghncxa03w 10-07-19 21:16:37 GMT EAGLE5 42.0.0
IP TPS USAGE REPORT
```

	THRESH	CONFIG/ RSVD	CONFIG/ MAX		TPS	PEAK	PEAKTIMESTAMP

LSN							
ipgwx1	100%	----	32000	TX:	3700	4000	10-07-19 09:49:19
				RCV:	3650	4000	10-07-19 09:49:19
ipgwx2	100%	----	16000	TX:	4800	5000	10-07-19 09:49:09
				RCV:	4850	5000	10-07-19 09:49:09
ipgwx3	100%	----	32000	TX:	427	550	10-07-19 09:49:19
				RCV:	312	450	10-07-19 09:49:19
ipsglsn	100%	600	24000	TX:	4800	5000	10-07-19 09:49:19
				RCV:	4800	5000	10-07-19 09:49:19
ipsglsn2	100%	600	4000	TX:	427	550	10-07-19 09:49:19
				RCV:	312	450	10-07-19 09:49:19

```
Command Completed.
```

If linksets are displayed in the `rept-stat-iptps` output, continue the procedure with [Step 11](#).

If linksets are not displayed in the `rept-stat-iptps` output, perform one or more of these actions to increase the available TPS.

Note: If one or more of these actions are not performed to increase the available TPS and the available TPS will not allow the IPSG M3UA linkset to be added, the IPSG M3UA linkset cannot be added and the remainder of this procedure cannot be performed.

- An IPLIMx card that contains signaling links has to be removed. To perform this action, continue the procedure with [Step 9](#).
- Some ATM high-speed signaling links have to be removed. To perform this action, continue the procedure with [Step 8](#).

If you do not wish to perform other actions to increase the available TPS and the available TPS will allow the IPSG M3UA linkset to be added, continue the procedure with [Step 12](#).

11. Display the attributes of the linksets shown in [Step 10](#) by entering the `rtrv-ls` command with the name of the linkset shown in [Step 10](#).

For this example enter these commands.

```
rtrv-ls:lsn=ipgwx1
```

This is an example of the possible output.

```
rlghncxa03w 10-07-19 21:16:37 GMT EAGLE5 42.0.0

LSN              APCA   (SS7)  L3T SLT          GWS GWS GWS
ipgwx1          001-001-002  none 1   1   no  A   8   off off off no  off

              SPCA              CLLI              TFATCABMLQ MTPRSE ASL8
              -----
              4              ---   no

RANDSLS
off

IPSG  IPGWAPC  GTTMODE          CGGTMOD
no    yes     CdPA              no

MATELSN  IPTPS  LSUSEALM  SLKUSEALM
-----  32000  100%     80%

LOC  LINK  SLC  TYPE
1101 A    0   SS7IPGW
1102 A    1   SS7IPGW
1103 A    2   SS7IPGW
1104 A    3   SS7IPGW
1105 A    4   SS7IPGW
1106 A    5   SS7IPGW
1107 A    6   SS7IPGW
1108 A    7   SS7IPGW

Link set table is (8 of 1024) 1% full.
```

```
rtrv-ls:lsn=ipgwx2
```

This is an example of the possible output.

```
rlghncxa03w 10-07-19 21:16:37 GMT EAGLE5 42.0.0

LSN              APCA   (SS7)  L3T SLT          GWS GWS GWS
ipgwx2          001-001-003  none 1   1   no  A   8   off off off no  off

              SPCA              CLLI              TFATCABMLQ MTPRSE ASL8
              -----
              4              ---   no

RANDSLS
off

IPSG  IPGWAPC  GTTMODE          CGGTMOD
no    yes     CdPA              no

MATELSN  IPTPS  LSUSEALM  SLKUSEALM
-----  16000  100%     80%
```

```

LOC  LINK  SLC  TYPE
1111 A    0   SS7IPGW
1112 A    1   SS7IPGW
1201 A    2   SS7IPGW
1202 A    3   SS7IPGW
1203 A    4   SS7IPGW
1204 A    5   SS7IPGW
1205 A    6   SS7IPGW
1206 A    7   SS7IPGW
    
```

Link set table is (8 of 1024) 1% full.

rtrv-ls:lsn=ipgwx3

This is an example of the possible output.

```

rlghncxa03w 10-07-19 21:16:37 GMT EAGLE5 42.0.0

LSN          APCA  (SS7)  SCRN  L3T  SLT  BEI  LST  LNKS  GWS  GWS  GWS  SLSCI  NIS
ipgwx3      001-001-004  none  1    1   no  A    0    off  off  off  no    off

          SPCA          CLLI          TFATCABMLQ  MTPRSE  ASL8
          -----          -----          1          ---    no

RANDSLS
off

IPSG  IPGWAPC  GTTMODE          CGGTMOD
no    yes     CdPA          no

MATELSN  IPTPS  LSUSEALM  SLKUSEALM
-----  32000  100%     80%
    
```

Link set table is (8 of 1024) 1% full.

rtrv-ls:lsn=ipsglsn

This is an example of the possible output.

```

rlghncxa03w 10-07-19 21:16:37 GMT EAGLE5 42.0.0

LSN          APCA  (SS7)  SCRN  L3T  SLT  BEI  LST  LNKS  GWS  GWS  GWS  SLSCI  NIS
ipsglsn     003-003-003  none  1    1   no  A    6    off  off  off  no    off

          SPCA          CLLI          TFATCABMLQ  MTPRSE  ASL8
          -----          -----          3          ---    no

RANDSLS
off

IPSG  IPGWAPC  GTTMODE          CGGTMOD
yes   no      CdPA          no

ADAPTER  RSVDSLKTPS  MAXSLKTPS
m2pa    600        4000
    
```

```

TPSALM      LSUSEALM      SLKUSEALM
rsvdsltktps 100%          100%

LOC  LINK  SLC  TYPE      ANAME
1303 A    0    IPSE      ipsgm2pa1
1303 A1   1    IPSE      ipsgm2pa2
1303 B1   2    IPSE      ipsgm2pa3
1303 A2   3    IPSE      ipsgm2pa4
1303 A3   4    IPSE      ipsgm2pa5
1307 A    5    IPSE      m2pa2

```

Link set table is (8 of 1024) 1% full.

```
rtrv-ls:lsn=ipsglsn2
```

This is an example of the possible output.

```

rlghncxa03w 10-07-19 21:16:37 GMT EAGLE5 42.0.0

LSN          APCA      (SS7)      SCRN  SET  SET  BEI  LST  LNKS  ACT  MES  DIS  SLSCI  NIS
ipsglsn2     005-005-005  none  1    1    no  A    1    off  off  off  no    off

          SPCA          CLLI          TFATCABMLQ  MTPRSE  ASL8
          -----  -----  1          ---    no

RANDSLS
off

IPSG  IPGWAPC  GTTMODE          CGGTMOD
yes   no      CdPA              no

ADAPTER  RSVDSLKTPS  MAXSLKTPS
m2pa     600         4000

TPSALM      LSUSEALM      SLKUSEALM
rsvdsltktps 100%          100%

LOC  LINK  SLC  TYPE      ANAME
1303 B3  0    IPSE      ipsgm2pa6

Link set table is (8 of 1024) 1% full.

```

Perform one or both of these actions as necessary.

- Perform the [Configuring an IPGWx Linkset](#) procedure to change the IPTPS value for any linksets shown in the `rtrv-ls` output whose IPGWAPC value is yes.
- Perform the [Changing an IPSG M2PA Linkset](#) procedure (for linkset whose IPSG value is yes and ADAPTER value is M2PA) or the [Changing an IPSG M3UA Linkset](#) procedure (for linkset whose IPSG value is yes and ADAPTER value is M3UA) to change the MAXSLKTPS value (and RSVDSLKTPS value if necessary) for any linksets shown in the `rtrv-ls` output.

Perform one or both of these actions to increase the available TPS if needed.

- An IPLIMx card that contains signaling links has to be removed. To perform this action, continue the procedure with [Step 9](#).

- Some ATM high-speed signaling links have to be removed. To perform this action, continue the procedure with [Step 8](#).

If you do not wish to perform other actions to increase the available TPS and the available TPS will allow the IPSG M3UA linkset to be added, continue the procedure with [Step 12](#).

12. Add the new linkset to the database using the `ent -ls` command. The new linkset must meet these conditions.

The name of this linkset cannot be used by another linkset – the linkset configuration is shown in the output of [Step 1](#).

The APC of the new linkset must be in the destination point code table, but cannot be either the EAGLE's point code or the EAGLE's capability point code – shown in the outputs of [Step 2](#), [Step 3](#), and [Step 4](#). The adjacent point code can be one of the following types of point codes:

:apc/apca – ANSI point code, ANSI private point code

:apci – ITU-I point code, ITU-I spare point code, ITU-I private point code, ITU-I private spare point code.

:apcn – 14-bit ITU-N point code, 14-bit ITU-N spare point code, 14-bit ITU-N private point code, 14-bit ITU-N private spare point code.

:apcn24 – 24-bit ITU-N point code, 24-bit ITU-N private point code.

These parameters and values must also be specified for the IPSG M3UA linkset:

- `ipsg=yes`
- `adapter=m3ua`
- `lst=a`
- `maxslktps=<100 - >` see [Maximum Card Capacity for Different Card Types](#).
- `rsvdslktps=<0 - >` see [Maximum Card Capacity for Different Card Types](#).

Note: The `maxslktps` parameter value must be greater than or equal to the `rsvdslktps` parameter value. The `slktps` parameter can be used in place of the `rsvdslktps` parameter.

- The `ipgwpc`, `iptps`, `mtprese`, `multgc`, `spc/spca/spci/spcn/spcn24`, `ppc/ppca/ppci/ppcn/ppcn24`, and `sapci/sapcn/sapcn24` parameters cannot be specified for an IPSG M3UA linkset.
- These optional parameters can be specified with the `ent -ls` command.
 - `lsusealm` - the linkset's IP TPS alarm threshold. The default value for the `lsusealm` parameter is 100.
 - `slkusealm` - the signaling link IP TPS alarm threshold. The default value for the `slkusealm` parameter is 80.
 - `rcontext` - the routing context value. The default value for the `rcontext` parameter is none.
 - `asnotif` - Are AS notifications for the linkset sent. The default value for the `asnotif` parameter is yes.
 - `tpsalmtype` - The TPS threshold that will generate alarms, either `rsvdslktps` or `maxslktps`. The default value for the `tpsalmtype` parameter is `rsvdslktps`.

Note: There are other optional parameters that can be specified with the `ent -ls` command, but are not required for an IPSG M3UA linkset. These parameters and their usage are discussed in the Other Optional Parameters section of this procedure.

For this example, enter this command.

```
ent-ls:lsn=lsgw1107:apca=010-020-005:lst=a:ipsg=yes:rsvdslktps=300:maxslktps=1000
:lsusealm=70:slkusealm=70:adapter=m3ua:rcontext=250
```

When this command has successfully completed, this message should appear.

```
rlghncxa03w 06-10-17 16:23:21 GMT EAGLE5 37.5.0
Link set table is ( 14 of 1024) 1% full
ENT-LS: MASP A - COMPLTD
```

13. Verify the changes using the `rtrv-ls` command specifying the linkset name specified in [Step 12](#) with the `lsn` parameter. For this example, enter these commands.

```
rtrv-ls:lsn=lsgw1107
```

This is an example of the possible output.

```
rlghncxa03w 10-07-17 11:43:04 GMT EAGLE5 42.0.0

LSN          APCA   (SS7)  SCRN  L3T  SLT          GWS  GWS  GWS
lsgw1107     010-020-005  none  1    1    no  A    0    off off off no  off

          SPCA          CLLI          TFATCABMLQ  MTPRSE  ASL8
          -----          -----          ---      ---      no

          IPGWAPC  GTTMODE          CGGTMOD
          yes    no      CdPA          no

          ADAPTER  RSVDSLKTPS  MAXSLKTPS
          m3ua    300        1000

          TPSALM   LSUSEALM    SLKUSEALM
          rsvdslktps 70%        70%

          RCONTEXT  ASNOTIF     NUMSLKALW  NUMSLKRSTR  NUMSLKPROH
          250      yes         1          1            1

Link set table is ( 14 of 1024) 1% full
```

14. Back up the new changes using the `chg-db:action=backup:dest=fixed` command. These messages should appear, the active Maintenance and Administration Subsystem Processor (MASP) appears first.

```
BACKUP (FIXED) : MASP A - Backup starts on active MASP.
BACKUP (FIXED) : MASP A - Backup on active MASP to fixed disk complete.
BACKUP (FIXED) : MASP A - Backup starts on standby MASP.
BACKUP (FIXED) : MASP A - Backup on standby MASP to fixed disk complete.
```

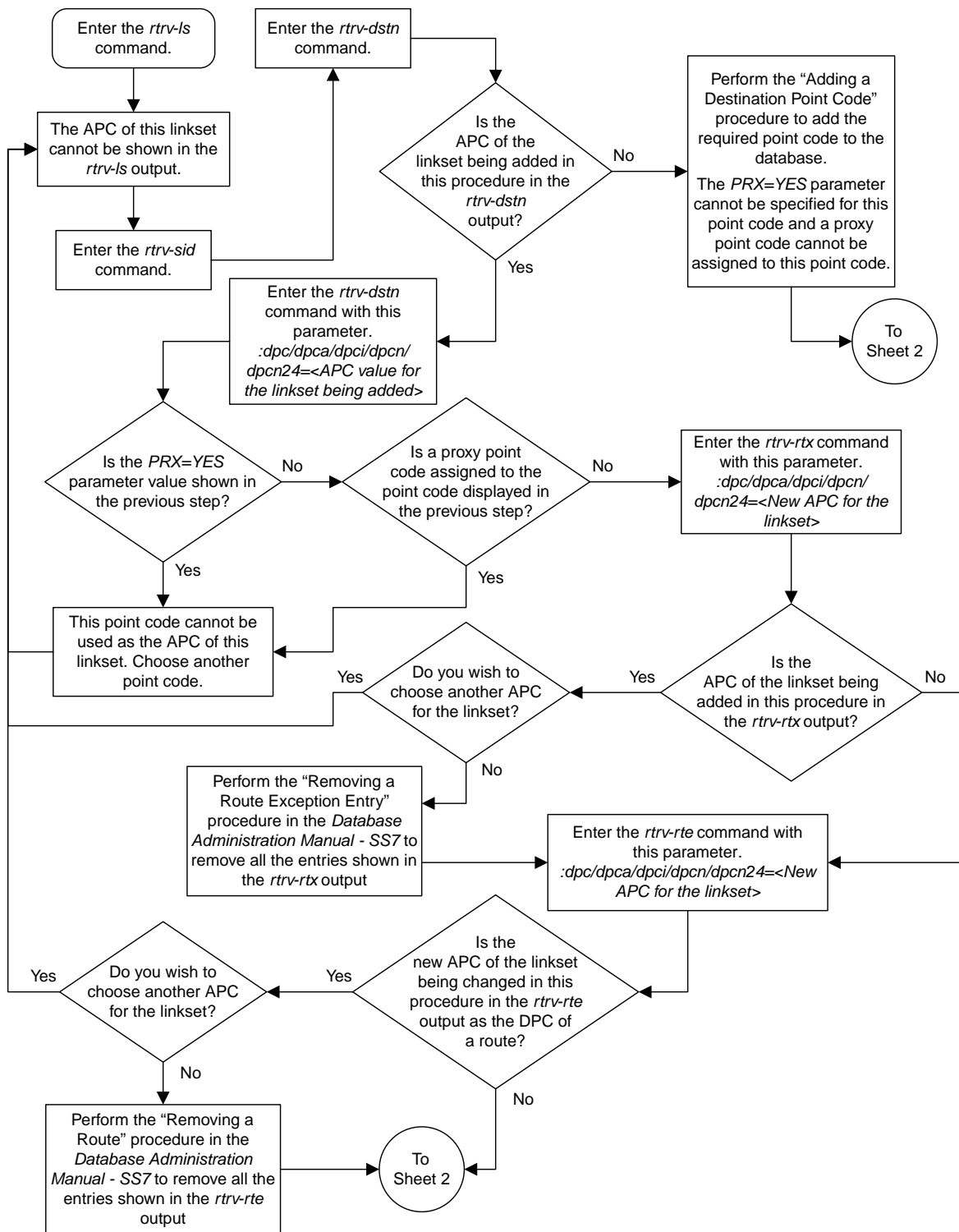

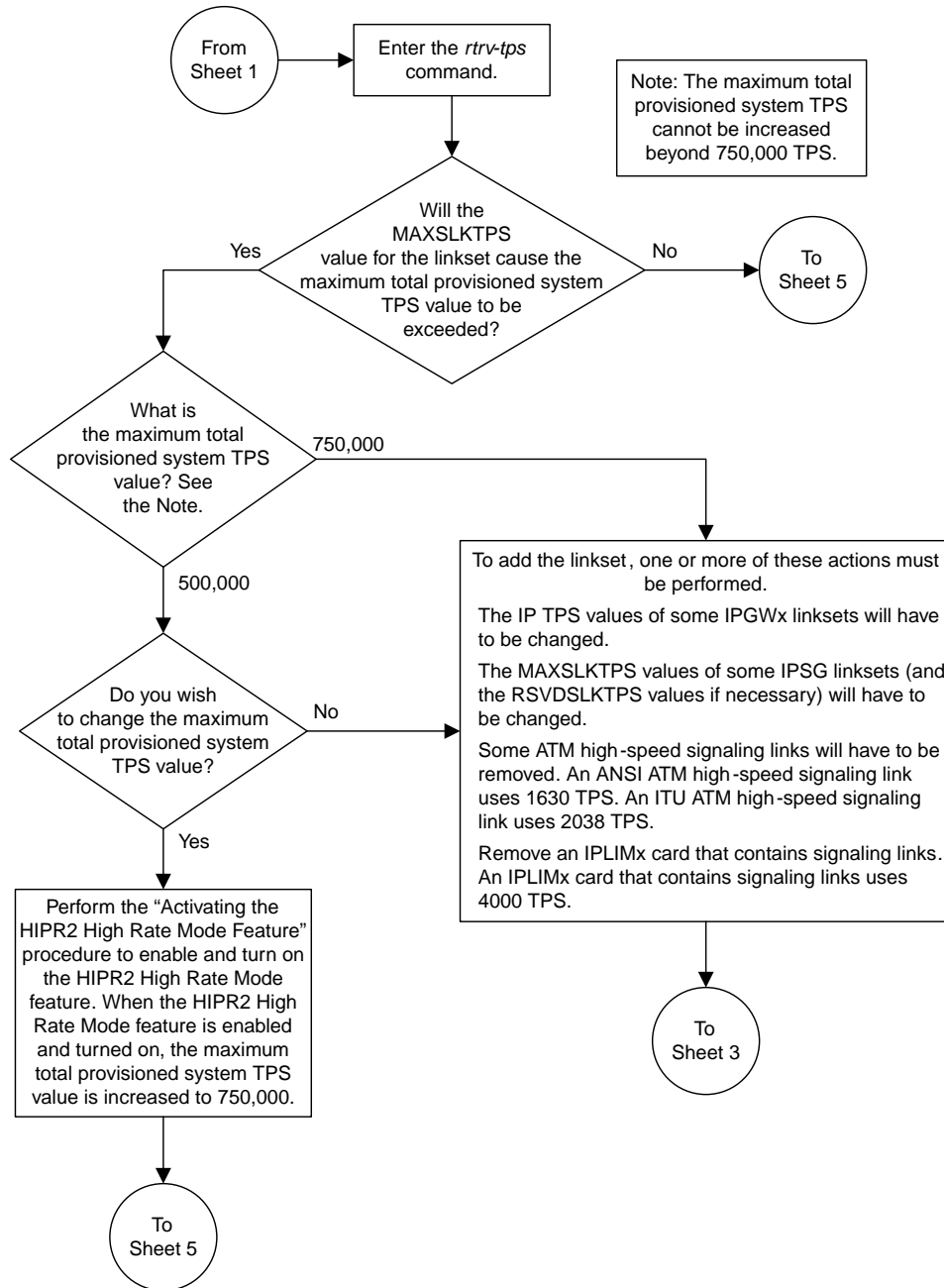

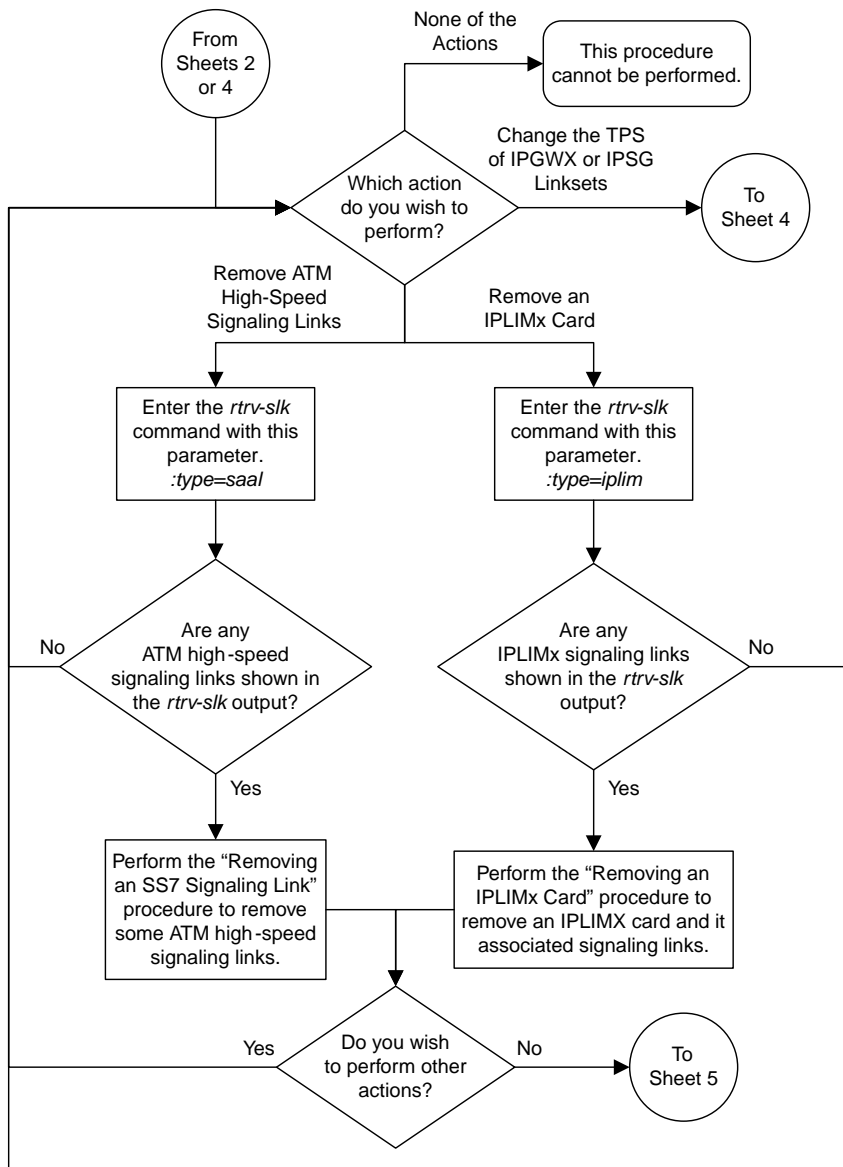

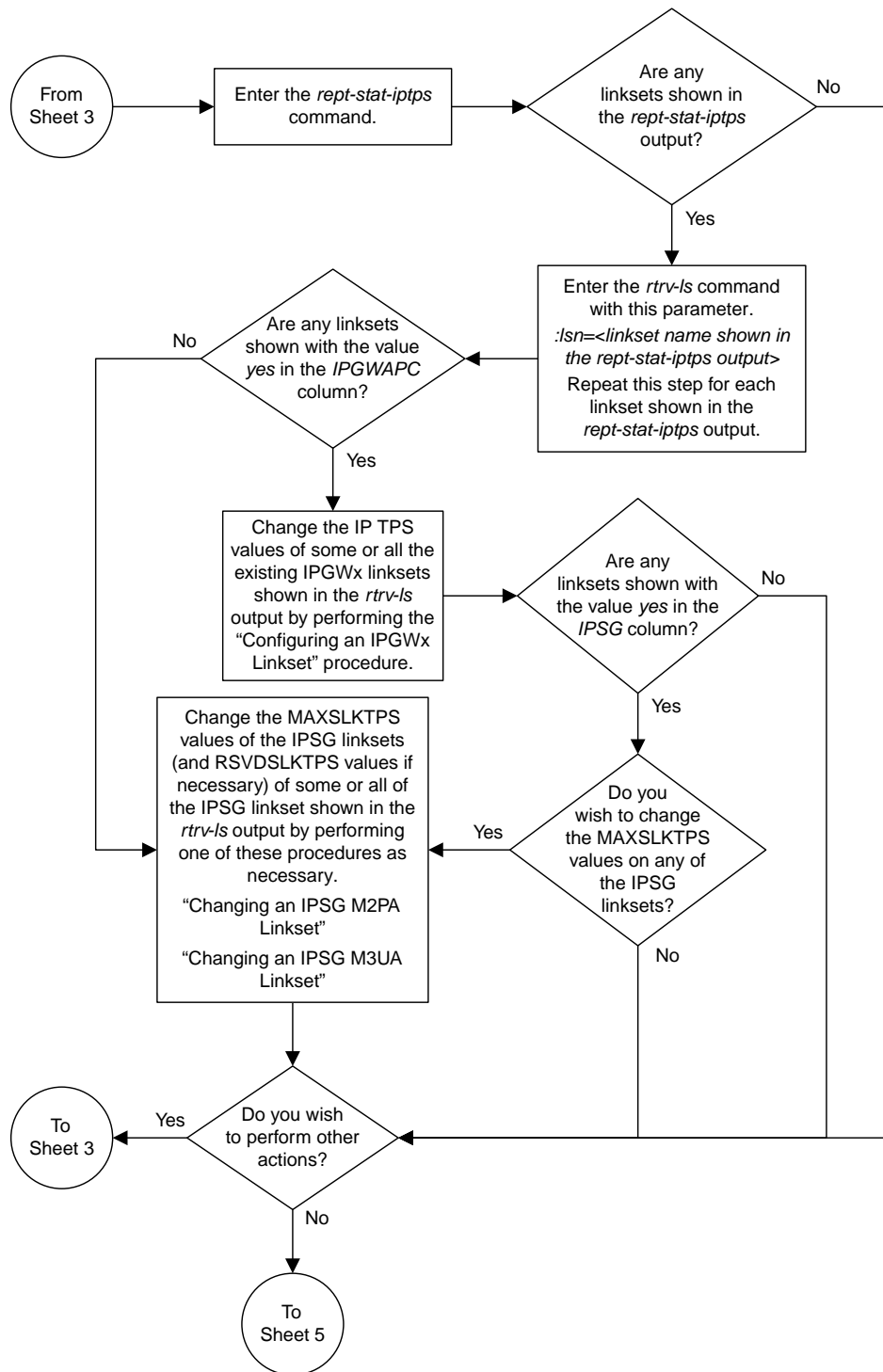

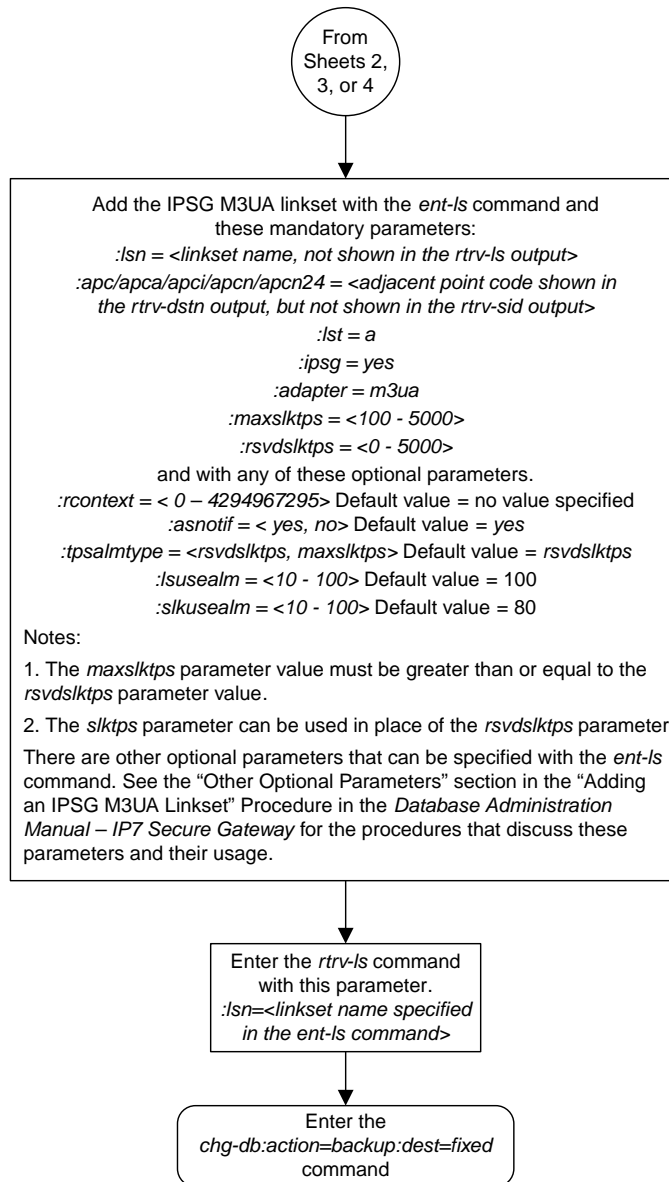

Sheet 5 of 5

Figure 91: Adding an IPSG M3UA Linkset

Configuring an IP Link

This procedure is used to configure the link parameters for IP cards using the `chg-ip-lnk` command. These link parameters are used to configure the Ethernet hardware.

The `chg-ip-lnk` command uses the following parameters.

- `:loc` – The card location of the IP card.
- `:port` – The Ethernet interface on the IP card, A or B.
- `:ipaddr` – IP address assigned to the Ethernet interface on the IP card. This is an IP address expressed in standard “dot notation.” IP addresses consist of the system’s network number and the machine’s unique host number.
- `:submask` – The subnet mask of the IP interface. A subnet mask is an IP address with a restricted range of values. The bits in the mask must be a string of one’s followed by a string of zero’s. There must be at least two one’s in the mask, and the mask cannot be all one’s. See [Table 49: Valid Subnet Mask Parameter Values](#) to assign the correct parameter values.
- `:auto` – Tells hardware whether to automatically detect the duplex and speed.
- `:duplex` – This is the mode of operation of the interface.
- `:speed` – This is the bandwidth in megabits per second of the interface.
- `:mactype` – This is the Media Access Control Type of the interface.
- `:mcast` – The multicast control flag. This parameter enables or disables multicast support for the interface.

The EAGLE can contain a maximum of 2048 IP links.

A zero `ipaddr` parameter value (0 . 0 . 0 . 0) indicates the IP card Ethernet interface to IP link association is disabled. The host to the original IP address must be removed before the `ipaddr=0 . 0 . 0 . 0` can be specified.

If the `defrouter` parameter of the `chg-ip-card` command contains an IP address for the card specified in this procedure, the network portion of one of the IP addresses assigned to the card in this procedure must match the network portion of the IP address specified by the `defrouter` parameter of the `chg-ip-card` command.

The network portion of the IP address is based on the class of the IP address (shown in [Table 49: Valid Subnet Mask Parameter Values](#)). If the IP address is a Class A IP address, the first field is the network portion of the IP address. If the IP address is a Class B IP address, the first two fields are the network portion of the IP address. If the IP address is a Class C IP address, the first three fields are the network portion of the IP address. For example, if the IP address is 193.5.207.150, a Class C IP address, the network portion of the IP address is 193.5.207.

If the `auto=yes` parameter is specified, then the `duplex` and `speed` parameters are not allowed.

The `loc` parameter value must be shown in the `rtvr-ip-card` output.

The IP card must be placed out of service.

If either the `ipaddr` or `submask` parameters are specified, then both parameters must be specified. If the `ipaddr` parameter value is zero (0.0.0.0), the `submask` parameter is not required.

The IP address and subnet mask values cannot be changed to an address representing a different network if:

- If the network interface specified by the `loc` and `port` parameters has a default router, `dnsa`, or `dsnb` parameter values assigned to it, as shown in the `rtrv-ip-card` output.
- Any IP routes, shown in the `rtrv-ip-rte` output, reference the IP address for the network interface specified by the `loc` and `port` parameters.

The IP link cannot be changed if open associations reference the IP link being changed.

The network portion of the IP addresses assigned to the IP links on an IP card must be unique. For example, if IP links are assigned to IP card 1103, the network portion of the IP address for Ethernet interface A (`port=a`) must be different from the IP address for Ethernet interface B (`port=b`).

The `submask` parameter value is based upon the `ipaddr` setting. See [Table 49: Valid Subnet Mask Parameter Values](#) for the valid input values for the `submask` and `ipaddr` parameter combinations.

Table 49: Valid Subnet Mask Parameter Values

Network Class	IP Network Address Range	Valid Subnet Mask Values
A	1.0.0.0 to 127.0.0.0	255.0.0.0 (the default value for a class A IP address) 255.192.0.0 255.224.0.0 255.240.0.0 255.248.0.0 255.252.0.0 255.254.0.0 255.255.128.1
A+B	128.0.0.0 to 191.255.0.0	255.255.0.0 (the default value for a class B IP address) 255.255.192.0 255.255.224.0 255.255.240.0 255.255.248.0 255.255.252.0 255.255.254.0 255.255.255.128
A+B+C	192.0.0.0 to 223.255.255.0	255.255.255.0 (the default value for a class C IP address) 255.255.255.192

Network Class	IP Network Address Range	Valid Subnet Mask Values
		255.255.255.224
		255.255.255.240
		255.255.255.248
		255.255.255.252

If a Class B IP address is specified for the `ipaddr` parameter of the `chg-ip-lnk` command, the subnet address that results from the `ipaddr` and `submask` parameter values cannot be the same as the subnet address that results from the `pvn` and `pvnmask`, `fcna` and `fcnamask`, or `fcnb` and `fcnbmask` parameter values of the `chg-netopts` command. The `pvn` and `pvnmask`, `fcna` and `fcnamask`, or `fcnb` and `fcnbmask` parameter values can be verified by entering the `rtrv-netopts` command. Choose `ipaddr` and `submask` parameter values for the IP link whose resulting subnet address is not be the same as the subnet address resulting from the `pvn` and `pvnmask`, `fcna` and `fcnamask`, or `fcnb` and `fcnbmask` parameter values of the `chg-netopts` command.

Canceling the RTRV-ASSOC Command

Because the `rtrv-assoc` command used in this procedure can output information for a long period of time, the `rtrv-assoc` command can be canceled and the output to the terminal stopped. There are three ways that the `rtrv-assoc` command can be canceled.

- Press the F9 function key on the keyboard at the terminal where the `rtrv-assoc` command was entered.
- Enter the `canc-cmd` without the `trm` parameter at the terminal where the `rtrv-assoc` command was entered.
- Enter the `canc-cmd:trm=<xx>`, where `<xx>` is the terminal where the `rtrv-assoc` command was entered, from another terminal other than the terminal where the `rtrv-assoc` command was entered. To enter the `canc-cmd:trm=<xx>` command, the terminal must allow Security Administration commands to be entered from it and the user must be allowed to enter Security Administration commands. The terminal's permissions can be verified with the `rtrv-secu-trm` command. The user's permissions can be verified with the `rtrv-user` or `rtrv-secu-user` commands.

For more information about the `canc-cmd` command, go to *Commands User's Guide*.

1. Display the current link parameters associated with the IP card in the database by entering the `rtrv-ip-lnk` command.

The following is an example of the possible output.

```

rlghncxa03w 08-12-28 21:14:37 GMT EAGLE5 40.0.0
LOC  PORT  IPADDR          SUBMASK          DUPLEX  SPEED  MACTYPE  AUTO  MCAST
1201  A     192.1.1.10     255.255.255.128  HALF    10     802.3    NO   NO
1201  B     -----        -----          HALF    10     DIX      NO   NO
1203  A     192.1.1.12     255.255.255.0   ----    ---    DIX      YES  NO
1203  B     -----        -----          HALF    10     DIX      NO   NO
1205  A     192.1.1.14     255.255.255.0   FULL    100    DIX      NO   NO
1205  B     -----        -----          HALF    10     DIX      NO   NO
2101  A     192.1.1.20     255.255.255.0   FULL    100    DIX      NO   NO
2101  B     -----        -----          HALF    10     DIX      NO   NO
2103  A     192.1.1.22     255.255.255.0   FULL    100    DIX      NO   NO
2103  B     -----        -----          HALF    10     DIX      NO   NO
2105  A     192.1.1.24     255.255.255.0   FULL    100    DIX      NO   NO

```

```

2105 B -----
2205 A 192.1.1.30 255.255.255.0 FULL 100 DIX NO NO
2205 B -----
2207 A 192.1.1.32 255.255.255.0 FULL 100 DIX NO NO
2207 B -----
2213 A 192.1.1.50 255.255.255.0 FULL 100 DIX NO NO
2213 B -----
2301 A 192.1.1.52 255.255.255.0 FULL 100 DIX NO NO
2301 B -----

```

```
IP-LNK table (20 of 2048) 1% full.
```

Note: If the `ipaddr=0.0.0.0` is not being specified in this procedure, continue the procedure with [Step 3](#).

- If IP address information is being added or changed (not deleted) in the link parameters, verify that the IP address is present in the IP host table by using the `rtrv-ip-host:display=all` command.

The following is an example of the possible output.

```

rlghncxa03w 08-12-28 21:15:37 GMT EAGLE5 40.0.0

LOCAL IPADDR    LOCAL HOST
192.1.1.10      IPNODE1-1201
192.1.1.12      IPNODE1-1203
192.1.1.14      IPNODE1-1205
192.1.1.20      IPNODE2-1201
192.1.1.22      IPNODE2-1203
192.1.1.24      IPNODE2-1205
192.1.1.30      KC-HLR1
192.1.1.32      KC-HLR2
192.1.1.50      DN-MS1
192.1.1.52      DN-MS2

REMOTE IPADDR    REMOTE HOST
150.1.1.5        NCDEPTECONOMIC_DEVELOPMENT. SOUTHEASTERN_COORIDOR_ASHVL. GOV

IP Host table is (11 of 4096) 0.26% full

```

If the current IP address of the IP link is shown in the `rtrv-ip-host` output, remove the host assigned to the IP address by performing the [Removing an IP Host Assigned to an IPSG Card](#) procedure.

- To change IP link parameters, the signaling links assigned to the IP card and the IP card have to be inhibited.

Display the signaling links assigned to the card shown in [Step 1](#) using the `rtrv-slk` command specifying the card location.

For this example, enter this command.

```
rtrv-slk:loc=1201
```

This is an example of the possible output.

```

rlghncxa03w 08-04-12 15:36:20 GMT 38.0.0

LOC LINK LSN          SLC TYPE      ANAME          SLKTPS
1201 A   nc001            0  IPSG         m2pa1         1015

```

```

IPTPS for LOC = 1102 is (1015 of 5000) 20%

```

- Retrieve the status of the signaling links assigned to the IP card to be changed using the `rept-stat-slk` command.

For example, enter this command.

```
rept-stat-slk:loc=1201:link=a
```

The output lists the signaling link assigned to this card:

```

rlghncxa03w 06-10-28 21:16:37 GMT EAGLE5 36.0.0
SLK      LSN      CLLI      PST      SST      AST
1201,A   nc001     -----  IS-NR
Command Completed.

```

If the signaling link is in service-normal (IS-NR), continue the procedure with [Step 5](#) to deactivate the signaling link. If the signaling link is out-of-service-maintenance disabled (OOS-MT-DSBLD), continue the procedure with [Step 7](#) to verify the IP card status.

- Deactivate the signaling links assigned to the IP card using the `dact-slk` command.

For example, enter this command.

```
dact-slk:loc=1201:link=a
```



CAUTION

Caution: This command impacts network performance and should only be used during periods of low traffic.

After this command has successfully completed, this message appears.

```

rlghncxa03w 06-10-12 09:12:36 GMT EAGLE5 36.0.0
Deactivate Link message sent to card.

```

- Verify the new link status using the `rept-stat-slk` command.

For example, enter this command.

```
rept-stat-slk:loc=1201:link=a
```

The output displays the link status as OOS-MT-DSBLD and gives off a minor alarm:

```

rlghncxa03w 06-10-27 17:00:36 GMT EAGLE5 36.0.0
SLK      LSN      CLLI      PST      SST      AST
1201,A   nc001     -----  OOS-MT-DSBLD  AVAIL  ---
ALARM STATUS = * 0236 REPT-LKS:not aligned
UNAVAIL REASON = NA
Command Completed.

```

- Verify the status of the IP card to be inhibited using the `rept-stat-card` command.

For example, enter this command.

```
rept-stat-card:loc=1201
```

This is an example of the possible output.

```

rlghncxa03w 10-12-01 09:12:36 GMT EAGLE5 43.0.0
CARD  VERSION      TYPE      GPL      PST      SST      AST
1201  133-003-000  E5ENET   IPSG     IS-NR    Active   -----
  ALARM STATUS      = No Alarms.
  BLIXP  GPL version = 133-003-000
  IMT BUS A         = Conn
  IMT BUS B         = Conn
  CURRENT TEMPERATURE = 32C ( 90F)   [ALARM TEMP: 60C (140F)]
  PEAK TEMPERATURE:  = 39C (103F)   [06-05-02 13:40]
  SIGNALING LINK STATUS
    SLK  PST      LS      CLLI
    A    IS-NR   nc001   -----
Command Completed.

```

If the IP card to be inhibited is in service-normal (IS-NR), continue the procedure with [Step 8](#) to inhibit the card. If the IP card is out-of-service-maintenance disabled (OOS-MT-DSBLD), continue the procedure with [Step 10](#) to change the IP link parameters.

- Inhibit the IP card using the `inh-card` command.

For example, enter this command.

```
inh-card:loc=1201
```

This message should appear.

```

rlghncxa03w 06-10-28 21:18:37 GMT EAGLE5 36.0.0
Card has been inhibited.

```

- Display the status of the IP card to verify that it is out-of-service maintenance-disabled (OOS-MT-DSBLD).

Enter this command.

```
rept-stat-card:loc=1201
```

This is an example of the possible output.

```

rlghncxa03w 06-10-01 09:12:36 GMT EAGLE5 36.0.0
CARD  VERSION      TYPE      GPL      PST      SST      AST
1201  133-003-000  E5ENET   IPSG     OOS-MT-DSBLD  Manual   -----
  ALARM STATUS      = No Alarms.
  BLIXP  GPL version = 133-003-000
  IMT BUS A         = Conn
  IMT BUS B         = Conn
  CURRENT TEMPERATURE = 32C ( 90F)   [ALARM TEMP: 60C (140F)]
  PEAK TEMPERATURE:  = 39C (103F)   [06-05-02 13:40]
  SIGNALING LINK STATUS
    SLK  PST      LS      CLLI
    A    IS-NR   nc001   -----
Command Completed

```

- Display the attributes of the IP card assigned to the IP link being changed by entering the `rtrv-ip-card` command and specifying the card location of the IP link.

Note: If the `ipaddr` or `submask` parameter values are not being changed, continue the procedure with [Step 13](#).

For this example, enter this command.

```
rtrv-ip-card:loc=1201
```

This is an example of the possible output.

```
rlghncxa03w 08-06-28 21:17:37 GMT EAGLE5 39.0.0
LOC 1201
  SRCHORDR  LOCAL
  DNSA      150.1.1.1
  DNSB      -----
  DEFROUTER -----
  DOMAIN    -----
  SCTPCSUM  crc32c
  BPIPADDR  -----
  BPSUBMASK -----
```

If the `rtrv-ip-card` output shows an IP address for the default router (DEFROUTER) whose network portion matches the network portion of the IP address being changed, perform the [Configuring an IP Card](#) procedure and change the IP address of the default router to 0.0.0.0.

11. Display any IP routes referencing the IP link being changed by entering the `rtrv-ip-rte` command and specifying the card location of the IP link.

For this example, enter this command.

```
rtrv-ip-rte:loc=1201
```

This is an example of the possible output.

```
rlghncxa03w 06-10-28 21:17:37 GMT EAGLE5 36.0.0
LOC  DEST          SUBMASK          GTWY
1201 128.252.10.5     255.255.255.255 140.188.13.33
1201 128.252.0.0      255.255.0.0     140.188.13.34
1201 150.10.1.1       255.255.255.255 140.190.15.3

IP Route table is (5 of 2048) 0.24% full
```

If the `rtrv-ip-rte` output shows that the card has IP routes assigned to it, perform the [Removing an IP Route](#) procedure and remove the IP routes from the database.

12. The subnet address that results from the `ipaddr` and `submask` parameter values of the `chg-ip-lnk` command cannot be the same as the subnet address that results from the `pvn` and `pvnmask`, `fcna` and `fcnamask`, or `fcnb` and `fcnbmask` parameter values of the `chg-netopts` command.

Note: If a Class A or CIP address (see [Table 49: Valid Subnet Mask Parameter Values](#)) will be specified for the `ipaddr` parameter in [Step 14](#), continue the procedure with [Step 13](#).

Display the `pvn`, `pvnmask`, `fcna`, `fcnamask`, `fcnb`, and `fcnbmask` parameter values of the `chg-netopts` command by entering the `rtrv-netopts` command.

If error message E3967 Cmd Rej: E5IS must be on is displayed after the `rtrv-netopts` command is executed, the `pvn`, `pvnmask`, `fcna`, `fcnamask`, `fcnb`, and `fcnbmask` parameters are not configured. Continue the procedure with [Step 13](#).

This is an example of the possible output if the E5IS feature is on.

```
rlghncxa03w 09-02-28 21:17:37 GMT EAGLE5 40.1.0
NETWORK OPTIONS
-----
PVN          = 128.20.30.40
PVNMASK      = 255.255.192.0
FCNA        = 170.120.50.0
FCNAMASK    = 255.255.240.0
FCNB        = 170.121.50.0
FCNBMASK    = 255.255.254.0
```

Choose `ipaddr` and `submask` parameter values for the IP link whose resulting subnet address is not be the same as the subnet address resulting from the `pvn` and `pvnmask`, `fcna` and `fcnamask`, or `fcnb` and `fcnbmask` parameter values of the `chg-netopts` command. Continue the procedure with [Step 13](#).

13. Display the associations referencing the local host name that is associated with the IP link being changed by entering the `rtrv-assoc` command and specifying the local host name shown in the `rtrv-ip-host` output in [Step 2](#).

For this example, enter this command.

```
rtrv-assoc:lhost="ipnode-1201"
```

This is an example of the possible output.

```
rlghncxa03w 06-10-28 09:12:36 GMT EAGLE5 36.0.0
CARD IPLNK
ANAME          LOC  PORT  LINK ADAPTER  LPORT  RPORT  OPEN  ALW
swbel32       1201 A    A    M2PA    1030   2345   YES   YES

IP Appl Sock/Assoc table is (3 of 4000) 1% full
Assoc Buffer Space Used (16 KB of 3200 KB) on LOC = 1201
```

If no associations are displayed in this step, continue the procedure with [Step 14](#).

If the `rtrv-assoc` output shows that the `open` parameter for any associations is `yes`, perform the [Changing the Attributes of an IPSG Association](#) procedure to change the value of the `open` parameter the associations to `no`.

14. Change the link parameters associated with the IP card in the database using the `chg-ip-lnk` command.

For this example, enter this command.

```
chg-ip-lnk:loc=1201:port=a:ipaddr=192.1.1.10:submask=255.255.255.0
:auto=yes:mactype=dix
```

When this command has successfully completed, the following message should appear.

```
rlghncxa03w 06-10-28 21:18:37 GMT EAGLE5 36.0.0
CHG-IP-LNK: MASP A - COMPLTD
```

15. Verify the new link parameters associated with the IP card that was changed in [Step 14](#) by entering the `rtrv-ip-lnk` command with the card location specified in [Step 14](#).

For this example, enter this command.

The following is an example of the possible output.

```
rlghncxa03w 07-05-28 21:14:37 GMT EAGLE5 37.0.0
LOC  PORT  IPADDR          SUBMASK          DUPLEX  SPEED  MACTYPE  AUTO  MCAST
1201  A      192.1.1.10        255.255.255.128  HALF    10     DIX      YES  NO
1201  B      -----          -----          HALF    10     DIX      NO   NO
```

16. Allow the IP card that was inhibited in [Step 8](#) by using by using the `alw-card` command.

Note: If [Step 8](#) was not performed, continue the procedure with [Step 18](#).

For example, enter this command.

```
alw-card:loc=1201
```

This message should appear.

```
rlghncxa03w 06-10-28 21:20:37 GMT EAGLE5 36.0.0
Card has been allowed.
```

17. Verify the in-service normal (IS-NR) status of the IP card using the `rept-stat-card` command.

For example, enter this command.

```
rept-stat-card:loc=1201
```

This is an example of the possible output.

```
rlghncxa03w 10-12-01 09:12:36 GMT EAGLE5 43.0.0
CARD  VERSION      TYPE      GPL      PST      SST      AST
1201  133-003-000    E5ENET   IPSG     IS-NR    Active   -----
ALARM STATUS          = No Alarms.
BLIXP  GPL version = 133-003-000
IMT BUS A              = Conn
IMT BUS B              = Conn
CURRENT TEMPERATURE   = 32C ( 90F)    [ALARM TEMP: 60C (140F)]
PEAK TEMPERATURE:     = 39C (103F)    [06-05-02 13:40]
SIGNALING LINK STATUS
  SLK  PST          LS          CLLI
  A    IS-NR       nc001      -----
Command Completed.
```

18. Activate the signaling link from [Step 5](#) using the `act-slk` command.

Note: If [Step 5](#) was not performed, continue the procedure with [Step 20](#).

For example, enter this command.

```
act-slk:loc=1201:link=a
```

The link changes its state from OOS-MT-DSBLD (out-of-service maintenance-disabled) to IS-NR (in-service normal).

The output confirms the activation.

```
rlghncxa03w 06-10-07 11:11:28 GMT EAGLE5 36.0.0
Activate Link message sent to card
```

19. Verify the in-service normal (IS-NR) status of the signaling link using the `rept-stat-slk` command.

For example, enter this command.

```
rept-stat-slk:loc=1201:link=a
```

This message should appear.

```
rlghncxa03w 06-10-28 21:16:37 GMT EAGLE5 36.0.0
SLK      LSN      CLLI      PST      SST      AST
1201,A   nc001     -----  IS-NR
Command Completed.
```

20. Perform the [Configuring an IP Card](#) procedure and change the IP address of the default router to a non-zero value, where the network portion of the default router IP address matches the network portion of the IP link's new IP address.

Note: If the `ipaddr` or `submask` values were not changed, continue the procedure with [Step 22](#).

Note: If the IP address of the default router was not changed to 0.0.0.0 in [Step 10](#), continue the procedure with [Step 21](#).

21. Perform the [Adding an IP Route](#) procedure and add the IP routes back into the database.

Note: If IP routes were not removed in [Step 11](#), continue the procedure with [Step 22](#).

22. Perform the [Changing the Attributes of an IPSG Association](#) procedure and change the value of the `open` parameter of the association to `yes`.

Note: If the `open` parameter value for an association was not changed in [Step 13](#), continue the procedure with [Step 23](#).

23. Back up the new changes using the `chg-db:action=backup:dest=fixed` command.

These messages should appear, the active Maintenance and Administration Subsystem Processor (MASP) appears first.

```
BACKUP (FIXED) : MASP A - Backup starts on active MASP.
BACKUP (FIXED) : MASP A - Backup on active MASP to fixed disk complete.
BACKUP (FIXED) : MASP A - Backup starts on standby MASP.
BACKUP (FIXED) : MASP A - Backup on standby MASP to fixed disk complete.
```

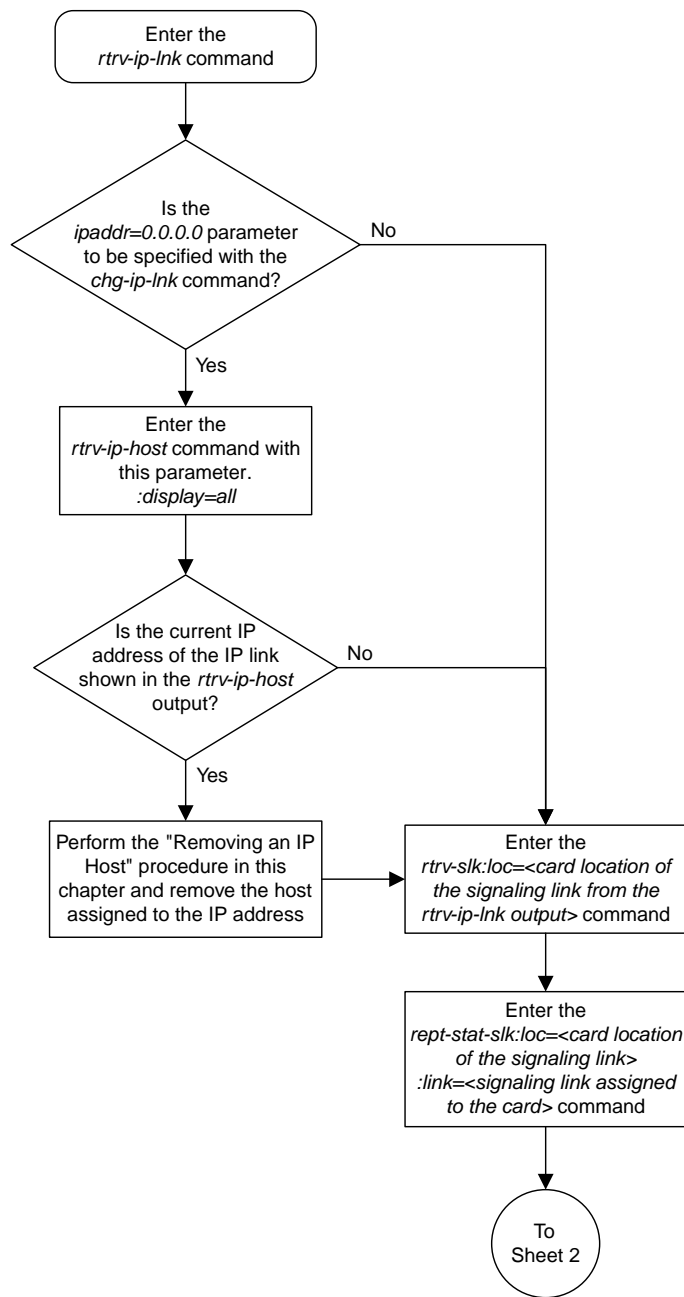

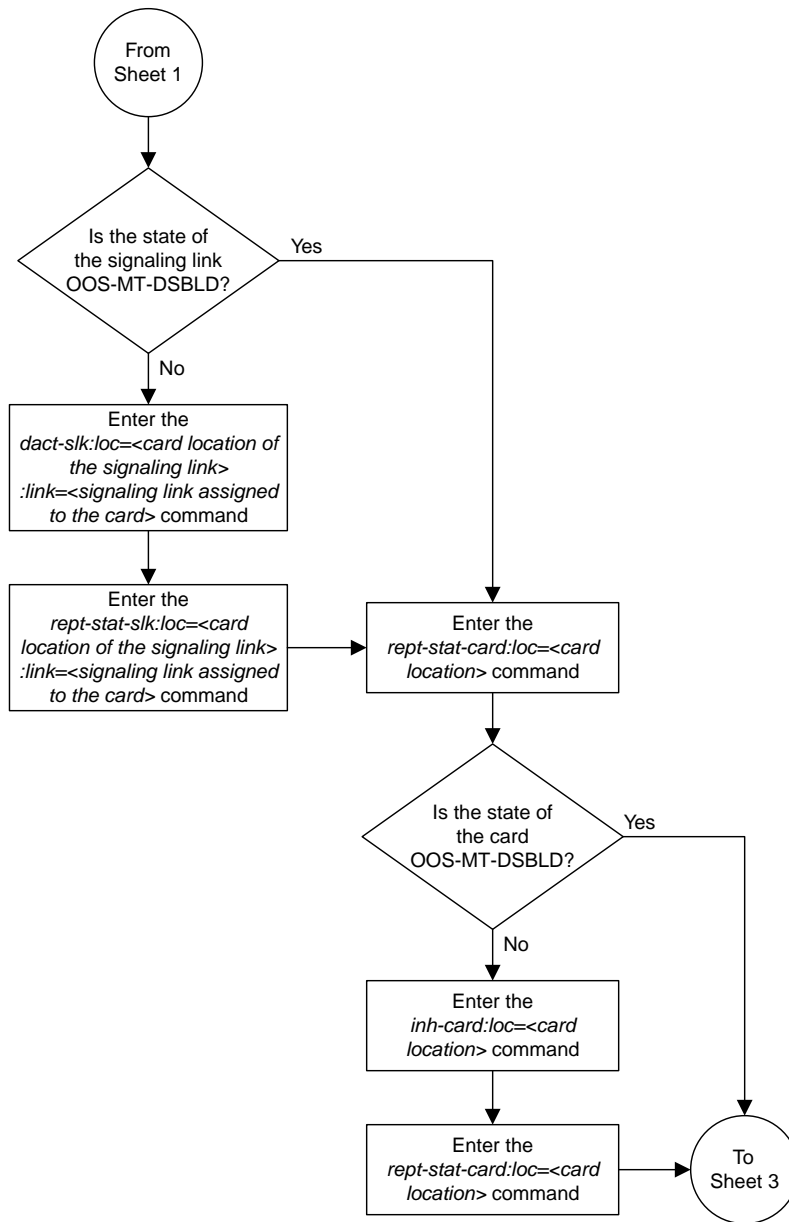

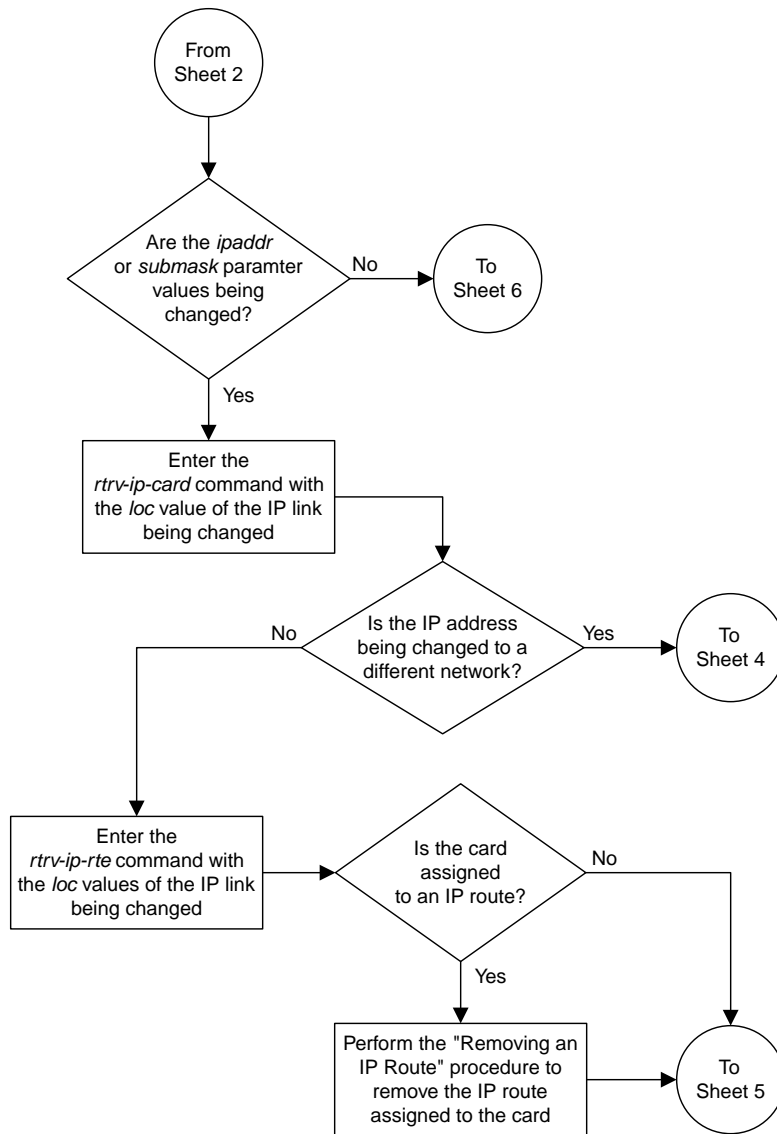

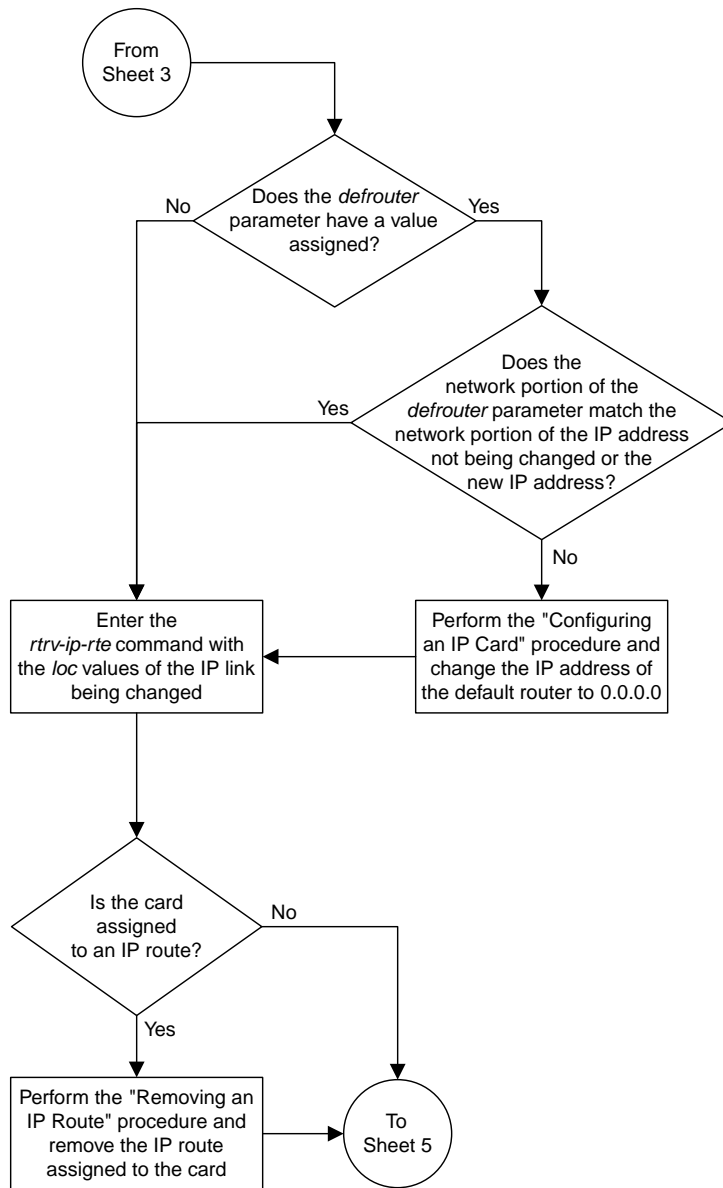

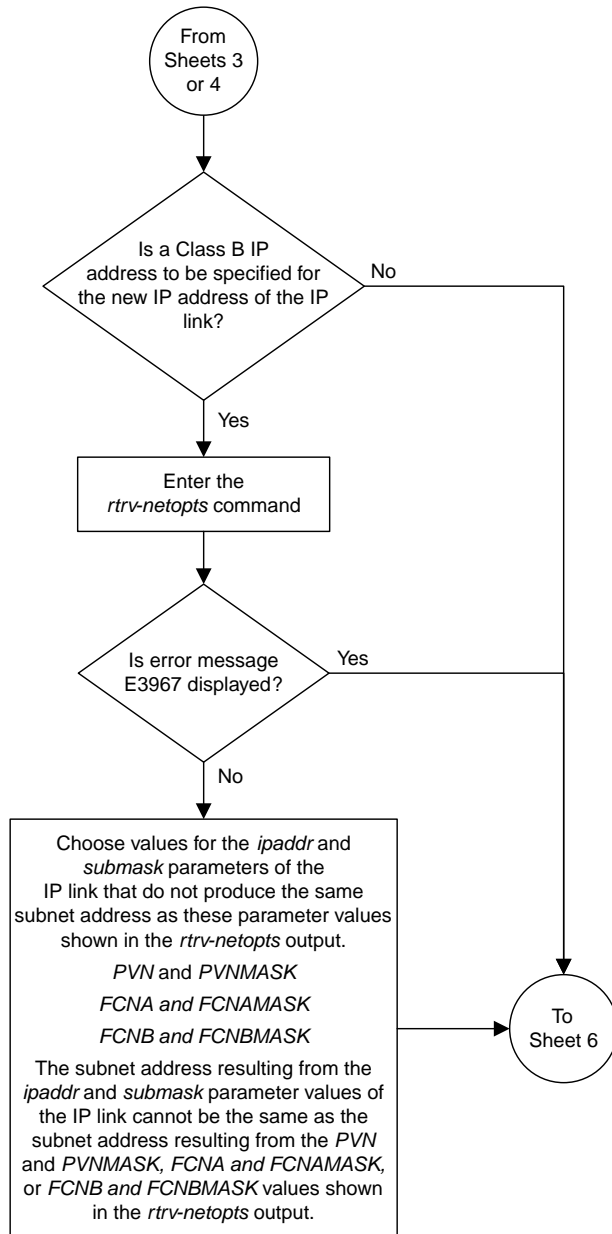

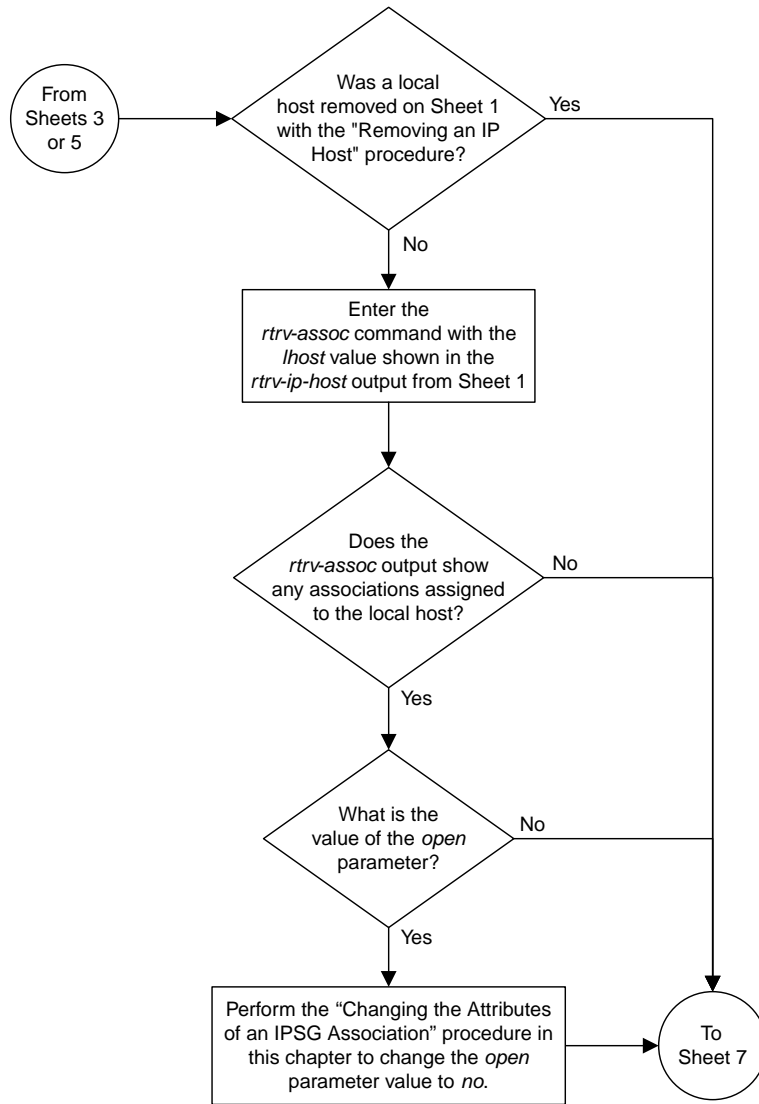

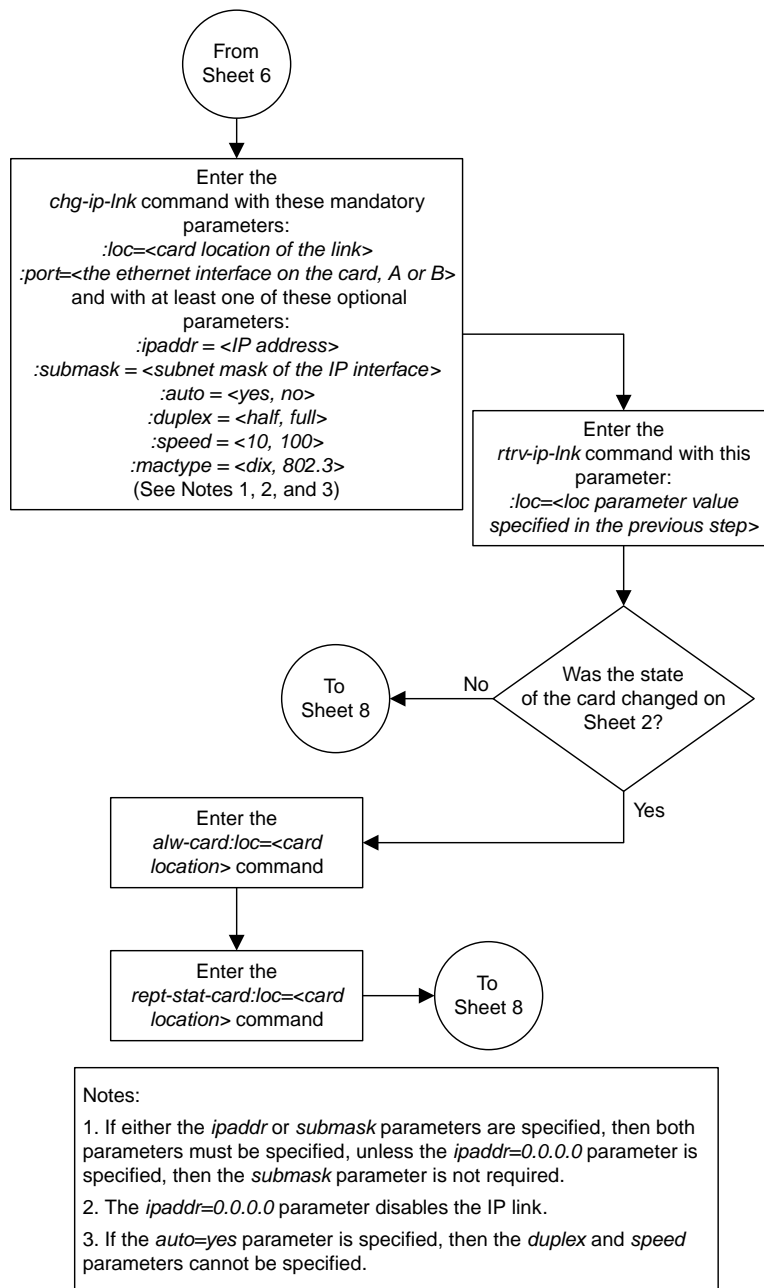

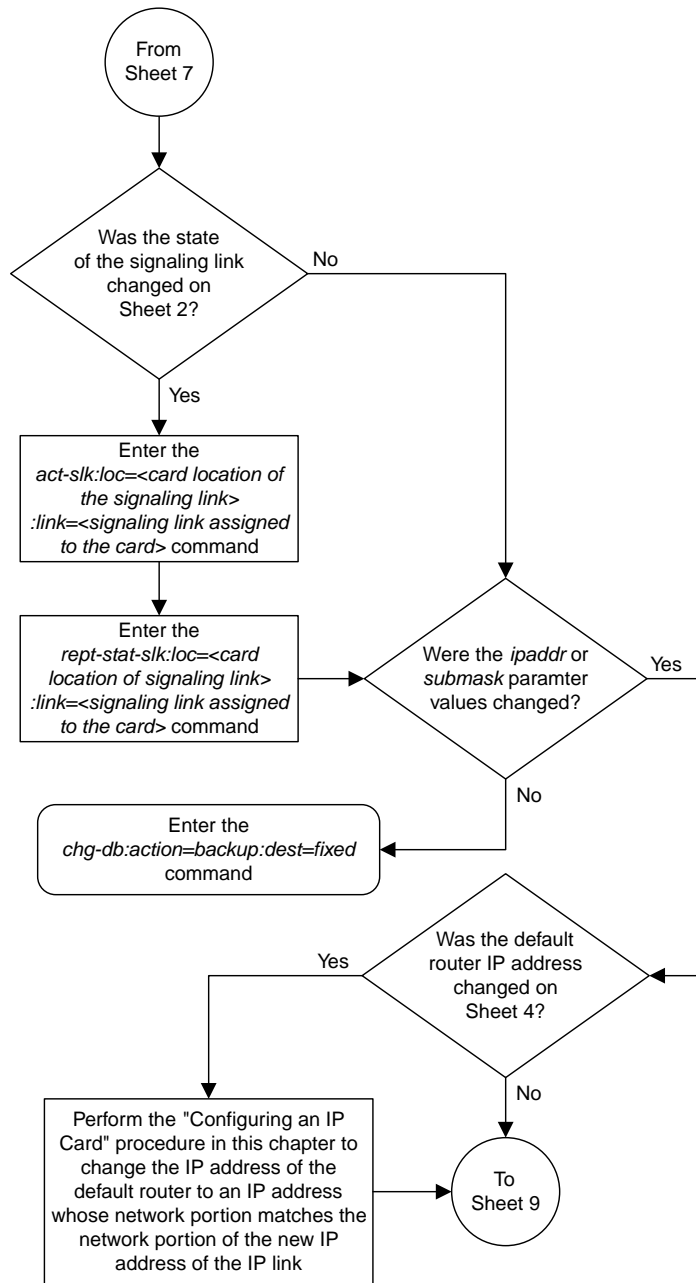

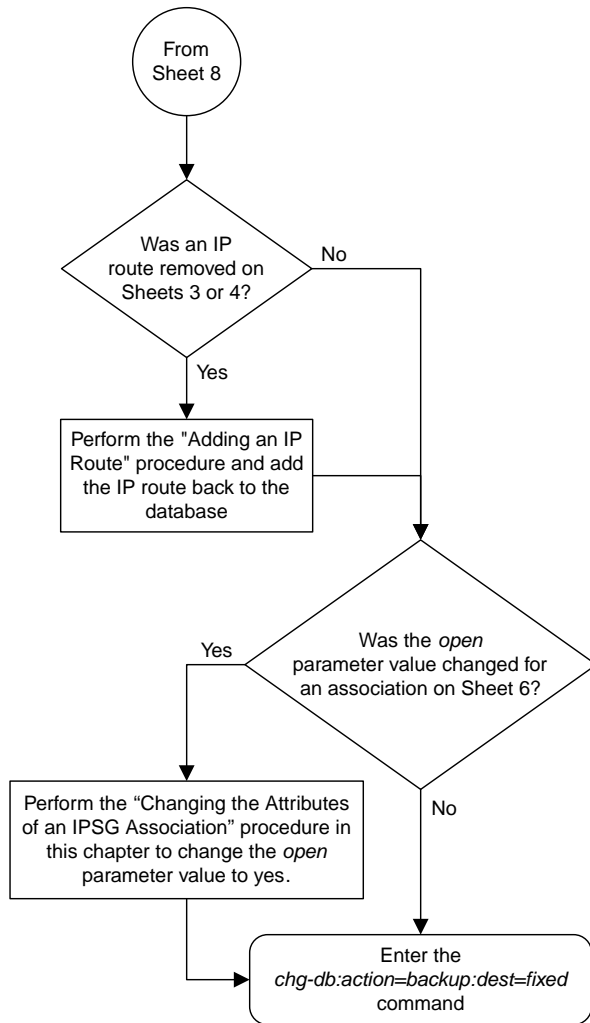

Sheet 9 of 9

Figure 92: Configuring an IP Link

Adding an IP Host

This procedure associates hostnames with IP addresses using the `ent-ip-host` command.

The `ent-ip-host` command uses the following parameters.

`:host` – The host name to be associated with the IP address. This parameter identifies the logical name assigned to the device with the IP address indicated. The host name can contain up to 60 characters (using only these characters: a-z, A-Z, 0-9, -, .) and is not case sensitive. The host name must begin with a letter. Host names containing a dash (-) must be enclosed in double quotes.

`:ipaddr` – The IP address to be associated with the hostname. The node's IP address. This is an IP address expressed in standard "dot notation." IP addresses consist of the system's network number and the machine's unique host number.

`:type` – Specifies if the host resides on the IP card on the EAGLE 5 (`type=local`, the default value), or if the host resides on equipment that is not in the EAGLE 5 (`type=remote`). This parameter is optional.

The EAGLE 5 can contain a maximum of 4026 IP hosts.

The IP address for a local host must be shown in the `rtrv-ip-lnk` output.

The IP address for a remote host must not be shown in the `rtrv-ip-lnk` output.

1. Display the current IP host information in the database by entering the `rtrv-ip-host:display=all` command.

The following is an example of the possible output.

```
rlghncxa03w 13-06-28 21:17:37 GMT EAGLE5 45.0.0
LOCAL IPADDR      LOCAL HOST
192.1.1.10        IPNODE1-1201
192.1.1.12        IPNODE1-1203
192.1.1.14        IPNODE1-1205
192.1.1.20        IPNODE2-1201
192.1.1.22        IPNODE2-1203
192.1.1.24        IPNODE2-1205
192.1.1.32        KC-HLR2
192.1.1.50        DN-MS1
192.1.1.52        DN-MS2

REMOTE IPADDR     REMOTE HOST
150.1.1.5         NCDEPTECONOMIC_DEVELOPMENT. SOUTHEASTERN_COORIDOR_ASHVL. GOV

IP Host table is (10 of 4096) .24% full
```

2. Verify that the IP address assigned to the IP links by entering the `rtrv-ip-lnk` command.

The following is an example of the possible output.

```

rlghncxa03w 08-12-28 21:14:37 GMT EAGLE5 40.0.0
LOC  PORT  IPADDR          SUBMASK          DUPLEX  SPEED  MACTYPE  AUTO  MCAST
1201  A    192.1.1.10     255.255.255.128 HALF     10    802.3   NO   NO
1201  B    -----          -----          HALF     10    DIX     NO   NO
1203  A    192.1.1.12     255.255.255.0   ---     ---    DIX     YES  NO
1203  B    -----          -----          HALF     10    DIX     NO   NO
1205  A    192.1.1.14     255.255.255.0   FULL    100   DIX     NO   NO
1205  B    -----          -----          HALF     10    DIX     NO   NO
2101  A    192.1.1.20     255.255.255.0   FULL    100   DIX     NO   NO
2101  B    -----          -----          HALF     10    DIX     NO   NO
2103  A    192.1.1.22     255.255.255.0   FULL    100   DIX     NO   NO
2103  B    -----          -----          HALF     10    DIX     NO   NO
2105  A    192.1.1.24     255.255.255.0   FULL    100   DIX     NO   NO
2105  B    -----          -----          HALF     10    DIX     NO   NO
2207  A    192.1.1.32     255.255.255.0   FULL    100   DIX     NO   NO
2207  B    -----          -----          HALF     10    DIX     NO   NO
2213  A    192.1.1.50     255.255.255.0   FULL    100   DIX     NO   NO
2213  B    -----          -----          HALF     10    DIX     NO   NO
2301  A    192.1.1.52     255.255.255.0   FULL    100   DIX     NO   NO
2301  B    -----          -----          HALF     10    DIX     NO   NO

IP-LNK  table is (20 of 2048) 1 % full.

```

If a local host is being configured in this procedure, the IP address assigned to the local host must be shown in the `rtrv-ip-lnk` output. If the IP address is not shown in the `rtrv-ip-lnk` output, add the IP address by performing the [Configuring an IP Link](#) procedure.

If a remote host is being configured in this procedure, the IP address assigned to the remote host cannot be shown in the `rtrv-ip-lnk` output.

3. Add IP host information to the database by entering the `ent-ip-host` command.

If a local host is being configured, enter the `ent-ip-host` command with the IP address from [Step 2](#), and the `type=local` parameter or without the `type` parameter. If the `type` parameter is not specified with the `ent-ip-host` command, the `type` parameter value defaults to `local`.

If a remote host is being configured, enter the `ent-ip-host` command with the IP address that is not shown in [Step 2](#), and the `type=remote` parameter.

For example, enter this command.

```
ent-ip-host:host="kc-hlr1":ipaddr=192.1.1.30
```

When this command has successfully completed, the following message should appear.

```

rlghncxa03w 06-10-28 21:18:37 GMT EAGLE5 36.0.0
ENT-IP-HOST: MASP A - COMPLTD

```

4. Verify the new IP host information in the database by entering the `rtrv-ip-host` command with the `host` parameter value specified in [Step 3](#).

For this example, enter this command.

```
rtrv-ip-host:host="kc-hlr1"
```

The following is an example of the possible output.

```
rlghncxa03w 13-06-28 21:19:37 GMT EAGLE5 45.0.0
LOCAL IPADDR      LOCAL HOST
192.1.1.30        KC-HLR1

IP Host table is (11 of 4096) .26% full
```

5. Back up the new changes using the `chg-db:action=backup:dest=fixed` command.

These messages should appear, the active Maintenance and Administration Subsystem Processor (MASP) appears first.

```
BACKUP (FIXED) : MASP A - Backup starts on active MASP.
BACKUP (FIXED) : MASP A - Backup on active MASP to fixed disk complete.
BACKUP (FIXED) : MASP A - Backup starts on standby MASP.
BACKUP (FIXED) : MASP A - Backup on standby MASP to fixed disk complete.
```

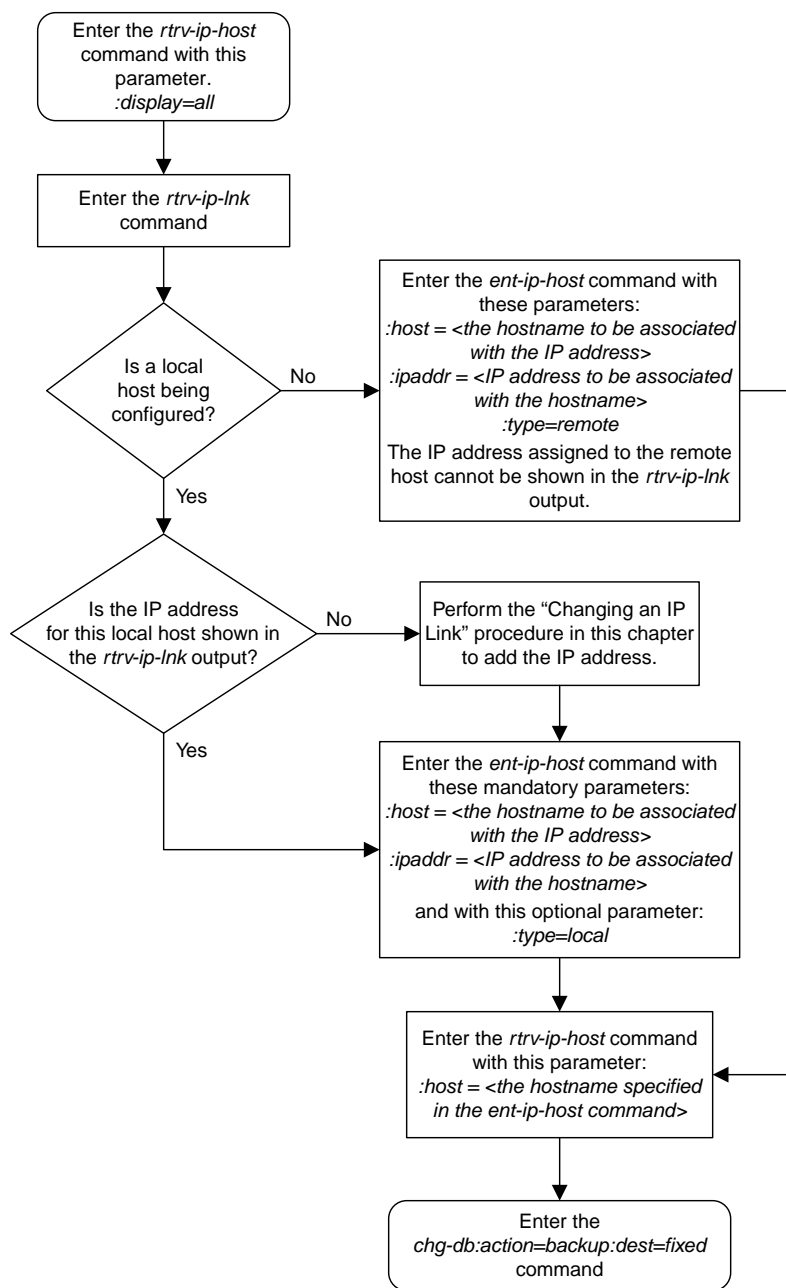

Figure 93: Adding an IP Host

Configuring an IP Card

This procedure is used to change the IP stack parameters associated with an IP card in the database using the `chg-ip-card` command.

The `chg-ip-card` command uses the following parameters.

`:loc` – The card location of the IP card

`:srchordr` – Host Table Search Order

`:dnrsa` – Domain name server A's IP address. This is an IP address expressed in standard "dot notation." IP addresses consist of the system's network number and the machine's unique host number.

`:dnspb` – Domain name server B's IP address. This is an IP address expressed in standard "dot notation." IP addresses consist of the system's network number and the machine's unique host number.

`:domain` – The domain name is used to construct a fully-qualified DNS name consisting of 120 characters or less. For example, a domain name can be `tekelec.com`, the hostname is `john.doe`. The fully-qualified DNS name would be `john.doe@tekelec.com`.

`:defrouter` – Default router IP address. This is an IP address expressed in standard "dot notation." IP addresses consist of the system's network number and the machine's unique host number.

`:rstdomain` – Reset Domain name. The parameter is used to reset the domain to a NULL value.

`:sctpcsum` – The SCTP checksum algorithm that will be applied to the traffic on the IP card, either `adler32` or `crc32c`. The `sctpcsum` parameter can be specified only if the `SCTPCSUM` value in the `rtrv-sg-opts` output is `percard`.

The `chg-ip-card` command contains other parameters that cannot be used in this procedure. Refer to *Commands User's Guide* for more information about these parameters.

The IP card must be placed out of service.

The `rstdomain` parameter cannot be specified if the `domain` parameter is specified.

There is only one default router (`defrouter` parameter) for each IP card. The default router is used as the primary route unless a static IP routes is defined for the destination IP address. Static IP routes are assigned using the `ent-ip-rte` command in the [Adding an IP Route](#) procedure.

The network portion of the IP address of the default router must match the network portion of one of the IP addresses assigned to the card.

The network portion of the IP address is based on the class of the IP address (shown in [Table 49: Valid Subnet Mask Parameter Values](#)). If the IP address is a Class A IP address, the first field is the network portion of the IP address. If the IP address is a Class B IP address, the first two fields are the network portion of the IP address. If the IP address is a Class C IP address, the first three fields are the network portion of the IP address. For example, if the IP address is 193.5.207.150, a Class C IP address, the network portion of the IP address is 193.5.207.

The default router can be associated with only one IP address assigned to the card if the `defrouter` parameter is specified. For example, the `dnrsa` value for card 1101 is 150.1.1.10. The `dnspb` value for card 1101 is 160.25.37.1. A default router is provisioned with the IP address 150.1.1.4. The default router is associated with the Ethernet A IP address (the `dnrsa` parameter value), but not the Ethernet B IP address (the `dnspb` parameter value).

If the default router is associated with one of the IP card's IP addresses, a second gateway router can be assigned to the other IP address on the IP card by provisioning a static IP route for the IP card using the `ent-ip-rte` command in the [Adding an IP Route](#) procedure. Static IP routes can provide gateway routers associated with the other IP address on the IP card. To provision the gateway router (the `gtwy` parameter of the `ent-ip-rte` command) for the other IP address assigned to the IP card, the network portion of the gateway router's IP address must match the network portion of the other IP address assigned to the IP card.

Specifying the IP address 0.0.0.0 for the `dnsa` or `dnsb` parameters, removes the IP address for Ethernet A (`dnsa`) or Ethernet B (`dnsb`).

When an IP card is entered into the database with the `ent-card` command, the IP stack parameters associated with this card are initially set with these default values:

- `:srchordr` – SRVR
- `:dnsa` – No DNSA IP address is specified
- `:dnsb` – No DNSB IP address is specified
- `:domain` – No domain name is specified
- `:defrouter` – No default router IP address is specified
- `:rstdomain` – No
- `:sctpcsum` – CRC32C

The value of any optional parameter not specified with the `chg-ip-card` command is not changed.

1. Display the current IP parameters associated with card in the database by entering the `rtrv-ip-card` command.

The following is an example of the possible output.

```
rlghncxa03w 08-06-28 21:17:37 GMT EAGLE5 39.0.0
  LOC 1201
    SRCHORDR  SRVR
    DNSA      150.1.1.1
    DNSB      -----
    DEFROUTER -----
    DOMAIN    -----
    SCTPCSUM  crc32c
    BPIPADDR  -----
    BPSUBMASK -----
  LOC 1203
    SRCHORDR  LOCAL
    DNSA      192.1.1.40
    DNSB      -----
    DEFROUTER -----
    DOMAIN    NC. TEKELEC. COM
    SCTPCSUM  crc32c
    BPIPADDR  -----
    BPSUBMASK -----
  LOC 1205
    SRCHORDR  SRVROONLY
    DNSA      192.1.1.40
    DNSB      -----
    DEFROUTER -----
    DOMAIN    NC. TEKELEC. COM
    SCTPCSUM  crc32c
    BPIPADDR  -----
    BPSUBMASK -----
```

To change the parameters of an IP card, the signaling link to the card and the card have to be inhibited.

2. Display the signaling link associated with the card shown in [Step 1](#) using the `rtrv-slk` command specifying the card location.

For this example, enter this command.

```
rtrv-slk:loc=1201
```

This is an example of the possible output.

```
rlghncxa03w 08-04-12 15:36:20 GMT 38.0.0
LOC LINK LSN          SLC TYPE      ANAME          SLKTPS
1201 A   nc001        0   IPSG        m2pa1          1015
IPTPS for LOC = 1102 is (1015 of 5000) 20%
```

3. Retrieve the status of the signaling link shown in [Step 2](#) using the `rept-stat-slk` command specifying the card location and signaling link.

For example, enter this command.

```
rept-stat-slk:loc=1201:link=a
```

The output lists the signaling link assigned to this card:

```
rlghncxa03w 06-10-28 21:16:37 GMT EAGLE5 36.0.0
SLK      LSN          CLLI          PST          SST          AST
1201,A   nc001        -----      IS-NR
          Avail      ----
Command Completed.
```

If the signaling link is in service-normal (IS-NR), continue the procedure with [Step 4](#) to deactivate the signaling link. If the signaling link is out-of-service-maintenance disabled (OOS-MT-DSBLD), continue the procedure with [Step 6](#) to verify the card status.

4. Deactivate the signaling link assigned to the IP card using the `rept-stat-slk` command.

For example, enter this command.

```
dact-slk:loc=1201:link=a
```



CAUTION

Caution: This command impacts network performance and should only be used during periods of low traffic.

After this command has successfully completed, this message appears.

```
rlghncxa03w 06-10-12 09:12:36 GMT EAGLE5 36.0.0
Deactivate Link message sent to card.
```

5. Verify the new link status using the `rept-stat-slk` command.

For example, enter this command.

```
rept-stat-slk:loc=1201:link=a
```

The output displays the link status as OOS-MT-DSBLD and gives off a minor alarm:

```
rlghncxa03w 06-10-27 17:00:36 GMT EAGLE5 36.0.0
SLK      LSN      CLLI      PST      SST      AST
1201,A  nc001      ----- OOS-MT-DSBLD AVAIL  ---
ALARM STATUS = * 0236 REPT-LKS:not aligned
UNAVAIL REASON = NA
Command Completed.
```

6. Verify the status of the IP card to be inhibited using the `rept-stat-card` command.

For example, enter this command.

```
rept-stat-card:loc=1201
```

This is an example of the possible output.

```
rlghncxa03w 10-12-01 09:12:36 GMT EAGLE5 43.0.0
CARD  VERSION      TYPE      GPL      PST      SST      AST
1201  133-003-000  E5ENET   IPSG     IS-NR    Active  -----
ALARM STATUS      = No Alarms.
BLIXP  GPL version = 133-003-000
IMT BUS A          = Conn
IMT BUS B          = Conn
CURRENT TEMPERATURE = 32C ( 90F)    [ALARM TEMP: 60C (140F)]
PEAK TEMPERATURE:  = 39C (103F)    [06-05-02 13:40]
SIGNALING LINK STATUS
SLK    PST          LS          CLLI
A      IS-NR        nc001      -----
Command Completed.
```

If the IP card to be inhibited is in service-normal (IS-NR), continue the procedure with [Step 7](#) to inhibit the card. If the IP card is out-of-service-maintenance disabled (OOS-MT-DSBLD), continue the procedure with [Step 9](#).

7. Inhibit the IP card using the `inh-card` command.

For example, enter this command.

```
inh-card:loc=1201
```

This message should appear.

```
rlghncxa03w 06-10-28 21:18:37 GMT EAGLE5 36.0.0
Card has been inhibited.
```

8. Display the status of the IP card to verify that it is out-of-service maintenance-disabled (OOS-MT-DSBLD).

Enter this command.

```
rept-stat-card:loc=1201
```

This is an example of the possible output.

```

rlghncxa03w 10-12-01 09:12:36 GMT EAGLE5 43.0.0
CARD  VERSION      TYPE      GPL      PST      SST      AST
1201  133-003-000  E5ENET   IPSG     OOS-MT-DSBLD  Manual  -----
  ALARM STATUS      = No Alarms.
  BLIXP  GPL version = 133-003-000
  IMT BUS A          = Conn
  IMT BUS B          = Conn
  CURRENT TEMPERATURE = 32C ( 90F)   [ALARM TEMP: 60C (140F)]
  PEAK TEMPERATURE:  = 39C (103F)   [06-05-02 13:40]
  SIGNALING LINK STATUS
    SLK  PST      LS      CLLI
    A    IS-NR   nc001  -----
Command Completed

```

If the `defrouter` parameter will be specified in [Step 11](#), continue the procedure with [Step 11](#).

If the `defrouter` parameter will not be specified in [Step 11](#), continue the procedure by performing one of these steps.

- If the `sctpcsum` parameter value for the card will not be changed, continue the procedure with [Step 11](#).
 - If the `sctpcsum` parameter value for the card will be changed, continue the procedure with [Step 10](#).
9. Verify that the IP address of either Ethernet A or B (the address whose network portion matches the network portion of the `defrouter` parameter value to be used in [Step 11](#)) is in the IP link table by entering the `rtrv-ip-lnk` command with the card location specified in this procedure.

For this example, enter this command.

```
rtrv-ip-lnk:loc=1201
```

The following is an example of the possible output.

```

rlghncxa03w 06-10-28 21:17:37 GMT EAGLE5 36.0.0
LOC  PORT  IPADDR      SUBMASK      DUPLEX  SPEED  MACTYPE  AUTO  MCAST
1201  A    192.1.1.10  255.255.255.0  ----   ---   DIX      YES  NO
1201  B    -----    -----    ----   ---   DIX      YES  NO

```

If the network portion of the IP address specified by the `defrouter` value does not match the network portions of either IP address displayed in this step, perform one of these actions:

- Choose another value for the `defrouter` parameter, making sure that the network portion of the new IP address matches the network portion of one of the IP addresses displayed in this step.
- Perform the [Configuring an IP Link](#) procedure and change one of the IP addresses shown in this step so that the network portion of the new IP address changed in the [Configuring an IP Link](#) procedure matches the network portion of the IP address value for the `defrouter` parameter.

After this step has been completed, continue the procedure by performing one of these steps.

- If the `sctpcsum` parameter value for the card will not be changed, continue the procedure with [Step 11](#).

- If the `sctpchecksum` parameter value for the card will be changed, continue the procedure with [Step 11](#).
10. To change the `sctpchecksum` parameter value for the IP card, the `sctpchecksum` parameter value in the `rtrv-sg-opts` output must be `percard`. Verify the `sctpchecksum` parameter value by entering the `rtrv-sg-opts` command.

The following is an example of the possible output.

```
rlghncxa03w 08-04-13 09:19:43 GMT EAGLE5 38.0.0
SRKQ:          1500
SNMPCONT:     tekelec
GETCOMM:      public
SETCOMM:      private
TRAPCOMM:     public
SCTPCSUM:     adler32
IPGWABATE:    NO
UAMEASUSEDFTAS: NO
```

If the `sctpchecksum` parameter value in the `rtrv-sg-opts` output is `percard`, continue the procedure with [Step 11](#).

If the `sctpchecksum` parameter value in the `rtrv-sg-opts` output is `adler 32` or `crc32c`, perform the one of these procedures to change the `sctpchecksum` parameter value to `percard`, depending on the ADAPTER value of the association.

- [Changing the SCTP Checksum Algorithm Option for IPSG M2PA Associations](#)
- [Changing the SCTP Checksum Algorithm Option for IPSG M3UA Associations](#)

After the SCTP checksum algorithm has been changed, continue the procedure with [Step 11](#).

11. Change the IP stack parameters associated with an IP card in the database using the `chg-ip-card` command.

For this example, enter this command.

```
chg-ip-card:loc=1201:srchordr=local:dnsa=192.1.1.40:domain=nc.tekelec.com
:sctpchecksum=adler32
```

When this command has successfully completed, the following message should appear.

```
rlghncxa03w 06-10-28 21:20:37 GMT EAGLE5 36.0.0
CHG-IP-CARD: MASP A - COMPLTD
```

12. Verify the new IP parameters associated with the IP card that was changed in [Step 11](#) by entering the `rtrv-ip-card` command with the card location specified in [Step 11](#).

For this example, enter this command.

```
rtrv-ip-card:loc=1201
```

The following is an example of the possible output.

```
rlghncxa03w 08-06-28 21:17:37 GMT EAGLE5 39.0.0
LOC 1201
SRCHORDR LOCAL
```



```

DNSA      192.1.1.40
DNSB      -----
DEFROUTER -----
DOMAIN    NC. TEKELEC. COM
SCTPCSUM  adler32
BPIPADDR  -----
BPSUBMASK -----

```

Note: If [Step 7](#) was not performed, continue the procedure with [Step 15](#).

13. Allow the IP card that was inhibited in [Step 7](#) by using the `alw-card` command.

For example, enter this command.

```
alw-card:loc=1201
```

This message should appear.

```

rlghncxa03w 06-10-28 21:22:37 GMT EAGLE5 36.0.0
Card has been allowed.

```

14. Verify the in-service normal (IS-NR) status of the IP card using the `rept-stat-card` command.

For example, enter this command.

```
rept-stat-card:loc=1201
```

This is an example of the possible output.

```

rlghncxa03w 10-12-01 09:12:36 GMT EAGLE5 43.0.0
CARD  VERSION  TYPE      GPL      PST      SST      AST
1201  133-003-000 E5ENET   IPSG     IS-NR    Active   -----
ALARM STATUS      = No Alarms.
BLIXP  GPL version = 133-003-000
IMT BUS A         = Conn
IMT BUS B         = Conn
CURRENT TEMPERATURE = 32C ( 90F)    [ALARM TEMP: 60C (140F)]
PEAK TEMPERATURE:  = 39C (103F)    [06-05-02 13:40]
SIGNALING LINK STATUS
  SLK  PST           LS           CLLI
  A    IS-NR        nc001       -----
Command Completed.

```

15. Activate the signaling link from [Step 4](#) using the `act-slk` command.

Note: If [Step 4](#) was not performed, continue the procedure with [Step 17](#).

For example, enter this command.

```
act-slk:loc=1201:link=a
```

The link changes its state from OOS-MT-DSBLD (out-of-service maintenance-disabled) to IS-NR (in-service normal).

The output confirms the activation.

```
rlghncxa03w 06-10-07 11:11:28 GMT EAGLE5 36.0.0
Activate Link message sent to card
```

16. Verify the in-service normal (IS-NR) status of the signaling link using the `rept-stat-slk` command.

For example, enter this command.

```
rept-stat-slk:loc=1201:link=a
```

This message should appear.

```
rlghncxa03w 06-10-28 21:16:37 GMT EAGLE5 36.0.0
SLK      LSN      CLLI      PST      SST      AST
1201,A   nc001     -----  IS-NR
          Avail     ----
Command Completed.
```

17. Back up the new changes using the `chg-db:action=backup:dest=fixed` command.

These messages should appear, the active Maintenance and Administration Subsystem Processor (MASP) appears first.

```
BACKUP (FIXED) : MASP A - Backup starts on active MASP.
BACKUP (FIXED) : MASP A - Backup on active MASP to fixed disk complete.
BACKUP (FIXED) : MASP A - Backup starts on standby MASP.
BACKUP (FIXED) : MASP A - Backup on standby MASP to fixed disk complete.
```

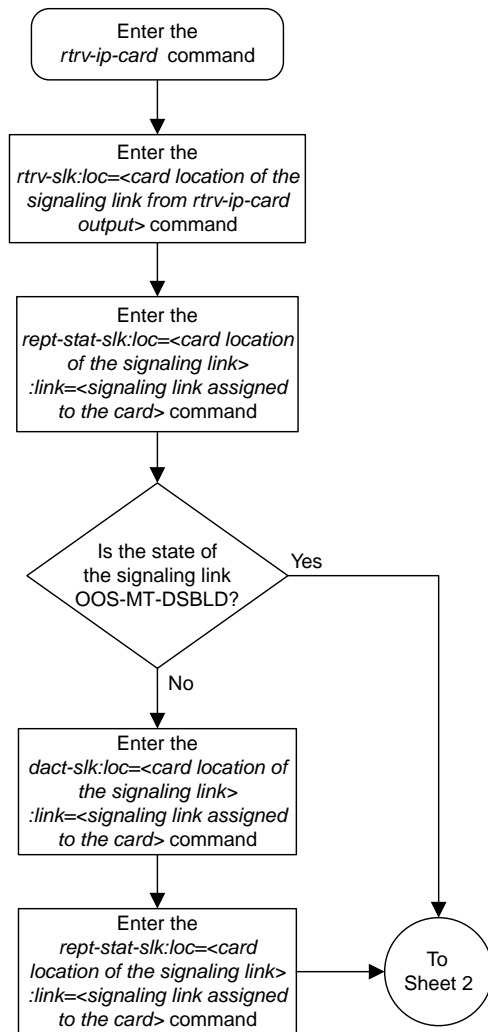

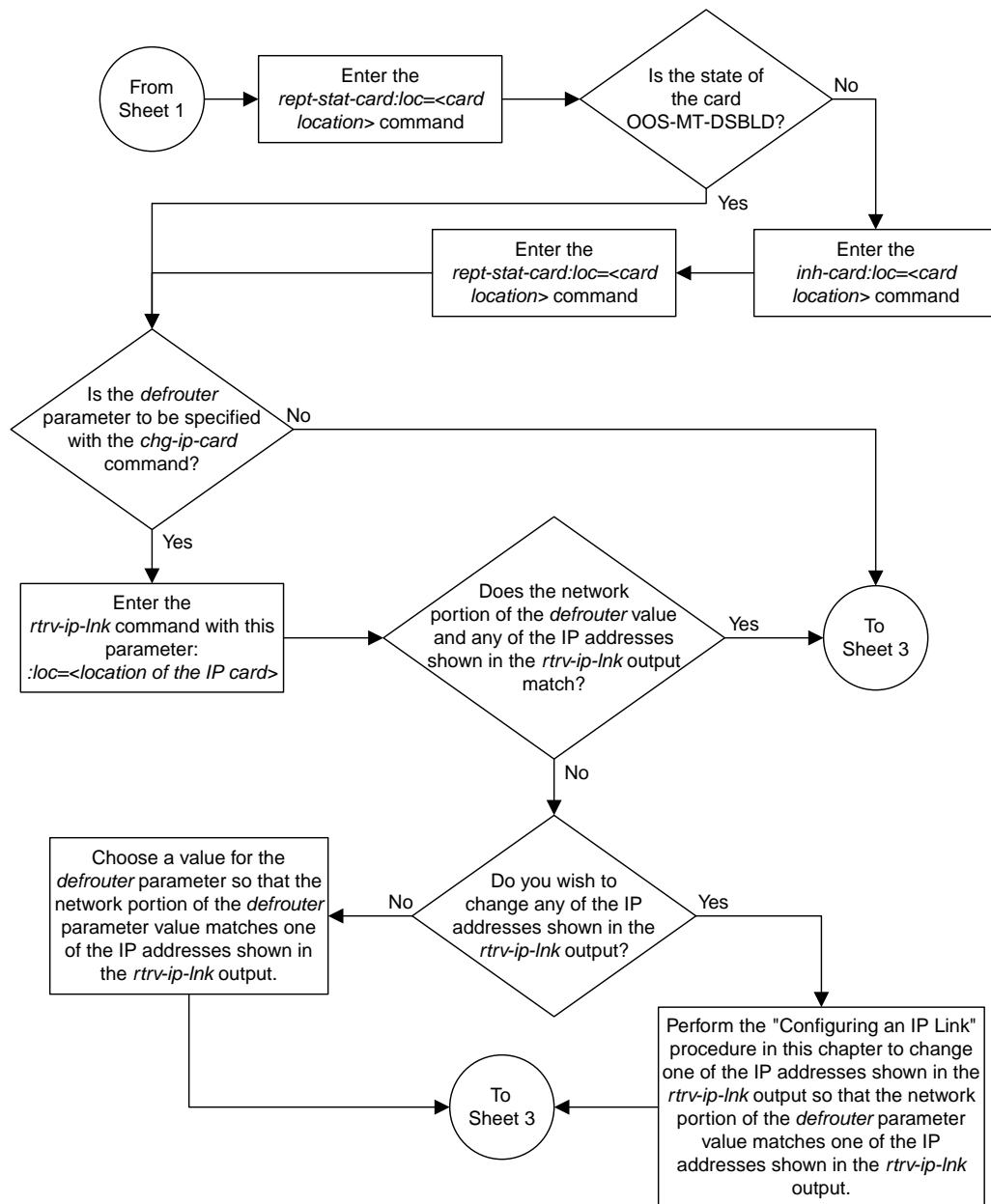

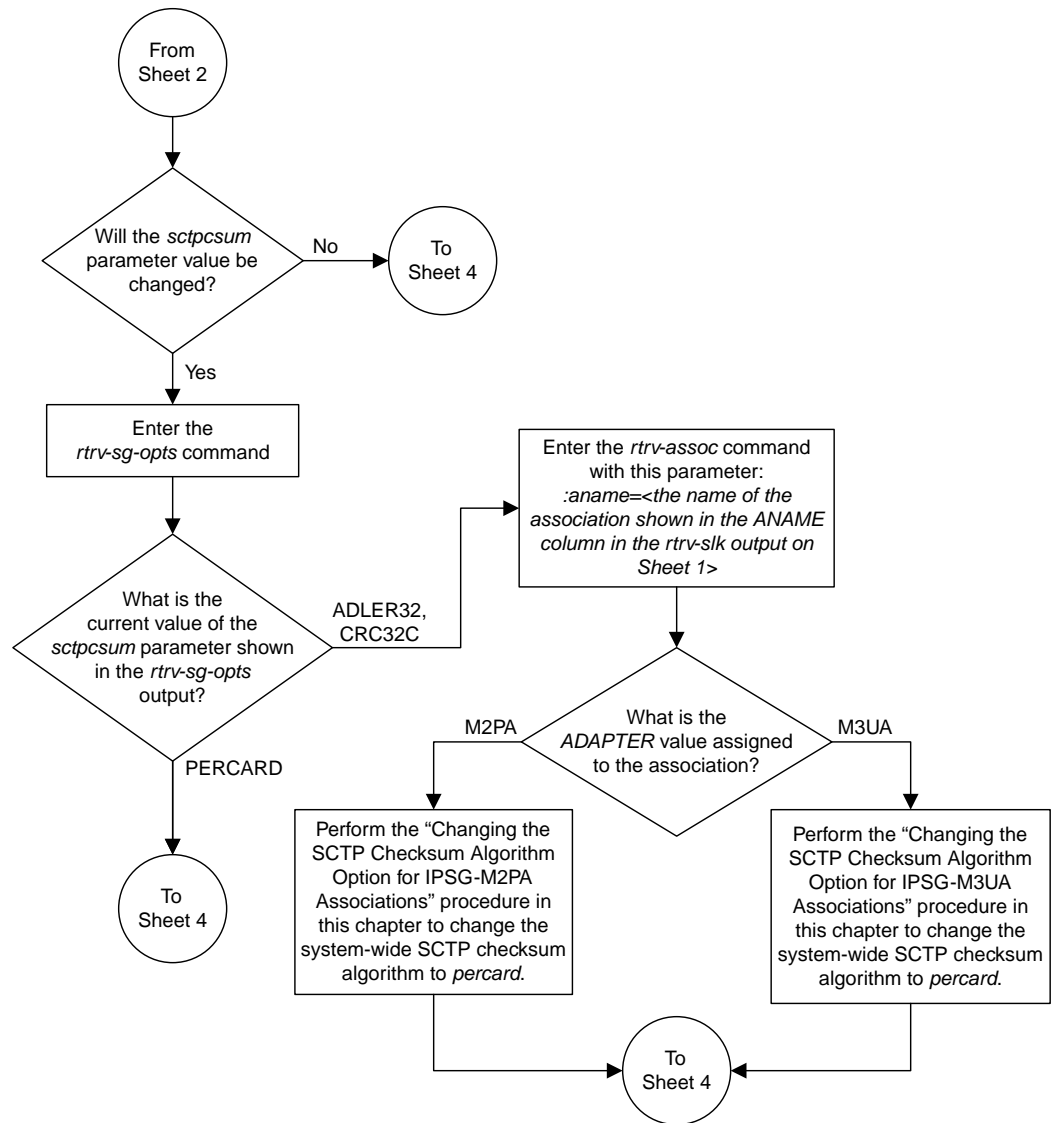

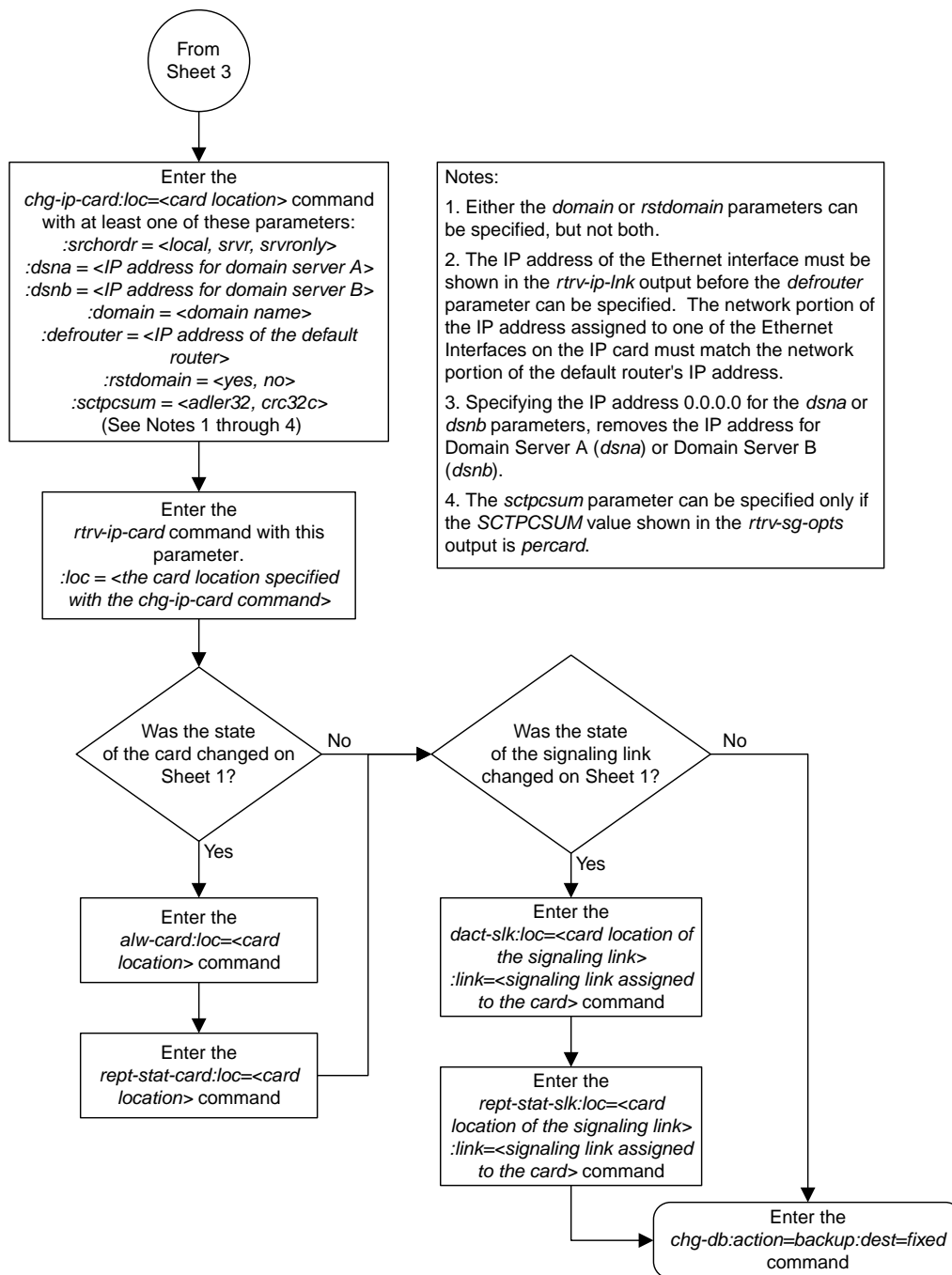

Sheet 4 of 4

Figure 94: Configuring an IP Card

Adding an IP Route

This procedure is used to add an IP route to the database using the `ent-ip-rte` command.

The `ent-ip-rte` command uses these parameters.

`:loc` – The location of the IP card that the IP route will be assigned to.

`:dest` – The IP address of the remote host or network.

`:submask` – The subnet mask of the destination IP address.

`:gtwy` – The IP address of the gateway or router that will send the IP data to its final destination.

There can be a maximum of 64 IP routes assigned to an IP card.

The EAGLE can contain a maximum of 2048 IP routes.

Ethernet Interfaces A and B on the IP card specified by the `loc` parameter can be used.

The network portion of the IP address value of the `gtwy` parameter must be the same as the network portion of the IP addresses shown for either the A or B interfaces in the `rtrv-ip-card` output.

The value of the `dest` and `gtwy` parameters cannot be 127.x.x.x (the loopback address), 0.0.0.0, or the IP addresses of the A or B interfaces on the IP card, and cannot be assigned to another IP card.

If the `dest` parameter value represents a host IP address, the value for the `submask` parameter must be 255.255.255.255. Otherwise, the `submask` parameter value identifies the network/host ID portions that must be entered when the `dest` parameter value represents a network address.

The submask is applied to the IP address which is being routed to see if it yields a route match. For example, if IP address 192.1.1.2 is being routed and the IP routing table contains these entries.

Table 50: Sample IP Routing Table

IP address	Submask	Gateway
191.1.0.0	255.255.0.0	192.168.110.250
192.0.0.0	255.0.0.0	192.168.110.251

IP routing occurs as follows:

1. The subnet mask of route 1 (255.255.0.0) is applied to the IP address being routed (192.1.1.2) with the resulting IP address of 192.1.0.0. IP address 192.1.0.0 does not match IP address 191.1.0.0 in the IP routing table, so the next route is chosen.
2. The subnet mask of route 2 (255.0.0.0) is applied to the IP address being routed (192.1.1.2) with the resulting IP address of 192.0.0.0 which matches the second route in the IP routing table, so this route is selected for routing this datagram.

See [Table 51: Valid Subnet Mask Parameter Values](#) for the valid input values for the `submask` and `dest` parameter combinations.

Table 51: Valid Subnet Mask Parameter Values

Network Class	IP Network Address Range	Valid Subnet Mask Values
A	1.0.0.0 to 127.0.0.0	255.0.0.0 (the default value for a class A IP address) 255.192.0.0 255.224.0.0 255.240.0.0 255.248.0.0 255.252.0.0 255.254.0.0 255.255.128.1
A+B	128.1.0.0 to 191.255.0.0	255.255.0.0 (the default value for a class B IP address) 255.255.192.0 255.255.224.0 255.255.240.0 255.255.248.0 255.255.252.0 255.255.254.0 255.255.255.128
A+B+C	192.0.0.0 to 223.255.255.0	255.255.255.0 (the default value for a class C IP address) 255.255.255.192 255.255.255.224 255.255.255.240 255.255.255.248 255.255.255.252

If a Class B IP address is specified for the `dest` parameter of the `ent-ip-rte` command, the subnet address that results from the `dest` and `submask` parameter values cannot be the same as the subnet address that results from the `pvn` and `pvnmask`, `fcna` and `fcnamask`, or `fcnb` and `fcnbmask` parameter values of the `chg-netopts` command. The `pvn` and `pvnmask`, `fcna` and `fcnamask`, or `fcnb` and `fcnbmask` parameter values can be verified by entering the `rtrv-netopts` command. Choose `dest` and `submask` parameter values for the IP route whose resulting subnet address is not

be the same as the subnet address resulting from the `pvn` and `pvnmask`, `fcna` and `fcnamask`, or `fcnb` and `fcnbmask` parameter values of the `chg-netopts` command.

1. Display the IP routes in the database with the `rtrv-ip-rte` command.

This is an example of the possible output.

```
rlghncxa03w 06-10-28 09:12:36 GMT EAGLE5 36.0.0
LOC  DEST          SUBMASK          GTWY
1301 128.252.10.5     255.255.255.255 140.188.13.33
1301 128.252.0.0      255.255.0.0      140.188.13.34
1301 150.10.1.1       255.255.255.255 140.190.15.3
1303 192.168.10.1     255.255.255.255 150.190.15.23
1303 192.168.0.0      255.255.255.0    150.190.15.24

IP Route table is (5 of 2048) 0.24% full
```

2. Display the IP cards in the database with the `rtrv-ip-card` command.

This is an example of the possible output.

```
rlghncxa03w 08-08-28 21:17:37 GMT EAGLE5 39.0.0
LOC 1212
  SRCHORDR LOCAL
  DNSA     150.1.1.1
  DNSB     -----
  DEFROUTER 150.1.1.100
  DOMAIN    NC. TEKELEC. COM
  SCTPCSUM  crc32c
  BPIPADDR  -----
  BPSUBMASK -----
LOC 1301
  SRCHORDR SRVROONLY
  DNSA     140.188.13.10
  DNSB     140.190.15.28
  DEFROUTER -----
  DOMAIN    NC. TEKELEC. COM
  SCTPCSUM  crc32c
  BPIPADDR  -----
  BPSUBMASK -----
LOC 1303
  SRCHORDR LOCAL
  DNSA     150.190.15.1
  DNSB     -----
  DEFROUTER 150.190.15.25
  DOMAIN    NC. TEKELEC. COM
  SCTPCSUM  crc32c
  BPIPADDR  -----
  BPSUBMASK -----
```

If the required IP card is not shown in the `rtrv-ip-card` output, perform the [Adding an IPSG Card](#) procedure to add the card to the database.

Perform the [Configuring an IP Link](#) procedure and make sure that the network portion of the IP addresses assigned for the A or B interfaces of the IP card is the same as the network portion of the IP address that will be assigned to the `gtwy` parameter of the IP route

Note: If a Class A or C IP address (see [Table 51: Valid Subnet Mask Parameter Values](#)) will be specified for the `dest` parameter in [Step 4](#), continue the procedure with [Step 4](#).

- The subnet address that results from the `dest` and `submask` parameter values of the `ent-ip-rte` command cannot be the same as the subnet address that results from the `pvn` and `pvnmask`, `fcna` and `fcnamask`, or `fcnb` and `fcnbmask` parameter values of the `chg-netopts` command.

Display the `pvn`, `pvnmask`, `fcna`, `fcnamask`, `fcnb`, and `fcnbmask` parameter values of the `chg-netopts` command by entering the `rtrv-netopts` command.

If error message E3967 Cmd Rej: E5IS must be on is displayed after the `rtrv-netopts` command is executed, the `pvn`, `pvnmask`, `fcna`, `fcnamask`, `fcnb`, and `fcnbmask` parameters are not configured. Continue the procedure with [Step 4](#).

This is an example of the possible output if the E5IS feature is on.

```
rlghncxa03w 09-02-28 21:17:37 GMT EAGLE5 40.1.0
NETWORK OPTIONS
-----
PVN           = 128.20.30.40
PVNMASK      = 255.255.192.0
FCNA         = 170.120.50.0
FCNAMASK     = 255.255.240.0
FCNB         = 170.121.50.0
FCNBMASK     = 255.255.254.0
```

Choose `dest` and `submask` parameter values for the IP route whose resulting subnet address is not be the same as the subnet address resulting from the `pvn` and `pvnmask`, `fcna` and `fcnamask`, or `fcnb` and `fcnbmask` parameter values of the `chg-netopts` command. Continue the procedure with [Step 4](#).

- Add the IP route to the database using the `ent-ip-rte` command.

For this example, enter this command.

```
ent-ip-rte:loc=1212:dest=132.10.175.20:submask=255.255.255.255
:gtwy=150.1.1.50
```

When this command has successfully completed, this message should appear.

```
rlghncxa03w 06-10-12 09:12:36 GMT EAGLE5 36.0.0
ENT-IP-RTE: MASP A - COMPLTD
```

- Verify the changes using the `rtrv-ip-rte` command with the card location specified with the `ent-ip-rte` command in [Step 4](#).

For this example, enter these commands.

```
rtrv-ip-rte:loc=1212
```

This is an example of the possible output.

```
rlghncxa03w 06-10-28 09:12:36 GMT EAGLE5 36.0.0
LOC  DEST          SUBMASK          GTWY
1212 132.10.175.20  255.255.255.255 150.1.1.50
IP Route table is (6 of 2048) 0.29% full
```

- Back up the new changes using the `chg-db:action=backup:dest=fixed` command.

These messages should appear, the active Maintenance and Administration Subsystem Processor (MASP) appears first.

```
BACKUP (FIXED) : MASP A - Backup starts on active MASP.  
BACKUP (FIXED) : MASP A - Backup on active MASP to fixed disk complete.  
BACKUP (FIXED) : MASP A - Backup starts on standby MASP.  
BACKUP (FIXED) : MASP A - Backup on standby MASP to fixed disk complete.
```

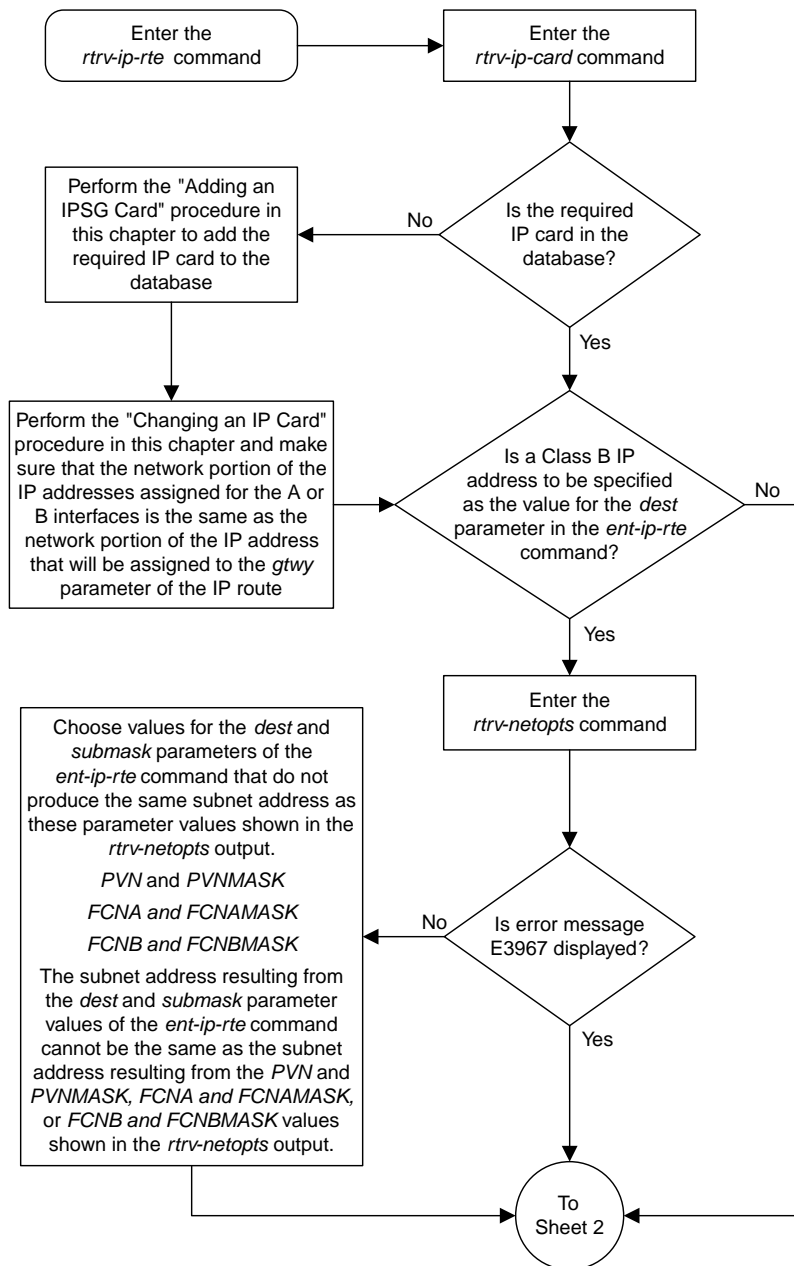

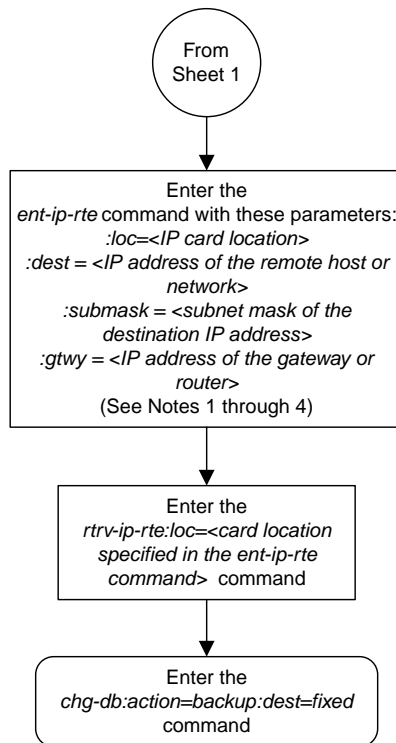
**Notes:**

1. The network portion of the IP address value of the *gtwy* parameter must be the same as the network portion of the IP addresses shown for either the A or B interfaces in the *rtrv-ip-card* output.
2. The value of the *dest* and *gtwy* parameters cannot be the 127.x.x.x (the loopback address), 0.0.0.0, or the IP addresses of the A or B interfaces on the IP card, and cannot be assigned to another IP card.
3. There can be a maximum of 64 IP routes assigned to an IP card.
4. The EAGLE 5 ISS can contain a maximum of 1024 IP routes.

Sheet 2 of 2

Figure 95: Adding an IP Route**Adding an IPSG M2PA Association**

This procedure is used to configure IPSG M2PA associations using the `ent-assoc` command. The combination of a local host, local SCTP port, remote host and remote SCTP port defines an association. IPSG M2PA associations are assigned to E5-ENET cards running the IPSG application (IPSG cards).

The `ent-assoc` command uses these parameters to add an IPSG M2PA association to the database.

`:aname` – The name assigned to the association. Valid association names can contain up to 15 alphanumeric characters where the first character is a letter and the remaining characters are alphanumeric characters. The `aname` parameter value is not case-sensitive.

`:lhost` – Local Hostname. The logical name assigned to the local host device.

`:lport` – The SCTP port number for the local host.

`:rhost` – Remote Hostname. The logical name assigned to the remote host device.

`:rport` – The SCTP port number for the remote host.

`:adapter` – The adapter layer for this association, `m2pa`. The `adapter` parameter is optional. The default value for the `adapter` parameter is `m2pa`.

`:alhost` – The alternate local host name.

`:m2patset` – The M2PA timer set assigned to the association. The `m2patset` parameter can be specified only with the `adapter=m2pa` parameter. If the `adapter=m2pa` parameter is specified, and the `m2patset` parameter is not specified with the `ent-assoc` command, the default value for the `m2patset` parameter (1 - M2PA timer set 1) is assigned to the association.

Associations contain fields whose values are not assigned using the `ent-assoc` command. When an association is added to the database, these fields receive their default values. If a different value is desired, the `chg-assoc` command must be used. To change these values perform the [Changing the Attributes of an IPSG Association](#) procedure.

These fields and their default values are shown in [Table 52: IPSG M2PA Association Fields and Default Values](#).

Table 52: IPSG M2PA Association Fields and Default Values

<code>open=no</code>	<code>rmax=800</code>	<code>cwmin=3000</code>	<code>alw=no</code>	<code>uaps=10</code>
<code>istrms=2</code>	<code>rmode=lin</code>	<code>rtimes=10</code>	<code>ostrms=2</code>	<code>rmin=120</code>
<code>ver=rfc</code>	<code>bufsize=200</code>	<code>rtxthr=0</code>	<code>rhostval=relaxed</code>	

The `link` parameter cannot be specified for an IPSG M2PA association.

An IPSG M2PA association can contain an alternate remote host. The alternate remote host is provisioned with the `rhost` and `rhosttype=alternate` parameters of the `chg-assoc` command. A primary remote host can be provisioned on this procedure by specifying the `rhost` parameter with

the `ent-assoc` command. To provision an alternate remote host for an IPSG M2PA association, perform [Changing the Attributes of an IPSG Association](#).

The size of the buffers on the IPSG cards is 3200 KB. The size of the buffers assigned to each association that is assigned to the IPSG card cannot exceed the maximum buffer size for the IPSG card. When a new association is added, the default buffer size for the association is assigned to the association. If adding the new association causes the total buffer size for all the associations on the IPSG card to exceed the maximum buffer size for that IPSG card, the `ent-assoc` command will be rejected. If you wish to add the association and the maximum buffer size for the IPSG card will be exceeded, the buffer size of the other associations assigned to the IPSG card must be decreased by performing the [Changing the Buffer Size of an IPSG Association](#) procedure. The available size of the buffers on the IPSG card can be verified by entering this command.

```
rtrv-assoc:lhost=<local host name assigned to the association>
```

The `alhost` parameter can also be used with the `rtrv-assoc` command to display the available size of the buffers on the IPSG card.

The `aname` parameter can be used with the `rtrv-assoc` command to display the available size of the buffers on the IPSG card and the size of the buffer assigned to the association.

The value of the `lhost`, `rhost`, or `alhost` parameters is a text string of up to 60 characters, with the first character being a letter. The command line on the terminal can contain up to 150 characters. If the host names are too long to fit on the `ent-assoc` command line, perform the `chg-assoc` command with the parameters and values necessary to complete the entry of the M2PA association.

The EAGLE can contain a maximum of 4000 connections (association to application server assignments).

A maximum of 32 IPSG M2PA associations can be assigned to an IPSG card.

The B Ethernet interface of the IPSG card can be used.

To activate the association after the association is assigned to a signaling link, the association must contain values for the `lhost`, `lport`, `rhost`, `rport` parameters.

Uni-homed endpoints are associations configured with the `lhost` parameter only. The `lhost` parameter value represents an IP address that corresponds to either the A or B network interface of the IPSG card. Multi-homed endpoints are associations configured with both the `lhost` and `alhost` parameters. The `lhost` parameter value represents an IP address corresponding to one of the network interfaces (A or B) of the IP card while the `alhost` parameter value represents an IP address corresponding to the other network interface of the same IPSG card.

An alternate remote host can be configured for multi-homed associations using the `rhost` and `rhosttype` parameters of the `chg-assoc` command. The `rhost` parameter value with the `rhosttype=primary` parameter represents an IP address that corresponds to one of the network interfaces at the remote end while the `rhost` parameter value with the `rhosttype=alternate` parameter represents an IP address that corresponds to the other network interface at the remote end.

Canceling the RTRV-ASSOC Command

Because the `rtrv-assoc` command used in this procedure can output information for a long period of time, the `rtrv-assoc` command can be canceled and the output to the terminal stopped. There are three ways that the `rtrv-assoc` command can be canceled.

- Press the F9 function key on the keyboard at the terminal where the `rtrv-assoc` command was entered.
- Enter the `canc-cmd` without the `trm` parameter at the terminal where the `rtrv-assoc` command was entered.

- Enter the `canc-cmd:trm=<xx>`, where `<xx>` is the terminal where the `rtrv-assoc` command was entered, from another terminal other than the terminal where the `rtrv-assoc` command was entered. To enter the `canc-cmd:trm=<xx>` command, the terminal must allow Security Administration commands to be entered from it and the user must be allowed to enter Security Administration commands. The terminal's permissions can be verified with the `rtrv-secu-trm` command. The user's permissions can be verified with the `rtrv-user` or `rtrv-secu-user` commands.

For more information about the `canc-cmd` command, go to *Commands User's Guide*.

1. Display the associations in the database using the `rtrv-assoc` command. This is an example of possible output.

```
rlghncxa03w 08-04-28 09:12:36 GMT EAGLE5 38.0.0
CARD IPLNK
ANAME      LOC  PORT  LINK ADAPTER  LPORT  RPORT  OPEN  ALW
swbel32    1201 A     A    M3UA    1030    2345   YES   YES
a2         1305 A     A    SUA     1030    2345   YES   YES
a3         1307 A     A    SUA     1030    2346   YES   YES
assoc3     1203 A     A1   M2PA    2048    1030   NO    NO
```

Perform one of these actions.

- If the desired IP link (shown by the entries in the `CARD LOC` and `IPLNK PORT` columns for an association whose `ADAPTER` value is `M2PA`) is shown in the `rtrv-assoc` output, continue the procedure with [Step 2](#).
 - If the desired IP link is not shown in the `rtrv-assoc` output, continue the procedure with [Step 4](#).
2. Display the card that the new M2PA association will be assigned to by entering the `rtrv-card` command with the card location displayed in [Step 1](#). For this example, enter this command.

```
rtrv-card:loc=1203
```

The following is an example of the possible output.

```
rlghncxa03w 08-04-28 09:12:36 GMT EAGLE5 38.0.0
CARD  TYPE      APPL      LSET NAME  LINK SLC  LSET NAME  LINK SLC
1203  ENET        IPSG      m2pa1     A1    0
```

If the value in the `TYPE` column is `IPSG`, continue the procedure with [Step 3](#).

If the value in the `TYPE` column is either `IPLIM` or `IPLIMI`, the host assigned to this card cannot be used in this procedure. If you wish to use this card to configure an M2PA association, perform the [Adding an M2PA Association](#) procedure.

If you do not wish to use this card to configure an IPSG M2PA association, perform one of these actions.

- Choose another card from the `rtrv-assoc` output in [Step 1](#) and repeat this step.
 - Continue the procedure with [Step 4](#) to choose another IPSG card and IP link for the new IPSG M2PA association.
3. Display the associations assigned to the card that the new association will be assigned to by entering the `rtrv-assoc` command with the card location specified in [Step 2](#). For this example, enter this command.

```
rtrv-assoc:loc=1203
```

The following is an example of the possible output.

```
rlghncxa03w 08-04-28 09:12:36 GMT EAGLE5 38.0.0
CARD IPLNK
ANAME LOC PORT LINK ADAPTER LPORT RPORT OPEN ALW
assoc3 1203 A A1 M2PA 2048 1030 NO NO

IP Appl Sock/Assoc table is (4 of 4000) 1% full
Assoc Buffer Space Used (200 KB of 800 KB) on LOC = 1203
```

An IPSG card can contain a maximum of 32 IPSG M2PA or M3UA associations. If 32 associations are displayed in the `rtrv-assoc` output, the new IPSG M2PA association cannot be added to this card. Choose another IPSG card and repeat this procedure from [Step 1](#).

If less than 32 associations are shown in the `rtrv-assoc` output, continue the procedure with [Step 6](#).

4. Display the IP links in the database by entering the `rtrv-ip-lnk` command. The following is an example of the possible output.

```
rlghncxa03w 08-12-28 21:14:37 GMT EAGLE5 40.0.0
LOC PORT IPADDR SUBMASK DUPLEX SPEED MACTYPE AUTO MCAST
1201 A 192.1.1.10 255.255.255.128 HALF 10 802.3 NO NO
1201 B ----- HALF 10 DIX NO NO
1203 A 192.1.1.12 255.255.255.0 ---- DIX YES NO
1203 B ----- HALF 10 DIX NO NO
1205 A 192.1.1.14 255.255.255.0 FULL 100 DIX NO NO
1205 B ----- HALF 10 DIX NO NO
2101 A 192.1.1.20 255.255.255.0 FULL 100 DIX NO NO
2101 B ----- HALF 10 DIX NO NO
2103 A 192.1.1.22 255.255.255.0 FULL 100 DIX NO NO
2103 B ----- HALF 10 DIX NO NO
2105 A 192.1.1.24 255.255.255.0 FULL 100 DIX NO NO
2105 B ----- HALF 10 DIX NO NO
2205 A 192.1.1.30 255.255.255.0 FULL 100 DIX NO NO
2205 B ----- HALF 10 DIX NO NO
2207 A 192.1.1.32 255.255.255.0 FULL 100 DIX NO NO
2207 B ----- HALF 10 DIX NO NO
2213 A 192.1.1.50 255.255.255.0 FULL 100 DIX NO NO
2213 B ----- HALF 10 DIX NO NO
2301 A 192.1.1.52 255.255.255.0 FULL 100 DIX NO NO
2301 B ----- HALF 10 DIX NO NO

IP-LNK table is (20 of 2048) 1% full.
```

If the required IP link is not in the database, add the IP link using the [Configuring an IP Link](#) procedure.

5. Verify that the local host name to be assigned to the association is in the database by using the `rtrv-ip-host:display=all` command. The following is an example of the possible output.

```
rlghncxa03w 13-06-28 21:15:37 GMT EAGLE5 45.0.0

LOCAL IPADDR LOCAL HOST
192.1.1.10 IPNODE1-1201
192.1.1.12 IPNODE1-1203
```

```

192.1.1.14      IPNODE1-1205
192.1.1.20      IPNODE2-1201
192.1.1.22      IPNODE2-1203
192.1.1.24      IPNODE2-1205
192.1.1.30      KC-HLR1
192.1.1.32      KC-HLR2
192.1.1.50      DN-MS1
192.1.1.52      DN-MS2

REMOTE IPADDR  REMOTE HOST
150.1.1.5      NCDEPTECONOMIC_DEVELOPMENT. SOUTHEASTERN_COORIDOR_ASHVL. GOV

IP Host table is (11 of 4096) .26% full

```

The IP address of the IP link should be assigned to the local host name that will be assigned to the association.

The values of the `lhost` and `alhost` parameters must be in the `LOCAL HOST` column in the `rtrv-ip-host` output.

If the required hostname is not in the database, add the IP host name using the [Adding an IP Host](#) procedure.

- Verify the values of the M2PA timer set you wish to assign to the association by entering the `rtrv-m2pa-tset` command with the `ver=rfc` parameter.

When an IPSG M2PA association is provisioned in this procedure, the RFC M2PA version is assigned to the IPSG M2PA association by default.

The M2PA version of the association determines the version of the M2PA timer set that is assigned to the association. For example, if M2PA timer set 3 is assigned to the IPSG M2PA association, and the association is an RFC IPSG M2PA association, the RFC version of M2PA timer set 3 is used with the association. If M2PA timer set 7 is assigned to the IPSG M2PA association, and the association is a Draft 6 IPSG M2PA association, the Draft 6 version of M2PA timer set 7 is used with the association.

If you wish to assign the Draft 6 M2PA version to this association and use the Draft 6 M2PA timer sets, perform the [Changing the Attributes of an IPSG Association](#) procedure after this procedure is completed to change the M2PA version of this association.

Note: If the `them2patset` parameter will not be specified with the `ent-assoc` command, the M2PA timer set 1 will be assigned to the association.

To display the M2PA Draft 6 timer values, enter this command.

```
rtrv-m2pa-tset:ver=d6
```

This is an example of the possible output.

```

rlghncxa03w 08-04-28 21:16:37 GMT EAGLE5 38.0.0

M2PA Draft 6 Timers (in msec, T16 in microsec)
TSET T1      T2      T3      T4N    T4E    T5      T6      T7      T16    T17    T18
1     6000    ----- 5000    20000  500    5000    4000  1000    100000 150    500
2     7500    ----- 1500    2000   500    9000    1250  300    150000 175    600
3     100000  ----- 2000    3000   500    4000    1500  500    170000 200    800
4     200000  ----- 20000   4000   500    6000    2000  700    480000 225    900
5     250000  ----- 30000   30000  500    100     2250  400    400000 400    8000
6     50000   ----- 50000   60000  500    500     4500  800    300000 300    7000

```

7	10000	-----	10000	10000	500	1000	3000	1200	200000	250	1000
8	80000	-----	1500	15000	500	8000	2750	1100	350000	350	5000
9	27500	-----	3850	4859	450	5700	3750	1150	250	375	8750
10	90000	-----	2500	50000	500	7500	5000	1750	440000	450	3000
11	20000	-----	4500	5500	500	6500	5500	1600	250000	475	4500
12	30000	-----	7500	7000	500	750	4250	1800	275000	275	3500
13	40000	-----	35000	9000	500	1250	3500	1900	500	325	9000
14	70000	-----	45000	11000	500	1500	1750	900	1000	125	6000
15	9000	-----	25000	40000	500	2500	3250	600	5000	425	5500
16	75000	-----	15000	25000	500	4500	1600	1400	6000	240	9500
17	350000	-----	60000	70000	600	10000	6000	2000	500000	500	10000
18	150000	-----	55000	35000	500	3500	5750	1500	125000	440	750
19	175000	-----	12500	45000	500	1100	2600	1300	7000	340	850
20	1000	-----	1000	1000	400	80	1000	200	100	100	100

To display the M2PARFC values, enter this command.

```
rtrv-m2pa-tset:ver=rfc
```

This is an example of the possible output.

```
rlghncxa03w 08-04-28 21:16:37 GMT EAGLE5 38.0.0
```

M2PA RFC Timers (in msec, T16 in microsec)

TSET	T1	T2	T3	T4N	T4E	T5	T6	T7	T16	T17	T18
1	6000	75000	5000	20000	500	5000	4000	1000	100000	150	500
2	7500	8000	1500	2000	500	9000	1250	300	150000	175	600
3	100000	10000	2000	3000	500	4000	1500	500	170000	200	800
4	200000	6000	20000	4000	500	6000	2000	700	480000	225	900
5	250000	140000	30000	30000	500	100	2250	400	400000	400	8000
6	50000	100000	50000	60000	500	500	4500	800	300000	300	7000
7	300000	20000	2000	10000	500	1000	3000	1200	200000	250	1000
8	80000	130000	1500	15000	500	8000	2750	1100	350000	350	5000
9	27500	120000	3850	4859	450	5700	3750	1150	250	375	8750
10	90000	9000	2500	50000	500	7500	5000	1750	440000	450	3000
11	20000	60000	4500	5500	500	6500	5500	1600	250000	475	4500
12	30000	50000	7500	7000	500	750	4250	1800	275000	275	3500
13	40000	90000	35000	9000	500	1250	3500	1900	500	325	9000
14	70000	45000	45000	11000	500	1500	1750	900	1000	125	6000
15	9000	30000	25000	40000	500	2500	3250	600	5000	425	5500
16	75000	15000	15000	25000	500	4500	1600	1400	6000	240	9500
17	350000	150000	60000	70000	600	10000	6000	2000	500000	500	10000
18	150000	20000	55000	35000	500	3500	5750	1500	125000	440	750
19	175000	12500	12500	45000	500	1100	2600	1300	7000	340	850
20	1000	5000	1000	1000	400	80	1000	200	100	100	100

If the ver parameter is not specified when entering the rtrv-m2pa-tset command, both the Draft 6 and RFC values are displayed. This is an example of the possible output.

```
rlghncxa03w 08-04-28 21:16:37 GMT EAGLE5 38.0.0
```

M2PA Draft 6 Timers (in msec, T16 in microsec)

TSET	T1	T2	T3	T4N	T4E	T5	T6	T7	T16	T17	T18
1	6000	-----	5000	20000	500	5000	4000	1000	100000	150	500
2	7500	-----	1500	2000	500	9000	1250	300	150000	175	600
3	100000	-----	2000	3000	500	4000	1500	500	170000	200	800
4	200000	-----	20000	4000	500	6000	2000	700	480000	225	900
5	250000	-----	30000	30000	500	100	2250	400	400000	400	8000
6	50000	-----	50000	60000	500	500	4500	800	300000	300	7000

7	10000	-----	10000	10000	500	1000	3000	1200	200000	250	1000
8	80000	-----	1500	15000	500	8000	2750	1100	350000	350	5000
9	27500	-----	3850	4859	450	5700	3750	1150	250	375	8750
10	90000	-----	2500	50000	500	7500	5000	1750	440000	450	3000
11	20000	-----	4500	5500	500	6500	5500	1600	250000	475	4500
12	30000	-----	7500	7000	500	750	4250	1800	275000	275	3500
13	40000	-----	35000	9000	500	1250	3500	1900	500	325	9000
14	70000	-----	45000	11000	500	1500	1750	900	1000	125	6000
15	9000	-----	25000	40000	500	2500	3250	600	5000	425	5500
16	75000	-----	15000	25000	500	4500	1600	1400	6000	240	9500
17	350000	-----	60000	70000	600	10000	6000	2000	500000	500	10000
18	150000	-----	55000	35000	500	3500	5750	1500	125000	440	750
19	175000	-----	12500	45000	500	1100	2600	1300	7000	340	850
20	1000	-----	1000	1000	400	80	1000	200	100	100	100

M2PA RFC Timers (in msec, T16 in microsec)

TSET	T1	T2	T3	T4N	T4E	T5	T6	T7	T16	T17	T18
1	6000	75000	5000	20000	500	5000	4000	1000	100000	150	500
2	7500	8000	1500	2000	500	9000	1250	300	150000	175	600
3	100000	10000	2000	3000	500	4000	1500	500	170000	200	800
4	200000	6000	20000	4000	500	6000	2000	700	480000	225	900
5	250000	140000	30000	30000	500	100	2250	400	400000	400	8000
6	50000	100000	50000	60000	500	500	4500	800	300000	300	7000
7	300000	20000	2000	10000	500	1000	3000	1200	200000	250	1000
8	80000	130000	1500	15000	500	8000	2750	1100	350000	350	5000
9	27500	120000	3850	4859	450	5700	3750	1150	250	375	8750
10	90000	9000	2500	50000	500	7500	5000	1750	440000	450	3000
11	20000	60000	4500	5500	500	6500	5500	1600	250000	475	4500
12	30000	50000	7500	7000	500	750	4250	1800	275000	275	3500
13	40000	90000	35000	9000	500	1250	3500	1900	500	325	9000
14	70000	45000	45000	11000	500	1500	1750	900	1000	125	6000
15	9000	30000	25000	40000	500	2500	3250	600	5000	425	5500
16	75000	15000	15000	25000	500	4500	1600	1400	6000	240	9500
17	350000	150000	60000	70000	600	10000	6000	2000	500000	500	10000
18	150000	20000	55000	35000	500	3500	5750	1500	125000	440	750
19	175000	12500	12500	45000	500	1100	2600	1300	7000	340	850
20	1000	5000	1000	1000	400	80	1000	200	100	100	100

If the M2PA timer set you wish to assign to the association does not contain the desired values, go to the [Changing an M2PA Timer Set](#) procedure and changed the desired timer values.



CAUTION

Caution: Changing an M2PA timer set may affect the performance of any associations using the timer set being changed.

- Verify the available buffer size for the IPSG card that will contain the association being added in this procedure by entering the `rtrv-assoc` command with the local host name assigned to the association being added. For this example, enter this command.

Note: If a new host was added in [Step 5](#), continue the procedure with [Step 8](#).

```
rtrv-assoc:lhost="IPNODE2-1203"
```

This is an example of the possible output.

```
rlghncxa03w 08-04-28 09:12:36 GMT EAGLE5 38.0.0
CARD IPLNK
ANAME          LOC  PORT  LINK ADAPTER LPORT RPORT OPEN ALW
```

```

assoc3          1203 A      A1    M2PA    2048  1030  NO    NO
IP Appl Sock/Assoc table is (8 of 4000) 1% full
Assoc Buffer Space Used (200 KB of 1600 KB) on LOC = 1203

```

If adding the new association causes the total buffer size for all the associations on the IP card to exceed the maximum buffer size for that IP card, the `ent-assoc` command will be rejected.

The default buffer value for an IPSG M2PA association is 200.

If you wish to add the association and the maximum buffer size for the IP card will be exceeded, the buffer size of the other associations assigned to the IP card must be decreased by performing the [Changing the Buffer Size of an IPSG Association](#) procedure.

8. Add the associations using the `ent-assoc` command. For this example, enter this command.

```

ent-assoc:aname=assoc2:lhost=gw107.nc.tekelec.com:lport=2000:
rhost=gw100.nc.tekelec.com:rport=1030:adapter=m2pa

```

These are the rules that apply to adding IPSG M2PA associations.

1. The EAGLE can contain a maximum of 4000 connections (association – application server assignments).
2. The default value for the `adapter` parameter is `m2pa`.
3. A maximum of 32 IPSG M2PA or M3UA associations can be assigned to the IPSG card.
4. The value of the `lhost`, `rhost`, or `alhost` parameters is a text string of up to 60 characters, with the first character being a letter. The command line on the terminal can contain up to 150 characters. If the host names are too long to fit on the `ent-assoc` command line, perform the `chg-assoc` command with the parameters and values necessary to complete the entry of the IPSG M2PA association.
5. To activate the association after the association is assigned to a signaling link, the association must contain values for the `lhost`, `rhost`, `lport`, and `rport` parameters.
6. If the `lhost` and `alhost` parameters are specified, the `lhost` parameter value represents the IP address corresponding to one of the network interfaces (A or B) on the IP card while the `alhost` parameter value represents the IP address corresponding to the other network interface of the same IP card.
7. The `m2patset` parameter can be specified only with the `adapter=m2pa` parameter.
8. The `m2patset` parameter value defaults to M2PA timer set 1 (`m2patset=1`) if the `m2patset` parameter is not specified.
9. When the `adapter=m2pa` parameter is specified, the RFC M2PA version is assigned to the M2PA association by default. If you wish to assign the Draft 6 M2PA version to this association, perform the [Changing the Attributes of an IPSG Association](#) procedure after this procedure is completed to change the M2PA version of this association.

When this command has successfully completed, this message should appear.

```

rlghncxa03w 08-04-28 09:12:36 GMT EAGLE5 38.0.0
ENT-ASSOC: MASP A - COMPLTD

```

9. Verify the changes using the `rtrv-assoc` command specifying the association name specified in [Step 8](#). For this example, enter this command.

```

rtrv-assoc:aname=assoc2

```

This is an example of possible output.

```

rlghncxa03w 10-07-28 09:12:36 GMT EAGLE5 42.0.0
ANAME assoc2
  LOC      1203          IPLNK PORT A      LINK      --
ADAPTER  M2PA          VER          M2PA RFC
LHOST    gw105.nc.tekelec.com
ALHOST   ---
RHOST    gw100.nc.tekelec.com
ARHOST   ---
LPORT    1030          RPORT      1030
ISTRMS   2            OSTRMS     2          BUFSIZE   200
RMODE    LIN          RMIN       120        RMAX      800
RTIMES   10           CWMIN      3000       UAPS      10
OPEN     NO           ALW        YES         RTXTHR    0
RHOSTVAL RELAXED      M2PATSET   1
IP Appl Sock table is (5 of 4000) 1% full
Assoc Buffer Space Used (400 KB of 1600 KB) on LOC = 1203

```

10. Back up the new changes, using the `chg-db:action=backup:dest=fixed` command. These messages should appear; the active Maintenance and Administration Subsystem Processor (MASP) appears first.

```

BACKUP (FIXED) : MASP A - Backup starts on active MASP.
BACKUP (FIXED) : MASP A - Backup on active MASP to fixed disk complete.
BACKUP (FIXED) : MASP A - Backup starts on standby MASP.
BACKUP (FIXED) : MASP A - Backup on standby MASP to fixed disk complete.

```

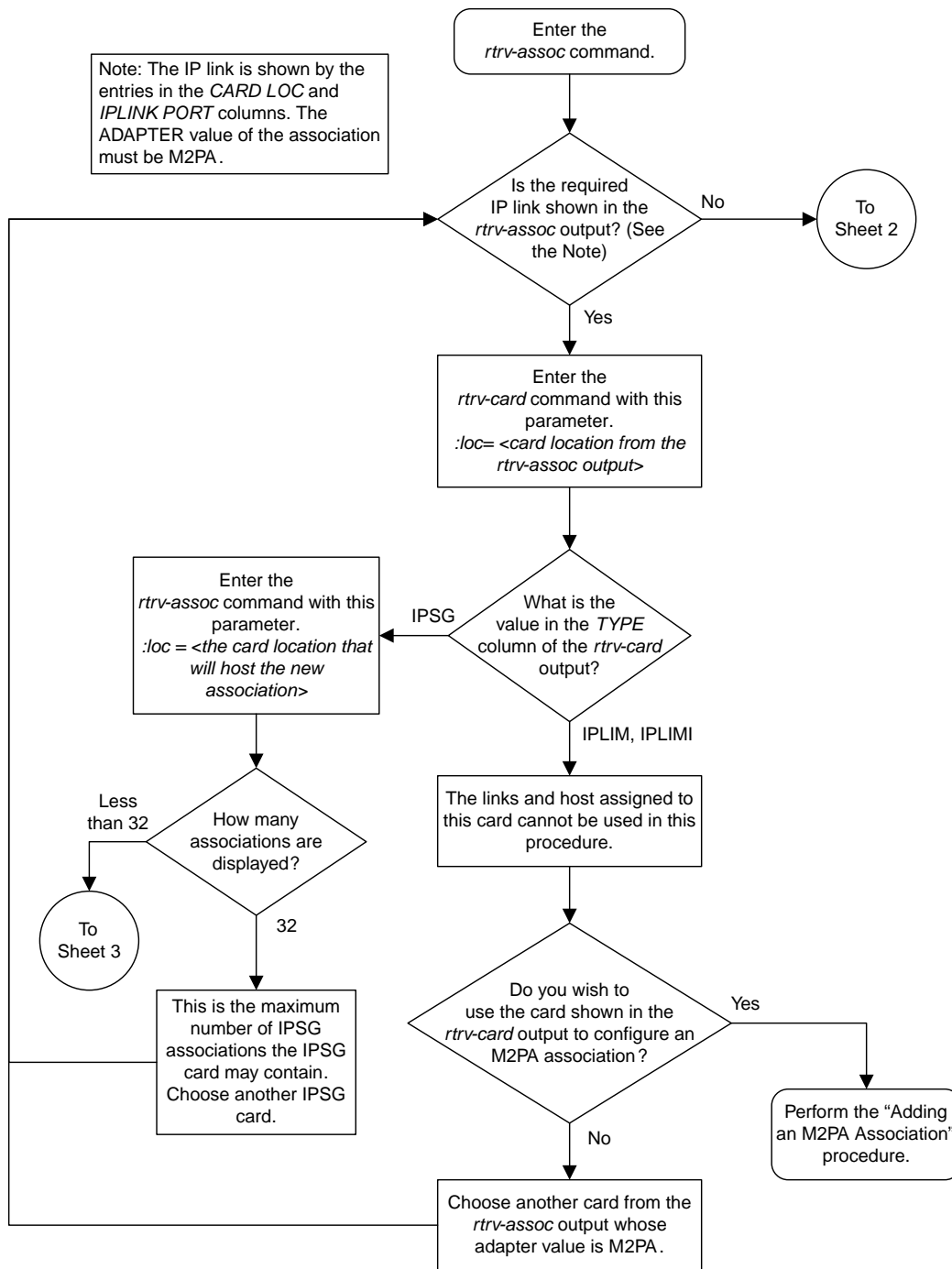

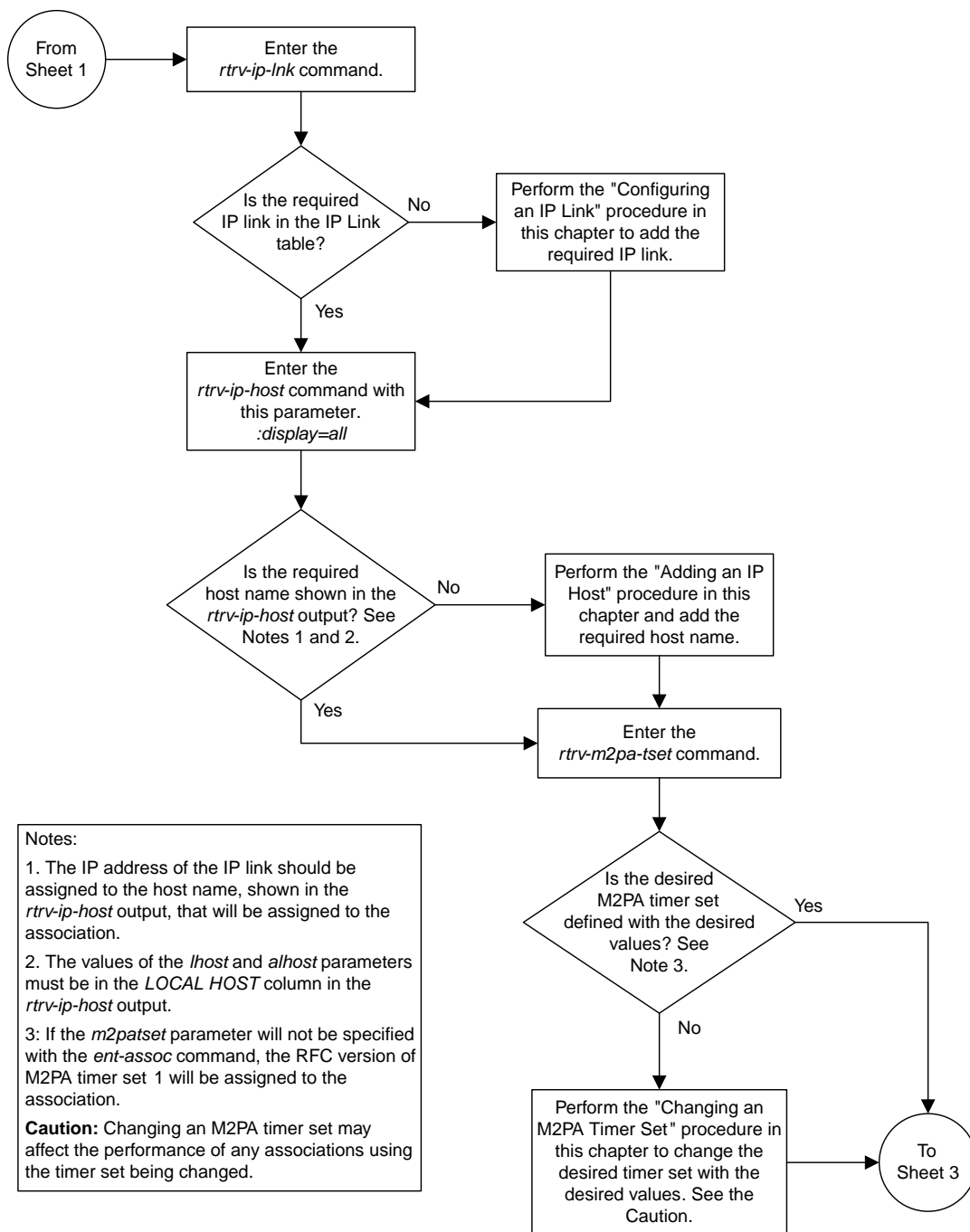

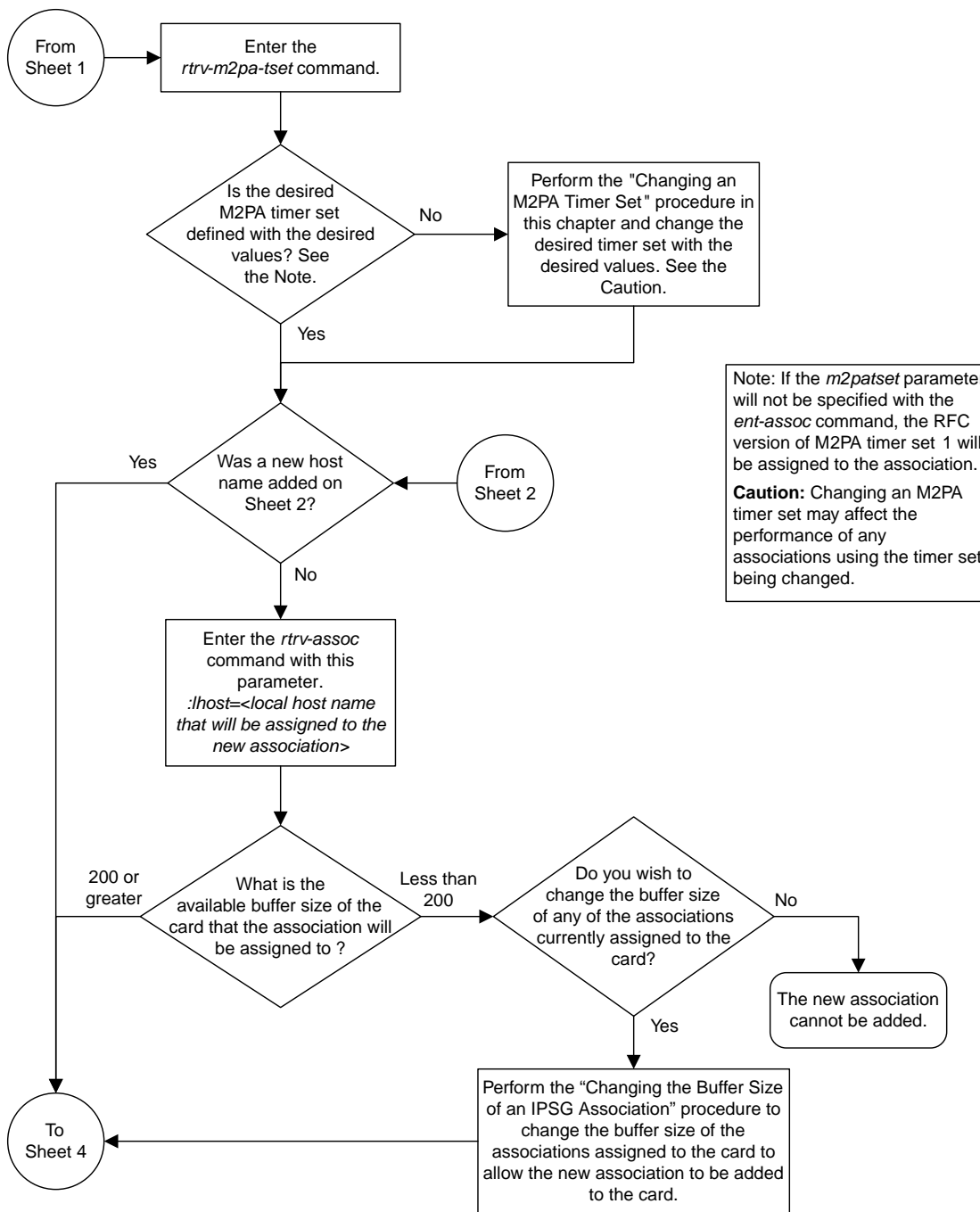

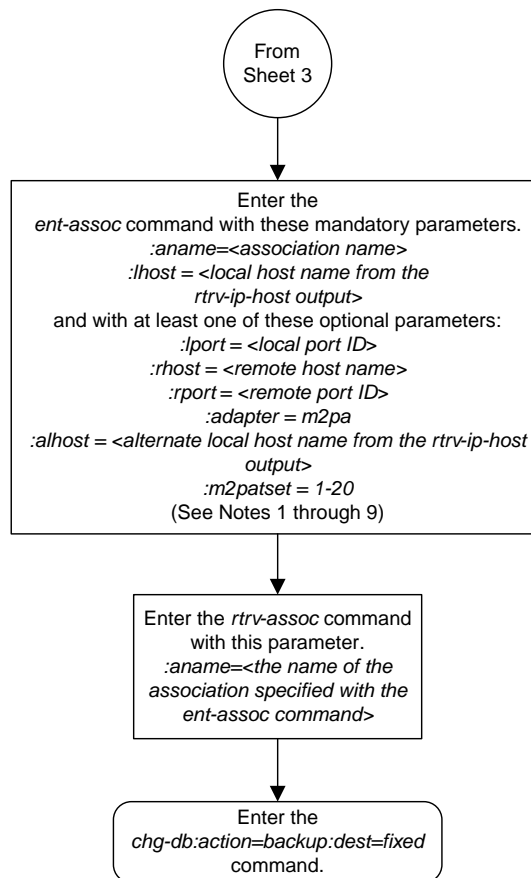

Notes:

1. The EAGLE 5 ISS can contain a maximum of 4000 connections (association – application server assignments).
2. The default value for the *adapter* parameter is *m2pa*.
3. A maximum of 32 IPSG M2PA or M3UA associations can be assigned to the IPSG card.
4. The value of the *lhost*, *rhost*, or *alhost* parameters is a text string of up to 60 characters, with the first character being a letter. The command line on the terminal can contain up to 150 characters. If the host names are too long to fit on the *ent-assoc* command line, perform the *chg-assoc* command with the parameters and values necessary to complete the entry of the IPSG M2PA association.
5. To activate the association after the association is assigned to a signaling link, the association must contain values for the *lhost*, *rhost*, *lport*, and *rport* parameters.
6. If the *lhost* and *alhost* parameters are specified, the *lhost* parameter value represents the IP address corresponding to one of the network interfaces (A or B) on the IP card while the *alhost* parameter value represents the IP address corresponding to the other network interface of the same IP card.
7. The *m2patset* parameter can be specified only with the *adapter=m2pa* parameter.
8. The *m2patset* parameter value defaults to M2PA timer set 1 (*m2patset=1*) if the *m2patset* parameter is not specified.
9. When the *adapter=m2pa* parameter is specified, the RFC M2PA version is assigned to the M2PA association by default. If you wish to assign the Draft 6 M2PA version to this association, perform the "Changing the Attributes of an IPSG Association" procedure in this chapter after this procedure is completed to change the M2PA version of this association.

Sheet 4 of 4

Figure 96: Adding an IPSG M2PA Association**Adding an IPSG M3UA Association**

This procedure is used to configure IPSG M3UA associations using the `ent-assoc` command. The combination of a local host, local SCTP port, remote host and remote SCTP port defines an association. IPSG M3UA associations are assigned to E5-ENET cards running the IPSG application (IPSG cards).

The `ent-assoc` command uses these parameters to add an IPSG M3UA association to the database.

`:aname` – The name assigned to the association. Valid association names can contain up to 15 alphanumeric characters where the first character is a letter and the remaining characters are alphanumeric characters. The `aname` parameter value is not case-sensitive.

`:lhost` – Local Hostname. The logical name assigned to the local host device.

`:lport` – The SCTP port number for the local host.

`:rhost` – Remote Hostname. The logical name assigned to the remote host device.

`:rport` – The SCTP port number for the remote host.

`:adapter` – The adapter layer for this association, `m3ua`. The `adapter` parameter is required for adding an IPSG M3UA association. The default value for the `adapter` parameter is `m2pa`.

`:alhost` – The alternate local host name.

The `link` parameter cannot be specified for an IPSG M3UA association.

The `adapter=m2pa` and `m2patset` parameters can be used only when configuring M2PA associations. Perform the [Adding an M2PA Association](#) or [Adding an IPSG M2PA Association](#) procedures to configure M2PA associations.

Associations contain fields whose values are not assigned using the `ent-assoc` command. When an association is added to the database, these fields receive their default values. If a different value is desired, the `chg-assoc` command must be used. To change these values perform the [Changing the Attributes of an IPSG Association](#) procedure.

These fields and their default values are shown in [Table 53: IPSG M3UA Association Fields and Default Values](#).

Table 53: IPSG M3UA Association Fields and Default Values

<code>open=no</code>	<code>rmax=800</code>	<code>cwmin=3000</code>	<code>alw=no</code>	<code>uaps=10</code>
<code>istrms=2</code>	<code>rmode=lin</code>	<code>rtimes=10</code>	<code>ostrms=2</code>	<code>rmin=120</code>
<code>bufsize=200</code>	<code>rtxthr=0</code>	<code>rhostval=relaxd</code>		

An IPSG M3UA association can contain an alternate remote host. The alternate remote host is provisioned with the `rhost` and `rhostype=alternate` parameters of the `chg-assoc` command. A primary remote host can be provisioned on this procedure by specifying the `rhost` parameter with

the `ent-assoc` command. To provision an alternate remote host for an IPSG M3UA association, perform [Changing the Attributes of an IPSG Association](#).

The size of the buffers on the IPSG cards is 3200 KB. The size of the buffers assigned to each association that is assigned to the IPSG card cannot exceed the maximum buffer size for the IPSG card. When a new association is added, the default buffer size for the association is assigned to the association. If adding the new association causes the total buffer size for all the associations on the IPSG card to exceed the maximum buffer size for that IPSG card, the `ent-assoc` command will be rejected. If you wish to add the association and the maximum buffer size for the IPSG card will be exceeded, the buffer size of the other associations assigned to the IPSG card must be decreased by performing the [Changing the Buffer Size of an IPSG Association](#) procedure. The available size of the buffers on the IPSG card can be verified by entering this command.

```
rtrv-assoc:lhost=<local host name assigned to the association being changed>
```

The `alhost` parameter can also be used with the `rtrv-assoc` command to display the available size of the buffers on the IP card.

The `aname` parameter can be used with the `rtrv-assoc` command to display the available size of the buffers on the IP card and the size of the buffer assigned to the association.

The value of the `lhost`, `rhost`, or `alhost` parameters is a text string of up to 60 characters, with the first character being a letter. The command line on the terminal can contain up to 150 characters. If the host names are too long to fit on the `ent-assoc` command line, perform the `chg-assoc` command with the parameters and values necessary to complete the entry of the M3UA association.

The EAGLE can contain a maximum of 4000 connections (association to application server assignments).

The B Ethernet interface of the IPSG card can be used.

To activate the association after the association is assigned to a signaling link, the association must contain values for the `lhost`, `lport`, `rhost`, `rport` parameters.

Uni-homed endpoints are associations configured with the `lhost` parameter only. The `lhost` parameter value represents an IP address that corresponds to either the A or B network interface of the IPSG card. Multi-homed endpoints are associations configured with both the `lhost` and `alhost` parameters. The `lhost` parameter value represents an IP address corresponding to one of the network interfaces (A or B) of the IPSG card while the `alhost` parameter value represents an IP address corresponding to the other network interface of the same IPSG card.

An alternate remote host can be configured for multi-homed associations using the `rhost` and `rhosttype` parameters of the `chg-assoc` command. The `rhost` parameter value with the `rhosttype=primary` parameter represents an IP address that corresponds to one of the network interfaces at the remote end while the `rhost` parameter value with the `rhosttype=alternate` parameter represents an IP address that corresponds to the other network interface at the remote end.

Canceling the RTRV-ASSOC Command

Because the `rtrv-assoc` command used in this procedure can output information for a long period of time, the `rtrv-assoc` command can be canceled and the output to the terminal stopped. There are three ways that the `rtrv-assoc` command can be canceled.

- Press the F9 function key on the keyboard at the terminal where the `rtrv-assoc` command was entered.
- Enter the `canc-cmd` without the `trm` parameter at the terminal where the `rtrv-assoc` command was entered.

- Enter the `canc-cmd:trm=<xx>`, where `<xx>` is the terminal where the `rtrv-assoc` command was entered, from another terminal other than the terminal where the `rtrv-assoc` command was entered. To enter the `canc-cmd:trm=<xx>` command, the terminal must allow Security Administration commands to be entered from it and the user must be allowed to enter Security Administration commands. The terminal's permissions can be verified with the `rtrv-secu-trm` command. The user's permissions can be verified with the `rtrv-user` or `rtrv-secu-user` commands.

For more information about the `canc-cmd` command, go to *Commands User's Guide*.

1. Display the associations in the database using the `rtrv-assoc` command. This is an example of possible output.

```
rlghncxa03w 06-10-28 09:12:36 GMT EAGLE5 36.0.0
CARD IPLNK
ANAME      LOC  PORT  LINK ADAPTER  LPORT  RPORT  OPEN  ALW
swbel32    1201 A     A    M3UA    1030    2345   YES   YES
a2         1305 A     A    SUA     1030    2345   YES   YES
a3         1307 A     A    SUA     1030    2346   YES   YES
assoc3     1203 A     A1   M2PA    2048    1030   NO    NO
```

Perform one of these actions.

- If the desired IP link (shown by the entries in the `CARD LOC` and `IPLNK PORT` columns for an association whose `ADAPTER` value is `M3UA`) is shown in the `rtrv-assoc` output, continue the procedure with [Step 2](#).
 - If the desired IP link is not shown in the `rtrv-assoc` output, continue the procedure with [Step 4](#).
2. Display the card that the new M3UA association will be assigned to by entering the `rtrv-card` command with the card location displayed in [Step 1](#). For this example, enter this command.

```
rtrv-card:loc=1201
```

The following is an example of the possible output.

```
rlghncxa03w 08-04-28 09:12:36 GMT EAGLE5 38.0.0
CARD  TYPE      APPL      LSET NAME  LINK SLC LSET NAME  LINK SLC
1201  ENET        IPSG      m3ua1     A    0
```

If the value in the `TYPE` column is `IPSG`, continue the procedure with [Step 3](#).

If the value in the `TYPE` column is either `SS7IPGW` or `IPGWI`, the host assigned to this card cannot be used in this procedure. If you wish to use this card to configure an M3UA association, perform the [Adding an M3UA or SUA Association](#) procedure.

If you do not wish to use this card to configure an M3UA association, perform one of these actions.

- Choose another card from the `rtrv-assoc` output in [Step 1](#) and repeat this step.
 - Continue the procedure with [Step 4](#) to choose another `IPSG` card and IP link for the new `IPSG M3UA` association.
3. Display the associations assigned to the card that the new association will be assigned to by entering the `rtrv-assoc` command with the card location specified in [Step 2](#). For this example, enter this command.

```
rtrv-assoc:loc=1203
```

The following is an example of the possible output.

```
rlghncxa03w 08-04-28 09:12:36 GMT EAGLE5 38.0.0
CARD IPLNK
ANAME LOC PORT LINK ADAPTER LPORT RPORT OPEN ALW
swbel32 1201 A A M3UA 1030 2345 YES YES

IP Appl Sock/Assoc table is (4 of 4000) 1% full
Assoc Buffer Space Used (200 KB of 800 KB) on LOC = 1203
```

An IPSG card can contain a maximum of 32 IPSG M2PA or M3UA associations. If 32 associations are displayed in the `rtrv-assoc` output, the new IPSG M3UA association cannot be added to this card. Choose another IPSG card and repeat this procedure from [Step 1](#).

If less than 32 associations are shown in the `rtrv-assoc` output, continue the procedure with [Step 6](#).

4. Display the IP links in the database by entering the `rtrv-ip-lnk` command. The following is an example of the possible output.

```
rlghncxa03w 08-12-28 21:14:37 GMT EAGLE5 40.0.0
LOC PORT IPADDR SUBMASK DUPLEX SPEED MACTYPE AUTO MCAST
1201 A 192.1.1.10 255.255.255.128 HALF 10 802.3 NO NO
1201 B ----- HALF 10 DIX NO NO
1203 A 192.1.1.12 255.255.255.0 ---- DIX YES NO
1203 B ----- HALF 10 DIX NO NO
1205 A 192.1.1.14 255.255.255.0 FULL 100 DIX NO NO
1205 B ----- HALF 10 DIX NO NO
2101 A 192.1.1.20 255.255.255.0 FULL 100 DIX NO NO
2101 B ----- HALF 10 DIX NO NO
2103 A 192.1.1.22 255.255.255.0 FULL 100 DIX NO NO
2103 B ----- HALF 10 DIX NO NO
2105 A 192.1.1.24 255.255.255.0 FULL 100 DIX NO NO
2105 B ----- HALF 10 DIX NO NO
2205 A 192.1.1.30 255.255.255.0 FULL 100 DIX NO NO
2205 B ----- HALF 10 DIX NO NO
2207 A 192.1.1.32 255.255.255.0 FULL 100 DIX NO NO
2207 B ----- HALF 10 DIX NO NO
2213 A 192.1.1.50 255.255.255.0 FULL 100 DIX NO NO
2213 B ----- HALF 10 DIX NO NO
2301 A 192.1.1.52 255.255.255.0 FULL 100 DIX NO NO
2301 B ----- HALF 10 DIX NO NO

IP-LNK table (20 of 2048) 1% full.
```

If the required IP link is not in the database, add the IP link using the [Configuring an IP Link](#) procedure.

5. Verify that the local host name to be assigned to the association is in the database by using the `rtrv-ip-host:display=all` command. The following is an example of the possible output.

```
rlghncxa03w 13-06-28 21:15:37 GMT EAGLE5 45.0.0

LOCAL IPADDR LOCAL HOST
192.1.1.10 IPNODE1-1201
192.1.1.12 IPNODE1-1203
```

```

192.1.1.14      IPNODE1-1205
192.1.1.20      IPNODE2-1201
192.1.1.22      IPNODE2-1203
192.1.1.24      IPNODE2-1205
192.1.1.30      KC-HLR1
192.1.1.32      KC-HLR2
192.1.1.50      DN-MS1
192.1.1.52      DN-MS2

REMOTE IPADDR  REMOTE HOST
150.1.1.5      NCDEPTECONOMIC_DEVELOPMENT. SOUTHEASTERN_COORIDOR_ASHVL. GOV

IP Host table is (11 of 4096) .26% full

```

The IP address of the IP link should be assigned to the local host name that will be assigned to the association.

The values of the `lhost` and `alhost` parameters must be in the `LOCAL HOST` column in the `rtrv-ip-host` output.

If the required hostname is not in the database, add the IP host name using the [Adding an IP Host](#) procedure.

6. Verify the available buffer size for the IP card that will contain the association being added in this procedure by entering the `rtrv-assoc` command with the local host name assigned to the association being added. For this example, enter this command.

Note: If a new IP host was added in [Step 5](#), continue the procedure with [Step 7](#).

```
rtrv-assoc:lhost="IPNODE2-1305"
```

This is an example of the possible output.

```

rlghncxa03w 06-10-28 09:12:36 GMT EAGLE5 36.0.0
                CARD IPLNK
ANAME          LOC  PORT  LINK ADAPTER LPORT RPORT OPEN ALW
a2             1305 A    A   SUA     1030 2345 YES  YES

IP Appl Sock/Assoc table is (8 of 4000) 1% full
Assoc Buffer Space Used (16 KB of 800 KB) on LOC = 1305

```

If adding the new association causes the total buffer size for all the associations on the IP card to exceed the maximum buffer size for that IP card, the `ent-assoc` command will be rejected.

The default buffer value for an M3UA or SUA association is 16.

If you wish to add the association and the maximum buffer size for the IP card will be exceeded, the buffer size of the other associations assigned to the IP card must be decreased by performing the [Changing the Buffer Size of an IPSG Association](#) procedure.

7. Add the associations using the `ent-assoc` command. For this example, enter these commands.

```
ent-assoc:aname=assoc1:lhost=gw105.nc.tekelec.com:lport=1030:
rhost=gw100.nc.tekelec.com:rport=1030:adapter=m3ua
```

These are the rules that apply to adding IPSG M3UA associations.

1. The EAGLE can contain a maximum of 4000 connections (association – application server assignments).

2. A maximum of 32 IPSG M2PA or M3UA associations can be assigned to the IPSG card.
3. The value of the `lhost`, `rhost`, or `alhost` parameters is a text string of up to 60 characters, with the first character being a letter. The command line on the terminal can contain up to 150 characters. If the host names are too long to fit on the `ent-assoc` command line, perform the `chg-assoc` command with the parameters and values necessary to complete the entry of the IPSG M3UA association.
4. To activate the association after the association is assigned to a signaling link, the association must contain values for the `lhost`, `rhost`, `lport`, and `rport` parameters.
5. If the `lhost` and `alhost` parameters are specified, the `lhost` parameter value represents the IP address corresponding to one of the network interfaces (A or B) on the IP card while the `alhost` parameter value represents the IP address corresponding to the other network interface of the same IP card.

When each of these commands have successfully completed, this message should appear.

```
rlghncxa03w 06-10-28 09:12:36 GMT EAGLE5 36.0.0
ENT-ASSOC: MASP A - COMPLTD
```

8. Verify the changes using the `rtrv-assoc` command specifying the association name specified in [Step 7](#). For this example, enter these commands.

```
rtrv-assoc:aname=assoc1
```

This is an example of possible output.

```
rlghncxa03w 09-05-28 09:12:36 GMT EAGLE5 41.0.0
ANAME assoc1
  LOC      1305          IPLNK PORT  A          LINK  A
ADAPTER  M3UA          VER      M3UA RFC
LHOST    gw105.nc.tekelec.com
ALHOST   ---
RHOST    gw100.nc.tekelec.com
ARHOST   ---
LPORT    1030          RPORT    1030
ISTRMS   2              OSTRMS   2          BUFSIZE  16
RMODE    LIN          RMIN     120        RMAX     800
RTIMES   10          CWMIN    3000      UAPS     10
OPEN     YES          ALW      YES        RTXTHR   0
RHOSTVAL RELAXED

IP Appl Sock table is (5 of 4000) 1% full
Assoc Buffer Space Used (16 KB of 800 KB) on LOC = 1305
```

9. Back up the new changes, using the `chg-db:action=backup:dest=fixed` command. These messages should appear; the active Maintenance and Administration Subsystem Processor (MASP) appears first.

```
BACKUP (FIXED) : MASP A - Backup starts on active MASP.
BACKUP (FIXED) : MASP A - Backup on active MASP to fixed disk complete.
BACKUP (FIXED) : MASP A - Backup starts on standby MASP.
BACKUP (FIXED) : MASP A - Backup on standby MASP to fixed disk complete.
```

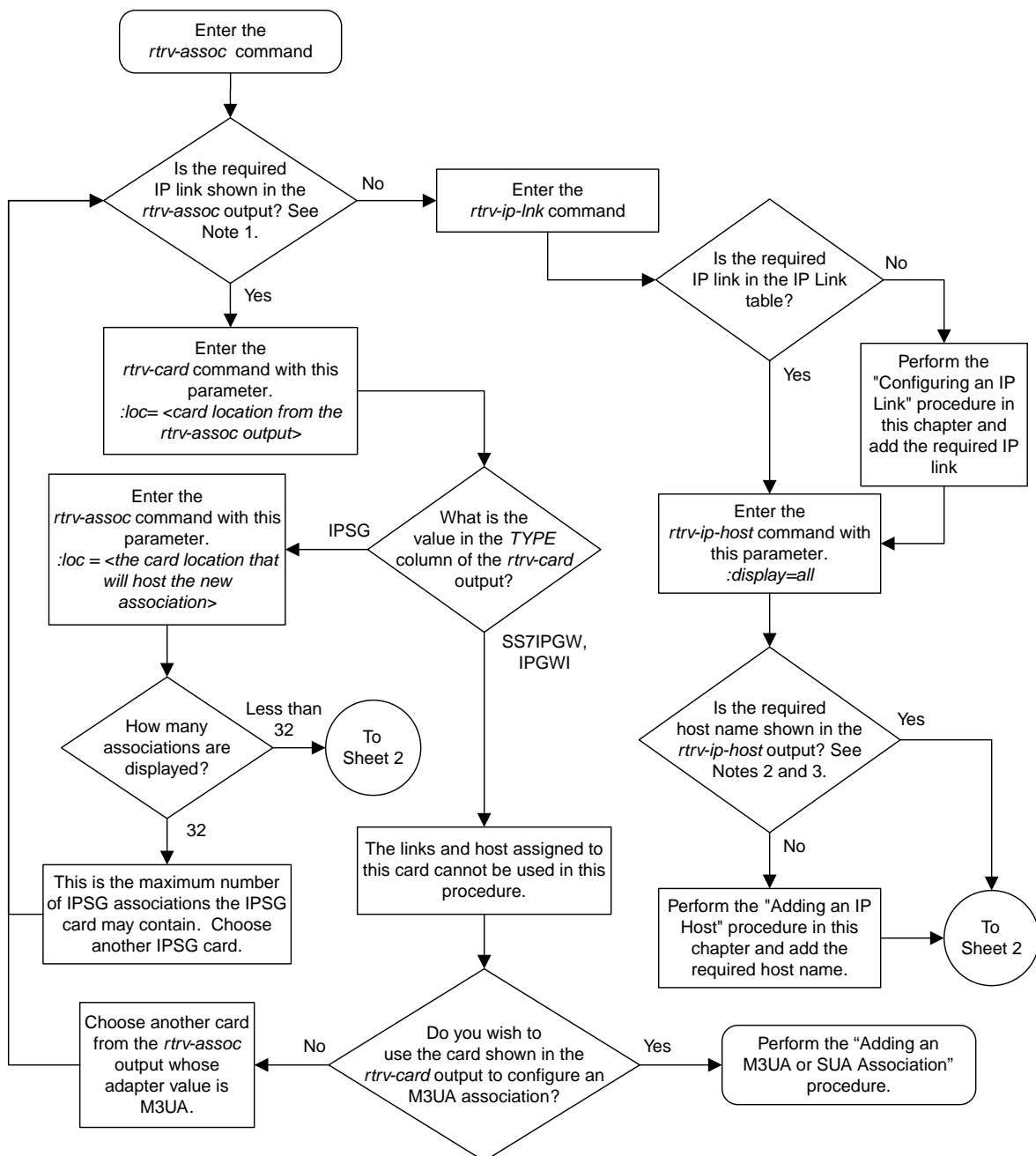
Notes:

1. The IP link is shown by the entries in the *CARD LOC* and *IPLINK PORT* columns. The *ADAPTER* value of the association must be M3UA.
2. The IP address of the IP link should be assigned to the host name, shown in the *rtrv-ip-host* output, that will be assigned to the association.
3. The values of the *lhost* and *alhost* parameters must be in the *LOCAL HOST* column in the *rtrv-ip-host* output.

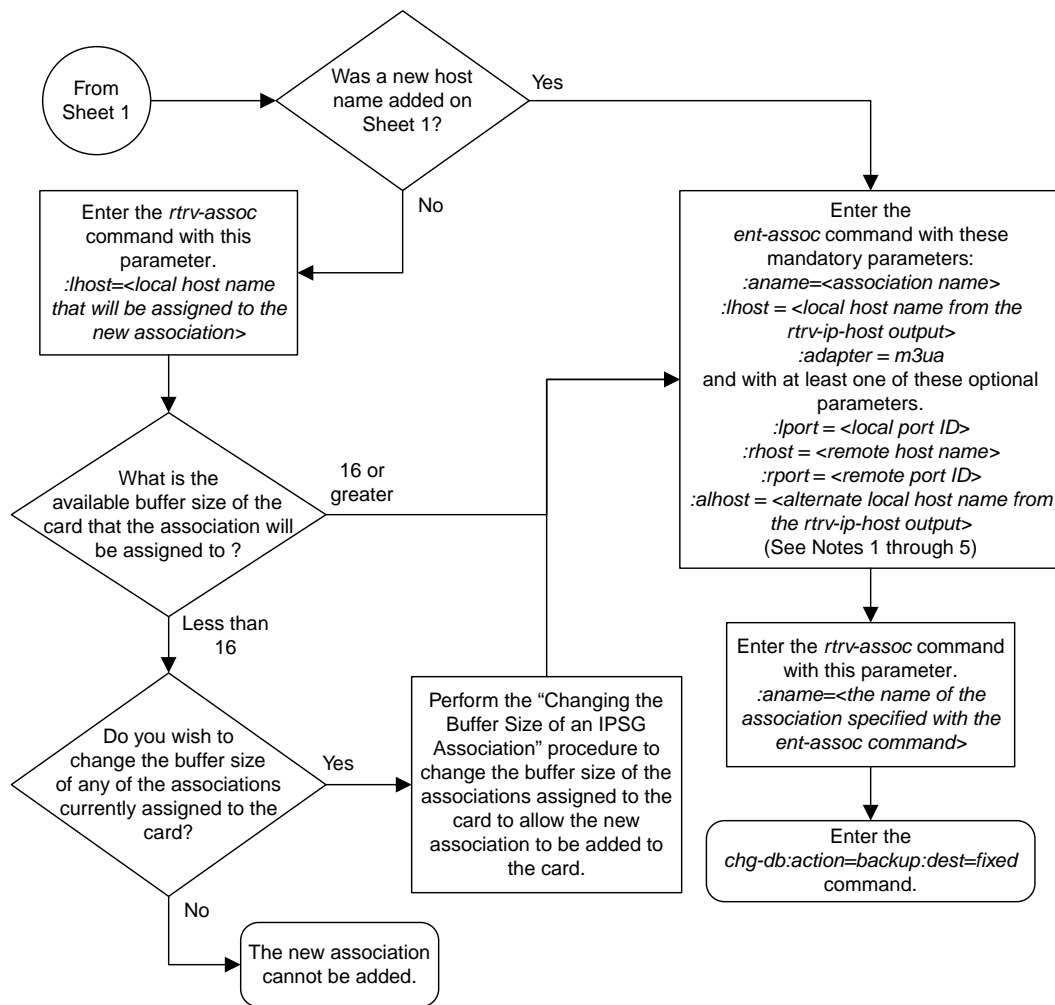

- Notes:
1. The EAGLE 5 ISS can contain a maximum of 4000 connections (association – application server assignments).
 2. A maximum of 32 IPSG M2PA or M3UA associations can be assigned to the IPSG card.
 3. The value of the *lhost*, *rhost*, or *alhost* parameters is a text string of up to 60 characters, with the first character being a letter. The command line on the terminal can contain up to 150 characters. If the host names are too long to fit on the *ent-assoc* command line, perform the *chg-assoc* command with the parameters and values necessary to complete the entry of the IPSG M3UA association.
 4. To activate the association after the association is assigned to a signaling link, the association must contain values for the *lhost*, *rhost*, *lport*, and *rport* parameters.
 5. If the *lhost* and *alhost* parameters are specified, the *lhost* parameter value represents the IP address corresponding to one of the network interfaces (A or B) on the IP card while the *alhost* parameter value represents the IP address corresponding to the other network interface of the same IP card.

Sheet 2 of 2

Figure 97: Adding an IPSG M3UA Association

Adding an IPSG M2PA Signaling Link

This procedure is used to add an IPSG M2PA signaling link to the database using the `ent-slk` command. An IPSG M2PA signaling link is a signaling link that is assigned to an IPSG card and that contains an IPSG linkset and IPSG association whose `ADAPTER` value is M2PA. The `ent-slk` command uses these parameters to add an IPSG M2PA signaling link.

`:loc` – The card location of the IPSG card that the IPSG M2PA signaling link will be assigned to. The cards specified by this parameter are E5-ENET cards running the IPSG application.

`:link` – The signaling link on the card specified in the `loc` parameter.

`:lsn` – The name of the linkset that will contain the signaling link.

`:slc` – The signaling link code. The SLC must be unique within the linkset. It must be the same at both the EAGLE location and the distant node.

`:aname` – The name of the IPSG M2PA association that will be assigned to the IPSG M2PA signaling link.

The `ent-slk` command contains other optional parameters that are not used to configure an IPGWx signaling link. These parameters are discussed in more detail in *Commands User's Guide* or in these sections.

- These procedures in this manual:
 - [Adding an IPLIMx Signaling Link](#)
 - [Adding an IPGWx Signaling Link](#)
- These procedures in *Database Administration - SS7 User's Guide*
 - Adding an SS7 Signaling Link
 - Adding an E1 Signaling Link
 - Adding a T1 Signaling Link
 - Adding an ATM High-Speed Signaling Link

These items must be configured in the database before an IPSG M2PA signaling link can be added:

- Shelf – perform the "Adding a Shelf" procedure in *Database Administration - System Management User's Guide*.
- IPSG Card – perform the [Adding an IPSG Card](#) procedure.
- Destination Point Code – perform the "Adding a Destination Point Code" procedure in *Database Administration - SS7 User's Guide*.
- IPSG M2PA Linkset – perform the [Adding an IPSG M2PA Linkset](#) procedure.
- IPSG M2PA Association – perform the [Adding an IPSG M2PA Association](#) procedure.

Verify that the link has been physically installed (all cable connections have been made).

To configure the EAGLE to perform circular routing detection test on the signaling links, "Configuring Circular Route Detection" procedure in *Database Administration - SS7 User's Guide*.

Note: Circular route detection is not supported in ITU networks.

To provision a EAGLE with more than 1200 signaling links, the EAGLE must have certain levels of hardware installed. See the [Requirements for EAGLEs Containing more than 1200 Signaling Links](#) section for more information on these hardware requirements.

The EAGLE can contain a mixture of low-speed, E1, T1, ATM high-speed, and IP signaling links. The [Determining the Number of High-Speed and Low-Speed Signaling Links](#) section describes how to determine the quantities of the different types of signaling links the EAGLE can have.

When the IPSG M2PA signaling link is added, the RSVDSLKTPS value that is assigned to the linkset will be assigned to the signaling link. The sum of the TPS used by all the signaling links that are assigned to the IPSG card cannot exceed MaxTPS. See [Maximum Card Capacity for Different Card Types](#) for MaxTPS values. The TPS used by the IPSG card and the TPS used by each signaling link that is assigned to the IPSG card is shown by entering the `rtrv-slk` command with the location of the IPSG card. If the MaxTPS limit for the IPSG card will be exceeded by adding the IPSG M2PA signaling link, one of these actions must be performed.

- Another IPSG card must be used for the IPSG M2PA signaling link.
- The RSVDSLKTPS values for the linksets shown in the `rtrv-slk` output for the IPSG card must be reduced enough to allow the IPSG M2PA linkset to be added.

If adding the IPSG M2PA signaling link will exceed the maximum total provisioned system TPS, and the maximum total provisioned system TPS is 500,000, perform the "Activating the HIPR2 High Rate Mode" feature in *Database Administration - System Management User's Guide* to enable and turn on the HIPR2 High Rate Mode feature. When the HIPR2 High Rate Mode feature is enabled and turned on, the maximum total provisioned system TPS is increased to 1,000,000 (1M). If the maximum total provisioned system TPS is 1M, or the maximum total provisioned system TPS is 500,000 and will not be increased, and adding the IPSG M2PA signaling link will exceed the maximum total provisioned system TPS, the IPSG M2PA signaling link cannot be added unless the amount of available TPS is reduced enough to allow the IPSG M2PA signaling link to be added. The available TPS can be reduced by performing one or more of these actions.

- The IP TPS values of some IPGWx linksets have to be changed.
- The MAXSLKTPS values of some IPSG linksets (and the RSVDSLKTPS values if necessary) have to be changed.
- Some ATM high-speed signaling links have to be removed.
- An IPLIMx card that contains signaling links has to be removed.

Canceling the `REPT-STAT-SLK`, `RTRV-LS`, and `RTRV-SLK` Commands

Because the `rept-stat-slk`, `rtrv-ls`, and `rtrv-slk` commands used in this procedure can output information for a long period of time, the `rept-stat-slk`, `rtrv-ls`, and `rtrv-slk` commands can be canceled and the output to the terminal stopped. There are three ways that the `rept-stat-slk`, `rtrv-ls`, and `rtrv-slk` commands can be canceled.

- Press the F9 function key on the keyboard at the terminal where the `rept-stat-slk`, `rtrv-ls`, or `rtrv-slk` commands were entered.
- Enter the `canc-cmd` without the `trm` parameter at the terminal where the `rept-stat-slk`, `rtrv-ls`, or `rtrv-slk` commands were entered.
- Enter the `canc-cmd:trm=<xx>`, where `<xx>` is the terminal where the `rept-stat-slk`, `rtrv-ls`, or `rtrv-slk` commands were entered, from another terminal other than the terminal where the `rept-stat-slk`, `rtrv-ls`, or `rtrv-slk` commands were entered. To enter the `canc-cmd:trm=<xx>` command, the terminal must allow Security Administration commands to be entered from it and the user must be allowed to enter Security Administration commands. The

terminal's permissions can be verified with the `rtrv-secu-trm` command. The user's permissions can be verified with the `rtrv-user` or `rtrv-secu-user` commands.

For more information about the `canc-cmd` command, go to *Commands User's Guide*.

1. Display the maximum number of signaling links the EAGLE can have and the number of signaling links that are currently provisioned by entering the `rtrv-tbl-capacity` command.

This is an example of the possible output.

```
rlghncxa03w 09-07-19 21:16:37 GMT EAGLE5 41.1.0
SLK      table is (          5 of      1200)    1% full
```

Note: The `rtrv-tbl-capacity` command output contains other fields that are not used by this procedure. If you wish to see all the fields displayed by the `rtrv-tbl-capacity` command, refer to the `rtrv-tbl-capacity` command description in *Commands User's Guide*.

If the addition of the new signaling link will not exceed the maximum number of signaling links the EAGLE can have, continue the procedure with [Step 2](#).

If the addition of the new signaling link will exceed the maximum number of signaling links the EAGLE can have, and the maximum number of signaling links is less than 2800, perform the [Enabling the Large System # Links Controlled Feature](#) procedure to enable the desired quantity of signaling links. After the new quantity of signaling links has been enabled, continue the procedure with [Step 2](#).

If the addition of the new signaling link will exceed the maximum number of signaling links the EAGLE can have (in this example, the maximum number of signaling links is 1200), and the maximum number of signaling links is 2800, this procedure cannot be performed. The EAGLE cannot contain more than 2800 signaling links.

2. Display the current signaling link configuration using the `rtrv-slk` command.

```
rlghncxa03w 10-07-19 21:16:37 GMT EAGLE5 42.0.0
rtrv-slk
Command entered at terminal #4.
```

LOC	LINK	LSN	SLC	TYPE	L2T SET	BPS	ECM	PCR N1	PCR N2		
1312	A	lsnds0	0	LIMDS0	1	56000	BASIC	----	-----		
LOC	LINK	LSN	SLC	TYPE	LP SET	BPS	ATM TSEL	VCI	VPI	LL	
1305	A	lsnds0	1	LIMATM	1	1.544M	LINE	5	0	0	
LOC	LINK	LSN	SLC	TYPE	LP SET	BPS	ATM TSEL	VCI	VPI	E1ATM	
1306	A	lsnituatm	0	LIME1ATM	21	2.048M	LINE	5	0	ON	3 0
LOC	LINK	LSN	SLC	TYPE	ANAME		SLKTPS				
1303	A	ipsglsn	0	IPSG	ipsgm2pa1		600				
1303	A1	ipsglsn	1	IPSG	ipsgm2pa2		600				
1303	B1	ipsglsn	2	IPSG	ipsgm2pa3		600				
1303	A2	ipsglsn	3	IPSG	ipsgm2pa4		600				
1303	A3	ipsglsn	4	IPSG	ipsgm2pa5		600				
1303	B3	ipsglsn2	0	IPSG	ipsgm2pa6		1000				
1307	A	ipsglsn	5	IPSG	m2pa2		600				
2204	B	lsnlp2	0	IPSG	m2pa		500				

```

LOC LINK LSN          SLC TYPE      IPLIML2
1301 A  lsniplim      0  IPLIM      M2PA
1301 A1 lsniplim      1  IPLIM      M2PA
1301 B1 lsniplim      2  IPLIM      M2PA

```

```

LOC LINK LSN          SLC TYPE
1201 A  ipgwx2        2  SS7IPGW
1202 A  ipgwx2        3  SS7IPGW
1203 A  ipgwx2        4  SS7IPGW
1204 A  ipgwx2        5  SS7IPGW
1205 A  ipgwx2        6  SS7IPGW
1206 A  ipgwx2        7  SS7IPGW
1101 A  ipgwx1        0  SS7IPGW
1102 A  ipgwx1        1  SS7IPGW
1103 A  ipgwx1        2  SS7IPGW
1104 A  ipgwx1        3  SS7IPGW
1105 A  ipgwx1        4  SS7IPGW
1106 A  ipgwx1        5  SS7IPGW
1107 A  ipgwx1        6  SS7IPGW
1108 A  ipgwx1        7  SS7IPGW
1111 A  ipgwx2        0  SS7IPGW
1112 A  ipgwx2        1  SS7IPGW

```

SLK table is (30 of 1200) 2% full.

3. Display the cards in the database using the `rtrv-card` command.

This is an example of the possible output.

```

rlghncxa03w 13-06-28 09:12:36 GMT EAGLE5 45.0.0
CARD   TYPE      APPL      LSET NAME  LINK SLC LSET NAME  LINK SLC
1101   DCM         SS7IPGW  ipgwx1    A    0
1102   DCM         SS7IPGW  ipgwx1    A    1
1103   DCM         SS7IPGW  ipgwx1    A    2
1104   DCM         SS7IPGW  ipgwx1    A    3
1105   DCM         SS7IPGW  ipgwx1    A    4
1106   DCM         SS7IPGW  ipgwx1    A    5
1107   DCM         SS7IPGW  ipgwx1    A    6
1108   DCM         SS7IPGW  ipgwx1    A    7
1111   DCM         SS7IPGW  ipgwx2    A    0
1112   DCM         SS7IPGW  ipgwx2    A    1
1113   E5MCAP      OAMHC
1114   E5TDM-A
1115   E5MCAP      OAMHC
1116   E5TDM-B
1117   E5MDAL
1201   DCM         SS7IPGW  ipgwx2    A    2
1202   DCM         SS7IPGW  ipgwx2    A    3
1203   DCM         SS7IPGW  ipgwx2    A    4
1204   DCM         SS7IPGW  ipgwx2    A    5
1205   DCM         SS7IPGW  ipgwx2    A    6
1206   DCM         SS7IPGW  ipgwx2    A    7
1301   DCM         IPLIM    lsniplim  A    0  lsniplim  A1    1
      lsniplim  B1    2
1303   ENET        IPSG     ipsglsn   A    0  ipsglsn   A1    1
      ipsglsn   B1    2  ipsglsn   A2    3
      ipsglsn   A3    4  ipsglsn2  B3    0
1305   LIMATM     ATMANSI  lsnds0    A    1
1306   LIME1ATM   ATMITU   lsniuatm  A    0
1307   ENET        IPSG     ipsglsn   A    5

```

```
1311 DCM IPLIM
1312 LIMDS0 SS7ANSI lsnds0 A 0
```

If the required IPSG card is not in the database, perform the [Adding an IPSG Card](#) procedure and add the IPSG card to the database. After the IPSG card has been added, continue the procedure with [Step 5](#).

If the required IPSG card is in the database, continue the procedure with [Step 4](#).

4. Display the signaling links assigned to the IPSG card by entering the `rtrv-slk` command with the card location of the IPSG card. For this example, enter this command.

```
rtrv-slk:loc=2204
```

This is an example of the possible output.

```
rlghncxa03w 06-10-28 09:12:36 GMT EAGLE5 36.0.0

LOC LINK LSN          SLC TYPE      ANAME          SLKTPS
2204 B  lsnlp2          0  IPSG        m2pa           500

IPTPS for LOC = 2204 is ( 500 of 5000) 10%
```

An IPSG card can contain a maximum of 32 IPSG signaling links. If 32 signaling links are shown in the `rtrv-slk` output, the new signaling link cannot be added to this card. Choose another IPSG card and repeat this procedure from [Step 3](#).

If less than 32 signaling links are shown in the `rtrv-slk` output, continue the procedure by performing one of these actions.

- If the IPTPS value shown in the `rtrv-slk` output is less than the MaxTPS (see [Maximum Card Capacity for Different Card Types](#) for MaxTPS values), continue the procedure with [Step 5](#).
- If the IPTPS value shown in the `rtrv-slk` output is the MaxTPS, the new signaling link cannot be added to this card. Choose another IPSG card and repeat this procedure from [Step 3](#).

5. Display the IPSG and IPGWx linksets by entering the `rept-stat-iptps` command.

This is an example of the possible output.

```
rlghncxa03w 10-07-19 21:16:37 GMT EAGLE5 42.0.0
IP TPS USAGE REPORT
```

	THRESH	CONFIG/ RSVD	CONFIG/ MAX		TPS	PEAK	PEAKTIMESTAMP
LSN							
ipgwx1	100%	----	32000	TX:	3700	4000	10-07-19 09:49:19
				RCV:	3650	4000	10-07-19 09:49:19
ipgwx2	100%	----	16000	TX:	4800	5000	10-07-19 09:49:09
				RCV:	4850	5000	10-07-19 09:49:09
ipgwx3	100%	----	32000	TX:	427	550	10-07-19 09:49:19
				RCV:	312	450	10-07-19 09:49:19
ipsglsn	100%	600	24000	TX:	4800	5000	10-07-19 09:49:19
				RCV:	4800	5000	10-07-19 09:49:19
ipsglsn2	100%	600	4000	TX:	427	550	10-07-19 09:49:19
				RCV:	312	450	10-07-19 09:49:19
isipgw	100%	500	4000	TX:	427	550	10-07-19 09:49:19

```
RCV:      312      450  10-07-19 09:49:19
```

```
-----
Command Completed.
```

If the desired linkset is shown in the `rept-stat-iptps` output, continue the procedure with [Step 6](#).

If the desired linkset is not shown in the `rept-stat-iptps` output, add the linkset by performing the [Adding an IPSG M2PA Linkset](#) procedure. Continue the procedure with one of these actions.

- If a new IPSG card was added in [Step 3](#), continue the procedure with [Step 7](#).
 - If the signaling link will be assigned to an existing IPSG card, the `RSVDSLKTPS` value that is assigned to the linkset will be assigned to the signaling link. The sum of the TPS used by all the signaling links that are assigned to the IPSG card cannot exceed the `MaxTPS`. See [Maximum Card Capacity for Different Card Types](#) for `MaxTPS` values. The TPS used by the IPSG card and the TPS used by each signaling link that is assigned to the IPSG card is shown by entering the `rtrv-slk` command with the location of the IPSG card. If the `MaxTPS` limit for the IPSG card will be exceeded by adding the IPSG M2PA signaling link, one of these actions must be performed.
 - Another IPSG card must be used for the IPSG M2PA signaling link. Repeat this procedure from [Step 3](#).
 - The `RSVDSLKTPS` values for the linksets shown in the `rtrv-slk` output for the IPSG card, shown in [Step 4](#), must be reduced enough to allow the IPSG M2PA linkset to be added. Perform these procedures as necessary to change the `RSVDSLKTPS` values for the linksets. After the linksets have been changed, continue the procedure with [Step 7](#).
 - [Changing an IPSG M2PA Linkset](#)
 - [Changing an IPSG M3UA Linkset](#)
6. Display the linkset that the signaling link is being assigned to using the `rtrv-ls` command, specifying the name of the linkset that the signaling link is being assigned to.

For this example, enter this command.

```
rtrv-ls:lsn=lsipgw
```

This is an example of the possible output.

```
rlghncxa03w 10-07-17 11:43:04 GMT EAGLE5 42.0.0
                L3T SLT                GWS GWS GWS
LSN            APCN  (SS7)  SCRN  SET SET BEI LST LNKS ACT MES DIS SLSCI NIS
lsipgw        2968          none  1   1  no  A   1   off off off  ---  off
                SPCN            CLLI            TFATCABMLQ MTPRSE ASL8
                -----            -----            1           ---   ---
                SLRSRB RANDSL S ITUTFR
                1         off   off
                IP SG  IPGWAPC GTTMODE            CGGTMOD
                yes   no      CdPA            no
                ADAPTER  RSVDSLKTPS  MAXSLKTPS
                m2pa    500          4000
```



```

          TPSALM      LSUSEALM      SLKUSEALM
          rsvdslktps 100%           100%

          LOC  LINK  SLC  TYPE      ANAME
          1317 A    0    IPSG      m2pa2

Link set table is (13 of 1024) 1% full.

```

If the IPSG value of the linkset is no, choose another linkset and repeat this procedure from [Step 5](#).

If the IPSG value of the linkset is yes and the ADAPTER value is m3ua, choose another linkset and repeat this procedure from [Step 5](#).

If the IPSG value of the linkset is yes, and the ADAPTER value is m2pa, continue the procedure by performing one of these actions.

- If a new IPSG card was added in [Step 3](#), continue the procedure with [Step 7](#).
- If the signaling link will be assigned to an existing IPSG card, the RSVDSLKTPS value that is assigned to the linkset will be assigned to the signaling link. The sum of the TPS used by all the signaling links that are assigned to the IPSG card cannot exceed the MaxTPS. See [Maximum Card Capacity for Different Card Types](#) for MaxTPS values. The TPS used by the IPSG card and the TPS used by each signaling link that is assigned to the IPSG card is shown by entering the `rtrv-slk` command with the location of the IPSG card. If the MaxTPS limit for the IPSG card will be exceeded by adding the IPSG M2PA signaling link, one of these actions must be performed.
 - Another IPSG card must be used for the IPSG M2PA signaling link. Repeat this procedure from [Step 3](#).
 - The RSVDSLKTPS values for the linksets shown in the `rtrv-slk` output for the IPSG card, shown in [Step 4](#), must be reduced enough to allow the IPSG M2PA linkset to be added. Perform these procedures as necessary to change the RSVDSLKTPS values for the linksets. After the linksets have been changed, continue the procedure with [Step 7](#).
 - [Changing an IPSG M2PA Linkset](#)
 - [Changing an IPSG M3UA Linkset](#)

7. Display the total provisioned system TPS by entering the `rtrv-tps` command. This is an example of the possible output.

```

rlghncxa03w 10-07-10 16:20:46 GMT  EAGLE 42.0.0

CARD      NUM      NUM      RSVD      MAX
TYPE     CARDS   LINKS    TPS       TPS
-----  -
IPGW      17      16      48000    80000
IPSG      4        8      4700     12000
IPLIM     2        4      8000     8000
ATM       2        2      3668     3668

Total provisioned System TPS (103668 of 500000) 21%

Command Completed.

```

An IPSG M2PA signaling link can use as much as the MaxTPS (see [Maximum Card Capacity for Different Card Types](#) for MaxTPS values, as provisioned by the `rsvds1ktps` parameter of the linkset that the IPSG M2PA signaling link will be added to. If adding the new IPSG M2PA signaling link will not exceed the maximum total provisioned system TPS, continue the procedure with [Step 11](#).

If adding the new IPSG M2PA signaling link will exceed the maximum total provisioned system TPS, and the maximum total provisioned system TPS is 500,000 shown, perform the "Activating the HIPR2 High Rate Mode Feature" procedure in *Database Administration - System Management User's Guide* to enable and turn on the HIPR2 High Rate Mode feature. When the HIPR2 High Rate Mode feature is enabled and turned on, the maximum total provisioned system TPS is increased to 1M. After the HIPR2 High Rate Mode feature has been enabled and turned on, continue the procedure with [Step 11](#).

If the maximum total provisioned system TPS is 1M, or the maximum total provisioned system TPS is 500,000 and will not be increased, and adding the IPSG M2PA signaling link will exceed the maximum total provisioned system TPS, the IPSG M2PA signaling link cannot be added unless the amount of available TPS is reduced enough to allow the IPSG M2PA signaling link to be added. The available TPS can be increased by performing one or more of these actions.

- Some ATM high-speed signaling links have to be removed. To perform this action, continue the procedure with [Step 8](#).
- An IPLIMx card that contains signaling links has to be removed. To perform this action, continue the procedure with [Step 9](#).
- The IP TPS values of some IPGWx linksets have to be changed or the MAXSLKTPS values of some IPSG linksets (and the RSVDSLKTPS values if necessary) have to be changed.

If linksets are displayed in the `rept-stat-iptps` output in [Step 5](#), continue the procedure with [Step 10](#).

If linksets are not displayed in the `rept-stat-iptps` output in [Step 5](#), perform one or more of these actions to increase the available TPS.

Note: If one or more of these actions are not performed to increase the available TPS and the available TPS will not allow the IPSG M2PA signaling link to be added, the IPSG M2PA signaling link cannot be added and the remainder of this procedure cannot be performed.

- An IPLIMx card that contains signaling links has to be removed. To perform this action, continue the procedure with [Step 9](#).
- Some ATM high-speed signaling links have to be removed. To perform this action, continue the procedure with [Step 8](#).

8. Display the ATM high-speed signaling links by entering this command.

```
rtrv-slk:type=saal
```

This is an example of the possible output.

```
rlghncxa03w 10-07-19 21:16:37 GMT EAGLE5 42.0.0
```

LOC	LINK	LSN	SLC	TYPE	LP SET	ATM BPS	TSEL	VCI	VPI	LL
1303	A	lsnds0	1	LIMATM	1	1.544M	LINE	5	0	0

LOC	LINK	LSN	SLC	TYPE	LP SET	ATM BPS	TSEL	VCI	VPI	E1ATM CRC4	SI	SN

```
1306 A    lsnituatm 0    LIME1ATM 21  2.048M LINE    5    0    ON    3    0
SLK table is (30 of 1200) 2% full.
```

If ATM high-speed signaling links are shown in the `rtrv-slk` output, perform the "Removing an SS7 Signaling Link" procedure in *Database Administration - SS7 User's Guide* to remove some of the ATM high-speed signaling links.

If ATM high-speed signaling links are not displayed in the `rtrv-slk` output, perform one or more of these actions to increase the available TPS.

Note: If one or more of these actions are not performed to increase the available TPS and the available TPS will not allow the IPSG M2PA signaling link to be added, the IPSG M2PA signaling link cannot be added and the remainder of this procedure cannot be performed.

- An IPLIMx card that contains signaling links has to be removed. To perform this action, continue the procedure with [Step 9](#).
- The IP TPS values of some IPGWx linksets have to be changed or the MAXSLKTPS values of some IPSG linksets (and the RSVDSLKTPS values if necessary) have to be changed.

If linksets are displayed in the `rept-stat-iptps` output in [Step 5](#), continue the procedure with [Step 10](#).

If linksets are not displayed in the `rept-stat-iptps` output in [Step 5](#), an IPLIMx card that contains signaling links has to be removed. To perform this action, continue the procedure with [Step 9](#).

If you do not wish to perform other actions to increase the available TPS and the available TPS will allow the IPSG M2PA signaling link to be added, continue the procedure with [Step 11](#).

9. Display the signaling links that are assigned to IPLIMx cards by entering this command.

```
rtrv-slk:type=iplim
```

This is an example of the possible output.

```
rlghncxa03w 10-07-19 21:16:37 GMT EAGLE5 42.0.0
LOC LINK LSN          SLC TYPE        ANAME          SLKTPS
1301 A    lsniplim        0    IPLIM        M2PA
1301 A1   lsniplim        1    IPLIM        M2PA
1301 B1   lsniplim        2    IPLIM        M2PA
1317 A    lsniplimi       0    IPLIMI       M2PA
SLK table is (30 of 1200) 2% full.
```

If IPLIMx cards containing signaling links are shown in the `rtrv-slk` output, perform the [Removing an IPLIMx Card](#) procedure to remove an IPLIMx card and its associated signaling links.

If IPLIMx cards containing signaling links are not displayed in the `rtrv-slk` output, perform one or more of these actions to increase the available TPS.

Note: If one or more of these actions are not performed to increase the available TPS and the available TPS will not allow the IPSG M2PA signaling link to be added, the IPSG M2PA signaling link cannot be added and the remainder of this procedure cannot be performed.

- Some ATM high-speed signaling links have to be removed. To perform this action, continue the procedure with [Step 8](#).
- The IP TPS values of some IPGWx linksets have to be changed or the MAXSLKTPS values of some IPSG linksets (and the RSVDSLKTPS values if necessary) have to be changed.

If linksets are displayed in the `rept-stat-iptps` output in [Step 5](#), continue the procedure with [Step 10](#).

If linksets are not displayed in the `rept-stat-iptps` output in [Step 5](#), some ATM high-speed signaling links have to be removed. To perform this action, continue the procedure with [Step 8](#).

If you do not wish to perform other actions to increase the available TPS and the available TPS will allow the IPSG M2PA signaling link to be added, continue the procedure with [Step 11](#).

10. Display the attributes of the linksets shown in [Step 5](#) by entering the `rtrv-ls` command with the name of the linkset shown in [Step 5](#).

For this example enter these commands.

```
rtrv-ls:lsn=ipgwx1
```

This is an example of the possible output.

```
rlghncxa03w 10-07-19 21:16:37 GMT EAGLE5 42.0.0

LSN              APCA  (SS7)  L3T SLT          GWS GWS GWS
ipgwx1          001-001-002  none 1  1  no  A  8  off off off no  off
              SPCA          CLLI          TFATCABMLQ MTPRSE ASL8
              -----
              4          ---  no

RANDSLS
off

IPSG  IPGWAPC  GTTMODE          CGGTMOD
no    yes     CdPA          no

MATELSN  IPTPS  LSUSEALM  SLKUSEALM
-----  32000  100%     80%

LOC  LINK  SLC  TYPE
1101 A    0    SS7IPGW
1102 A    1    SS7IPGW
1103 A    2    SS7IPGW
1104 A    3    SS7IPGW
1105 A    4    SS7IPGW
1106 A    5    SS7IPGW
1107 A    6    SS7IPGW
1108 A    7    SS7IPGW

Link set table is (8 of 1024) 1% full.
```

```
rtrv-ls:lsn=ipgwx2
```

This is an example of the possible output.

```

rlghncxa03w 10-07-19 21:16:37 GMT EAGLE5 42.0.0

LSN              APCA   (SS7)   SCRN  SET  SET  BEI  LST  LNKS  GWS  GWS  GWS
ipgwx2           001-001-003  none  1   1   no  A   8   off  off  off  no  off

              SPCA              CLLI              TFATCABMLQ  MTPRSE  ASL8
              -----              -----              4           ---    no

RANDSLS
off

IPSG  IPGWAPC  GTTMODE              CGGTMOD
no    yes     CdPA              no

MATELSN      IPTPS      LSUSEALM  SLKUSEALM
-----      -----      -----      -----
          16000      100%      80%

LOC  LINK  SLC  TYPE
1111 A    0   SS7IPGW
1112 A    1   SS7IPGW
1201 A    2   SS7IPGW
1202 A    3   SS7IPGW
1203 A    4   SS7IPGW
1204 A    5   SS7IPGW
1205 A    6   SS7IPGW
1206 A    7   SS7IPGW

Link set table is (8 of 1024) 1% full.

```

rtrv-ls:lsn=ipgwx3

This is an example of the possible output.

```

rlghncxa03w 10-07-19 21:16:37 GMT EAGLE5 42.0.0

LSN              APCA   (SS7)   SCRN  SET  SET  BEI  LST  LNKS  GWS  GWS  GWS
ipgwx3           001-001-004  none  1   1   no  A   0   off  off  off  no  off

              SPCA              CLLI              TFATCABMLQ  MTPRSE  ASL8
              -----              -----              1           ---    no

RANDSLS
off

IPSG  IPGWAPC  GTTMODE              CGGTMOD
no    yes     CdPA              no

MATELSN      IPTPS      LSUSEALM  SLKUSEALM
-----      -----      -----      -----
          32000      100%      80%

Link set table is (8 of 1024) 1% full.

```

rtrv-ls:lsn=ipsglsn

This is an example of the possible output.

```
rlghncxa03w 10-07-19 21:16:37 GMT EAGLE5 42.0.0

LSN              APCA  (SS7)  L3T SLT          GWS GWS GWS
ipsglsn         003-003-003  none 1  1  no  A  6  off off off no  off

              SPCA          CLLI          TFATCABMLQ MTPRSE ASL8
              -----
              3          ---          no

RANDSLS
off

IPSG  IPGWAPC  GTTMODE          CGGTMOD
yes   no      CdPA          no

ADAPTER  SLKTPS  LSUSEALM  SLKUSEALM  RCONTEXT  ASNOTIF
m2pa     600    100%     80%        none      no

LOC  LINK  SLC  TYPE  ANAME
1303 A  0    IPSG  ipsgm2pa1
1303 A1 1    IPSG  ipsgm2pa2
1303 B1 2    IPSG  ipsgm2pa3
1303 A2 3    IPSG  ipsgm2pa4
1303 A3 4    IPSG  ipsgm2pa5
1307 A  5    IPSG  m2pa2
```

Link set table is (8 of 1024) 1% full.

```
rtrv-ls:lsn=ipsglsn2
```

This is an example of the possible output.

```
rlghncxa03w 10-07-19 21:16:37 GMT EAGLE5 42.0.0

LSN              APCA  (SS7)  L3T SLT          GWS GWS GWS
ipsglsn2         005-005-005  none 1  1  no  A  1  off off off no  off

              SPCA          CLLI          TFATCABMLQ MTPRSE ASL8
              -----
              1          ---          no

RANDSLS
off

IPSG  IPGWAPC  GTTMODE          CGGTMOD
yes   no      CdPA          no

ADAPTER  SLKTPS  LSUSEALM  SLKUSEALM  RCONTEXT  ASNOTIF
m2pa     1000  100%     80%        none      no

LOC  LINK  SLC  TYPE  ANAME
1303 B3 0    IPSG  ipsgm2pa6
```

Link set table is (8 of 1024) 1% full.

Perform one or both of these actions as necessary.

- Perform the [Configuring an IPGWx Linkset](#) procedure to change the IPTPS value for any linksets shown in the `rtrv-ls` output whose IPGWAPC value is `yes`.
- Perform the [Changing an IPSG M2PA Linkset](#) procedure (for linkset whose IPSG value is `yes` and ADAPTER value is M2PA) or the [Changing an IPSG M3UA Linkset](#) procedure (for linkset whose IPSG value is `yes` and ADAPTER value is M3UA) to change the MAXSLKTPS value (and RSVDSLKTPS value if necessary) for any linksets shown in the `rtrv-ls` output.

Perform one or both of these actions to increase the available TPS if needed.

- An IPLIMx card that contains signaling links has to be removed. To perform this action, continue the procedure with [Step 9](#).
- Some ATM high-speed signaling links have to be removed. To perform this action, continue the procedure with [Step 8](#).

If you do not wish to perform other actions to increase the available TPS and the available TPS will allow the IPSG M2PA signaling link to be added, continue the procedure with [Step 11](#).

11. Display the associations that are assigned to the card that will be assigned to the signaling link by entering `rtrv-assoc` command with the location of the card. For this example, enter this command.

```
rtrv-assoc:loc=2204
```

This is an example of the possible output.

```
rlghncxa03w 08-04-22 19:24:18 EST 38.0.0

          CARD  IPLNK
ANAME     LOC  PORT  LINK ADAPTER LPORT RPORT OPEN ALW
m2pa2     2204 A    B    M2PA  3001  3000 NO  YES
m2pa3     2204 A    --   M2PA  3002  3000 YES YES
m2pa4     2204 A    --   M2PA  3003  3000 YES YES

IP Appl Sock/Assoc table is (7 of 4000) 1% full
Assoc Buffer Space Used (1400 KB of 6400 KB) on LOC = 2204
```

Associations that can be assigned to an IPSG M2PA signaling link cannot be assigned to a signaling link shown by dashes in the LINK column, and the ADAPTER value of the association must be M2PA. If the associations displayed in this step do not meet these requirements, add the IPSG M2PA association by performing the [Adding an IPSG M2PA Association](#) procedure. After the association has been added, continue the procedure with [Step 12](#).

If the associations displayed in this step meet these requirements, continue the procedure with [Step 12](#).

12. Add the signaling link to the database using the `ent-slk` command.

[Table 54: IPSG M2PA Signaling Link Parameter Combinations](#) shows the parameters and values that can be specified with the `ent-slk` command.

Table 54: IPSG M2PA Signaling Link Parameter Combinations

IPSG M2PA Signaling Link
Mandatory Parameters
:loc = location of the IPSG card
:link = a - a15, b - b15

IPSG M2PA Signaling Link
:lsn = linkset name
:slc = 0 - 15
:aname = the name of the IPSG M2PA association

For this example, enter this command.

```
ent-slk:loc=2204:link=a10:lsn=lsipgw:slc=1:aname=m2pa3
```

When this command has successfully completed, this message should appear.

```
rlghncxa03w 06-10-07 08:29:03 GMT EAGLE5 36.0.0
ENT-SLK: MASP A - COMPLTD
```

Note: If adding the new signaling link will result in more than 700 signaling links in the database and the OAMHCMEAS value in the `rtrv-measopts` output is on, the scheduled UI measurement reports will be disabled.

13. Verify the changes using the `rtrv-slk` command with the card location and link parameter values specified in [Step 12](#). For this example, enter these commands.

```
rtrv-slk:loc=2204:link=a10
```

This is an example of the possible output.

```
rlghncxa03w 06-10-19 21:16:37 GMT EAGLE5 36.0.0

LOC LINK LSN          SLC TYPE      ANAME      SLKTPS
2204 A10 lsipgw       1  IPSG       m2pa3      500
```

14. If any cards contain the first signaling link on a card, those cards must be brought into service with the `rst-card` command, specifying the location of the card. For this example, enter this command.

```
rst-card:loc=2205
```

When this command has successfully completed, this message should appear.

```
rlghncxa03w 06-10-23 13:05:05 GMT EAGLE5 36.0.0
Card has been allowed.
```

15. Activate all signaling links on the cards using the `act-slk` command, specifying the card location and link parameter value of each signaling link. For this example, enter this command.

```
act-slk:loc=2204:link=a10
```

When this command has successfully completed, this message should appear.

```
rlghncxa03w 06-10-07 08:31:24 GMT EAGLE5 36.0.0
Activate Link message sent to card
```

16. Check the status of the signaling links added in [Step 12](#) using the `rept-stat-slk` command with the card location and link parameter values specified in [Step 12](#). The state of each signaling link

should be in service normal (IS-NR) after the link has completed alignment (shown in the PST field). For this example, enter these commands.

```
rept-stat-slk:loc=2204:link=a10
```

This is an example of the possible output.

```
rlghncxa03w 07-05-23 13:06:25 GMT EAGLE5 37.0.0
SLK      LSN      CLLI      PST      SST      AST
2204,A10 lsipgw  ----- IS-NR      Avail    ----
  ALARM STATUS      =
  UNAVAIL REASON    =
```

- Change the open parameter value of the association that was assigned to the signaling link by entering the `chg-assoc` command with the `open=yes` parameter and the name of the association that was association. For this example, enter this command.

```
chg-assoc:aname=m2pa3:open=yes
```

When this command has successfully completed, this message should appear.

```
rlghncxa03w 06-10-07 08:29:03 GMT EAGLE5 36.0.0
CHG-ASSOC: MASP A - COMPLTD
```

- Back up the new changes using the `chg-db:action=backup:dest=fixed` command. These messages should appear, the active Maintenance and Administration Subsystem Processor (MASP) appears first.

```
BACKUP (FIXED) : MASP A - Backup starts on active MASP.
BACKUP (FIXED) : MASP A - Backup on active MASP to fixed disk complete.
BACKUP (FIXED) : MASP A - Backup starts on standby MASP.
BACKUP (FIXED) : MASP A - Backup on standby MASP to fixed disk complete.
```

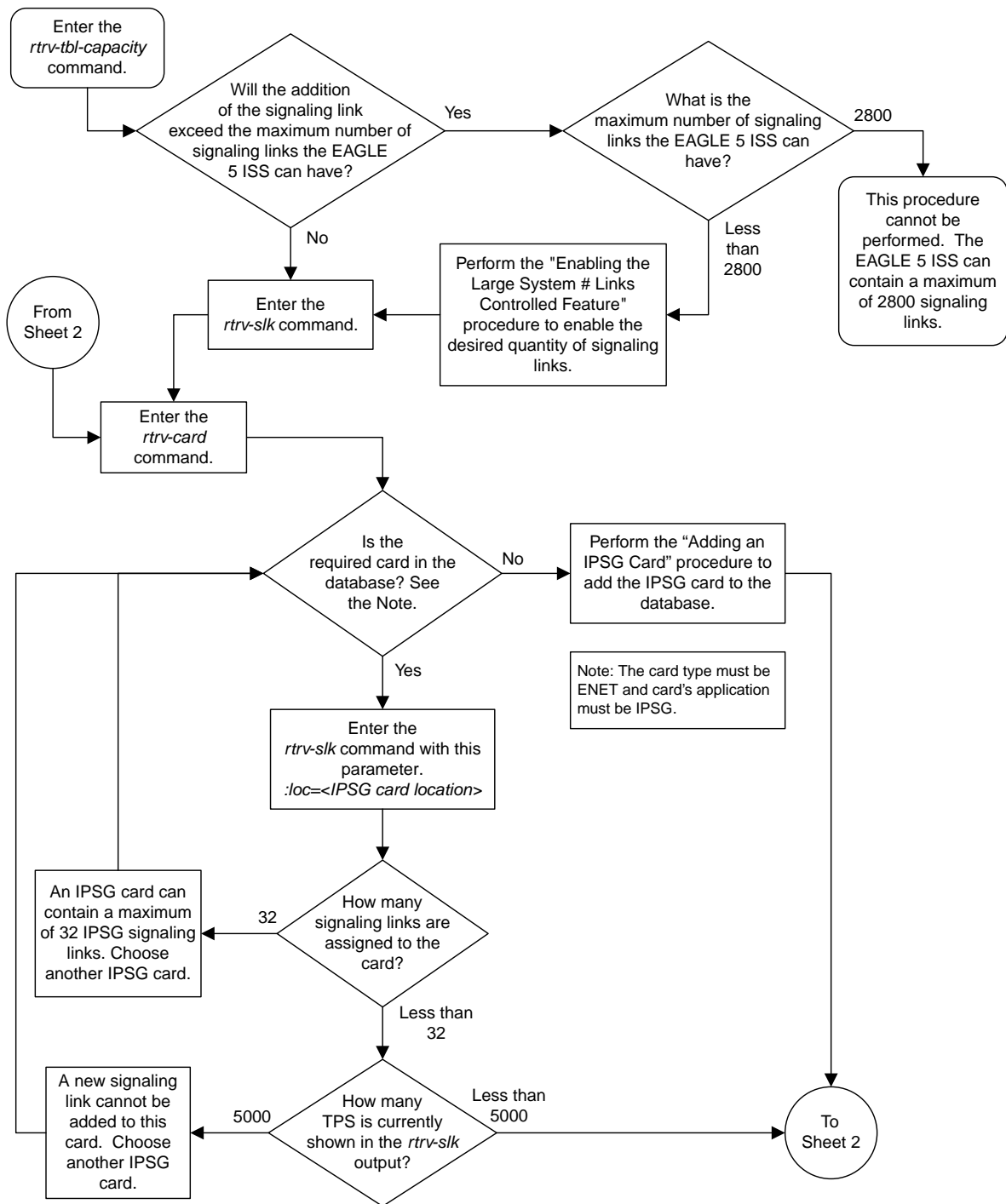

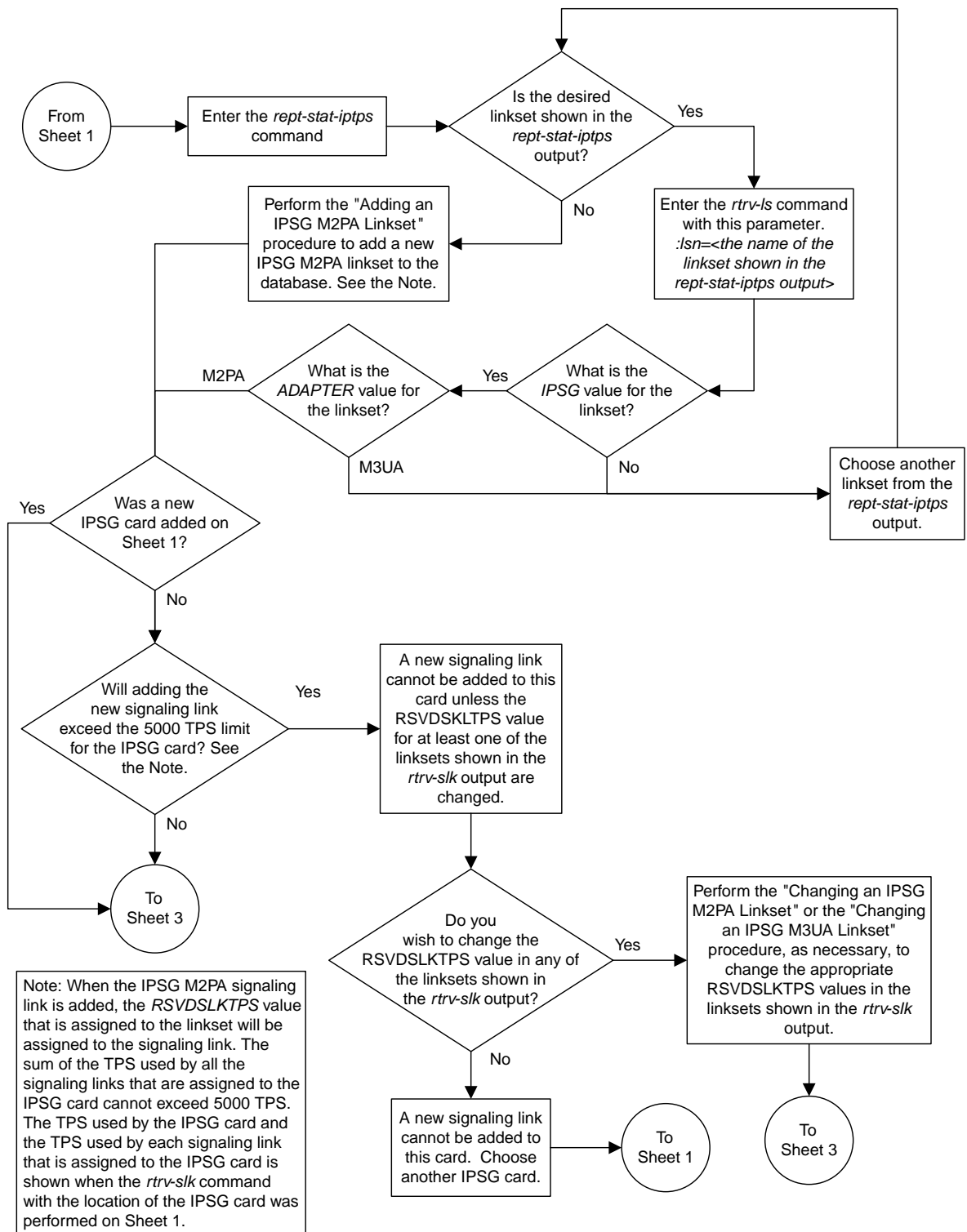

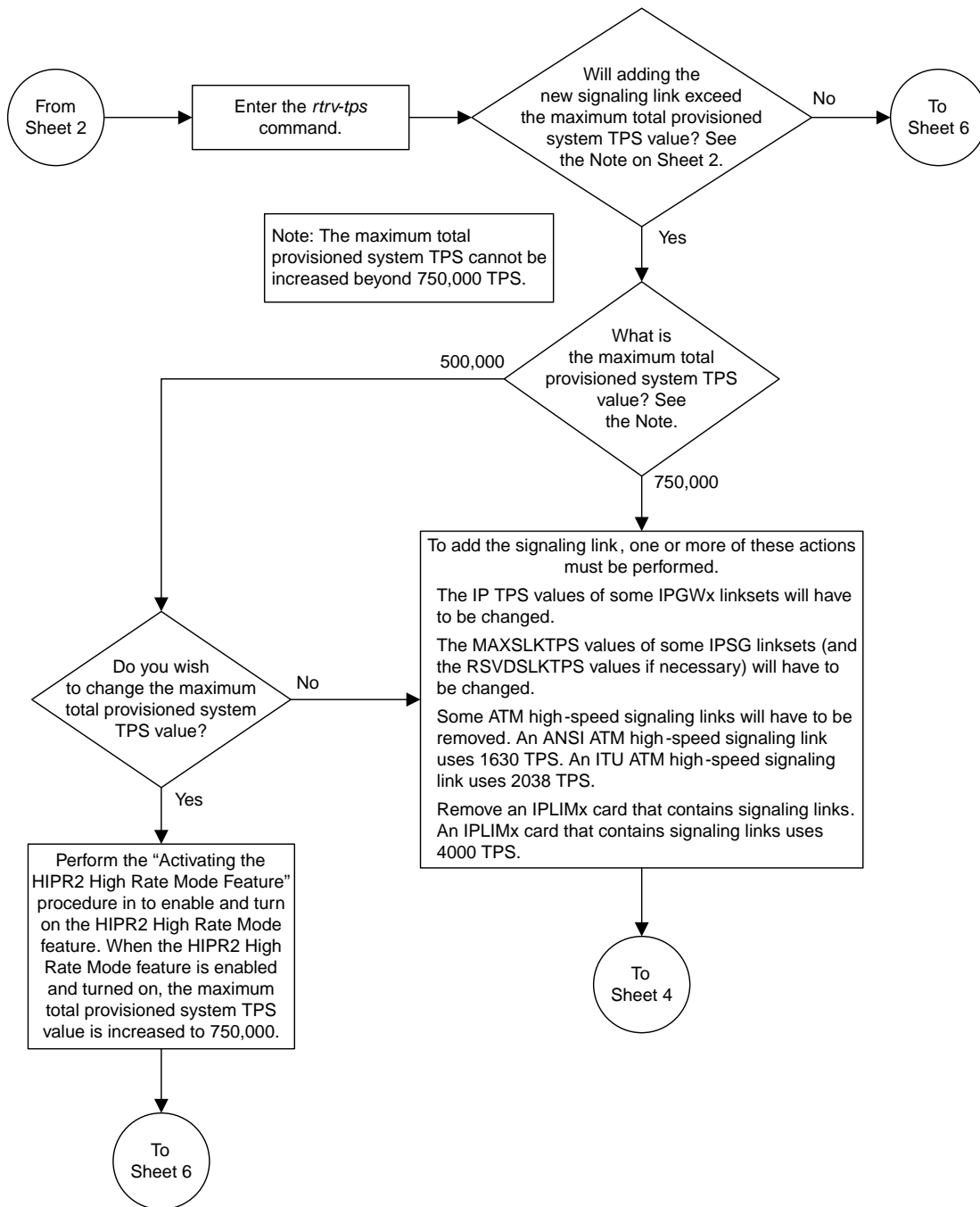

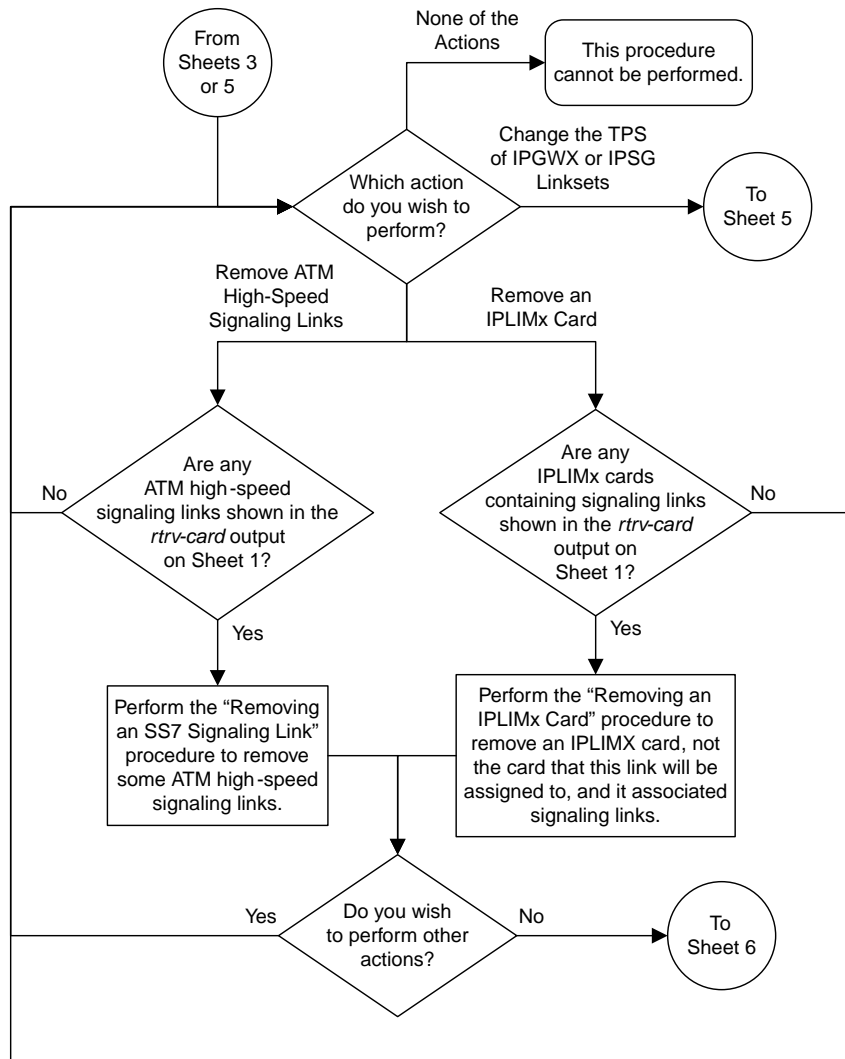

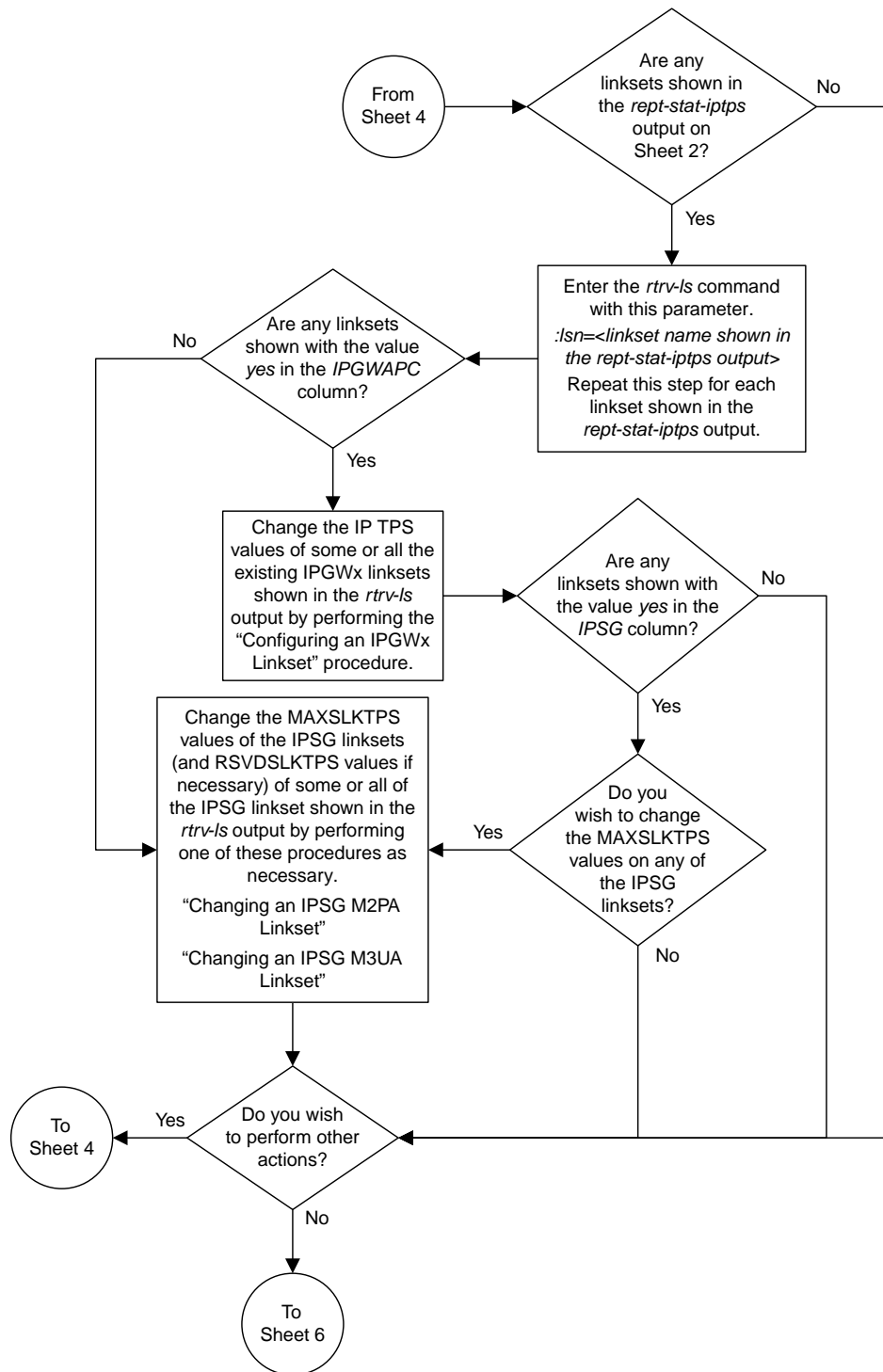

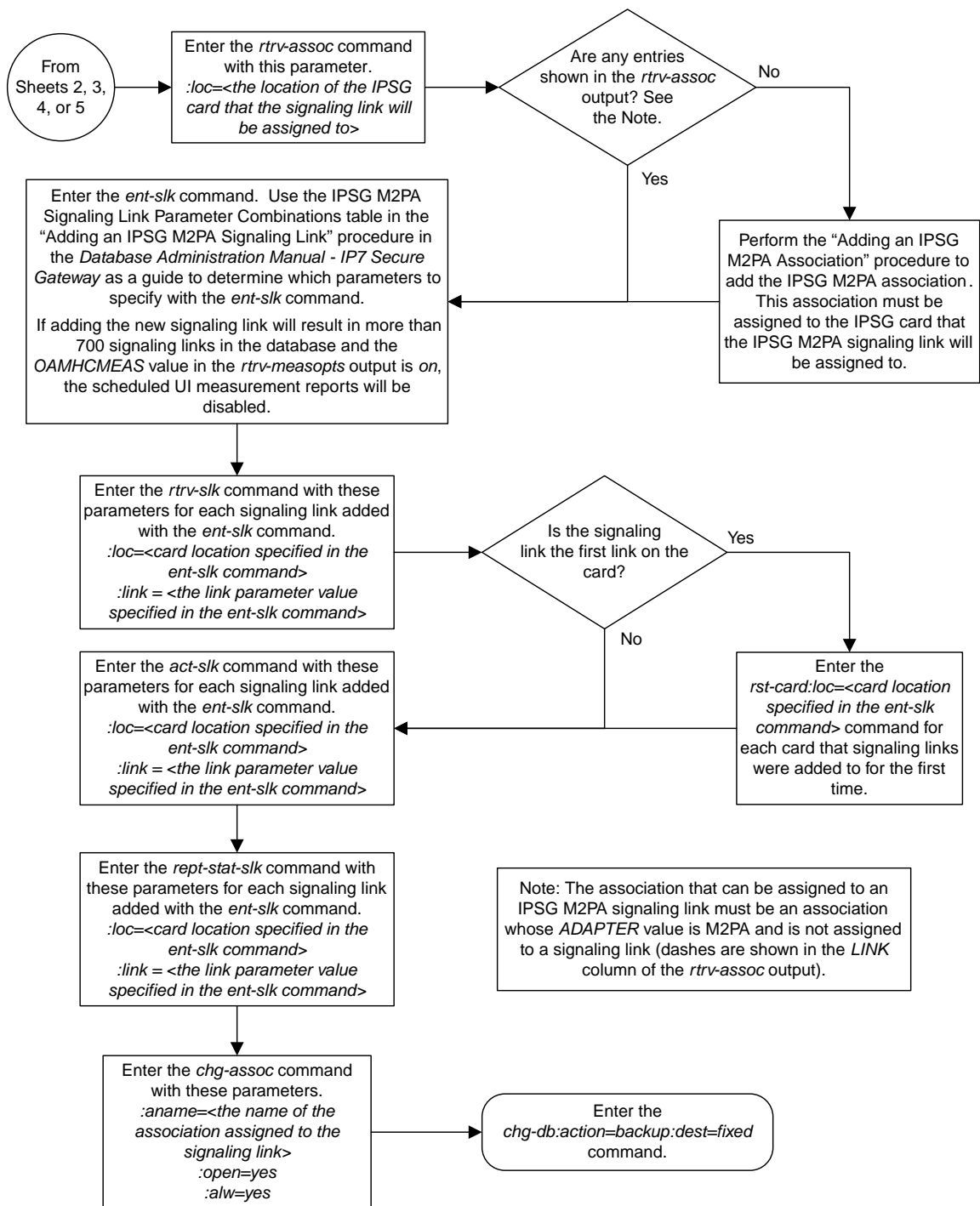

Sheet 6 of 6

Figure 98: Adding an IPSG M2PA Signaling Link

Adding an IPSG M3UA Signaling Link

This procedure is used to add an IPSG M3UA signaling link to the database using the `ent-slk` command. An IPSG M3UA signaling link is a signaling link that is assigned to an IPSG card and that contains an IPSG linkset and IPSG association whose `ADAPTER` value is M3UA. The `ent-slk` command uses these parameters to add an IPSG M3UA signaling link.

`:loc` – The card location of the IPSG card that the IPSG M3UA signaling link will be assigned to. The cards specified by this parameter are E5-ENET cards running the IPSG application.

`:link` – The signaling link on the card specified in the `loc` parameter.

`:lsn` – The name of the linkset that will contain the signaling link.

`:slc` – The signaling link code. The SLC must be unique within the linkset. It must be the same at both the EAGLE location and the distant node.

`:aname` – The name of the IPSG M3UA association that will be assigned to the IPSG M3UA signaling link.

The `ent-slk` command contains other optional parameters that are not used to configure an IPGWx signaling link. These parameters are discussed in more detail in *Commands User's Guide* or in these sections.

- These procedures in this manual:
 - [Adding an IPLIMx Signaling Link](#)
 - [Adding an IPGWx Signaling Link](#)
- These procedures in *Database Administration - SS7 User's Guide*
 - Adding an SS7 Signaling Link
 - Adding an E1 Signaling Link
 - Adding a T1 Signaling Link
 - Adding an ATM High-Speed Signaling Link

These items must be configured in the database before an IPSG M3UA signaling link can be added:

- Shelf – perform the "Adding a Shelf" procedure in *Database Administration - System Management User's Guide*.
- IPSG Card – perform the [Adding an IPSG Card](#) procedure.
- Destination Point Code – perform the "Adding a Destination Point Code" procedure in *Database Administration - SS7 User's Guide*.
- IPSG M3UA Linkset – perform the [Adding an IPSG M3UA Linkset](#) procedure.
- IPSG M3UA Association - perform the [Adding an IPSG M3UA Association](#) procedure.

Verify that the link has been physically installed (all cable connections have been made).

To configure the EAGLE to perform circular routing detection test on the signaling links, "Configuring Circular Route Detection" procedure in the *Database Administration - SS7*.

Note: Circular route detection is not supported in ITU networks.

To provision a EAGLE with more than 1200 signaling links, the EAGLE must have certain levels of hardware installed. See the [Requirements for EAGLEs Containing more than 1200 Signaling Links](#) section for more information on these hardware requirements.

The EAGLE can contain a mixture of low-speed, E1, T1, ATM high-speed, and IP signaling links. The [Determining the Number of High-Speed and Low-Speed Signaling Links](#) section describes how to determine the quantities of the different types of signaling links the EAGLE can have.

- HC-MIM
- E5-E1/T1
- E5-ATM
- E5-SM4G
- E5-ENET
- E5-based control cards
- E5-SLAN card for the STPLAN feature
- E5-STC card for the EAGLE Integrated Monitoring Support feature

When the IPSG M3UA signaling link is added, the `RSVDSLKTPS` value that is assigned to the linkset will be assigned to the signaling link. The sum of the TPS used by all the signaling links that are assigned to the IPSG card cannot exceed the `MaxTPS`. See [Maximum Card Capacity for Different Card Types](#) for `MaxTPS` values. The TPS used by the IPSG card and the TPS used by each signaling link that is assigned to the IPSG card is shown by entering the `rtrv-slk` command with the location of the IPSG card. If the `MaxTPS` limit for the IPSG card will be exceeded by adding the IPSG M3UA signaling link, one of these actions must be performed.

- Another IPSG card must be used for the IPSG M3UA signaling link.
- The `RSVDSLKTPS` values for the linksets shown in the `rtrv-slk` output for the IPSG card must be reduced enough to allow the IPSG M3UA linkset to be added.

If adding the IPSG M3UA signaling link will exceed the maximum total provisioned system TPS, and the maximum total provisioned system TPS is 500,000, perform the "Activating the HIPR2 High Rate Mode" feature in *Database Administration - System Management* to enable and turn on the HIPR2 High Rate Mode feature. When the HIPR2 High Rate Mode feature is enabled and turned on, the maximum total provisioned system TPS is increased to 1,000,000 (1M). If the maximum total provisioned system TPS is 1M, or the maximum total provisioned system TPS is 500,000 and will not be increased, and adding the IPSG M3UA signaling link will exceed the maximum total provisioned system TPS, the IPSG M3UA signaling link cannot be added unless the amount of available TPS is reduced enough to allow the IPSG M3UA signaling link to be added. The available TPS can be reduced by performing one or more of these actions.

- The IP TPS values of some IPGWx linksets have to be changed.
- The `MAXSLKTPS` values of some IPSG linksets (and the `RSVDSLKTPS` values if necessary) have to be changed.
- Some ATM high-speed signaling links have to be removed.
- An IPLIMx card that contains signaling links has to be removed.

Canceling the `REPT-STAT-SLK`, `RTRV-LS`, and `RTRV-SLK` Commands

Because the `rept-stat-slk`, `rtrv-ls`, and `rtrv-slk` commands used in this procedure can output information for a long period of time, the `rept-stat-slk`, `rtrv-ls`, and `rtrv-slk` commands can be canceled and the output to the terminal stopped. There are three ways that the `rept-stat-slk`, `rtrv-ls`, and `rtrv-slk` commands can be canceled.

- Press the F9 function key on the keyboard at the terminal where the `rept-stat-slk`, `rtrv-ls`, or `rtrv-slk` commands were entered.
- Enter the `canc-cmd` without the `trm` parameter at the terminal where the `rept-stat-slk`, `rtrv-ls`, or `rtrv-slk` commands were entered.
- Enter the `canc-cmd:trm=<xx>`, where `<xx>` is the terminal where the `rept-stat-slk`, `rtrv-ls`, or `rtrv-slk` commands were entered, from another terminal other than the terminal where the `rept-stat-slk`, `rtrv-ls`, or `rtrv-slk` commands were entered. To enter the `canc-cmd:trm=<xx>` command, the terminal must allow Security Administration commands to be entered from it and the user must be allowed to enter Security Administration commands. The terminal's permissions can be verified with the `rtrv-secu-trm` command. The user's permissions can be verified with the `rtrv-user` or `rtrv-secu-user` commands.

For more information about the `canc-cmd` command, go to *Commands User's Guide*.

1. Display the maximum number of signaling links the EAGLE can have and the number of signaling links that are currently provisioned by entering the `rtrv-tbl-capacity` command.

This is an example of the possible output.

```
rlghncxa03w 09-07-19 21:16:37 GMT EAGLE5 41.1.0
SLK      table is (          5 of      1200)  1% full
```

Note: The `rtrv-tbl-capacity` command output contains other fields that are not used by this procedure. If you wish to see all the fields displayed by the `rtrv-tbl-capacity` command, refer to the `rtrv-tbl-capacity` command description in the *Commands User's Guide*.

If the addition of the new signaling link will not exceed the maximum number of signaling links the EAGLE can have, continue the procedure with [Step 2](#).

If the addition of the new signaling link will exceed the maximum number of signaling links the EAGLE can have, and the maximum number of signaling links is less than 2800, perform the [Enabling the Large System # Links Controlled Feature](#) procedure to enable the desired quantity of signaling links. After the new quantity of signaling links has been enabled, continue the procedure with [Step 2](#).

If the addition of the new signaling link will exceed the maximum number of signaling links the EAGLE can have (in this example, the maximum number of signaling links is 1200), and the maximum number of signaling links is 2800, this procedure cannot be performed. The EAGLE cannot contain more than 2800 signaling links.

2. Display the current signaling link configuration using the `rtrv-slk` command.

```
rlghncxa03w 10-07-19 21:16:37 GMT EAGLE5 42.0.0
rtrv-slk
Command entered at terminal #4.

LOC LINK LSN          SLC TYPE          L2T          PCR PCR
SET BPS          ECM N1 N2
1312 A  lsnds0      0  LIMDS0      1  56000  BASIC  ----  -----

LOC LINK LSN          SLC TYPE          LP          ATM
SET BPS          TSEL          VCI VPI LL
1305 A  lsnds0      1  LIMATM      1  1.544M  LINE   5   0   0

LOC LINK LSN          SLC TYPE          LP          ATM          E1ATM
SET BPS          TSEL          VCI VPI CRC4 SI SN
```

```

1306 A    lsnituatm  0    LIME1ATM 21  2.048M LINE      5      0    ON    3    0

LOC LINK LSN          SLC TYPE      ANAME          SLKTPS
1303 A    ipsglsn     0    IPSG      ipsgm2pa1     600
1303 A1   ipsglsn     1    IPSG      ipsgm2pa2     600
1303 B1   ipsglsn     2    IPSG      ipsgm2pa3     600
1303 A2   ipsglsn     3    IPSG      ipsgm2pa4     600
1303 A3   ipsglsn     4    IPSG      ipsgm2pa5     600
1303 B3   ipsglsn2    0    IPSG      ipsgm2pa6     1000
1307 A    ipsglsn     5    IPSG      m2pa2         600
2204 B    lsnlp2       0    IPSG      m3ua          500

LOC LINK LSN          SLC TYPE      IPLIML2
1301 A    lsniplim    0    IPLIM     M2PA
1301 A1   lsniplim    1    IPLIM     M2PA
1301 B1   lsniplim    2    IPLIM     M2PA

LOC LINK LSN          SLC TYPE
1201 A    ipgwx2     2    SS7IPGW
1202 A    ipgwx2     3    SS7IPGW
1203 A    ipgwx2     4    SS7IPGW
1204 A    ipgwx2     5    SS7IPGW
1205 A    ipgwx2     6    SS7IPGW
1206 A    ipgwx2     7    SS7IPGW
1101 A    ipgwx1     0    SS7IPGW
1102 A    ipgwx1     1    SS7IPGW
1103 A    ipgwx1     2    SS7IPGW
1104 A    ipgwx1     3    SS7IPGW
1105 A    ipgwx1     4    SS7IPGW
1106 A    ipgwx1     5    SS7IPGW
1107 A    ipgwx1     6    SS7IPGW
1108 A    ipgwx1     7    SS7IPGW
1111 A    ipgwx2     0    SS7IPGW
1112 A    ipgwx2     1    SS7IPGW

SLK table is (30 of 1200) 2% full.

```

3. Display the cards in the database using the `rtrv-card` command.

This is an example of the possible output.

```

rlghncxa03w 13-06-28 09:12:36 GMT EAGLE5 45.0.0
CARD  TYPE      APPL      LSET NAME  LINK SLC LSET NAME  LINK SLC
1101  DCM          SS7IPGW   ipgwx1    A    0
1102  DCM          SS7IPGW   ipgwx1    A    1
1103  DCM          SS7IPGW   ipgwx1    A    2
1104  DCM          SS7IPGW   ipgwx1    A    3
1105  DCM          SS7IPGW   ipgwx1    A    4
1106  DCM          SS7IPGW   ipgwx1    A    5
1107  DCM          SS7IPGW   ipgwx1    A    6
1108  DCM          SS7IPGW   ipgwx1    A    7
1111  DCM          SS7IPGW   ipgwx2    A    0
1112  DCM          SS7IPGW   ipgwx2    A    1
1113  E5MCAP      OAMHC
1114  E5TDM-A
1115  E5MCAP      OAMHC
1116  E5TDM-B
1117  E5MDAL
1201  DCM          SS7IPGW   ipgwx2    A    2
1202  DCM          SS7IPGW   ipgwx2    A    3
1203  DCM          SS7IPGW   ipgwx2    A    4

```

1204	DCM	SS7IPGW	ipgwx2	A	5			
1205	DCM	SS7IPGW	ipgwx2	A	6			
1206	DCM	SS7IPGW	ipgwx2	A	7			
1301	DCM	IPLIM	lsniplim	A	0	lsniplim	A1	1
			lsniplim	B1	2			
1303	ENET	IPSG	ipsglsn	A	0	ipsglsn	A1	1
			ipsglsn	B1	2	ipsglsn	A2	3
			ipsglsn	A3	4	ipsglsn2	B3	0
1305	LIMATM	ATMANSI	lsnds0	A	1			
1306	LIME1ATM	ATMITU	lsnituatm	A	0			
1307	ENET	IPSG	ipsglsn	A	5			
1311	DCM	IPLIM						
1312	LIMDS0	SS7ANSI	lsnds0	A	0			

If the required IPSG card is not in the database, perform the [Adding an IPSG Card](#) procedure and add the IPSG card to the database. After the IPSG card has been added, continue the procedure with [Step 5](#).

If the required IPSG card is in the database, continue the procedure with [Step 4](#).

4. Display the signaling links assigned to the IPSG card by entering the `rtrv-slk` command with the card location of the IPSG card. For this example, enter this command.

```
rtrv-slk:loc=2204
```

This is an example of the possible output.

```
rlghncxa03w 06-10-28 09:12:36 GMT EAGLE5 36.0.0
LOC LINK LSN          SLC TYPE      ANAME          SLKTPS
2204 B   lsnlp2           0  IPSG      m3ua           500
IPTPS for LOC = 2204 is ( 500 of 5000) 10%
```

An IPSG card can contain a maximum of 32 IPSG signaling links. If 32 signaling links are shown in the `rtrv-slk` output, the new signaling link cannot be added to this card. Choose another IPSG card and repeat this procedure from [Step 3](#).

If less than 32 signaling links are shown in the `rtrv-slk` output, continue the procedure by performing one of these actions.

- If the IPTPS value shown in the `rtrv-slk` output is less than the MaxTPS (see [Maximum Card Capacity for Different Card Types](#) for MaxTPS values), continue the procedure with [Step 5](#).
- If the IPTPS value shown in the `rtrv-slk` output is the MaxTPS, the new signaling link cannot be added to this card. Choose another IPSG card and repeat this procedure from [Step 3](#).

5. Display the IPSG and IPGWx linksets by entering the `rept-stat-iptps` command.

This is an example of the possible output.

```
rlghncxa03w 10-07-19 21:16:37 GMT EAGLE5 42.0.0
IP TPS USAGE REPORT
-----
          THRESH  CONFIG/  CONFIG/          TPS   PEAK   PEAKTIMESTAMP
                   RSVd    MAX
-----
LSN
```

```

ipgwx1      100%    ----    32000  TX:    3700    4000    10-07-19 09:49:19
              RCV:    3650    4000    10-07-19 09:49:19
ipgwx2      100%    ----    16000  TX:    4800    5000    10-07-19 09:49:09
              RCV:    4850    5000    10-07-19 09:49:09
ipgwx3      100%    ----    32000  TX:     427     550    10-07-19 09:49:19
              RCV:     312     450    10-07-19 09:49:19
ipsglsn     100%     600    24000  TX:    4800    5000    10-07-19 09:49:19
              RCV:    4800    5000    10-07-19 09:49:19
ipsglsn2    100%     600     4000  TX:     427     550    10-07-19 09:49:19
              RCV:     312     450    10-07-19 09:49:19
isipgw      100%     500     4000  TX:     427     550    10-07-19 09:49:19
              RCV:     312     450    10-07-19 09:49:19
-----
Command Completed.

```

If the desired linkset is shown in the `rept-stat-iptps` output, continue the procedure with [Step 6](#).

If the desired linkset is not shown in the `rept-stat-iptps` output, add the linkset by performing the [Adding an IPSG M2PA Linkset](#) procedure. Continue the procedure with one of these actions.

- If a new IPSG card was added in [Step 3](#), continue the procedure with [Step 7](#).
 - If the signaling link will be assigned to an existing IPSG card, the RSVDSLKTPS value that is assigned to the linkset will be assigned to the signaling link. The sum of the TPS used by all the signaling links that are assigned to the IPSG card cannot exceed the MaxTPS. See [Maximum Card Capacity for Different Card Types](#) for MaxTPS values. The TPS used by the IPSG card and the TPS used by each signaling link that is assigned to the IPSG card is shown by entering the `rtrv-slk` command with the location of the IPSG card. If the MaxTPS limit for the IPSG card will be exceeded by adding the IPSG M2PA signaling link, one of these actions must be performed.
 - Another IPSG card must be used for the IPSG M2PA signaling link. Repeat this procedure from [Step 3](#).
 - The RSVDSLKTPS values for the linksets shown in the `rtrv-slk` output for the IPSG card, shown in [Step 4](#), must be reduced enough to allow the IPSG M2PA linkset to be added. Perform these procedures as necessary to change the RSVDSLKTPS values for the linksets. After the linksets have been changed, continue the procedure with [Step 7](#).
 - [Changing an IPSG M2PA Linkset](#)
 - [Changing an IPSG M3UA Linkset](#)
6. Display the linkset that the signaling link will be assigned to using the `rtrv-ls` command, specifying the name of the linkset that the signaling link is being assigned to.

For this example, enter this command.

```
rtrv-ls:lsn=lsipgw
```

This is an example of the possible output.

```

rlghncxa03w 10-07-17 11:43:04 GMT EAGLE5 42.0.0

LSN          APCA  (SS7)  SCRN  L3T  SLT          GWS  GWS  GWS
lsipgw       010-010-101  none  1    1    no  A    1    off off off  ---  off

```

```

          SPCN          CLLI          TFATCABMLQ MTPRSE ASL8
          -----          -
RANDSLS
off

IPSG  IPGWAPC  GTTMODE          CGGTMOD
yes   no      CdPA          no

ADAPTER  RSVDSLKTPS  MAXSLKTPS
m3ua    500        4000

TPSALM   LSUSEALM   SLKUSEALM
rsvdsltkps 80%     80%

RCONTEXT ASNOTIF   NUMSLKALW  NUMSLKRSTR  NUMSLKPROH
none     yes     1          1          1

LOC  LINK  SLC  TYPE  ANAME
1317 A   0   IPSG  m3ua20

Link set table is (13 of 1024) 1% full.

```

If the IPSG value of the linkset is no, choose another linkset and repeat this procedure from [Step 5](#).

If the IPSG value of the linkset is yes and the ADAPTER value is m2pa, choose another linkset and repeat this procedure from [Step 5](#).

If the IPSG value of the linkset is yes, and the ADAPTER value is m3ua, continue the procedure by performing one of these actions.

- If a new IPSG card was added in [Step 3](#), continue the procedure with [Step 7](#).
- If the signaling link will be assigned to an existing IPSG card, the RSVDSLKTPS value that is assigned to the linkset will be assigned to the signaling link. The sum of the TPS used by all the signaling links that are assigned to the IPSG card cannot exceed MaxTPS. See [Maximum Card Capacity for Different Card Types](#) for MaxTPS values. The TPS used by the IPSG card and the TPS used by each signaling link that is assigned to the IPSG card is shown by entering the `rtrv-slk` command with the location of the IPSG card. If the MaxTPS limit for the IPSG card will be exceeded by adding the IPSG M2PA signaling link, one of these actions must be performed.
 - Another IPSG card must be used for the IPSG M2PA signaling link. Repeat this procedure from [Step 3](#).
 - The RSVDSLKTPS values for the linksets shown in the `rtrv-slk` output for the IPSG card, shown in [Step 4](#), must be reduced enough to allow the IPSG M2PA linkset to be added. Perform these procedures as necessary to change the RSVDSLKTPS values for the linksets. After the linksets have been changed, continue the procedure with [Step 7](#).
 - [Changing an IPSG M3UA Linkset](#)
 - [Changing an IPSG M2PA Linkset](#)

7. Display the total provisioned system TPS by entering the `rtrv-tps` command. This is an example of the possible output.

```

rlghncxa03w 10-07-10 16:20:46 GMT EAGLE 42.0.0

```

CARD TYPE	NUM CARDS	NUM LINKS	RSVD TPS	MAX TPS
IPGW	17	16	48000	80000
IPSG	4	8	4700	12000
IPLIM	2	4	8000	8000
ATM	2	2	3668	3668

Total provisioned System TPS (103668 of 500000) 21%

Command Completed.

An IPSG M3UA signaling link can use as much as the MaxTPS RSVDSLKTPS (see [Maximum Card Capacity for Different Card Types](#) for MaxTPS values), as provisioned by the `rsvds1ktps` parameter of the linkset that the IPSG M3UA signaling link will be added to. If adding the new IPSG M3UA signaling link will not exceed the maximum total provisioned system TPS, continue the procedure with [Step 11](#).

If adding the new IPSG M3UA signaling link will exceed the maximum total provisioned system TPS, and the maximum total provisioned system TPS is 500,000 shown, perform the "Activating the HIPR2 High Rate Mode Feature" procedure in the *Database Administration - System Management* to enable and turn on the HIPR2 High Rate Mode feature. When the HIPR2 High Rate Mode feature is enabled and turned on, the maximum total provisioned system TPS is increased to 1M. After the HIPR2 High Rate Mode feature has been enabled and turned on, continue the procedure with [Step 11](#).

If the maximum total provisioned system TPS is 1M, or the maximum total provisioned system TPS is 500,000 and will not be increased, and adding the IPSG M3UA signaling link will exceed the maximum total provisioned system TPS, the IPSG M3UA signaling link cannot be added unless the amount of available TPS is reduced enough to allow the IPSG M3UA signaling link to be added. The available TPS can be increased by performing one or more of these actions.

- Some ATM high-speed signaling links have to be removed. To perform this action, continue the procedure with [Step 8](#).
- An IPLIMx card that contains signaling links has to be removed. To perform this action, continue the procedure with [Step 9](#).
- The IP TPS values of some IPGWx linksets have to be changed or the MAXSLKTPS values of some IPSG linksets (and the RSVDSLKTPS values if necessary) have to be changed.

If linksets are displayed in the `rept-stat-iptps` output in [Step 5](#), continue the procedure with [Step 10](#).

If linksets are not displayed in the `rept-stat-iptps` output in [Step 5](#), perform one or more of these actions to increase the available TPS.

Note: If one or more of these actions are not performed to increase the available TPS and the available TPS will not allow the IPSG M3UA signaling link to be added, the IPSG M3UA signaling link cannot be added and the remainder of this procedure cannot be performed.

- An IPLIMx card that contains signaling links has to be removed. To perform this action, continue the procedure with [Step 9](#).
- Some ATM high-speed signaling links have to be removed. To perform this action, continue the procedure with [Step 8](#).

8. Display the ATM high-speed signaling links by entering this command.

```
rtrv-slk:type=saal
```

This is an example of the possible output.

```
rlghncxa03w 10-07-19 21:16:37 GMT EAGLE5 42.0.0

LOC LINK LSN          SLC TYPE      LP          ATM
1303 A  lsnds0          1  LIMATM     1  1.544M LINE      VCI  VPI  LL
                    5      0      0

LOC LINK LSN          SLC TYPE      LP          ATM          E1ATM
1306 A  lsnituatm      0  LIME1ATM  21  2.048M LINE      VCI  VPI  CRC4 SI SN
                    5      0      ON   3   0

SLK table is (30 of 1200) 2% full.
```

If ATM high-speed signaling links are shown in the `rtrv-slk` output, perform the "Removing an SS7 Signaling Link" procedure in *Database Administration - SS7* to remove some of the ATM high-speed signaling links.

If ATM high-speed signaling links are not displayed in the `rtrv-slk` output, perform one or more of these actions to increase the available TPS.

Note: If one or more of these actions are not performed to increase the available TPS and the available TPS will not allow the IPSG M3UA signaling link to be added, the IPSG M3UA signaling link cannot be added and the remainder of this procedure cannot be performed.

- An IPLIMx card that contains signaling links has to be removed. To perform this action, continue the procedure with [Step 9](#).
- The IP TPS values of some IPGWx linksets have to be changed or the MAXSLKTPS values of some IPSG linksets (and the RSVDSLKTPS values if necessary) have to be changed.

If linksets are displayed in the `rept-stat-iptps` output in [Step 5](#), continue the procedure with [Step 10](#).

If linksets are not displayed in the `rept-stat-iptps` output in [Step 5](#), an IPLIMx card that contains signaling links has to be removed. To perform this action, continue the procedure with [Step 9](#).

If you do not wish to perform other actions to increase the available TPS and the available TPS will allow the IPSG M3UA signaling link to be added, continue the procedure with [Step 11](#).

9. Display the signaling links that are assigned to IPLIMx cards by entering this command.

```
rtrv-slk:type=iplim
```

This is an example of the possible output.

```
rlghncxa03w 10-07-19 21:16:37 GMT EAGLE5 42.0.0

LOC LINK LSN          SLC TYPE      ANAME          SLKTPS
1301 A  lsniplim      0  IPLIM      M2PA
1301 A1 lsniplim      1  IPLIM      M2PA
1301 B1 lsniplim      2  IPLIM      M2PA
1317 A  lsniplimi     0  IPLIMI     M2PA

SLK table is (30 of 1200) 2% full.
```

If IPLIMx cards containing signaling links are shown in the `rtrv-slk` output, perform the [Removing an IPLIMx Card](#) procedure to remove an IPLIMx card and its associated signaling links.

If IPLIMx cards containing signaling links are not displayed in the `rtrv-slk` output, perform one or more of these actions to increase the available TPS.

Note: If one or more of these actions are not performed to increase the available TPS and the available TPS will not allow the IPSG M3UA signaling link to be added, the IPSG M3UA signaling link cannot be added and the remainder of this procedure cannot be performed.

- Some ATM high-speed signaling links have to be removed. To perform this action, continue the procedure with [Step 8](#).
- The IP TPS values of some IPGWx linksets have to be changed or the MAXSLKTPS values of some IPSG linksets (and the RSVDSLKTPS values if necessary) have to be changed.

If linksets are displayed in the `rept-stat-iptps` output in [Step 5](#), continue the procedure with [Step 10](#).

If linksets are not displayed in the `rept-stat-iptps` output in [Step 5](#), some ATM high-speed signaling links have to be removed. To perform this action, continue the procedure with [Step 8](#).

If you do not wish to perform other actions to increase the available TPS and the available TPS will allow the IPSG M3UA signaling link to be added, continue the procedure with [Step 11](#).

10. Display the attributes of the linksets shown in [Step 5](#) by entering the `rtrv-ls` command with the name of the linkset shown in [Step 5](#).

For this example enter these commands.

```
rtrv-ls:lsn=ipgwx1
```

This is an example of the possible output.

```
rlghncxa03w 10-07-19 21:16:37 GMT EAGLE5 42.0.0

LSN              APCA  (SS7)  L3T SLT          GWS GWS GWS
ipgwx1          001-001-002  none 1 1  no  A  8  off off off no  off
              SPCA          CLLI          TFATCABMLQ MTPRSE ASL8
              -----
              4          ---      no

RANDSLS
off

IPSG  IPGWAPC  GTTMODE          CGGTMOD
no    yes     CdPA          no

MATELSN  IPTPS  LSUSEALM  SLKUSEALM
-----  32000  100%     80%

LOC  LINK  SLC  TYPE
1101 A    0    SS7IPGW
1102 A    1    SS7IPGW
1103 A    2    SS7IPGW
1104 A    3    SS7IPGW
1105 A    4    SS7IPGW
1106 A    5    SS7IPGW
```

```

1107 A    6    SS7IPGW
1108 A    7    SS7IPGW
    
```

Link set table is (8 of 1024) 1% full.

```
rtrv-ls:lsn=ipgwx2
```

This is an example of the possible output.

```

rlghncxa03w 10-07-19 21:16:37 GMT EAGLE5 42.0.0

LSN          APCA  (SS7)  L3T SLT          GWS GWS GWS
ipgwx2      001-001-003  none 1  1  no  A  8  off off off no  off

          SPCA          CLLI          TFATCABMLQ MTPRSE ASL8
          -----          -----          4          ---  no

RANDSLS
off

IPSG  IPGWAPC  GTTMODE          CGGTMOD
no    yes     CdPA          no

MATELSN  IPTPS  LSUSEALM  SLKUSEALM
-----  -----  -----  -----
16000    100%    80%

LOC  LINK  SLC  TYPE
1111 A    0    SS7IPGW
1112 A    1    SS7IPGW
1201 A    2    SS7IPGW
1202 A    3    SS7IPGW
1203 A    4    SS7IPGW
1204 A    5    SS7IPGW
1205 A    6    SS7IPGW
1206 A    7    SS7IPGW
    
```

Link set table is (8 of 1024) 1% full.

```
rtrv-ls:lsn=ipgwx3
```

This is an example of the possible output.

```

rlghncxa03w 10-07-19 21:16:37 GMT EAGLE5 42.0.0

LSN          APCA  (SS7)  L3T SLT          GWS GWS GWS
ipgwx3      001-001-004  none 1  1  no  A  0  off off off no  off

          SPCA          CLLI          TFATCABMLQ MTPRSE ASL8
          -----          -----          1          ---  no

RANDSLS
off

IPSG  IPGWAPC  GTTMODE          CGGTMOD
no    yes     CdPA          no
    
```

```
MATELSN      IPTPS      LSUSEALM     SLKUSEALM
-----      -
32000        100%         80%
```

Link set table is (8 of 1024) 1% full.

```
rtrv-ls:lsn=ipsglsn
```

This is an example of the possible output.

```
rlghncxa03w 10-07-19 21:16:37 GMT EAGLE5 42.0.0

LSN          APCA   (SS7)   L3T SLT          GWS GWS GWS
ipsglsn     003-003-003  none 1 1  no  A  6  off off off no  off

          SPCA          CLLI          TFATCABMLQ MTPRSE ASL8
          -----          -----          3          ---  no

RANDSLS
off

IPSG  IPGWAPC  GTTMODE          CGGTMOD
yes   no      CdPA              no

ADAPTER  SLKTPS  LSUSEALM  SLKUSEALM  RCONTEXT  ASNOTIF
m2pa     600    100%     80%        none       no

LOC  LINK  SLC  TYPE  ANAME
1303 A  0    IPSG  ipsgm2pa1
1303 A1 1    IPSG  ipsgm2pa2
1303 B1 2    IPSG  ipsgm2pa3
1303 A2 3    IPSG  ipsgm2pa4
1303 A3 4    IPSG  ipsgm2pa5
1307 A  5    IPSG  m2pa2
```

Link set table is (8 of 1024) 1% full.

```
rtrv-ls:lsn=ipsglsn2
```

This is an example of the possible output.

```
rlghncxa03w 10-07-19 21:16:37 GMT EAGLE5 42.0.0

LSN          APCA   (SS7)   L3T SLT          GWS GWS GWS
ipsglsn2     005-005-005  none 1 1  no  A  1  off off off no  off

          SPCA          CLLI          TFATCABMLQ MTPRSE ASL8
          -----          -----          1          ---  no

RANDSLS
off

IPSG  IPGWAPC  GTTMODE          CGGTMOD
yes   no      CdPA              no

ADAPTER  SLKTPS  LSUSEALM  SLKUSEALM  RCONTEXT  ASNOTIF
m2pa     1000   100%     80%        none       no
```

```

LOC LINK SLC TYPE ANAME
1303 B3 0 IPSG ipsgm2pa6

```

Link set table is (8 of 1024) 1% full.

Perform one or both of these actions as necessary.

- Perform the [Configuring an IPGWx Linkset](#) procedure to change the IPTPS value for any linksets shown in the `rtrv-ls` output whose IPGWAPC value is yes.
- Perform the [Changing an IPSG M2PA Linkset](#) procedure (for linkset whose IPSG value is yes and ADAPTER value is M2PA) or the [Changing an IPSG M3UA Linkset](#) procedure (for linkset whose IPSG value is yes and ADAPTER value is M3UA) to change the MAXSLKTPS value (and RSVDSLKTPS value if necessary) for any linksets shown in the `rtrv-ls` output.

Perform one or both of these actions to increase the available TPS if needed.

- An IPLIMx card that contains signaling links has to be removed. To perform this action, continue the procedure with [Step 9](#).
- Some ATM high-speed signaling links have to be removed. To perform this action, continue the procedure with [Step 8](#).

If you do not wish to perform other actions to increase the available TPS and the available TPS will allow the IPSG M3UA signaling link to be added, continue the procedure with [Step 11](#).

11. Display the associations that are assigned to the card that will be assigned to the signaling link by entering `rtrv-assoc` command with the location of the card. For this example, enter this command.

```
rtrv-assoc:loc=2204
```

This is an example of the possible output.

```

rlghncxa03w 06-10-17 11:43:04 GMT EAGLE5 36.0.0

          CARD  IPLNK
ANAME     LOC  PORT  LINK ADAPTER LPORT RPORT OPEN ALW
m3ua2     2204  A    B   M3UA   3001  3000  NO  YES
m3ua3     2204  A    --  M3UA   3002  3000  YES YES
m3ua4     2204  A    **  M3UA   3003  3000  YES YES

```

```

IP Appl Sock/Assoc table is (7 of 4000) 1% full
Assoc Buffer Space Used (1400 KB of 6400 KB) on LOC = 2204

```

To assign an association to an IPSG M3UA signaling link, the ADAPTER value for that association must be M3UA. If the ADAPTER value for the associations displayed in this step is not M3UA, add the IPSG M3UA association by performing the [Adding an IPSG M3UA Association](#) procedure. After the association has been added, continue the procedure with [Step 15](#).

If the ADAPTER value of the associations displayed in this step is M3UA, and the association is not assigned to a signaling link (shown by dashes in the LINK column), continue the procedure with [Step 15](#).

If the ADAPTER value of the associations displayed in this step is M3UA, and the association is assigned to a signaling link, continue the procedure with [Step 12](#).

12. Display the signaling links that the association is assigned to by entering the `rtrv-slk` command with the name of the association that will be added to the signaling link. For this example, enter this command.

```
rtrv-slk:aname=m3ua4
```

This is an example of the possible output.

```
rlghncxa03w 06-10-17 11:43:04 GMT EAGLE5 36.0.0

LOC LINK LSN          SLC TYPE      ANAME          SLKTPS
2204 A  m3ua1          0  IPSG      m3ua4          300
2204 A2 m3ua2          0  IPSG      m3ua4          300
2204 A12 m3ua3         1  IPSG      m3ua4          300
```

An IPSG M3UA association can be assigned to a maximum of 16 IPSG M3UA signaling links. If 16 signaling links are shown in this step, choose another IPSG card and repeat this procedure from [Step 3](#).

If 15 or less signaling links are shown in this step, continue the procedure from [Step 13](#).

13. Display all the linksets that contain the signaling links shown in [Step 12](#) by entering the `rtrv-ls` command with the linkset name shown in [Step 12](#). For this example, enter this command.

```
rtrv-ls:lsn=m3ua1
```

This is an example of the possible output.

```
rlghncxa03w 10-07-17 11:43:04 GMT EAGLE5 42.0.0

LSN          APCA  (SS7)  SCRN  L3T  SLT  BEI  LST  LNKS  GWS  GWS  GWS
m3ua1        002-002-003  none  1    1    no  A    1    off  off  off  no  off

          SPCA          CLLI          TFATCABMLQ  MTPRSE  ASL8
          -----  -----  ---      ---      no

RANDSLS
off

IPSG  IPGWAPC  GTTMODE          CGGTMOD
yes   no      CdPA              no

ADAPTER  RSVDSLKTPS  MAXSLKTPS
m3ua     300         4000

TPSALM   LSUSEALM    SLKUSEALM
rsvdslktps 100%      80%

RCONTEXT  ASNOTIF    NUMSLKALW  NUMSLKRSTR  NUMSLKPROH
25        yes        1          1          1

LOC  LINK  SLC  TYPE      ANAME
2204 A  0    IPSG      m3ua4

Link set table is (13 of 1024) 1% full.
```

```
rtrv-ls:lsn=m3ua2
```

This is an example of the possible output.

```

rlghncxa03w 10-07-17 11:43:04 GMT EAGLE5 42.0.0

LSN          APCA  (SS7)  SCRN  L3T  SLT          GWS  GWS  GWS
m3ua2       002-002-004  none  1    1    no  A    1    off off off no  off

          SPCA          CLLI          TFATCABMLQ  MTPRSE  ASL8
          -----          -----          ---          ---          no

RANDSLS
off

IPSG  IPGWAPC  GTTMODE          CGGTMOD
yes   no      CdPA          no

ADAPTER  RSVDSLKTPS  MAXSLKTPS
m3ua     300      4000

TPSALM   LSUSEALM   SLKUSEALM
rsvdslktps 100%    80%

RCONTEXT  ASNOTIF   NUMSLKALW  NUMSLKRSTR  NUMSLKPROH
50        yes     1           1           1

LOC  LINK  SLC  TYPE          ANAME
2204 A2  0   IPSG         m3ua4

Link set table is (13 of 1024) 1% full.

```

rtrv-ls:lsn=m3ua3

This is an example of the possible output.

```

rlghncxa03w 10-07-17 11:43:04 GMT EAGLE5 42.0.0

LSN          APCA  (SS7)  SCRN  L3T  SLT          GWS  GWS  GWS
m3ua3       002-002-005  none  1    1    no  A    1    off off off no  off

          SPCA          CLLI          TFATCABMLQ  MTPRSE  ASL8
          -----          -----          ---          ---          no

RANDSLS
off

IPSG  IPGWAPC  GTTMODE          CGGTMOD
yes   no      CdPA          no

ADAPTER  RSVDSLKTPS  MAXSLKTPS
m3ua     300      4000

TPSALM   LSUSEALM   SLKUSEALM
rsvdslktps 100%    80%

RCONTEXT  ASNOTIF   NUMSLKALW  NUMSLKRSTR  NUMSLKPROH
75        yes     1           1           1

LOC  LINK  SLC  TYPE          ANAME

```

```

                2204 A12  0   IPSG      m3ua4

Link set table is (13 of 1024) 1% full.

```

14. Display the linkset that will be assigned to the new signaling link by entering the `rtrv-ls` command with the name of the linkset. For this example, enter this command.

```
rtrv-ls:lsn=lsipgw
```

This is an example of the possible output.

```

rlghncxa03w 10-07-17 11:43:04 GMT EAGLE5 42.0.0

LSN              APCA  (SS7)  SCRNR  L3T  SLT          GWS  GWS  GWS
lsipgw           010-010-101  none  1    1    no  A    1    off off off ---  off
                SPCN          CLLI          TFATCABMLQ  MTPRSE  ASL8
                -----  -----  ---      ---      ---

RANDSLS
off

IPSG  IPGWAPC  GTTMODE          CGGTMOD
yes   no      CdPA              no

ADAPTER  RSVDSLKTPS  MAXSLKTPS
m3ua     500        4000

TPSALM   LSUSEALM    SLKUSEALM
rsvdslktps 100%      80%

RCONTEXT  ASNOTIF    NUMSLKALW  NUMSLKRSTR  NUMSLKPROH
none      yes        1          1          1

LOC  LINK  SLC  TYPE    ANAME
1317 A    0    IPSG    m3ua20

Link set table is (13 of 1024) 1% full.

```

To assign an IPSG M3UA association to more than one signaling link, the linksets that contain the signaling links must contain unique routing context (RCONTEXT) values. If the linkset displayed in this step contains a unique routing context value, compared to the routing context values shown in [Step 13](#), continue the procedure with [Step 15](#).

If the linkset displayed in this step does not contain a unique routing context value, perform the [Changing an IPSG M3UA Linkset](#) procedure to change the routing context value in this linkset that is unique, compared to the routing context values shown in [Step 13](#). After the [Changing an IPSG M3UA Linkset](#) procedure has been performed, continue the procedure with [Step 15](#).

15. Add the signaling link to the database using the `ent-slk` command.

[Table 55: IPSG M3UA Signaling Link Parameter Combinations](#) shows the parameters and values that can be specified with the `ent-slk` command.

Table 55: IPSG M3UA Signaling Link Parameter Combinations

IPSG M3UA Signaling Link
Mandatory Parameters
:loc = location of the IPSG card
:link = a - a15, b - b15
:lsn = linkset name
:slc = 0 - 15
:aname = the name of the IPSG M3UA association

For this example, enter this command.

```
ent-slk:loc=2204:link=a10:lsn=lsipgw:slc=1:aname=m3ua4
```

When this command has successfully completed, this message should appear.

```
rlghncxa03w 06-10-07 08:29:03 GMT EAGLE5 36.0.0
ENT-SLK: MASP A - COMPLTD
```

Note: If adding the new signaling link will result in more than 700 signaling links in the database and the OAMHCMEAS value in the `rtv-measopts` output is on, the scheduled UI measurement reports will be disabled.

16. Verify the changes using the `rtrv-slk` command with the card location and link parameter values specified in [Step 15](#). For this example, enter these commands.

```
rtrv-slk:loc=2204:link=a10
```

This is an example of the possible output.

```
rlghncxa03w 06-10-19 21:16:37 GMT EAGLE5 36.0.0

LOC LINK LSN          SLC TYPE      ANAME          SLKTPS
2204 A10 lsipgw      1   IPSG         m3ua4          500
```

17. If any cards contain the first signaling link on a card, those cards must be brought into service with the `rst-card` command, specifying the location of the card. For this example, enter this command.

```
rst-card:loc=2205
```

When this command has successfully completed, this message should appear.

```
rlghncxa03w 06-10-23 13:05:05 GMT EAGLE5 36.0.0
Card has been allowed.
```

18. Activate all signaling links on the cards using the `act-slk` command, specifying the card location and link parameter value of each signaling link. For this example, enter this command.

```
act-slk:loc=2204:link=a10
```

When this command has successfully completed, this message should appear.

```
rlghncxa03w 06-10-07 08:31:24 GMT EAGLE5 36.0.0
Activate Link message sent to card
```

19. Check the status of the signaling links added in [Step 15](#) using the `rept-stat-slk` command with the card location and link parameter values specified in [Step 15](#). The state of each signaling link should be in service normal (IS-NR) after the link has completed alignment (shown in the PST field). For this example, enter these commands.

```
rept-stat-slk:loc=2204:link=a10
```

This is an example of the possible output.

```
rlghncxa03w 07-05-23 13:06:25 GMT EAGLE5 37.0.0
SLK      LSN      CLLI      PST      SST      AST
2204,A10 lsipgw ----- IS-NR      Avail      ----
  ALARM STATUS      =
  UNAVAIL REASON    =
```

If the OPEN value of the association that was assigned to the signaling link is `yes`, continue the procedure with [Step 21](#).

If the OPEN value of the association that was assigned to the signaling link is `nos`, continue the procedure with [Step 20](#).

20. Change the open parameter value of the association that was assigned to the signaling link by entering the `chg-assoc` command with the `open=yes` parameter and the name of the association that was association. For this example, enter this command.

```
chg-assoc:aname=m3ua4:open=yes
```

When this command has successfully completed, this message should appear.

```
rlghncxa03w 06-10-07 08:29:03 GMT EAGLE5 36.0.0
CHG-ASSOC: MASP A - COMPLTD
```

21. Back up the new changes using the `chg-db:action=backup:dest=fixed` command. These messages should appear, the active Maintenance and Administration Subsystem Processor (MASP) appears first.

```
BACKUP (FIXED) : MASP A - Backup starts on active MASP.
BACKUP (FIXED) : MASP A - Backup on active MASP to fixed disk complete.
BACKUP (FIXED) : MASP A - Backup starts on standby MASP.
BACKUP (FIXED) : MASP A - Backup on standby MASP to fixed disk complete.
```

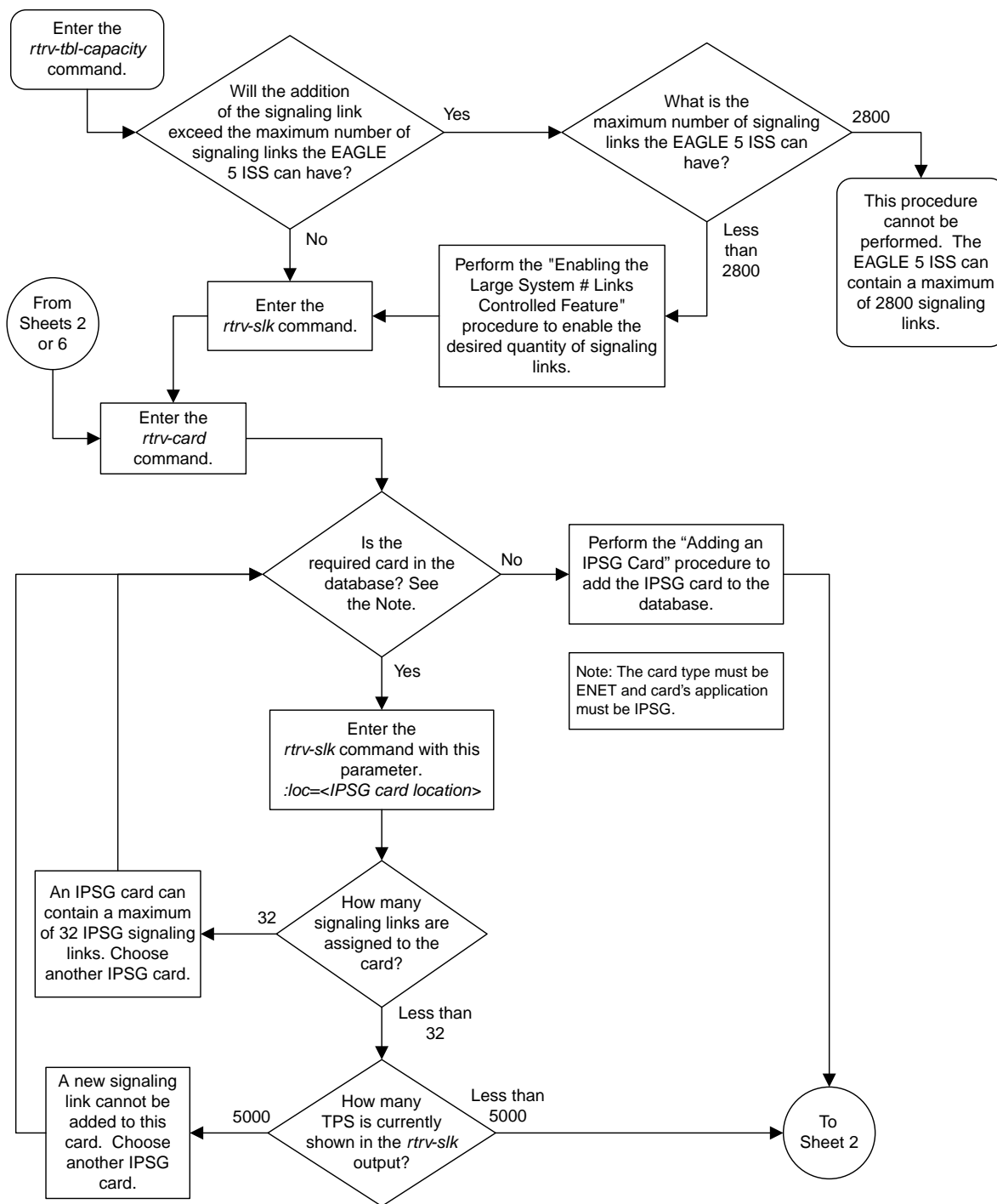

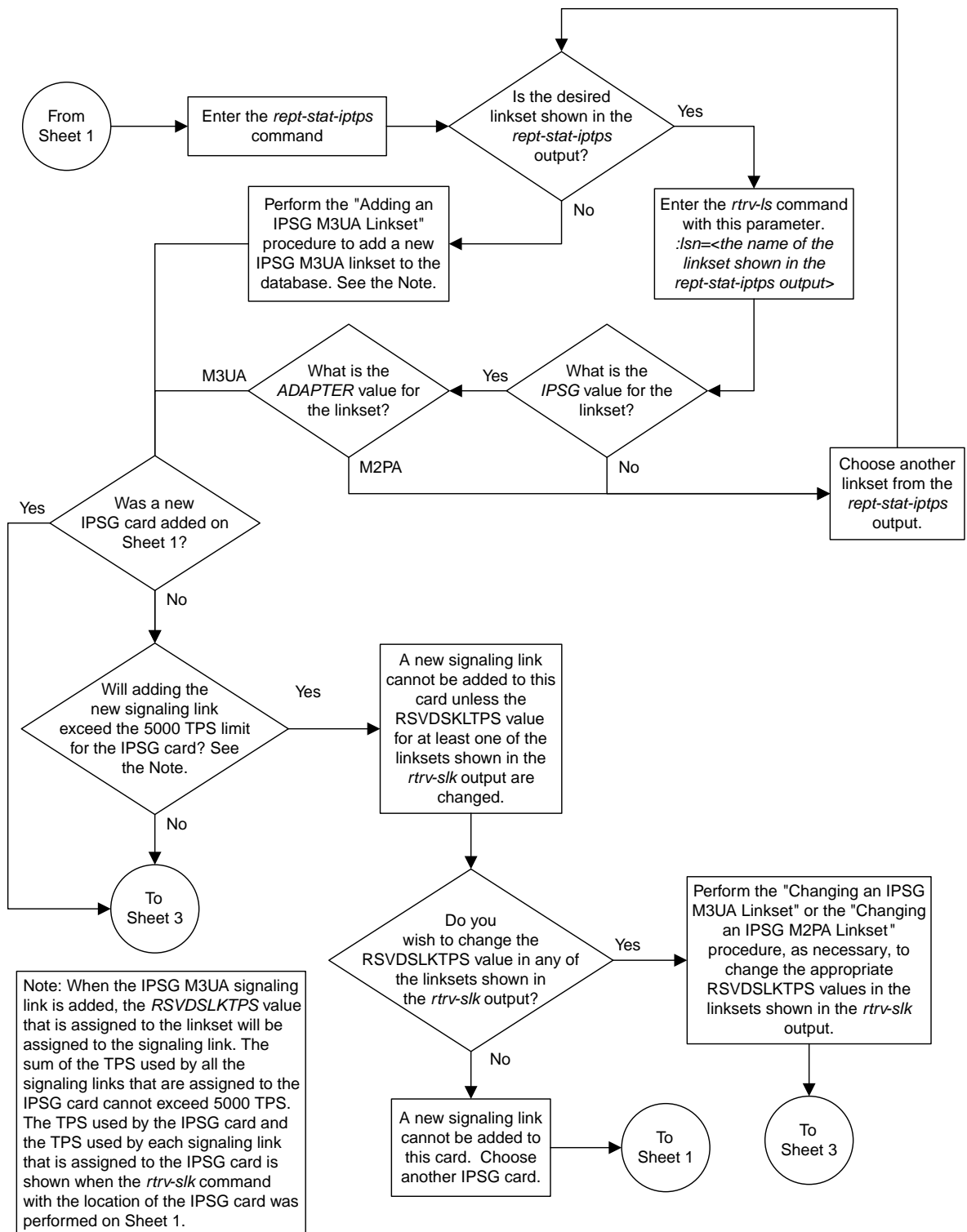

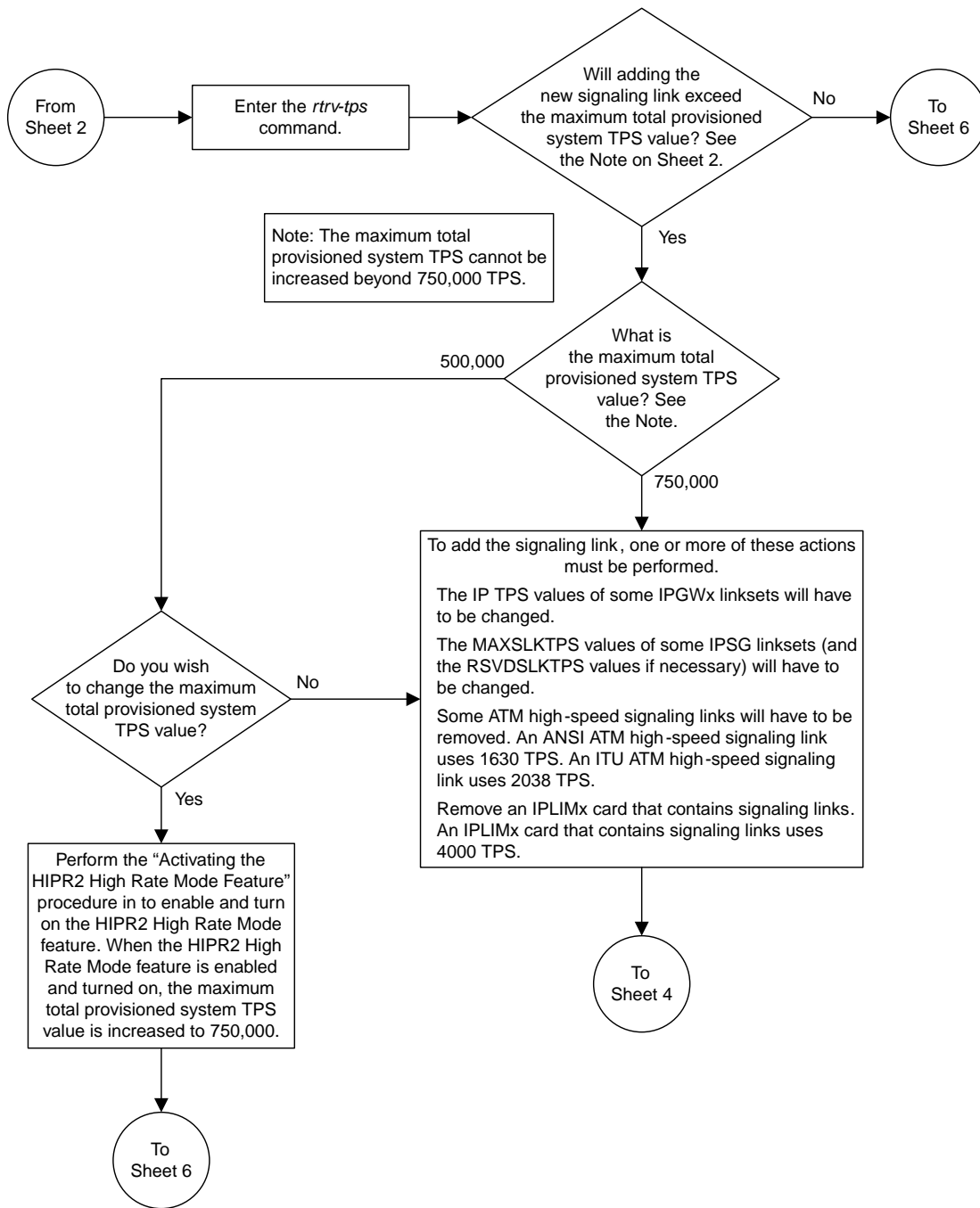

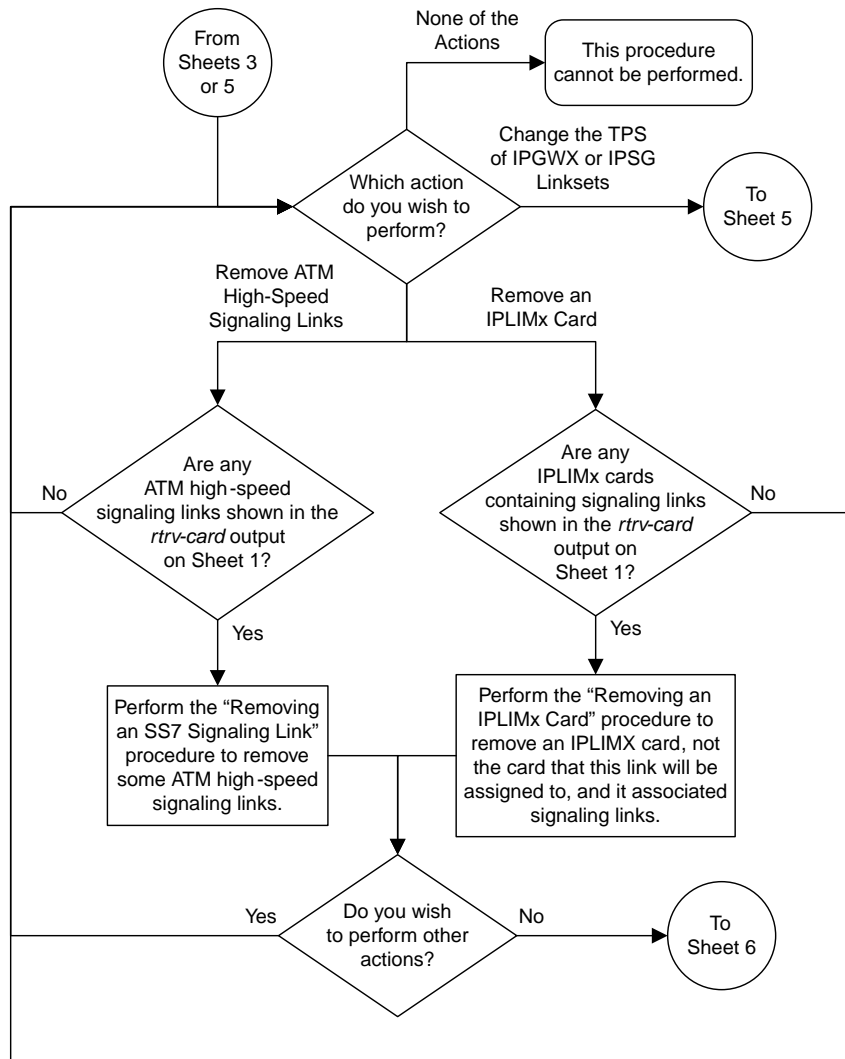

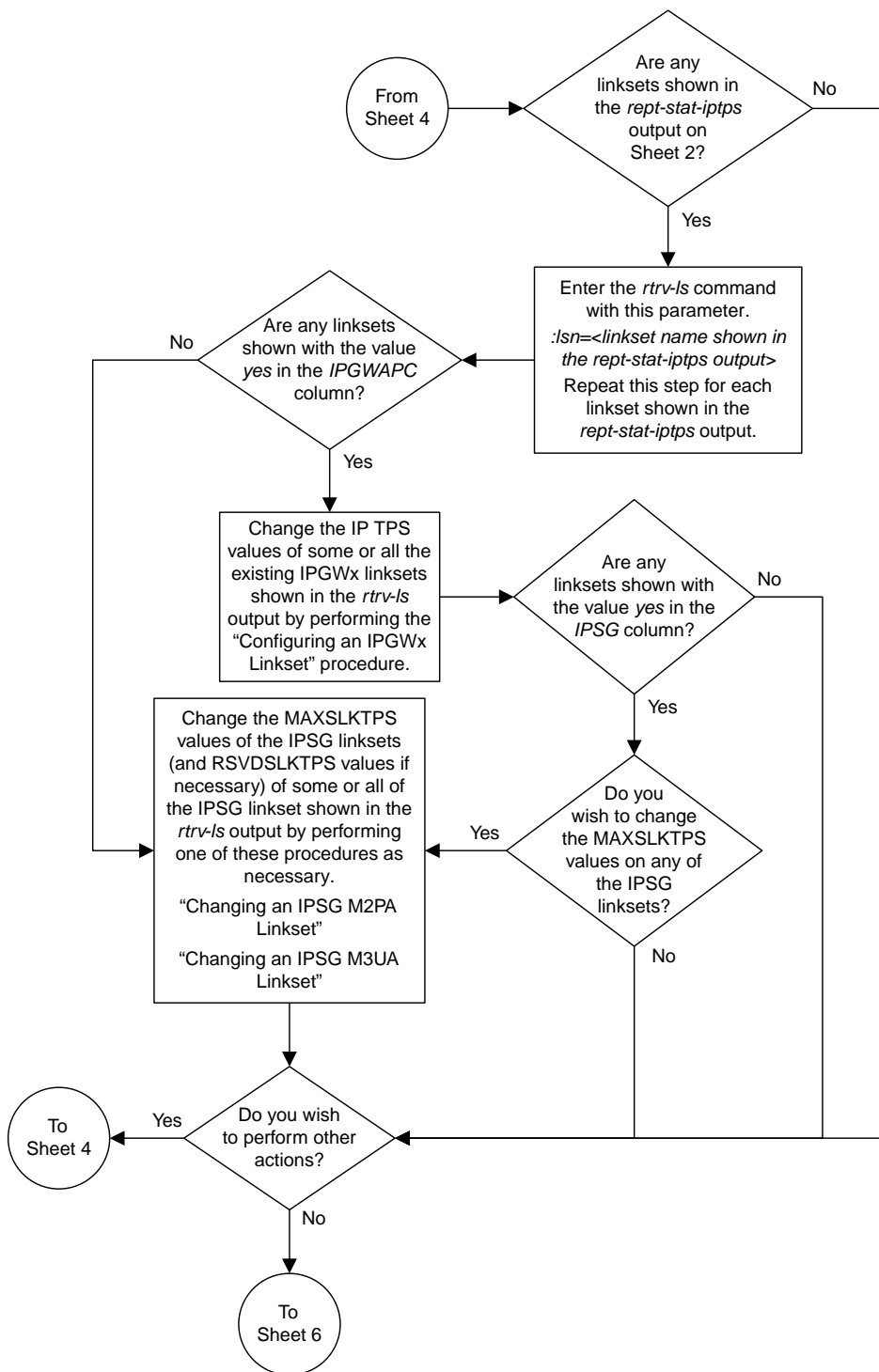

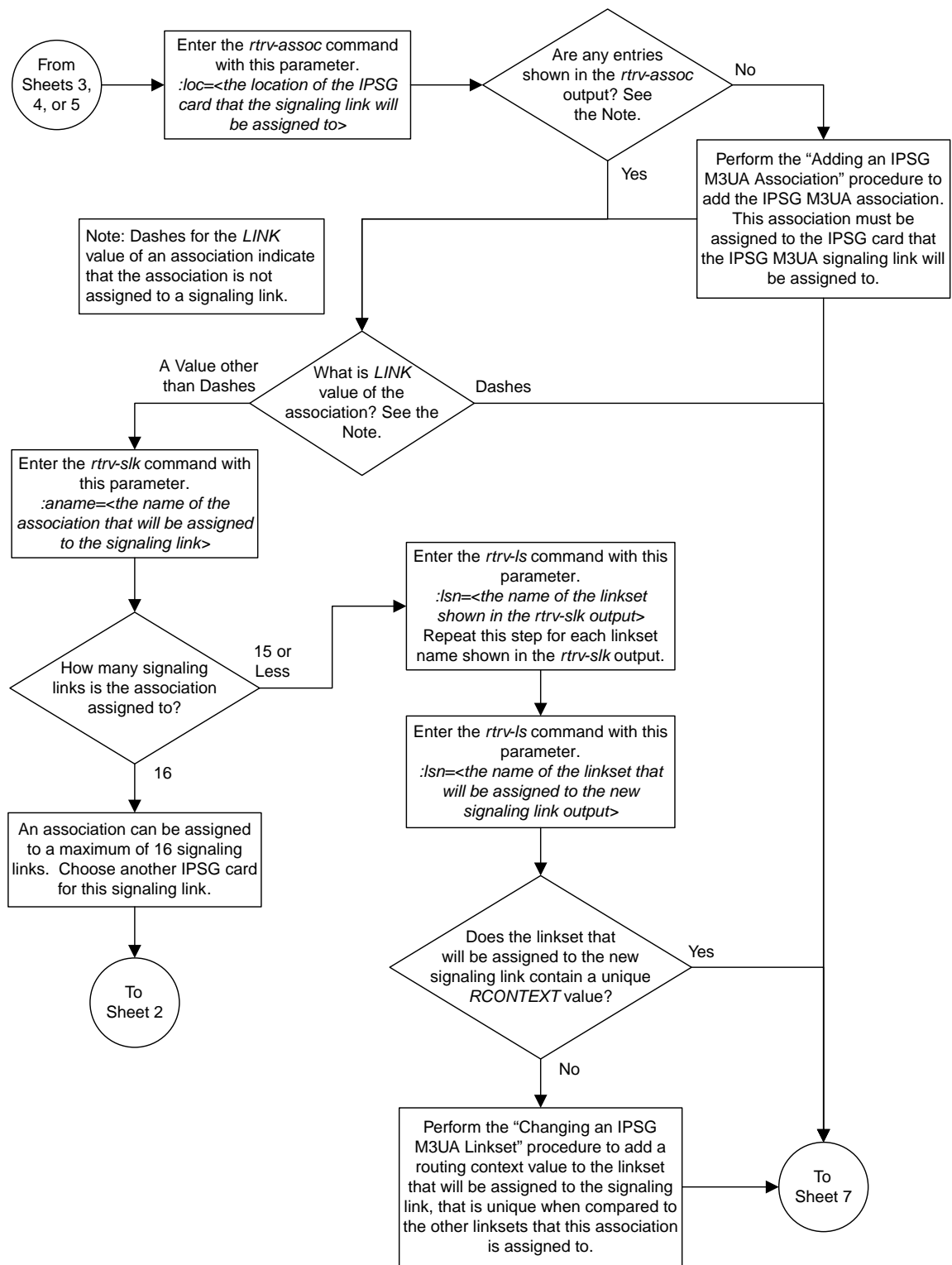

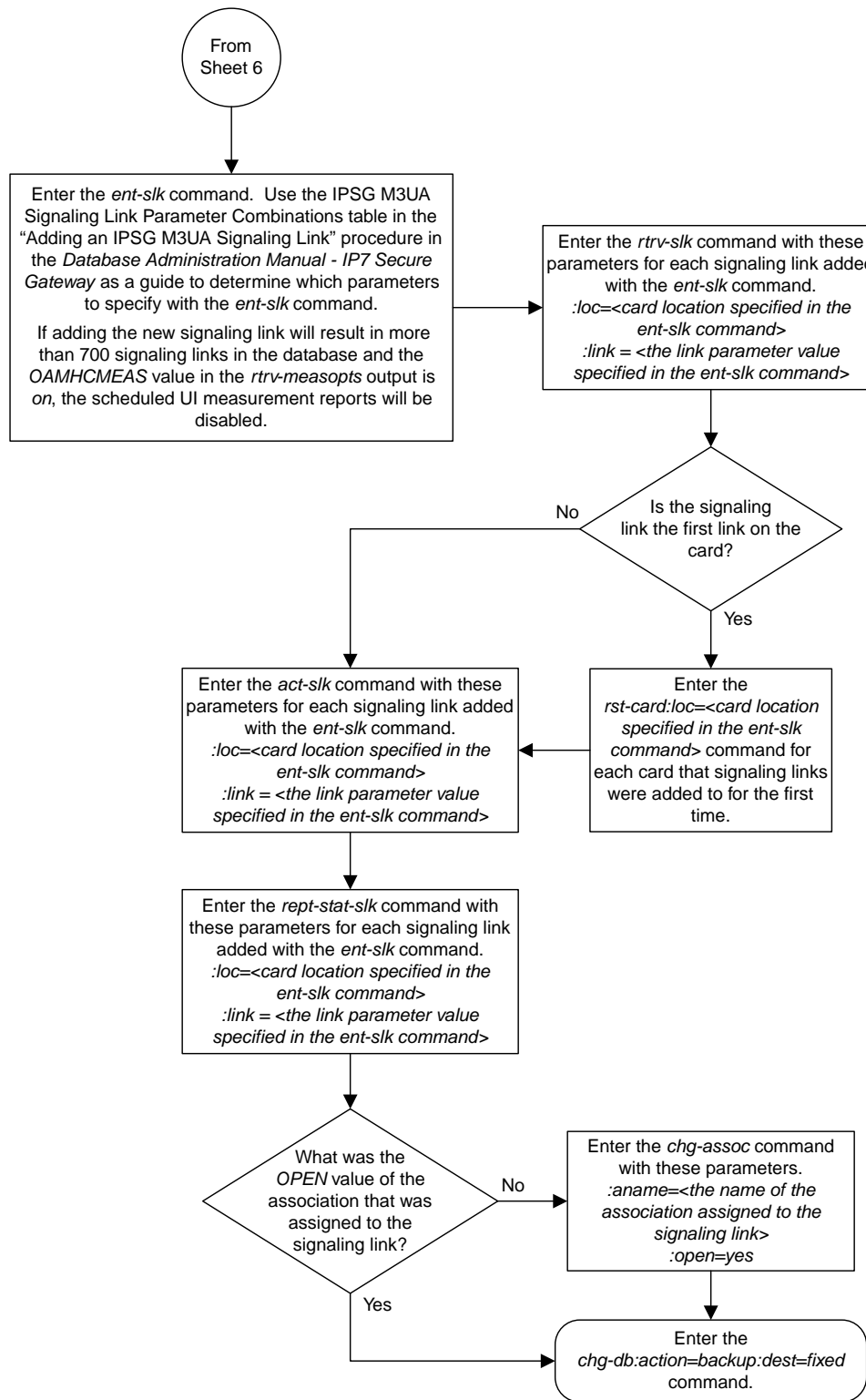

Sheet 7 of 7

Figure 99: Adding an IPSG M3UA Signaling Link

Adding a Network Appearance

The network appearance field identifies the SS7 network context for the message, for the purpose of logically separating the signaling traffic between the SGP (signaling gateway process) and the ASP (application server process) over a common SCTP (stream control transmission protocol) association. This field is contained in the DATA, DUNA, DAVA, DRST, DAUD, SCON, and DUPU messages.

The network appearance is provisioned in the database using the `ent-na` command with these parameters.

`:na` – the 32-bit value of the network appearance, from 0 to 4294967295.

`:type` – the network type of the network appearance, `ansi` (ANSI), `itui` (ITU-I), `itun` (14-bit ITU-N), `itun24` (24-bit ITU-N), `ituis` (ITU-I Spare), `ituns` (14-bit ITU-N Spare).

`:gc` – the specific ITU-N group code associated with the network appearance.

The `gc` parameter can be specified only with the `type=itun` or `type=ituns` parameters.

The `gc` parameter must be specified with the `type=itun` or `type=ituns` parameters if the ITU Duplicate Point Code feature is on. If the ITU Duplicate Point Code feature is off, the `gc` parameter cannot be specified.

The `gc` parameter value must be shown in the `rtrv-spc` or `rtrv-sid` outputs.

The `ituis` or `ituns` parameters can be specified only if the ITU National and International Spare Point Code Support feature is enabled.

1. Display the network appearances in the database with the `rtrv-na` command. This is an example of the possible output.

```
rlghncxa03w 06-10-28 09:12:36 GMT EAGLE5 36.0.0
TYPE  GC      NA
ANSI  --      100
ITUN  FR      4000000000
ITUN  GE      1000000000
```

Note: If the `gc` parameter is not being specified in this procedure, continue the procedure with [Step 4](#).

2. Display the self-identification of the EAGLE using the `rtrv-sid` command. This is an example of the possible output.

```
rlghncxa03w 06-10-28 09:12:36 GMT EAGLE5 36.0.0
PCA          PCI          PCN          CLLI          PCTYPE
001-001-001  1-200-6          13482        rlghncxa03w  OTHER

CPCA
002-002-002  002-002-003     002-002-004     002-002-005
002-002-006  002-002-007     002-002-008     002-002-009
004-002-001  004-003-003     144-212-003
```

CPCA (LNP)			
005-005-002	005-005-004	005-005-005	
CPCI			
1-001-1	1-001-2	1-001-3	1-001-4
CPCN			
02091	02092	02094	02097
02191	02192	11177	

If the desired group code is shown in the `rtrv-sid` output, continue the procedure with [Step 4](#).

3. Display the secondary point codes in the database with the `rtrv-spc` command. This is an example of the possible output.

```

rlghncxa03w 06-10-28 09:12:36 GMT EAGLE5 36.0.0
SPC (Secondary Point Codes)

SPCA
001-010-010
002-010-010
003-010-010

SPC-I
1-253-5
2-254-6
3-255-7

SPC-N
10-01-11-1-fr
13-02-12-0-ge
13-02-12-0-uk

SPC-N24
none

Secondary Point Code table is (9 of 40) 23% full

```

If the desired group code is not shown in the `rtrv-spc` or `rtrv-sid` outputs, go to the “Adding a Secondary Point Code” procedure in *Database Administration - SS7 User’s Guide* to turn the ITU Duplicate Point Code feature on, and add a secondary point code to the database with the desired group code value.

If the `ituis` or `ituns` parameters will not be specified in this procedure, continue the procedure with [Step 5](#).

If the `ituis` or `ituns` parameters will be specified in this procedure, and ITU-I spare or 14-bit ITU-N spare network appearances are shown in the `rtrv-na` output in [Step 1](#), or ITU-I spare or 14-bit ITU-N spare point codes are shown in the `rtrv-sid` output in [Step 2](#), continue the procedure with [Step 5](#).

4. Display the status of the ITU National and International Spare Point Code Support feature by entering the `rtrv-ctrl-feat` command with the ITU National and International Spare Point Code Support feature part number. Enter this command.

```
rtrv-ctrl-feat:partnum=893013601
```

The following is an example of the possible output.

```
rlghncxa03w 06-10-28 21:15:37 GMT EAGLE5 36.0.0
The following features have been permanently enabled:

Feature Name          Partnum   Status   Quantity
Spare Point Code Support 893013601 on      ----

The following features have been temporarily enabled:

Feature Name          Partnum   Status   Quantity   Trial Period Left
Zero entries found.

The following features have expired temporary keys:

Feature Name          Partnum
Zero entries found.
```

If the ITU National and International Spare Point Code Support feature is not enabled, perform the “Activating the ITU National and International Spare Point Code Support feature” procedure in *Database Administration - SS7 User’s Guide* and enable and turn on the ITU National and International Spare Point Code Support feature.

5. Add the network appearance to the database with the `ent-na` command.

If the `gc` parameter is specified with the `ent-na` command, the `gc` parameter value must be shown in the `rtrv-sid` output in [Step 2](#), or assigned to an ITU-N point code (SPC-N) shown in the `rtrv-spc` output in [Step 3](#). For this example, enter these commands.

```
ent-na:na=1000:type=itui
ent-na:na=3:type=itun24
ent-na:na=150000:type=itun:gc=uk
ent-na:na=2000:type=ituis
ent-na:na=5000:type=ituns:gc=sp
```

When each of these commands have successfully completed, this message should appear.

```
rlghncxa03w 06-10-28 09:12:36 GMT EAGLE5 36.0.0
ENT-NA:  MASP A - COMPLTD
```

6. Verify the changes using the `rtrv-na` command. This is an example of the possible output.

```
rlghncxa03w 06-10-28 09:12:36 GMT EAGLE5 36.0.0
TYPE    GC      NA
ANSI    --      100
ITUI    --      1000
ITUN    uk      150000
ITUN    fr      4000000000
ITUN    ge      1000000000
ITUN24  --      3
ITUIS   --      2000
ITUNS   sp      5000
```

7. Back up the new changes, using the `chg-db:action=backup:dest=fixed` command.

These messages should appear; the active Maintenance and Administration Subsystem Processor (MASP) appears first.

```
BACKUP (FIXED) : MASP A - Backup starts on active MASP.  
BACKUP (FIXED) : MASP A - Backup on active MASP to fixed disk complete.  
BACKUP (FIXED) : MASP A - Backup starts on standby MASP.  
BACKUP (FIXED) : MASP A - Backup on standby MASP to fixed disk complete.
```

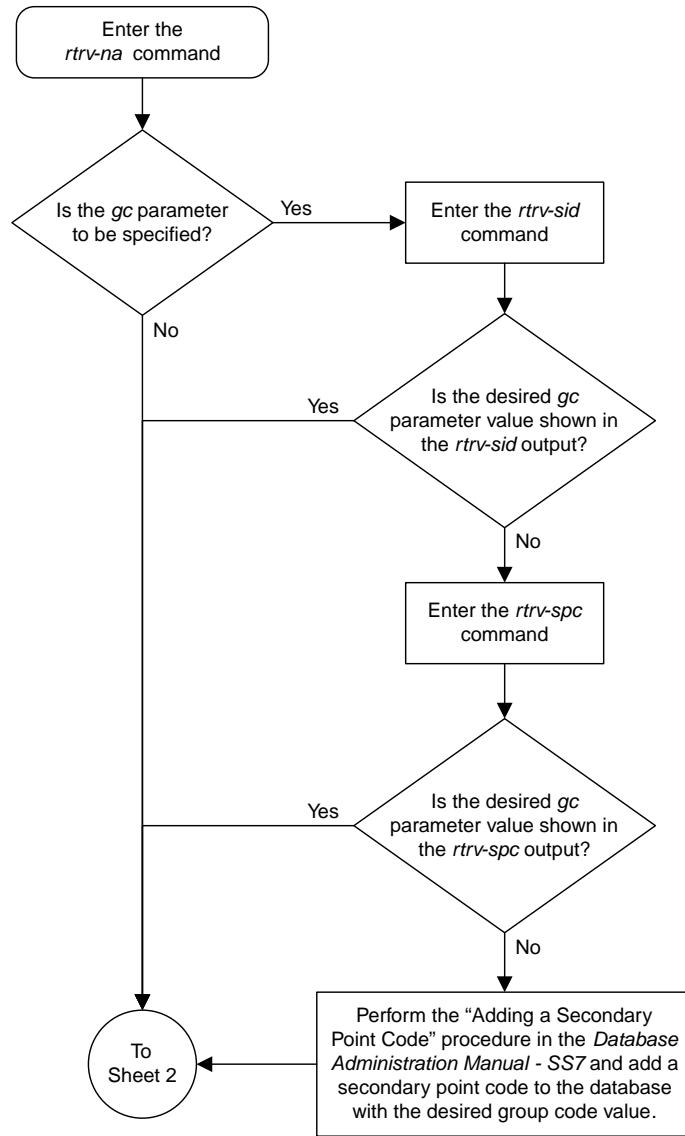

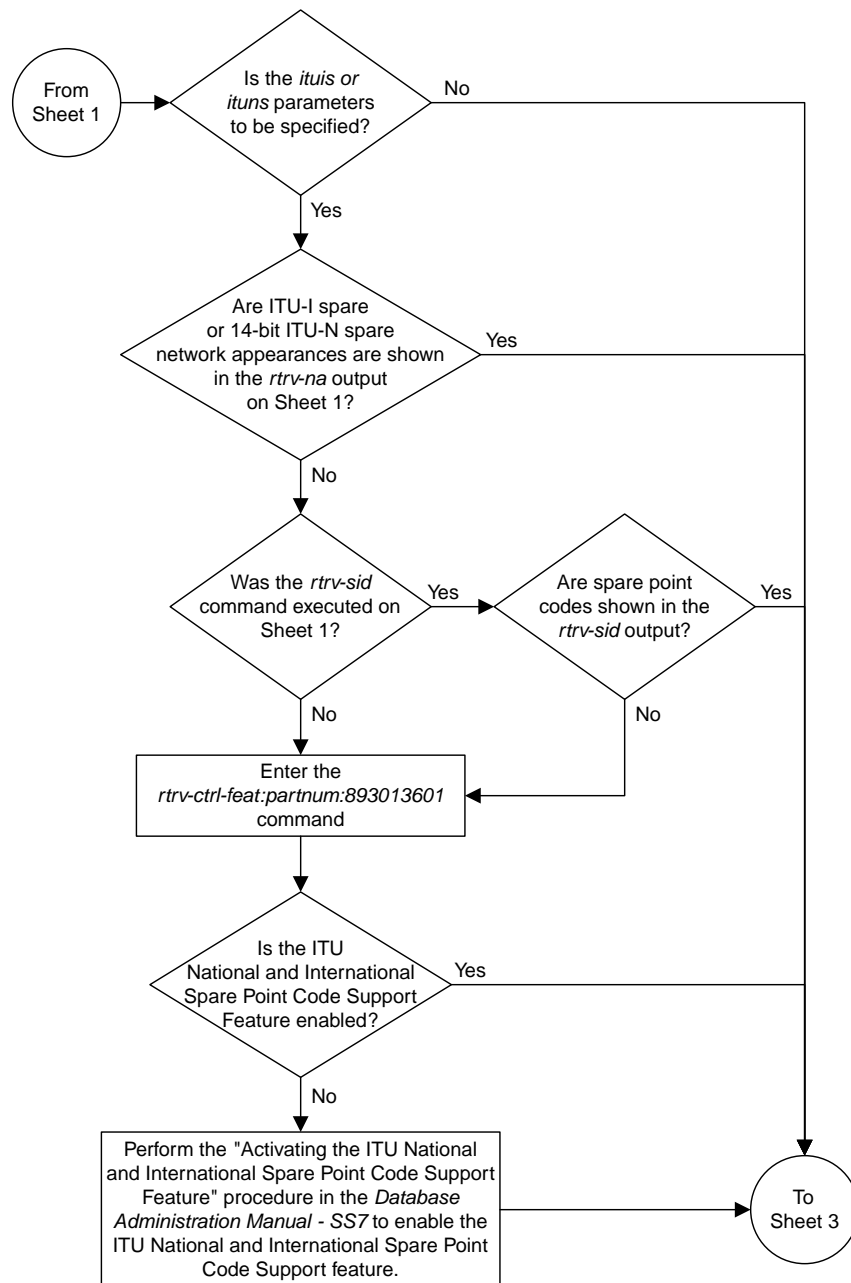

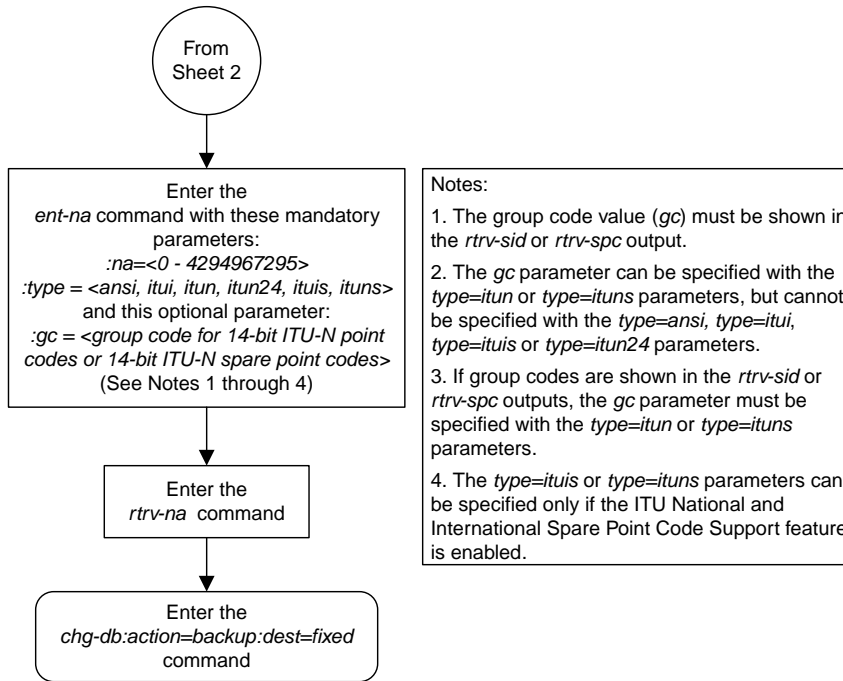

Sheet 3 of 3

Figure 100: Adding a Network Appearance

Activating the Large MSU Support for IP Signaling Feature

This procedure is used to enable and turn on the Large MSU Support for IP Signaling feature using the feature's part number and a feature access key.

The feature access key for the Large MSU Support for IP Signaling feature is based on the feature's part number and the serial number of the EAGLE, making the feature access key site-specific.

The `enable-ctrl-feat` command enables the controlled feature by inputting the controlled feature's access key and the controlled feature's part number with these parameters:

Note: As of Release 46.3, the `fak` parameter is no longer required. This parameter is only used for backward compatibility.

`: fak` – The feature access key provided by Oracle. The feature access key contains 13 alphanumeric characters and is not case sensitive.

`: partnum` – The Oracle-issued part number of the Large MSU Support for IP Signaling feature, 893018401.

The `enable-ctrl-feat` command requires that the database contain a valid serial number for the EAGLE, and that this serial number is locked. This can be verified with the `rtrv-serial-num` command. The EAGLE is shipped with a serial number in the database, but the serial number is not locked. The serial number can be changed, if necessary, and locked once the EAGLE is on-site, by using the `ent-serial-num` command. The `ent-serial-num` command uses these parameters.

`: serial` – The serial number assigned to the EAGLE. The serial number is not case sensitive.

`: lock` – Specifies whether or not the serial number is locked. This parameter has only one value, `yes`, which locks the serial number. Once the serial number is locked, it cannot be changed.

Note: To enter and lock the EAGLE's serial number, the `ent-serial-num` command must be entered twice, once to add the correct serial number to the database with the `serial` parameter, then again with the `serial` and the `lock=yes` parameters to lock the serial number. You should verify that the serial number in the database is correct before locking the serial number. The serial number can be found on a label affixed to the control shelf (shelf 1100).

This feature cannot be temporarily enabled (with the temporary feature access key).

Once this feature has been enabled, the feature must be turned on with the `chg-ctrl-feat` command. The `chg-ctrl-feat` command uses these parameters:

`: partnum` – The Oracle-issued part number of the Large MSU Support for IP Signaling feature, 893018401.

`: status=on` – used to turn the Large MSU Support for IP Signaling feature on.

Once the Large MSU Support for IP Signaling feature has been turned on, it can be turned off. For more information about turning the Large MSU Support for IP Signaling feature off, go to the [Turning Off the Large MSU Support for IP Signaling Feature](#) procedure.

The status of the features in the EAGLE is shown with the `rtrv-ctrl-feat` command.

The Large MSU Support for IP Signaling feature allows the EAGLE to process messages with a service indicator value of 6 to 15 and with a service information field (SIF) that is larger than 272 bytes. The large messages are processed only on E5-ENET cards. There are certain software components that if enabled or provisioned, that will not process large messages even if the Large MSU Support for IP Signaling feature is enabled and turned on. UIMs are displayed when most of these circumstances occur. These UIMs are:

- UIM 1333 – Displayed when a large message is received on an M3UA association and the Large MSU Support for IP Signaling feature is not enabled or is enabled and turned off. The large message is discarded.
- UIM 1350 – Displayed when a M2PA IP connection receives message with an SIF greater than 272 bytes and the Large MSU Support for IP Signaling feature is not enabled or is enabled and turned off. The large message is discarded.
- UIM 1352 – Displayed when a message with an SIF greater than 272 bytes is received; the Large MSU Support for IP Signaling feature is enabled and turned on; there are routes available for the destination point code; but the selected outbound card does not support large messages.
- UIM 1353 – Displayed when a large message passes a gateway screening screenset that redirects messages for the Database Transport Access (DTA) feature. Large messages are not redirected for the DTA feature.
- UIM 1354 – Displayed when a large message passes a gateway screening screenset that copies messages for the STPLAN feature. Large messages are not copied for the STPLAN feature.

For more information on these UIMs, refer to *Unsolicited Alarm and Information Messages Reference*.

Note: Large messages are not monitored by the EAGLE 5 Integrated Monitoring Support feature and are not sent to the IMF. A UIM is not generated.

1. Display the status of the controlled features by entering the `rtrv-ctrl-feat` command.

The following is an example of the possible output.

```
rlghncxa03w 08-04-28 21:15:37 GMT EAGLE5 38.0.0
The following features have been permanently enabled:

Feature Name          Partnum    Status    Quantity
Command Class Management 893005801  on       ----
LNP Short Message Service 893006601  on       ----
Intermed GTT Load Sharing 893006901  on       ----
XGTT Table Expansion     893006101  on       400000
XMAP Table Expansion     893007710  off      ----
Large System # Links     893005910  on       2000
Routesets                893006401  on       6000
HC-MIM SLK Capacity      893012707  on       64

The following features have been temporarily enabled:

Feature Name          Partnum    Status    Quantity    Trial Period Left
Zero entries found.

The following features have expired temporary keys:

Feature Name          Partnum
Zero entries found.
```

If the Large MSU Support for IP Signaling feature is enabled and turned on, no further action is necessary. This procedure does not need to be performed.

If the Large MSU Support for IP Signaling feature is enabled and but not turned on, continue this procedure with [Step 7](#).

If the Large MSU Support for IP Signaling feature is not enabled, continue this procedure with [Step 2](#).

Note: If the `rtrv-ctrl-feat` output in [Step 1](#) shows any controlled features, continue this procedure with [Step 6](#). If the `rtrv-ctrl-feat` output shows only the HC-MIM SLK Capacity feature with a quantity of 64, [Step 2](#) through [Step 5](#) must be performed.

2. Display the serial number in the database with the `rtrv-serial-num` command.

This is an example of the possible output.

```
rlghncxa03w 06-10-28 21:15:37 GMT EAGLE5 36.0.0
System serial number = nt00001231

System serial number is not locked.

rlghncxa03w 06-10-28 21:15:37 GMT EAGLE5 36.0.0
Command Completed
```

Note: If the serial number is correct and locked, continue the procedure with [Step 6](#). If the serial number is correct but not locked, continue the procedure with [Step 5](#). If the serial number is not correct, but is locked, this feature cannot be enabled and the remainder of this procedure cannot be performed. Contact the Customer Care Center to get an incorrect and locked serial number changed. Refer to [My Oracle Support \(MOS\)](#) for the contact information. The serial number can be found on a label affixed to the control shelf (shelf 1100).

3. Enter the correct serial number into the database using the `ent-serial-num` command with the `serial` parameter.

For this example, enter this command.

```
ent-serial-num:serial=<EAGLE's correct serial number>
```

When this command has successfully completed, the following message should appear.

```
rlghncxa03w 06-10-28 21:15:37 GMT EAGLE5 36.0.0
ENT-SERIAL-NUM: MASP A - COMPLTD
```

4. Verify that the serial number entered into [Step 3](#) was entered correctly using the `rtrv-serial-num` command.

This is an example of the possible output.

```
rlghncxa03w 06-10-28 21:15:37 GMT EAGLE5 36.0.0
System serial number = nt00001231

System serial number is not locked.

rlghncxa03w 06-10-28 21:15:37 GMT EAGLE5 36.0.0
Command Completed
```

If the serial number was not entered correctly, repeat [Step 3](#) and [Step 4](#) and re-enter the correct serial number.

5. Lock the serial number in the database by entering the `ent-serial-num` command with the serial number shown in [Step 2](#), if the serial number shown in [Step 2](#) is correct, or with the serial number shown in [Step 4](#), if the serial number was changed in [Step 3](#), and with the `lock=yes` parameter.

For this example, enter this command.

```
ent-serial-num:serial=<EAGLE's serial number>:lock=yes
```

When this command has successfully completed, the following message should appear.

```
rlghncxa03w 06-10-28 21:15:37 GMT EAGLE5 36.0.0
ENT-SERIAL-NUM: MASP A - COMPLTD
```

6. Enable the Large MSU Support for IP Signaling feature with the `enable-ctrl-feat` command specifying the part number for the Large MSU Support for IP Signaling feature and the feature access key. Enter this command.

```
enable-ctrl-feat:partnum=893018401:fak=<Large MSU Support for IP Signaling
feature access key>
```

Note: A temporary feature access key cannot be specified to enable this feature.

Note: The values for the feature access key (the `fak` parameter) are provided by Oracle. If you do not have the feature access key for the feature you wish to enable, contact your Sales Representative or Account Representative.

When the `enable-ctrl-feat` command has successfully completed, this message should appear.

```
rlghncxa03w 06-10-28 21:15:37 GMT EAGLE5 36.0.0
ENABLE-CTRL-FEAT: MASP B - COMPLTD
```

7. Turn the Large MSU Support for IP Signaling feature on with the `chg-ctrl-feat` command specifying the part number for the Large MSU Support for IP Signaling feature and the `status=on` parameter. Enter this command.

```
chg-ctrl-feat:partnum=893018401:status=on
```

When the `chg-ctrl-feat` command has successfully completed, this message should appear.

```
rlghncxa03w 07-05-28 21:15:37 GMT EAGLE5 37.0.0
CHG-CTRL-FEAT: MASP B - COMPLTD
```

8. Verify the changes by entering the `rtrv-ctrl-feat` command with the Large MSU Support for IP Signaling feature part number. Enter this command.

```
rtrv-ctrl-feat:partnum=893018401
```

The following is an example of the possible output.

```
rlghncxa03w 10-04-28 21:15:37 GMT EAGLE5 42.0.0
The following features have been permanently enabled:
```

Feature Name	Partnum	Status	Quantity
Large MSU for IP Sig	893018401	on	----

```
The following features have been temporarily enabled:
```

```
Feature Name          Partnum   Status   Quantity   Trial Period Left
Zero entries found.
```

```
The following features have expired temporary keys:
```

```
Feature Name          Partnum
Zero entries found.
```

9. Back up the new changes using the `chg-db:action=backup:dest=fixed` command. These messages should appear, the active Maintenance and Administration Subsystem Processor (MASP) appears first.

```
BACKUP (FIXED) : MASP A - Backup starts on active MASP.
BACKUP (FIXED) : MASP A - Backup on active MASP to fixed disk complete.
BACKUP (FIXED) : MASP A - Backup starts on standby MASP.
BACKUP (FIXED) : MASP A - Backup on standby MASP to fixed disk complete.
```

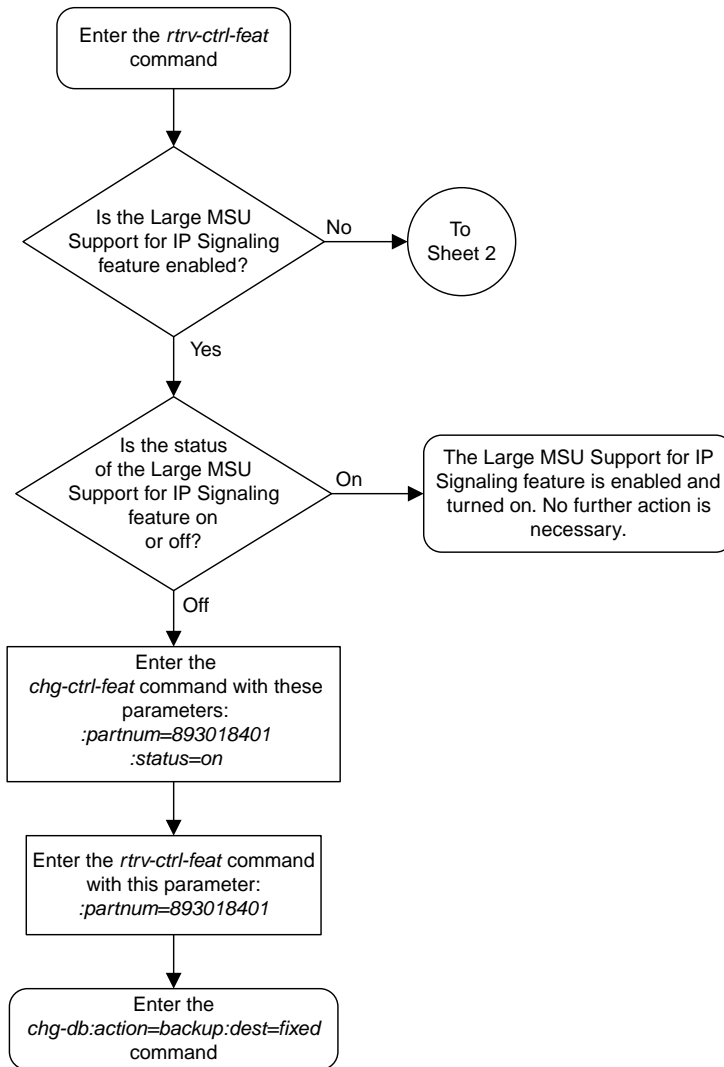

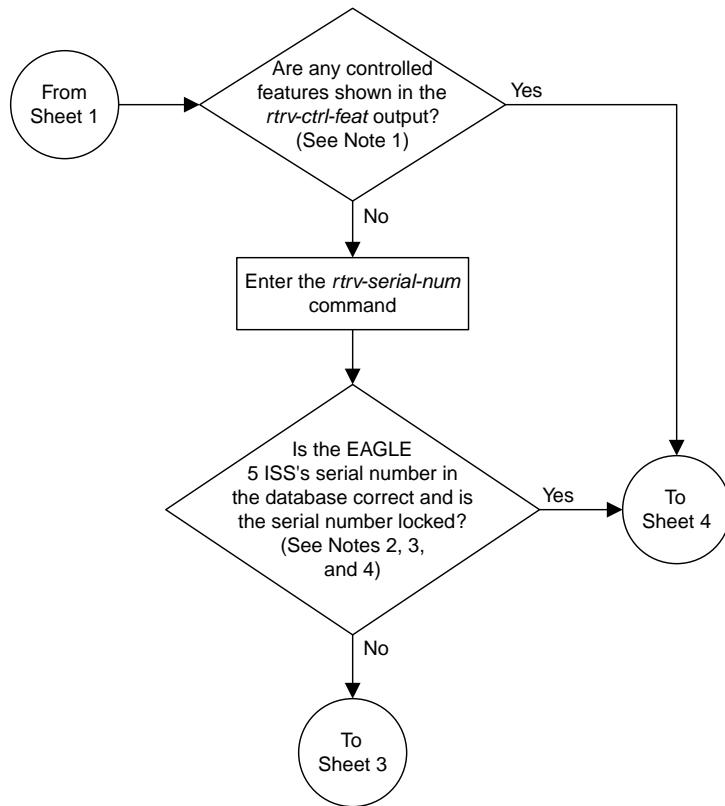

Notes:

1. If the *rtrv-ctrl-feat* output shows only the HC -MIM SLK Capacity feature with a quantity of 64, the answer to this question is no and the Eagle 5 ISS's serial number must be verified. This is the default entry for the *rtrv-ctrl-feat* output. This entry is shown whether or not the Eagle 5 ISS's serial number is in the database.
2. If the serial number is locked, it cannot be changed.
3. If the serial number is not locked, the controlled feature cannot be enabled.
4. The serial number can be found on a label affixed to the control shelf (shelf 1100).

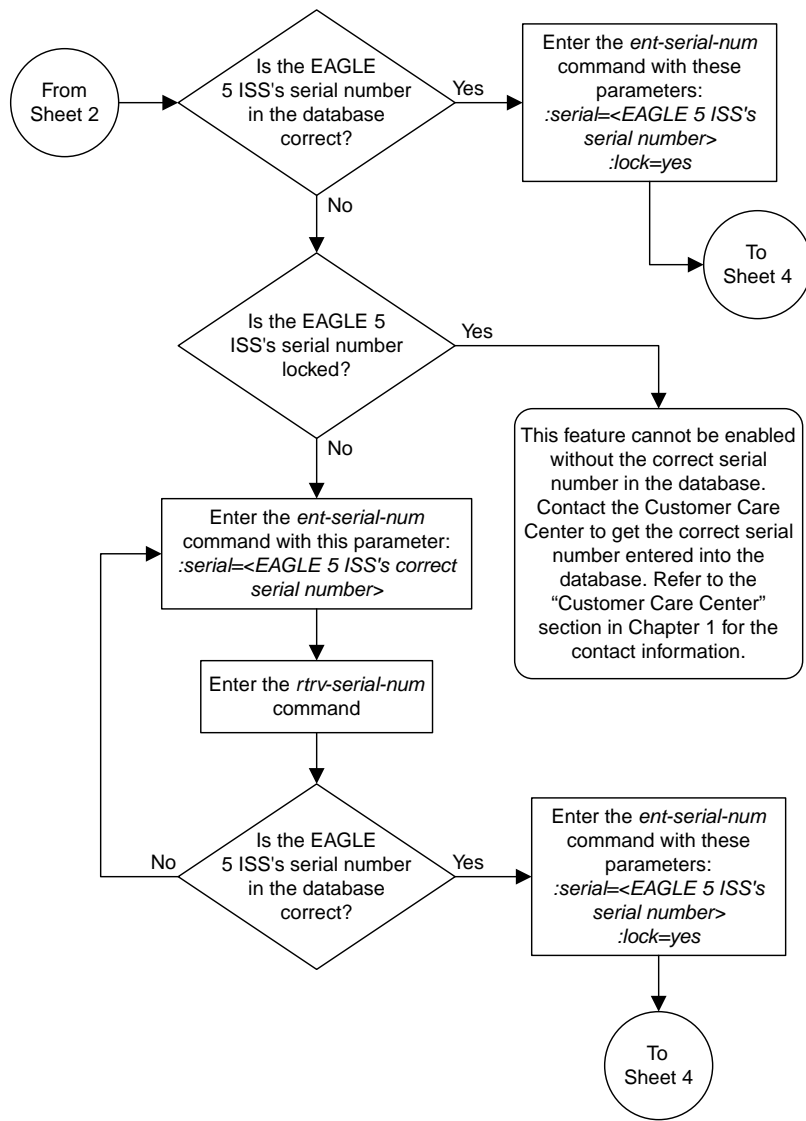

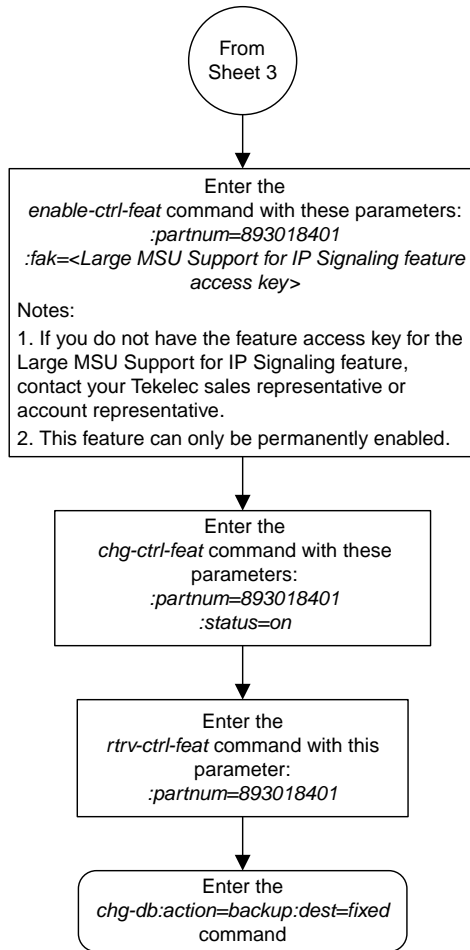

Sheet 4 of 4

Figure 101: Activating the Large MSU Support for IP Signaling Feature

Removing IPSG Components

This section describes how to remove the following components from the database.

- An IPSG Card – Perform the [Removing an IPSG Card](#) procedure
- An IPSG Linkset – Perform the [Removing an IPSG Linkset](#) procedure
- An IP Host – Perform the [Removing an IP Host Assigned to an IPSG Card](#) procedure
- An IP Route – Perform the [Removing an IP Route](#) procedure
- An IPSG Association – Perform the [Removing an IPSG Association](#) procedure
- An IPSG M2PA Signaling Link – Perform the [Removing an IPSG M2PA Signaling Link](#) procedure
- An IPSG M3UA Signaling Link – Perform the [Removing an IPSG M3UA Signaling Link](#) procedure

Removing an IPSG Card

Use this procedure to remove an IPSG card, a card running the `ipsg` application, from the database using the `dlt-card` command.

The card cannot be removed if it does not exist in the database. Before removing the card from the database, the signaling links assigned to the card must be removed.



Caution: If the IPGW_x card is the last IP card in service, removing this card from the database will cause traffic to be lost.

CAUTION

1. Display the cards in the database using the `rtrv-card` command.

This is an example of the possible output.

```

rlghncxa03w 09-04-13 17:00:02 GMT EAGLE5 41.0.0
CARD   TYPE      APPL      LSET NAME      LINK SLC LSET NAME      LINK SLC
1101   DSM        VSCCP
1102   TSM        GLS
1104   DCM        STPLAN
1113   GSPM      EOAM
1114   TDM-A
1115   GSPM      EOAM
1116   TDM-B
1117   MDAL
1201   LIMDS0    SS7ANSI    lsn1           A      0      lsn2           B      1
1203   LIMDS0    SS7ANSI    lsn2           A      0      lsn1           B      1
1204   LIMATM    ATMANSI    atmgwy         A      0
1205   ENET      IPSG      ipsgnode1     A      0      ipsgnode1     B      1
1207   ENET      IPSG      ipsgnode2     A      0
1303   DCM      IPLIM     ipnode1       A      0      ipnode3       B      0
1305   DCM      IPLIM     ipnode4       A      0

```

Select a card whose application is IPSG.

2. Display the linksets that are assigned to the IPSG card by entering the `rtrv-ls` command with the names of the linksets that are assigned to the IPSG card, shown in the `rtrv-card` output in [Step 1](#).

For this example, enter these commands.

```
rtrv-ls:lsn=ipsgnode1
```

This is an example of the possible output.

```
rlghncxa03w 08-04-13 17:00:02 GMT 38.0.0

LSN              APCA  (SS7)  L3T SLT          GWS GWS GWS
ipsgnode1        001-001-003  none 1  1  no  A  2  off off off no  off

              SPCA          CLLI          TFATCABMLQ MTPRSE ASL8
              -----
              1              no          no

IPSG  IPGWAPC  GTTMODE          CGGTMOD
yes   no      CdPA          no

ADAPTER  SLKTPS  LSUSEALM  SLKUSEALM  RCONTEXT  ASNOTIF
m2pa     1015   100%     80%       none      no

LOC  LINK  SLC  TYPE  ANAME
1205 A   0   IPSG  m2pa1
1205 B   1   IPSG  m2pa1

Link set table is (11 of 1024) 1% full.
```

```
rtrv-ls:lsn=ipsgnode2
```

This is an example of the possible output.

```
rlghncxa03w 08-04-13 17:17:00 GMT 38.0.0

LSN              APCA  (SS7)  L3T SLT          GWS GWS GWS
ipsgnode2        003-003-004  none 1  1  no  A  1  off off off no  off

              SPCA          CLLI          TFATCABMLQ MTPRSE ASL8
              -----
              ---              no          no

IPSG  IPGWAPC  GTTMODE          CGGTMOD
yes   no      CdPA          no

ADAPTER  SLKTPS  LSUSEALM  SLKUSEALM  RCONTEXT  ASNOTIF
m3ua     2000   100%     80%       none      yes

NUMSLKALW  NUMSLKRSTR  NUMSLKPROH
1           1           1

LOC  LINK  SLC  TYPE  ANAME
1207 A   0   IPSG  m3ua1
```

```
Link set table is (11 of 1024) 1% full.
```

If the ADAPTER value assigned to the linkset is m2pa, perform the [Removing an IPSG M2PA Signaling Link](#) procedure to remove the M2PA signaling links assigned to the card.

If the ADAPTER value assigned to the linkset is m3ua, perform the [Removing an IPSG M3UA Signaling Link](#) procedure to remove the M3UA signaling links assigned to the card.

After the signaling links have been removed from the database, continue the procedure with [Step 3](#).

3. Remove the card from the database using the `dlt-card` command.

The `dlt-card` command has only one parameter, `loc`, which is the location of the card. For this example, enter these commands.

```
dlt-card:loc=1205
```

```
dlt-card:loc=1207
```

When these commands have successfully completed, this message appears.

```
rlghncxa03w 08-04-13 17:00:02 GMT EAGLE5 36.0.0
DLT-CARD: MASP A - COMPLTD
```

4. Verify the changes using the `rtrv-card` command and specifying the card that was removed in [Step 3](#).

For this example, enter these commands.

```
rtrv-card:loc=1205
```

```
rtrv-card:loc=1207
```

When these commands have successfully completed, this message appears.

```
E2144 Cmd Rej: Location invalid for hardware configuration
```

5. Back up the new changes using the `chg-db:action=backup:dest=fixed` command.

These messages appear, the active Maintenance and Administration Subsystem Processor (MASP) appears first.

```
BACKUP (FIXED) : MASP A - Backup starts on active MASP.
BACKUP (FIXED) : MASP A - Backup on active MASP to fixed disk complete.
BACKUP (FIXED) : MASP A - Backup starts on standby MASP.
BACKUP (FIXED) : MASP A - Backup on standby MASP to fixed disk complete.
```

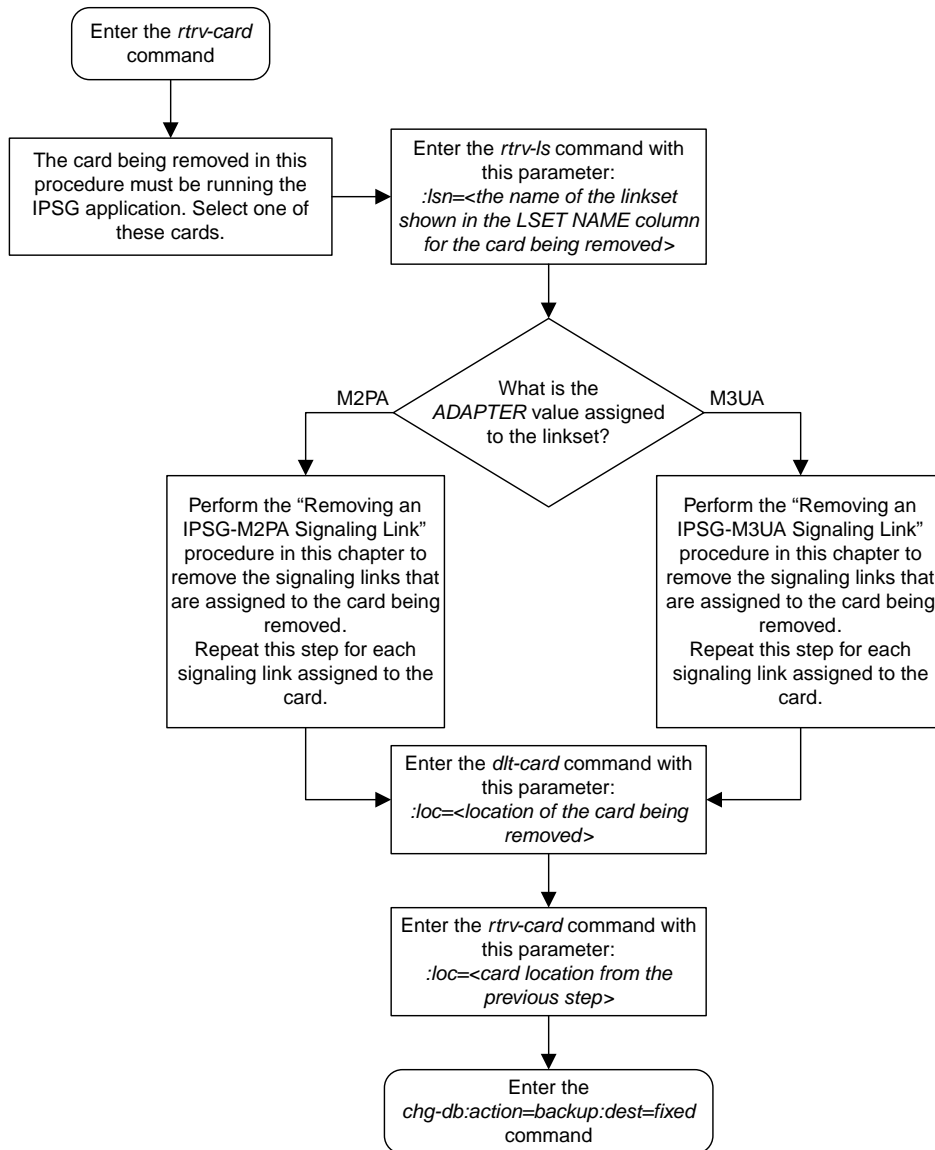

Figure 102: Removing an IPSG Card

Removing an IPSG Linkset

This procedure is used to remove a IPSG linkset from the database using the `dlt-ls` command. An IPSG linkset is a linkset whose `ipsg` parameter value is `yes`.

The `dlt-ls` command has only one parameter, `lsn`, which is the name of the linkset to be removed from the database.

The linkset to be removed must exist in the database.

To remove a linkset, all links associated with the linkset must be removed.

The linkset to be removed cannot be referenced by a routeset.

If the Flexible Linkset Optional Based Routing feature is enabled and turned on, and the linkset is referenced by a GTT selector, the linkset cannot be removed.

A proxy linkset whose APC is assigned to more than one proxy linkset cannot be removed if the linkset contains the proxy point code (shown in the `PPCA/PPCI/PPCN/PPCN24` field in the `rtrv-ls:apc/apca/apci/apcn/apcn24=<APC of the linkset>` output) that is also assigned to the APC of the linkset. The proxy point code assigned to the APC of the linkset is shown in the `rtrv-dstn:dpc/dpca/dpci/dpcn/dpcn24=<APC of the linkset>` output. The linksets that do not contain the proxy point code that is assigned to the APC of the linkset must be removed before the linkset containing proxy point code that is assigned to the APC of the linkset can be removed.

Canceling the RTRV-LS Command

Because the `rtrv-ls` command used in this procedure can output information for a long period of time, the `rtrv-ls` command can be canceled and the output to the terminal stopped. There are three ways that the `rtrv-ls` command can be canceled.

- Press the F9 function key on the keyboard at the terminal where the `rtrv-ls` command was entered.
- Enter the `canc-cmd` without the `trm` parameter at the terminal where the `rtrv-ls` command was entered.
- Enter the `canc-cmd:trm=<xx>`, where `<xx>` is the terminal where the `rtrv-ls` command was entered, from another terminal other than the terminal where the `rtrv-ls` command was entered. To enter the `canc-cmd:trm=<xx>` command, the terminal must allow Security Administration commands to be entered from it and the user must be allowed to enter Security Administration commands. The terminal's permissions can be verified with the `rtrv-secu-trm` command. The user's permissions can be verified with the `rtrv-user` or `rtrv-secu-user` commands.

For more information about the `canc-cmd` command, go to *Commands User's Guide*.

1. Display the IPSG linksets by entering the `rept-stat-iptps` command. This is an example of the possible output.

```
rlghncxa03w 10-07-19 21:16:37 GMT EAGLE5 42.0.0
IP TPS USAGE REPORT
```

LSN	THRESH	CONFIG/ RSVD	CONFIG/ MAX	TPS	PEAK	PEAKTIMESTAMP
isl	100%	500	2000	TX: 427	550	10-07-19 09:49:19

```
RCV:      312      450  10-07-19 09:49:19
```

```
-----
Command Completed.
```

2. Display the linkset that will be removed by entering the `rtrv-ls` command with the name of the linkset shown in [Step 1](#). This is an example of the possible output.

```
rtrv-ls:lsn=ls1
```

This is an example of the possible output.

```
rlghncxa03w 07-05-17 11:43:04 GMT EAGLE5 37.0.0

LSN          APCA  (SS7)  SCRN  SET  SET  BEI  LST  LNKS  GWS  GWS  GWS  SLSCI  NIS
ls1          240-012-004  scr1  1    1    no  a    4    off  off  off  yes   off

          SPCA          CLLI          TFATCABMLQ  MTPRSE  ASL8
          -----  -----  2          ---    no

RANDSLS
off

IPSG  IPGWAPC  GTTMODE          CGGTMOD
yes   no      CdPA          no

ADAPTER  RSVDSLKTPS  MAXSLKTPS
m2pa     500         500

TPSALM   LSUSEALM   SLKUSEALM
rsvdslktps 100%     80%

LOC  LINK  SLC  TYPE  ANAME
1101 B    1    IPSG  m2pa2
1101 B3   2    IPSG  m2pa3
1101 B4   3    IPSG  m2pa4
1103 B15  4    IPSG  m2pa1

Link set table is ( 14 of 1024)  1% full
```

If the `IPSG` value of the linkset is no, perform the "Removing a Linkset Containing SS7 Signaling Links" procedure to remove the linkset.

If the `IPSG` value of the linkset is yes, perform one of these actions.

- If the linkset being removed is a proxy linkset (`LST=PRX`), and more than one linkset is shown in the `rtrv-ls` output that contains the APC of the linkset being removed, continue the procedure with [Step 3](#).
- If the linkset being removed is not a proxy linkset, or is a proxy linkset whose APC is not used by more than one linkset, continue the procedure with [Step 5](#).

3. Display the linksets that contain the APC of the linkset being removed by entering the `rtrv-ls` command with the APC of the linkset. For this example, enter this command.

```
rtrv-ls:apca=150-001-002
```

This is an example of the possible output.

```
rlghncxa03w 07-08-23 11:09:57 EST 37.0.0
APCA = 150-001-002

LSN          PPCA          L3T SLT          GWS GWS GWS
lsn150       150-001-001   none 1 1 no PRX 1 off off off no off
lsn151       150-001-004   none 1 1 no PRX 1 off off off no off

Link set table is (14 of 1024) 1% full.
```

4. Display the attributes of the APC of the linkset being removed by entering the `rtrv-dstn` command with the APC of the linkset. For this example, enter this command.

```
rtrv-dstn:dpca=150-001-002
```

This is an example of the possible output.

```
rlghncxa03w 10-12-15 09:22:39 GMT EAGLE5 43.0.0

DPCA          CLLI          BEI ELEI  ALIASI          ALIASN/N24  DMN
150-001-002   ----- no  --- -----  -----  SS7

PPCA          NCAI PRX          RCAUSE NPRST SPLITIAM HMSMSC HMSCP SCCPMSGCNV
150-001-001   ---- no          50    on   20          no    no    none

Destination table is (14 of 2000) 1% full
Alias table is (0 of 12000) 0% full
PPC table is (2 of 10) 20% full
```

A proxy linkset whose APC is assigned to more than one proxy linkset cannot be removed if the linkset contains the proxy point code (shown in the PPCA/PPCI/PPCN/PPCN24 field in [Step 3](#)) that is also assigned to the APC of the linkset (shown in [Step 4](#)). The linksets that do not contain the proxy point code that is assigned to the APC of the linkset must be removed before the linkset containing proxy point code that is assigned to the APC of the linkset can be removed.

5. Display the routes in the database by using the `rtrv-rte` command, specifying the name of the linkset you wish to remove. For this example, enter this command.

```
rtrv-rte:lsn=ls1
```

This is an example of the possible output.

```
rlghncxa03w 07-05-10 11:43:04 GMT EAGLE5 37.0.0
LSN          DPC
RC
ls1          240-012-004 10
```

If any routes reference the linkset to be removed, remove these routes by performing the "Removing a Route" procedure in the *Database Administration - SS7 User's Guide*.

6. Remove all links in the linkset by performing one of these procedures.

If the ADAPTER value of the linkset is M2PA, shown in the `rtrv-ls` output in [Step 2](#), perform the [Removing an IPSG M2PA Signaling Link](#) procedure.

If the ADAPTER value of the linkset is M3UA, shown in the `rtrv-ls` output in [Step 2](#), perform the [Removing an IPSG M3UA Signaling Link](#) procedure.

7. Display any entries in the route exception table whose linkset name is the name of the linkset being removed in this procedure. Enter the `rtrv-rtx` command with the `lsn` parameter. For this example, enter this command.

```
rtrv-rtx:lsn=ls1
```

This is an example of the possible output.

```
rlghncxa03w 07-05-10 11:43:04 GMT EAGLE5 37.0.0

      DPCA          RTX-CRITERIA          LSN          RC          APC

240-012-006      OPCA
                  008-008-008          ls1          40          240-012-004

DESTINATION ENTRIES ALLOCATED: 2000
FULL DPC(s): 15
EXCEPTION DPC(s): 5
NETWORK DPC(s): 0
CLUSTER DPC(s): 1
TOTAL DPC(s): 21
CAPACITY (% FULL): 1%
ALIASES ALLOCATED: 12000
ALIASES USED: 0
CAPACITY (% FULL): 0%
X-LIST ENTRIES ALLOCATED: 500
```

If the linkset being removed in this procedure is not assigned to a route exception table entry, no entries are displayed in the `rtrv-rtx` output, but a summary of the point code quantities is displayed.

If the name of the linkset being removed in this procedure shown in the LSN column in this step, perform one of these procedures:

- a) Change the name of the linkset in the entries displayed in this step by performing the "Changing a Route Exception Entry" procedure in the *Database Administration - SS7 User's Guide*.
 - b) Remove all the entries displayed in this step by performing the "Removing a Route Exception Entry" procedure in the *Database Administration - SS7 User's Guide*.
8. Verify whether or not the Flexible Linkset Optional Based Routing feature is enabled and turned on by entering this command.

```
rtrv-ctrl-feat:partnum=893027701
```

This is an example of the possible output.

```
rlghncxa03w 09-05-10 11:43:04 GMT EAGLE5 41.0.0
The following features have been permanently enabled:

Feature Name          Partnum    Status Quantity
Flex Lset Optnl Based Rtg 893027701 on      ----

The following features have been temporarily enabled:

Feature Name          Partnum    Status Quantity    Trial Period Left
```



```
Zero entries found.
```

The following features have expired temporary keys:

```
Feature Name          Partnum
Zero entries found.
```

If the Flexible Linkset Optional Based Routing feature is enabled and turned on, continue the procedure with [Step 9](#).

If the Flexible Linkset Optional Based Routing feature is not enabled or not turned on, continue the procedure with [Step 10](#).

9. Display the GTT selectors that contain the linkset that is being removed by entering the `rtrv-gttset` command with the name of the linkset. For this example, enter this command.

```
rtrv-gttset:lsn=ls1
```

This is an example of the possible output.

```
rlghncxa03w 09-05-10 11:43:04 GMT EAGLE5 41.0.0

GTI          CG          CDPA          CGPA
ANSI TT NP      NAI  SSN SELID LSN      GTTSET      GTTSET
2      180 --      ---  any none  ls1      -----      (--- ) cdgta4      (cdgta)

GTI          CG          CDPA          CGPA
INTL TT NP      NAI  SSN SELID LSN      GTTSET      GTTSET

GTI          CG          CDPA          CGPA
NATL TT NP      NAI  SSN SELID LSN      GTTSET      GTTSET

GTI          CG          CDPA          CGPA
N24  TT NP      NAI  SSN SELID LSN      GTTSET      GTTSET
```

If GTT selectors are shown in the `rtrv-gttset` output, perform the "Removing a GTT Selector" procedure in the *Database Administration - GTT User's Guide* to remove all entries shown in this step. After the GTT selectors have been removed, continue the procedure with [Step 10](#).

If GTT selectors are not shown in the `rtrv-gttset` output, continue the procedure with [Step 10](#).

10. Remove the linkset using the `dlt-ls` command. For this example, enter this command.

```
dlt-ls:lsn=ls1
```

When this command has successfully completed, this message should appear.

```
rlghncxa03w 07-05-17 16:03:12 GMT EAGLE5 37.0.0
Link set table is ( 23 of 1024) 2% full
DLT-LS: MASP A - COMPLTD
```

11. Verify the changes using the `rtrv-ls` command with the linkset name used in [Step 10](#).

For this example, enter this command.

```
rtrv-ls:lsn=ls1
```

If the removal of the linkset was successful, the following message is displayed.

```
E2346 Cmd Rej: Linkset not defined
```

Continue the procedure with [Step 12](#) if the linkset that was removed in [Step 10](#) has any of these attributes:

- The linkset was not a proxy linkset.
- The linkset was a proxy linkset whose APC was assigned to only the proxy linkset that was removed in [Step 10](#).
- The linkset was a proxy linkset and:
 - The APC of this linkset is assigned to more than one linkset.
 - The linkset did not contain the proxy point code that was assigned to the APC of the linkset.
 - The linkset that contains the proxy point code that is assigned to the APC of the linkset will not be removed from the database.

If you wish to remove the proxy linkset that contains the proxy point code that is also assigned to the APC of the linkset, and the database contains other linksets that are assigned to this APC, these other linksets must be removed before the proxy linkset that contains the proxy point code that is also assigned to the APC of the linkset can be removed. Repeat this procedure from [Step 4](#) to remove these linksets. After these linksets have been removed, perform this procedure again from [Step 4](#) to remove the proxy linkset that contains the proxy point code that is also assigned to the APC of the linkset.

12. Back up the new changes using the `chg-db:action=backup:dest=fixed` command. These messages should appear, the active Maintenance and Administration Subsystem Processor (MASP) appears first.

```
BACKUP (FIXED) : MASP A - Backup starts on active MASP.  
BACKUP (FIXED) : MASP A - Backup on active MASP to fixed disk complete.  
BACKUP (FIXED) : MASP A - Backup starts on standby MASP.  
BACKUP (FIXED) : MASP A - Backup on standby MASP to fixed disk complete.
```

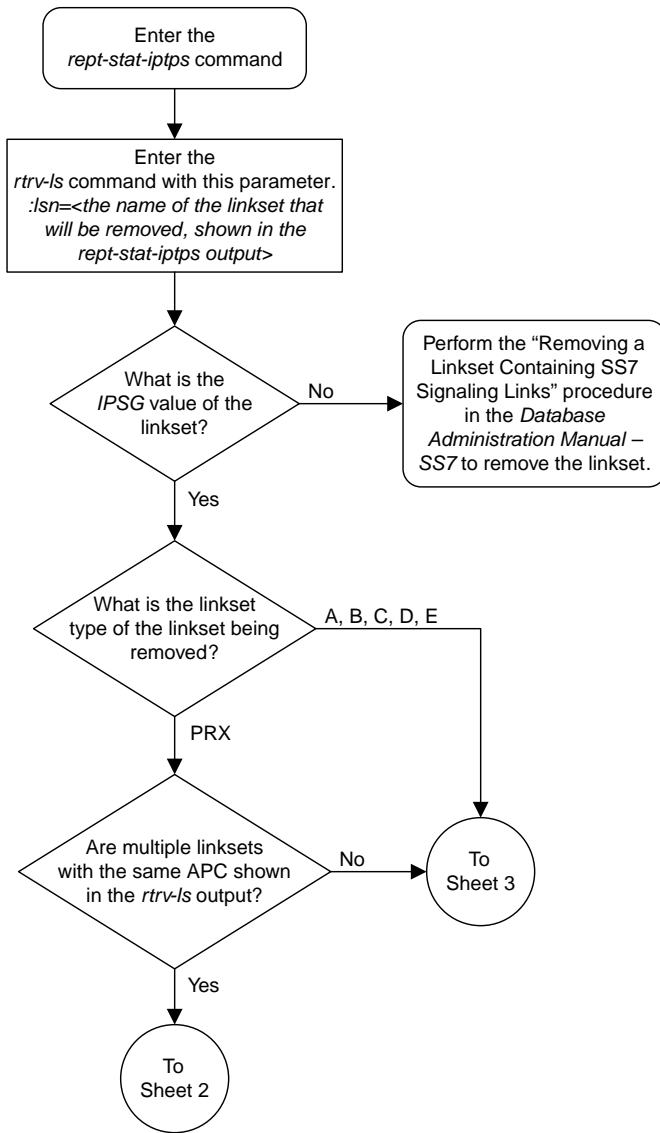

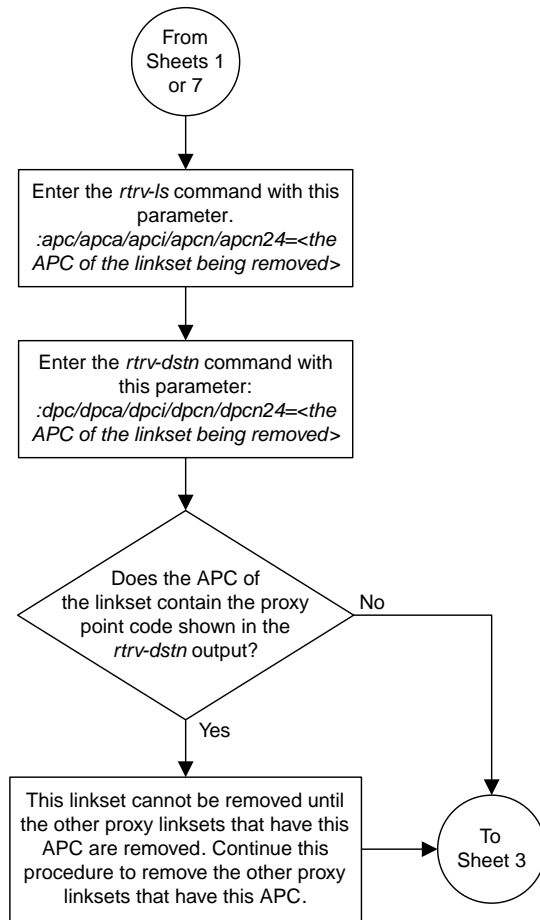

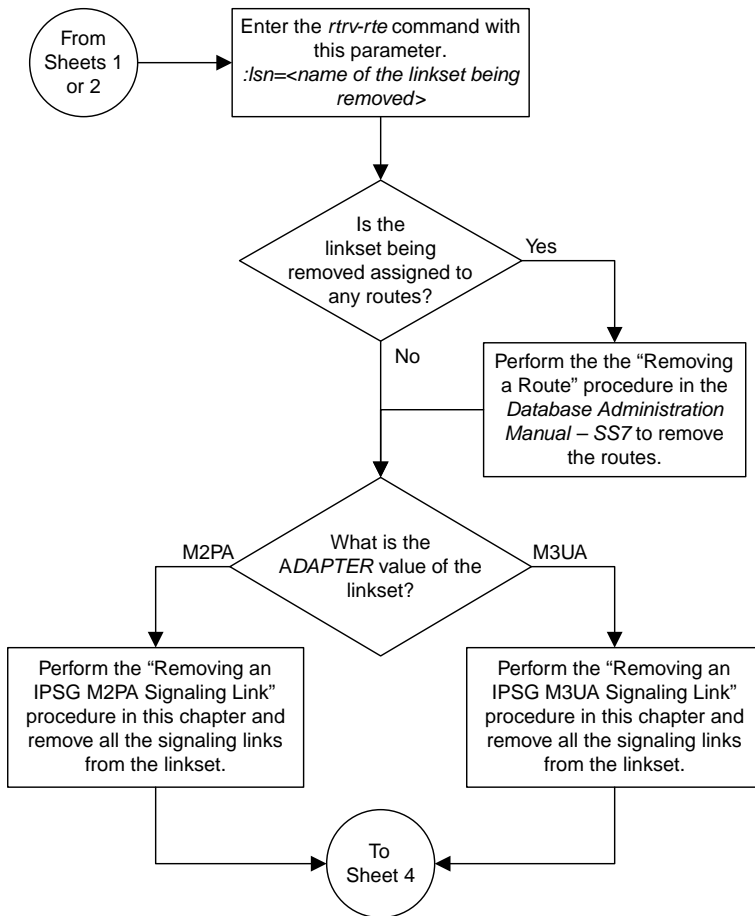

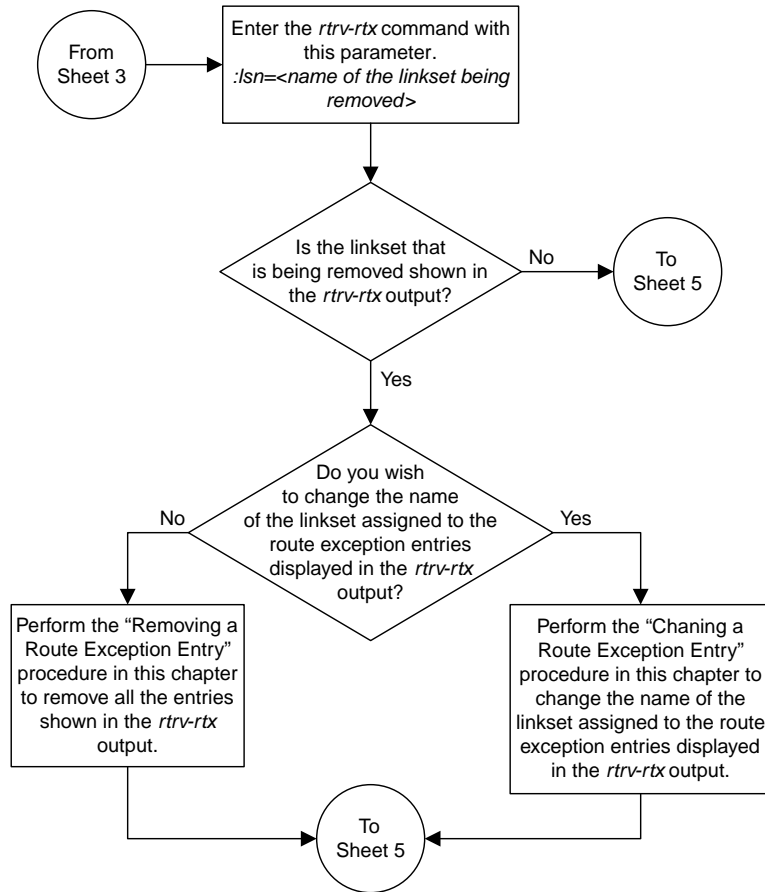

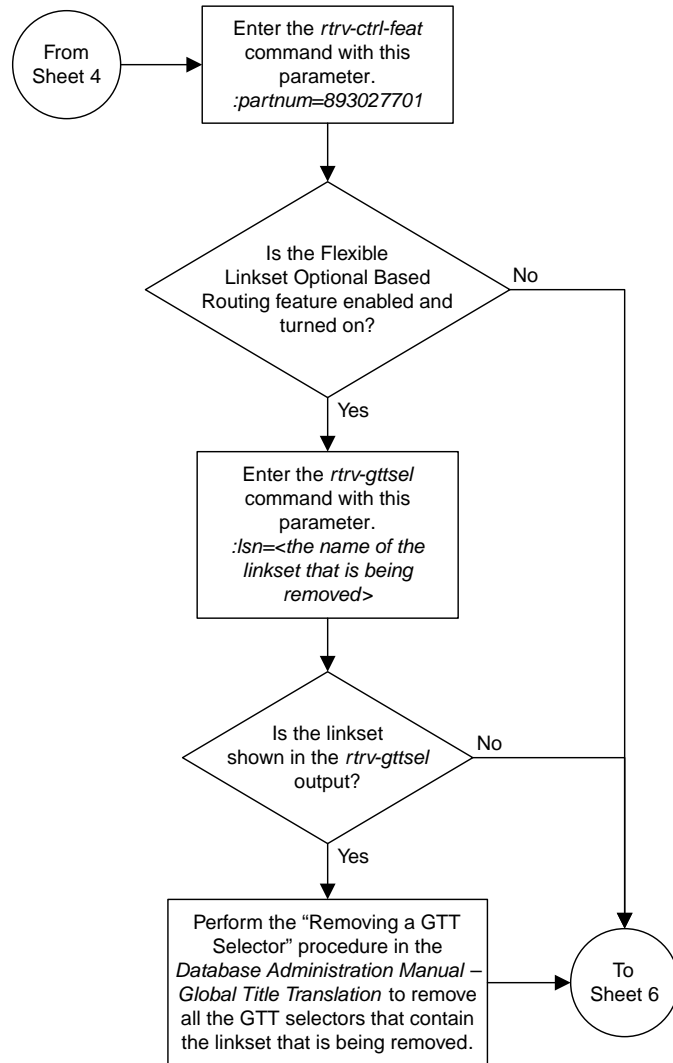

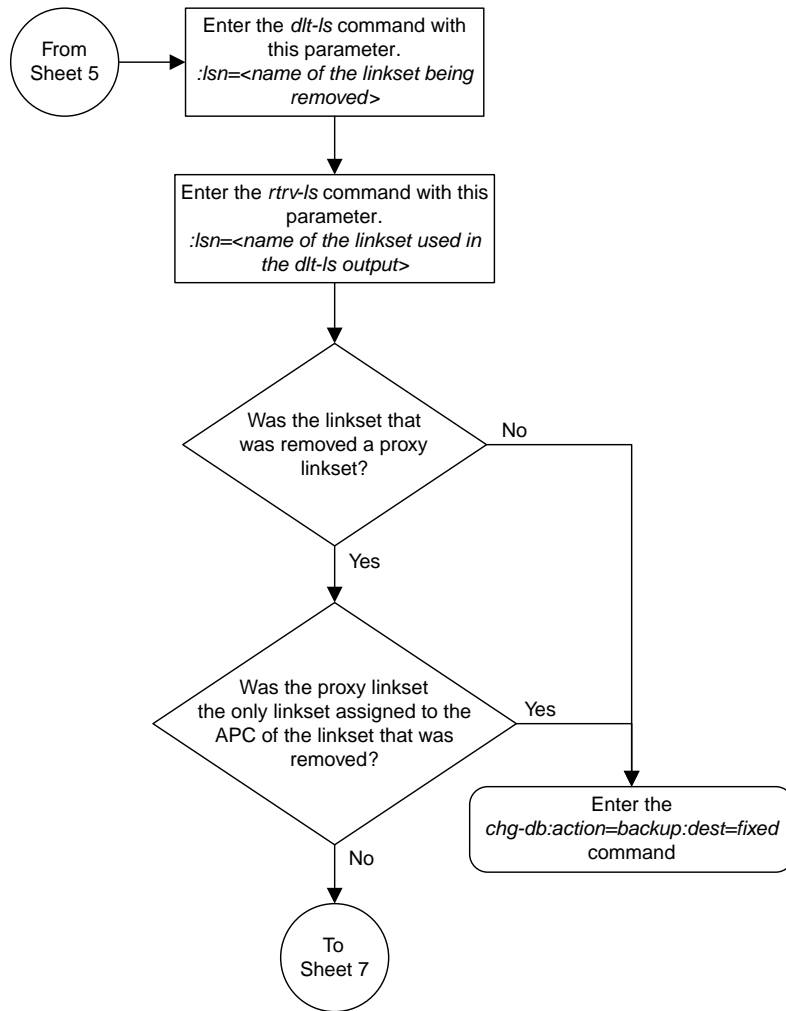

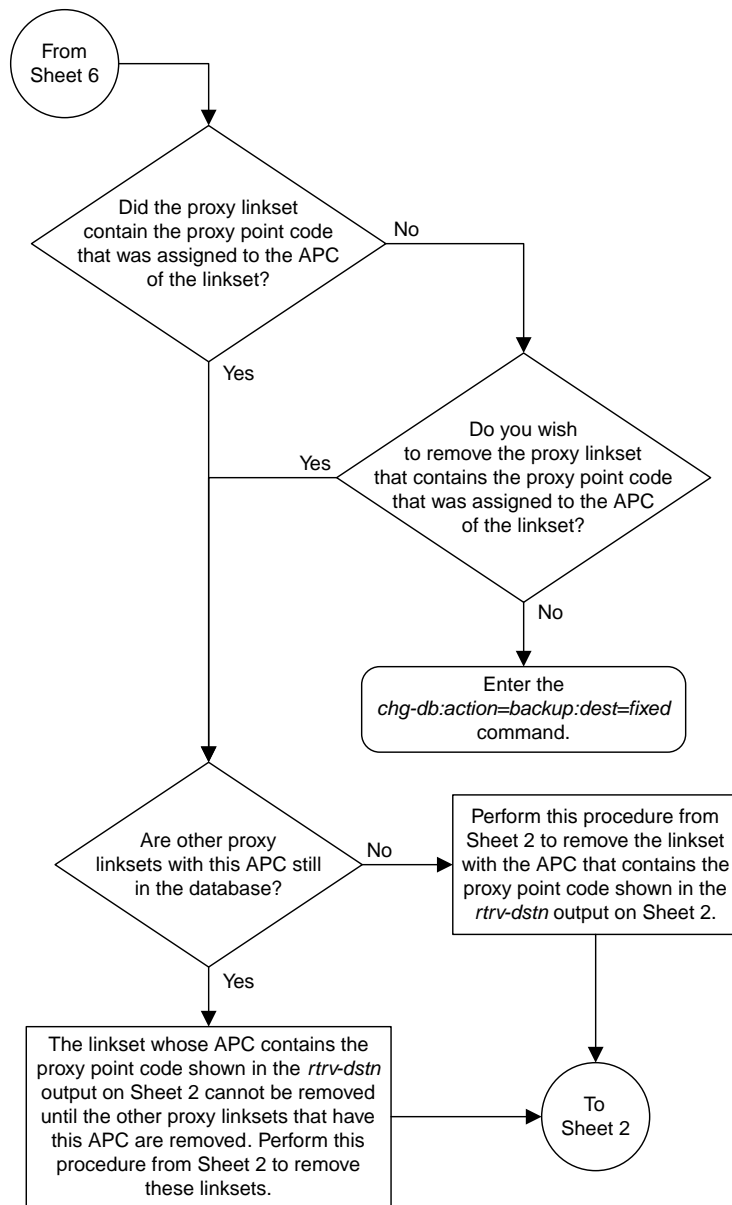

Sheet 7 of 7

Figure 103: Removing an IPSG Linkset

Removing an IP Host Assigned to an IPSG Card

This procedure removes an IP host that is assigned to an IPSG card using the `dlt-ip-host` command.

The `dlt-ip-host` command uses the following parameter.

`:host` – Hostname. The hostname to be removed. This parameter identifies the logical name assigned to a device with an IP address.

No associations can reference the host name being removed in this procedure.

The associations referencing the host name can be removed by performing the [Removing an IPSG Association](#) procedure or the host name in these associations can be changed by performing the [Changing the Host Values of an IPSG Association](#) procedure. The host name assigned to associations is displayed in the `rtrv-assoc` outputs.

1. Display the current IP host information in the database by entering the `rtrv-ip-host:display=all` command.

The following is an example of the possible output.

```
rlghncxa03w 13-06-28 21:17:37 GMT EAGLE5 45.0.0

LOCAL IPADDR      LOCAL HOST
192.1.1.10        IPNODE1-1201
192.1.1.12        IPNODE1-1203
192.1.1.14        IPNODE1-1205
192.1.1.20        IPNODE2-1201
192.1.1.22        IPNODE2-1203
192.1.1.24        IPNODE2-1205
192.1.1.30        KC-HLR1
192.1.1.32        KC-HLR2
192.1.1.50        DN-MS1
192.1.1.52        DN-MS2
192.3.3.33        GW100. NC. TEKELEC. COM

REMOTE IPADDR     REMOTE HOST
150.1.1.5         NCDEPTECONOMIC_DEVELOPMENT. SOUTHEASTERN_COORIDOR_ASHVL. GOV

IP Host table is (12 of 4096) .29% full
```

If the IP host that is being removed is a remote host, continue the procedure with [Step 5](#).

If the IP host that is being removed is a local host, continue the procedure with [Step 2](#).

2. Display the current link parameters associated with the IP card in the database by entering the `rtrv-ip-lnk` command. The following is an example of the possible output.

```
rlghncxa03w 08-12-28 21:14:37 GMT EAGLE5 40.0.0
LOC  PORT  IPADDR      SUBMASK          DUPLEX  SPEED  MACTYPE  AUTO  MCAST
1303 A    192.1.1.10  255.255.255.128 HALF        10    802.3    NO    NO
1303 B    -----    -----          HALF        10    DIX      NO    NO
```

```

1305 A 192.1.1.12 255.255.255.0 ---- --- DIX YES NO
1305 B ----- HALF 10 DIX NO NO
1313 A 192.1.1.14 255.255.255.0 FULL 100 DIX NO NO
1313 B ----- HALF 10 DIX NO NO
2101 A 192.1.1.20 255.255.255.0 FULL 100 DIX NO NO
2101 B ----- HALF 10 DIX NO NO
2103 A 192.1.1.22 255.255.255.0 FULL 100 DIX NO NO
2103 B ----- HALF 10 DIX NO NO
2105 A 192.1.1.24 255.255.255.0 FULL 100 DIX NO NO
2105 B ----- HALF 10 DIX NO NO
2205 A 192.1.1.30 255.255.255.0 FULL 100 DIX NO NO
2205 B ----- HALF 10 DIX NO NO
2207 A 192.1.1.32 255.255.255.0 FULL 100 DIX NO NO
2207 B ----- HALF 10 DIX NO NO
2213 A 192.1.1.50 255.255.255.0 FULL 100 DIX NO NO
2213 B ----- HALF 10 DIX NO NO
2301 A 192.1.1.52 255.255.255.0 FULL 100 DIX NO NO
2301 B ----- HALF 10 DIX NO NO
2305 A 192.3.3.33 255.255.255.0 FULL 100 DIX NO NO
2305 B ----- HALF 10 DIX NO NO

```

IP-LNK table is (22 of 2048) 1% full.

3. Display the cards in the database using the `rtrv-card` command. This is an example of the possible output.

```

rlghncxa03w 13-05-28 09:12:36 GMT EAGLE5 45.0.0
CARD TYPE APPL LSET NAME LINK SLC LSET NAME LINK SLC
1101 DSM VSCCP
1102 TSM GLS
1113 E5MCAP EOAM
1114 E5TDM-A
1115 E5MCAP EOAM
1116 E5TDM-B
1117 E5MDAL
1201 LIMDS0 SS7ANSI sp2 A 0 sp1 B 0
1203 LIMDS0 SS7ANSI sp3 A 0
1204 LIMDS0 SS7ANSI sp3 A 1
1206 LIMDS0 SS7ANSI nsp3 A 1 nsp4 B 1
1216 DCM STPLAN
1301 LIMDS0 SS7ANSI sp6 A 1 sp7 B 0
1302 LIMDS0 SS7ANSI sp7 A 1 sp5 B 1
1303 DCM IPLIM ipnode1 A 0 ipnode3 B 1
1305 DCM IPLIM ipnode4 A 0
1307 DCM STPLAN
1313 DCM SS7IPGW ipgtwy1 A 0
2101 ENET IPSG ipgtwy2 A 0
2103 DCM SS7IPGW ipgtwy3 A 0
2105 DCM IPLIM ipnode1 A1 1 ipnode5 B 2
2205 DCM IPLIM ipnode3 A2 0 ipnode6 B1 2
2207 DCM IPLIM ipnode5 A 0 ipnode4 B3 1
2213 DCM IPLIM ipnode5 A3 1 ipnode3 B2 2
2301 DCM IPLIM ipnode6 A 0 ipnode1 B 2
2305 ENET IPSG ipnode6 A1 1 ipnode1 B1 3

```

Select an IP host whose IP address is assigned to a card running the IPSG application.

4. Display the associations referencing the host name being removed in this procedure by entering the `rtrv-assoc` command with the local host name.

For this example, enter these commands.

```
rtrv-assoc: lhost=gw100.nc.tekelec.com
```

The following is an example of the possible output.

```
rlghncxa03w 06-10-28 21:14:37 GMT EAGLE5 36.0.0
CARD IPLNK
ANAME          LOC  PORT  LINK ADAPTER LPORT RPORT OPEN ALW
a2             2305 A    A    M2PA    7205  7001 NO  NO

IP Appl Sock/Assoc table is (4 of 4000) 1% full
Assoc Buffer Space Used (200 KB of 1600 KB) on LOC = 2305
```

```
rtrv-assoc: lhost=ipnode2-1201
```

The following is an example of the possible output.

```
rlghncxa03w 06-10-28 21:14:37 GMT EAGLE5 36.0.0
CARD IPLNK
ANAME          LOC  PORT  LINK ADAPTER LPORT RPORT OPEN ALW
m3ua1         2101 A    A    M3UA    2000  2000 NO  NO

IP Appl Sock/Assoc table is (4 of 4000) 1% full
Assoc Buffer Space Used (16 KB of 800 KB) on LOC = 2101
```

If no associations referencing the host name being removed in this procedure are shown in this step, continue the procedure with [Step 5](#).

Any associations referencing the host name must either be removed or the host name assigned to the association must be changed.

To remove the associations, perform the [Removing an IPSG Association](#) procedure.

Continue the procedure with [Step 5](#) after the associations have been removed.

To change the host name assigned to the associations, perform the [Changing the Host Values of an IPSG Association](#) procedure.

Continue the procedure with [Step 5](#) after the host name assigned to the associations have been changed.

5. Delete IP host information from the database by entering the `dlt-ip-host` command.

For example, enter these commands.

```
dlt-ip-host: host=gw100.nc.tekelec.com
```

```
dlt-ip-host: host="ipnode2-1201"
```

When these commands have successfully completed, the following message should appear.

```
rlghncxa03w 06-10-28 21:19:37 GMT EAGLE5 36.0.0
DLT-IP-HOST: MASP A - COMPLTD
```

6. Verify the changes by entering the `rtrv-ip-host` command with the host name specified in [Step 5](#).

For this example, enter these commands.

```
rtrv-ip-host:host=gw100.nc.tekelec.com
```

```
rtrv-ip-host:host="ipnode2-1201"
```

The following is an example of the possible output.

```
rlghncxa03w 13-06-28 21:20:37 GMT EAGLE5 45.0.0
```

```
No matching entries found.
```

```
IP Host table is (10 of 4096) .24% full
```

7. Back up the new changes using the `chg-db:action=backup:dest=fixed` command.

These messages should appear, the active Maintenance and Administration Subsystem Processor (MASP) appears first.

```
BACKUP (FIXED) : MASP A - Backup starts on active MASP.  
BACKUP (FIXED) : MASP A - Backup on active MASP to fixed disk complete.  
BACKUP (FIXED) : MASP A - Backup starts on standby MASP.  
BACKUP (FIXED) : MASP A - Backup on standby MASP to fixed disk complete.
```

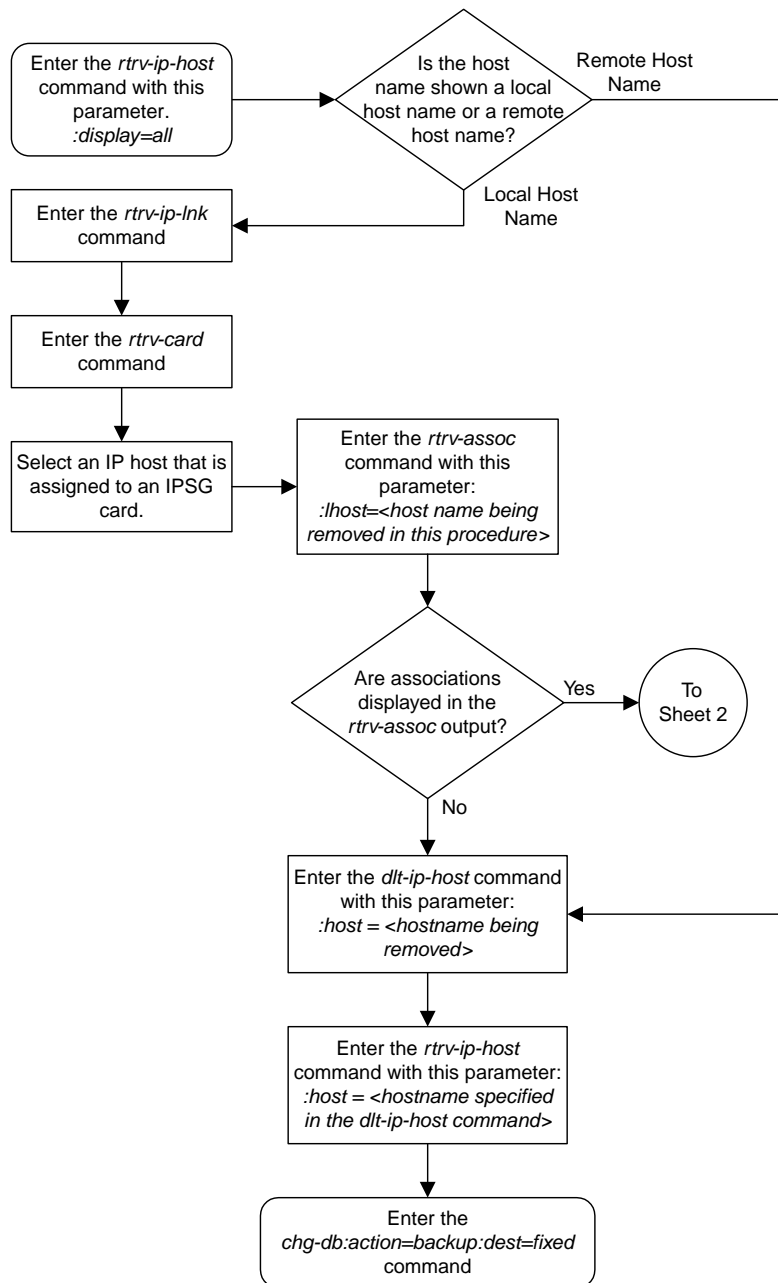

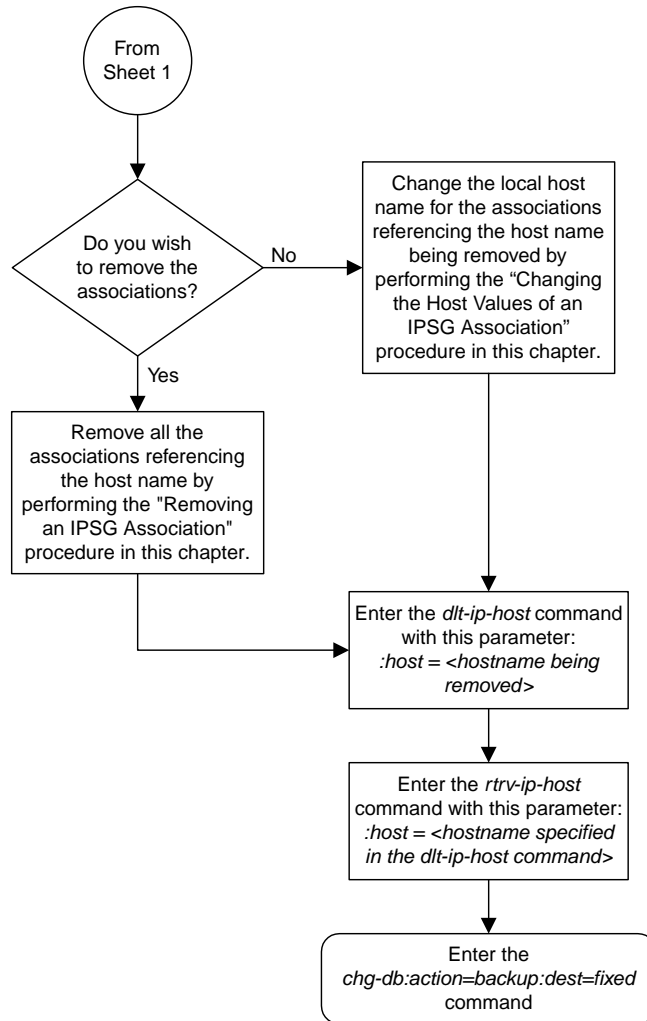

Sheet 2 of 2

Figure 104: Removing an IP Host Assigned to an IPSG Card

Removing an IP Route

This procedure is used to remove an IP route from the database using the `dlt-ip-rte` command.

The `dlt-ip-rte` command uses these parameters.

`:loc` – The location of the IP card containing the IP route being removed.

`:dest` – The IP address of the remote host or network assigned to the IP route being removed.

`:force` – To remove the IP route, the IP card that the route is assigned to must be out of service, or the `force=yes` parameter must be specified with the `dlt-ip-rte` command. The `force=yes` parameter allows the IP route to be removed if the IP card is in service.



CAUTION

Caution: Removing an IP route while the IP card is still in service can result in losing the ability to route outbound IP traffic on the IP card. This can cause both TCP and SCTP sessions on the IP card to be lost.

1. Display the IP routes in the database with the `rtrv-ip-rte` command.

This is an example of the possible output.

```
rlghncxa03w 06-10-28 09:12:36 GMT EAGLE5 36.0.0
LOC  DEST          SUBMASK          GTWY
1212 132.10.175.20    255.255.0.0      150.1.1.50
1301 128.252.10.5     255.255.255.255 140.188.13.33
1301 128.252.0.0      255.255.0.0      140.188.13.34
1301 150.10.1.1       255.255.255.255 140.190.15.3
1303 192.168.10.1     255.255.255.255 150.190.15.23
1303 192.168.0.0      255.255.255.0    150.190.15.24
```

```
IP Route table is (6 of 2048) 0.29% full
```

2. Verify the state of the IP card containing the IP route being removed by entering the `rept-stat-card` command and specifying the card location of the IP card.

The IP card should be in the out-of-service maintenance-disabled (OOS-MT-DSBLD) in order to remove the IP route. If the IP card's state is out-of-service maintenance-disabled, the entry OOS-MT-DSBLD is shown in the PST column of the `rept-stat-card` output. For this example, enter this command.

```
rept-stat-card:loc=1301
```

This is an example of the possible output.

```
rlghncxa03w 10-12-01 09:12:36 GMT EAGLE5 43.0.0
CARD  VERSION  TYPE  GPL  PST  SST  AST
1301  133-003-000  E5ENET  IPSG  IS-NR  Active  -----
ALARM STATUS      = No Alarms.
BLIXP  GPL version = 133-003-000
IMT BUS A         = Conn
```



```

IMT BUS B           = Conn
CURRENT TEMPERATURE = 32C ( 90F)   [ALARM TEMP: 60C (140F)]
PEAK TEMPERATURE:  = 39C (103F)   [06-05-02 13:40]
SIGNALING LINK STATUS
  SLK   PST           LS           CLLI
  A     IS-NR         nc001        -----
Command Completed.

```

Note: If the output of [Step 2](#) shows that the IP card's state is not OOS-MT-DSBLD, and you do not wish to change the state of the IP card, continue the procedure with [Step 4](#).

3. Change the IP card's state to OOS-MT-DSBLD using the `inh-card` command and specifying the card location of the IP card.

For this example, enter these commands.

```
inh-card:loc=1301
```

When this command has successfully completed, this message appears.

```

rlghncxa03w 06-10-12 09:12:36 GMT EAGLE5 36.0.0
Card has been inhibited.

```

4. Remove the IP route from the database using the `dlt-ip-rte` command.

If the state of the IP card is not OOS-MT-DSBLD, the `force=yes` parameter must be specified with the `dlt-ip-rte` command. For this example, enter this command.

```
dlt-ip-rte:loc=1301:dest=128.252.0.0
```



CAUTION

Caution: Removing an IP route while the IP card is still in service can result in losing the ability to route outbound IP traffic on the IP card. This can cause both TCP and SCTP sessions on the IP card to be lost.

When this command has successfully completed, this message should appear.

```

rlghncxa03w 06-10-12 09:12:36 GMT EAGLE5 36.0.0
DLT-IP-RTE: MASP A - COMPLTD

```

5. Verify the changes using the `rtrv-ip-rte` command.

This is an example of the possible output.

```

rlghncxa03w 06-10-28 09:12:36 GMT EAGLE5 36.0.0
LOC   DEST           SUBMASK           GTWY
1212  132.10.175.20    255.255.0.0       150.1.1.50
1301  128.252.10.5     255.255.255.255   140.188.13.33
1301  150.10.1.1       255.255.255.255   140.190.15.3
1303  192.168.10.1     255.255.255.255   150.190.15.23
1303  192.168.0.0      255.255.0.0       150.190.15.24

IP Route table is (5 of 2048) 0.24% full

```

6. Place the IP card back into service by using the `alw-card` command.

Note: If the IP card containing the IP route that was removed from the database does not contain other IP routes, continue the procedure with [Step 7](#).

For example, enter this command.

```
alw-card:loc=1301
```

This message should appear.

```
rlghncxa03w 06-10-28 21:22:37 GMT EAGLE5 36.0.0  
Card has been allowed.
```

7. Back up the new changes using the `chg-db:action=backup:dest=fixed` command.

These messages should appear, the active Maintenance and Administration Subsystem Processor (MASP) appears first.

```
BACKUP (FIXED) : MASP A - Backup starts on active MASP.  
BACKUP (FIXED) : MASP A - Backup on active MASP to fixed disk complete.  
BACKUP (FIXED) : MASP A - Backup starts on standby MASP.  
BACKUP (FIXED) : MASP A - Backup on standby MASP to fixed disk complete.
```

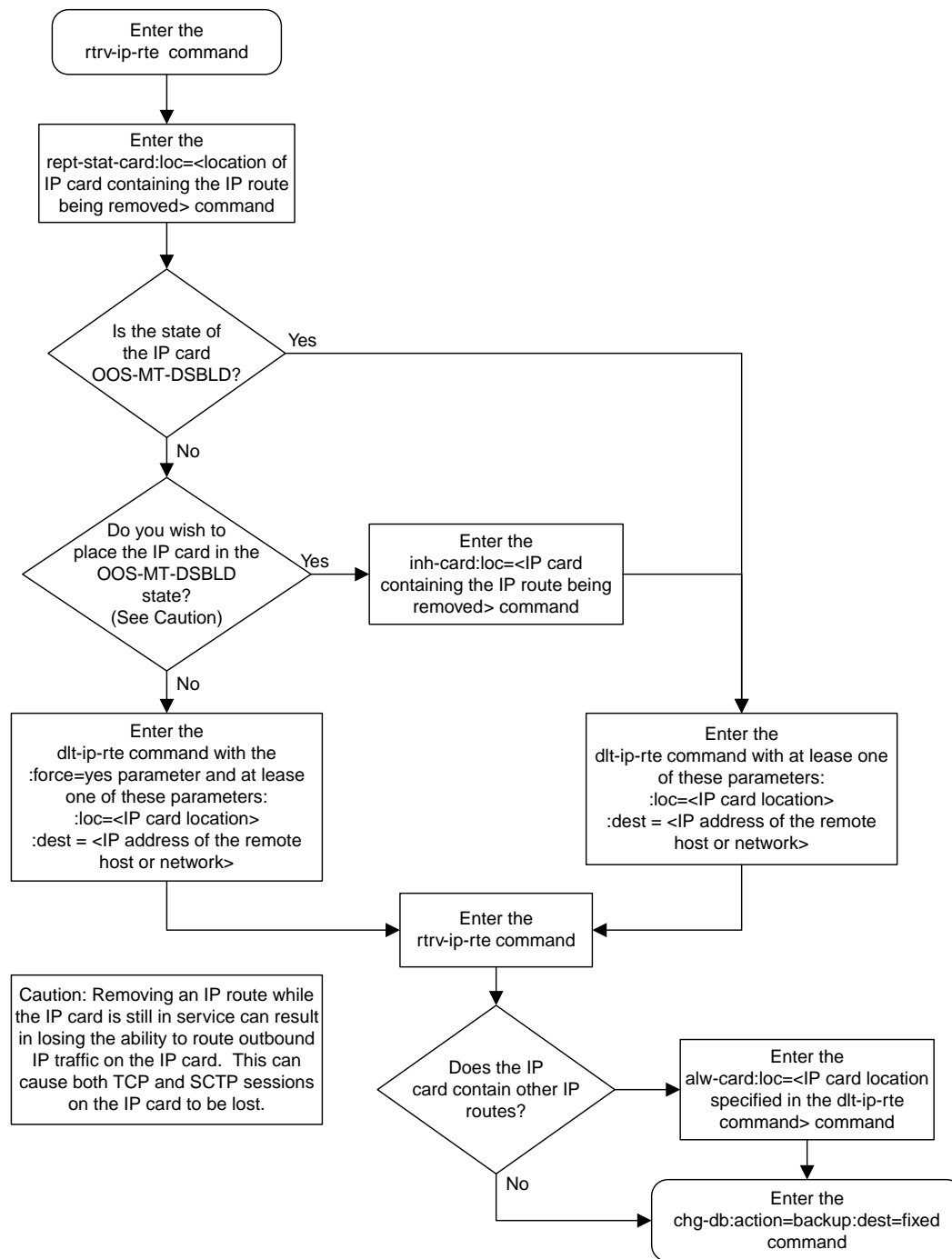

Figure 105: Removing an IP Route

Removing an IPSG Association

This procedure is used to remove an IPSG association from the database using the `dlt-assoc` command. An IPSG association is an M2PA or M3UA association that is assigned to an IPSG card.

The `dlt-assoc` command uses one parameter, `aname`, the name of the association being removed from the database. The association being removed must be in the database.

The `open` parameter must be set to `no` before the association can be removed. Use the `chg-assoc` command to change the value of the `open` parameter.

The `adapter` value assigned to the association being removed in this procedure must be either `m2pa` or `m3ua`. The application assigned to the card that is hosting the association must be IPSG.

If the `adapter` value of the association is `m2pa` and the application assigned to the card is either IPLIM or IPLIMI (an IPLIMx card), perform the [Removing an M2PA Association](#) to remove an M2PA association assigned to an IPLIMx card.

If the `adapter` value of the association is `m3ua` and the application assigned to the card is either SS7IPGW or IPGWI (an IPGWx card), perform the [Removing a M3UA or SUA Association](#) to remove an M3UA association assigned to an IPGWx card.

Canceling the RTRV-ASSOC Command

Because the `rtrv-assoc` command used in this procedure can output information for a long period of time, the `rtrv-assoc` command can be canceled and the output to the terminal stopped. There are three ways that the `rtrv-assoc` command can be canceled.

- Press the F9 function key on the keyboard at the terminal where the `rtrv-assoc` command was entered.
- Enter the `canc-cmd` without the `trm` parameter at the terminal where the `rtrv-assoc` command was entered.
- Enter the `canc-cmd:trm=<xx>`, where `<xx>` is the terminal where the `rtrv-assoc` command was entered, from another terminal other than the terminal where the `rtrv-assoc` command was entered. To enter the `canc-cmd:trm=<xx>` command, the terminal must allow Security Administration commands to be entered from it and the user must be allowed to enter Security Administration commands. The terminal's permissions can be verified with the `rtrv-secu-trm` command. The user's permissions can be verified with the `rtrv-user` or `rtrv-secu-user` commands.

For more information about the `canc-cmd` command, go to *Commands User's Guide*.

1. Display the associations in the database using the `rtrv-assoc` command.

This is an example of possible output.

```
rlghncxa03w 06-10-28 09:12:36 GMT EAGLE5 36.0.0

          CARD IPLNK
ANAME    LOC  PORT  LINK ADAPTER LPORT RPORT OPEN ALW
swbel32  1201 A      A   M3UA   1030  2345  YES  YES
a2       1305 A      A   SUA    1030  2345  YES  YES
a3       1307 A      A   SUA    1030  2346  YES  YES
assoc1   1203 A      A1  M2PA   2048  1030  NO   NO
```

Select an association whose ADAPTER value is either M3UA or M2PA.

2. Enter the `rtrv-card` command with the location of the card that is hosting the association that will be removed in this procedure. For this example, enter these commands.

```
rtrv-card:loc=1201
```

This is an example of possible output.

```
rlghncxa03w 08-03-06 15:17:20 EST EAGLE5 38.0.0
CARD   TYPE      APPL      LSET NAME   LINK SLC LSET NAME   LINK SLC
1201   ENET        IPSG      lsn2        A     0
```

```
rtrv-card:loc=1203
```

This is an example of possible output.

```
rlghncxa03w 08-03-06 15:17:20 EST EAGLE5 38.0.0
CARD   TYPE      APPL      LSET NAME   LINK SLC LSET NAME   LINK SLC
1203   ENET        IPSG      lsn1        A1    0
```

If the application assigned to the card is IPSG, shown in the APPL column, and signaling links are not assigned to the card, continue the procedure with [Step 3](#).

If the application assigned to the card is IPSG, shown in the APPL column, and signaling links are assigned to the card, perform one of these procedures depending on the ADAPTER value that is assigned to the association that will be removed.

- If the ADAPTER value is M2PA, perform the [Removing an IPSG M2PA Signaling Link](#) procedure.
- If the ADAPTER value is M3UA, perform the [Removing an IPSG M3UA Signaling Link](#) procedure.

After the signaling links have been removed from the card, continue the procedure with [Step 3](#).

If the application assigned to the card is IPLIM or IPLIMI, perform the [Removing an M2PA Association](#) procedure.

If the application assigned to the card is SS7IPGW or IPGWI, perform the [Removing a M3UA or SUA Association](#) procedure.

3. Change the value of the open parameter to no by specifying the `chg-assoc` command with the `open=no` parameter.

Note: If the value of the open parameter for the association being removed from the database (shown in [Step 1](#)) is no, continue this procedure with [Step 4](#).

For this example, enter these commands.

```
chg-assoc:aname=assoc1:open=no
```

```
chg-assoc:aname=swbel32:open=no
```

When the `chg-assoc` command has successfully completed, this message should appear.

```
rlghncxa03w 06-10-28 09:12:36 GMT EAGLE5 36.0.0
CHG-ASSOC: MASP A - COMPLTD;
```

4. Remove the association from the database using the `dlt-assoc` command.

For this example, enter these commands.

```
dlt-assoc:aname=assoc1  
dlt-assoc:aname=swbel32
```

When this command has successfully completed, this message should appear.

```
rlghncxa03w 06-10-28 09:12:36 GMT EAGLE5 36.0.0  
DLT-ASSOC: MASP A - COMPLTD
```

5. Verify the changes using the `rtrv-assoc` command with the name of the association specified in [Step 4](#).

For this example, enter these commands.

```
rtrv-assoc:aname=assoc1  
rtrv-assoc:aname=swbel32
```

This is an example of possible output.

```
rlghncxa03w 06-10-28 09:12:36 GMT EAGLE5 36.0.0  
No matching entries found  
IP Appl Sock table is (2 of 4000) 1% full
```

6. Back up the new changes, using the `chg-db:action=backup:dest=fixed` command. These messages should appear; the active Maintenance and Administration Subsystem Processor (MASP) appears first.

```
BACKUP (FIXED) : MASP A - Backup starts on active MASP.  
BACKUP (FIXED) : MASP A - Backup on active MASP to fixed disk complete.  
BACKUP (FIXED) : MASP A - Backup starts on standby MASP.  
BACKUP (FIXED) : MASP A - Backup on standby MASP to fixed disk complete.
```

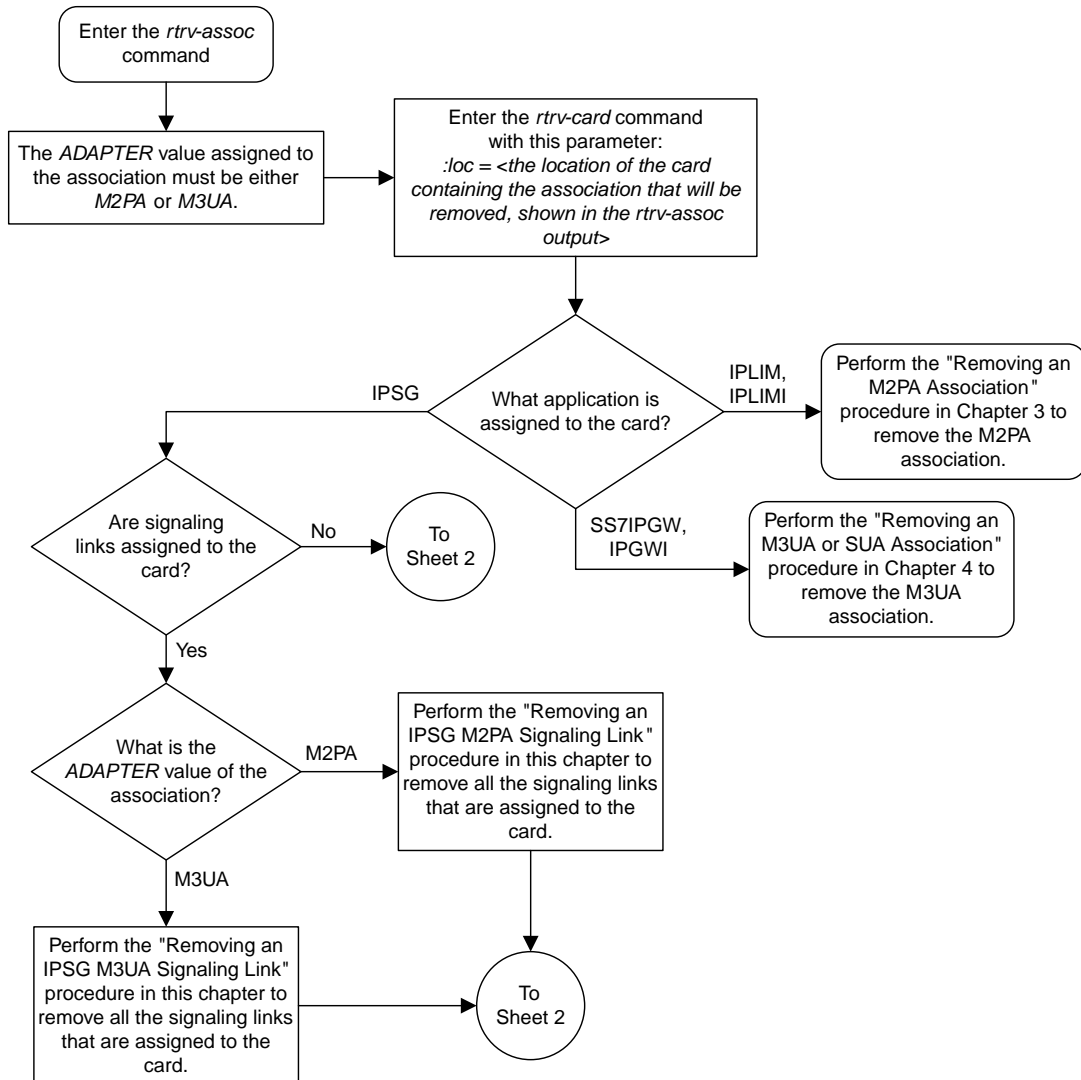

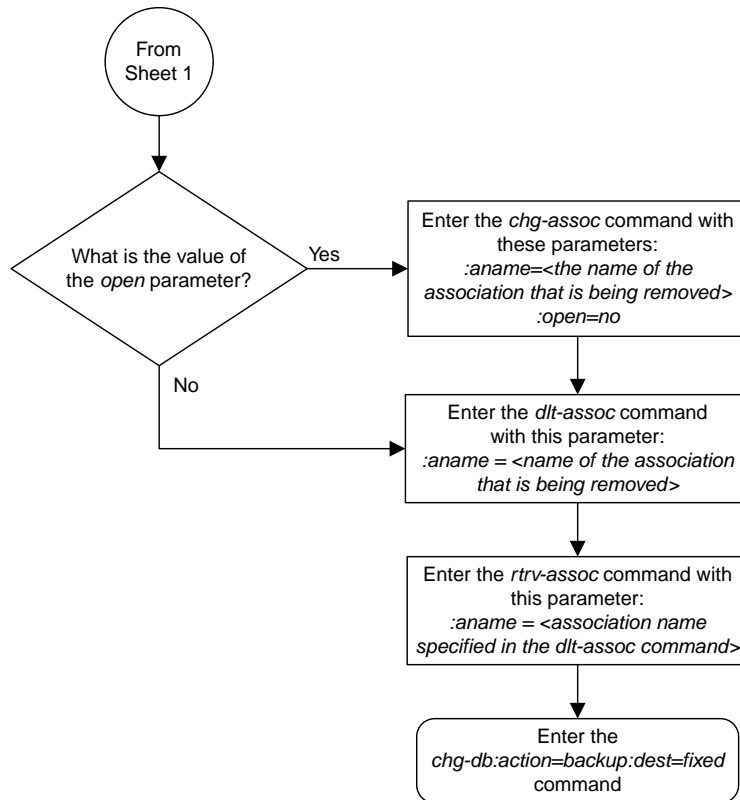

Sheet 2 of 2

Figure 106: Removing an IPSG Association

Removing an IPSG M2PA Signaling Link

This procedure is used to remove an IPSG M2PA signaling link from the database using the `dlt-slk` command. The `dlt-slk` command uses these parameters.

`:loc` – The card location of the IPSG card that the IPSG M2PA signaling link is assigned to.

`:link` – The signaling link on the card specified in the `loc` parameter.

`:force` – This parameter must be used to remove the last link in a linkset without having to remove all of the routes that referenced the linkset.

The `tfatcabmlq` parameter (TFA/TCA Broadcast Minimum Link Quantity), assigned to linksets, shows the minimum number of links in the given linkset (or in the combined link set in which it resides) that must be available for traffic. When the number of signaling links in the specified linkset is equal to or greater than the value of the `tfatcabmlq` parameter, the status of the routes that use the specified linkset is set to allowed and can carry traffic. Otherwise, these routes are restricted. The value of the `tfatcabmlq` parameter cannot exceed the total number of signaling links contained in the linkset.

If the linkset type of the linkset that contains the signaling link that is being removed is either A, B, D, E, or PRX, the signaling link can be removed regardless of the `tfatcabmlq` parameter value of the linkset and regardless of the `LSRESTRICT` option value. When a signaling link in one of these types of linksets is removed, the `tfatcabmlq` parameter value of the linkset is decreased automatically.

If the linkset type of the linkset that contains the signaling link that is being removed is C, the signaling link can be removed only:

- If the `LSRESTRICT` option is off. The `LSRESTRICT` option value is shown in the `rtrv-ss7opts` output.
- If the `LSRESTRICT` option is on and the number of signaling links assigned to the linkset will be equal to or greater than the value of the `tfatcabmlq` parameter value of the linkset after the signaling link is removed.

The `tfatcabmlq` parameter value of the linkset is shown in the `TFATCABMLQ` column of the `rtrv-ls:lsn=<linkset name>` output. The `tfatcabmlq` parameter value can be a fixed value (1 to 16) or 0. If the `tfatcabmlq` parameter value of the linkset is a fixed value, the number of signaling links that are in the linkset after the signaling link is removed must be equal to or greater than the `tfatcabmlq` parameter value of the linkset.

If the `tfatcabmlq` parameter value is 0, the signaling link can be removed. When the `tfatcabmlq` parameter value is 0, the value displayed in the `TFATCABMLQ` column of the `rtrv-ls` output is 1/2 of the number of signaling links contained in the linkset. If the number of signaling links in the linkset is an odd number, the `tfatcabmlq` parameter value is rounded up to the next whole number. As the signaling links are removed, the `tfatcabmlq` parameter value of the linkset is decreased automatically.

Canceling the `RTRV-SLK` Command

Because the `rtrv-slk` command used in this procedure can output information for a long period of time, the `rtrv-slk` command can be canceled and the output to the terminal stopped. There are three ways that the `rtrv-slk` command can be canceled.

- Press the F9 function key on the keyboard at the terminal where the `rtrv-slk` command was entered.
- Enter the `canc-cmd` without the `trm` parameter at the terminal where the `rtrv-slk` command was entered.
- Enter the `canc-cmd:trm=<xx>`, where `<xx>` is the terminal where the `rtrv-slk` command was entered, from another terminal other than the terminal where the `rtrv-slk` command was entered. To enter the `canc-cmd:trm=<xx>` command, the terminal must allow Security Administration commands to be entered from it and the user must be allowed to enter Security Administration commands. The terminal's permissions can be verified with the `rtrv-secu-trm` command. The user's permissions can be verified with the `rtrv-user` or `rtrv-secu-user` commands.

For more information about the `canc-cmd` command, go to *Commands User's Guide*.

1. Display the IPSG signaling links by entering this command.

```
rtrv-slk:type=ipsg
```

This is an example of the possible output.

```
rlghncxa03w 06-10-19 21:16:37 GMT EAGLE5 36.0.0

LOC LINK LSN          SLC TYPE    ANAME          SLKTPS
2202 A  lsnlp1          0  IPSP      assoc2         500
2205 A  lsnip1          1  IPSP      assoc3         500
2204 A  ls04            0  IPSP      assoc1         500
2213 A  lsnip5          0  IPSP      assoc4         750
2215 A  lsnlp2          1  IPSP      assoc5        1000
```

2. Display the associations assigned to the IPSG card containing the signaling link that will be removed by entering the `rtrv-assoc` command and specifying the card location of the IPSG card. For this example, enter this command.

For this example, enter this command.

```
rtrv-assoc:loc=2204
```

This is an example of possible output.

```
rlghncxa03w 06-10-28 09:12:36 GMT EAGLE5 36.0.0
CARD IPLNK
ANAME          LOC PORT  LINK ADAPTER LPORT RPORT OPEN ALW
assoc1         2204 A    A    M2PA   1030  1030 YES  YES

IP Appl Sock/Assoc table is (4 of 4000) 1% full
Assoc Buffer Space Used (16 KB of 3200 KB) on LOC = 2204
```

If the ADAPTER value of the associations shown in this step is M2PA, continue the procedure with [Step 3](#).

If the ADAPTER value for the associations is M3UA, perform one of these actions.

- If you wish to remove the signaling link assigned to this card, perform the [Removing an IPSG M3UA Signaling Link](#).

- If you do not wish to remove the signaling link assigned to this card, select another card from [Step 1](#) and repeat this step.
3. Display the linkset that contains the signaling link that is being removed by entering the `rtrv-ls` command with the name of the linkset shown in the LSN column of the `rtrv-slks` output.

For this example, enter these commands.

```
rtrv-ls:lsn=ls04
```

This is an example of the possible output.

```
rlghncxa03w 10-07-17 11:43:04 GMT EAGLE5 42.0.0

LSN          APCA  (SS7)  L3T SLT          GWS GWS GWS
ls04         002-009-003  scr2 1  1  no  a  1  on  off  on  no  off

          SPCA          CLLI          TFATCABMLQ MTPRSE ASL8
          -----
          1          no          no

RANDSLS
off

IPSG  IPGWAPC  GTTMODE          CGGTMOD
yes   no      CdPA          no

ADAPTER  RSVDSLKTPS  MAXSLKTPS
m2pa     1000      4000

TPSALM  LSUSEALM  SLKUSEALM
rsvdsstktps 100%    100%

LOC  LINK  SLC  TYPE  ANAME
2204 A  0    IPSG  m2pa2

Link set table is ( 20 of 1024) 2% full
```

If the linkset type of the linkset is A, B, D, E, or PRX, continue the procedure by performing one of these steps.

- If the OPEN or ALW values for the associations is YES, continue the procedure with [Step 6](#).
- If the OPEN and ALW values for the associations is NO, continue the procedure with [Step 7](#).

If the linkset type of the linkset is C, continue the procedure with [Step 4](#).

4. Display the LSRESTRICT option value by entering the `rtrv-ss7opts` command.

This is an example of the possible output.

```
rlghncxa03w 10-07-30 15:09:00 GMT 42.0.0

SS7 OPTIONS
-----
LSRESTRICT      on
```

Note: The `rtrv-feat` command output contains other fields that are not used by this procedure. If you wish to see all the fields displayed by the `rtrv-feat` command, refer to the `rtrv-feat` command description in *Commands User's Guide*.

The signaling link cannot be removed, if the `LSRESTRICT` option is on and the number of signaling links assigned to the linkset will be less than the value of the `tfatcabmlq` parameter value of the linkset if the signaling link is removed.

If the `LSRESTRICT` option is on and the number of signaling links assigned to the linkset will be less than the value of the `tfatcabmlq` parameter value of the linkset if the signaling link is removed, the signaling link cannot be removed unless the `tfatcabmlq` parameter value of the linkset is changed to 0. Continue the procedure with [Step 5](#).

If the `LSRESTRICT` option is on and the number of signaling links assigned to the linkset will be equal to or greater than the value of the `tfatcabmlq` parameter value of the linkset if the signaling link is removed, the "Configuring the Restricted Linkset Option" procedure has been performed, or if the `LSRESTRICT` value is `off`, continue the procedure by performing one of these steps.

- If the `OPEN` or `ALW` values for the associations is `YES`, continue the procedure with [Step 6](#).
- If the `OPEN` and `ALW` values for the associations is `NO`, continue the procedure with [Step 7](#).

5. Change the `tfatcabmlq` parameter value of the linkset to 0 by entering the `chg-ls` command with the name of the linkset that contains the signaling link that is being removed and the `tfatcabmlq` parameters. For this example, enter this command.

```
chg-ls:lsn=ls17:tfatcabmlq=0
```

When this command has successfully completed, this message should appear.

```
rlghncxa03w 10-07-07 08:41:12 GMT EAGLE5 42.0.0
Link set table is (20 of 1024) 2% full.
CHG-LS: MASP A - COMPLTD
```

Continue the procedure by performing one of these steps.

- If the `OPEN` or `ALW` values for the associations is `YES`, continue the procedure with [Step 6](#).
- If the `OPEN` and `ALW` values for the associations is `NO`, continue the procedure with [Step 7](#).

6. Change the value of the `open` and `alw` parameters to `no` by specifying the `chg-assoc` command with the `open=no` and `alw=no` parameters, as necessary.

For this example, enter this command.

```
chg-assoc:aname=assoc1:open=no:alw=no
```

When this command has successfully completed, this message should appear.

```
rlghncxa03w 06-10-28 09:12:36 GMT EAGLE5 36.0.0
CHG-ASSOC: MASP A - COMPLTD;
```

7. Deactivate the link to be removed using the `dact-slk` command, using the output from [Step 1](#) to obtain the card location and link parameter value of the signaling link to be removed.

For this example, enter these commands.

```
dact-slk:loc=2204:link=a
```

When this command has successfully completed, this message should appear.

```
rlghncxa03w 06-10-07 08:41:12 GMT EAGLE5 36.0.0
Deactivate Link message sent to card
```

- Verify that the link is out of service - maintenance disabled (OOS-MT-DSBLD) using the `rept-stat-slk` command with the card location and `link` parameter values specified in [Step 7](#).

For this example, enter this command.

```
rept-stat-slk:loc=2204:link=a
```

This is an example of the possible output.

```
rlghncxa03w 06-10-23 13:06:25 GMT EAGLE5 36.0.0
SLK      LSN      CLLI      PST      SST      AST
2204,A   ls04      ls04clli  OOS-MT   Unavail   ----
  ALARM STATUS      = *    0235 REPT-LNK-MGTINH: local inhibited
  UNAVAIL REASON    = LI
```

- If the signaling link to be removed is the last signaling link on a card, the card must be inhibited before the signaling link is removed.

Note: If the signaling link being removed is not the last signaling link on the card, continue the procedure with [Step 11](#).

Enter the `rmv-card` command and specify the location of the card to be inhibited. The card location is shown in the output of `rept-stat-slk` command executed in [Step 8](#).

In the example used for this procedure, the signaling link is the last signaling link on the card and must be inhibited. Enter this command.

```
rmv-card:loc=2204
```

When each of these command has successfully completed, this message should appear.

```
rlghncxa03w 06-10-07 08:41:12 GMT EAGLE5 36.0.0
Card has been inhibited.
```

- Verify that the card has been inhibited by entering the `rept-stat-card` command with the card location specified in [Step 9](#). For this example, enter this command.

```
rept-stat-card:loc=2204
```

This is an example of the possible output.

```
rlghncxa03w 10-12-01 09:12:36 GMT EAGLE5 43.0.0
CARD  VERSION  TYPE  GPL  PST  SST  AST
2204  133-003-000 E5ENET  IPSG  OOS-MT-DSBLD  Isolated  -----
  ALARM STATUS      = No Alarms.
  BLIXP  GPL version = 133-003-000
  IMT BUS A          = Disc
  IMT BUS B          = Disc
  CURRENT TEMPERATURE = 32C ( 90F)    [ALARM TEMP: 60C (140F)]
```

```

PEAK TEMPERATURE:      = 39C (103F)      [06-05-02 13:40]
SIGNALING LINK STATUS
  SLK   PST              LS              CLLI
  A     OOS-MT           lsnlp2       -----
Command Completed.

```

11. Display the linkset that contains the signaling link that is being removed by entering the `rtrv-ls` command with the name of the linkset shown in the LSN column in [Step 10](#). For this example, enter this command.

```
rtrv-ls:lsn=ls04
```

This is an example of the possible output.

```

rlghncxa03w 08-05-27 16:43:42 GMT EAGLE5 38.0.0

LSN          APCA   (SS7)  L3T  SLT          GWS  GWS  GWS
ls04         001-001-003  none 1   1   no  A   1   off off off no  off

          SPCA          CLLI          TFATCABMLQ  MTPRSE  ASL8
          -----          -----          1          no      no

          IPG   IPGWAPC  GTTMODE          CGGTMOD
          yes  no      CdPA          no

          ADAPTER  SLKTPS  LSUSEALM  SLKUSEALM  RCONTEXT  ASNOTIF
          m2pa    500     100%     80%       none      no

          LOC  LINK  SLC  TYPE      ANAME
          1102 A    2    IPSG     assoc1

Link set table is (22 of 1024) 2% full.

```

12. Remove the signaling link from the EAGLE using the `dlt-slk` command.

If there is only one signaling link in the linkset, shown in [Step 11](#), the `force=yes` parameter must be specified to remove the signaling link.

In the example used in this procedure, the signaling link is the last signaling link in the linkset. Enter this command.

```
dlt-slk:loc=2204:link=a:force=yes
```

When this command has successfully completed, this message should appear.

```

rlghncxa03w 06-10-07 08:41:17 GMT EAGLE5 36.0.0
DLT-SLK: MASP A - COMPLTD

```

Note: If removing the signaling link will result in 700 or less signaling links in the database and the `OAMHCMEAS` value in the `rtrv-measopts` output is on, the scheduled UI measurement reports will be enabled.

13. Verify the changes using the `rtrv-slk` command with the card location and link values specified in [Step 12](#). For this example, enter this command.

```
rtrv-slk:loc=2204:link=a
```

When the `rtrv-slk` command has completed, the specified signaling link is not shown in the `rtrv-slk` output, as shown in this example.

```
rlghncxa03w 09-09-18 13:43:31 GMT EAGLE5 41.1.0
E2373 Cmd Rej: Link is unequipped in the database
```

14. Back up the new changes using the `chg-db:action=backup:dest=fixed` command. These messages should appear, the active Maintenance and Administration Subsystem Processor (MASP) appears first.

```
BACKUP (FIXED) : MASP A - Backup starts on active MASP.
BACKUP (FIXED) : MASP A - Backup on active MASP to fixed disk complete.
BACKUP (FIXED) : MASP A - Backup starts on standby MASP.
BACKUP (FIXED) : MASP A - Backup on standby MASP to fixed disk complete.
```

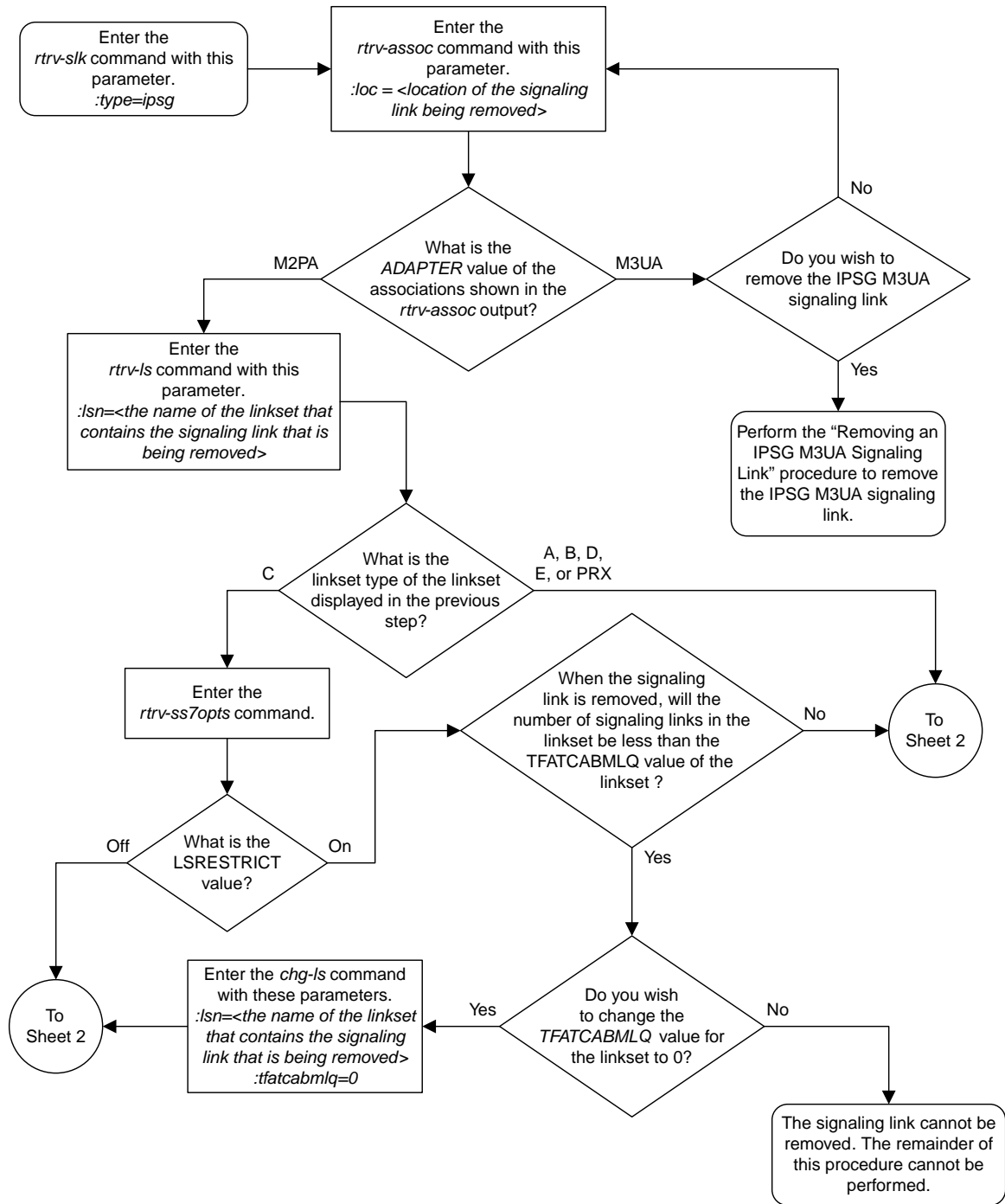

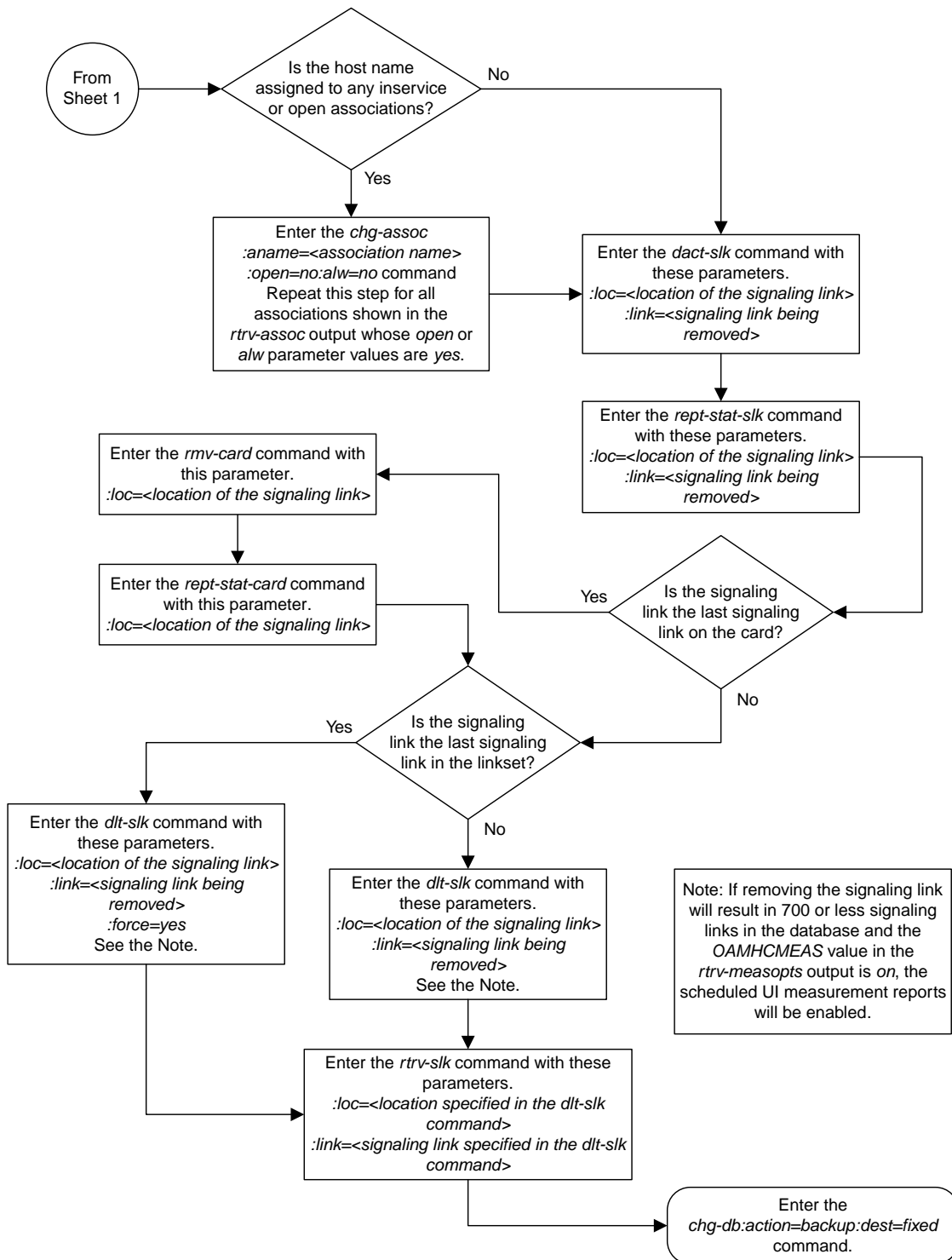

Sheet 2 of 2

Figure 107: Removing an IPSG M2PA Signaling Link

Removing an IPSG M3UA Signaling Link

This procedure is used to remove an IPSG M3UA signaling link from the database using the `dlt-slk` command. The `dlt-slk` command uses these parameters.

- `:loc` – The card location of the IPSG card that the IPSG M3UA signaling link is assigned to.
- `:link` – The signaling link on the card specified in the `loc` parameter.
- `:force` – This parameter must be used to remove the last link in a linkset without having to remove all of the routes that referenced the linkset.

The IPSG M3UA signaling link cannot be removed if removing the IPSG M3UA signaling link will cause the number of IS-NR IPSG M3UA signaling links in the linkset to be less than the `NUMSLKALW`, `NUMSLKRSTR`, or `NUMSLKPROH` values shown in the `rtrv-ls` output. The `NUMSLKALW`, `NUMSLKRSTR`, and `NUMSLKPROH` values are defined as follows.

- `NUMSLKALW` - specifies the number of IS-NR (in-service normal) signaling links in the IPSG M3UA linkset required to change the state of the linkset from the Restricted or Prohibited state to the Allowed state.
- `NUMSLKRSTR` - specifies the number of signaling links in the IPSG M3UA linkset required to change the state of the linkset from the Allowed state to the Restricted state.
- `NUMSLKPROH` - specifies the number of signaling links in the IPSG M3UA linkset required to change the state of the linkset from the Allowed or Restricted state to the Prohibited state.

For more information about the `NUMSLKALW`, `NUMSLKRSTR`, and `NUMSLKPROH` values, refer to the [Configuring IPSG M3UA Linkset Options](#) procedure.

If the `NUMSLKALW`, `NUMSLKRSTR`, and `NUMSLKPROH` values are 1 or 0, then the IPSG M3UA signaling link can be removed. The value 0 is shown in the `rtrv-ls` output as a number with an asterisk (*), for example, 2*.

Canceling the `RTRV-SLK` Command

Because the `rtrv-slk` command used in this procedure can output information for a long period of time, the `rtrv-slk` command can be canceled and the output to the terminal stopped. There are three ways that the `rtrv-slk` command can be canceled.

- Press the F9 function key on the keyboard at the terminal where the `rtrv-slk` command was entered.
- Enter the `canc-cmd` without the `trm` parameter at the terminal where the `rtrv-slk` command was entered.
- Enter the `canc-cmd:trm=<xx>`, where `<xx>` is the terminal where the `rtrv-slk` command was entered, from another terminal other than the terminal where the `rtrv-slk` command was entered. To enter the `canc-cmd:trm=<xx>` command, the terminal must allow Security Administration commands to be entered from it and the user must be allowed to enter Security Administration commands. The terminal's permissions can be verified with the `rtrv-secu-trm` command. The user's permissions can be verified with the `rtrv-user` or `rtrv-secu-user` commands.

For more information about the `canc-cmd` command, go to *Commands User's Guide*.

1. Display the IPSG signaling links by entering this command.

```
rtrv-slk:type=ipsg
```

This is an example of the possible output.

```
rlghncxa03w 06-10-19 21:16:37 GMT EAGLE5 36.0.0

LOC LINK LSN          SLC TYPE    ANAME          SLKTPS
2202 A  lsnlp1          0  IPSG    assoc2         500
2205 A  lsnipl          1  IPSG    assoc3         500
2204 A  ls04            0  IPSG    assoc1         500
2207 A  lsnlp3          0  IPSG    assoc11        850
2211 A  lsnlp4          0  IPSG    assoc12        950
2213 A  lsnipl5         0  IPSG    assoc4         750
2215 A  lsnlp2          1  IPSG    assoc5        1000
```

2. Display the associations assigned to the IPSG card containing the signaling link that will be removed by entering the `rtrv-assoc` command and specifying the card location of the IPSG card. For this example, enter this command.

For this example, enter this command.

```
rtrv-assoc:loc=2207
```

This is an example of possible output.

```
rlghncxa03w 06-10-28 09:12:36 GMT EAGLE5 36.0.0
CARD IPLNK
ANAME          LOC PORT LINK ADAPTER LPORT RPORT OPEN ALW
assoc11        2207 A  A    M3UA    1030  1030  YES  YES

IP Appl Sock/Assoc table is (7 of 4000) 1% full
Assoc Buffer Space Used (16 KB of 3200 KB) on LOC = 2207
```

If the ADAPTER value of the associations shown in this step is M3UA, continue the procedure with [Step 3](#).

If the ADAPTER value for the associations is M2PA, perform one of these actions.

- If you wish to remove the signaling link assigned to this card, perform the [Removing an IPSG M2PA Signaling Link](#).
- If you do not wish to remove the signaling link assigned to this card, select another card from [Step 1](#) and repeat this step.

3. Display the linkset that contains the signaling link that is being removed by entering the `rtrv-ls` command with the name of the linkset shown in the LSN column in [Step 1](#). For this example, enter this command.

```
rtrv-ls:lsn=lsnlp3
```

This is an example of the possible output.

```
rlghncxa03w 08-05-27 16:43:42 GMT EAGLE5 38.0.0

L3T SLT          GWS GWS GWS
```

```

LSN          APCA   (SS7)  SCRN SET SET BEI LST LNKS ACT MES DIS SLSCI NIS
lsnlp3      001-001-003 none 1  1  no  A  1  off off off no  off

          SPCA          CLLI          TFATCABMLQ MTPRSE ASL8
          -----          -----          ---
          IPGS  IPGWAPC  GTTMODE          CGGTMOD
          yes  no      CdPA          no

ADAPTER      SLKTPS  LSUSEALM  SLKUSEALM  RCONTEXT  ASNOTIF
m3ua         500     100%     80%        none       yes

NUMSLKALW   NUMSLKRSTR  NUMSLKPROH
1           1           1

LOC  LINK  SLC  TYPE      ANAME
2207 A    0   IPSG     assoc11

```

Link set table is (22 of 1024) 2% full.

The IPSG M3UA signaling link cannot be removed if removing the IPSG M3UA signaling link will cause the number of IS-NR IPSG M3UA signaling links in the linkset to be less than the NUMSLKALW, NUMSLKRSTR, and NUMSLKPROH values shown in the `rtrv-ls` output. If the NUMSLKALW, NUMSLKRSTR, and NUMSLKPROH values are 1 or 0, then the IPSG M3UA signaling link can be removed. The value 0 is shown in the `rtrv-ls` output as a number with an asterisk (*) is displayed in the `rtrv-ls` output, for example, 2*.

If you do not wish to change the NUMSLKALW, NUMSLKRSTR, or NUMSLKPROH values, this signaling link cannot be removed and the remainder of this procedure cannot be performed.

If you wish to change the NUMSLKALW, NUMSLKRSTR, or NUMSLKPROH values, perform the [Configuring IPSG M3UA Linkset Options](#) procedure to change the required values. After the [Configuring IPSG M3UA Linkset Options](#) has been performed, continue the procedure with [Step 4](#)

- Any in-service IP connections on the signaling link being removed in this procedure must be placed out of service.

Have the far-end node for the signaling link being removed place the M3UA associations in either the ASP-INACTIVE or ASP-DOWN state.

- If the OPEN or ALW values for the associations is YES, continue the procedure with [Step 5](#).
- If the OPEN and ALW values for the associations is NO, continue the procedure with [Step 6](#).

- Change the value of the `open` and `alw` parameters to `no` by specifying the `chg-assoc` command with the `open=no` and `alw=no` parameters, as necessary. For this example, enter this command.

```
chg-assoc:aname=assoc11:open=no:alw=no
```

When this command has successfully completed, this message should appear.

```

rlghncxa03w 06-10-28 09:12:36 GMT EAGLE5 36.0.0
CHG-ASSOC: MASP A - COMPLTD;

```

- Deactivate the link to be removed using the `dact-slk` command, using the output from [Step 1](#) to obtain the card location and link parameter value of the signaling link to be removed. For this example, enter these commands.

```
dact-slk:loc=2207:link=a
```

When each of these command has successfully completed, this message should appear.

```
rlghncxa03w 06-10-07 08:41:12 GMT EAGLE5 36.0.0
Deactivate Link message sent to card
```

7. Verify that the link is out of service - maintenance disabled (OOS-MT-DSBLD) using the `rept-stat-slk` command with the card location and link parameter values specified in [Step 6](#). For this example, enter these commands.

```
rept-stat-slk:loc=2207:link=a
```

This is an example of the possible output.

```
rlghncxa03w 06-10-23 13:06:25 GMT EAGLE5 36.0.0
SLK      LSN      CLLI      PST      SST      AST
2207,A   lsnlp3    ls07clli  OOS-MT   Unavail  ----
ALARM STATUS      = *    0235 REPT-LNK-MGTINH: local inhibited
UNAVAIL REASON    = LI
```

8. Place the card that contains the signaling link shown in [Step 7](#) out of service by entering the `rmv-card` command specifying the card location shown in [Step 7](#). For this example, enter this command.

```
rmv-card:loc=2207
```

When this command has successfully completed, this message should appear.

```
rlghncxa03w 06-10-07 08:41:12 GMT EAGLE5 36.0.0
Card has been inhibited.
```

9. Verify that the card has been inhibited by entering the `rept-stat-card` command with the card location specified in [Step 8](#). For this example, enter this command.

```
rept-stat-card:loc=2207
```

This is an example of the possible output.

```
rlghncxa03w 10-12-01 09:12:36 GMT EAGLE5 43.0.0
CARD  VERSION  TYPE  GPL  PST  SST  AST
2207  133-003-000 E5ENET IPGS OOS-MT-DSBLD Isolated -----
ALARM STATUS      = No Alarms.
BLIXP  GPL version = 133-003-000
IMT BUS A          = Disc
IMT BUS B          = Disc
CURRENT TEMPERATURE = 32C ( 90F)    [ALARM TEMP: 60C (140F)]
PEAK TEMPERATURE:  = 39C (103F)    [06-05-02 13:40]
SIGNALING LINK STATUS
SLK  PST  LS  CLLI
A    OOS-MT  lsnlp2  -----
Command Completed.
```

10. Remove the signaling link from the EAGLE using the `dlt-slk` command. If there is only one signaling link in the linkset, the `force=yes` parameter must be specified to remove the signaling link.

In the example used in this procedure, the signaling link is the last signaling link in the linkset. Enter this command.

```
dlt-slk:loc=2207:link=a:force=yes
```

When this command has successfully completed, this message should appear.

```
rlghncxa03w 06-10-07 08:41:17 GMT EAGLE5 36.0.0
DLT-SLK: MASP A - COMPLTD
```

Note: If removing the signaling link will result in 700 or less signaling links in the database and the `OAMHCMEAS` value in the `rtrv-measopts` output is on, the scheduled UI measurement reports will be enabled.

11. Verify the changes using the `rtrv-slk` command, with the card location and link values specified in [Step 10](#). For this example, enter this command.

```
rtrv-slk:loc=2207:link=a
```

When the `rtrv-slk` command has completed, no entry is displayed showing that the signaling link has been removed.

```
rlghncxa03w 09-09-18 13:43:31 GMT EAGLE5 41.1.0
E2373 Cmd Rej: Link is unequipped in the database
```

12. Back up the new changes using the `chg-db:action=backup:dest=fixed` command. These messages should appear, the active Maintenance and Administration Subsystem Processor (MASP) appears first.

```
BACKUP (FIXED) : MASP A - Backup starts on active MASP.
BACKUP (FIXED) : MASP A - Backup on active MASP to fixed disk complete.
BACKUP (FIXED) : MASP A - Backup starts on standby MASP.
BACKUP (FIXED) : MASP A - Backup on standby MASP to fixed disk complete.
```

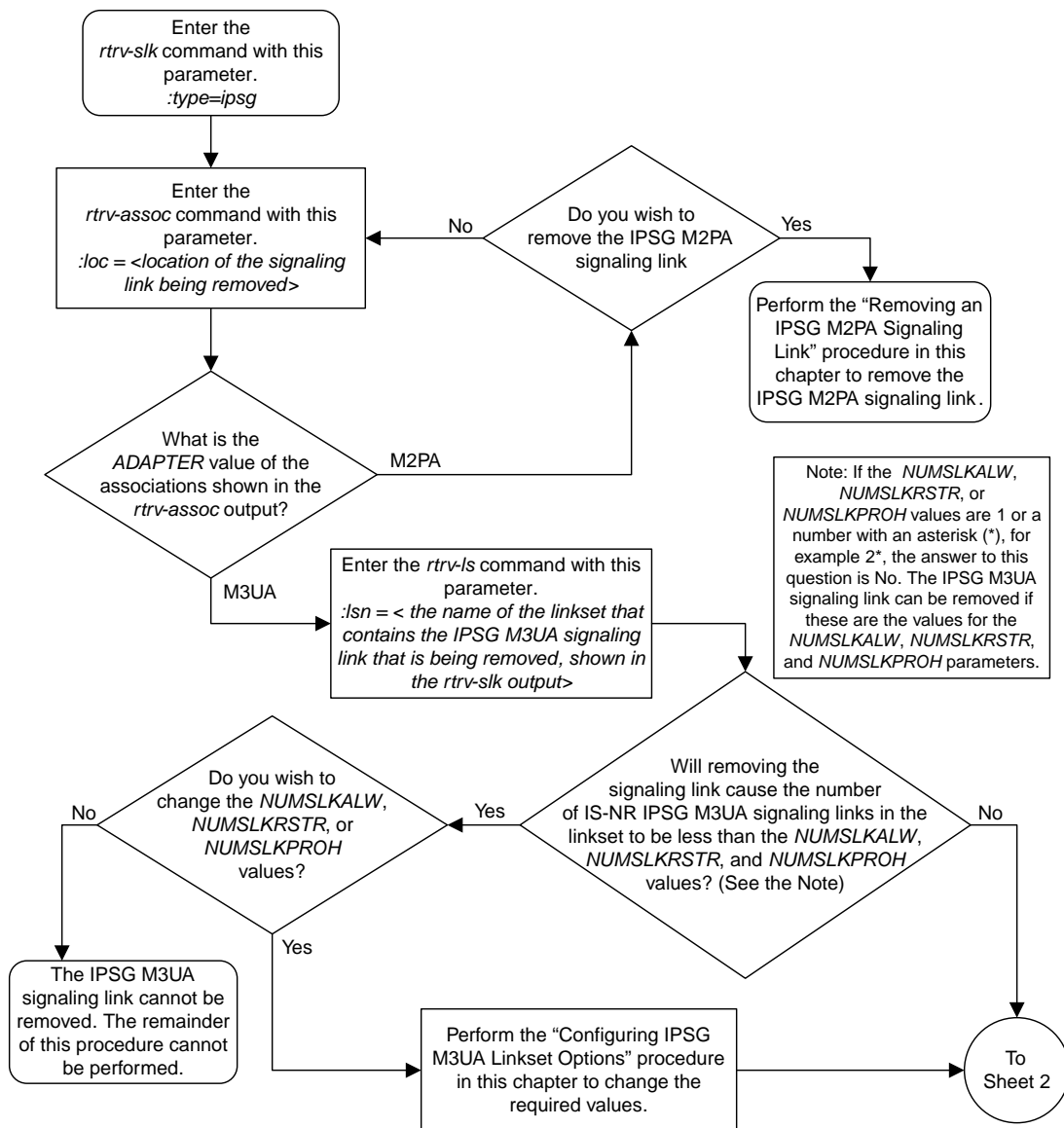

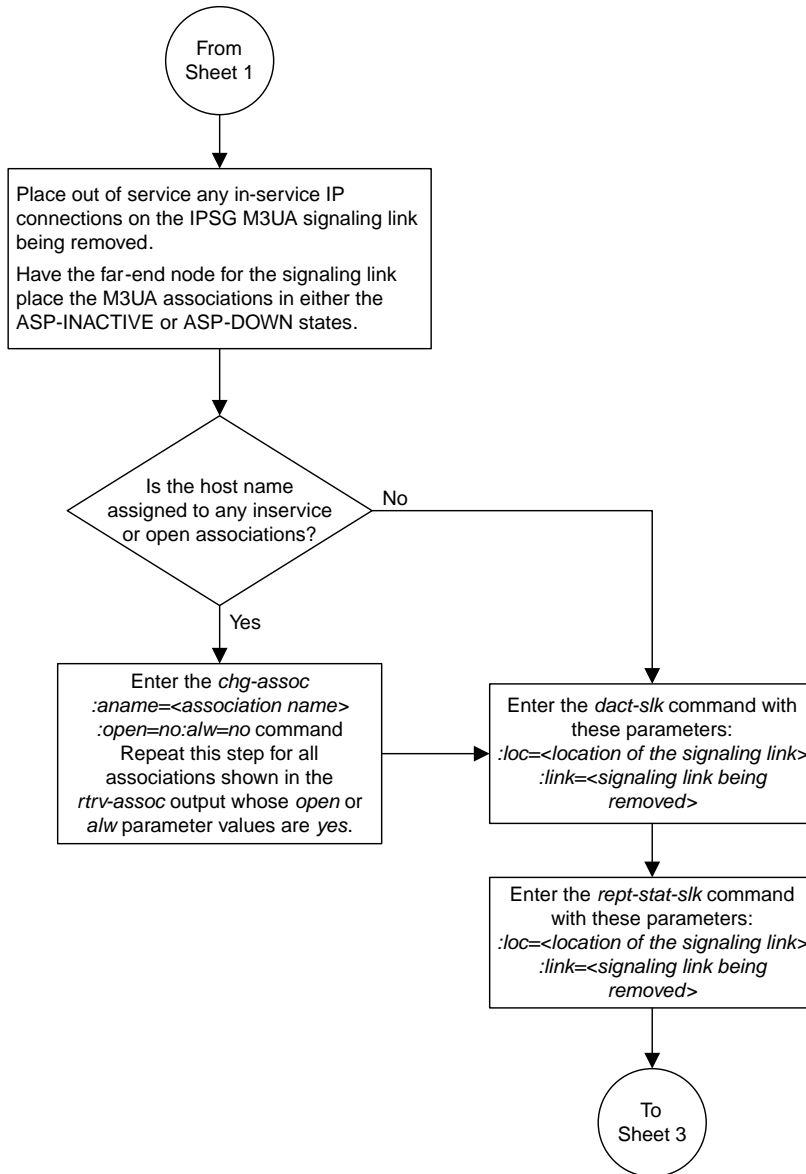

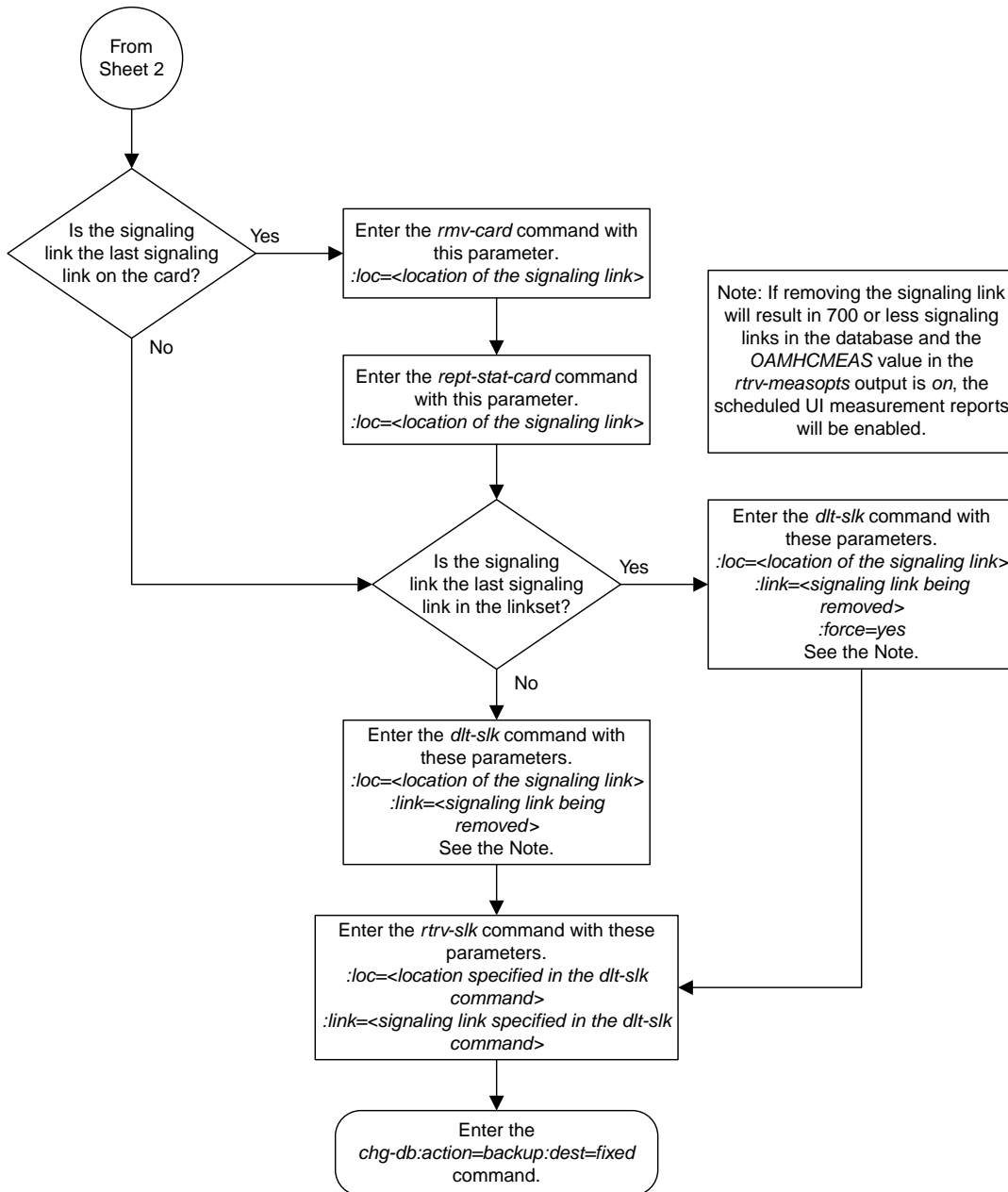

Sheet 3 of 3

Figure 108: Removing an IPSG M3UA Signaling Link

Removing a Network Appearance

This procedure removes the network appearance from the database using the `dlt-na` command with these parameters.

`:na` – the 32-bit value of the network appearance, from 0 to 4294967295.

`:type` – the network type of the network appearance, `ansi` (ANSI), `itui` (ITU-I), `itun` (14-bit ITU-N), `itun24` (24-bit ITU-N), `ituis` (ITU-I Spare), `ituns` (14-bit ITU-N Spare).

`:gc` – the specific ITU-N group code associated with the network appearance.

Specifying the `gc` parameter removes the specific network appearance containing the `na` and `gc` parameter values.

Specifying the `type=itun` or `type=ituns` parameter without the `gc` parameter removes all 14-bit ITU-N or 14-bit ITU-N spare network appearances containing the specified `na` parameter value.

1. Display the network appearances in the database with the `rtrv-na` command.

This is an example of the possible output.

```
rlghncxa03w 06-10-28 09:12:36 GMT EAGLE5 36.0.0
TYPE      GC      NA
ANSI      --      100
ITUI      --      1000
ITUN      uk      150000
ITUN      fr      4000000000
ITUN      ge      1000000000
ITUN24    --      3
ITUIS     --      2000
ITUNS     sp      5000
```

2. Remove the network appearance from the database with the `dlt-na` command.

For this example, enter these commands.

```
dlt-na:na=100:type=ansi
```

```
dlt-na:na=4000000000:type=itun:gc=fr
```

When each of these commands have successfully completed, this message should appear.

```
rlghncxa03w 06-10-28 09:12:36 GMT EAGLE5 36.0.0
DLT-NA:  MASP A - COMPLTD
```

3. Verify the changes using the `rtrv-na` command.

This is an example of possible output.

```
rlghncxa03w 06-10-28 09:12:36 GMT EAGLE5 36.0.0
TYPE      GC      NA
```

```
ITUI    --      1000
ITUN    uk     150000
ITUN    ge    1000000000
ITUN24  --      3
ITUIS   --     2000
ITUNS   sp     5000
```

4. Back up the new changes, using the `chg-db:action=backup:dest=fixed` command.

These messages should appear; the active Maintenance and Administration Subsystem Processor (MASP) appears first.

```
BACKUP (FIXED) : MASP A - Backup starts on active MASP.
BACKUP (FIXED) : MASP A - Backup on active MASP to fixed disk complete.
BACKUP (FIXED) : MASP A - Backup starts on standby MASP.
BACKUP (FIXED) : MASP A - Backup on standby MASP to fixed disk complete.
```

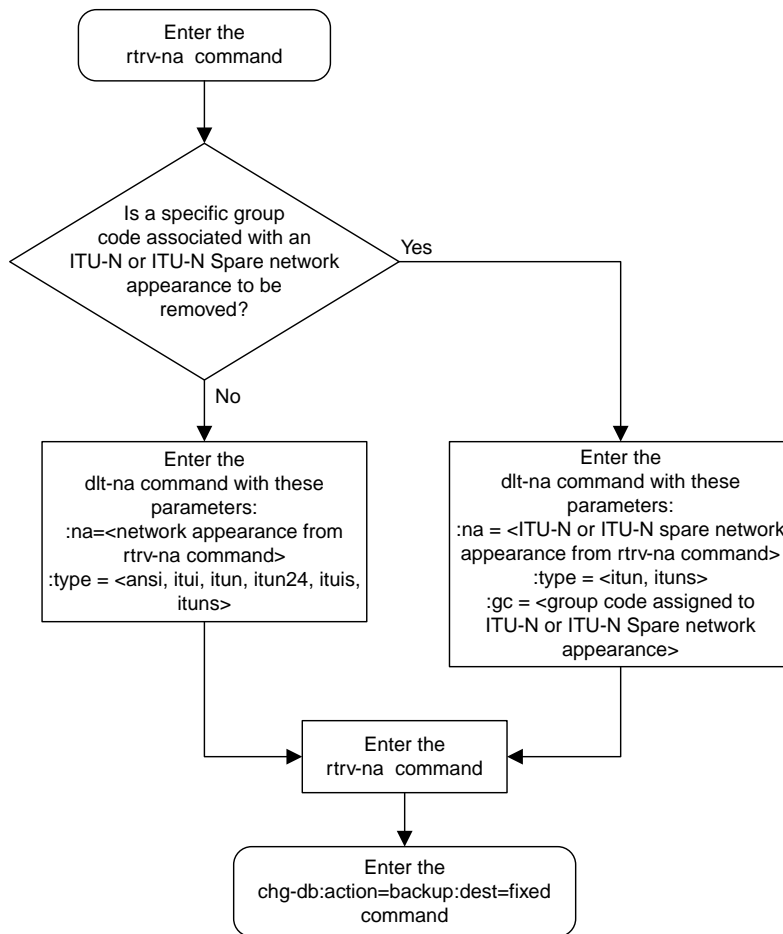

Figure 109: Removing a Network Appearance

Changing IPSG Components

This section describes how to change the attributes of the following components in the database.

- Changing an IPLIMx card that contains IPLIMx M2PA signaling links to an IPSG card that contains IPSG M2PA signaling links – perform the [Changing an IPLIMx Card to an IPSG Card](#) procedure.
- IP options – perform the [Configuring IP Options](#) procedure.
- The options for an IPSG M3UA linkset – perform the [Configuring IPSG M3UA Linkset Options](#) procedure.
- An IPSG Linkset – Perform these procedures.
 - [Changing an IPSG M2PA Linkset](#)
 - [Changing an IPSG M3UA Linkset](#)
- An IPSG Association – Perform these procedures.
 - [Changing the Attributes of an IPSG Association](#)
 - [Changing the Buffer Size of an IPSG Association](#)
 - [Changing the Host Values of an IPSG Association](#)
- The SCTP retransmission parameters – Perform the [Configuring an IPSG Association for SCTP Retransmission Control](#) procedure.
- The SCTP Checksum Algorithm – Perform these procedures.
 - [Changing the SCTP Checksum Algorithm Option for IPSG M2PA Associations](#)
 - [Changing the SCTP Checksum Algorithm Option for IPSG M3UA Associations](#)
- The M2PA timer set for an IPSG M2PA association – perform the [Changing an M2PA Timer Set](#) procedure.
- The UA parameter set for an IPSG M3UA association – perform the [Changing a UA Parameter Set](#) procedure.
- Turn off the Large MSU Support for IP Signaling feature – Perform the [Turning Off the Large MSU Support for IP Signaling Feature](#) procedure.

Changing an IPLIMx Card to an IPSG Card

This procedure is used to change an IPLIMx card to an IPSG card. The linksets, signaling links, and M2PA associations that are assigned to the IPLIMx card are changed to IPSG M2PA linksets, IPSG M2PA signaling links, and IPSG M2PA associations. To change an IPLIMx card to an IPSG card, the `chg-card` command is used with these parameters.

`:loc` – The card location of the IPLIMx card.

`:napp1` – The new application that is assigned to the card, `ipsg`.

The IPLIMx card must be an E5-ENET card that is running either the IPLIM or IPLIMI applications. IPLIMx signaling links must be assigned to the card. M2PA associations must be assigned to the signaling links. Before the `chg-card` command can be executed, the IPLIMx card and its signaling links must be taken out of service.

If adding the IPLIMx signaling link will exceed the maximum total provisioned system TPS, and the maximum total provisioned system TPS is 500,000, perform the "Activating the HIPR2 High Rate Mode" feature in *Database Administration - System Management* to enable and turn on the HIPR2 High Rate Mode feature. When the HIPR2 High Rate Mode feature is enabled and turned on, the maximum total provisioned system TPS is increased to 1,000,000 (1M). If the maximum total provisioned system TPS is 1M, or the maximum total provisioned system TPS is 500,000 and will not be increased, and adding the IPLIMx signaling link will exceed the maximum total provisioned system TPS, the IPLIMx signaling link cannot be added unless the amount of available TPS is reduced enough to allow the IPLIMx signaling link to be added. The available TPS can be reduced by performing one or more of these actions.

1. Display the cards in the database by entering the `rtrv-card` command.

This is an example of the possible output.

```

rlghncxa03w 13-06-19 21:16:37 GMT EAGLE5 45.0.0
CARD   TYPE     APPL      LSET NAME      LINK SLC LSET NAME      LINK SLC
1101   DSM       VSCCP
1102   TSM       GLS
1113   E5MCAP    EOAM
1114   E5TDM-A
1115   E5MCAP    EOAM
1116   E5TDM-B
1117   E5MDAL
1201   LIMDS0    SS7ANSI    sp2             A     0     sp1            B     0
1203   LIMDS0    SS7ANSI    sp3             A     0
1204   LIMDS0    SS7ANSI    sp3             A     1
1206   LIMDS0    SS7ANSI    nsp3            A     1     nsp4           B     1
1216   DCM       STPLAN
1301   LIMDS0    SS7ANSI    sp6             A     1     sp7            B     0
1302   LIMDS0    SS7ANSI    sp7             A     1     sp5            B     1
1303   DCM       IPLIM      ipnode1         A     0     ipnode3        B     0
1305   DCM       IPLIM      ipnode4         A     0
1307   DCM       STPLAN
2101   ENET      IPSG
2103   ENET      IPSG
2105   ENET      IPSG
2107   ENET      IPSG
2201   DCM       IPLIM
2203   DCM       IPLIM
2207   DCM       IPLIM
2211   DCM       SS7IPGW
2213   DCM       SS7IPGW
2215   DCM       IPGWI
2217   DCM       IPGWI
2301   DCM       SS7IPGW
2303   DCM       SS7IPGW
2305   DCM       IPGWI
2307   DCM       IPGWI
2311   DCM       IPLIMI
2313   DCM       IPLIMI

```

If no card that are assigned to the IPLIM or IPLIMI applications are shown in the `rtrv-card` output, this procedure cannot be performed.

If cards that are assigned to the IPLIM or IPLIMI applications are shown in the `rtrv-card` output, continue the procedure with [Step 2](#).

2. Display the attributes of the IPLIMx card that will be changed by entering the `rept-stat-card` command with the card location of the IPLIMx card. For this example, enter this command.

```
rept-stat-card:loc=1303
```

This is an example of possible output.

```
rlghncxa03w 10-12-28 09:12:36 GMT EAGLE5 43.0.0
CARD  VERSION      TYPE      GPL      PST      SST      AST
1303  133-003-000  ENET      IPLIM    IS-NR    Active   -----
ALARM STATUS      = No Alarms.
BLIXP  GPL version = 133-003-000
IMT BUS A         = Conn
IMT BUS B         = Conn
CURRENT TEMPERATURE = 32C ( 90F)      [ALARM TEMP: 60C (140F)]
PEAK TEMPERATURE:  = 39C (103F)      [06-05-02 13:40]
SIGNALING LINK STATUS
SLK   PST          LS          CLLI
A     IS-NR        ipnode1     -----
B     IS-NR        ipnode3     -----
Command Completed.
```

If the TYPE value for the card is not ENET, this card is not an E5-ENET card. Choose another card from the `retrv-card` output in [Step 1](#) and repeat this step.

If the TYPE value for the card is ENET, this card is an E5-ENET card.

If signaling links are not assigned to the card, this procedure cannot be performed. To make this card an IPSG card, perform the [Removing an IPLIMx Card](#) to remove the card from the database. After the card has been removed from the database, perform the procedures in [IPSG M2PA and M3UA Configuration Procedures](#) to configure an IPSG card with IPSG M2PA signaling links.

If signaling links are assigned to the card, continue the procedure by performing one of these steps.

- If the state of all the signaling links that are assigned to the card is OOS-MT-DSBLD and the state of the card is OOS-MT-DSBLD, continue the procedure with [Step 5](#).
 - If the state of all the signaling links that are assigned to the card is OOS-MT-DSBLD, but the state of the card is not OOS-MT-DSBLD, continue the procedure with [Step 4](#).
 - If the state of any of the signaling links that are assigned to the card is not OOS-MT-DSBLD, continue the procedure with [Step 3](#).
3. Place the signaling links shown in [Step 2](#) whose state is not OOS-MT-DSBLD out of service by entering the `dact-slk` command with the card location shown in the CARD column of the `rept-stat-card` output, and link value of the signaling link shown in the SLK column of the `rept-stat-card` output.

For this example, enter these commands.

```
dact-slk:loc=1303:link=a
```

```
dact-slk:loc=1303:link=b
```

When these commands have successfully completed, this message appears.

```
rlghncxa03w 10-07-17 11:43:04 GMT EAGLE5 42.0.0
Deactivate Link message sent to card.
```

Continue the procedure by performing one of these steps.

- If the state of the card is OOS-MT-DSBLD, continue the procedure with [Step 5](#).

- If the state of the card is not OOS-MT-DSBLD, continue the procedure with [Step 4](#).
4. Place the card out of service by entering the `rmv-card` command with the card location shown in the `CARD` column of the `rept-stat-card` output [Step 2](#). For this example, enter this command.

```
rmv-card:loc=1303
```

When the command has successfully completed, this message appears.

```
rlghncxa03w 10-07-17 11:43:04 GMT EAGLE5 42.0.0
Card has been inhibited.
```

5. Display the linksets that contain the signaling links shown in the `rept-stat-card` output in [Step 2](#) by entering the `rtrv-ls` command with the name of the linkset shown in the `LS` column in the `rept-stat-card` output. Repeat this step for each linkset shown in the `rept-stat-card` output.

For this example, enter these commands.

```
rtrv-ls:lsn=ipnode1
```

This is an example of possible output.

```
rlghncxa03w 10-07-17 11:43:04 GMT EAGLE5 42.0.0

LSN          APCA  (SS7)  L3T  SLT          GWS  GWS  GWS
ipnode1      002-002-002  none  1   1   no  A   1   off off off no  off

          SPCA          CLLI          TFATCABMLQ  MTPRSE  ASL8
          -----  -----  1          no      no

RANDSLS
off

IPSG  IPGWAPC  GTTMODE          CGGTMOD
no    no      CdPA          no

LOC  LINK  SLC  TYPE          IPLIML2
1303 A    0   IPLIM  M2PA

Link set table is (25 of 1024) 2% full.
```

```
rtrv-ls:lsn=ipnode3
```

This is an example of possible output.

```
rlghncxa03w 10-07-17 11:43:04 GMT EAGLE5 42.0.0

LSN          APCA  (SS7)  L3T  SLT          GWS  GWS  GWS
ipnode3      002-002-003  none  1   1   no  A   1   off off off no  off

          SPCA          CLLI          TFATCABMLQ  MTPRSE  ASL8
          -----  -----  1          no      no

RANDSLS
off
```



```

          IPSG  IPGWAPC  GTTMODE          CGGTMOD
          no    no      CdPA              no

          LOC  LINK  SLC  TYPE      IPLIML2
          1303 B    0    IPLIM     M2PA

Link set table is (25 of 1024) 2% full.

```

When the `chg-card` command is executed, the `RSVDSLKTPS` and `MAXSLKTPS` values of the linkset will be assigned based on the current `IPSG` value of the linkset.

If the current `IPSG` value of the linkset is `no`, the `RSVDSLKTPS` value of the linkset will be 0 (zero) and the `MAXSLKTPS` value of the linkset will be 4000.

If the current `IPSG` value of the linkset is `yes`, the `RSVDSLKTPS` and the `MAXSLKTPS` values will not be changed. The total TPS used by the signaling links in this linkset will be the number of signaling links in the linkset multiplied by the `RSVDSLKTPS` value of the linkset.

6. Display the associations that are assigned to the card by entering the `rtrv-assoc` command with the card location of the card that is being changed.

For this example, enter this command.

```
rtrv-assoc:loc=1303
```

This is an example of possible output.

```

rlghncxa03w 10-07-17 11:43:04 GMT EAGLE5 42.0.0
          CARD  IPLNK
ANAME      LOC  PORT  LINK  ADAPTER  LPORT  RPORT  OPEN  ALW
iplim1     1303  A    A    M2PA     2000   2000   YES   YES
iplim2     1303  A    B    M2PA     3000   2000   YES   YES

IP Appl Sock/Assoc ( 19 of 4000) 1%
Assoc Buffer Space Used (400 KB of 3200 KB) on LOC = 1303

```

If M2PA associations are not shown in the `rtrv-assoc` output, perform the [Adding an M2PA Association](#) procedure to add M2PA associations to the card.

If M2PA associations are shown in the `rtrv-assoc` output, or after the M2PA associations have been added in this step, continue the procedure by performing one of these actions.

- If the current `IPSG` value of all the linksets shown in [Step 5](#) is `no`, continue the procedure with [Step 7](#).
- If the current `IPSG` value of all the linksets shown in [Step 5](#) is `yes`, and the card's MaxTPS (see [Maximum Card Capacity for Different Card Types](#) for MaxTPS values) will not be exceeded when the `chg-card` command is executed, continue the procedure with [Step 7](#).
- If the current `IPSG` value of any of the linksets shown in [Step 5](#) is `yes`, and the card's MaxTPS value will be exceeded when the `chg-card` command is executed, perform the [Changing an IPSG M2PA Linkset](#) procedure to change the `RSVDSLKTPS` value, and the `MAXSLKTPS` value if necessary, of each `IPSG` linkset shown in the `rept-stat-card` output in [Step 2](#) as required. After the linksets have been changed, continue the procedure with [Step 7](#).

7. Display the total provisioned system TPS by entering the `rtrv-tps` command. This is an example of the possible output.

```
rlghncxa03w 10-07-10 16:20:46 GMT EAGLE 42.0.0

CARD      NUM      NUM      RSVD      MAX
TYPE     CARDS   LINKS    TPS       TPS
-----
IPGW      17      16      48000    80000
IPSG      4       8       4700     12000
IPLIM     2       4       8000     8000
ATM       2       2       3668     3668

Total provisioned System TPS (103668 of 500000) 21%

Command Completed.
```

If the `RSVDSLKTPS` or the `MAXSLKTPS` values of each linkset shown in [Step 5](#) will not exceed the maximum total provisioned system TPS value shown in the `rtrv-tps` output, continue the procedure with [Step 8](#).

If the `RSVDSLKTPS` or the `MAXSLKTPS` values of any linkset shown in [Step 5](#) will exceed the maximum total provisioned system TPS value shown in the `rtrv-tps` output, continue the procedure by performing one of these actions.

- If the maximum total provisioned system TPS value is 500,000, perform the "Activating the HIPR2 High Rate Mode Feature" procedure in *Database Administration - System Management* to increase the maximum total provisioned system TPS value to 1M. After the "Activating the HIPR2 High Rate Mode Feature" procedure has been performed, continue the procedure with [Step 8](#)
 - If the maximum total provisioned system TPS value is 1M, perform the [Changing an IPSG M2PA Linkset](#) procedure as necessary to change the `MAXSLKTPS` value, and the `RSVDSLKTPS` value if necessary, of the linksets shown in [Step 2](#) to allow the `IPLIMx` card to be changed to an `IPSG` card with this procedure. After the [Changing an IPSG M2PA Linkset](#) procedure has been performed, continue the procedure with [Step 8](#).
8. Change the `IPLIMx` card to an `IPSG` card by entering the `chg-card` command with the card location of the card being changed and the new card application, `ipsg`.

For this example, enter this command.

```
chg-card:loc=1303:nappl=ipsg
```

When this command has successfully completed, this message should appear.

```
rlghncxa03w 10-07-10 16:20:46 GMT EAGLE 42.0.0
CHG-CARD: MASP A - COMPLTD
```

9. Verify that the card has been changed by entering the `rtrv-card` command with the card location specified in [Step 8](#).

For this example, enter this command.

```
rtrv-card:loc=1303
```

This is an example of the possible output.

```
rlghncxa03w 10-07-10 16:20:46 GMT EAGLE 42.0.0
CARD   TYPE      APPL      LSET NAME      LINK SLC LSET NAME      LINK SLC
1311   ENET        IPSG      ipnode1        A    0    ipnode3        B    0
```

10. Display the linksets that were displayed in [Step 5](#) by entering the `rtrv-ls` command with the name of each linkset that was specified in [Step 5](#).

For this example, enter these commands.

```
rtrv-ls:lsn=ipnode1
```

This is an example of possible output.

```
rlghncxa03w 10-07-17 11:43:04 GMT EAGLE5 42.0.0

LSN              APCA  (SS7)  L3T SLT          GWS GWS GWS
ipnode1          002-002-002  none 1  1  no  A  1  off off off no  off

              SPCA          CLLI          TFATCABMLQ MTPRSE ASL8
              -----
              1          ---      no

RANDSLS
off

IPSG  IPGWAPC  GTTMODE          CGGTMOD
yes   no      CdPA          no

ADAPTER  RSVDSLKTPS  MAXSLKTPS
m2pa     0          4000

TPSALM   LSUSEALM   SLKUSEALM
rsvdslktps 80%    100%

LOC  LINK SLC TYPE      ANAME
1303 A  0  IPSG      iplim1

Link set table is (25 of 1024) 2% full.
```

```
rtrv-ls:lsn=ipnode3
```

This is an example of possible output.

```
rlghncxa03w 10-07-17 11:43:04 GMT EAGLE5 42.0.0

LSN              APCA  (SS7)  L3T SLT          GWS GWS GWS
ipnode3          002-002-003  none 1  1  no  A  1  off off off no  off

              SPCA          CLLI          TFATCABMLQ MTPRSE ASL8
              -----
              1          ---      no

RANDSLS
off

IPSG  IPGWAPC  GTTMODE          CGGTMOD
yes   no      CdPA          no
```

```

ADAPTER      RSVDSLKTPS  MAXSLKTPS
m2pa         0           4000

TPSALM       LSUSEALM   SLKUSEALM
rsvdslktps  80%         100%

LOC  LINK  SLC  TYPE      ANAME
1303 B    0   IPSG     iplim2

```

Link set table is (25 of 1024) 2% full.

Continue the procedure by performing these steps or actions as needed.

- If IPSG value of the linksets displayed in this step was `no` when this procedure was started, and you wish to change the RSVDSLKTPS value of any of the linksets, perform the [Changing an IPSG M2PA Linkset](#) procedure to change the RSVDSLKTPS value, and the MAXSLKTPS value if necessary, of each IPSG linkset.
- If [Step 4](#) was performed to the state of the IPLIMx card, continue the procedure with [Step 11](#).
- If [Step 3](#) was performed to change the state of the signaling links in the linksets, continue the procedure with [Step 12](#).
- If IPSG value of the linksets displayed in this step was `yes` when this procedure was started, [Step 4](#) was not performed to the state of the IPLIMx card, and [Step 3](#) was not performed to change the state of the signaling links in the linksets, continue the procedure with [Step 13](#).

11. Put the card back into service by entering the `rst-card` command with the card location specified in [Step 9](#).

For this example, enter this command.

```
rst-card:loc=1303
```

When this command has successfully completed, this message should appear.

```
rlghncxa03w 10-07-17 11:43:04 GMT EAGLE5 42.0.0
Card has been allowed.
```

If [Step 3](#) was not performed to change the state of the signaling links in the linksets, continue the procedure with [Step 13](#).

If [Step 3](#) was performed to change the state of the signaling links in the linksets, continue the procedure with [Step 12](#).

12. Put the signaling links that were taken out of service in [Step 3](#) back into service by entering the `act-slk` command with the card location and link values specified in [Step 3](#). For this example, enter these commands.

```
act-slk:loc=1303:link=a
```

```
act-slk:loc=1303:link=b
```

When these commands have successfully completed, this message appears.

```
rlghncxa03w 10-07-17 11:43:04 GMT EAGLE5 42.0.0
Activate Link message sent to card
```

13. Back up the new changes using the `chg-db:action=backup:dest=fixed` command. These messages should appear, the active Maintenance and Administration Subsystem Processor (MASP) appears first.

```
BACKUP (FIXED) : MASP A - Backup starts on active MASP.  
BACKUP (FIXED) : MASP A - Backup on active MASP to fixed disk complete.  
BACKUP (FIXED) : MASP A - Backup starts on standby MASP.  
BACKUP (FIXED) : MASP A - Backup on standby MASP to fixed disk complete.
```

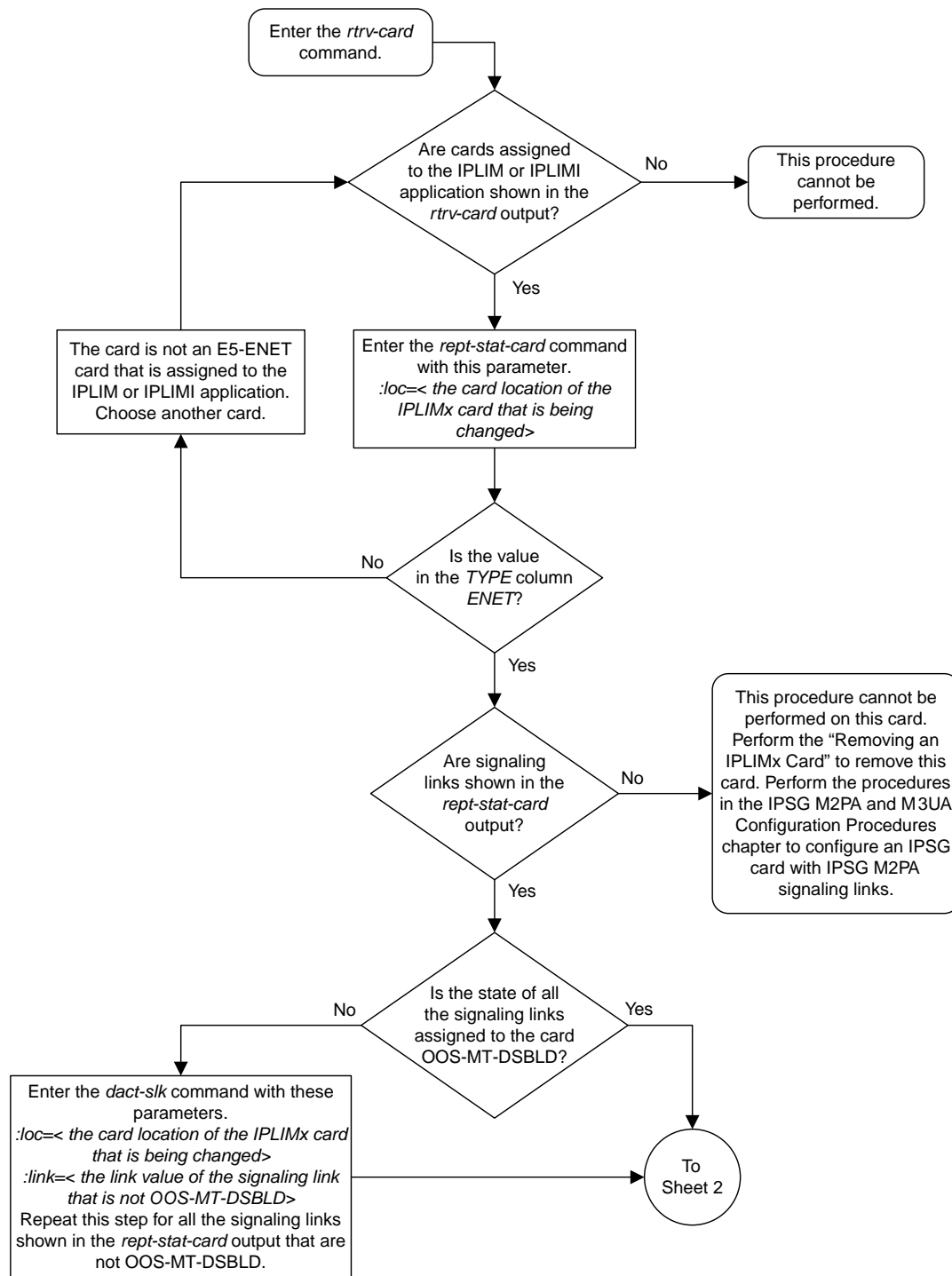

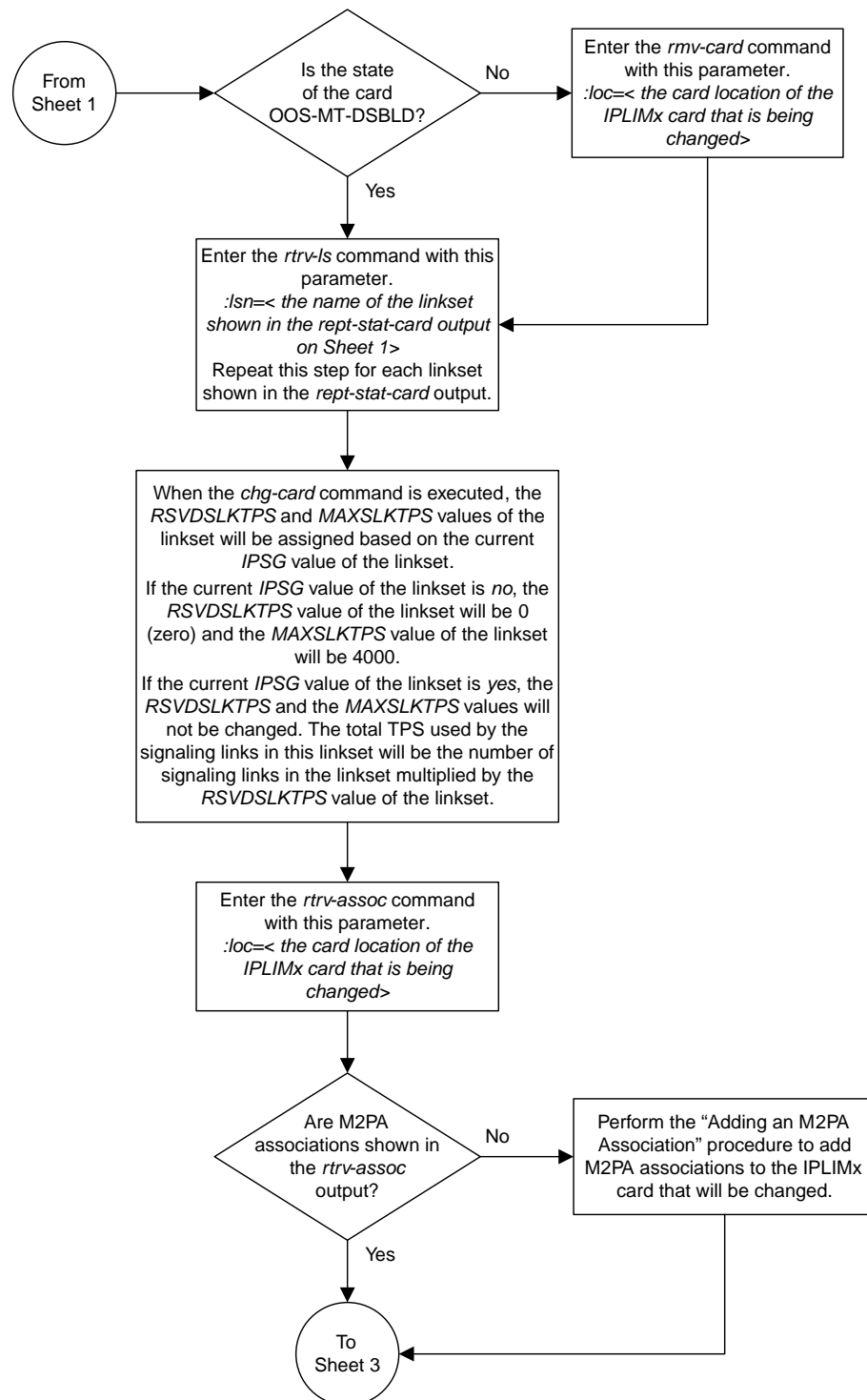

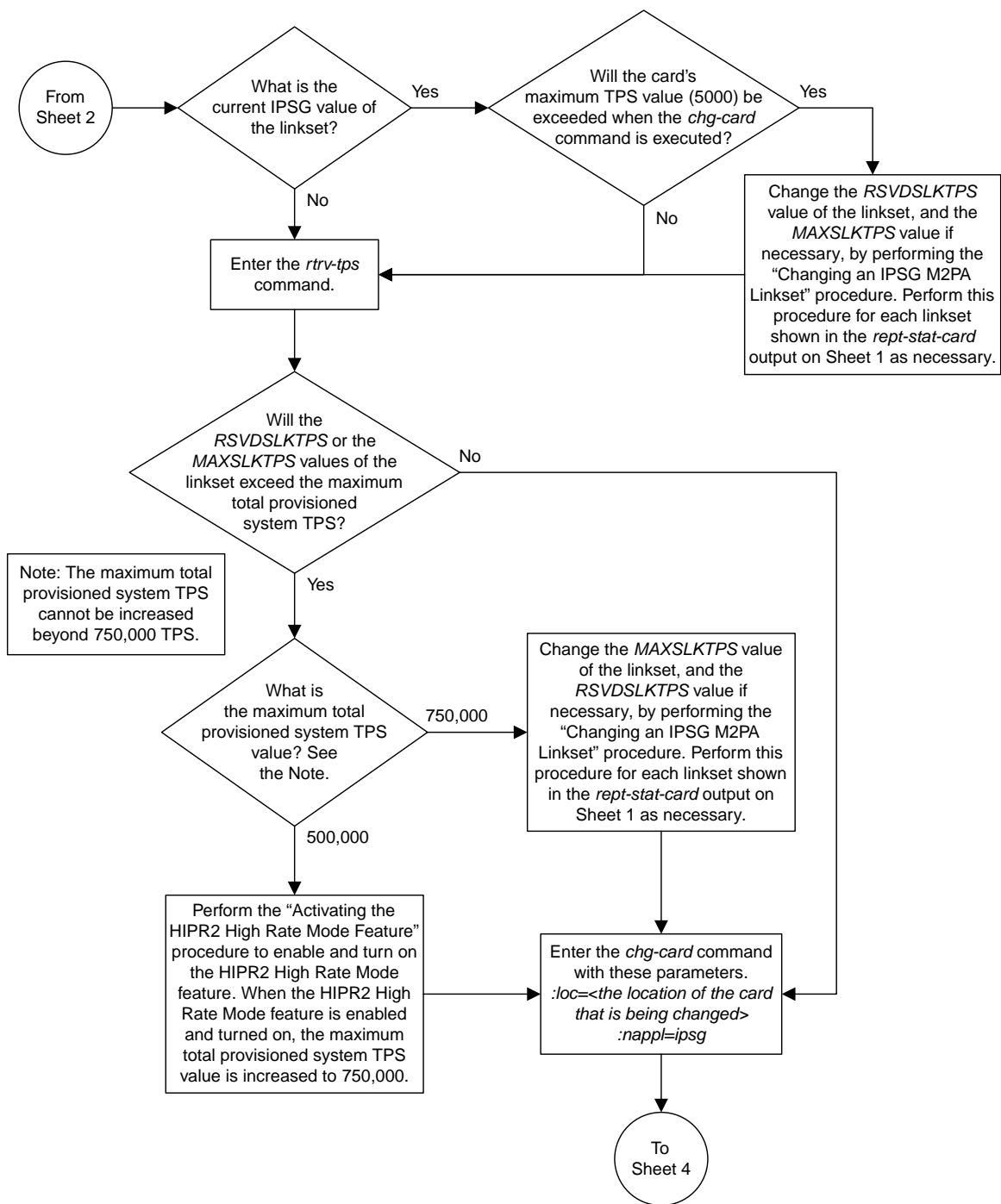

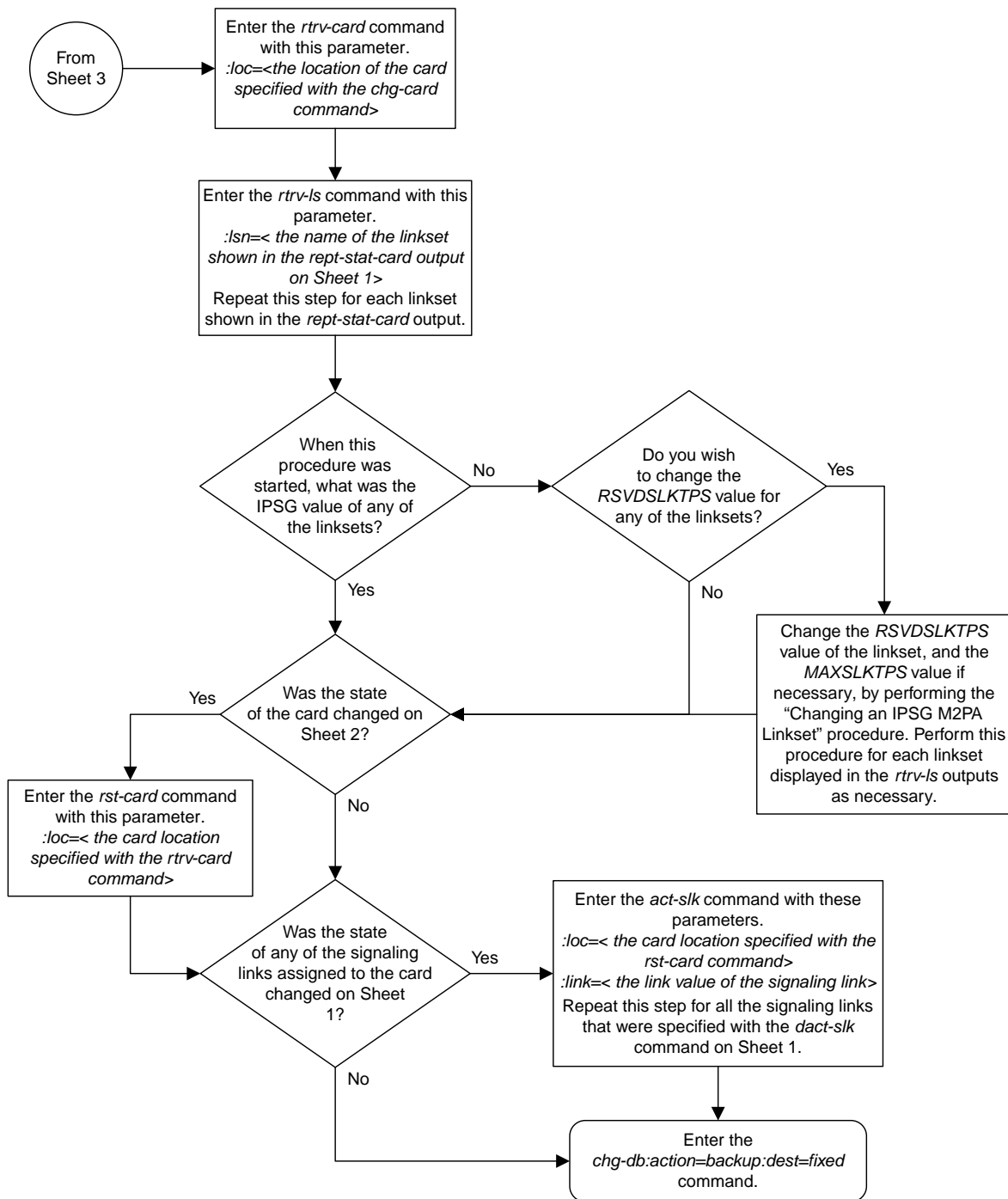

Sheet 4 of 4

Figure 110: Changing IPLIMx Card to IPSG Card

Configuring IP Options

Use this procedure to change the IP options defined by these parameters: `getcomm`, `setcomm`, `snmpcont`, `srkq`, `trapcomm`, `ipgwabate`, and `uameasusedftas`.

The `chg-sg-opts` command also contains the `sctpcsum` parameter. Perform the one of these procedures to change the `sctpcsum` parameter value.

- [Changing the SCTP Checksum Algorithm Option for M3UA and SUA Associations](#)
- [Changing the SCTP Checksum Algorithm Option for M2PA Associations](#)
- [Changing the SCTP Checksum Algorithm Option for IPSG M2PA Associations](#)
- [Changing the SCTP Checksum Algorithm Option for IPSG M3UA Associations](#)

`:getcomm` – The community name used to validate SNMP *Get* and *GetNext* requests. This value applies to each IP card SNMP agent.

`:setcomm` – The community name used to validate SNMP *Set* requests. This value applies to each IP card SNMP agent.

`:snmpcont` – The system contact information for each IP card SNMP agent, used to define the *sysContact* object in the SNMP MIB II System Group.

`:srkq` – The static routing key quantity used to specify the maximum number of static routing key entries in the Routing Key table of each `ss7ipgw` and `ipgwi` card.

`:trapcomm` – The community name used when sending SNMP traps. This value applies to each IP card SNMP agent.

`:ipgwabate` – enables (`ipgwabate=yes`) or disables (`ipgwabate=no`) SS7 congestion abatement procedures for IPGWx signaling links (signaling links assigned to cards running the `ss7ipgw` or `ipgwi` applications). The default value for this parameter is `no`.

`:uameasusedftas` - specifies whether UA measurements are pegged against the default application server or against the application server shown by the routing context. The values for this parameter are `yes` and `no`. The system default value for this parameter is `yes`.

- `yes` - UA measurement registers are pegged against the default application server.
- `no` - UA measurements are pegged against the application server shown by the routing context.

The maximum value of the `srkq` parameter is 2500.

The value specified for the `srkq` parameter cannot be less than the current number of provisioned routing keys. The number of routing keys that are currently provisioned is shown in the `rtrv-appl-rtkey` or `rtrv-tbl-capacity` command outputs.

The values of the `snmpcont`, `getcomm`, `setcomm`, and `trapcomm` parameters are a string of up to 32 characters that is not case sensitive. If the character string contains characters other than alphanumeric characters, the character string must be enclosed in single quotes.

1. Display the current IP options in the database by entering the `rtrv-sg-opts` command.

The following is an example of the possible output.

```
rlghncxa03w 08-04-28 21:17:37 GMT EAGLE5 38.0.0
SRKQ:                250
SNMPCONT:            john doe 555-123-4567
GETCOMM:             public
SETCOMM:             private
TRAPCOMM:            public
SCTPCSUM:            crc32c
IPGWABATE:           NO
UAMEASUSEDFTAS      YES
```

If the `srkq` parameter value will not be changed, continue the procedure with [Step 3](#).

If the `srkq` parameter value will be changed, verify the number of routing keys that are currently provisioned by performing [Step 2](#).

2. Enter the `rtrv-tbl-capacity` command to verify the number of routing keys that are currently provisioned.

The following is an example of the possible output.

```
rlghncxa03w 08-04-28 21:17:37 GMT EAGLE5 38.0.0
RTEKEY  table is (      53 of      2500)  2% full
```

Note: The `rtrv-tbl-capacity` command output contains other fields that are not used by this procedure. If you wish to see all the fields displayed by the `rtrv-tbl-capacity` command, see the `rtrv-tbl-capacity` command description in the *Commands Manual*.

The number of routing keys that are currently provisioned is shown in the `RTEKEY` row of the `rtrv-tbl-capacity` output. In this example, there are 53 routing keys provisioned in the database. The new `srkq` parameter value cannot be less than 53.

3. Change the IP options in the database using the `chg-sg-opts` command.

For this example, enter this command.

```
chg-sg-opts:srkq=200:ipgwabate=yes:uameasusedftas=no
```

When this command has successfully completed, the following message should appear.

```
rlghncxa03w 08-04-28 21:18:37 GMT EAGLE5 38.0.0
CHG-SG-OPTS: MASP A - COMPLTD
```

4. Verify the new IP options in the database by entering the `rtrv-sg-opts` command.

The following is an example of the possible output.

```
rlghncxa03w 08-04-28 21:19:37 GMT EAGLE5 38.0.0
SRKQ:                200
SNMPCONT:            john doe 555-123-4567
GETCOMM:             public
SETCOMM:             private
TRAPCOMM:            public
```

```
SCTPCSUM:      crc32c
IPGWABATE:     YES
UAMEASUSEDFTAS NO
```

5. Back up the new changes using the `chg-db:action=backup:dest=fixed` command. These messages should appear, the active Maintenance and Administration Subsystem Processor (MASP) appears first.

```
BACKUP (FIXED) : MASP A - Backup starts on active MASP.
BACKUP (FIXED) : MASP A - Backup on active MASP to fixed disk complete.
BACKUP (FIXED) : MASP A - Backup starts on standby MASP.
BACKUP (FIXED) : MASP A - Backup on standby MASP to fixed disk complete.
```

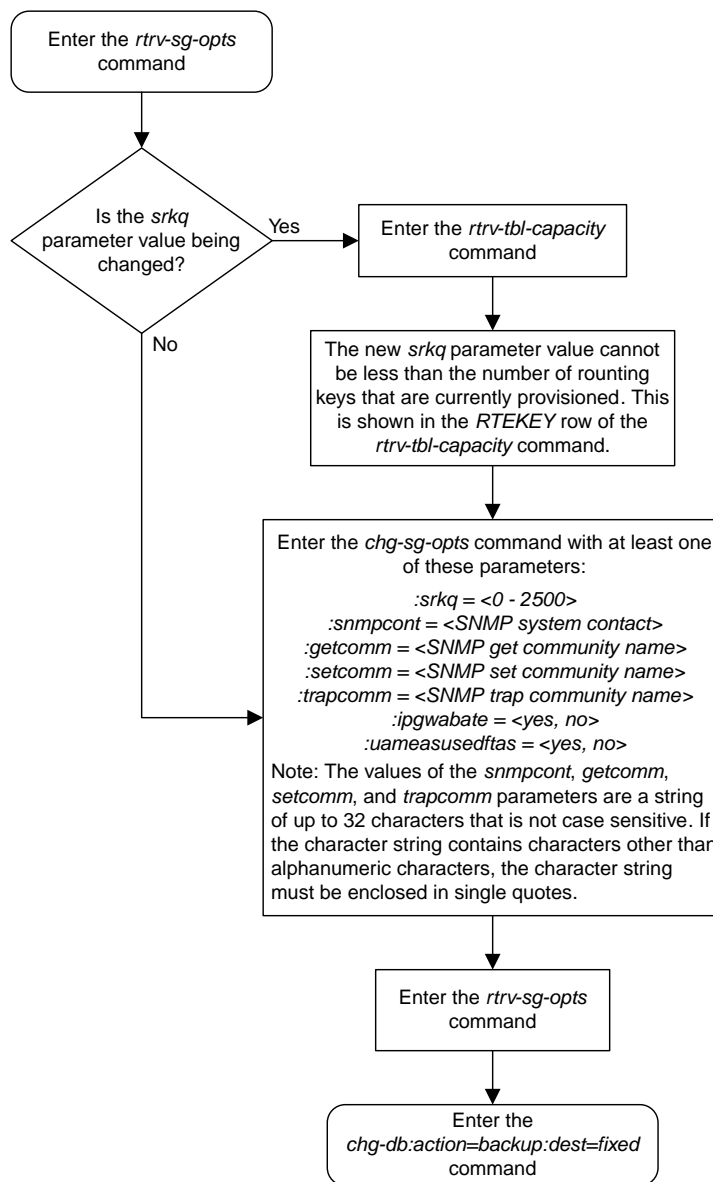

Figure 111: Configuring IP Options

Configuring IPSG M3UA Linkset Options

This procedure is used to configure the options for an IPSG M3UA linkset with the `chg-lsopts` command and these parameters.

`:lsn` - The name of the IPSG M3UA linkset.

`:numslkalw` - This parameter specifies the number of IS-NR (in-service normal) signaling links in the IPSG M3UA linkset required to change the state of the linkset from the Restricted or Prohibited state to the Allowed state. When the number of IS-NR signaling links in the linkset changes from a value that is less than the `numslkalw` parameter value to a value that is equal or greater than the `numslkalw` value, the state of the linkset changes to the Allowed state. The value of this parameter is from 0 to 16. The value of this parameter cannot exceed the number of signaling links that are assigned to the linkset. The value 0 represents half the number of signaling links that are assigned to the linkset. If this parameter is not specified, the current value of this parameter is not changed. The system default value for this parameter is 1.

`:numslkrstr` - This parameter specifies the number of signaling links in the IPSG M3UA linkset required to change the state of the linkset from the Allowed state to the Restricted state. When the number of IS-NR signaling links in the linkset changes from a value that is equal to or greater than the `numslkrstr` parameter value to a value that is less than the `numslkrstr` parameter value and greater than the `numslkproh` parameter value, the state of the linkset changes from the Allowed state to the Restricted state. Changing the state of the linkset from the Prohibited state to the Restricted state is not supported. The value of this parameter is from 0 to 16. The value of this parameter cannot exceed the number of signaling links that are assigned to the linkset. The value 0 represents half the number of signaling links that are assigned to the linkset. If this parameter is not specified, the current value of this parameter is not changed. The system default value for this parameter is 1.

`:numslkproh` - This parameter specifies the number of signaling links in the IPSG M3UA linkset required to change the state of the linkset from the Allowed or Restricted state to the Prohibited state. When the number of IS-NR signaling links in the linkset changes from a value that is equal to or greater than the `numslkproh` parameter value to a value that is less than the `numslkproh` parameter value, the state of the linkset changes from the Allowed or Restricted state to the Prohibited state. The value of this parameter is from 0 to 16. The value of this parameter cannot exceed the number of signaling links that are assigned to the linkset. The value 0 represents half the number of signaling links that are assigned to the linkset. If this parameter is not specified, the current value of this parameter is not changed. The system default value for this parameter is 1.

An IPSG M3UA linkset is a linkset that contains these values: `IPSG=yes, ADAPTER=m3ua`.

If the IPSG M3UA linkset contains no signaling links, the value of the `numslkalw`, `numslkrstr`, or `numslkproh` parameters can only be changed to 0 or 1.

If 0 is specified as the value of the `numslkalw`, `numslkrstr`, or `numslkproh` parameters, a number with an asterisk (*) is shown as the value of the `numslkalw`, `numslkrstr`, or `numslkproh` parameter.

1. Display the IPSG and IPGWx linksets that are provisioned in the database by entering the `rept-stat-iptps` command.

The following is an example of the possible output.

```
rlghncxa03w 10-07-19 21:16:37 GMT EAGLE5 42.0.0
```

```

IP TPS USAGE REPORT

          THRESH  CONFIG/  CONFIG/          TPS  PEAK          PEAKTIMESTAMP
          RSVD    MAX
-----
LSN
ipgwx1    100%    ----    32000 TX:    3700    4000    10-07-19 09:49:19
          RCV:    3650    4000    10-07-19 09:49:19
ipgwx2    100%    ----    16000 TX:    4800    5000    10-07-19 09:49:09
          RCV:    4850    5000    10-07-19 09:49:09
ipgwx3    100%    ----    32000 TX:     427     550    10-07-19 09:49:19
          RCV:     312     450    10-07-19 09:49:19
ipsglsn   100%     600    24000 TX:    4800    5000    10-07-19 09:49:19
          RCV:    4800    5000    10-07-19 09:49:19
ipsglsn2  100%     600     4000 TX:     427     550    10-07-19 09:49:19
          RCV:     312     450    10-07-19 09:49:19
ipsgm3ua  100%     100     500  TX:     312     450    10-07-19 09:49:19
          RCV:     312     450    10-07-19 09:49:19
-----
Command Completed.
    
```

If no linksets are shown in this step, this procedure cannot be performed.

If linksets are shown in this step, continue the procedure with [Step 2](#).

2. Display one of the linksets shown in [Step 1](#) by entering the `rtrv-ls` command with the name of one of the linksets shown in [Step 1](#). For this example, enter this command.

```
rtrv-ls:lsn=ipsgm3ua
```

The following is an example of the possible output.

```

rlghncxa03w 08-04-28 21:17:37 GMT EAGLE5 38.0.0

LSN          APCA  (SS7)  L3T  SLT          GWS  GWS  GWS
ipsgm3ua    008-008-004  none  1   1   no  A   5   off off off no  off

          SPCA          CLLI          TFATCABMLQ  MTPRSE  ASL8
          -----          -----          ---          ---          no

RANDSLS
off

IPSG  IPGWAPC  GTTMODE          CGGTMOD
yes   no      CdPA          no

ADAPTER  RSVDSLKTPS  MAXSLKTPS
m3ua     100          500

TPSALM  LSUSEALM  SLKUSEALM
rsvdslktps 100%      80%

RCONTEXT  ASNOTIF  NUMSLKALW  NUMSLKRSTR  NUMSLKPROH
1234567890 yes      1*          1            1

LOC  LINK  SLC  TYPE  ANAME
1102 A   0   IPSG  ipsgm3ua1102
1202 A   1   IPSG  ipsgm3ua1202
1302 A   2   IPSG  ipsgm3ua1302
    
```

```

1303 A    3    IPSG    ipsgm3ua1303
1305 A    4    IPSG    ipsgm3ua1305

```

```
Link set table is (13 of 1024) 1% full.
```

IPSG M3UA linksets are shown by the entry `m3ua` in the `ADAPTER` column of the `rtrv-ls` output. If the linkset is an IPSG M3UA linkset, continue the procedure with [Step 3](#)

If the linkset is not an IPSG M3UA linkset, perform one of these actions.

- Choose another linkset from [Step 1](#) and repeat this step.
- If you do not wish to choose another linkset, the remainder of this procedure cannot be performed. This procedure is finished.

3. Change the IPSG M3UA linkset options by entering the `chg-lsopts` command.

For this example, enter this command.

```
chg-lsopts:lsn=ipsgm3ua:numslkalw=3:numslkrstr=2:numslkproh=2
```

The value of the `numslkalw`, `numslkrstr`, or `numslkproh` parameters cannot exceed the number of signaling links that are assigned to the linkset.

The value of the `numslkrstr` parameter must be less than or equal to the `numslkalw` parameter value.

The value of the `numslkproh` parameter must be less than or equal to the `numslkrstr` parameter value.

When this command has successfully completed, the following message should appear.

```

rlghncxa03w 08-04-28 21:18:37 GMT EAGLE5 38.0.0
Link set table is (13 of 1024) 1% full.
CHG-LSOPTS: MASP A - COMPLTD

```

4. Verify the changes by entering the `rtrv-ls` command with the name of the linkset specified in [Step 3](#). For this example, enter this command.

```
rtrv-ls:lsn=ipsgm3ua
```

The following is an example of the possible output.

```

rlghncxa03w 08-04-28 21:17:37 GMT EAGLE5 38.0.0

LSN              APCA  (SS7)  SCRN SET SET BEI LST LNKS ACT MES DIS SLSCI NIS
ipsgm3ua         008-008-004  none 1  1  no  A  5  off off off no  off

              SPCA              CLLI              TFATCABMLQ MTPRSE ASL8
              -----              ---              ---      no

RANDSLS
off

IPSG  IPGWAPC  GTTMODE              CGGTMOD
yes   no      CdPA              no

```



```

ADAPTER      RSVDSLKTPS  MAXSLKTPS
m3ua         100         500

TPSALM      LSUSEALM    SLKUSEALM
rsvdslktps  100%       80%

RCONTEXT    ASNOTIF     NUMSLKALW  NUMSLKRSTR  NUMSLKPROH
1234567890  yes         3          2           2

LOC  LINK  SLC  TYPE  ANAME
1102 A    0   IPSE  ipsgm3ua1102
1202 A    1   IPSE  ipsgm3ua1202
1302 A    2   IPSE  ipsgm3ua1302
1303 A    3   IPSE  ipsgm3ua1303
1305 A    4   IPSE  ipsgm3ua1305

```

Link set table is (13 of 1024) 1% full.

5. Back up the new changes using the `chg-db:action=backup:dest=fixed` command. These messages should appear, the active Maintenance and Administration Subsystem Processor (MASP) appears first.

```

BACKUP (FIXED) : MASP A - Backup starts on active MASP.
BACKUP (FIXED) : MASP A - Backup on active MASP to fixed disk complete.
BACKUP (FIXED) : MASP A - Backup starts on standby MASP.
BACKUP (FIXED) : MASP A - Backup on standby MASP to fixed disk complete.

```

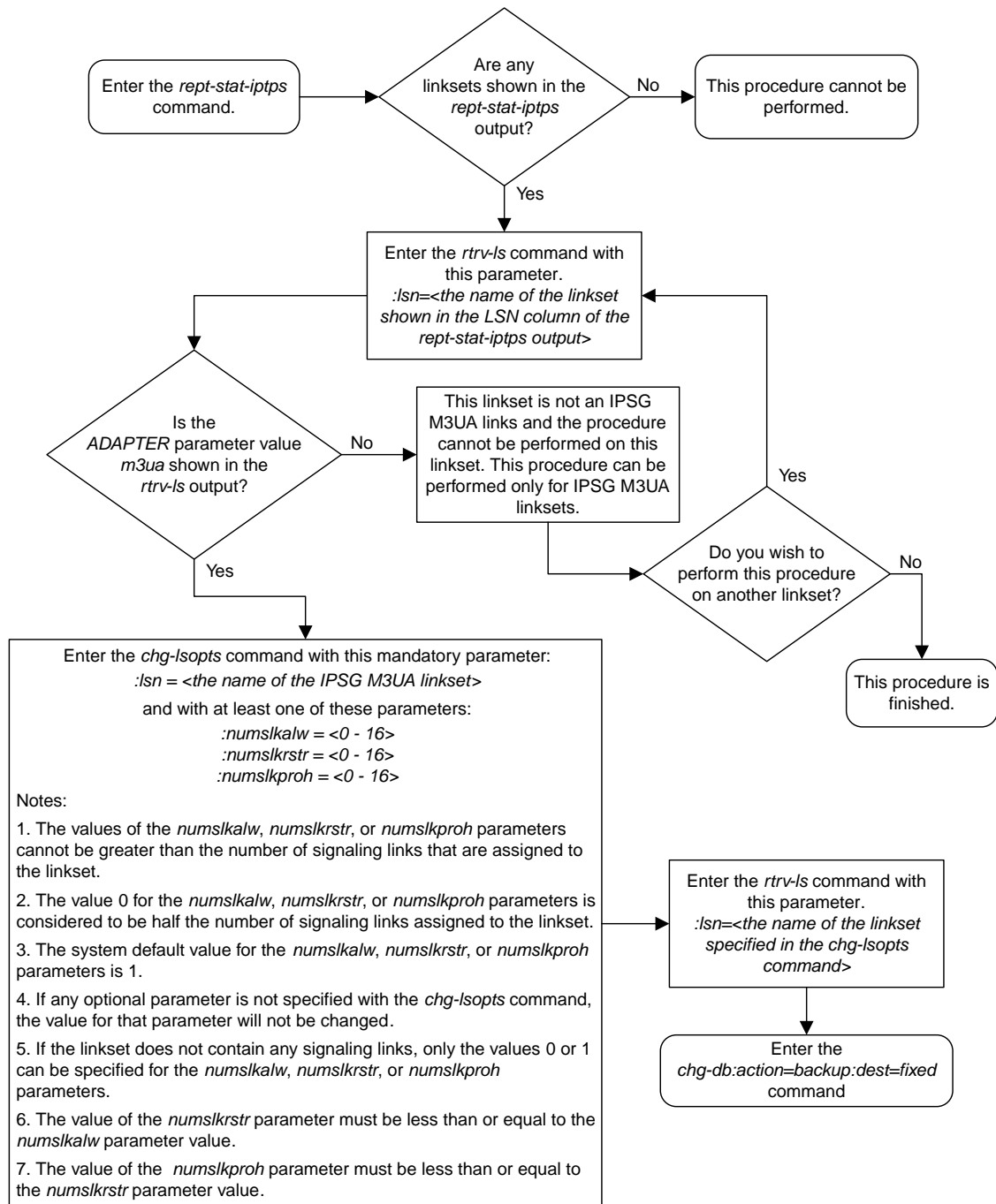

Figure 112: Configuring IPSG M3UA Linkset Options

Changing an IPSG M2PA Linkset

This procedure is used to change an IPSG M2PA linkset, a linkset that contains the `IPSG` value `yes` and whose `ADAPTER` value is `m2pa`, in the EAGLE using the `chg-ls` commands with these parameters.

`:lsn` – The name of the linkset that will be changed, shown in the `rtv-ls` output.

`:ipsg` – This parameter specifies whether or not the linkset is an IPSG linkset. This parameter has two values, `yes` (if the linkset is an IPSG linkset) or `no` (if the linkset is not an IPSG linkset). For this procedure, the `ipsg` parameter value must be `yes`.

`:maxslktps` – The maximum number of transactions per second (TPS) for all signaling links that are assigned to the IPSG M2PA linkset. See [Maximum Card Capacity for Different Card Types](#) for MaxTPS values.

`:rsvdslktps` – The number of transactions per second (TPS) that is assigned to each IPSG signaling link that will be in the linkset. See [Maximum Card Capacity for Different Card Types](#) for MaxTPS values. The `slktps` parameter can be used in place of the `rsvdslktps` parameter.

`:tpsalmtype` – The TPS threshold that will generate alarms. This parameter has two values.

- `rsvdslktps` - The RSVDSLKTPS threshold generates alarms.
- `maxslktps` - The MAXSLKTPS threshold generates alarms.

`:adapter` - This parameter specifies the adapter layer for the signaling links that will be assigned to the IPSG M2PA linkset. This parameter has two values, `m2pa` and `m3ua`. For an IPSG M2PA linkset, the `adapter` parameter value must be `m2pa`.

`:lsusealm` – The linkset's TPS alarm threshold, from 10 to 100 percent of the linkset's TPS. When this threshold is reached, a major alarm (UAM 0115) is generated. When the linkset's TPS falls below this threshold, UAM 0115 is automatically cleared and UAM 0118 is generated.

`:slkusealm` – The signaling link TPS alarm threshold, from 10 to 100 percent of the signaling link's fair share of the linkset's TPS or from 10 to 100 percent of the IPSG card's capacity. See [Maximum Card Capacity for Different Card Types](#) for MaxTPS values. This threshold is reached when the signaling link's actual usage exceeds the percentage of the signaling link's fair share of the linkset's TPS or the percentage of the IPSG card's capacity.

A signaling link's fair share of linkset's TPS is the linkset's TPS divided by the number of in-service links in the linkset. For example, if the linkset TPS is 4000 and there are 4 signaling links in the linkset, all in-service, then the signaling link's fair-share would be 1000 TPS ($4000/4=1000$). [Table 56: Signaling Link Fair Share Example](#) shows this calculation for a linkset with 1, 2, 3 and 4 in-service signaling links.

Table 56: Signaling Link Fair Share Example

Number of In-Service Signaling Links	Linkset TPS	Signaling Link Fair Share of the Linkset TPS
4	4000	1000
3	4000	1333
2	4000	2000

Number of In-Service Signaling Links	Linkset TPS	Signaling Link Fair Share of the Linkset TPS
1	4000	4000

When this threshold is exceeded, a minor alarm (UAM 0116) is generated. When the amount of traffic on the signaling link falls below this threshold, UAM 0116 is automatically cleared and UAM 0119 is generated.

The signaling link TPS alarm shows that the linkset TPS is set too low for the linkset or that the IPSG card's capacity has been exceeded. Setting the signaling link TPS alarm threshold lower than the linkset TPS alarm threshold can give the user an earlier indication that the linkset TPS is inadequate or that traffic is not balanced across the links in the linkset.

Changing the MAXSLKTPS or RSVDSLKTPS values for the IPSG M2PA linkset cannot exceed the maximum total provisioned system TPS shown in the `rtrv-tps` output. If changing the IPSG M2PA linkset will exceed the maximum total provisioned system TPS, and the maximum total provisioned system TPS is 500,000, perform the "Activating the HIPR2 High Rate Mode" feature in *Database Administration - System Management* to enable and turn on the HIPR2 High Rate Mode feature. When the HIPR2 High Rate Mode feature is enabled and turned on, the maximum total provisioned system TPS is increased to 1,000,000 (1M). If the maximum total provisioned system TPS is 1M or the maximum total provisioned system TPS is 500,000 and will not be increased, and changing the MAXSLKTPS or RSVDSLKTPS values for the IPSG M2PA linkset will exceed the maximum total provisioned system TPS, the MAXSLKTPS or RSVDSLKTPS values for the IPSG M2PA linkset cannot be changed unless the amount of available TPS is reduced enough to allow the MAXSLKTPS or RSVDSLKTPS values for the IPSG M2PA linkset to be changed. The available TPS can be reduced by performing one or more of these actions.

- The IP TPS values of some IPGWx linksets have to be changed.
- The MAXSLKTPS values of some IPSG linksets (and the RSVDSLKTPS values if necessary) have to be changed.
- Some ATM high-speed signaling links have to be removed.
- An IPLIMx card that contains signaling links has to be removed.

This procedure can also be used to change an IPSG M3UA linkset or a non-IPSG linkset to an IPSG M2PA linkset.

Other Optional Parameters

There are other optional parameters for an IPSG M2PA that can be changed. These parameters are not required for IPSG M2PA linkset. These parameters are discussed in more detail in *Commands User's Guide* or in these sections.

- These procedures in this manual:
 - [Adding a Mate IPGWx Linkset to another IPGWx Linkset](#)
 - [Removing a Mate IPGWx Linkset from another IPGWx Linkset](#)
 - [Configuring an IPGWx Linkset](#)
- These procedures in *Database Administration - SS7 User's Guide*
 - Adding an SS7 Linkset
 - Changing an SS7 Linkset
 - Configuring an ITU Linkset with a Secondary Adjacent Point Code (SAPC)

- The "Configuring a Linkset for the GSM MAP Screening Feature" procedure in *Database Administration - Features User's Guide*.

Canceling the RTRV-LS Command

Because the `rtrv-ls` command used in this procedure can output information for a long period of time, the `rtrv-ls` command can be canceled and the output to the terminal stopped. There are three ways that the `rtrv-ls` command can be canceled.

- Press the F9 function key on the keyboard at the terminal where the `rtrv-ls` command was entered.
- Enter the `canc-cmd` without the `trm` parameter at the terminal where the `rtrv-ls` command was entered.
- Enter the `canc-cmd:trm=<xx>`, where `<xx>` is the terminal where the `rtrv-ls` command was entered, from another terminal other than the terminal where the `rtrv-ls` command was entered. To enter the `canc-cmd:trm=<xx>` command, the terminal must allow Security Administration commands to be entered from it and the user must be allowed to enter Security Administration commands. The terminal's permissions can be verified with the `rtrv-secu-trm` command. The user's permissions can be verified with the `rtrv-user` or `rtrv-secu-user` commands.

For more information about the `canc-cmd` command, go to *Commands User's Guide*.

1. Display the current linksets in the database using the `rtrv-ls` command.

This is an example of the possible output.

```
rlghncxa03w 08-04-10 11:43:04 GMT EAGLE5 38.0.0
                                L3T SLT
LSN          APCA   (SS7)  SCRN  SET  SET  BEI  LST  LNKS  ACT  MES  DIS  SLSCI  NIS
ele2         001-207-000  none  1    1    no  B    6    off  off  off  no    off
elm1s1      001-001-001  none  1    1    no  A    7    off  off  off  no    off
elm1s2      001-001-002  none  1    1    no  A    7    off  off  off  no    off
ls1305      001-005-000  none  1    1    no  A    1    off  off  off  no    off
ls1307      001-007-000  none  1    1    no  A    1    off  off  off  no    off
lsgw1101    008-012-003  none  1    1    no  A    1    off  off  off  no    off
lsgw1103    003-002-004  none  1    1    no  A    1    off  off  off  no    off
lsgw1105    009-002-003  none  1    1    no  A    1    off  off  off  no    off

                                L3T SLT
LSN          APCI   (SS7)  SCRN  SET  SET  BEI  LST  LNKS  ACT  MES  DIS  SLSCI  NIS
ele2i       1-207-0      none  1    1    no  B    4    off  off  off  ---   on
ls1315      0-015-0      none  1    1    no  A    1    off  off  off  ---   off
ls1317      0-017-0      none  1    1    no  A    1    off  off  off  ---   on
elm2s1      1-011-1      none  1    1    no  A    7    off  off  off  ---   off
elm2s2      1-011-2      none  1    1    no  A    7    off  off  off  ---   off

Link set table is (13 of 1024) 1% full.
```

2. Display a linkset shown in [Step 1](#) by entering the `rtrv-ls` command with the name of the linkset shown in [Step 1](#). For this example, enter these commands.

```
rtrv-ls:lsn=lsgw1101
```

This is an example of the possible output.

If you do not wish to change this linkset, choose another linkset from [Step 1](#) and repeat this step.

If this linkset will be changed, perform one of these steps.

- If the IPGWAPC value of the linkset is *yes* or if the IPGWAPC and IPSG values of the linkset are *no*, the linkset must be removed from the database and then an IPSG M2PA linkset must be added. Perform the "Removing a Linkset Containing SS7 Signaling Links" procedure in *Database Administration - SS7 User's Guide* to remove the linkset. After the linkset has been removed, perform the [Adding an IPSG M2PA Linkset](#) procedure to add the IPSG M2PA linkset. After the IPSG M2PA linkset has been added, perform the [Adding an IPSG M2PA Signaling Link](#) procedure to add IPSG M2PA signaling links to the new IPSG M2PA linkset. This procedure is finished.
 - If the IPSG value of the linkset is *yes*, continue the procedure with one of these steps.
 - If the ADAPTER value of the linkset is M3UA, perform the [Adding an IPSG M3UA Signaling Link](#) procedure to remove the IPSG M3UA signaling links from the linkset. After the IPSG M3UA linksets have been removed from the linkset, continue the procedure with [Step 3](#).
 - If the ADAPTER value of the linkset is M2PA, continue the procedure with one of these steps.
 - If the RSVDSLKTPS value of the linkset will not be changed, continue the procedure with [Step 5](#).
 - If the RSVDSLKTPS value of the linkset will be changed, continue the procedure with [Step 4](#).
3. Change the ADAPTER value of the linkset to M2PA by entering the `chg-ls` command with the `adapter=m2pa` parameter and the name of the linkset that is being changed. For this example, enter this command.

```
chg-ls:lsn=lssg1101:adapter=m2pa
```

When the `chg-ls` command has successfully completed, this message should appear.

```
rlghncxa03w 08-04-20 13:34:40 GMT EAGLE5 38.0.0
Link set table is (13 of 1024) 1% full.
CHG-LS: MASP A - COMPLTD
```

After the ADAPTER value of the linkset has been changed, continue the procedure by performing one of these steps.

- If the RSVDSLKTPS value of the linkset will not be changed, continue the procedure with [Step 5](#).
 - If the RSVDSLKTPS value of the linkset will be changed, continue the procedure with [Step 4](#).
4. The new RSVDSLKTPS value for the linkset cannot allow the sum of the TPS used by all the IPSG signaling links that are assigned to each IPSG card shown in the linkset to exceed the MaxTPS (see [Maximum Card Capacity for Different Card Types](#) for MaxTPS values) and cannot exceed the maximum total provisioned system TPS.

To verify the TPS for the IPSG cards containing the IPSG signaling links in the linkset, enter the `rtrv-slk` command with the card location of each signaling link that is assigned to the linkset. For this example, enter these commands.

```
rtrv-slk:loc=1101
```

This is an example of the possible output.

```
rlghncxa03w 08-04-24 14:02:40 EST 38.0.0
rtrv-slk:loc=1101
Command entered at terminal #4.

LOC LINK LSN          SLC TYPE      ANAME          SLKTPS
1101 A2  lssg1101      0  IPSG        m2pa2          1000

IPTPS for LOC = 1101 is (1000 of 5000) 20%
```

```
rtrv-slk:loc=1105
```

This is an example of the possible output.

```
rlghncxa03w 08-04-24 14:02:40 EST 38.0.0
rtrv-slk:loc=1101
Command entered at terminal #4.

LOC LINK LSN          SLC TYPE      ANAME          SLKTPS
1105 A7  lssg1101      0  IPSG        m2pa2          1000

IPTPS for LOC = 1105 is (1000 of 5000) 20%
```

If the new RSVDSLKTPS value for the linkset will allow the TPS for the IPSG cards containing the IPSG signaling links in the linkset to exceed the MaxTPS (See [Maximum Card Capacity for Different Card Types](#) for MaxTPS values), choose an RSVDSLKTPS value that will not exceed the MaxTPS limit for the IPSG card.

5. Display the total provisioned system TPS by entering the `rtrv-tps` command. This is an example of the possible output.

```
rlghncxa03w 10-07-10 16:20:46 GMT EAGLE 42.0.0

CARD      NUM      NUM      RSVD      MAX
TYPE     CARDS   LINKS    TPS       TPS
-----  -
IPGW      17       16      48000     80000
IPSG       3         7       4200      8000
IPLIM     2         4       8000      8000
ATM       2         2       3668      3668

Total provisioned System TPS (99668 of 500000) 20%

Command Completed.
```

An IPSG M2PA linkset uses MAXSLKTPS (see [Maximum Card Capacity for Different Card Types](#) for MaxTPS values), as provisioned by the `maxslktps` parameter. If adding the new IPSG M2PA linkset will not exceed the maximum total provisioned system TPS, continue the procedure with [Step 11](#).

If adding the new IPSG M2PA linkset will exceed the maximum total provisioned system TPS, and the maximum total provisioned system TPS is 500,000 shown, perform the "Activating the HIPR2 High Rate Mode Feature" procedure in *Database Administration - System Management User's Guide* to enable and turn on the HIPR2 High Rate Mode feature. When the HIPR2 High Rate Mode feature is enabled and turned on, the maximum total provisioned system TPS is increased to 1M. After the

HIPR2 High Rate Mode feature has been enabled and turned on, continue the procedure with [Step 11](#).

If the maximum total provisioned system TPS is 1M, or the maximum total provisioned system TPS is 500,000 and will not be increased, and adding the IPSG M2PA linkset will exceed the maximum total provisioned system TPS, the IPSG M2PA linkset cannot be added unless the amount of available TPS is reduced enough to allow the IPSG M2PA linkset to be changed. The available TPS can be increased by performing one or more of these actions.

- The IP TPS values of some IPGWx linksets have to be changed. To perform this action, continue the procedure with [Step 8](#).
- The MAXSLKTPS values of some IPSG linksets (and the RSVDSLKTPS values if necessary) have to be changed. To perform this action, continue the procedure with [Step 8](#).
- Some ATM high-speed signaling links have to be removed. To perform this action, continue the procedure with [Step 6](#).
- An IPLIMx card that contains signaling links has to be removed. To perform this action, continue the procedure with [Step 7](#).

6. Display the ATM high-speed signaling links by entering this command.

```
rtrv-slk:type=saal
```

This is an example of the possible output.

```
rlghncxa03w 10-07-19 21:16:37 GMT EAGLE5 42.0.0

LOC LINK LSN          SLC TYPE      LP          ATM
1303 A  lsnds0          1  LIMATM     1  1.544M LINE    5  0  0

LOC LINK LSN          SLC TYPE      LP          ATM          E1ATM
1306 A  lsniuatm        0  LIM1ATM    21  2.048M LINE    5  0  ON  3  0

SLK table is (30 of 1200) 2% full.
```

If ATM high-speed signaling links are shown in the `rtrv-slk` output, perform the "Removing an SS7 Signaling Link" procedure in *Database Administration - SS7 User's Guide* to remove some of the ATM high-speed signaling links.

If ATM high-speed signaling links are not displayed in the `rtrv-slk` output, perform one or more of these actions to increase the available TPS.

Note: If one or more of these actions are not performed to increase the available TPS and the available TPS will not allow the IPSG M2PA linkset to be changed, the IPSG M2PA linkset cannot be added and the remainder of this procedure cannot be performed.

- The IP TPS values of some IPGWx linksets have to be changed. To perform this action, continue the procedure with [Step 8](#).
- The MAXSLKTPS values of some IPSG linksets (and the RSVDSLKTPS values if necessary) have to be changed. To perform this action, continue the procedure with [Step 8](#).
- An IPLIMx card that contains signaling links has to be removed. To perform this action, continue the procedure with [Step 7](#).

If you do not wish to perform other actions to increase the available TPS and the available TPS will allow the IPSG M2PA linkset to be changed, continue the procedure with [Step 11](#).

7. Display the signaling links that are assigned to IPLIMx cards by entering this command.

```
rtrv-slk:type=iplim
```

This is an example of the possible output.

```
rlghncxa03w 10-07-19 21:16:37 GMT EAGLE5 42.0.0

LOC LINK LSN          SLC TYPE      ANAME          SLKTPS
1301 A  lsniplim      0  IPLIM      M2PA
1301 A1 lsniplim      1  IPLIM      M2PA
1301 B1 lsniplim      2  IPLIM      M2PA
1317 A  lsniplimi     0  IPLIMI     M2PA

SLK table is (30 of 1200) 2% full.
```

If IPLIMx cards containing signaling links are shown in the `rtrv-slk` output, perform the [Removing an IPLIMx Card](#) procedure to remove an IPLIMx card and its associated signaling links.

If IPLIMx cards containing signaling links are not displayed in the `rtrv-slk` output, perform one or more of these actions to increase the available TPS.

Note: If one or more of these actions are not performed to increase the available TPS and the available TPS will not allow the IPSG M2PA linkset to be changed, the IPSG M2PA linkset cannot be added and the remainder of this procedure cannot be performed.

- The IP TPS values of some IPGWx linksets have to be changed. To perform this action, continue the procedure with [Step 8](#).
- The MAXSLKTPS values of some IPSG linksets (and the RSVDSLKTPS values if necessary) have to be changed. To perform this action, continue the procedure with [Step 8](#).
- Some ATM high-speed signaling links have to be removed. To perform this action, continue the procedure with [Step 6](#).

If you do not wish to perform other actions to increase the available TPS and the available TPS will allow the IPSG M2PA linkset to be changed, continue the procedure with [Step 11](#).

8. Display the IPGWx and IPSG linksets by entering this command.

```
rept-stat-iptps
```

This is an example of the possible output.

```
rlghncxa03w 10-07-19 21:16:37 GMT EAGLE5 42.0.0
IP TPS USAGE REPORT
```

LSN	THRESH	CONFIG/ RSVD	CONFIG/ MAX		TPS	PEAK	PEAKTIMESTAMP
ipgwx1	100%	----	32000	TX:	3700	4000	10-07-19 09:49:19
				RCV:	3650	4000	10-07-19 09:49:19
ipgwx2	100%	----	16000	TX:	4800	5000	10-07-19 09:49:09
				RCV:	4850	5000	10-07-19 09:49:09
ipgwx3	100%	----	32000	TX:	427	550	10-07-19 09:49:19
				RCV:	312	450	10-07-19 09:49:19
ipsglsn	100%	600	24000	TX:	4800	5000	10-07-19 09:49:19
				RCV:	4800	5000	10-07-19 09:49:19
ipsglsn2	100%	600	4000	TX:	427	550	10-07-19 09:49:19

```
-----
RCV:      312      450  10-07-19 09:49:19
-----
```

Command Completed.

If linksets are displayed in the `rept-stat-iptps` output, continue the procedure with [Step 9](#).

If linksets are not displayed in the `rept-stat-iptps` output, perform one or more of these actions to increase the available TPS.

Note: If one or more of these actions are not performed to increase the available TPS and the available TPS will not allow the IPSG M2PA linkset to be changed, the IPSG M2PA linkset cannot be added and the remainder of this procedure cannot be performed.

- An IPLIMx card that contains signaling links has to be removed. To perform this action, continue the procedure with [Step 7](#).
- Some ATM high-speed signaling links have to be removed. To perform this action, continue the procedure with [Step 6](#).

If you do not wish to perform other actions to increase the available TPS and the available TPS will allow the IPSG M2PA linkset to be changed, continue the procedure with [Step 11](#).

9. Display the attributes of the linksets shown in [Step 8](#) by entering the `rtrv-ls` command with the name of the linkset shown in [Step 8](#).

For this example enter these commands.

```
rtrv-ls:lsn=ipgwx1
```

This is an example of the possible output.

```
rlghncxa03w 10-07-19 21:16:37 GMT EAGLE5 42.0.0

LSN          APCA  (SS7)  L3T SLT          GWS GWS GWS
ipgwx1       001-001-002  none 1 1  no  A  8  off off off  no  off

          SPCA          CLLI          TFATCABMLQ MTPRSE ASL8
          -----          -----          4          ---          no

RANDSLS
off

IPSG  IPGWAPC  GTTMODE          CGGTMOD
no    yes     CdPA          no

MATELSN  IPTPS  LSUSEALM  SLKUSEALM
-----  -----  -----  -----
          32000  100%     80%

LOC  LINK  SLC  TYPE
1101 A    0    SS7IPGW
1102 A    1    SS7IPGW
1103 A    2    SS7IPGW
1104 A    3    SS7IPGW
1105 A    4    SS7IPGW
1106 A    5    SS7IPGW
1107 A    6    SS7IPGW
1108 A    7    SS7IPGW
```

Link set table is (8 of 1024) 1% full.

rtrv-ls:lsn=ipgwx2

This is an example of the possible output.

```
rlghncxa03w 10-07-19 21:16:37 GMT EAGLE5 42.0.0

LSN          APCA   (SS7)  SCRN  SET  SET  BEI  LST  LNKS  ACT  MES  DIS  SLSCI  NIS
ipgwx2      001-001-003  none  1   1   no  A   8   off  off  off  no   off

          SPCA          CLLI          TFATCABMLQ  MTPRSE  ASL8
          -----  -----  4          ---    no

RANDSLS
off

IPSG  IPGWAPC  GTTMODE          CGGTMOD
no    yes    CdPA          no

MATELSN  IPTPS  LSUSEALM  SLKUSEALM
-----  -----  -----  -----
16000    100%    80%

LOC  LINK  SLC  TYPE
1111 A   0   SS7IPGW
1112 A   1   SS7IPGW
1201 A   2   SS7IPGW
1202 A   3   SS7IPGW
1203 A   4   SS7IPGW
1204 A   5   SS7IPGW
1205 A   6   SS7IPGW
1206 A   7   SS7IPGW
```

Link set table is (8 of 1024) 1% full.

rtrv-ls:lsn=ipgwx3

This is an example of the possible output.

```
rlghncxa03w 10-07-19 21:16:37 GMT EAGLE5 42.0.0

LSN          APCA   (SS7)  SCRN  SET  SET  BEI  LST  LNKS  ACT  MES  DIS  SLSCI  NIS
ipgwx3      001-001-004  none  1   1   no  A   0   off  off  off  no   off

          SPCA          CLLI          TFATCABMLQ  MTPRSE  ASL8
          -----  -----  1          ---    no

RANDSLS
off

IPSG  IPGWAPC  GTTMODE          CGGTMOD
no    yes    CdPA          no

MATELSN  IPTPS  LSUSEALM  SLKUSEALM
-----  -----  -----  -----
32000    100%    80%
```

Link set table is (8 of 1024) 1% full.

```
rtrv-ls:lsn=ipsglsn
```

This is an example of the possible output.

```
rlghncxa03w 10-07-19 21:16:37 GMT EAGLE5 42.0.0
```

LSN	APCA	(SS7)	SCRN	L3T	SLT	BEI	LST	LNKS	GWS	GWS	GWS	SLSCI	NIS	
ipsglsn	003-003-003		none	1	1	no	A	6	off	off	off	no	off	
	SPCA		CLLI				TFATCABMLQ	MTPRSE	ASL8					
	-----		-----				3	---	no					
	RANDSLS													
	off													
	IPSG	IPGWAPC	GTTMODE					CGGTMOD						
	yes	no	CdPA					no						
	ADAPTER	RSVDSLKTPS	MAXSLKTPS											
	m2pa	600	4000											
	TPSALM	LSUSEALM	SLKUSEALM											
	rsvdslktps	100%	100%											
	LOC	LINK	SLC	TYPE	ANAME									
	1303	A	0	IPSG	ipsgm2pa1									
	1303	A1	1	IPSG	ipsgm2pa2									
	1303	B1	2	IPSG	ipsgm2pa3									
	1303	A2	3	IPSG	ipsgm2pa4									
	1303	A3	4	IPSG	ipsgm2pa5									
	1307	A	5	IPSG	m2pa2									

Link set table is (8 of 1024) 1% full.

```
rtrv-ls:lsn=ipsglsn2
```

This is an example of the possible output.

```
rlghncxa03w 10-07-19 21:16:37 GMT EAGLE5 42.0.0
```

LSN	APCA	(SS7)	SCRN	L3T	SLT	BEI	LST	LNKS	GWS	GWS	GWS	SLSCI	NIS	
ipsglsn2	005-005-005		none	1	1	no	A	1	off	off	off	no	off	
	SPCA		CLLI				TFATCABMLQ	MTPRSE	ASL8					
	-----		-----				1	---	no					
	RANDSLS													
	off													
	IPSG	IPGWAPC	GTTMODE					CGGTMOD						
	yes	no	CdPA					no						
	ADAPTER	RSVDSLKTPS	MAXSLKTPS											
	m2pa	600	4000											

```

TPSALM      LSUSEALM      SLKUSEALM
rsvds1ktps 100%          100%

LOC  LINK  SLC  TYPE      ANAME
1303 B3   0   IPSG      ipsgm2pa6

```

```
Link set table is (8 of 1024) 1% full.
```

Perform these actions as necessary.

- Perform the [Configuring an IPGWx Linkset](#) procedure to change the IPTPS value for any linksets shown in the `rtrv-ls` output whose IPGWAPC value is `yes`.
- Perform one of these actions to change the MAXSLKTPS value (and RSVDSLKTPS value if necessary) for any linksets shown in the `rtrv-ls` output whose IPSG value is `yes`.
 - If the ADAPTER value of the linkset is M3UA, perform the [Changing an IPSG M3UA Linkset](#) procedure.
 - If the ADAPTER value of the linkset is M2PA, continue the procedure with [Step 10](#).

Perform one or both of these actions to increase the available TPS if needed.

- An IPLIMx card that contains signaling links has to be removed. To perform this action, continue the procedure with [Step 7](#).
- Some ATM high-speed signaling links have to be removed. To perform this action, continue the procedure with [Step 6](#).

If you do not wish to perform other actions to increase the available TPS and the available TPS will allow the IPSG M2PA linkset to be changed, continue the procedure with [Step 11](#).

10. Reduce the MAX SLKTPS, and RSVDSLKTPS value if necessary, for the linksets displayed in [Step 9](#) by entering the `chg-ls` command with the new `maxslktps` and `rsvds1ktps` values. For this example, enter these commands.

```
chg-ls:lsn=ipsglsn:maxslktps=3000
```

```
chg-ls:lsn=ipsglsn2:maxslktps=3000
```

Note: The `rsvds1ktps` value must be less than or equal to the `maxslktps` value.

When this command has successfully completed, this message should appear.

```

rlghncxa03w 10-07-17 16:23:21 GMT  EAGLE5 42.0.0

Link set table is ( 13 of 1024)  1% full

CHG-LS: MASP A - COMPLTD

```

11. Change the linkset by entering the `chg-ls` command with the name of the linkset and at least one of these optional parameters and values.
 - `rsvds1ktps = 100 - MaxTPS`
 - `maxslktps = 0 - MaxTPS`
 - `tpsalmtype = rsvds1ktps or maxslktps`
 - `lsusealm = 10 - 100`

- `slkusealm = 10 - 100`

For this example, enter this command.

```
chg-ls:lsn=lssg1101:rsvds1ktps=500:maxslktps=3000:tpsalmtype=maxslktps
:lsusealm=60:slkusealm=70
```

Note: The `rsvds1ktps` value must be less than or equal to the `maxslktps` value.

When this command has successfully completed, this message should appear.

```
rlghncxa03w 06-10-17 16:23:21 GMT EAGLE5 37.5.0
Link set table is ( 13 of 1024) 1% full
CHG-LS: MASP A - COMPLTD
```

Note: There are other optional parameters that can be specified with the `chg-ls` command, but are not required for an IPSG M2PA linkset. These parameters and their usage are discussed in the Other Optional Parameters section of this procedure.

12. Verify the changes using the `rtrv-ls` command specifying the linkset name specified in [Step 11](#). For this example, enter this command.

```
rtrv-ls:lsn=lssg1101
```

This is an example of the possible output.

```
rlghncxa03w 10-07-20 13:34:40 GMT EAGLE5 42.0.0

LSN          APCA   (SS7)  L3T SLT          GWS GWS GWS
lssg1101     008-012-003 none 1   1   no A   2   off off off no  off

          SPCA          CLLI          TFATCABMLQ MTPRSE ASL8
          -----
          2           ---      no

RANDSLS
off

IPSG IPGWAPC GTTMODE          CGGTMOD
yes  no    CdPA          no

ADAPTER  RSVDSLKTPS  MAXSLKTPS
m2pa     500        3000

TPSALM   LSUSEALM    SLKUSEALM
maxslktps 60%       70%

LOC  LINK  SLC  TYPE  ANAME
1101 A2   0    IPSG  m2pa2
1105:A7 1    IPSG  m2pa3

Link set table is (13 of 1024) 1% full.
```

13. Back up the new changes using the `chg-db:action=backup:dest=fixed` command. These messages should appear, the active Maintenance and Administration Subsystem Processor (MASP) appears first.

```
BACKUP (FIXED) : MASP A - Backup starts on active MASP.  
BACKUP (FIXED) : MASP A - Backup on active MASP to fixed disk complete.  
BACKUP (FIXED) : MASP A - Backup starts on standby MASP.  
BACKUP (FIXED) : MASP A - Backup on standby MASP to fixed disk complete.
```

If the linkset that was changed in this procedure was an IPSG M2PA linkset when this procedure was started, this procedure is finished.

If the linkset that was changed in this procedure was either a non-IPSG linkset or an IPSG M3UA linkset when this procedure was started, perform the [Adding an IPSG M2PA Signaling Link](#) procedure to add IPSG M2PA signaling links to the linkset.

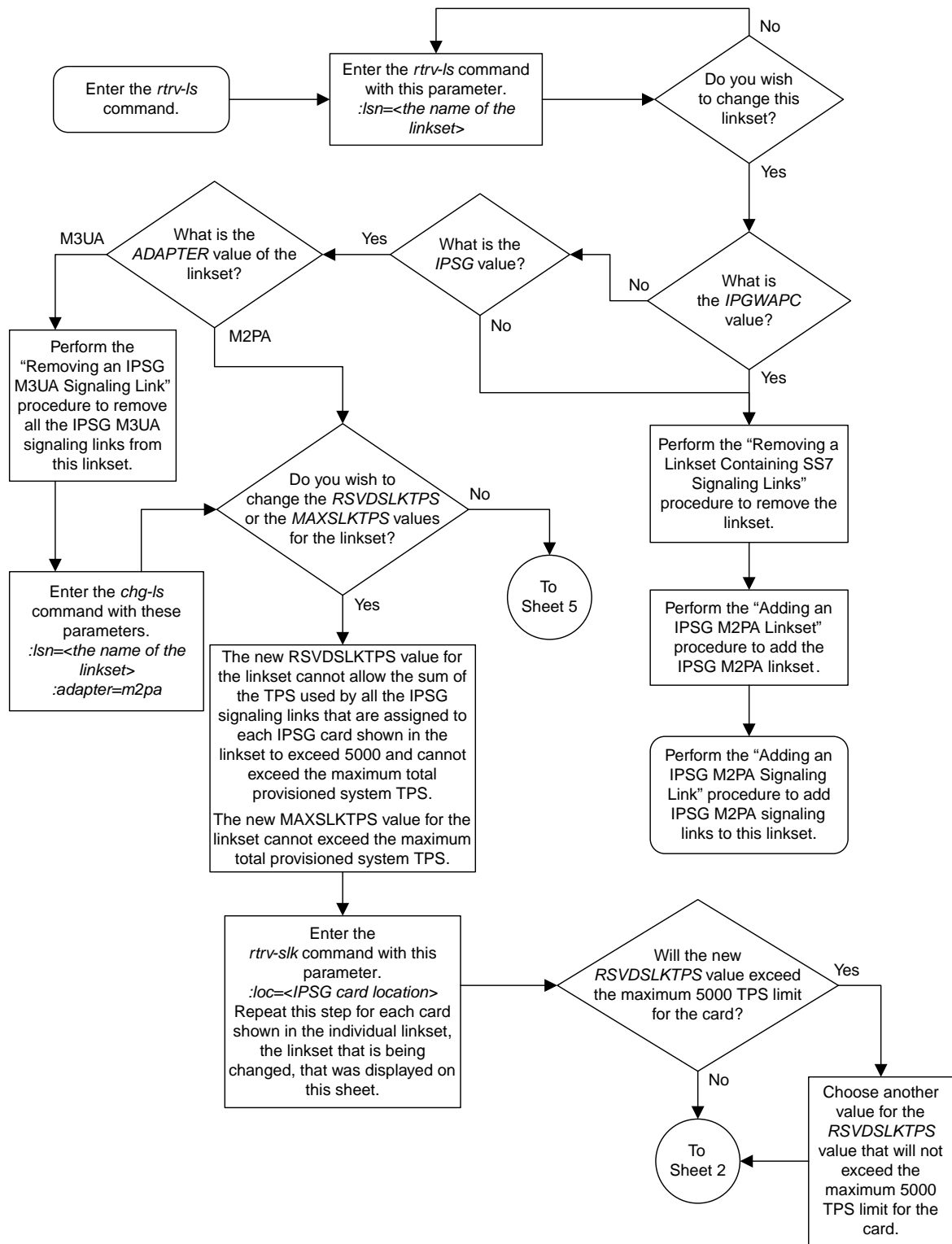

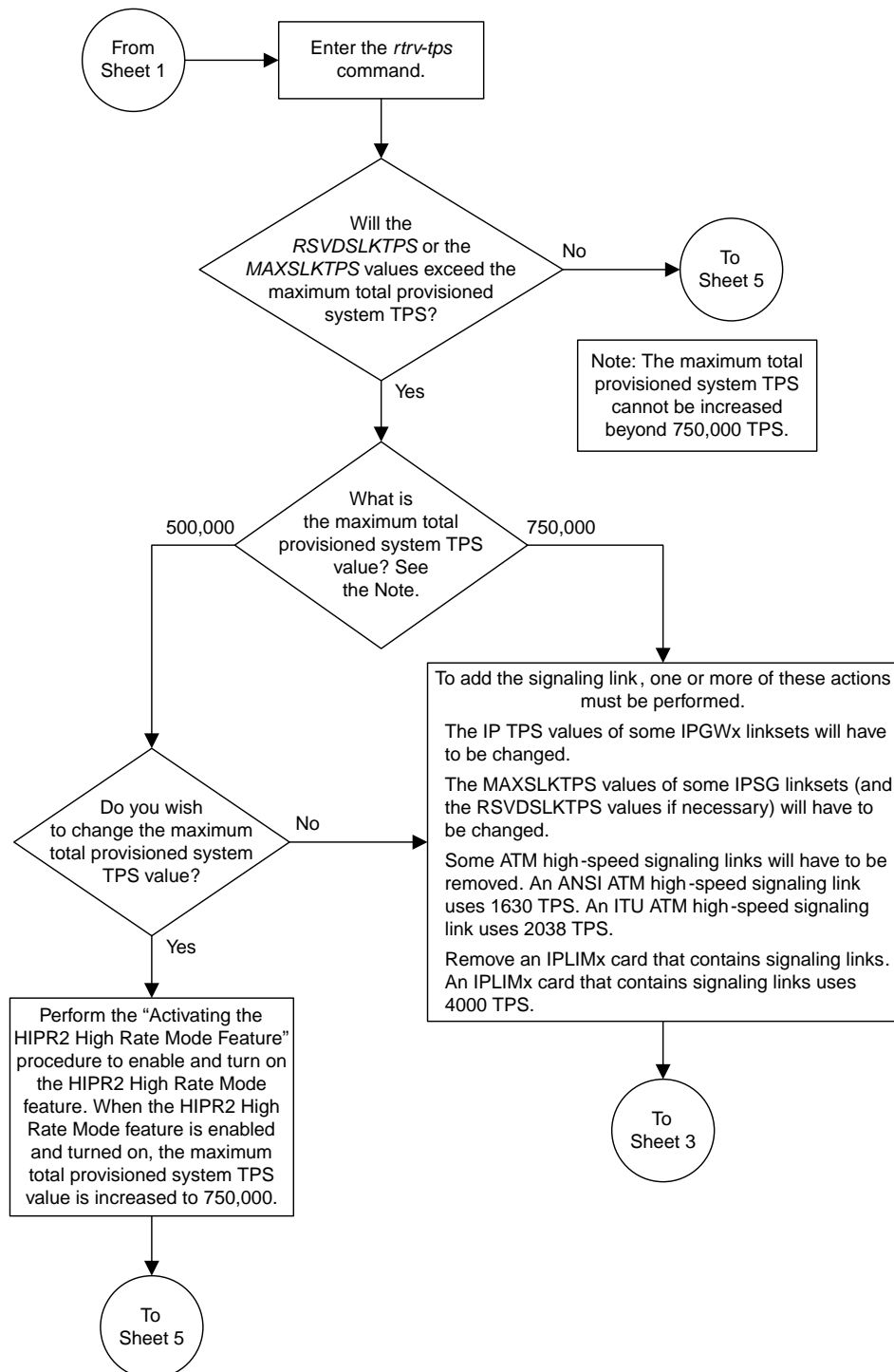

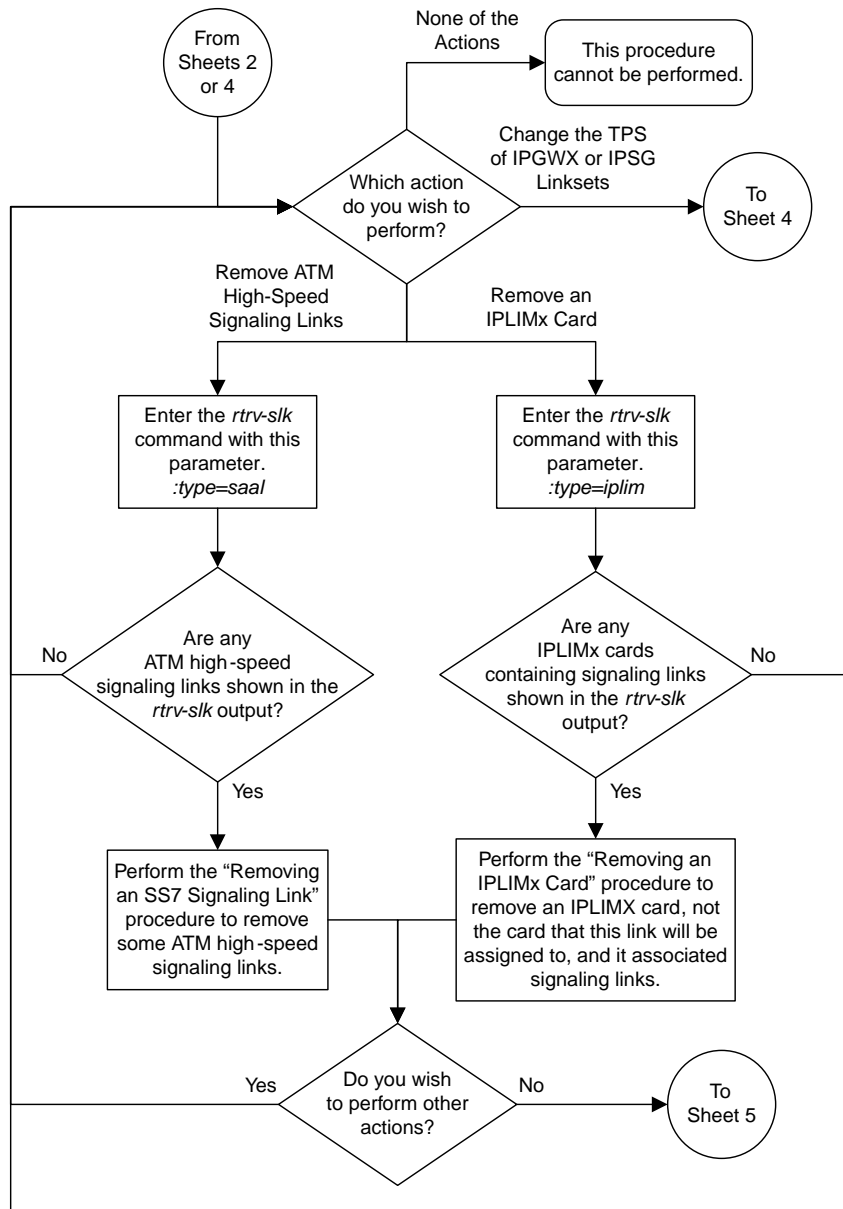

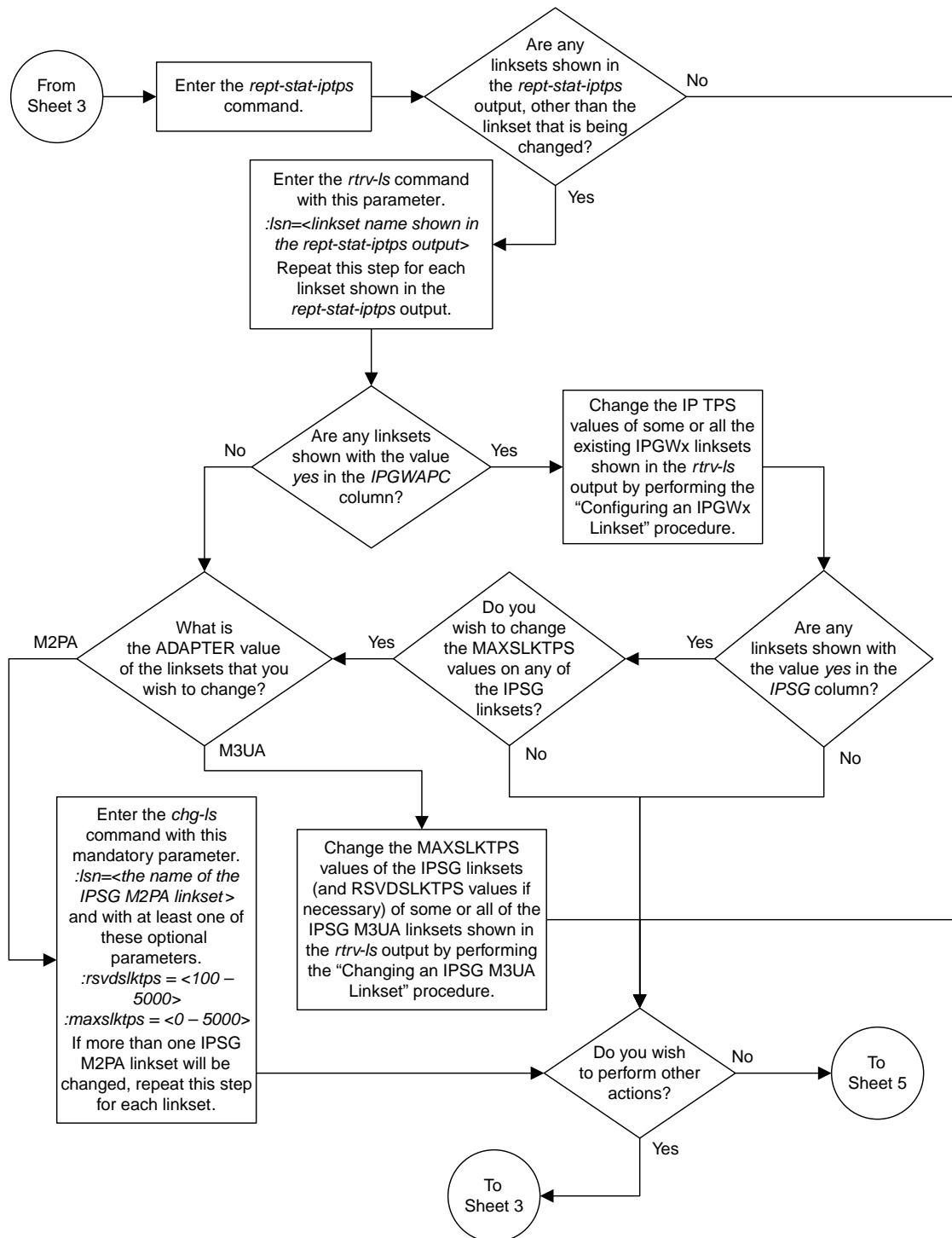

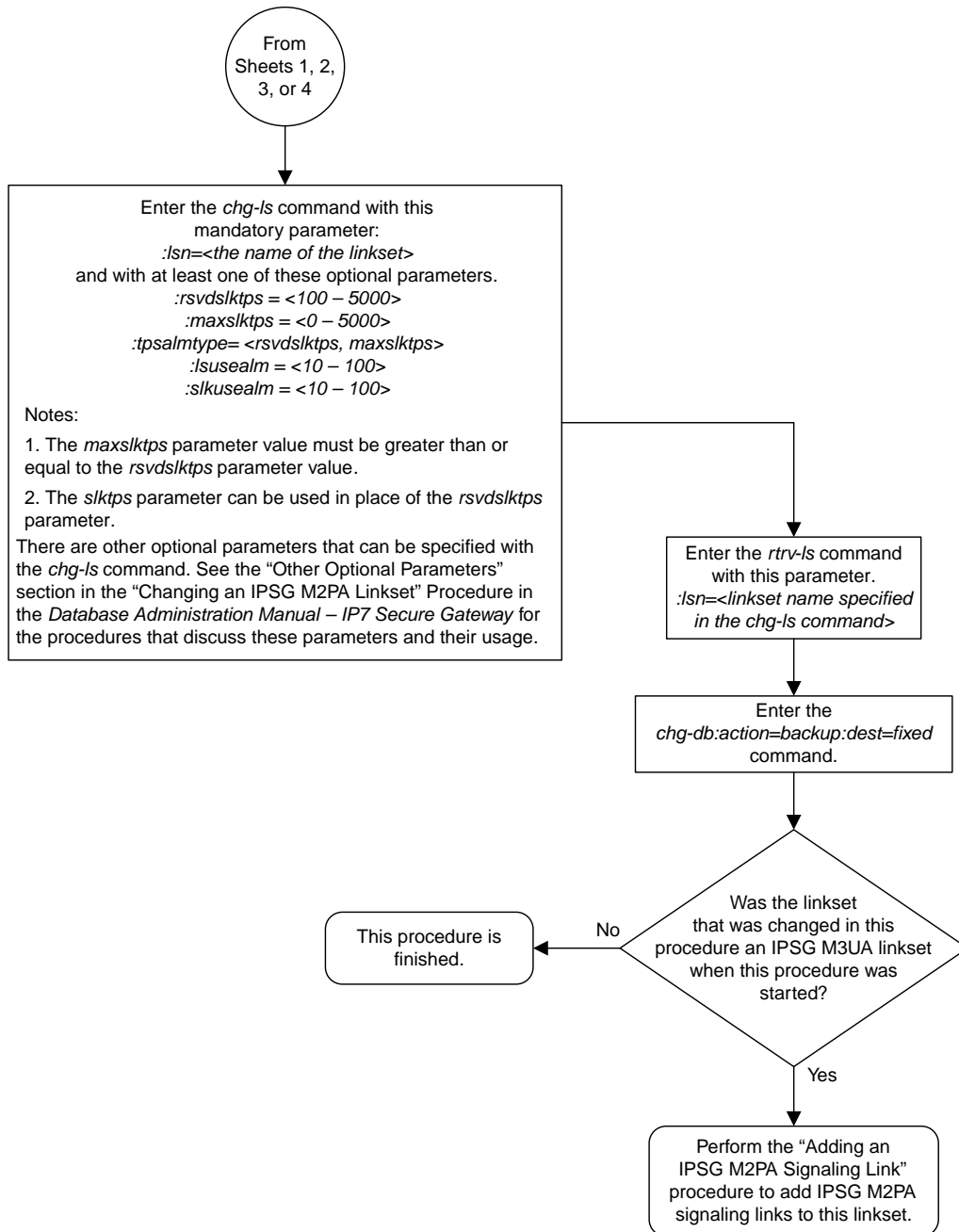

Sheet 5 of 5

Figure 113: Changing an IPSG M2PA Linkset

Changing an IPSG M3UA Linkset

This procedure is used to change an IPSG M3UA linkset, a linkset that contains the `IPSG` value `yes` and whose `ADAPTER` value is `m3ua`, in the EAGLE using the `chg-ls` commands with these parameters.

`:lsn` – The name of the linkset that will be changed, shown in the `rttrv-ls` output.

`:ipsg` – This parameter specifies whether or not the linkset is an IPSG linkset. This parameter has two values, `yes` (if the linkset is an IPSG linkset) or `no` (if the linkset is not an IPSG linkset). For this procedure, the `ipsg` parameter value must be `yes`.

`:maxslktps` – The maximum number of transactions per second (TPS) for all signaling links that are assigned to the IPSG M3UA linkset. See [Maximum Card Capacity for Different Card Types](#) for MaxTPS values.

`:rsvdslktps` – The number of transactions per second (TPS) that is assigned to each IPSG signaling link that will be in the linkset. See [Maximum Card Capacity for Different Card Types](#) for MaxTPS values. The `slktps` parameter can be used in place of the `rsvdslktps` parameter.

`:tpsalmtype` – The TPS threshold that will generate alarms. This parameter has two values.

- `rsvdslktps` - The RSVDSLKTPS threshold generates alarms.
- `maxslktps` - The MAXSLKTPS threshold generates alarms.

`:adapter` - This parameter specifies the adapter layer for the signaling links that will be assigned to the IPSG M3UA linkset. This parameter has two values, `m2pa` and `m3ua`. For an IPSG M3UA linkset, the `adapter` parameter value must be `m3ua`.

`:rcontext` - This parameter specifies the routing context value that is assigned to the IPSG M3UA linkset. The value for this parameter is from 0 to 4294967295. The default value for this parameter is `none`, no value is specified.

`:action=delete` - This parameter is used to remove an existing routing context (RCONTEXT) value from the IPSG M3UA linkset. If the `rcontext` value for the IPSG M3UA linkset is `none`, the linkset does not contain a routing context value.

`:asnotif` - This parameter specifies whether or not AS notifications will be sent for the IPSG M3UA linkset. This parameter has two values, `yes`, AS notifications will be sent for the linkset, and `no`, AS notifications will not be sent for the linkset. The default value for this parameter is `yes`.

`:lsusealm` – The linkset's TPS alarm threshold, from 10 to 100 percent of the linkset's TPS. When this threshold is reached, a major alarm (UAM 0115) is generated. When the linkset's TPS falls below this threshold, UAM 0115 is automatically cleared and UAM 0118 is generated.

`:slkusealm` – The signaling link TPS alarm threshold, from 10 to 100 percent of the signaling link's fair share of the linkset's TPS or from 10 to 100 percent of the IPSG card's capacity. See [Maximum Card Capacity for Different Card Types](#) for MaxTPS values. This threshold is reached when the signaling link's actual usage exceeds the percentage of the signaling link's fair share of the linkset's TPS or the percentage of the IPSG card's capacity.

A signaling link's fair share of linkset's TPS is the linkset's TPS divided by the number of in-service links in the linkset. For example, if the linkset TPS is 4000 and there are 4 signaling links in the linkset, all in-service, then the signaling link's fair-share would be 1000 TPS ($4000/4=1000$). [Table 57: Signaling Link Fair Share Example](#) shows this calculation for a linkset with 1, 2, 3 and 4 in-service signaling links.

Table 57: Signaling Link Fair Share Example

Number of In-Service Signaling Links	Linkset TPS	Signaling Link Fair Share of the Linkset TPS
4	4000	1000
3	4000	1333
2	4000	2000
1	4000	4000

When this threshold is exceeded, a minor alarm (UAM 0116) is generated. When the amount of traffic on the signaling link falls below this threshold, UAM 0116 is automatically cleared and UAM 0119 is generated.

The signaling link TPS alarm shows that the linkset TPS is set too low for the linkset or that the IPSG card's capacity has been exceeded. Setting the signaling link TPS alarm threshold lower than the linkset TPS alarm threshold can give the user an earlier indication that the linkset TPS is inadequate or that traffic is not balanced across the links in the linkset.

Changing the MAXSLKTPS or RSVDSLKTPS values for the IPSG M3UA linkset cannot exceed the maximum total provisioned system TPS shown in the `rtrv-tps` output. If changing the IPSG M3UA linkset will exceed the maximum total provisioned system TPS, and the maximum total provisioned system TPS is 500,000, perform the "Activating the HIPR2 High Rate Mode" feature in *Database Administration - System Management User's Guide* to enable and turn on the HIPR2 High Rate Mode feature. When the HIPR2 High Rate Mode feature is enabled and turned on, the maximum total provisioned system TPS is increased to 1,000,000 (1M). If the maximum total provisioned system TPS is 1M or the maximum total provisioned system TPS is 500,000 and will not be increased, and changing the MAXSLKTPS or RSVDSLKTPS values for the IPSG M3UA linkset will exceed the maximum total provisioned system TPS, the MAXSLKTPS or RSVDSLKTPS values for the IPSG M3UA linkset cannot be changed unless the amount of available TPS is reduced enough to allow the MAXSLKTPS or RSVDSLKTPS values for the IPSG M3UA linkset to be changed. The available TPS can be reduced by performing one or more of these actions.

- The IP TPS values of some IPGWx linksets have to be changed.
- The MAXSLKTPS values of some IPSG linksets (and the RSVDSLKTPS values if necessary) have to be changed.
- Some ATM high-speed signaling links have to be removed.
- An IPLIMx card that contains signaling links has to be removed.

This procedure can also be used to change an IPSG M2PA linkset or a non-IPSG linkset to an IPSG M3UA linkset.

Other Optional Parameters

There are other optional parameters for an IPSG M3UA that can be changed. These parameters are not required for IPSG M3UA linkset. These parameters are discussed in more detail in the *Commands User's Guide* or in these sections.

- The [Configuring IPSG M3UA Linkset Options](#) procedure in this manual.
- These procedures in *Database Administration - SS7 User's Guide*
 - Adding an SS7 Linkset
 - Changing an SS7 Linkset
 - Configuring an ITU Linkset with a Secondary Adjacent Point Code (SAPC)
- The "Configuring a Linkset for the GSM MAP Screening Feature" procedure in the *Database Administration - Features User's Guide*.

Note: The `mtprse`, `spc/spca/spci/spcn/spcn24`, `sapci/sapcn/sapcn24`, and `ppc/ppca/ppci/ppcn/ppcn24` parameters cannot be specified for an IPSG M3UA linkset.

Canceling the RTRV-LS Command

Because the `rtrv-ls` command used in this procedure can output information for a long period of time, the `rtrv-ls` command can be canceled and the output to the terminal stopped. There are three ways that the `rtrv-ls` command can be canceled.

- Press the F9 function key on the keyboard at the terminal where the `rtrv-ls` command was entered.
- Enter the `canc-cmd` without the `trm` parameter at the terminal where the `rtrv-ls` command was entered.
- Enter the `canc-cmd:trm=<xx>`, where `<xx>` is the terminal where the `rtrv-ls` command was entered, from another terminal other than the terminal where the `rtrv-ls` command was entered. To enter the `canc-cmd:trm=<xx>` command, the terminal must allow Security Administration commands to be entered from it and the user must be allowed to enter Security Administration commands. The terminal's permissions can be verified with the `rtrv-secu-trm` command. The user's permissions can be verified with the `rtrv-user` or `rtrv-secu-user` commands.

For more information about the `canc-cmd` command, go to *Commands User's Guide*.

1. Display the current linksets in the database using the `rtrv-ls` command.

This is an example of the possible output.

```

rlghncxa03w 08-04-10 11:43:04 GMT EAGLE5 38.0.0

```

LSN	APCA (SS7)	SCRN	L3T SET	SLT SET	BEI	LST	LNKS	GWS ACT	GWS MES	GWS DIS	SLSCI	NIS
e1e2	001-207-000	none	1	1	no	B	6	off	off	off	no	off
e1m1s1	001-001-001	none	1	1	no	A	7	off	off	off	no	off
e1m1s2	001-001-002	none	1	1	no	A	7	off	off	off	no	off
ls1305	001-005-000	none	1	1	no	A	1	off	off	off	no	off
ls1307	001-007-000	none	1	1	no	A	1	off	off	off	no	off
lsgw1101	008-012-003	none	1	1	no	A	1	off	off	off	no	off
lsgw1103	003-002-004	none	1	1	no	A	1	off	off	off	no	off
lsgw1105	009-002-003	none	1	1	no	A	1	off	off	off	no	off

LSN	APCI (SS7)	SCRN	L3T SET	SLT SET	BEI	LST	LNKS	GWS ACT	GWS MES	GWS DIS	SLSCI	NIS
e1e2i	1-207-0	none	1	1	no	B	4	off	off	off	---	on
ls1315	0-015-0	none	1	1	no	A	1	off	off	off	---	off
ls1317	0-017-0	none	1	1	no	A	1	off	off	off	---	on
e1m2s1	1-011-1	none	1	1	no	A	7	off	off	off	---	off

```
e1m2s2      1-011-2      none 1 1 no A 7 off off off --- off
Link set table is (13 of 1024) 1% full.
```

2. Display a linkset shown in [Step 1](#) by entering the `rtrv-ls` command with the name of the linkset shown in [Step 1](#). For this example, enter these commands.

```
rtrv-ls:lsn=lsgw1101
```

This is an example of the possible output.

```
rlghncxa03w 10-07-20 13:34:40 GMT EAGLE5 42.0.0

LSN          APCA  (SS7)  L3T SLT          GWS GWS GWS
lssg1101     008-012-003 none 1 1 no A 2 off off off no off
           SPCA          CLLI          TFATCABMLQ MTPRSE ASL8
           -----
           2          ---          no

RANDSLS
off

IPSG IPGWAPC GTTMODE          CGGTMOD
yes  no    CdPA          no

ADAPTER  RSVDSLKTPS  MAXSLKTPS
m3ua     1000        4000

TPSALM   LSUSEALM    SLKUSEALM
rsvds1ktps 100%        80%

RCONTEXT ASNOTIF     NUMSLKALW  NUMSLKRSTR  NUMSLKPROH
100      no         1          1            1

LOC  LINK  SLC  TYPE  ANAME
1101 A2   0   IPSG  mu3a2
1105 A7   1   IPSG  m3ua3

Link set table is (13 of 1024) 1% full.
```

If you do not wish to change this linkset, choose another linkset from [Step 1](#) and repeat this steps.

If this linkset will be changed, perform one of these steps.

- If the IPGWAPC value of the linkset is `yes`, the linkset must be removed from the database and then an IPSG M3UA linkset must be added. Perform the "Removing a Linkset Containing SS7 Signaling Links" procedure in *Database Administration - SS7 User's Guide* to remove the linkset. After the linkset has been removed, perform the [Adding an IPSG M3UA Linkset](#) procedure to add the IPSG M3UA linkset. After the IPSG M3UA linkset has been added, perform the [Adding an IPSG M3UA Signaling Link](#) procedure to add IPSG M3UA signaling links to the new IPSG M3UA linkset. This procedure is finished.
- If the IPGWAPC value of the linkset is `no`, continue the procedure by performing one of these steps.
 - If the LST value of the linkset is PRX, the linkset must be removed from the database and then an IPSG M3UA linkset must be added. Perform the "Removing a Linkset Containing SS7 Signaling Links" procedure in *Database Administration - SS7 User's Guide* to remove the linkset. After the linkset has been removed, perform the [Adding an IPSG M3UA Linkset](#)

procedure to add the IPSG M3UA linkset. After the IPSG M3UA linkset has been added, perform the [Adding an IPSG M3UA Signaling Link](#) procedure to add IPSG M3UA signaling links to the new IPSG M3UA linkset. This procedure is finished.

- If the LST value of the linkset is a value other than PRX and the IPSG value of the linkset is no, remove the signaling links from the linkset by performing these procedures as necessary.
 - Removing an SS7 Signaling Link in *Database Administration - SS7 User's Guide*.
 - [Removing an IPLIMx Signaling Link](#)

After the signaling links have been removed from the linkset, continue the procedure with [Step 3](#)

- If the IPSG value of the linkset is yes, continue the procedure with one of these steps.
 - If the ADAPTER value of the linkset is M2PA, remove the signaling links from the linkset by performing these procedures as necessary.
 - Removing an SS7 Signaling Link in the *Database Administration - SS7 User's Guide*.
 - [Removing an IPLIMx Signaling Link](#)
 - [Removing an IPSG M2PA Signaling Link](#)

After the signaling links have been removed from the linkset, continue the procedure with [Step 4](#) if the linkset type for the linkset is B, C, D, or E. If the linkset type of the linkset is A, continue the procedure with [Step 5](#).

- If the ADAPTER value of the linkset is M3UA, continue the procedure with one of these steps.
 - If the RSVDSLKTPS value of the linkset will not be changed, continue the procedure with [Step 12](#).
 - If the RSVDSLKTPS value of the linkset will be changed, continue the procedure with [Step 5](#).

3. Change the IPSG value of the linkset by entering the `chg-ls` command with the `ipsg=yes` parameter and the name of the linkset that is being changed. For this example, enter this command.

```
chg-ls:lsn=lssg1101:ipsg=yes
```

When the `chg-ls` command has successfully completed, this message should appear.

```
rlghncxa03w 08-04-20 13:34:40 GMT EAGLE5 38.0.0
Link set table is (13 of 1024) 1% full.
CHG-LS: MASP A - COMPLTD
```

After the IPSG value of the linkset has been changed, continue the procedure with [Step 5](#).

When the IPSG value is changed to `yes`, the ADAPTER value of the linkset is set to `m2pa`, the RSVDSLKTPS value of the linkset is set to 5000.

4. The linkset type of an IPSG M3UA linkset must be A. If the linkset type of the linkset is not A, change the linkset type of the linkset by entering the `chg-ls` command with the name of the linkset and the `lst=a` parameter. For this example, enter this command.

If the linkset type of the linkset is A, this step does not need to be performed. Continue the procedure with [Step 5](#).

```
chg-ls:lsn=lssg1101:lst=a
```

When the `chg-ls` command has successfully completed, this message should appear.

```
rlghncxa03w 08-04-20 13:34:40 GMT EAGLE5 38.0.0
Link set table is (13 of 1024) 1% full.
CHG-LS: MASP A - COMPLTD
```

- The new `RSVDSLKTPS` value for the linkset cannot allow the sum of the TPS used by all the IPSG signaling links that are assigned to each IPSG card shown in the linkset to exceed the `MaxTPS` (see [Maximum Card Capacity for Different Card Types](#) for `MaxTPS` values) and cannot exceed the maximum total provisioned system TPS.

To verify the TPS for the IPSG cards containing the IPSG signaling links in the linkset, enter the `rtrv-slk` command with the card location of each signaling link that is assigned to the linkset. For this example, enter these commands.

```
rtrv-slk:loc=1101
```

This is an example of the possible output.

```
rlghncxa03w 08-04-24 14:02:40 EST 38.0.0
LOC LINK LSN          SLC TYPE  ANAME          SLKTPS
1101 A2  lssg1101          0  IPSG          m3ua2          1000
IPTPS for LOC = 1101 is (1000 of 5000) 20%
```

```
rtrv-slk:loc=1105
```

This is an example of the possible output.

```
rlghncxa03w 08-04-24 14:02:40 EST 38.0.0
LOC LINK LSN          SLC TYPE  ANAME          SLKTPS
1105 A7  lssg1101          0  IPSG          m3ua3          1000
IPTPS for LOC = 1105 is (1000 of 5000) 20%
```

If the new `RSVDSLKTPS` value for the linkset will allow the TPS for the IPSG cards containing the IPSG signaling links in the linkset to exceed the `MaxTPS` (see [Maximum Card Capacity for Different Card Types](#) for `MaxTPS` values), choose an `RSVDSLKTPS` value that will not exceed the `MaxTPS` limit for the IPSG card.

- Display the total provisioned system TPS by entering the `rtrv-tps` command. This is an example of the possible output.

```
rlghncxa03w 10-07-10 16:20:46 GMT EAGLE 42.0.0
CARD      NUM      NUM      RSVL      MAX
```

TYPE	CARDS	LINKS	TPS	TPS
IPGW	17	16	48000	80000
IPSG	3	7	4200	8000
IPLIM	2	4	8000	8000
ATM	2	2	3668	3668

Total provisioned System TPS (99668 of 500000) 20%

Command Completed.

An IPSG M3UA linkset uses 100 to MAXSLKTPS (see [Maximum Card Capacity for Different Card Types](#) for MaxTPS values), as provisioned by the `maxslktps` parameter. If adding the new IPSG M3UA linkset will not exceed the maximum total provisioned system TPS, continue the procedure with [Step 12](#).

If adding the new IPSG M3UA linkset will exceed the maximum total provisioned system TPS, and the maximum total provisioned system TPS is 500,000 shown, perform the "Activating the HIPR2 High Rate Mode Feature" procedure in *Database Administration - System Management User's Guide* to enable and turn on the HIPR2 High Rate Mode feature. When the HIPR2 High Rate Mode feature is enabled and turned on, the maximum total provisioned system TPS is increased to 1M. After the HIPR2 High Rate Mode feature has been enabled and turned on, continue the procedure with [Step 12](#).

If the maximum total provisioned system TPS is 1M, or the maximum total provisioned system TPS is 500,000 and will not be increased, and adding the IPSG M3UA linkset will exceed the maximum total provisioned system TPS, the IPSG M3UA linkset cannot be added unless the amount of available TPS is reduced enough to allow the IPSG M3UA linkset to be changed. The available TPS can be increased by performing one or more of these actions.

- The IP TPS values of some IPGWx linksets have to be changed. To perform this action, continue the procedure with [Step 9](#).
- The MAXSLKTPS values of some IPSG linksets (and the RSVDSLKTPS values if necessary) have to be changed. To perform this action, continue the procedure with [Step 9](#).
- Some ATM high-speed signaling links have to be removed. To perform this action, continue the procedure with [Step 7](#).
- An IPLIMx card that contains signaling links has to be removed. To perform this action, continue the procedure with [Step 8](#).

7. Display the ATM high-speed signaling links by entering this command.

```
rtrv-slk:type=saal
```

This is an example of the possible output.

```
rlghncxa03w 10-07-19 21:16:37 GMT EAGLE5 42.0.0
```

LOC	LINK	LSN	SLC	TYPE	LP SET	BPS	ATM TSEL	VCI	VPI	LL
1303	A	lsnds0	1	LIMATM	1	1.544M	LINE	5	0	0

LOC	LINK	LSN	SLC	TYPE	LP SET	BPS	ATM TSEL	VCI	VPI	E1ATM		
										CRC4	SI	SN
1306	A	lsnituatm	0	LIME1ATM	21	2.048M	LINE	5	0	ON	3	0

SLK table is (30 of 1200) 2% full.

If ATM high-speed signaling links are shown in the `rtrv-slk` output, perform the "Removing an SS7 Signaling Link" procedure in *Database Administration - SS7 User's Guide* to remove some of the ATM high-speed signaling links.

If ATM high-speed signaling links are not displayed in the `rtrv-slk` output, perform one or more of these actions to increase the available TPS.

Note: If one or more of these actions are not performed to increase the available TPS and the available TPS will not allow the IPSG M3UA linkset to be changed, the IPSG M3UA linkset cannot be added and the remainder of this procedure cannot be performed.

- The IP TPS values of some IPGWx linksets have to be changed. To perform this action, continue the procedure with [Step 9](#).
- The MAXSLKTPS values of some IPSG linksets (and the RSVDSLKTPS values if necessary) have to be changed. To perform this action, continue the procedure with [Step 9](#).
- An IPLIMx card that contains signaling links has to be removed. To perform this action, continue the procedure with [Step 8](#).

If you do not wish to perform other actions to increase the available TPS and the available TPS will allow the IPSG M3UA linkset to be changed, continue the procedure with [Step 12](#).

8. Display the signaling links that are assigned to IPLIMx cards by entering this command.

```
rtrv-slk:type=iplim
```

This is an example of the possible output.

```
rlghncxa03w 10-07-19 21:16:37 GMT EAGLE5 42.0.0

LOC LINK LSN          SLC TYPE      ANAME          SLKTPS
1301 A   lsniplim      0   IPLIM      M2PA
1301 A1  lsniplim      1   IPLIM      M2PA
1301 B1  lsniplim      2   IPLIM      M2PA
1317 A   lsniplimi     0   IPLIMI     M2PA

SLK table is (30 of 1200) 2% full.
```

If IPLIMx cards containing signaling links are shown in the `rtrv-slk` output, perform the [Removing an IPLIMx Card](#) procedure to remove an IPLIMx card and its associated signaling links.

If IPLIMx cards containing signaling links are not displayed in the `rtrv-slk` output, perform one or more of these actions to increase the available TPS.

Note: If one or more of these actions are not performed to increase the available TPS and the available TPS will not allow the IPSG M3UA linkset to be changed, the IPSG M3UA linkset cannot be added and the remainder of this procedure cannot be performed.

- The IP TPS values of some IPGWx linksets have to be changed. To perform this action, continue the procedure with [Step 9](#).
- The MAXSLKTPS values of some IPSG linksets (and the RSVDSLKTPS values if necessary) have to be changed. To perform this action, continue the procedure with [Step 9](#).
- Some ATM high-speed signaling links have to be removed. To perform this action, continue the procedure with [Step 7](#).

If you do not wish to perform other actions to increase the available TPS and the available TPS will allow the IPSG M3UA linkset to be changed, continue the procedure with [Step 12](#).

9. Display the IPGWx and IPSG linksets by entering this command.

```
rept-stat-iptps
```

This is an example of the possible output.

```
rlghncxa03w 10-07-19 21:16:37 GMT EAGLE5 42.0.0
IP TPS USAGE REPORT
```

	THRESH	CONFIG/ RSVD	CONFIG/ MAX		TPS	PEAK	PEAKTIMESTAMP
LSN							
ipgwx1	100%	----	32000	TX:	3700	4000	10-07-19 09:49:19
				RCV:	3650	4000	10-07-19 09:49:19
ipgwx2	100%	----	16000	TX:	4800	5000	10-07-19 09:49:09
				RCV:	4850	5000	10-07-19 09:49:09
ipgwx3	100%	----	32000	TX:	427	550	10-07-19 09:49:19
				RCV:	312	450	10-07-19 09:49:19
ipsglsn	100%	600	24000	TX:	4800	5000	10-07-19 09:49:19
				RCV:	4800	5000	10-07-19 09:49:19
ipsglsn2	100%	600	4000	TX:	427	550	10-07-19 09:49:19
				RCV:	312	450	10-07-19 09:49:19

Command Completed.

If linksets are displayed in the `rept-stat-iptps` output, continue the procedure with [Step 10](#).

If linksets are not displayed in the `rept-stat-iptps` output, perform one or more of these actions to increase the available TPS.

Note: If one or more of these actions are not performed to increase the available TPS and the available TPS will not allow the IPSG M3UA linkset to be changed, the IPSG M3UA linkset cannot be added and the remainder of this procedure cannot be performed.

- An IPLIMx card that contains signaling links has to be removed. To perform this action, continue the procedure with [Step 8](#).
- Some ATM high-speed signaling links have to be removed. To perform this action, continue the procedure with [Step 7](#).

If you do not wish to perform other actions to increase the available TPS and the available TPS will allow the IPSG M3UA linkset to be changed, continue the procedure with [Step 12](#).

10. Display the attributes of the linksets shown in [Step 9](#) by entering the `rtrv-ls` command with the name of the linkset shown in [Step 9](#).

For this example enter these commands.

```
rtrv-ls:lsn=ipgwx1
```

This is an example of the possible output.

```
rlghncxa03w 10-07-19 21:16:37 GMT EAGLE5 42.0.0
```

LSN	APCA	(SS7)	SCRN	L3T	SLT	SET	BEI	LST	LNKS	GWS	GWS	GWS	SLSCI	NIS
ipgwx1	001-001-002		none	1	1	no	A	8	off	off	off	no	off	

```

          SPCA          CLLI          TFATCABMLQ MTPRSE ASL8
          -----          -
          4              ---         no

RANDSLS
off

IPSG  IPGWAPC  GTTMODE          CGGTMOD
no    yes      CdPA              no

MATELSN      IPTPS      LSUSEALM  SLKUSEALM
-----      -          -          -
          32000      100%          80%

LOC  LINK  SLC  TYPE
1101 A    0    SS7IPGW
1102 A    1    SS7IPGW
1103 A    2    SS7IPGW
1104 A    3    SS7IPGW
1105 A    4    SS7IPGW
1106 A    5    SS7IPGW
1107 A    6    SS7IPGW
1108 A    7    SS7IPGW

Link set table is (8 of 1024) 1% full.

```

rtrv-ls:lsn=ipgwx2

This is an example of the possible output.

```

rlghncxa03w 10-07-19 21:16:37 GMT EAGLE5 42.0.0

LSN          APCA  (SS7)  L3T  SLT          GWS  GWS  GWS
ipgwx2      001-001-003  none  1    1    no  A    8    off off off no  off

          SPCA          CLLI          TFATCABMLQ MTPRSE ASL8
          -----          -
          4              ---         no

RANDSLS
off

IPSG  IPGWAPC  GTTMODE          CGGTMOD
no    yes      CdPA              no

MATELSN      IPTPS      LSUSEALM  SLKUSEALM
-----      -          -          -
          16000      100%          80%

LOC  LINK  SLC  TYPE
1111 A    0    SS7IPGW
1112 A    1    SS7IPGW
1201 A    2    SS7IPGW
1202 A    3    SS7IPGW
1203 A    4    SS7IPGW
1204 A    5    SS7IPGW
1205 A    6    SS7IPGW
1206 A    7    SS7IPGW

Link set table is (8 of 1024) 1% full.

```

rtrv-ls:lsn=ipgwx3

This is an example of the possible output.

```

rlghncxa03w 10-07-19 21:16:37 GMT EAGLE5 42.0.0

LSN              APCA  (SS7)  SCRN  SET  SET  BEI  LST  LNKS  ACT  MES  DIS  SLSCI  NIS
ipgwx3           001-001-004  none  1   1   no  A   0   off  off  off  no   off

              SPCA              CLLI              TFATCABMLQ  MTPRSE  ASL8
              -----              -----              1           ---    no

RANDSLS
off

IPSG  IPGWAPC  GTTMODE              CGGTMOD
no    yes     CdPA              no

MATELSN      IPTPS      LSUSEALM      SLKUSEALM
-----      32000      100%         80%

Link set table is (8 of 1024) 1% full.

```

```
rtrv-ls:lsn=ipsglsn
```

This is an example of the possible output.

```

rlghncxa03w 10-07-19 21:16:37 GMT EAGLE5 42.0.0

LSN              APCA  (SS7)  SCRN  SET  SET  BEI  LST  LNKS  ACT  MES  DIS  SLSCI  NIS
ipsglsn          003-003-003  none  1   1   no  A   6   off  off  off  no   off

              SPCA              CLLI              TFATCABMLQ  MTPRSE  ASL8
              -----              -----              3           ---    no

RANDSLS
off

IPSG  IPGWAPC  GTTMODE              CGGTMOD
yes   no      CdPA              no

ADAPTER      RSVDSLKTPS  MAXSLKTPS
m3ua         600         4000

TPSALM      LSUSEALM      SLKUSEALM
maxslktps   100%         100%

RCONTEXT     ASNOTIF      NUMSLKALW      NUMSLKRSTR      NUMSLKPROH
400          yes          1              1              1

LOC  LINK  SLC  TYPE      ANAME
1303 A    0    IPSG      ipsgm2pa1
1303 A1   1    IPSG      ipsgm2pa2
1303 B1   2    IPSG      ipsgm2pa3
1303 A2   3    IPSG      ipsgm2pa4
1303 A3   4    IPSG      ipsgm2pa5
1307 A    5    IPSG      m2pa2

Link set table is (8 of 1024) 1% full.

```

```
rtrv-ls:lsn=ipsglsn2
```

This is an example of the possible output.

```
rlghncxa03w 10-07-19 21:16:37 GMT EAGLE5 42.0.0

LSN              APCA  (SS7)  L3T SLT          GWS GWS GWS
ipsglsn2         005-005-005  none 1  1  no  A  1  off off off no  off

              SPCA          CLLI          TFATCABMLQ MTPRSE ASL8
              -----
              1          ---          no

RANDSLS
off

IPSG  IPGWAPC  GTTMODE          CGGTMOD
yes   no      CdPA          no

ADAPTER  RSVDSLKTPS  MAXSLKTPS
m3ua     600        4000

TPSALM  LSUSEALM  SLKUSEALM
maxslktps 100%     100%

RCONTEXT  ASNOTIF  NUMSLKALW  NUMSLKRSTR  NUMSLKPROH
300       yes     1          1          1

LOC  LINK  SLC  TYPE  ANAME
1303 B3  0    IPSG  ipsgm2pa6
```

Link set table is (8 of 1024) 1% full.

Perform these actions as necessary.

- Perform the [Configuring an IPGWx Linkset](#) procedure to change the IPTPS value for any linksets shown in the `rtrv-ls` output whose IPGWAPC value is yes.
- Perform one of these actions to change the MAXSLKTPS value (and RSVDSLKTPS value if necessary) for any linksets shown in the `rtrv-ls` output whose IPSG value is yes.
 - If the ADAPTER value of the linkset is M2PA, perform the [Changing an IPSG M2PA Linkset](#) procedure.
 - If the ADAPTER value of the linkset is M3UA, continue the procedure with [Step 11](#).

Perform one or both of these actions to increase the available TPS if needed.

- An IPLIMx card that contains signaling links has to be removed. To perform this action, continue the procedure with [Step 8](#).
- Some ATM high-speed signaling links have to be removed. To perform this action, continue the procedure with [Step 7](#).

If you do not wish to perform other actions to increase the available TPS and the available TPS will allow the IPSG M3UA linkset to be changed, continue the procedure with [Step 12](#).

11. Reduce the MAX SLKTPS, and RSVDSLKTPS value if necessary, for the linksets displayed in [Step 10](#) by entering the `chg-ls` command with the new `maxslktps` and `rsvds1ktps` values. For this example, enter these commands.

```
chg-ls:lsn=ipsglsn:maxslktps=3000
chg-ls:lsn=ipsglsn2:maxslktps=3000
```

Note: Thersvdslktps value must be less than or equal to themaxslktps value.

When this command has successfully completed, this message should appear.

```
rlghncxa03w 10-07-17 16:23:21 GMT EAGLE5 42.0.0
Link set table is ( 13 of 1024) 1% full
CHG-LS: MASP A - COMPLTD
```

12. Change the linkset by entering the `chg-ls` command with the name of the linkset and any of these optional parameters and values.

if the ADAPTER, SLKTPS, ASNOTIF, LSUSEALM, and SLKUSEALM values will not be changed, do not perform this step. Continue the procedure with [Step 16](#).

- adapter = m3ua
- rsvdslktps = 100 - MaxTPS
- maxslktps = 0 - MaxTPS
- tpsalmtype = rsvdslktps or maxslktps
- lsusealm = 10 - 100
- slkusealm = 10 - 100
- asnotif = yes or no

For this example, enter this command.

```
chg-ls:lsn=lssgl101:slktps=500:lsusealm=60:slkusealm=70
chg-ls:lsn=lssgl101:rsvdslktps=500:maxslktps=3000:tpsalmtype=maxslktps
:lsusealm=60:slkusealm=70
```

Note: Thersvdslktps value must be less than or equal to themaxslktps value.

When the `chg-ls` command has successfully completed, this message should appear.

```
rlghncxa03w 06-10-17 16:23:21 GMT EAGLE5 37.5.0
Link set table is ( 13 of 1024) 1% full
CHG-LS: MASP A - COMPLTD
```

Note: There are other optional parameters that can be specified with the `chg-ls` command, but are not required for anIPSG M3UA linkset. These parameters and their usage are discussed in the Other Optional Parameters section of this procedure.

If you do not wish to change the RCONTEXT value of the linkset, continue the procedure with [Step 17](#).

If you wish to change the RCONTEXT value of the linkset, continue the procedure with by performing one of these steps.

- If the ADAPTER value of the linkset was changed to m3ua in [Step 12](#) continue the procedure with [Step 16](#).

- If the ADAPTER value of the linkset was m3ua when this procedure was started, and the linkset contains signaling links, continue the procedure with [Step 13](#).
- If the ADAPTER value of the linkset was m3ua when this procedure was started, and the linkset does not contain signaling links, continue the procedure with [Step 16](#).
- If the ADAPTER value of the linkset was m3ua when this procedure was started, the RCONTEXT value is being removed from the linkset, perform one of these actions. If the linkset does not contain signaling links, continue the procedure with [Step 16](#). If the linkset does contain signaling links, remove the signaling links from the linkset by performing the [Removing an IPSG M3UA Signaling Link](#) procedure. After the signaling links have been removed, continue the procedure with [Step 16](#).

13. Deactivate all the signaling links in the linkset by entering the `dact-slk` command with the location and link value of each signaling link in the linkset. For this example, enter these commands.

```
dact-slk:loc=1101:link=a2
```

```
dact-slk:loc=1101:link=a7
```

When the `dact-slk` command has successfully completed, this message should appear.

```
rlghncxa03w 08-04-25 06:49:44 EST 38.0.0
Deactivate Link message sent to card
Command Completed.
```

14. Display the signaling links that the association, shown in the `rtrv-ls` output in [Step 2](#), is assigned to by entering the `rtrv-slk` command with the name of the association that will be added to the signaling link. For this example, enter this command.

```
rtrv-slk:aname=m3ua2
```

This is an example of the possible output.

```
rlghncxa03w 06-10-17 11:43:04 GMT EAGLE5 36.0.0

LOC LINK LSN          SLC TYPE      ANAME          SLKTPS
1101 A2  lssg1101          0  IPSP        m3ua2          1000
2204 A   m3ua1             0  IPSP        m3ua2          300
```

```
rtrv-slk:aname=m3ua3
```

This is an example of the possible output.

```
rlghncxa03w 06-10-17 11:43:04 GMT EAGLE5 36.0.0

LOC LINK LSN          SLC TYPE      ANAME          SLKTPS
1105 A7  lssg1101          1  IPSP        m3ua3          1000
2204 B6  m3ua1             1  IPSP        m3ua3          300
```

15. Display all the linksets that contain the signaling links shown in [Step 14](#), other than the linkset that is being changed in this procedure (this linkset has been displayed in [Step 2](#)), by entering the `rtrv-ls` command with the linkset name shown in [Step 14](#). For this example, enter this command.

```
rtrv-ls:lsn=m3ua1
```

This is an example of the possible output.

```

rlghncxa03w 10-07-17 11:43:04 GMT EAGLE5 42.0.0

LSN          APCA  (SS7)  SCRNL3T SLT          GWS GWS GWS
m3ua1        002-002-003  none  1   1   no  A   2   off off off no  off

          SPCA          CLLI          TFATCABMLQ MTPRSE ASL8
          -----          -----          ---    ---    no

RANDSLS
off

IPSG  IPGWAPC  GTTMODE          CGGTMOD
yes   no      CdPA          no

ADAPTER  RSVDSLKTPS  MAXSLKTPS
m3ua     300      4000

TPSALM   LSUSEALM   SLKUSEALM
rsvdslktps 100%     80%

RCONTEXT  ASNOTIF  NUMSLKALW  NUMSLKRSTR  NUMSLKPROH
25        yes    1           1            1

LOC  LINK  SLC  TYPE  ANAME
2204 A   0   IPSG  m3ua2
2204 B6  1   IPSG  m3ua3

Link set table is (13 of 1024) 1% full.

```

An IPSG M3UA association can be assigned to different signaling links in different linksets only if the routing context (RCONTEXT) values in the linksets are different. Choose a routing context value for the linkset that is being changed that is different from the routing context values shown in this step.

16. Change the existing routing context value by entering the `chg-ls` command with the `rcontext` parameter.

If the routing context value of the linkset is being changed to a new value, for this example, enter this command.

```
chg-ls:lsn=lssg1101:rcontext=200
```

If the existing routing context value is being removed from the linkset, for this example, enter this command.

```
chg-ls:lsn=lssg1101:rcontext=100:action=delete
```

When the `chg-ls` command has successfully completed, this message should appear.

```

rlghncxa03w 06-10-17 16:23:21 GMT EAGLE5 37.5.0

Link set table is ( 13 of 1024) 1% full

CHG-LS: MASP A - COMPLTD

```

17. Verify the changes using the `rtrv-ls` command specifying the linkset name specified in [Step 12](#) and [Step 16](#). For this example, enter this command.

```
rtrv-ls:lsn=lssg1101
```

This is an example of the possible output.

```
rlghncxa03w 10-07-20 13:34:40 GMT EAGLE5 42.0.0

LSN          APCA  (SS7)  L3T SLT          GWS GWS GWS
lssg1101     008-012-003  none 1 1  no  A  2  off off off no  off

          SPCA          CLLI          TFATCABMLQ MTPRSE ASL8
          -----
          2          ---  no

RANDSLS
off

IPSG  IPGWAPC  GTTMODE          CGGTMOD
yes   no     CdPA          no

ADAPTER  RSVDSLKTPS  MAXSLKTPS
m3ua     500        4000

TPSALM   LSUSEALM    SLKUSEALM
maxslktps 60%       70%

RCONTEXT  ASNOTIF    NUMSLKALW  NUMSLKRSTR  NUMSLKPROH
200       yes        1           1            1

LOC  LINK  SLC  TYPE  ANAME
1101 A2    0    IPSG  m2pa2
1105:A7 1    IPSG  m2pa3

Link set table is (13 of 1024) 1% full.
```

If signaling links were deactivated in [Step 13](#), continue the procedure with [Step 18](#).

If signaling links were not deactivated in [Step 13](#), continue the procedure with [Step 19](#).

18. Activate all signaling links that were deactivated in [Step 13](#) using the `act-slk` command, specifying the card location and link parameter value of each signaling link. For this example, enter this command.

```
act-slk:loc=1101:link=a2
```

```
act-slk:loc=1101:link=a7
```

When the `act-slk` command has successfully completed, this message should appear.

```
rlghncxa03w 06-10-07 08:31:24 GMT EAGLE5 36.0.0
Activate Link message sent to card
```

19. Back up the new changes using the `chg-db:action=backup:dest=fixed` command. These messages should appear, the active Maintenance and Administration Subsystem Processor (MASP) appears first.

```
BACKUP (FIXED) : MASP A - Backup starts on active MASP.  
BACKUP (FIXED) : MASP A - Backup on active MASP to fixed disk complete.  
BACKUP (FIXED) : MASP A - Backup starts on standby MASP.  
BACKUP (FIXED) : MASP A - Backup on standby MASP to fixed disk complete.
```

If the linkset that was changed in this procedure contained signaling links that were deactivated when [Step 16](#) was performed, this procedure is finished.

If the linkset that was changed in this procedure contained no signaling links when [Step 12](#) or [Step 16](#) were performed, perform the [Adding an IPSG M3UA Signaling Link](#) procedure to add IPSG M3UA signaling links to the linkset.

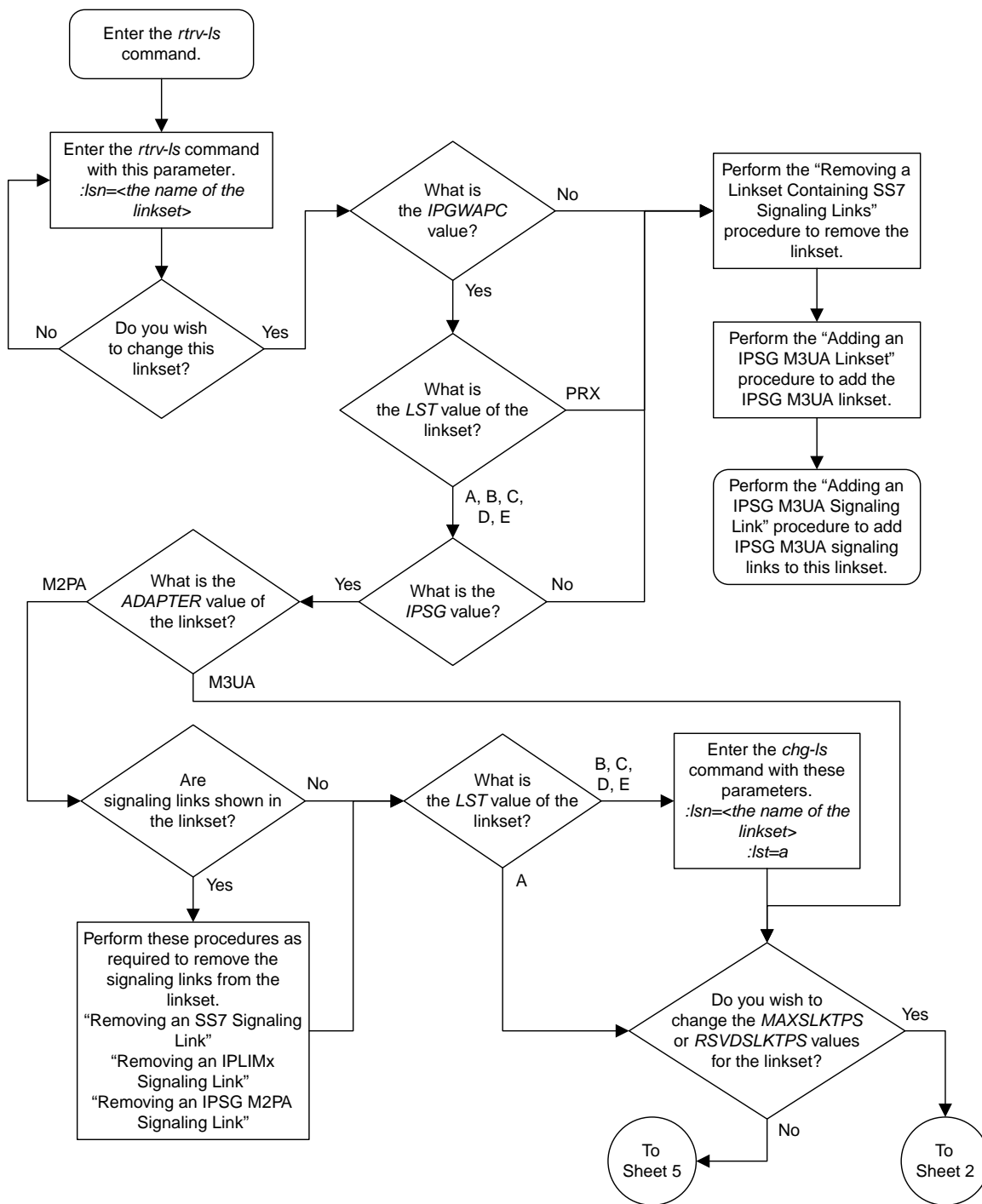

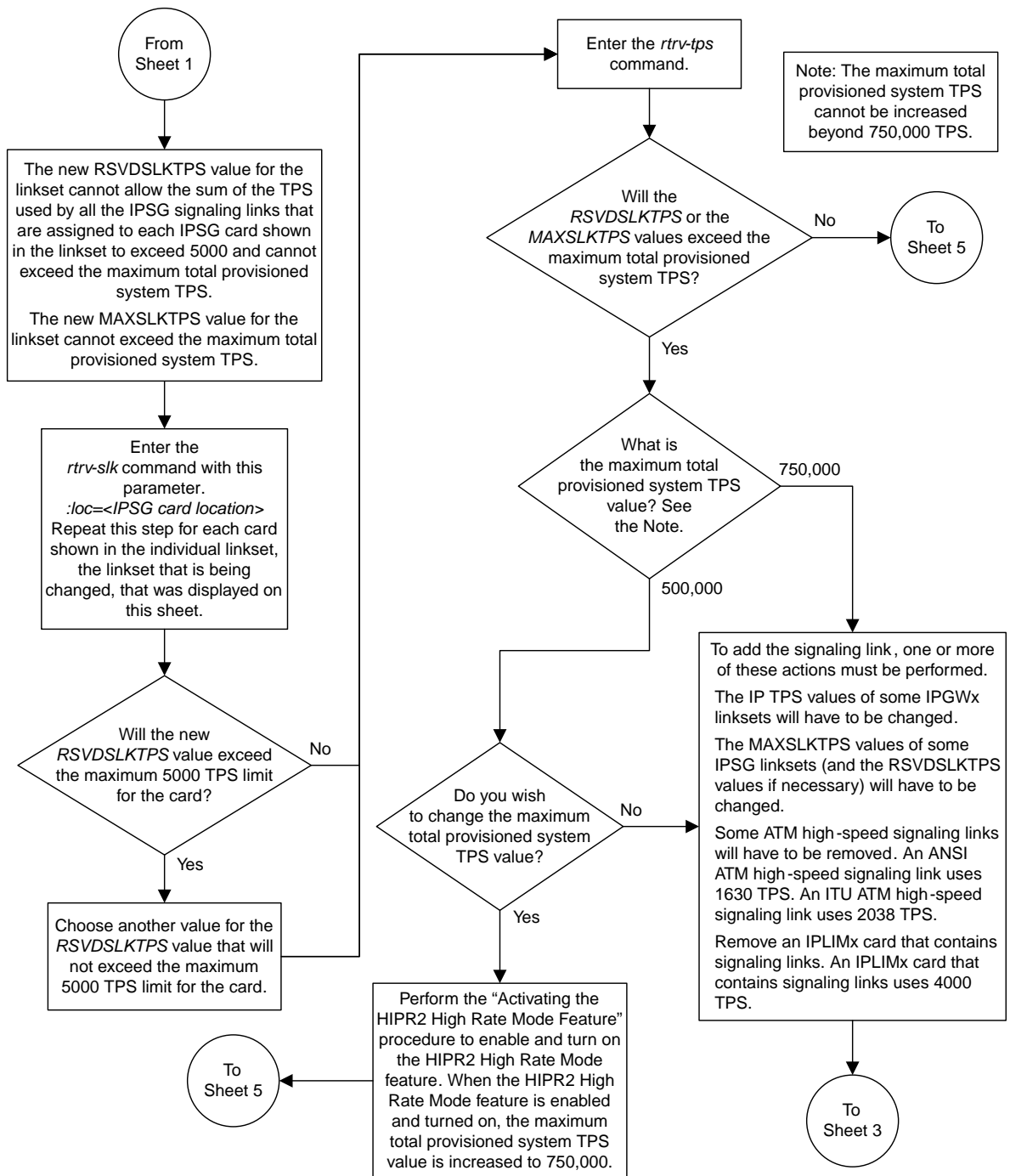

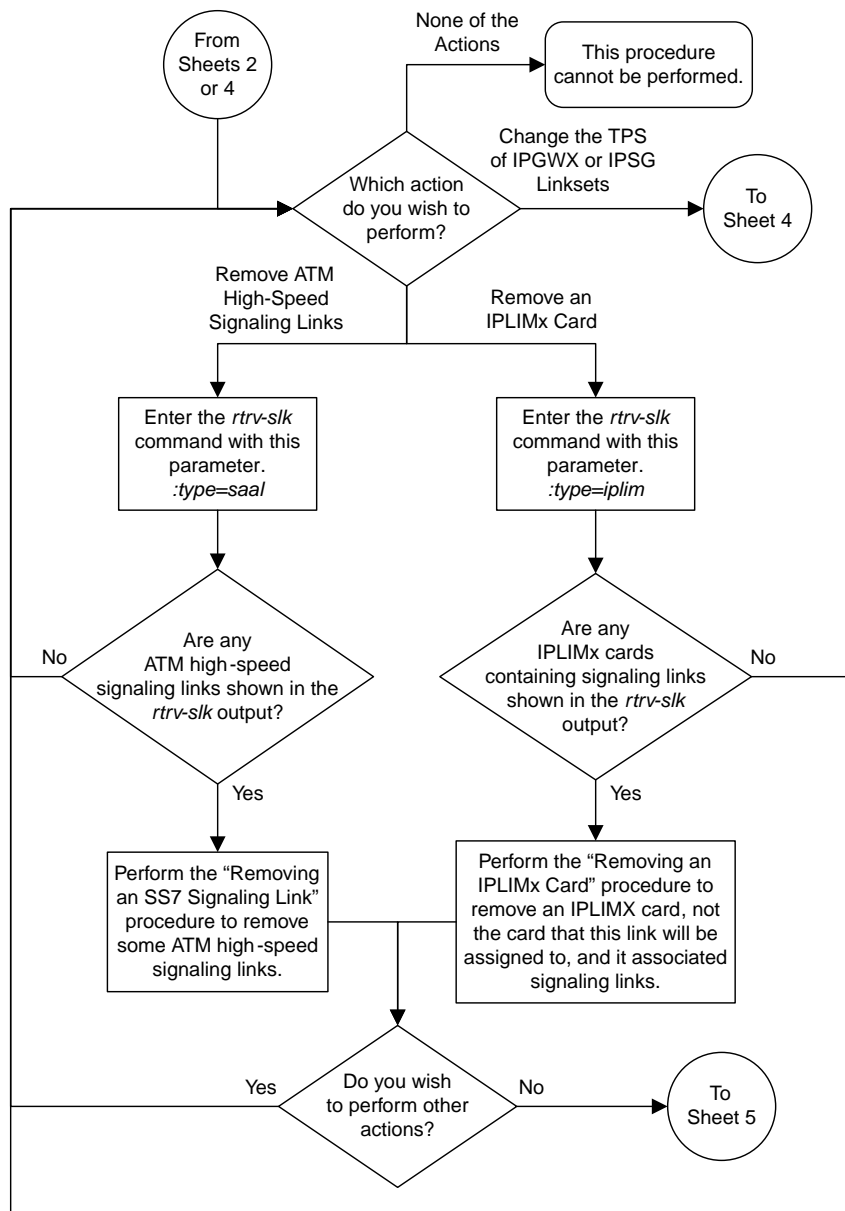

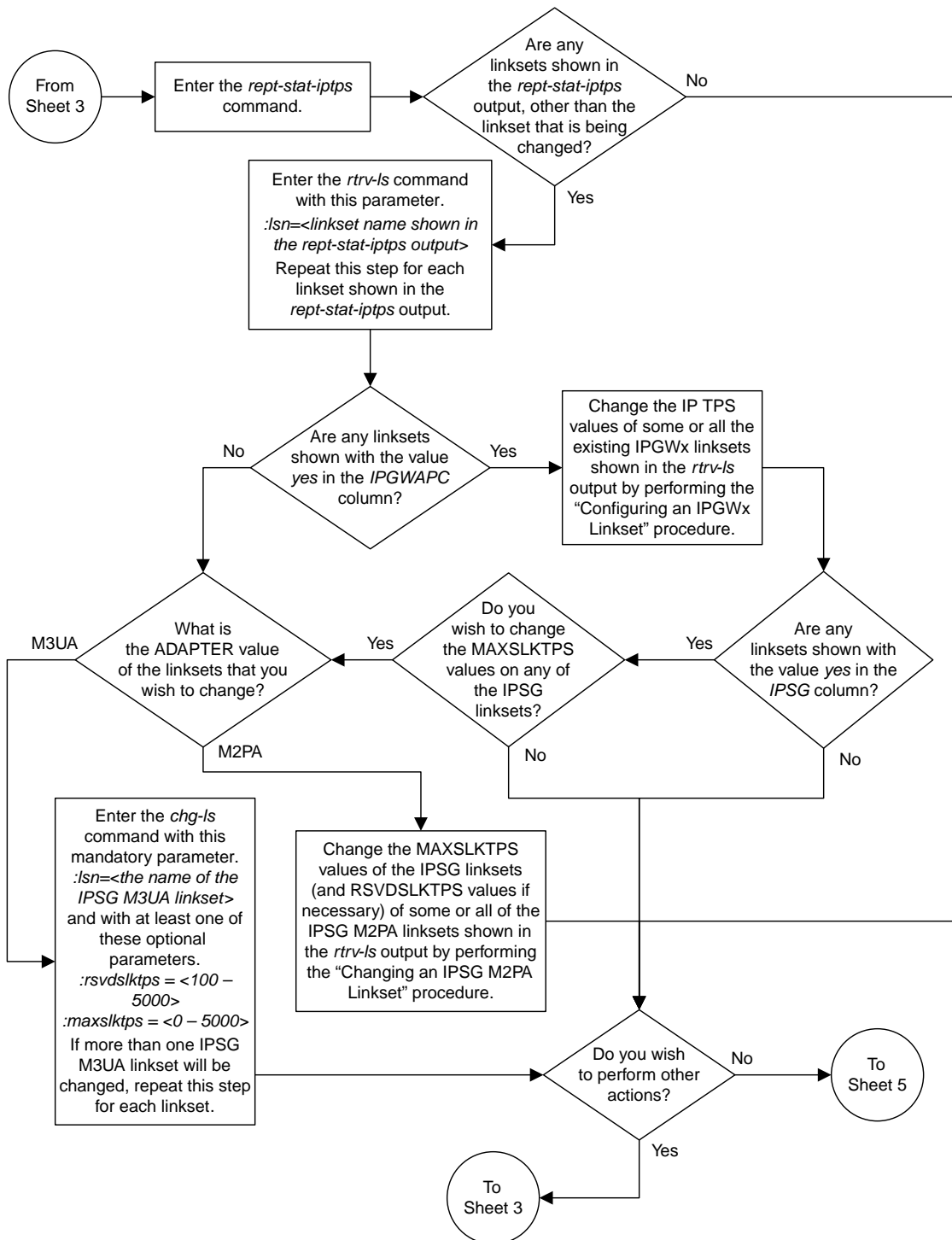

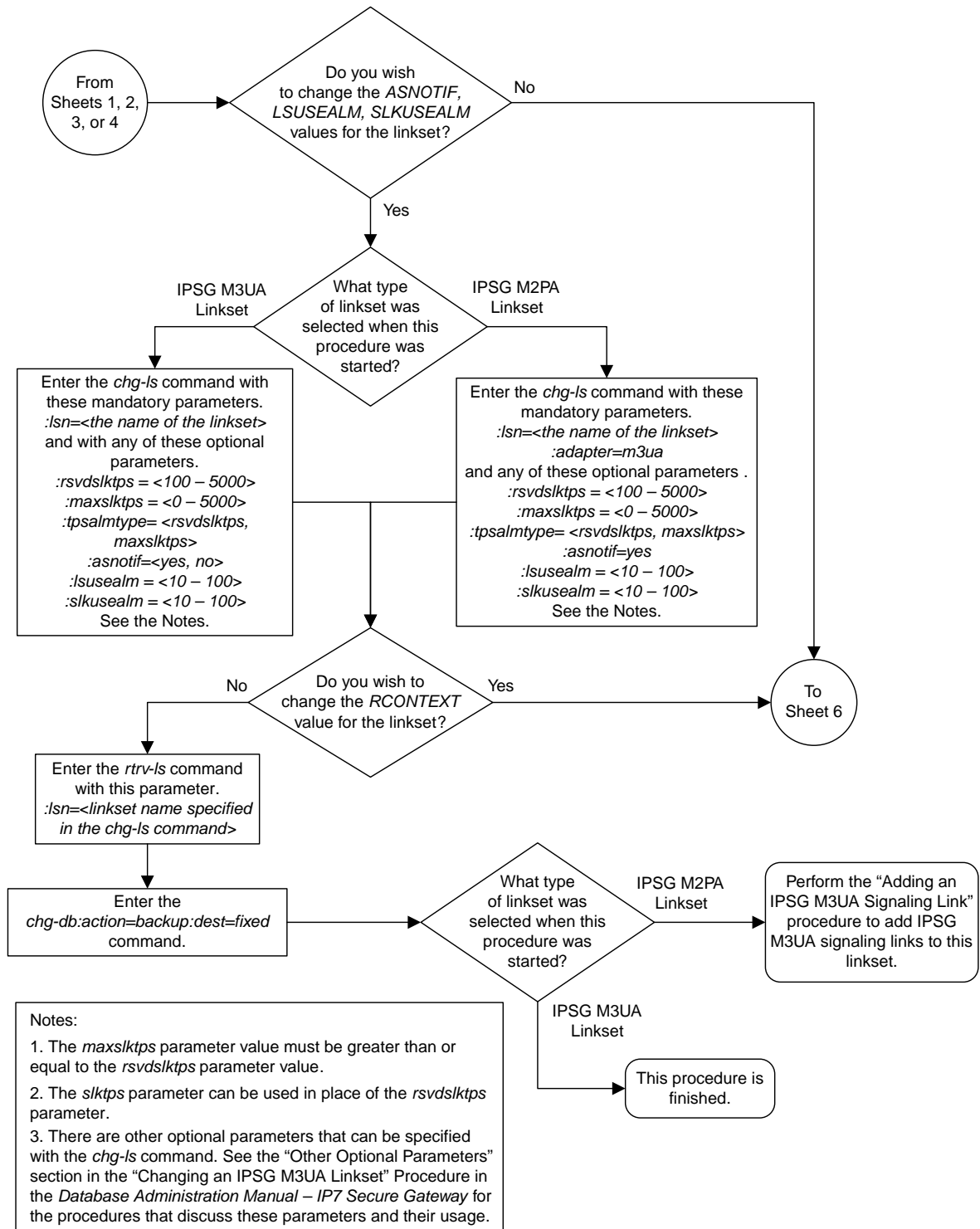

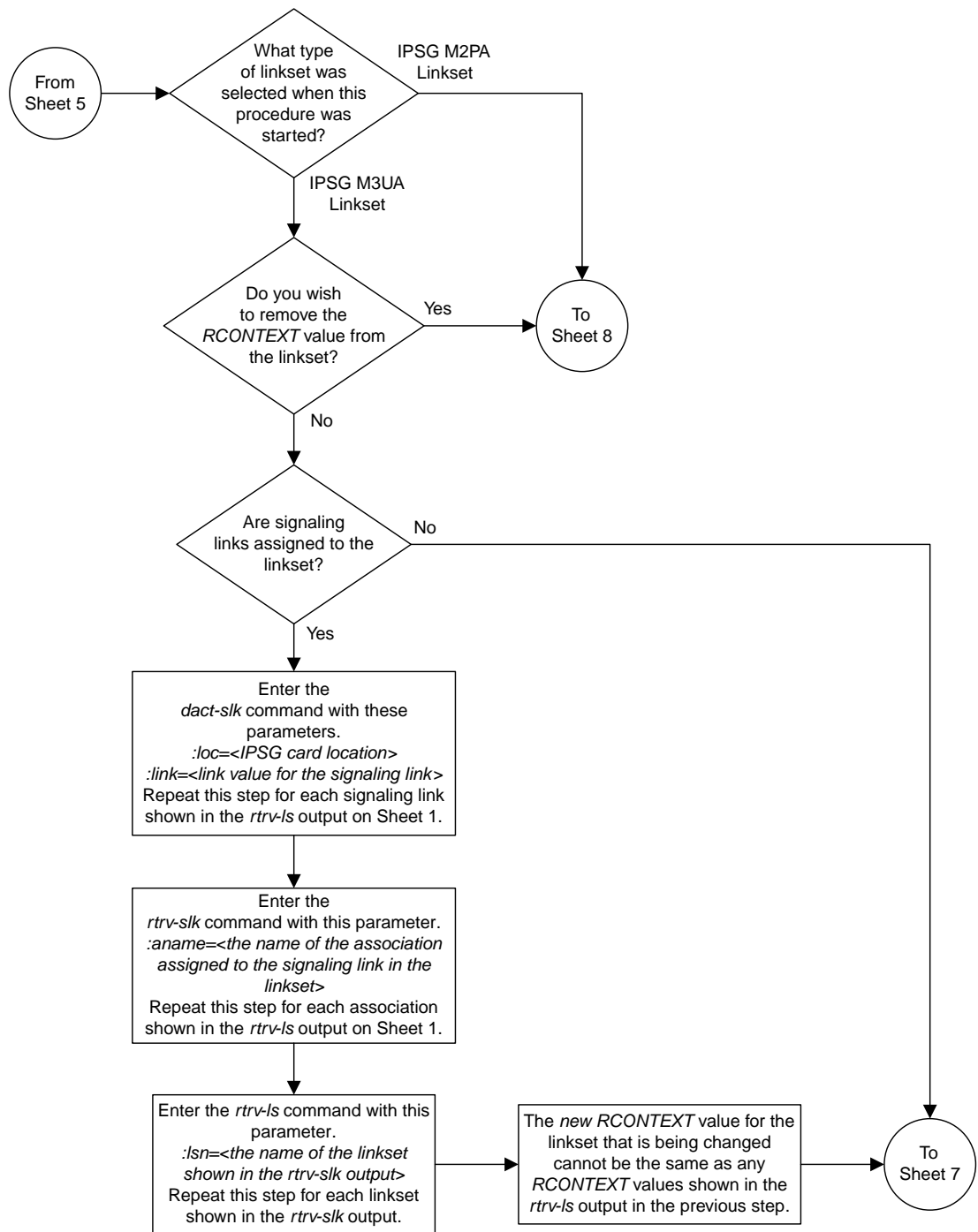

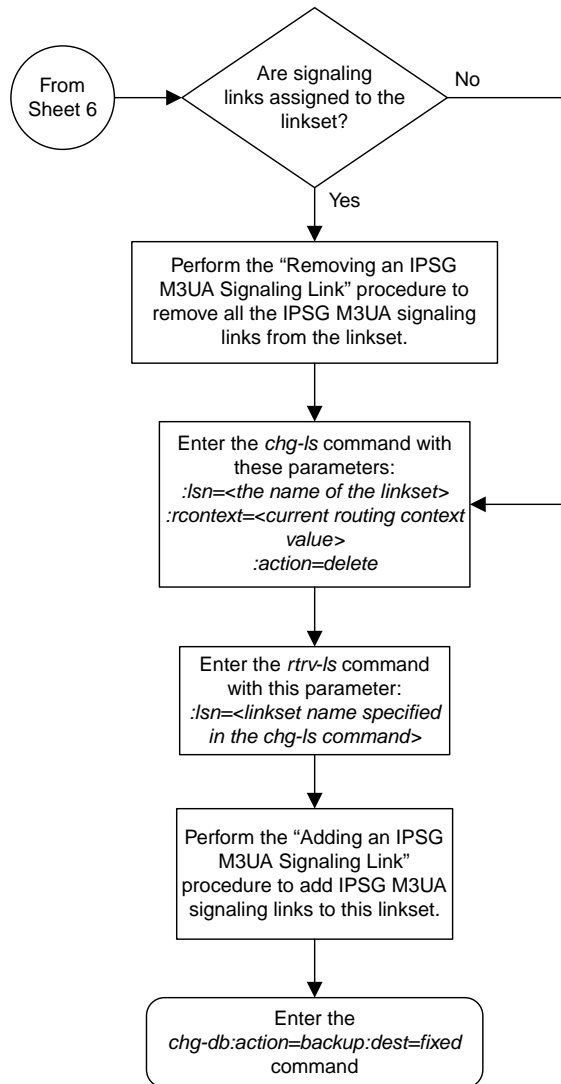

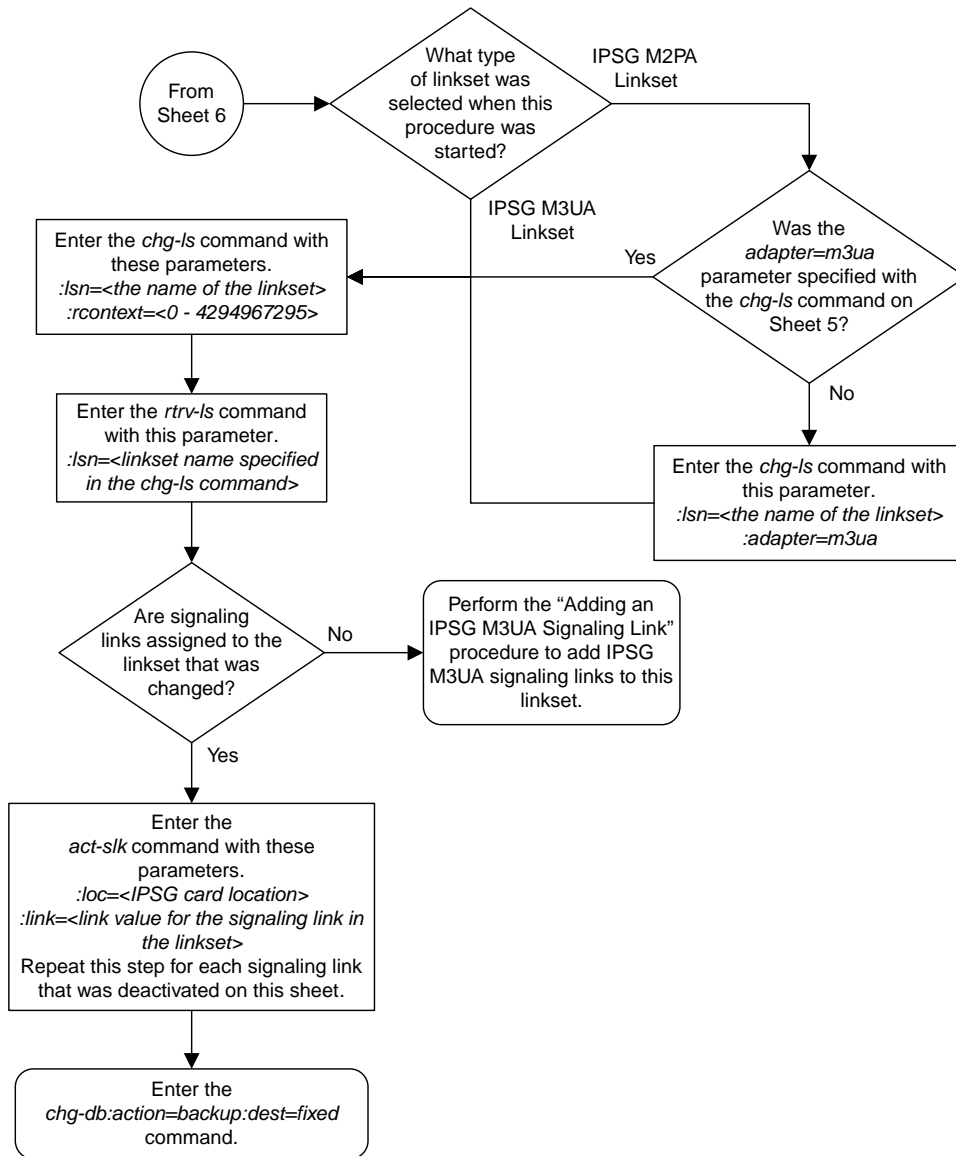

Sheet 8 of 8

Figure 114: Changing an IPSG M3UA Linkset

Changing the Attributes of an IPSG Association

This procedure is used to change the values of the attributes of an IPSG association, assigned to cards that are running the IPSG application, IPSG cards, using the `chg-assoc` command and the following parameters.

Table 58: Change IPSG Association Parameters

aname	lport	rhost	rport	open	alw
rmode	rmin	rmax	rtimes	cwmin	istrms
ostrms	m2patset	ver	rtxthr	uaps	rhosttype
rhostval					

If you wish to change the attributes of M2PA associations assigned to cards that are running the IPLIM or IPLIMI applications, perform [Changing the Attributes of an M2PA Association](#).

If you wish to change the attributes of M3UA associations assigned to cards that are running the SS7IPGW or IPGWI applications, perform [Changing the Attributes of a M3UA or SUA Association](#).

The `chg-assoc` command contains other parameters that are not used in this procedure. To change these parameters, perform these procedures.

- `lhost` and `alhost` - [Changing the Host Values of an IPSG Association](#).
- `bufsize` - [Changing the Buffer Size of an IPSG Association](#)

`:aname` – The name assigned to the association, shown in the `rtrv-assoc` output.

`:lport` – The SCTP port number for the local host.

`:rhost` – The host name for the remote host, `rhost` can be any string of characters starting with a letter and comprising these characters [‘a’..‘z’, ‘A’..‘Z’, ‘0’..‘9’, ‘-’, ‘.']. Hostnames are not case-sensitive and can contain up to 60 characters. The default value of this optional parameter is empty (null string).

`:rport` – The SCTP port number for the remote host.

`:open` – The connection state for this association. Valid values are `yes` or `no`. When the `open=yes` parameter is specified, the connection manager opens the association if the association is operational. When the `open=no` parameter is specified, the connection manager will not open the association. If the `open=no` parameter is specified for an established IPSG M3UA association, and the UA Graceful Shutdown option is enabled (refer to [Changing a UA Parameter Set](#) for more information), the IPSG M3UA connection will be gracefully shutdown.

`:alw` – The connection state for this association. Valid values are `yes` or `no`. When the `alw=yes` parameter is specified, the connection manager allows the association to carry SS7 traffic. When the `alw=no` parameter is specified, the connection manager prohibits the association from carrying SS7 traffic.

Note: If the `adapter` parameter value for the association is M3UA, the `alw` parameter cannot be specified.

`:rmode` – The retransmission policy used when packet loss is detected. The values are `rfc` or `lin`.

- `rfc` – Standard RFC 2960 algorithm in the retransmission delay doubles after each retransmission. The RFC 2960 standard for congestion control is also used.
- `lin` – Oracle's linear retransmission policy where each retransmission timeout value is the same as the initial transmission timeout and only the slow start algorithm is used for congestion control.

`:rmin` – The minimum value of the calculated retransmission timeout in milliseconds, from 10 - 1000.

`:rmax` – The maximum value of the calculated retransmission timeout in milliseconds, from 10 - 1000.

`:rtimes` – The number of times a data retransmission will occur before closing the association from 3 - 12.

`:cwmn` – The minimum size in bytes of the association's congestion window and the initial size in bytes of the congestion window, from 1500 - 409600. The `cwmn` parameter value must be less than or equal to the size of the buffer used by the association, shown by the `bufsize` parameter value. If the buffer size for the association needs to be changed, perform [Changing the Buffer Size of a M2PA Association](#).

The `rmode`, `rmin`, `rmax`, `rtimes`, and `cwmn` parameters are used to configure the SCTP retransmission controls for an association, in addition to other commands. Perform [Configuring SCTP Retransmission Control for a M2PA Association](#) to configure the SCTP retransmission controls for an association.

`:istrms` – The number of inbound streams (1 or 2) advertised by the SCTP layer for the association.

`:ostrms` – The number of outbound streams (1 or 2) advertised by the SCTP layer for the association.

`:m2patset` – The M2PA timer set assigned to the association. The `m2patset` parameter can be specified only with the `adapter=m2pa` parameter, or if the association already has the `adapter=m2pa` parameter assigned and the `adapter` parameter value is not being changed. If the `adapter` parameter value is being changed to `m2pa`, and the `m2patset` parameter is not specified, the default value for the `m2patset` parameter (1 - M2PA timer set 1) is assigned to the association. If the `adapter` parameter value for the association is `m2pa`, is not being changed, and the `m2patset` parameter is not specified with the `chg-assoc` command, the `m2patset` parameter value is not changed.

`:ver` – The M2PA version assigned to the M2PA association, either the RFC version (`ver=rfc`), or the Draft 6 version (`ver=d6`). The `ver` parameter can be specified only if, when this procedure is completed, the `adapter` parameter value is `m2pa`. If the `adapter` parameter value is being changed to `m2pa`, and the `ver` parameter is not specified, the default M2PA version of RFC is assigned to the association. To change the `ver` parameter value, the `open` parameter value for the association must be `no`.

`:uaps` – The UA parameter set value being assigned to an M2PA or an M3UA association.

`:rtxthr` – The retransmission threshold for the association. The `rtxthr` parameter value indicates the number of retransmissions that can occur on the association that when exceeded will generate UAM 0537, Ethernet Error Threshold Exceeded. The value of this parameter is 0 to 65,535. The value of this parameter is shown in the `RTXTHR` field of the `rtrv-assoc:aname=<association name>` output. The `rtxthr` parameter value can be changed if the `open` parameter value is either `yes` or `no`.

`:rhosttype` – The type of remote host assigned to the association, `primary` or `alternate`. The primary remote host is shown in the `RHOST` field of the `rtrv-assoc:aname=<association name>` output. The alternate remote host is shown in the `ARHOST` field of the `rtrv-assoc:aname=<association name>` output.

An alternate remote host can be configured for multi-homed associations using the `rhost` and `rhosttype` parameters of the `chg-assoc` command. The `rhost` parameter value with the `rhosttype=primary` parameter represents an IP address that corresponds to one of the network interfaces at the remote end while the `rhost` parameter value with the `rhosttype=alternate` parameter represents an IP address that corresponds to the other network interface at the remote end.

`:rhostval` – The validation mode used for the association when an SCTP INIT/INIT-ACK message is received. The value of this parameter is shown in the `RHOSTVAL` field of the `rtrv-assoc:aname=<association name>` output. This parameter has two values.

- `relaxed` - accept the message if the IP address for the primary or alternate remote host matches the IP address, source IP address, or the host name in the message.
- `match` - accept the message if the message contains the primary remote host value and the alternate remote host value (if the alternate remote host is provisioned). If the alternate remote host is not provisioned, then accept the message if the message contains the primary remote host value. Reject the message if it contains any IP address other than that of the primary or alternate remote host.

Refer to the `chg-assoc` command description in *Commands User's Guide* for more information about this parameter.

If the value of the `open` parameter is `yes`, only the value of the `alw` and `rtxthr` parameters can be changed. To change the values of other parameters, the value of the `open` parameter must be `no`.

To set the `open` parameter value to `yes`, the association specified by the `aname` parameter must contain values for the `lhost`, `lport`, `rhost`, and `rport` parameters. The association must be assigned to a signaling link.

At least one optional parameter is required.

The command input is limited to 150 characters, including the hostnames.

The value of the `rmin` parameter must be less than or equal to the `rmax` parameter value.

The `m2patset` and `ver` parameters can be specified only for IPSG M2PA associations.

Canceling the RTRV-ASSOC Command

Because the `rtrv-assoc` command used in this procedure can output information for a long period of time, the `rtrv-assoc` command can be canceled and the output to the terminal stopped. There are three ways that the `rtrv-assoc` command can be canceled.

- Press the F9 function key on the keyboard at the terminal where the `rtrv-assoc` command was entered.
- Enter the `canc-cmd` without the `trm` parameter at the terminal where the `rtrv-assoc` command was entered.
- Enter the `canc-cmd:trm=<xx>`, where `<xx>` is the terminal where the `rtrv-assoc` command was entered, from another terminal other than the terminal where the `rtrv-assoc` command was entered. To enter the `canc-cmd:trm=<xx>` command, the terminal must allow Security Administration commands to be entered from it and the user must be allowed to enter Security Administration commands. The terminal's permissions can be verified with the `rtrv-secu-trm` command. The user's permissions can be verified with the `rtrv-user` or `rtrv-secu-user` commands.

For more information about the `canc-cmd` command, go to *Commands User's Guide*.

1. Display the associations in the database using the `rtrv-assoc` command.

This is an example of possible output.

```
rlghncxa03w 06-10-28 09:12:36 GMT EAGLE5 36.0.0

CARD IPLNK
ANAME LOC PORT LINK ADAPTER LPORT RPORT OPEN ALW
swbel32 1201 A A M3UA 1030 2345 YES YES
a2 1305 A A SUA 1030 2345 YES YES
a3 1307 A A SUA 1030 2346 YES YES
assoc1 1201 A A M3UA 2000 1030 YES YES
assoc2 1205 A A M2PA 2048 2048 YES YES
assoc3 1205 A B2 M2PA 3000 3000 YES YES
assoc5 1205 A A3 M2PA 1500 3000 YES YES
```

2. Enter the `rtrv-card` command with the location of the card that is hosting the M2PA or M3UA association that will be changed in this procedure. For this example, enter these commands.

```
rtrv-card:loc=1205
```

This is an example of possible output.

```
rlghncxa03w 08-04-06 15:17:20 EST EAGLE5 38.0.0
CARD TYPE APPL LSET NAME LINK SLC LSET NAME LINK SLC
1205 ENET IPSG e5e6a A 0 e5e6a B2 1
e5e6a A3 2
```

```
rtrv-card:loc=1201
```

This is an example of possible output.

```
rlghncxa03w 08-04-06 15:17:20 EST EAGLE5 38.0.0
CARD TYPE APPL LSET NAME LINK SLC LSET NAME LINK SLC
1201 ENET IPSG ipsgm3ua1 A 0
```

If the application assigned to the card is IPSG, shown in the APPL column, and the values of any of these parameters are being changed: `lport`, `rhost`, `rport`, `rmode`, `rmin`, `rmax`, `rtimes`, `cwmin`, `istrms`, `ostrms`, `ver`, `m2patset`, or `uaps`, continue the procedure by performing one of these steps.

- If the open parameter value for the association is `yes`, continue the procedure with [Step 3](#).
- If the open parameter value for the association is `no`, continue the procedure with [Step 4](#).

If the application assigned to the card is IPSG, shown in the APPL column, and only the values of the `alw`, `open`, or `rtxtthr` parameters are being changed, continue the procedure by performing one of these steps.

Note: If the adapter parameter value for the association is M3UA, the `alw` parameter cannot be specified.

- If only the values of the `alw` parameter is being changed, or the `open` parameter value is being changed to `no`, continue the procedure with [Step 10](#).
- If the value of the `rtxtthr` parameter is being changed, continue the procedure with [Step 4](#).
- If the value of the `open` parameter value is being changed to `yes`, the association must be assigned to a signaling link. If the association is assigned to a signaling link, the signaling link value is shown in the LINK column in the `rtrv-assoc` output, in [Step 1](#). If the association is

not assigned to a signaling link, dashes are shown in the LINK column in the `rtrv-assoc` output. If association is assigned to a signaling link, perform one of these actions.

- If only the `alw` parameter is being specified with the `open=yes` parameter, continue the procedure with [Step 10](#).
- If the value of the `rtxtthr` parameter is being changed, continue the procedure with [Step 4](#).
- If the value of the `open` parameter value is being changed to `yes` and the association is not assigned to a signaling link, perform one of these procedures.
 - If the ADAPTER value of the association is M2PA, perform [Adding an IPSG M2PA Signaling Link](#).
 - If the ADAPTER value of the association is M3UA, perform [Adding an IPSG M3UA Signaling Link](#).
- After the association has been assigned to a signaling link, perform one of these actions.
 - If only the `alw` parameter is being specified with the `open=yes` parameter, continue the procedure with [Step 10](#).
 - If the value of the `rtxtthr` parameter is being changed, continue the procedure with [Step 4](#).

If the application assigned to the card is IPLIM or IPLIMI, perform [Changing the Attributes of an M2PA Association](#).

If the application assigned to the card is SS7IPGW or IPGWI, perform [Changing the Attributes of a M3UA or SUA Association](#).

3. Change the value of the `open` parameter to `no` by specifying the `chg-assoc` command with the `open=no` parameter.

For this example, enter these commands.

```
chg-assoc:aname=assoc2:open=no
```

```
chg-assoc:aname=assoc1:open=no
```

When these commands have successfully completed, this message should appear.

```
rlghncxa03w 06-10-28 09:12:36 GMT EAGLE5 36.0.0
CHG-ASSOC: MASP A - COMPLTD;
```

4. Display the association being changed by entering the `rtrv-assoc` command with the `aname` parameter specified in [Step 3](#) or selected in [Step 1](#).

For this example, enter these commands.

```
rtrv-assoc:aname=assoc2
```

This is an example of the possible output.

```
rlghncxa03w 10-07-28 21:14:37 GMT EAGLE5 42.0.0
ANAME assoc2
  LOC      1205          IPLNK PORT  A          LINK  A
  ADAPTER  M2PA          VER      M2PA RFC
  LHOST    IPNODE2-1205
  ALHOST    ---
  RHOST     remotehost1
```

```

ARHOST ---
LPORT 2048          RPORT 2048
ISTRMS 2           OSTRMS 2           BUFSIZE 400
RMODE  LIN         RMIN 120          RMAX 800
RTIMES 10          CWMIN 3000        UAPS 10
OPEN   NO           ALW  YES           RTXTHR 2000
RHOSTVAL RELAXED   M2PATSET 1

```

LSN
e5e6a

IP Appl Sock/Assoc table is (7 of 4000) 1% full
Assoc Buffer Space Used (800 KB of 6400 KB) on LOC = 1205

```
rtrv-assoc:aname=assoc1
```

This is an example of the possible output.

```

rlghncxa03w 09-05-28 21:14:37 GMT EAGLE5 41.0.0

ANAME assoc1
LOC 1201          IPLNK PORT A          LINK A
ADAPTER M3UA      VER M3UA RFC
LHOST m3ua1
ALHOST ---
RHOST remotel
ARHOST ---
LPORT 2000        RPORT 1030
ISTRMS 2          OSTRMS 2           BUFSIZE 200
RMODE  LIN         RMIN 120          RMAX 800
RTIMES 10          CWMIN 3000        UAPS 10
OPEN   NO           ALW NO            RTXTHR 0
RHOSTVAL RELAXED

LSN
ipsgm3ua1

```

IP Appl Sock/Assoc table is (7 of 4000) 1% full
Assoc Buffer Space Used (200 KB of 6400 KB) on LOC = 1201

Continue the procedure by performing one of these actions.

- If the `cwmin` parameter will be specified in this procedure, continue the procedure with [Step 5](#).
5. To change the `cwmin` value, the new `cwmin` parameter value must be less than or equal to the `bufsize` parameter value.

The `cwmin` parameter is the number of bytes specified for the association's congestion window. The `bufsize` is the number of kilobytes specified for the size of the association's buffer. To determine whether or not the `cwmin` value is less than or equal to the `bufsize` value, perform one of these actions.

- Multiply the `bufsize` value by 1024.
- Divide the `cwmin` value by 1024.

Continue the procedure by performing one of these actions.

- If the new `cwmin` value is less than or equal to the `bufsize` value, continue the procedure with by performing one of these actions.

- If the `m2patset` parameter will be specified for an M2PA association, continue the procedure with [Step 6](#).
 - If the `uaps` parameter will be specified for an M3UA association, continue the procedure with [Step 7](#).
 - If the `rhost` parameter will be specified for the association, continue the procedure with [Step 8](#).
 - If the `m2patset`, `uaps`, or `rhost` parameter will not be specified for the association, continue the procedure with [Step 10](#).
- If the new `cwmin` value is not less than or equal to the `bufsize` value, either choose another value for the `cwmin` parameter that is less than or equal to the `bufsize` value, or perform [Changing the Buffer Size of an IPSG Association](#) to change the `bufsize` value so that the `bufsize` value is greater than or equal to the `cwmin` value. After the new `cwmin` value has been chosen or the `bufsize` value has been changed, continue the procedure by performing one of these actions.
- If the `m2patset` parameter will be specified for an M2PA association, continue the procedure with [Step 6](#).
 - If the `uaps` parameter will be specified for an M3UA association, continue the procedure with [Step 7](#).
 - If the `rhost` parameter will be specified for the association, continue the procedure with [Step 8](#).
 - If the `m2patset`, `uaps`, or `rhost` parameter will not be specified for the association, continue the procedure with [Step 10](#).
6. Verify the values of the M2PA timer set you wish to assign to the association by entering the `rtrv-m2pa-tset` command with the M2PA version (either `ver=rfc` to display the RFCM2PA timer values or `ver=d6` to display the Draft 6 M2PA timer values) of the timer set you wish to assign to the association.

If the `ver` parameter is not specified with the `rtrv-m2pa-tset` command, both the RFC and Draft 6 timer values are displayed.

To display the M2PA Draft 6 timer values, enter this command.

```
rtrv-m2pa-tset:ver=d6
```

This is an example of the possible output.

```
rlghncxa03w 06-10-28 21:16:37 GMT EAGLE5 36.0.0
```

```
M2PA Draft 6 Timers (in msec, T16 in microsec)
```

TSET	T1	T2	T3	T4N	T4E	T5	T6	T7	T16	T17	T18
1	6000	-----	5000	20000	500	5000	4000	1000	100000	150	500
2	7500	-----	1500	2000	500	9000	1250	300	150000	175	600
3	100000	-----	2000	3000	500	4000	1500	500	170000	200	800
4	200000	-----	20000	4000	500	6000	2000	700	480000	225	900
5	250000	-----	30000	30000	500	100	2250	400	400000	400	8000
6	50000	-----	50000	60000	500	500	4500	800	300000	300	7000
7	10000	-----	10000	10000	500	1000	3000	1200	200000	250	1000
8	80000	-----	1500	15000	500	8000	2750	1100	350000	350	5000
9	27500	-----	3850	4859	450	5700	3750	1150	250	375	8750
10	90000	-----	2500	50000	500	7500	5000	1750	440000	450	3000
11	20000	-----	4500	5500	500	6500	5500	1600	250000	475	4500

```

12 30000 ----- 7500 7000 500 750 4250 1800 275000 275 3500
13 40000 ----- 35000 9000 500 1250 3500 1900 500 325 9000
14 70000 ----- 45000 11000 500 1500 1750 900 1000 125 6000
15 9000 ----- 25000 40000 500 2500 3250 600 5000 425 5500
16 75000 ----- 15000 25000 500 4500 1600 1400 6000 240 9500
17 350000 ----- 60000 70000 600 10000 6000 2000 500000 500 10000
18 150000 ----- 55000 35000 500 3500 5750 1500 125000 440 750
19 175000 ----- 12500 45000 500 1100 2600 1300 7000 340 850
20 1000 ----- 1000 1000 400 80 1000 200 100 100 100

```

To display the M2PARFC values, enter this command.

```
rtrv-m2pa-tset:ver=rfc
```

This is an example of the possible output.

```

rlghncxa03w 06-10-28 21:16:37 GMT EAGLE5 36.0.0

M2PA RFC Timers (in msec, T16 in microsec)

TSET T1      T2      T3      T4N    T4E    T5      T6      T7      T16    T17    T18
1     6000    75000  5000   20000  500    5000   4000  1000   100000 150    500
2     7500    8000   1500   2000   500    9000   1250  300   150000 175    600
3     100000  10000  2000   3000   500    4000   1500  500   170000 200    800
4     200000  6000   20000  4000   500    6000   2000  700   480000 225    900
5     250000  140000 30000  30000  500    100    2250  400   400000 400    8000
6     50000   100000 50000  60000  500    500    4500  800   300000 300    7000
7     300000  20000  2000   10000  500    1000   3000  1200  200000 250    1000
8     80000   130000 1500   15000  500    8000   2750  1100  350000 350    5000
9     27500   120000 3850   4859   450    5700   3750  1150  250    375   8750
10    90000   9000   2500   50000  500    7500   5000  1750  440000 450    3000
11    20000   60000  4500   5500   500    6500   5500  1600  250000 475    4500
12    30000   50000  7500   7000   500    750    4250  1800  275000 275    3500
13    40000   90000  35000  9000   500    1250   3500  1900  500    325   9000
14    70000   45000  45000  11000  500    1500   1750  900   1000   125   6000
15    9000    30000  25000  40000  500    2500   3250  600   5000   425   5500
16    75000   15000  15000  25000  500    4500   1600  1400  6000   240   9500
17    350000  150000 60000  70000  600    10000  6000  2000  500000 500    10000
18    150000  20000  55000  35000  500    3500   5750  1500  125000 440    750
19    175000  12500  12500  45000  500    1100   2600  1300  7000   340   850
20    1000    5000   1000   1000   400    80     1000  200   100    100  100

```

If the ver parameter is not specified when entering the rtrv-m2pa-tset command, both the Draft 6 and RFC values are displayed. This is an example of the possible output.

```

rlghncxa03w 06-10-28 21:16:37 GMT EAGLE5 36.0.0

M2PA Draft 6 Timers (in msec, T16 in microsec)

TSET T1      T2      T3      T4N    T4E    T5      T6      T7      T16    T17    T18
1     6000    ----- 5000   20000  500    5000   4000  1000   100000 150    500
2     7500    ----- 1500   2000   500    9000   1250  300   150000 175    600
3     100000  ----- 2000   3000   500    4000   1500  500   170000 200    800
4     200000  ----- 20000  4000   500    6000   2000  700   480000 225    900
5     250000  ----- 30000  30000  500    100    2250  400   400000 400    8000
6     50000   ----- 50000  60000  500    500    4500  800   300000 300    7000
7     10000   ----- 10000  10000  500    1000   3000  1200  200000 250    1000
8     80000   ----- 1500   15000  500    8000   2750  1100  350000 350    5000
9     27500   ----- 3850   4859   450    5700   3750  1150  250    375   8750
10    90000   ----- 2500   50000  500    7500   5000  1750  440000 450    3000

```

11	20000	-----	4500	5500	500	6500	5500	1600	250000	475	4500
12	30000	-----	7500	7000	500	750	4250	1800	275000	275	3500
13	40000	-----	35000	9000	500	1250	3500	1900	500	325	9000
14	70000	-----	45000	11000	500	1500	1750	900	1000	125	6000
15	9000	-----	25000	40000	500	2500	3250	600	5000	425	5500
16	75000	-----	15000	25000	500	4500	1600	1400	6000	240	9500
17	350000	-----	60000	70000	600	10000	6000	2000	500000	500	10000
18	150000	-----	55000	35000	500	3500	5750	1500	125000	440	750
19	175000	-----	12500	45000	500	1100	2600	1300	7000	340	850
20	1000	-----	1000	1000	400	80	1000	200	100	100	100

M2PA RFC Timers (in msec, T16 in microsec)

TSET	T1	T2	T3	T4N	T4E	T5	T6	T7	T16	T17	T18
1	6000	75000	5000	20000	500	5000	4000	1000	100000	150	500
2	7500	8000	1500	2000	500	9000	1250	300	150000	175	600
3	100000	10000	2000	3000	500	4000	1500	500	170000	200	800
4	200000	6000	20000	4000	500	6000	2000	700	480000	225	900
5	250000	140000	30000	30000	500	100	2250	400	400000	400	8000
6	50000	100000	50000	60000	500	500	4500	800	300000	300	7000
7	300000	20000	2000	10000	500	1000	3000	1200	200000	250	1000
8	80000	130000	1500	15000	500	8000	2750	1100	350000	350	5000
9	27500	120000	3850	4859	450	5700	3750	1150	250	375	8750
10	90000	9000	2500	50000	500	7500	5000	1750	440000	450	3000
11	20000	60000	4500	5500	500	6500	5500	1600	250000	475	4500
12	30000	50000	7500	7000	500	750	4250	1800	275000	275	3500
13	40000	90000	35000	9000	500	1250	3500	1900	500	325	9000
14	70000	45000	45000	11000	500	1500	1750	900	1000	125	6000
15	9000	30000	25000	40000	500	2500	3250	600	5000	425	5500
16	75000	15000	15000	25000	500	4500	1600	1400	6000	240	9500
17	350000	150000	60000	70000	600	10000	6000	2000	500000	500	10000
18	150000	20000	55000	35000	500	3500	5750	1500	125000	440	750
19	175000	12500	12500	45000	500	1100	2600	1300	7000	340	850
20	1000	5000	1000	1000	400	80	1000	200	100	100	100



CAUTION

Caution: Changing an M2PA timer set may affect the performance of any associations using the timer set being changed.

If the M2PA timer set you wish to assign to the association does not contain the desired values, perform the [Changing an M2PA Timer Set](#) procedure to change the desired timer values.

After the M2PA timer set values have been changed, or if you have decided not to change the M2PA timer set values, continue the procedure by performing one of these actions.

- If the `uaps` parameter will be specified for an M3UA association, continue the procedure with [Step 7](#).
 - If the `rhost` parameter will be specified for the association, continue the procedure with [Step 8](#).
 - If the `uaps` or `rhost` parameter will not be specified for the association, continue the procedure with [Step 10](#).
7. Verify the values of the UA parameter set you wish to assign to the association by entering the `rtrv-uaps` command with the desired parameter set.

For this example, enter this command.

```
rtrv-uaps:set=3
```

This is an example of possible output.

```

rlghncxa03w 10-07-28 09:12:36 GMT EAGLE5 42.0.0
  SET  TIMER      TVALUE  PARM      PVALUE
    3    1          10      1          3
    3    2         3000     2          0
    3    3        10000     3          1
    3    4          5000     4          0
    3    5           0       5          0
    3    6           0       6          0
    3    7           0       7          0
    3    8           0       8          0
    3    9           0       9          0
    3   10           0      10          0

TIMER 2: False IP Connection Congestion Timer, max time an
association can be congested before failing due to false
congestion. SS7IPGW and IPGWI applications enforce
0-30000(ms). Not supported on IPSG application.
TVALUE : Valid range = 32-bits

TIMER 3: UA HeartBeat Period Timer T(beat), time (ms) between sending
of BEAT msgs by NE. IPSG, SS7IPGW and IPGWI applications
enforce 100(ms)-60000(ms).
TVALUE : Valid range = 32-bits

TIMER 4: UA HeartBeat Received Timer T(beat ack), timeout period for
response BEAT ACK msgs by NE. IPSG, SS7IPGW and IPGWI
applications enforce 100(ms)-10000(ms).
TVALUE : Valid range = 32-bits

PARM 1: ASP SNM options. Each bit is used as an enabled/disabled
flag for a particular ASP SNM option. Not supported on IPSG
application.
PVALUE : Valid range = 32-bits
  BIT                                BIT VALUE
  0=Broadcast                        0=Disabled , 1=Enabled
  1=Response Method                  0=Disabled , 1=Enabled
  2-5=Reserved
  6=Broadcast Congestion Status Change 0=Disabled , 1=Enabled
  7-31=Reserved

PARM 2: ASP/AS Notification options. Each bit is used as an
enabled/disabled flag for a particular ASP/AS
Notification option. Not supported on IPSG application.
PVALUE : Valid range = 32-bits
  BIT                                BIT VALUE
  0=ASP Active Notifications          0=Disabled , 1=Enabled
  1=ASP Inactive Notifications        0=Disabled , 1=Enabled
  2=ASP AS State Query                0=Disabled , 1=Enabled
  3-31=Reserved

PARM 3: UA Serviceability Options. Each bit is used as an
enabled/disabled flag for a particular UA Serviceability
option. Supported on IPSG, SS7IPGW, and IPGWI applications.
UA Graceful Shutdown supported on IPSG for M3UA only.
PVALUE : Valid range = 32-bits
  BIT                                BIT VALUE
  0=UA Heartbeats                    0=Disabled , 1=Enabled
  1=UA Graceful Shutdown              0=Disabled , 1=Enabled
  2-31=Reserved

PARM 4: SCTP Payload Protocol Indicator byte order option. Bit indicates

```

```

PPI value is RCV/TX in Big Endian or Little Endian byte format.
Supported on IPSG-M2PA associations only.
PVALUE : Valid range = 32-bits
        BIT                               BIT VALUE
        0=Payload Protocol Indicator       0=Big Endian , 1=Little Endian
        1-31=Reserved

```

**CAUTION**

Caution: Changing aUA parameter set may affect the performance of any associations using the parameter set being changed.

If the UA parameter set you wish to assign to the association does not contain the desired values, perform the [Changing a UA Parameter Set](#) procedure to change the desired parameter set values.

After the UA parameter set values have been changed, or if you have decided not to change the UA parameter set values, continue the procedure by performing one of these actions.

- If the rhost parameter will be specified for the association, continue the procedure with [Step 8](#).
 - If the uaps or rhost parameter will not be specified for the association, continue the procedure with [Step 10](#).
8. The remote hosts assigned to the association can be changed by specifying the rhost and rhosttype parameters with the chg-assoc command.

If the primary and alternate remote hosts are not being changed in this procedure, or if only the primary remote host is being changed, continue the procedure with [Step 10](#).

To change the alternate remote host value for the association, the association must have a primary remote host assigned to it. If the association has a primary remote host, continue the procedure with [Step 10](#). If the association does not have a primary remote host, continue the procedure with [Step 9](#).

9. Assign a primary remote host to the association by entering the chg-assoc command with the name of the association and the primary remote host name.

For this example, enter this command.

```
chg-assoc:aname=assoc2:rhost="gw200.nc-Oracle.com"
```

The rhosttype=primary parameter can be specified with the chg-assoc command, but is not necessary.

When this command has successfully completed, this message should appear.

```

rlghncxa03w 09-05-28 09:12:36 GMT EAGLE5 41.0.0
CHG-ASSOC: MASP A - COMPLTD;

```

10. Change the association using the chg-assoc command.

For this example, enter these commands.

```
chg-assoc:aname=assoc2:rhost="gw200.nc-Oracle.com"
:rport=3000:rtxthr=10000:rhostval=match
```

```
chg-assoc:aname=assoc1:rport=3000:rtxthr=10000:uaps=3:rhostval=match
```

If an alternate remote host is being specified for the association, for this example enter this command.

```
chg-assoc:aname=assoc2:rhost="gw210.nc-Oracle.com":rhosttype=alternate
:rport=3000:rtxthr=10000:rhostval=match
```

Note: Them2patset and ver parameters can be specified only for M2PA associations.

If only the alw, open, rtxthr parameter values are being changed in this step, for this example, enter this command.

Note: If the adapter parameter value for the association is M3UA, the alw parameter cannot be specified.

```
chg-assoc:aname=assoc2:alw=no:open=yes:rtxthr=10000
```

These are the rules that apply to changing the attributes of an IPSG association.

1. If any optional parameters are not specified with the chg-assoc command, those values are not changed.
2. The value of the rhost parameter is a text string of up to 60 characters, with the first character being a letter. The command input is limited to 150 characters, including the hostname.
3. If the value of the open parameter is yes, only the values of the alw and rtxthr parameters can be changed. To change the values of the other parameters, the value of the open parameter value must be no.
4. The value of the rmin parameter must be less than or equal to the rmax parameter value.
5. The M2PA version of the association determines the version of the M2PA timer set that is assigned to the association. For example, if M2PA timer set 3 is assigned to the M2PA association, and the association is an RFC M2PA association, the RFC version of M2PA timer set 3 is used with the association. If M2PA timer set 7 is assigned to the M2PA association, and the association is a Draft 6 M2PA association, the Draft 6 version of M2PA timer set 7 is used with the association.
6. The m2patset and ver parameters can be specified only for IPSG M2PA associations.
7. If the adapter parameter value for the association is M3UA, the alw parameter cannot be specified.

When these commands have successfully completed, this message should appear.

```
rlghncxa03w 06-10-28 09:12:36 GMT EAGLE5 36.0.0
CHG-ASSOC: MASP A - COMPLTD;
```

If the value of the open parameter was not changed in [Step 3](#), continue the procedure with [Step 12](#).

11. Change the value of the open parameter to yes by specifying the chg-assoc command with the open=yes parameter.

For this example, enter these commands.

```
chg-assoc:aname=assoc2:open=yes
```

```
chg-assoc:aname=assoc1:open=yes
```

When this command has successfully completed, this message should appear.

```
rlghncxa03w 06-10-28 09:12:36 GMT EAGLE5 36.0.0
CHG-ASSOC: MASP A - COMPLTD;
```

12. Verify the changes using the `rtrv-assoc` command specifying the association name specified in [Step 10](#) and [Step 11](#).

For this example, enter these commands.

```
rtrv-assoc:aname=assoc2
```

This is an example of possible output.

```
rlghncxa03w 10-07-28 21:14:37 GMT EAGLE5 42.0.0
ANAME assoc2
  LOC      1205          IPLNK PORT  A          LINK  A
  ADAPTER  M2PA          VER      M2PA RFC
  LHOST    IPNODE2-1205
  ALHOST   ---
  RHOST    gw200.nc-Oracle.com
  ARHOST   gw210.nc-Oracle.com
  LPORT    2048          RPORT    2048
  ISTRMS   2            OSTRMS   2          BUFSIZE 400
  RMODE    LIN          RMIN     120         RMAX    800
  RTIMES   10          CWMIN    3000        UAPS    10
  OPEN     YES          ALW      NO           RTXTHR  10000
  RHOSTVAL MATCH       M2PATSET  1

LSN
e5e6a

IP Appl Sock/Assoc table is (7 of 4000) 1% full
Assoc Buffer Space Used (800 KB of 6400 KB) on LOC = 1205
```

```
rtrv-assoc:aname=assoc1
```

This is an example of the possible output.

```
rlghncxa03w 09-05-28 21:14:37 GMT EAGLE5 41.0.0
ANAME assoc1
  LOC      1201          IPLNK PORT  A          LINK  A
  ADAPTER  M3UA          VER      M3UA RFC
  LHOST    m3ua1
  ALHOST   ---
  RHOST    remotel
  ARHOST   ---
  LPORT    2000          RPORT    3000
  ISTRMS   2            OSTRMS   2          BUFSIZE 200
  RMODE    LIN          RMIN     120         RMAX    800
  RTIMES   10          CWMIN    3000        UAPS    3
  OPEN     YES          ALW      NO           RTXTHR  10000
  RHOSTVAL MATCH

LSN
ipsgm3ua1

IP Appl Sock/Assoc table is (7 of 4000) 1% full
Assoc Buffer Space Used (200 KB of 6400 KB) on LOC = 1201
```

13. Back up the new changes, using the `chg-db:action=backup:dest=fixed` command.

These messages should appear; the active Maintenance and Administration Subsystem Processor (MASP) appears first.

```
BACKUP (FIXED) : MASP A - Backup starts on active MASP.  
BACKUP (FIXED) : MASP A - Backup on active MASP to fixed disk complete.  
BACKUP (FIXED) : MASP A - Backup starts on standby MASP.  
BACKUP (FIXED) : MASP A - Backup on standby MASP to fixed disk complete.
```

If you wish to change the `lhost`, `alhost`, or `bufsize` values of the IPSG association, perform one of these procedures.

- `lhost` and `alhost` - [Changing the Host Values of an IPSG Association](#)
- `bufsize` - [Changing the Buffer Size of an IPSG Association](#)

If you do not wish to change the `lhost`, `alhost`, `bufsize`, or `link` values of the IPSG association, this procedure is finished.

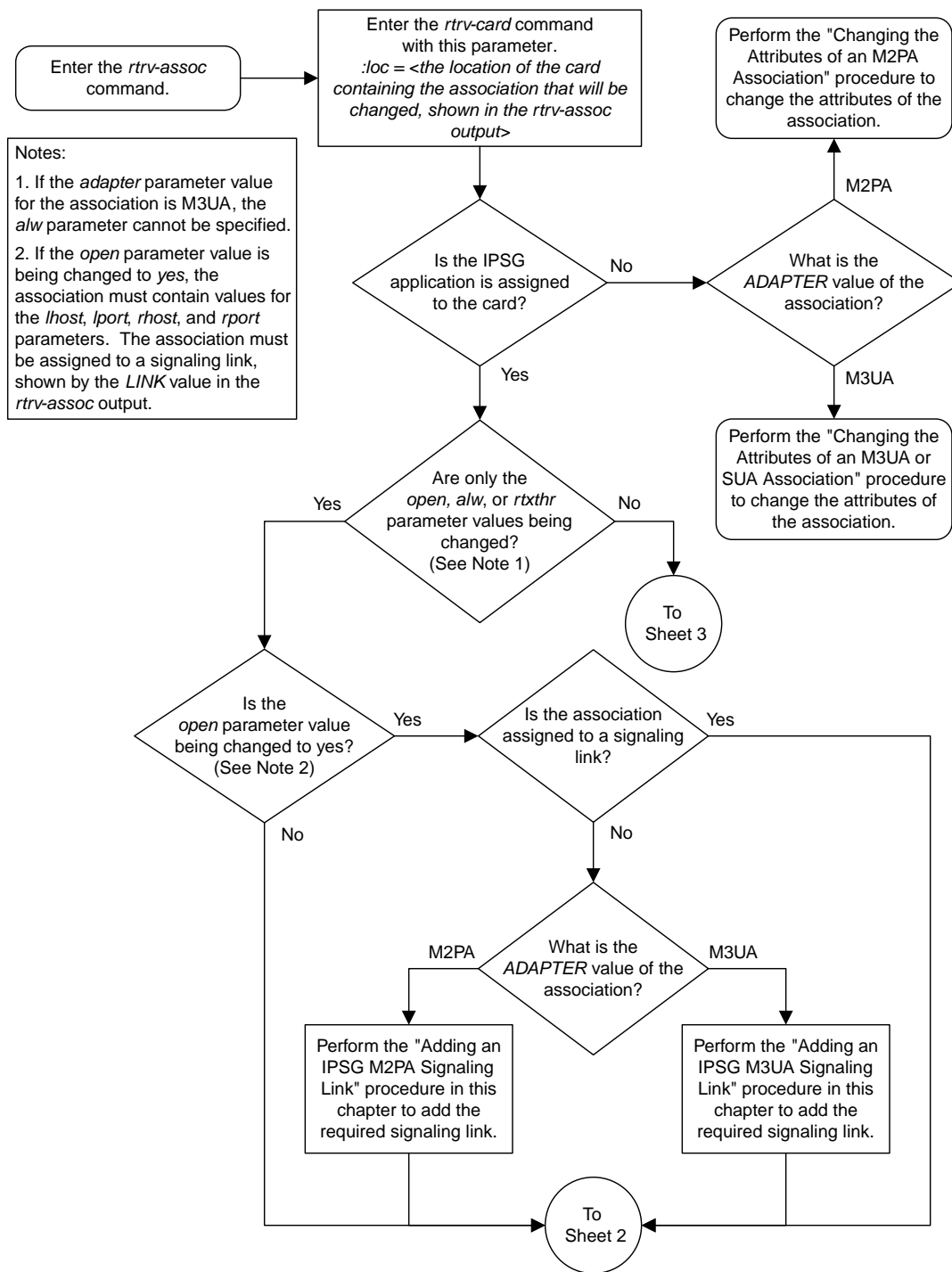

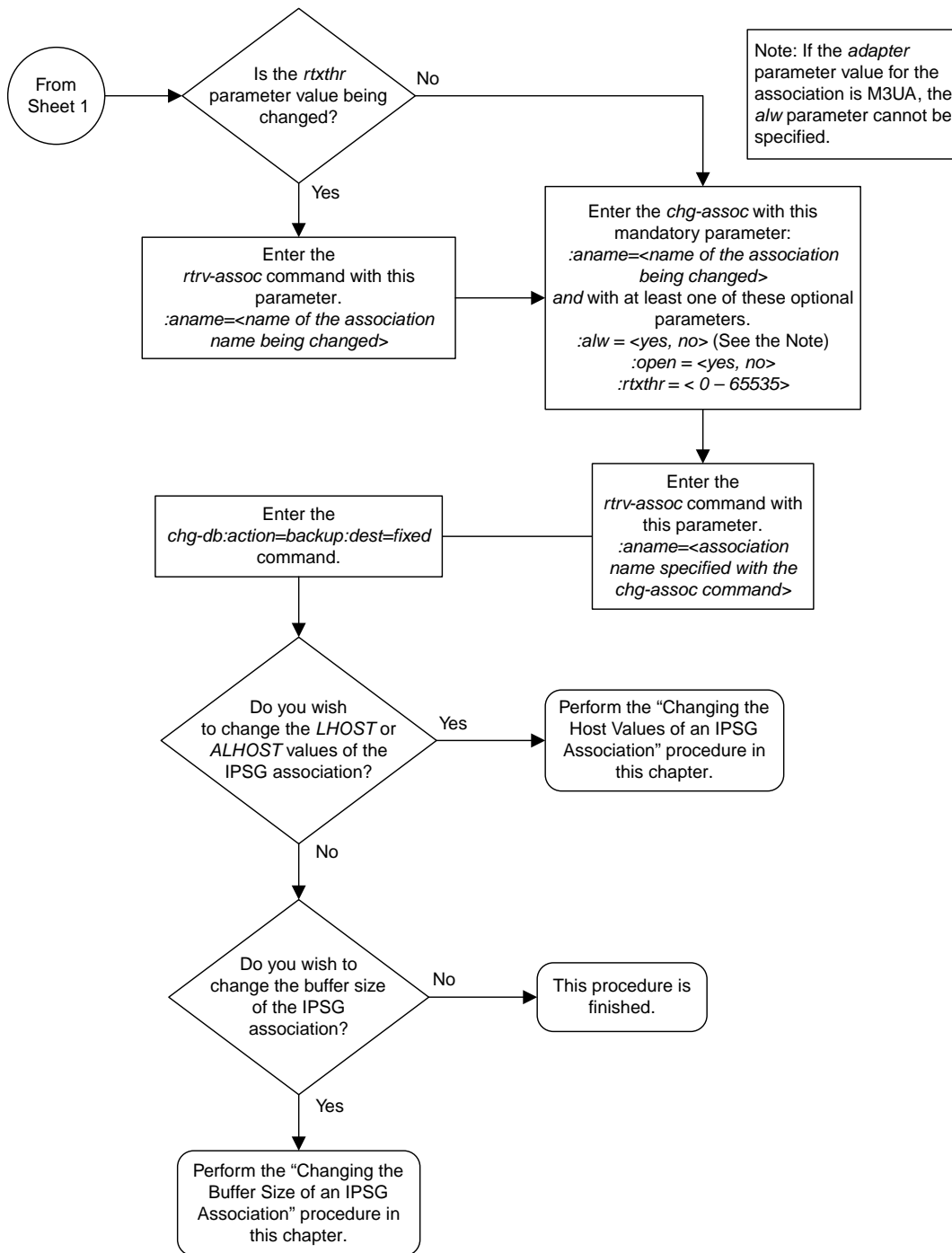

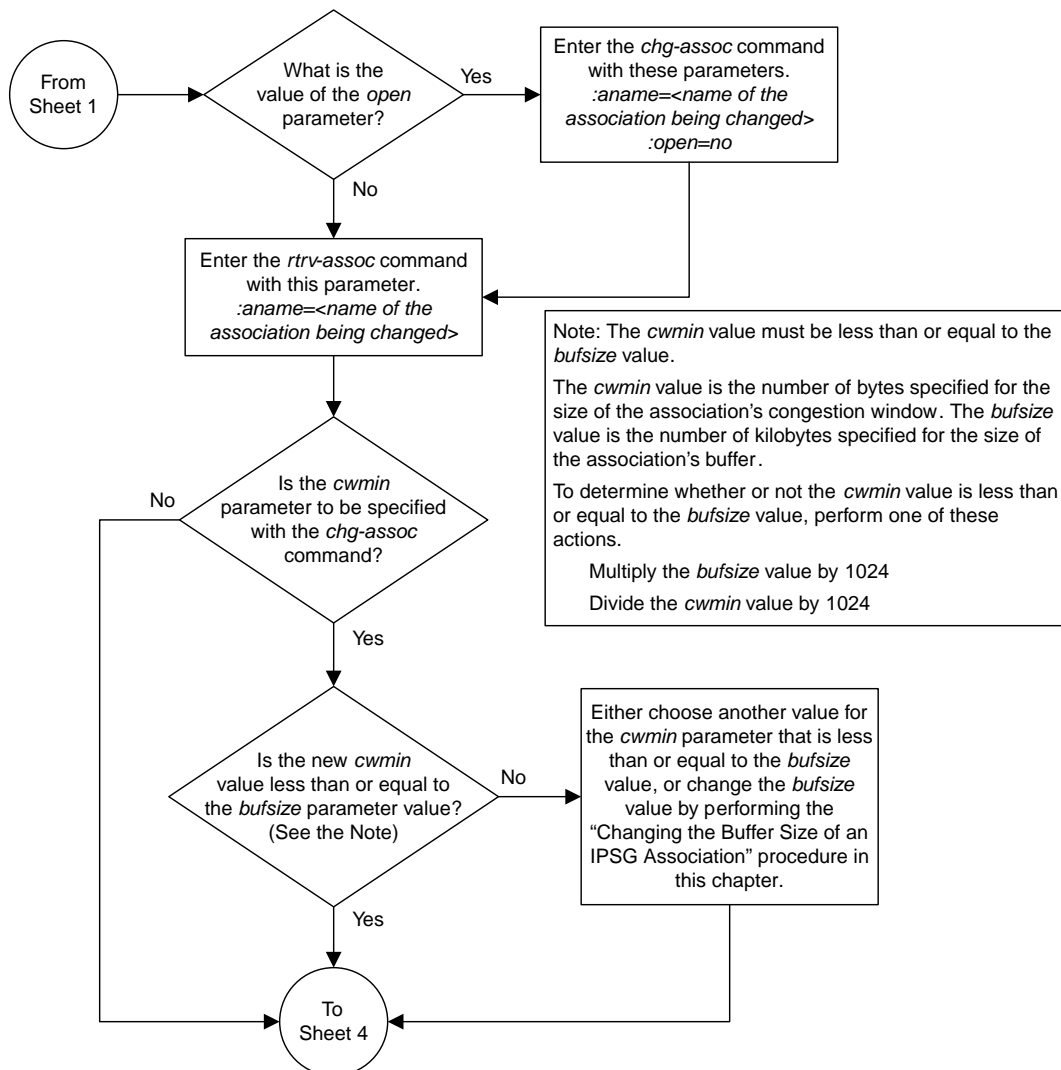

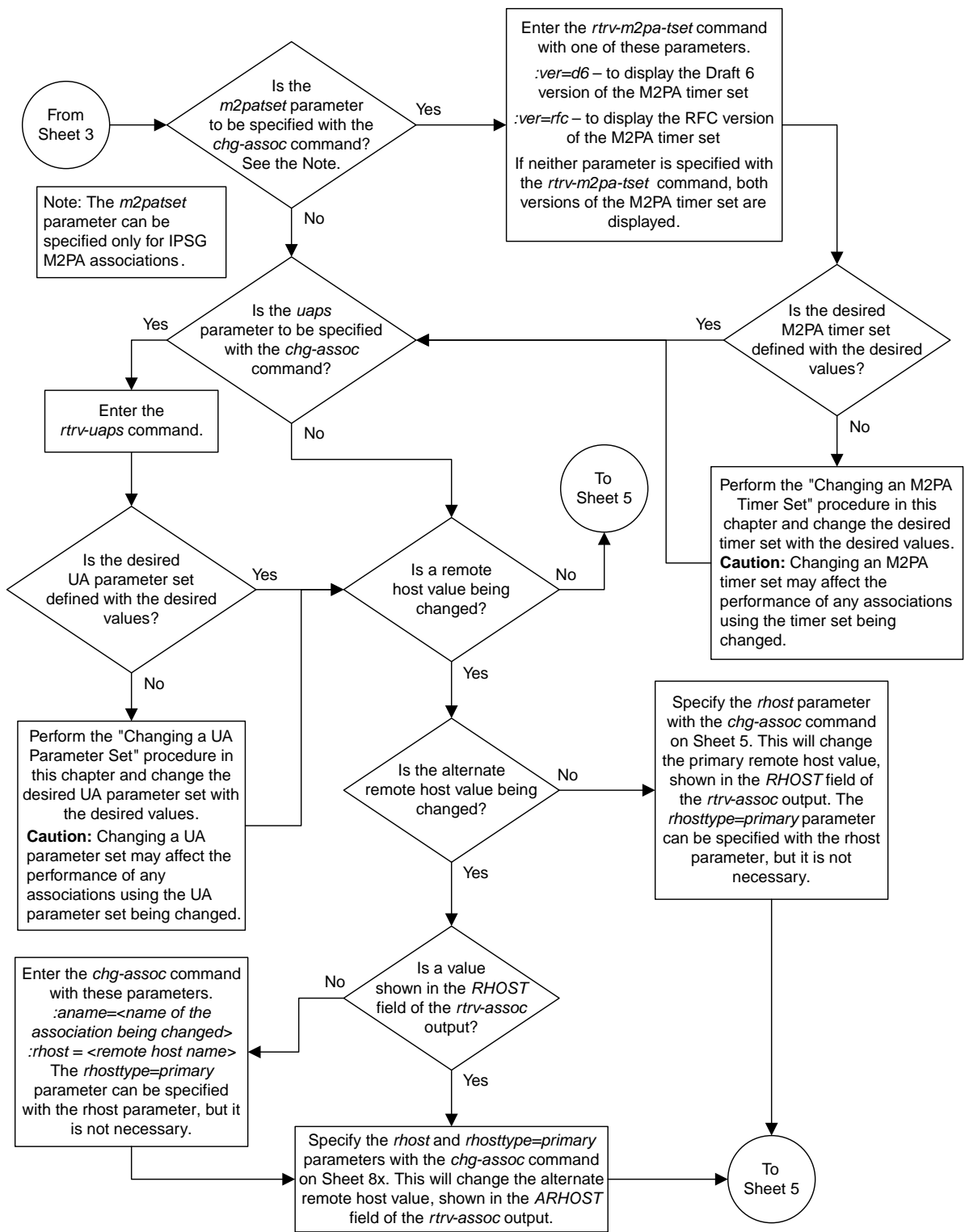

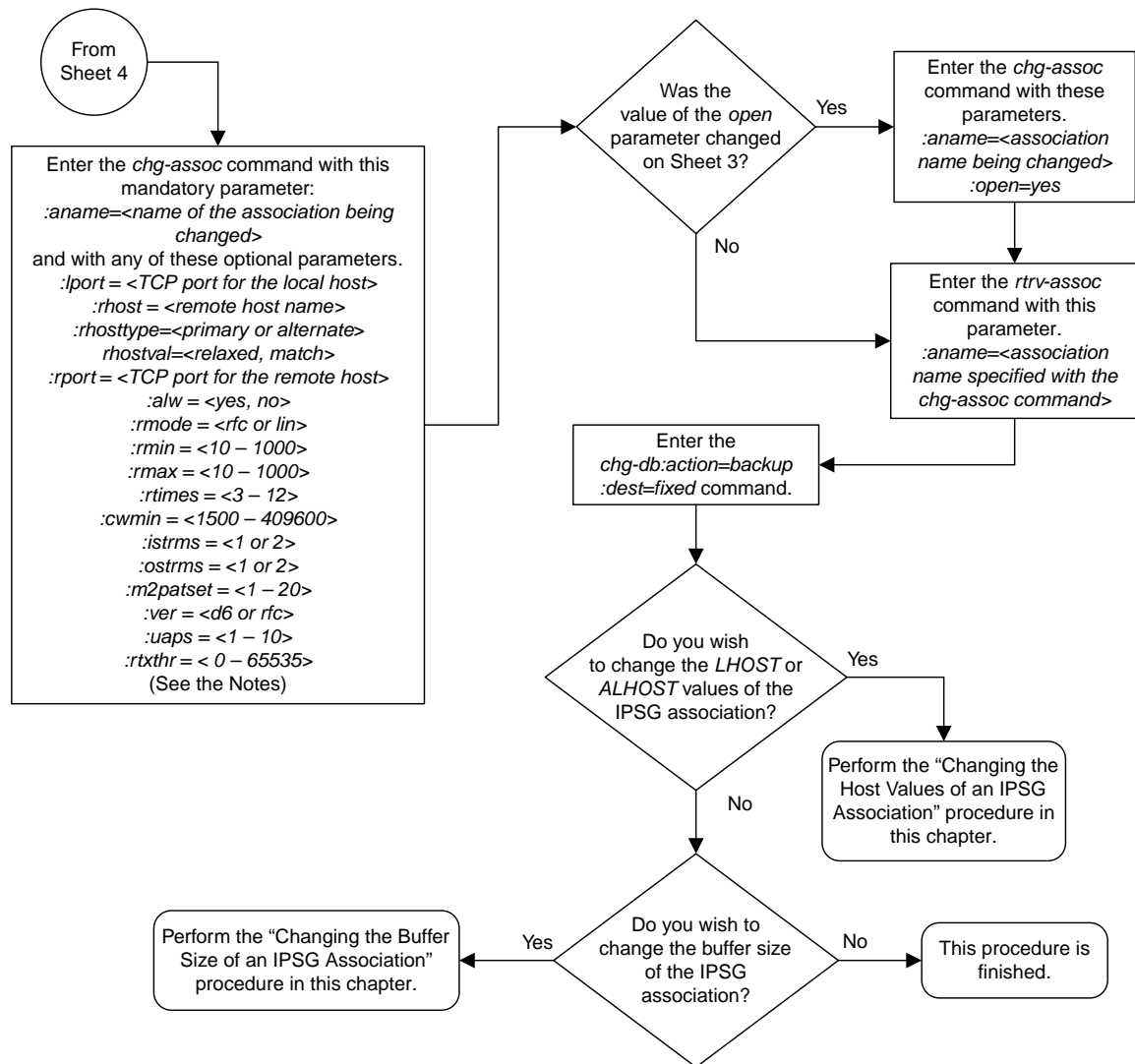

- Notes:
1. If any optional parameters are not specified with the *chg-assoc* command, those values are not changed.
 2. The value of the *rhost* parameter is a text string of up to 60 characters, with the first character being a letter. The command input is limited to 150 characters, including the hostname.
 3. If the value of the *open* parameter is *yes*, only the values of the *alw* and *rtxthr* parameters can be changed. To change the values of the other parameters, the value of the *open* parameter value must be *no*.
 4. The value of the *rmin* parameter must be less than or equal to the *rmax* parameter value.
 5. The M2PA version of the association determines the version of the M2PA timer set that is assigned to the association. For example, if M2PA timer set 3 is assigned to the M2PA association, and the association is an RFC M2PA association, the RFC version of M2PA timer set 3 is used with the association. If M2PA timer set 7 is assigned to the M2PA association, and the association is a Draft 6 M2PA association, the Draft 6 version of M2PA timer set 7 is used with the association.
 6. The *m2patset* and *ver* parameters can be specified only for IPSG M2PA associations.
 7. If the *adapter* parameter value for the association is M3UA, the *alw* parameter cannot be specified.

Sheet 5 of 5

Figure 115: Changing the Attributes of an IPSG Association

Changing the Buffer Size of an IPSG Association

This procedure is used to change the buffer size of an IPSG association, assigned to E5-ENET cards that are running the IPSG application, IPSG cards, using the `chg-assoc` command.

If you wish to change the buffer size of M2PA associations assigned to cards that are running the IPLIM or IPLIMI applications, perform the [Changing the Buffer Size of a M2PA Association](#) procedure.

If you wish to change the buffer size of M3UA associations assigned to cards that are running the SS7IPGW or IPGWI applications, perform the [Changing the Buffer Size of a M3UA or SUA Association](#) procedure.

These parameters of the `chg-assoc` command are used in this procedure:

`:aname` – The name assigned to the association, shown in the `rtrv-assoc` output.

`:open` – The connection state for this association. Valid values are `yes` or `no`. When the `open=yes` parameter is specified, the connection manager opens the association if the association is operational. When the `open=no` parameter is specified, the connection manager will not open the association. If the `open=no` parameter is specified for an established IPSG M3UA association, and the UA Graceful Shutdown option is enabled (refer to [Changing a UA Parameter Set](#) for more information), the IPSG M3UA connection will be gracefully shutdown.

`:bufsize` – The size, in kilobytes, of the buffer used by the association. The values for this parameter are 8 kilobytes to 400 kilobytes. The maximum size of the buffers on an IPSG card is 6400 KB.

The size of the buffers assigned to each association that is assigned to the IP card cannot exceed the maximum buffer size for that card. If the `bufsize` parameter value causes the total buffer size for all the associations on the IPSG card to exceed the maximum buffer size for that IPSG card, the `chg-assoc` command will be rejected. The available size of the buffers on the IPSG card can be verified by entering this command.

```
rtrv-assoc:lhost=<local host name assigned to the association being changed>
```

The `alhost` parameter can also be used with the `rtrv-assoc` command to display the available size of the buffers on the IP card.

The `aname` parameter can be used with the `rtrv-assoc` command to display the available size of the buffers on the IP card and the size of the buffer assigned to the association.

If you wish to increase the buffer size for this association to a value that is greater than available buffer size for the card, the buffer size of the other associations assigned to the card must be decreased.

The `chg-assoc` command contains other parameters that are not used in this procedure. To change these parameters, perform these procedures.

- `lhost` and `alhost` - [Changing the Host Values of an IPSG Association](#)
- Other attributes of the IPSG Association - [Changing the Buffer Size of an IPSG Association](#)

Canceling the RTRV-ASSOC Command

Because the `rtrv-assoc` command used in this procedure can output information for a long period of time, the `rtrv-assoc` command can be canceled and the output to the terminal stopped. There are three ways that the `rtrv-assoc` command can be canceled.

- Press the F9 function key on the keyboard at the terminal where the `rtrv-assoc` command was entered.
- Enter the `canc-cmd` without the `trm` parameter at the terminal where the `rtrv-assoc` command was entered.
- Enter the `canc-cmd:trm=<xx>`, where `<xx>` is the terminal where the `rtrv-assoc` command was entered, from another terminal other than the terminal where the `rtrv-assoc` command was entered. To enter the `canc-cmd:trm=<xx>` command, the terminal must allow Security Administration commands to be entered from it and the user must be allowed to enter Security Administration commands. The terminal's permissions can be verified with the `rtrv-secu-trm` command. The user's permissions can be verified with the `rtrv-user` or `rtrv-secu-user` commands.

For more information about the `canc-cmd` command, go to *Commands User's Guide*.

1. Display the associations in the database using the `rtrv-assoc` command.

This is an example of possible output.

```
rlghncxa03w 06-10-28 09:12:36 GMT EAGLE5 36.0.0

          CARD IPLNK
ANAME     LOC  PORT  LINK ADAPTER LPORT RPORT OPEN ALW
swbel32   1201 A     A   M3UA  1030  2345 YES  YES
a2        1305 A     A   SUA   1030  2345 YES  YES
a3        1307 A     A   SUA   1030  2346 YES  YES
assoc1    1201 A     A   M3UA  2000  1030 YES  YES
assoc2    1205 A     A   M2PA  2048  2048 YES  YES
assoc3    1205 A     B2  M2PA  3000  3000 YES  YES
assoc5    1205 A     A3  M2PA  1500  3000 YES  YES
```

2. Enter the `rtrv-card` command with the location of the card that is hosting the association that will be changed in this procedure. For this example, enter this command.

```
rtrv-card:loc=1205
```

This is an example of possible output.

```
rlghncxa03w 08-04-06 15:17:20 EST EAGLE5 38.0.0
CARD  TYPE      APPL      LSET NAME  LINK SLC LSET NAME  LINK SLC
1205  ENET        IPSG      e5e6a     A   0   e5e6a     B2   1
          e5e6a     A3   2
```

```
rtrv-card:loc=1201
```

This is an example of possible output.

```
rlghncxa03w 08-04-06 15:17:20 EST EAGLE5 38.0.0
CARD  TYPE      APPL      LSET NAME  LINK SLC LSET NAME  LINK SLC
1201  ENET        IPSG      ipsgm3ua1 A   0
```

If the application assigned to the card is IPSG, shown in the APPL column, continue the procedure by performing one of these steps.

- If the open parameter value for the association being changed is yes, continue the procedure with [Step 3](#).
- If the open parameter value for the association being changed is no, continue the procedure with [Step 4](#).

If the application assigned to the card is IPLIM or IPLIMI, perform the [Changing the Buffer Size of a M2PA Association](#) procedure.

If the application assigned to the card is SS7IPGW or IPGWI, perform the [Changing the Buffer Size of a M3UA or SUA Association](#) procedure.

3. Change the value of the open parameter to no by specifying the chg-assoc command with the open=no parameter.

For this example, enter these commands.

```
chg-assoc:aname=assoc2:open=no
```

```
chg-assoc:aname=assoc1:open=no
```

When these commands have successfully completed, this message should appear.

```
rlghncxa03w 06-10-28 09:12:36 GMT EAGLE5 36.0.0
CHG-ASSOC: MASP A - COMPLTD;
```

4. Display the association that is being changed by entering the rtrv-assoc command with the aname parameter and the name of the association specified in [Step 3](#).

For this example, enter this command.

```
rtrv-assoc:aname=assoc2
```

This is an example of the possible output.

```
rlghncxa03w 10-07-28 21:14:37 GMT EAGLE5 42.0.0
ANAME assoc2
  LOC          1205          IPLNK PORT  A          LINK  A
ADAPTER M2PA          VER          M2PA RFC
LHOST IPNODE2-1205
ALHOST ---
RHOST remotehost1
ARHOST ---
LPORT 2048          RPORT      2048
ISTRMS 2          OSTRMS     2          BUFSIZE 300
RMODE  LIN          RMIN       120          RMAX    800
RTIMES 10          CWMIN      3000          UAPS    10
OPEN   NO          ALW        YES          RTXTHR  2000
RHSTVAL RELAXED    M2PATSET   1

LSN
e5e6a

IP Appl Sock/Assoc table is (7 of 4000) 1% full
Assoc Buffer Space Used (700 KB of 6400 KB) on LOC = 1205
```

```
rtrv-assoc:aname=assoc1
```

This is an example of the possible output.

```

rlghncxa03w 09-05-28 21:14:37 GMT EAGLE5 41.0.0

ANAME assoc1
LOC 1201 IPLNK PORT A LINK A
ADAPTER M3UA VER M3UA RFC
LHOST m3ua1
ALHOST ---
RHOST remotel
ARHOST ---
LPORT 2000 RPORT 1030
ISTRMS 2 OSTRMS 2 BUFSIZE 200
RMODE LIN RMIN 120 RMAX 800
RTIMES 10 CWMIN 3000 UAPS 10
OPEN NO ALW YES RTXTHR 0
RHOSTVAL RELAXED

LSN
ipsgm3ua1

IP Appl Sock/Assoc table is (7 of 4000) 1% full
Assoc Buffer Space Used (400 KB of 6400 KB) on LOC = 1201

```

5. If the `bufsize` parameter value causes the total buffer size for all the associations on the IPSG card to exceed the maximum buffer size for that IPSG card, the `chg-assoc` command will be rejected.

If you wish to increase the buffer size for this association to a value that is greater than available buffer size for the card, the buffer size of the other associations assigned to the card must be decreased. Perform this step, [Step 6](#), [Step 7](#), and [Step 8](#).

If the buffers on the other associations assigned to the card do not need to be changed, continue the procedure with [Step 9](#).

Display the associations assigned to the IP card (and its corresponding local host) by entering the `rtrv-assoc` command with the local host name assigned to the association being changed. For this example, enter these commands.

```
rtrv-assoc: lhost=IPNODE2-1205
```

This is an example of the possible output.

```

rlghncxa03w 06-10-28 21:14:37 GMT EAGLE5 36.0.0
CARD IPLNK
ANAME LOC PORT LINK ADAPTER LPORT RPORT OPEN ALW
assoc2 1205 A A M2PA 2048 2048 YES YES
assoc3 1205 A B2 M2PA 3000 3000 YES YES
assoc5 1205 A A3 M2PA 1500 3000 YES YES

IP Appl Sock/Assoc table is (7 of 4000) 1% full
Assoc Buffer Space Used (800 KB of 6400 KB) on LOC = 1205

rtrv-assoc: lhost=m3ua1

```

This is an example of the possible output.

```
rlghncxa03w 06-10-28 09:12:36 GMT EAGLE5 36.0.0

CARD IPLNK
ANAME      LOC  PORT  LINK ADAPTER LPORT RPORT OPEN ALW
swbel32    1201 A     A   M3UA   1030  2345  YES  YES
assoc1     1201 A     A   M3UA   2000  1030  YES  YES

IP Appl Sock/Assoc table is (7 of 4000) 1% full
Assoc Buffer Space Used (400 KB of 6400 KB) on LOC = 1201
```

- Display each association shown in [Step 5](#) by entering the `rtrv-assoc` command with the name of each association shown in [Step 5](#).

For this example, enter these commands.

```
rtrv-assoc:aname=assoc2
```

This is an example of the possible output.

```
ANAME assoc2
LOC      1205          IPLNK PORT  A          LINK  A
ADAPTER  M2PA          VER          M2PA RFC
LHOST    IPNODE2-1205
ALHOST    ---
RHOST    remotehost1
ARHOST    ---
LPORT    2048          RPORT        2048
ISTRMS   2             OSTRMS       2           BUFSIZE  300
RMODE    LIN          RMIN         120         RMAX     800
RTIMES   10           CWMIN        3000        UAPS     10
OPEN     NO            ALW          YES          RTXTHR  2000
RHOSTVAL RELAXED      M2PATSET    1

LSN
e5e6a

IP Appl Sock/Assoc table is (7 of 4000) 1% full
Assoc Buffer Space Used (700 KB of 6400 KB) on LOC = 1205
```

```
rtrv-assoc:aname=assoc3
```

This is an example of the possible output.

```
ANAME assoc3
LOC      1205          IPLNK PORT  A          LINK  B2
ADAPTER  M2PA          VER          M2PA RFC
LHOST    IPNODE2-1205
ALHOST    ---
RHOST    remotehost3
ARHOST    ---
LPORT    3000          RPORT        3000
ISTRMS   2             OSTRMS       2           BUFSIZE  200
RMODE    LIN          RMIN         120         RMAX     800
RTIMES   10           CWMIN        3000        UAPS     10
OPEN     YES          ALW          YES          RTXTHR  2000
RHOSTVAL RELAXED      M2PATSET    1
```

```
LSN
e5e6a
```

```
IP Appl Sock/Assoc table is (7 of 4000) 1% full
Assoc Buffer Space Used (700 KB of 6400 KB) on LOC = 1205
```

```
rtrv-assoc:aname=assoc5
```

This is an example of the possible output.

```
ANAME assoc5
LOC      1205          IPLNK PORT  A          LINK  A3
ADAPTER  M2PA           VER          M2PA RFC
LHOST    IPNODE2-1205
ALHOST   ---
RHOST    remotehost3
ARHOST   ---
LPORT    1500          RPORT      3000
ISTRMS   2             OSTRMS     2          BUFSIZE  200
RMODE    LIN        RMIN       120        RMAX     800
RTIMES   10         CWMIN      3000      UAPS     10
OPEN     YES        ALW        YES        RTXTHR  2000
RHOSTVAL RELAXED    M2PATSET   1
```

```
LSN
e5e6a
```

```
IP Appl Sock/Assoc table is (7 of 4000) 1% full
Assoc Buffer Space Used (700 KB of 6400 KB) on LOC = 1205
```

```
rtrv-assoc:aname=assoc1
```

This is an example of the possible output.

```
rlghncxa03w 09-05-28 21:14:37 GMT EAGLE5 41.0.0
```

```
ANAME assoc1
LOC      1201          IPLNK PORT  A          LINK  A
ADAPTER  M3UA           VER          M3UA RFC
LHOST    m3ua1
ALHOST   ---
RHOST    remotel
ARHOST   ---
LPORT    2000          RPORT      1030
ISTRMS   2             OSTRMS     2          BUFSIZE  200
RMODE    LIN        RMIN       120        RMAX     800
RTIMES   10         CWMIN      3000      UAPS     10
OPEN     NO         ALW        YES        RTXTHR  0
RHOSTVAL RELAXED
```

```
LSN
ipsgm3ua1
```

```
IP Appl Sock/Assoc table is (7 of 4000) 1% full
Assoc Buffer Space Used (400 KB of 6400 KB) on LOC = 1201
```

```
rtrv-assoc:aname=swbel32
```

This is an example of the possible output.

```
rlghncxa03w 09-05-28 21:14:37 GMT EAGLE5 41.0.0

ANAME swbel32
LOC 1201 IPLNK PORT A LINK A
ADAPTER M3UA VER M3UA RFC
LHOST m3ua1
ALHOST ---
RHOST remotel
ARHOST ---
LPORT 1030 RPORT 2345
ISTRMS 2 OSTRMS 2 BUFSIZE 200
RMODE LIN RMIN 120 RMAX 800
RTIMES 10 CWMIN 3000 UAPS 10
OPEN NO ALW YES RTXTHR 0
RHOSTVAL RELAXED

LSN
ipsgm3ua1

IP Appl Sock/Assoc table is (7 of 4000) 1% full
Assoc Buffer Space Used (400 KB of 6400 KB) on LOC = 1201
```

- To change the `bufsize` value for the associations shown in [Step 6](#), the new `bufsize` parameter value must be greater than or equal to the `cwmin` parameter value.

The `cwmin` parameter is the number of bytes specified for the association's congestion window. The `bufsize` is the number of kilobytes specified for the size of the association's buffer. To determine whether or not the `cwmin` value is less than or equal to the `bufsize` value, perform one of these actions.

- Multiply the `bufsize` value by 1024.
- Divide the `cwmin` value by 1024.

Continue the procedure by performing one of these actions.

- If the new `bufsize` value is greater than or equal to the `cwmin` value, continue the procedure with [Step 8](#).
- If the new `bufsize` value is not greater than or equal to the `cwmin` value, either choose another value for the `bufsize` parameter that is greater than or equal to the `cwmin` value, or perform the [Changing the Attributes of an IPSG Association](#) procedure to change the `bufsize` value so that the `bufsize` value is greater than or equal to the `cwmin` value. After the new `bufsize` value has been chosen or the `cwmin` value has been changed, continue the procedure with [Step 8](#).

- Change the size of the buffers for one or more of the associations displayed in [Step 6](#) to allow the buffer of the association displayed in [Step 4](#) to be changed.

Enter the `chg-assoc` command with the `bufsize` parameter. For this example, enter this command.

```
chg-assoc:aname=assoc3:bufsize=100
```

When this command has successfully completed, this message should appear.

```
rlghncxa03w 06-10-28 09:12:36 GMT EAGLE5 36.0.0
CHG-ASSOC: MASP A - COMPLTD;
```

9. To change the `bufsize` value for the association shown in [Step 4](#), the new `bufsize` parameter value must be greater than or equal to the `cwmin` parameter value.

The `cwmin` parameter is the number of bytes specified for the association's congestion window. The `bufsize` is the number of kilobytes specified for the size of the association's buffer. To determine whether or not the `cwmin` value is less than or equal to the `bufsize` value, perform one of these actions.

- Multiply the `bufsize` value by 1024.
- Divide the `cwmin` value by 1024.

Continue the procedure by performing one of these actions.

- If the new `bufsize` value is greater than or equal to the `cwmin` value, continue the procedure with [Step 10](#).
- If the new `bufsize` value is not greater than or equal to the `cwmin` value, either choose another value for the `bufsize` parameter that is greater than or equal to the `cwmin` value, or perform the [Changing the Attributes of an IPSG Association](#) procedure to change the `bufsize` value so that the `bufsize` value is greater than or equal to the `cwmin` value. After the new `bufsize` value has been chosen or the `cwmin` value has been changed, continue the procedure with [Step 10](#).

10. Change the association using the `chg-assoc` command.

For this example, enter these commands.

```
chg-assoc:aname=assoc2:bufsize=400
```

```
chg-assoc:aname=assoc1:bufsize=400
```

When these commands have successfully completed, this message should appear.

```
rlghncxa03w 06-10-28 09:12:36 GMT EAGLE5 36.0.0
CHG-ASSOC: MASP A - COMPLTD;
```

If the value of the `open` parameter was not changed in [Step 3](#), continue the procedure with [Step 12](#).

If the value of the `open` parameter was changed in [Step 3](#), continue the procedure with [Step 11](#).

11. Change the value of the `open` parameter to `yes` by specifying the `chg-assoc` command with the `open=yes` parameter.

For this example, enter this command.

```
chg-assoc:aname=assoc2:open=yes
```

```
chg-assoc:aname=assoc1:open=yes
```

When this command has successfully completed, this message should appear.

```
rlghncxa03w 06-10-28 09:12:36 GMT EAGLE5 36.0.0
CHG-ASSOC: MASP A - COMPLTD;
```

12. Verify the changes using the `rtrv-assoc` command specifying the association name specified in [Step 10](#) and [Step 11](#).

For this example, enter these commands.

```
rtrv-assoc:aname=assoc2
```

This is an example of possible output.

```

RTIMES    10          CWMIN      3000      UAPS      10
OPEN      NO           ALW        YES        RTXTHR   2000
RHOSTVAL  RELAXED      M2PATSET   1

```

```

ANAME assoc2
LOC      1205          IPLNK PORT A          LINK  A
ADAPTER  M2PA          VER          M2PA RFC
LHOST    IPNODE2-1205
ALHOST    ---
RHOST    remotehost1
ARHOST    ---
LPORT    2048          RPORT      2048
ISTRMS   2           OSTRMS     2          BUFSIZE  400
RMODE    LIN          RMIN       120        RMAX     800
RTIMES   10          CWMIN      3000      UAPS     10
OPEN     YES         ALW        YES        RTXTHR   2000
RHOSTVAL RELAXED      M2PATSET   1

LSN
e5e6a

```

```

IP Appl Sock/Assoc table is (7 of 4000) 1% full
Assoc Buffer Space Used (800 KB of 6400 KB) on LOC = 1205

```

For this example, enter these commands.

```
rtrv-assoc:aname=assoc1
```

```
rlghncxa03w 09-05-28 21:14:37 GMT EAGLE5 41.0.0
```

```

ANAME assoc1
LOC      1201          IPLNK PORT A          LINK  A
ADAPTER  M3UA          VER          M3UA RFC
LHOST    m3ua1
ALHOST    ---
RHOST    remotel
ARHOST    ---
LPORT    2000          RPORT      1030
ISTRMS   2           OSTRMS     2          BUFSIZE  400
RMODE    LIN          RMIN       120        RMAX     800
RTIMES   10          CWMIN      3000      UAPS     10
OPEN     YES         ALW        YES        RTXTHR   0
RHOSTVAL RELAXED

LSN
ipsgm3ua1

```

```

IP Appl Sock/Assoc table is (7 of 4000) 1% full
Assoc Buffer Space Used (600 KB of 6400 KB) on LOC = 1201

```

13. Back up the new changes, using the `chg-db:action=backup:dest=fixed` command.

These messages should appear; the active Maintenance and Administration Subsystem Processor (MASP) appears first.

```
BACKUP (FIXED) : MASP A - Backup starts on active MASP.  
BACKUP (FIXED) : MASP A - Backup on active MASP to fixed disk complete.  
BACKUP (FIXED) : MASP A - Backup starts on standby MASP.  
BACKUP (FIXED) : MASP A - Backup on standby MASP to fixed disk complete.
```

If you wish to change the other attributes of the IPSG association, perform one of these procedures.

- lhost and alhost - *Changing the Host Values of an IPSG Association*
- Other attributes of the IPSG Association - *Changing the Attributes of an IPSG Association*

If you do not wish to change the other attributes of the IPSG association, this procedure is finished.

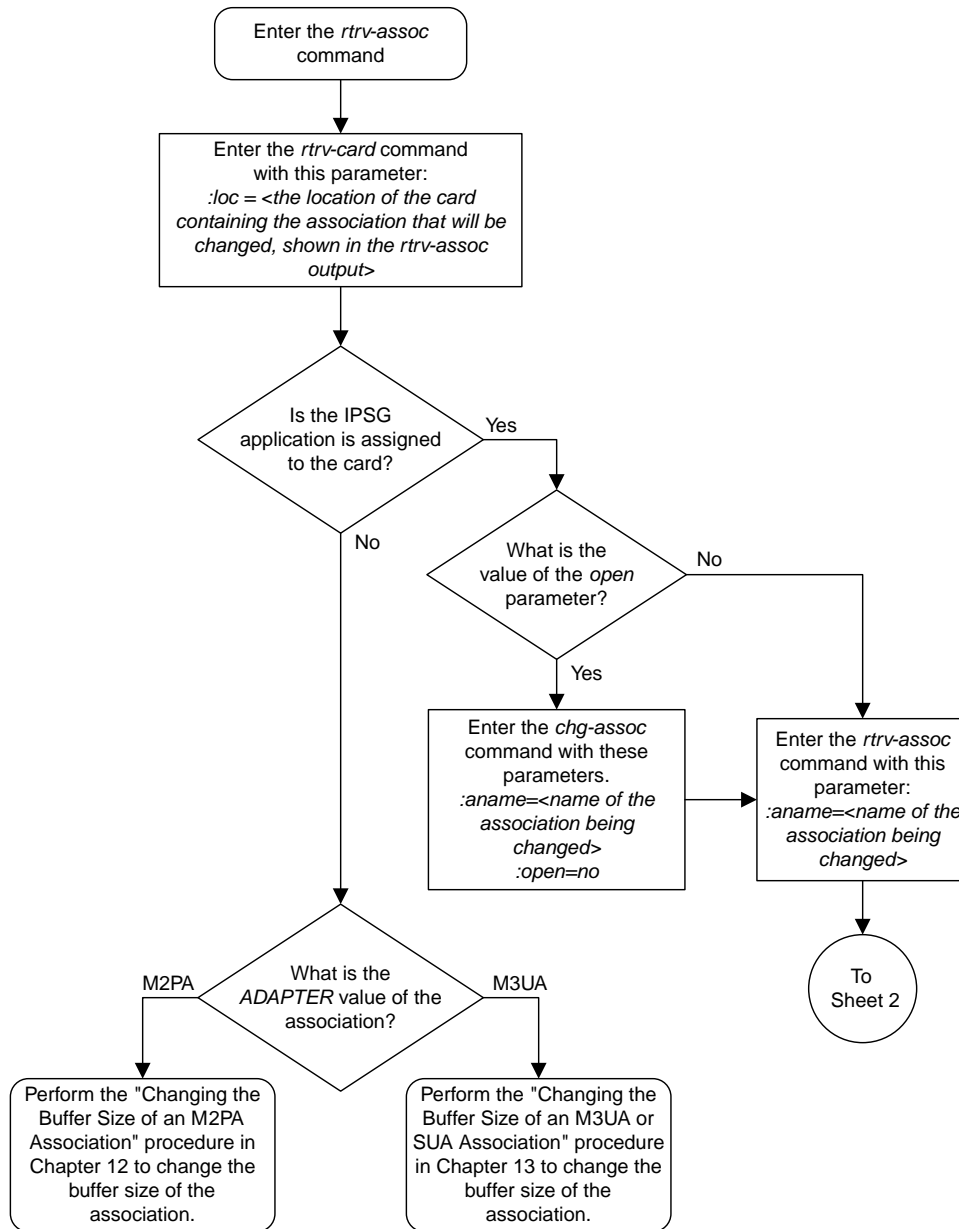

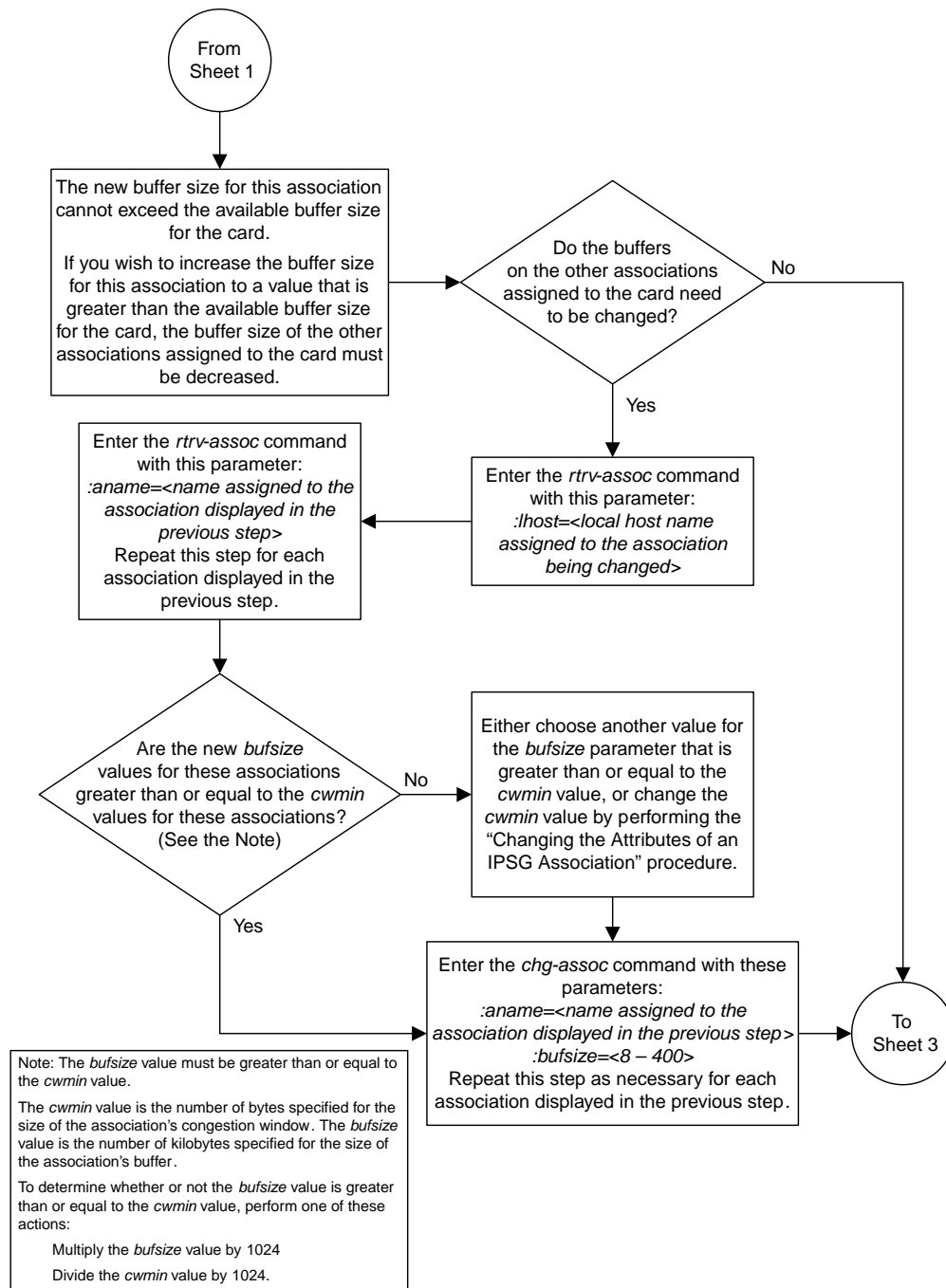

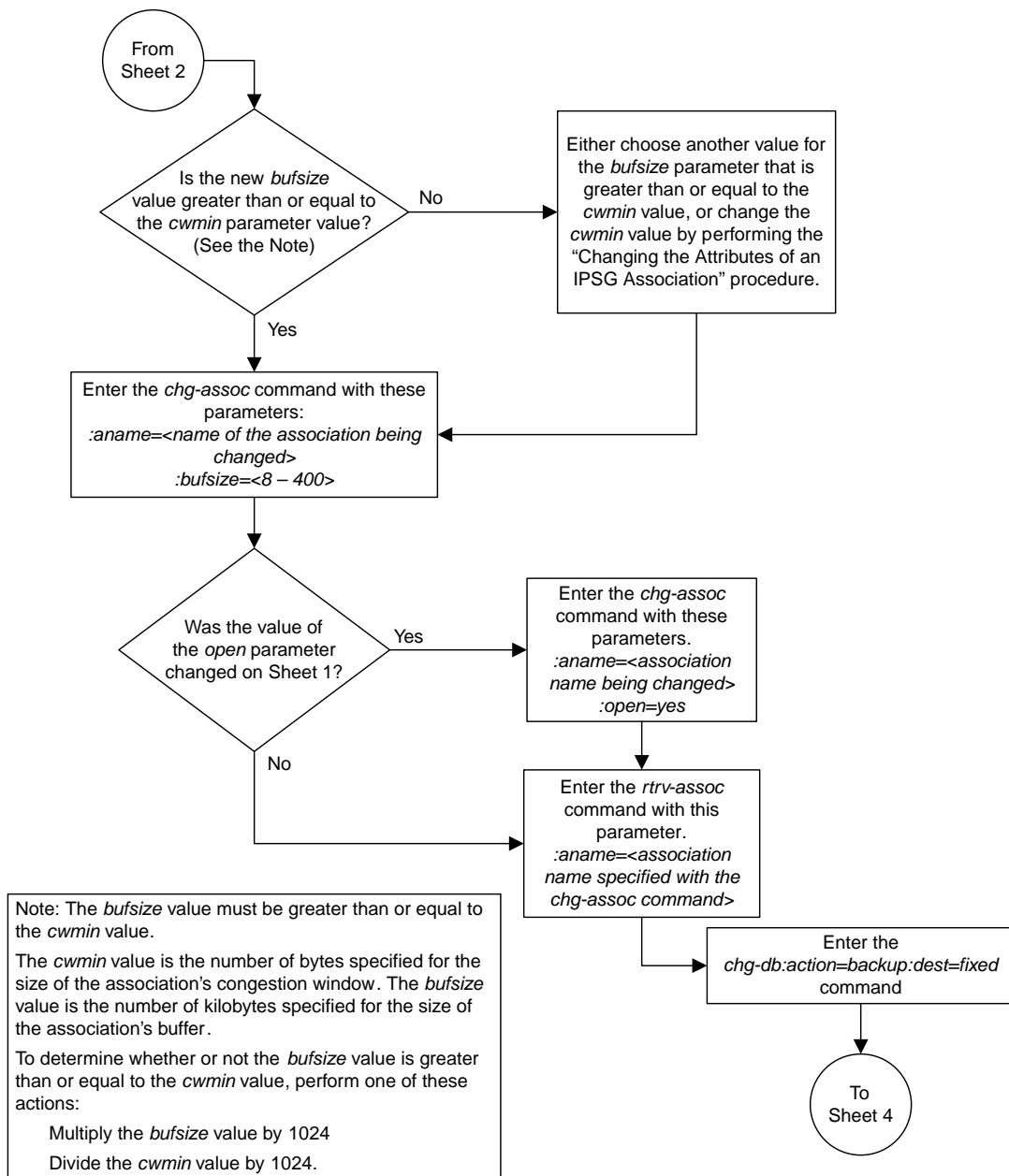

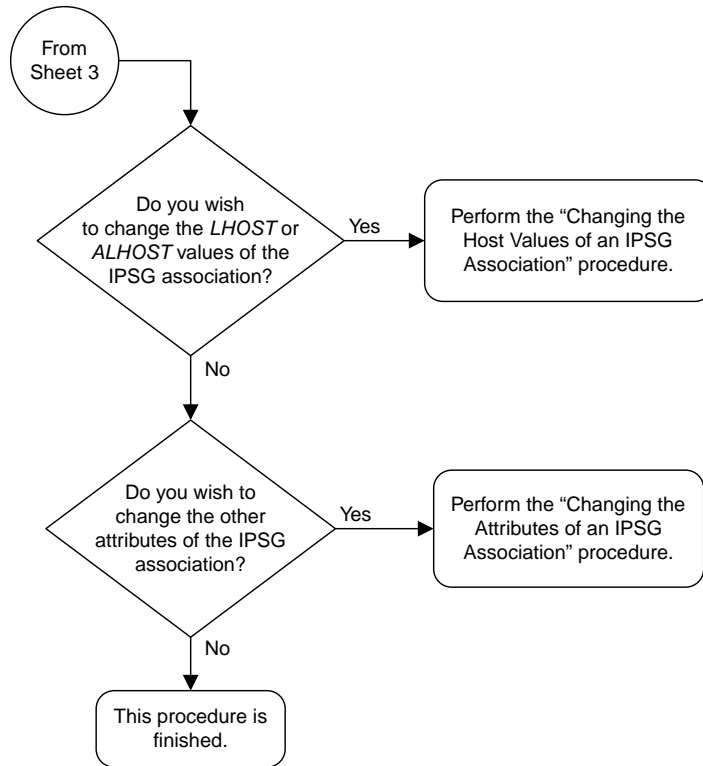

Sheet 4 of 4

Figure 116: Changing the Buffer Size of an IPSG Association

Changing the Host Values of an IPSG Association

This procedure is used to change the host values of an IPSG association, assigned to E5-ENET cards that are running the IPSG application, IPSG cards, using the `chg-assoc` command.

If you wish to change the host values of M2PA associations assigned to cards that are running the IPLIM or IPLIMI applications, perform the [Changing the Host Values of a M2PA Association](#) procedure.

If you wish to change the host values of M3UA associations assigned to cards that are running the SS7IPGW or IPGWI applications, perform the [Changing the Host Values of a M3UA or SUA Association](#) procedure.

These parameters of the `chg-assoc` command are used in this procedure:

`:aname` – The name assigned to the association, shown in the `rtrv-assoc` output.

`:lhost` – The host name for the local host, shown in the `rtrv-ip-host` output.

`:lport` – The SCTP port number for the local host.

`:alhost` – The alternate local host name, shown in the `rtrv-ip-host` output.

`:adapter` – The adapter layer for this association, `m2pa` or `m3ua`.

`:open` – The connection state for this association. Valid values are `yes` or `no`. When the `open=yes` parameter is specified, the connection manager opens the association if the association is operational. When the `open=no` parameter is specified, the connection manager will not open the association. If the `open=no` parameter is specified for an established IPSG M3UA association, and the UA Graceful Shutdown option is enabled (refer to [Changing a UA Parameter Set](#) for more information), the IPSG M3UA connection will be gracefully shutdown.

`:m2patset` – The M2PA timer set assigned to the association. The `m2patset` parameter can be specified only with the `adapter=m2pa` parameter, or if the association already has the `adapter=m2pa` parameter assigned and the `adapter` parameter value is not being changed. If the `adapter` parameter value is being changed to `m2pa`, and the `m2patset` parameter is not specified, the default value for the `m2patset` parameter (1 - M2PA timer set 1) is assigned to the association. If the `adapter` parameter value for the association is `m2pa`, is not being changed, and the `m2patset` parameter is not specified with the `chg-assoc` command, the `m2patset` parameter value is not changed.

`:ver` – The M2PA version assigned to the M2PA association, either the RFC version (`ver=rfc`), or the Draft 6 version (`ver=d6`). The `ver` parameter can be specified only if, when this procedure is completed, the `adapter` parameter value is `m2pa`. If the `adapter` parameter value is being changed to `m2pa`, and the `ver` parameter is not specified, the default M2PA version of RFC is assigned to the association. To change the `ver` parameter value, the `open` parameter value for the association must be `no`.

`:uaps` – The UA parameter set value being assigned to an M2PA or an M3UA association.

The `chg-assoc` command contains other parameters that are not used in this procedure. To change these parameters, perform these procedures.

- `bufsize` - [Changing the Buffer Size of an IPSG Association](#)

- Other attributes of the IPSG association - [Changing the Attributes of an IPSG Association](#)

At least one optional parameter must be specified.

The command input is limited to 150 characters, including the hostnames.

The EAGLE can contain a maximum of 4000 connections.

A maximum of 32 associations can be assigned to an IPSG card.

Before the local host value of the IPSG association can be changed, the signaling link that the association is assigned to must be removed by performing one of these procedures.

- If the ADAPTER value of the association is M2PA, perform the [Removing an IPSG M2PA Signaling Link](#) procedure.
- If the ADAPTER value of the association is M3UA, perform the [Removing an IPSG M3UA Signaling Link](#) procedure.

Uni-homed endpoints are associations configured with the `lhost` parameter only. The `lhost` parameter value represents an IP address that corresponds to either the A or B network interface of the IPSG card. Multi-homed endpoints are associations configured with both the `lhost` and `alhost` parameters. The `lhost` parameter value represents an IP address corresponding to one of the network interfaces (A or B) of the IPSG card while the `alhost` parameter value represents an IPSG address corresponding to the other network interface of the same IPSG card.

The `alhost=none` parameter removes the alternate local host from the specified association, which also removes the multi-homed endpoint capability.

Canceling the RTRV-ASSOC Command

Because the `rtrv-assoc` command used in this procedure can output information for a long period of time, the `rtrv-assoc` command can be canceled and the output to the terminal stopped. There are three ways that the `rtrv-assoc` command can be canceled.

- Press the F9 function key on the keyboard at the terminal where the `rtrv-assoc` command was entered.
- Enter the `canc-cmd` without the `trm` parameter at the terminal where the `rtrv-assoc` command was entered.
- Enter the `canc-cmd:trm=<xx>`, where `<xx>` is the terminal where the `rtrv-assoc` command was entered, from another terminal other than the terminal where the `rtrv-assoc` command was entered. To enter the `canc-cmd:trm=<xx>` command, the terminal must allow Security Administration commands to be entered from it and the user must be allowed to enter Security Administration commands. The terminal's permissions can be verified with the `rtrv-secu-trm` command. The user's permissions can be verified with the `rtrv-user` or `rtrv-secu-user` commands.

For more information about the `canc-cmd` command, go to *Commands User's Guide*.

1. Display the associations in the database using the `rtrv-assoc` command.

This is an example of possible output.

```
rlghncxa03w 08-04-28 09:12:36 GMT EAGLE5 38.0.0

          CARD IPLNK
ANAME    LOC  PORT  LINK ADAPTER LPORT RPORT OPEN ALW
swbel32  1201 A     A   M3UA   1030  2345  YES  YES
a2       1305 A     A   SUA    1030  2345  YES  YES
```

a3	1307	A	A	SUA	1030	2346	YES	YES
assoc1	1201	A	A	M3UA	2000	1030	YES	YES
assoc2	2105	A	A	M2PA	2048	2048	YES	YES
assoc3	2105	A	B2	M2PA	3000	3000	YES	YES
assoc5	2105	A	A3	M2PA	1500	3000	YES	YES

2. Enter the `rtrv-card` command with the location of the card that is hosting the IPSG association that will be changed in this procedure. For this example, enter this command.

```
rtrv-card:loc=2105
```

This is an example of possible output.

```
rlghncxa03w 08-04-06 15:17:20 EST EAGLE5 38.0.0
CARD   TYPE      APPL      LSET NAME   LINK SLC  LSET NAME   LINK SLC
2105   ENET        IPSG      e5e6a       A    0    e5e6a       B2   1
                e5e6a       A3    2
```

If the application assigned to the card is IPSG, shown in the APPL column, continue the procedure by performing one of these steps.

- If the open parameter value for the association being changed is `yes`, continue the procedure with [Step 3](#).
- If the open parameter value for the association being changed is `no`, continue the procedure with [Step 4](#).

If the application assigned to the card is IPLIM or IPLIMI, perform the [Changing the Host Values of a M2PA Association](#) procedure.

If the application assigned to the card is SS7IPGW or IPGWI, perform the [Changing the Host Values of a M3UA or SUA Association](#) procedure.

3. Change the value of the open parameter to `no` by specifying the `chg-assoc` command with the `open=no` parameter.

For this example, enter this command.

```
chg-assoc:aname=assoc2:open=no
```

When this command has successfully completed, this message should appear.

```
rlghncxa03w 08-04-28 09:12:36 GMT EAGLE5 38.0.0
CHG-ASSOC: MASP A - COMPLTD;
```

4. Display the association being changed by entering the `rtrv-assoc` command with the `aname` parameter specified in [Step 3](#).

For this example, enter this command.

```
rtrv-assoc:aname=assoc2
```

This is an example of the possible output.

```
rlghncxa03w 10-07-28 21:14:37 GMT EAGLE5 42.0.0
ANAME assoc2
      LOC      2105      IPLNK PORT  A,B      LINK  A
```

```

ADAPTER M2PA          VER          M2PA RFC
LHOST   IPNODE2-1205
ALHOST  M2PA1
RHOST   gw200.nc-Oracle.com
ARHOST  ---
LPORT   2048          RPORT       2048
ISTRMS  2           OSTRMS      2           BUFSIZE    400
RMODE   LIN        RMIN        120         RMAX       800
RTIMES  10         CWMIN       3000        UAPS       10
OPEN    NO          ALW         YES         RTXTHR     2000
RHOSTVAL RELAXED    M2PATSET    1
LSN
e5e6a

```

```

IP Appl Sock/Assoc table is (8 of 4000) 1% full
Assoc Buffer Space Used (800 KB of 6400 KB) on LOC = 2105

```

Continue the procedure by performing one of these actions.

- If the association does not have an ALHOST value, continue the procedure with [Step 5](#).
 - If the association does have an ALHOST value, and the ALHOST value will be removed along with changing the LHOST value of the association, continue the procedure with [Step 5](#).
 - If the association does have an ALHOST value, and the only action that will be performed in this procedure is to remove the ALHOST value from the association, continue the procedure with [Step 11](#).
5. Verify that the local host name to be assigned to the association is in the database by entering the `rtrv-ip-host:display=all` command.

The following is an example of the possible output.

```

rlghncxa03w 13-06-28 21:15:37 GMT EAGLE5 45.0.0

LOCAL IPADDR   LOCAL HOST
192.1.1.10     IPNODE1-1201
192.1.1.12     GW105. NC. Oracle. COM
192.1.1.14     IPNODE1-1205
192.1.1.20     IPNODE2-1201
192.1.1.22     IPNODE2-1203
192.1.1.24     IPNODE2-1205
192.1.1.30     KC-HLR1
192.1.1.32     KC-HLR2
192.1.1.50     DN-MS1
192.1.1.52     DN-MS2
192.1.1.54     M2PA1

REMOTE IPADDR  REMOTE HOST
150.1.1.5      NCDEPTECONOMIC_DEVELOPMENT. SOUTHEASTERN_COORIDOR_ASHVL. GOV

IP Host table is (12 of 4096) .29% full

```

If the required IP host is shown in the `rtrv-ip-host` output, continue the procedure with [Step 7](#).

If the required IP host is not shown in the `rtrv-ip-host` output, continue the procedure with [Step 6](#).

6. Display the IP links in the database by entering the `rtrv-ip-lnk` command.

The following is an example of the possible output.

```

rlghncxa03w 08-12-28 21:14:37 GMT EAGLE5 40.0.0
LOC  PORT  IPADDR          SUBMASK          DUPLEX  SPEED  MACTYPE  AUTO  MCAST
1201  A    192.1.1.20      255.255.255.0    FULL    100    DIX      NO   NO
1201  B    -----          -----          HALF    10     DIX      NO   NO
1303  A    192.1.1.10      255.255.255.128 HALF    10     802.3    NO   NO
1303  B    -----          -----          HALF    10     DIX      NO   NO
1305  A    192.1.1.12      255.255.255.0    ----   ---    DIX      YES  NO
1305  B    -----          -----          HALF    10     DIX      NO   NO
1313  A    192.1.1.14      255.255.255.0    FULL    100    DIX      NO   NO
1313  B    -----          -----          HALF    10     DIX      NO   NO
2103  A    192.1.1.22      255.255.255.0    FULL    100    DIX      NO   NO
2103  B    -----          -----          HALF    10     DIX      NO   NO
2105  A    192.1.1.24      255.255.255.0    FULL    100    DIX      NO   NO
2105  B    192.1.1.54      255.255.255.0    FULL    100    DIX      NO   NO
2205  A    192.1.1.30      255.255.255.0    FULL    100    DIX      NO   NO
2205  B    -----          -----          HALF    10     DIX      NO   NO
2207  A    192.1.1.32      255.255.255.0    FULL    100    DIX      NO   NO
2207  B    -----          -----          HALF    10     DIX      NO   NO
2213  A    192.1.1.50      255.255.255.0    FULL    100    DIX      NO   NO
2213  B    -----          -----          HALF    10     DIX      NO   NO
2301  A    192.1.1.52      255.255.255.0    FULL    100    DIX      NO   NO
2301  B    -----          -----          HALF    10     DIX      NO   NO

IP-LNK  table is (20 of 2048) 1% full.

```

If the required IP link, one that contains the desired IP address, is not shown in the `rtrv-ip-lnk` output, add the IP link using the [Configuring an IP Link](#) procedure. After the IP link has been added, assign the IP address of the IP link to the IP host name using the [Adding an IP Host](#) procedure.

If the required IP link is shown in the `rtrv-ip-lnk` output, but the IP host is not shown in the `rtrv-ip-host` output in [Step 5](#), assign the IP address of the IP link to the IP host name using the [Adding an IP Host](#) procedure.

Note: The `rtrv-ip-host` output must contain a host name for the association's `slhost` parameter and a host name for the association's `alhost` parameter, if the `alhost` parameter will be specified for the association. The IP address of the IP link should be assigned to the host name, shown in the `rtrv-ip-host` output, that will be used as the association's `slhost` parameter value. If the `alhost` parameter will be specified for the association, the IP address of the IP link must be assigned to the host name that will be used as the `alhost` parameter value. The IP links associated with the association's `slhost` and `alhost` values must be assigned to the same card.

After the new IP host has been added, continue the procedure by performing one of these steps.

- If the ADAPTER value of the association is not being changed, continue the procedure with [Step 11](#).
- If the ADAPTER value of the association is being changed, continue the procedure by performing one of these steps.
 - If the ADAPTER value of the association is being changed to M2PA, perform one of these steps.
 - If the `m2patset`, `ver`, and `uaps` parameters will not be specified for the association, continue the procedure with [Step 11](#).
 - If the `m2patset` and `ver` parameters will be specified for the association, continue the procedure with [Step 9](#).

- If only the `uaps` parameter will be specified for the association, continue the procedure with [Step 10](#).
 - If the `ADAPTER` value of the association is being changed to M3UA, perform one of these steps.
 - If the `uaps` parameter will not be specified for the association, continue the procedure with [Step 11](#).
 - If the `uaps` parameter will be specified for the association, continue the procedure with [Step 10](#).
7. Display the associations that are assigned to the new local host by entering the `rtrv-assoc` command with the name of the new local host. For this example, enter this command.

```
rtrv-assoc: lhost="IPNODE2-1201"
```

The following is an example of the possible output.

```
rlghncxa03w 08-04-19 21:17:04 GMT EAGLE5 38.0.0
                CARD  IPLNK
ANAME          LOC  PORT  LINK ADAPTER LPORT RPORT OPEN ALW
swbel32        1201 A    A    M3UA  1030  2345 YES  YES
assoc1         1201 A    A    M3UA  2000  1030 YES  YES

IP Appl Sock/Assoc table is (7 of 4000) 1% full
Assoc Buffer Space Used (400 KB of 6400 KB) on LOC = 1201
```

A maximum of 32 associations can be assigned to a local host. If 32 associations are shown in this step, repeat this procedure from [Step 5](#) and choose another local host.

If the number of associations shown in this step is less than 32, continue the procedure with [Step 8](#).

8. Before the local host of the association can be changed, the association cannot be assigned to a signaling link.

If dashes are shown in the `LINK` column of the `rtrv-assoc` output in [Step 1](#), the association is not assigned to a signaling link.

If the association is assigned to a signaling link, perform one of these procedures.

- If the `ADAPTER` value of the association is M2PA, perform the [Removing an IPSG M2PA Signaling Link](#) procedure.
- If the `ADAPTER` value of the association is M3UA, perform the [Removing an IPSG M3UA Signaling Link](#) procedure.

After the signaling link has been removed, or if the association is not assigned to a signaling link, continue the procedure by performing one of these steps.

- If the `ADAPTER` value of the association is not being changed, continue the procedure with [Step 11](#).
- If the `ADAPTER` value of the association is being changed, continue the procedure by performing one of these steps.
 - If the `ADAPTER` value of the association is being changed to M2PA, perform one of these steps.

- If the `m2patset`, `ver`, and `uaps` parameters will not be specified for the association, continue the procedure with [Step 11](#).
 - If the `m2patset` and `ver` parameters will be specified for the association, continue the procedure with [Step 9](#).
 - If only the `uaps` parameter will be specified for the association, continue the procedure with [Step 10](#).
9. Verify the values of the M2PA timer set you wish to assign to the association by entering the `rtrv-m2pa-tset` command with the M2PA version (either `ver=rfc` to display the RFCM2PA timer values or `ver=d6` to display the Draft 6 M2PA timer values) of the timer set you wish to assign to the association.

If the `ver` parameter is not specified with the `rtrv-m2pa-tset` command, both the RFC and Draft 6 timer values are displayed.

To display the M2PA Draft 6 timer values, enter this command.

```
rtrv-m2pa-tset:ver=d6
```

This is an example of the possible output.

```
rlghncxa03w 06-10-28 21:16:37 GMT EAGLE5 36.0.0
M2PA Draft 6 Timers (in msec, T16 in microsec)
TSET T1      T2      T3      T4N     T4E     T5      T6      T7      T16     T17     T18
1     6000    ----- 5000    20000   500     5000    4000   1000    100000  150     500
2     7500    ----- 1500    2000    500     9000    1250   300     150000  175     600
3     100000  ----- 2000    3000    500     4000    1500   500     170000  200     800
4     200000  ----- 20000   4000    500     6000    2000   700     480000  225     900
5     250000  ----- 30000   30000   500     100     2250   400     400000  400     8000
6     50000   ----- 50000   60000   500     500     4500   800     300000  300     7000
7     10000   ----- 10000   10000   500     1000    3000   1200    200000  250     1000
8     80000   ----- 1500    15000   500     8000    2750   1100    350000  350     5000
9     27500   ----- 3850    4859    450     5700    3750   1150    250     375     8750
10    90000   ----- 2500    50000   500     7500    5000   1750    440000  450     3000
11    20000   ----- 4500    5500    500     6500    5500   1600    250000  475     4500
12    30000   ----- 7500    7000    500     750     4250   1800    275000  275     3500
13    40000   ----- 35000   9000    500     1250    3500   1900    500     325     9000
14    70000   ----- 45000   11000   500     1500    1750   900     1000    125     6000
15    9000    ----- 25000   40000   500     2500    3250   600     5000    425     5500
16    75000   ----- 15000   25000   500     4500    1600   1400    6000    240     9500
17    350000  ----- 60000   70000   600     10000   6000   2000    500000  500     10000
18    150000  ----- 55000   35000   500     3500    5750   1500    125000  440     750
19    175000  ----- 12500   45000   500     1100    2600   1300    7000    340     850
20    1000    ----- 1000    1000    400     80     1000   200     100     100     100
```

To display the M2PARFC values, enter this command.

```
rtrv-m2pa-tset:ver=rfc
```

This is an example of the possible output.

```
rlghncxa03w 06-10-28 21:16:37 GMT EAGLE5 36.0.0

M2PA RFC Timers (in msec, T16 in microsec)

TSET T1      T2      T3      T4N    T4E    T5      T6      T7      T16    T17    T18
1     6000    75000   5000   20000  500    5000   4000  1000   100000 150    500
2     7500    8000    1500   2000   500    9000   1250  300    150000 175    600
3     100000  10000   2000   3000   500    4000   1500  500    170000 200    800
4     200000  6000    20000  4000   500    6000   2000  700    480000 225    900
5     250000  140000 30000  30000  500    100    2250  400    400000 400    8000
6     50000   100000 50000  60000  500    500    4500  800    300000 300    7000
7     300000  20000   2000   10000  500    1000   3000  1200   200000 250    1000
8     80000   130000 1500   15000  500    8000   2750  1100   350000 350    5000
9     27500   120000 3850   4859   450    5700   3750  1150   250    375   8750
10    90000   9000    2500   50000  500    7500   5000  1750   440000 450    3000
11    20000   60000   4500   5500   500    6500   5500  1600   250000 475    4500
12    30000   50000   7500   7000   500    750    4250  1800   275000 275    3500
13    40000   90000   35000  9000   500    1250   3500  1900   500    325   9000
14    70000   45000   45000  11000  500    1500   1750  900    1000   125   6000
15    9000    30000   25000  40000  500    2500   3250  600    5000   425   5500
16    75000   15000   15000  25000  500    4500   1600  1400   6000   240   9500
17    350000  150000 60000  70000  600    10000  6000  2000   500000 500    10000
18    150000  20000   55000  35000  500    3500   5750  1500   125000 440    750
19    175000  12500   12500  45000  500    1100   2600  1300   7000   340   850
20    1000    5000    1000   1000   400    80     1000  200    100    100   100
```

If the ver parameter is not specified when entering the rtrv-m2pa-tset command, both the Draft 6 and RFC values are displayed. This is an example of the possible output.

```
rlghncxa03w 06-10-28 21:16:37 GMT EAGLE5 36.0.0

M2PA Draft 6 Timers (in msec, T16 in microsec)

TSET T1      T2      T3      T4N    T4E    T5      T6      T7      T16    T17    T18
1     6000    ----- 5000   20000  500    5000   4000  1000   100000 150    500
2     7500    ----- 1500   2000   500    9000   1250  300    150000 175    600
3     100000  ----- 2000   3000   500    4000   1500  500    170000 200    800
4     200000  ----- 20000  4000   500    6000   2000  700    480000 225    900
5     250000  ----- 30000  30000  500    100    2250  400    400000 400    8000
6     50000   ----- 50000  60000  500    500    4500  800    300000 300    7000
7     10000   ----- 10000  10000  500    1000   3000  1200   200000 250    1000
8     80000   ----- 1500   15000  500    8000   2750  1100   350000 350    5000
9     27500   ----- 3850   4859   450    5700   3750  1150   250    375   8750
10    90000   ----- 2500   50000  500    7500   5000  1750   440000 450    3000
11    20000   ----- 4500   5500   500    6500   5500  1600   250000 475    4500
12    30000   ----- 7500   7000   500    750    4250  1800   275000 275    3500
13    40000   ----- 35000  9000   500    1250   3500  1900   500    325   9000
14    70000   ----- 45000  11000  500    1500   1750  900    1000   125   6000
15    9000    ----- 25000  40000  500    2500   3250  600    5000   425   5500
16    75000   ----- 15000  25000  500    4500   1600  1400   6000   240   9500
17    350000  ----- 60000  70000  600    10000  6000  2000   500000 500    10000
18    150000  ----- 55000  35000  500    3500   5750  1500   125000 440    750
19    175000  ----- 12500  45000  500    1100   2600  1300   7000   340   850
20    1000    ----- 1000   1000   400    80     1000  200    100    100   100

M2PA RFC Timers (in msec, T16 in microsec)

TSET T1      T2      T3      T4N    T4E    T5      T6      T7      T16    T17    T18
```

1	6000	75000	5000	20000	500	5000	4000	1000	100000	150	500
2	7500	8000	1500	2000	500	9000	1250	300	150000	175	600
3	100000	10000	2000	3000	500	4000	1500	500	170000	200	800
4	200000	6000	20000	4000	500	6000	2000	700	480000	225	900
5	250000	140000	30000	30000	500	100	2250	400	400000	400	8000
6	50000	100000	50000	60000	500	500	4500	800	300000	300	7000
7	300000	20000	2000	10000	500	1000	3000	1200	200000	250	1000
8	80000	130000	1500	15000	500	8000	2750	1100	350000	350	5000
9	27500	120000	3850	4859	450	5700	3750	1150	250	375	8750
10	90000	9000	2500	50000	500	7500	5000	1750	440000	450	3000
11	20000	60000	4500	5500	500	6500	5500	1600	250000	475	4500
12	30000	50000	7500	7000	500	750	4250	1800	275000	275	3500
13	40000	90000	35000	9000	500	1250	3500	1900	500	325	9000
14	70000	45000	45000	11000	500	1500	1750	900	1000	125	6000
15	9000	30000	25000	40000	500	2500	3250	600	5000	425	5500
16	75000	15000	15000	25000	500	4500	1600	1400	6000	240	9500
17	350000	150000	60000	70000	600	10000	6000	2000	500000	500	10000
18	150000	20000	55000	35000	500	3500	5750	1500	125000	440	750
19	175000	12500	12500	45000	500	1100	2600	1300	7000	340	850
20	1000	5000	1000	1000	400	80	1000	200	100	100	100

**CAUTION**

Caution: Changing an M2PA timer set may affect the performance of any associations using the timer set being changed.

If the M2PA timer set you wish to assign to the association does not contain the desired values, go to the [Changing an M2PA Timer Set](#) procedure and changed the desired timer values.

After the M2PA timer set values have been changed, or if you do not wish to change any of the M2PA timer set values, continue the procedure by performing one of these steps.

- If the uaps parameter will not be specified for the association, continue the procedure with [Step 11](#).
- If the uaps parameter will be specified for the association, continue the procedure with [Step 10](#).

10. Verify the values of the UA parameter set you wish to assign to the association by entering the `rtrv-uaps` command with the desired parameter set.

For this example, enter this command.

```
rtrv-uaps:set=3
```

This is an example of possible output.

```
rlghncxa03w 10-07-28 09:12:36 GMT EAGLE5 42.0.0
  SET  TIMER      TVALUE  PARM      PVALUE
   3    1           10       1          3
   3    2          3000       2          0
   3    3          10000      3          1
   3    4           5000       4          0
   3    5            0         5          0
   3    6            0         6          0
   3    7            0         7          0
   3    8            0         8          0
   3    9            0         9          0
   3   10            0        10          0
```

TIMER 2: False IP Connection Congestion Timer, max time an

```

association can be congested before failing due to false
congestion. SS7IPGW and IPGWI applications enforce
0-30000(ms). Not supported on IPSG application.
TVALUE : Valid range = 32-bits

TIMER 3: UA HeartBeat Period Timer T(beat), time (ms) between sending
of BEAT msgs by NE. IPSG, SS7IPGW and IPGWI applications
enforce 100(ms)-60000(ms).
TVALUE : Valid range = 32-bits

TIMER 4: UA HeartBeat Received Timer T(beat ack), timeout period for
response BEAT ACK msgs by NE. IPSG, SS7IPGW and IPGWI
applications enforce 100(ms)-10000(ms).
TVALUE : Valid range = 32-bits

PARM 1: ASP SNM options. Each bit is used as an enabled/disabled
flag for a particular ASP SNM option. Not supported on IPSG
application.
PVALUE : Valid range = 32-bits
BIT                               BIT VALUE
0=Broadcast                       0=Disabled , 1=Enabled
1=Response Method                 0=Disabled , 1=Enabled
2-5=Reserved
6=Broadcast Congestion Status Change 0=Disabled , 1=Enabled
7-31=Reserved

PARM 2: ASP/AS Notification options. Each bit is used as an
enabled/disabled flag for a particular ASP/AS
Notification option. Not supported on IPSG application.
PVALUE : Valid range = 32-bits
BIT                               BIT VALUE
0=ASP Active Notifications        0=Disabled , 1=Enabled
1=ASP Inactive Notifications      0=Disabled , 1=Enabled
2=ASP AS State Query              0=Disabled , 1=Enabled
3-31=Reserved

PARM 3: UA Serviceability Options. Each bit is used as an
enabled/disabled flag for a particular UA Serviceability
option. Supported on IPSG, SS7IPGW, and IPGWI applications.
UA Graceful Shutdown supported on IPSG for M3UA only.
PVALUE : Valid range = 32-bits
BIT                               BIT VALUE
0=UA Heartbeats                   0=Disabled , 1=Enabled
1=UA Graceful Shutdown            0=Disabled , 1=Enabled
2-31=Reserved

PARM 4: SCTP Payload Protocol Indicator byte order option. Bit indicates
PPI value is RCV/TX in Big Endian or Little Endian byte format.
Supported on IPSG-M2PA associations only.
PVALUE : Valid range = 32-bits
BIT                               BIT VALUE
0=Payload Protocol Indicator      0=Big Endian , 1=Little Endian
1-31=Reserved

```

If you do not wish to change the UA parameter set values, continue the procedure with [Step 11](#).

If the UA parameter set you wish to assign to the association does not contain the desired values, go to the [Changing a UA Parameter Set](#) procedure and change the desired parameter set values. After the UA parameter set values have been changed, continue the procedure with [Step 11](#).

**CAUTION**

Caution: Changing aUA parameter set may affect the performance of any associations using the parameter set being changed.

11. Change the association using the `chg-assoc` command.

For this example, enter this command.

```
chg-assoc :aname=assoc2:lhost=m2pa2:alhost=m2pa3
```

Note: See (Sheet 7) for the rules that apply to the `chg-assoc` command.

These are the rules that apply to changing the host values of an IPSG association.

- If any optional parameters are not specified with the `chg-assoc` command, those values are not changed.
- The EAGLE can contain a maximum of 4000 connections.
- The host of an IPSG association can contain a maximum of 32 IPSG associations.
- The value of the `lhost` parameter is a text string of up to 60 characters, with the first character being a letter. The command input is limited to 150 characters, including the hostnames.
- Specifying the `lhost` parameter only creates a uni-homed endpoint. The network portion of the endpoint's IP address must be the same as the network portion of the IP address assigned to either the A or B network interface of the IP card.
- Specifying the `lhost` and `alhost` parameters creates a multi-homed endpoint. The network portion of the IP address associated with the `lhost` parameter must be the same as the network portion of the IP address assigned to one of the network interfaces (A or B) of the IP card, and the network portion of the IP address associated with the `alhost` parameter must be the same as the network portion of the IP address assigned to the other network interface on the IP card.
- The `alhost=none` parameter removes the alternate local host from the specified association, which also removes the multi-homed endpoint capability.
- The `m2patset` and `ver` parameters can be specified only for IPSG M2PA associations.
- If the `mp2atset` parameter is not specified with the `chg-assoc` command, and the `adapter` parameter value is being changed to `m2pa`, the `m2patset` parameter value defaults to M2PA timer set 1 (`m2patset=1`).
- The M2PA version of the association determines the version of the M2PA timer set that is assigned to the association. For example, if M2PA timer set 3 is assigned to the M2PA association, and the association is an RFC M2PA association, the RFC version of M2PA timer set 3 is used with the association. If M2PA timer set 7 is assigned to the M2PA association, and the association is a Draft 6 M2PA association, the Draft 6 version of M2PA timer set 7 is used with the association.
- If the `adapter` parameter value of the association is changed to `m2pa` in this procedure and the `ver` parameter is not specified, the version of the association will be RFC. To make this association a M2PA Draft 6 association, the `ver=d6` parameter must be specified for this association.

When this command has successfully completed, this message should appear.

```
r1ghncxa03w 08-04-28 09:12:36 GMT EAGLE5 38.0.0
CHG-ASSOC: MASP A - COMPLTD;
```

Continue the procedure by performing one of these steps.

- If the association was not assigned to a signaling link when this procedure was started, and the open parameter value was not changed in [Step 3](#), continue the procedure with [Step 14](#).
- If the association was not assigned to a signaling link when this procedure was started, and the open parameter value was changed in [Step 3](#), continue the procedure with [Step 12](#).
- If the association was assigned to a signaling link when this procedure was started, continue the procedure with [Step 12](#).

12. Assign the association to a signaling link by performing one of these procedures.

If the ADAPTER value of the association is M2PA, perform the [Adding an IPSG M2PA Signaling Link](#) procedure.

If the ADAPTER value of the association is M3UA, perform the [Adding an IPSG M3UA Signaling Link](#) procedure.

After the association has been assigned to a signaling link, continue the procedure with one of these steps.

- If the open parameter value was not changed in [Step 3](#), continue the procedure with [Step 14](#).
- If the open parameter value was changed in [Step 3](#), continue the procedure with [Step 13](#)

13. Change the value of the open parameter to yes by specifying the chg-`assoc` command with the `open=yes` parameter.

For this example, enter this command.

```
chg-assoc:aname=assoc2:open=yes
```

When this command has successfully completed, this message should appear.

```
rlghncxa03w 08-04-28 09:12:36 GMT EAGLE5 38.0.0
CHG-ASSOC: MASP A - COMPLTD;
```

14. Verify the changes using the `rtrv-assoc` command specifying the association name specified in [Step 11](#) and [Step 13](#).

For this example, enter this command.

```
rtrv-assoc:aname=assoc2
```

This is an example of possible output.

```
rlghncxa03w 10-07-28 21:14:37 GMT EAGLE5 42.0.0
ANAME assoc2
  LOC          2107          IPLNK PORT  A,B          LINK  --
  ADAPTER      M2PA          VER          M2PA RFC
  LHOST        M2PA2
  ALHOST       M2PA3
  RHOST        gw200.nc-tekelec.com
  ARHOST       ---
  LPORT        2048          RPORT        2048
  ISTRMS       2            OSTRMS       2            BUFSIZE    400
  RMODE        LIN          RMIN         120          RMAX       800
  RTIMES       10          CWMIN        3000        UAPS       10
  OPEN         NO           ALW          YES          RTXTHR     2000
  RHOSTVAL     RELAXED      M2PATSET     1
LSN
```

```

e5e6a

IP Appl Sock/Assoc table is (8 of 4000) 1% full
Assoc Buffer Space Used (200 KB of 6400 KB) on LOC = 2107

rlghncxa03w 09-05-28 21:14:37 GMT EAGLE5 41.0.0
ANAME assoc2
  LOC      2107          IPLNK PORT  A,B          LINK  --
  ADAPTER  M2PA          VER          M2PA RFC
  LHOST    M2PA2
  ALHOST   M2PA3
  RHOST    gw200.nc-tekelec.com
  ARHOST   ---
  LPORT    2048          RPORT        2048
  ISTRMS   2            OSTRMS       2            BUFSIZE  400
  RMODE    LIN          RMIN         120          RMAX     800
  RTIMES   10          CWMIN        3000        M2PATSET 1
  OPEN     NO           ALW          YES          RTXTHR   2000
  RHOSTVAL RELAXED

LSN
e5e6a

IP Appl Sock/Assoc table is (8 of 4000) 1% full
Assoc Buffer Space Used (200 KB of 6400 KB) on LOC = 2107

```

15. Back up the new changes, using the `chg-db:action=backup:dest=fixed` command.

These messages should appear; the active Maintenance and Administration Subsystem Processor (MASP) appears first.

```

BACKUP (FIXED) : MASP A - Backup starts on active MASP.
BACKUP (FIXED) : MASP A - Backup on active MASP to fixed disk complete.
BACKUP (FIXED) : MASP A - Backup starts on standby MASP.
BACKUP (FIXED) : MASP A - Backup on standby MASP to fixed disk complete.

```

If you wish to change the other attributes of the IPSG association, perform one of these procedures.

- `bufsize` - [Changing the Buffer Size of an IPSG Association](#)
- Other attributes of the IPSG Association - [Changing the Attributes of an IPSG Association](#)

If you do not wish to change the other attributes of the IPSG association, this procedure is finished.

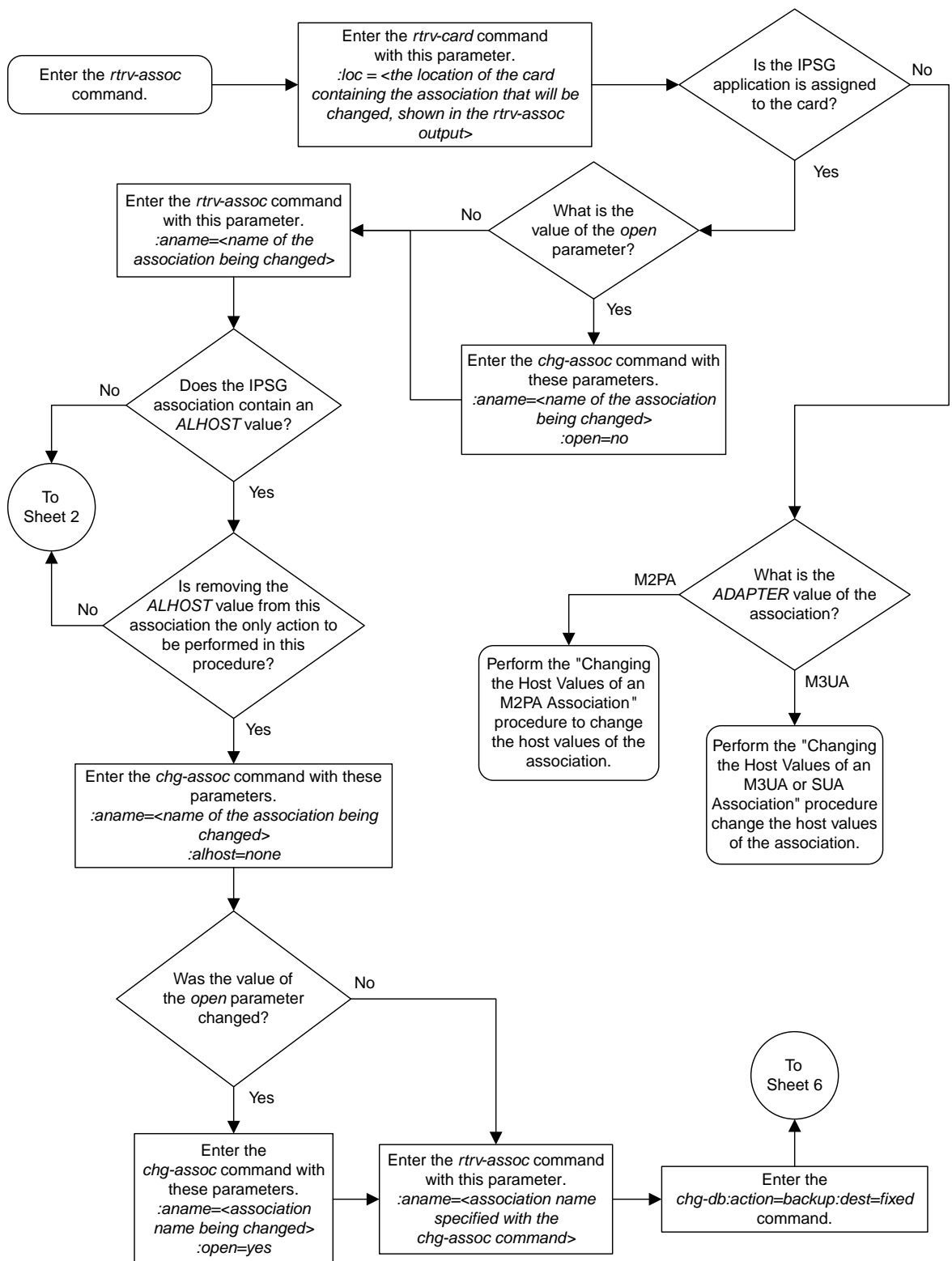

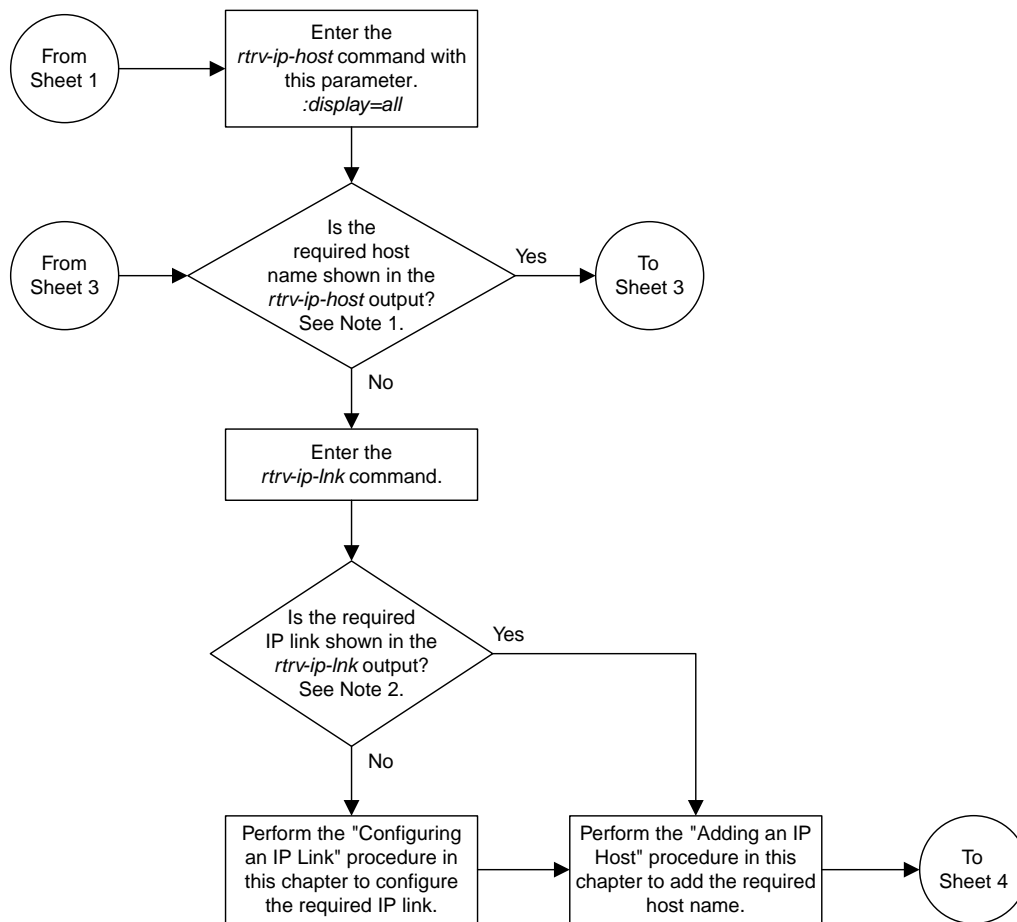

Notes:

1. The *rtrv-ip-host* output must contain a host name for the association's *lhost* parameter and a host name for the association's *alhost* parameter, if the *alhost* parameter will be specified for the association.
2. The IP address of the IP link should be assigned to the host name, shown in the *rtrv-ip-host* output, that will be used as the association's *lhost* parameter value. If the *alhost* parameter will be specified for the association, the IP address of the IP link must be assigned to the host name that will be used as the *alhost* parameter value. The IP links associated with the association's *lhost* and *alhost* values must be assigned to the same card.

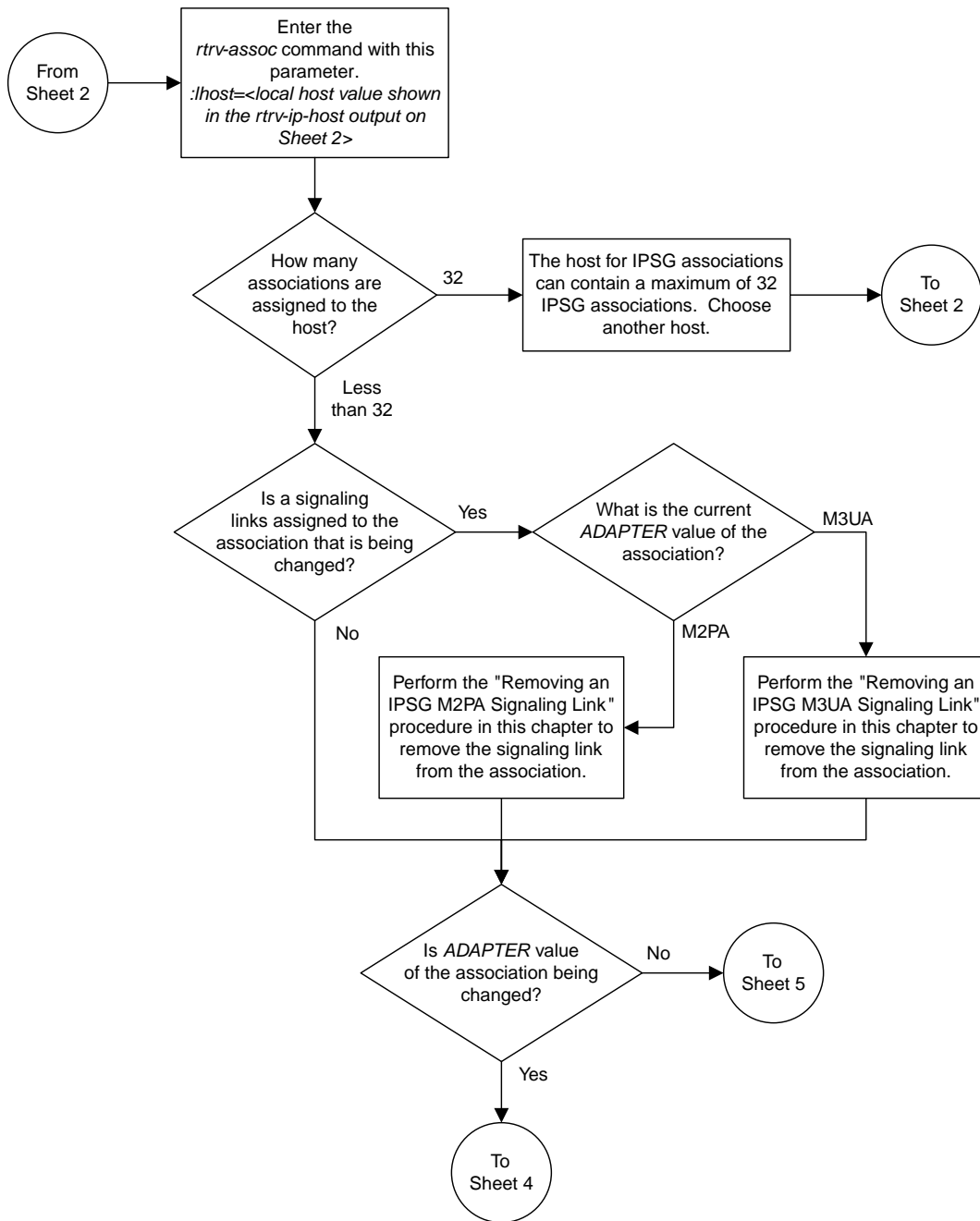

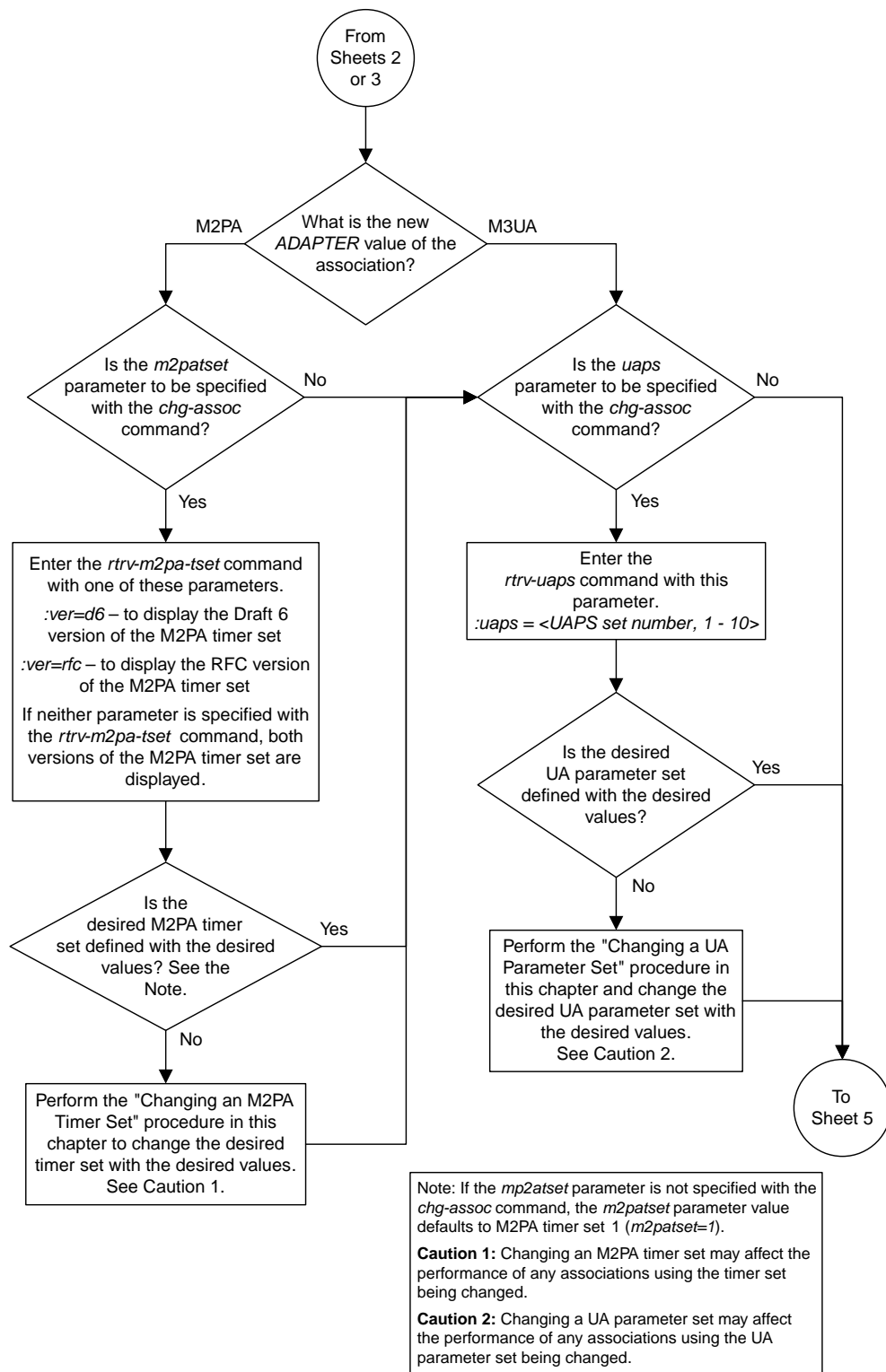

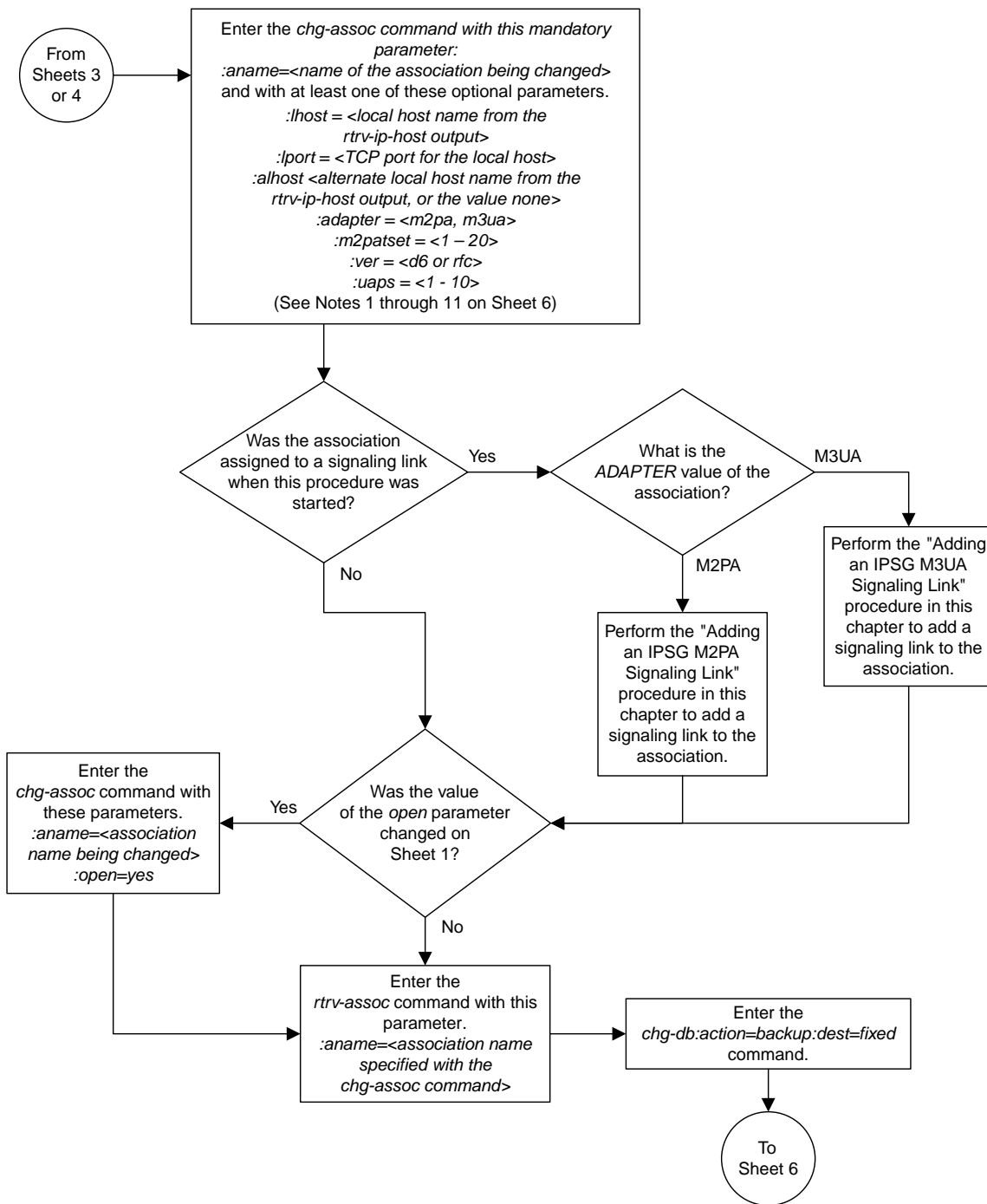

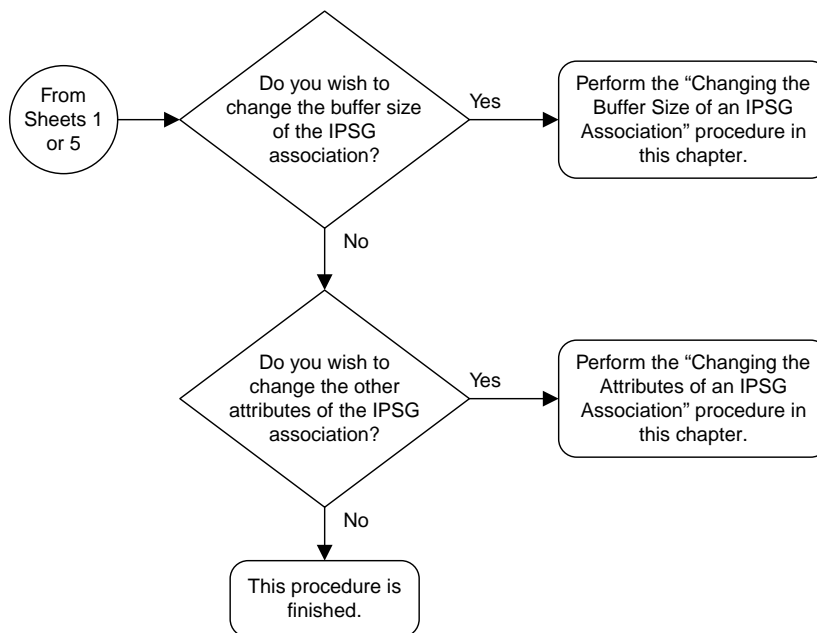

Notes:

1. If any optional parameters are not specified with the *chg-assoc* command, those values are not changed.
2. The EAGLE 5 ISS can contain a maximum of 4000 connections.
3. The host of an IPSG association can contain a maximum of 32 IPSG associations.
4. The value of the *lhost* and *rhost* parameters is a text string of up to 60 characters, with the first character being a letter. The command input is limited to 150 characters, including the hostnames.
5. Specifying the *lhost* parameter only creates a uni-homed endpoint. The network portion of the endpoint's IP address must be the same as the network portion of the IP address assigned to either the A or B network interface of the IP card.
6. Specifying the *lhost* and *alhost* parameters creates a multi-homed endpoint. The network portion of the IP address associated with the *lhost* parameter must be the same as the network portion of the IP address assigned to one of the network interfaces (A or B) of the IP card, and the network portion of the IP address associated with the *alhost* parameter must be the same as the network portion of the IP address assigned to the other network interface on the IP card.
7. The *alhost=none* parameter removes the alternate local host from the specified association, which also removes the multi-homed endpoint capability.
8. The *m2patset* and *ver* parameters can be specified only for IPSG M2PA associations.
9. If the *mp2atset* parameter is not specified with the *chg-assoc* command, and the *adapter* parameter value is being changed to *m2pa*, the *m2patset* parameter value defaults to M2PA timer set 1 (*m2patset=1*).
10. The M2PA version of the association determines the version of the M2PA timer set that is assigned to the association. For example, if M2PA timer set 3 is assigned to the M2PA association, and the association is an RFC M2PA association, the RFC version of M2PA timer set 3 is used with the association. If M2PA timer set 7 is assigned to the M2PA association, and the association is a Draft 6 M2PA association, the Draft 6 version of M2PA timer set 7 is used with the association.
11. If the *adapter* parameter value of the association is changed to *m2pa* in this procedure and the *ver* parameter is not specified, the version of the association will be RFC. To make this association a M2PA Draft 6 association, the *ver=d6* parameter must be specified for this association.

Sheet 6 of 6

Figure 117: Changing the Host Values of an IPSG Association

Configuring an IPSG Association for SCTP Retransmission Control

This procedure is used to gather the information required to configure the retransmission parameters for M2PA or M3UA associations assigned to cards running the IPSG application. Perform the [Configuring SCTP Retransmission Control for a M2PA Association](#) procedure to configure the retransmission parameters for M2PA associations assigned to IPLIMx cards. Perform the [Configuring SCTP Retransmission Control for a M3UA or SUA Association](#) procedure to configure the retransmission parameters for M3UA associations assigned to IPLIMx cards. If any assistance is needed to configure the retransmission parameters for associations, contact [My Oracle Support \(MOS\)](#).

The retransmission parameters are configured using the `rmode`, `rmin`, `rmax`, `rtimes`, and `cwmin` parameters of the `chg-assoc` command.

`:rmode` – The retransmission mode used when packet loss is detected. The values are `rfc` or `lin`.

- `rfc` – Standard RFC 2960 algorithm in the retransmission delay doubles after each retransmission. The RFC 2960 standard for congestion control is also used.
- `lin` – Oracle's linear retransmission mode where each retransmission timeout value is the same as the initial transmission timeout and only the slow start algorithm is used for congestion control.

`:rmin` – The minimum value of the calculated retransmission timeout in milliseconds.

`:rmax` – The maximum value of the calculated retransmission timeout in milliseconds.

Note: The `rmin` and `rmax` parameter values form a range of retransmission values. The value of the `rmin` parameter must be less than or equal to the `rmax` parameter value.

`:rtimes` – The number of times a data retransmission occurs before closing the association.

`:cwmin` – The minimum size in bytes of the association's congestion window and the initial size in bytes of the congestion window.

The [Changing the Attributes of an IPSG Association](#) procedure is used to change the values of these parameters. In addition to using the [Changing the Attributes of an IPSG Association](#) procedure, these `pass` commands are also used in this procedure.

- `ping` – tests for the presence of hosts on the network.
- `assocrtt` – displays the SCTP round trip times for a specified association. Minimum, maximum, and average times are kept for each open association. The Retransmission Mode (RFC or LIN) and the configured Minimum and Maximum Retransmission Timeout limits are also displayed.
- `sctp` – provides a summary list of all SCTP instances.
- `sctp -a <association name>` – displays the measurements and information for a specific association.

Note: The values for the minimum and maximum retransmission times in the output from this command are shown in microseconds.

For more information on the `pass` commands, see *Commands User's Guide*.

The `chg-assoc` command contains other optional parameters that can be used to configure an association. These parameters are not shown here because they are not necessary for configuring the

SCTP retransmission parameters. These parameters are explained in more detail in the [Changing the Attributes of an IPSG Association](#) procedure, or in the `and chg-assoc` command description in *Commands User's Guide*.

Canceling the RTRV-ASSOC Command

Because the `rtrv-assoc` command used in this procedure can output information for a long period of time, the `rtrv-assoc` command can be canceled and the output to the terminal stopped. There are three ways that the `rtrv-assoc` command can be canceled.

- Press the F9 function key on the keyboard at the terminal where the `rtrv-assoc` command was entered.
- Enter the `canc-cmd` without the `trm` parameter at the terminal where the `rtrv-assoc` command was entered.
- Enter the `canc-cmd:trm=<xx>`, where `<xx>` is the terminal where the `rtrv-assoc` command was entered, from another terminal other than the terminal where the `rtrv-assoc` command was entered. To enter the `canc-cmd:trm=<xx>` command, the terminal must allow Security Administration commands to be entered from it and the user must be allowed to enter Security Administration commands. The terminal's permissions can be verified with the `rtrv-secu-trm` command. The user's permissions can be verified with the `rtrv-user` or `rtrv-secu-user` commands.

For more information about the `canc-cmd` command, go to *Commands User's Guide*.

1. Display the associations in the database using the `rtrv-assoc` command.

This is an example of possible output.

```
rlghncxa03w 06-10-28 09:12:36 GMT EAGLE5 36.0.0
          CARD IPLNK
ANAME      LOC  PORT  LINK ADAPTER  LPORT  RPORT  OPEN  ALW
swbel32    1201 A      A    M3UA    1030    2345   YES   YES
a2         1305 A      A    SUA     1030    2345   YES   YES
a3         1307 A      A    SUA     1030    2346   YES   YES
assoc1     1201 A      A    M2PA    2000    1030   YES   YES
```

2. Enter the `rtrv-card` command with the location of the card that is hosting the M2PA association that will be changed in this procedure. For this example, enter this command.

```
rtrv-card:loc=1201
```

This is an example of possible output.

```
rlghncxa03w 08-03-06 15:17:20 EST EAGLE5 38.0.0
CARD  TYPE  APPL  LSET NAME  LINK SLC  LSET NAME  LINK SLC
1201  DCM    IPLIM  lsn1      A    0
```

If the application assigned to the card is IPSG, shown in the `APPL` column, continue the procedure with [Step 3](#).

If the application assigned to the card is `IPLIM` or `IPLIMI`, perform the [Configuring SCTP Retransmission Control for a M2PA Association](#) procedure.

If the application assigned to the card is `SS7IPGW` or `IPGWI`, perform the [Configuring SCTP Retransmission Control for a M3UA or SUA Association](#) procedure.

3. Display the association that will be changed by entering the `rtrv-assoc` command with the name of the association. For this example, enter this command.

```
rtrv-assoc:aname=assoc1
```

This is an example of the possible output.

```
rlghncxa03w 10-07-28 21:14:37 GMT EAGLE5 42.0.0
ANAME assoc1
  LOC      1201          IPLNK PORT  A          LINK  A
  ADAPTER  M2PA          VER          M2PA RFC
  LHOST    IPNODE2-1205
  ALHOST    ---
  RHOST    gw100.nc.tekelec.com
  ARHOST    ---
  LPORT    2000          RPORT        1030
  ISTRMS   2            OSTRMS        2          BUFSIZE  400
  RMODE    LIN          RMIN          120        RMAX      800
  RTIMES   10          CWMIN         3000       UAPS      10
  OPEN     NO           ALW           YES         RTXTHR   2000
  RHOSTVAL RELAXED      M2PATSET     1
IP Appl Sock/Assoc table is (8 of 4000) 1% full
Assoc Buffer Space Used (1600 KB of 1600 KB) on LOC = 1201
```

4. Enter the `ping` pass command specifying the card location of the local host, shown in [Step 3](#), and the name of the remote host assigned to the association being changed, shown in [Step 3](#).

This command is entered several times to obtain the average round trip time. For this example, enter this command.

```
pass:loc=1201:cmd="ping gw100.nc.tekelec.com"
```

The following is an example of the possible output

```
rlghncxa03w 06-10-28 21:15:37 GMT EAGLE5 36.0.0
PASS: Command sent to card

rlghncxa03w 06-10-28 21:15:37 GMT EAGLE5 36.0.0
PING command in progress

rlghncxa03w 06-10-28 21:15:37 GMT EAGLE5 36.0.0
PING GW100. NC. TEKELEC. COM (192.1.1.30): 56 data bytes
64 bytes from tekral.nc.tekelec.com (192.1.1.30): icmp_seq=0. time=5. ms
64 bytes from tekral.nc.tekelec.com (192.1.1.30): icmp_seq=1. time=9. ms
64 bytes from tekral.nc.tekelec.com (192.1.1.30): icmp_seq=2. time=14. ms
----tekral PING Statistics----
3 packets transmitted, 3 packets received, 0% packet loss
round-trip (ms)  min/avg/max = 5/9/14

PING command complete
```

If the SCTP retransmission parameters are not to be changed, do not perform [Step 5](#) through [Step 8](#). This procedure is finished.

5. Perform the [Changing the Attributes of an IPSG Association](#) procedure to change the retransmission parameters of the association based on the results of pinging the remote host.
6. Enter the `assocrtt` pass command to display the round trip time data collected after an association is established when an SCTP INIT message is sent and an acknowledgment is received.

The `assocrtt` command is entered with the card location from [Step 4](#) (the card location assigned to the association being changed), and the name of the association being changed. This association must contain the host name used in [Step 4](#). For this example, enter this command.

```
pass:loc=1201:cmd="assocrtt assoc1"
```

The following is an example of the possible output

```
rlghncxa03w 06-10-28 21:15:37 GMT EAGLE5 36.0.0
PASS: Command sent to card

rlghncxa03w 06-10-28 21:15:37 GMT EAGLE5 36.0.0

ASSOCRTT: Association round-trip time report (in milliseconds)

Retransmission Configuration
  Retransmission Mode           : LIN
  Minimum RTO: 120
  Maximum RTO: 800

Traffic Round-Trip Times
  Minimum round-trip time       : 5
  Maximum round-trip time       : 120
  Weighted Average round-trip time : 10
  Last recorded round-trip time  : 10

Measured Congested Traffic Round-Trip Times
  Minimum round-trip time       : 0
  Maximum round-trip time       : 0
  Weighted Average round-trip time : 0
  Last recorded round-trip time  : 0
;
rlghncxa03w 06-10-28 21:15:37 GMT EAGLE5 36.0.0
ASSOCRTT command complete
```

7. Enter the `sctp -a <association name> pass` command to determine if retransmissions have occurred.

The association name is the association name specified in [Step 6](#). Specify the card location used in [Step 6](#). For this example, enter this command.

```
pass:loc=1201:cmd="sctp -a assoc1"
```

The following is an example of the possible output

```
rlghncxa03w 10-12-28 21:15:37 GMT EAGLE5 43.0.0

Aname           Local           Local Remote           Remote
                IP Address      Port  Address           Port
Assoc1          192.168.110.12 2222  192.168.112.4    5555
                192.168.112.12

                Configuration           State
                Retransmission Mode = LIN           State = OPEN
Min. Retransmission Timeout = 10           ULP association id = 18
Max. Retransmission Timeout = 800         Number of nets = 2
                Max. Number of Retries = 10         Inbound Streams = 1
                Min. Congestion Window = 3000       Outbound Streams = 2
```

```

Inbound Streams = 2
Outbound Streams = 2
Checksum Algorithm = crc32c
Send/Rcv Buffer Size = 204800

```

Nets Data

IP Address	192.168.112.4	State	Reachable
Port	7777	Primary	YES
MTU	1500	cwnd	16384
ssthresh	16384	RTO	120
IP Address	192.168.113.5	State	Reachable
Port	7777	Primary	NO
MTU	1500	cwnd	16384
ssthresh	16384	RTO	120

```

Last Net Sent To = 192.168.112.4
Last Net Rcvd From = 192.168.112.4
Over All Error Count = 0
Peers Rwnd = 13880
My Rwnd = 16384
Max Window = 16384
Initial Seq Number = 24130
Next Sending Seq Number = 124686
Last Acked Seq Number = 124669
Maximum Outbound Char Count = 16384
Current Outbound Char Count = 2112
Number Unsent Char Count = 0
Outbound Data Chunk Count = 16
Number Unsent = 0
Number To Retransmit = 0

ip datagrams rcvd = 155402
ip datagrams with data chunks rcvd = 120844
data chunks rcvd = 367908
data chunks read = 367900
dup tsns rcvd = 8
sacks rcvd = 38734
gap ack blocks rcvd = 3
heartbeat requests rcvd = 135
heartbeat acks rcvd = 52
heartbeat requests sent = 52
ip datagrams sent = 129254
ip datagrams with data chunks sent = 73084
data chunks sent = 396330
retransmit data chunks sent = 135
sacks sent = 64872
send failed = 0
retransmit timer count = 0
consecutive retransmit timeouts = 0
RTT between RMIN and RMAX inclusive = 6
RTT greater than RMAX = 0
fast retransmit count = 135
recv timer count = 0
heartbeat timer count = 244
none left tosend = 0
none left rwnd gate = 5
none left cwnd gate = 8

;

rlghncxa03w 10-12-28 21:15:37 GMT EAGLE5 43.0.0

```

SCTP command complete

rlghncxa03w 06-10-28 21:15:37 GMT EAGLE5 36.0.0

Aname	Local IP Address	Local Port	Remote Address	Remote Port
Assoc1	192.168.110.12	2222	192.168.112.4	5555
	192.168.112.12			

Configuration	State
Retransmission Mode = LIN	State = OPEN
Min. Retransmission Timeout = 10	ULP association id = 18
Max. Retransmission Timeout = 800	Number of nets = 2
Max. Number of Retries = 10	Inbound Streams = 1
Min. Congestion Window = 3000	Outbound Streams = 2
Inbound Streams = 2	
Outbound Streams = 2	

Nets Data

IP Address	192.168.112.4	State	Reachable
Port	7777	Primary	YES
MTU	1500	cwnd	16384
ssthresh	16384	RTO	120
IP Address	192.168.113.5	State	Reachable
Port	7777	Primary	NO
MTU	1500	cwnd	16384
ssthresh	16384	RTO	120

```

Last Net Sent To = 192.168.112.4
Last Net Rcvd From = 192.168.112.4
Over All Error Count = 0
  Peers Rwnd = 13880
  My Rwnd = 16384
  Max Window = 16384
  Initial Seq Number = 24130
  Next Sending Seq Number = 124686
  Last Acked Seq Number = 124669
Maximum Outbound Char Count = 16384
Current Outbound Char Count = 2112
Number Unsent Char Count = 0
Outbound Data Chunk Count = 16
  Number Unsent = 0
Number To Retransmit = 0

ip datagrams rcvd = 155402
ip datagrams with data chunks rcvd = 120844
  data chunks rcvd = 367908
  data chunks read = 367900
  dup tsns rcvd = 8
  sacks rcvd = 38734
  gap ack blocks rcvd = 3
  heartbeat requests rcvd = 135
  heartbeat acks rcvd = 52
  heartbeat requests sent = 52
  ip datagrams sent = 129254
ip datagrams with data chunks sent = 73084
  data chunks sent = 396330
retransmit data chunks sent = 135

```

```
sacks sent = 64872
send failed = 0
retransmit timer count = 0
consecutive retransmit timeouts = 0
RTT between RMIN and RMAX inclusive = 6
RTT greater than RMAX = 0
fast retransmit count = 135
recv timer count = 0
heartbeat timer count = 244
none left tosend = 0
none left rwnd gate = 5
none left cwnd gate = 8

SCTP command complete
```

8. Perform the *Changing the Attributes of an IPSP Association* procedure to change the retransmission parameters of the association based on the results of the outputs of *Step 6* and *Step 7*.

The Weighted Average round-trip time shown in the `assocrtt pass` command output in *Step 6*, and the data retransmission counts shown in the `sctp -a pass` command output in *Step 7* are used as a guide to determine the appropriate values for the `rmode`, `rmin`, `rmax`, and `rtimes` parameters. If the retransmission parameters do not have to be adjusted, do not perform this step. This procedure is finished.

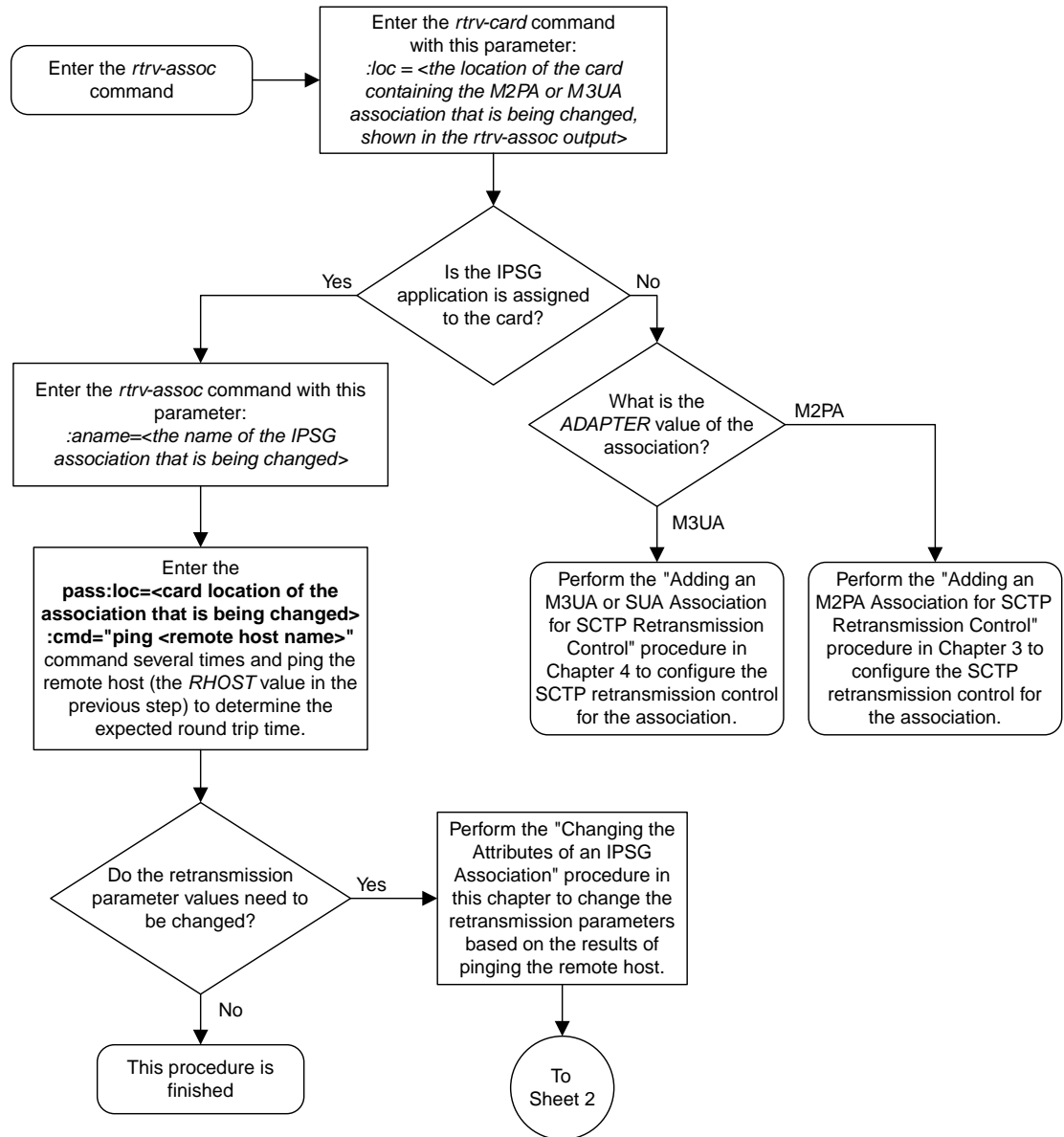

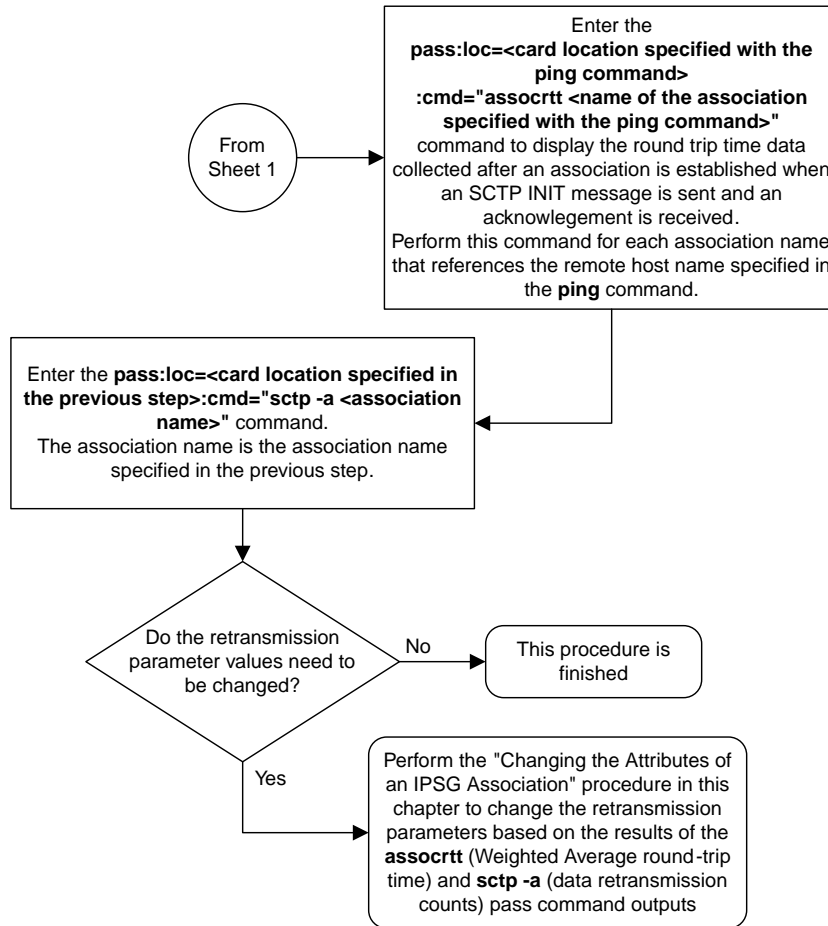

Sheet 2 of 2

Figure 118: Configuring an IPSG Association for SCTP Retransmission Control

Changing the SCTP Checksum Algorithm Option for IPSG M2PA Associations

Use this procedure to change the SCTP checksum algorithm, either Adler-32 or CRC-32c, applied to traffic on SCTP associations. The `sctpchecksum` parameter of the `chg-sg-opts` command is used to change this option. The Adler-32 and CRC-32c checksum algorithms specified in this procedure applies to all the M2PA associations that are assigned to all the IP cards running the IPSG application. This option is a system-wide option. To apply this option to associations assigned to cards running the IPLIM, IPLIMI, SS7IPGW, or IPGWI applications, or to IPSG M3UA associations, perform these procedures.

- [Changing the SCTP Checksum Algorithm Option for M3UA and SUA Associations](#)
- [Changing the SCTP Checksum Algorithm Option for M2PA Associations](#)
- [Changing the SCTP Checksum Algorithm Option for IPSG M3UA Associations](#)

The `sctpchecksum` parameter contains another value, `percard`, that allows either the Adler-32 or CRC-32c SCTP checksum algorithm to be specified for the all the associations assigned to a specific card. With this option specified, the Adler-32 checksum algorithm can be specified for the associations on one card and the CRC-32c checksum algorithm can be specified for the associations on another card. Setting the `sctpchecksum` parameter to `percard` changes the SCTP checksum algorithm for the associations assigned to a card to the SCTP checksum algorithm value for that card. The checksum algorithm for individual cards is provisioned by performing the [Configuring an IP Link](#) procedure.

Once the SCTP checksum option has been changed, the associations on each IP card need to be reset by changing the `open` parameter value for each association to `no`, then back to `yes`. This ensures that the associations on the IP card are using the new SCTP checksum algorithm.

Canceling the `RTRV-ASSOC` Command

Because the `rtrv-assoc` command used in this procedure can output information for a long period of time, the `rtrv-assoc` command can be canceled and the output to the terminal stopped. There are three ways that the `rtrv-assoc` command can be canceled.

- Press the F9 function key on the keyboard at the terminal where the `rtrv-assoc` command was entered.
- Enter the `canc-cmd` without the `trm` parameter at the terminal where the `rtrv-assoc` command was entered.
- Enter the `canc-cmd:trm=<xx>`, where `<xx>` is the terminal where the `rtrv-assoc` command was entered, from another terminal other than the terminal where the `rtrv-assoc` command was entered. To enter the `canc-cmd:trm=<xx>` command, the terminal must allow Security Administration commands to be entered from it and the user must be allowed to enter Security Administration commands. The terminal's permissions can be verified with the `rtrv-secu-trm` command. The user's permissions can be verified with the `rtrv-user` or `rtrv-secu-user` commands.

For more information about the `canc-cmd` command, go to *Commands User's Guide*.

1. Display the current IP options in the database by entering the `rtrv-sg-opts` command. The following is an example of the possible output.

```
rlghncxa03w 06-10-28 21:16:37 GMT EAGLE5 36.0.0
SCTPCSUM:      adler32
```

The `rtrv-sg-opts` command output contains other fields that are not used by this procedure. If you wish to see all the fields displayed by the `rtrv-sg-opts` command, see the `rtrv-sg-opts` command description in *Commands User's Guide*.

2. Display the cards in the EAGLE by entering the `rtrv-card` command. This is an example of the possible output.

```
rlghncxa03w 09-10-15 16:34:56 GMT EAGLE5 41.0.0
CARD  TYPE      APPL      LSET NAME      LINK SLC  LSET NAME      LINK SLC
1101  DSM          VSCCP
1102  TSM          GLS
1104  DCM          STPLAN
1113  GSPM        EOAM
1114  TDM-A
1115  GSPM        EOAM
1116  TDM-B
1117  MDAL
1201  LIMDS0      SS7ANSI   lsn1           A    0    lsn2           B    1
1202  DCM          IPLIM     ipnode2       A    1
1203  LIMDS0      SS7ANSI   lsn2           A    0    lsn1           B    1
1204  LIMATM      ATMANSI   atmgwy        A    0
1205  DCM          IPLIM     ipnode1       A    0    ipnode3        B    1
1207  DCM          IPLIM     ipnode2       A    0
1303  DCM          IPLIM     ipnode3       A    0    ipnode1        B    1
1305  DCM          IPLIM     ipnode4       A    0
1308  ENET        IPSG      ipnode3       B    2
          ipnode1     A1    2    ipnode4        B2   1
1315  DCM          SS7IPGW   ipgtwy1       A
1317  DCM          IPGWI     ipgtwy2       A
```

Record the card location, shown in the `LOC` column, and signaling link, shown in the `LINK` column, information for all cards running the IPSG application.

3. Select one of the IPSG cards shown in [Step 2](#). Display the associations assigned to the IPSG card by entering the `rrtrv-assoc` command and specifying the card location of the IPSG card. For this example, enter this command.

```
rtrv-assoc:loc=1308
```

The following is an example of the possible output.

```
rlghncxa03w 08-04-28 09:12:36 GMT EAGLE5 38.0.0
          CARD  IPLNK
ANAME      LOC  PORT  LINK ADAPTER  LPORT  RPORT  OPEN  ALW
assoc2     1308 A     A1   M2PA    2187   1025   YES   YES
assoc4     1308 A     B    M2PA    3290   1025   YES   YES
assoc5     1308 A     B2   M2PA    1057   1025   YES   YES
```

```
IP Appl Sock/Assoc table is (9 of 4000) 1% full
Assoc Buffer Space Used (600 KB of 3200 KB) on LOC = 1308
```

If the ADAPTER value of the associations shown in the `rtrv-assoc` output is M2PA, continue the procedure with [Step 4](#).

If the ADAPTER value of the associations shown in the `rtrv-assoc` output is M3UA, do not perform the remainder of this procedure. Perform the [Changing the SCTP Checksum Algorithm Option for IPSG M3UA Associations](#) procedure to change the SCTP checksum algorithm for IPSG M3UA associations.

4. Change the SCTP checksum option in the database using the `chg-sg-opts` command. For this example, enter this command.

```
chg-sg-opts:sctpcsum=crc32c
```

When this command has successfully completed, the following message should appear.

```
rlghncxa03w 06-10-28 21:19:37 GMT EAGLE5 36.0.0
CHG-SG-OPTS: MASP A - COMPLTD
```

Continue the procedure by performing one of these actions.

- If the `sctpcsum` parameter value was changed to either `adler32` or `crc32c`, continue the procedure with [Step 5](#).
 - If the `sctpcsum` parameter value was changed to `perc`, perform the [Configuring an IP Card](#) procedure to assign an `sctpcsum` parameter value to all the cards containing IPSG M2PA associations. After the [Configuring an IP Card](#) procedure has been performed, continue the procedure with [Step 6](#).
5. Verify that the SCTP checksum algorithm was changed using the `rtrv-sg-opts` command. The SCTP checksum algorithm option value is shown in the SCTPCSUM parameter. The following is an example of the possible output.

```
rlghncxa03w 06-10-28 21:16:37 GMT EAGLE5 36.0.0
SCTPCSUM:          crc32c
```

The `rtrv-sg-opts` command output contains other fields that are not used by this procedure. If you wish to see all the fields displayed by the `rtrv-sg-opts` command, see the `rtrv-sg-opts` command description in *Commands User's Guide*.

6. Place the signaling links assigned to the IPSG card out of service using the `dact-slk` command, specifying the LOC and LINK values shown in [Step 3](#). For this example, enter these commands.

```
dact-slk:loc=1308:link=a1
```

```
dact-slk:loc=1308:link=b
```

```
dact-slk:loc=1308:link=b2
```

When these commands have successfully completed, this message appears.

```
rlghncxa03w 06-10-12 09:12:36 GMT EAGLE5 36.0.0
Deactivate Link message sent to card
```

7. Change the value of the open parameter of the associations shown in [Step 3](#) to `no` by specifying the `chg-assoc` command with the `open=no` parameter. For this example, enter this command.

```
chg-assoc:aname=assoc2:open=no
```

```
chg-assoc:aname=assoc4:open=no
```

```
chg-assoc:aname=assoc5:open=no
```

When this command has successfully completed, this message should appear.

```
rlghncxa03w 06-10-28 09:12:36 GMT EAGLE5 36.0.0
CHG-ASSOC: MASP A - COMPLTD;
```

8. Change the value of the `open` parameter of the associations changed in [Step 7](#) to `yes` by specifying the `chg-assoc` command with the `open=yes` parameter. For this example, enter this command.

```
chg-assoc:aname=assoc2:open=yes
```

```
chg-assoc:aname=assoc4:open=yes
```

```
chg-assoc:aname=assoc5:open=yes
```

When this command has successfully completed, this message should appear.

```
rlghncxa03w 06-10-28 09:12:36 GMT EAGLE5 36.0.0
CHG-ASSOC: MASP A - COMPLTD;
```

9. Verify the checksum algorithm that is assigned to the associations shown in [Step 8](#) by entering the `sctp -a` pass command with the card location of the IP card specified in [Step 6](#) and the name of the associations specified in [Step 8](#). For this example, enter this command.

```
pass:loc=1308:cmd="sctp -a assoc2 "
```

The following is an example of the possible output.

```
rlghncxa03w 10-12-28 21:16:37 GMT EAGLE5 43.0.0
Aname          Local          Local  Primary      Remote
               IP Address     Port   Address      Port
assoc2         192.1.1.24    2187   192.168.112.4 1025
               192.1.1.24

Configuration                               State
Retransmission Mode = LIN                    State = OPEN
Min. Retransmission Timeout = 10000          ULP association id = 18
Max. Retransmission Timeout = 800000        Number of nets = 2
Max. Number of Retries = 10                 Inbound Streams = 1
Min. Congestion Window = 3000               Outbound Streams = 2
Inbound Streams = 2
Outbound Streams = 2
Checksum Algorithm = crc32c
Send/Rcv Buffer Size = 204800

Nets Data

IP Address    192.168.112.4    State    Reachable
Port          1025             Primary  YES
MTU           1500             cwnd    16384
ssthresh      16384            RTO     120

IP Address    192.168.112.5    State    Reachable
Port          7777             Primary  NO
MTU           1500             cwnd    16384
ssthresh      16384            RTO     120
```

```

        Last Net Sent To = 192.168.112.4
        Last Net Rcvd From = 192.168.112.4
    Over All Error Count = 0
        Peers Rwnd = 13880
        My Rwnd = 16384
        Max Window = 16384
    Initial Seq Number = 24130
    Next Sending Seq Number = 124686
    Last Acked Seq Number = 124669
    Maximum Outbound Char Count = 16384
    Current Outbound Char Count = 2112
    Number Unsent Char Count = 0
    Outbound Data Chunk Count = 16
        Number Unsent = 0
    Number To Retransmit = 0

    ip datagrams rcvd = 155402
ip datagrams with data chunks rcvd = 120844
    data chunks rcvd = 367908
    data chunks read = 367900
    dup tsns rcvd = 8
    sacks rcvd = 38734
    gap ack blocks rcvd = 3
    heartbeat requests rcvd = 135
    heartbeat acks rcvd = 52
    heartbeat requests sent = 52
    ip datagrams sent = 129254
ip datagrams with data chunks sent = 73084
    data chunks sent = 396330
    retransmit data chunks sent = 135
    sacks sent = 64872
    send failed = 0
    retransmit timer count = 0
    consecutive retransmit timeouts = 0
    RTT between RMIN and RMAX inclusive = 6
    RTT greater than RMAX = 0
    fast retransmit count = 135
    rcv timer count = 0
    heartbeat timer count = 244
    none left tosend = 0
    none left rwnd gate = 5
    none left cwnd gate = 8

;

rlghncxa03w 10-12-28 21:16:37 GMT EAGLE5 43.0.0

SCTP command complete

rlghncxa03w 08-04-28 21:16:37 GMT EAGLE5 38.0.0
Aname          Local          Local  Primary      Remote
                IP Address      Port   Address     Port
assoc2         192.1.1.24     2187   192.168.112.4  1025
                192.1.1.24

        Configuration                               State
    Retransmission Mode = LIN                       State = OPEN
    Min. Retransmission Timeout = 10                 ULP association id = 18
    Max. Retransmission Timeout = 800                Number of nets = 2
    Max. Number of Retries = 10                      Inbound Streams = 1

```

```

Min. Congestion Window = 3000      Outbound Streams = 2
      Inbound Streams = 2
      Outbound Streams = 2
Checksum Algorithm = crc32c

```

Nets Data

IP Address	192.168.112.4	State	Reachable
Port	1025	Primary	YES
MTU	1500	cwnd	16384
ssthresh	16384	RTO	120
IP Address	192.168.112.5	State	Reachable
Port	7777	Primary	NO
MTU	1500	cwnd	16384
ssthresh	16384	RTO	120

```

      Last Net Sent To = 192.168.112.4
      Last Net Rcvd From = 192.168.112.4
      Over All Error Count = 0
      Peers Rwnd = 13880
      My Rwnd = 16384
      Max Window = 16384
      Initial Seq Number = 24130
      Next Sending Seq Number = 124686
      Last Acked Seq Number = 124669
      Maximum Outbound Char Count = 16384
      Current Outbound Char Count = 2112
      Number Unsent Char Count = 0
      Outbound Data Chunk Count = 16
      Number Unsent = 0
      Number To Retransmit = 0

```

```

      ip datagrams rcvd = 155402
ip datagrams with data chunks rcvd = 120844
      data chunks rcvd = 367908
      data chunks read = 367900
      dup tsns rcvd = 8
      sacks rcvd = 38734
      gap ack blocks rcvd = 3
      heartbeat requests rcvd = 135
      heartbeat acks rcvd = 52
      heartbeat requests sent = 52
      ip datagrams sent = 129254
ip datagrams with data chunks sent = 73084
      data chunks sent = 396330
      retransmit data chunks sent = 135
      sacks sent = 64872
      send failed = 0
      retransmit timer count = 0
      consecutive retransmit timeouts = 0
      RTT between RMIN and RMAX inclusive = 6
      RTT greater than RMAX = 0
      fast retransmit count = 135
      rcv timer count = 0
      heartbeat timer count = 244
      none left tosend = 0
      none left rwnd gate = 5
      none left cwnd gate = 8

```

;

```
rlghncxa03w 08-04-28 21:16:37 GMT EAGLE5 38.0.0
```

```
SCTP command complete
```

```
pass:loc=1308:cmd="sctp -a assoc4 "
```

The following is an example of the possible output.

```
rlghncxa03w 10-12-28 21:16:37 GMT EAGLE5 43.0.0
Aname          Local          Local Primary          Remote
                IP Address      Port   Address           Port
assoc4         192.1.1.24     3290   192.168.112.4    1025
                192.1.1.24
```

```

Configuration                               State
Retransmission Mode = LIN                    State = OPEN
Min. Retransmission Timeout = 10000          ULP association id = 18
Max. Retransmission Timeout = 800000        Number of nets = 2
Max. Number of Retries = 10                 Inbound Streams = 1
Min. Congestion Window = 3000               Outbound Streams = 2
      Inbound Streams = 2
      Outbound Streams = 2
Checksum Algorithm = crc32c
Send/Rcv Buffer Size = 204800
```

Nets Data

```

IP Address      192.168.112.4      State      Reachable
  Port          1025                Primary    YES
  MTU           1500                cwnd      16384
  ssthresh      16384                RTO       120

IP Address      192.168.112.5      State      Reachable
  Port          7777                Primary    NO
  MTU           1500                cwnd      16384
  ssthresh      16384                RTO       120
```

```

      Last Net Sent To = 192.168.112.4
      Last Net Rcvd From = 192.168.112.4
      Over All Error Count = 0
      Peers Rwnd = 13880
      My Rwnd = 16384
      Max Window = 16384
      Initial Seq Number = 24130
      Next Sending Seq Number = 124686
      Last Acked Seq Number = 124669
      Maximum Outbound Char Count = 16384
      Current Outbound Char Count = 2112
      Number Unsent Char Count = 0
      Outbound Data Chunk Count = 16
      Number Unsent = 0
      Number To Retransmit = 0
```

```

      ip datagrams rcvd = 155402
      ip datagrams with data chunks rcvd = 120844
      data chunks rcvd = 367908
      data chunks read = 367900
      dup tsns rcvd = 8
      sacks rcvd = 38734
      gap ack blocks rcvd = 3
```

```

        heartbeat requests rcvd = 135
        heartbeat acks rcvd = 52
        heartbeat requests sent = 52
            ip datagrams sent = 129254
    ip datagrams with data chunks sent = 73084
        data chunks sent = 396330
        retransmit data chunks sent = 135
            sacks sent = 64872
            send failed = 0
        retransmit timer count = 0
        consecutive retransmit timeouts = 0
    RTT between RMIN and RMAX inclusive = 6
        RTT greater than RMAX = 0
        fast retransmit count = 135
            recv timer count = 0
        heartbeat timer count = 244
            none left tosend = 0
            none left rwnd gate = 5
            none left cwnd gate = 8

```

;

```
rlghncxa03w 10-12-28 21:16:37 GMT EAGLE5 43.0.0
```

```
SCTP command complete
```

```
rlghncxa03w 08-04-28 21:16:37 GMT EAGLE5 38.0.0
```

Aname	Local	Local	Primary	Remote
	IP Address	Port	Address	Port
assoc4	192.1.1.24	3290	192.168.112.4	1025
	192.1.1.24			

Configuration	State
Retransmission Mode = LIN	State = OPEN
Min. Retransmission Timeout = 10	ULP association id = 18
Max. Retransmission Timeout = 800	Number of nets = 2
Max. Number of Retries = 10	Inbound Streams = 1
Min. Congestion Window = 3000	Outbound Streams = 2
Inbound Streams = 2	
Outbound Streams = 2	
Checksum Algorithm = crc32c	

Nets Data

IP Address	192.168.112.4	State	Reachable
Port	1025	Primary	YES
MTU	1500	cwnd	16384
ssthresh	16384	RTO	120
IP Address	192.168.112.5	State	Reachable
Port	7777	Primary	NO
MTU	1500	cwnd	16384
ssthresh	16384	RTO	120

```

        Last Net Sent To = 192.168.112.4
        Last Net Rcvd From = 192.168.112.4
    Over All Error Count = 0
        Peers Rwnd = 13880
        My Rwnd = 16384
        Max Window = 16384
    Initial Seq Number = 24130

```

```

        Next Sending Seq Number = 124686
        Last Acked Seq Number = 124669
        Maximum Outbound Char Count = 16384
        Current Outbound Char Count = 2112
        Number Unsent Char Count = 0
        Outbound Data Chunk Count = 16
        Number Unsent = 0
        Number To Retransmit = 0

        ip datagrams rcvd = 155402
ip datagrams with data chunks rcvd = 120844
        data chunks rcvd = 367908
        data chunks read = 367900
        dup tsns rcvd = 8
        sacks rcvd = 38734
        gap ack blocks rcvd = 3
        heartbeat requests rcvd = 135
        heartbeat acks rcvd = 52
        heartbeat requests sent = 52
        ip datagrams sent = 129254
ip datagrams with data chunks sent = 73084
        data chunks sent = 396330
        retransmit data chunks sent = 135
        sacks sent = 64872
        send failed = 0
        retransmit timer count = 0
        consecutive retransmit timeouts = 0
RTT between RMIN and RMAX inclusive = 6
        RTT greater than RMAX = 0
        fast retransmit count = 135
        rcv timer count = 0
        heartbeat timer count = 244
        none left tosend = 0
        none left rwnd gate = 5
        none left cwnd gate = 8

;

rlghncxa03w 08-04-28 21:16:37 GMT EAGLE5 38.0.0

SCTP command complete

```

```
pass:loc=1308:cmd="sctp -a assoc5 "
```

The following is an example of the possible output.

```

rlghncxa03w 10-12-28 21:16:37 GMT EAGLE5 43.0.0
Aname          Local          Local Primary          Remote
              IP Address      Port   Address          Port
assoc5         192.1.1.24     1057   192.168.112.4   1025
              192.1.1.24

Configuration                                     State
Retransmission Mode = LIN                        State = OPEN
Min. Retransmission Timeout = 10000              ULP association id = 18
Max. Retransmission Timeout = 800000            Number of nets = 2
Max. Number of Retries = 10                      Inbound Streams = 1
Min. Congestion Window = 3000                    Outbound Streams = 2
Inbound Streams = 2
Outbound Streams = 2
Checksum Algorithm = crc32c

```

```

Send/Rcv Buffer Size = 204800

                                Nets Data

IP Address      192.168.112.4      State      Reachable
  Port          1025                Primary    YES
  MTU           1500                cwnd      16384
  ssthresh      16384                RTO       120

IP Address      192.168.112.5      State      Reachable
  Port          7777                Primary    NO
  MTU           1500                cwnd      16384
  ssthresh      16384                RTO       120

      Last Net Sent To = 192.168.112.4
      Last Net Rcvd From = 192.168.112.4
      Over All Error Count = 0
          Peers Rwnd = 13880
          My Rwnd = 16384
          Max Window = 16384
      Initial Seq Number = 24130
      Next Sending Seq Number = 124686
      Last Acked Seq Number = 124669
      Maximum Outbound Char Count = 16384
      Current Outbound Char Count = 2112
      Number Unsent Char Count = 0
      Outbound Data Chunk Count = 16
          Number Unsent = 0
      Number To Retransmit = 0

      ip datagrams rcvd = 155402
ip datagrams with data chunks rcvd = 120844
      data chunks rcvd = 367908
      data chunks read = 367900
      dup tsns rcvd = 8
      sacks rcvd = 38734
      gap ack blocks rcvd = 3
      heartbeat requests rcvd = 135
      heartbeat acks rcvd = 52
      heartbeat requests sent = 52
      ip datagrams sent = 129254
ip datagrams with data chunks sent = 73084
      data chunks sent = 396330
      retransmit data chunks sent = 135
      sacks sent = 64872
      send failed = 0
      retransmit timer count = 0
      consecutive retransmit timeouts = 0
      RTT between RMIN and RMAX inclusive = 6
      RTT greater than RMAX = 0
      fast retransmit count = 135
      rcv timer count = 0
      heartbeat timer count = 244
      none left tosend = 0
      none left rwnd gate = 5
      none left cwnd gate = 8

;

rlghncxa03w 10-12-28 21:16:37 GMT EAGLE5 43.0.0

```

SCTP command complete

```

rlghncxa03w 08-04-28 21:16:37 GMT EAGLE5 38.0.0
Aname          Local          Local  Primary      Remote
                IP Address      Port   Address      Port
assoc5         192.1.1.24     1057   192.168.112.4 1025
                192.1.1.24

```

```

                Configuration                               State
Retransmission Mode = LIN                                State = OPEN
Min. Retransmission Timeout = 10                       ULP association id = 18
Max. Retransmission Timeout = 800                      Number of nets = 2
Max. Number of Retries = 10                            Inbound Streams = 1
Min. Congestion Window = 3000                          Outbound Streams = 2
                Inbound Streams = 2
                Outbound Streams = 2
Checksum Algorithm = crc32c

```

Nets Data

```

IP Address      192.168.112.4      State  Reachable
  Port          1025                Primary YES
  MTU           1500                cwnd  16384
  ssthresh      16384                RTO   120

IP Address      192.168.112.5      State  Reachable
  Port          7777                Primary NO
  MTU           1500                cwnd  16384
  ssthresh      16384                RTO   120

```

```

                Last Net Sent To = 192.168.112.4
                Last Net Rcvd From = 192.168.112.4
Over All Error Count = 0
                Peers Rwnd = 13880
                My Rwnd = 16384
                Max Window = 16384
                Initial Seq Number = 24130
                Next Sending Seq Number = 124686
                Last Acked Seq Number = 124669
Maximum Outbound Char Count = 16384
Current Outbound Char Count = 2112
Number Unsent Char Count = 0
Outbound Data Chunk Count = 16
                Number Unsent = 0
                Number To Retransmit = 0

```

```

                ip datagrams rcvd = 155402
ip datagrams with data chunks rcvd = 120844
                data chunks rcvd = 367908
                data chunks read = 367900
                dup tsns rcvd = 8
                sacks rcvd = 38734
                gap ack blocks rcvd = 3
                heartbeat requests rcvd = 135
                heartbeat acks rcvd = 52
                heartbeat requests sent = 52
                ip datagrams sent = 129254
ip datagrams with data chunks sent = 73084
                data chunks sent = 396330
                retransmit data chunks sent = 135

```

```

                sacks sent = 64872
                send failed = 0
                retransmit timer count = 0
                consecutive retransmit timeouts = 0
                RTT between RMIN and RMAX inclusive = 6
                RTT greater than RMAX = 0
                fast retransmit count = 135
                rcv timer count = 0
                heartbeat timer count = 244
                none left tosend = 0
                none left rwnd gate = 5
                none left cwnd gate = 8
;

rlghncxa03w 08-04-28 21:16:37 GMT EAGLE5 38.0.0

SCTP command complete

```

If the checksum algorithm shown in any of the associations displayed in this step do not match the checksum algorithm specified in [Step 4](#), contact the Customer Care Center. Refer to [My Oracle Support \(MOS\)](#) for the contact information.

If the checksum algorithm shown in all of the associations displayed in this step match the checksum algorithm specified in [Step 4](#), continue the procedure with [Step 10](#).

- Put the signaling links that were placed out of service in [Step 6](#) back into service using the `act-slk` command. For example, enter this command.

```
act-slk:loc=1308:link=a1
act-slk:loc=1308:link=b
act-slk:loc=1308:link=b2
```

When these commands have successfully completed, this message appears.

```
rlghncxa03w 06-10-07 11:11:28 GMT EAGLE5 36.0.0
Activate Link message sent to card
```

- Verify the in-service normal (IS-NR) status of the signaling link by using the `rept-stat-slk` command and specifying the card location and link values specified in [Step 10](#).

For example, enter these commands.

```
rept-stat-slk:loc=1308:link=a1
```

This message should appear.

```
rlghncxa03w 06-10-28 21:16:37 GMT EAGLE5 36.0.0
SLK      LSN      CLLI      PST      SST      AST
1308,A1  ipnode1  -----  IS-NR    Avail    ----
Command Completed.
```

```
rept-stat-slk:loc=1308:link=b
```

This message should appear.

```
rlghncxa03w 06-10-28 21:16:37 GMT EAGLE5 36.0.0
SLK      LSN      CLLI      PST      SST      AST
1308,B  ipnode3  -----  IS-NR    Avail    ----
Command Completed.
```

```
rept-stat-slk:loc=1308:link=b2
```

This message should appear.

```
rlghncxa03w 06-10-28 21:16:37 GMT EAGLE5 36.0.0
SLK      LSN      CLLI      PST      SST      AST
1308,B2 ipnode4  -----  IS-NR    Avail    ----
Command Completed.
```

12. Enter the netstat -p sctp pass command with the card location of the IP card to determine if any errors have occurred. For this example, enter this command.

```
pass:loc=1308:cmd="netstat -p sctp"
```

The following is an example of the possible output.

```
rlghncxa03w 08-04-28 21:16:37 GMT EAGLE5 38.0.0
ip packets sent..... 1474882
  ip packets sent with data chunk..... 306354
  control chunks (excluding retransmissions)..... 1172759
  ordered data chunks (excluding retransmissions).. 1534350
  unordered data chunks (excluding retransmissions) 0
  user messages fragmented due to MTU..... 0
  retransmit data chunks sent..... 4
  sacks sent..... 496302
  send failed..... 0
ip packets received..... 1816035
  ip packets received with data chunk..... 989957
  control chunks (excluding duplicates)..... 833141
  ordered data chunks (excluding duplicates)..... 989968
  unordered data chunks (excluding duplicates)..... 0
  user messages reassembled..... 0
  data chunks read..... 988601
  duplicate tsns received..... 0
  sacks received..... 153763
  gap ack blocks received..... 0
  out of the blue..... 4
  with invalid checksum..... 0
connections established..... 2954
  by upper layer..... 0
  by remote endpoint..... 2958
connections terminated..... 4
  ungracefully..... 2952
  gracefully..... 0
associations dropped due to retransmits..... 0
consecutive retransmit timeouts..... 4
retransmit timer count..... 6
fast retransmit count..... 0
heartbeat requests received..... 330275
heartbeat acks received..... 340239
heartbeat requests sent..... 340258
associations supported..... 50
milliseconds cookie life at 4-way start-up handshake. 5000
```

```

retransmission attempts allowed at start-up phase.... 8
;
rlghncxa03w 08-04-28 21:16:37 GMT EAGLE5 38.0.0
NETSTAT command complete

```

If errors are shown in the pass command output, contact the Customer Care Center. Refer to [My Oracle Support \(MOS\)](#) for the contact information.

13. Repeat [Step 6](#) through [Step 12](#) to update the other IPSG cards in the EAGLE that contain IPSG M2PA associations with the new SCTP checksum algorithm.
14. Back up the database by entering the `chg-db:action=backup:dest=fixed` command. These messages should appear, the active Maintenance and Administration Subsystem Processor (MASP) appears first.

```

BACKUP (FIXED) : MASP A - Backup starts on active MASP.
BACKUP (FIXED) : MASP A - Backup on active MASP to fixed disk complete.
BACKUP (FIXED) : MASP A - Backup starts on standby MASP.
BACKUP (FIXED) : MASP A - Backup on standby MASP to fixed disk complete.

```

15. If the `rtrv-card` output in [Step 2](#) shows cards running the SS7IPGW or IPGWI applications, perform the [Changing the SCTP Checksum Algorithm Option for M3UA and SUA Associations](#) procedure.
If the `rtrv-card` output in [Step 2](#) shows cards running the IPLIM or IPLIMI applications, perform the [Changing the SCTP Checksum Algorithm Option for M2PA Associations](#) procedure.
If the `rtrv-card` output in [Step 2](#) shows that there are no cards running the SS7IPGW, IPGWI, IPLIM, or IPLIMI applications, this procedure is finished.

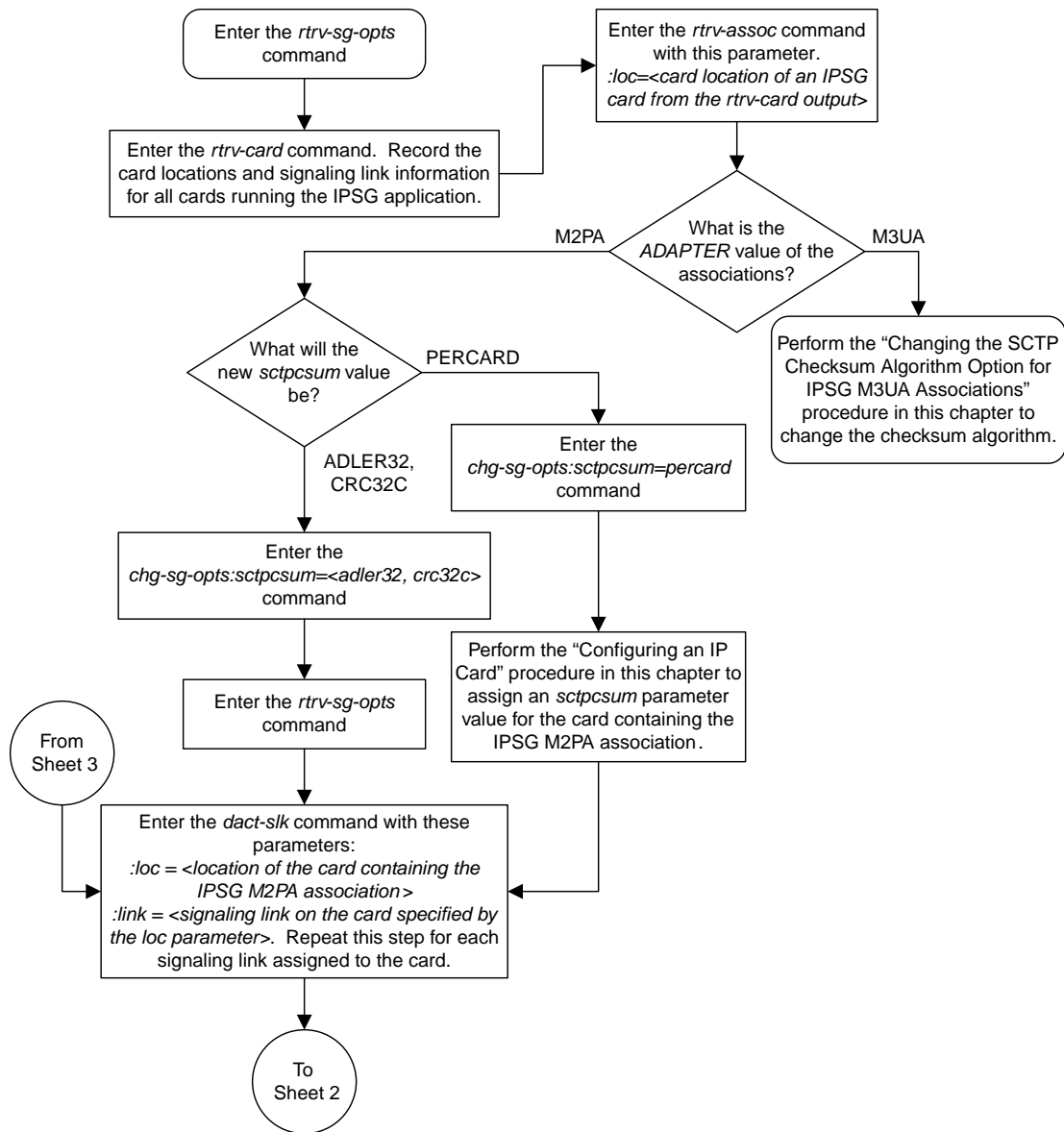

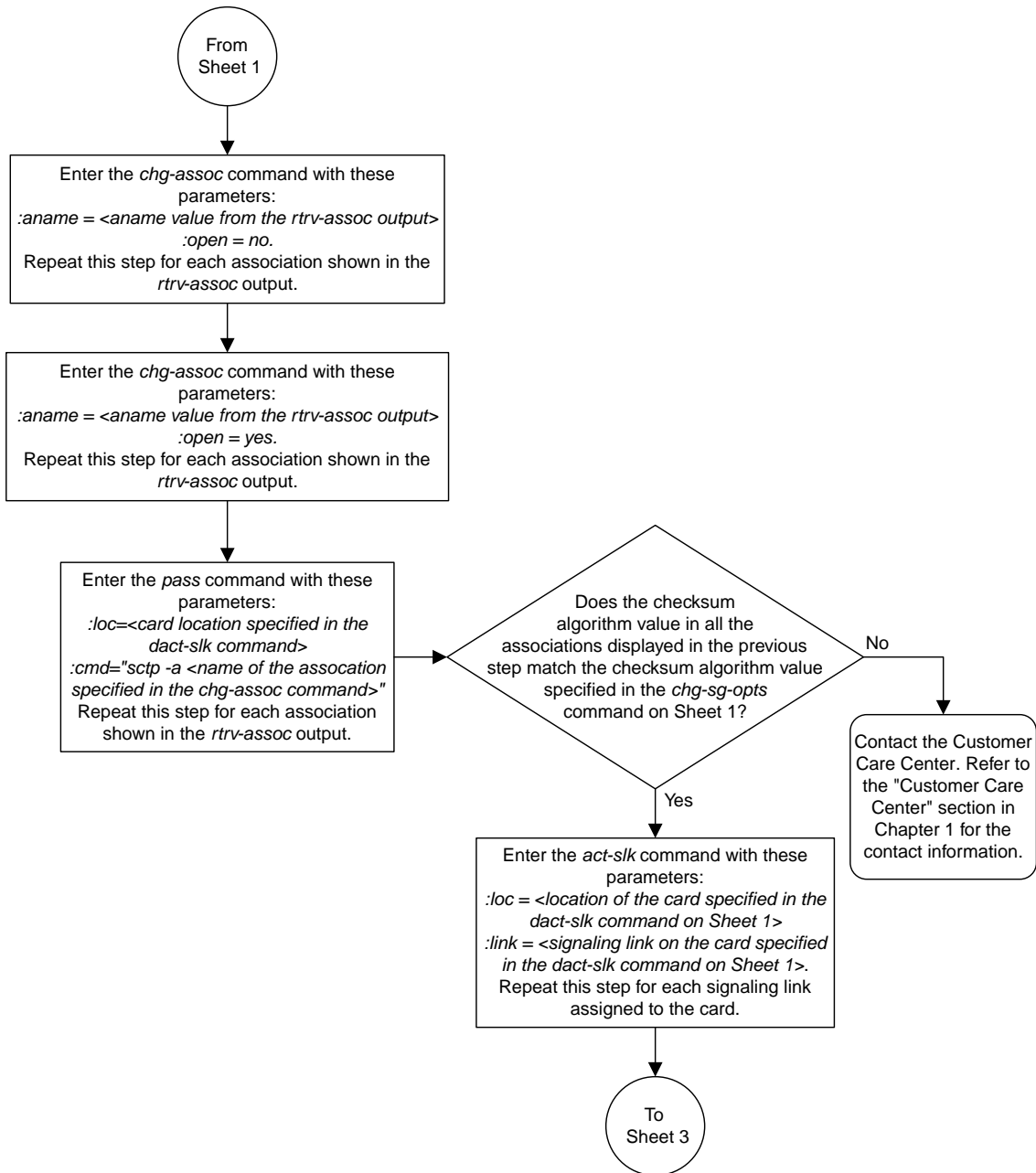

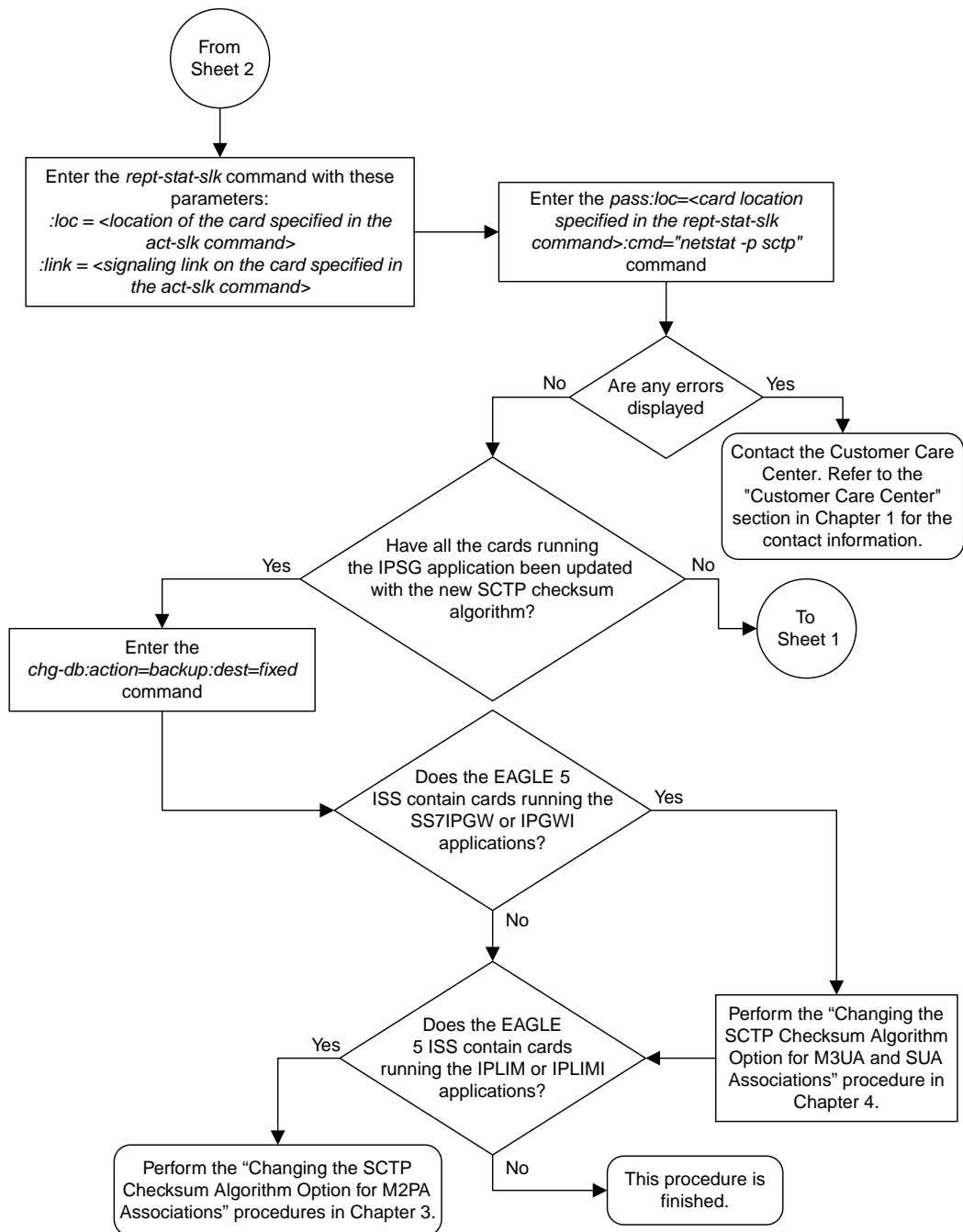

Sheet 3 of 3

Figure 119: Changing the SCTP Checksum Algorithm Option for IPSG M2PA Associations

Changing the SCTP Checksum Algorithm Option for IPSG M3UA Associations

Use this procedure to change the SCTP checksum algorithm, either Adler-32 or CRC-32c, applied to traffic on SCTP associations. The `sctpchecksum` parameter of the `chg-sg-opts` command is used to change this option. The Adler-32 and CRC-32c checksum algorithms specified in this procedure applies to all the M3UA associations that are assigned to all the IP cards running the IPSG application. This option is a system-wide option. To apply this option to associations assigned to cards running the IPLIM, IPLIMI, SS7IPGW, or IPGWI applications, or to IPSG M2PA associations, perform these procedures.

- [Changing the SCTP Checksum Algorithm Option for IPSG M2PA Associations](#)
- [Changing the SCTP Checksum Algorithm Option for M3UA and SUA Associations](#)
- [Changing the SCTP Checksum Algorithm Option for M2PA Associations](#)

The `sctpchecksum` parameter contains another value, `percard`, that allows either the Adler-32 or CRC-32c SCTP checksum algorithm to be specified for the all the associations assigned to a specific card. With this option specified, the Adler-32 checksum algorithm can be specified for the associations on one card and the CRC-32c checksum algorithm can be specified for the associations on another card. Setting the `sctpchecksum` parameter to `percard` changes the SCTP checksum algorithm for the associations assigned to a card to the SCTP checksum algorithm value for that card. The checksum algorithm for individual cards is provisioned by performing the [Configuring an IP Card](#) procedure.

Once the SCTP checksum option has been changed, the associations on each IP card need to be reset by changing the `open` parameter value for each association to `no`, then back to `yes`. This ensures that the associations on the IP card are using the new SCTP checksum algorithm.

Canceling the `RTRV-ASSOC` Command

Because the `rtrv-assoc` command used in this procedure can output information for a long period of time, the `rtrv-assoc` command can be canceled and the output to the terminal stopped. There are three ways that the `rtrv-assoc` command can be canceled.

- Press the F9 function key on the keyboard at the terminal where the `rtrv-assoc` command was entered.
- Enter the `canc-cmd` without the `trm` parameter at the terminal where the `rtrv-assoc` command was entered.
- Enter the `canc-cmd:trm=<xx>`, where `<xx>` is the terminal where the `rtrv-assoc` command was entered, from another terminal other than the terminal where the `rtrv-assoc` command was entered. To enter the `canc-cmd:trm=<xx>` command, the terminal must allow Security Administration commands to be entered from it and the user must be allowed to enter Security Administration commands. The terminal's permissions can be verified with the `rtrv-secu-trm` command. The user's permissions can be verified with the `rtrv-user` or `rtrv-secu-user` commands.

For more information about the `canc-cmd` command, go to *Commands User's Guide*.

1. Display the current IP options in the database by entering the `rtrv-sg-opts` command. The following is an example of the possible output.

```
rlghncxa03w 06-10-28 21:16:37 GMT EAGLE5 36.0.0
SCTPCSUM:      adler32
```

The `rtrv-sg-opts` command output contains other fields that are not used by this procedure. If you wish to see all the fields displayed by the `rtrv-sg-opts` command, see the `rtrv-sg-opts` command description in *Commands User's Guide*.

2. Display the cards in the EAGLE by entering the `rtrv-card` command. This is an example of the possible output.

```
rlghncxa03w 09-10-15 16:34:56 GMT EAGLE5 41.0.0
CARD  TYPE      APPL      LSET NAME      LINK SLC  LSET NAME      LINK SLC
1101  DSM          VSCCP
1102  TSM          GLS
1104  DCM          STPLAN
1113  GSPM        EOAM
1114  TDM-A
1115  GSPM        EOAM
1116  TDM-B
1117  MDAL
1201  LIMDS0      SS7ANSI   lsn1           A    0    lsn2           B    1
1202  DCM          IPLIM     ipnode2        A    1
1203  LIMDS0      SS7ANSI   lsn2           A    0    lsn1           B    1
1204  LIMATM      ATMANSI   atmgwy         A    0
1205  DCM          IPLIM     ipnode1        A    0    ipnode3        B    1
1207  DCM          IPLIM     ipnode2        A    0
1303  DCM          IPLIM     ipnode3        A    0    ipnode1        B    1
1305  DCM          IPLIM     ipnode4        A    0
1308  DCM          IPLIM     ipnode3        B    2
      ipnode1        A1   2    ipnode4        B2   1
1315  ENET        IPSG      ipgtwy1        A
1317  DCM          IPGWI     ipgtwy2        A
```

Record the card location, shown in the `LOC` column, and signaling link, shown in the `LINK` column, information for all cards running the IPSG application.

3. Select one of the IPSG cards shown in [Step 2](#). Display the associations assigned to the IPSG card by entering the `rtrv-assoc` command and specifying the card location of the IPSG card. For this example, enter this command.

```
rtrv-assoc:loc=1315
```

The following is an example of the possible output.

```
rlghncxa03w 08-04-28 09:12:36 GMT EAGLE5 38.0.0
      CARD  IPLNK
ANAME      LOC  PORT  LINK ADAPTER LPORT RPORT OPEN ALW
assoc3     1315 A     A    M3UA   2345  1025 YES  YES

IP Appl Sock/Assoc table is (9 of 4000) 1% full
Assoc Buffer Space Used (19 KB of 800 KB) on LOC = 1315
```

If the `ADAPTER` value of the associations shown in the `rtrv-assoc` output is `M3UA`, continue the procedure with [Step 4](#).

If the ADAPTER value of the associations shown in the `rtrv-assoc` output is M2PA, do not perform the remainder of this procedure. Perform the [Changing the SCTP Checksum Algorithm Option for M2PA Associations](#) procedure to change the SCTP checksum algorithm for IPSG M2PA associations.

- At the IP near end node, stop all traffic to the IP card specified in [Step 3](#) on the EAGLE.
- At the EAGLE, enter the `msucount -1` pass command with the card location of the IP card selected in [Step 3](#). For this example, enter this command.

```
pass:loc=1315:cmd="msucount -1"
```

The following is an example of the possible output.

```
rlghncxa03w 06-10-28 21:16:37 GMT EAGLE5 36.0.0
PASS: Command sent to card

rlghncxa03w 06-10-28 21:16:37 GMT EAGLE5 36.0.0
MSUCOUNT: Command In Progress

rlghncxa03w 06-10-28 21:16:37 GMT EAGLE5 36.0.0

MSUCOUNT: MSU Count Report

-----
Link Measurements (Link A)
-----
Transmit Counts                                Receive Counts
-----
rate  msus          bytes          rate  msus          bytes
-----
2000  4294967295  4294967295  2000  4294967295  4294967295
MTP Primitive (MTPP) counts
Reroute Counts
-----
sent pdus  rcvd pdus  dscrd pdus  sent msus  rcvd msus
-----
4294967295 4294967295 4294967295 4294967295 4294967295

END of Report
```

- At the EAGLE, enter the `msucount -a` pass command with the card location specified in [Step 5](#) and the association names shown in [Step 3](#). For this example, enter this command.

```
pass:loc=1315:cmd="msucount -a assoc3"
```

The following is an example of the possible output.

```
rlghncxa03w 06-10-28 21:17:37 GMT EAGLE5 36.0.0
PASS: Command sent to card

rlghncxa03w 06-10-28 21:17:37 GMT EAGLE5 36.0.0
MSUCOUNT: Command In Progress

rlghncxa03w 06-10-28 21:17:37 GMT EAGLE5 36.0.0
MSUCOUNT: MSU Count Report

-----
IP Connection Measurements
-----
Receive Counts                                Transmit Counts
-----
msus          bytes          msus          bytes
-----
```

```

-----
4294967295      4294967295      4294967295      4294967295
Receive Discard Counts      Transmit Discard Counts
-----
reason          count          reason          count
-----
link state      4294967295    sccp msg type   4294967295
sccp msg type   4294967295    sccp class      4294967295
sccp class      4294967295    normalization error 4294967295
sccp called party 4294967295    invalid traffic type 4294967295
sccp calling party 4294967295    M3UA conversion error 4294967295
isup sio        4294967295    SUA conversion error 4294967295
normalization error 4294967295
error in XSRV packet 4294967295
M3UA PDU error  4294967295
SUA PDU error   4294967295
invalid rcontext 4294967295
Stored Transmit Discard Data
-----
no stored transmit discard data
Stored Receive Discard Data
-----
53 41 53 49 69 73 6f 74 11 00 87 0a 01 03 01 05
05 00 01 02 03 04 05 06 07 08 09 00 00 00 00

END of Report

```

7. At the IP near end node, disconnect all the associations attached to the IP card specified in [Step 6](#).
8. At the EAGLE, place the signaling link on this IP card out of service using the `dact-slk` command. For this example, enter this command.

```
dact-slk:loc=1315:link=a
```

When this command has successfully completed, this message appears.

```
rlghncxa03w 06-10-12 09:12:36 GMT EAGLE5 36.0.0
Deactivate Link message sent to card
```

9. Change the SCTP checksum option in the database using the `chg-sg-opts` command. For this example, enter this command.

```
chg-sg-opts:sctpcsum=crc32c
```

When this command has successfully completed, the following message should appear.

```
rlghncxa03w 06-10-28 21:19:37 GMT EAGLE5 36.0.0
CHG-SG-OPTS: MASP A - COMPLTD
```

Continue the procedure by performing one of these actions.

- If the `sctpcsum` parameter value was changed to either `adler32` or `crc32c`, continue the procedure with [Step 10](#).
- If the `sctpcsum` parameter value was changed to `percard`, perform the [Configuring an IP Card](#) procedure to assign an `sctpcsum` parameter value to all the cards running the IPLIM or IPLIMI applications. After the [Configuring an IP Card](#) procedure has been performed, continue the procedure with [Step 11](#).

10. Verify that the SCTP checksum algorithm was changed using the `rtrv-sg-opts` command. The SCTP checksum algorithm option value is shown in the `SCTPCSUM` parameter. The following is an example of the possible output.

```
rlghncxa03w 06-10-28 21:16:37 GMT EAGLE5 36.0.0
SCTPCSUM:      crc32c
```

The `rtrv-sg-opts` command output contains other fields that are not used by this procedure. If you wish to see all the fields displayed by the `rtrv-sg-opts` command, see the `rtrv-sg-opts` command description in *Commands User's Guide*.

11. Change the value of the `open` parameter of the associations shown in [Step 3](#) to `no` by specifying the `chg-assoc` command with the `open=no` parameter. For this example, enter this command.

```
chg-assoc:aname=assoc3:open=no
```

When this command has successfully completed, this message should appear.

```
rlghncxa03w 06-10-28 09:12:36 GMT EAGLE5 36.0.0
CHG-ASSOC: MASP A - COMPLTD;
```

12. Change the value of the `open` parameter of the associations changed in [Step 11](#) to `yes` by specifying the `chg-assoc` command with the `open=yes` parameter. For this example, enter this command.

```
chg-assoc:aname=assoc3:open=yes
```

When this command has successfully completed, this message should appear.

```
rlghncxa03w 06-10-28 09:12:36 GMT EAGLE5 36.0.0
CHG-ASSOC: MASP A - COMPLTD;
```

13. Verify the checksum algorithm that is assigned to the associations shown in [Step 12](#) by entering the `sctp -a pass` command with the card location of the IP card specified in [Step 8](#) and the name of the associations specified in [Step 12](#). For this example, enter this command.

```
pass:loc=1315:cmd="sctp -a assoc3 "
```

The following is an example of the possible output.

```
rlghncxa03w 10-12-28 21:16:37 GMT EAGLE5 43.0.0
Aname          Local          Local   Primary      Remote
                IP Address      Port    Address      Port
assoc3         192.1.1.50     2345    192.168.112.4 1025
                192.1.1.50

                Configuration                               State
                Retransmission Mode = LIN                State = OPEN
Min. Retransmission Timeout = 10000                    ULP association id = 18
Max. Retransmission Timeout = 800000                   Number of nets = 2
                Max. Number of Retries = 10              Inbound Streams = 1
                Min. Congestion Window = 3000            Outbound Streams = 2
                Inbound Streams = 2
                Outbound Streams = 2
                Checksum Algorithm = crc32c
                Send/Rcv Buffer Size = 204800

                Nets Data
```



```

IP Address      192.168.112.4      State      Reachable
  Port          1025                Primary    YES
  MTU           1500                cwnd       16384
  ssthresh      16384                RTO        120

IP Address      192.168.112.5      State      Reachable
  Port          7777                Primary    NO
  MTU           1500                cwnd       16384
  ssthresh      16384                RTO        120

      Last Net Sent To = 192.168.112.4
      Last Net Rcvd From = 192.168.112.4
      Over All Error Count = 0
          Peers Rwnd = 13880
          My Rwnd = 16384
          Max Window = 16384
          Initial Seq Number = 24130
          Next Sending Seq Number = 124686
          Last Acked Seq Number = 124669
      Maximum Outbound Char Count = 16384
      Current Outbound Char Count = 2112
          Number Unsent Char Count = 0
      Outbound Data Chunk Count = 16
          Number Unsent = 0
      Number To Retransmit = 0

      ip datagrams rcvd = 155402
ip datagrams with data chunks rcvd = 120844
      data chunks rcvd = 367908
      data chunks read = 367900
      dup tsns rcvd = 8
          sacks rcvd = 38734
      gap ack blocks rcvd = 3
      heartbeat requests rcvd = 135
      heartbeat acks rcvd = 52
      heartbeat requests sent = 52
          ip datagrams sent = 129254
ip datagrams with data chunks sent = 73084
      data chunks sent = 396330
      retransmit data chunks sent = 135
          sacks sent = 64872
          send failed = 0
      retransmit timer count = 0
      consecutive retransmit timeouts = 0
      RTT between RMIN and RMAX inclusive = 6
      RTT greater than RMAX = 0
      fast retransmit count = 135
          recv timer count = 0
      heartbeat timer count = 244
          none left tosend = 0
          none left rwnd gate = 5
          none left cwnd gate = 8

;

rlghncxa03w 10-12-28 21:16:37 GMT EAGLE5 43.0.0

SCTP command complete

rlghncxa03w 08-04-28 21:16:37 GMT EAGLE5 38.0.0
Aname          Local          Local  Primary      Remote

```

```

assoc3          IP Address      Port      Address      Port
                192.1.1.50      2345      192.168.112.4 1025
                192.1.1.50

Configuration                                     State
Retransmission Mode = LIN                          State = OPEN
Min. Retransmission Timeout = 10                   ULP association id = 18
Max. Retransmission Timeout = 800                  Number of nets = 2
Max. Number of Retries = 10                        Inbound Streams = 1
Min. Congestion Window = 3000                      Outbound Streams = 2
Inbound Streams = 2
Outbound Streams = 2
Checksum Algorithm = crc32c

Nets Data

IP Address      192.168.112.4      State      Reachable
Port            1025                Primary    YES
MTU             1500                cwnd       16384
ssthresh        16384                RTO        120

IP Address      192.168.112.5      State      Reachable
Port            7777                Primary    NO
MTU             1500                cwnd       16384
ssthresh        16384                RTO        120

Last Net Sent To = 192.168.112.4
Last Net Rcvd From = 192.168.112.4
Over All Error Count = 0
Peers Rwnd = 13880
My Rwnd = 16384
Max Window = 16384
Initial Seq Number = 24130
Next Sending Seq Number = 124686
Last Acked Seq Number = 124669
Maximum Outbound Char Count = 16384
Current Outbound Char Count = 2112
Number Unsent Char Count = 0
Outbound Data Chunk Count = 16
Number Unsent = 0
Number To Retransmit = 0

ip datagrams rcvd = 155402
ip datagrams with data chunks rcvd = 120844
data chunks rcvd = 367908
data chunks read = 367900
dup tsns rcvd = 8
sacks rcvd = 38734
gap ack blocks rcvd = 3
heartbeat requests rcvd = 135
heartbeat acks rcvd = 52
heartbeat requests sent = 52
ip datagrams sent = 129254
ip datagrams with data chunks sent = 73084
data chunks sent = 396330
retransmit data chunks sent = 135
sacks sent = 64872
send failed = 0
retransmit timer count = 0
consecutive retransmit timeouts = 0
RTT between RMIN and RMAX inclusive = 6
RTT greater than RMAX = 0

```

```

fast retransmit count = 135
  recv timer count = 0
heartbeat timer count = 244
  none left tosend = 0
  none left rwnd gate = 5
  none left cwnd gate = 8

;

rlghncxa03w 08-04-28 21:16:37 GMT EAGLE5 38.0.0

SCTP command complete

```

If the checksum algorithm shown in any of the associations displayed in this step do not match the checksum algorithm specified in [Step 9](#), contact the Customer Care Center. Refer to [My Oracle Support \(MOS\)](#) for the contact information.

If the checksum algorithm shown in all of the associations displayed in this step match the checksum algorithm specified in [Step 9](#), continue the procedure with [Step 14](#).

14. At the IP near end node, configure all the associations attached to the IP card specified in [Step 12](#) to use the SCTP checksum algorithm.
15. Put the signaling link that was placed out of service in [Step 7](#) back into service using the `act-slk` command. For example, enter this command.

```
act-slk:loc=1315:link=a
```

When this command has successfully completed, this message appears.

```

rlghncxa03w 06-10-07 11:11:28 GMT EAGLE5 36.0.0
Activate Link message sent to card

```

16. Verify the in-service normal (IS-NR) status of the signaling link by using the `rept-stat-slk` command and specifying the card location and link value specified in [Step 15](#). For example, enter this command.

```
rept-stat-slk:loc=1315:link=a
```

The following is an example of the possible output.

```

rlghncxa03w 06-10-28 21:16:37 GMT EAGLE5 36.0.0
SLK      LSN      CLLI      PST      SST      AST
1315,A  ipgtwyl  -----  IS-NR    Avail    ----
Command Completed.

```

17. At the IP near end node, connect one of the associations attached to the IP card specified in [Step 11](#).
18. At the EAGLE, enter the `rept-stat-assoc` command specifying the association names specified with the `chg-assoc` command in [Step 11](#) and [Step 12](#) to verify that the association is established with the IP near end node. For this example, enter this command.

```
rept-stat-assoc:aname=assoc3
```

The following is an example of the possible output.

```
rlghncxa03w 06-10-28 21:16:37 GMT EAGLE5 36.0.0

      CARD IPLNK
ANAME  LOC  PORT  LINK PST           SST           ASPID
as1    1315 A    A    IS-NR        ESTABLISHED   undefined

      ANAME          ASP STATE
LSN    lpgtwy1      assoc3          ACTIVE

Command Completed.
```

19. Enter the `netstat -p sctp` pass command with the card location of the IP card to determine if any errors have occurred. For this example, enter this command. For this example, enter this command.

```
pass:loc=1315:cmd="netstat -p sctp"
```

The following is an example of the possible output.

```
rlghncxa03w 08-04-28 21:16:37 GMT EAGLE5 38.0.0
ip packets sent..... 1474882
  ip packets sent with data chunk..... 306354
  control chunks (excluding retransmissions)..... 1172759
  ordered data chunks (excluding retransmissions).. 1534350
  unordered data chunks (excluding retransmissions) 0
  user messages fragmented due to MTU..... 0
  retransmit data chunks sent..... 4
  sacks sent..... 496302
  send failed..... 0
ip packets received..... 1816035
  ip packets received with data chunk..... 989957
  control chunks (excluding duplicates)..... 833141
  ordered data chunks (excluding duplicates)..... 989968
  unordered data chunks (excluding duplicates)..... 0
  user messages reassembled..... 0
  data chunks read..... 988601
  duplicate tsns received..... 0
  sacks received..... 153763
  gap ack blocks received..... 0
  out of the blue..... 4
  with invalid checksum..... 0
connections established..... 2954
  by upper layer..... 0
  by remote endpoint..... 2958
connections terminated..... 4
  ungracefully..... 2952
  gracefully..... 0
associations dropped due to retransmits..... 0
consecutive retransmit timeouts..... 4
retransmit timer count..... 6
fast retransmit count..... 0
heartbeat requests received..... 330275
heartbeat acks received..... 340239
heartbeat requests sent..... 340258
associations supported..... 50
milliseconds cookie life at 4-way start-up handshake. 5000
retransmission attempts allowed at start-up phase.... 8

;
```

```
rlghncxa03w 08-04-28 21:16:37 GMT EAGLE5 38.0.0
NETSTAT command complete
```

If errors are shown in the pass command output, contact the Customer Care Center. Refer to [My Oracle Support \(MOS\)](#) for the contact information.

20. At the IP near end node, connect all the other associations attached to the IP card specified in [Step 19](#).
21. At the IP near end node, activate one of the associations attached to the IP card specified in [Step 19](#).
22. At the EAGLE, enter the `msucount -l` pass command with the card location of the IP card specified in [Step 19](#). For this example, enter this command.

```
pass:loc=1315:cmd="msucount -l"
```

The following is an example of the possible output.

```
rlghncxa03w 06-10-28 21:16:37 GMT EAGLE5 36.0.0
PASS: Command sent to card

rlghncxa03w 06-10-28 21:16:37 GMT EAGLE5 36.0.0
MSUCOUNT: Command In Progress

rlghncxa03w 06-10-28 21:16:37 GMT EAGLE5 36.0.0
MSUCOUNT: MSU Count Report

-----
Link Measurements (Link A)
-----

Transmit Counts                                Receive Counts
-----
rate  msus          bytes          rate  msus          bytes
-----
2000  4294967295      4294967295    2000  4294967295      4294967295

MTP Primitive (MTPP) counts                    Reroute Counts
-----
sent pdus  rcvd pdus  dscrd pdus  sent msus  rcvd msus
-----
4294967295 4294967295 4294967295 4294967295 4294967295

END of Report
```

23. At the EAGLE, enter the `msucount -a` pass command with the card location specified in [Step 22](#) and the association names specified in [Step 18](#). For this example, enter this command.

```
pass:loc=1315:cmd="msucount -a assoc3"
```

The following is an example of the possible output.

```
rlghncxa03w 06-10-28 21:17:37 GMT EAGLE5 36.0.0
PASS: Command sent to card

rlghncxa03w 06-10-28 21:17:37 GMT EAGLE5 36.0.0
```

```

MSUCOUNT: Command In Progress

rlghncxa03w 06-10-28 21:17:37 GMT EAGLE5 36.0.0
MSUCOUNT: MSU Count Report

-----
IP Connection Measurements
-----

Receive Counts                               Transmit Counts
-----
msus          bytes                          msus          bytes
-----
4294967295    4294967295    4294967295    4294967295
Receive Discard Counts                       Transmit Discard Counts
-----
reason          count                                reason          count
-----
link state      4294967295    sccp msg type   4294967295
sccp msg type   4294967295    sccp class      4294967295
sccp class      4294967295    normalization error 4294967295
sccp called party 4294967295    invalid traffic type 4294967295
sccp calling party 4294967295    M3UA conversion error 4294967295
isup sio        4294967295    SUA conversion error 4294967295
normalization error 4294967295
error in XSRV packet 4294967295
M3UA PDU error  4294967295
SUA PDU error    4294967295
invalid rcontext 4294967295

Stored Transmit Discard Data
-----
no stored transmit discard data
Stored Receive Discard Data
-----
53 41 53 49 69 73 6f 74 11 00 87 0a 01 03 01 05
05 00 01 02 03 04 05 06 07 08 09 00 00 00 00 00

END of Report

```

If the outputs of the pass commands in [Step 22](#) and [Step 23](#) show that traffic is not flowing over the association, refer to [My Oracle Support \(MOS\)](#).

24. At the IP near end node, activate all the other associations attached to the IP card specified in [Step 23](#).
25. Repeat [Step 4](#) through [Step 24](#) to update the other IPSG cards in the EAGLE that contain IPSG M3UA associations with the new SCTP checksum algorithm.
26. Back up the new changes using the `chg-db:action=backup:dest=fixed` command. These messages should appear, the active Maintenance and Administration Subsystem Processor (MASP) appears first.

```

BACKUP (FIXED) : MASP A - Backup starts on active MASP.
BACKUP (FIXED) : MASP A - Backup on active MASP to fixed disk complete.
BACKUP (FIXED) : MASP A - Backup starts on standby MASP.
BACKUP (FIXED) : MASP A - Backup on standby MASP to fixed disk complete.

```

27. If the `rtrv-card` output in [Step 2](#) shows cards running the IPLIM or IPLIMI applications, perform the [Changing the SCTP Checksum Algorithm Option for M2PA Associations](#) procedure.

If the `rtrv-card` output in [Step 2](#) shows cards running the SS7IPGW or IPGWI applications, perform the [Changing the SCTP Checksum Algorithm Option for M3UA and SUA Associations](#) procedure.

If the `rtrv-card` output in [Step 2](#) shows that there are no cards running the IPLIM, IPLIMI, SS7IPGW, or IPGWI applications, this procedure is finished.

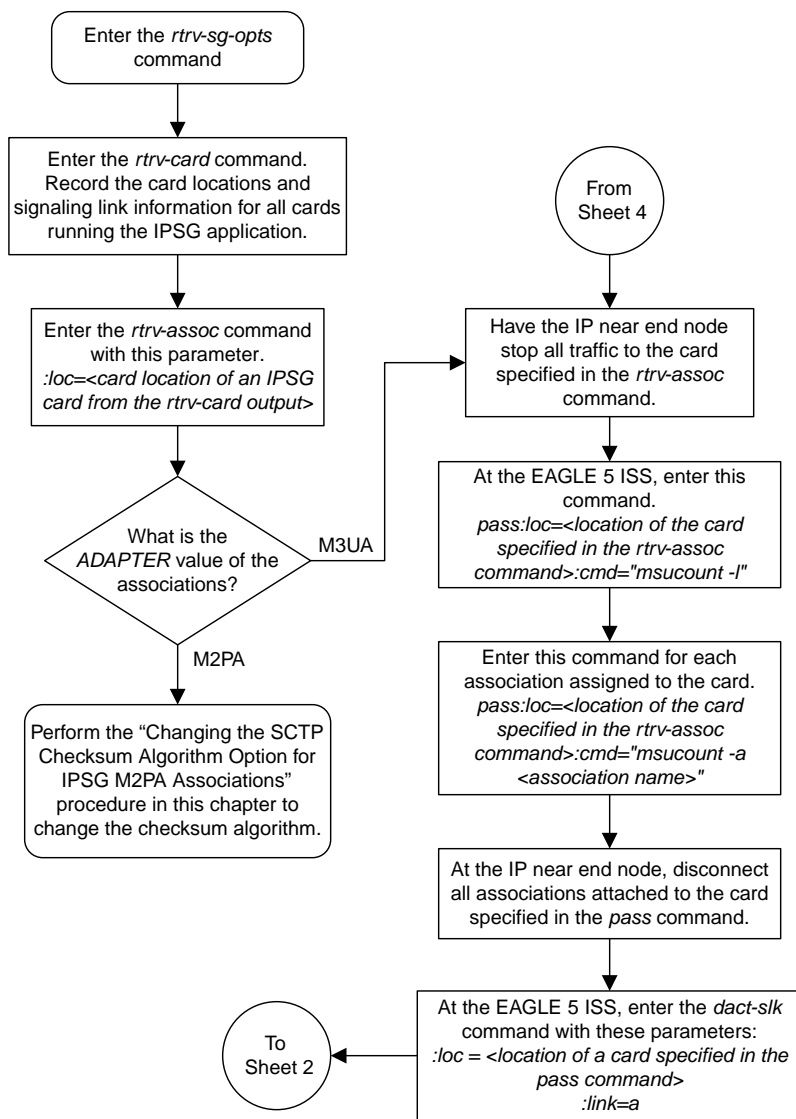

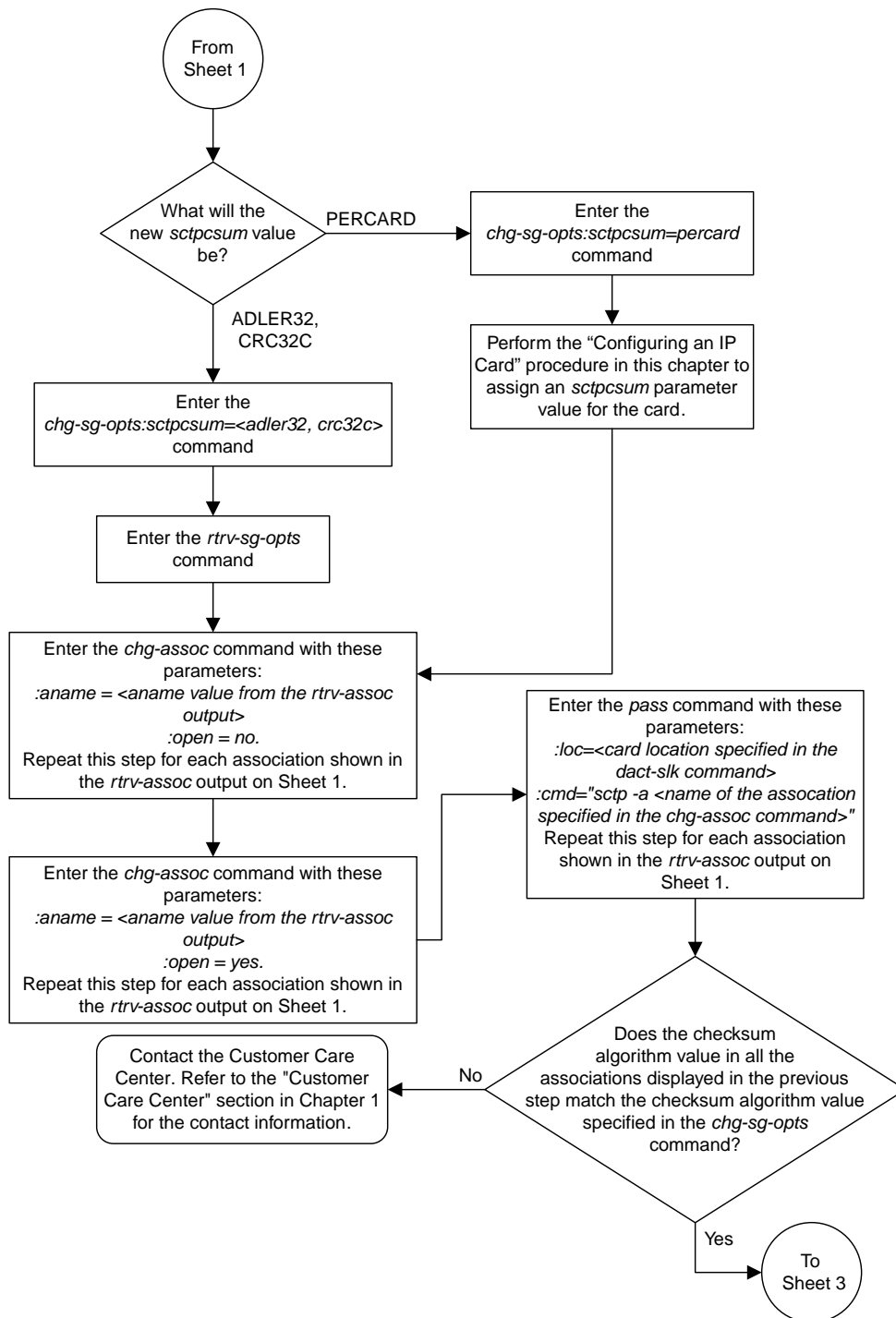

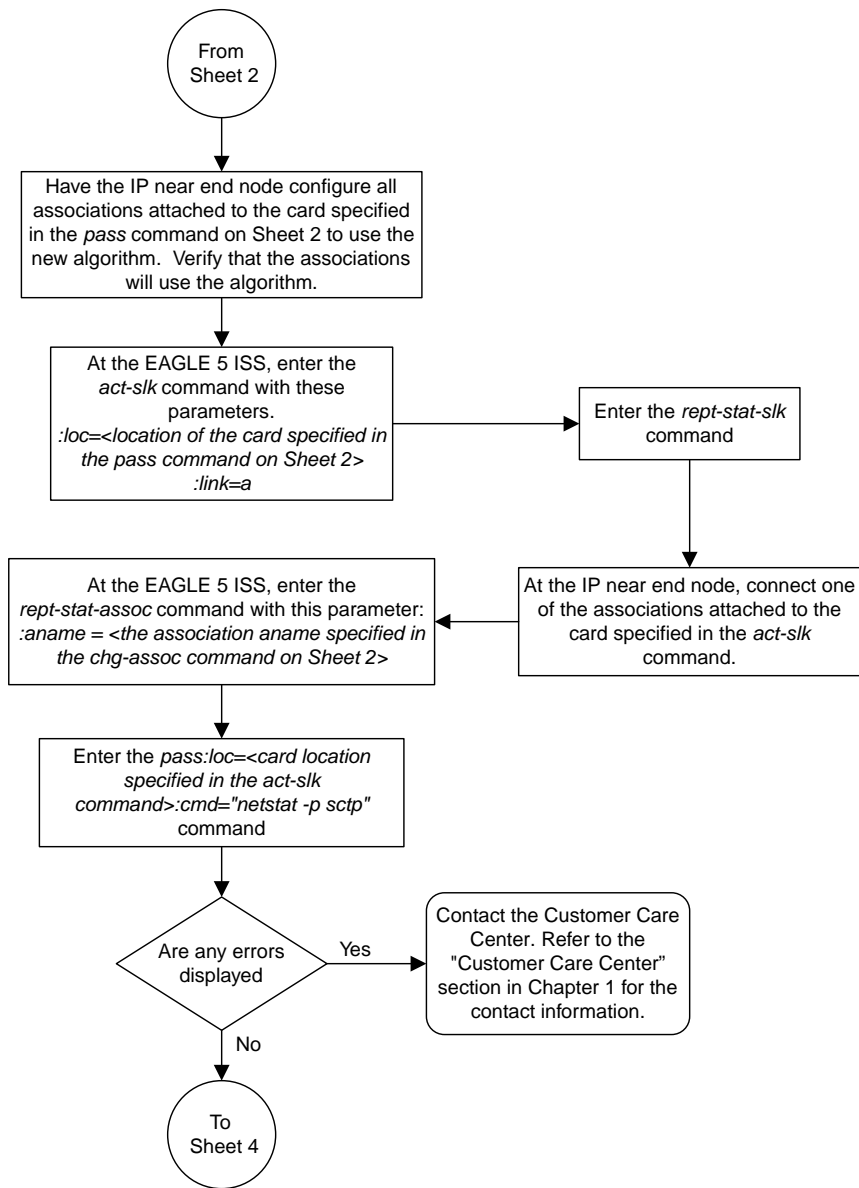

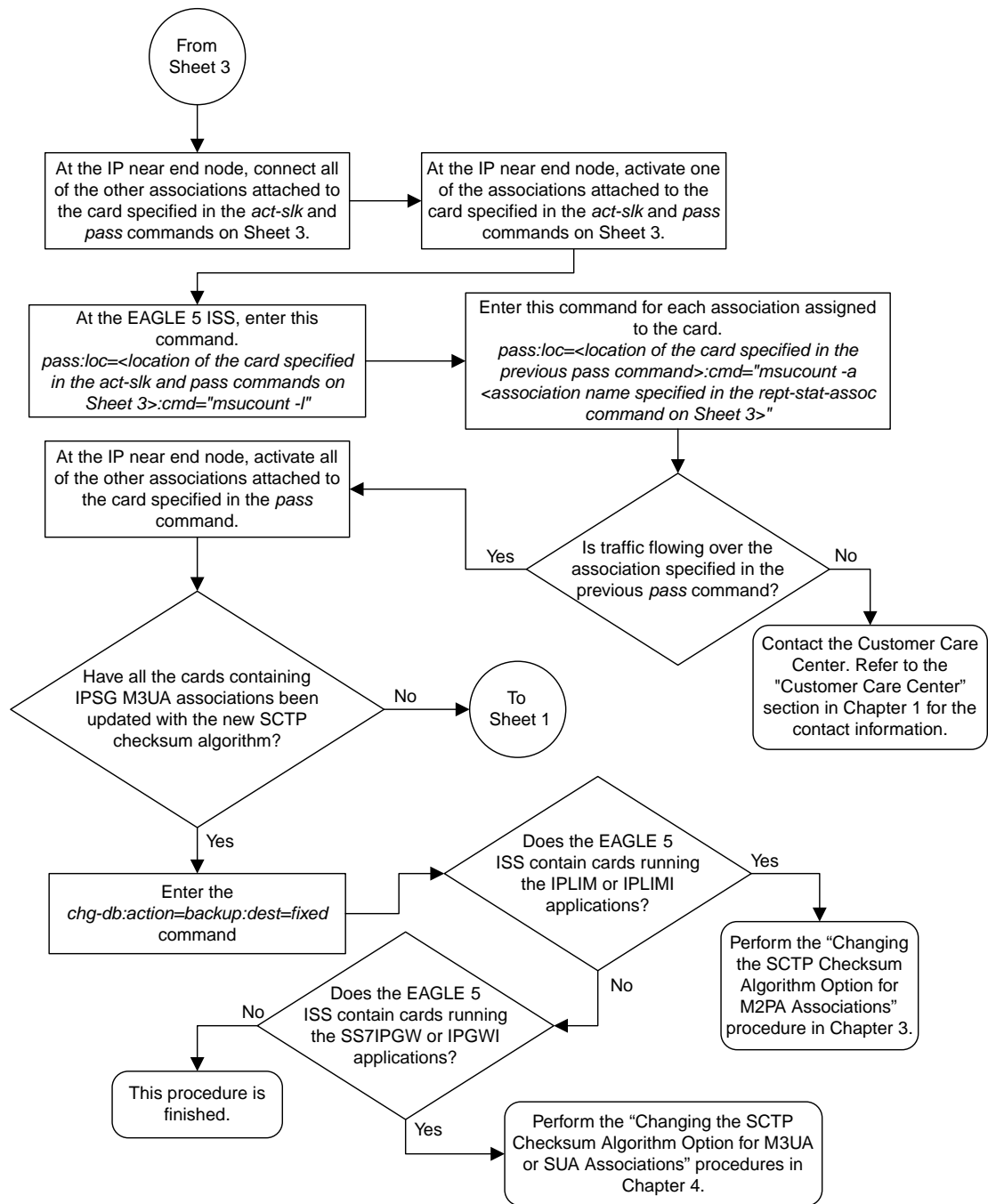

Sheet 4 of 4

Figure 120: Changing the SCTP Checksum Algorithm Option for IPSG M3UA Associations

Changing an M2PA Timer Set

This procedure is used to change the values of the M2PA timers in an M2PA timer set using the `chg-m2pa-tset` command. The M2PA timers are used to control the behavior of the signaling link assigned to an M2PA association (an association containing the M2PA adapter layer - `adapter=m2pa`) during signaling link alignment and proving, and during times of transmit congestion.

The EAGLE contains 20 M2PA timer sets. One of these timer sets is assigned to an M2PA association using the `m2patset` parameter of either the `ent-assoc` or `chg-assoc` command. If the `m2patset` parameter is not specified with the `ent-assoc` command, or with the `chg-assoc` command if the adapter layer for that association is being changed to M2PA, timer set 1 is automatically assigned to the association.



Caution: Changing an M2PA timer set may affect the performance of any associations using the timer set being changed.

CAUTION

The `chg-m2pa-tset` command uses these parameters.

`:tset` – The M2PA timer set being changed, 1 - 20.

`:srctset` – The timer values in an existing M2PA timer set can be copied to another M2PA timer set, specified by the `tset` parameter. The `srctset` parameter specifies the timer set that is to be copied. If the `srctset` parameter is specified, no other timer values can be specified, The `srctset` parameter value cannot be the timer set specified by the `tset` parameter.

`:ver` – The M2PA version, either Draft 6 (`ver=d6`) or RFC (`ver=rfc`).

Note: The definitions of timers T1 and T3 for the Draft 6 version are different from the RFC version. The T2 timer applies only to the RFC version. The definitions of timers T4N, T4E, T5, T6, T7, T16, T17 and T18 for are the same for the Draft 6 version and the RFC version.

The timer parameter descriptions and values are shown in [Table 59: M2PA Timers](#).

Table 59: M2PA Timers

Timer	Draft 6 Timer Name	RFC Timer Name	Definition	Value (in msec)	DRAFT 6 System Default Value (in msec)	RFC System Default Value (in msec)
<code>:t1</code>	N/A	Ready Timer	The amount of time after proving the M2PA adapter layer waits to receive a Link Status Ready message from the peer.	1000 - 350000	N/A	300000
<code>:t1</code>	Alignment Timer	N/A	The amount of time the M2PA adapter layer waits to receive a	1000 -	10000	N/A

Timer	Draft 6 Timer Name	RFC Timer Name	Definition	Value (in msecs)	DRAFT 6 System Default Value (in msecs)	RFC System Default Value (in msecs)
			Link Status Alignment message from the peer.	350000		
:t2*	N/A	Not Aligned Timer	The the amount of time the M2PA adapter layer waits to receive a Link Status Alignment/Link Status Proving message after sending a Link Status Alignment message. Timer T2 is not used in M2PA Draft 6 timer sets.	5000 - 150000	N/A	20000
:t3	N/A	Alignment Timer	The amount of time the M2PA layer waits to receive a Link Status Alignment message from the peer.	1000 - 60000	N/A	2000
	Ready Timer	N/A	The amount of time after proving the M2PA adapter layer waits to receive a Link Status Ready message from the peer.	1000 - 60000	10000	N/A
:t4n	Proving Timer (Normal)		The amount of time the M2PA adapter layer generates Link Status Proving messages during normal proving.	1000 - 70000	10000	30000
:t4e	Proving Timer (Emergency)		The amount of time the M2PA adapter layer generates Link Status Proving messages during emergency proving.	400 - 5000	500	500
:t5	Busy Rate Timer		The amount of time between sending Link Status Busy messages while the link is in-service.	80 - 10000	1000	100
:t6	Remote Congestion Timer		The amount of time that a congested link will remain in service.	1000 - 6000	3000	3000
:t7	Excess Delay in Acknowledgement Timer		The maximum amount of time that may pass between when a user data message is transmitted and an acknowledgement for that message is received from the	200 - 2000	1200	1200

Timer	Draft 6 Timer Name	RFC Timer Name	Definition	Value (in msec)	DRAFT 6 System Default Value (in msec)	RFC System Default Value (in msec)
			peer. If this timer expires, the link is taken out of service.			
:t16	Proving Rate Timer		The amount of time between sending Link Status Proving messages while the T4N or T4E timer is running.	100 - 500000 **	200000 **	200000 **
:t17	Ready Rate Timer		The amount of time between sending Link Status Ready messages while the T3 timer is running.	100 - 500	250	250
:t18	Processor Outage Rate Timer		The amount of time between sending Link Status Processor Outage messages while the link is in-service.	100 - 10000	1000	1000
msecs - milliseconds						
* The T2 Timer can be specified only for the M2PA RFC version.						
** The value of the T16 Timer is in microseconds.						

The value of any timer parameter not specified with the `chg-m2pa-tset` command is not changed.

1. Display the M2PA timer sets in the database by entering the `rtrv-m2pa-tset` command with the version of the M2PA timer sets you wish to change with the `ver` parameter.

To display the M2PA Draft 6 timer values, enter this command.

```
rtrv-m2pa-tset:ver=d6
```

```
rlghncxa03w 06-10-28 21:16:37 GMT EAGLE5 36.0.0
```

```
M2PA Draft 6 Timers (in msec, T16 in microsec)
```

```
TSET T1    T2    T3    T4N  T4E  T5    T6    T7    T16  T17  T18
1     6000  ----- 5000  20000 500  5000  3000 1000  200000 250 1000
2     10000 ----- 10000 10000 500  1000  3000 1200  200000 250 1000
3     10000 ----- 10000 10000 500  1000  3000 1200  200000 250 1000
4     10000 ----- 10000 10000 500  1000  3000 1200  200000 250 1000
5     10000 ----- 10000 10000 500  1000  3000 1200  200000 250 1000
6     10000 ----- 10000 10000 500  1000  3000 1200  200000 250 1000
7     10000 ----- 10000 10000 500  1000  3000 1200  200000 250 1000
8     10000 ----- 10000 10000 500  1000  3000 1200  200000 250 1000
9     27500 ----- 3850  4859  450  5700  3750 1150  250  375  8750
10    10000 ----- 10000 10000 500  1000  3000 1200  200000 250 1000
11    10000 ----- 10000 10000 500  1000  3000 1200  200000 250 1000
12    10000 ----- 10000 10000 500  1000  3000 1200  200000 250 1000
13    10000 ----- 10000 10000 500  1000  3000 1200  200000 250 1000
```

```

14 10000 ----- 10000 10000 500 1000 3000 1200 200000 250 1000
15 10000 ----- 10000 10000 500 1000 3000 1200 200000 250 1000
16 10000 ----- 10000 10000 500 1000 3000 1200 200000 250 1000
17 10000 ----- 10000 10000 500 1000 3000 1200 200000 250 1000
18 10000 ----- 10000 10000 500 1000 3000 1200 200000 250 1000
19 10000 ----- 10000 10000 500 1000 3000 1200 200000 250 1000
20 10000 ----- 10000 10000 500 1000 3000 1200 200000 250 1000

```

To display the M2PARFC timer values, enter this command.

```
rtrv-m2pa-tset:ver=rfc
```

```
rlghncxa03w 06-10-28 21:16:37 GMT EAGLE5 36.0.0
```

```
M2PA RFC Timers (in msec, T16 in microsec)
```

TSET	T1	T2	T3	T4N	T4E	T5	T6	T7	T16	T17	T18
1	6000	20000	5000	20000	500	5000	3000	1000	200000	250	1000
1	300000	20000	2000	30000	500	100	3000	1200	200000	250	1000
2	300000	20000	2000	30000	500	100	3000	1200	200000	250	1000
3	300000	20000	2000	30000	500	100	3000	1200	200000	250	1000
4	300000	20000	2000	30000	500	100	3000	1200	200000	250	1000
5	300000	20000	2000	30000	500	100	3000	1200	200000	250	1000
6	300000	20000	2000	30000	500	100	3000	1200	200000	250	1000
7	300000	20000	2000	30000	500	100	3000	1200	200000	250	1000
8	300000	20000	2000	30000	500	100	3000	1200	200000	250	1000
9	27500	10000	3850	4859	450	5700	3750	1150	250	375	8750
10	300000	20000	2000	30000	500	100	3000	1200	200000	250	1000
11	300000	20000	2000	30000	500	100	3000	1200	200000	250	1000
12	300000	20000	2000	30000	500	100	3000	1200	200000	250	1000
13	300000	20000	2000	30000	500	100	3000	1200	200000	250	1000
14	300000	20000	2000	30000	500	100	3000	1200	200000	250	1000
15	300000	20000	2000	30000	500	100	3000	1200	200000	250	1000
16	300000	20000	2000	30000	500	100	3000	1200	200000	250	1000
17	300000	20000	2000	30000	500	100	3000	1200	200000	250	1000
18	300000	20000	2000	30000	500	100	3000	1200	200000	250	1000
19	300000	20000	2000	30000	500	100	3000	1200	200000	250	1000
20	300000	20000	2000	30000	500	100	3000	1200	200000	250	1000

If the ver parameter is not specified when entering the rtrv-m2pa-tset command, both the Draft 6 and RFC values are displayed. This is an example of the possible output.

```
rlghncxa03w 06-10-28 21:16:37 GMT EAGLE5 36.0.0
```

```
M2PA Draft 6 Timers (in msec, T16 in microsec)
```

TSET	T1	T2	T3	T4N	T4E	T5	T6	T7	T16	T17	T18
1	6000	-----	5000	20000	500	5000	3000	1000	200000	250	1000
2	10000	-----	10000	10000	500	1000	3000	1200	200000	250	1000
3	10000	-----	10000	10000	500	1000	3000	1200	200000	250	1000
4	10000	-----	10000	10000	500	1000	3000	1200	200000	250	1000
5	10000	-----	10000	10000	500	1000	3000	1200	200000	250	1000
6	10000	-----	10000	10000	500	1000	3000	1200	200000	250	1000
7	10000	-----	10000	10000	500	1000	3000	1200	200000	250	1000
8	10000	-----	10000	10000	500	1000	3000	1200	200000	250	1000
9	27500	-----	3850	4859	450	5700	3750	1150	250	375	8750
10	10000	-----	10000	10000	500	1000	3000	1200	200000	250	1000
11	10000	-----	10000	10000	500	1000	3000	1200	200000	250	1000
12	10000	-----	10000	10000	500	1000	3000	1200	200000	250	1000
13	10000	-----	10000	10000	500	1000	3000	1200	200000	250	1000

14	10000	-----	10000	10000	500	1000	3000	1200	200000	250	1000
15	10000	-----	10000	10000	500	1000	3000	1200	200000	250	1000
16	10000	-----	10000	10000	500	1000	3000	1200	200000	250	1000
17	10000	-----	10000	10000	500	1000	3000	1200	200000	250	1000
18	10000	-----	10000	10000	500	1000	3000	1200	200000	250	1000
19	10000	-----	10000	10000	500	1000	3000	1200	200000	250	1000
20	10000	-----	10000	10000	500	1000	3000	1200	200000	250	1000

M2PA RFC Timers (in msec, T16 in microsec)

TSET	T1	T2	T3	T4N	T4E	T5	T6	T7	T16	T17	T18
1	6000	20000	5000	20000	500	5000	3000	1000	200000	250	1000
2	300000	20000	2000	30000	500	100	3000	1200	200000	250	1000
3	300000	20000	2000	30000	500	100	3000	1200	200000	250	1000
4	300000	20000	2000	30000	500	100	3000	1200	200000	250	1000
5	300000	20000	2000	30000	500	100	3000	1200	200000	250	1000
6	300000	20000	2000	30000	500	100	3000	1200	200000	250	1000
7	300000	20000	2000	30000	500	100	3000	1200	200000	250	1000
8	300000	20000	2000	30000	500	100	3000	1200	200000	250	1000
9	27500	10000	3850	4859	450	5700	3750	1150	250	375	8750
10	300000	20000	2000	30000	500	100	3000	1200	200000	250	1000
11	300000	20000	2000	30000	500	100	3000	1200	200000	250	1000
12	300000	20000	2000	30000	500	100	3000	1200	200000	250	1000
13	300000	20000	2000	30000	500	100	3000	1200	200000	250	1000
14	300000	20000	2000	30000	500	100	3000	1200	200000	250	1000
15	300000	20000	2000	30000	500	100	3000	1200	200000	250	1000
16	300000	20000	2000	30000	500	100	3000	1200	200000	250	1000
17	300000	20000	2000	30000	500	100	3000	1200	200000	250	1000
18	300000	20000	2000	30000	500	100	3000	1200	200000	250	1000
19	300000	20000	2000	30000	500	100	3000	1200	200000	250	1000
20	300000	20000	2000	30000	500	100	3000	1200	200000	250	1000

- Change the desired timer set with the `chg-m2pa-tset` command. To change a specific timer set, enter the `chg-m2pa-tset` command with the `tset` and `ver` parameters and the timer parameters you wish to change. For this example, to change the values of the RFC version of timer set 1, enter this command.

```
chg-m2pa-tset:tset=1:t1=27500:t2=10000:t3=3850:t4e=450:t4n=45000:t5=5700
:t6=3750:t7=1150:t16=250000:t17=375:t18=8750:ver=rfc
```

To change the values of the Draft 6 version of timer set 1, enter this command.

```
chg-m2pa-tset:tset=1:t1=27500:t3=3850:t4e=450:t4n=45000:t5=5700
:t6=3750:t7=1150:t16=250000:t17=375:t18=8750:ver=d6
```

Note: The values for the M2PA timers are shown in [Table 59: M2PA Timers](#).

To copy an M2PA timer set to another timer set, enter the `chg-m2pa-tset` command with the `tset`, `ver`, and `srctset` parameters. For this example, to copy the RFC version of timer set 9 to timer set 1, enter this command.

```
chg-m2pa-tset:tset=1:srctset=9:ver=rfc
```

To copy the Draft 6 version of timer set 9 to timer set 1, enter this command.

```
chg-m2pa-tset:tset=1:srctset=9:ver=d6
```

Note: The `ver` parameter is optional and does not have to be specified to change the M2PA RFC timer values. The default value for the `ver` parameter is `rfc`. If you wish to change the M2PA Draft 6 timer values, the `ver=d6` parameter must be specified with the `chg-m2pa-tset` command.

When the `chg-m2pa-tset` command has successfully completed, the following message should appear.

```
rlghncxa03w 06-10-28 21:16:37 GMT EAGLE5 36.0.0
CHG-M2PA-TSET: MASP A - COMPLTD
```

3. Verify the changes by entering the `rtrv-m2pa-tset` command specifying the timer set and version parameter values specified in [Step 2](#). For this example, enter one of these commands.

```
rtrv-m2pa-tset:tset=1:ver=rfc
```

```
rlghncxa03w 06-10-28 21:16:37 GMT EAGLE5 36.0.0
M2PA RFC Timers (in msec, T16 in microsec)
TSET T1      T2      T3      T4N   T4E   T5      T6      T7      T16    T17   T18
1     27500  10000  3850   45000 450   5700   3750  1150   250000 375   8750
```

```
rtrv-m2pa-tset:tset=1:ver=d6
```

```
rlghncxa03w 06-10-28 21:16:37 GMT EAGLE5 36.0.0
M2PA Draft 6 Timers (in msec, T16 in microsec)
TSET T1      T2      T3      T4N   T4E   T5      T6      T7      T16    T17   T18
1     27500  ----- 3850   45000 450   5700   3750  1150   250000 375   8750
```

```
rtrv-m2pa-tset:tset=9:ver=rfc
```

```
rlghncxa03w 06-10-28 21:16:37 GMT EAGLE5 36.0.0
M2PA RFC Timers (in msec, T16 in microsec)
TSET T1      T2      T3      T4N   T4E   T5      T6      T7      T16    T17   T18
9     27500  10000  3850   45000 450   5700   3750  1150   250000 375   8750
```

```
rtrv-m2pa-tset:tset=9:ver=d6
```

```
rlghncxa03w 06-10-28 21:16:37 GMT EAGLE5 36.0.0
M2PA Draft 6 Timers (in msec, T16 in microsec)
TSET T1      T2      T3      T4N   T4E   T5      T6      T7      T16    T17   T18
9     27500  ----- 3850   45000 450   5700   3750  1150   250000 375   8750
```

4. Back up the new changes, using the `chg-db:action=backup:dest=fixed` command. These messages should appear; the active Maintenance and Administration Subsystem Processor (MASP) appears first.

```
BACKUP (FIXED) : MASP A - Backup starts on active MASP.
BACKUP (FIXED) : MASP A - Backup on active MASP to fixed disk complete.
```

```
BACKUP (FIXED) : MASP A - Backup starts on standby MASP.  
BACKUP (FIXED) : MASP A - Backup on standby MASP to fixed disk complete.
```

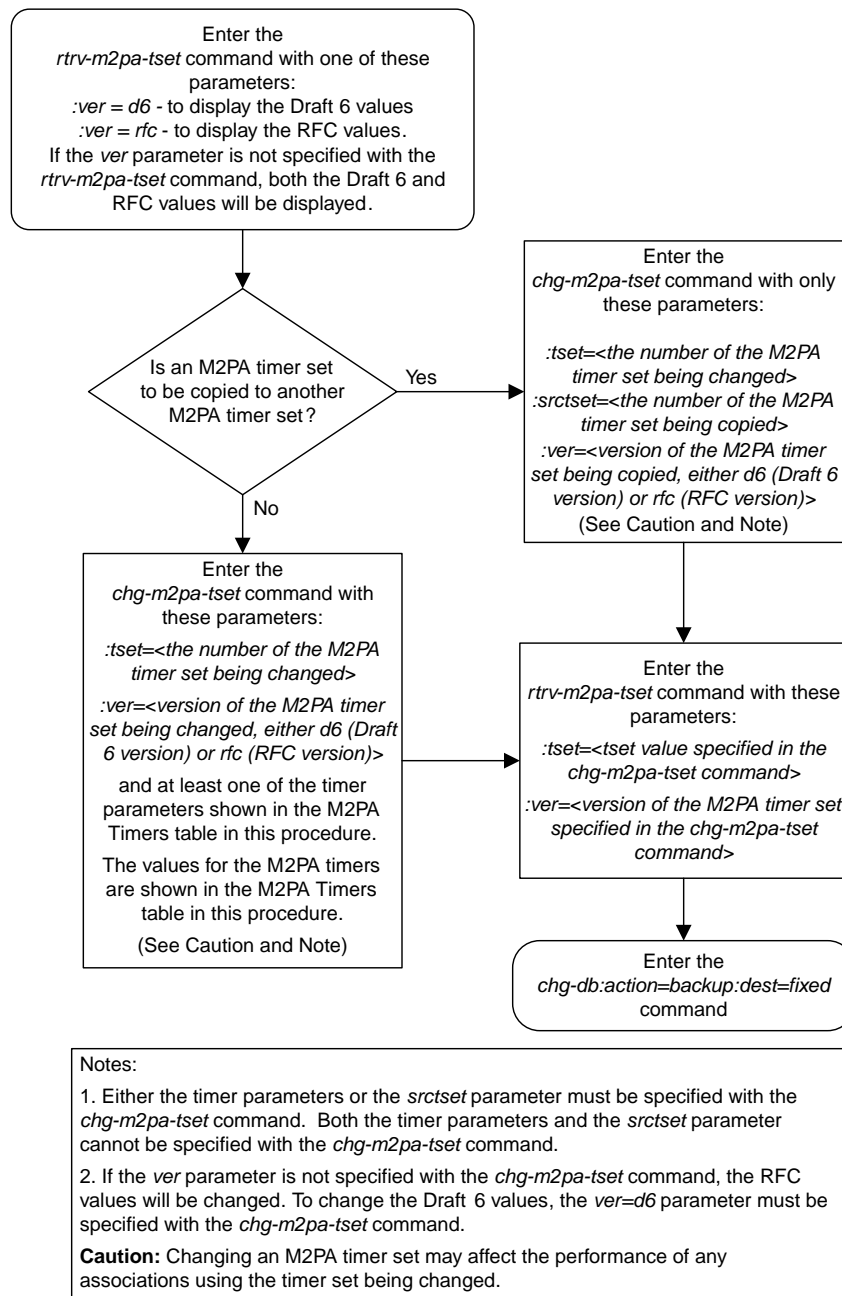

Figure 121: Changing an M2PA Timer Set

Changing a UA Parameter Set

Use this procedure to change the values in a UA (user adapter) parameter set using the `chg-uaps` command. The `chg-uaps` command uses these parameters.

`:set` – the UA parameter set being changed, from 1 - 9

`:scrset` – the source UA parameter set used to copy the values from one UA parameter set to another, from 1 to 10.

`:timer` – the timer being changed, from 1 to 10. Currently, there are only three timers defined:

- Timer 2 – The False IP Connection Congestion Timer – the maximum amount of time (in milliseconds) that an association is allowed to remain congested before failing due to false connection congestion.
- Timer 3 – The UA Heartbeat Period Timer – The frequency, in milliseconds, that heartbeat messages are transmitted.
- Timer 4 – The UA Heartbeat Received Timer – The amount of time, in milliseconds, that the EAGLE waits for a response to the heartbeat message that was transmitted. If a response to the heartbeat message is not received in the amount of time defined by Timer 4, the association is torn down

`:tvalue` – The value of the timer specified by the `timer` parameter.

- The value of timer 2 is from 10 to 30,000 milliseconds. The system default value is 3,000 milliseconds.
- The value of timer 3 is from 100 to 60,000 milliseconds. The system default value is 10,000 milliseconds.
- The value of timer 4 is from 100 to 10,000 milliseconds. The system default value is 5,000 milliseconds.

`:parm` – the UA parameters, from 1 to 10. Currently, only four UA parameters are defined.

- 1 – Controlling ASPSNM Behavior
- 2 – Controlling ASP/Application Server State Notification Behavior
- 3 – UA Serviceability Options
- 4 – SCTP Payload Protocol Indicator Option

`:pvalue` – the value of the UA parameters, which is dependent on the `parm` parameter value. The value of the `pvalue` parameter is a bit-mapped value, requiring a 0 in the specific bit position to disable the item, or a 1 in the specific bit position to enable the item. The value of the `pvalue` parameter is a 32-bit number. Any bits not specified in the following lists are not used.

- If the `parm` value is 1, the bits used by the `pvalue` parameter are:
 - 0 – Broadcast – controls broadcast phase SNMTFPs, TFRs and TFAs that are sent when a destination's status changes. If this flag is set, SNMTFPs/TFRs/TFAs are replicated to all associations/sockets that meet the Multicast SNM Criteria and have this enabled. The default is to enable all broadcast phase messages.
 - 1 – Response Method – controls the sending of an SNMTFC/UPU as a reply to a message received on an association/socket for an unavailable destination. The SNMTFC/UPU is replicated to all associations/sockets that have this capability and meet the Response SNM Criteria. The default is to allow the response to be sent.
 - 6 – Broadcast Congestion Status Change – controls the sending of unsolicited congestion status changes by an ASP. Unsolicited congestion status messages (TFCs generated when a destination's

congestion status changes) are replicated to all ASPs who have this capability and meet the Multicast SNM Criteria. The default is to generate no unsolicited congestion status changes.

Table 60: Valid PVALUE Parameter Values if PARM=1 shows the values can be entered for the `pvalue` parameter if the `parm` value is 1. The `pvalue` parameter value can be entered as a hexadecimal or a decimal number.

Table 60: Valid PVALUE Parameter Values if PARM=1

Bits Enabled	Bits Disabled	Hexadecimal Value	Decimal Value
None	Bit 0 - Broadcast Bit 1 - Response Method Bit 6 - Broadcast Congestion Status Change	h'0	0
Bit 0 - Broadcast	Bit 1 - Response Method Bit 6 - Broadcast Congestion Status Change	h'1	1
Bit 1 - Response Method	Bit 0 - Broadcast Bit 6 - Broadcast Congestion Status Change	h'2	2
Bit 0 - Broadcast Bit 1 - Response Method	Bit 6 - Broadcast Congestion Status Change	h'3*	3*
Bit 6 - Broadcast Congestion Status Change	Bit 0 - Broadcast Bit 1 - Response Method	h'40	64
Bit 6 - Broadcast Congestion Status Change Bit 0 - Broadcast	Bit 1 - Response Method	h'41	65
Bit 6 - Broadcast Congestion Status Change Bit 1 - Response Method	Bit 0 - Broadcast	h'42	66
Bit 0 - Broadcast Bit 1 - Response Method Bit 6 - Broadcast Congestion Status Change	None	h'43	67
* The system default value			

- If the `parm` value is 2, the bits used by the `pvalue` parameter are:

- 0 – ASP Active Notifications – controls the sending of ASP-Active notifications. If this value is specified, an ASP-Default notification is sent when an ASP transitions to the ASP-ACTIVE state. The default is not to send ASP-Active notifications.
- 1 – ASP Inactive Notifications – controls the sending of ASP-Inactive notifications. If this value is specified, an ASP-Inactive notification is sent when an ASP transitions to the ASP-INACTIVE state. The default is not to send ASP-Inactive notifications.

Note: To see the ASP activations and inactivations, bits 0 and 1 of the `pvalue` parameter value need to be enabled. See [Table 61: Valid PVALUE Parameter Values if PARM=2](#).

- 2 – ASPAS State Query – controls the sending of ASP/AS State notifications on request by an ASP. If this value is specified, the EAGLE responds with ASP and AS state notifications if the remote ASP sends ASP-UP or ASP-INACTIVE, while the local ASP is in the ASP-INACTIVE state, or the remote ASP sends an ASP-ACTIVE notification while the local ASP is in the ASP-ACTIVE state. The default is not to send ASP/AS state notifications.

[Table 61: Valid PVALUE Parameter Values if PARM=2](#) shows the values can be entered for the `pvalue` parameter if the `parm` value is 2. The `pvalue` parameter value can be entered as a hexadecimal or a decimal number.

Table 61: Valid PVALUE Parameter Values if PARM=2

Bits Enabled	Bits Disabled	Hexadecimal Value	Decimal Value
None	Bit 0 - ASP Activate Notifications Bit 1 - ASP Inactivate Notifications Bit 2 - ASP AS State Query	h'0*	0*
Bit 0 - ASP Activate Notifications	Bit 1 - ASP Inactivate Notifications Bit 2 - ASP AS State Query	h'1	1
Bit 1 - ASP Inactivate Notifications	Bit 0 - ASP Activate Notifications Bit 2 - ASP AS State Query	h'2	2
Bit 0 - ASP Activate Notifications Bit 1 - ASP Inactivate Notifications	Bit 2 - ASP AS State Query	h'3	3
Bit 2 - ASP AS State Query	Bit 0 - ASP Activate Notifications Bit 1 - ASP Inactivate Notifications	h'4	4
Bit 0 - ASP Activate Notifications Bit 2 - ASP AS State Query	Bit 1 - ASP Inactivate Notifications	h'5	5
Bit 1 - ASP Inactivate Notifications	Bit 0 - ASP Activate Notifications	h'6	6

Bits Enabled	Bits Disabled	Hexadecimal Value	Decimal Value
Bit 2 - ASP AS State Query			
Bit 0 - ASP Activate Notifications Bit 1 - ASP Inactivate Notifications Bit 2 - ASP AS State Query	None	h'7	7
* The system default value			

- If the `parm` value is 3, the bits used by the `pvalue` parameter are:
 - 0 – UA Heartbeats – heartbeat messages are sent on connections from the EAGLE to the far-end node that are in the ASP-Down, ASP-Active, and ASP-Inactive states if the bit is enabled.
 - 1 – UA Graceful Shutdown – enables the graceful shutdown of IPSG M3UA connections if the bit is enabled.

Table 62: Valid PVALUE Parameter Values if PARM=3 shows the values can be entered for the `pvalue` parameter if the `parm` value is 3. The `pvalue` parameter value can be entered as a hexadecimal or a decimal number.

Table 62: Valid PVALUE Parameter Values if PARM=3

Bits Enabled	Bits Disabled	Hexadecimal Value	Decimal Value
None	Bit 0 - UA Heartbeats Bit 1 - UA Graceful Shutdown	h'0*	0*
Bit 0 - UA Heartbeats	Bit 1 - UA Graceful Shutdown	h'1	1
Bit 1 - UA Graceful Shutdown	Bit 0 - UA Heartbeats	h'2	2
Bit 0 - UA Heartbeats Bit 1 - UA Graceful Shutdown	None	h'3	3
* The system default value			

- If the `parm` value is 4, the bit 0, the SCTP Payload Protocol Indicator byte order option, is used by the `pvalue` parameter. This bit indicates whether the SCTP Payload Protocol Indicator (PPI) in the received or transmitted message should be in the Big Endian and Little Endian byte format.

Table 63: Valid PVALUE Parameter Values if PARM=4 shows the values can be entered for the `pvalue` parameter if the `parm` value is 4. The `pvalue` parameter value can be entered as a hexadecimal or a decimal number.

Table 63: Valid PVALUE Parameter Values if PARM=4

SCTP Payload Protocol Indicator Byte Order Option - Bit 0	Hexadecimal Value	Decimal Value
Big Endian Byte Format	h'0*	0*
Little Endian Byte Format	h'1	1
* The system default value		

UA parameter set 10 contains the default values for the UA parameter sets and cannot be changed.

The `set` and `scrset` parameter values cannot be the same.

If the `scrset` parameter is specified, no other optional parameter may be specified.

The `timer` and `tvalue` parameters must be specified together. If one is specified, the other must be specified.

The `parm` and `pvalue` parameters must be specified together. If one is specified, the other must be specified.

Canceling the RTRV-UAPS Command

Because the `rtrv-uaps` command used in this procedure can output information for a long period of time, the `rtrv-uaps` command can be canceled and the output to the terminal stopped. There are three ways that the `rtrv-uaps` command can be canceled.

- Press the F9 function key on the keyboard at the terminal where the `rtrv-uaps` command was entered.
- Enter the `canc-cmd` without the `trm` parameter at the terminal where the `rtrv-uaps` command was entered.
- Enter the `canc-cmd:trm=<xx>`, where `<xx>` is the terminal where the `rtrv-uaps` command was entered, from another terminal other than the terminal where the `rtrv-uaps` command was entered. To enter the `canc-cmd:trm=<xx>` command, the terminal must allow Security Administration commands to be entered from it and the user must be allowed to enter Security Administration commands. The terminal's permissions can be verified with the `rtrv-secu-trm` command. The user's permissions can be verified with the `rtrv-user` or `rtrv-secu-user` commands.

For more information about the `canc-cmd` command, go to *Commands User's Guide*.

1. Display the values in the UA parameter set being changed by entering the `rtrv-uaps` command and specifying the desired UA parameter set number, from 1 to 9. For this example, enter this command.

```
rtrv-uaps:set=3
```

This is an example of possible output.

```
rlghncxa03w 10-07-28 09:12:36 GMT EAGLE5 42.0.0
  SET  TIMER      TVALUE  PARM  PVALUE
   3     1           0        1      3
   3     2         3000        2      0
   3     3        10000        3      0
```



```

3      4      5000    4      0
3      5      0      5      0
3      6      0      6      0
3      7      0      7      0
3      8      0      8      0
3      9      0      9      0
3     10      0     10      0

```

TIMER 2: False IP Connection Congestion Timer, max time an association can be congested before failing due to false congestion. SS7IPGW and IPGWI applications enforce 0-30000(ms). Not supported on IPSG application.

TVALUE : Valid range = 32-bits

TIMER 3: UA HeartBeat Period Timer T(beat), time (ms) between sending of BEAT msgs by NE. IPSG, SS7IPGW and IPGWI applications enforce 100(ms)-60000(ms).

TVALUE : Valid range = 32-bits

TIMER 4: UA HeartBeat Received Timer T(beat ack), timeout period for response BEAT ACK msgs by NE. IPSG, SS7IPGW and IPGWI applications enforce 100(ms)-10000(ms).

TVALUE : Valid range = 32-bits

PARAM 1: ASP SNM options. Each bit is used as an enabled/disabled flag for a particular ASP SNM option. Not supported on IPSG application.

PVALUE : Valid range = 32-bits

BIT	BIT VALUE
0=Broadcast	0=Disabled , 1=Enabled
1=Response Method	0=Disabled , 1=Enabled
2-5=Reserved	
6=Broadcast Congestion Status Change	0=Disabled , 1=Enabled
7-31=Reserved	

PARAM 2: ASP/AS Notification options. Each bit is used as an enabled/disabled flag for a particular ASP/AS Notification option. Not supported on IPSG application.

PVALUE : Valid range = 32-bits

BIT	BIT VALUE
0=ASP Active Notifications	0=Disabled , 1=Enabled
1=ASP Inactive Notifications	0=Disabled , 1=Enabled
2=ASP AS State Query	0=Disabled , 1=Enabled
3-31=Reserved	

PARAM 3: UA Serviceability Options. Each bit is used as an enabled/disabled flag for a particular UA Serviceability option. Supported on IPSG, SS7IPGW, and IPGWI applications. UA Graceful Shutdown supported on IPSG for M3UA only.

PVALUE : Valid range = 32-bits

BIT	BIT VALUE
0=UA Heartbeats	0=Disabled , 1=Enabled
1=UA Graceful Shutdown	0=Disabled , 1=Enabled
2-31=Reserved	

PARAM 4: SCTP Payload Protocol Indicator byte order option. Bit indicates PPI value is RCV/TX in Big Endian or Little Endian byte format. Supported on IPSG-M2PA associations only.

PVALUE : Valid range = 32-bits

BIT	BIT VALUE
0=Payload Protocol Indicator	0=Big Endian , 1=Little Endian
1-31=Reserved	

If the new values of the UA parameter set are being copied from another UA parameter set, continue the procedure with [Step 2](#).

If the new values of the UA parameter set are not being copied from another UA parameter set, continue the procedure with [Step 3](#).

2. Display the values in the UA parameter set that will be copied to the UA parameter set displayed in [Step 1](#) by entering the `rtrv-uaps` command and specifying the desired UA parameter set number, from 1 to 10. For this example, enter this command.

```
rtrv-uaps:set=10
```

This is an example of possible output.

```
rlghncxa03w 10-07-28 09:12:36 GMT EAGLE5 42.0.0
SET  TIMER      TVALUE  PARM      PVALUE
 10    1           0        1          3
 10    2          3000     2          0
 10    3         10000    3          0
 10    4           5000     4          0
 10    5           0         5          0
 10    6           0         6          0
 10    7           0         7          0
 10    8           0         8          0
 10    9           0         9          0
 10   10           0        10         0

TIMER 2: False IP Connection Congestion Timer, max time an
association can be congested before failing due to false
congestion. SS7IPGW and IPGWI applications enforce
0-30000(ms). Not supported on IPSG application.
TVALUE : Valid range = 32-bits

TIMER 3: UA HeartBeat Period Timer T(beat), time (ms) between sending
of BEAT msgs by NE. IPSG, SS7IPGW and IPGWI applications
enforce 100(ms)-60000(ms).
TVALUE : Valid range = 32-bits

TIMER 4: UA HeartBeat Received Timer T(beat ack), timeout period for
response BEAT ACK msgs by NE. IPSG, SS7IPGW and IPGWI
applications enforce 100(ms)-10000(ms).
TVALUE : Valid range = 32-bits

PARM  1: ASP SNM options. Each bit is used as an enabled/disabled
flag for a particular ASP SNM option. Not supported on IPSG
application.
PVALUE : Valid range = 32-bits
      BIT                               BIT VALUE
      0=Broadcast                        0=Disabled , 1=Enabled
      1=Response Method                   0=Disabled , 1=Enabled
      2-5=Reserved
      6=Broadcast Congestion Status Change 0=Disabled , 1=Enabled
      7-31=Reserved

PARM  2: ASP/AS Notification options. Each bit is used as an
enabled/disabled flag for a particular ASP/AS
Notification option. Not supported on IPSG application.
PVALUE : Valid range = 32-bits
      BIT                               BIT VALUE
      0=ASP Active Notifications          0=Disabled , 1=Enabled
      1=ASP Inactive Notifications        0=Disabled , 1=Enabled
      2=ASP AS State Query                0=Disabled , 1=Enabled
```

	3-31=Reserved	
PARAM 3:	UA Serviceability Options. Each bit is used as an enabled/disabled flag for a particular UA Serviceability option. Supported on IPSG, SS7IPGW, and IPGWI applications. UA Graceful Shutdown supported on IPSG for M3UA only.	
PVALUE :	Valid range = 32-bits	
	BIT	BIT VALUE
	0=UA Heartbeats	0=Disabled , 1=Enabled
	1=UA Graceful Shutdown	0=Disabled , 1=Enabled
	2-31=Reserved	
PARAM 4:	SCTP Payload Protocol Indicator byte order option. Bit indicates PPI value is RCV/TX in Big Endian or Little Endian byte format. Supported on IPSG-M2PA associations only.	
PVALUE :	Valid range = 32-bits	
	BIT	BIT VALUE
	0=Payload Protocol Indicator	0=Big Endian , 1=Little Endian
	1-31=Reserved	

3. Change the UA parameter set values using the `chg-uaps` command with the UA parameter set value used in [Step 1](#). If the `parm` and `pvalue` parameters are being specified, see these tables for the valid values of the `pvalue` parameter.

- [Table 60: Valid PVALUE Parameter Values if PARM=1](#)
- [Table 61: Valid PVALUE Parameter Values if PARM=2](#)
- [Table 62: Valid PVALUE Parameter Values if PARM=3](#)
- [Table 63: Valid PVALUE Parameter Values if PARM=4](#)

For this example, enter this command.

```
chg-uaps:set=3:timer=2:tvalue=2000:parm=2:pvalue=1:parm=3:pvalue=3
```

The value of the `pvalue` parameter can be entered as either a decimal value or a hexadecimal value. This example shows the `pvalue` parameter value of the `chg-uaps` command being entered as a decimal value. If the decimal value of the `pvalue` parameter is 3, specify the `pvalue=h'3` parameter to specify the hexadecimal value for the `pvalue` parameter.

```
chg-uaps:set=3:timer=2:tvalue=2000:parm=2:pvalue=h'1:parm=3:pvalue=h'3
```

If the values from one UA parameter set are being copied to another UA parameter set, only the `set` and `scrset` parameters can be specified with the `chg-uaps` command. For example, to copy the values from UA parameter set 10 to UA parameter set 5, enter this command.

```
chg-uaps:set=5:scrset=10
```

When this command has successfully completed, this message should appear.

```
rlghncxa03w 06-10-28 09:12:36 GMT EAGLE5 36.0.0
CHG-UAPS: MASP A - COMPLTD
```

4. Verify the changes using the `rtrv-uaps` command with the UA parameter set name used in [Step 3](#). For this example, enter this command.

```
rtrv-uaps:set=3
```

This is an example of possible output.

```

rlghncxa03w 10-07-28 09:12:36 GMT EAGLE5 42.0.0
SET  TIMER      TVALUE  PARM      PVALUE
 3     1           0        1          3
 3     2          2000      2          1
 3     3          10000     3          3
 3     4           5000      4          0
 3     5           0         5          0
 3     6           0         6          0
 3     7           0         7          0
 3     8           0         8          0
 3     9           0         9          0
 3    10           0        10          0

TIMER 2: False IP Connection Congestion Timer, max time an
association can be congested before failing due to false
congestion. SS7IPGW and IPGWI applications enforce
0-30000(ms). Not supported on IPSG application.
TVALUE : Valid range = 32-bits

TIMER 3: UA HeartBeat Period Timer T(beat), time (ms) between sending
of BEAT msgs by NE. IPSG, SS7IPGW and IPGWI applications
enforce 100(ms)-60000(ms).
TVALUE : Valid range = 32-bits

TIMER 4: UA HeartBeat Received Timer T(beat ack), timeout period for
response BEAT ACK msgs by NE. IPSG, SS7IPGW and IPGWI
applications enforce 100(ms)-10000(ms).
TVALUE : Valid range = 32-bits

PARM 1: ASP SNM options. Each bit is used as an enabled/disabled
flag for a particular ASP SNM option. Not supported on IPSG
application.
PVALUE : Valid range = 32-bits
BIT                                     BIT VALUE
0=Broadcast                            0=Disabled , 1=Enabled
1=Response Method                       0=Disabled , 1=Enabled
2-5=Reserved
6=Broadcast Congestion Status Change 0=Disabled , 1=Enabled
7-31=Reserved

PARM 2: ASP/AS Notification options. Each bit is used as an
enabled/disabled flag for a particular ASP/AS
Notification option. Not supported on IPSG application.
PVALUE : Valid range = 32-bits
BIT                                     BIT VALUE
0=ASP Active Notifications              0=Disabled , 1=Enabled
1=ASP Inactive Notifications            0=Disabled , 1=Enabled
2=ASP AS State Query                    0=Disabled , 1=Enabled
3-31=Reserved

PARM 3: UA Serviceability Options. Each bit is used as an
enabled/disabled flag for a particular UA Serviceability
option. Supported on IPSG, SS7IPGW, and IPGWI applications.
UA Graceful Shutdown supported on IPSG for M3UA only.
PVALUE : Valid range = 32-bits
BIT                                     BIT VALUE
0=UA Heartbeats                         0=Disabled , 1=Enabled
1=UA Graceful Shutdown                  0=Disabled , 1=Enabled
2-31=Reserved

PARM 4: SCTP Payload Protocol Indicator byte order option. Bit indicates

```

```

PPI value is RCV/TX in Big Endian or Little Endian byte format.
Supported on IPSG-M2PA associations only.
PVALUE : Valid range = 32-bits
          BIT
          0=Payload Protocol Indicator
          1-31=Reserved
          BIT VALUE
          0=Big Endian , 1=Little Endian

```

If [Step 2](#) was performed, for this example, enter this command.

```
rtrv-uaps:set=5
```

This is an example of possible output.

```

rlghncxa03w 10-07-28 09:12:36 GMT EAGLE5 42.0.0
SET  TIMER      TVALUE  PARM      PVALUE
 5     1           0        1          3
 5     2          3000       2          0
 5     3          10000      3          0
 5     4           5000       4          0
 5     5           0          5          0
 5     6           0          6          0
 5     7           0          7          0
 5     8           0          8          0
 5     9           0          9          0
 5    10           0         10          0

TIMER 2: False IP Connection Congestion Timer, max time an
association can be congested before failing due to false
congestion. SS7IPGW and IPGWI applications enforce
0-30000(ms). Not supported on IPSG application.
TVALUE : Valid range = 32-bits

TIMER 3: UA HeartBeat Period Timer T(beat), time (ms) between sending
of BEAT msgs by NE. IPSG, SS7IPGW and IPGWI applications
enforce 100(ms)-60000(ms).
TVALUE : Valid range = 32-bits

TIMER 4: UA HeartBeat Received Timer T(beat ack), timeout period for
response BEAT ACK msgs by NE. IPSG, SS7IPGW and IPGWI
applications enforce 100(ms)-10000(ms).
TVALUE : Valid range = 32-bits

PARM 1: ASP SNM options. Each bit is used as an enabled/disabled
flag for a particular ASP SNM option. Not supported on IPSG
application.
PVALUE : Valid range = 32-bits
          BIT
          0=Broadcast
          1=Response Method
          2-5=Reserved
          6=Broadcast Congestion Status Change
          7-31=Reserved
          BIT VALUE
          0=Disabled , 1=Enabled
          0=Disabled , 1=Enabled

PARM 2: ASP/AS Notification options. Each bit is used as an
enabled/disabled flag for a particular ASP/AS
Notification option. Not supported on IPSG application.
PVALUE : Valid range = 32-bits
          BIT
          0=ASP Active Notifications
          1=ASP Inactive Notifications
          2=ASP AS State Query
          BIT VALUE
          0=Disabled , 1=Enabled
          0=Disabled , 1=Enabled

```

```

3-31=Reserved

PARAM 3: UA Serviceability Options. Each bit is used as an
enabled/disabled flag for a particular UA Serviceability
option. Supported on IPSG, SS7IPGW, and IPGWI applications.
UA Graceful Shutdown supported on IPSG for M3UA only.
PVALUE : Valid range = 32-bits
BIT                                     BIT VALUE
0=UA Heartbeats                        0=Disabled , 1=Enabled
1=UA Graceful Shutdown                 0=Disabled , 1=Enabled
2-31=Reserved

PARAM 4: SCTP Payload Protocol Indicator byte order option. Bit indicates
PPI value is RCV/TX in Big Endian or Little Endian byte format.
Supported on IPSG-M2PA associations only.
PVALUE : Valid range = 32-bits
BIT                                     BIT VALUE
0=Payload Protocol Indicator           0=Big Endian , 1=Little Endian
1-31=Reserved

```

5. Back up the new changes, using the `chg-db:action=backup:dest=fixed` command. These messages should appear; the active Maintenance and Administration Subsystem Processor (MASP) appears first.

```

BACKUP (FIXED) : MASP A - Backup starts on active MASP.
BACKUP (FIXED) : MASP A - Backup on active MASP to fixed disk complete.
BACKUP (FIXED) : MASP A - Backup starts on standby MASP.
BACKUP (FIXED) : MASP A - Backup on standby MASP to fixed disk complete.

```

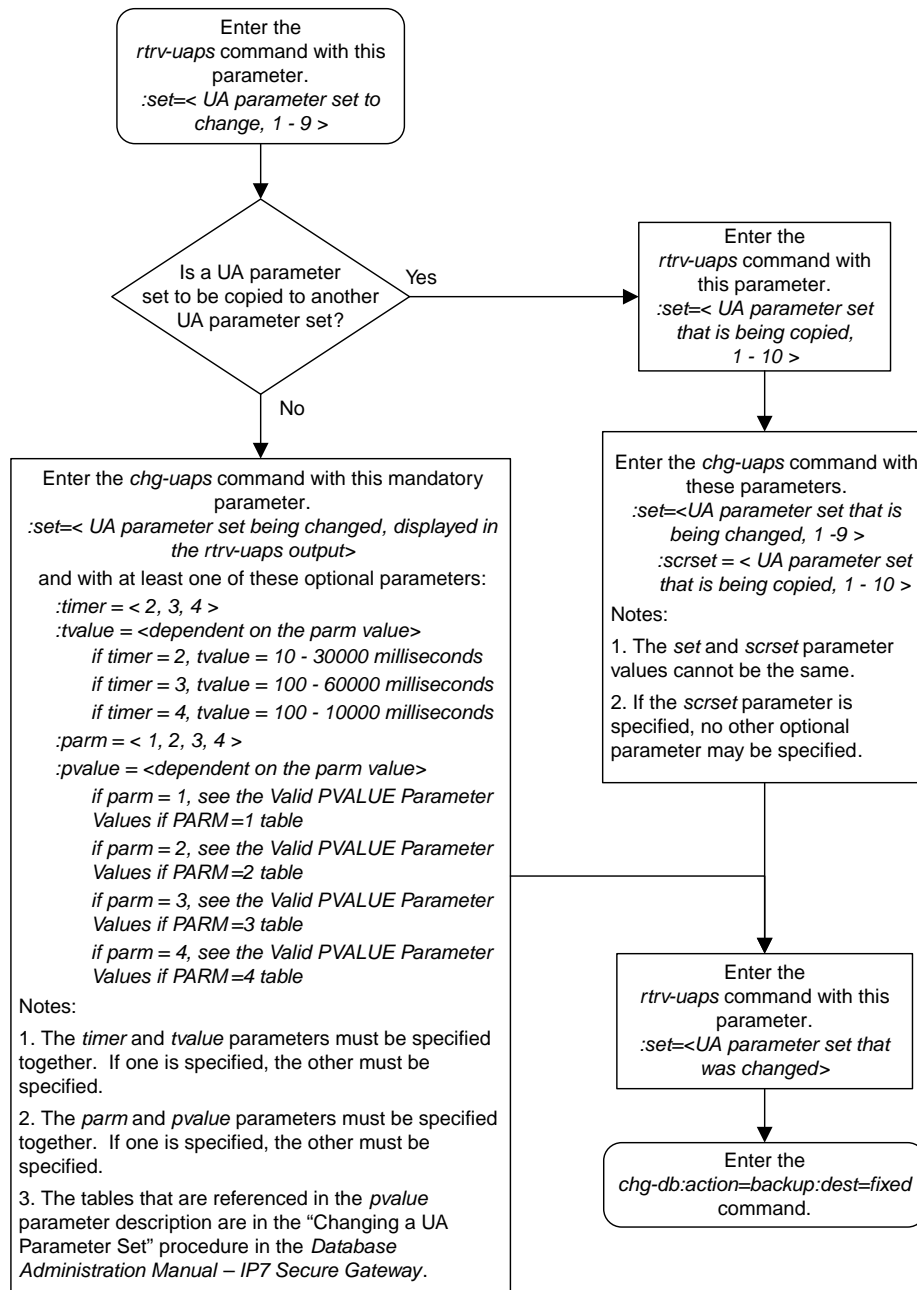

Figure 122: Changing a UA Parameter Set

Turning Off the Large MSU Support for IP Signaling Feature

This procedure is used to turn off the Large MSU Support for IP Signaling feature, using the `chg-ctrl-feat` command.

The `chg-ctrl-feat` command uses these parameters:

`:partnum` – The part number of the Large MSU Support for IP Signaling feature, 893018401.

`:status=off` – used to turn off the Large MSU Support for IP Signaling feature.

The status of the Large MSU Support for IP Signaling feature must be on and is shown with the `rtrv-ctrl-feat` command.



Caution: If the Large MSU Support for IP Signaling feature is turned off, the EAGLE will not process messages with a signaling information field (SIF) that is larger than 272 bytes.

1. Display the status of the Large MSU Support for IP Signaling feature by entering the `rtrv-ctrl-feat:partnum=893018401` command. The following is an example of the possible output.

```
rlghncxa03w 10-04-28 21:15:37 GMT EAGLE5 42.0.0
The following features have been permanently enabled:

Feature Name          Partnum    Status    Quantity
Large MSU for IP Sig  893018401  on       ----

The following features have been temporarily enabled:

Feature Name          Partnum    Status    Quantity    Trial Period Left
Zero entries found.

The following features have expired temporary keys:

Feature Name          Partnum
Zero entries found.
```

If the status of the Large MSU Support for IP Signaling feature is off, or if the Large MSU Support for IP Signaling feature is not enabled, this procedure cannot be performed.

2. Turn off the Large MSU Support for IP Signaling feature by entering the `chg-ctrl-feat` command with the `status=off` parameter. For example, enter this command.

```
chg-ctrl-feat:partnum=893018401:status=off
```

When this command has successfully completed, the following message should appear.

```
rlghncxa03w 06-10-28 21:15:37 GMT EAGLE5 36.0.0
CHG-CTRL-FEAT: MASP B - COMPLTD
```

3. Verify that the Large MSU Support for IP Signaling feature has been turned off by using the `rtrv-ctrl-feat:partnum=893018401` command. The following is an example of the possible output.

```
rlghncxa03w 10-04-28 21:15:37 GMT EAGLE5 42.0.0
The following features have been permanently enabled:

Feature Name           Partnum   Status   Quantity
Large MSU for IP Sig   893018401 off      ----

The following features have been temporarily enabled:

Feature Name           Partnum   Status   Quantity   Trial Period Left
Zero entries found.

The following features have expired temporary keys:

Feature Name           Partnum
Zero entries found.
```

4. Back up the new changes using the `chg-db:action=backup:dest=fixed` command. These messages should appear, the active Maintenance and Administration Subsystem Processor (MASP) appears first.

```
BACKUP (FIXED) : MASP A - Backup starts on active MASP.
BACKUP (FIXED) : MASP A - Backup on active MASP to fixed disk complete.
BACKUP (FIXED) : MASP A - Backup starts on standby MASP.
BACKUP (FIXED) : MASP A - Backup on standby MASP to fixed disk complete.
```

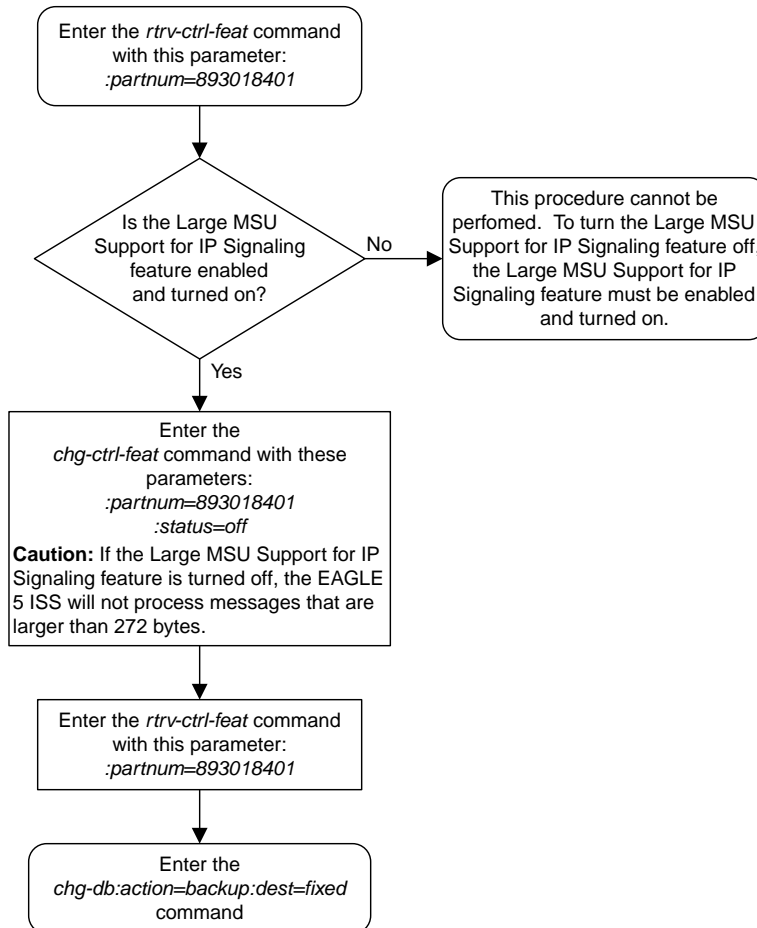

Figure 123: Turning Off the Large MSU Support for IP Signaling Feature

Appendix

A

Reference Information

Topics:

- *Maximum Card Capacity for Different Card Types.....1076*
- *Requirements for EAGLEs Containing more than 1200 Signaling Links.....1076*
- *Determining the Number of High-Speed and Low-Speed Signaling Links.....1076*
- *Enabling the Large System # Links Controlled Feature.....1078*

Appendix D, Reference Information, contains the following information that is used by more than one procedure in this manual: Requirements for EAGLEs Containing more than 700 Signaling Links
Determining the Number of High-Speed and Low-Speed Signaling Links

Maximum Card Capacity for Different Card Types

Maximum Card Capacity (MaxTPS), Maximum RSVDSLKTPS and MAXSLKTPS, And Allowable Value Ranges for RSVDSLKTPS and MAXSLKTPS.

If the E5-ENET-B IPSPG High Throughput feature is turned ON, then the maximum capacity supported on the E5-ENET-B IPSPG card is 9500 TPS, otherwise the capacity is limited to a maximum of 6500 TPS. See the following table:

Table 64: MaxTPS Per Card

Card Type	IPSPG High Throughput FAK Status	MaxTPS (Maximum Card Capacity)	Max RSVDSLKTPS	Max MAXSLKTPS	Range	
					RSVDSLKTPS	MAXSLKTPS
E5-ENET-A	N/A	5000	5000	5000	0-5000	100-5000
E5-ENET-B	OFF	6500	6500	6500	0-6500	100-6500
E5-ENET-B	ON	9500	9500	9500	0-9500	100-9500

Requirements for EAGLEs Containing more than 1200 Signaling Links

To provision an EAGLE with more than 1200 signaling links (currently the EAGLE can have maximum capacities of 1200, 1500, 2000, or 2800 signaling links), the following additional requirements must be met:

- The Measurements Platform feature must be enabled. Perform these procedures in *Database Administration - System Management User's Guide* to enable the Measurements Platform Feature:
 - Adding an MCPM
 - Configuring the IP Communications Link for the Measurements Platform Feature
 - Adding an FTP Server
- To provision more than 1200 signaling links, the Large System # Links controlled feature must be enabled for 1500, 2000, or 2800 signaling links. For more information on enabling this feature, go to the [Enabling the Large System # Links Controlled Feature](#) procedure.

Determining the Number of High-Speed and Low-Speed Signaling Links

The EAGLE can contain these quantities of signaling links.

- The maximum number of IP signaling links (signaling links assigned to IPLIMx cards, IPGWx cards, or IPSPG cards) or ATM high-speed signaling links (signaling links assigned to

to cards running either ATMANSI or ATMITU applications), is limited by the total provisioned system TPS (transactions per second). If the HIPR2 High Rate Mode feature is not enabled or turned on, the total provisioned system TPS is 500,000 TPS. If the HIPR2 High Rate Mode feature is enabled and turned on, the total provisioned system TPS is 1,000,000 (1M) TPS. The total provisioned system TPS is shown in the `rtrv-tps` output. The EAGLE supports these quantities.

- 187 IPLIMx cards with each card supporting 4000 TPS. An IPLIMx card can contain up to 16 signaling links. For more information about configuring an IPLIMx signaling link, see the [Adding an IPLIMx Signaling Link](#) procedure. The EAGLE can support a maximum of 250 IPLIMx cards but not all the IPLIMx cards can contain provisioned signaling links.
- 187 IPGWx cards with each card supporting 4000 TPS. An IPGWx card can contain one signaling link. For more information about configuring an IPGWx signaling link, see the [Adding an IPGWx Signaling Link](#) procedure. The EAGLE can support a maximum of 250 IPGWx cards if the TPS that is assigned to some of the IPGWx cards is less than 4000, and there are no other types of cards are in the database other than the control cards.
- 150 IPGS cards with each card supporting 5000 TPS. An IPGS card can contain up to 32 signaling links. For more information about configuring an IPGS signaling link, see the [Adding an IPGS M2PA Signaling Link](#) procedure or the [Adding an IPGS M3UA Signaling Link](#) procedure. The EAGLE can support a maximum of 250 IPGS cards if the TPS that is assigned to some of the IPGS cards is less than 5000, and there are no other types of cards are in the database other than the control cards.
- The amount of TPS for an ANSI ATM high-speed signaling link is 1630. The amount of TPS for an ITU ATM high-speed signaling link is 2038. The EAGLE supports a maximum of 460 ANSI ATM high-speed signaling links and a maximum of 368 ITU ATM high-speed signaling links. For more information about configuring an ATM high-speed signaling link, see the "Adding an ATM High-Speed Signaling Link procedure in *Database Administration - SS7 User's Guide*.
- A maximum of 80 unchannelized E1 signaling links. An HC MIM can contain two unchannelized E1 signaling links. An E5-E1T1 card can contain one unchannelized E1 signaling link.
- A maximum of 180 unchannelized T1 signaling links. An unchannelized T1 signaling link can be assigned only to an E5-E1T1 card. An E5-E1T1 card can contain one unchannelized T1 signaling link.

The EAGLE can contain a maximum of 250 cards. This quantity does not include the control cards. The sum of the quantities of the signaling links shown in this list cannot be provisioned in the EAGLE as the EAGLE cannot contain enough cards to support the sum of the quantities of these signaling links.

Other signaling links, not shown in this list, can be provisioned if there is space in the shelves for the cards that support these signaling links, and the enabled signaling link quantity is not exceeded.

This hardware is the only hardware that is supported for an EAGLE containing 2001 to 2800 signaling links.

- E5-E1/T1/E5-E1T1-B
- E5-ATM-E5-ATM-B
- E5-SM4G/E5-SM8G
- E5-ENET/E5-ENET-B
- E5-SLAN card for the STPLAN feature
- E5-STC card for the EAGLE 5 Integrated Monitoring Support feature

Enabling the Large System # Links Controlled Feature

This procedure is used to enable the Large System # Links controlled feature using the feature's part number and a feature access key.

The feature access key for the Large System # Links controlled feature is based on the feature's part number and the serial number of the EAGLE, making the feature access key site-specific.

This feature allows the EAGLE to contain a maximum of either 1500, 2000, or 2800 signaling links.

The `enable-ctrl-feat` command enables the controlled feature by inputting the controlled feature's access key and the controlled feature's part number with these parameters:

Note: As of Release 46.3, the `fak` parameter is no longer required. This parameter is only used for backward compatibility.

`: fak` – The feature access key provided by Oracle. The feature access key contains 13 alphanumeric characters and is not case sensitive.

`: partnum` – The Oracle-issued part number associated with the signaling link quantity being enabled:

- 893005901 for the 1500 signaling link quantity
- 893005910 for the 2000 signaling link quantity.
- 893005911 for the 2800 signaling link quantity.

The `enable-ctrl-feat` command requires that the database contain a valid serial number for the EAGLE, and that this serial number is locked. This can be verified with the `rtrv-serial-num` command. The EAGLE is shipped with a serial number in the database, but the serial number is not locked. The serial number can be changed, if necessary, and locked once the EAGLE is on-site, by using the `ent-serial-num` command. The `ent-serial-num` command uses these parameters.

`: serial` – The serial number assigned to the EAGLE. The serial number is not case sensitive.

`: lock` – Specifies whether or not the serial number is locked. This parameter has only one value, `yes`, which locks the serial number. Once the serial number is locked, it cannot be changed.

Note: To enter and lock the EAGLE's serial number, the `ent-serial-num` command must be entered twice, once to add the correct serial number to the database with the `serial` parameter, then again with the `serial` and the `lock=yes` parameters to lock the serial number. You should verify that the serial number in the database is correct before locking the serial number. The serial number can be found on a label affixed to the control shelf (shelf 1100).

This feature cannot be temporarily enabled (with the temporary feature access key).

Once this feature is enabled with the `enable-ctrl-feat` command, the feature is also activated. The `chg-ctrl-feat` command is not necessary to activate the feature.

This feature cannot be turned off with the `chg-ctrl-feat` command and the `status=off` parameter.

Hardware Supported for Signaling Link Quantities Greater than 2000

This hardware is the only hardware that is supported for an EAGLE containing 2001 to 2800 signaling links.

- HC-MIM
- E5-E1/T1
- E5-ATM

- E5-SM4G
- E5-ENET
- E5-based control cards
- E5-SLAN card for the STPLAN feature
- E5-STC card for the EAGLE Integrated Monitoring Support feature

To increase the signaling link quantity to more than 2000 signaling links, or HIPR2 cards must be installed into card locations 9 and 10 in each shelf in the EAGLE. Enter the `rept-stat-gpl:gpl=hipr2` command to verify whether or not HIPR2 cards are installed in the EAGLE shelves.

1. Display the status of the Large System # Links controlled feature by entering the `rtrv-ctrl-feat` command.

The following is an example of the possible output.

```
rlghncxa03w 06-10-28 21:15:37 GMT EAGLE5 36.0.0
The following features have been permanently enabled:

Feature Name          Partnum    Status    Quantity
Command Class Management 893005801  on       ----
LNP Short Message Service 893006601  on       ----
Intermed GTT Load Sharing 893006901  on       ----
XGTT Table Expansion    893006101  on       400000
XMAP Table Expansion     893007710  off      ----
Routesets              893006401  on       6000
HC-MIM SLK Capacity     893012707  on       64

The following features have been temporarily enabled:

Feature Name          Partnum    Status    Quantity    Trial Period Left
Zero entries found.

The following features have expired temporary keys:

Feature Name          Partnum
Zero entries found.
```

If the `rtrv-ctrl-feat` output shows that the controlled feature is enabled for the desired quantity or for a quantity that is greater than the desired quantity, no further action is necessary. This procedure does not need to be performed.

2. Display the serial number in the database with the `rtrv-serial-num` command.

This is an example of the possible output.

```
rlghncxa03w 06-10-28 21:15:37 GMT EAGLE5 36.0.0
System serial number = nt00001231

System serial number is not locked.

rlghncxa03w 06-10-28 21:15:37 GMT EAGLE5 36.0.0
Command Completed
```

If the serial number is correct and locked, continue the procedure by performing one of these steps.

- If the enabled quantity will be 1500, continue the procedure with [Step 8](#).

- If the enabled quantity will be 2000 or 2800, continue the procedure with [Step 6](#).

If the serial number is correct but not locked, continue the procedure with [Step 5](#).

If the serial number is not correct and not locked, continue the procedure with [Step 3](#).

If the serial number is not correct, but is locked, this feature cannot be enabled and the remainder of this procedure cannot be performed. Contact the Customer Care Center to get an incorrect and locked serial number changed. Refer to [My Oracle Support \(MOS\)](#) for the contact information. The serial number can be found on a label affixed to the control shelf (shelf 1100).

3. Enter the correct serial number into the database using the `ent-serial-num` command with the `serial` parameter.

For this example, enter this command.

```
ent-serial-num:serial=<EAGLE's correct serial number>
```

When this command has successfully completed, the following message should appear.

```
rlghncxa03w 06-10-28 21:15:37 GMT EAGLE5 36.0.0
ENT-SERIAL-NUM: MASP A - COMPLTD
```

4. Verify that the serial number entered into [Step 3](#) was entered correctly using the `rtrv-serial-num` command.

This is an example of the possible output.

```
rlghncxa03w 06-10-28 21:15:37 GMT EAGLE5 36.0.0
System serial number = nt00001231

System serial number is not locked.

rlghncxa03w 06-10-28 21:15:37 GMT EAGLE5 36.0.0
Command Completed
```

If the serial number was not entered correctly, repeat [Step 3](#) and [Step 4](#) and re-enter the correct serial number.

5. Lock the serial number in the database by entering the `ent-serial-num` command with the serial number shown in [Step 2](#), if the serial number shown in [Step 2](#) is correct, or with the serial number shown in [Step 4](#), if the serial number was changed in [Step 3](#), and with the `lock=yes` parameter.

For this example, enter this command.

```
ent-serial-num:serial=<EAGLE's serial number>:lock=yes
```

When this command has successfully completed, the following message should appear.

```
rlghncxa03w 06-10-28 21:15:37 GMT EAGLE5 36.0.0
ENT-SERIAL-NUM: MASP A - COMPLTD
```

Continue the procedure by performing one of these steps.

- If the enabled quantity will be 1500, continue the procedure with [Step 8](#).
- If the enabled quantity will be 2000 or 2800, continue the procedure with [Step 6](#).

- Verify that HIPR2 cards are installed in card locations 9 and 10 in each shelf of the EAGLE. Enter this command.

```
rept-stat-gpl:gpl=hipr2
```

This is an example of the possible output.

```
rlghncxa03w 09-07-01 11:40:26 GMT EAGLE5 41.1.0
GPL          CARD          RUNNING          APPROVED        TRIAL
HIPR2       1109         132-002-000    132-002-000    132-003-000
HIPR2       1110         132-002-000    132-002-000    132-003-000
HIPR2       1209         132-002-000    132-002-000    132-003-000
HIPR2       1210         132-002-000    132-002-000    132-003-000
HIPR2       1309         132-002-000    132-002-000    132-003-000
HIPR2       1310         132-002-000    132-002-000    132-003-000
HIPR2       2109         132-002-000    132-002-000    132-003-000
HIPR2       2110         132-002-000    132-002-000    132-003-000
Command Completed
```

If HIPR2 cards are installed at the card locations 9 and 10 on the shelf where the E5-SLAN card is to be installed, continue the procedure with [Step 7](#).

If HIPR2 cards are not installed at the card locations 9 and 10 on the shelf where the E5-SLAN card is to be installed, refer to *Installation Guide* to install the HIPR2 cards. Once the HIPR2 cards have been installed, continue the procedure with [Step 7](#).

- Before the 2000 or 2800 signaling link quantity can be enabled, make sure the EAGLE is configured with the hardware shown in the *"Hardware Supported for Signaling Link Quantities Greater than 2000"* section.

If hardware other than the hardware shown in the *"Hardware Supported for Signaling Link Quantities Greater than 2000"* section is installed and provisioned, contact the Customer Care Center before enabling the 2000 or 2800 signaling link quantity. Refer to *My Oracle Support (MOS)* for the contact information.

- Enable the Large System # Links controlled feature for the desired quantity with the `enable-ctrl-feat` command specifying the part number corresponding to the new quantity of signaling links and the feature access key.

To increase the number of signaling links the EAGLE can contain to 1500, enter this command.

```
enable-ctrl-feat:partnum=893005901:fak=<feature access key>
```

To increase the number of signaling links the EAGLE can contain to 2000, enter this command.

```
enable-ctrl-feat:partnum=893005910:fak=<feature access key>
```

To increase the number of signaling links the EAGLE can contain to 2800, enter this command.

```
enable-ctrl-feat:partnum=893005911:fak=<feature access key>
```

Note: A temporary feature access key cannot be specified to enable this feature.

Note: The values for the feature access key (the `fak` parameter) are provided by Oracle. If you do not have the feature access key for the feature you wish to enable, contact your Sales Representative or Account Representative.

When the `enable-ctrl-feat` command has successfully completed, this message should appear.

```
rlghncxa03w 06-10-28 21:15:37 GMT EAGLE5 36.0.0
ENABLE-CTRL-FEAT: MASP B - COMPLTD
```

9. Verify the changes by entering the `rtrv-ctrl-feat` command with the part number specified in [Step 8](#).

If the 1500 signaling link quantity was enabled in [Step 8](#), enter this command.

```
rtrv-ctrl-feat:partnum=893005901
```

The following is an example of the possible output.

```
rlghncxa03w 06-10-28 21:15:37 GMT EAGLE5 36.0.0
The following features have been permanently enabled:

Feature Name          Partnum   Status   Quantity
Large System # Links  893005901 on       1500

The following features have been temporarily enabled:

Feature Name          Partnum   Status   Quantity   Trial Period Left
Zero entries found.

The following features have expired temporary keys:

Feature Name          Partnum
Zero entries found.
```

If the 2000 signaling link quantity was enabled in [Step 8](#), enter this command.

```
rtrv-ctrl-feat:partnum=893005910
```

The following is an example of the possible output.

```
rlghncxa03w 06-10-28 21:15:37 GMT EAGLE5 36.0.0
The following features have been permanently enabled:

Feature Name          Partnum   Status   Quantity
Large System # Links  893005910 on       2000

The following features have been temporarily enabled:

Feature Name          Partnum   Status   Quantity   Trial Period Left
Zero entries found.

The following features have expired temporary keys:

Feature Name          Partnum
Zero entries found.
```

If the 2800 signaling link quantity was enabled in [Step 8](#), enter this command.

```
rtrv-ctrl-feat:partnum=893005911
```

The following is an example of the possible output.

```
rlghncxa03w 09-07-28 21:15:37 GMT EAGLE5 41.1.0
The following features have been permanently enabled:

Feature Name          Partnum   Status   Quantity
Large System # Links  893005911 on       2800

The following features have been temporarily enabled:

Feature Name          Partnum   Status   Quantity   Trial Period Left
Zero entries found.

The following features have expired temporary keys:

Feature Name          Partnum
Zero entries found.
```

10. Back up the new changes using the `chg-db:action=backup:dest=fixed` command.

These messages should appear, the active Maintenance and Administration Subsystem Processor (MASP) appears first.

```
BACKUP (FIXED) : MASP A - Backup starts on active MASP.
BACKUP (FIXED) : MASP A - Backup on active MASP to fixed disk complete.
BACKUP (FIXED) : MASP A - Backup starts on standby MASP.
BACKUP (FIXED) : MASP A - Backup on standby MASP to fixed disk complete.
```

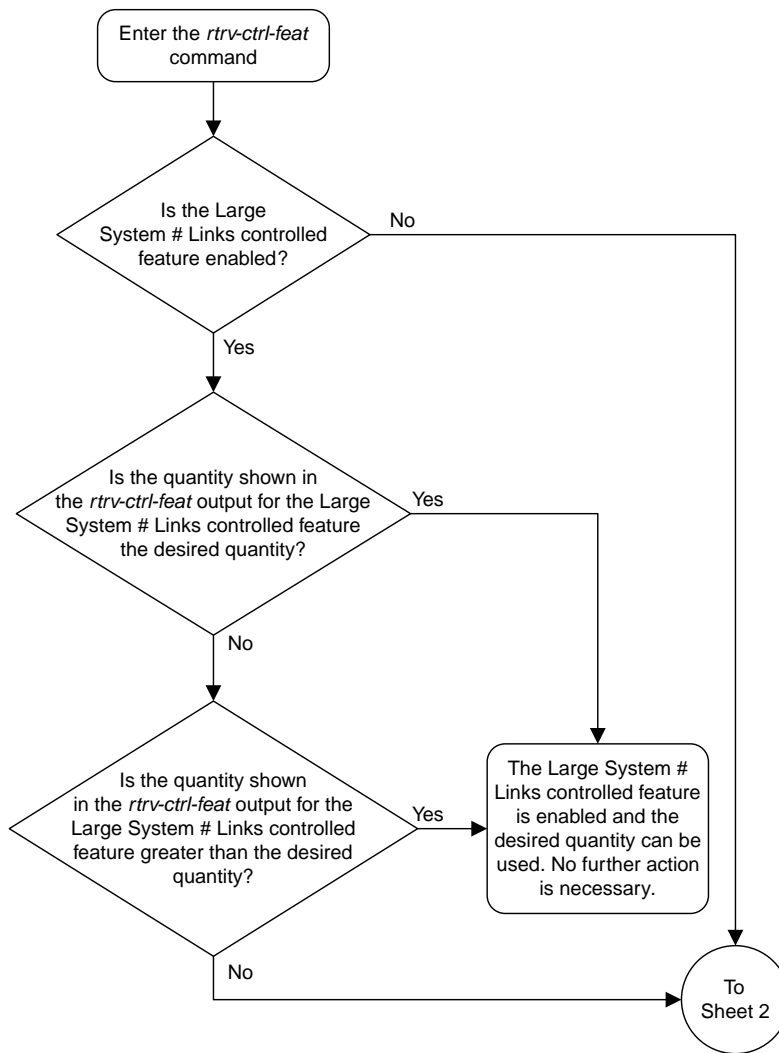

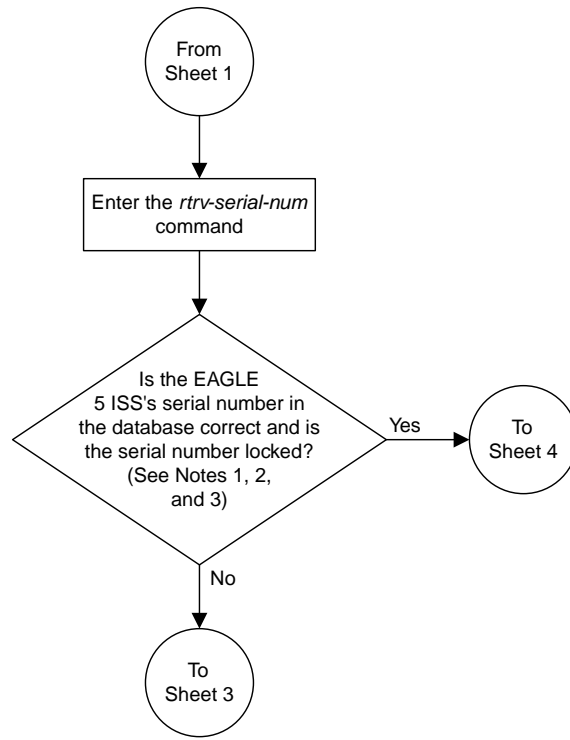

Notes:

1. If the serial number is locked, it cannot be changed.
2. If the serial number is not locked, the controlled feature cannot be enabled.
3. The serial number can be found on a label affixed to the control shelf (shelf 1100).

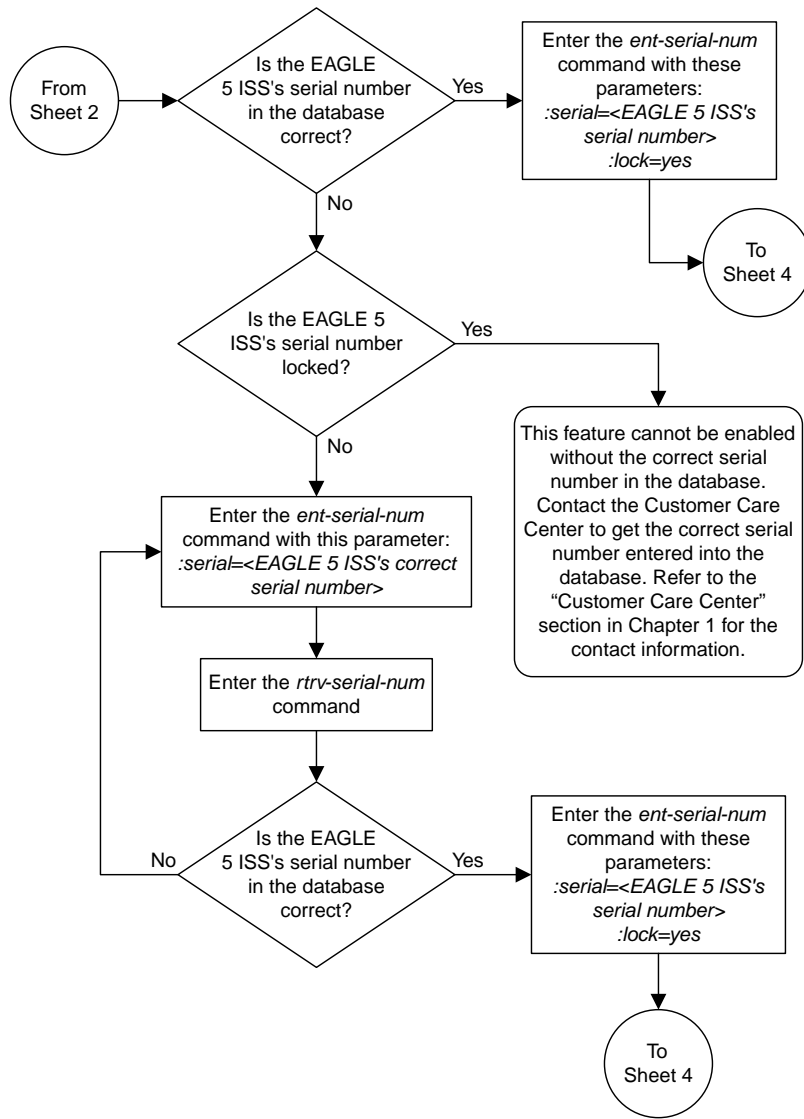

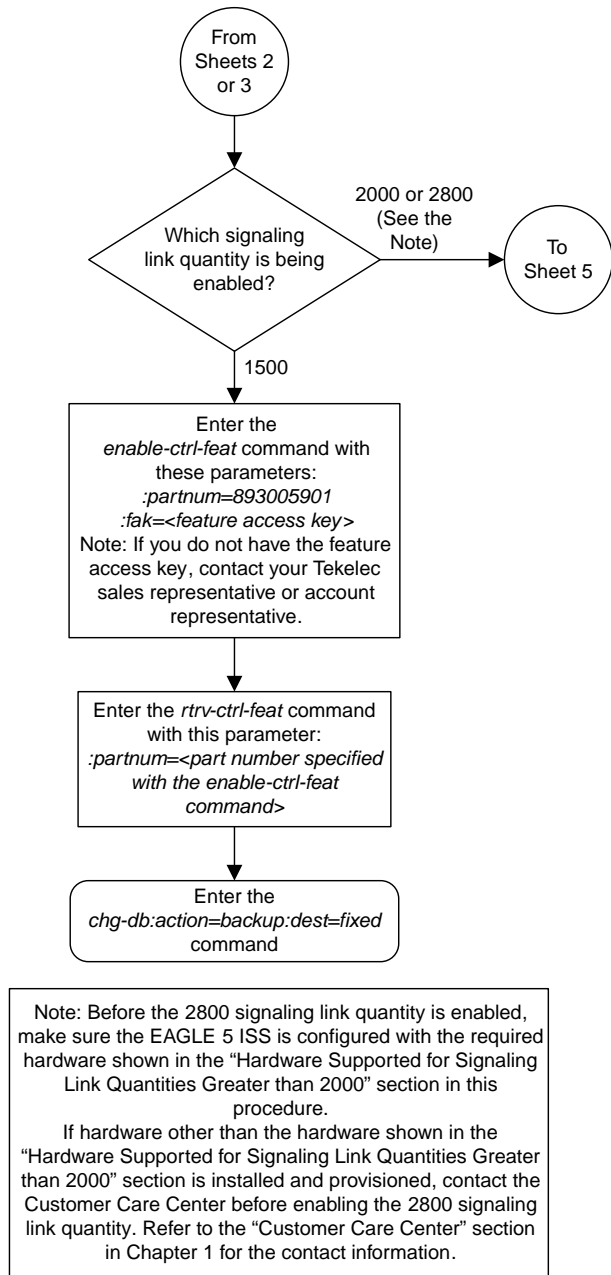

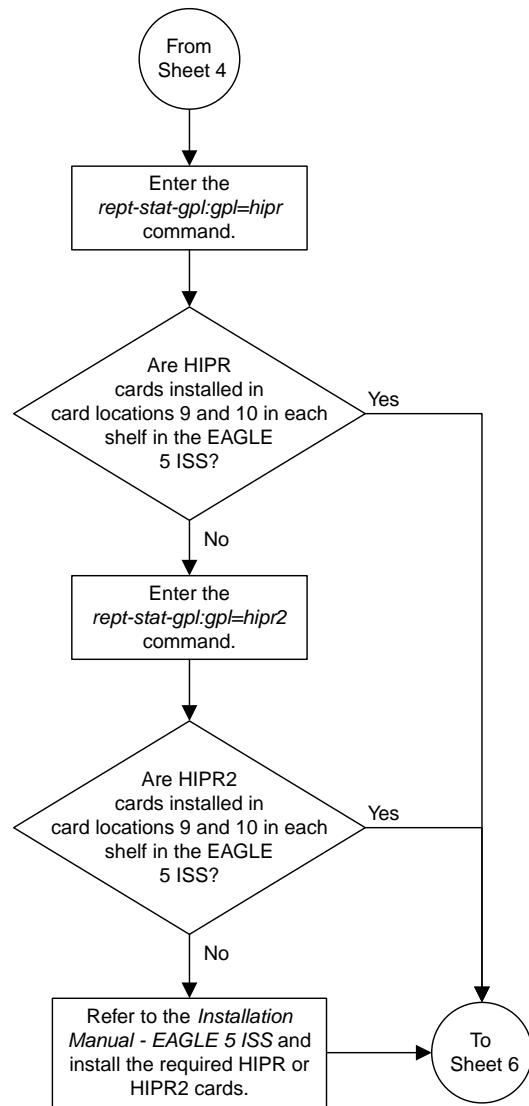

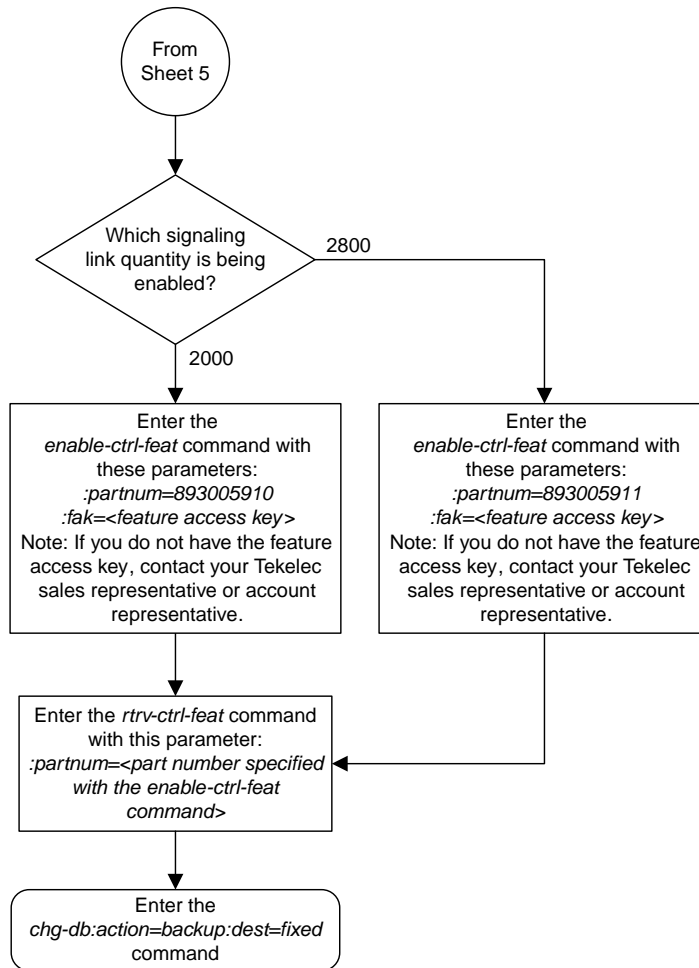

Sheet 6 of 6

Figure 124: Enabling the Large System # Links Controlled Feature

A

ANSI

American National Standards Institute

An organization that administers and coordinates the U.S. voluntary standardization and conformity assessment system. ANSI develops and publishes standards. ANSI is a non-commercial, non-government organization which is funded by more than 1000 corporations, professional bodies, and enterprises.

APC

Adjacent Point Code

The point code that identifies a node adjacent to the EAGLE. This term is used in link sets and routes.

Application Processing Chassis

AS

Action Set

Application Server

A logical entity serving a specific Routing Key. An example of an Application Server is a virtual switch element handling all call processing for a unique range of PSTN trunks, identified by an SS7 DPC/OPC/CIC_range. Another example is a virtual database element, handling all HLR transactions for a particular SS7 DPC/OPC/SCCP_SSN combination. The AS contains a set of one or more unique Application Server Processes, of which one or more normally is actively processing traffic.

A

Application Server

A logical entity that hosts and executes services in an IMS network, interfacing through SIP or a similar protocol.

Application Simulator

Test tool that can simulate applications and/or SMSCs.

Authentication Server

Authentication servers provide public access to certificates, and are integrated with electronic information retrieval systems to this end. Free access to certificates is necessary to support authentication in open systems.

ASCII

American Standard Code for Information Interchange

ASP

Abstract Service Primitive

Application Server Process

A process instance of an Application Server. An Application Server Process serves as an active or standby process of an Application Server (for example, part of a distributed virtual switch or database). Examples of ASPs are processes (or process instances of) MGCs, IP SCPs or IP HLRs. An ASP contains an SCTP end-point, and may be configured to process signaling traffic within more than one Application Server.

Application Service Part

Association

An association refers to an SCTP association. The association provides the transport for protocol

A

data units and adaptation layer peer messages.

ATM

Asynchronous Transfer Mode

A packet-oriented transfer mode that uses an asynchronous time division multiplexing technique to multiplex information flow in fixed blocks, called cells.

A high-bandwidth, low-delay switching, and multiplexing technology to support applications that include high-speed data, local area network interconnection, multimedia application and imaging, and residential applications such as video telephony and other information-based services.

ATMANSI

The application used for high-speed ANSI ATM signaling links.

ATMITU

The application used for high-speed E1 ATM signaling links.

B

BICC

Bearer Independent Call Control

C

CAP

Communication and Application Processor
CAMEL Application Part

Changeover

A network management event that routes traffic from a failed signaling link to another signaling link that can carry the traffic.

C

CIC	<p>Carrier Identification Code</p> <p>A 4-digit code that controls the routing applied to a message.</p> <p>Circuit Identification Code</p>
CICE	Ending Circuit Identification Code
CICS	Starting Circuit Identification Code
CLLI	<p>Common Language Location Identifier</p> <p>The CLLI uniquely identifies the STP in terms of its physical location. It is usually comprised of a combination of identifiers for the STP's city (or locality), state (or province), building, and traffic unit identity. The format of the CLLI is:</p> <ul style="list-style-type: none">• The first four characters identify the city, town, or locality• The first character of the CLLI must be an alphabetical character• The fifth and sixth characters identify state or province• The seventh and eighth characters identify the building• The last three characters identify the traffic unit
control cards	<p>Cards that occupy slots 1113 through 1118 of the control shelf on an EAGLE and perform OAM, TDM, and database functions for the EAGLE. The legacy set consists of the single-slot GPSM-II card running the OAM application and EOAM GPL, the single-slot TDM card, and the dual-slot MDAL card. The E5-based set consists of the dual-slot E5-MASP card (the</p>

C

E5-MCAP module and the E5-TDM module) and the dual-slot E5-MDAL card.

Cards that occupy slots 1113 through 1118 of the control shelf control cards on an EAGLE and perform basic OAM. The E5-based set consists of the dual-slot E5-MASP card (the E5-MCAP module and the E5-TDM module) and the dual-slot E5-MDAL card.

CPC

Capability Point Code

A capability point code used by the SS7 protocol to identify a group of functionally related STPs in the signaling network.

CRC

CAM Redundancy Controller

Cyclic Redundancy Check

A number derived from, and stored or transmitted with, a block of data in order to detect corruption. By recalculating the CRC and comparing it to the value originally transmitted, the receiver can detect some types of transmission errors.

D

DAUD

Destination Audit

DAVA

Destination Available

Destination

The node to which the signaling link traffic is routed. This destination is identified by a point code, either a full point code or a cluster point code.

D

DIX	Digital/Intel/Xerox DIX is de facto standard for Ethernet Media Access Control Type.
DN	Directory number A DN can refer to any mobile or wireline subscriber number, and can include MSISDN, MDN, MIN, or the wireline Dialed Number.
DNS	Domain Name Services Domain Name System A system for converting Internet host and domain names into IP addresses.
Domain	A group of computers and devices on a network that are administered as a unit with common rules and procedures. The network in which the destination entity or node exists, SS7.
DPC	Destination Point Code - DPC refers to the scheme in SS7 signaling to identify the receiving signaling point. In the SS7 network, the point codes are numeric addresses which uniquely identify each signaling point. This point code can be adjacent to the EAGLE, but does not have to be.
DPCN	Destination Point Code National
DRST	Destination Restricted

D

DTA	Database Transport Access - A feature in the EAGLE that encapsulates specific MSUs into the data portion of SCCP within a new SS7 MSU and sends the new MSU to the destination using global title translation. The EAGLE uses gateway screening to determine which MSUs are used by the DTA feature.
DUNA	Destination Unavailable
DUPU	Destination User Part Unavailable An M3UA management message.

E

E1	The European equivalent of T1 that transmits digital data over a telephone network at 2.048 Mbps.
E5-ENET	EPM-based Ethernet card A high capacity single-slot IP signaling card (EPM card plus Gig Ethernet PMC cards).
E5IS	EAGLE 5 Integrated Monitoring Support The EAGLE Integrated Monitoring Support feature allows the network traffic on the EAGLE's signaling links to be monitored by an ESP (extended services platform) or IMP (integrated message feeder) without additional intrusive cabling. Message Signaling Units (MSUs), alarms, and events are copied to the Sentinel/IMF to provide the network traffic monitoring. The monitored traffic is delivered to the Sentinel/IMF

E

using the EAGLE'S STCs (Signaling Transport Cards) which are connected to the ESP/IMF subsystem by Ethernet links. The ESP/IMF subsystem delivers the monitored traffic to the Sentinel/IMF.

E5-MASP card

E5-based dual-slot card that consists of the E5-MCAP module (occupies slot 1113 and slot 1115) and the E5-TDM module (occupies slot 1114 and slot 1116) in an EAGLE control shelf. Used when the E5-MDAL card is used.

E5-MCAP card

The module contains the Communications Processor and Applications Processor and provides connections to the IMT bus. Controls the maintenance and database administration activity and performs both application and communication processing. Runs the OAM application and OAMHC GPL. Occupies slot 1113 and slot 1115 in an EAGLE control shelf. Used when the E5-MDAL card is used. Contains two USB ports.

E5-MDAL card

The E5 MDAL card processes alarm requests, provides general purpose relays, and provides fan control. Occupies slots 1117 and 1118 in an EAGLE Control Shelf. Used with E5-MASP cards. Does NOT contain a drive for removable cartridges.

E5-SLAN

E5-ENET card used to support the STP LAN application.

E

E5-TDM card	The E5-TDM card provides the EAGLE with 16 ports for user terminals, contains fixed disk storage and distributes Composite Clocks and High Speed Master clocks throughout the EAGLE. Occupies slot 1114 and slot 1116 in an EAGLE Control Shelf. Used when the E5-MDAL card is used.
EDCM	Enhanced DCM Enhanced Database Communication Module
ENET	Ethernet Can refer to a generic hardware type that supports one or more Ethernet interfaces.

F

flush-mounted USB port	USB port on the E5-MCAP card; used with credit card flash memory drives for upgrades and could be used for disaster recovery.
------------------------	---

G

GPL	Generic Program Load Software that allows the various features in the system to work. GPLs and applications are not the same software.
GTT	Global Title Translation A feature of the signaling connection control part (SCCP) of the SS7 protocol that the EAGLE uses to determine which service database to send the query message when an MSU enters the EAGLE and more information is needed to route the MSU. These service

G

databases also verify calling card numbers and credit card numbers. The service databases are identified in the SS7 network by a point code and a subsystem number.

H

HIPR2

High-Speed IMT Packet Router 2

A card that provides increased system throughput and traffic capacity on the existing Fibre-Channel ring. A high rate Fibre-Channel option of 2.5 Gbps is available when an EAGLE is provisioned with all HIPR2 cards. In a mixed topology where a HIPR2 is used in an EAGLE along with HMUX and HIPR, the Fibre-Channel ring runs at the lower rate of 1.0625 Gbps.

I

ICMP

Internet Control Message Protocol

ID

Identity
Identifier

IEEE

Institute of Electrical and Electronic Engineers

IETF

Internet Engineering Task Force
The Internet Engineering Task Force is an open international community of network designers, professional users, and manufacturers who promote the development and operations of the Internet.

IMF

Integrated Message Feeder

I

The IMF sits on the EAGLE and replicates the signaling data that is processed through the EAGLE to send to an off-board processor (the IXP in the case of IAS). Because it replicates the data (and doesn't introduce a new element in the path) it does not introduce any delay to the signaling and it does not create a separate footprint for a "probe" system.

IMT

Inter-Module-Transport

The communication software that operates the inter-module-transport bus on all cards except the LIMATM, DCM, DSM, and HMUX.

IP

Intelligent Peripheral

Internet Protocol - IP specifies the format of packets, also called datagrams, and the addressing scheme. The network layer for the TCP/IP protocol suite widely used on Ethernet networks, defined in STD 5, RFC 791. IP is a connectionless, best-effort packet switching protocol. It provides packet routing, fragmentation and re-assembly through the data link layer.

IP Address

The location of a device on a TCP/IP network. The IP Address is either a number in dotted decimal notation which looks something like (IPv4), or a 128-bit hexadecimal string such as (IPv6).

IPC

Internal Point Code

I

IPGWI	An application that is used by the SSEDCEM/E5-ENET card for IP point-to-multi-point connectivity within an ITU-I or ITU-N network. The system allows a maximum of 64 cards to be assigned the IPGWI application.
IPGWx	Point-to-multipoint MTP-User signaling (for example, ISUP, TCAP) over IP capability. Typically used for A link connectivity which require routing keys. Far End not required to support MTP3. The IPGWx GPLs (IPGWI, SS7IPGW) run on the SSEDCEM/E5-ENET cards.
IPLIM	The application used by the SSEDCEM/E5-ENET card for IP point-to-point connectivity for ANSI point codes.
IPLIMI	The application used by the SSEDCEM/E5-ENET card for IP point-to-point connectivity for ITU point codes.
IPLIMx	Point-to-point MTP3 and MTP3-User signaling over IP capability. Typically used for B-C-D links but can be used for A links but does not have routing key functionality. Far End required to support MTP3. The IPLIMx GPLs (IPLIMI, IPLIM) run on the SSEDCEM/E5-ENET cards.
IPNE	Internet Protocol Network Element
IPSP	IP Server Process

I

A process instance of an IP-based application. An IPSP is essentially the same as an ASP, except that it uses MU3A in a peer-to-peer fashion. Conceptually, an IPSP does not use the services of a signaling gateway.

IS-NR

In Service - Normal

ISUP

ISDN User Part

The ISDN-specific part of the transmission with additional information via a signaling channel between exchanges.

ITU

International Telecommunications Union

An organization that operates worldwide to allow governments and the private telecommunications sector to coordinate the deployment and operating of telecommunications networks and services. The ITU is responsible for regulating, coordinating and developing international telecommunications, and for harmonizing national political interests.

K

Key

For the ICNP feature, a unique DS value used to access a table entry, consisting of a number length and number type.

L

LAN

Local Area Network

A private data network in which serial transmission is used for

L

	<p>direct data communication among data stations located in the same proximate location. LAN uses coax cable, twisted pair, or multimode fiber.</p> <p>See also STP LAN.</p>
latched USB port	<p>On the E5-MCAP card, a USB port with a lockable latch. Used with removable media (flash memory "thumb" drives) to install and back up customer data.</p>
LIM	<p>Link Interface Module</p> <p>Provides access to remote SS7, IP, and other network elements such as a Signaling Control Point (SCP) through a variety of signaling interfaces (DS0, MPL, E1/T1 MIM, LIM-ATM, E1-ATM, IPLIMx, IPGWx). The LIMs consist of a main assembly and possibly, an interface appliqué board. These appliqué boards provide level one and some level two functionality on SS7 signaling links.</p>
Link	<p>Signaling Link</p> <p>Carries signaling within a Link Set using a specific Association. A Link can belong to only one Link Set and one Association. There is generally one Link per Association in a Link Set.</p>
LNP	<p>Local Number Portability</p> <p>The ability of subscribers to switch local or wireless carriers and still retain the same phone number.</p>

L

LSN
Link Set Name
The name of the link set.

M

M2PA
SS7 MTP2-User Peer-to-Peer
Adaptation Layer

M3UA
SS7 MTP3-User Adaptation Layer
M3UA enables an MTP3 User Part
to be connected to a remote MTP3
via a reliable IP transport.

MAP
Mated Application Part
Mobile Application Part
An application part in SS7
signaling for mobile
communications systems.

MAS
Maintenance and Administration
Subsystem
A set of cards located in the Control
Shelf, used to provide a central
management point for the EAGLE.
The MAS provides user interface,
maintenance communication,
peripheral services, alarm
processing, system disk interface,
and measurements using the
following three subassemblies:
GPSM-II, TDM, and MDAL.

MASP
Maintenance and Administration
Subsystem Processor
The Maintenance and
Administration Subsystem
Processor (MASP) function is a
logical pairing of the GPSM-II card
and the TDM card. The GPSM-II
card is connected to the TDM card

M

by means of an Extended Bus Interface (EBI) local bus.

The MDAL card contains the removable cartridge drive and alarm logic. There is only one MDAL card in the Maintenance and Administration Subsystem (MAS) and it is shared between the two MASPs.

MFC

Message Flow Control

MFC controls all traffic across the IMT bus. With MFC, an EAGLE card can inform all EAGLE cards that it has reached the allotted capacity of a particular advertised service.

MGC

Media Gateway Controller

A system used in certain Voice over IP telephony architectures.

MIB

Management Information Database

A database of network management information that is used and maintained by the SNMP protocol.

MSU

Message Signal Unit

The SS7 message that is sent between signaling points in the SS7 network with the necessary information to get the message to its destination and allow the signaling points in the network to set up either a voice or data connection between themselves. The message contains the following information:

- The forward and backward sequence numbers assigned to

M

the message which indicate the position of the message in the traffic stream in relation to the other messages.

- The length indicator which indicates the number of bytes the message contains.
- The type of message and the priority of the message in the signaling information octet of the message.
- The routing information for the message, shown in the routing label of the message, with the identification of the node that sent message (originating point code), the identification of the node receiving the message (destination point code), and the signaling link selector which the EAGLE uses to pick which link set and signaling link to use to route the message.

MTP

Message Transfer Part

The levels 1, 2, and 3 of the SS7 protocol that control all the functions necessary to route an SS7 MSU through the network

Module Test Plan

MTP2

Message Transfer Part, Level 2

MTP3

Message Transfer Part, Level 3

MTPP

MTP Primitives

Messages that the IPGWx application generates to communicate SS7 network management events (SNMs) to IP-attached network elements.

M

Multiple Point Code See MPC.

N

NI Network Indicator

NMS Network Management System
 An NMS is typically a standalone device, such as a workstation, that serves as an interface through which a human network manager can monitor and control the network. The NMS usually has a set of management applications (for example, data analysis and fault recovery applications).

O

OAM Operations, Administration, and Maintenance. These functions are generally managed by individual applications and not managed by a platform management application, such as PM&C.

Operations – Monitoring the environment, detecting and determining faults, and alerting administrators.

Administration – Typically involves collecting performance statistics, accounting data for the purpose of billing, capacity planning, using usage data, and maintaining system reliability.

Maintenance – Provides such functions as upgrades, fixes, new feature enablement, backup and restore tasks, and monitoring media health (for example, diagnostics).

OOS-MT Out of Service - Maintenance

O

The entity is out of service and is not available to perform its normal service function. The maintenance system is actively working to restore the entity to service.

OOS-MT-DSBLD

Out of Service - Maintenance Disabled

The entity is out of service and the maintenance system is preventing the entity from performing its normal service function.

OPC

Within an SS7 network, the point codes are numeric addresses which uniquely identify each signaling point. The OPC identifies the sending signaling point.

P

PST

Primary State

A field in the rept-stat command outputs showing the primary state of the specified entity.

PSTN

Public Switched Telephone Network.

A public communication system for voice communication between remote subscribers.

R

RC

Relative Cost
Restriction Criteria
Resource Controller

removable media

Flash memory or "thumb" drives used in the latched USB port on an

R

E5-MCAP card for installation and backup of customer data.

RFC

Request for Comment

RFCs are standards-track documents, which are official specifications of the Internet protocol suite defined by the Internet Engineering Task Force (IETF) and its steering group the IESG.

Route

A signaling path from an LSP to an RSP using a specified Link Set.

Routing Key

A set of SS7 parameter and parameter values that uniquely define the range of signaling traffic to be handled by a particular Application Server. For example, where all traffic directed to an SS7 DPC, OPC, and ISUP CIC_range(s), or SCCP SSN is to be sent to a particular Application Server, that SS7 data defines the associated Routing Key.

S

SAPC

Secondary Adjacent Point Code

SCCP

Signaling Connection Control Part

The signaling connection control part with additional functions for the Message Transfer Part (MTP) in SS7 signaling. Messages can be transmitted between arbitrary nodes in the signaling network using a connection-oriented or connectionless approach.

S

SCMG	<p>SCCP Management</p> <p>SCMG manages the status of subsystems and SCCP-capable signaling points (SPs). It maintains the status of remote SCCP SPs and that of local subsystems.</p>
SCN	<p>Switched Circuit Network</p> <p>A network that carries traffic within channelized bearers of predefined sizes. Examples include Public Switched Telephone Networks (PSTNs) and Public Land Mobile Networks (PLMNs). Examples of signaling protocols used in SCN include Q.931, SS7 MTP Level 3, and SS7 Application/User parts.</p>
SCON	<p>Signaling Congested</p>
SCP	<p>Secure Copy</p> <p>Service Control Point</p> <p>SCPs are network intelligence centers where databases or call processing information is stored. The primary function of SCPs is to respond to queries from other SPs by retrieving the requested information from the appropriate database, and sending it back to the originator of the request.</p>
SCTP	<p>Stream Control Transmission Protocol</p> <p>An IETF transport layer protocol, similar to TCP, that sends a message in one operation. The transport layer for all standard IETF-SIGTRAN protocols.</p>

S

SCTP is a reliable transport protocol that operates on top of a connectionless packet network such as IP and is functionally equivalent to TCP. It establishes a connection between two endpoints (called an association; in TCP, these are sockets) for transmission of user messages.

SEAS

Signaling Engineering and Administration System

An interface defined by Bellcore and used by the Regional Bell Operating Companies (RBOCs), as well as other Bellcore Client Companies (BCCs), to remotely administer and monitor the signaling points in their network from a central location.

SEP

Signaling End Point

A node in an SS7 network that originates or terminates signaling messages. One example is a central office switch.

SG

Secure Gateway

Signaling Gateway

A network element that receives/sends SCN native signaling at the edge of the IP network. The SG function may relay, translate or terminate SS7 signaling in an SS7-Internet Gateway. The SG function may also be coresident with the MG function to process SCN signaling associated with line or trunk terminations controlled by the MG (for example, signaling backhaul). A Signaling Gateway could be modeled as one

S

or more Signaling Gateway Processes, which are located at the border of the SS7 and IP networks. Where an SG contains more than one SGP, the SG is a logical entity and the contained SGPs are assumed to be coordinated into a single management view to the SS7 network and to the supported Application Servers.

SGP	<p>Signaling Gateway Process</p> <p>A process instance of a Signaling Gateway. It serves as an active, backup, load-sharing, or broadcast process of a Signaling Gateway [RFC 4666].</p>
SI	<p>Service Indicator</p>
SIF	<p>Service Information Field</p> <p>MTP Service Information Field is the payload field of an SS7 MSU header. The first byte of the SIF is the start of the MTP3 routing label. For MTP3-variant networks, the maximum SIF size is 272 bytes. For MTP3b-variant networks, the maximum SIF size is 4095 bytes.</p>
Signaling Link	<p>The transmission path connecting the EAGLE to other signaling points in the network and providing access to ANSI SS7 and ITU SS7 network elements. The signaling link is connected to the EAGLE at the link interface module (LIM).</p>
Simple Network Management Protocol	<p>See SNMP.</p>

S

SIO	<p>Service Information Octet</p> <p>The network indicator code (NIC), priority (PRI), and service indicator (SI) in the SIO field in the message signaling unit (MSU). This information identifies the type of MSU (ISUP, TCAP, and so forth) that is allowed in the network where the EAGLE is located.</p>
SLC	<p>Signaling Link Code</p>
SLIC	<p>Service and Link Interface Card</p> <p>A single-slot, multi-use card with the same functionality as the E5-ENET-B card running the IPSP application.</p>
SLS	<p>Signaling Link Selector</p>
SNM	<p>Signaling Network Management</p> <p>The set of networking cards and the shared database of dynamic network status information that they collectively maintain.</p> <p>The messages that maintain MTP status level 3 of SS7.</p>
SNMP	<p>Simple Network Management Protocol.</p> <p>An industry-wide standard protocol used for network management. The SNMP agent maintains data variables that represent aspects of the network. These variables are called managed objects and are stored in a management information base (MIB). The SNMP protocol</p>

S

arranges managed objects into groups.

Spare Point Code

The EAGLE ITU International/National Spare Point Code feature allows a network operator to use the same Point Codes across two networks (either ITU-I or ITU-N). The feature also enables National and National Spare traffic to be routed over the same linkset. The EAGLE uses the MSU Network Indicator (NI) to differentiate the same point code of one network from the other. In accordance with the SS7 standard, unique Network Indicator values are defined for Point Code types ITU-I, ITU-N, ITU-I Spare, and ITU-N Spare.

SPC

Secondary Point Code

The SPC enables the EAGLE to assume more than one point code for SS7 routing. The EAGLE uses the SPC for routing and provisioning as if the SPC were an actual point code of the EAGLE. The EAGLE supports one ANSI true point code and up to seven secondary point codes.

Service Provisioning over COPS (Common Open Policy Service protocol)

Signaling Point Code

Spare Point Code

Stored Program Control

SS

Subsystem

Supplementary Services

SS7

Signaling System #7

S

A communications protocol that allows signaling points in a network to send messages to each other so that voice and data connections can be set up between these signaling points. These messages are sent over its own network and not over the revenue producing voice and data paths. The EAGLE is an STP, which is a device that routes these messages through the network.

SS7IPGW

SS7 IP Gateway

An application used by the DCM/SSEDCM card for IP point-to-multipoint capability within an ANSI network.

SSN

SS7 Subsystem Number

The subsystem number of a given point code. The subsystem number identifies the SCP application that should receive the message, or the subsystem number of the destination point code to be assigned to the LNP subsystem of the EAGLE.

Subsystem Number

A value of the routing indicator portion of the global title translation data commands indicating that no further global title translation is required for the specified entry.

Subsystem Number

Used to update the CdPA.

SSP

Subsystem Prohibited network management message

S

Subsystem Prohibited SCCP (SCMG) management message. (CER)

Service Switching Point (SS7 Network)

Signal Switching Point

Signal Switching Points are switches that originate, terminate, or tandem calls. An SSP sends signaling messages to other SSPs to setup, manage, and release voice circuits required to complete a call.

SST

Secondary State

The secondary state of the specified entity.

Subsystem Status Test

Subsystem Status Test network management message.

Subsystem Status Test SCCP (SCMG) management message. (CER)

STC

Sentinel Transport Card

Signaling Transport Card

The Signaling Transport Card (STC) is a member of the DCM card family with an "eroute" generic program load (GPL) installed. The STCs provide the IP interface between the LIM cards on the IMT bus and the Signaling Extended Services Platform (ESP) subassembly. The STC is used for sending MSU data to the ESP/IMF.

STP

Signal Transfer Point

The STP is a special high-speed switch for signaling messages in SS7 networks. The STP routes core

S

INAP communication between the Service Switching Point (SSP) and the Service Control Point (SCP) over the network.

Spanning Tree Protocol

STPLAN

Signaling Transfer Point Local Area Network

The application used by the SLAN card and E5-SLAN card to support the STP LAN feature. This application does not support 24-bit ITU-N point codes.

SUA

SCCP User Adaptation Layer

A protocol for the transport of any SCCP-User signaling over IP using the SCTP. The protocol is designed to be modular and symmetric, to allow it to work in diverse architectures.

Subsystem Number

See SSN.

T

T1

Transmission Level 1

A T1 interface terminates or distributes T1 facility signals for the purpose of processing the SS7 signaling links carried by the E1 carrier.

A leased-line connection capable of carrying data at 1,544,000 bits-per-second.

TCA

Transfer Cluster Allowed

T

TCAP	Transaction Capabilities Application Part A protocol in the SS7 protocol suite that enables the deployment of advanced intelligent network services by supporting non-circuit related information exchange between signaling points using the Signaling Connection Control Part connectionless service. TCAP also supports remote control - ability to invoke features in another remote network switch.
TCP	Transfer-Cluster-Prohibited Transfer Control Protocol Transmission Control Protocol A connection-oriented protocol used by applications on networked hosts to connect to one another and to exchange streams of data in a reliable and in-order manner.
TFA	TransFer Allowed (Msg)
TFC	Transfer Control TransFer Controlled (Msg) Transfer Congested
TPC	True Point Code
TPS	Transactions Per Second A method of measuring how quickly a network can transmit and receive data. Capacities listed with "TPS" units involve the maximum of the receive rate and the transmit rate, and the worst-case assumption is that the transmit and

T

receive rates are the same. Under the TU model, transaction units per second are calculated with the total transaction unit value and the advertised card capacity.

TSPC True or Secondary Point Code

TUP Telephone User Part

U

UA ETF User Adaptation Layers
User Agent

UAM Unsolicited Alarm Message
A message sent to a user interface whenever there is a fault that is service-affecting or when a previous problem is corrected. Each message has a trouble code and text associated with the trouble condition.

UDP User Datagram Protocol

UIM Unsolicited Information Message
A message sent to a user interface whenever there is a fault that is not service-affecting or when a previous problem is corrected. Each message has a trouble code and text associated with the trouble condition.

UPU User Part Unavailable
An MTP3 management message.

U

USB port

Receptacle for flash memory drives on personal computers. On the E5-MDAL card, a flush-mounted USB port used with credit card flash memory drives for upgrade. On the E5-MCAP card, a latched USB port for use with flash memory "thumb" drives for installation and backup of customer data.

X

XCA

Extended Changeover Acknowledgment (Msg)

XCO

Extended Changeover Order (Msg)