

**Oracle**  
**Real-Time Scheduler**  
Administrative User Guide  
Release 2.3.0.2.0  
**E92639-01**

January 2018

Oracle Real-Time Scheduler Administrative User Guide

Release 2.3.0.2.0

E92639-01

January 2018

Documentation build: 1.5.2018 13:9:36 [M1\_1515175776000]

Copyright © 2018, Oracle and/or its affiliates. All rights reserved.

This software and related documentation are provided under a license agreement containing restrictions on use and disclosure and are protected by intellectual property laws. Except as expressly permitted in your license agreement or allowed by law, you may not use, copy, reproduce, translate, broadcast, modify, license, transmit, distribute, exhibit, perform, publish, or display any part, in any form, or by any means. Reverse engineering, disassembly, or decompilation of this software, unless required by law for interoperability, is prohibited.

The information contained herein is subject to change without notice and is not warranted to be error-free. If you find any errors, please report them to us in writing.

If this is software or related documentation that is delivered to the U.S. Government or anyone licensing it on behalf of the U.S. Government, then the following notice is applicable:

U.S. GOVERNMENT END USERS: Oracle programs, including any operating system, integrated software, any programs installed on the hardware, and/or documentation, delivered to U.S. Government end users are "commercial computer software" pursuant to the applicable Federal Acquisition Regulation and agency-specific supplemental regulations. As such, use, duplication, disclosure, modification, and adaptation of the programs, including any operating system, integrated software, any programs installed on the hardware, and/or documentation, shall be subject to license terms and license restrictions applicable to the programs. No other rights are granted to the U.S. Government.

This software or hardware is developed for general use in a variety of information management applications. It is not developed or intended for use in any inherently dangerous applications, including applications that may create a risk of personal injury. If you use this software or hardware in dangerous applications, then you shall be responsible to take all appropriate fail-safe, backup, redundancy, and other measures to ensure its safe use. Oracle Corporation and its affiliates disclaim any liability for any damages caused by use of this software or hardware in dangerous applications.

Oracle and Java are registered trademarks of Oracle and/or its affiliates. Other names may be trademarks of their respective owners. Intel and Intel Xeon are trademarks or registered trademarks of Intel Corporation. All SPARC trademarks are used under license and are trademarks or registered trademarks of SPARC International, Inc. AMD, Opteron, the AMD logo, and the AMD Opteron logo are trademarks or registered trademarks of Advanced Micro Devices. UNIX is a registered trademark of The Open Group.

This software or hardware and documentation may provide access to or information about content, products, and services from third parties. Oracle Corporation and its affiliates are not responsible for and expressly disclaim all warranties of any kind with respect to third-party content, products, and services unless otherwise set forth in an applicable agreement between you and Oracle. Oracle Corporation and its affiliates will not be responsible for any loss, costs, or damages incurred due to your access to or use of third-party content, products, or services, except as set forth in an applicable agreement between you and Oracle.

# Contents

<b>Framework Administrative User Guide.....</b>	<b>17</b>
Defining General Options.....	17
Defining Installation Options.....	17
Installation Options - Main.....	17
Installation Options - Messages.....	18
Installation Options - Algorithms.....	18
Installation Options - Accessible Modules.....	20
Installation Options - Installed Products.....	20
Support For Different Languages.....	21
User Language.....	21
Customer Language.....	22
Defining Languages.....	22
Defining Countries.....	23
Country - Main.....	23
Country - States.....	23
Defining Currency Codes.....	24
Defining Time Zones.....	24
Designing Time Zones.....	24
Setting Up Time Zones.....	25
Setting Up Seasonal Time Shift.....	25
Defining Geographic Types.....	26
Defining Work Calendar.....	26
Defining Display Profiles.....	27
Additional Hijri Date Configuration.....	29
Defining Phone Types.....	29
Setting Up Characteristic Types & Values.....	29
There Are Four Types Of Characteristics.....	29
Searching By Characteristic Values.....	30
Characteristic Type - Main.....	31
Characteristic Type - Characteristic Entities.....	32
Setting Up Foreign Key Reference Information.....	32
Information Description Is Dynamically Derived.....	33
Navigation Information Is Dynamically Derived.....	33
Search Options.....	33
Foreign Key Reference - Main.....	34
Defining Feature Configurations.....	35
Feature Configuration - Main.....	35
Feature Configuration - Messages.....	36
Defining Master Configurations.....	36
Defining Security & User Options.....	37
The Big Picture of Application Security.....	37
Application Security.....	37
Action Level Security.....	39
Field Level Security.....	39
Encryption and Masking.....	40
User Interface Masking.....	40
Database Encryption and Masking.....	44
The Base Package Controls One User, One User Group, And Many Application Services.....	46
Importing Security Configuration from an External Source.....	47
The Big Picture of Row Security.....	47
Defining Application Services.....	48
Application Service - Main.....	48
Application Service - Application Security.....	48
Defining Security Types.....	48
Security Type - Main.....	49
Defining User Groups.....	49
User Group - Main.....	49
User Group - Application Services.....	50

User Group - Users.....	50
Defining Access Groups.....	51
Defining Data Access Roles.....	51
Data Access Role - Main.....	51
Data Access Role - Access Group.....	52
Defining Users.....	52
User Interface Tools.....	52
Defining Menu Options.....	52
Menu - Main.....	53
Menu - Menu Items.....	54
The Big Picture of System Messages.....	55
Defining System Messages.....	55
Message - Main.....	55
Message - Details.....	56
The Big Picture of Portals and Zones.....	57
There Are Three Types of Portals.....	57
Common Characteristics of All Portals.....	57
Portals Are Made Up of Zones.....	57
Configuring Zones for a Portal.....	58
Granting Access to Zones.....	58
Common Characteristics of Stand-Alone Portals.....	59
Putting Portals on Menus.....	59
Granting Access to A Portal.....	59
Custom Look and Feel Options.....	60
User Interface.....	60
UI Map Help.....	60
Setting Up Portals and Zones.....	61
Defining Zone Types.....	61
Defining Zones.....	62
Zone - Main.....	62
Zone - Portal.....	63
Zone Configuration Topics.....	63
Defining Context-Sensitive Zones.....	85
Defining Portals.....	86
Portal - Main.....	86
Portal - Options.....	87
Defining Display Icons.....	87
Defining Navigation Keys.....	88
Navigation Key Types.....	88
Navigation Key vs. Navigation Option.....	88
The Flexibility of Navigation Keys.....	89
Linking to External Locations.....	89
Overriding Navigation Keys.....	89
Maintaining Navigation Keys.....	89
Defining Navigation Options.....	91
Navigation Option - Main.....	91
Navigation Option - Tree.....	93
Database Tools.....	93
Defining Table Options.....	93
Table - Main.....	93
Table - Table Field.....	95
Table - Constraints.....	96
Table - Referred by Constraints.....	97
Defining Field Options.....	97
Field - Main.....	98
Field - Tables Using Field.....	99
Defining Maintenance Object Options.....	99
Maintenance Object - Main.....	99
Maintenance Object - Options.....	100
Maintenance Object - Algorithms.....	100
Maintenance Object - Maintenance Object Tree.....	102
Defining Valid Values.....	102
Defining Lookup Options.....	103
Lookup - Main.....	104

Defining Extendable Lookups.....	105
Defining Additional Attributes.....	105
The Big Picture Of Audit Trails.....	106
Captured Information.....	106
How Auditing Works.....	107
The Audit Trail File.....	107
How To Enable Auditing.....	108
Turn On Auditing For a Table.....	108
Specify The Fields and Actions To Be Audited.....	108
Audit Queries.....	109
Audit Query by User.....	109
Audit Query by Table / Field / Key.....	109
Bundling.....	110
About Bundling.....	111
Sequencing of Objects in a Bundle.....	111
Recursive Key References.....	111
Owner Flags on Bundled Entities.....	111
Configuring Maintenance Objects for Bundling.....	112
Making Maintenance Objects Eligible for Bundling.....	112
Adding a Foreign Key Reference.....	112
Creating a Physical Business Object.....	112
Creating a Bundling Add Business Object.....	113
Adding the Current Bundle Zone.....	113
Adding a Customized Entity Search Query Zone to the Bundle Export Portal.....	113
Working with Bundles.....	114
Creating Export Bundles.....	114
Creating and Applying Import Bundles.....	115
Editing Export Bundles.....	116
Editing Import Bundles.....	116
Revision Control.....	116
About Revision Control.....	116
Turning On Revision Control.....	117
Configuring Maintenance Objects for Revision Control.....	117
Working with the Revision Control Zones.....	118
Checking Out an Object.....	118
Checking In an Object.....	118
Reverting Changes.....	119
Forcing a Check In or Restore.....	119
Deleting an Object.....	119
Restoring an Object.....	119
Working with the Revision Control Portal.....	120
Revision Control Search.....	120
Information Lifecycle Management .....	121
The Approach to Implementing Information Lifecycle Management.....	121
Batch Processes.....	122
Eligibility Algorithm.....	123
Enabling ILM for Supported Maintenance Objects.....	123
Ongoing ILM Tasks.....	124
Archived Foreign Keys.....	125
Configuration Tools.....	125
Business Objects.....	125
The Big Picture of Business Objects.....	125
What Is A Business Object?.....	125
Business Object Inheritance.....	131
Each Business Object Can Have A Different Lifecycle.....	132
BO Algorithm Execution Summary.....	139
Granting Access To Business Objects.....	140
Defining Business Objects.....	140
Business Object - Main.....	141
Business Object - Schema.....	142
Business Object - Algorithms.....	142
Business Object - Lifecycle.....	144
Business Object - Summary.....	147
Advanced BO Tips and Techniques.....	147

Managing To Do Entries.....	147
Submitting a Batch Job.....	148
Defining Status Reasons.....	148
Business Services.....	148
Service Program.....	149
Defining Business Services.....	149
Business Service - Main.....	149
Business Service - Schema.....	150
Useful Services and Business Services.....	151
User Interface (UI) Maps.....	154
Defining UI Maps.....	156
UI Map - Main.....	156
UI Map - Schema.....	157
UI Map Attributes and Functions.....	158
UI Map Standards.....	215
Ensuring Unique Element IDs for UI Maps.....	227
Maintaining Managed Content.....	227
Managed Content - Main.....	227
Managed Content - Schema.....	228
Data Areas.....	228
Defining Data Areas.....	228
Data Area - Main.....	228
Data Area - Schema.....	229
Advanced Schema Topics.....	229
Schema Nodes and Attributes.....	230
UI Hint Syntax.....	249
Schema Designer.....	257
Schema Viewer.....	258
Business Event Log.....	259
Miscellaneous Topics.....	259
Module Configuration.....	259
Menu Item Suppression.....	260
Menu Suppression.....	260
Turn Off A Function Module.....	260
Global Context Overview.....	261
System Data Naming Convention.....	261
Base Product System Data.....	261
Implementation System Data.....	262
URI Validation and Substitution.....	262
Caching Overview.....	263
Server Cache.....	263
Batch Cache.....	263
Client Cache.....	264
Expression Parser.....	264
Debug Mode.....	266
System Override Date.....	267
Advanced Search Options.....	267
To Do Lists.....	268
The Big Picture of To Do Lists.....	268
To Do Entries Reference A To Do Type.....	268
To Do Entries Reference A Role.....	268
To Do Entries Can Be Rerouted (Or Suppressed) Based On Message Number.....	269
The Priority Of A To Do Entry.....	270
Working On A To Do Entry.....	270
Launching Scripts When A To Do Is Selected.....	270
To Do Entries Have Logs.....	271
How Are To Do Entries Created?.....	271
To Do Entries Created By Background Processes.....	271
To Do Entries Created By Algorithms.....	273
To Do Entries Created Manually.....	273
The Lifecycle Of A To Do Entry.....	274
Linking Additional Information To A To Do Entry.....	274
Implementing Additional To Do Entry Business Rules.....	275
To Do Entries May Be Routed Out Of The System.....	275

Periodically Purging To Do Entries.....	275
Setting Up To Do Options.....	275
Installation Options.....	276
To Do Information May Be Formatted By An Algorithm.....	276
Set Additional Information Before A To Do Is Created.....	276
Alerts.....	276
Next Assignment Algorithm.....	276
Messages.....	276
Feature Configuration.....	277
Defining To Do Roles.....	277
To Do Role - Main.....	277
To Do Role - To Do Types.....	278
Defining To Do Types.....	278
To Do Type - Main.....	278
To Do Type - Roles.....	279
To Do Type - Sort Keys.....	279
To Do Type - Drill Keys.....	280
To Do Type - Message Overrides.....	280
To Do Type - To Do Characteristics.....	280
To Do Type - Algorithms.....	281
List of System To Do Types.....	282
Implementing The To Do Entries.....	282
Background Processes.....	282
Understanding Background Processes.....	283
Background Processing Overview.....	283
Parallel Background Processes.....	284
Optimal Thread Count.....	285
Parameters Supplied To Background Processes.....	285
Indicating a File Path.....	288
Processing Errors.....	288
Error Post-Processing Logic.....	288
Post-Processing Logic.....	289
Timed Batch Processes.....	289
Monitor Background Processes.....	289
Plug-in Driven Background Processes.....	290
How to Re-extract Information.....	293
How to Submit Batch Jobs.....	293
How to Track Batch Jobs.....	293
How to Restart Failed Jobs and Processes.....	293
Assessing Level of Service.....	293
System Background Processes.....	294
Defining Batch Controls.....	294
Batch Control - Algorithms.....	296
On-Line Batch Submission.....	297
Batch Submission Creates a Batch Run.....	297
Jobs Submitted in the Background.....	297
Email Notification.....	298
Running Multi-Threaded Processes.....	298
Batch Jobs May End in Error.....	298
Submitting Jobs in the Future.....	298
Lifecycle of a Batch Job Submission.....	299
Granting Access To Batch Submission.....	299
Batch Job Submission - Main.....	299
Tracking Batch Processes.....	301
Batch Run Tree - Main.....	301
Batch Run Tree - Run Control.....	302
Service Health Check.....	303
The Big Picture of Requests.....	304
Request Type Defines Parameters.....	304
Previewing and Submitting a Request .....	304
To Do Summary Email.....	304
Exploring Request Data Relationships.....	305
Defining a New Request.....	305
Setting Up Request Types.....	305

Maintaining Requests.....	305
Defining Algorithms.....	306
The Big Picture Of Algorithms.....	306
Algorithm Type Versus Algorithm.....	306
How To Add A New Algorithm.....	307
Minimizing The Impact Of Future Upgrades.....	307
Setting Up Algorithm Types.....	308
List of Algorithm Types.....	309
Setting Up Algorithms.....	309
Defining Script Options.....	310
The Big Picture Of Scripts.....	310
Scripts Are Business Process-Oriented.....	310
A Script Is Composed Of Steps.....	310
A Script May Declare Data Areas.....	310
Securing Script Execution.....	311
The Big Picture Of BPA Scripts.....	311
How To Invoke Scripts.....	312
Developing and Debugging Your BPA Scripts.....	312
Launching A Script From A Menu.....	312
Launching A Script When Starting The System.....	312
Executing A Script When A To Do Entry Is Selected.....	314
The Big Picture Of Script Eligibility Rules.....	314
Script Eligibility Rules Are Not Strictly Enforced.....	314
You Can Mark A Script As Always Eligible.....	315
You Can Mark A Script As Never Eligible.....	315
Criteria Groups versus Eligibility Criteria.....	315
Defining Logical Criteria.....	316
Examples Of Script Eligibility Rules.....	316
The Big Picture Of Server-Based Scripts.....	318
Additional Coding Options For Server Scripts.....	318
Using Groovy Within Scripts.....	319
Plug-In Scripts.....	320
A Plug-In Script's API.....	320
Setting Up Plug-In Scripts.....	321
Service Scripts.....	321
A Service Script's API.....	321
Invoking Service Scripts.....	321
Groovy Library Scripts.....	322
A Groovy Library Script's API.....	322
Invoking Groovy Library Methods.....	322
Debugging Server-Based Scripts.....	322
Maintaining Scripts.....	322
Script - Main.....	322
Script - Step.....	324
How To Set Up Each Step Type.....	325
Additional Topics.....	356
Script - Data Area.....	363
Script - Schema.....	364
Script - Eligibility.....	364
Merging Scripts.....	366
Script Merge.....	367
Maintaining Functions.....	369
Function - Main.....	369
Function - Send Fields.....	370
Function - Receive Fields.....	371
Attachments.....	371
Attachment Overview.....	372
Configuring Your System for Attachments.....	372
Maintaining Attachments.....	373
Adding Attachments.....	374
Application Viewer.....	374
Application Viewer Toolbar.....	374
Data Dictionary Button.....	374
Physical and Logical Buttons.....	375



Collapse Button.....	375
Attributes and Schema Button.....	375
Maintenance Object Button.....	375
Algorithm Button.....	376
Batch Control Button.....	376
To Do Type Button.....	376
Description and Code Buttons.....	376
Service XML Button.....	376
Select Service Button.....	377
Java Docs Button.....	377
Groovy Java Docs Button.....	377
Classic Button.....	377
Preferences Button.....	377
Help Button.....	377
About Button.....	378
Slider Icon.....	378
Data Dictionary.....	378
Using the Data Dictionary List Panel.....	378
Primary And Foreign Keys.....	379
Field Descriptions Shown.....	379
Using the Data Dictionary Detail Panel.....	379
Related Tables View.....	379
Table Detail View.....	380
Column Detail View.....	380
Maintenance Object Viewer.....	380
Using the Maintenance Object List Panel.....	381
Using the Maintenance Object Detail Panel.....	381
Algorithm Viewer.....	381
Using the Algorithm Viewer List Panel.....	381
Using the Algorithm Plug-In Spot Detail Panel.....	381
Using the Algorithm Type Detail Panel.....	381
Using the Algorithm Detail Panel.....	382
Batch Control Viewer.....	382
Using the Batch Control Viewer List Panel.....	382
Using the Batch Control Detail Panel.....	382
To Do Type Viewer.....	382
Using the To Do Type Viewer List Panel.....	383
Using the To Do Type Detail Panel.....	383
Service XML Viewer.....	383
Using the Service XML Viewer Overview Panel.....	383
Using the Service XML Viewer Detail Panel.....	383
Java Docs Viewer.....	384
Using the Java Docs Viewer List Panel.....	384
Using the Java Package Detail Panel.....	384
Using the Java Interface / Class Detail Panel.....	384
Groovy Java Docs Viewer.....	385
Application Viewer Preferences.....	385
Application Viewer Stand-Alone Operation.....	385
Stand-Alone Configuration Options.....	385
Example Application Viewer Configuration.....	386
Application Viewer Generation.....	386
Reporting and Monitoring Tools.....	387
Reporting Tool Integration.....	387
The Big Picture Of Reports.....	387
Integration with BI Publisher.....	387
How To Request Reports.....	388
Viewing Reports.....	389
Configuring The System To Enable Reports.....	389
Configuring BI Publisher Reports.....	389
Defining Reporting Options.....	389
Defining Report Definitions.....	390
Sample Reports Supplied with the Product.....	391
How to Use a Sample Report Provided with the System.....	391
How To Define A New Report.....	392

Use a Sample Report as a Starting Point.....	392
Publishing Reports in BI Publisher.....	393
Designing Your Report Definition.....	393
Measuring Performance.....	395
About Performance Targets.....	395
Performance Target Objects Overview.....	396
Calculating and Displaying Performance Targets.....	396
Performance Target Metrics and Metric Types.....	397
Performance Target Categories and Types.....	397
Performance Targets Define Specific Metrics.....	397
Objects Linked to a Performance Target.....	398
Creating Performance Target Zones.....	398
Setting Up Performance Target Configuration.....	398
Performance Target Category Lookup.....	398
Defining Performance Target Types.....	399
Maintaining Performance Targets.....	399
Capturing Statistics.....	399
About Statistics.....	399
Configuring Your System for Statistics.....	400
Defining and Monitoring Statistics.....	400
External Messages.....	401
Incoming Messages.....	401
Inbound Web Services.....	401
Overview.....	401
Configuring Inbound Web Service Options.....	402
Deploying Web Services.....	404
Guaranteed Delivery.....	405
Outgoing Messages.....	406
Outbound Messages.....	406
Polling Outbound Messages Using OSB.....	407
Batch Message Processing.....	407
Real Time Messages.....	408
Designing the System for Outbound Messages.....	408
Configuring the System for Outbound Messages.....	410
Managing Outbound Messages.....	421
Web Service Adapters.....	422
Understanding Web Service Adapters.....	423
Setting Up Web Service Adapters.....	424
Sending Email.....	424
JMS Message Browser.....	425
Integration Cloud Service Catalog.....	425
Web Service Catalog Configuration.....	426
Web Service Catalog Master Configuration.....	426
Maintaining the Web Service Catalog.....	426
XML Application Integration.....	427
The Big Picture of XAI.....	427
XAI Architecture.....	427
XML Background Topics.....	430
Inbound Messages.....	433
Outgoing Messages.....	442
Designing Your XAI Environment.....	444
Installation.....	444
Designing XAI Inbound Services.....	446
Designing XML Schemas.....	446
Designing XSL Transformations.....	447
Designing Your Registry Options.....	447
Configuring the System for NDS Messages.....	454
Schema Editor.....	454
Opening the Schema Editor.....	454
Schema Editor Window.....	454
Validating a Schema.....	457
Registering a Service.....	458
Testing a Schema.....	458
System Wide Functions for Schema Editor.....	458

Setting Up Your XAI Environment.....	460
Message Class.....	460
XAI Envelope Handler.....	461
Setting Up Your Registry.....	461
XAI Route Type.....	469
Running Your XAI Environment.....	469
XAI Staging Control.....	469
XAI Upload Staging.....	470
Uploading XAI Staging Records.....	471
XAI Upload Exception.....	473
XAI Download Staging.....	473
XAI Download Exception.....	473
Maintaining Your XAI Environment.....	474
XAI Submission.....	474
Additional XAI Tools.....	474
Server Trace.....	476
Integrations.....	478
LDAP Integration.....	478
LDAP Integration Overview.....	479
Configuring LDAP Integration .....	480
LDAP Mapping.....	481
Oracle Identity Manager Integration.....	483
Batch Scheduler Integration.....	484
Data Synchronization.....	485
About Data Synchronization.....	485
Maintaining Sync Requests.....	486
Analytics Integration.....	487
About Analytics Integration.....	487
Maintaining Bucket Configurations.....	487
ETL Mapping Control.....	488
Business Flags.....	489
About Business Flags.....	489
Standard Name.....	489
Business Flag Type Defines Behavior for a Standard Name.....	490
Business Flag Type Algorithms.....	490
Objects Linked to a Business Flag.....	490
Impacted Business Process.....	490
Dates.....	491
Creating Business Flags.....	491
Confidence.....	492
Setting Up Business Flag Configuration.....	492
Standard Name Category Characteristic Type.....	492
Business Flag Standard Name Lookup.....	493
Business Process Lookup.....	493
Integration Configuration.....	493
Defining Business Flag Types.....	493
Maintaining Business Flags.....	493
Configuration Migration Assistant (CMA).....	494
Understanding CMA.....	494
The CMA Process Flow.....	495
Migration Assumptions, Restrictions and Recommendations.....	496
CMA Configuration.....	499
Master Configuration - Migration Assistant.....	499
Migration Plans.....	499
Defining a Migration Plan.....	499
Understanding the BO Filtering Process.....	501
Migration Plans for Objects with XML-Embedded Links.....	501
Defining a Migration Request.....	502
Wholesale and Targeted Migrations.....	503
Wholesale Migrations.....	504
Targeted Migrations.....	504
Identifying Tables to Exclude From Migrations.....	504
Configuring Custom Objects for Migration.....	505
The CMA Execution Process.....	506

Exporting a Migration.....	506
Migration Data Set Export.....	507
Export Lifecycle.....	507
Importing and Applying a Migration.....	508
Import Step.....	509
Compare Step.....	510
Approval Step.....	513
Apply Step.....	513
Adjusting Data Prior to Comparing.....	517
Import Process Summary .....	518
Cancelling a Data Set.....	523
Additional Note Regarding Imports.....	523
Caching Considerations.....	523
Maintaining Import Data.....	523
Running Batch Jobs.....	525
CMA Reference.....	526
Framework-Provided Migration Configuration.....	526
Configuring Facts.....	528
Fact Is A Generic Entity.....	528
Fact's Business Object Controls Everything.....	528
Fact Supports A Log.....	528
Cloud Service Foundation.....	529
Process Automation Tool.....	529
Creating an Infrastructure Process.....	530
Executing an Infrastructure Process.....	530
Monitoring Infrastructure Process Progress.....	532
Infrastructure Process Control.....	532
Monitoring a Running Infrastructure Process.....	532
Dealing with Exceptions.....	532
Process Automation Tool Setup.....	533
Security Setup.....	533
Master Configuration Setup.....	534
External Systems and Message Senders.....	534
Configuring New Infrastructure Processes.....	535
Configuring a New Infrastructure Process Step Type.....	535
Configuring a New Infrastructure Process Type.....	535
CMA Migration Infrastructure Process Types.....	536
CMA Accelerator Load (K1-CMA-LOAD).....	536
CMA Migration (K1-CMA-MIGRATE).....	537
Integration Configuration (SOA) Infrastructure Process Types.....	537
Integration Configuration Migration (K1-INTEG-CONFIG-MIGR).....	538
Data Conversion Support for Cloud Implementations.....	538
Data Conversion Overview.....	538
Conversion Steps.....	538
SQL Loader.....	540
Conversion Artifacts.....	542
Configuring Conversion.....	542
Conversion Master Configuration.....	543
Conversion Task Types.....	543
Conversion Artifact Generator.....	543
Conversion Tasks.....	544
Conversion Batch Controls.....	545
Input Data Files.....	547
Overview.....	547
Input Data for a Staging Table.....	550
Input Data for Maintenance Object.....	550
Limitations for Input Data.....	551
Conversion Orchestration.....	551
Input and Output File Location.....	552
Understanding Load Data Process.....	552
Understanding the Conversion Orchestration Process.....	554
Security Setup for Conversion.....	555
Conversion Reconciliation Reports.....	555
<b>Real-Time Scheduler Administrative User Guide.....</b>	<b>556</b>

General Options.....	556
Defining Installation Options.....	556
Base Time Zone.....	556
Formatted Address.....	557
Address Geocoding.....	557
Defining Locations.....	557
Configuring Mapping Options.....	558
Defining Geographic Areas.....	558
Setting Up Global Configuration.....	558
Service Areas.....	558
Understanding Service Areas.....	558
Different Service Areas For Different Service Types.....	559
Geographic Boundaries.....	559
Service Area Hierarchy.....	559
Configuring Service Areas.....	560
Defining Service Area Hierarchy Levels.....	560
Defining Service Area Hierarchy.....	560
Prepare Postal Code Boundary Data.....	560
Defining Service Areas.....	560
Postal Code to Service Area Mappings.....	561
Capabilities.....	561
Understanding Capabilities.....	561
Worker Capabilities.....	562
Vehicle Equipment.....	563
Limited Time.....	563
Load Category.....	563
Defining Worker Capabilities.....	563
Defining Equipment.....	564
Defining Load Categories.....	564
Tasks.....	564
Understanding Activity Types.....	564
Activity Business Object Controls Everything.....	565
The Activity's Host System.....	565
Service Type.....	565
Service Category.....	565
Default Resource Capabilities.....	565
When Can Work Be Performed.....	565
Determine Activity Priority.....	567
Taking a Break While On Site.....	567
Advance Allocation.....	568
Activity Time Tracking.....	568
Handling Expired Activities.....	568
Assist Activity Types.....	568
Creating Activities By The Crew.....	569
Contracting Work.....	569
Understanding Service Classes.....	569
Designing Activity Types.....	570
The Lifecycle Business Objects.....	570
Activity And Assignment Business Objects Are Related.....	570
Extending Existing Business Objects.....	570
Custom Activity Business Objects.....	571
Configuring Activity Options.....	572
Defining Site ID Configuration.....	572
Host External System Configuration.....	573
Defining Remark Types.....	573
Defining Priority Profiles.....	573
Defining Work Profiles.....	574
Defining Appointment Booking Groups.....	574
Uploading Common Attachments.....	574
Defining Activity Types.....	574
Defining Service Classes.....	574
Defining Task Types.....	575
Crews.....	575
Understanding Crew Hierarchies.....	576

Configuring Crew Hierarchy.....	576
Defining Crew Hierarchy Levels.....	576
Defining Crew Hierarchy.....	576
Configuring Crew Options.....	577
Defining Mobile Worker Types.....	577
Defining Vehicle Types.....	577
Defining Crew Types.....	577
Configuring Crew Shift Options.....	578
Defining Shift Types.....	578
Defining Shift Cost Profiles.....	578
Defining Shift Related Task Types.....	579
Periods of Unavailability (POUs).....	579
Understanding POU Configuration.....	579
Defining Period of Unavailability Task Types.....	579
Defining Period of Unavailability Types.....	579
Dispatchers.....	580
Understanding Dispatch Areas.....	580
Defining Dispatcher Types.....	580
Defining Dispatch Areas.....	580
Customizing The CDI Portal.....	581
Gantt Customizations.....	581
CDI Map Customizations.....	583
Alerts.....	584
Understanding Alert Types.....	584
Alert Business Object Controls Everything.....	584
Alert Creation.....	585
Alert Creation Threshold.....	585
Valid Activity Types.....	585
Alert Distribution.....	586
Alert Priority.....	586
Alert Evaluation.....	586
Snoozing Options.....	586
Can A Dispatcher Manually Close Alerts?.....	587
Should The Alert Expire?.....	587
Should The Alert Recycle?.....	587
Designing Alert Types.....	587
When Should The Alert Be Raised?.....	587
When Should The Alert Be Closed?.....	588
Use The Base Business Objects.....	588
Defining Alert Types.....	588
Key Performance Indicators (KPIs).....	588
Understanding Key Performance Indicators (KPIs).....	589
Calculation Algorithm.....	589
Alert Based KPIs.....	589
Severity Thresholds.....	589
Designing Your KPIs.....	590
Defining KPIs.....	590
Procedures.....	590
Understanding Procedure Types.....	590
Related Entity.....	590
Questionnaire.....	591
Effective Dated Procedures.....	591
Attendance.....	591
Override Results.....	591
Designing Procedure Types.....	591
Defining Procedure Types.....	592
Timesheet.....	592
Understanding Timesheet Configuration.....	592
Timesheet Business Objects Control Everything.....	592
Work And Travel Time 'Buckets'.....	592
Designing Timesheet Types.....	593
Integration with Timekeeping Systems.....	593
Approval.....	593
Configuring Timesheet Options.....	593

Defining Timesheet Types.....	593
Defining Custom Timesheet Time Types.....	594
Enable Timesheet Functionality.....	594
Mail.....	594
Defining Mailing Lists.....	594
Defining Mail Templates.....	594
Transfer of Goods.....	595
Understanding Transfer of Goods.....	595
Depot Related Business Objects.....	595
Depot Task Types.....	595
Using Capacity Limits.....	596
Configuring Transfer of Goods.....	596
Defining Types Of Load Capacity.....	596
Defining Depot Related Task Types.....	596
Defining Depot Related Vehicle Types.....	597
Defining Depot Related Crew Types.....	597
Defining Depot Related Shift Types.....	597
Defining Depot Transfer Shift Type.....	598
Defining Depots.....	598
Defining Bays.....	598
Contractor Management.....	599
Understanding Contractor Configuration.....	599
Contractor Users.....	599
Contracting Work.....	601
Configuring Shift Based Contractors.....	601
Configuring Capacity Based Contractors.....	601
Defining Resource Group Types.....	602
Configuring Capacity Model Options.....	602
Defining Capacity Types.....	602
Integration with Contractor Systems.....	602
Mobile Application.....	603
Understanding Mobile Devices.....	603
Mobile Platform.....	603
Mobile Device Terminals (MDT).....	603
Registration.....	604
Sending GPS Data.....	604
Managing Attachments.....	604
Data Encryption.....	604
Understanding Mobile Application Files.....	605
Oracle Utilities Mobile Library (OUML).....	605
Business Logic Resides in Mobile Components.....	606
Packaged by a Batch Process.....	606
Testing.....	607
Understanding Deployments.....	609
Deployment Types.....	610
Deployment Parts.....	610
Deployment.....	610
Out of Date Deployments.....	611
Downloading Deployments.....	611
Mobile Application Versioning.....	611
Setting Up Deployments.....	612
Understanding The Legacy Mobile Platform.....	612
Mobile Application Connection Modes.....	613
Configuration Tools.....	614
Navigation and Display.....	616
Remote Script Invocation.....	617
Device Capabilities.....	618
Mobile Data Cleanup.....	618
Configuring Mobile Devices.....	618
Defining MDT Types.....	618
Defining MDTs.....	619
Configuring Deployment Options.....	619
Defining Deployment Parts.....	619
Defining Deployment Types.....	620

Maintaining Deployments.....	620
Defining Mobile Components.....	621
Schedulers.....	621
Understanding Schedulers.....	621
The Scheduling Process.....	621
Multiple Schedulers.....	622
Scheduler Process Types.....	622
Request Types.....	623
Schedules are Continuously Running Batch Processes.....	623
Auto-Dispatching.....	623
The Scheduler Registry.....	624
Current Crew Location.....	626
Monitoring Schedulers.....	626
Understanding Scheduler Areas.....	626
Multiple Service Areas within a Scheduler Area.....	626
Using Optimization Areas.....	627
Scheduler Map Files.....	631
Understanding Scheduler Parameters.....	631
Parameter Types.....	632
Scheduler Configurations.....	632
Cost Control Parameters.....	633
Understanding Speed Profiles.....	637
Speed Profile Is Made Of Daily Templates.....	637
Speed Profile Area.....	637
Speed Profile Overrides.....	637
Designing Your Schedulers.....	637
Using Multiple Schedulers to Scale the Scheduling Process.....	637
Failover and Load Balancing.....	639
Business Drivers Related to Cost Control Settings.....	640
Configuring Schedulers.....	643
Configuring Scheduler Options.....	643
Defining Parameter Definitions.....	643
Defining Scheduler Areas.....	643
Defining Scheduler Configurations.....	644
Setting Up Scheduler Batch Controls.....	645
Defining Schedulers.....	645
Defining Speed Profiles.....	645
Viewing the Scheduler Registry.....	646
Integrations.....	646
Understanding Web Services.....	646
Appointment Booking.....	646
Activity Maintenance By Host.....	647
Activity Completion To Host.....	648
Activity Status Update To Host.....	648
New Activities to Host.....	648
Contractor Management.....	649
Crews Managed By Host.....	649
Depot Management.....	650
Miscellaneous.....	651
Web Service Statistics.....	651
Configuring Outbound Messages.....	652
Configuration Options.....	652
Batch Control Global View.....	652
Configuration Migration Assistant (CMA).....	653
Executing Wholesale Migrations.....	653
Data that Cannot be Migrated Using CMA.....	653
BI Configuration.....	653
Table Setup Sequence.....	653
Control Data Setup.....	654
Resource Setup.....	654
Transfer of Goods Setup.....	655
Contractor Management Setup.....	655
BI Setup.....	655



# Chapter 1

---

## Framework Administrative User Guide

---

The topics in this section describe how to administer Oracle Utilities Application Framework v4.3.0 SP4.

### Defining General Options

---

This section describes control tables that are used throughout your product.

### Defining Installation Options

The topics in this section describe the various installation options that control various aspects of the system.

### Installation Options - Main

Select **Admin > General > Installation Options - Framework** to define system wide installation options.

#### Description of Page

The **Environment ID** is a unique universal identifier of this instance of the system. When the system is installed, the environment id is populated with a six digit random number. While it is highly unlikely that multiple installs of the system at a given implementation would have the same environment ID, it is the obligation of the implementers to ensure that the environment ID is unique across all installed product environments.

**System Owner** will be **Customer Modification**.

The **Admin Menu Order** controls how the various control tables are grouped on Admin.

- If you choose **Functional**, each control table appears under a menu item that corresponds with its functional area. Note, the [menu](#) that is used when this option is chosen is the one identified with a menu type of **Admin**.
- If you choose **Alphabetical**, each control table appears under a menu item that corresponds with its first letter, using a Roman alphabet. For example, the Language control table will appear under the L menu item entry.

---

**NOTE:** The **Alphabetical** option only supports the Roman alphabet. For languages that do not use the Roman alphabet, the recommendation is to configure the system for the **Functional** setting.

---

**CAUTION:** In order to improve response times, installation options are cached the first time they are used after a web server is started. If you change the Admin Menu Order and you don't want to wait for the cache to rebuild, you must clear the cached information so it will be immediately rebuilt using current information. Refer to [Caching Overview](#) for information on how to clear the system login cache (this is the cache in which installation options are stored).

---

The **Language** should be set to the primary language used by the installation. Note that if multiple languages are supported, each user may define their preferred language.

The **Currency Code** is the default currency code for transactions in the product.

If your product supports effective dated characteristics on any of its objects, define the date to be used as the **Characteristic Default Date** on objects without an implicit start date. The date you enter in this field will default when new characteristics are added to these objects (and the default date can be overridden by the user).

**Active Owner** displays the owner of newly added system data (system data is data like algorithm types, zones, To Do types, etc.). This will be **Customer Modification** unless you are working within a development region.

**Country** and **Time Zone** represent the default country and time zone that should be used throughout the application.

---

**CAUTION:** In most implementations, the time zone defined here matches the database time zone. However, if there is some reason that the database time zone does not match the installation time zone, an implementation may configure a setting in the properties file to automatically convert data from the database time zone to the time zone defined here when displaying dates. Note that when this property setting is defined, changes to the installation time zone will require the server and the thread pool workers to be restarted in order for the changes to take effect.

---

Turn on **Seasonal Time Shift** if your company requires seasonal time shift information to be defined. Note that this is currently only applicable to Oracle Customer Care and Billing > Interval Billing functionality.

## Installation Options - Messages

Select **Admin > General > Installation Options - Framework** and the **Messages** tab to review or enter messages that will appear throughout the application when a given event occurs.

The **Message** collection contains messages that are used in various parts of the system. For each message, define the **Installation Message Type** and **Installation Message Text**. The following table describes the **Message Types** provided by the framework product and how they are used in the system. Your specific product may have introduced additional message types.

Message Type	How The Message Is Used
Company Title for Reports	This message appears as a title line on the <a href="#">sample reports</a> provided with the system. Generally it is your company name. It is only used if you have installed reporting functionality and are using the sample reports (or have designed your reports to use this message).

---

## Installation Options - Algorithms

Select **Admin > General > Installation Options - Framework** and the **Algorithms** tab to review or enter the algorithms that should be evoked when a given event occurs.

The grid contains **Algorithms** that control important functions in the system. You must define the following for each algorithm:

- Specify the **System Event** with which the algorithm is associated (see the table that follows for a description of all possible events).
- Specify the **Sequence Number** and **Algorithm** for each system event. You can set the **Sequence Number** to 10 unless you have a **System Event** that has multiple **Algorithms**. In this case, you need to tell the system the **Sequence** in which they should execute.

---

**CAUTION:** These algorithms are typically significant processes. The absence of an algorithm might prevent the system from operating correctly.

---

The following table describes each **System Event**.

<b>System Event</b>	<b>Optional / Required</b>	<b>Description</b>
<b>Validate Email Attachment</b>	Optional	Algorithms of this type are used to validate the attachments for size and total count while sending attachments using the Email service. Click <a href="#">here</a> to see the algorithm types available for this system event.
<b>Geocoding Service</b>	Optional	Algorithms of this type use Oracle Locator to retrieve latitude and longitude coordinates using address information. Click <a href="#">here</a> to see the algorithm types available for this system event.
<b>Global Context</b>	Optional	Algorithms of this type are called whenever the value of one of the global context fields is changed. Algorithms of this type are responsible for populating other global context values based on the new value of the field that was changed. Refer to <a href="#">Global Context Overview</a> for more information. Click <a href="#">here</a> to see the algorithm types available for this system event.
<b>Guaranteed Delivery</b>	Optional	Algorithms of this type may be called by processes that receive incoming messages that should 'guarantee delivery'. Refer to <a href="#">Guaranteed Delivery</a> for more information. The business service <b>F1-GuaranteedDelivery</b> may be used to invoke this plug-in spot. Click <a href="#">here</a> to see the algorithm types available for this system event.
<b>Ldap Import</b>	Optional	Algorithms of this type are called for operations on users, groups, and group memberships after they have been processed. Click <a href="#">here</a> to see the algorithm types available for this system event.
<b>Ldap Import Preprocess</b>	Optional	Algorithms of this type are called to preprocess data retrieved from LDAP. Click <a href="#">here</a> to see the algorithm types available for this system event.
<b>Next To Do Assignment</b>	Optional	This type of algorithm is used to find the next <b>To Do entry</b> a user should work on. It is called from the <b>Current To Do</b> dashboard zone when the user ask for the next assignment. Click <a href="#">here</a> to see the algorithm types available for this system event.
<b>Reporting Tool</b>	Optional	If your installation has integrated with a third party reporting tool, you may wish to allow your users to submit reports on-line using <a href="#">report submission</a> or to review <a href="#">report history</a>

System Event	Optional / Required	Description
		<p>online. This algorithm is used by the two on-line reporting pages to properly invoke the reporting tool from within the system.</p> <p>Click <a href="#">here</a> to see the algorithm types available for this system event.</p>
SMS Receive Service	Optional	<p>This type of algorithm is used to provide SMS receive service. Only one algorithm of this type should be plugged in.</p> <p>Click <a href="#">here</a> to see the algorithm types available for this system event.</p>
SMS Send Service	Optional	<p>This type of algorithm is used to provide SMS send service. If your installation uses the base algorithm that uses BPEL, you will need to create a feature configuration with the SMS Send Configuration feature type to define your Oracle BPEL server and service call details. If your installation has integrated with a third-party SMS service, you may want to override this algorithm type with your own implementation. Only one algorithm of this type should be plugged in.</p> <p>Click <a href="#">here</a> to see the algorithm types available for this system event.</p>
To Do Information	Optional	<p>We use the term To Do information to describe the basic information that appears throughout the system to describe a <a href="#">To Do entry</a>.</p> <p>Plug an algorithm into this spot to override the system default "To Do information".</p> <p>Click <a href="#">here</a> to see the algorithm types available for this system event.</p>
To Do Pre-creation	Optional	<p>These types of algorithms are called when a <a href="#">To Do entry</a> is being added.</p> <p>Click <a href="#">here</a> to see the algorithm types available for this system event.</p>

## Installation Options - Accessible Modules

Select **Admin > General > Installation Options - Framework** and the **Accessible Modules** tab to view the list of accessible modules.

### Description of Page

This page displays the full list of the application's function modules. A **Turned Off** indication appears adjacent to a module that is not accessible based on your system's module configuration setup.

**FASTPATH:** Refer to [Module Configuration](#) for more information on function modules and how to turn off modules that are not applicable to your organization.

## Installation Options - Installed Products

Select **Admin > General > Installation Options - Framework** and the **Installed Products** tab to view a read only summary of the products that are installed in the application version that you are logged into.

### Description of Page

The **Product Name** indicates the name of the "products" that are installed. The collection should include **Framework**, an entry for your specific product and an entry for **Customer Release**.

**Release ID** shows the current release of the application that is installed. This field is used by the system to ensure that the software that executes on your application server is consistent with the release level of the database. If your implementation of the product has developed implementation-specific transactions, you can populate the Release Id for the **Customer Release** entry to define the latest release of implementation-specific logic that has been applied to this environment. In order for this to work, your implementation team should populate this field as part of their upgrade scripts.

The **Release ID Suffix**, **Build Number** and **Patch Number** further describe the details of your specific product release.

The **Display** column indicates the product whose name and release information should be displayed in the title bar. Only one product sets this value to **Yes**.

**Owner** indicates if this entry is owned by the base package or by your implementation (**Customer Modification**).

**Product Type** indicates if the product is a Parallel Application. A parallel application is one that is independent of, and does not conflict with, other parallel applications. Multiple parallel applications can be installed in the same database and application server.

---

**NOTE: About Information.** The information on this tab is used to populate the information displayed in the [About](#) information for your product.

---

## Support For Different Languages

### User Language

The system provides support for multiple languages in a single environment. System users can use the system in their preferred language, as long as a translation into that language has been provided. A user sees the system in the language defined on their [user record](#). If enabled, users can use the [Switch Language](#) zone to switch to another supported language real time.

---

**NOTE:** Normally, setting up the system for another language is an implementation issue, not an administrative setup issue. However, there are several online administrative features that are used to set up a new language, and these are described here.

---

The following steps are required to support a new language:

- 1. Define a language code and indicate that it is enabled.** For details on this procedure, see [Defining Languages](#).
- 2. Copy descriptions of all language-enabled tables from an existing translation (e.g., English).** The copied values act merely as placeholders while the strings are translated into the new language. It is necessary to do this as a first step in order to create records using the new language code created in the previous step. Language-based descriptions can be copied using a supplied batch process, [FI-LANG](#). The batch copies all English labels in the system.
- 3. Apply the language pack.** If the product supplies a language pack with translations for the system metadata descriptions, follow the instructions provided with the language pack to add the translated text.
- 4. Translate additional content.** Translatable descriptions and labels for implementation data may be updated / entered in the application. First the user record must be updated to reference the new language. This may be done in one of the following ways:
  - a.** Switch to the new language using the [Switch Language](#) zone.
  - b.** If that zone is not available, navigate to the user page, assign the new language code to your User ID, sign out, and sign back in again.

Any online functions that you access will use your new language code. You can change the language code for all users who plan to use/modify the new language.

# Customer Language

Your specific product may also support capturing the language of a customer. Such that correspondence sent from the product may be produced in a language set on a customer record. Refer to your specific product's documentation for more information about additional language support.

## Defining Languages

Your product may support multiple languages. For example, the field labels, input text, and even outputs and reports can be configured to appear in a localized language. A language code for every potential language exists in the system to supply this information in various languages.

Select **Admin > General > Language** to define a language.

### Description of Page

Enter a unique **Language Code**. If you are applying a language pack provided by the product, use the language code designed by the language pack.

Enter the **Description** for the language. Typically this should be the name of the language in that language.

Turn on **Language Enable** if the system should add a row for this language whenever a row is added in another language. For example, if you add a new currency code, the system will create language specific record for each language that has been enabled. You would only enable multiple languages if you have users who work in multiple languages. Languages that are configured as enabled, appear in the [Switch Language](#) dashboard zone. In addition, the login page for the application displays all the languages that are enabled, allowing the user to toggle the login instructions in that language.

---

**NOTE:** The list of enabled languages is captured on the server at startup time. If a new language is enabled, contact your server administrator to refresh the server in order to see the new language displayed in the login page.

---

The following two fields control how the contents of grids and search results are sorted by the Java virtual machine (JVM) on your web server:

- The **Locale** is a string containing three portions:
  - ISO language code (lower case, required)
  - ISO country code (upper case, optional)
  - Variant (optional).
- Underscores separate the various portions, and the variant can include further underscores to designate multiple variants. The specific JVM in use by your particular hardware/OS configuration constrains the available **Locales**. Validating the **Locale** against the JVM is outside the scope of this transaction. This means you are responsible for choosing valid **Locales**.

The following are examples of valid locales:

Locale	Comments
en_US	American English
en_AU	Australian English
pt_BR	Brazilian Portuguese
fr_FR_EURO	European French
ja_JP	Japanese

In addition, the Java collation API can take a **Collator Strength** parameter. This parameter controls whether, for example, upper and lower-case characters are considered equivalent, or how accented characters are sorted. Valid values for collator

strength are **PRIMARY**, **SECONDARY**, **TERTIARY**, and **IDENTICAL**. If you leave this field blank, Java will use its default value for the language. We'd like to stress that the impact of each value depends on the language.

Please see <https://docs.oracle.com/javase/7/docs/api/java/text/Collator.html> for more information about the collator strength for your language.

**Display Order** indicates if this language is written **Left to Right** or **Right to Left**.

**Owner** indicates if this language is owned by the base package or by your implementation (**Customer Modification**). The system sets the owner to **Customer Modification** when you add a language. This information is display-only.

### Where Used

Follow this link to open the data dictionary where you can view the tables that reference [CI\\_LANGUAGE](#).

Note that all administrative control tables and system metadata that contain language-specific columns (e.g., a description) reference a language code.

In addition, other tables may reference the language as a specific column. For example, on the User record you indicate the preferred language of the user.

## Defining Countries

The topics in this section describe how to maintain countries.

### Country - Main

To add or review Country definitions choose **Admin > General > Country**.

The **Main** page is used to customize the fields and field descriptions that will be displayed everywhere addresses are used in the system. This ensures that the all addresses conform to the customary address format and conventions of the particular country you have defined.

#### Description of Page

Enter a unique **Country** and **Description** for the country.

The address fields that appear in the **Main** page are localization options that are used to customize address formats so that they conform to address requirements around the world. By turning on an address field, you make that field available everywhere addresses for this country are used in the system. You can enter your own descriptions for the labels that suffix each switch; these labels will appear wherever addresses are maintained in the system.

---

**NOTE:** For any country where the **State** switch is checked, the valid states for the country must be entered on the **Country - State** tab. When entering address constituents on a record that captures this detail, the value for State is verified against the data in the State table. For any country where there is a component of the address that represents a "state" but your implementation does not want to populate the valid states for that country, choose a different field such as County for this constituent (and define an appropriate label). When entering address constituents on a record that captures this detail, no validation is done for the County column.

---

### Where Used

Follow this link to open the data dictionary where you can view the tables that reference [CI\\_COUNTRY](#).

### Country - States

To maintain the states located in a country, choose **Admin > Country > Search** and navigate to the **State** page.

## Description of Page

For any country where you have enabled the State switch, use the **State** collection to define the valid states in the **Country**.

- Enter the standard postal abbreviation for the **State** or province.
- Enter a **Description** for this state or province.

## Defining Currency Codes

The currency page allows you to define display options related to currency codes that are used by your system. Use **Admin** > **General** > **Currency** to define the currency codes in which financial information is denominated.

### Description of Page

Enter a unique **Currency** and **Description** for the currency.

Use Currency **Symbol** to define the character that prefixes currency amounts in the system (e.g., \$ for U.S. dollars).

Enter the number of **Decimals** that will appear in the notation for the currency.

---

**NOTE:** Please contact your specific product to verify whether it supports a currency with more than 2 decimals.

---

The **Currency Position** indicates whether the currency symbol should be displayed as a **Prefix** or a **Suffix** to the currency amount.

### Where Used

Follow this link to open the data dictionary where you can view the tables that reference [CI\\_CURRENCY\\_CD](#).

## Defining Time Zones

The following topics describe how to design and set up time zones.

## Designing Time Zones

---

**NOTE:** Oracle Utilities Customer Care and Billing - Interval Billing applications customers should consult the topic *Time Issues* (search the Help index for "time issues") for specific information relating to that product's interval billing time related functionality.

---

It is recommended that all time sensitive data is stored in the standard time (also called 'physical time') of the base time zone as defined on the installation options. This will prevent any confusion when analyzing data and will ensure that your algorithms do not have to perform any shifting of data that may be stored in different time zones.

The Time Zone entity is used to define all the time zones where your customers may operate. Each time zone should define an appropriate Time Zone Name. This is a reference to an external source that defines time zones, their relationship to Greenwich Mean Time, whether the time zone follows any shifting for summer / winter time (daylight savings time) and when this shift occurs.

When designing your time zones, the first thing to determine is the base time zone. You may choose the time zone where the company's main office resides. Once this is done you can link the time zone code to the installation option as the base time zone. Refer to [Installation Options - Main](#) for more information.



---

**NOTE:** An attribute in the system properties file may be configured to indicate that the DB session time zone should be synchronized with the value defined on the Installation Options. Refer to the *Server Administration Guide* for more information.

---

If your company does business beyond your main office's time zone, define the other time zones where you may have customers or other systems with which you exchange data. At this point, your specific product may include configuration tables to capture default time zones, for example based on a postal code or geographic location.

---

**NOTE: Date and time in business object schemas.** When defining date / time fields in a BO schema, schema attributes can be used to define whether or not data should be stored in standard time for the base time zone or if it should be stored in the standard time of another time zone (related to the data). In addition, schema attributes can be used to indicate if the display of the time should be shifted to represent the "local time". This is used to adjust for seasonal time differences. For example, if the data is stored in the appropriate time zone, but currently daylight savings time is being observed, the data will be shifted and shown in the "local" time. In addition, if the data is stored in the base time zone but the data is related to a different time zone, the data will be shown in the time zone appropriate for the data (including the appropriate seasonal adjustment). Refer to [Schema Nodes and Attributes- Standard Time Considerations](#) for more information.

---

## Setting Up Time Zones

Refer to [Designing Time Zones](#) for background information about defining time zones.

Open **Admin > General > Time Zone > Search** to define the time zones and their relation to the base time.

### Description of Page

Enter a unique **Time Zone** and **Description** for the time zone.

Select the **Time Zone Name** from the list of Olson time zone values. This value is a reference to an external definition that allows the system to know how the time zone relates to Greenwich Mean Time and information about whether the time zone shifts for summer / winter time and when.

Indicate the **Shift in Minutes** that this time zone differs from the base time zone defined on the Installation Options. This is only applicable for the *Oracle Utility Customer Care and Billing - Interval Billing* application.

Indicate the **Seasonal Time Shift** applicable for this time zone. This is only applicable for the *Oracle Utility Customer Care and Billing - Interval Billing* application.

**Default Time Zone Label** and **Shifted Time Zone Label** are used for data that is sensitive to time zones and time shifting. It indicates whether the data displayed or data to be input is related to the "standard" time or the "shifted" time. For example, on a day when clocks are turned back one hour, a time entry of 1:30 a.m. needs to be labeled as either 1:30 a.m. standard time or 1:30 a.m. daylight savings time.

### Where Used

Follow this link to open the data dictionary where you can view the tables that reference [CI\\_TIME\\_ZONE](#).

## Setting Up Seasonal Time Shift

---

**NOTE:** The information in this topic applies only to Oracle Utilities Customer Care and Billing - Interval Billing applications.

---

Open **Admin > General > Seasonal Time Shift > Search** to define the seasonal time shift schedule.

### Description of Page

Enter a unique **Seasonal Time Shift** code and **Description** for the seasonal time shift.

The Collection defines the **Effective Date/Time** (in standard time) that a time zone may shift in and out of standard time. If time is changed from standard time on the effective date/time, enter the **Shift in Minutes** that the time changes from standard time (usually **60**). If the time is changed back to standard time on the effective date/time, enter a **Shift in Minutes** of **0**.

#### Where Used

Follow this link to open the data dictionary where you can view the tables that reference [CI\\_SEAS\\_TM\\_SHIFT](#).

## Defining Geographic Types

If your company uses geographic coordinates for dispatching or geographic information system integration, you need to setup a geographic (coordinate) type for each type of geographic coordinate you capture on your premises and/or service points (geographic coordinates can be defined on both premises and service points).

To define geographic types, open **Admin > Geographic > Geographic Type**.

---

**NOTE: Product specific.** There is no framework functionality that uses this information. Refer to your specific product documentation to verify how this table is used in your specific product. In addition, use the data dictionary link below to determine if this object is a foreign key on any tables specific to your product.

---

#### Description of Page

Enter an easily recognizable **Geographic Type** code and **Description**.

Define the algorithm used to validate the **Validation Format Algorithm**. If an algorithm is specified, the system will validate that the geographic location entered on the premise and/or service point for the geographic type is in the format as defined in the algorithm. If you require validation, you must set up this [algorithm](#) in the system.

Click [here](#) to see the algorithm types available for this plug-in spot.

#### Where Used

Follow this link to open the data dictionary where you can view the tables that reference [CI\\_GEO\\_TYPE](#).

## Defining Work Calendar

Workday calendars are used to ensure system-calculated dates fall on a workday. Select **Admin > General > Work Calendar > Search** to define a workday calendar.

#### Description of Page

The information on this transaction is used to define the days of the week on which your organization works.

Enter a unique **Work Calendar** and **Description**.

Turn on (check) the days of the week that are considered normal business days for your organization.

Use the collection to define the **Holiday Date**, **Holiday Start Date**, **Holiday End Date**, and **Holiday Name** for each company holiday. Holiday Start Date and Holiday End Date define the date and time that the holiday begins and ends. For example, your organization might begin a holiday at 5:00 p.m. on the day before the actual holiday.

#### Where Used

Follow this link to open the data dictionary where you can view the tables that reference [CI\\_CAL\\_WORK](#).

# Defining Display Profiles

When you set up your [users](#), you reference a display profile. A user's display profile controls how dates, times, and numbers displayed. Choose **Admin > General > Display Profile > Search** to maintain display profiles.

## Description of Page

Enter a unique **Display Profile ID** and **Description** to identify the profile.

Enter a **Date Format**. This affects how users view dates and how entered dates are parsed. The following table highlights standard supported date mnemonics and what is displayed at runtime.

Mnemonic	Comments
dd	Day of the month.
d	Day of the month, suppressing the leading 0.
MM	Month number.
M	Month number, suppressing the leading 0.
yyyy	The 4-digit year.
yy	The 2-digit year.
y	Allows entry in either 2 or 4-digit form and is displayed in 2-digit form.

Other characters are displayed as entered. Typically, these other characters should be separators, such as "-", ".", or "/". Separators are optional; a blank space cannot be use.

Examples:

Configuration Format	Sample Output
MM-dd-yyyy	04-09-2001
d/M/yyyy	9/4/2001
yy.MM.dd	01.04.09
MM-dd-y	04-09-01 - In this case you could also enter the date as 04-09-2001

**NOTE:** For centuries, the default pivot for 2-digit years is **80**. Entry of a 2-digit year greater than or equal to **80** results in the year being interpreted as 19xx. Entry of a 2-digit year less than **80** results in the year being interpreted as 20xx.

In addition, the following date localization functionality is supported. Note that in every case, the date is stored in the database using the Gregorian format. The settings below result in a conversion of the date for the user interface.

- **Hijri Dates**

Entering **iiii** for the year is interpreted as a year entered and displayed in Hijri format. For example, the Gregorian date 2014-05-30 may be entered / displayed as 1435/07/30 for a user whose display profile date format is **iiii/MM/dd**. Note that this functionality relies on date mapping to be defined in the Hijri to Gregorian Date Mapping [master configuration](#) entry. Refer to [Additional Hijri Date Configuration](#) for more information.

- **Taiwanese Dates**

Entering **tttt** for the year is interpreted as a year entered and displayed in Taiwanese format where year 1911 is considered year 0000. For example, if the Gregorian date is 01-01-2005, it is displayed as 01-01-0094 for a user whose display profile date format is **dd-mm-tttt**.

- **Japanese Dates**

There are two options available for configuring Japanese Era date support. The setting **Gyy** for the year is interpreted as a year entered and displayed using an English character for the era followed by the era number. The letter 'T' is used for dates that fall within the *Taisho* era. The letter 'S' is used for dates that fall within the *Showa* era and the letter 'H' is used for dates that fall within the *Heisei* era. For example, for a user whose display profile date format is **Gyy/mm/**

**dd** the Gregorian date 2008/01/01 is shown as **H20/01/01** ; the Gregorian date 1986/03/15 is shown as **S61/03/15**. The setting **GGGGyy** is interpreted as a year entered and displayed using Japanese characters for the era followed by the era number.

Japanese date limitations are as follows:

- The years 1912 through the current date are supported.
- Any functionality that displays Month and Year does not support Japanese Era dates. These dates are shown in Gregorian format.
- Graphs that display dates do not support the **GGGGyy** format.

Enter a **Time Format**. The following table highlights standard supported date mnemonics.

Mnemonic	Comments
hh	The hour 1-12.
h	The hour 1-12, suppressing the leading 0.
HH	The hour 0-23.
H	The hour 0-23, suppressing the leading 0.
KK	The hour 0-11.
K	The hour 0-11, suppressing the leading 0.
kk	The hour 1-24.
k	The hour 1-24, suppressing the leading 0.
mm	Minutes.
m	Minutes, suppressing the leading 0.
ss	Seconds.
s	Seconds, suppressing the leading 0.
a	Indicates to include <b>am</b> or <b>pm</b> . This is only needed for 12 hour formats, not 24 hour formats. ( <b>hh, h, KK, K</b> ). If an <b>am</b> or <b>pm</b> is not entered, it defaults to <b>am</b> .

Examples:

Configuration Format	Sample Output
hh:mma	09:34PM (can be entered as 09:34p)
hh:mm:ss	21:34:00
h:m:s	9:34:0

There are several options for displaying Numbers.

**Decimal Symbol** defines the separator between the integer and decimal parts of a number. Valid values are "." (a period) or "," (a comma),

**Group Symbol** defines the means to separate groups of bigger numbers. Valid values are as follows:

- A comma (","). Large numbers group by threes separated by a comma, for example 1,000,000.
- A period ("."). Large numbers group by threes separated by a period, for example 1.000.000.
- **None**. Large numbers do not have any separator, for example 1000000.
- **South Asian**. This option uses a comma for its separator but will group large numbers as follows: the first comma is used for the thousands separation and numbers over 9,999 are grouped with 2 units, for example 10,00,000.
- **Space**. Large numbers group by threes separated by a space, for example 1 000 000.

**Negative Format** defines how negative values are displayed. Valid values are **-9.9**, **(9.9)**, or **9.9-**.

**Currency** values can have a different **Negative Format** from other numbers. Valid values are **-S9.9**, **(S9.9)**, or **S9.9-**, where the "S" represents the currency symbol.

**Where Used**

Follow this link to open the data dictionary where you can view the tables that reference [CI\\_DISP\\_PROF](#).

## Additional Hijri Date Configuration

For implementations that wish to support displaying dates according to the Hijri calendar, besides appropriate configuration in the [Display Profile](#), the mapping between the Hijri dates and the Gregorian dates must be entered. This mapping is defined in the [Hijri to Gregorian Date Mapping](#) master configuration record.

The mapping record contains a collection of entries for each year in the Islamic calendar.

For each year, clicking the Expand Zone icon shows the mapping collection with the first date of each month of the Hijri calendar. The corresponding date in the Gregorian calendar should be entered for each row.

## Defining Phone Types

Phone types define the format for entering and displaying phone numbers.

To add or review phone types, choose **Admin > General > Phone Type**.

### Description of Page

Enter a unique **Phone Type** and **Description** for each type of phone number you support.

Select an appropriate **Phone Number Format Algorithm** for each **Phone Type**. This algorithm controls the format for entry and display of phone numbers. Click [here](#) to see the algorithm types available for this plug-in spot.

Use **Phone Type Flag** to define if this type of phone number is a **Fax** number. Defining which phone type is used for facsimile transmittal is only pertinent if your product supports routing of information via fax. For example, in Oracle Utilities Customer Care and Billing, the system may be configured to fax a bill to a customer.

### Where Used

Follow this link to open the data dictionary where you can view the tables that reference [CI\\_PHONE\\_TYPE](#).

## Setting Up Characteristic Types & Values

Many objects in the system support a collection of Characteristics, which are used to capture additional fields for the object that are not already supported by the object's provided attributes. Each characteristic is associated with a characteristic type, which defines attributes of the field you wish to capture.

All characteristics are captured as a list. However, the user interface for characteristics differ based on the type of page that is used to maintain the object.

- For portal based pages the business object drives the display and maintenance of an object. For these types of pages, it is recommended that characteristics are defined as part of the business object schema allowing the user interface to display the characteristic as if it is another field. However, the display / maintenance of the characteristic is determined by the business object's user interface design.
- There are some fixed pages in the system that do not support customization of the user interface. For these objects, the characteristics are displayed / maintained as a generic list.

The topics in this section describe how to setup a characteristic type.

## There Are Four Types Of Characteristics

Every characteristic referenced on an object references a characteristic type. The characteristic type controls the validity of the information entered by a user when they enter the characteristic's values. For example, if you have a characteristic type

on user called "skills", the information you setup on this characteristic type controls the valid values that may be specified by a user when defining another user's skills.

When you setup a characteristic type, you must classify it as one of the following categories:

- **Predefined value.** When you setup a characteristic of this type, you define the individual valid values that may be entered by a user. A good example of such a characteristic type would be one on User to define one or more predefined skills for that user. The valid values for this characteristic type would be defined in a discreet list.
- **Ad hoc value.** Characteristics of this type do not have their valid values defined in a discreet list because the possible values are infinite. Good examples of such a characteristic type would be ones used to define a user's birth date or their mother's maiden name. Optionally, you can plug-in an algorithm on such a characteristic type to validate the value entered by the user. For example, you can plug-in an algorithm on a characteristic type to ensure the value entered is a date.
- **Foreign key value.** Characteristics of this type have their valid values defined in another table. For example perhaps you want to link a user to a table where User is not already a foreign key. Valid values for this type of characteristic would be defined on the user table. Please be aware of the following in respect of characteristics of this type:
  - Before you can create a characteristic of this type, information about the table that contains the valid values must be defined on the [foreign key reference table](#).
  - The referenced table does not have to be a table within the system.
  - Not all entities that support characteristics support foreign key characteristics. Refer to the data dictionary to identify the entities that include the foreign key characteristic columns.
  - As described in [Search Options](#), there are two different searching metaphors supported on FK reference. If the object that a characteristic is being linked to is defined on a fixed page, it will display a search icon if the characteristic type's FK reference defines a navigation key based search. If the object is maintained on a portal based page, it will display a search icon if the characteristic type's FK reference defines a search zone.
- **File Location.** Characteristics of this type contain a URL. The URL can point to a file or any web site. Characteristics of this type might be useful to hold references to documentation / images associated with a given entity. For example, the image of a letter sent to you by one of your customers could be referenced as a file location characteristic on a customer contact entry. When such a characteristic is defined on an entity, a button can be used to open the URL in a separate browser window. Note that for references to a file, the recommendation is to use the Attachment functionality to link documents to an object rather than a characteristic type of File Location. Refer to [Attachment Overview](#) for more information. The documentation related to file location remains for upgrade purposes.

## Searching By Characteristic Values

For certain entities in the system that have characteristics, you may search for a record linked to a given characteristic value. The search may be done in one of the following ways:

- Some base searches provide an option to search for an object by entering Characteristic Type and Characteristic Value.
- Your implementation may define a customized search for an entity by a characteristic value for a specific characteristic type using a query data explorer.
- Your implementation may require a business service to find a record via a given characteristic value. For example, maybe an upload of user information attempts to find the user via an Employee ID, defined as a characteristic.

Not all entities that support characteristics support searching by characteristics. Refer to the data dictionary to identify the characteristic collections that include the search characteristic column.

---

**CAUTION:** For ad-hoc characteristics, only the first 50 bytes are searchable. For foreign key characteristics, the search value is populated by concatenating the values of each foreign key column to a maximum of 50 bytes.

---

For the base searches that provide a generic option to search by characteristic type and value, you can restrict the characteristic types that can be used to search for an entity. For example, imagine you use a characteristic to define a

"jurisdiction" associated with a To Do for reporting purposes. If your company operates within a very small number of jurisdictions, you wouldn't want to allow searching for a To Do by jurisdiction, as a large number of To Do entries would be returned.

A flag on the [characteristic type](#) allows an administrator to indicate if searching by this characteristic type is **allowed** or **not allowed**.

## Characteristic Type - Main

To define a characteristic type, open **Admin > General > Characteristic Type**.

### Description of Page

Enter an easily recognizable **Characteristic Type** and **Description** for the characteristic type. **Owner** indicates if this characteristic type is owned by the base package or by your implementation (**Customer Modification**).

---

**CAUTION:** Important! If you introduce a new characteristic type, carefully consider its naming convention. Refer to [System Data Naming Convention](#) for more information.

---

Use **Type of Char Value** to classify this characteristic type using one of the following options (refer to [There Are Four Types Of Characteristics](#) for more information):

- **Predefined value.** Characteristics of this type have their valid values defined in the **Characteristic Value** scroll, below. For each valid value, enter an easily recognizable **Characteristic Value** and **Description**.
- **Ad hoc value.** Characteristics of this type capture free form text. If you use this option, you can optionally define the **Validation Rule** used to validate the user-entered characteristic value. Click [here](#) to see the algorithm types available for this plug-in spot.
- **File location value.** Characteristics of this type contain a URL. The URL can point to a file or any web site. Note that for references to a file, the recommendation is to use the Attachment functionality to link documents to an object rather than a characteristic type of File Location. Refer to [Attachment Overview](#) for more information. The documentation related to file location remains for upgrade purposes.

File location characteristic values must be entered in a "non-relative" format. For example, if you want to define a characteristic value of *www.msn.com*, enter the characteristic value as `http://www.msn.com`. If you omit the `http://` prefix, the system will suffix the characteristic value to the current URL in your browser and attempt to navigate to this location when the launch button is pressed. This may or may not be the desired result.

---

#### NOTE:

Due to browser security restrictions, opening URLs using the file protocol ("file://") from pages retrieved using http does not work for Internet Explorer version 7 or later, or in Firefox. If the file protocol is used, the browser either does not return properly or an error is thrown (e.g., "Access Denied", which usually results from cross site scripting features added for security reasons).

This issue has no known workaround. To comply with browser security standards, the recommendation is to move the target files to an FTP or HTTP server location to avoid protocols that are subject to browser security restrictions.

---

- **Foreign key reference.** Characteristics of this type have their valid values defined in another table. If you choose this option, you must use **FK Reference** to define the table that controls the valid values of this characteristic type. Refer to [Setting Up Foreign Key References](#) for more information.

Use the **Allow Search by Char Val** to indicate if searching for an entity by this characteristic type is **Allowed** or **Not Allowed**. Refer to [Searching by Characteristic Values](#) for more information.

The **Custom** switch is only applicable to **Predefined value** types. It indicates whether or not an implementation is allowed to add values for a characteristic type whose owner is not **Customer Modification**



- If this switch is turned on, an implementation may add characteristic values to the grid for system owned characteristic types.
- If this switch is turned off, an implementation may not add characteristic values to the grid for system owned characteristic types.

---

**NOTE:** Regardless of the value of the Custom switch, an implementation may not update or remove system owned characteristic values.

---

The **Characteristic Value** grid defines the valid values for a **Predefined value** type of characteristic.

The **Characteristic Value** is the unique identifier of the value.

**Description** is the text that is visible in the dropdowns and display when viewing this characteristic value.

**Owner** indicates if this characteristic value is owned by the system or by your implementation (**Customer Modification**). The system sets the owner to **Customer Modification** when you add characteristic values to a characteristic type. This information is display-only.

#### Where Used

Follow this link to open the data dictionary where you can view the tables that reference [CI\\_CHAR\\_TYPE](#) in the data dictionary schema viewer.

## Characteristic Type - Characteristic Entities

To define the entities (objects) on which a given characteristic type can be defined, open **Admin > General > Characteristic Type** and navigate to the **Characteristic Entities** tab.

#### Description of Page

Use the **Characteristic Entity** collection to define the entities on which the characteristic type can be used. **Owner** indicates if this is owned by the base package or by your implementation (**Customer Modification**).

---

**NOTE:** The values for this field are customizable using the Lookup table. This field name is **CHAR\_ENTITY\_FLG**.

---

**NOTE:** For some entities in the system, the valid characteristics for a record are defined on a related "type" entity. For example, the To Do type defines valid characteristics for manually created To Do entries of that type. When configuring your system, in addition to defining the appropriate entity for a characteristic type, you may also need to link the characteristic type to an appropriate entity "type". This technique is typically not followed for business object driven maintenance objects, where the business objects can be configured with the appropriate "flattened" characteristic types in the schema.

---

## Setting Up Foreign Key Reference Information

A Foreign Key Reference defines the necessary information needed to reference an entity in certain table.

You need to set up this control table if you need to validate a foreign key value against a corresponding table. For example, if a schema element is associated with an FK Reference the system validates the element's value against the corresponding table. Refer to [Configuration Tools](#) to learn more about schema-based objects. Another example is characteristics whose valid values are defined in another table (i.e., you use "foreign key reference" characteristic types). Refer to [There Are Four Types Of Characteristics](#) for a description of characteristics of this type.

A FK Reference is used not just for validation purposes. It also used to display the standard information description of the reference entity as well as provide navigation information to its maintenance transaction. Info descriptions appear throughout the UI, for example, whenever an account is displayed on a page, a description of the account appears. The



product provides base product FK references for many of its entities as they are used for validation and display of elements in both fixed page user interfaces as well as portal based user interfaces.

An implementation may also see the need to define a foreign key reference. The following points describe what you should know before you can setup a foreign key reference for a table.

- The physical name of the table. Typically this is the primary table of a maintenance object.
- The program used by default to construct the referenced entity's info description. Refer to [Information Description Is Dynamically Derived](#) for more information on how this is used.
- The transaction used to maintain the referenced entity. This is where the user navigates to when using the "go to" button or hyperlink associated with the entity. Refer to [Navigation Information Is Dynamically Derived](#) for more information on how this is used.
- The name of the search page used to look for a valid entity. Refer to [Search Options](#) for more information.

## Information Description Is Dynamically Derived

Typically a FK Reference is defined for a maintenance object's primary table. In this case the system dynamically derives the standard information associated with a specific referenced entity as follows:

- Attempt to determine the business object associated with the referenced entity. Refer to the [Determine BO](#) maintenance object algorithm system event for more information. If a business object has been determined, the system lets the business object's [Information](#) plug-in, if any, format the description.
- If a business object has not been determined or the business object has no such plug-in, the system lets the maintenance object's [information](#) plug-in, if any, format the description.
- If the maintenance object has no such plug-in, the system uses the info program specified on the FK Reference to format the information.

---

**NOTE: Technical note.** The class that returns the information displayed adjacent to the referenced entity is generated specifically for use as an info routine. Please speak to your support group if you need to generate such a class.

---

**NOTE: Generic routine.** The system provides a generic information routine that returns the description of control table objects from its associated language table. By "control table" we mean a table with an associated language table that contains a **DESCR** field. Refer to [Defining Table Options](#) for more information on tables and fields. The java class is `com.splwg.base.domain.common.foreignKeyReference.DescriptionRetriever`.

---

## Navigation Information Is Dynamically Derived

Typically a FK Reference is defined for a maintenance object's primary table. In this case the system dynamically derives the actual transaction to navigate to for a given referenced entity as follows:

- Attempt to determine the business object associated with the referenced entity. Refer to the [Determine BO](#) maintenance object algorithm system event for more information. If a business object has been determined, use the maintenance portal defined as its **Portal Navigation Option** business object option.
- If a business object has not been determined or the business object defines no such option, the system uses the transaction specified on the FK Reference.

## Search Options

The product provides two main metaphors for implementing a user interface. For input fields that are foreign keys, search options are dependent on the metaphor used by the page in question.

- A [portal based](#) user interface is a more flexible user interface where an implementation has more options for customizing the look and feel. The base product uses UI maps or automatic UI rendering to display input fields. Elements that are foreign keys may display a search icon if the FK reference defines a Search Zone.

---

**NOTE: Defining search zones directly.** It's possible for elements on a UI map to define a specific search zone directly in the HTML, rather than using the search zone defined on an FK reference. Refer to the UI map tips for more information on implementing searches using zones.

---

- A [fixed maintenance page](#) user interface is a page supplied by the base product where only minor enhancements, if any, can be introduced by implementations. The foreign key reference may be used in one of two ways.
  - The based product may use an FK reference to define a base element on one of these pages. If a search is available for such elements, the FK reference's Search Navigation Key is used to implement the search.
  - Entities that support characteristics typically include a generic characteristic collection UI metaphor on these types of pages. In this metaphor, a foreign key characteristic displays a search icon if the FK Reference has configured a Search Navigation Key.

---

**NOTE:** Not every FK reference provided with the product is configured with both search options. Specifically, objects that are maintained in a portal based page typically do not provide a navigation key based search. It means that if linking this type of object as a characteristic to an object that is maintained on a fixed page, a search will not be available.

---

## Foreign Key Reference - Main

To setup a foreign key reference, open **Admin > Database > FK Reference**.

---

**CAUTION:** Important! If you introduce a new foreign key reference, carefully consider its naming convention. Refer to [System Data Naming Convention](#) for more information.

---

### Description of Page

Enter an easily recognizable **FK** (foreign key) **Reference** code and **Description** for the record.

Enter the name of the **Table** whose primary key is referenced. After selecting a **Table**, the columns in the table's primary key are displayed adjacent to **Table PK Sequence**.

Use **Navigation Option** to define the page to which the user will be transferred when they press the go to button or hyperlink associated with the referenced entity. Refer to [Navigation Information Is Dynamically Derived](#) for more information on how this is used.

The **Info Program Type** indicates whether the default program that returns the standard information description is **Java** or **Java (Converted)**, meaning it was converted into Java.

---

**NOTE: Java (Converted)** program types are not applicable to all products.

---

Use **Info Program Name** to enter the Java class / program name.

Refer to [Information Description Is Dynamically Derived](#) for more information on the info program is used.

---

**NOTE: View the source.** If the program is shipped with the base package, you can use the adjacent button to display the source code of this program in the [Java docs viewer](#).

---

Use **Context Menu Name** to specify the context menu that appears to the left of the value.

---

**NOTE:** Context Menu Name is not applicable to user interface elements displaying a generic collection using a foreign key characteristic type. It is only applicable for pages utilizing the foreign key compound element type for fixed page user interface and for data displayed in a portal based user interface where the foreign key reference is defined as an

attribute for an element. Report parameters that reference foreign key characteristics are an example of a user interface where a context menu is not displayed even if the foreign key reference defines one.

---

Use **Search Zone** to define the search zone that opens when a user searches for valid values when the foreign key reference is configured as an input field on a portal based page. Refer to [Search Options](#) for more information.

Use **Search Navigation Key** to define the search page that will be opened when a user searches for valid values on a user interface that is a fixed page. Refer to [Search Options](#) for more information.

Use **Search Type** to define the default set of search criteria used by the **Search Navigation Key's** search page.

Use **Search Tooltip** to define a label that describes the **Search Navigation Key's** search page.

---

**NOTE: Search Type and Search Tooltip.** These attributes are only applicable to user interface elements utilizing the foreign key compound element type on fixed page user interfaces. Report parameters that reference foreign key characteristics are an example of a user interface where this information is not used even if the foreign key reference defines them.

---

### Where Used

Follow this link to open the data dictionary where you can view the tables that reference [CI\\_FK\\_REF](#).

## Defining Feature Configurations

Some system features are configured by populating options on a "feature configuration". Because various options throughout the system may be controlled by settings in feature configuration, this section does not document all the disparate possible options. The topics below simply describe how to use this transaction in a generic way.

For information about specific features:

- Refer to the detailed description of each option type.
- Use the index in the online help and search for 'feature configuration' to find any specific topics describing feature options in the administration guide.

You can create options to control features that you develop for your implementation. To do this:

- Review the lookup values for the lookup field **EXT\_SYS\_TYP\_FLG**. If your new option can be logically categorized within an existing feature type, note the lookup value. If your new option warrants a new feature type, add a lookup value to this lookup field.
- Define the feature's option types. If you have identified an existing feature type to add the options to, find the lookup with the name **xxxx\_OPT\_TYP\_FLG** where **xxxx** is the lookup value of **EXT\_SYS\_TYP\_FLG** noted above. If you decided to create a new feature type (by adding a new lookup value to the **EXT\_SYS\_TYP\_FLG** lookup, you must create a new lookup with the name **xxxx\_OPT\_TYP\_FLG** where **xxxx** is the new value you defined above.
- Flush all caches.

## Feature Configuration - Main

To define your feature configuration, open **Admin > General > Feature Configuration**.

### Description of Page

Enter an easily recognizable **Feature Name** code.

Indicate the **Feature Type** for this configuration. For example, if you were setting up the options for the external messages, you'd select **External Messages**.

---

**NOTE: You can add new Feature Types.** Refer to the description of the page above for how you can add Feature Types to control features developed for your implementation.

---

**NOTE: Multiple Feature Configurations for a Feature Type.** Some Feature Types allow multiple feature configurations. The administration documentation for each feature will tell you when this is possible.

---

The **Options** grid allows you to configure the feature. To do this, select the **Option Type** and define its **Value**. Set the **Sequence** to **1** unless the option may have more than value. **Detailed Description** may display additional information on the option type.

---

**NOTE: Each option is documented elsewhere.** The administration documentation for each feature describes its options and whether an option supports multiple values. Use the index to look for 'feature configuration' to find the various types of feature options.

---

---

**NOTE: You can add new options to base-package features.** Your implementation may want to add additional options to one of the base-package's feature types. For example, your implementation may have plug-in driven logic that would benefit from a new option. To do this, display the lookup field that holds the desired feature's options. The lookup field's name is **xxxx\_OPT\_TYP\_FLG** where **xxxx** is the identifier of the feature on the **EXT\_SYS\_TYP\_FLG** lookup value. For example, to add new batch scheduler options, display the lookup field **BS\_OPT\_TYP\_FLG**.

---

## Feature Configuration - Messages

If the feature exists to interface with an external system, you can use this page to define the mapping between error and warning codes in the external system and our system.

Open this page using **Admin > General > Feature Configuration** and navigate to the **Messages** tab.

### Description of Page

For each message that may be received from an external system, define the **Feature Message Category** and **Feature Message Code** to identify the message.

A corresponding message must be defined in the [system message](#) tables. For each message identify the **Message Category** and **Message Number**. For each new message, the Message Category defaults to **90000** (because an implementation's messages should be added into this category or greater so as to avoid collisions during upgrades).

## Defining Master Configurations

A master configuration is an object that enables an implementation to define configuration for features in the system. It is an alternative to using feature configuration for defining options. A master configuration is defined using a business object. Only one master configuration may exist for a given business object.

The product provides one or more master configuration that may be used for configuration. Some examples, of base master configuration business objects are as follows

- **Hijri to Gregorian Date Mapping.** This allows an implementation that uses Hijri dates to define the mapping between those dates and Gregorian dates.
- **ILM Configuration.** For implementations that use Information Lifecycle Management, the ILM configuration record defines some parameters used by the process.
- **Migration Assistant Configuration.** For implementations that use the configuration migration assistant (CMA), the configuration record defines some parameters used by the process.

For a list of all the master configuration records provided by the product, navigate to the master configuration page in the application. To find help topics related to functionality controlled by the master configuration records, use the keyword 'master configuration' in the index.

To set up a master configuration, open **Admin > General > Master Configuration**.

The topics in this section describe the base-package zones that appear on the Master Configuration portal.

### Master Configuration

The Master Configuration List zone lists every category of master configuration.

The following functions are available:

- If a master configuration record exists for a given master configuration business object, the broadcast icon may be used to view details information about the adjacent master configuration. In addition, an edit icon is visible to allow a user to update the record.
- If a master configuration record does not exist for a given master configuration business object, the add icon is visible to allow a user to define the record.

### Master Configuration Details

The Master Configuration Details zone contains display-only information about a master configuration.

This zone appears when a master configuration has been broadcast from the Master Configuration zone.

Please see the zone's help text for information about this zone's fields.

## Defining Security & User Options

---

The contents of this section describe how to maintain a user's access rights.

## The Big Picture of Application Security

The contents of this section provide background information about application security.

### Application Security

The system restricts access to its transactions as follows:

- An [application service](#) may be associated with every securable function in the system.
  - All maintenance objects define an application service that includes the basic actions available, typically **Add**, **Change**, **Delete**, and **Inquire**. The base product supplies an application service for every maintenance object.
  - For maintenance objects whose user interface page is not portal-based, the application service also controls whether the menu entry appears. If a user doesn't have access to the maintenance object's application service, the menu item that corresponds with the application service will not be visible.
  - For portal based user interfaces, each main portal defines an explicit application service with the access mode **Inquire**, allowing the user interface to be secured independently of the underlying object security. If a user doesn't have access to the portal's application service, the menu item that corresponds with the application service will not be visible. The base product supplies an application service for every portal that is accessible from the menu.
  - Menu items may define an application service. Use this technique for the following scenarios:
    - Suppress a menu item if the underlying application security for the transaction does not provide enough fine grained control. For example, imagine your implementation creates a special BPA script to add a To Do Entry and would like users to use the special BPA rather than the base supplied Add dialogue for To Do Entry. The

underlying security settings for To Do Entry should grant Add access to these users given that the special BPA will still add a record. To suppress the base Add dialogue, link a special application service and access mode for the base supplied menu item for To Do Entry Add. Then define a menu entry for the new special BPA for adding.

- Suppress the add option if a user does not have add security for the object. By default the product does not suppress the add function if a user does not have add access to the object. Rather, the user is prevented from adding the record at the back-end. If your implementation would like to suppress the menu option, link the object's application service and the Add access mode to the Add menu item.
- Zones define an application service
  - For zones linked to a portal, if a user doesn't have access to the zone's application service, the zone will not be visible on the portal. In most cases the zone defines the same application service as its portal. In special cases, such as the zones on the Dashboard, the product supplies separate application services for each zone allowing implementations to determine at a more granular level which users should have access to which zones.
  - For query zones that are configured on a multi-query zone, if a user doesn't have access to the zone's application service, the zone will not be visible in the dropdown on the multi-query zone. In most cases all zones in a multi-query zone define the same application service as the multi-query zone. The product may supply a special application service for one or more zones in a multi-query zone if the functionality is special to certain markets or jurisdictions and not applicable to all implementations.
  - For zones that are used by business services to perform SQL queries, the product supplies a default application service. Security for these zones is not checked by the product as they are used for internal purposes.
- Business objects define an application service. If the business object defines a lifecycle, the application service must include access modes that correspond to each state. In addition, the standard maintenance object access modes of **Add**, **Change**, **Delete** and **Inquire** are included. The base product business objects are supplied with appropriate application services.
- Batch controls define an application service which provides the ability to secure submission of individual batch processes. The application service must include an access mode of **Execute**. The base product batch controls are supplied with appropriate application services. These services will typically have an ID that matches the batch control ID.
- Other configuration tool objects are securable but the base product typically does not supply special application services for each object. An implementation may supply custom application services and link them to the appropriate record:
  - BPA scripts may define an application service with the access mode **Execute**. The base BPA scripts are typically not configured with any application service. An implementation may define one. Note that as mentioned above, a menu item may also be configured with an application service and access mode. This allows for a BPA that is invoked via a menu entry to be secured in more than one way.
  - Business Services and Service Scripts define an application service with the access mode **Execute**. This is needed for services that may be executed from an external system, for example via an inbound web service. Base business services and service scripts that are linked to an inbound web service are configured with special application service. All other business services and service scripts are delivered with a default application service, which may be overridden by an implementation.
- Users are granted access to application services via [user groups](#). For example, you may create a user group called Senior Management and give it access to senior manager-oriented pages and portals.
  - When you grant a user group access to an application service with multiple access modes, you must also define the access modes that are allowed. Often the access modes correspond to an action on a user interface. For example, you may indicate a given user group has **inquire**-only access to an application service, whereas another user group has **add**, **change**, **cancel** and **complete** access to the same service. Refer to [action level security](#) for more information.
  - If the application service has [field level security](#) enabled, you must also define the user group's security level for each secured field on the transaction.
  - And finally, you link individual [users](#) to the user groups to which they belong. When you link a user to a user group, this user inherits all of the user group's access rights.

---

**CAUTION:** Menus may be suppressed! If all menu items on a menu are suppressed, the menu is suppressed.

---

## Action Level Security

When you grant a user group access to an [application service](#), you must indicate the actions to which they have access.

- For application services that only query the database, there is a single action to which you must provide access - this is called **Inquire**.
- For application services that can modify the database, you must define the actions that the user may perform. At a minimum, most maintenance transactions support **Add**, **Change**, and **Inquire** actions. Additional actions are available depending on the application service's functions.

---

**CAUTION:** Important! If an application service supports actions that modify the database other than **Add**, **Change**, and **Delete**; you must provide the user with **Change** access in addition to the other access rights. Consider a transaction that supports special actions in addition to **Add**, **Change**, and **Inquire** (e.g., **Freeze**, **Complete**, **Cancel**). If you want to give a user access to any of these special actions, you must also give the user access to the **Inquire** and **Change** actions.

---

## Field Level Security

Sometimes transaction and action security is not sufficient. There are situations where you may need to restrict access based on the values of data. For example, in Oracle Utilities Customer Care and Billing you might want to prevent certain users from completing a bill for more than \$10,000. This is referred to as "field level security".

Field level security can be complex and idiosyncratic. Implementing field level security always requires some programming by your implementation group. This programming involves the introduction of the specific field-level logic into the respective application service(s).

---

**NOTE:** **Field level security logic is added to user exits.** Refer to the Public API chapter of the Software Development Kit Developer Guide for more information on how to introduce field-level security logic into an application service's user exits.

---

Even though the validation of a user's field-level security rights requires programming, the definition of a user's access rights is performed using the same transactions used to define transaction / action level security. This is achieved as follows:

- Create a [security type](#) for each type of field-level security.
- Define the various access levels for each security type. For example, assume you have some users who can complete bills for less than \$300, and other users who can complete bills for less than \$1,000, and still other users who can complete bills for any value. In this scenario, you'd need 3 access levels on this security type:
  - Level 1 (lowest): May authorize bills <= \$300
  - Level 2 (medium): May authorize bills <= \$1,000
  - Level 3 (highest): May authorize all bills
- Link this security type to each [application service](#) where this type of field level security is implemented. This linkage is performed on the [security type](#) transaction.
- Defining each [user group's](#) access level for each security type (this is done for each application service on which the security type is applicable).

---

**NOTE:**



Highest value grants highest security. The system expects the highest authorization level value to represent highest security level. Moreover, authorization level is an alphanumeric field so care should be taken to ensure that it's set up correctly.

---

## Encryption and Masking

"Encryption" refers to encrypting data stored in the database using an encryption key.

"Masking" refers to overwriting all or part of an un-encrypted field value with a masking character. For example, perhaps only the last 4 digits of a credit card number are visible with the other digits changed to an asterisk. The system provides support for masking in two ways:

- A field value is stored as plain text and is masked for the presentation layer only.
- If a field is encrypted, the encrypted data is stored in a special field. The field visible to the user interface is stored with a masked value.

The system provides the ability to define configuration to indicate that data should be encrypted or masked. The following sections provide more information about each feature.

## User Interface Masking

The functionality described in this section is used to take data that is stored in plain text in the database and mask the value before it is presented to a user (or an external system). This feature includes the ability to allow some users to view the data unmasked using security configuration. The system allows different masking rules to be applied to different fields. For example, a credit card number can be masked differently than a social security number.

The following topics describe how to mask field values.

### Identify the Data to be Masked

Identify the data that is stored as plain text, but should be masked for display to users. For example, imagine that you have identified that Credit Card Numbers and a person's federal ID number (for example, in the United States, the Social Security Number or SSN). Each field identified may be displayed and maintained in different user interfaces throughout the system, but the masking rules for a given field are probably uniform regardless of where the data is displayed.

**Primary keys cannot be masked.** A field defined as a unique identifier of a row cannot be configured for masking. Masking a field that is part of the primary key causes a problem when attempting to update the record. This restriction also applies to elements that are part of a "list" in an XML column on a maintenance object. One or more elements in the list must be defined as a primary identifier of the list. Be sure that primary key elements in the list are not ones that require masking.

**List members that contain different "types".** Consider a page with a list that contains a person's identification numbers. You can set up the system so that a person's social security number has different masking rules than their drivers license number. If your implementation has this type of requirement, the list of masked fields should contain an entry for each masking rule.

For each field, if there are some users that may see the data unmasked on one or more of the user interfaces, then security configuration is required. If the value of a field should be masked for all users across all pages in the application, then the security configuration is not needed.

### Security Configuration

Define a [security type](#) for each field with two authorization levels:

- **1** - Can only see the element masked
- **2** - Can only see the element unmasked



Link all of the security types to an [application service](#) of your choosing. We recommend linking every masking-oriented security type to a single application service (e.g., **CM\_MASK**) as it makes granting access easier.

For each security type, identify which users can see its data unmasked and which users can only see its data masked. If the masked and unmasked users fit into existing user groups, no additional user groups are necessary. Otherwise, create new user groups for the masked and unmasked users.

After the user groups for each security type are defined, [link each user group to the application service](#) defined above. When a user group is linked to the application service, you will define the authorization level for each security type linked to the application service. If a user group's users should see the security type's field values unmasked, set the authorization level to 2; otherwise set it to 1.

---

**NOTE:** Flush the cache. Remember that any time you change access rights you should [flush the security cache](#) (by entering `flushAll.jsp` on the URL of the application) if you want the change to take effect immediately.

---

## Configure a Masking Algorithm

A data masking algorithm must be created for each combination of masking rules and security type. These algorithms determine if a user has the rights to view a given field unmasked, and, if not, how the field should be masked.

The base package provides the algorithm type **FI-MASK** whose parameters are designed to handle most masking needs. If certain users may see the data unmasked, parameters capture the application service, security type and authorization level defined above used to evaluate this. In addition, parameters allow you to configure how much of the data to mask, what masking character to use. Refer to the algorithm type description for more information.

Click [here](#) for a list of all the algorithms supplied for this plug-in spot.

## Determine How the Fields are Displayed

The masking configuration differs based on how a field is retrieved for access to the user interface. So for the masking of one “logical” field (like a person’s SSN), there may be multiple configuration entries required to cover all the access methods. Review each user interface where a given field is displayed and create the following categories:

- The field is an element that is retrieved by invoking a business object, a business service, or a service script
- The field is displayed on a fixed maintenance page (and is therefore retrieved by invoking a page service)
- The field is displayed on a fixed search page (and is therefore retrieved by invoking a search service)
- The field is stored as an ad hoc characteristic

## Create a Feature Configuration for Each Masked Element

Create a feature configuration with a Feature Type of **Data Masking**. An option entry with option type of **Field Masking** is needed for every combination of field to mask and the method used to display the data. The value will contain mnemonics that reference the appropriate data masking algorithm along with configuration that differs depending on how the field is retrieved for display as described below.

### Schema Based Object Field Masking

For data that is accessed via a schema-based object call and displayed in a UI map, the field to be masked must reference a meta-data field name in its schema definition: **field="fld\_name", alg="algorithm name"**

If the element references an `mdField` in the schema, that is the field used to identify the masking rule. If there is no `mdField` reference but only a `mapField` reference, that is the field used to identify the masking rule. For example, if you want to mask a credit card number, let's assume that field is defined in the schema is the following:

```
<creditCard mdField="CCNBR" mapField="EXT_ACCT_ID"/>
```

In this case, the option value should be **field="CCNBR", alg="algorithm name"**. An option value of **field="EXT\_ACCT\_ID", alg="algorithm name"** would not result in masking.

A "where" clause may also be specified. This is useful for data that resides in a list where only data of a certain type needs to be masked: **field="fld\_name", alg="algorithm name", where="fld\_name='value'"**

For example, person can have a collection of IDs and only IDs of type 'SSN' (social security number) should be masked. If the person data including its collection of person IDs is displayed on a UI map via a business object call, let's assume the collection is defined in the following way:

```
<personIDs type="list" mapChild=CI_PER_ID">  
  <isPrimaryId mapField="PRIM_SW"/>  
  <idType mapField="ID_TYPE_CD"/>  
  <personIdNumber mapField="PER_ID_NBR"/>  
</personIDs>
```

The option value may look like this: **field="PER\_ID\_NBR", alg="algorithm name", where="ID\_TYPE\_CD='SSN'"**

Please note the following important points for schema based masking:

- **Limitation of 'where' field** Although the main use of a 'where' clause for schema oriented elements is to mask certain elements in a list based on a 'type', it is also possible to mask a single field in the schema based on the value of another field. For example, imagine that a customer submits a registration form that defines an ID type and ID value. Although this data is not in a list, the implementation may still want to only mask the ID value if the ID type is "SSN". The framework is only able to mask an element in the schema based on a 'where' clause if the element in the 'where' clause is a "sibling" in the schema.
  - If the element to be masked is in a list, the element in the 'where' clause must be in the same list.
  - If an element to be masked maps to a real column in a table, the element in the 'where' clause must also map to a real column in the table.
  - If an element to be masked maps to an XML column in the table as a single element, the element in the 'where' clause must map to the same XML column as a single element.
- **Multiple feature option entries for the same field.** It's possible that different schemas in the system have a similar type of data that may be masked based on different conditions. For example, imagine that an implementation has different schemas that captured or referenced person identifiers in different ways:

- One schema captures a single person ID without any corresponding "type" record and it should always be masked using Algorithm CM\_SSN\_MASK:

```
<personSSN mapXML=BO_DATA_AREA mdField=PER_ID_NBR/>
```

- One schema captures a person ID and a corresponding ID Type and it should be masked with Algorithm CM\_SSN\_MASK if the type is "SSN" and masked with algorithm CM\_FEIN\_MASK if the type is "FEIN".

```
<personIdType mapXML=BO_DATA_AREA mdField=ID_TYPE_CD/>  
<personId mapXML=BO_DATA_AREA mdField=PER_ID_NBR/>
```

- One schema captures a person ID and a corresponding ID Type and it has the same masking rules as the previous schema, but a different field name is used for the ID Type code. (This scenario could happen if for example a different label is desired for ID Type on the user interface for this schema.)

```
<personIdType mapXML=BO_DATA_AREA mdField=CM_ID_TYPE/>  
<personId mapXML=BO_DATA_AREA mdField=PER_ID_NBR/>
```

For this scenario, the feature options may look like this:

1. **field="PER\_ID\_NBR", alg="CM\_SSN\_MASK"**
2. **field="PER\_ID\_NBR", alg="CM\_SSN\_MASK", where="ID\_TYPE\_CD='SSN'"**
3. **field="PER\_ID\_NBR", alg="CM\_FEIN\_MASK", where="ID\_TYPE\_CD='FEIN'"**
4. **field="PER\_ID\_NBR", alg="CM\_SSN\_MASK", where="CM\_ID\_TYPE='SSN'"**
5. **field="PER\_ID\_NBR", alg="CM\_FEIN\_MASK", where="CM\_ID\_TYPE='FEIN'"**

For each schema, the system will first find whether the element applies to any masking option. It will find 5 masking options for the field PER\_ID\_NBR. Then it will determine if any sibling elements match the 'where' clause.

- If more than one sibling element matches a 'where' clause, a runtime error is issued. For example if a schema has an element that references "mdField=ID\_TYPE\_CD" and an element that references "mdField=CM\_ID\_TYPE", this is an error. Additionally, if multiple elements reference mdField=ID\_TYPE\_CD", this is an error.
- If one and only one sibling element matches a 'where' clause, the value of the element is compared to the values defined in the 'where' clause. If it finds a match on the value, the appropriate masking algorithm is applied. If no match is found (for example, the Person ID Type is "LICENSE") the element is displayed as is.
- If no sibling element matches a 'where' clause and a feature option exists with no 'where' clause (option 1 above), then the masking algorithm of the option with no 'where' clause is applied.
- **Changing the value in the 'where' clause.** If your implementation has some users that are allowed to change records where some data is masked based on a condition, it is recommended to design the user interface to reset the masked value when the value in the 'where' clause changes. For example, if a user is prevented from viewing a person's social security number, but the user is allowed to make updates to the person's record, changing the value of the Person ID Type should reset the Person ID Number. This would ensure that the user does not 'unmask' the social security number by simply changing the ID Type.

## Records Maintained Using Page Maintenance

For data that is accessed via a page maintenance service call, indicate the table name and the field name where the data resides: **table="table\_name", field="fld\_name", alg="algorithm name"**

For example if the Person record and its collection of identifiers are displayed and maintained using page maintenance, the option value should be **table="CI\_PER\_ID", field="PER\_ID\_NBR", alg="algorithm name"**

A "where" clause may also be specified: **table="table\_name", field="fld\_name", where="fld\_name='value'", alg="algorithm name"**

This is useful for data that resides in a child table where only data of a certain type needs to be masked. For the person ID example, **table="CI\_PER\_ID", field="PER\_ID\_NBR", alg="algorithm name", where="ID\_TYPE\_CD='SSN'"**

## Characteristic Data

For data that is stored as a characteristic, simply indicate the characteristic type: **CHAR\_TYPE\_CD='char type', alg="algorithm name"**

This needs to be defined only once regardless of which characteristic entity the char type may reside on. Note that only ad-hoc characteristics are supported.

## Masking Fields in Explorer Zones or Info Strings

In explorer zones data is often retrieved using SQL directly from the database. No masking is applied automatically in this case. If there is data in the explorer zone results that should be masked, the masking must be applied by calling a business service.

Similarly, an MO Info algorithm may not use BO interaction to get data. It may access data using SQL for efficiency purposes. No masking is applied when retrieving data via SQL. To apply masking to a string prior to including it in an info string, the masking must be applied by calling a business service.

The system supplies two business services to be called to determine if masking rules apply for a specific field.

- **F1-TableFieldMask.** Mask a Table field. This business service receives a table name, field name and one or more field values. If masking applies it returns the masked value.
- **F1-SchemaFieldMask.** Mask a Schema field. This business service receives a schema name and type, XPath and field value. If masking applies it returns the masked value.

## Search Service Results

For data that is displayed on a 'fixed' search page, it is retrieved via a search service call. Indicate the search name and the appropriate field to mask along with the masking algorithm. For example: **search="SearchServiceName", field="PER\_ID\_NBR", where="ID\_TYPE\_CD='SSN'", alg="algorithm name"**

To find the name of the search service, launch the search in question, right click in the filter area and choose View Source. Search for ServiceName. The service name is listed there. To find the field name to mask, go back to the search window and right click on the results area and choose View Source. Look for the Widget Info section and find the field name in the SEARCH RESULTS (do not include the \$). Note, the "where" statement can only apply to fields that are also part of the search results.

## Additional Masking Information

The following points provide additional information to assist in your masking configuration:

- If the demonstration database includes a **Data Masking** feature configuration, review the settings because it will probably contain masking rules that will match your own.
- On data input pages, a user might be able to enter or change masked data, such as a bank account number, but not be able to subsequently see what they added or changed.
- External systems can request information by performing a service call via a web service. Please keep in mind that some web service requests require data to be masked and some do not. For example, a request from an external system to synchronize person information needs the person's social security number unmasked; whereas a request from a web self service application to retrieve the same person information for display purposes needs the person's social security number masked. To implement this type of requirement, different users must be associated with each of the requests and these users must belong to separate user groups with different access rights.
- If a maintenance object (MO) contains a field that holds an XML document and a service call invokes the MO's service program directly, the system will mask individual XML elements in the field if a **Determine BO** algorithm has been plugged into the [maintenance object](#) and the element(s) in the respective BO schema have been secured as described above.

## Database Encryption and Masking

The functionality described in this section is used to encrypt data when storing it in the database. This functionality is mutually exclusive from the User Interface Masking functionality described in the previous section. The following points highlight the features of the encryption functionality:

- The encryption key is defined using a keystore, which must be set up in order to use this functionality. For details about setting up the keystore in the system, see the Installation Guide.
- When a field is configured to be encrypted, the encrypted data is stored in a special encryption field that is not the source field (the one exposed to the user on the user interface). The source field captures the data as masked. Because a special field is required to support encryption, the product must provide support for that field to be encrypted.
- For encrypted data that must allow searching, the system supports capturing a hash value in a special field. The product must provide support for this functionality. Besides providing a special field to capture the hash value, base search functionality for that data must also cater for this configuration.
- The system supports encrypting data that is captured as an element within an XML field. If the XML field is provided in a schema owned by the product, then the product must provide specific support for the capture of the encrypted data.

The following sections provide additional information about the support for encryption provided by the framework. Refer to the security chapter of the administration guide for your particular product for more information.

## Encrypting and Masking the Data

When a product enables encrypting for a given type of data, a special encryption field should be created to capture the encrypted value. Because encrypting is optional, the source field (the one exposed to the user) should not be this special encrypted field. If encryption is configured, the system will internally populate the encrypted field. The source field will be populated with asterisks by default. That way the masked data is what is shown to the user on page rather than the encrypted value.

The following points highlight how the system behaves when encryption is configured and when it is not. Assume as an example, the field is a credit card number. The user views and populates a field with the field name CC\_NBR. The table also has a second field ENCR\_CC\_NBR. A user populates the credit card number:

- If encryption is not configured, CC\_NBR will be updated with the entered credit card number and ENCR\_CC\_NBR will be empty. Note that in this case, an implementation may choose to configure [user interface masking](#).
- If encryption is configured, CC\_NBR will be updated with '\*\*\*\*\*' and ENCR\_CC\_NBR will contain the encrypted value. The asterisks for the standard field will fill the full field size up to 50 characters.

If for some reason the standard masking using all asterisks is not desired, the system supports supplying an explicit masking algorithm using the same [Data Masking](#) plug-in spot used for [User Interface Masking](#).

---

**WARNING:** Unlike user interface masking, the masking of encrypted fields is not driven by security. The data stored in the source field for all encrypted data should be masked. Be sure not to configure security authorization logic in algorithms used for this type of masking.

---

## Feature Option Configuration

Create a feature configuration with a Feature Type of **Encryption**. For each source field you are encrypting, enter an option with option type of **Field Encryption**. The value will contain mnemonics that reference the appropriate encryption key alias defined in the keystore along with configuration related to the field and its table location. Unlike the user interface data masking, the configuration for data encryption is related to how the data is stored rather than how it is displayed. In addition, each entry may define an explicit masking algorithm to override the default and if supported, may also define a hash field and hash alias.

For data that is stored in a specific column on a table, an explicit field to capture the encrypted value must exist. Indicate the table name, source field name and encrypted field name along with the alias: **table='table\_name', field='fld\_name', encryptedField='encr\_fld\_name', alias='alias key'**

A "where" clause may also be specified when data resides in a child table and only data of a certain type needs to be encrypted.

Example, **table='CI\_PER\_ID', field='PER\_ID\_NBR', encryptedField='ENCR\_PER\_ID\_NBR', alias='key alias', where='ID\_TYPE\_CD='SSN''**

For data that is stored in an XML column in a record, the source field to be encrypted must reference a meta-data field name in its schema definition along with the element that captures the encrypted data and the alias: **field='field\_name', encryptedField='encr\_field\_name', alias='key alias'**

The syntax for adding a reference to a masking algorithm is **maskAlg='algorithm name'** .

The syntax for adding configuration for capturing a hash value for searching purposes is **hashAlias='hashAliasKey' hashField='HASH\_FLD\_NAME'**.

The following is an example of configuration that uses all the possible options (specific masking algorithm, where clause and hash field support):

**table='CI\_PER\_ID', field='PER\_ID\_NBR', alias='aliasKey', encryptedField='ENCR\_PER\_ID\_NBR', hashAlias='hashAliasKey' hashField='HASH\_PER\_ID\_NBR', where='ID\_TYPE\_CD=SSN', maskAlg='CM-PERIDMASK'**

## Searching by an Encrypted Value

If the product supports a hashed value for an encrypted field for searching purposes, the following points highlight explorer zone configuration for this purpose

- The user filter value should reference the source field and should include an additional **encrypt=** mnemonic. For example

```
type=STRING
label=PER_ID_NBR
encrypt=[CI_PER_ID,PER_ID_NBR,ID_TYPE_CD,F1]
```

Refer to [User Filters](#) for more information.

- The SQL should include the hashed value in the WHERE clause. Note that because encryption is optional, a product zone that includes searching by a field eligible for encryption will include finding a match for the filter in the source field (as plain text) or in the hashed field. For example:

```
WHERE
  [(F2) (ID.PER_ID_NBR = :F2 OR ID.HASH_PER_ID_NBR = :F2)]
```

## Customizing Encryption Algorithm

Although the encryption algorithm to use with a given key can be gleaned from the key in the keystore, there is sometimes extra information associated with an algorithm that might need to be used to encrypt or decrypt data.

The system provides a feature configuration option for the **Encryption** feature type using the option type **Algorithm Info** that can be used to adjust the behavior of the encryption.

- You can modify the default mode and padding of the encryption algorithm.
- If a key will be used to digitally sign anything, the signing algorithm can also be specified for the key.

For details about the syntax, refer to the feature option type's detailed description.

## The Base Package Controls One User, One User Group, And Many Application Services

When the system is initially installed, the following information is delivered:

- Application services for all secured transactions, maintenance objects, business objects, business services, scripts and zones in the base package.
- A user identified by the user id **SYSUSER**.
- A user group identified by the user group code **ALL\_SERVICES**. This user group is associated with all supported application services delivered with the base product. This user group is given access to all access modes for all application services (i.e., all actions on all transactions).
- The user **SYSUSER** is linked to the **ALL\_SERVICES** user group. This means that this user has access to all transactions and all actions.

You cannot change or remove the information delivered for **ALL\_SERVICES**. This information is owned by the base package. It is provided so that an "initial user" has access to the entire system and can setup user groups and users as per your organization's business requirements. It is not recommended to provide your own users with access to the **ALL\_SERVICES** user group. Rather, create user groups that are appropriate for the organization's business requirements and define user access to these user groups. If you introduce new transactions, configure them for the appropriate custom user groups.

In addition, **SYSUSER** is provided to allow for an initial user to define appropriate users in your implementation. Once proper administrative users have been defined, it is recommended that **SYSUSER** is updated to set the User Enable setting to Disabled.

When you receive an upgrade:

- New application services are delivered for the new transactions, business objects, zones introduced in the release. The release notes highlights the additions / changes.
- Existing application services are updated with changes in their access modes (e.g., if a new action is added to a transaction, its application service is updated accordingly).
- The **ALL\_SERVICES** user group is updated so it can access the new / changed application services.
- Implementations should review the release notes and determine which user groups created for your implementation should be updated with the additions, if applicable.

## Importing Security Configuration from an External Source

The product provides support for importing security information from an external source:

- If your organization uses Lightweight Directory Access Protocol (LDAP), you can import your existing LDAP users and groups into the system. Once imported, all user and group functions are available. You can import a user group, or a single user. You can resynchronize your LDAP users and groups at any time.

---

**FASTPATH:** For more information refer to [LDAP Integration](#).

---

- The system provides an integration with Oracle Identity Manager. When a user is created in the identity manager product, its information can automatically be interfaced to the product. Once the user is successfully created in the system, all functions are available.

---

**FASTPATH:** For more information refer to [Oracle Identity Manager Integration](#).

---

## The Big Picture of Row Security

Some products allow you to limit a user's access to specific rows. For example, in Oracle Utilities Customer Care and Billing, row level security prevents users without appropriate rights from accessing specific accounts.

A combination of framework configuration and configuration in your edge product is required for row level security. The following points describe the configuration:

- For each record that should be secured, associate it with an **Access Group**. Note that if your edge product supports row level security, that product is providing a link between the secure-able record and Access Group. Your access groups may be granular and only referenced by one secured record or they may be more broad and be referenced by multiple secured records that require the same type of security restriction.
- To define which users have access to the secured records, you define a **Data Access Role**. For each data access role, define which Access Groups the role has security clearance for. An access group may be linked to one or more data access roles. In addition, define the **Users** that have access rights to these secured records. When you grant a data access role rights to an access group, you are giving all users in the data access role rights to all secured records all the referenced access groups. A user may belong to many data access roles.

If your edge product supports row level security, it will include logic in the appropriate areas of the system to limit the secured rows that a user may view or maintain based on this configuration. For example, in Oracle Utilities Customer Care and Billing, throughout the system users are only able to view and maintain information about an account and any of its detail if the user is in a Data Access Role for the account's Access Group (or the account is not linked to an Access Group).

---

**FASTPATH:** Refer to your product's documentation for more information on row level security, if applicable.

---

# Defining Application Services

An application service exists for every transaction in the system. Please refer to [Application Security](#) for a description of how application services are used when you grant user groups access rights transactions.

---

**CAUTION:** Important! If you introduce a new application service, carefully consider its naming convention. Refer to [System Data Naming Convention](#) for more information.

---

## Application Service - Main

Select **Admin > Security > Application Service** to define an application service.

### Description of Page

Enter a unique **Application Service** code and **Description** for the application service.

Indicate the application service's various **Access Modes** (i.e., actions). Refer to [Action Level Security](#) for more information about the significance of these fields.

### Where Used

Follow this link to open the data dictionary where you can view the tables that reference [SC\\_APP\\_SERVICE](#).

## Application Service - Application Security

Use the Application Security portal to set up security for an application service.

Open this page using **Admin > Security > Application Service**, and then navigate to the **Application Security** tab.

This section describes the available zones on this page.

**Application Service Details** zone. This zone contains display-only information about the selected application service, including the Access Modes for the application service and its security type.

**User Groups Linked** zone. This zone lists the user groups that currently have a link to the application service. Note that expired links are also included. The following actions are available:

- Click the **Description** link to navigate to the [User Group - Users](#) page for the adjacent user group. This allows you to add or remove users linked to the user group.
- Click **Deny Access** to remove the selected Application Service's link to this user group.

**User Groups not Linked** zone. This zone lists the user groups that do not have a link to the application service. The following actions are available:

- Click the **Description** link to navigate to the [User Group - Users](#) page for the adjacent user group.
- Click **Grant Access** to navigate to the [User Group - Application Services](#) page for the user group. The page is automatically positioned at the selected application service allowing you to set the access modes and the expiration date.

## Defining Security Types

Security types are used to define the types of [field level security](#).

---

**NOTE: Programming is required.** You cannot have field level security without introducing logic to user exits. Refer to [Field Level Security](#) for more information on how security types are used to define field level security.

---



## Security Type - Main

Select **Admin > Security > Security Type** to define your security types.

### Description of Page

Enter a unique **Security Type** and **Description**.

Use the **Authorization Level** grid to define the different authorization levels recognized for this security type. Enter an **Authorization Level Number** and its **Description**.

---

**NOTE: Programming is required.** Note that the values that you enter are not interpreted by the system itself, but by the user exit code used to implement the special security. Check with the developer of the user exit logic for the correct values. Refer to [Field Level Security](#) for more information on how security types are used to define field level security.

---

Use the **Application Services** grid to define the application service(s) to which this security type is applicable. If this application service is already associated with user groups, you must update each user group to define their respective security level. This is performed using [User Group - Application Service](#).

### Where Used

Follow this link to open the data dictionary where you can view the tables that reference [CI\\_SC\\_TYPE](#).

## Defining User Groups

A user group is a group of users who have the same degree of security access. Think of a user group as a "role"; associated with a role are:

- The users who play this role
- The application services to which the role's users have access (along with the actions they can execute for each service and their field level security authorization levels).

## User Group - Main

Select **Admin > Security > User Group** to view the application services to which a user has access.

---

**CAUTION:** Application services may not be changed or removed from the **ALL\_SERVICES** user group. Refer to [The Base Package Controls One User, One User Group, And Many Application Services](#) for an explanation.

---

### Description of Page

Enter a unique **User Group** code and **Description** for the user group.

**Owner** indicates if this user group is owned by the base package or by your implementation (**Customer Modification**). The system sets the owner to **Customer Modification** when you add a user group. This information is display-only.

The **Application Services** grid displays the various application services to which users in this group have access. Please note the following in respect of this grid:

- Use the **Application Service** search to restrict the application services displayed in the grid. For example, if you only want to see application services that start with the word "field", you can enter this word and press enter.
- To add additional application services to this user group, navigate to the [User Group - Application Services](#) page and click the add icon.

- To remove or change this user group's access to an application service, click the go to button adjacent to the respective application service. This will cause you to be transferred to the [User Group - Application Services](#) tab where you should click the - icon to remove the application service from the user group.
- Note, **Owner** indicates if this user group / application service relationship is owned by the base package or by your implementation (**Customer Modification**). The system sets the owner to **Customer Modification** when you add an application service to the user group. This information is display-only.

### Where Used

Follow this link to open the data dictionary where you can view the tables that reference [SC\\_USER\\_GROUP](#).

## User Group - Application Services

Select **Admin > Security > User Group** and navigate to the **Application Services** tab to maintain a user group's access rights to an application service.

---

**NOTE: Important!** When you grant a user group access rights to an application service, you are actually granting all users in the user group access rights to the application service.

---

### Description of Page

The **Application Service** scroll contains the application services to which the **User Group** has access.

---

**NOTE:** You can also use Main page to select the application service for which you wish to change the access privileges. To do this, simply click the go to button adjacent to the respective application service.

---

To add additional application services to this user group, click the + icon and specify the following:

- Enter the **Application Service ID** to which the group has access.
- Define the **Expiration Date** when the group's access to the application service expires.

Define the **Access Modes** that users in this group have to the **Application Service**. When a new application service is added, the system will default all potential **Access Modes** associate with the **Application Service**. You need only remove those modes that are not relevant for the **User Group**. Refer to [Action Level Security](#) for more information about access modes.

---

**CAUTION:** Important! If an application service supports actions that modify the database other than **Add**, **Change**, and **Delete**; you must provide the user with **Change** access in addition to the other access rights. Consider a transaction that supports actions in addition to **Add**, **Change**, and **Inquire** (e.g., **Freeze**, **Complete**, **Cancel**). If you want to give a user access to any of these additional actions, you must also give the user access to the **Inquire** and **Change** actions.

---

If you require additional security options, often referred to as "field level" security, then you use **Security Type Code** and assign an **Authorization Level** to each. When a new application service is added, the system will display a message indicating how many security types are associated with this application service. Use the search to define each Security Type Code and indicate the appropriate Authorization Level for this user group. Refer to [Field Level Security](#) for more information about security types.

## User Group - Users

Select **Admin > Security > User Group** and navigate to the **Users** tab to maintain the users in a user group.

### Description of Page

The scroll area contains the users who are part of this user group.

---

**NOTE:** Keep in mind that when you add a **User** to a **User Group**, you are granting this user access to all of the application services defined on the **Application Services** tab.

---

The following fields are included for each user:

- Enter the **User ID** of the user.
- Use **Expiration Date** to define when the user's membership in the group expires.
- **Owner** will be **Customer Modification**.

---

**NOTE:** You can also add a user to a user group using [User - Main](#).

---

## Defining Access Groups

---

**FASTPATH:** Refer to [The Big Picture of Row Security](#) for a description of how access groups are use to restrict access to specific objects.

---

Access groups control which groups of users (referred to as Data Access Roles) have rights to accounts (or other objects) associated with the access group. Select **Admin > Security > Access Group** to define your access groups.

### Description of Page

Enter a unique **Access Group** code and **Description** for the data access group.

Use the **Data Access Role** collection to define the data access roles whose users have access to the access group's accounts (or other objects). Keep in mind that when you add a **Data Access Role** to an **Access Group**, you are granting all users who belong to this role access to all of the accounts (or other objects) linked to the access groups.

---

**NOTE:** You can also use [Data Access Role - Access Group](#) to maintain a data access role's access groups.

---

### Where Used

Follow this link to open the data dictionary where you can view the tables that reference [CI\\_ACC\\_GRP](#).

## Defining Data Access Roles

---

**FASTPATH:** Refer to [The Big Picture of Row Security](#) for a description of how access groups are use to restrict access to specific objects.

---

The data access role transaction is used to define two things:

- The users who belong to the data access role.
- The access groups whose accounts (or other objects) may be accessed by these users.

## Data Access Role - Main

Select **Admin > Security > Data Access Role** to define the users who belong to a data access role.

### Description of Page

Enter a unique **Data Access Role** code and **Description** for the data access role.

The scroll area contains the **Users** who belong to this role. A user's data access roles play a part in determining the accounts (or other objects) whose data they can access.

To add additional users to this data access role, press the add button, , and specify the following:

- Enter the **User ID**. Keep in mind that when you add a **User** to a **Data Access Role**, you are granting this user access to all of the accounts (or other objects) linked to the data access role's access groups.
- Use **Expiration Date** to define when the user's membership in this data access role expires.

---

**NOTE:** Also maintained on the user page. You can also use [User - Access Security](#) to maintain a user's membership in data access roles.

---

### Where Used

Follow this link to open the data dictionary where you can view the tables that reference [CL\\_DAR](#).

## Data Access Role - Access Group

Select **Admin > Security > Data Access Role** and navigate to the **Access Groups** tab to define the access groups whose accounts (or other objects) may be accessed by the users in this data access role.

### Description of Page

Use the **Access Group** collection to define the access groups whose objects can be accessed by this role's users. Keep in mind that when you add an **Access Group** to a **Data Access Role**, you are granting all users who belong to this role access to all of the accounts (or other objects) linked to the access groups.

---

**NOTE:** You can also use [Access Group - Main](#) to maintain an access group's data access roles.

---

## Defining Users

The user maintenance transaction is used to define a user's user groups, data access roles, portal preferences, default values, and To Do roles. To access the user maintenance transaction, select **Admin > Security > User**.

The user maintenance transaction is the same transaction invoked when the user launches [Preferences](#).

## User Interface Tools

---

This section describes tools that impact many aspects of the user interface.

## Defining Menu Options

The contents of this section describe how you can add and change menus.

---

**CAUTION:** Updating menus requires technical knowledge of the system. This is an implementation and delivery issue and should not be attempted if you do not have previous experience with menus.

---

**NOTE: Security and menus.** Refer to [Application Security](#) for a discussion of how application security can prevent menu items (or an entire menu) from appearing.

---

**NOTE: Module configuration and menus.** Your [module configuration](#) can prevent menu items (or an entire menu) from appearing.

---

## Menu - Main

This transaction is used to define / change any menu in the system. Navigate to this page using **Admin > System > Menu**.

### Description of Page

Enter a meaningful, unique **Menu Name**.

**Owner** indicates if this menu line is owned by the base product or by your implementation (**Customer Modification**). The system sets the owner to **Customer Modification** when you add a menu line. This information is display-only.

The **Flush Menu** button is used to flush the cached menu items so you can see any modified or newly created menus. Refer to [Caching Overview](#) for more information.

**Menu Type** defines how the menu is used. You have the following options:

- **Admin** is one of the menus that appears in the Application Toolbar. It is a special type of menu because [admin menu](#) items can be grouped alphabetically or by functional group. Refer to the description of Admin Menu Order on [Installation Options - Framework](#) for more information about admin menu options.
- **Context** refers to a [context menu](#).
- **Main** is another menu that appears in the Application Toolbar that is simply titled [Menu](#).
- **Page Action Menu** defines buttons that appear in the [Page Title Area](#).
- **Submenu** defines a menu group that appears when an Application Toolbar menu is selected. For the Admin menu, this is only visible when it's organized functionally.
- Enter **User Menu** refers to the menu items that appear on the [user menu](#); for example, User Preferences.

**Description** provides a description of the menu. Note that this is not the text used when displaying a menu option.

**Sequence** is only enabled for the **Main** and **Admin** menu types.

The grid contains a summary of the menu's lines. Besides the standard add and delete icons available in a grid, the following information is displayed:

- **Menu Line ID** is the unique identifier of the line on the menu. This information is display-only. Before the menu line id is a Go To icon that allows a user to drill into the Menu Items for the displayed menu line.
- **Sequence** is the relative position of the line on the menu. Note, if two lines have the same **Sequence**, the system organizes the lines alphabetically (based on the **Long Label**, which is defined on the next tab).

---

**NOTE:** An implementation may override the sequence of a base product owned menu line. Also note that the sequence is defined on the menu line language table, allowing for different orders to be used for different languages (or to let the menu be sorted alphabetically in one language and in a specified order in a different one).

---

- **Navigation Option / Submenu** contains information about the line's items. If the line's item invokes a submenu, the submenu's unique identifier is displayed. If the line's item(s) invoke a transaction, the description of the first item's [navigation option](#) is displayed.
- **Long Label** is the verbiage that appears on the menu line.
- **Item Count** is the number of menu items on the line.
- **Owner** indicates if this menu line is owned by the base product or by your implementation (**Customer Modification**). The system sets the owner to **Customer Modification** when you add a menu line. This information is display-only.

---

**NOTE: Adding menu lines to base owned menus.** An implementation may choose to add custom menu lines along with its menu item (or items) to a base owned menu.

---

Refer to the description of [Menu Items](#) for how to add items to a menu line.

## Menu - Menu Items

Once a menu has lines (these are maintained on the main page), you use this page to maintain a menu line's items.

Each menu line can contain one or two menu items. The line's items control what happens when a user selects an option on the menu.

There are two types of menu lines that define a single menu item: one type causes a submenu to appear; the other type causes a transaction or script to be invoked when it's selected.

- The following is an example of a menu line with a single item that opens a submenu:

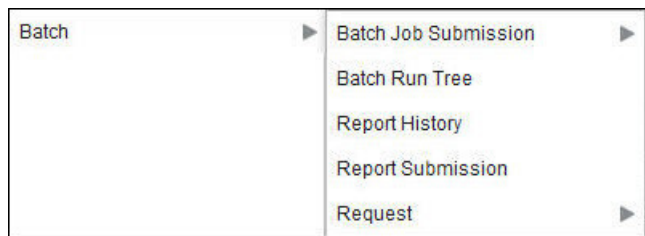

- The following is an example of a menu line with a single menu item that launches a transaction or script:



A menu line that defines two menu items is used to provide an Add option and a Search option for the same type of object. In this case each menu item defines a transaction or script to be launched. The menu is rendered with the Add and Search options displayed. The following is an example of a menu line with two menu items.



Navigate to this tab by clicking the Go To button adjacent to a menu line from the Main tab.

### Description of Page

**Menu Name** is the name of the menu on which the line appears. **Menu Line ID** is the unique identifier of the line on the menu. **Owner** indicates if this menu is owned by the base product or by your implementation (**Customer Modification**). This information is display-only.

The **Menu Line Items** scroll contains the line's menu items. The following points describe how to maintain a line's items:

- **Menu Item ID** is the system assigned unique identifier of the item.
- **Owner** indicates if this item is owned by the base product or by your implementation (**Customer Modification**).
- If the menu item should invoke a submenu:
  - Use **Sub-menu Name** to identify the menu that should appear when the line is selected
  - Use **Long Label** to define the verbiage that should appear on the menu line
  - Populate the **Override Label** to override the long label of a base product owned sub-menu.
- If the item should invoke a transaction or BPA script:
  - Use **Sequence** to define the order the item should appear in the menu line (we recommend this be set to **1** or **2** as a menu line can have a maximum of 2 menu items). The “search” menu item should be defined as sequence 1 and the “add” menu item as sequence 2 given that the label of the “search” menu item is used for the menu line’s label.
  - Use **Navigation Option** to define the transaction or script to open. Refer to [Defining Navigation Options](#) for more information.

- For a menu line that includes two items — one for Add and one for Search, if one of the items includes configuration for **Image GIF Location and Name**, the system assumes that this represents the Add. This functionality is a carry over from earlier releases where the Add function rendered in the menu with a “+” image, which also identified the item that represents the Add. If neither item includes Image configuration (because it is no longer needed for rendering the menu), the system relies on the order of the items as mentioned above. The first item is the “search” and the second item is the “add”.
- **Image Height, Image Width and Balloon Description** are not applicable at this time.
- Use the **Long Label** to define the text to appear on the menu entry. Note that when a menu line defines two menu items, the long label on the search entry is used to build the menu entry text. The label long on the menu line that defines the Add option is information only.
- The **Override Label** is provided in case you want to override the base-package's label.
- Use **Application Service** and **Access Mode** to easily suppress a menu item for one or more users. Refer to [Application Security](#) for more information.

## The Big Picture of System Messages

All error, warning and informational messages that are displayed in the system are maintained on the message table. Every message is identified by a combination of two fields:

- **Message category number.** Think of a message category as a library of messages related to a given functional area. For example, there is a message category for billing messages and another one for payment messages.
- **Message number.** A unique number identifies each message within a category.

Every message has two components: a brief text message and a long description. On the **Main** tab, you can only maintain the brief message. If you need to update a message's long description, you must display the message on the **Details** tab.

---

**NOTE: You cannot change the product's text.** If the message is "owned" by the product, you cannot change the product's message or detailed description. If you want your users to see a different message or detailed description other than that supplied by the product, display the message on the **Details** tab and enter your desired verbiage in the "customer specific" fields (and flush the [cache](#)).

---

## Defining System Messages

The contents of this section describe how to maintain messages that appear throughout the system. An implementation may introduce messages used in custom processes or may choose to override the text for messages delivered by the product.

### Message - Main

Select **Admin > System > Message** to maintain a message category and its messages.

#### Description of Page

To add a new message category, enter a **Message Category** number and **Description**.

---

**CAUTION:** Message category 80000 or greater must be used to define new messages introduced for a specific implementation of the system. Changes to other Message Text will be overwritten when you next upgrade. If you want to make a change to a Message, drill down on the message and specify Customer Specific Message Text. Note that even for message categories 80000 and higher, message numbers lower than 1000 are reserved for common base product messages.

---



---

**NOTE: Owner** indicates if this message category is owned by the base product or by your implementation (**Customer Modification**). The system sets the owner to **Customer Modification** when you add a category. This information is display-only.

---

To update a message, you must first display its **Message Category**. You can optionally start the message grid at a **Starting Message Number**.

To override the message text or detailed description of messages owned by the base product, click on the message's go to button. When clicked, the system takes you to the **Details** tab on which you can enter your implementation's override text.

The following points describe how to maintain messages owned by your implementation:

- Click the - button to delete a message.
- Click the + button to add a new message. After clicking this button, enter the following fields:
- Use **Message Number** to define the unique identifier of the message within the category.
- Use **Message Text** to define a basic message. You can use the %n notation within the message text to cause field values to be substituted into a message. For example, the message text **The %1 non-cash deposit for %2 expires on %3** will have the values of 3 fields merged into it before it is displayed to the user (%1 is the type of non-cash deposit, %2 is the name of the customer, and %3 is the expiration date of the non-cash deposit).

---

**NOTE:** The system merges whatever values are supplied to it. Therefore, if a programmer supplies a premise address as the second merge parameter in the above message, this address is merged into the message (rather than the customer's name).

---

- **Owner** indicates if this message number is owned by the base product or by your implementation (**Customer Modification**). The system sets the owner to **Customer Modification** when you add a message. This information is display-only.
- Click the go to button to enter a detailed description of the message. Clicking this button transfers you to the **Details** tab.

### Where Used

Follow this link to open the data dictionary where you can view the tables that reference [CL\\_MSG](#). In addition, messages are used throughout the system for error messages and other system messages.

## Message - Details

Select **Admin > System > Message** and navigate to the **Details** tab to define detailed information about a message.

---

**NOTE: Drilling in from the Main tab.** Rather than scrolling through the messages, you can display a message by clicking the respective go to button in the grid on the main tab.

---

### Description of Page

The **Message Collection** scroll contains an entry for every message in the grid on the Main tab. It's helpful to categorize messages into two categories when describing the fields on this page:

- Product messages
- Implementation-specific messages (i.e., a message added to **Message Category** 80000 or greater)

For product messages, you can use this page as follows:

- If you want to override a message, specify **Customer Specific Message Text**.
- You are limited to the same substitution values used in the original **Message Text**. For example, if the original **Message Text** is **The %1 non-cash deposit for %2 expires on %3** and %1 is the type of non-cash deposit, %2 is the name of the customer, and %3 is the expiration date of the non-cash deposit; your **Customer Specific Message Text** is limited to the



same three substitution variables. However, you don't have to use any substitution variable in your message and you can use the substitution variables in whatever order you please (e.g., %3 can be referenced before %1, and %2 can be left out altogether).

- If you want to override the detailed description of an error message, specify **Customer Specific Description**. Note that the system does not present detailed descriptions when warnings are shown to users. Therefore, it doesn't make sense to enter this information for a warning message.

For implementation-specific messages, you can use this page as follows:

- **Message Text** is the same Message Text displayed on the main tab.

---

**CAUTION:** If both **Message Text** and **Customer Specific Message Text** are specified, the system will only display the **Customer Specific Message Text** in the dialog presented to the user.

---

- Use **Detailed Description** to define additional information about an error message. Note that the system does not present detailed descriptions when warnings are shown to users. Therefore, it doesn't make sense to enter this information for a warning message.

---

**CAUTION:** If both **Detailed Description** and **Customer Specific Description** are specified, the system will only display the **Customer Specific Description** in the dialog presented to the user.

---

## The Big Picture of Portals and Zones

A portal is a page that is comprised of one or more information zones. The base product pages are built using either a fixed page metaphor or using portals and zones. The contents of this section describe general information about portals and zones.

### There Are Three Types of Portals

There are three broad classes of portals:

- **Standalone Portal.** Standalone portals are separate pages where the main tab of the page is built using a portal. These pages are opened using any of the standard methods (e.g., by selecting a menu item, by selecting a favorite link, etc.). Additional tabs for a stand-alone portal may be included using tab page portals.
- **Tab Page Portals.** These types of portals cannot be attached to a menu. They simply define the zones for a tab on either a standalone portal or on a “fixed” page. Please contact customer support if you need to add portals to existing transactions.
- **Dashboard Portal.** The dashboard portal is a portal that appears in the [Dashboard Area](#) on the user’s desktop. Its zones contain tools and information that exist on the user's desktop regardless of the transaction.

There is only one dashboard portal. This portal and several zones are delivered as part of the base-package. Your implementation can add additional zones to this portal. Please contact customer support if you need to add zones to the dashboard portal.

### Common Characteristics of All Portals

The topics that follow describe characteristics common to all types of portals.

### Portals Are Made Up of Zones

A portal is a page that contains one or more zones, and each zone contains data of some sort.

All zones reference a **Zone Type**. The zone type controls the behavior of the zone and the parameters available to configure the zone.

## Configuring Zones for a Portal

The portal includes configuration of how the zones should appear on the portal by default. This includes the following options, all of which may be overridden by an implementation.

- The order in which the zone should appear. An implementation may configure an override sequence to change the order zones on a base delivered portal.
- Whether the zone is visible on the portal. Zones delivered in the base product should be configured to be visible. But an implementation may override this if desired.
- Whether the zone should display initially collapsed or not. A zone's data is only retrieved when it is expanded. As such, a zone may be configured to be initially collapsed when the data is not needed very often. A user can expand the zone when the information is required. Implementations may change the collapsed setting of a base product portal / zone.

---

**FASTPATH:** Refer to [Zones May Appear Initially Collapsed When a Page Opens](#) for more information.

---

**FASTPATH:** Refer to [Defining Portals](#) for more information about this configuration.

---

In addition, the portal includes configuration to indicate whether or not the portal should appear on a user's portal preferences. This is typically enabled for a portal that provides disparate information where not all zones are applicable to all users or where users may wish to adjust the order of the zones. An example of a portal enabled for portal preferences is the Dashboard portal. The user can override zone oriented configuration for the portal:

- Which zones appear on that portal
- The order in which the zones appear
- Whether the zones should be initially collapsed when the portal opens.
- The refresh seconds. This is applicable to zones displaying data that changes often.

An implementation can optionally configure the system to define portal preferences on one or more "template" users. When a template user is linked to a "real" user, the real user's preferences are inherited from the "template" user and the "real" user cannot change their preferences. Some implementations opt to work this way to enforce a standard look and feel for users in the same business area.

---

**FASTPATH:** Refer to [User — Portal Preferences](#) for more information about how users configure their zones.

---

## Granting Access to Zones

An [application service](#) is associated with each zone. A user must be granted access rights to the respective application service in order to see a zone on a portal.

---

**FASTPATH:** Refer to [The Big Picture Of Application Security](#) for information about granting users access rights to an application service.

---

Please note the following with respect to zone application security:

- For most base product portals, all the zones for all the portals reference the same application service that is used to grant access to the main (stand-alone) portal for the page. In other words, if the user has access to the page, then he has access to all the zones on all portals for the page. There may be exceptions to this rule for certain portals.

- For a base product multi-query zones, typically the individual query zones and the multi-query zone reference the same application service that is used to grant access to the main (stand-alone) portal for the page. However, there may be individual query zones provided with a unique application service. This may occur when the query option is unusual and not applicable to all users or even to all implementations. If a user does not have security access to an individual query zone, that option will not be available in the dropdown.
- For base product portals that are configured to show on portal preferences, it is common that the portal contains different types of zones that may be applicable to different types of users. Typically these types of portals will deliver a unique application service for each zone so that an implementation may configure which user groups are allowed to view each zone. For these types of portals, please note the following:
  - A user's [Portal Preferences](#) page contains a row for a zone regardless of whether the user has access rights to the zone. Because of this, the system displays an indication of the user's access rights to each zone.
  - If a user's access rights to a zone are revoked, the zone will be suppressed when the user navigates to the respective portal.
  - Revoking a user's access rights does not change the user's [portal preferences](#) (i.e., a user can indicate they want to see a zone even if they don't have access to the zone - such a zone just won't appear when the respective portal appears).

---

**NOTE: If you don't need to use zone security.** When defining a zone, an application service is required. For zones that don't require special security, the product provides a "default" application service (F1-DFLT) that may be used. The expectation is that all user groups are granted access to this application service.

---

## Common Characteristics of Stand-Alone Portals

The topics that follow describe additional characteristics specific to [stand-alone portals](#).

### Putting Portals on Menus

A stand-alone portal should appear as a menu item on one of your menus. The following points provide how to do this:

- Every stand-alone portal has an associated navigation option. You can see a portal's navigation option on the [Portal - Main](#) page.
- To add a portal to a menu, you must add a [menu item](#) to the desired menu. This menu item must reference the portal's navigation option. There are two ways to add a menu item:
- If the portal's navigation option doesn't currently exist on a menu, you can press the **Add To Menu** button on the [Portal - Main](#) page. When you press this button, you will be prompted for the menu. The system will then create a menu item on this menu that references the portal's navigation option.
- You can always use the [Menu](#) page to add, change and delete menu items.

---

**NOTE: No limit.** A portal's navigation option can appear on any number of menu items (i.e., you can create several menu items that reference the same portal).

---

**NOTE: Favorite links.** Your users can set up their preferences to include the portal's navigation option on their [Favorite Links](#). This way, they can easily navigate to the portal without going through menus.

---

### Granting Access to A Portal

An [application service](#) is associated with each [stand-alone portal](#). A user must be granted access rights to the respective application service in order to see a portal. Tab portals do not have separate security access. If a user has access to the main stand-alone portal, then the user will have security access to all its tabs. However, as mentioned in [Granting Access](#)

to Zones, in some scenarios, the individual zones on the portal may have different security access rights depending on the functionality.

---

**FASTPATH:** Refer to [The Big Picture Of Application Security](#) for information about granting users access rights to an application service.

---

**NOTE: Automatically created.** When you add a new stand-alone portal, the system automatically creates an application service behind the scenes. You'll need to know the name of this application service as this is what you use to grant access to the portal. The name of each stand-alone portal's application service is shown on the portal transaction.

---

Please note the following in respect of how application security impacts a user's portals:

- A user's [Portal Preferences](#) page only shows the portals configured to show on user preferences and where they have security access.
- The system's menus only show portals to which a user has security access.
- Users can set up favorite links to all portals, but they must have security rights to the portal's application service in order to invoke the favorite link.

## Custom Look and Feel Options

The default look and feel of the application can be customized via feature configuration and cascading style sheets. The base product is provided with a **Custom Look And Feel** [Feature Configuration](#) type. You may want to set up a feature configuration of this type to define style sheet and UI Map help options.

## User Interface

The base product allows for the conditional inclusion of custom style sheets into the system style set. Custom styles may override any style provided by the base product. The style sheet may also include new styles for use in customer zone definitions. Use the **Style Sheet** option on the **Custom Look And Feel** Feature Configuration to define your custom style sheet.

---

**NOTE:** Some styles cannot change if they are part of the HTML code.

---

**CAUTION:** Implementers must ensure that the customized user interface is stable and scalable. Changing font, alignment padding, border size, and other user interface parameters may cause presentation problems, like scrollbars appearing or disappearing, cursors not working as expected, and unanticipated look and feel alterations of some layouts.

---

## UI Map Help

A [tool tip](#) can be used to display additional help information to the user. This applies to section elements as well as individual elements on a map zone or UI Map. Refer to the tips context sensitive zone associated with the UI Map page for more information. The **Custom Look And Feel** Feature Configuration provides options to control the following:

- Whether UI Map Help functionality is turned on or off. By default it is turned on.
- Override the default help image with a custom image
- The location of the help image, either before or after the element.

---

**FASTPATH:** Refer to the feature configuration for a detailed description of each option.

---

# Setting Up Portals and Zones

The topics in this section describe how to set up portals and zones. Please refer to [The Big Picture of Portals and Zones](#) for background information.

## Defining Zone Types

A Zone Type represents a particular type of zone with a specific behavior. For example, a data explorer zone type is used to select data using a specific SQL statement and display the data based on parameter configuration. The zone type defines the Java Class that controls the behavior of the zone and defines the parameters that the Java Class supports. The base product supports many zone types used to build the portal / zone user interface. Implementations may introduce their own zone types.

---

**NOTE:** It is not very common for an implementation to introduce their own zone types.

---

Select **Admin > System > Zone Type** to maintain zone types.

### Description of Page

Specify an easily recognizable **Zone Type** code and **Description**. Use the **Detailed Description** to describe in detail what the zone type does.

---

**CAUTION:** When adding new zone types, carefully consider its naming convention. Refer to [System Data Naming Convention](#) for more information.

---

**Owner** indicates if this zone type is owned by the base product or by your implementation (**Customer Modification**). The system sets the owner to **Customer Modification** when you add a zone type. This information is display-only.

**Java Class Name** is the Java class responsible for building the zone using the parameters defined below.

Two types of parameters are specified when defining a zone type:

- Parameter values that have a **Usage of Zone** are defined on the zones and control the functionality of each zone governed by the zone type. A **Usage** value of **Zone - Override Allowed** indicates that an implementation may override the parameter value for a base zone.
- Parameter values that have a **Usage of Zone Type** are defined directly on the zone type and control how the zone type operates (e.g., the name of the XSL template, the name of the application service). A **Usage** value of **Zone Type - Override Allowed** indicates that an implementation may override the parameter value for a base zone type.

The following points describe the fields that are defined for each parameter:

- **Sequence** defines the relative position of the parameter.
- **Parameter Name** is the name of the parameter.
- **Description** is a short description that allows you to easily identify the purpose of the parameter.
- **Comments** contain information that you must know about the parameter or its implementation. For parameters with a usage of **Zone** or **Zone — Override Allowed**, this information is visible to the user when viewing or defining this parameter for a zone of this type.
- **Usage** indicates whether the parameter value is defined in a **Zone** of this type or in the **Zone Type**. **Zone - Override Allowed** and **Zone Type - Override Allowed** indicate that override values for the parameters defined in a base zone or base zone type can be entered.
- **Required** is checked to indicate that a zone must define a value for the parameter. It is not checked if a value for the parameter is optional. This field is protected if the **Usage** is **Zone Type** or **Zone Type - Override Allowed**.

- **Parameter Value** is used to define the value of zone type parameters. This field is protected if the **Usage** is **Zone** or **Zone - Override Allowed**.
- **Owner** indicates if this parameter is owned by the base product or by your implementation (**Customer Modification**). The system sets the owner to **Customer Modification** when you add a parameter. This information is display-only.

### Where Used

Follow this link to open the data dictionary where you can view the tables that reference [CI\\_ZONE\\_HDL](#).

## Zone Type Parameter Comments

For the product owned zone type parameters, the parameter's detailed description provides the detail needed for properly configuring the parameter. For the Action parameters (IMPLEMENTOR\_ACTION\_n), the parameter description is abbreviated. Additional detail about configuring this parameter may be found in the [Zone Action Parameter](#) detailed information. The same details apply.

## Defining Zones

The contents of this section describe how to maintain zones.

### Zone - Main

Implementations may use the zone page to define custom zones. In addition, an implementation may override descriptions or some parameter values for base product zones.

Select **Admin > System > Zone** to create or maintain a zone.

#### Description of Page

Specify an easily recognizable **Zone** identifier and **Description**. Note that if this zone appears on a portal, this description acts as the zone title.

**Override Description** is provided if your implementation wishes to override the description of the value provided by the product.

---

**CAUTION:** Important! When introducing a new zone, carefully consider its naming convention. Refer to [System Data Naming Convention](#) for more information.

---

**Owner** indicates if this zone is owned by the base product or by your implementation (**Customer Modification**). The system sets the owner to **Customer Modification** when you add a zone. This information is display-only.

**Zone Type** identifies the zone type that defines how the zone functions.

**Application Service** is the application service that is used to provide security for the zone. Refer to [Granting Access To Zones](#) for more information.

The **Width** defines if the zone occupies the **Full** width of the portal or only **Half**.

---

**NOTE:** Zones on the [dashboard portal](#) are always the width of the dashboard.

---

If the zone type supports help text, you can use **Zone Help Text** to describe the zone to the end-users. Note that for multi-query zones, if the multi-query zone has help text, that is displayed for any zone selected. If the multi-query zone does not have help text, but the selected zone has help text, the selected zone's help text is displayed. Please refer to the section on [zone help text](#) for more information on how you can use HTML and cascading style sheets to format the help text.

Use **Override Zone Help Text** to override the product provided help text for this zone.

---

**NOTE: Viewing Your Text.** You can press the **Test** button to see how the help text will look when it's displayed in the zone.

---

The grid contains the zone's parameter values. The Zone Type controls the list of parameters. The grid contains the following fields:

- **Description** describes the parameter. This is display-only. Note that if there is a detailed description on the zone type parameter, an **icon** appears next to the parameter's description. Click the icon to see details related to the parameter, including tips on how to populate the parameter value.

---

**NOTE: Additional Details for Some Parameters.** There are several parameter types that have a lot of detail related to the possible configuration that cannot easily fit into the detailed description. Refer to [Zone Parameter Details](#) for additional information about these parameters.

---

- **Parameter Value** is the value for the parameter.
- Use **Override Parameter Value** to override the existing value for this parameter. This field is enabled when the related zone type parameter value is **Zone - Override Allowed**, and the zone is owned by the base product.
- **Owner** indicates if this parameter is owned by the base product or by your implementation (**Customer Modification**). This information is display-only.

#### Where Used

Follow this link to open the data dictionary where you can view the tables that reference [CI\\_ZONE](#).

## Zone - Portal

Select **Admin > System > Zone** and navigate to the **Portal** tab to define the portals on which a zone appears.

#### Description of Page

The scroll area contains the portals on which the zone appears.

To add a zone to a portal, press the + button and specify the **Portal**.

---

**NOTE: Owner** indicates if this portal / zone relationship is owned by the base product or by your implementation (**Customer Modification**). This information is display-only.

---

---

**NOTE:** You can also add a zone to a portal using [Portal - Main](#). Additional configuration about how the zone appears on the portal is available only on the Portal.

---

## Zone Configuration Topics

The topics in this section provide additional information related to setting up your zones.

### Zone Help Text

Most zone types support a button that allows a user to see zone-specific help text, which is defined on the zone page.

You can use HTML tags in the zone help text. The following is an example of help text that contains a variety of HTML tags:

**This zone summarizes <font color=blue><b>revenue</b></font> in 4 periods:<br>**

The above would cause the word **revenue** to be bold and blue:

- **<b>** and **</b>** are the HTML tags used to indicate that the surrounded text should be bold

- `<font color=blue>` and `</font>` are the HTML tags used to indicate that the surrounded text should be blue.

The following are other useful HTML tags:

- `<br>` causes a line break in a text string. If you use `<br><br>` a blank line will appear.
- `<I>` causes the surrounded text to be italicized

Please refer to an HTML reference manual or website for more examples.

You can also use "spans" to customize the look of the contents of a text string. For example, your text string could be `<span style="font-family:Courier; font-size:large; font-weight:bold;">revenue</span>`. This would make the word "revenue" appear as large, bold, Courier text. Please refer to a Cascading Style Sheets (CSS) reference manual or website for more examples.

The following is an example of help text using a variety of HTML tags:

```
<font FACE="arial" size=2>
```

This zone summarizes `<font color=blue><b>revenue</b></font>` in 4 periods:`<br>`

- The `<b>1st period</b>` is under your control. You simply select the desired `<b>Period</b>`, above `<i>`(you may need to click the down arrow to expose the filter section)`</i><br>`
- The `<b>2nd period</b>` is the period before the 1st period`<br>`
- The `<b>3rd period</b>` is the same as the 1st period, but in the previous year`<br>`
- The `<b>4th period</b>` is the period before the 3rd period`<br>`

```
<br>
```

The traffic light's color is determined as follows:`<br>`

- The ratio of the 1st and 3rd period is calculated`<br>`
- If this value is between 80 and 100, `<font color=orange><b>yellow</b></font>` is shown`<br>`
- If this value is < 80, `<font color=red><b>red</b></font>` is shown`<br>`
- If this value is > 100, `<font color=green><b>green</b></font>` is shown`<br>`
- If the value of the 3rd period is 0, no color is shown`<br>`

```
</font>
```

---

**NOTE:** It is possible to associate tool tip help with individual HTML and UI map elements. For more information, see [UI Map Help](#).

---

## Zone Parameter Details

For most zone parameters, the embedded help for the parameter provides the detailed information needed for configuring the parameter values. For some parameters with very detailed descriptions, the embedded help is abbreviated and more detail is provided here.

## Zone Visibility Service Script

All zones support a visibility script that is used to determine if the zone should be displayed to the user or not based on conditions. The script may receive input parameters and is expected to return a Boolean value indicating if the zone should be displayed or not. The inline help for the **Zone Visibility Service Script** parameter provides details related to the syntax.

The following table highlights some service scripts provided by the product that may be used if applicable to your zone's requirements. This is not an exhaustive list of visibility scripts. There may be others that are specific to a given zone.



Script Code	Description	Comments
F1-ShldShwZn	Zone Visibility - Display Zone in Portal	This script simply returns a value of 'true' and is used when the zone should always appear.
F1-CondShwZn	Zone Visibility - Display Zone in Portal Conditionally	This is used when the condition for showing the zone is based on the population of a context value. This is commonly used when one zone in the portal should only appear after a broadcast of a record from another zone in the portal.  For an example of a zone the uses this visibility script, refer to <b>F1-BSFTYPE</b> .
F1-RwCtShwZn	Zone Visibility - Based on Row Count	This is used when the condition for showing the zone is based on the existence of one or more rows that can be determined using SQL. This script accepts a zone code, user filters 1 through 25 and hidden filters 1 through 10. The script returns an indication of 'true' if at least one row count is returned by the zone.  To use this visibility script, a specific data explorer zone must be developed for the specific use case.  For an example of a zone the uses this visibility script, refer to <b>F1-MIGRREQEL</b> .

## SQL Statement

Data explorer zones are used to select data to display using one or more SQL statements. The SQL parameters are applicable to the following zone types

- Info Data Explorer - Single SQL (**F1-DE-SINGLE**). The parameter has the description **SQL Statement**.
- Info Data Explorer - Multiple SQLs (**F1-DE**). The parameters follow the description pattern of **SQL Statement x**.
- Query Data Explorer - Multiple SQLs (**F1-DE-QUERY**). The parameters follow the description pattern of **SQL Statement x**.

**NOTE:** If your implementation has been configured to restrict the functions that may be used when defining an SQL then an error is issued at runtime if there are functions found that are not in the whitelist. The whitelist may be viewed using the **View SQL function whitelist** link in the Tips zone on the zone maintenance page.

The following table provides a list of SQL substituted keywords that may be used in the SQL Statement parameters in explorer zones. At execution time, the system determines the database and substitutes the keyword with the database specific syntax:

Keyword	Description	Examples
@toCharacter()	Converts the input to Character data type.	select @toCharacter(batch_cd) as batchCode from ci_batch_ctrl
@toDate()	Converts the input to Date data type.	select @toDate(last_update_dttm) as lastUpdateDate from ci_batch_ctrl
@toNumber()	Converts the input to Number data type.	select @toNumber(next_batch_nbr) from ci_batch_ctrl
@currentDate	Fetches the current date.  <b>CAUTION:</b> The Oracle functions <b>SYSDATE</b> and <b>CURRENT_DATE</b> should not be used because they do not properly cater for adjusting dates from the database time zone to the installation time zone, if needed.	select batch_cd, @currentDate as today from ci_batch_ctrl

Keyword	Description	Examples
<b>@currentTimestamp</b>	Fetches the current date / time.  <b>CAUTION:</b> The Oracle functions <b>SYSTIMESTAMP</b> and <b>CURRENT_TIMESTAMP</b> should not be used because they do not properly cater for adjusting the date / time from the database time zone to the installation time zone, if needed.	select batch_cd from ci_batch_ctrl where last_update_dttm > <b>@currentTimestamp</b>
<b>@concat</b>	Combines the result list of two or more columns.	select batch_cd <b>@concat</b> next_batch_nbr concatNbr from ci_batch_ctrl
<b>@substr(string, start)</b>	<b>String</b> is the input String that you are trying to get a substring of. <b>Start</b> is the position of the character for the output results.	select batch_cd batchCode from ci_batch_ctrl Result: TESTCD  select <b>@substr</b> (batch_cd,3) batchCode from ci_batch_ctrl Result: STCD
<b>@substr(string, start, end)</b>	<b>String</b> is the input String that you are trying to get a substring of. <b>Start</b> is the position of the character for the output results. <b>End</b> is the number of characters required in the output from starting position.	Select batch_cd batchCode from ci_batch_ctrl Result: TESTCD  select <b>@substr</b> (batch_cd,3,2) batchCode from ci_batch_ctrl Result: ST
<b>@trim</b>	Trims the white spaces of the output on both sides.	select <b>@trim</b> (batch_cd) as batchCode from ci_batch_ctrl
<b>The following syntax is related to 'fuzzy' searching. It is only applicable if Oracle DB Text is enabled and a context text index has been created. Refer to <a href="#">Advanced Search Options</a> for more information.</b>		
<b>@fuzzy(string, score, numresult, 'weight')</b>	<b>String</b> is the input value for the search. <b>Score</b> is the degree of 'fuzziness'. Valid values are between 1 - 80. The higher the number the more precise the search. Default is 60. <b>Numresults</b> is the number of variations to consider for the string. Valid values are between 1 and 5000. Default is 100. Indicate <b>'weight'</b> to signal that the results are returned in order of weight. Leave this setting off to indicate that the results are returned in order of score.	Set score to 70, number results to 6, and specify weight.  select user_id, last_name from sc_user where contains(last_name, <b>@fuzzy</b> (:F1,70, 6, 'weight')) > 0
<b>@fuzzy(string)</b>	This returns a string result from the fuzzy expansion operation where the default value of 60 is assumed for the <b>score</b> and the default value of 100 is assumed for the <b>numresult</b> .	To use default values:  select user_id, last_name from sc_user where contains(last_name, <b>@fuzzy</b> (:F1))> 0
<b>@fuzzy(string, score)</b>	This returns a string result from the fuzzy expansion operation with the <b>score</b> specified and the default value of 100 for the <b>numresult</b> .	Set score to 70.  select user_id, last_name from sc_user where contains(last_name, <b>@fuzzy</b> (:F1,70)) > 0
<b>@fuzzy(string, score, numresult)</b>	This returns a string result from the fuzzy expansion operation with the similarity score and the <b>numresults</b> specified.	Set score to 70, number results to 6.  select user_id, last_name from sc_user where contains(last_name, <b>@fuzzy</b> (:F1,70, 6)) > 0

## Column Parameters

Data explorer zones are used to select data to display using one or more SQL statements. For each SQL statement, the zone may configure up to 20 Columns that contain the formatting definition for displaying the output data.

These parameters are applicable to the zone types

- Info Data Explorer - Single SQL (**F1-DE-SINGLE**). The parameters follow the description pattern of **Column x**.
- Info Data Explorer - Multiple SQLs (**F1-DE**). The parameters follow the description pattern of **Column x for SQL y**.

- Query Data Explorer - Multiple SQLs (**F1-DE-QUERY**). The parameters follow the description pattern of **Column x for SQL y**.

The following sections describe the various types of mnemonics.

## Contents

- [Source Mnemonics](#)
- [Formatting Mnemonics](#)
- [Click Mnemonics](#)

## Source Mnemonics

This table describe the mnemonics that control how the data in a column is derived.

Mnemonic	Description	Valid Values	Comments
<b>source=</b>	Defines how the column's value is derived.	<b>SQLCOL</b>	Indicates that the source of the column's value comes from a column in the SQL statement. This type of column must also reference the <b>sqlcol=</b> mnemonic.
<b>BO</b>			Indicates that the source of the column's value comes from a <a href="#">business object</a> . This type of column must also reference the <b>bo=</b> , <b>input=</b> and <b>output=</b> mnemonics to define how to interact with the business object.
<b>BS</b>			Indicates that the source of the column's value comes from a <a href="#">business service</a> . This type of column must also reference the <b>bs=</b> , <b>input=</b> and <b>output=</b> mnemonics to define how to interact with the business service.
<b>SS</b>			Indicates that the source of the column's value comes from a <a href="#">service script</a> . This type of column must also reference the <b>ss=</b> , <b>input=</b> and <b>output=</b> mnemonics to define how to interact with the service script.
<b>FORMULA</b>			Indicates that the source of this column's value is calculated using a formula. This type of column must also reference the <b>formula=</b> mnemonic.
<b>SETFUNC</b>			Indicates that the source of this column's value is calculated using a superset of values from the rows in the SQL statement. This type of column must also reference the <b>setfunc=</b> mnemonic.
<b>ICON</b>			Indicates that the source of this column's value is a <a href="#">display icon</a> reference (meaning that an icon will be displayed in the column). This type of column must also reference the

Mnemonic	Description	Valid Values	Comments
			<p><b>icon=</b> mnemonic to define the icon reference.</p> <p><b>NOTE:</b> When using this source mnemonic, the <a href="#">formatting</a> <a href="#">mnemonic</a> is not applicable.</p>
		<b>FKREF</b>	<p>Indicates that the source of this column's value is an <a href="#">FK reference</a> (meaning that the FK reference's context menu and information string will be displayed in the column). This type of column must also reference the <b>fkref=</b> and <b>input=</b> mnemonics to define how the FK reference is called.</p> <p><b>NOTE:</b> When using this source mnemonic, the <a href="#">formatting</a> <a href="#">mnemonic</a> is not applicable.</p>
		<b>SPECIFIED</b>	<p>Indicates that the source of this column's value is specified by concatenating literals and other column values. This type of column must also reference the <b>spec=</b> mnemonic.</p>
		<b>MSG</b>	<p>Indicates that the source of this column is a message from the <a href="#">message</a> table (along with any substitution variables). This type of column must also reference the <b>msg=</b> mnemonic.</p>
<b>sqlcol=</b>	Defines the column in the SQL statement when <b>source=SQLCOL</b> .	COLUMN_NAME	Enter the name of a column that is retrieved in the SELECT statement. Note that if the select statement uses an alias for a column, then the alias should be referenced here.
		x	Where x is an integer value that references a column by its relative position in the SELECT statement. For example, <b>sqlcol=3</b> would display the 3rd column in the SELECT statement).
<b>bo=</b>	<p>Defines the business object to invoke when <b>source=BO</b>.</p> <p>This mnemonic must be used in conjunction with the <b>input=</b> and <b>output=</b> mnemonics to define how information is sent to / received from the business object.</p>	'Business Object Code'	
<b>bs=</b>	Defines the business service to invoke when <b>source=BS</b> .	'Business Service Code'	

Mnemonic	Description	Valid Values	Comments
	This mnemonic must be used in conjunction with the <b>input=</b> and <b>output=</b> mnemonics to define how information is sent to/received from the business service.		
<b>ss=</b>	Defines the service script to invoke when <b>source=SS</b> .  This mnemonic must be used in conjunction with the <b>input=</b> and <b>output=</b> mnemonics to define how information is sent to / received from the service script.	'Service Script Code'	
<b>fkref=</b>	Defines the FK reference used to retrieve the column's information when <b>source=FKREF</b> .  This mnemonic must be used in conjunction with the <b>input=</b> mnemonic to define how information is sent to the FK reference to build the information.	Cx  COLUMN_NAME  'FK Reference Code'	This means FK reference code is defined in an earlier column. For example, define <b>C1</b> if column 1 defines the FK reference value.  This means the FK reference was retrieved by the SELECT statement. The value should match the name defined in the SELECT clause.  This means the FK Reference is defined directly. For example 'F1-ROLE'.
<b>formula=</b>	Defines the formula to use when <b>source=FORMULA</b> .  Examples:  <ul style="list-style-type: none"> <li><b>formula=C1*.90/C2</b></li> <li><b>formula=(C1/C2)*100</b></li> </ul>	The formula can contain numeric constants, operators and column references.	For column references, use the format Cx where x represents the column number.  Refer to <a href="#">Expression Parser</a> for information about the functions supported.
<b>setfunc=</b>	Defines the function to apply to the rows of a given column when <b>source=SETFUNC</b> .	function(Cx)	Where Cx represents a column whose rows should have the function applied and the function is one of the following: <ul style="list-style-type: none"> <li><b>MAX</b>. This derives the maximum value of all rows in the column.</li> <li><b>MIN</b>. This derives the minimum value of all rows in the column.</li> <li><b>TOT</b>. This derives the sum (total value) of all rows in the column.</li> <li><b>ACC</b>. This derives the cumulative total of all rows up to an including the current row.</li> </ul>
<b>input=</b>	This is used to define one or more input fields and values passed to business objects, business services, service scripts, and FK references.	Cx  COLUMN_NAME	Where Cx represents the value of a previous column. If the value to pass is in the first column, reference C1.  This means the value to pass in was retrieved by the SELECT statement.

Mnemonic	Description	Valid Values	Comments
	<p>The syntax is as follows: [ELEMENT_NAME=ELEMENT_REF ELEMENT_NAME=ELEMENT_REF ...]</p> <p>In other words, the list of input values is surrounded by square brackets separated by a space. Each passed value first defines the ELEMENT_NAME, which is the name of the element / field in the target. ELEMENT_REF is the value passed in. The next column indicates the possible values for ELEMENT_REF.</p>	<p>'literal value'</p> <p><b>userTimeZone</b></p> <p><b>installationTimeZone</b></p> <p>Examples:</p> <ul style="list-style-type: none"> <li>• <b>input=[USER_ID=C1]</b></li> <li>• <b>input=[USER_ID=USER_ID]</b></li> <li>• <b>input=[input/targetTimeZone=userTimeZone]</b></li> </ul>	<p>The value should match the name defined in the SELECT clause.</p> <p>This means a literal value within the single quotes should be passed in.</p> <p>This means the current user's time zone should be passed in. This is typically used with the business service <b>F1-ShiftDateTime</b> to convert data in the storage time zone to the user's time zone for display.</p> <p>This means the installation time zone should be passed in. This is typically used with the business service <b>F1-ShiftDateTime</b> to convert data in the storage time zone to the installation time zone for display.</p>
<b>output=</b>	This is used to define the name of the element retrieved from the business object, business service or service script used to populate this column.	elementName	Example: <b>output=personInfo</b>
<b>pagingkey=</b>	<p>This mnemonic is only applicable when the <b>Enable Paging</b> parameter has been configured. It indicates that this column is one of the keys used by the SQL statement to orchestrate paging through results. This mnemonic can only be specified when the <b>source=SQLCOL</b>.</p> <p><b>FASTPATH:</b> Refer to <a href="#">Pagination Configuration</a> for more information.</p>	<p>Y</p> <p>N</p>	<p>This is the default, meaning that you don't need to indicate <b>pagingkey=N</b> at all to indicate that the column is not one of the paging keys.</p>

## Formatting Mnemonics

This table describe the mnemonics that control how a column is formatted.

Mnemonic	Description	Valid Values	Comments
<b>type=</b>	<p>Defines how the column's value is formatted.</p> <p><b>NOTE: Icon and Foreign Key columns.</b> The <b>source=source mnemonic</b> may be used to indicate a column should be derived from</p>	<p><b>STRING</b></p> <p><b>DATE</b></p> <p><b>TIME</b></p>	<p>Columns of this type capture a string. This is the default value.</p> <p>Columns of this type capture a date.</p> <p>Columns of this type capture a time (in database format) and will be displayed using the user's <a href="#">display profile</a>.</p>

Mnemonic	Description	Valid Values	Comments
	an icon reference or a foreign key (FK) reference. If you use either of these sources, the <b>type=</b> mnemonic is not relevant as either an icon or a context menu / info string will appear in the column.	<p><b>DATE/TIME</b></p> <hr/> <p><b>MONEY</b></p> <hr/> <p><b>NUMBER</b></p>	<p>Columns of this type capture a date and time (in database format) and will be displayed using the user's <a href="#">display profile</a>.</p> <hr/> <p>Columns of this type capture a monetary field. This type of column may also reference the <b>cur=</b> mnemonic. If the cur mnemonic is not specified, the currency code on the installation record is used.</p> <hr/> <p>Columns of this type capture a numeric field. This type of column may also reference the <b>dec=</b> mnemonic.</p>
<b>label=</b>	<p>Defines the column's override label. The label appears in the column's heading and in the zone's drag and drop area.</p> <p>If this mnemonic is not defined, the system uses the column's default label. The source of a column's default label differs depending on the column's <a href="#">source</a>. Note that some sources don't have a default value and omitting this mnemonic will result in a blank label.</p>	<p>FIELD_NAME</p> <hr/> <p>'text'</p>	<p>Enter a valid <a href="#">field</a> name whose label should be used for the column label. This should always be the option used if multiple languages are needed.</p> <hr/> <p>Defines the text directly.</p>
<b>cur=</b>	Defines the <a href="#">currency code</a> applied when <b>type=MONEY</b> if the installation record's currency should not be used.	<p>Cx</p> <hr/> <p>COLUMN_NAME</p> <hr/> <p>'Currency Code'</p>	<p>This means currency code value is defined in an earlier column. For example, define <b>C1</b> if column 1 defines the currency code.</p> <hr/> <p>This means the currency code was retrieved by the SELECT statement. The value should match the name defined in the SELECT clause.</p> <hr/> <p>This means the currency code is defined directly. For example 'USD'.</p>
<b>dec=</b>	<p>Defines the number of decimal places when <b>type=NUMBER</b>.</p> <p>It is optional. If provided it should be an integer. If not provided, the number of decimals will default to the number of decimal places defined on the currency code specified on the installation record.</p>	nR	<p>Where n is the number of decimal places to show. Suffixing the number of decimal places with R means that the system should round up / down. Simply specifying n (without an R) means that decimal places should be truncated. For example, entering <b>dec=4</b> will display 4 decimal places and truncate the remainder.</p> <p><b>NOTE: Formatting only.</b> This mnemonic is only used for formatting, it does not impact the precision used for subsequent calculations. For example, if a</p>

Mnemonic	Description	Valid Values	Comments
			column retrieved from the database contains 6 significant digits and <b>dec=0</b> , the column will be shown with no decimal places (truncated), however any references to the column in subsequent calculations will use 6 decimal places. For example, if the column is referenced in a formula or set function, all 6 decimal places will be used.
<b>char=</b>	This mnemonic applies special character(s) to the column's value.	'x[]x'	Where x references the literal value to display and [ ] defines the relative position of the characters (before or after the value).  You need only include the [ ] if you want to position characters in front of the value. For example, <b>char=%'</b> will place a percent sign after the value. If you want to position the word 'minutes' before a value, enter <b>char='minutes [ ]'</b> . If you want to output a value like <b>BUDGET \$123.12 (YTD)</b> , enter <b>char='BUDGET [ ] (YTD)'</b> .
<b>suppress=</b>	This is used to indicate a column should not be displayed.  A column would be suppressed if it's only defined for use by subsequent columns, for example, if there is a formula that derives a column using two other columns. In this scenario, the columns referenced in the formula can be suppressed.	<b>true</b>  <b>false</b>	This is the default, meaning that you don't need to indicate <b>suppress=false</b> at all to indicate that the field should be shown.
<b>suppressSearch=</b>	This is used to indicate a column should not be displayed when the zone is invoked in search mode only.	<b>true</b>  <b>false</b>	This is the default, meaning that you don't need to indicate <b>suppressSearch=false</b> at all to indicate that the field should be shown.
<b>suppressExport=</b>	This is used to indicate a column should not be downloaded to Excel.	<b>true</b>  <b>false</b>	This is the default, meaning that you don't need to indicate <b>suppressExport=false</b> at all to indicate that the field should be included in a download.
<b>width=</b>	This is used to override the width of a column (number of pixels). The default value is the maximum width of any cell in the column.	n	Where n is a number between 0 and 999.  <b>NOTE:</b>



Mnemonic	Description	Valid Values	Comments
			<p>If there is no available breaking point in the data, the column will be longer than the specified number of pixels.</p> <p>The length of the column's label (which appears in the column's heading) may also make the width wider than specified.</p>
<b>color=</b>	This is used to override the column's text color.	<p>A valid HTML "named" color</p> <hr/> <p>A valid RGB color model combination</p>	<p>For example <b>color=red</b> or <b>color=yellow</b>.</p> <hr/> <p>For example <b>color=#FF0000</b> or <b>color=#CCCCCC</b>. Note that the # is required.</p>
<b>bgcolor=</b>	This is used to override the column's background color.	<p>A valid HTML "named" color</p> <hr/> <p>A valid RGB color model combination</p>	<p>Similar to the <b>color=</b> mnemonic.</p> <hr/> <p>Similar to the <b>color=</b> mnemonic.</p>
<b>order=</b>	Defines the column's default sort order.	<p><b>ASC</b></p> <hr/> <p><b>DESC</b></p>	<p>Indicates that the order is ascending. This is the default meaning that it is not necessary to indicate <b>order=ASC</b>.</p> <hr/> <p>Indicates that the order is descending.</p>

## Click Mnemonics

This table describe the mnemonics that define whether a column value may be clicked and if so, what should happen.

Mnemonic	Description	Valid Values	Comments
<b>navopt=</b>	<p>Defines the navigation option that references the target transaction or script when the user clicks a column.</p> <p>Note, this mnemonic should be used in conjunction with the <b>context=</b> mnemonic to define what information is sent to the navigation option's target transaction.</p> <p>This mnemonic is ignored if <b>source=FKREF</b> because the FK reference code defines the hyperlink's destination.</p>	<p>Cx</p> <hr/> <p>COLUMN_NAME</p> <hr/> <p>'Navigation Option Code'</p>	<p>This means navigation option code is defined in an earlier column. For example, define <b>C1</b> if column 1 defines the navigation option.</p> <hr/> <p>This means the navigation option was retrieved by the SELECT statement. The value should match the name defined in the SELECT clause.</p> <p>Example: <b>navopt=MAIN_PORTAL</b></p> <hr/> <p>This means the navigation option code is defined directly. For example <b>navopt='userMaint'</b>.</p>
<b>context=</b>	<p>This is used to define one or more context fields and values passed to the target navigation option to go along with the <b>navopt=</b> mnemonic.</p> <p>The syntax is as follows: [FIELD_NAME=FIELD_REF FIELD_NAME=FIELD_REF ...]</p> <p>In other words, the list of input values is surrounded by square brackets</p>	<p>Cx</p> <hr/> <p>COLUMN_NAME</p>	<p>Where Cx represents the value of a previous column. For example, if the value to pass is in the first column, reference <b>C1</b>.</p> <hr/> <p>This means the value to pass in was retrieved by the SELECT statement. The value should match the name defined in the SELECT clause.</p>

Mnemonic	Description	Valid Values	Comments
	separated by a space. Each passed value first defines the FIELD_NAME, which is the name of the context field in the navigation option. FIELD_REF is the value passed in. The next column indicates the possible values for FIELD_REF.	'literal value'	This means a literal value within the single quotes should be passed in.
<b>bpa=</b>	<p>Indicates that a BPA script should be executed with the user clicks the column and indicates the BPA to execute.</p> <p>Note, this mnemonic should be used in conjunction with the <b>tempstorage=</b> mnemonic to define the temporary storage values that will be initiated when the script is executed.</p> <p>This mnemonic is ignored if <b>source=FKREF</b> because the FK reference code defines the hyperlink's destination.</p>	Cx	Indicates that the BPA script is defined in a previous column.
		COLUMN_NAME	This means the BPA script to execute was retrieved by the SELECT statement. The value should match the name defined in the SELECT clause.
		'BPA Script Code'	This means that the BPA script to execute is defined directly.
<b>tempstorage=</b>	<p>This is used to define how temporary storage variables are initiated when the <b>bpa=</b> mnemonic is used.</p> <p>The syntax is as follows: [FIELD_NAME=FIELD_REF FIELD_NAME=FIELD_REF ...]</p> <p>In other words, the list of input values is surrounded by square brackets separated by a space. Each passed value first defines the FIELD_NAME, which is the name of the field in temporary storage. FIELD_REF is the value passed in. The next column indicates the possible values for FIELD_REF.</p>	Cx	Where Cx represents the value of a previous column. For example, if the value to pass is in the first column, reference <b>C1</b> .
		COLUMN_NAME	This means the value to pass in was retrieved by the SELECT statement. The value should match the name defined in the SELECT clause.
		'literal value'	This means a literal value within the single quotes should be passed in.
<b>list=</b>	<p>This is used to enable <a href="#">work list</a> capability for this column.</p> <p>You may optionally populate the <b>listdesc=</b> mnemonic to override the text that will be placed in the worklist zone.</p>	<b>true</b>	<p>Setting <b>list=true</b> will cause the work list icon to appear in the column's header. If a user clicks the column, it will populate all the rows in the output into the <a href="#">work list zone</a>.</p> <p><b>NOTE:</b> In the case of the zone type Info Data Explorer - Multiple SQLs (<b>F1-DE</b>), the output may be showing a union of the results of multiple SQL statements. In this case, if some of the SQL statements configure a given column with <b>list=true</b>, but not all, only the data in the cells for</p>

Mnemonic	Description	Valid Values	Comments
			the statements that configure this mnemonic are put into the work list when the user clicks the icon.
<b>listdesc=</b>	This is an optional mnemonic when using the <b>list=</b> mnemonic. It can be used to override the text that is placed in the work list zone.	Cx	Where Cx represents the value of a previous column. For example, if the text to use is in the first column, reference <b>C1</b> .
<b>listbroadcast=</b>	Indicates that the broadcast information for the column is also to be made available in the work list zone. This means that the work list can be used to broadcast information to a portal in the same manner as a data explorer.	<b>true</b>	Use this setting to turn on the feature.

## Zone Action

Most zone types provided by the product allow for one or more Zone Actions to be defined to appear in the zone header. An action can appear as a hyperlink, icon or button. The action can also be provided as an HTML string.

**NOTE:** Zone types also include parameters for actions defined at the zone type level using **IMPLEMENTOR\_ACTION\_n** (Action n) parameters. These are rarely used by the product zone types. The actions defined here override any actions defined on the zone type (if present). The details below apply to the zone type level actions as well.

A zone action is defined using the following mnemonics:

Mnemonic	Description	Valid Values	Comments
<b>type=</b>	This mnemonic defines the appearance of the action in the zone header.	<b>LINK</b>	Indicates that the action is shown as a textual hyperlink.
		<b>ICON</b>	Indicates that the action is shown as a graphical icon.
		<b>BUTTON</b>	Indicates that the action is shown as an HTML button.
		<b>ASIS</b>	Indicates that the parameter will provide the HTML to be used for the action.
<b>action=</b>	This mnemonic defines the action to take when the link/icon/button is clicked. This is ignored when the <b>type=ASIS</b> .	<b>NAVIGATION</b>	Indicates that the action is navigation to a page.
		<b>SCRIPT</b>	Indicates that the action is to run a BPA script.
<b>navopt=</b>	Defines the navigation option to use when the <b>action=NAVIGATION</b> .	'NAV_OPT_CD'	Enter a reference to a valid navigation option in single quotes.
<b>bpa=</b>	Defines the script to run when the <b>action=SCRIPT</b> .	'SCRIPT_CD'	Enter a reference to a valid BPA script in single quotes.
<b>icon=</b>	Indicates the icon to use when <b>type=ICON</b> .	DISP_ICON_CD	Enter a reference to a valid display icon.
		'path'	Enter an explicit path to the icon, for example 'images/gotoZone.gif'.
<b>asis=</b>	This is required when the <b>type=ASIS</b> . This provides	['HTML']	

Mnemonic	Description	Valid Values	Comments
	the ability to precisely define the HTML you wish to have included in the header. All valid HTML is permitted including the use of "ora" css classes and JavaScript functions.		
<b>label=</b>	By default, the label or tooltip will come from the navigation option or BPA script description. Use this mnemonic to override that label.	FIELD_NAME  'text'	Enter a valid field name whose label should be used. This should always be the option used if multiple languages are needed.  Enter the text directly in single quotes.
<b>context=[target1=source1 target2=source2]</b>	This is used to pass context data when navigating to a page or executing a BPA script. The mnemonic supports passing multiple values.  In each case the target context field or BPA script variable is defined first followed by an equal sign, followed by source data defined using one of the valid values defined in the next column.  One or more values may be defined. Each context value is defined separated by spaces. The whole set of context values should be surrounded by square brackets.	FIELD_NAME  xpath  'constant'	Indicates that the value should be taken from the field with this name from portal context, global context or the page data model. The mnemonic sourceLoc is used for defining the source.  Indicates that the value should be taken from a schema field, represented by the Xpath, displayed in this zone. This is valid when the zone is displaying a UI Map.  Indicates that the value defined in single quotes should be passed.
<b>sourceLoc=</b>	This mnemonic defines the source of the FIELD_NAME's value in the context mnemonic.  If this mnemonic is left blank, the default behavior is as follows:  - The portal context is checked.  - If no portal context value is found, the global context is checked.  - If neither value is available, the field is ignored.	<b>G</b>  <b>P</b>  <b>D</b>	Indicates that the field's value is retrieved from the global context.  Indicates that the field's value is retrieved from the portal context.  Indicates that the field's value is retrieved from the page data model.
<b>class=</b>	Use this mnemonic to override the look and feel of the link / icon / button using a different CSS style.	'className1' 'className2'	Enter one or more classes in single quotes. Multiple class names may be provided.
<b>style=</b>	Use this mnemonic to override the look and feel of the action element using the indicated css style.	Standard style= format.	All allowed css style definitions may be used.

Examples:

- **type=BUTTON action=SCRIPT bpa='F1-SET-USER' context=[USER\_ID=USER\_ID] label=UPDATE\_LBL**
- **type=LINK action=NAVIGATION navopt='gotoUser' context=[USER\_ID=path(schema/userId)]**
- **type=ASIS asis=['<A class="oraLink" href="www.google.com">Search</a>']**

**NOTE:** If the zone type has actions defined and there is a desire to simply remove the zone type actions, the Zone Action can be set with the following configuration: **type=ASIS asis=[]**

## User Filters

Data explorer zones include the ability to define User filters to allow a user to enter data to restrict the zone's rows and / or columns. The filters may be defined individually using User Filter parameters 1–25. Alternatively, a UI map may be defined for capturing filters. In this case, the map's input fields must be associated with the zone's filters by specifying the **xpath=** mnemonic on the respective User Filter parameters.

These parameters are applicable to the zone types

- Info Data Explorer - Multiple SQLs (**F1–DE**)
- Query Data Explorer - Multiple SQLs (**F1–DE-QUERY**)
- Info Data Explorer - Single SQL (**F1–DE-SINGLE**)

A user filter is defined using the following mnemonics:

Mnemonic	Description	Valid Values	Comments
<b>name=</b>	This mnemonic is used if the zone's filter should be pre-populated with a value from global context, portal context or broadcast from another zone.	MD Field Name	
<b>datasource=</b>	This mnemonic defines the source of the filter's pre-populated value defined in the name mnemonic. If this mnemonic is left blank, the default behavior is as follows: - If the field has been broadcast from another zone, the broadcast value is used. - If no value is broadcast, the portal context is checked to determine if this field exists (if so, its value is taken). - If still no value, the global context is checked. - If still no value, no default value is shown.	<b>G</b> <b>P</b> <b>D</b>	Indicates that the zone should look for the filter value in global context. Indicates that the zone should look for the filter value in portal context. Indicates that the zone should look for the filter value in the page data model.
<b>type=</b>	Defines the visual metaphor used to capture the filter values.	<b>DATE</b> <b>DATE/TIME</b> <b>STRING</b> <b>MONEY</b> <b>NUMBER</b> <b>LOOKUP</b> <b>TABLE</b> <b>CHARTYPE</b>	Filters of this type capture a date. Filters of this type capture a date and time. Filters of this type capture a string Filters of this type capture a monetary field. This type of filter must also reference the cur mnemonic. Filters of this type capture a numeric field. This type of filter may also reference the decimals mnemonic. Filters of this type capture a lookup value. This type of filter must also reference the lookup mnemonic. Filters of this type capture an administrative table's value (code and description). This type of filter must also reference the table mnemonic. Filters of this type capture predefined characteristic values for a characteristic type (code

Mnemonic	Description	Valid Values	Comments
			and description). This type of filter must also reference the chartype mnemonic.
		<b>ASIS</b>	Filters of this type capture a list of values to be referenced within an 'IN' clause within the SQL statement.
<b>label=</b>	Defines the filter's label that appears in the zone's description bar and in the input area.	MD Field Name  'text'	Enter a valid field name whose label should be used for the filter label. This should always be the option used if multiple languages are needed.  Defines the text directly.
<b>cur=</b>	Defines the currency code applied when <b>type=MONEY</b> .	Currency Code	Enter a reference to a valid currency code.
<b>dec=</b>	Defines the number of decimal places when <b>type=NUMBER</b> .	Valid number	It is optional. If provided it should be an integer. If not provided, the number of decimals will default to the number of decimal places defined on the currency code specified on the installation record.
<b>lookup=</b>	Defines the lookup flag whose values appear when <b>type=LOOKUP</b> .	Lookup Field Name	Enter a reference to a valid lookup field name.
<b>table=</b>	Defines the admin table whose values appear when <b>type=TABLE</b> .	Table Name	Enter a reference to a valid control table name.
<b>chartype=</b>	Defines the characteristic type code whose values appear when <b>type=CHARTYPE</b> .	Char Type code	Enter a reference to a valid characteristic type code.
<b>xpath=</b>	This mnemonic is used in conjunction with a Filter Area UI Map. For each filter, you must specify the XPath to the corresponding UI map schema element.	XPath	The <b>type=</b> mnemonic must also be appropriate for the map's input field, otherwise the query's SQL could fail.
<b>likeable=</b>	This mnemonic defines if a likeable search is performed on the entered value when <b>type=STRING</b> .	<b>S</b>  <b>P</b>  <b>PS</b>	The query will add % to the suffix of the filter value.  The query will add % to the prefix of the filter value.  The query will add % to the prefix and suffix of the filter value.
<b>divide=</b>	The mnemonic controls if a divider line appears above and/or below the filter.  Note, you can specify this parameter twice if you want divider lines placed above and below a filter, e.g., <b>divide=above divide=below</b> .	<b>above</b>  <b>below</b>	This results in a divider line placed above the filter.  This results in a divider line placed below the filter.
<b>searchField=</b>	This mnemonic controls the initial population of the filter when the zone is launched as a search from a UI map.	MD Field Name	Enter the field name that exactly matches the searchField name specified in the oraSearchField HTML element in the UI map.
<b>encrypt=</b>	This mnemonic defines if the user filter is <b>encrypted</b> and needs to be searched by hashed value.	[TBL_NAME,FLD_NAME,WHERE_FLD,WHERE_VALUE]  <b>NOTE:</b> The field name referenced here should be the source value of the field. However, the SQL should use the hashed value in its filter.	A valid table name and field name are required.  The WHERE_FLD and WHERE_VALUE are optional, but if entered, both are required. Use this to only encrypt the field if another field has a certain value. The following is an example.  <b>encrypt=[CI_PERSON,PER_ID_NBR,ID_TYPE_NBR,'SSN']</b> . The WHERE_VALUE may also reference another filter. The following is an example.

Mnemonic	Description	Valid Values	Comments
			encrypt=[CI_PERSON,PER_ID_NBR,ID_TYPE_NBR,F1].

Examples:

- **label=F1\_NBR\_DAYS type=NUMBER**
- **label=F1\_SHOW\_ALL\_REQ\_FLG type=LOOKUP lookup=F1\_SHOW\_ALL\_REQ\_FLG**
- Filter value where a Filter UI Map is defined and Description is one of the filters. **type=STRING xpath=description likeable=S**
  - **type=STRING label=DESCR likeable=S divide=below**
  - **label=REQ\_TYPE\_CD type=TABLE table=F1\_REQ\_TYPE**

## Hidden Filters

Data explorer zones include the ability to define Hidden filters to restrict the rows and / or columns that appear in the zone. The following are the potential sources of a hidden filter's value:

- The global area contains the fields whose values are maintained in [global context](#).
- The portal area contains the fields describing the object currently displayed in a portal.
- Other zones on a portal can broadcast information to the portal area, which can then in turn be used by the zone as a hidden filter.

These parameters are applicable to the zone types

- Info Data Explorer - Multiple SQLs (**F1-DE**)
- Query Data Explorer - Multiple SQLs (**F1-DE-QUERY**)
- Info Data Explorer - Single SQL (**F1-DE-SINGLE**)

A hidden filter is defined using the following mnemonics:

Mnemonic	Description	Valid Values	Comments
<b>name=</b>	This mnemonic defines the name of the field that needs to be broadcast from other zones or populated in the portal context	FIELD_NAME	
<b>datasource=</b>	This mnemonic defines the source of the hidden filter's value. If this mnemonic is left blank, the default behavior is as follows: - If the field has been broadcast from another zone, the broadcast value is used. - If no value is broadcast, the portal context is checked to determine if this field exists (if so, its value is taken). - If still no value, the global context is checked. - If still no value, the zone appears as per the poprule mnemonic.	<b>G</b> <b>P</b> <b>D</b>	Indicates that the zone should look for the filter value in global context. Indicates that the zone should look for the filter value in portal context. Indicates that the zone should look for the filter value in the page data model.
<b>poprule=</b>	This mnemonic controls what happens if the hidden filter is not present.	<b>R</b>	Indicates that a value for the filter is required. The zone will be set to the "empty state" and the "please broadcast" message will appear in the zone. This is the default value.

Mnemonic	Description	Valid Values	Comments
		O	Indicates that the value is optional. If no value is required, the zone is still built without that value.
<b>type=</b>	Defines the visual metaphor used to capture the filter values.	<b>DATE</b> <b>DATE/TIME</b> <b>STRING</b> <b>MONEY</b> <b>NUMBER</b> <b>LOOKUP</b> <b>TABLE</b> <b>CHARTYPE</b> <b>ASIS</b>	Filters of this type capture a date. Filters of this type capture a date and time. Filters of this type capture a string Filters of this type capture a monetary field. This type of filter must also reference the cur mnemonic. Filters of this type capture a numeric field. This type of filter may also reference the decimals mnemonic. Filters of this type capture a lookup value. This type of filter must also reference the lookup mnemonic. Filters of this type capture an administrative table's value (code and description). This type of filter must also reference the table mnemonic. Filters of this type capture predefined characteristic values for a characteristic type (code and description). This type of filter must also reference the chartype mnemonic. Filters of this type capture a list of values to be referenced within an 'IN' clause within the SQL statement.
<b>label=</b>	Defines the filter's label that appears in the zone's description bar.	FIELD_NAME  'text'	Enter a valid field name whose label should be used. This should always be the option used if multiple languages are needed.  Defines the text directly.
<b>cur=</b>	Defines the currency code applied when <b>type=MONEY</b> .	CURRENCY_CD	Enter a reference to a valid currency code.
<b>dec=</b>	Defines the number of decimal places when <b>type=NUMBER</b> .	N	It is optional. If provided it should be an integer. If not provided, the number of decimals will default to the number of decimal places defined on the currency code specified on the installation record.
<b>lookup=</b>	Defines the lookup flag whose values appear when <b>type=LOOKUP</b> .	LOOKUP_FIELD_NAME	Enter a reference to a valid lookup field name.
<b>table=</b>	Defines the admin table whose values appear when <b>type=TABLE</b> .	TABLE_NAME	Enter a reference to a valid admin table name.
<b>chartype=</b>	Defines the characteristic type code whose values appear when <b>type=CHARTYPE</b> .	CHAR_TYPE_CD	Enter a reference to a valid characteristic type code.
<b>searchField=</b>	This mnemonic controls the initial population of the filter when the zone is launched as a search from a UI map.	FIELD_NAME	Enter the field name that exactly matches the searchField name specified in the oraSearchField html element in the UI map.



## Multi-Select Action

This parameter defines an action to be included in the action area for multi-selection processing. Note that a multi-selection action can only be used if the Multi Select parameter has been set to YES, which causes a checkbox to appear on each row displayed. The action defined here will trigger against all rows selected by the user via the checkbox.

These parameters are applicable to the zone types

- Info Data Explorer - Multiple SQLs (**F1-DE**)
- Query Data Explorer - Multiple SQLs (**F1-DE-QUERY**)
- Info Data Explorer - Single SQL (**F1-DE-SINGLE**)

A multi select action has the following mnemonics:

Mnemonic	Description	Valid Values	Comments
<b>script=</b>	This mnemonic defines the script to be invoked when the action is clicked. This is required.	SCR_CD	Enter a reference to a valid BPA script or Service Script.
<b>type=</b>	This mnemonic defines how the action should be rendered.	<b>BUTTON</b>	The action is rendered as a button. This is the default.
		<b>LINK</b>	The action is rendered as hypertext.
		<b>ICON</b>	The action is rendered as a graphic icon. For this option, the icon mnemonic is required.
<b>icon=</b>	This mnemonic defines the icon to display when <b>type=ICON</b> .	DISPLAY_ICON_CD	Enter a reference to a valid display icon code.
<b>refresh=</b>	This mnemonic indicates how and if a refresh should occur after the script completes.	<b>NO</b>	Indicates that no refresh is performed. This is the default.
		<b>ZONE</b>	Indicates that a refresh of the zone is performed.
		<b>PORTAL</b>	Indicates that a refresh of the entire portal is performed.
<b>label=</b>	By default, the button label, link text or icon tooltip will come from the script description. Use this mnemonic to override that label.	FIELD_NAME	Enter a valid field name whose label should be used. This should always be the option used if multiple languages are needed.
		'text'	Enter the text directly in single quotes.
<b>list=</b>	When executing the script, the framework builds an XML list containing information from each row selected. This list must be defined in the script's schema and referenced in this mnemonic.	listElementName	Enter a valid list element name from the script schema.
<b>context=[elementName1=rowData1 elementName2=rowData2]</b>	This mnemonic is used to populate the list	Cx	Indicates that the element should be

Mnemonic	Description	Valid Values	Comments
	<p>with the appropriate information from each selected row. The mnemonic supports passing multiple values.</p> <p>In each case the element in the schema list is defined first followed by an equal sign, followed by information about the data used to populate the element defined using one of the valid values defined in the next column.</p> <p>One or more values may be defined. Each context value is defined separated by spaces. The whole set of context values should be surrounded by square brackets.</p> <p>Example of a schema:</p> <pre>&lt;schema&gt;   &lt;accountInfo type="list"&gt;     &lt;accountId/&gt;     &lt;name/&gt;     &lt;amount/&gt;     &lt;process/&gt;   &lt;/accountInfo&gt; &lt;/schema&gt;</pre> <p>Example of list and context mnemonics.</p> <p><b>list=accountInfo</b>  <b>context=[accountId=ACCT_</b>  <b>ID name=C2</b>  <b>amount=P3</b>  <b>process='O']</b></p>	<p>Px</p> <p>COLUMN_NAME</p> <p>'constant'</p>	<p>populated with a value in the referenced column parameter.</p> <p>Indicates that the element should be populated with a value in the referenced post processing parameter.</p> <p>Indicates that the element should be populated with a value from a column in the SQL statement.</p> <p>Indicates that the value defined in single quotes should be passed.</p>
<b>class=</b>	Use this mnemonic to override the look and feel of the action using a different CSS style.	'className1' 'className2'	Enter one or more classes in single quotes to be appended to the standard class(es). Multiple class names may be provided.
<b>style=</b>	Use this mnemonic to override the look and feel of the action element using the indicated css style.	Standard style= format.	All allowed css style definitions may be used.

## Pagination Configuration

The various data explorer zones in the product support the ability to configure pagination so that a user can 'page through' a large set of results using "previous" and "next" buttons or links.

There are several zone parameters that are impacted when attempting to configure this functionality. The following steps highlight the configuration.

- The **Enable Pagination** parameter must be configured to define the basic setup for pagination for the zone. This parameter defines whether the "previous" and "next" actions are defined as buttons, links or icons and indicates the

location of the actions. It also allows an indication as to whether the additional rows are simply appended, rather than shown in a new "page". Refer to the parameter's embedded help for information about the specific syntax.

- It is recommended that the zone is configured with record count and page information by properly configuring the **Record Count Display** parameter. Refer to the parameter's embedded help for information about the specific syntax.
- Configure the **Number of Rows to Retrieve for SQL** parameter to define the number of records displayed per page. If this parameter is not specified the value in the **Number of Rows to Display** parameter is used.
- Configure the key that will be used for paging so that the system can keep track of the 'page break'. The data must be sorted by the paging key; as a result, the decision for identifying the paging key must take into account the design for the zone and the data being displayed. In addition, the paging key must be unique to ensure that the page breaks occur correctly. See below for configuration examples.
  - The **SQL Statement** must include additional clauses **PAGENEXT** and **PAGEPREV** based on the paging key. In addition, as mentioned above, the paging key must be used in the ORDER BY clause.
  - The **SQL Column** parameters must define the paging key mnemonic to be used in conjunction with the SQL statement paging clauses.

The following zone types support this capability:

- Info Data Explorer - Single SQL (**F1-DE-SINGLE**).
- Info Data Explorer - Multiple SQLs (**F1-DE**). Note that zones of this type support a union of the results of all the SQL statements. As a result, pagination may only be enabled for zones of this type if a single SQL is used. The system is not able to keep track of the pagination across disparate SQL statements.
- Query Data Explorer - Multiple SQLs (**F1-DE-QUERY**).
- Multi Query Data Explorer (**F1-DE-MULQRY**). Zones of this type do not include configuration for SQL statements or column display. However, they do include configuration for the **Enable Pagination**. This parameter must be configured in order for pagination on the individual zones to work.

---

**NOTE: Zones used for a Business Service.** Note that pagination is ignored when invoking a data explorer zone via a business service. In this scenario, the zone will return the first "chunk" of rows as defined by the Number of Rows parameters.

---

## Examples

### Simple Paging Key

In this example, the Extendable Lookup Value is defined as Column 1 (C1) and is marked as the paging key. This field is unique for the table and works well as a simple paging key.

```
SELECT A.F1_EXT_LOOKUP_VALUE , A.BUS_OBJ_CD
FROM
  F1_EXT_LOOKUP_VAL A,
  F1_EXT_LOOKUP_VAL_L B
WHERE
  A.BUS_OBJ_CD = :H1
  AND A.BUS_OBJ_CD = B.BUS_OBJ_CD
  AND A.F1_EXT_LOOKUP_VALUE = B.F1_EXT_LOOKUP_VALUE
  AND B.LANGUAGE_CD = :LANGUAGE
  [(F1) AND UPPER(A.F1_EXT_LOOKUP_VALUE) like UPPER(:F1)]
  [(F2) AND ((UPPER(B.DESCR_OVRD) like UPPER(:F2))
  OR (B.DESCR_OVRD = ' ' AND UPPER(B.DESCR) like UPPER(:F2)))]
  [(PAGENEXT) AND A.F1_EXT_LOOKUP_VALUE > :C1]
  [(PAGEPREV) AND A.F1_EXT_LOOKUP_VALUE < :C1]
ORDER BY A.F1_EXT_LOOKUP_VALUE
```

### Complex Paging Key

Most queries however do not sort by a unique value. In this case, the paging key needs to be set based on the sorting of the query and should include a unique field, such as the primary key, as the last paging key. In this example, the query

is showing results sorted by To Do Type, Role and User. All fields, including the To Do Entry ID (the primary key) are marked as paging keys.

```
SELECT TD_TYPE_CD, ROLE_ID, ASSIGNED_TO, ASSIGNED_DTTM, TD_PRIORITY_FLG, TD_ENTRY_ID
FROM CI_TD_ENTRY
WHERE
ENTRY_STATUS_FLG IN ('O', 'W')
[(F1) and TD_TYPE_CD = :F1]
[(F2) AND ASSIGNED_TO = :F2]
[(F3) AND ROLE_ID = :F3]
[(PAGENEXT) and ((TD_TYPE_CD>:C1) or (TD_TYPE_CD=:C1 and ROLE_ID>:C2) or (TD_TYPE_CD=:C1 and ROLE_ID=:C2
and ASSIGNED_TO>:C3) or (TD_TYPE_CD=:C1 and ROLE_ID=:C2 and ASSIGNED_TO=:C3 AND TD_ENTRY_ID>:C4))]
[(PAGEPREV) and ((TD_TYPE_CD<:C1) or (TD_TYPE_CD=:C1 and ROLE_ID<:C2) or (TD_TYPE_CD=:C1 and ROLE_ID=:C2
and ASSIGNED_TO<:C3) or (TD_TYPE_CD=:C1 and ROLE_ID=:C2 and ASSIGNED_TO=:C3 AND TD_ENTRY_ID<:C4))]
ORDER BY TD_TYPE_CD, ROLE_ID, ASSIGNED_TO, TD_ENTRY_ID
```

## Use Data Explorer for Derived Data

There are times when a design warrants displaying data in a data explorer zone that is not accessible via SQL. For example, perhaps the data is from another system and it requires a web service call. The [JMS Message Browser](#) is another example.

The product provides functionality in the data explorer that allows you to call a script after the user filters are populated but before the SQL is executed. The script can retrieve the data as appropriate, store the data in table format so that the SQL can retrieve the data from the table.

The following points provide more detail:

- Create a service script that retrieves the data as needed. This script should store the retrieved data in a temporary table.
  - The product provides a table that may be used. It is called F1\_GENERIC\_GTT (Generic Global Temporary Table). There is a business service — Create Global Temporary Table Records (**F1-InsertGTTRecords**) that the service script may call to insert the records.
  - Note that if the data is accessed via a web service call, it may be appropriate to execute the web service in a separate session using the business service F1-ExecuteScriptInNewSession to trap errors that may be issued by the web service call and provide a better error.
- In the data explorer zone use this service script in the zone's pre-processing script parameter. If any user or hidden filters should be passed into the script, the parameter supports mnemonics for this purpose. Refer to the parameter's embedded help for the supported syntax.
- The SQL for the data explorer should access the temporary table that was populated by the service script.

## Configuring Timeline Zones

This topic highlights information related to configuring a [timeline zone](#). The zone type is **F1-TIMELINE**. A timeline zone contains one or more "lines" where each line shows when significant events have occurred. The output of each line is driven by an algorithm configured on a timeline zone. Each algorithm is responsible for retrieving a single type of data. For example, one algorithm may retrieve bills for an account in a given time period whereas another algorithm may retrieve payments for that account for the same time period.

The algorithms to configure for a timeline zone use the **Zone — Timeline** plug-in spot. Please note the following details about the behavior for algorithms for this plug-in spot.

- The timeline algorithm receives all the global context values currently populated. In addition, it receives a start and end date from the zone, based on the time period chosen by the user, along with the maximum number of events that can be reasonably display for the chosen time period. The algorithm should use this information to retrieve data for a given type of transaction related to one or more of the input context values for the provided time period.
- For each event found, the algorithm returns information about the event along with many options that assist the user in getting more detail about each event or acting on an event.
  - Event date

- Primary key of the record (key / value pairs)
- FK Reference. With this information, the timeline zone will display the appropriate info string to display in the zone's info area when clicking on the event. In addition, the FK reference identifies the appropriate navigation option to use when a user clicks the info string hypertext to view the record on its maintenance page.
- Background Color and Text Color to use for the event. (Optional). The algorithm may be configured to provide one color for all events or it may be configured to return different colors for different events based on other factors such as status or priority.
- Icon use for the event. (Optional). The algorithm may be configured to provide an icon to display adjacent to the event.
- [BPA script](#) to launch when a user clicks on an event. (Optional). The algorithm may return one or more BPA scripts that a user may launch to act on an event. For example, for an event that has a status of **Error**, perhaps a BPA is provided to walk a user through resolving the error.

When a script is initiated from a timeline, the system puts the prime key of the event into a field in the page data model. The name of the field is the column name(s) of the event's prime key. For example, when a script associated with a payment event is kicked off, the system populates a field called PAY\_ID with the prime-key of the selected payment.

Note that your specific edge application may supply algorithm types for a timeline zone as part of the base product. Click [here](#) to see the algorithm types available for this plug-in spot. Although algorithm types may be provided, typically the product does not deliver algorithms because the parameters for the algorithms are driven by a particular implementation's business rules and preferences. As a result, the product will also not deliver pre-configured timeline zones. Please refer to your edge application's documentation for more information about what timeline algorithm types are delivered, if any and recommendations for configuration.

## Defining Context-Sensitive Zones

A context-sensitive zone allows you to associate a zone with a specific user-interface transaction. A context-sensitive zone appears at the top of the Dashboard when a user accesses a page for which the zone is specified as the context. For example, when viewing a business object, additional zones are visible that are specific to the business object page.

---

**CAUTION:** Make sure that the zone is appropriate for the transaction on which you are specifying it. For example, if your zone requires a business object ID as one of its keys, it should not be displayed on the To Do entry transaction.

---

Select **Admin > Context Sensitive Zone** to maintain context-sensitive zones.

### Description of Page

The **Navigation Key** is a unique identifier of a tab page within the system. **Owner** indicates if this navigation key is owned by the base product or by your implementation (**Customer Modification**).

---

**CAUTION:** Important! When introducing a new context sensitive zone, carefully consider its naming convention. Refer to [System Data Naming Convention](#) for more information.

---

The grid contains the list of context-sensitive zones and the sequence in which they appear in the dashboard for the selected navigation key. The grid contains the following fields:

- **Zone** is the name of the zone to display in the Dashboard.
- **Sequence** is the sequence in which the zone is displayed (if multiple context-sensitive zones are defined).
- **Owner** indicates if this context sensitive zone is owned by the base product or by your implementation (**Customer Modification**).

### Where Used

A context-sensitive zone displays at the top of the Dashboard whenever a user accesses the transaction for with the zone is specified.

## Defining Portals

This transaction is used to define / change portals. An implementation may define their own portals. In addition, an implementation may override some of the settings for base product provided portals.

### Portal - Main

Navigate to this page using **Admin > System > Portal**.

#### Description of Page

Enter a meaningful and unique **Portal** code and **Description**. Please be aware that for [stand-alone portals](#), the Description is the portal's title (i.e., the end-users will see this title whenever they open the portal).

---

**CAUTION:** Important! When introducing a new portal, carefully consider its naming convention. Refer to [System Data Naming Convention](#) for more information.

---

**Owner** indicates if this portal is owned by the base product or by your implementation (**Customer Modification**). The system sets the owner to **Customer Modification** when you add a portal. This information is display-only.

**Type** flag indicates whether the portal is a **Standalone Portal**, a **Tab Page Portal** or the **Dashboard**. Refer to [There Are Three Types of Portals](#) for more information.

The following fields are only enabled for **Standalone Portals**:

- **Navigation Option** defines the navigation option that is used to navigate to this portal from menus, scripts and your favorite links. The navigation option is automatically created when a **Standalone Portal** is added.
- You'll find an **Add To Menu** button adjacent. This field is only enabled if the navigation option is not referenced on a menu. When you click this button, a pop-up appears where you define a menu. If you subsequently press **OK**, a menu item is added to the selected menu. This menu item references the portal's navigation option. You can reposition the menu item on the menu by navigating to the [Menu page](#). Refer to [Putting Portals on Menus](#) for more information.
- **Application Services** defines the service used to secure this portal. The application service is automatically created when a **Standalone Portal** is added. Please note that only users with access to this application service will be able to view this portal and its zones. Refer to [Granting Access to A Portal](#) for more information.
- **Show on Portal Preferences** indicates if a user is allowed to have individual control of the zones on this portal. The portal will not appear in the accordion on the user's Portal Preferences page if this value is set to No. Note that an implementation may change this value for a product delivered portal.

The grid contains a list of zones that are available in the portal. Click + to add a new zone to the portal. Click - to remove a zone from the portal. The grid displays the following fields:

- **Zone** is the name of the zone as defined on the Zone page.
- **Description** is a description of the zone as defined on the Zone page.
- **Display** controls whether or not the zone is visible in the portal. For portals that are configured to Show on Portal Preferences, users may override this value for their view of the portal.
- **Initially Collapsed** controls whether or not the zone is initially collapsed in the portal. For portals that are configured to Show on Portal Preferences, users may override this value for their view of the portal.

---

**NOTE: Recommendation.** It is recommended that zones that have information that is always needed when users first display a portal be set up to be initially collapsed. That way the data in the zone is only built when the user expands the zone. This improves response times.

---

- **Default Sequence** is the default sequence number for the zone within the portal. It does not need to be unique within the portal. Note that a sequence of zero will appear last, not first, in the portal. For portals that are configured to Show on Portal Preferences, users may override this value for their view of the portal.
- **Override Sequence** can be used by an implementation team to override the Default Sequence value that is set in the base product.
- **Refresh Seconds** defines in seconds how often the zone is automatically refreshed. The minimum valid value is 15. The maximum valid value is 3600 (1 hour). A value of 0 indicates no automatic refresh. Implementers can change this value as needed.
- **Owner** indicates if this portal / zone relationship is owned by the base product or by your implementation (**Customer Modification**). This information is display-only.

---

**NOTE: Removing zones from a portal.** You cannot remove a base product zone from a base product portal. An implementation may override the Display setting to prevent a zone from displaying on the portal. In addition, you cannot remove a zone if a user has enabled it on their Portal Preferences. To remove a zone from the portal list, first make sure that no user has it enabled in their portal preferences.

---

### Where Used

Follow this link to open the data dictionary where you can view the tables that reference [CI\\_PORTAL](#).

## Portal - Options

Use this page to maintain a portal's options. Open this page using **Admin > System > Portal** and then navigate to the **Options** page.

### Description of Page

The options grid allows you to configure the options that provide additional information related to the portal.

Select the **Option Type** dropdown to define its **Value**. **Detailed Description** may display additional information on the option type.

Set the **Sequence** to **1** unless the option can have more than one value.

**Owner** indicates if this is owned by the base product or by your implementation (**Customer Modification**).

---

**NOTE: You can add new option types.** Your implementation may want to add additional portal option types. To do that, add your new values to the customizable lookup field **PORTAL\_OPT\_FLG**.

---

## Defining Display Icons

Icons are used to assist users in identifying different types of objects or instructions. A limited number of control tables allow administrative users to select an icon when they are configuring the system. Select **Admin > System > Display Icon Reference** to maintain the population of icons available for selection.

### Description of Page

Each icon requires the following information:

- **Display Icon** is a code that uniquely identifies the icon.

- **Icon Type** defines how big the icon is (in pixels). The permissible values are: **30 x 21**, **21 x 21**, and **20 x 14**. Note that only icons that are **20 x 14** can be used on base product instructions.
- **Description** contains a brief description of the icon.
- **URL** describes where the icon is located. Your icons can be located on the product's web server or on an external web server.
- To add a new icon to the product web server, place it under the **/cm/images** directory under the **DefaultWebApp**. Then, in the **URL** field, specify the relative address of the icon. For example, if the icon's file name is **myIcon.gif**, the **URL** would be **/cm/images/myIcon.gif**.
  - If the icon resides on an external web server, the **URL** must be fully qualified (for example, **http://myWebServer/images/myIcon.gif**).
  - **Owner** indicates if this icon is owned by the base product or by your implementation (**Customer Modification**). This information is display-only.

### Where Used

Follow this link to open the data dictionary where you can view the tables that reference [CI\\_DISP\\_ICON](#).

## Defining Navigation Keys

Each location to which a user can navigate (e.g., transactions, tab pages, tab menus, online help links, etc.) is identified by a navigation key. A navigation key is a logical identifier for a URL.

### Navigation Key Types

There are three types of navigation keys:

- **System navigation keys** define locations where the target for the navigation is a transaction or portal within the system. The navigation keys define the program component that identifies the page to navigate to.
- **External navigation keys** define a URL that identifies the target location. External URLs can be specified as relative to the product web server or fully qualified. External navigation keys always launch in a new instance of a browser window. Examples of external navigation keys include application viewer links and URLs to external systems.
- **Help navigation keys** define a online help topic that identifies the specific page within the online help to launch. Help navigation keys may be related to a program component when the help is related to a specific page in system.

### Navigation Key vs. Navigation Option

The system has two entities that work in conjunction with each other to specify how navigation works:

- **Navigation Key** defines a unique location to which a user can navigate. For example, each page in the system has a unique navigation key. Navigation keys can also define locations that are "outside" of the system. For example, you can create a navigation key that references an external URL. Think of a navigation key as defining "where to go".
- **Navigation Option** defines how a page is opened when a user wants to navigate someplace. For example, you might have a navigation key that identifies a specific page. This navigation key can then be referenced on two navigation options; the first navigation option may allow users to navigate to the page with no context included, while the second navigates to the page with context data provided to automatically display information related to that context.
- Please note that a wide variety of options can be defined on a navigation option. In addition to defining if data is passed to the page, it could also define search options. In addition, there are some navigation options that do not reference a navigation key but rather refer to a BPA script that should be launched.



## The Flexibility of Navigation Keys

Navigation keys provide a great deal of functionality to your users. Use navigation keys to:

- Allow users to navigate to new pages or search programs
- Allow users to transfer to an external system or web page. After setting up this data, your users may be able to access this external URL from a menu, a context menu, their favorite links, etc. Refer to [Linking to External Locations](#) for more information.

Refer to the Tool Suite Guide for more information on developing program components.

---

**NOTE: Replacing Base-Package Pages or Searches.** If your new page or search has been designed to replace a module in the base-package, the navigation key must indicate that it is [overriding an existing navigation key](#).

---

## Linking to External Locations

If you want to include links to external systems or locations from within the system, you need to:

- Define a [navigation key](#) that specifies the URL of the location. For example, define an external navigation key that as a URL of <http://www.oracle.com/>.
- Define a [navigation option](#) that specifies from where in the system a user can go to your external location. For example, define a navigation option with a usage of **Favorites** or with a usage of **Menu**. Your navigation option points to the navigation key you defined above.
- Add your navigation option to the appropriate location within the system. For example, have users add the navigation option to their [Favorite Links](#) or add the navigation option as an item on a [menu](#).

## Overriding Navigation Keys

Your implementation may choose to design a program component (e.g., a maintenance transaction or search page) to replace a component provided by the system. When doing this, the new navigation key must indicate that it is overriding the system navigation key. As a result, any menu entry or navigation options that reference this overridden navigation key automatically navigates to the custom component.

For example, if you have a custom On-line Batch Submission page and would like users to use this page rather than the one provided by the system, setting up an override navigation key ensures that if a user chooses to navigate to the On-line Batch Submission from Menu or a context menu, the user is brought to the custom On-line Batch Submission page.

To create an override navigation key, you need to:

- Define a [navigation key](#) using an appropriate [naming convention](#).
- If the Navigation Key Type of the navigation key being overridden is **External**, specify a Navigation Key Type of **Override (Other)** and define the appropriate URL Component.
- If the Navigation Key Type of navigation key being overridden is **System**, specify a Navigation Key Type of **Override (System)** and populate the Program Component ID with your custom program component ID.
- Specify the navigation key that you are overriding in the **Overridden Navigation Key** field.

Refer to the Tool Suite Guide for more information about developing your own program components.

## Maintaining Navigation Keys

Select **Admin > System > Navigation Key** to maintain navigation keys.

---

**CAUTION:** Important! When introducing a new navigation key, carefully consider its naming convention. Refer to [System Data Naming Convention](#) for more information.

---

### Description of Page

The **Navigation Key** is a unique name of the navigation key for internal use.

**Owner** indicates if this navigation key is owned by the base product or by your implementation (**Customer Modification**). This information is display-only.

**Navigation Key Type** includes the following possible values:

- **External** indicates that the location is specified in the **URL Component** field.
- **Help** indicates that the navigation key is used to launch online help where the specific help topic is defined in the **URL Component** field.
- **Override (Other)** indicates that the navigation key overrides another navigation key of type **External** or **Help**. For this option, the name of the navigation key being overridden is populated in the **Overridden Navigation Key** field.
- **Override (System)** indicates that the navigation key overrides a system navigation key. For this option, the name of the navigation key being overridden is populated in the **Overridden Navigation Key** field.
- **System** indicates that the navigation key refers to a transaction in the system identified by its program component.

---

**FASTPATH:** Refer to [Navigation Key Types](#) for more information about navigation key types.

---

**FASTPATH:** Refer to [Overriding Navigation Keys](#) for more information about settings required to override a system navigation key.

---

**Program Component ID** is the name of the program component identified by the key (for system navigation keys). The program component ID can also be used to specify the transaction with which an online help link is associated.

**Overridden Navigation Key** is the name of the navigation key that the current navigation key is overriding (if **Override (Other)** or **Override (System)** is selected for the **Navigation Key Type**). Refer to [Overriding Navigation Keys](#) for more information.

**URL Component** is the specific URL or portion of the URL for the navigation key (external and help navigation keys only). The URL can be relative to the product web server or fully qualified.

**Open Window Options** allows you to specify options (e.g., width and height) for opening a browser window for an external navigation key. (External navigation keys always launch in a new browser window.) You can use any valid features available in the `Window.open()` JavaScript method. The string should be formatted the same way that it would be for the features argument (e.g., **height=600,width=800,resizeable=yes,scrollbars=yes,toolbar=no**). Refer to a JavaScript reference book for a complete list of available features.

**Application Service** is the application service that is used to secure access to transactions associated with **External** navigation keys. If a user has access to the specified application service, the user can navigate to the URL defined on the navigation key. Refer to [The Big Picture of Application Security](#) for more information.

The grid displays menu items that reference the navigation key (actually, it shows menu items that reference navigation options that, in turn, reference the navigation key).

### Where Used

Follow this link to open the data dictionary where you can view the tables that reference [CI\\_MD\\_NAV](#).

# Defining Navigation Options

Every time a user navigates to a transaction, the system retrieves a navigation option to determine which transaction should open. For example:

- A navigation option is associated with every menu item. When a user selects a menu item, the system retrieves the related navigation option to determine which transaction to open.
- A navigation option is associated with every [favorite link](#). When a user selects a favorite link, the system retrieves the related navigation option to determine which transaction to open.
- A navigation option is associated with every node in the various trees. When a user clicks a node in a tree, the system retrieves the related navigation option to determine which transaction to open.
- Etc.

Many navigation options are shipped with the base product and cannot be modified as these options support core functionality. As part of your implementation, you may add additional navigation options to support your specific business processes.

Navigation options may also be used to launch a BPA script.

The topics in this section describe how to maintain navigation options.

---

**CAUTION:** In order to improve response times, navigation options are cached the first time they are used after a web server is started. If you change a navigation option and you don't want to wait for the cache to rebuild, you must clear the cached information so it will be immediately rebuilt using current information. A special button has been provided on the Main tab of the navigation option transaction that performs this function. Please refer to [Caching Overview](#) for information on the various caches.

---

## Navigation Option - Main

Select **Admin > System > Navigation Option** to maintain a navigation option.

### Description of Page

Enter a unique **Navigation Option** code and **Description**.

---

**CAUTION:** When introducing a new navigation option, carefully consider its naming convention. Refer to [System Data Naming Convention](#) for more information.

---

The **Flush System Login Info** button is used to flush the cached navigation options so you can use any modified navigation options. Refer to [Caching Overview](#) for more information.

**Owner** indicates if this navigation option is owned by the base product or by your implementation (**Customer Modification**). This field is display-only. The system sets the owner to **Customer Modification** when you add a navigation option.

---

**NOTE:** You may not change navigation options that are owned by the base product.

---

Use **Navigation Option Type** to define if the navigation option navigates to a **Transaction**, launches a BPA **Script** or opens an **Attachment**.

---

**NOTE:** The **Attachment** option type is only applicable to navigation options that are used to launch a file attached to a record in the Attachment maintenance object.

---

For navigation option types of **script**, indicate the **Script** to launch. You can use the **Context Fields** at the bottom of the page if you want to transfer the contents of specific fields to temporary storage variables available to the script. The script engine creates temporary storage variables with names that match the Context Field names.

For navigation option types of **transaction**, define the **Target Transaction** (navigation key) and optionally a specific **Tab Page** (also a navigation key) if a specific tab on the transaction (other than the Main tab) should be opened when navigating to that transaction.

---

**NOTE: Finding transaction navigation keys.** When populating the **Target Transaction** and **Tab Page** you are populating an appropriate navigation key. Because the system has a large number of transactions, we recommend using the "%" metaphor when you search for the transaction identifier. For example, if you want to find the currency maintenance transaction, enter "%currency" in the search criteria.

---

The additional information depends on whether the target transaction is a fixed page or a portal-based page:

- For portal-based pages:
  - **Navigation Mode** is not applicable and should just be set to **Add Mode**.
  - If navigating to a query portal, by default the query portal will open with the default search option defined. If the navigation should open a different search option, define the **Multi-Query Zone** for that query portal and indicate the **Sub-Query Zone** to open by default. Note that for this configuration, it is common to define **Context Fields** to pre-populate search criteria in the target query zone. When using this configuration, be sure that the target query zone's user filters are defined to populate data from context.
- For fixed pages:
  - **Navigation Mode** indicates if the **Target Transaction** should be opened in **Add Mode** or **Change Mode**.
  - **Add Mode** should be used if the option is used to navigate to a transaction ready to add a new object. You can use the **Context Fields** at the bottom of the page if you want to transfer the contents of specific fields to the transaction when it opens.
  - **Change Mode** is only applicable for fixed pages and should be used if the option is used to navigate to a transaction ready to update an object. You have two ways to define the object to be changed:
    - Define the name of the fields that make up the unique identifier of the object in the **Context Fields** (and make sure to turn on **Key Field** for each such field).
    - Define the **Search Transaction** (navigation key) if you want to open a search window to retrieve an object before the target transaction opens. Select the appropriate **Search Type** to define which search method should be used. The options in the drop down correspond with the sections in the search (where **Main** is the first section, **Alternate** is the 2<sup>nd</sup> section, **Alternate 2** is the 3<sup>rd</sup> section, etc.). You should execute the search window in order to determine what each section does.

When you select a **Search Type**, define appropriate **Context Fields** so that the system will try to pre-populate the search transaction with these field values when the search first opens. Keep in mind that if a search is populated with field values the search is automatically triggered and, if only one object is found that matches the search criteria, it is selected and the search window closes.

- **Search Group** is only visible if the **Development Tools** module is [not turned off](#). It is used to define the correlation between fields on the search page and the tab page. You can view a tab page's **Search Groups** by viewing the HTML source and scanning for **allFieldPairs**.

The **Go To Tooltip** is used to specify the label associated with the tool tip that appears when hovering over a **Go To** object. Refer to the **Usage** grid below.

The **Usage** grid defines the objects on which this navigation option is used:

- Choose **Favorites** if the navigation option can be used as a [favorite link](#).
- Choose **Menus** if the navigation option can be used as a user's [home page](#) or as a menu or context menu item.
- Choose **Script** if the navigation option can be used in a [script](#).

- Choose **Foreign Key** if the navigation option can be used as a [foreign key reference](#).
- Choose **Go To** if the navigation option can be used as a "go to" destination ("go to" destinations are used on Go To buttons, tree nodes, and hyperlinks).
- If your product supports marketing campaigns, you can choose **Campaign** if the navigation option can be used as a "post completion" transaction on a campaign. For more information refer to that product's documentation for campaigns.

The **Context Fields** grid contains the names of the fields whose contents will be passed to the **Target Transaction** or **Script** or used to launch an **Attachment**. The system retrieves the values of these fields from the "current" page and transfers them to the target transaction or to the script's temporary storage. Turn on **Key Field** for each context field that makes up the unique identifier when navigating to a transaction in **Change Mode**.

---

**NOTE:** For an **Attachment**, the grid should contain the Attachment ID.

---

**NOTE: Navigating from a Menu.** The standard followed for many base main **menu** navigation options for fixed transactions is that navigation options launched from the Menu dropdown are configured with no context.

---

### Where Used

Follow this link to open the data dictionary where you can view the tables that reference [CI\\_NAV\\_OPT](#).

## Navigation Option - Tree

This page contains a tree that shows how a navigation option is used. Select **Admin > System > Navigation Option** and navigate to the **Tree** tab to view this page.

### Description of Page

The tree shows every menu item, favorite link, and tree node that references the navigation option. This information is provided to make you aware of the ramifications of changing a navigation option.

## Database Tools

---

This section describes a variety of database tools that are supplied with the your product.

## Defining Table Options

The topics in this section describe the transaction that allows you to define metadata for the application's tables.

### Table - Main

Navigate using **Admin > Database > Table**.

#### Description of Page

**Table Name** is the identifier of this table.

**Description** contains a brief description of the table.

**System Table** defines if the table includes rows that are owned by the base product.

**Enable Referential Integrity** defines if the system performs referential integrity validation when rows in this table are deleted.

**Data Group ID** is used for internal purposes.

**Enable Data Dictionary** defines if the table is to be included in the [Data Dictionary](#) application viewer.

**Table Type** defines if the table is an **External Table**, a **View** or a physical **Table**.

**Date / Time Data Type** defines if the system shows times on this table in **Local Legal Time** or in **Local Standard Time**. Local Legal Time is the time as adjusted for daylight savings / summer time.

**Table Classification Type** specifies the category of data the table will hold. This is for information purposes only and is not used by any system processing. Valid values are **Admin System Table**, **Admin Non System Table**, **Master Table**, **Transaction Table**, and **Unclassified**.

**Table Volume Type** specifies the expected amount of data the table will hold. This is for information purposes only and is not used by any system processing. Valid values are **High Volume**, **Low Volume**, **Medium Volume**, and **Unclassified**. The volume of data in a particular table in the system may differ greatly from one implementation to another based on unique business requirements. The values populated for base product tables are set to volumes that are typical but may not be true for a given implementation. The value may be updated to reflect the situation for a given implementation.

**Audit Table** is the name of the table on which this table's audit logs are stored. Refer to [The Audit Trail File](#) for more information.

Use **Audit Program Type** to define if the audit program is written in **Java** or **Java (Converted)**, meaning it was converted into Java.

---

**NOTE: Java (Converted)** program types are not applicable to all products.

---

**Audit Program** is the name of the program that is executed to store an audit log. Refer to [Turn On Auditing For a Table](#) for more information.

---

**NOTE: View the source.** If the program is shipped with the base package, you can use the adjacent button to display the source code of this program in the [Java docs viewer](#).

---

**Upgrade** controls what happens to the rows in this table when the system is upgraded to a new release:

- **Keep** means that the rows on this table are not touched during an upgrade
- **Merge** means that the rows on this table are merged with rows owned by the base product
- **Refresh** means that the rows on this table are deleted and refreshed with rows owned by the base product.

**Data Conversion Role** controls if / how the table is used by the conversion tool:

- **Convert (Retain PK)** means that the table's rows are populated from the conversion schema and the prime key in the conversion schema is used when the rows are converted. A new key is not assigned by the system.
- **Convert (New PK)** means that the table's rows are populated from the conversion schema and the prime key is reassigned by the system during conversion.
- **Not Converted** means that the table's rows are not managed by the conversion tool.
- **View of Production** means that the conversion tool uses a view of the table in production when accessing the rows in the table. This is commonly used for administrative tables.

A **Language Table** is specified when fields containing descriptions are kept in a child table. The child table keeps a separate record for each language for which a description is translated.

A **Characteristic Entity** is populated if this table is used to capture characteristics and indicates the associated characteristic entity lookup value for this table. When defining characteristic types, you indicate the characteristic entities where that characteristic type is applicable / valid.

A **Key Table** is specified when the prime-key is assigned by the system. This table holds the identity of the prime keys allocated to both live and archived rows.

**Type of Key** specifies how prime key values are generated when records are added to the table:

- **Other** means a foreign-system allocates the table's prime-key.

- **Sequential** means a sequence number is incremented whenever a record is added to the table. The next number in the sequence determines the key value.
- **System-generated** means a program generates a random key for the record when it is added. If the record's table is the child of another table, it may inherit a portion of the random number from its parent's key.
- **User-defined** means the user specifies the key when a record is added.

**Inherited Key Prefix Length** defines the number of most significant digits used from a parent record's primary key value to be used as the prefix for a child record's key value. This is only specified when the Type of Key is **System-generated** and the high-order values of the table's key is inherited from the parent table.

**Java Table Name.** This field is used to identify the entity/Java class name of the class that represents the table in the Java code. It should contain a short "camelCased" name to be used as the name of the entity within the system. It must also be a valid Java name, and must be unique across the system. This name is used as follows:

- As the short class name on all classes in the Java hierarchy for the class: the Impl class, the Gen, and the interface.
- In HQL queries, it is used to identify the hibernate entity being selected.

**Caching Regime** determines if the table's values should be cached when they are accessed by a batch process. The default value is **Not Cached**. You should select **Cached for Batch** if you know the values in the table will not change during the course of a batch job. For example, currency codes will not change during a batch process. Caching a table's values will reduce unnecessary SQL calls and improve performance.

**Key Validation** determines if and when keys are checked for uniqueness. The default value is **Always Check Uniqueness**. Select **Check Uniqueness Online Only** when the database constructs the keys in the table, such as in log tables. Select **Never Perform Uniqueness Checking** when you know that the database constructs the keys in the table and that users cannot add rows directly to the table, such as in log parameter tables. This will reduce unnecessary SQL calls and improve performance.

**Help URL** is the link to the user documentation that describes this table.

**Help Text** contains additional information about the table.

**Extract for Translation** is only visible in a development environment. It indicates whether or not the table includes strings that are eligible for product translation.

**Translation Context** is only visible in a development environment. It is used to provide information to a translator about the nature and purpose of rows in the table.

---

**NOTE: Changes to base owned tables.** Only the following attributes of tables that are owned by the product are modifiable: Audit Table, Audit Program Type, Audit Program, Caching Regime, Key Validation and Table Volume Type.

---

The grid contains an entry for every field on the table. Drilling down on the field takes you to the [Table Field](#) tab where you may modify certain attributes. The following fields may also be modified from the grid: **Description**, **Override Label**, **Audit Delete**, **Audit Insert** and **Audit Update**. Refer to the Table Field tab for descriptions of these fields.

## Table - Table Field

Navigate using **Admin > Database > Table** and click the **Table Field** tab.

### Description of Page

**Field Name** is the name of the field. It is followed by its **Java Field Name**.

**Field Help Text** displays the help text listed for this field on the Field page, if populated.

**Nullable**, **Required** and **Validate** are for internal use.

Turn on **Audit Delete** if an audit record should be stored for this field when a row is deleted. Refer to [How To Enable Auditing](#) for more information.



Turn on **Audit Insert** if an audit record should be stored for this field when a row is added. Refer to [How To Enable Auditing](#) for more information.

Turn on **Audit Update** if an audit record should be stored for this field when it is changed. Refer to [How To Enable Auditing](#) for more information.

The **Allow Customization** is only applicable if the table is an Admin System Table. It indicates fields that an implementation is allowed to change for a base owned record. Changes to the field value of one of these types of fields by an implementation are maintained when upgrading to a new version of the product.

**Standard Time Type** is only enabled if the Table indicates that the Date/Time Data Type is **Local Standard Time**. Each field that represent date/time should define if it uses **Logical Standard Time**, **Physical Standard Time** or uses a **Referenced Time Zone**.

**Sequence** is a unique sequence of this field with respect to other fields on the table.

The **Label** column is used to define a special label for this field when it relates to this table if it should be different from the field's label. Note that this only impacts the label on a fixed page user interface. Labels on portal based user interfaces do not use this information.

The **Override Label** is provided if an implementation wants to override the base-product label.

---

**NOTE:** If you want the Override Label to be shown in the [data dictionary](#), you must regenerate the data dictionary.

---

**Help Text** contains any additional information about the field with respect to its use on this table.

**Extract for Translation** is only visible in a development environment. For tables marked to extract for translation, each translatable field on the table should indicate **Yes**.

**Translation Context** is only visible in a development environment. It is used to provide information to a translator about the nature and purpose of the data in this field on this table.

---

**NOTE: Changes to base owned table / fields.** Only the following attributes of table / fields that are owned by the product are modifiable: Audit Delete, Audit Insert, Audit Update, Override Label.

---

## Table - Constraints

Select **Admin > Database > Table** and navigate to the **Constraints** tab to view the constraints defined on the table.

### Description of Page

The fields on this page are protected as only the product development group may change them.

This page represents a collection of constraints defined for the table. A constraint is a field (or set of fields) that represents the unique identifier of a given record stored in the table or a field (or set of fields) that represents a given record's relationship to another record in the system.

**Constraint ID** is a unique identifier of the constraint.

**Owner** indicates if this is owned by the base package or by your implementation (**Customer Modification**)

**Constraint Type Flag** defines how the constraint is used in the system:

- **Primary Key** represents the field or set of fields that represent the unique identifier of a record stored in a table.
- **Logical Key** represents an alternate unique identifier of a record based on a different set of fields than the Primary key.
- **Foreign Key** represents a field or set of fields that specifies identifying and non-identifying relationships to other tables in the application. A foreign key constraint references the primary key constraint of another table.
- **Conditional Foreign Key** represents rare relationships between tables where a single field (or set of fields) may reference multiple primary key constraints of other tables within the application as a foreign key.



When **Enable Referential Integrity** is checked, the system validates the integrity of the constraint when a row in the table is modified.

**Referring Constraint Owner** indicates if this is owned by the base package or by your implementation (**Customer Modification**).

**Referring Constraint ID** is the **Primary Key** constraint of another table whose records are referenced by records stored in this table.

**Referring Constraint Table** displays the table on which the Referring Constraint ID is defined. You can use the adjacent go-to button to open the table.

**Additional Conditional SQL Text** is only specified when the constraint is a **Conditional Foreign Key**. The SQL represents the condition under which the foreign key represents a relationship to the referring constraint table.

---

**NOTE: Additional Conditional SQL Syntax.** When specifying additional conditional SQL text, all table names are prefixed with a pound (#) sign.

---

The Constraint Field grid at the bottom of the page is for maintaining the field or set of fields that make up this constraint.

**Field** is the name of the table's field that is a component of the constraint.

**Sequence** The rank of the field as a component of the constraint.

The Referring Constraint Field grid at the bottom of the page displays the field or set of fields that make up the **Primary key** constraint of the referring constraint.

**Field** is the name of the table's field that is a component of the referring constraint.

**Sequence** is the rank of the field as a component of the referring constraint.

## Table - Referred by Constraints

Select **Admin > Database > Table** and navigate to the **Referred By Constraints** tab to view the constraints defined on other tables that reference the **Primary Key** constraint of this table.

### Description of Page

This page is used to display the collection of constraints defined on other tables that reference the table.

**Referred By Constraint Id** is the unique identifier of the constraint defined on another table.

**Referred By Constraint Owner** indicates if this constraint is owned by the base package or by your implementation (**Customer Modification**).

**Prime Key Constraint Id** is the **Primary Key** constraint of the current table.

**Prime Key Owner** indicates if this prime key is owned by the base package or by your implementation (**Customer Modification**).

**Referred By Constraint Table** is the table on which Referred By Constraint Id is defined.

When **Enable Referential Integrity** is checked, the system validates the integrity of the constraint when a row in the table is modified.

The grid at the bottom of the page displays the **Field** and **Sequence** for the fields that make up the constraint defined on the other table.

## Defining Field Options

The topics in this section describe the transaction that can be used to view information about a field and to change the name of a field on the various pages in the system.

# Field - Main

Open this page using **Admin > Database > Field**.

## Description of Page

**Field Name** uniquely identifies this field.

---

**CAUTION:** As described in [System Data Naming Convention](#) for most system data tables, the base product follows a specific naming convention. However, this is not true for the Field table. If you introduce new fields, you must prefix the field with **CM**. If you do not do this, there is a possibility that a future release of the application could introduce a new field with the name you allocated.

---

**Owner** indicates if this field is owned by the base package or by your implementation (**Customer Modification**). The system sets the owner to **Customer Modification** when you add a field.

**Base Field** indicates that the field inherits some of its definitions from another field.

**Data Type** indicates if the type of data the field will hold. Valid values are **Character, Character Large Object, Date, DateTime, Number, Time, Varchar2** and **XML Type**. This field is protected if the field refers to a Base Field.

**Ext Data Type** or Extended Data Type is used to further define the type of data for certain data types. Valid values are **Currency Source, Day of Month, Duration, Money, Month of Year, Flag, Switch** and **URI**. This field is protected if the field refers to a Base Field.

**Precision** defines the length of the field. In the case of variable length fields, it is the maximum length possible. For number fields that include decimal values, the precision includes the decimal values. This field is protected if the field refers to a Base Field.

**Scale** is only applicable for number fields. It indicates the number of decimal places supported by the field. This field is protected if the field refers to a Base Field.

**Sign** is only applicable for numbers. It indicates if the data may contain positive or negative numbers.

**Value List** is only visible for products that had at one point included COBOL. It defines the copybook that includes the list of valid values for the field.

**Description** contains the label of the field. This is the label of the field that appears on the various pages on which the field is displayed. Note, the field's label can be overridden for a specific table by specifying an Override Label on the [table / field](#) information. However, this override is not used in portal based user interfaces. It is only applicable if the field is displayed on fixed page user interfaces.

**Java Field Name** is the reference to this field used in Java code.

**Override Label** is used if an implementation would like to override the label that appear on user interfaces in the system.

---

**CAUTION:** For fixed pages, if the field's label is overridden for a specific table, that override takes precedence. In this is the case the override on the [table / field](#) page should be used.

---

**Work Field** indicates that the field does not represent a database table column.

**Help Text** is used to provide field level embedded help to this field. If the field is displayed on a user interface that supports display of embedded help, this text may be displayed.

Use **Override Help Text** to override the existing embedded help text for this field.

**Extract for Translation** is only visible in a development environment. It indicates whether or not the field and its description should be included in an extract of translatable strings when doing a product translation. This flag may be set to "No" for work fields whose label is not visible to a user on any user interface.

**Translation Context** is only visible in a development environment. It is used to provide information to a translator about the use of the field's label so that an appropriate translation can be provided.

## Field - Tables Using Field

Select **Admin > Database > Field** and navigate to the **Tables Using Field** tab to view the tables that contain a field.

### Description of Page

The grid on this page contains the **Tables** that reference the **Field**. You can use the adjacent go to button to open the [Table Maintenance](#) transaction.

## Defining Maintenance Object Options

A maintenance object defines the configuration of a given “entity” in the system. It includes the definition of the tables that together capture the physical data for the entity. In addition, the maintenance object includes options that define important information related to the maintenance object that may be accessed for logic throughout the system. Several algorithm plug-in spots are also defined on the maintenance object, allowing for business rules that govern all records for this maintenance object.

Many maintenance objects in the system support the use of business objects to further define configuration and business rules for a given record. Refer to [The Big Picture of Business Objects](#) for more information.

## Maintenance Object - Main

Select **Admin > Database > Maintenance Object** to view information about a maintenance object.

### Description of Page

Most maintenance objects are provided with the base package. An implementation can introduce custom maintenance objects when needed. Most fields may not be changed if owned by the base package.

Enter a unique **Maintenance Object** name and **Description**. **Owner** indicates if this business object is owned by the base package or by your implementation (**Customer Modification**).

---

**IMPORTANT:** If you introduce a new maintenance object, carefully consider its naming convention. Refer to [System Data Naming Convention](#) for more information.

---

**Service Name** is the name of the internal service associated with the maintenance object.

Click the **View XML** hyperlink to view the XML document associated with the maintenance object service in the [Service XML Viewer](#).

Click the **View MO** hyperlink to view the definition of the maintenance object in the [Maintenance Object Viewer](#).

The grid displays the following for each table defined under the maintenance object:

- **Table** is the name of a given table maintained as part of the maintenance object.
- **Table Role** defines the table's place in the maintenance object hierarchy. Only one **Primary** table may be specified within a maintenance object, but the maintenance object may contain many **Child** tables.
- **Parent Constraint ID** specifies the [constraint](#) used to link the table to its parent table within the maintenance object table hierarchy.
- **Owner** indicates if this is owned by the base package or by your implementation (**Customer Modification**).

## Maintenance Object - Options

Use this page to maintain a maintenance object's options. Open this page using **Admin > Database > Maintenance Object** and then navigate to the **Options** tab.

### Description of Page

The options grid allows you to configure the maintenance object to support extensible options.

Select the **Option Type** drop-down to define its **Value**. **Detailed Description** may display additional information on the option type.

Set the **Sequence** to **1** unless the option can have more than one value.

**Owner** indicates if this is owned by the base package or by your implementation (**Customer Modification**).

---

**NOTE: You can add new option types.** Your implementation may want to add additional maintenance option types. For example, your implementation may have plug-in driven logic that would benefit from a new type of option. To do that, add your new values to the customizable lookup field **MAINT\_OBJ\_OPT\_FLG**.

---

## Maintenance Object - Algorithms

Use this page to maintain a maintenance object's algorithms. Open this page using **Admin > Database > Maintenance Object** and then navigate to the **Algorithms** tab.

### Description of Page

The **Algorithms** grid contains algorithms that control important functions for instances of this maintenance object. You must define the following for each algorithm:

- Specify the **System Event** with which the algorithm is associated (see the table that follows for a description of all possible events).
- Specify the **Sequence Number** and **Algorithm** for each system event. You can set the **Sequence Number** to 10 unless you have a **System Event** that has multiple **Algorithms**. In this case, you need to tell the system the **Sequence** in which they should execute.
- If the algorithm is implemented as a script, a link to the **Script** is provided. Refer to [Plug-in Scripts](#) for more information.
- **Owner** indicates if this is owned by the base package or by your implementation (**Customer Modification**).

The following table describes each **System Event**.

System Event	Optional / Required	Description
Audit	Optional	Algorithms of this type are called to notify of any changes to the maintenance object's set of tables. These algorithms are invoked just before the commit at the end of a logical transaction. The system keeps track of what records are added or changed in the course of a transaction and all MO audit algorithms are executed in order of when each record was first added or updated.  Click <a href="#">here</a> to see the algorithm types available for this system event.
Determine BO	Optional	Algorithm of this type is used to determine the Business Object associated with an instance of the maintenance object. It is necessary to plug in such an algorithm on a Maintenance

System Event	Optional / Required	Description
ILM Eligibility	Optional	<p>Object to enable the business object rules functionality.</p> <p>The system invokes a single algorithm of this type. If more than one algorithm is plugged-in the system invokes the one with the greatest sequence number.</p> <p>Click <a href="#">here</a> to see the algorithm types available for this system event.</p>
Information	Optional	<p>We use the term "Maintenance Object Information" to describe the basic information that appears throughout the system to describe an instance of the maintenance object. The data that appears in this information description is constructed using this algorithm.</p> <p>The system invokes a single algorithm of this type. If more than one algorithm is plugged-in the system invokes the one with the greatest sequence number.</p> <p>Click <a href="#">here</a> to see the algorithm types available for this system event.</p>
Revision Control	Optional	<p>An algorithm of this type is used to enforce revision control rules when an object is added, changed or deleted. The maintenance object service calls the plug-in once before the object is processed and once more after applying all business object rules. This allows revision rules to take place in proper revision timings.</p> <p>Click <a href="#">here</a> to see the algorithm types available for this system event.</p>
Transition	Optional	<p>The system calls algorithms of this type upon each successful state transition of a business object as well as when it is first created. These are typically used to record the transition on the maintenance object's log.</p> <p>Note that most base maintenance objects are already shipped with an automatic logging of state transitions. In this case you may use these algorithms to override the base logging functionality with your own. Refer to <a href="#">State Transitions are Audited</a> for more information.</p> <p>Click <a href="#">here</a> to see the algorithm types available for this system event.</p>
Transition Error	Optional	<p>The system calls this type of algorithm when a state transition fails and the business object should be saved in its latest successful <a href="#">state</a>. The algorithm is responsible for logging the transition error somewhere, typically on the maintenance object's log.</p> <p>Notice that in this case, the caller does NOT get an error back but rather the call ends</p>

System Event	Optional / Required	Description
		<p>successfully and the exception is recorded somewhere, as per the plug-in logic.</p> <p>The system invokes a single algorithm of this type. If more than one algorithm is plugged-in the system invokes the one with the greatest sequence number.</p> <p>Click <a href="#">here</a> to see the algorithm types available for this system event.</p>

**NOTE: You can inactivate algorithms on Maintenance Objects.** Your implementation may want to inactivate one or more algorithms plugged into the base maintenance object. To do that, go to the options grid on Maintenance Object - Options and add a new option, setting the option type to **Inactive Algorithm** and setting the option value to the algorithm code.

## Maintenance Object - Maintenance Object Tree

You can navigate to the **Maintenance Object Tree** to see an overview of the tables and table relationships associated with the maintenance objects.

### Description of Page

This page is dedicated to a [tree](#) that shows the maintenance object's tables as well as [business objects](#), if you have defined any. You can use this tree to both view high-level information about these objects and to transfer to the respective page in which an object is maintained.

## Defining Valid Values

The product provides several options for defining valid values for a column on a table:

- Lookup
- Extendable Lookup
- Control Table

The following provides more information about the functionality of each of the options available for defining valid values for a column.

### Lookup

The simplest mechanism for defining valid values for a column on a table is via the Lookup table. This is sometimes referred to as a “simple” lookup to distinguish it from an extendable lookup (described below). Using the lookup table, you can define valid values and their descriptions. When choosing a valid value that is defined by a lookup, a dropdown UI metaphor is used.

The following highlights functionality related to lookups:

- Lookups are associated with a [Field](#). The field is defined as a character data type with an extended data type of **Flag**. The field's label serves as the description for the prompt to select the valid value.
- The lookup code is limited to four characters and must be all uppercase. If there is any functionality where a valid value in the application must match valid values in an external system, the lookup table may not be the appropriate choice.
- The lookup table does not support additional attributes to be defined for each value. This option is only appropriate when a simple code and description pair is needed.
- The product may also use Lookups to define valid values for functionality unrelated to a column on a table. For example, an algorithm plug-in spot may define an input parameter that supports one or more valid values. The plug-in spot may

define the valid values using a lookup, allowing for a simple way to validate the value supplied when invoking the algorithm and to document the valid values.

---

**FASTPATH:** For more information, refer to [Defining Lookup Options](#).

---

## Extendable Lookup

The extendable lookup provides a way of defining valid values for a column with additional capabilities that are not supported using the Lookup table. When choosing a valid value that is defined by an extendable lookup, a dropdown UI metaphor is used.

The following highlights functionality related to extendable lookups:

- Each Extendable Lookups is defined using a business object.
- A field should be defined for the extendable lookup code. The field defines the label for the lookup code and defines the size of the lookup code. The size is determined based on the business use case. In addition, there are standard fields included in all extendable lookups, including a description, detailed description and an override description (so that implementations can override the description of base delivered values).
- The extendable lookup may define additional information for each value if warranted by the business requirement. See [Additional Attributes](#) for technical information about additional attributes.

---

**FASTPATH:** For more information, refer to [Defining Extendable Lookups](#).

---

## Control Table

There may be scenarios where a list of valid values warrants a standalone maintenance object, which is considered an administrative or control table object. When choosing a valid value that is defined by a control, either a dropdown UI metaphor or a search metaphor is used, depending on how it has been designed.

The following points highlight some reasons why this option may be chosen:

- The records require a lifecycle such that BO status is warranted.
- The additional attributes are sophisticated enough that they warrant their own column definition rather than relying on using CLOB or flattened characteristic. For example, if a list of information needs to be captured with several attributes in the list and the information in the list needs to be searchable.

In this situation, if a product has provided a control table for this type of functionality, it will be documented fully in the appropriate functional area. If an implementation determines that a custom control table is warranted, all the standard functionality for a maintenance object is required: database tables, maintenance object metadata, appropriate Java maintenance classes, portals, zones, etc. Refer to the Software Development Kit for more information. No further information is provided in this section for this option.

## Defining Lookup Options

Lookup fields may be used to define valid values for a column in a table or for other types of values like parameters to an algorithm.

---

**FASTPATH:** Refer to [Defining Valid Values](#) for some background information.

---

The base product provides many different lookup fields and their values as part of the product. The following points highlight some functionality related to base-package lookups.

- Fields that are owned by the product will typically provide base lookup values. Implementations are not permitted to remove base delivered lookup values. Implementations may be able to add custom values to base owned lookups. This is controlled with the Custom switch on lookup.

- When the custom switch is unchecked, it means that there is functionality controlled by the base values and an implementation may not extend or customize this functionality. An example of this type of lookup is the Data Type field on the [Field](#) table. The system supports a distinct list of data types and an implementation may not add additional values.
- When the custom switch is checked, it means that there is base functionality supplied for the base values but that an implementation can extend the functionality by supplying their own values. An example of this type of lookup is the Access Mode on [Application Service](#). The product provides many values for the access mode lookup, representing various actions a user may perform. Implementations may add their own values to this lookup. Documentation should indicate when functionality may be extended and should highlight the lookup value that can be extended.

---

**CAUTION:** Important! If you introduce new lookup values, you must prefix the lookup value code with **X** or **Y**. If you do not do this, there is a possibility that a future release of the application could introduce a new lookup value with the name you allocated.

---

- There may be some scenarios where the product supplies a base field and base lookup field with no base lookup values supplied. This occurs when the product doesn't have any base functionality driven by the lookup values. Typically this type of lookup is for information or categorization purposes. The configuration guide for the functional area associated with the lookup should include a configuration step regarding defining values for this type of lookup.
- The description of base delivered values may be overridden by an implementation.

An implementation may also identify the need for defining a new lookup field with its values.

## Lookup - Main

Select **Admin > Database > Lookup** to maintain lookup values.

### Description of Page

**Field Name** is the name of the field whose lookup values are maintained in the grid. If you need to add a new lookup field, you must first add the lookup field here, then navigate to the [Field](#) page to create a field with a data type of **Character** and an extended data type of **Flag**.

**Owner** indicates if this lookup field is owned by the base package or by your implementation (**Customer Modification**). This information is display-only.

**Custom** switch is used to indicate whether you are allowed to add valid values for a lookup field whose owner is not **Customer Modification**.

- If this switch is turned on, you may add new values to the grid for system owned lookup fields.
- If this switch is turned off, you may not add, remove or change any of the values for system owned lookup fields, with the exception of the override description.

This field is always protected for system owned lookup fields because you may not change a field from customizable to non-customizable (or vice versa).

**Java Field Name** indicates the name of the field as it is referenced in Java code.

The grid contains the lookup values for a specific field. The following fields are visible:

**Field Value** is the unique identifier of the lookup value. If you add a new value, it must begin with an **X** or **Y** (in order to allow future upgrades to differentiate between your implementation-specific values and base-package values).

**Description** is the name of the lookup value that appears on the various transactions in the system

**Java Value Name** indicates the unique identifier of the lookup value as it is referenced in Java code.

**Status** indicates if the value is **Active** or **Inactive**. The system does not allow **Inactive** values to be used (the reason we allow **Inactive** values is to support historical data that references a value that is no longer valid).



**Detailed Description** is the detailed description for a lookup value, which is provided in certain cases.

**Override Description** is provided if your implementation wishes to override the description of the value provided by the product.

---

**NOTE:** If you wish the override descriptions of your lookup values to appear in the application viewer, you must [regenerate](#) the data dictionary application viewer background process.

---

**Owner** indicates if this lookup value is owned by the base package or by your implementation (**Customer Modification**). The system sets the owner to **Customer Modification** when you add lookup values to a field. This information is display-only.

## Defining Extendable Lookups

Extendable lookups are a way of defining valid values that are more sophisticated than simple lookups.

---

**FASTPATH:** Refer to [Defining Valid Values](#) for some background information.

---

The base product provides extendable lookups as part of the product. The following points highlight some functionality related to base-package extendable lookups.

- The base product may supply base extendable lookup values. Implementations are not permitted to remove base delivered extendable lookup values. It is also possible that implementations may be able to add custom values to base owned lookups. If an implementation is not permitted to add lookup values to the base extendable lookup, the extendable lookup's business object will include validation to prevent this. There is no equivalent of the Custom switch that is on the [lookup](#) field.
- There may be some scenarios where the product supplies a base extendable lookup with no base lookup values supplied. This occurs when the product doesn't have any base functionality driven by the extendable lookup values. The configuration guide for the functional area associated with the extendable lookup should include a configuration step regarding defining values for this type of extendable lookup.
- The description of base delivered values may be overridden by an implementation.

Open this page using **Admin > General > Extendable Lookup**.

You are brought to the **Extendable Lookup Query** where you need to search for the extendable lookup object (i.e., its business object).

Once you have found the appropriate extendable lookup, select the value and you are brought to a standard [All-in-One](#) portal that lists the existing lookup values for the extendable lookup. The standard actions for an All-in-One portal are available here.

## Defining Additional Attributes

The product provides a few different ways to define additional values for an extendable lookup. Some of the methods are only relevant for base delivered lookup values as they may impact whether or not an implementation can update the values.

The following table highlights the options available and some summary information about what the option provides.

Option	Brief Description	Extendable Lookup Value Searchable by this Attribute?	Base Delivered Value Modifiable?
Element mapped to BO_DATA_AREA	The element is mapped to a CLOB field that allows for base delivered values to be modified.	No	Yes
Element mapped to BASE_BO_DATA_AREA	The element is mapped to a CLOB field that does not allow	No	No

Option	Brief Description	Extendable Lookup Value Searchable by this Attribute?	Base Delivered Value Modifiable?
	for base delivered values to be modified.		
Flattened characteristic	The element is defined using the flattened characteristic mechanism.	Yes	No

The following points highlight information from the table above:

- The decision of defining an additional attribute using a CLOB mapping or a flattened characteristic will depend on whether the functionality expects that the lookup will be known when the attribute is needed (in which case a CLOB mapping is appropriate) or if the functionality expects to determine the extendable lookup based on the attribute (in which case, a flattened characteristic is appropriate).
- When the base product defines an extendable lookup with additional attributes and intends to provide base extendable lookup values, it needs to determine whether or not implementations may update the additional attribute or not.
  - If no and the value is mapped to a CLOB, it will map the value to the BASE\_BO\_DATA\_AREA column. This means that implementations will receive an owner mismatch error when attempting to change the value. In addition, upgrading to a new release will replace the value with the base value.
  - If yes and the value is mapped to a CLOB, it will map the value to the BO\_DATA\_AREA column. This means that implementations will be able to change the value for a base owned record. In addition, upgrading to a new release will not make any changes to the value.
  - For values mapped to a characteristic, the product does not support an implementation changing the value of a base delivered record. If the product would like to support an implementation overriding this type of value, the business object will need to be designed with a corresponding “override” element (also a flattened characteristic), similar to how the product supplies an Override Description field to support an implementation overriding the base product delivered description for a base value. This element will not be delivered with any value and will allow an implementation to populate that value.

---

**NOTE:** Note that in this situation, the product functionality that uses this value must cater for the override value.

---

- All of this detail is only relevant for base provided extendable lookup values. If an implementation adds custom values for a base supplied extendable lookup, all the additional attributes may be populated as appropriate.
- If an implementation defines a custom extendable lookup business object and wants to define an additional attribute using a CLOB, it doesn’t matter which CLOB column is used. Both BO\_DATA\_AREA and BASE\_BO\_DATA\_AREA provide the same functionality for custom business objects.

## The Big Picture Of Audit Trails

The topics in this section describe auditing, enabling auditing for fields, and auditing queries that you can use to view audit records.

### Captured Information

When auditing is enabled for a field, the following information is recorded when the field is changed, added and/or deleted (depending on the actions that you are auditing for that field):

- User ID
- Date and time
- Table name
- Row's prime key value

- Field name
- Before image (blank when a row is added)
- After image (blank when a row is deleted)
- Row action (add, change, delete)

## How Auditing Works

You enable auditing on a table in the table's meta-data by specifying the name of the table in which to insert the audit information (the audit table) and the name of the program responsible for inserting the data (the audit trail insert program). Then you define the fields you want to audit by turning on each field's audit switch in the table's field meta-data. You can audit fields for delete, insert and update actions.

Once auditing is enabled for fields in a table, the respective row maintenance program for the table assembles the list of changed fields and calls the audit trail insert program ( **CIPZADTA** is supplied with the base package). If any of the changed fields are marked for audit, **CIPZADTA** inserts audit rows into the audit table ( **CI\_AUDIT** is the audit table supplied with the base package).

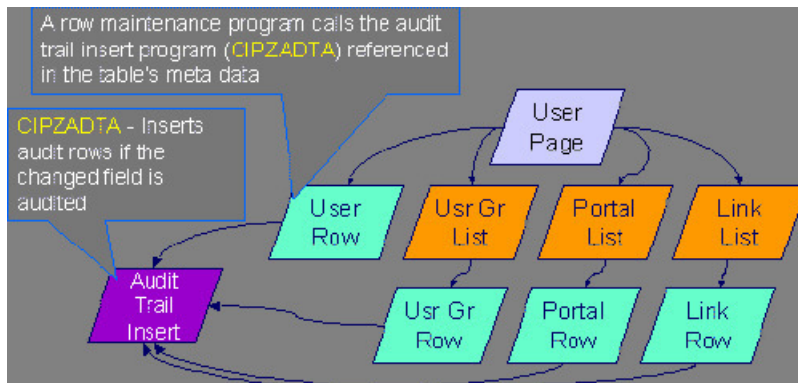

**NOTE: Customizing Audit Information.** You may want to maintain audit information other than what is described in [Captured Information](#) or you may want to maintain it in a different format. For example, you may want to maintain audit information for an entire row instead of a field. If so, your implementation team can use **CIPZADTA** and **CI\_AUDIT** as examples when creating your own audit trail insert program and audit table structures.

## The Audit Trail File

Audit log records are inserted in the audit tables you define. The base product contains a single such table (called **CI\_AUDIT**). However, the audit insert program ( **CIPZADTA**) is designed to allow you to use multiple audit tables.

If you want to segregate audit information into multiple tables, you must create these tables. Use the following guidelines when creating new audit tables (that use the **CIPZADTA** audit insert program):

- The new audit tables must look identical to the base table ( **CI\_AUDIT** ).
- The new tables must be prefixed with **CM** (e.g., **CM\_AUDIT\_A**, **CM\_AUDIT\_B**, etc.).
- The name of the new table must be referenced on the various tables whose changes should be logged in the new table.

**NOTE: Interesting fact.** It's important to note if you use your own tables (as opposed to using the base package table called **CI\_AUDIT**), the SQL used to insert and access audit trail records (in **CIPZADTA**) is dynamic. Otherwise, if the base package's table is used, the SQL is static.

# How To Enable Auditing

Enabling audits is a two-step process:

- First, you must turn on auditing for a table by specifying an audit table and an audit trail insert program.
- Second, you must specify the fields and actions to be audited for the table.

The following topics describe this process.

## Turn On Auditing For a Table

In order to tell the system which fields to audit, you must know the name of the table on which the field is located. You must specify the audit table and the audit trail insert program for a table in the table's meta-data.

---

**NOTE:** Most of the system's table names are fairly intuitive. For example, the user table is called [SC\\_USER](#), the navigation option table is called [CI\\_NAV\\_OPT](#), etc. If you cannot find the table using the search facility on the [Table Maintenance](#) page, try using the [Data Dictionary](#). If you still cannot find the name of the table, please contact customer support.

---

To enable auditing for a table:

- Navigate to the [Table maintenance](#) page and find the table associated with the field(s) for which you want to capture audit information.
- Specify the name of the **Audit Table**.

---

**NOTE: Specifying the Audit Table.** You can use the audit table that comes supplied with the base package ( [CI\\_AUDIT](#)) to audit multiple tables and fields. All the audit logs are combined in a single table ( [CI\\_AUDIT](#)). However, you can also have a separate audit table for each audited table. Refer to [The Audit Trail File](#) for more information.

---

- Specify the name of the **Audit Program** ( [CIPZADTA](#) is the default audit program supplied with the base package).

---

**CAUTION:** By default, none of a table's fields are marked for audit. Even though you have enabled auditing for a table, you must still specify the fields and actions on those fields to be audited (see below).

---

## Specify The Fields and Actions To Be Audited

The system only audits actions (insert, update and delete) made to fields that you want audited.

To specify the fields and actions to be audited:

- Navigate to the [Table - Table Field maintenance](#) page for a table on which you have enabled auditing.
- For each field you want to audit, specify the actions you want to audit by turning on the **Audit Delete**, **Audit Insert** and **Audit Update** switches as appropriate.

---

**NOTE: Note.** You can also turn on the audit switches using the Field grid at the bottom of the [Table maintenance page](#).

---

---

**CAUTION: Audit Program Caching!** The audit program from the table meta-data is read into a program cache on the application server whenever the data changes or when the server starts. If you implement new auditing on a table, your audit trail does not become effective until this program cache is reloaded. In other words, new audits on tables where the audit program was not previously specified do not become effective until the next day (or the next restart of the

application server). However, if you change the fields to be audited for a table where the audit program is already in the cache, your changes are effective immediately.

---

## Audit Queries

There are two queries that can be used to access the audit information.

### Audit Query by User

This transaction is used to view changes made by a user that are stored on a given [Audit Trail File](#).

---

**CAUTION:** The system only audits changes that you've told it to audit. Refer to [The Big Picture Of Audit Trails](#) for more information.

---

Navigate to this page by selecting **Admin > Database > Audit Query By User**.

#### Description of Page

To use this transaction:

- Enter the **User ID** of the user whose changes you wish to view.
- Enter the name of the table on which the audit trail information is stored in **Audit Table**. Refer to [The Audit Trail File](#) for more information about this field.

---

**NOTE: Default Note.** If only one audit table is used to store audit trail information, that table is defaulted.

---

- Specify a date and time range in **Created between** to restrict the records that result from the query.

---

**NOTE: Default Note.** The current date is defaulted.

---

- Click the search button to display all changes recorded on a specific audit table associated with a given user.

Information on this query is initially displayed in reverse chronological order.

The following information is displayed in the grid:

- **Row Creation Date** is the date and time that the change was made.
- **Audited Table Name** contains the name of the table whose contents were changed.
- **Primary Key** is the prime key of the row in the **Audited Table** whose contents were changed.
- **Audited Field Name** is the name of the field that was changed.
- **Audit Action** indicates whether the row action was **Add**, **Change** or **Delete**.
- **Field Value Before Update** contains the content of the field before the change. This column is blank if information was **Added**.
- **Field Value After Update** contains the content of the field after the change. This column is blank if information was **Deleted**.

### Audit Query by Table / Field / Key

This transaction is used to view audited changes made to a given table.

---

**CAUTION:** The system only audits changes that you've told it to audit. Refer to [The Big Picture Of Audit Trails](#) for more information.

---

**NOTE:** Most of the system's table names are fairly intuitive. For example, the user table is called `SC_USER`, the navigation option table is called `CL_NAV_OPT`, etc. If you cannot find the table using the search facility on the [Table Maintenance](#) page, try using the [Data Dictionary](#). If you still cannot find the name of the table, please contact customer support.

---

This transaction can be used in several different ways:

- You can view all audited changes to a table. To do this, enter the **Audited Table Name** and leave the other input fields blank.
- You can view all audited changes to a given row in a table (e.g., all changes made to a given user). To do this, enter the **Audited Table Name** and row's prime key (the row's prime key is entered in the field(s) beneath **Audited Field Name**).
- You can view all audited changes to a given field in a table (e.g., all changes made to all customers' rates). To do this, enter the **Audited Table Name** and the **Audited Field Name**.
- You can view all audited changes to a given field on a specific row. To do this, enter the **Audited Table Name**, the **Audited Field Name**, and row's prime key (the row's prime key is entered in the field(s) beneath **Audited Field Name**).

Navigate to this page by selecting **Admin > Database > Audit Query By Table/Field/Key**.

### Description of Page

To use this transaction:

- Enter the name of the table whose changes you wish to view in **Audited Table Name**.
- If you wish to restrict the audit trail to changes made to a specific field, enter the **Audited Field Name**.
- If you wish to restrict the audit trail to changes made to a given row, enter the row's prime key (the row's prime key is entered in the field(s) beneath **Audited Field Name**). These fields are dynamic based on the **Audited Table Name**.
- Specify a date and time range in **Created between** to restrict the records that result from the query.

---

**NOTE:** The current date is defaulted.

---

- Click the search button to display all changes made to this data.

Information on this query is initially displayed in reverse chronological order by field.

The following information is displayed in the grid:

- **Create Date/Time** is the date / time that the change was made.
- **User Name** is the name of the person who changed the information.
- **Primary Key** is the prime key of the row in the **Audited Table** whose contents were changed.
- **Audited Field Name** is the name of the field that was changed.
- **Audit Action** indicates whether the row action was **Add**, **Change** or **Delete**.
- **Value Before Update** contains the content of the field before the change. This column is blank if information was **Added**.
- **Value After Update** contains the content of the field after the change. This column is blank if information was **Deleted**.

## Bundling

The topics in this section describe the bundling features in the application.

## About Bundling

Bundling is the process of grouping entities for export or import from one environment to another.

For example, you might export a set of business objects and service scripts from a development environment and import them into a QA environment for testing. The group of entities is referred to as a bundle. You create export bundles in the source environment; you create import bundles in the target environment.

Working with bundles involves the following tasks:

- Configuring entities for bundling if they are not preconfigured
- Creating an export bundle, which contains a list of entities to be exported from the source environment
- Creating an import bundle to import those entities to the target environment
- Applying the import bundle, which adds or updates the bundled entities to the target environment

## Sequencing of Objects in a Bundle

Bundle entities are added or updated to the target environment in the sequence defined in the bundle

Typically, the sequence of entities does not matter. However, sequence is important in the following situations:

- Entities that are referenced as foreign keys should be at the top of the sequence, before the entities that reference them. Specify zones last, as they typically contain numerous foreign key references.
- When importing a business object, specify the business object first, then its plug-in scripts, then the algorithms that reference the scripts, and then the algorithm types that reference the algorithms.
- When importing a portal and its zones, specify the portal first and then its zones.
- When importing a multi-query zone, specify the referenced zones first and then the multi-query zone.
- Always specify algorithms types before algorithms.

You can specify the sequence when you define the export bundle or when you import the bundle to the target environment.

## Recursive Key References

Recursive foreign keys result when one object has a foreign key reference to another object that in turn has a foreign key reference to the first object.

For example, a zone has foreign keys to its portals, which have foreign keys to their zones. If the objects you want to bundle have recursive relationships, you must create a 'bundling add' business object that has only the minimal number of elements needed to add the entity. A bundling add business object for a zone contains only the zone code and description, with no references to its portals. In the same way, a bundling add business object for a portal defines only its code and description.

When you apply the bundle, the system initially adds the maintenance object based on the elements defined in the bundling add business object. Before committing the bundle, the system updates the maintenance object with the complete set of elements based on its physical business object.

## Owner Flags on Bundled Entities

The owner flag of the entities in an import bundle must match the owner flag of the target environment.

If you need to import objects that your source environment does not own, you must replace the owner flag in the import bundle with the owner flag of the target environment.

## Configuring Maintenance Objects for Bundling

All base package meta-data objects are pre-configured to support bundling. All other objects must be manually configured.

If a base package maintenance object is pre-configured for bundling, the **Eligible For Bundling** option will be set to "Y" on the Options tab for the maintenance object.

To configure other objects for bundling, review the configuration tasks below and complete all those that apply:

Configuration Task	Scope of Task
Make maintenance objects eligible for bundling	All objects to be included in the bundle
Add a foreign key reference	All objects to be included in the bundle
Create a physical business object	All objects to be included in the bundle
Create a bundling add business object	Objects with recursive foreign key references
Add the Current Bundle zone	All objects, if you want the Current Bundle zone to appear on the maintenance object's dashboard. This is not required by the bundling process.
Create a custom Entity Search zone and add it to the Bundle Export portal	All objects, if you want them to be searchable in the Bundle Export portal. This is not required by the bundling process.

## Making Maintenance Objects Eligible for Bundling

The "Eligible For Bundling" maintenance object option must be set to "Y" for all bundled objects.

To make maintenance objects eligible for bundling:

1. Go to the [Maintenance Object](#) page and search for the maintenance object.
2. On the Options tab, add a new option with the type **Eligible For Bundling**.
3. Set the value to "Y" and click **Save**.

## Adding a Foreign Key Reference

Each maintenance object in a bundle must have a foreign key reference. Bundling zones use the foreign key reference to display the standard information string for the maintenance object.

To add a foreign key reference to the maintenance object:

1. Navigate to [FK Reference](#) and set up a foreign key reference for the primary table of the maintenance object.
2. Navigate to [Maintenance Object](#) and search for the maintenance object.
3. On the **Option** tab, add a new option with the type **Foreign Key Reference**. The value is the name of the foreign key reference you just created.

## Creating a Physical Business Object

Each maintenance object in a bundle must have a physical business object. The physical business object's schema represents the complete physical structure of the maintenance object, and includes elements for all fields in the maintenance object's tables. The bundling process uses this schema to generate the XML for the import bundle.

To create a physical business object for the maintenance object:

1. Navigate to [Business Object](#) and specify the maintenance object.



2. Click **Generate** in the **BO Schema** dashboard zone to generate a schema that looks like the physical structure of the maintenance object.
3. Save the physical business object.
4. Navigate to [Maintenance Object](#) and search for the maintenance object.
5. On the **Option** tab, add a new option with the type **Physical Business Object**. The value is the name of the physical business you just created.

## Creating a Bundling Add Business Object

If the objects to be bundled have recursive foreign key references, you must create a bundling add business object to avoid problems with referential integrity.

To create a bundling add business object:

1. Navigate to [Business Object](#) and specify the maintenance object.
2. Click **Generate** in the **BO Schema** dashboard zone to generate a schema that looks like the physical structure of the maintenance object.
3. Remove all elements that are not essential. Typically, only a code and description are required.
4. Save the physical business object.
5. Navigate to [Maintenance Object](#) and search for the maintenance object you want to bundle.
6. On the **Option** tab, add a new option with the type **Bundling Add BO**. The value is the name of the bundling add business object you just created.

## Adding the Current Bundle Zone

If you want the Current Bundle zone to appear on the maintenance object's dashboard, you must add the Current Bundle zone as a context-sensitive zone for the maintenance object.

To add the Current Bundle zone to the maintenance object:

1. Navigate to [Context Sensitive Zone](#) and search for the navigation key for the maintenance object.
2. Add the Current Bundle zone F1-BNDLCTXT, to that navigation key.

## Adding a Customized Entity Search Query Zone to the Bundle Export Portal

If you want the maintenance object to be searchable in the Bundle Export portal, you must first create an entity-specific query zone to search for the maintenance object. Then you must create a customized entity search zone that references this new query zone. Finally, you must add the customized entity search zone to the Bundle Export portal.

To make the maintenance object searchable:

1. Create an entity-specific query zone to search for the maintenance object:
  - a) Navigate to [Zone](#) and search for one of the base query zones, such as the Algorithm Search zone F1-BNALGS.
  - b) Click the **Duplicate** button in the page actions toolbar.
  - c) Enter a name for the new zone.
  - d) Click **Save**.

- e) Locate the **User Filter** parameter in the parameter list. Add SQL to search for the maintenance object(s) you want to appear in the zone.
  - f) Save the query zone.
2. Create a customized entity search zone:
- This step only needs to be done once. If you already have a customized search zone in the Bundle Export portal go to step 3
- a) Navigate to [Zone](#) and search for the F1-BNDLENTQ Entity Search zone.
  - b) Duplicate this zone (as described above).
  - c) Remove any references to base query zones.
3. Add the new entity-specific query zone to the customized entity search zone:
- a) Locate the customized entity search zone for your Bundle Export portal. This is the zone created in Step 2.
  - b) Locate the Query Zone parameter in the parameter list. Add the name of the query zone you created in Step 1.
  - c) Save the entity search zone.
4. Add the customized entity search zone to the Bundle Export portal:
- This step needs to be done only once.
- a) Navigate to [Portal](#) and search for the Bundle Export portal, F1BNDLEM.
  - b) In the zone list, add the entity search zone you created in Step 2. (Add the new zone after the base entity search zone).
  - c) Save the portal.

## Working with Bundles

Use the Bundle Export portal to create an export bundle. The export bundle contains a list of entities to be exported from the source environment. When you are ready to import the objects, use the Bundle Import portal to import the objects to the target environment.

## Creating Export Bundles

An export bundle contains a list of entities that can be imported into another environment.

To create an export bundle:

1. Log on to the source environment from which objects will be exported.
2. Select **Admin > Implementation Tools > Bundle Export > Add**.
3. Complete the fields in the Main section to define the bundle's basic properties.

---

**NOTE:** You can use the Entities section to add bundle entities now, or save the bundle and then add entities as described in step 5.

---

4. Click **Save** to exit the Edit dialog. The export bundle status is set to Pending.
5. While an export bundle is in Pending state, use any of the following methods to add entities to the bundle:
  - a) Use the **Entity Search** zone on the Bundle Export portal to search for entities and add them to the bundle. If an entity is already in the bundle, you can remove it.

- b) To import entities from a .CSV file, click **Edit** on the Bundle Export portal, and then click **CSV File to Upload**. Specify the file name and location of the .CSV file containing the list of entities. Click **Submit** to upload the file, and then click **Save** to save the changes.
  - c) Use the **Current Bundle** zone in the dashboard of the entity you want to add. (All entities that are configured to support bundling display a Current Bundle zone). This zone displays a list of all pending export bundles to which you can add the entity.
  - d) When you check an entity into revision control, specify the export bundle on the **Revision Info** dialog.
6. When you have added all entities, click **Bundle** in the Bundle Actions zone on the Bundle Export portal. The export bundle state is set to Bundled and the Bundle Details zone displays the XML representation of every entity in the bundle.

---

**NOTE:** The owner flags of the entities in the bundle must match the owner flag of the bundle itself. If the owner flags do not match, the system displays a warning message. Click **OK** to continue or **Cancel** to abort the bundle. If you click OK, you will need to resolve the owner flag discrepancy before you import the bundle to the target environment.

---

7. Copy the XML from the **Bundle Detail** zone to the clipboard (or to a text file). You can now create an import bundle and apply it to the target environment.

---

**NOTE:** If you need to make additional changes to the bundle, you must change the bundle state by selecting the **Back to Pending** button in the **Bundle Actions** zone.

---

## Creating and Applying Import Bundles

Import bundles define a group of entities to be added or updated in the target environment.

Before you create an import bundle, you must have already created an export bundle, added entities, and set the bundle's state to Bundled.

To create an import bundle and apply it to the target environment:

1. If you have not already copied the XML from the export bundle, do so now:
  - a) Select **Admin > Implementation Tools > Bundle Export** and search for the bundle.
  - b) Copy the XML from the **Bundle Detail** zone to the clipboard (or to a text file).
2. Log on to the target environment.
3. Select **Admin > Implementation Tools > Bundle Import > Add**.
4. In the **Bundle Actions** zone, click **Edit XML**.
5. Paste the contents of the clipboard (or text file if you created one) into the **Bundle Detail** zone.
6. Make any necessary changes to the XML and click **Save**. The status of the import bundle is set to Pending.

---

**NOTE:** Use caution when editing the XML to avoid validation errors.

---

7. To remove entities from the import bundle or change their sequence, click **Edit**. Enter your changes and click **Save** to exit the Edit dialog.
8. When you are ready to apply the bundle, click **Apply**. The import bundle state is set to Applied and the entities are added or updated in the target environment.

## Editing Export Bundles

You can add or remove entities from an export bundle when it is in Pending state. You can also change the sequence of entities.

To edit to an export bundle that has already been bundled, you must change the bundle state by selecting the **Back to Pending** button on the Bundle Export portal.

To edit a pending export bundle:

1. Open the bundle in edit mode.
2. Click **Edit** on the Export Bundle portal.
3. Make any necessary changes on the edit dialog and then click **Save**.

## Editing Import Bundles

You can remove entities from an import when it is in Pending state. You can also change the sequence of entities and edit the generated XML.

To edit a pending import bundle:

1. Open the bundle in edit mode.
2. To edit the XML snapshot, click **Edit XML**. Edit the XML code as needed, then click **Save**.

---

**NOTE:** Use caution when editing the XML to avoid validation errors.

---

3. To remove entities or change their sequence, click **Edit**. Make any necessary changes and click **Save**.

## Revision Control

The topics in this section describe the revision control features in the application.

### About Revision Control

Revision control is a tool provided for the development phase of a project to allow a user to check out an object that is being worked on. In addition, it captures the version of the maintenance object when users check in an update, maintaining a history of the changes to the object.

If revision control is enabled for an object you must check out the object to change it. While the object is checked out no one else can work on it. You can revert all changes made since checking out an object, reinstate an older version of an object, recover a deleted object, and force a check in of an object if someone else has it checked out.

---

**NOTE:** Revision control does not keep your work separate from the environment. Because the metadata for maintenance objects is in the central database, any changes you make to an object while it is checked out will be visible to others and may impact their work.

---

Many of the maintenance objects used as configuration tools are already configured for revision control, but it is turned off by default. For example, business objects, algorithms, data areas, UI maps, and scripts are pre-configured for revision control.

## Turning On Revision Control

Revision control is turned off by default for maintenance objects that are configured for revision control.

To turn on revision control:

1. Add the base package **Checked Out** zone to the Dashboard portal.
  - a) Navigate to [Portal](#).
  - b) Search for the portal CI\_DASHBOARD.
  - c) In the zone list for the **Dashboard** portal, add the zone F1-USRCHKOUT.
2. Set up application security.

For users to have access to revision control, they must belong to a user group that has access to the application service F1-OBJREVBOAS.
3. Add the revision control algorithm to the maintenance object that you want to have revision control.

This step must be repeated for each maintenance object that you want to have revision control.

  - a) Go to the [Maintenance Object](#) page and search for the maintenance object that you want to have revision control.
  - b) On the **Algorithms** tab of the maintenance object, add the revision control algorithm F1-REVCTL.

## Configuring Maintenance Objects for Revision Control

Most configuration tool maintenance objects are pre-configured for revision control. You can configure other maintenance objects for revision control, as well.

To configure other objects for revision control:

1. Create a physical business object for the maintenance object.

A physical business object is one that has a schema with elements for all of the fields for the tables in the maintenance object. Follow these steps to create a physical business object:

  - a) Navigate to [Business Object](#) and specify the maintenance object.
  - b) Use the **BO Schema** dashboard zone to generate a schema that looks like the physical structure of the maintenance object.
  - c) Save the physical business object.
  - d) Go to the [Maintenance Object](#) page and search for the maintenance object for which you want to enable revision control.
  - e) On the **Options** tab of the maintenance object add a new option with the type **Physical Business Object**. The value is the name of the physical business object that you just created.
2. Add a foreign key reference to the maintenance object.

The revision control zones will display the standard information string for the object based on the foreign key reference. Follow these steps to create a foreign key reference:

  - a) Navigate to [FK Reference](#) and set up a foreign key reference for the primary table of the maintenance object.
  - b) Go to the [Maintenance Object](#) page and search for the maintenance object.
  - c) On the **Options** tab of the maintenance object, add a new option with the type **Foreign Key Reference**. The value is the name of the foreign key reference that you just created.
3. Add the **Revision Control** zone to the maintenance object.

- a) Navigate to [Context Sensitive Zone](#) and search for the navigation key for the maintenance object.
  - b) Add the Revision Control zone, F1-OBJREVCTL, to that navigation key.
4. Add the revision control algorithm to the maintenance object.
- a) Go to the [Maintenance Object](#) page and search for the maintenance object that you want to have revision control.
  - b) On the **Algorithms** tab of the maintenance object, add the revision control algorithm F1-REVCTL.

## Working with the Revision Control Zones

You use two zones in the dashboard to work with revision controlled objects when revision control is turned on.

The **Revision Control** zone gives you several options for managing the revision of the currently displayed object. This zone also shows when the object was last revised and by whom. This information is linked to the **Revision Control Search** portal which lists all of the versions of the object.

Using the Revision Control zone you can:

- Check out an object in order to change it.
- Check in an object so others will be able to work on it.
- Revert the object back to where it was at the last checkout.
- Force a check in of an object that is checked out by someone else. You need special access rights to force a check in.
- Delete an object.

The **Checked Out** zone lists all of the objects that you currently have checked out. Clicking on an object listed in this zone will take you to the page for that object. The zone is collapsed if you have no objects checked out.

See [Revision Control Search](#) for more information about Check In, Force Check In, and Check Out one or more records simultaneously.

## Checking Out an Object

You must check out a revision controlled object in order to change it.

An object must have revision control turned on before you can check it out.

---

**NOTE:** When you first create or update an object a dialog box informs you that the object is under revision control. You can select **OK** to check out the object and save your changes, or **Cancel** to stop the update.

---

1. Go to the object that you want to work on.
2. Select **Check Out** in the **Revision Control** dashboard zone.

## Checking In an Object

You must check in a revision controlled object in order to create a new version of it. Checking in an object also allows others to check it out.

1. Select a link in the **Checked Out** dashboard zone to go to the object that you want to check in.
2. Select **Check In** in the **Revision Control** dashboard zone.
3. Provide details about the version:
  - In the **External References** field state the bug number, enhancement number, or a reason for the revision.

- In the **Detailed Description** field provide additional details regarding the revision.
- In the **Keep Checked Out** box specify if you want to keep the object checked out. If you keep the object checked out then your revision is a new version that you can restore later.
- In the **Add To Bundle** box specify if the object belongs to a bundle.

4. Select **OK** to check in the object.

## Reverting Changes

Reverting changes will undo any changes you made since you checked out an object.

To revert changes:

1. Go to the object that you want to revert.
2. Select **Revert** in the **Revision Control** dashboard zone.
3. In the confirmation dialog box select **OK** to confirm the action or **Cancel** to return to the object page.

Once reverted, the object can be checked out by another user.

## Forcing a Check In or Restore

You can force a check in if an object is checked out by another user and that person is not available to check it in.

You must have proper access rights to force a check in or restore.

To force a check in or restore:

1. Go to the object that is checked out by another user.
2. Select **Force Check In** or **Force Restore** in the **Revision Control** zone.

The **Force Check In** option is the same as a regular check in. The **Force Restore** option checks in the object and restores it to the previously checked in version.

## Deleting an Object

If revision control is turned on for an object, you must use the **Revision Control** zone to delete it.

The object must be checked in before it can be deleted.

To delete a revision controlled object:

1. Go to the object that you want to delete.
2. Select **Delete** in the **Revision Control** zone.
3. Provide details regarding the deletion.
4. Select **OK** to delete the object.

The system creates a revision record before the object is deleted so that the deleted object can be restored.

## Restoring an Object

You can restore an older version of either a current object or a deleted object.

An object must be checked in before an older version can be restored.

To restore an object:

1. Go to the **Revision History** portal for the object.  
If the object was deleted you must search for it by going to **Admin > Implementation Tools > Revision Control**.
2. Select the desired entity by clicking the hyperlink in the **Details** column.
3. Locate the row in the version history that has the version that you want to restore and click **Restore**.
4. In the confirmation dialog box select **OK** to confirm the action or **Cancel** to return to the object page.

## Working with the Revision Control Portal

The **Revision Control** portal lists information about each version of a revision controlled object.

You can navigate to the **Revision Control** portal from either a link in the **Revision Control** dashboard zone or by going to **Revision Control** portal through **Admin**.

If you want to find the Revision History entry for an earlier version or deleted object, you must search for the object using the **Revision Control Search** portal. Once you select the desired entry, you can restore a previous version of the object clicking **Restore** in the row for the version that you want to restore. You can also see the details of each version by clicking the broadcast icon for that version.

See [Working with Revision Control Zones](#) for more information about tasks that can be performed through Revision Control.

## Revision Control Search

The **Revision Control Search** portal allows users to search for entities that have a revision history. The **Search By** dropdown provides additional functionality so that users can search for revisions that are associated to theirs or other's user ID. Users can also **Check In**, **Force Check In**, or **Check Out** one or more entities through this portal.

### Zone Options

- **Revision History Search** allows the user to query for revised entities based on a combination of criteria.
  - In the **User ID** field, enter the user ID that is associated with a revision.
  - In the **External Reference** field, enter an ID from an external system and is associated with a revision.
  - In the **Maintenance Object** dropdown menu, select the Maintenance Object that is associated with a revision. The options in this list are populated by the Maintenance Objects that are active to track revision.
  - In the **Key 1**, **Key 2**, **Key 3**, **Key 4**, **Key 5** fields, enter the primary identifier(s) for the revised entity. Typically, the entity only requires a single key, but some entities require more than one (for example, Oracle Utilities Customer Care and Billing SA Type require CIS Division and SA Type).
  - In the **Status** dropdown menu, select the entity status for your search.
- **Check In** allows the user to search for entities currently checked out to the logged in user ID and a combination of criteria. Once the search results are returned, the user has the option to select one or more entities and check them in.
  - In the **Maintenance Object** dropdown menu, select the Maintenance Object that is associated with a revision. The options in this list are populated by the Maintenance Objects that are active to track revision.
  - In the **Key** field, enter the primary identifier(s) for the revised entity.
- **Force Check In** allows the user to search for entities that are currently checked out by other user IDs (excluding the logged in user ID) based on a combination of criteria. Once the search results are returned, the user has the option to select one or more entities and check them in.
  - In the **Checked Out By User** field, enter the user ID that has the entity in a Checked Out status.



- In the **Maintenance Object** dropdown menu, select the Maintenance Object that is associated with a revision. The options in this list are populated by the Maintenance Objects that are active to track revision.
- In the **Key** field, enter the primary identifier(s) for the revised entity.
- **Check Out** allows the user to search for entities currently checked in user ID and a combination of criteria. Once the search results are returned, the user has the option to select one or more entities and check them out.
- In the **Maintenance Object** dropdown menu, select the Maintenance Object that is associated with a revision. The options in this list are populated by the Maintenance Objects that are active to track revision.
- In the **Key** field, enter the primary identifier(s) for the revised entity.

Please see [Working with Revision Control Zones](#) for more information about working with individual entities.

## Information Lifecycle Management

Information Lifecycle Management (ILM) is designed to address data management issues, with a combination of processes and policies so that the appropriate solution can be applied to each phase of the data's lifecycle.

Data lifecycle typically refers to the fact that the most recent data is active in the system. As time progresses, the same data becomes old and unused. Older data becomes overhead to the application not only in terms of storage, but also in terms of performance. This older data's impact can be reduced by using advanced compression techniques, and can be put into slower and cheaper storage media. Depending on how often it's accessed, it can be removed from the system to make an overall savings of cost and performance. The target tables for ILM are transactional tables that have the potential to grow and become voluminous over time.

## The Approach to Implementing Information Lifecycle Management

This section describes the product approach to implementing ILM for its maintenance objects (MOs).

---

**NOTE:** The term archiving is used to cover any of the possible steps an implementation may take in their data management strategy, including compression, moving to cheaper storage, and removing the data altogether.

---

Age is the starting point of the ILM product implementation for some of its high volume data. In general "old" records are considered eligible to be archived. In the product solution, maintenance objects (MOs) that are enabled for ILM have an ILM Date on the primary table and the date is typically set to the record's creation date. (An MO may have special business rules for setting this date, in which case, a different date may be used to set the initial ILM Date). For implementations that want to use ILM to manage the records in the MO, the ILM date is used for defining partitions for the primary table.

There are cases where a record's age is not the only factor in determining whether or not it is eligible to be archived. There may be some MOs where an old record is still 'in progress' or 'active' and should not be archived. There may be other MOs where certain records should never be archived. To evaluate archive eligibility using information other than the ILM Date, the ILM enabled MOs include an ILM Archive switch that is used to explicitly mark records that have been evaluated and should be archived. This allows DBAs to monitor partitions based on age and the value of this switch to evaluate data that may be ready to be archived.

Evaluating records to determine their archive eligibility should still occur on "old" records. The expectation is that a large percentage of the old records will be eligible for archiving. The small number that may be ineligible could be updated with a more recent ILM date. This may cause the records to move into a different partition and can delay any further evaluation of those records until more time has passed.

For each MO enabled for ILM, the product provides a batch process to review "old" records and an ILM eligibility algorithm that contains business logic to evaluate the record and mark it eligible for archiving or not. The following sections provide more information about the batch process and algorithm functionality.

## Batch Processes

There are two main types of batch processes that manage data for ILM in the application: ILM Crawler Initiator and individual ILM Crawlers (one for each MO that is configured for ILM).

- **ILM Crawler Initiator: (F1-ILMIN)** - The ILM Crawler Initiator is a *driver* batch process that starts the individual ILM Crawler batch control as defined by the MO's options.

**Restartable:** In case of server failure, the ILM Crawler Initiator process can be restarted, which will also restart the ILM Crawler processes.

- **ILM Crawler:** Each maintenance object that is configured for ILM defines an ILM Crawler. These are *child* batch processes that can be started either by the ILM Crawler Initiator or by a standalone batch submission.

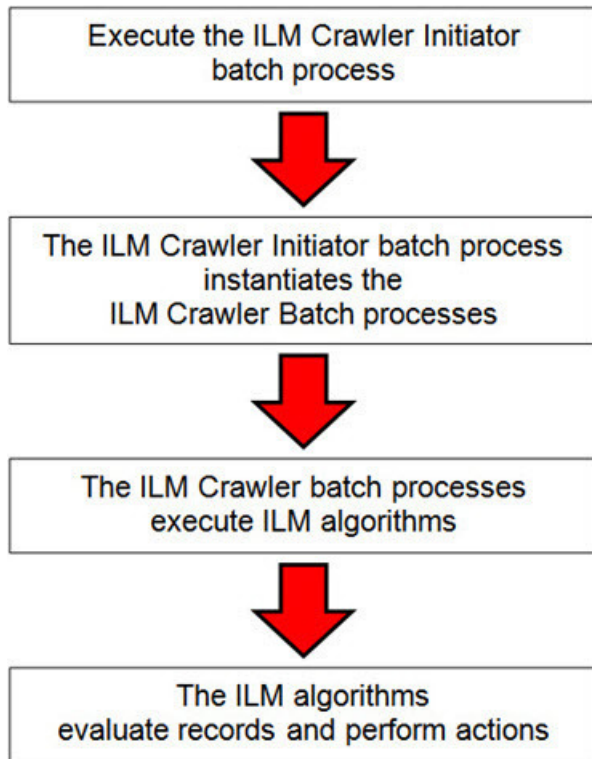

The ILM Crawler batch process selects records whose retention period has elapsed and invokes the MO's ILM eligibility algorithm to determine if the record is ready to be archived or not. The ILM eligibility algorithm is responsible for setting the record's ILM archive switch to 'Y' and updating the ILM date, if necessary.

The retention period defines the period that records are considered active. It spans the system date and cutoff date (calculated as system date - retention days).

The retention days of an MO is derived as follows:

- If the ILM Retention Days MO option is defined, that is used.
- Otherwise, the Default Retention Days from the ILM Master Configuration record is used.

An error is issued if no retention period is found.

The crawler calculates the cutoff date and selects all records whose ILM archive switch is 'N' and whose ILM date is prior to the cutoff date. Each record returned is subject to ILM eligibility.

If the Override Cutoff Date parameter is supplied, it will be used instead of the calculated cutoff date. An error is issued if the override cutoff date is later than the calculated cutoff date. This parameter is useful if an object has many years of

historic data eligible for archiving. Setting this parameter allows for widening the retention period and therefore limiting the process to a shorter period for initial processing

---

**NOTE:** ILM Crawler batch processes are designed not to interfere with current online or batch processing. Because of this, these batch processes can run throughout the day.

---

**NOTE:** Before passing the cut-off date to the algorithm, the ILM crawler ensures that the number of days calculated (System Date – override cut-off date) is more than the retention period specified in the MO option or the Master Configuration. If the number of days calculated is **less than** the retention period specified on the MO option or the Master Configuration, then it throws an error.

---

## Eligibility Algorithm

Algorithms are triggered by the ILM batch crawler for the maintenance object. The key responsibility of the ILM algorithm is to determine whether a record can be marked as ready to be archived or not. If a record is determined to be ready for archive, the algorithm should set the ILM Archive switch to Y. If not, the algorithm leaves the switch set to N and may decide to update the ILM Date to something more recent (like the System Date) to ensure that the record does not get evaluated again until the future.

This algorithm is plugged into the [Maintenance Object — Algorithm](#) collection.

Oracle Utilities Application Framework provides the algorithm **ILM Eligibility Based on Status (F1-ILMELIG)** to support the ILM batch crawler. Refer to the algorithm type description for details about how this algorithm works. If a maintenance object has special business rules that are evaluated to determine the eligibility for ILM, a custom algorithm can be created and applied by the implementation team.

## Enabling ILM for Supported Maintenance Objects

In order to enable ILM for one or more maintenance objects, several steps are needed in both the configuration and in the database. This section describes some configuration enabled by default and some steps that must be taken in order to fully implement ILM.

There is some configuration enabled by default, but it won't be used unless ILM is fully configured. Each maintenance object that the product has configured for ILM has the following provided out of the box:

- **Special Table Columns:** Maintenance objects that support ILM include two specific columns: ILM Archive Switch (**ILM\_ARCH\_SW**) and ILM Date (**ILM\_DT**).
- **Crawler Batch Process:** A “crawler” batch process is provided for each maintenance object that supports ILM and it is plugged into the MO as an option. Refer to [Batch Processes](#) for more information.
- **ILM Eligibility Algorithm:** Each maintenance object that is configured for ILM defines an [eligibility algorithm](#) that executes the logic to set the ILM Archive switch appropriately. This is plugged in to the MO algorithm collection.

If an implementation decides to implement ILM, there are steps that need to be followed, which are highlighted below.

### Create the Master Configuration Record

The first step when enabling ILM is to create the **ILM Configuration**[master configuration](#) record.

The master configuration for ILM Configuration defines global parameters for all ILM eligible maintenance objects. For example, the Default Retention Period. In addition, your product may implement additional configuration. Refer to the embedded help for specific details about the information supported for your product's ILM configuration.

In addition, the user interface for this master configuration record displays summary information about all the maintenance objects that are configured to use ILM.

## Confirm the Maintenance Objects to Enable

In viewing the list of maintenance objects that support ILM in the ILM master configuration page, your implementation may choose to enable ILM for only a subset of the supported maintenance objects. For example, some of the maintenance objects may not be relevant for your implementation. Or perhaps, the functionality provided by the maintenance object is used, but your implementation does not expect a high volume of data.

For each maintenance object that your implementation has confirmed for ILM, the following steps should be taken:

- Determine if the maintenance object should have a different default retention days than the system wide value defined on the master configuration. If so, use the MO option **ILM Retention Period in Days** to enter an override option for this maintenance object.
- Review the functionality of the ILM Eligibility algorithm provided by the product for this maintenance object. Each algorithm may support additional configuration based on business needs. If your organization has special business rules that aren't satisfied by the algorithm provided by the product, a custom algorithm may be provided to override the base algorithm.

For each maintenance object that your implementation does not want to enable for ILM, inactivate the eligibility algorithm. This will ensure that the ILM Crawler Initiator background process does not submit the crawler batch job for the maintenance object in question.

- Go to the [Maintenance Object — Algorithm](#) tab for each maintenance object and take note of the **ILM Eligibility** algorithm code.
- Go to the [Maintenance Object — Option](#) tab for the same maintenance object and add an option with an option type of **Inactivate Algorithm** and the value set to the ILM eligibility algorithm noted in the previous step.

## Database Administrator Tasks

In order to implement ILM for each of the maintenance objects determined above, your database administrator must perform several steps in the database for the tables related to each MO. The following points are a summary of those steps. More detail can be found in the Information Lifecycle Management section of your product's *Database Administration Guide*.

- **Initializing ILM Date:** Your existing tables that are enabled for ILM may not have the ILM Date and ILM Archive switch initialized on all existing records. When choosing to enable ILM, a first step is to initialize this data based on recommendations provided in the DBA guide.
- **Referential Integrity:** The recommended partitioning strategy for child tables in a maintenance object is referential partitioning. In order to implement this, database referential integrity features must be enabled.
- **Partitioning:** This provides a way in which the data can segregate into multiple table partitions and will help in better management of the lifecycle of the data.

## Schedule the ILM Crawler Initiator

The final step of enabling the system for ILM is to schedule the ILM crawler initiator **F1-ILMIN** regularly based on your implementation's need. It is recommended to only schedule this batch process once all the required database activities are complete.

## Ongoing ILM Tasks

For an environment where ILM is enabled, besides the periodic execution of the ILM crawler batch processes to review and mark records, your database administrator has ongoing tasks.

The DBA reviews and maintains partitions and identifies partitions that may warrant some type of archiving step. The Information Lifecycle Management section of your product's *Database Administration Guide* provides more information for your DBA.

## Archived Foreign Keys

If your DBA choose to archive a partition, there may be records in the system that refer to one of the archived records as a foreign key.

When a user attempts to view a record using a hyperlink or drill down mechanism, if the implementation of the navigation uses FK Reference functionality, the system will first check if the record exists. If not, it will display a message to the user indicating that the record has been archived.

## Configuration Tools

---

This section describes tools to facilitate detailed business configuration. The configuration tools allow you to extend both the front-end user interface as well as create and define specialized back-end services.

## Business Objects

A [maintenance object](#) defines the physical tables that are used to capture all the possible details for an entity in the system. A business object is tool provided to further define business rules for a maintenance object.

This section provides an overview of business objects and describes how to maintain them.

## The Big Picture of Business Objects

The topics in this section describe background topics relevant to business objects.

## What Is A Business Object?

A business object (BO) is a powerful tool used throughout the system. For many maintenance objects, a BO is a key attribute of the record used to define the data it captures, its user interface behavior and its business rules. Some business objects support the definition of a lifecycle, capturing different states that a record may go through, allowing for different business rules to be executed along the way. This type of business object is considered the “identifying” or “governing” business object. We will see later that other types of BOs exist that are different from the “identifying” business object.

The use of business objects allows for extensibility and customization of product delivered maintenance objects. There are many options to adjust the behavior of base delivered business objects. In addition, implementations may introduce their own business objects if the base product delivered objects do not meet their business needs.

---

**NOTE:** Not all maintenance objects in the product support business objects as a “identifying” or “governing” tool. This is the standard going forward for new maintenance objects. However, there are some maintenance objects created before this became a standard.

---

## A Business Object Has a Schema

A business object has elements. The elements are a logical view of fields and columns in one of the maintenance object’s tables. The structure of a business object is defined using an XML schema. The main purpose of the schema is to identify all the elements from the maintenance object that are included in the business object and map them to the corresponding maintenance object fields. Every element in the BO schema must be stored somewhere in the maintenance object. The BO may not define elements that are derived.

When defining elements for the primary table or the language table (for an administrative object) there is no need to define the name of the physical table in the schema. The system infers this information. The following is a snippet of a schema:

```
<schema>
  <migrationPlan mapField="MIGR_PLAN_CD" suppress="true" isPrimeKey="true"/>
  <bo mapField="BUS_OBJ_CD" fkRef="F1-BUSOB"/>
  <customizationOwner mapField="OWNER_FLG" suppress="input"/>
  <version mapField="VERSION" suppress="true"/>
  <description mapField="DESCR"/>
  <longDescription mapField="DESCRLONG"/>
  ...

```

Many maintenance objects have child table collections (e.g., a collection of names for a person, or a collection of persons on an account). Depending on the requirements, the business object may define the full collection such that the user will maintain the information in a grid. However, the schema also supports “flattening” records in a child table so that they can be treated as if they were singular elements. The following are examples of each:

**Example** of a child table. This is a snippet of the Instructions collection on the migration plan business object. You can see that the list attribute defines the child table and all elements within it map to the appropriate column in that table.

```
<migrationPlanInstruction type="list" mapChild="F1_MIGR_PLAN_INSTR">
  <migrationPlan mapField="MIGR_PLAN_CD" suppress="true"/>
  <sequence mapField="PLAN_INSTR_SEQ" suppress="true"/>
  <instructionSequence mapField="INSTR_SEQ"/>
  <instructionType mapField="INSTR_TYPE_FLG"/>
  <parentInstructionSequence mapField="PARENT_INSTR_SEQ"/>
  <businessObject mapField="BUS_OBJ_CD" fkRef="F1-BOMO"/>
  ...

```

**Example** of a simple “flattened” field. The business object for Status Reason includes an element called Usage, which maps to a pre-defined characteristic of type **F1-SRUSG**. The “row” defines which child table is being flattened and the attributes of the row in that child that uniquely identify it.

```
<usage mdField="STATUS_RSN_USAGE" mapField="CHAR_VAL">
  <row mapChild="F1_BUS_OBJ_STATUS_RSN_CHAR">
    <CHAR_TYPE_CD is="F1-SRUSG"/>
    <SEQ_NUM is="1"/>
  </row>
</usage>

```

**Example** of a “flattened row”. This business object for Account includes a single row for the Person collection where only the “financially responsible, main” customer is defined. The “accountPerson” attribute defines one field from that row (the Person Id) and includes the ‘flattening’ criteria in the “row” information. In addition, a second field from that same row (“accountRelType”) is defined. Instead of having to repeat the flattening criteria, the “rowRef” attribute identifies the element that includes the flattening.

```
<accountPerson mapField="PER_ID">
  <row mapChild="CI_ACCT_PER">
    <MAIN_CUST_SW is="true"/>
    <FIN_RESP_SW default="true"/>
  </row>
</accountPerson>
<accountRelType mapField="ACCT_REL_TYPE_CD" rowRef="accountPerson" dataType="string"/>

```

**Example** of a “flattened list”. The business object for Tax Bill Type includes an list of valid algorithms for “bill completion”. The Sequence and the Algorithm are presented in a list. The list element identifies the child table and the ‘rowFilter’ identifies the information about the list that is common.

```
<taxBillCompletion type="list" mapChild="C1_TAX_BILL_TYPE_ALG">
  <rowFilter suppress="true" private="true">
    <TAX_BILL_TYPE_SEVT_FLG is="C1BC"/>
  </rowFilter>
  <sequence mapField="SEQ_NUM"/>
  <algorithm mapField="ALG_CD" fkRef="F1-ALG"/>
</taxBillCompletion>

```

In addition, many maintenance objects support an XML structure field within the entity. These fields may be of data type CLOB or XML. One or more business object elements may be mapped to the MO's XML structure field. These elements may be defined in different logical places in the business object schema based on what makes sense for the business rules.

When updating the MO, the system builds a type of XML document that includes all the elements mapped to the XML structure and stores it in one column. The following is an example of elements mapped to an XML column:

```
<filePath mdField="F1_FILE_PATH" mapXML="MST_CONFIG_DATA" required="true"/>
<characterEncoding mdField="F1_CHAR_ENCODING" mapXML="MST_CONFIG_DATA"/>
```

---

**NOTE:** If the MO's XML structure field is of the data type XML, the database will allow searching for records based on that data, assuming appropriate indexes are defined. If the MO's XML structure field is of the data type CLOB, indexing or joining to elements in this column via an SQL statement is not typically supported. Note that most MOs are currently using the CLOB data type for the XML structure column, if provided.

---

Some business objects may have child tables that allow data to be stored in an XML structure field. The schema language supports defining elements from those fields in your schema as well.

Besides including information about the physical "mapping" of the element to its appropriate table / field location in the maintenance object, the schema supports additional syntax to provide the ability to define basic validation and data manipulation rules, including:

- Identifying the primary key of the record or the primary key of the a row in a list.
- Identifying which elements are required when adding or changing a record.
- Default values when no data is supplied on an Add.
- For elements that are lookup values, the lookup may be specified to validate that the value of the element is a valid lookup value.
- For elements that are foreign keys to another table, the FK Reference may be specified to validate the data.

The system will check the validity of the data based on the schema definition obviating the need for any special algorithm to check this validation.

In addition, the schema language may include some attributes that are used to auto-render the view of the record on the user interface, such as the **suppress** attribute. Refer to [BO Defines its User Interface](#) for more information.

---

**NOTE:** Refer to [Schema Syntax](#) for the complete list of the XML nodes and attributes available to you when you construct a schema.

---

A business object's schema may include a subset of the fields and tables defined in the maintenance object. There are two reasons for this:

- The fields or tables may not be applicable to the type of record the business object is governing. For example, a field that is specific to gas may not be included on a Device business object that is specific to electric meters.
- The information is not maintained through the business object, but rather maintained separately. For example, many BO based maintenance objects include a Log table. The records in the log table are typically not included the BO because they are viewed and maintained separately from the business object.

## A Business Object May Define Business Rules

A business object may define business rules that govern the behavior of entities of this type.

- Simple element-level validation is supported by schema attributes. Note that element-level validation is executed before any maintenance object processing. For more sophisticated rules you create **Validation** algorithms and associate them with your business object. BO validation algorithms are only executed after "core validation" held in the MO is passed.
- A **Pre-Processing** algorithm may be used to "massage" a business object's elements prior to any maintenance object processing. For example, although simple element-level defaulting is supported by schema attributes. you may use this type of algorithm to default element values that are more sophisticated.
- A **Post-Processing** algorithm may be used to perform additional steps such as creating a To Do Entry or add a log record as part of the business object logical transaction. These plug-ins are executed after all the validation rules are executed.



- An **Audit** algorithm may be used to audit changes made to entities of this type. Any time a business entity is added, changed or deleted, the system detects and summarizes the list of changes that took place in that transaction and hands it over to **Audit** plug-ins associated with the business object. These plug-ins are executed after all the post-processing rules are executed. It is the responsibility of such algorithms to log the changes if and where appropriate, for example as a log entry or an entry in an audit trail table or an entry in the [business event log](#)

By default all elements of the business object are subject to auditing. You can however mark certain elements to be excluded from the auditing process using the **noAudit** schema attribute. Marking an element as not auditable will prevent it from ever appearing as a changed element in the business object's audit plug-in spot. In addition, if the only elements that changed in a BO are ones marked to not audit, the audit algorithm is not even called. Refer to [Schema Syntax](#) for more information on this attribute.

Refer to [Business Object - Algorithms](#) for more information on the various types of algorithms.

The system applies business object rules (schema based and algorithms) whenever a business object instance is added, changed or deleted. This is only possible when the call is made via the maintenance object service. For example, when made via business object interaction ("invoke BO"), the MO's maintenance page or inbound web services that reference the BO. In addition the system must be able to [determine the identifying business object](#) associated with the actual object being processed. If the business object cannot be determined for a maintenance object instance business object rules are not applied.

---

**NOTE:**

**Pre-Processing is special.** The pre-processing algorithm plug-in spot is unique in that it only applies during a BO interaction. It is executed prior to any maintenance object processing. It means that when performing add, change or delete via the maintenance object service, the pre-processing plug-in is not executed.

---

**CAUTION:** Direct entity updates bypass business rules! As mentioned above, it is the maintenance object service layer that applies business object rules. Processes that directly update entities not via the maintenance object service bypass any business object rules you may have configured.

---

**FASTPATH:** Refer to [BO Algorithm Execution Order](#) for a summary of when these algorithms are executed with respect to lifecycle algorithms.

---

The plug-in spots described above are available for all business objects and they are executed by the system when processing adds or updates to the business object. It is possible for a specific maintenance object to define a special plug-in spot for business objects of that MO. When this happens, the maintenance object identifies the special algorithm entity lookup value as an **MO option: Valid BO System Event**, causing the BO Algorithm collection to include that system event in its list.

## A Business Object Defines its User Interface

One of the responsibilities of an identifying business object is to define its user interface rules for viewing and maintenance of its record. The standard implementation for maintaining a business object is that a [maintenance portal](#) is used to display a record. This portal includes a "map" zone that displays the information about the business object. To add or make changes to a record, the user clicks a button that launches a maintenance BPA script which displays a maintenance "map".

The display and maintenance "maps" are driven by the business object. The BO may define a full **UI map** where all the information is displayed based on the map's HTML. Note that for a child BO, the maps may be [inherited](#) by a parent BO (or any BO "up the chain").

The standard going forward is to use schema definition and UI Hints to define user interface behavior so that a full UI map is not needed but rather the HTML is derived. The schema language includes some basic display attributes such as **label** and **suppress**. UI hints provide many additional tags and elements that allow dynamic generation of formatted UI Maps. For more complex behavior in the user interface, for example where javascript is needed, UI map fragments may be defined within the schema via UI hints. In this way only complex UI behavior warrants small snippets of javascript and HTML.



However the rendering of standard fields can be dynamically rendered. UI map fragments also allow for derived fields to be included in the user interface.

A business object schema may include [data areas](#) for segments of its schema definition to allow for reusable components. In this case the data area would also include schema attributes and UI hints for the elements that it is including.

---

**NOTE:** Refer to [UI Hint Syntax](#) for detailed information about the supported syntax.

---

As mentioned in [Business Object Inheritance](#), schemas are not inherited on a child business object. As such, when using UI hints for automatic UI rendering, the child BO must define the full schema with all the definitions. A good business object hierarchy will be designed for reuse meaning that the child BO will include the parent BO schema or alternatively, the BO schemas will include reusable data areas.

## Invoking A Business Object

We have talked about defining a business object. This section describes how business objects are used throughout the system to view, add and update records.

- Various parameters for zones that are used to display data in the system include support for retrieving data by referencing a business object. The zone code will “invoke” the BO, meaning that the record will be retrieved using the referenced BO.
- The system’s [scripting](#) language includes a step type to “invoke BO”. This allows for BPA scripts, service scripts and plug-in scripts to retrieve information and add or update records using BO interaction.
- [Inbound web services](#) may reference a business object in its operations collection. This allows external systems to add or update records in our product via web service interaction.

Often when configuring a zone or writing a script, the BO to use in the “invoke BO” statement should be the identifying BO of the record. As such, often the script will include steps prior to the “invoke BO” step to “[determine the identifying BO](#) of the record” and once the identifying BO is found, the script step will invoke that BO. Note that zones and inbound web services reference a BO directly. In each case, if the BO to use should be dynamic, then the zone / inbound web service should reference a service script that can perform the steps to identify the BO and then invoke that BO.

It should be noted however that the BO used in an “invoke BO” statement (or referenced in an inbound web service) **does not have to match** the identifying BO for the record. Here are some examples of where this may be true:

- A script may only require a subset of elements for a record and not the entire record. In this case, it is better for performance purposes to define a special BO (sometimes called a “lite” BO or a “mini” BO) that only defines the needed elements. When the system retrieves the data, it will only access the tables that are included in the BO’s schema definition. In addition, if there are no elements that map to an XML structure field, the system will skip any parsing of that column. Similarly, if a script is **updating** a subset of elements on a record, it may be beneficial to use a “mini” BO to do the updates.

---

**NOTE:** Please note the following with respect to using a mini BO. This BO is only used for its schema. This type of BO would not define algorithms or a lifecycle. Because the BO is special, it often should not be able to be used as any record’s identifying BO. To control that, these BOs are often configured to not allow new instances. Refer to [Determine the Identifying BO](#) for more information.

---

- The maintenance object to be added or updated in a script may not support business objects as “identifying BOs”. For example, Batch Control maintenance object does not have an identifying BO. However, scripts may still wish to retrieve data (or make updates) to these types of records. An easy way to achieve that goal is to define a business object and use “invoke BO” to access the data.

---

**NOTE:** Not all maintenance objects support being maintained through a business object interaction. This is true in a small number of older objects where the underlying maintenance service includes additional functionality besides

simply updating the database tables. These maintenance objects are identified via the [MO option](#) **BO Maintenance**, set to **N**.

---

- Some functionality may be trying to add or update records for a maintenance object in a ‘physical’ manner and do not want or need to use the object’s identifying BO. Or the MO may not have an identifying BO. For example, revision control takes a snapshot of a record for audit purpose and to be able to restore a previous version. In this case, the system wants to capture a full “physical” view of the record. To do this, a special “physical” BO may be created that includes all (or most of) the columns and the child tables.

---

**NOTE:** Like the mini BO, the physical BO would not define algorithms or a lifecycle and should not be able to be used as any record’s identifying BO. To control that, these BOs are often configured to not allow new instances. Refer to [Determine the Identifying BO](#) for more information.

---

**NOTE:** To reiterate, the BO referenced in the “invoke BO” statement or referenced in an inbound web service does not have to match the identifying BO and does not have to be configured to “allow new instances”.

---

## Determine the Identifying BO

As mentioned in other topics, the identifying BO is the business object that governs the business rules for a record. This is the business object that the record will be validated against when any additions or changes are made to the record as long as updates are made via the maintenance service. This includes using “invoke BO” for add or update, using inbound web service interaction and for access to the maintenance page service (via an old style fixed page or via a business service).

How does the system determine the identifying BO? An algorithm plugged into the maintenance object (the **Determine BO** plug-in spot) is responsible for this. If the maintenance object is not configured with an algorithm for this plug-in spot, or no BO is found by the algorithm, no BO business rules are applied.

Most maintenance objects in the system capture the record’s identifying BO directly on the record. However, it is possible to define the identifying BO somewhere else. For example, there may be some maintenance objects that are master or transaction objects with an associated “type” object where the identifying BO is defined on its “type” object. Note that the standard Determine BO algorithm plugged into most maintenance objects (**F1-STD-DTMBO — Determine Standard Business Object**) checks for these two conditions.

There may also be cases where a single identifying BO is used for all BOs for a given MO. This may be an option used for some older maintenance object created prior to the business object functionality when implementations wish to introduce custom business rules that are common for all records of that MO. The product provides a base algorithm type (**F1-MOBO — Determine Specific Business Object**) that captures the BO as a parameter.

## Base Business Objects

For each maintenance object (MO) that supports an “identifying” business object, the type of business object provided by the product depends on the functionality and expected use by implementations. The following are some common patterns.

- There are MOs where the product provides base BOs that implementations may use if applicable for their business rules. In addition, it is expected that implementation will define custom BOs to support their business needs. Good examples of this type of MO are any of the various “rule” MOs. For example, calculation rule in Oracle Utilities Customer Care and Billing or the usage rule in Oracle Utilities Meter Data Management or the form rule in Oracle Public Sector Revenue Management. The product provides business objects for common rules but each implementation could have special rules that they need to implement and will need to create custom business objects.
- There are MOs where the product provides base BOs that supply common behavior for an object. Implementations may find that supplied the business objects match their business requirements and use the BOs as is. It is expected, however that for many implementations, their business rules will require additional elements to be captured or have special rules

to apply. In this case the base business objects may be extended. This scenario may apply to ‘master’ data objects in various products such as the Device or Meter or Tax Role.

- There are MOs where the product may deliver a base BO that is not expected to satisfy most implementations because different jurisdictions or different implementations will typically have their own rules. In this case the base delivered BO can be used as a template or starting point for custom defined BOs. Some examples of this are Rebate Claim in Oracle Utilities Customer Care and Billing or the Appeal object in Oracle Public Sector Revenue Management.
- There are MOs where the expectation is that every implementation will have different requirements for the type of data to capture and the product will not supply base BOs that can be used as the “identifying” BO. However, it may supply a “parent” BO that defines the lifecycle and many of the business rules that it expects all records to follow. In these scenarios, the implementations will create “child” BOs that will serve as the “identifying” BOs and refer to the base “parent” BO for many of its rules through [inheritance](#). Some examples of the are Tax Form in Oracle Public Sector Revenue Management or Activity in Oracle Utilities Mobile Workforce Management.
- There are some scenarios where the base product provides business objects and the expectation is that implementations will use the business objects as delivered with little or no customization. This is a case where the system used business objects to implement product functionality, not because there is an expectation that the implementers will extend the functionality, but because the business object model is the favored development tool even for the product. The objects delivered for Configuration Migration Assistant are an example.

---

**NOTE:** Not all maintenance objects in the product support business objects as a “identifying” or “governing” tool. This is the standard going forward for new maintenance objects. However, there are some maintenance objects created before this became a standard.

---

For all maintenance objects, the base product may provide additional BOs that are not meant to be “identifying” BOs, but instead are provided to support functionality to interact with the MO using the BO as a tool as described in [Invoking a BO](#).

- One or more “mini” or “lite” BOs may be supplied for a maintenance object. This may be found when the product has functionality to retrieve a subset of elements for the maintenance object via scripting or via a user interface.
- A “physical” BO may be supplied. This a BO that typically includes all tables and all fields of the maintenance object in there “physical” form. In other words, there is no “flattening” of child tables and any XML structure fields are defined as a single field. Physical BOs are used in system processing where the full record needs to be captured as is. Some functionality that uses a physical BO includes [bundling](#), [revision control](#) and the pre-compare algorithm for CMA to [adjust data prior to comparing](#).

## Business Object Inheritance

A business object may inherit business rules from another business object by referencing the latter as its parent. A child business object can also have children, and so on. A parent's rules automatically apply to all of its children (no compilation - it's immediate). A child business object can always introduce rules of its own but never remove or bypass an inherited rule.

The following is an illustration of multiple levels of business object inheritance.

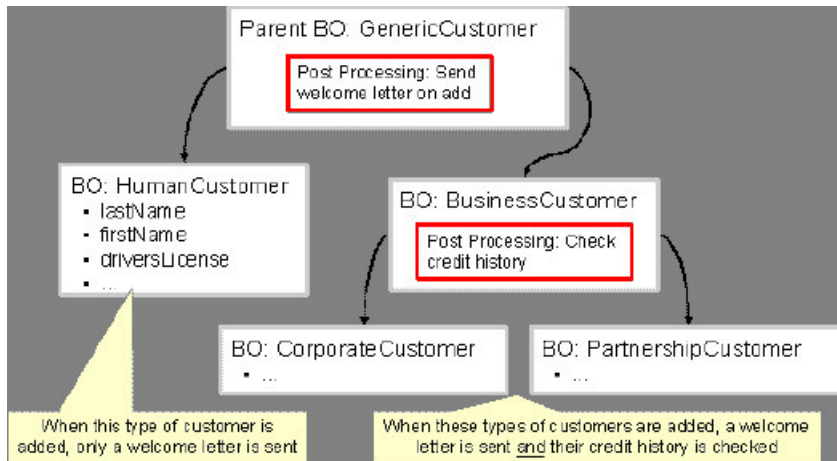

Notice how the "Business Customer" business object extends its parent rules to also enforce a credit history check on all types of customers associated with its child business objects.

Most types of business object system events allows for multiple algorithms to be executed. For example, you can have multiple **Validation** algorithms defined for a business object. For these, the system executes all algorithms at all levels in the inheritance chain starting from the highest-level parent business object moving on to lower levels.

Other types of system events allows for a single algorithm to be executed. For example, you can only have one **Information** algorithm to format the standard description of a business object instance. For these, the system executes the one at the level nearest to the business object currently being processed.

---

**NOTE:** The parent and its children must reference the same maintenance object.

---

**NOTE: Data structures are not inherited.** While you can declare schemas on parent business objects, their children will not inherit them. A good practice is to design child business object schemas to **include** their parent business object's schema.

---

**NOTE: User interface maps are inherited.** When determining if the business object has a UI map to use for UI rendering, the system looks for display and maintenance maps linked to the BO as options. If the identifying BO does not have maps defined, the system follows "up the chain" of inheritance until it finds a map to use. This allows for a child BO to be used to extend business rules of a parent BO but inherit its user interface behavior. Refer to [Business Object Defines its User Interface](#) for more information.

---

**NOTE: Use Inheritance Wisely.** While it is intellectually attractive to abstract behavior into parent BOs to avoid redundant logic and simplify maintenance, before doing this weigh the reuse benefits against the cost in transparency, as it is not easy to maintain a complex hierarchy of business objects.

---

## Each Business Object Can Have A Different Lifecycle

Many maintenance objects have a status column that holds the business entity's current state within its lifecycle. Rules that govern lifecycle state transition (e.g., what is its initial state, when can it transition to another state, etc.) and the behavior associated with each state are referred to as lifecycle rules. Older Maintenance Objects, such as To Do Entry, have predefined lifecycles whose rules are governed by the base-package and cannot be changed. The lifecycle of newer Maintenance Objects exists in business object meta-data and as such considered softly defined. This allows you to have completely different lifecycle rules for business objects belonging to the same maintenance object.

Here are examples of two business objects with different lifecycles that belong to the same maintenance object.

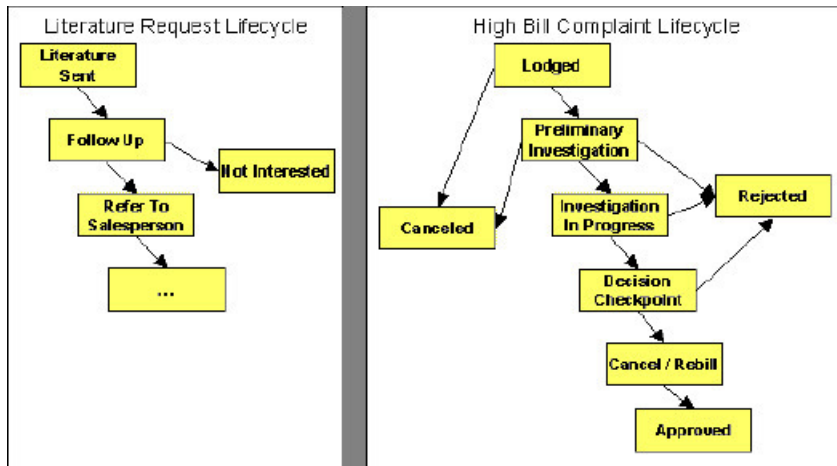

**NOTE:** A Maintenance Object supports soft lifecycle rules if it is defined with a **Status Field Maintenance Object** option.

The topics that follow describe important lifecycle oriented concepts.

## Valid States versus State Transition Rules

The boxes in the above diagram show the potential valid states a business entity of the above business object can be in. The lines between the boxes indicate the state transition rules. These rules govern the states it can move to while in a given state. For example, the above diagram indicates a high bill complaint that's in the **Lodged** state can be either **Canceled** or moved into the **Preliminary Investigation** state.

When you set up a business object, you define both its valid states and the state transition rules.

## One Initial State and Multiple Final States

When you set up lifecycle states, you must pick one as the initial state. The initial state is the state assigned to new entities associated with the business object. For example, the above high-bill complaint business object defines an initial state of **Lodged**, whereas the literature request one defines an initial state of **Literature Sent**.

You must also define which statuses are considered to be "final". Typically when an entity reaches a "final" state, its lifecycle is considered complete and no further processing is necessary.

**NOTE: Allowing An Entity To Be "Reopened".** You can set up your state transition rules to allow a business entity to be "reopened" (i.e., to be moved from a final state to a non-final state). Neither of the above examples allows this, but it is possible if you configure your business object accordingly.

## State-Specific Business Rules

For each state in a business object's lifecycle, you can define the following types of business rules.

**FASTPATH:** Refer to [BO Algorithm Execution Order](#) for a summary of when these lifecycle algorithms are executed with respect to BO level algorithms.

## Logic To Take Place When Entering A State

You can define algorithms that execute before a business entity enters a given state. For example, you could develop an algorithm that requires a cancellation reason before an entity is allowed to enter the **Canceled** state.

You can also incorporate state auto-transitioning logic within this type of algorithms. Refer to [auto-transition](#) for more information.

Also note that when a record is processed by the monitor batch program, by default the BO Post Processing, BO Audit and MO Audit algorithms are not executed. However, it is possible for an enter algorithm to indicate that the other algorithms should be executed by the batch process by setting the “force post processing” indicator to true.

## Logic To Take Place When Exiting A State

You can define algorithms that execute when a business entity exists a given state. For example, you could develop an algorithm that clears out error messages when a given entity exits the **Error** state.

Also note that when a record is processed by the monitor batch program, by default the BO Post Processing, BO Audit and MO Audit algorithms are not executed. However, it is possible for an exit algorithm to indicate that the other algorithms should be executed by the batch process by setting the “force post processing” indicator to true.

## Monitor Rules

You can define algorithms to monitor a business entity while it is in a given state. This type of logic is typically used to check if the conditions necessary to [transition](#) the entity to another state exist (and, if so, transition it). For example, transition an entity to the **Canceled** state if it's been in the **Error** state too long. Another common use is to perform ancillary work while an entity is in a given state. For example, update statistics held on the object while it's in the **Active** state.

Monitor algorithms are invoked when a business entity first enters a state and periodically after that in [batch](#). You have the option to defer the monitoring of a specific state until a specific monitoring batch job runs. You do so by associating the state with a specific monitoring process. In this case the system will only execute the monitoring rules of this state when that specific batch process runs. This is useful when processing one type of record typically creates another type of record. You may want the processing of the second set of records to be deferred to a later time.

A monitor algorithm can carry out any business logic. In addition it can optionally tell the system to do either of the following:

- Stop monitoring and transition to another state. The system will not call any further monitoring algorithm plugged in on the state and attempt to transition the entity to the requested new state.
- Stop monitoring. Same as above except that no transition takes place. You may want to use this option to prevent transitions while some condition is true.

If none of the above is requested the system keeps executing subsequent monitoring algorithms.

Also note that when a record is processed by the monitor batch program, by default the BO Post Processing, BO Audit and MO Audit algorithms are not executed. However, it is possible for a monitor algorithm to indicate that the other algorithms should be executed by the batch process by setting the “force post processing” indicator to true.

---

**FASTPATH:** Refer to [Business Object - Lifecycle](#) for more information on how to set up state-specific algorithms.

---

## Inheriting Lifecycle

If a business object references a parent business object, it always [inherits](#) its lifecycle from the highest-level business object in the hierarchy. In other words, only the highest-level parent business object can define the lifecycle and the valid



state transitions for each state. Child business objects, in all levels, may still extend the business rules for a given state by introducing their own state-specific algorithms.

The system executes all state-specific algorithms at all levels in the inheritance chain starting from the highest-level parent business object moving on to lower levels.

## Auto-Transition

In a single transition from one state to another, the system first executes the **Exit** algorithms of the current state, transitions the entity to the new state, executes the **Enter** algorithms of the new state followed by its **Monitor** algorithms. At this point if a **Monitor** algorithm determines that the entity should be further automatically transitioned to another state the remaining monitoring algorithm defined for the current state are not executed and the system initiates yet another transition cycle.

Notice that an **Enter** algorithm can also tell the system to automatically transition the entity to another state. In this case the remaining **Enter** algorithm as well as all **Monitor** algorithms defined for the current state are not executed.

The following illustration provides an example of an auto-transition chain of events.

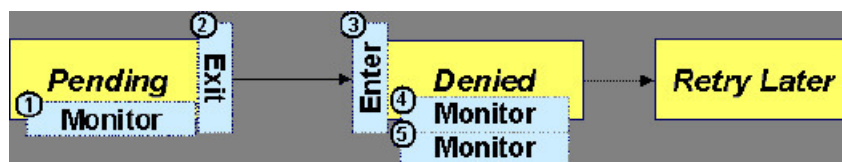

In this example a business entity is in a Pending state. While in that state a **Monitor** algorithm determines to auto-transition it to the Denied state. At this point the following takes place:

- No further **Monitor** algorithms of the Pending state are executed
- Pending state **Exit** algorithms are executed
- The system transitions the entity to the Denied state
- Denied state **Enter** algorithms are executed. No further auto-transition is requested.
- Denied state **Monitor** algorithms are executed. No further auto-transition is requested.

## Keeping An Entity In Its Last Successful State

By default, any error encountered while transitioning a business entity from one state to another rolls back all changes leaving the entity in its original state.

When applicable, the Maintenance Object can be configured to always keep an entity in its last successful state rather than rolling all the way back to the original state. This practice is often referred to as "taking save-points". In case of an error, the entity is rolled back to the last successfully entered state and the error is logged on the [maintenance object's log](#). Notice that with this approach no error is returned to the calling process, the error is just logged.

The logic to properly log the error is in a **Transition ErrorMaintenance Object plug-in**. The system considers a maintenance object to practice "save-points" when such an algorithm is plugged into it.

Even if the maintenance object practices "save-points", in case of an error the system will not keep an entity in the last successfully entered state if that state is either marked as **transitory** or one of its **Enter** algorithms has determined that the entity should proceed to a next state. The system will roll back to the first previous state that does not match these conditions.

## Monitoring Batch Processes

A monitor batch process may be used to transition a business object into its next state by executing the monitor algorithms associated with the current state of the entity. The use cases for performing the monitor logic in batch are as follows:

- The record may be waiting for something else to occur before transitioning. The monitor algorithm may be coded to determine if the condition is satisfied and initiate the transition then. For example perhaps when entering a state, a field activity is generated and the record should exit the state when the field activity is complete. The monitor algorithm can check the status of the field activity.
- Perhaps a record is added or updated manually and the next step in the BO lifecycle includes a large amount of processing such that the logic should occur in batch. In this case the BO status is configured with an explicit reference to a batch control (called a “deferred” batch control), which indicates to the system that the monitor algorithms should not be performed automatically (but should be deferred to batch). Later when the batch process runs, it selects all the records to process to progress the records.

---

**NOTE:** When a status includes a deferred batch control, it may also be configured to allow a user to manually transition the record to the next state rather than waiting for batch. When a user manually transitions a record that includes monitor algorithms, those algorithms are not executed.

---

- Perhaps a record is added or updated in batch, but a subsequent step in the overall lifecycle should be processed later. This may be accomplished by ensuring that the batch control linked to the state to process later does not match the batch control that added or updated the record.
- Monitor processes may also be used to periodically perform some logic related to the record without actually transitioning the record.

Note that only the parent business object may refer to a deferred monitor batch process. However, any business object in the “[inheritance](#)” chain may be configured with monitor algorithms, which will all be executed.

The base package provides a periodic monitoring batch process for each maintenance object that supports a configurable BO lifecycle. The process periodically executes the monitoring algorithms associated with the current state of an entity, excluding states explicitly referencing a deferred monitoring batch process that is for a different batch control.

A deferred monitoring process works in the same way except that it considers entities whose current state references this particular batch control as their monitor process in addition to records that don’t refer to any batch controls as their monitor process. Deferred monitoring is only needed when a given state should not execute its monitor algorithms immediately upon entering the state, but rather when the batch process is specifically executed.

---

**NOTE: MO option configuration.** The maintenance object includes options to indicate the batch controls delivered for periodic and deferred monitor batch controls.

---

Your business rules will dictate the execution frequency of each monitoring process and the order in which they should be scheduled. Refer to [Monitor Background Processes](#) in the background process chapter for more information about the parameters supported for this type of batch process.

---

**NOTE: Updates to the business object.** When the monitor algorithms indicate that the business object should transition, the monitor batch processes are responsible for ensuring the business object is transitioned appropriately and that the appropriate exit, enter and monitor algorithms are executed. Please note that the business object is not updated using a call to the maintenance object service and therefore by default the [business rules](#) plugged in to the business object are not executed. However, it is possible for an Enter algorithm, Exit algorithm or Monitor algorithm to indicate that the other algorithms should be executed by the batch process. If the “force post processing” indicator is set to true, then the batch process invokes the BO Post Processing, BO Audit and MO Audit algorithms.

---

## Transitory States

You can define a state as **Transitory** if you do not wish the business entity to ever exist in that particular state.

The following illustrates a lifecycle with a transitory Validate state.



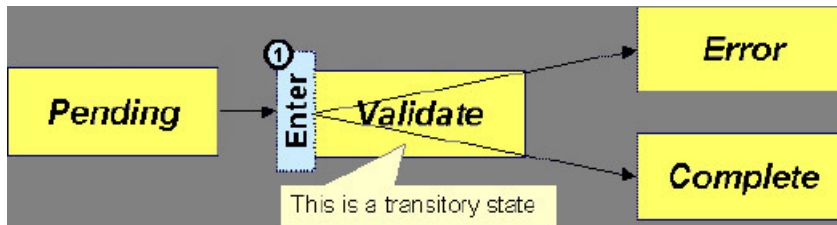

In this example, the business entity is saved still not validated in the Pending state. At some point, the user is ready to submit the entity for validation and transitions it into a transitory state **Validate** whose **Enter** rules contain the validation logic. The responsibility of the transitory state's **Enter** algorithms is to decide if the entity is valid or in error and then transitions it into the appropriate final state. In this scenario, you may not ever want the business entity to exist in the **Validate** state.

Let's also assume that the maintenance object in this example is practicing "save-points" and requires the entity to be kept in its last successful state. If an error were to occur during the transition from **Validate** to the next state, the system would roll back the entity back to Pending, and not **Validate** even though the entity has successfully entered the **Validate** state. Refer to the [Auto Transition](#) section for more information.

## State Transitions Are Audited

Most Maintenance Objects that support soft lifecycle definition also have a log to hold significant events throughout a business entity's lifecycle. For example, log entries are created to record:

- When the business entity is created (and who created it)
- When its status changes (and who changed it)
- If a transition error occurred (and the error message)
- References to other objects created throughout the entity's lifecycle. For example, if a To Do entry is created as part of processing the entity, the To Do Entry is referenced in the log.
- Manual entries added by a user (think of these as "diary" entries)

When a business entity is first created and when it transitions into a new state the system calls **Transition** algorithm(s) plugged in on the [Maintenance Object](#) to record these events. If the maintenance object supports a log these events can be captured as log entries.

---

**NOTE:** Most base package maintenance objects supporting a log may already provide state transition logging as part of their core logic. In this case you only need to provide a **Transition** plug-in if you wish to override base logging logic with your own.

---

## Required Elements Before Entering A State

You can define additional elements that are required before a business entity can enter a given state. For example, let's assume that a Cancel Reason must be defined before an object can enter the *Canceled* state. You do this by indicating that element as a **Required Element** [state-specific option](#) on the appropriate state on the business object.

## Capturing a Reason for Entering a State

Some business objects support configuring certain states to allow or require a status reason when an object enters the state. The product provides a centralized status reason table that may be used to define the valid BO status reasons for various business objects and various states. The status reasons are defined using the [Status Reason](#) portal.

The following sections provide additional information about the BO status reason functionality.

## Maintenance Object Must Support Status Reason

In order for a business object to use the centralized status reason table to define reasons, the maintenance object must first support the status reason. MOs that support status reason have the following characteristics:

- The primary table includes a column for Status Reason. This represents the status reason for the record's current status, if applicable.
- The log table includes a column for Status Reason. The standard logic for capturing a log record when entering a state also captures the status reason, if applicable. This allows a user to review the history of the changes in status and the status reason captured for a previous state transition, if applicable.
- The maintenance object option collection includes an option that defines the Status Reason field. This setting is a trigger for business objects of this MO to be able to configure states to allow or require status reason.

## Business Object State Indicates if Reasons are Applicable

Once the MO is configured to support status reason, configuration on the business object is required to indicate the states where a reason is applicable. States may be configured to require status reasons, allow status reasons as optional or not allow status reasons. With this configuration, the framework will automatically get the list of valid reasons for a state that allows or requires them and then prompt the user for a status reason when a manual state transition occurs for that state. It also automatically triggers an error if the state requires a status reason and no reason is provided.

---

**NOTE:** The status reason configuration on the business object state is customizable. That means that for a product owned business object, an implementation may opt to change the delivered configuration.

---

Status reasons are defined for the parent (or “lifecycle”) business object. All business objects in the hierarchy of the parent business object have the same valid reasons for their states.

The status reason code must be unique for the centralized status reason table. Business object and status are required fields, so it is not possible to share a common reason `code` (like “Not applicable”) across multiple business objects or states. If multiple BOs / states want to support a reason “Not applicable” then each must define a unique record for it. This point should be considered when planning for your status reasons.

## Selectable vs. Not Selectable

When defining a status reason, you may indicate whether it's **Selectable** or **Not Selectable**. When a manual transition is performed and a user is prompted for a status reason, only the **Selectable** reasons are presented. The **Not Selectable** reasons may be defined to support transitions that occur via algorithm processing.

---

**NOTE:** The Selectable setting is customizable. That means that if a product provides a base owned status reason for a business object state, an implementation may opt to change whether it is selectable or not. Careful consideration should be made before changing a base delivered status reason from **Not Selectable** to **Selectable** as this may affect base provided algorithm functionality that could be relying on the setting of **Not Selectable**.

---

## Status Reason Business Object

The status reason maintenance object, as with many maintenance objects in the product, references a business object used to define attributes and behavior related to defining status reasons. The framework provides a business object for status reason (**F1-BOStatusReason**). For the business objects that have states that require a status reason (let's call these “transactional BOs”), if there is some special logic required for defining the status reasons, it is possible to define a different status reason BO. In this situation, the override status reason BO to use for capturing status reasons should be defined as a BO option on the transactional BO using the **Status Reason Business Object** option type. If a transactional BO does not define any status reason BO option, then the **F1-BOStatusReason** is used when adding a status reason.

## Defining a Usage

The base product status reason BO provides the ability to define a “usage” value. This is useful for algorithms that perform state transitions where a status reason is needed and where the algorithm is usable by more than one business object. In this case, the status reason to use cannot be provided as a parameter because each business object must define its own set of status reasons for each state. The Usage value can be used instead. Each business object can configure the status reason to use in the algorithm and set the appropriate usage value. The algorithm can reference the usage value and retrieve the correct status reason to use based on the record’s transactional BO.

The status reason business object provided with the framework product (**F1–BOStatusReason**) supports capturing a usage. The valid usage values are defined in the **Status Reason Usage** characteristic type.

## Alternatives for Defining Reasons

There may be business objects in the system that capture reasons that are defined somewhere besides the BO status reason table. For example, some objects may have an explicit administrative table for status reasons. Some objects may use a Lookup or an Extendable Lookup to capture reasons. Refer to the business object description for information about how valid reasons are defined, if applicable.

If a business object supports a reason that is not related to a state transition (such as a creation reason), the BO status reason would not be used. One of the alternate methods for defining a reason, described above, would be used.

## BO Algorithm Execution Summary

This table highlights the processing steps that occur when adding or changing a record that is governed by a business object.

Invoke BO	
Event	Comments
BO Pre-processing algorithms executed	These algorithms are only executed when Invoke BO is used. The business object in the Invoke BO is the one whose rules are executed.
MO Processing	
Event	Comments
Determine if status has changed.	The system keeps a note of the new status value but initially proceeds with the old value.
MO Processing.	Standard MO processing, including MO validation is executed.
Determine BO algorithm executed.	The MO level algorithm is executed to <a href="#">determine the identifying BO</a> .
BO Validation algorithms executed.	
<a href="#">State transition rules</a> are performed if the status has changed.	<p>BO Status Exit algorithms for the “old” status executed.</p> <p>Status updated to the new value.</p> <p>BO Status Enter algorithms for the “new” status executed.</p> <p>If no error — MO Transition algorithms are executed.</p> <p><b>FASTPATH:</b> Refer to <a href="#">State Transitions are Audited</a> for more information.</p> <p>If error and there are “save points” the MO Transition Error algorithms are executed.</p> <p><b>FASTPATH:</b> Refer to <a href="#">Keeping An Entity In Its Last Successful State</a> for more information.</p> <p>Otherwise, the error is reported.</p>
BO Status Monitor algorithms are executed.	If the record transitions again, the prior step (State transition rule step) is repeated for the new transition.
BO Post-processing algorithms are executed.	

---

**NOTE:** To emphasize, the steps in the MO Processing table are only executed when the maintenance object service is invoked. Any add or update initiated by an “invoke BO” statement will invoke the MO service. This is also true for web service that invoke the business object. The [Monitor Batch Process](#) does not invoke the maintenance service. By default the monitor batch process only executes the monitor algorithms and the state transition rules (if the monitor algorithms indicate that a status change should occur). However, it is possible for an Enter algorithm, Exit algorithm or Monitor algorithm to indicate that the other algorithms should be executed by the batch process. If the “force post processing” indicator is set to true, then the batch process invokes the BO Post Processing, BO Audit and MO Audit algorithms.

---

**NOTE:** For records that do not have a status, the state transition rules and the monitor rules are not applicable.

---

## Granting Access To Business Objects

Every business object must reference an [application service](#). When you link a business object to an application service, you are granting all users in the group access to its instances. You can prevent users from transitioning a business object into specific states by correlating each business object status with each application service action (and then don't give the user group rights to the related action).

---

**FASTPATH:** Refer to [The Big Picture Of Application Security](#) for information about granting users access rights to an application service.

---

The system checks if a user has access rights each time the application is invoked to add, change, delete, read, or transition a business object. However, if a business object invokes another business object, we assume that access was controlled by the initial business object invocation and we do not check access for other business objects that it invokes. In other words, access rights are only checked for the initial business object invoked in a service call.

In order to apply business object security the system must be able to determine the business object associated with the actual object being processed. To do that the Maintenance Object itself has to have a **Determine BO** algorithm [plugged in](#). If this algorithm is not plugged in or it cannot determine the BO on the MO, the system will not invoke any BO rules. If the business object cannot be determined for a maintenance object instance, business object security is not checked. In this case the system checks the user's access rights using standard maintenance object security.

---

**NOTE: Parent business objects are ignored.** If a child business object exists, a user need only have access to the child business object's application service (not to every application service in the business object hierarchy).

---

## Defining Business Objects

The topics in this section describe how to maintain business objects.

Note that several context sensitive dashboard zones appear on this page and are visible on all tabs.

- **Schema Tips.** This zone provides several links to launch help topics related to valid schema syntax and UI Hint syntax in one click.
- **View UI Rendering.** This zone provides buttons to view the automatic rendering of the Display map or Input map based on the attributes defined in the schema, including UI hints.
- **Generate Schema.** This zone includes a button that can be used to generate a “physical” schema based on the maintenance object definition. The element names are taken from the Java field name for each column. Once generated, adjust the schema as desired.
- **Create a BO Algorithm.** This zone includes a button to create a script based algorithm related to this business object. You are then prompted for information regarding the plug-in spot (BO or BO Status) and the system event, the name,

description, etc. Once all the information is provided, the system creates an algorithm type, algorithm, links the algorithm to the business object, creates the script and brings you to the script step to start defining the logic for the plug-in script.

- **BOs Linked to the MO.** This zone displays other business objects for the same maintenance object as the BO currently displayed. You may drill into any of the other BOs by clicking its description.

## Business Object - Main

Use this page to define basic information about a business object. Open this page using **Admin > System > Business Object**

### Description of Page

Enter a unique **Business Object** name and **Description**. Use the **Detailed Description** to describe the purpose of this business object in detail. **Owner** indicates if this business object is owned by the base package or by your implementation (**Customer Modification**).

---

**CAUTION:** Important! If you introduce a new business object, carefully consider its naming convention. Refer to [System Data Naming Convention](#) for more information.

---

Enter the **Maintenance Object** that is used to maintain objects of this type.

Enter a **Parent Business Object** from which to [inherit](#) business rules.

**Lifecycle Business Object** is only displayed for child business objects, i.e. those that reference a parent business object. It displays the highest-level business object in the inheritance hierarchy. Refer to [Inheriting Lifecycle](#) for more information.

**Application Service** is the application service that is used to provide security for the business object. Refer to [Granting Access To Business Objects](#) for more information. The application service on the child business object must have the same valid actions as the application service on the parent business object.

Use **Instance Control** to allow or prevent new entities from referencing the business object. Typically only the [identifying BOs](#) are marked to allow new instances.

Click the **View Schema** hyperlink to view the business object's expanded schema definition. Doing this opens the [schema viewer](#) window.

Click the **View XSD** hyperlink to view the business object's expanded schema definition in XSD format.

Click the **View MO** hyperlink to view the maintenance object in the [Maintenance Object Viewer](#). You may find it useful to leave the application viewer window open while defining your business object schema.

The options grid allows you to configure the business object to support extensible options. Select the **Option Type** dropdown to define its **Value**. **Detailed Description** may display additional information on the option type. Set the **Sequence** to **1** unless the option can have more than one value. **Owner** indicates if this option is owned by the base package or by your implementation (**Customer Modification**).

---

**NOTE:** You can add new options types. Your implementation may want to add additional option types. For example, your implementation may have plug-in driven logic that would benefit from a new option. To do that, add your new values to the customizable lookup field **BUS\_OBJ\_OPT\_FLG**. If you add a new option type for a business option, you must update its maintenance object to declare this new option type. Otherwise, it won't appear on the option type dropdown. You do that by referencing the new option type as a **Valid BO Option Type**[maintenance object option](#).

---

### Where Used

Follow this link to open the data dictionary to view the tables that reference [F1\\_BUS\\_OBJ](#).

## Business Object - Schema

Use this page to maintain a business object's schema. Open this page using **Admin > System > Business Object** and then navigate to the **Schema** tab.

### Description of Page

The contents of this section describe the zones that are available on this portal.

The **General Information** zone displays main attributes of the business object.

Click the **View Schema** hyperlink to view the business object's expanded schema definition. Doing this opens the [schema viewer](#) window.

Click the **View XSD** hyperlink to view the business object's expanded schema definition in XSD format.

The [Schema Designer](#) zone allows you to edit the business object's schema. The purpose of the schema is to describe the business object's properties and map them to corresponding maintenance object fields.

---

**FASTPATH:** Refer to [Schema Syntax](#) and [UI Hint syntax](#) for a complete list of the XML nodes and attributes available to you when you construct a schema. Also note that the **Schema Tips** zone in the dashboard provides links to launch these help topics directly.

---

**NOTE: Generating a Schema** A context sensitive "Generate Schema" zone is associated with this page. The zone provides a button that allows the user to generate a basic schema that includes all the fields for all the tables for the BO's maintenance object.

---

**NOTE: View UI Rendering.** A context sensitive "View UI Rendering" zone is associated with this page. The zone is useful for [business objects that define the user interface detail](#) using schema attributes and UI Hints. The buttons allow you to view the automatically rendered display and input maps.

---

The **Schema Usage Tree** zone summarizes all cross-references to this schema. These may be other schemas, scripts, and web services. For each type of referencing entity, the [tree](#) displays a summary node showing a total count of referencing items. The summary node appears if at least one referencing item exists. Expand the node to list the referencing items and use their description to navigate to their corresponding pages.

## Business Object - Algorithms

Use this page to maintain a business object's algorithms. Open this page using **Admin > System > Business Object** and then navigate to the **Algorithms** tab.

### Description of Page

The **Algorithms** grid contains algorithms that control important functions for entities defined by this business object. You must define the following for each algorithm:

- Specify the **System Event** with which the algorithm is associated (see the table that follows for a description of all possible events).
- Specify the **Sequence Number** and **Algorithm** for each system event. You can set the **Sequence Number** to 10 unless you have a **System Event** that has multiple **Algorithms**. In this case, you need to tell the system the **Sequence** in which they should execute.
- If the algorithm is implemented as a script, a link to the **Script** is provided. Refer to [Plug-In Scripts](#) for more information.
- **Owner** indicates if this is owned by the base package or by your implementation (**Customer Modification**).

The following table describes each **System Event**. Refer to [A Business Object May Define Business Rules](#) for more information about these system events.

<b>System Event</b>	<b>Optional / Required</b>	<b>Description</b>
<b>Audit</b>	Optional	<p>Algorithms of this type may be used to audit certain changes made to business object instances.</p> <p>The system hands over to the algorithms a summary of all the elements that were changed throughout a specific call to update an object. Excluded from this processing are elements explicitly marked on the schema as requiring no audit. For each element its original value before the change as well as its new value are provided.</p> <p>It is the responsibility of the algorithms to record corresponding audit information.</p> <p>The system invokes all algorithms of this type defined on the business object's inheritance hierarchy. Refer to <a href="#">Business Object inheritance</a> for more information.</p> <p>Click <a href="#">here</a> to see the algorithm types available for this system event.</p>
<b>Information</b>	Optional	<p>We use the term "Business Object Information" to describe the basic information that appears throughout the system to describe an entity defined by the business object. The data that appears in this information description is constructed using this algorithm.</p> <p>The system invokes a single algorithm of this type. If more than one algorithm is plugged-in the system invokes the one with the greatest sequence number found on the business object closest to the current business object in the inheritance hierarchy. Refer to <a href="#">Business Object inheritance</a> for more information.</p> <p>Click <a href="#">here</a> to see the algorithm types available for this system event.</p>
<b>Post-Processing</b>	Optional	<p>Algorithms of this type may be used to perform additional business logic after a business object instance has been processed.</p> <p>The system invokes all algorithms of this type defined on the business object's inheritance hierarchy. Refer to <a href="#">Business Object inheritance</a> for more information.</p> <p>Click <a href="#">here</a> to see the algorithm types available for this system event.</p>
<b>Pre-Processing</b>	Optional	<p>Algorithms of this type further populates a request to maintain a business object instance right before it is processed.</p> <p>The system invokes all algorithms of this type defined on the business object's inheritance hierarchy. Refer to <a href="#">Business Object inheritance</a> for more information.</p> <p>Click <a href="#">here</a> to see the algorithm types available for this system event.</p>
<b>Validation</b>	Optional	<p>Algorithms of this type may be used to validate a business object instance when added, updated or deleted.</p> <p>The system invokes all algorithms of this type defined on the business object's inheritance hierarchy. Refer to <a href="#">Business Object inheritance</a> for more information.</p>



System Event	Optional / Required	Description
		Click <a href="#">here</a> to see the algorithm types available for this system event.
<b>FASTPATH:</b> Refer to <a href="#">BO Algorithm Execution Summary</a> for more information about how these algorithms fit within the business object processing.		
<b>NOTE: Generate Algorithm.</b> A context sensitive "Generate a BO Algorithm" zone is associated with this page. Refer to <a href="#">Defining Business Objects</a> for more information about this zone.		
<b>NOTE: You can add new system events.</b> Your implementation may want to add additional business object oriented system events. For example, your implementation may have plug-in driven logic that would benefit from a new system event. To do that, add your new values to the customizable lookup field <b>BO_SEVT_FLG</b> . If you add a new business object system event, you must update the maintenance object to declare this new system event. Otherwise, it won't appear on the system event dropdown. You do that by referencing the new system event as a <b>Valid BO System Event maintenance object option</b> .		
<b>NOTE: You can inactivate algorithms on base Business Objects.</b> Your implementation may want to use a business object provided by the base product, but may want to inactivate one or more algorithms provided by the base business object. To do that, on the business object where this algorithm is referenced, go to the options grid on Business Object - Main and add a new option, setting the option type to <b>Inactive Algorithm</b> and setting the option value to the algorithm code.		

## Business Object - Lifecycle

Use this page to maintain a business object's lifecycle oriented business rules and options. Open this page using **Admin > System > Business Object** and then navigate to the **Lifecycle** tab.

### Description of Page

The **Status** accordion contains an entry for every status in the object's [lifecycle](#). The entry appears differently for a child business object as it can only extend its inherited lifecycle by introducing algorithms and options of its own.

Use **Status** to define the unique identifier of the status. This is not the status's description, it is simply the unique identifier used by the system. Only the highest-level business object can define lifecycle statuses. For a child business object the inherited status description is displayed allowing navigation to the corresponding entry on the business object defining the lifecycle.

Use **Description** to define the label of the status. This field is hidden for a child business object.

Use **Access Mode** to define the action associated with this status. Refer to [Access Rights](#) for the details of how to use this field to restrict which users can transition a business entity into this state. This field is hidden for a child business object.

Enter a **Monitor Process** to defer the monitoring of entities in this state until the specific batch process runs. Refer to [Monitor Rules](#) for more information. This field is hidden for a child business object.

The **Status Reason** dropdown indicates if users should be prompted to provide a specific reason when the business object enters this state. This field appears only if the Status Reason Field is configured as an option on the business object's maintenance object. Valid values are blank, **Optional**, and **Required**. The default value is blank (users are not prompted to provide a status reason). See [Configuring Status Reasons](#) for more information about status reasons.

Use **Status Condition** to define if this status is an **Initial**, **Interim** or **Final** state. Refer to [One Initial State and Multiple Final States](#) for more information about how this field is used. This field is hidden for a child business object.

Use **Transitory State** to indicate whether a business entity should ever exist in this state. Only **Initial** or **Interim** states can have a transitory state value of **No**. Refer to [transitory states](#) for more information. This field is hidden for a child business object.



Use **Alert Flag** to indicate that being in this state warrants an application alert. This may be used by custom logic to provide an alert to a user that entities exist in this state. This field is hidden for a child business object.

Use **Display Sequence** to define the relative order of this status for display purposes. For example when displayed on the status accordion and on the summary tab page. This field is hidden for a child business object.

## Algorithms

The **Algorithms** grid contains algorithms that control important functions for a given status. You must define the following for each algorithm:

- Specify the **System Event** with which the algorithm is associated (see the table that follows for a description of all possible events).
- Specify the **Sequence Number** and **Algorithm** for each system event. You can set the **Sequence Number** to 10 unless you have a **System Event** that has multiple **Algorithms**. In this case, you need to tell the system the **Sequence** in which they should execute.
- If the algorithm is implemented as a script, a link to the **Script** is provided. Refer to [Plug-In Scripts](#) for more information.
- **Owner** indicates if this is owned by the base package or by your implementation (**Customer Modification**).

The following table describes each **System Event**.

System Event	Optional / Required	Description
Enter	Optional	<p>Algorithms of this type apply business rules when a business object instance enters a given state.</p> <p>The system invokes all algorithms of this type defined on the business object's inheritance hierarchy. Refer to <a href="#">Business Object Inheritance</a> for more information.</p> <p>Click <a href="#">here</a> to see the algorithm types available for this system event.</p>
Exit	Optional	<p>Algorithms of this type apply business rules when a business object instance exits a given state.</p> <p>The system invokes all algorithms of this type defined on the business object's inheritance hierarchy. Refer to <a href="#">Business Object Inheritance</a> for more information.</p> <p>Click <a href="#">here</a> to see the algorithm types available for this system event.</p>
Monitor	Optional	<p>Algorithms of this type monitor a business object instance while in a given state. Typically these are used to auto-transition it to another state.</p> <p>The system invokes all algorithms of this type defined on the business object's inheritance hierarchy. Refer to <a href="#">Business Object Inheritance</a> for more information.</p> <p>Click <a href="#">here</a> to see the algorithm types available for this system event.</p>

**FASTPATH:** Refer to [BO Algorithm Execution Summary](#) for more information about how these algorithms fit within other business object algorithms.

**NOTE: Generate Algorithm.** A context sensitive "Generate a BO Algorithm" zone is associated with this page. Refer to [Defining Business Objects](#) for more information about this zone.

---

**NOTE: You can inactivate status level algorithms on base Business Objects.** Your implementation may want to use a business object provided by the base product, but may want to inactivate one or more of the status oriented algorithms provided by the base business object. To do that, on the business object and status where this algorithm is referenced, go to the options grid and add a new option, setting the option type to **Inactive Algorithm** and setting the option value to the algorithm code.

---

## Next Statuses

Use the **Next Statuses** grid to define the valid statuses a business entity can transition into while it's in this state. This section is hidden for a child business object. Refer to [Valid States versus State Transition Rules](#) for more information. Please note the following about this grid:

- **Status** shows the statuses for the top-level business object, the **Status Code**, the **Lifecycle BO description**, and the **Status description** for each status.
- Use **Action Label** to indicate the verbiage to display on the button used to transition to this status.
- **Sequence** controls the relative order of one status compared to others for display purposes. This information may be used to control the order in which buttons are presented on a user interface.
- **Default** controls which next state (if any) is the default one. This information may be used by an **Enter** or **Monitor** algorithm to determine an auto-transition to the default state. It may also be used to also mark the associated button as the default one on a user interface.
- **Transition Condition** may be configured to identify a common transition path from the current state. By associating a given "next status" with a transition condition value, you can design your auto-transition rules to utilize those flag values without specifying a status particular to a given business object. Thus, similar logic may be used across a range of business objects to transition a business entity into, for example, the next **Ok** state for its current state. You'll need to add your values to the customizable lookup field **BO\_TR\_COND\_FLG**.
- **Transition Role** controls whether only the **System** or both **System and User** have the ability to transition a business entity into a given "next status".
- When you initially set up a business object lifecycle, none of the statuses will reside on the database and therefore you can't use the search to define a "next status". We recommend working as follows to facilitate the definition of this information:
  - Leave the Next Statuses grid blank when you initially define a business object's statuses
  - After all statuses have been saved on the database, update each status to define its Next Statuses (this way, you can use the search to select the status).

## Options

The options grid allows you to configure the business object status to support extensible options. Select the **Option Type** drop-down to define its **Value**. **Detailed Description** may display additional information on the option type. Set the **Sequence** to **1** unless the option can have more than one value. **Owner** indicates if this option is owned by the base package or by your implementation (**Customer Modification**).

---

**NOTE: You can add new options types.** Your implementation may want to add additional option types. For example, your implementation may have plug-in driven logic that would benefit from a new option. To do that, add your new values to the customizable lookup field **BO\_OPT\_FLG**. If you add a new option type for a status, you must update the business object's maintenance object to declare this new option type. Otherwise, it won't appear on the option type dropdown. You do that by referencing the new option type as a **Valid BO Status Option Type** [maintenance object option](#).

---

## Business Object - Summary

This page summarizes business object information in a high level. Open this page using **Admin > System > Business Object > Search** and then navigate to the **Summary** tab.

### Description of Page

The contents of this section describe the zones that are available on this portal.

The **General Information** zone displays main attributes of the business object.

Click the **View Schema** hyperlink to view the business object's expanded schema definition. Doing this opens the [schema viewer](#) window.

Click the **View XSD** hyperlink to view the business object's expanded schema definition in XSD format.

The **Business Object Hierarchy** zone displays in a tree view format the [hierarchy](#) of child business object associated with the current business object. It also shows the current business object's immediate parent business object.

For business objects with a lifecycle, the **Lifecycle Display** zone shows a graphical depiction of the lifecycle. Refer to the embedded help of that zone for more information.

The **Options** zone summarizes business object and state specific options throughout the [inheritance](#) chain.

The **Rules** zone summarizes business object and state specific rules throughout the [inheritance](#) chain.

## Advanced BO Tips and Techniques

The topics in this section describe some advanced tips and techniques for configuring business objects.

## Managing To Do Entries

The product provides several base algorithm types that may be used to manage To Do entries through status changes for a given record via BO lifecycle plug-ins.

### Create To Do Entry

The product supplies a BO status Enter algorithm type **Generic To Do Creation (F1-TDCREATE)** that creates a To Do entry based on parameter configuration. Refer to the algorithm type description for more information about how it determines the To Do type or To Do role and how to populate the appropriate message text onto the To Do. This algorithm may be used in conjunction with the Retry Logic (below).

If your implementation has a business rule that requires a To Do entry to be created when entering a given BO status and the logic provided by the algorithm type meets the needs of the business rule, this algorithm type may be used. Create an algorithm for the algorithm type, populate the algorithm parameters according to the business rules and plug the new algorithm into the appropriate business object status as an Enter algorithm.

### Retry Logic

The algorithm type **Retry for To Dos (F1-TODORETRY)** is supplied for a special use case. It is a BO status monitor plug-in and may be used for a state that is a type of 'error' or 'waiting' state. It relies on the To Do entry creation logic to set a Retry Frequency. The algorithm transitions to the originating state to retry the logic. The idea is that the condition that caused the record to enter the 'error' or 'waiting' state may be resolved after some period of time has passed, allowing the record to progress in its lifecycle. Refer to the algorithm type description for more information about its logic.

To use this functionality, create an algorithm for this algorithm type, populate the algorithm parameters according to the business rules and plug the new algorithm into the appropriate business object status as a Monitor algorithm. The

state should also have an algorithm for the **Generic To Do Creation** algorithm type plugged in as an Enter algorithm (or something equivalent) that sets the appropriate Retry Frequency.

## To Do Completion

It is common that one or more To Do entries associate with a given record should be completed when exiting a state (if it is not already completed). The system supplies the algorithm type **Generic To Do Completion (F1-TODOCOMPL)** that may be used for this purpose. Note that the algorithm type functionality is not tied to any To Do creation logic. It may be used for any use case where To Do entries should be completed on exiting a state. Refer to the algorithm type description for more information about its functionality and how to prevent certain To Do entries from being automatically completed.

To use this functionality, create an algorithm for this algorithm type, populate the algorithm parameters according to the business rules and plug the new algorithm into the appropriate business object status as an Exit algorithm.

## Submitting a Batch Job

The product provides a base algorithm type that submits a batch job when entering a BO state. This functionality allows for “event driven” batch submission where the event is the lifecycle transition for a certain record.

The algorithm type is **Create Batch Job Submission Entry for Batch Control (F1-SCHEDJOB)**. The batch control code is a parameter for the algorithm. Refer to the algorithm type description for more information about its logic.

To use this functionality, create an algorithm for this algorithm type, populate the algorithm parameter with the batch control that should be submitted and plug the new algorithm into the appropriate business object status as an Enter algorithm.

## Defining Status Reasons

Status Reasons are used to provide more information about why a business object transitioned to a given state. The status reason table provides a centralized place where status reasons can be defined across many different business objects and states.

---

**NOTE:** Refer to [Defining Reasons for Entering a State](#) for overview information.

---

If a business object has one or more states that are configured to capture a status reason, you may configure the valid reasons by navigating to the status reason portal using **Admin > System > Status Reason**.

The topics in this section describe the base-package zones that appear on the Status Reason portal.

### Business Objects with Status Reason List

This zone displays the business objects that have one or more status values that allow status reasons to be defined.

Click the broadcast icon to open other zones that contain more information about the business object’s status reasons.

### Status Reasons

The **Status Reasons** zone contains a list of the existing status reasons for the broadcasted business object.

## Business Services

A business service is used to expose a back-end service so that it may be invoked by a script or a zone or a map to retrieve information or perform functions, depending on the related service.

As with the business object, the business service’s interface to the internal service is defined using its schema. The schema maps the business service’s elements to the corresponding elements in the internal service program’s XML document. Just as

a business object can simplify the schema of its maintenance object by only defining elements that it needs and “flattening” entries in a child collection to be defined as a singular element, a business service schema may simplify its service XML in a similar way.

---

**FASTPATH:** Refer to [Schema Syntax](#) for a complete list of the XML nodes and attributes available to you when you construct a schema.

---

[Inbound web services](#) and [scripts](#) support interaction with business services. You can also invoke a business service from a Java class.

## Service Program

This transaction defines services available in the system. These include user interface services as well as stand-alone services that perform a specific function. A service may be referenced by a business service. Use this transaction to view existing service and introduce a new stand-alone service to be made available to a Business Service.

Select **Admin > System > Service Program** to maintain service programs.

### Description of Page

**Service Name** is the unique identifier of the service.

---

**CAUTION:** Important! When adding new service programs, carefully consider its naming convention. Refer to [System Data Naming Convention](#) for more information.

---

**Owner** indicates if this service is owned by the base package or by your implementation (**Customer Modification**). The system sets the owner to **Customer Modification** when you add a service. This information is display-only.

**Description** describes the service.

**Service Type** indicates whether the service is a **Java Based Service** or a **Java (Converted) Service**.

This **Program Component** grid shows the list of program user interface components associated with the service. For a stand-alone service, this list is typically not applicable.

### Where Used

Follow this link to open the data dictionary where you can view the tables that reference [CI\\_MD\\_SVC](#).

## Defining Business Services

The topics in this section describe how to maintain business services.

Note that several context sensitive dashboard zones appear on this page and are visible on all tabs.

- **Schema Tips.** This zone provides several links to launch help topics related to valid schema syntax.
- **Generate Schema.** This zone includes a button that can be used to generate the schema based on the XML of its related Service. Once generated, adjust the schema as desired.

## Business Service - Main

Use this page to define basic information about a Business Service. Open this page using **Admin > System > Business Service**

### Description of Page

Enter a unique **Business Service** name and **Description**. Use the **Detailed Description** to describe the purpose of this business service in detail. **Owner** indicates if the business service is owned by the base package or by your implementation (**Customer Modification**).

---

**CAUTION:** Important! If you introduce a new business service, carefully consider its naming convention. Refer to [System Data Naming Convention](#) for more information.

---

Enter the internal **Service Name** being called when this business service is invoked.

Enter the **Application Service** that is used to provide security for the business service. The application service must have an Access Mode of Execute.

Click the **View Schema** to view the business service's expanded schema definition. Doing this opens the [schema viewer](#) window.

Click the **View XSD** hyperlink to view the business object's expanded schema definition in XSD format.

Click the **View XML** hyperlink to view the XML document used to pass data to and from the service in the [Service XML Viewer](#). You may find it useful to leave the application viewer window open while defining your business service schema.

---

**NOTE:** XML document may not be viewable. If you create a new service program and do not regenerate the application viewer, you will not be able to view its XML document.

---

### Where Used

Follow this link to open the data dictionary to view the tables that reference [FI\\_BUS\\_SVC](#).

## Business Service - Schema

Use this page to maintain a Business Service's schema and to see where the Business Service is used in the system. Open this page using **Admin > System > Business Service** and then navigate to the **Schema** tab.

### Description of Page

The contents of this section describe the zones that are available on this portal.

The **General Information** zone displays main attributes of the business service.

The [Schema Designer](#) zone allows you to edit the business service's schema. The purpose of the schema is to map the business service's elements to the corresponding fields of the back-end service program it rides on.

---

**NOTE: Generating a Schema** A context sensitive "Generate Schema" zone is associated with this page. The zone provides a button that allows the user to generate a basic schema that includes all the elements that are found in the XML of the BS's service.

---

---

**FASTPATH:** Refer to [Schema Syntax](#) for a complete list of the XML nodes and attributes available to you when you construct a schema. Also note that the **Schema Tips** zone in the dashboard provides a link to launch this help topic directly.

---

The **Schema Usage Tree** zone summarizes all cross-references to this schema. These may be other schemas, scripts, and web services. For each type of referencing entity, the [tree](#) displays a summary node showing a total count of referencing items. The summary node appears if at least one referencing item exists. Expand the node to list the referencing items and use their description to navigate to their corresponding pages.

## Useful Services and Business Services

The following section highlights some business services and services provided by the product that may be useful for implementations to use.

### Data Explorer Service

The system provides a mechanism for performing an SQL select statement for use in scripting, Java plug-ins, or via a web service call. This is done by creating a zone using one of the data explorer zone types where the SQL is defined. Then, create a business service using the Data Explorer service (**FWLZDEXP**).

---

**NOTE:** There are numerous business services delivered with the base product that reference this service that may be used as a template.

---

The following points highlight how to create your own business service for this service. Note that typically a separate business service exists for each zone.

- Enter a **Business Service** code and a **Description**. It is recommended to define the business service code to match the zone code so that it's easier to manage which business service invokes which zone.
- Select the **Service Name**FWLZDEXP.
- On the **Schema** tab, under the *<schema>* node, enter mapping for the fields that are required for the Data Explorer service:
  - The **Zone** should be mapped into service field **ZONE\_CD** . Define the zone code as the default value.
  - For every **user filter** defined on the zone, create a schema mapping into the service field **Fx\_VALUE**, where "x" is the filter number (from the zone parameters).
  - For every **hidden filter** defined on the zone, create a mapping into the service field **Hx\_VALUE**, where "x" is the filter number (from the zone parameters).
  - The search results are returned as a list by the data explorer service. Each column value is in the service field **COL\_VALUE** with an appropriate sequence number (**SEQNO**). The results can be **flattened** based on sequence number allowing for a logical element name to be defined.
  - Another useful field is **ROW\_CNT**, which provides the number of rows retrieved by your search.

The following is an example of the schema for a BS that receives a business object code and returns a list of status values and their descriptions that allow status reasons to be defined.

```
<schema>
  <zone mapField="ZONE_CD" default="F1-BOSTSLST" />
  <bo mapField="H1_VALUE" />
  <rowCount mapField="ROW_CNT" />
  <results type="list" mapList="DE">
    <status dataType="string" mapField="COL_VALUE">
      <row mapList="DE_VAL">
        <SEQNO is="1" />
      </row>
    </status>
    <description dataType="string" mapField="COL_VALUE">
      <row mapList="DE_VAL">
        <SEQNO is="2" />
      </row>
    </description>
  </results>
</schema>
```

## Maintenance Object Log Service

Many maintenance objects support a log table that follows a pattern of column names and behavior. The system provides a service called Generic MO Log Service (**F1MOLOGP**) that may be used to perform common functions related to log entries:

- Read log entries. If you pass a certain MO, primary key and log sequence number, the service will return the details of that log entry. The product provides a generic business service that may be used for this purpose — Generic MO - Retrieve Log Details (**F1-ReadMOLog**). Alternatively, it is possible to create a business service for a given MO where the MO code is assigned to the MO element using the default syntax. This allows business functionality specific to that maintenance object to use the specific BS.
- Add log. The service may be used to add a log entry. If a user log is added, then the comments from the user are populated in the detailed description. System generated log entries typically supply a message category / message number along with other information such as the status, a specific log type and optionally a related object reference (via a characteristic). The product provides a generic business service that may be used for this purpose — Add Generic MO Log (**F1-AddMOLog**). Alternatively, it is possible to create a business service for a given MO where the MO code is assigned to the MO element using the default syntax. This allows business functionality specific to that maintenance object to use the specific BS.

## Base Business Services

The following table highlights some business services provided by the product that may be useful for custom logic for an implementation.

---

**CAUTION:** This is not intended to be a complete reference of Business Services. Refer to the business service page to find all the supported business services.

---

## Business Object Related Services

Business Service Name	Description
F1-AutoTransitionBO	Performs monitoring algorithms associated with the current state of a given business object instance (which may result in subsequent state transitioning).
F1-CompareBusinessObjectData	Compares two versions of a given business object instance.
F1-DetermineBo	Determines the business object of a given instance of a maintenance object by executing the MO's Determine BO logic.
F1-GetRequiredFieldsForBOState	Returns the required fields for a given business object status.
F1-RetrieveBOOption	Returns BO option values for a given BO and option type.
F1-RetrieveBOStatusOption	Returns BO option values for a given BO, status and option type.
F1-RetrieveBOStatusOption	Retrieves a list of BOs for a given MO that are accessible for the current user.
F1-RetrieveBoStatusDescription	Return the description of a given BO status.
F1-RetrieveBusinessObjectLabel	Return the label appropriate for a given path (e.g. element) within a BO schema.
F1-RetrieveNextStates	Return a list of next possible states based on the input of a MO and its prime key, or a BO and one of its statuses.



## Email Related Services

Business Service Name	Description
F1-EmailService	Sends an email message in real time.
F1-RetrieveEmailAddress	Retrieves the email addresses of users belonging to a To Do Role.
F1-RetrieveEnvironmentURL	Retrieves the current environment URL information for the installation.

## Tools for Maps and Scripting

Business Service Name	Description
F1-DateMath	Performs various date and time math calculations. Refer to the BS description for more details.
F1-DateTimeFormattingService	Formats a given date / time based on the user's display profile settings.
F1-ExecuteScriptInNewSession	Executes a Service Script in a new processing session/transaction.
F1-GetFieldLabel	Retrieves the label for a given field.
F1-GetForeignKeyReference	Returns foreign key reference information for a given FK Reference and primary key, including info description, navigation option, and context menu.
F1-GetFKReferenceDetails	Returns foreign key reference information for a given MO and primary key, including FK reference code, info description, navigation option, search zone and context menu.
F1-GetLookupDescription	Returns lookup description for a lookup field value given the lookup field name.
F1-GetExtLookUpVal	Returns the list of values for a given extendable lookup BO.
F1-GetMonthInYearAbbreviation	Returns a 3-character month abbreviation for an input date in system format.
F1-NumberAmountFormatter	Formats a given amount or number based on the user's display profile settings. It also may receive input to adjust the scale and optionally apply currency settings.
F1-OutmsgDispatcher	Dispatches a real-time message giving the user the option of whether to persist the message on the database, and whether to trap errors that may take place during the call.
F1-RethrowError	Issues an application error using the input message category / number / parameters.
F1-RetrieveMODescription	Retrieves the description for a maintenance object.
F1-ReturnMessage	Returns the expanded message given a message category, number, parameters, and parameter types.
F1-SavePointDispatcher	Allows for a service script to be executed where exceptions are trapped and the transaction is rolled back to a save point set before the service script execution.

## User Related Services

Business Service Name	Comments
F1-CheckApplicationSecurity	Checks a user's security for a given application service / access mode
F1-CheckUserAuthorization	Determine whether a given user is authorized for access based on the input application service, security code, and authorization level.
F1-DeterminelfUserCanApproveTD	Determine if the current user can approve a given To Do.

## User Interface (UI) Maps

The User Interface (UI) map holds HTML to be rendered within [portal zones](#) and [Business Process Assistant \(BPA\) scripts](#). UI maps allow your implementation to create input forms and output maps that closely match your customer's business practices. In other words, the UI Map is designed to facilitate the capture and display of your [business objects](#) and [business services](#).

The UI map is a repository for a single HTML document paired with an XML schema where the schema defines the data that the HTML document displays and/or modifies. The UI Map HTML gives you the ability to craft the display by any method that an html document can support, including JavaScript and full CSS functionality.

Configuration tool support for UI Maps hinges around the ability to inject and extract an XML document from the HTML. For more information on the specialized support for HTML and JavaScript functionality refer to [UI Map Attributes and Functions](#).

```

<html>
<head>
<title>Output Personal Information</title>
<link rel="stylesheet" type="text/css" href="cm_templates/cmStyles.css"/>
</head>
<body>

<table width="100%" border="0" cellpadding="2" style="margin-top:15px;" >

  <tr>
    <td/>
    <td/> <!-- locate the edit button on the bottom of the third column -->
    <td rowspan="99" style="vertical-align:bottom; margin-left:5px">
      <input type="button" value="edit" onClick="oraRunScript('HumanInfoU','personId');"/>
    </td>
  </tr>

  <tr>
    <td class="outputLabel">Name:</td>
    <td><span oraField="name" class="outputData"></span></td>
  </tr>
  <tr>
    <td class="outputLabel">Home Phone:</td>
    <td><span oraField="homePhone" class="outputData"></span></td>
  </tr>
  <tr>
    <td class="outputLabel">Business Phone:</td>
    <td><span oraField="businessPhone" class="outputData"></span></td>
  </tr>
  <tr>
    <td class="outputLabel">Cell Phone:</td>
    <td><span oraField="cellPhone" class="outputData"></span></td>
  </tr>
  <tr>
    <td class="outputLabel">FAX:</td>
    <td><span oraField="fax" class="outputData"></span></td>
  </tr>
  <tr>
    <td class="outputLabel">Social Security:</td>
    <td><span oraField="socialSecurity" class="outputData"></span></td>
  </tr>
  <tr>
    <td class="outputLabel">Drivers License:</td>
    <td><span oraField="driversLicense" class="outputData"></span></td>
  </tr>
  <tr>
    <td class="outputLabel">Email:</td>
    <td><span oraField="email" class="outputData"></span></td>
  </tr>

</table>

</body>

<xml>
<root>
  <name>Greer, Johan</name>
  <email>jurgen.greer@media.com</email>
  <socialSecurity>939-30-3939</socialSecurity>
  <driversLicense>C8392020</driversLicense>
  <homePhone>(838) 030-0303</homePhone>
  <cellPhone>(444) 444-4040</cellPhone>
  <businessPhone>(737) 393-3838</businessPhone>
  <fax>(373) 939-3939</fax>
  <personId>1239997654</personId>
</root>
</xml>
</html>

```

Figure 1: HTML to Display Customer Business Object

Name:	<b>Greer, Johan</b>	
Home Phone:	<b>(838) 030-0303</b>	
Business Phone:	<b>(737) 393-3838</b>	
Cell Phone:	<b>(444) 444-4040</b>	
FAX:	<b>(373) 939-3939</b>	
Social Security:	<b>939-30-3939</b>	
Drivers License:	<b>C8392020</b>	
Email:	<b>jurgen.greer@media.com</b>	<input type="button" value="edit"/>

Figure 2: Customer HTML Rendered (Output Data for Zone)

UI maps are typically crafted as output tables when used in conjunction with portal zones - please refer to [Map Zones](#) for more information. When referenced within [BPA scripts](#), UI maps are typically crafted as forms for the capture and update of data.

**Edit Personal Information**

[err](#)

**Name:** Greer,Johan  
Last-name suffix, prefix first-name middle-name/initial

**Home Phone:** 838 030 0303

**Business Phone:** 737 393 3838

**Cell Phone:** 444 444 4040

**FAX:** 373 939 3939

**Social Security:** 939 30 3939

**Drivers License:** C8392020

**Email:** jürgen.greer@media.com

Figure 3: HTML Input Form Rendered (for BPA Script)

Portal zones can reference a UI map for the zone header. They may also utilize a UI map to define their filter area. This type of UI map is not a complete HTML document, but is instead configured as a UI Map "fragment".

---

**NOTE:** UI Map Tips. A context sensitive "UI Map Tips" zone is visible on the UI map maintenance page. This zone provides several links to launch help topics related to valid schema syntax and UI Hint syntax in one click.

---

**NOTE:** Editing HTML. You can use a variety of HTML editors to compose your HTML, which you can then cut, and paste into your UI map. In addition, the zone provides a complete list of the XML schema nodes and attributes available to you when you construct the map's data schema.

---

## Defining UI Maps

The topics in this section describe how to maintain UI Maps.

### UI Map - Main

Use this page to define basic information about a user interface (UI) Map. Open this page using **Admin > System > UI Map**

#### Description of Page

Enter a unique **Map** name. **Owner** indicates if the UI map is owned by the base package or by your implementation (**Customer Modification**).

---

**CAUTION:** Important! If you introduce a new UI map, carefully consider its naming convention. Refer to [System Data Naming Convention](#) for more information.

---

Use **UI Map Type** to indicate whether the map is a **Complete HTML Document** or an **HTML Fragment**. Portal zones can reference a UI map to describe a fragment of their HTML, for example the zone header or filter area. In this case the UI map is not a complete HTML document, but is instead configured as a UI Map "fragment".

Enter a **Description**. Use the **Detailed Description** to describe how this map is used in detail.

Click on the **View Schema** to view the UI map's expanded schema definition. Doing this opens the [schema viewer](#) window.

Use the **Test UI Map** hyperlink to render your html in a test window.

---

**NOTE:** The **Test UI Map** hyperlink also exercises the proprietary functionality that binds an xml element with an html element so you can get immediate feedback on your html syntax.

---

### Where Used

Follow this link to open the data dictionary to view the tables that reference [FI\\_MAP](#).

## UI Map - Schema

Use this page to maintain a UI Map's HTML and schema and to see where the UI Map is used in the system. Open this page using **Admin > System > UI Map** and then navigate to the **Schema** tab.

### Description of Page

The contents of this section describe the zones that are available on this portal.

The **General Information** zone displays main attributes of the UI Map.

The **HTML Editor** zone allows you to edit the HTML document of the map.

---

**NOTE:** Refer to [UI Map Attributes and Functions](#) and [UI Map Standards](#) for more information about HTML definition syntax. These topics describe good ways to produce simple HTML, however, they are not an HTML reference. Note that you can use a variety of HTML editors to compose your HTML, which you can then cut and paste into your UI map.

---

---

**NOTE: Providing Help.** A [tool tip](#) can be used to display additional help information to the user. This applies to section elements as well as individual elements on a map. Refer to [UI Map Attributes and Functions](#) for more information on how to enable and provide UI map help.

---

The [Schema Designer](#) zone allows you to edit the data schema part of the map. The purpose of the schema is to describe the data elements being displayed by the map.

---

**FASTPATH:** Refer to [Schema Syntax](#) for a complete list of the XML nodes and attributes available to you when you construct a schema. Also note that the **UI Map Tips** zone in the dashboard provides a link to launch this help topic directly.

---

The **Schema Usage Tree** zone summarizes all cross-references to this schema. These may be other schemas, scripts, and web services. For each type of referencing entity, the [tree](#) displays a summary node showing a total count of referencing items. The summary node appears if at least one referencing item exists. Expand the node to list the referencing items and use their description to navigate to their corresponding pages.

# UI Map Attributes and Functions

**NOTE:** This topic uses the term "field" to refer to both the generic concept of displaying and capturing data in a 'field' as well as referring to the meta-data object supplied in the product to define [Fields](#). When referring to the latter, the term "MD Field" (meta-data Field) is used and a hyperlink to the Field documentation is provided.

## Contents

- [Bind XML to HTML](#)
- [Build a Dropdown List](#)
- [Format Input and Output Fields](#)
- [Display Labels](#)
- [Enable UI Map Help](#)
- [Search Using a Pop-Up Explorer Zone](#)
- [Display Errors](#)
- [Fire JavaScript for Browser Events](#)
- [Hide Elements](#)
- [Invoke Schema Based Services](#)
- [Refresh a Rendered Map or Portal Page](#)
- [Embed Framework Navigation](#)
- [Launch BPA Script](#)
- [Exit UI Map with Bound Values](#)
- [Include a Map Fragment](#)
- [Show Schema Default on Add](#)
- [Configure a Chart](#)
- [Upload and Download a CSV File](#)
- [Construct Portal Zone Map Fragments](#)
- [Required JavaScript Libraries](#)

## Bind XML to HTML

Only two different attributes are required to bind a UI Map's XML to its HTML. Both of these attributes require an XML document embedded within the HTML, where the XML is bounded by <xml> nodes.

**WARNING:** You must embed a pair of <xml></xml> tags within your HTML document for binding to occur.

## Linking a Field

Syntax	Values	Description
oraField=" "	Field element XPath	This attribute is used to link an HTML element directly with an XML element, where the XML element is defined within the UI Map's XML schema. The attribute can be used with any <i>rendering</i> HTML element, such as: <span>, <div>, and <input>.

- HTML for input element:

```
<html>
<body>
<table>
  <tr>
    <td>Address:</td>
    <td><input type="text" oraField="address"/></td>
  </tr>
</table>
</body>
</html>
```

```

    <tr>
        <td>City:</td>
        <td><input type="text" oraField="city"/></td>
    </tr>
    <tr>
        <td>State:</td>
        <td><input type="text" oraField="state"/></td>
    </tr>
    <tr>
        <td>Zip:</td>
        <td><input type="text" oraField="zip"/></td>
    </tr>
</table>
</body>
<xml>
    <root>
        <address>123 Main St</address>
        <city>Alameda</city>
        <state>CA</state>
        <zip>94770</zip>
    </root>
</xml>
</html>

```

#### Rendered HTML

Address:	<input type="text" value="123 Main St"/>
City:	<input type="text" value="Alameda"/>
State:	<input type="text" value="CA"/>
Zip:	<input type="text" value="94770"/>

- HTML for span and div elements:

```

<html>
<body>

<div oraField="address"></div>
<span oraField="city"></span>
<span>,</span>
<span oraField="state"></span>
<span oraField="zip"></span>
<span oraField="country"></span>

</body>
<xml>
    <root>
        <address>123 Main St</address>
        <city>Alameda</city>
        <state>CA</state>
        <zip>94770</zip>
    </root>
</xml>
</html>

```

HTML rendered:

123 Main St  
Alameda, CA 94770

### Linking a List

This attribute is used to link an HTML table with an XML list, where the XML list is defined within the UI Map's XML schema. The purpose of the element is to trigger the framework to replicate the table's HTML for each occurrence of the list.

Syntax	Values	Description
oraList=" "	List element XPath	This attribute is used to link an HTML table with an XML list, where the XML list is defined within the UI Map's XML schema. The purpose of the element is to trigger the framework to replicate the table's HTML for each occurrence of the list.

**NOTE:** The oraField attributes embedded within the list must contain XPath navigation relative to the list. See below for an example.

```

<html>
<head><title>Bind xml list element</title></head>
<body>
<table oraList="payment">
  <thead>
    <tr>
      <th><span>Pay Date</span></th>
<th><span>Amount</span></th>
    </tr>
  </thead>
  <tr>
    <td>
      <span oraField="date" oraType="date"></span>
    </td>
    <td align="right">
      <span oraField="amount" oraType="money"></span>
    </td>
  </tr>
</table>
</body>
<xml>
<root>
  <payment>
    <date>2008-01-01</date>
    <amount>44.28</amount>
  </payment>
  <payment>
    <date>2008-02-01</date>
    <amount>32.87</amount>
  </payment>
  <payment>
    <date>2008-03-01</date>
    <amount>21.76</amount>
  </payment>
</root>
</xml>
</html>

```

HTML rendered:

Pay Date	Amount
01-01-2008	\$44.28
02-01-2008	\$32.87
03-01-2008	\$21.76

## Build a Dropdown List

The following attributes are provided to build an HTML 'select' element, also called a dropdown, based on various sources.



Source	Syntax	Values	Examples
Lookup	oraSelect="lookup: ;"	Lookup field	<pre> ... &lt;td&gt;House Type:&lt;/td&gt; &lt;td&gt;   &lt;select oraField="houseType" oraSelect="lookup:HOUSE_TYPE;"&gt; &lt;/select&gt; &lt;/td&gt; </pre>
Extendable Lookup	oraSelect="lookupBO: ;"	BO code	<pre> ... &lt;td&gt;UI Device Display Type:&lt;/ td&gt; &lt;td&gt;   &lt;select oraField="uiDeviceType" oraSelect="lookupBO: F1- DeviceDisplayTypes;"&gt;&lt;/ select&gt; &lt;/td&gt; </pre>
Characteristic Type (pre-defined)	oraSelect="charType: ;"	Characteristic Type code	<pre> ... &lt;td&gt;Usage:&lt;/td&gt; &lt;td&gt;   &lt;select oraField="statusReasonUsage" oraSelect="charType:F1- SRUSG;"&gt;&lt;/select&gt; &lt;/td&gt; ... </pre>
Control Table	oraSelect="table: ;"  <p><b>NOTE:</b> This attribute only works with tables that follow the standard control table structure where there is a related language table that includes that includes the column <b>DESCR</b> as its description column. Use the Application Viewer data dictionary to identify tables that qualify for this functionality.</p> <p><b>WARNING:</b> The oraSelect function will only work if less than 500 values are displayed.</p>	Table name	<pre> ... &lt;td&gt;Currency: &lt;/td&gt; &lt;td&gt;   &lt;select oraField="currency" oraSelect="table:CI_CURRENCY_CD;"&gt; &lt;/select&gt; &lt;/td&gt; ... </pre>
Page Service	oraSelect="service: ;"	Page Service name	<pre> ... &lt;td&gt;Country:&lt;/td&gt; &lt;td&gt;   &lt;select oraField="country" oraSelect="service:CIPTCNTW;"&gt; &lt;/select&gt; &lt;/td&gt; ... </pre>
Embedded List	Used to build a select dropdown based on a list within the map's XML. oraSelect="valuePath: ;descPath: ;"	After the valuePath, indicate the XPath of the element that holds the values. After the descPath, indicate the XPath of the element that holds the descriptions.	<pre> &lt;html&gt; &lt;body&gt; &lt;table summary="" border="0" cellpadding="1" cellspacing="1"&gt;   &lt;tr&gt;     &lt;td&gt;Select: &lt;/td&gt;     &lt;td&gt;&lt;select oraSelect= "valuePath:list/value; descPath:list/desc" oraField="target"&gt;&lt;/ select&gt;&lt;/td&gt;   &lt;/tr&gt; &lt;/table&gt; </pre>

Source	Syntax	Values	Examples
			<pre> &lt;/body&gt; &lt;xml&gt; &lt;root&gt; &lt;target&gt;10&lt;/target&gt;   &lt;list&gt;     &lt;value&gt;10&lt;/value&gt;     &lt;desc&gt;Ten&lt;/desc&gt;   &lt;/list&gt;   &lt;list&gt;     &lt;value&gt;20&lt;/value&gt;     &lt;desc&gt;Twenty&lt;/desc&gt;   &lt;/list&gt;   &lt;list&gt;     &lt;value&gt;40&lt;/value&gt;     &lt;desc&gt;Forty&lt;/desc&gt;   &lt;/list&gt; &lt;/root&gt; &lt;/xml&gt; &lt;/html&gt; </pre>
Service Script	oraSelect="ss: ;"	Service Script code	See below for additional syntax needed when using this function.
Business Service	oraSelect="bs: ;"	Business Service code	See below for additional syntax needed when using this function.

When specifying a service script or a business service, extra mapping information is needed to pass data to and from the service.

Syntax	Values	Description
oraSelectIn=" ;"	serviceXPath:element;	Used to pass the value of another element into the service (mapping to the service's XPath).
	serviceXPath:'Literal';	Used to pass a constant or literal to the service (mapping to the service's XPath).
oraSelectOut="valuePath: ; descPath: "	See examples below	Used to indicate which element in the service's output holds the values and which one holds the descriptions.

Example using a business service:

```

...
<td>External System: </td>
<td>
  <select oraField="externalSystem" oraSelect="bs:F1-RetrieveExternalSystems"
oraSelectIn="outboundMsgType:boGroup/parameters/
outboundMsgType;" oraSelectOut="valuePath:results/externalSystem;
descPath:results/description"></select>
</td>
...

```

This method for building dropdowns is often used when there is a dependency between elements and the list of valid values in a dropdown (for the child element) is based on another element in the map (the parent element). When the parent element is changed, it may be required to refresh the child element. This behavior can be implemented using the function called within an **onChange** event in the map. The syntax is **oraHandleDependentElements('dependent element');** Multiple target elements (dependents) can be named.

The following example is related to the above business service example where the list of external systems is specific for a given outbound message type, which is passed in as input. The snippet below shows the configuration for the outbound message type element to trigger a refresh of the external system's dropdown list.

```

...
<div>

```

```

<label oraLabel="boGroup/parameters/outboundMsgType"></label>
  <span>
    <select oraSelect="table:F1_OUTMSG_TYPE" oraField="boGroup/parameters/outboundMsgType"
onChange="oraHandleDependentElements('boGroup/parameters/externalSystem');"></select>
  </span>
</div>
...

```

## Format Input and Output Fields

The following attributes are designed to apply data type formatting for input and output fields.

### Automatic Formatting

#### Syntax

---



---

```

oraSchemaDataTypes="false"

```

---



---

This attribute is used to trigger automatic formatting in the rendered HTML document. The automated formatting will occur according to the data type attributes defined in the UI map's schema. For details on specific data type formatting, please refer to the oraType attribute descriptions below.

---

**WARNING:** The attribute `oraSchemaDataTypes="true"` will be automatically injected into the UI map's HTML! If you do not wish to apply the schema's data types to the rendered HTML then you must specify this attribute in the body node with a value of false. The attribute `<body oraSchemaDataTypes="false">` is required to avoid automatic formatting!

---

- UI Map schema:

```

<schema>
  <schemaDate dataType="date" />
  <schemaDateTime dataType="dateTime" />
  <schemaFKRef fkRef="CI_USER" />
  <schemaLookup dataType="lookup" lookup="ACCESS_MODE" />
  <schemaMoney dataType="money" />
  <schemaNumber dataType="number" />
  <schemaTime dataType="time" />
</schema>

```

- UI Map HTML:

```

<html>
<body oraSchemaDataTypes="true">
<table border="1" cellpadding="1" cellspacing="1">
<tr><th>dataType</th><th>result type</th><th>input result</th><th> display-only result</th></tr>

  <tr>
    <td rowspan="2">date (from schema)</td>
<td>raw</td>
<td><input oraField="schemaDate" oraType="string" /></td>
<td><span oraField="schemaDate" oraType="string"></span></td>
  </tr>
  <tr>
<td>rendered</td>
    <td><input oraField="schemaDate"></td>
<td><span oraField="schemaDate"></span></td>
  </tr>

  <tr>
    <td rowspan="2">dateTime (from schema)</td>
<td>raw</td>
<td><input oraField="schemaDateTime" oraType="string"></td>
<td><span oraField="schemaDateTime" oraType="string"></span></td>
  </tr>

```

```

    <tr>
<td>rendered</td>
<td><input oraField="schemaDateTime"></td>
<td><span oraField="schemaDateTime"></span></td>
    </tr>

    <tr>
        <td rowspan="2">fkRef (from schema)**</td>
<td>raw</td>
<td><input oraField="schemaFkRef" oraType="string"></td>
<td><span oraField="schemaFkRef" oraType="string"></span></td>
    </tr>
    <tr>
<td>rendered</td>
<td><input oraField="schemaFkRef"></td>
<td><span oraField="schemaFkRef"></span></td>
    </tr>

    <tr>
        <td rowspan="2">lookup (from schema)</td>
<td>raw</td>
<td><input oraField="schemaLookup" oraType="string"></td>
<td><span oraField="schemaLookup" oraType="string"></span></td>
    </tr>
    <tr>
<td>rendered</td>
<td><input oraField="schemaLookup"></td>
<td><span oraField="schemaLookup"></span></td>
    </tr>

    <tr>
        <td rowspan="2">money (from schema)</td>
<td>raw</td>
<td><input oraField="schemaMoney" oraType="string"></td>
<td><span oraField="schemaMoney" oraType="string"></span></td>
    </tr>
    <tr>
<td>rendered</td>
<td><input oraField="schemaMoney"></td>
<td><span oraField="schemaMoney"></span></td>
    </tr>

    <tr>
        <td rowspan="2">number (from schema)</td>
<td>raw</td>
<td><input oraField="schemaNumber" oraType="string"/></td>
<td><span oraField="schemaNumber" oraType="string"></span></td>
    </tr>
    <tr>
<td>rendered</td>
<td><input oraField="schemaNumber"></td>
<td><span oraField="schemaNumber"></span></td>
    </tr>

    <tr>
        <td rowspan="2">time (from schema)</td>
<td>raw</td>
<td><input oraField="schemaTime" oraType="string"></span></td>
<td><span oraField="schemaTime" oraType="string"></span></td>
    </tr>
    <tr>
<td>rendered</td>
<td><input oraField="schemaTime"></td>
<td><span oraField="schemaTime"></span></td>
    </tr>
</table>

</body>
<xml>
<root>
<schemaDate>2007-11-02</schemaDate>

```

```

<schemaDateTime>2007-11-02-23.45.00</schemaDateTime>
<schemaFkRef>USD</schemaFkRef>
<schemaLookup>A</schemaLookup>
<schemaMoney>1000000</schemaMoney>
<schemaNumber>5661976.11548</schemaNumber>
<schemaTime>23.45.00</schemaTime>
</root>
</xml>
</html>

```

HTML rendered.

data Type	result type	input result	display-only result
date	raw	<input type="text" value="2007-11-02"/>	2007-11-02
	rendered	<input type="text" value="11-02-2007"/>	11-02-2007
dateTime	raw	<input type="text" value="2007-11-02-23.45.00"/>	2007-11-02-23.45.00
	rendered	<input type="text" value="11-02-2007"/> <input type="text" value="11:45PM"/>	11-02-2007 11:45PM
fkRef	raw	<input type="text" value="SYSUSER"/>	SYSUSER
	rendered	<input type="text" value="SYSUSER"/>	SYSUSER
lookup	raw	<input type="text" value="A"/>	A
	rendered	<input type="text" value="Add"/>	Add
money	raw	<input type="text" value="1000000"/>	1000000
	rendered	<input type="text" value="\$1,000,000.00"/>	\$1,000,000.00
number	raw	<input type="text" value="5661976.11548"/>	5661976.11548
	rendered	<input type="text" value="5,661,976.11548"/>	5,661,976.11548
time	raw	<input type="text" value="23.45.00"/>	23.45.00
	rendered	<input type="text" value="11:45PM"/>	11:45PM

## Date Formatting

This function is used to display a date according to the user's display profile. For input fields, the setting formats the data when the user tabs out of the field.

---

### Syntax

---

**oraType="date"**

---

```

<html>
<body>
<table summary="" border="0" cellpadding="1" cellspacing="1">
  <tr>
    <td>Date: </td>
  <td><span oraField="date" oraType="date"></span></td>
  </tr>
  <tr>
    <td>Date: </td>
  <td><input oraField="date" oraType="date" /></td>
  </tr>
</table>
</body>
<xml>
<root>
<date>2008-12-28</date>
</root>
</xml>

```

```
</html>
```

HTML rendered.

Date: 12-28-2008

Date:

## Time Formatting

This function is used to display a time according to the user's display profile. For input fields, the setting formats the data when the user tabs out of the field.

---

### Syntax

---

**oraType="time"**

---

---

```
<html>
<body>
<table summary="" border="0" cellpadding="1" cellspacing="1">
  <tr>
    <td>Time: </td>
  <td><span oraField="time" oraType="time"></span></td>
  </tr>
  <tr>
    <td>Time: </td>
  <td><input oraField="time" oraType="time" /></td>
  </tr>
</table>
</body>
<xml>
<root>
<time>00.28.54.389</time>
</root>
</xml>
</html>
```

HTML rendered.

Time: 12:28AM

Time:

## Date and Time Formatting

This function is used to display a timestamp according to the user's display profile. If this function is used for an input element, it is broken into two pieces, one for [date](#) and one for [time](#). Optionally, the time portion of the date time element can be suppressed using the attribute value 'time:suppress'.

---

### Syntax

---

**oraType="dateTime; time:suppress"**

---

---

```
<html>
<body>
<table summary="" border="0" cellpadding="1" cellspacing="1">
  <tr>
    <td>Date time: </td>
    <td><span oraField="dateTime" oraType="dateTime"></span></td>
  </tr>
  <tr>
    <td>Date only: </td>
    <td><span oraField="dateTime" oraType="dateTime; time:suppress"></span></td>
  </tr>
  <tr>
    <td></td>
    <td></td>
  </tr>
</table>
</body>
</html>
```

```

        <td>Date time: </td>
        <td><input oraField="dateTime" oraType="dateTime"/></td>
    </tr>
    <tr>
        <td>Date only: </td>
        <td><input oraField="dateTime" oraType="dateTime; time:suppress"/></td>
    </tr>
</table>
</body>
<xml>
<root>
<dateTime>2009-11-01-00.28.54</dateTime>
</root>
</xml>
</html>

```

HTML rendered.

Date time: 11-01-2009 12:28AM

Date only: 11-01-2009

Date time:	11-01-2009	12:28AM
------------	------------	---------

Date only:	11-01-2009
------------	------------

## Date / Time Formatting with Standard Time

This true function is used to render a date / time element according to the daylight savings time schedule of the 'base' time zone. The 'base' time zone is specified on the Installation table and represents the database time zone. For input elements with this setting, all time entered is assumed to correspond with the daylight savings time schedule of the base time zone. If a time is entered that cannot be unambiguously translated to standard time, then the user will be required to provide a time zone label to indicate whether daylight savings time, or standard time, has been entered.

---

### Syntax

---

**oraType="dateTime; stdTime:true;"**

---



---

```

<html>
<body>
<table summary="" border="0" cellpadding="1" cellspacing="1">
    <tr>
        <td>Date time: </td>
        <td><span oraField="dateTime" oraType="dateTime; stdTime:true;"></span></td>
    </tr>
    <tr>
        <td>Date time: </td>
        <td><input oraField="dateTime" oraType="dateTime; stdTime:true;" /></td>
    </tr>
</table>
</body>
<xml>
<root>
<dateTime>2009-11-01-00.28.54</dateTime>
</root>
</xml>
</html>

```

HTML rendered.

---

**NOTE:** The time zone label is displayed because 1:28 is ambiguous otherwise. Legally, November 1, 2009 1:28 AM occurs twice because daylight savings time (DST) is removed at 2:00 AM. With the stdTime function time zone labels are only displayed when required to clarify time overlaps.

---

Date time: 11-01-2009 01:28AM PDT

Date time:

HTML rendered for the following day.

Date time: 11-02-2009 12:28AM

Date time:

## Date and Time Formatting with Time Zone Reference

Syntax	Valid Values	Description
<code>oraType="dateTime; stdTimeRef: ;"</code>	Reference an XPath after the colon.	This function is used to render a date / time element according to the daylight savings time schedule of a time zone whose XPath is referenced. Note that the time processed is assumed to have been stored in the standard time of the referenced time zone - so only daylight savings time shifting will execute - not time zone shifting.
<code>oraType="dateTime; displayRef: ;"</code>	Reference an XPath after the colon.	This function is similar to the <code>stdTimeRef</code> function, except that this function will execute time zone shifting in addition to daylight savings time shifting. To use <code>displayRef</code> correctly, only associate it with time zone elements that have been stored in the base time zone.

For input elements, all time entered is assumed to correspond with the daylight savings time schedule of the referenced time zone. If a time is entered that cannot be unambiguously translated to standard time, then the user will be required to provide a time zone label to indicate whether daylight savings time, or standard time, has been entered.

```
<html>
<body>
<table summary="" border="0" cellpadding="1" cellspacing="1">
  <tr>
    <td>Date time: </td>
    <td><span oraField="dateTime" oraType="dateTime; stdTimeRef:timeZone;"></span></td>
  </tr>
  <tr>
    <td>Date time: </td>
    <td><input oraField="dateTime" oraType="dateTime; stdTimeRef:timeZone;" /></td>
  </tr>
</table>
</body>
<xml>
<root>
<timeZone>US-EAST</timeZone>
<dateTime>2009-11-01-00.28.54</dateTime>
</root>
</xml>
</html>
```

HTML rendered.

**NOTE:** The time zone label is always displayed for a referenced time zone.

Date time: 11-01-2009 01:28AM EDT

Date time:



HTML rendered for the following day.

Date time: 11-02-2009 12:28AM EST

Date time:

## Duration Formatting

---

### Syntax

---

`oraType="duration"`

---

---

This function is used to display time duration. For an input element, the value entered by the user is translated from minutes to hour and minutes as appropriate. For example, an entered value of '90', is converted to '00:01:30' when tabbing out of the input field.

```
<html>
<body>
<table summary="" border="0" cellpadding="1" cellspacing="1">
  <tr>
    <td>Duration: </td>
    <td><span oraField="duration" oraType="duration"></span></td>
  </tr>
  <tr>
    <td>Duration: </td>
    <td><input oraField="duration" oraType="duration"/></td>
  </tr>
</table>
</body>
<xml>
<root>
<duration>90</duration>
</root>
</xml>
</html>
```

HTML rendered.

Duration: 00:01:30

Duration:

## Day in Month Formatting

---

### Syntax

---

`oraType="dayInMonth"`

---

---

This function is used to display a concatenated day and month.

```
<html>
<body>
<table summary="" border="0" cellpadding="1" cellspacing="1">
  <tr>
    <td>Day In Month: </td>
    <td><span oraField="dayMonth" oraType="dayInMonth"></span></td>
  </tr>
  <tr>
    <td>Day In Month: </td>
    <td><input oraField="dayMonth" oraType="dayInMonth"/></td>
  </tr>
</table>
</body>
<xml>
<root>
<dayMonth>0228</dayMonth>
```

```
</root>
</xml>
</html>
```

HTML rendered.

Day In Month: 02-28

Day In Month:

## Month In Year Formatting

### Syntax

**oraType="monthInYear"**

This function is used to display a concatenated month and year.

```
<html>
<body>
<table summary="" border="0" cellpadding="1" cellspacing="1">
  <tr>
    <td>Month In Year: </td>
    <td><span oraField="month" oraType="monthInYear"></span></td>
  </tr>
  <tr>
    <td>Month In Year: </td>
    <td><input oraField="month" oraType="monthInYear" /></td>
  </tr>
</table>
</body>
<xml>
<root>
<month>200811</month>
</root>
</xml>
</html>
```

HTML rendered.

Month In Year: 11-2008

Month In Year:

## Monetary Formatting

This function is used to display a number as a monetary amount. See the table for configuration options with respect to the currency. For input elements, an error is issued if a non-numeric value is entered.

### Syntax

### Description

**oraType="money: "**

Directly specify a currency code after the colon.

**oraType="money;currencyRef: "**

Reference an XPath (after the colon) for an element that references a currency code.

**oraType="money"**

If no currency or currency reference is specified, the installation currency is used.

**NOTE:** You must specify a pair of stylesheet references, `cisEnabled` and `cisDisabled`, in the map's header for right alignment. The stylesheet controls how the field will be rendered. If you want to alter the rendering you must override the `oraMoney` style.

```
<html>
```

```

<head>
  <link rel="stylesheet" type="text/css" href="cisDisabled.css"/>
  <link rel="stylesheet" type="text/css" href="cisEnabled.css"/>
</head>
<body>
<table summary="" border="1" cellpadding="1" cellspacing="1">
  <tr>
    <td>Amount, currency specified:</td>
  <td><span oraType="money:EUR" oraField="totalAmt"></span></td>
  </tr>
  <tr>
    <td>Amount, default currency:</td>
  <td><span oraType="money" oraField="totalAmt"></span></td>
  </tr>
  <tr>
    <td>Amount, default input:</td>
  <td><input oraType="money" oraField="totalAmt" /></td>
  </tr>
  <tr>
    <td>Amount, currency reference:</td>
  <td><input oraType="money;currencyRef:cur" oraField="totalAmt" /></td>
  </tr>
</table>
</body>
<xml>
<root>
<totalAmt>50500.09</totalAmt>
<cur>EUR</cur>
</root>
</xml>
</html>

```

HTML rendered

```

Amount, currency specified: €50,500.09
Amount, default currency: $50,500.09
Amount, default input: 
Amount, currency reference: €50,500.09

```

## Number Formatting

This function is used to display a number or validate an input value. For input elements, the system will return an error if a non-numeric value is entered.

---

### Syntax

**oraType="number"**

---



---

**NOTE:** You must specify a pair of stylesheet references, cisEnabled and cisDisabled, in the map's header for right alignment. The stylesheet controls how the field will be rendered. If you want to alter the rendering you must override the oraNumber style.

---

```

<html>
<head>
  <link rel="stylesheet" type="text/css" href="cisDisabled.css"/>
  <link rel="stylesheet" type="text/css" href="cisEnabled.css"/>
</head>
<body>
<table summary="" border="1" cellpadding="1" cellspacing="1">
  <tr>
    <td>Count:</td>
  <td><span oraType="number" oraField="count"></span></td>
  </tr>
  <tr>
    <td>Count, input:</td>
  <td><input oraType="number" oraField="count" /></td>
  </tr>
</table>

```

```

</table>
</body>
<xml>
<root>
<count>989</count>
</root>
</xml>
</html>

```

HTML rendered.

Count:	989
Count, input:	<input type="text" value="989"/>

## FK Reference Formatting

By default, when an element with an **fkRef** oraType is displayed, an info string, context menu, navigation, and search are enabled (if the FK reference has been configured accordingly). Syntax is provided to allow you to selectively turn off any of these features.

Note that you can enable the foreign key hyperlink separately as well, refer to [Embed Framework Navigation](#) for more information. The various attributes used to control foreign key reference functionality are as follows. Note that in every case, the default value is **true**. A value of **false** should be used to disable the feature.

---

### Syntax

---

```
oraType="fkRef:true|false; info:true|false; context:true|false; navigation:true|false; search:true|false"
```

---

- **fkRef**. A value of 'true' enables all of the following foreign key reference processing. Use a value of 'false' to disable automatic FK Reference processing.
- **info**. A value of 'true' renders an [information string](#) on the UI map, if applicable.
- **context**. A value of 'true' renders a context menu to appear before the foreign key reference element, if applicable.
- **navigation**. A value of 'true' causes the information string to be rendered as a hyperlink, if applicable. Clicking the hyperlink [navigates](#) to the appropriate page.
- **search**. A value of 'true' displays a search icon that launches the [search zone](#) if applicable.

---

**NOTE:** Foreign key navigation and context menu functionality is only available for UI maps presented in a portal zone. UI Maps presented during BPA script processing cannot support navigation options. Search functionality is only available for input HTML elements.

---

- UI Map schema:

```

<schema>
  <userId fkRef="CI_USER" />
</schema>

```

- UI Map HTML:

```

<html>
<body>
<table summary="" border="1" cellpadding="1" cellspacing="1">
  <tr>
    <td>User</td>
    <td><span oraField="userId" oraType="fkRef:true; info:true; context:true; navigation:true;"></span></td>
  </tr>
</table>

```

```

</body>
<xml>
<root>
<userId>CZAAND</userId>
</root>
</xml>
</html>

```

- HTML rendered.

User  [Andrada, Czarina](#)

## Lookup Formatting

This function is used to display the description of a lookup value.

Syntax	Valid Values
<code>oraType="lookup: "</code>	Lookup field name after the colon.

```

<html>
<body>
<table summary="" border="1" cellpadding="1" cellspacing="1">
  <tr>
    <td>Status:</td>
    <td><span oraField="status" oraType="lookup: BATCH_JOB_STAT_FLG"></span></td>
  </tr>
</table>
</body>
</html>
<xml>
<root>
  <status>PD</status>
</root>
</xml>
</html>

```

HTML rendered.

Status: Pending

## Extendable Lookup Formatting

This function is used to display the description of an extendable lookup value.

Syntax	Valid Values
<code>oraType="lookupBO: "</code>	Business Object code name after the colon.

```

<html>
<body>
<table summary="" border="1" cellpadding="1" cellspacing="1">
  <tr>
    <td>Status:</td>
    <td><span oraField="status" oraType="lookupBO: F1-DeviceDisplayTypes"></span></td>
  </tr>
</table>
</body>
</html>
<xml>
<root>
  <status>PD</status>
</root>
</xml>
</html>

```

HTML rendered.

Status: Pending

## Characteristic Type Formatting

This function is used to display the description of a predefined characteristic value.

Syntax	Valid Values
<code>oraType="charType: "</code>	Characteristic Type code after the colon.

```
<html>
<body>
<table summary="" border="1" cellpadding="1" cellspacing="1">
  <tr>
    <td>Skill:</td>
    <td><span oraType="charType:CM-SKILL" oraField="skill"></span></td>
  </tr>
</table>
</body>
<xml>
<root>
  <skill>10</skill>
</root>
</xml>
</html>
```

HTML rendered.

Skill: Quality assurance

## Control Table Formatting

This function is used to display the description of a control table that has an associated language table.

Syntax	Valid Values
<code>oraType="table: "</code>	Table code after the colon.

```
<html>
<body>
<table summary="" border="1" cellpadding="1" cellspacing="1">
  <tr>
<td>Currency:</td>
<td><span oraType="table:CI_CURRENCY_CD" oraField="curr"></span></td>
  </tr>
</table>
</body>
<xml>
<root>
<curr>USD</curr>
</root>
</xml>
</html>
```

HTML rendered.

Currency: United States Dollars

## Add / Remove Grid Formatting

Syntax	Description
<code>oraType="addGridRow"</code>	<p>The <code>addGridRow</code> function is used to build "insert row" dialog into the UI map.</p> <ul style="list-style-type: none"><li>An 'add' image is displayed.</li><li>Clicking the image inserts a new row in the grid.</li><li>If the list is empty, by default, an empty grid row is automatically be added. This means that the user will always see at least one grid row when this attribute is used.</li></ul>
<code>oraType="deleteGridRow"</code>	<p>The <code>deleteGridRow</code> function is used to build "delete row" dialog into the UI map.</p> <ul style="list-style-type: none"><li>A 'delete' image is displayed.</li><li>Clicking the image removes the adjacent row from the grid.</li></ul>

**NOTE:** Because add and delete dialogs are relevant only inside a table, these attributes must be specified within a `<td>` element.

**WARNING:** These attributes are designed to work with the business object action of 'replace' rather than 'update'. Therefore, if the map contains a grid, the business object action of 'replace' must be used to update the business object. Refer to [BO Replace Action](#) for more information.

### Example:







```
<html>
<head>
<title>Demonstrate Grid Add and Grid Delete OraTypes</title>
  <link rel="stylesheet" type="text/css" href="cisDisabled.css"/>
  <link rel="stylesheet" type="text/css" href="cisEnabled.css"/>
</head>
<body>
<table oraList="listEntry">
  <thead>
    <tr>
      <th/>
      <th/>
    <th><span>Date</span></th>
    <th><span>Amount</span></th>
  </thead>
  <tr>
    <td oraType="addGridRow"></td>
    <td oraType="deleteGridRow"></td>
    <td>
      <input oraField="date" oraType="date"></input>
    </td>
    <td align="right">
      <input oraField="amount" oraType="money"></input>
    </td>
  </tr>
</table>
</body>
<xml>
<root>
  <listEntry>
<date>2008-01-01</date>
<amount>44.28</amount>
```

```

    </listEntry>
  </listEntry>
<date>2008-02-01</date>
<amount>32.87</amount>
  </listEntry>
  <listEntry>
<date>2008-03-01</date>
<amount>21.76</amount>
  </listEntry>
</root>
</xml>
</html>

```

HTML rendered.

	Date	Amount
 	01-01-2008	\$44.28
 	02-01-2008	\$32.87
 	03-01-2008	\$21.76

## Unformatted Elements

This function is used to display the contents of an element that contains 'raw' data as defined for the schema element being rendered.

---

### Syntax

---

**oraType="raw"**

---

- UI Map schema:

```

<schema>
  <rawStuff type="raw"/>
</schema>

```

- UI Map HTML:

```

<html>
<head>
  <link rel="stylesheet" type="text/css" href="cisDisabled.css"/>
  <link rel="stylesheet" type="text/css" href="cisEnabled.css"/>
</head>
<body>
<table summary="" border="1" cellpadding="1" cellspacing="1">
  <tr>
    <td>Raw Stuff:</td>
    <td><span oraType="raw" oraField="rawStuff"></span></td>
  </tr>
</table>
</body>
<xml>
<root>
  <rawStuff>
    <ele1>text in element 1</ele1>
    <group1>
      <ele2>text inside element 2, group 1</ele2>
      <ele3>text inside element 3, group 1</ele3>
    </group1>
  </rawStuff>
</root>
</xml>
</html>

```

HTML rendered.



Raw Stuff:	<pre>&lt;ele1&gt;text in element 1&lt;/ele1&gt; &lt;group1&gt;   &lt;ele2&gt;text inside element 2, group 1&lt;/ele2&gt;   &lt;ele3&gt;text inside element 3, group 1&lt;/ele3&gt; &lt;/group1&gt;</pre>
------------	--

## String Formatting

This function is used to display the contents of an element, as XML pretty-print, when the element contains escaped XML.

### Syntax

`oraType="xmlString"`

**NOTE:** It is not required, but the pretty print of the rendered XML is enhanced if you specify a pair of stylesheet references, `cisEnabled` and `cisDisabled`, in the map's header.

Example:

```
<html>
<head>
  <link rel="stylesheet" type="text/css" href="cisDisabled.css"/>
  <link rel="stylesheet" type="text/css" href="cisEnabled.css"/>
</head>
<body>
<table summary="" border="1" cellpadding="1" cellspacing="1">
  <tr>
    <td>XML Stuff:</td>
    <td><span oraType="xmlString" oraField="xmlStuff"></span></td>
  </tr>
</table>
</body>
<xml>
<root>
<xmlStuff>
  <ele1>text in element 1</ele1>
  <group1>
    <ele2>text inside element 2, group 1</ele2>
    <ele3>text inside element 3, group 1</ele3>
  </group1>
</xmlStuff>
</root>
</xml>
</html>
```

HTML rendered.

XML Stuff:	<pre>&lt;ele1&gt;text in element 1&lt;/ele1&gt; &lt;group1&gt;   &lt;ele2&gt;text inside element 2, group 1&lt;/ele2&gt;   &lt;ele3&gt;text inside element 3, group 1&lt;/ele3&gt; &lt;/group1&gt;</pre>
------------	--

HTML rendered without `oraType="xmlString"`

XML Stuff:	<pre>&lt;ele1&gt;text in element 1&lt;/ele1&gt;&lt;group1&gt;&lt;ele2&gt;text inside element 2, group 1&lt;/ele2&gt;&lt;ele3&gt;text inside element 3, group 1&lt;/ele3&gt;&lt;/group1&gt;</pre>
------------	--

## HTML Formatting

This function is used to display the contents of an element as HTML as opposed to plain text. An element defined as `oraType="fkref"` is automatically rendered as HTML.

---

## Syntax

---

`oraType="html"`

---

---

### WARNING:

To avoid execution of malicious HTML not all HTML tags are supported. The list of supported tags is defined in the "F1-HTMLWhiteList" managed content definition.

If unsupported HTML is detected the entire element is escaped and rendered as plain text. It is therefore recommended to properly escape any source string that contributes to the final HTML element if it is not expected to contain valid HTML. This way only the offending string is escaped and not the entire element.

If the HTML element is composed in scripting refer to the 'escape' function described in the [Edit Data Syntax](#) for more information. Use the `WebStringUtilities.asHTML` java API for escaping text composed in Java.

---

```
<html>
<head>
  <link rel="stylesheet" type="text/css" href="cisDisabled.css"/>
  <link rel="stylesheet" type="text/css" href="cisEnabled.css"/>
</head>
<body>
<table summary="" border="0" cellpadding="1" cellspacing="1">
  <tr>
    <td>Info :</td>
    <td><span oraType="html" oraField="info"></span></td>
  </tr>
</table>
</body>
<xml>
<root>
  <info><b>text in bold</b></info>
</root>
</xml>
</html>
```

HTML rendered.

Info : **text in bold**

HTML rendered without `oraType="html"`

Info : <b>text in bold</b>

## Display Labels

### Derive Label from an Element

This attribute is used to obtain a language sensitive label for a `<span>`, `<td>`, or `<input>` HTML element.

---

#### Syntax

`oraLabel=" "`

---

#### Valid Values

XPath of an element in the UI map schema. The element must reference either the `mapField=`, `mdField=`, or `label=` attribute.

---

**NOTE:** You can also define a field directly in your HTML for label definition, refer to [Deriving Label from a Field](#) for more information.

---

---

**NOTE:** If the schema contains multiple attributes, the oraLabel attribute will pick the label to render according to the following hierarchy: The label attribute overrides the mdField attribute, which in turn will override the mapField attribute.

---

- UI Map schema:

```
<schema>
  <user mapField="USER_ID"/>
  <info type="group" mapXML="CLOB">
    <city label="Metro Area"/>
    <age mdField="AGE_LBL"/>
  </info>
</schema>
```

- HTML:

```
<html>
<head><title oraMdLabel="BUS_LBL"></title></head>
<body>
<table>
  <tr>
    <td oraLabel="user"></td>
    <td><input oraField="user"/></td>
  </tr>
  <tr>
    <td oraLabel="info/city"></td>
    <td><input oraField="info/city"/></td>
  </tr>
  <tr>
    <td oraLabel="info/age"></td>
    <td><input oraField="info/age"/></td>
  </tr>
  <tr>
    <td/>
    <td><input type="button" oraMdLabel="ACCEPT_LBL"/></td>
  </tr>
</table>
</body>
<xml>
  <root>
    <user>RWINSTON</user>
    <info>
      <city>Alameda</city>
      <age>32</age>
    </info>
  </root>
</xml>
</html>
```

HTML rendered:

User	<input type="text" value="RWINSTON"/>
Metro Area	<input type="text" value="Alameda"/>
Age	<input type="text" value="32"/>
	<input type="button" value="Accept"/>

### Deriving Label from a Field

This attribute is used to obtain a language sensitive label for a <span>, <td>, <input>, or <title> HTML element. The label text is derived from the field referenced.

---

**Syntax****Valid Values**

---

**oraMdLabel=" "**[MD Field](#) code.

---

---

**NOTE:** You can also define labels derived from the map's schema definition, refer to [Derive Label from an Element](#) for more information.

---

- **HTML:**

```
<html>
<head><title oraMdLabel="NOTES_LBL"></title></head>
<body>
<table>
  <tr>
    <td oraLabel="user"></td>
    <td><input oraField="user"/></td>
  </tr>
  <tr>
    <td oraLabel="info/city"></td>
    <td><input oraField="info/city"/></td>
  </tr>
  <tr>
    <td oraLabel="info/age"></td>
    <td><input oraField="info/age"/></td>
  </tr>
  <tr>
    <td/>
    <td><input type="button" oraMdLabel="ACCEPT_LBL"/></td>
  </tr>
</table>
</body>
<xml>
  <root>
    <user>RWINSTON</user>
    <info>
      <city>Alameda</city>
      <age>32</age>
    </info>
  </root>
</xml>
</html>
```

HTML rendered:

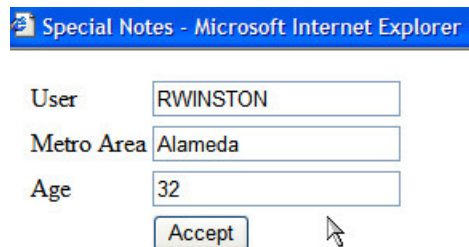

Special Notes - Microsoft Internet Explorer

User	<input type="text" value="RWINSTON"/>
Metro Area	<input type="text" value="Alameda"/>
Age	<input type="text" value="32"/>
	<input type="button" value="Accept"/>

## Enable UI Map Help

The [Display Labels](#) section describes ways to derive the label for an element using an underlying [MD Field](#). In addition, if the same MD field contains help text, the system will automatically generate a tool tip adjacent to the element label. Clicking the tool tip allows the user to view the help text.

It is possible to change the rendering of the tool tip. Refer to [Custom Look And Feel Options](#) for more information

## Search Using a Pop-Up Explorer Zone

### Search Option

This attribute is used to enable search zone functionality for input HTML elements.

Syntax	Valid Values
<code>oraSearch=" "</code>	Zone code.

**NOTE:** The `oraSearch` attribute is similar to the `oraType` attribute, because it will be 'automatically' included into HTML via the `oraSchemaDataTypes` attribute. This means that coding the `oraSearch` attribute into UI Map HTML is only required if a search zone has not been specified in the schema, or in the schema element's FK reference.

- Example of defining the search in the HTML. UI Map's Schema:

```
<schema>
  <uiMap/>
</schema>
```

#### UI Map's HTML

```
<html>
<body>
<table summary="" border="1" cellpadding="1" cellspacing="1">
  <tr>
    <td>UI Map with Search </td>
    <td><input oraField="uiMap" oraSearch="F1-UISRCH"></td>
  </tr>
</table>
</body>
<xml>
<root>
  <uiMap/>
</root>
</xml>
</html>
```

- Example of defining the search in the schema. UI Map's Schema:

```
<schema>
  <uiMap search="F1-UISRCH"/>
</schema>
```

#### UI Map's HTML

```
<html>
<body>
<table summary="" border="1" cellpadding="1" cellspacing="1">
  <tr>
    <td>UI Map with Search </td>
    <td><input oraField="uiMap"></td>
  </tr>
</table>
</body>
<xml>
<root>
  <uiMap/>
</root>
</xml>
</html>
```

- Example where the FK reference defines the search zone. UI Map's Schema:

```
<schema>
  <uiMap fkRef="F1-UISRC"/>
```

```
</schema>
```

## UI Map's HTML

```
<html>
<body>
<table summary="" border="1" cellpadding="1" cellspacing="1">
  <tr>
    <td>UI Map with Search </td>
    <td><input oraField="uiMap"></td>
  </tr>
</table>
</body>
</html>
<xml>
<root>
  <uiMap/>
</root>
</xml>
</html>
```

In all cases, the HTML rendered is the same.



## Initializing Search Fields

This optional attribute is used to initialize search zone filters. Multiple filters may be initialized. This attribute can only be used in conjunction with the oraSearch attribute.

Syntax	Valid Values	Field Value Options	Comments
<code>oraSearchField=""</code>	One or more pairs of field name and field value separated by colon. Each pair is separated by a semi-colon.  <b>oraSearchField="fieldName:fieldValue: ..."</b>	No value	If you do not specify a field value, then the value of the input element containing the oraSearchField attribute will be used.
	The field name is used to identify the zone filter to initialize when the search is launched. The field name must match the value of the searchField mnemonic specified on a search zone <a href="#">user filter</a> or <a href="#">hidden filter</a> parameter.	XPath  'literal'	Indicate the XPath to the schema element that contains the value to use.  Indicate a literal value to supply.

**NOTE:** If you do not specify an oraSearchField attribute and the schema element has a search enabled fkRef specified, the framework automatically builds an oraSearchField where the field name is equal to the FK reference's key (MD) [fields](#).

**WARNING:** The pop-up explorer zone can be invoked one of two ways: By clicking on the search button, or by hitting the enter key from the field to the left of the button. If you click on the button then no search field information will be passed to the zone. Search field information is only used to initialize zone filter values when enter is pressed.

Two filter values are initialized as shown in the following example:

```
<schema>
  <bo/>
  <uiMap/>
</schema>
```

```
<html>
<body>
```

```

<table summary="" border="1" cellpadding="1" cellspacing="1">
  <tr>
    <td>UI Map with Search </td>
    <td><input oraField="uiMap" oraSearch="F1-
UISRCH" oraSearchField="MAP_CD; BUS_OBJ_CD:bo;"></td>
  </tr>
</table>
</body>
<xml>
<root>
  <bo/>
  <uiMap/>
</root>
</xml>
</html>

```

## Mapping Returned Search Fields

This optional attribute is used to direct values returned by the search zone. Multiple fields may be specified. This attribute can only be used in conjunction with the oraSearch attribute.

Syntax	Valid Values	Field Value Options	Comments
<b>oraSearchOut=" "</b>	One or more pairs of field name and field value separated by colon. Each pair is separated by a semi-colon.	No value	If you do not specify a field value, then the input element containing the oraSearchField attribute receives the returned value.
<b>oraSearchOut="field name:xpath target; ..."</b>	The field name is used to identify the search result returned from the query zone. The field name must match the ELEMENT_NAME mnemonic defined within the explorer zone's search results parameter.	XPath	Indicate the XPath to the schema element that should receive the returned value.

**NOTE:** If you do not specify an oraSearchOut attribute, the framework will build a default where the field name will be set equal to the oraSearchField's field name.

Two values are returned in the following example:

```

<schema>
  <bo/>
  <mo/>
</schema>

```

```

<html>
<body>
<table summary="" border="1" cellpadding="1" cellspacing="1">
  <tr>
    <td>BO Search </td>
    <td><input oraField="bo" oraSearch="Z1-BOSRCH" oraSearchOut="BUS_OBJ_CD; MO_CD:mo;"></td>
  </tr>
</table>
</body>
<xml>
<root>
  <bo/>
  <mo/>
</root>
</xml>
</html>

```

## Display Errors

### Display Error Variables

One of the following error variables may be displayed.

---

#### Syntax

---

`oraErrorVar="ERRMSG-TEXT"`

---

`oraErrorVar="ERRMSG-LONG"`

---

`oraErrorVar="ERRMSG-CATEGORY"`

---

`oraErrorVar="ERRMSG-NUMBER"`

---

---

```
...  
<table width="100%" cellpadding="12">  
  <tr class="oraErrorText">  
    <td>  
      <a href="" onclick="oraShowErrorAlert(); return false;">  
<span class="oraErrorText" oraErrorVar="ERRMSG-TEXT"></span>  
      </a>  
    </td>  
  </tr>  
</table>  
...
```

HTML rendered



**Last name required**

**User Id** BOND007

**First Name**

**Last Name**

### Highlight a Field in Error

**NOTE:** For more information on throwing an error, refer to the [Terminate Statement](#) in the Edit Data Syntax.

---

---

#### Syntax

---

`oraError="automate:true|false; prefix: "`

---

#### Comments

---

Specifying **automate:true** automatically enables highlighting of the element in error when issuing an error. Note that **true** is the default and doesn't need to be specified. Specify **automate:false** to turn off field highlighting.

---

The system uses a match on the element name referenced in the error to the element names in the UI map. If the elements in the schema are within an XPath that may not match what is referenced by the error, use **prefix:XPath** to specify that.

---

---

**NOTE:** A pair of stylesheet references, `cisEnabled` and `cisDisabled`, must be specified for reference of the `oraError` style. The stylesheet controls how the field in error will be rendered. If you want to alter the rendering you must override the `oraError` style.

---



The following HTML example shows that the elements in the map are defined within a group called **boGroup**. The element name returned by the error will not include this group so in order for the field highlighting to work properly the **prefix:** attribute must indicate the group name.

```
<html>
<head>
  <title>User Zone Input</title>
  <link rel="stylesheet" type="text/css" href="cisDisabled.css"/>
  <link rel="stylesheet" type="text/css" href="cisEnabled.css"/>
</head>
<body oraError="automate:true; prefix:boGroup">
<table width="100%" cellpadding="12">
  <tr class="oraErrorText">
    <td>
      <a href="" onclick="oraShowErrorAlert(); return false;">
        <span class="oraErrorText" oraErrorVar="ERRMSG-TEXT"></span>
      </a>
    </td>
  </tr>
</table>
<table width="100%" border="0" cellpadding="4">
  <tr style="padding-top:30px;">
    <td align="right" class="label">User Id</td>
    <td>
      <span oraField="boGroup/userId" class="normal"/>
    </td>
  </tr>

  <tr>
    <td align="right" class="label">First Name</td>
    <td>
      <input oraField="boGroup/firstName" class="normal"/>
    </td>
  </tr>

  <tr>
    <td align="right" class="label">Last Name</td>
    <td>
      <input oraField="boGroup/lastName" class="normal"/>
    </td>
  </tr>
</table>
</body>

<xml>
<root>
<boGroup>
  <userId>BOND007</userId>
  <firstName>James</firstName>
  <lastName></lastName>
</boGroup>
</root>
</xml>
</html>
```

HTML rendered, where the error element thrown is equal to 'lastName':



### Overriding the Error Element Name

In the rare occasion where the element name returned by the error doesn't match the element name in the map, you can add an explicit attribute to indicate the error element name.

Syntax	Valid Values	Comments
<code>oraErrorElement=</code>	"element name"	The element name referenced here must exactly match the name of the error element assigned when the error was thrown. More than one HTML field can be referenced by the same error element name.

**NOTE:** A pair of stylesheet references, `cisEnabled` and `cisDisabled`, must be specified for reference of the `oraError` style. The stylesheet controls how the field in error will be rendered. If you want to alter the rendering you must override the `oraError` style.

This illustrates a scenario where the element name associated with the error differs from the element name on the map.

```
<html>
<head>
  <title>User Zone Input</title>
  <link rel="stylesheet" type="text/css" href="cisDisabled.css"/>
  <link rel="stylesheet" type="text/css" href="cisEnabled.css"/>
</head>
<body>
<table width="100%" cellpadding="12">
  <tr class="oraErrorText">
    <td>
      <a href="#" onclick="oraShowErrorAlert(); return false;">
        <span class="oraErrorText" oraErrorVar="ERRMSG-TEXT"></span>
      </a>
    </td>
  </tr>
</table>
<table width="100%" border="0" cellpadding="4">
  <tr style="padding-top:30px;">
    <td align="right" class="label">User Id</td>
    <td>
      <span oraField="userId" class="normal"/>
    </td>
  </tr>

  <tr>
    <td align="right" class="label">First Name</td>
    <td>
      <input oraField="firstName" class="normal" oraErrorElement="firstName"/>
    </td>
  </tr>

  <tr>
    <td align="right" class="label">Last Name</td>
    <td>
      <input oraField="familyName" class="normal" oraErrorElement="lastName"/>
    </td>
  </tr>
</table>
</body>

<xml>
<root>
  <userId>BOND007</userId>
  <firstName>James</firstName>
  <familyName></familyName>
</root>
</xml>
</html>
```

HTML rendered.

Last name required

**User Id** BOND007

**First Name**

**Last Name**

## Display Error Pop-Up

When the error text is displayed, this function may be used to pop-up the standard error dialog (which displays more information) when a user clicks the error message.

---

### Syntax

---

**oraShowErrorAlert(); return false;**

---

```
<html>
<head>
  <link rel="stylesheet" type="text/css" href="cisDisabled.css"/>
  <link rel="stylesheet" type="text/css" href="cisEnabled.css"/>
</head>
<body>
<table width="100%" cellpadding="12">
  <tr class="oraErrorText">
    <td>
      <a href="" onclick="oraShowErrorAlert(); return false;">
        <span class="oraErrorText" oraErrorVar="ERRMSG-TEXT"></span>
      </a>
    </td>
  </tr>
</table>
<table>
  <tr>
    <td>>Address:</td>
    <td><input type="text" oraField="address"/></td>
  </tr>
  <tr>
    <td>>City:</td>
    <td><input type="text" oraField="city"/></td>
  </tr>
  <tr>
    <td>>State:</td>
    <td><input type="text" oraField="state"/></td>
  </tr>
  <tr>
    <td>>Zip:</td>
    <td><input type="text" oraField="zip"/></td>
  </tr>
  <tr>
    <td/>
    <td style="padding-top:15px;">
<oraInclude map="F1-SaveCancelButtons"/>
    </td>
  </tr>
</table>
</body>
<xml>
  <root>
    <address>123 Main St</address>
    <city>Alameda</city>
    <state>CA</state>
    <zip>94770</zip>
  </root>
</xml>
</html>
```

HTML rendered.

**Address field missing**

Address:

City:

State:

Zip:

Standard error pop-up dialog launched via click on error message:

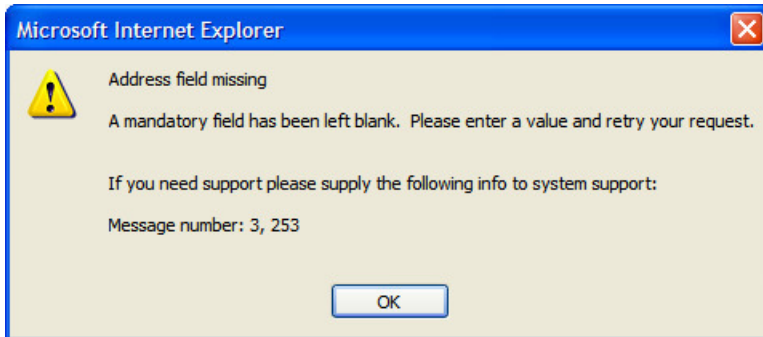

## Fire JavaScript for Browser Events

### Working with the JavaScript Framework

There are many JavaScript events that can be used within the HTML/Javascript environment. These include events such as `onLoad`, `onBlur`, `onChange`, etc. The UI Map Framework also makes use of some of these events. It is important that any UI Map you develop works with the framework in order to obtain consistent results (events may not always be executed in the same order at all times!).

---

#### **WARNING:**

The following describes the recommended approach for safely handling loading and processing field updates in your UI Maps.

If JavaScript is required within an XHTML UI Map or fragment, it will be necessary to bound it within a `![CDATA[ ]]` tag to ensure a valid XML document. Note that the tags themselves may need to be commented out to promote compatibility with older browsers. For example:

```
<script type="text/javascript">  
  
/* <![CDATA[ */  
  
//  
// javascript  
//  
  
/* ]]> */  
  
</script>
```

---

## Element Change Event

Syntax	Valid Values
<code>oraChange=" "</code>	A JavaScript function.

At the time of UI Map load, if there is an event handler already attached to an HTML element, the framework removes it and attaches a combined event handler. The combined handler calls any **framework handler first** and then calls the other (custom) handlers.

**WARNING:** Note that the function must not be used to execute logic that will modify the associated field data value again - or an endless loop will occur.

In the following example the **oraInvokeBS** function is executed when the button is clicked.

```
<html>
  <head>
    <title>oraInvokeBS test</title>
  </head>
  <body>
    <table>
      <tr>
        <td>User Id:</td>
        <td>
          <input oraField= "xmlGroup/userId" />
          <input type="button" value="Search" oraChange="oraInvokeBS('UserSearch', 'xmlGroup');" />
        </td>
      </tr>
      <tr>
        <td/>
        <td>Search Results</td>
      </tr>
      <tr>
        <td/>
        <td>
          <table oraList="xmlGroup/searchList">
            <tr>
              <td><span oraField="userId"></span>
            </td>
            </tr>
          </table>
        </td>
      </tr>
    </table>
  </body>
</html>
<xml>
  <root>
    <xmlGroup>
      <userId/>
      <searchList>
        <userId></userId>
      </searchList>
    </xmlGroup>
  </root>
</xml>
</html>
```

## Page Load Event

Syntax	Valid Values
<code>oraLoad=" "</code>	A JavaScript function.

**WARNING:** When executing `oraLoad` within a fragment UI map, and you need to execute a JavaScript function during page load (where the function invokes a business object, business service, or service script) you can use the special

syntax `oraLoad[$SEQUENCEID]`. For other special syntax used for map fragments, refer to the [Construct a Portal Zone Header](#) section.

- In the following example, the `oraDisplayNone` function is executed during page load:

```
<html>
<body>
<table summary="" border="1" cellpadding="1" cellspacing="1">
  <tr>
    <td oraLoad="oraDisplayNone(item,'userId','')">User Id: </td>
    <td><span oraField="userId"></span></td>
  </tr>
</table>
</body>
</html>
<xml>
<root>
  <userId>SPLAXT</userId>
</root>
</xml>
</html>
```

- HTML rendered

User Id: SPLAXT

## After Page Load Event

Syntax	Valid Values
<code>oraAfterLoad=" "</code>	A JavaScript function.

In the following example the `oraGetValueFromScript` function is executed after page load.

```
<div>
<label for="boGroup_parameters_externalSystem" oraLabel="boGroup/parameters/externalSystem">
</label>
<span>
  <select oraSelect="bs:F1-RetrieveExternalSystems" class="oraInput"
    id="boGroup_parameters_externalSystem" oraField="boGroup/parameters/externalSystem"
    oraSelectOut="valuePath:results/externalSystem; descPath:results/description"
    oraSelectIn="outboundMsgType:boGroup/parameters/outboundMsgType"
    oraAfterLoad
      ="oraGetValueFromScript(document.getElementById('boGroup_parameters_externalSystem'));">
  </select>
</span>
</div>
```

## Hide Elements

### Hide Using a Function

The system provides a function that is used to hide an HTML element based on the value on another element or based on the results of a JavaScript function. Note that the first parameter is the string **item**, which lets the function identify the HTML item being manipulated.

Syntax	Valid Values	Comments
<code>oraDisplayNone(item);</code>	(item, 'XPath', 'value', 'operator')	Used to hide an element based on the value of another element (referenced using its XPath). Enter a value of '' to interrogate a blank value. By default the operator is '='. This

Syntax	Valid Values	Comments
		may be set instead to another operator such as '!=', '>', or '<'.
	(item, function name, <b>true</b>   <b>false</b> )	Used to indicate a JavaScript function, which must return a Boolean.

- Example where the User Id label is hidden when no User Id value exists.

```
<html>
<body>
<table summary="" border="1" cellpadding="1" cellspacing="1">
  <tr>
    <td oraLoad="oraDisplayNone(item,'userId','')>User Id: </td>
    <td><span oraField="userId"></span></td>
  </tr>
</table>
</body>
<xml>
<root>
  <userId></userId>
</root>
</xml>
</html>
```

- Example where the Save button is hidden when the user does not have security access to the action of change ('C') for the application service 'F1-DFLTS'.

```
<html>
<body>
<table summary="" border="1" cellpadding="1" cellspacing="1">
  <tr>
    <td oraLoad="oraDisplayNone(item, oraHasSecurity('F1-DFLTS', 'C'), false );">
      <input name="Save" type="button" onclick="oraInvokeBO('CM-
IndividualTaxpayer', null, 'replace')"/>
    </td>
  </tr>
</table>
</body>
<xml>
<root>
  <userId></userId>
</root>
</xml>
</html>
```

## Check User's Security Access

The system provides two functions to check a user's security access to a given application service and access mode. These are commonly used for hiding elements.

Syntax	Parameters
<b>oraHasSecurity( )</b>	'Application Service code'
	'Access Mode'
<b>oraHasSecurityPath('x','y')</b>	'Application Service XPath'
	'Access Mode XPath'

See the previous section for an example of the **oraHasSecurity** function. The following shows an example where the status button is hidden when the user does not have security access to the access mode 'ACT' of the application service 'FORMTST'.

```
<html>
```

```

<body>
<table>
  <tr>
    <td oraLoad="oraDisplayNone(item, oraHasSecurityPath('appService', 'accessMode'), false );">
      <input oraField="statusLabel" type="button" onclick="oraRunScript('UpdateState','status');"/>
    </td>
  </tr>
</table>
</body>
<xml>
<root>
  <status>ACTIVATE</status>
<statusLabel>Activate</statusLabel>
<appService>FORMTST</appService>
  <accessMode>ACT</accessMode>
</root>
</xml>
</html>

```

## Invoke Schema Based Services

The system provides functions for invoking a business object, business service or service script.

### Invoke BO Function

This function is used to perform a BO interaction directly from the UI map's HTML. It returns a 'true' or a 'false' depending on whether the invocation encounters an error.

Syntax	Parameters	Comments
<code>oraInvokeBO( )</code>	'BO Name'	
	'XPath' or <b>null</b>	Identifies a group element via XPath. If you specify the word <b>null</b> , then the entire embedded XML object will be passed.
	'action'	Indicate the action to use. Valid values are <b>add</b> , <b>delete</b> , <b>read</b> , <b>update</b> , and <b>replace</b> .

- Example with the statement invoked in a JavaScript function.

```

function invokeBO {
  if (!oraInvokeBO('F1-User', 'xmlGroup', 'read')) {
    oraShowErrorAlert();
    return;
  }
}

```

- Example with the statement invoked within onClick.

```

<html>
  <head>
    <title>oraInvokeBO test</title>
  </head>
  <body>
    <table>
      <tr>
        <td>User Id:</td>
        <td>
          <input oraField= "xmlGroup/userId"/>
          <input type="button" value="Find" onClick="oraInvokeBO('F1-
User', 'xmlGroup', 'read');"/>
        </td>
      </tr>
      <tr>
        <td/>
        <td>Result</td>
      </tr>
    </table>
  </body>
</html>

```



```

        </tr>
        <tr>
            <td/>
            <td>
                <span oraField="xmlGroup/firstName"></span>
                <span oraField="xmlGroup/lastName"></span>
            </td>
        </tr>
    </table>
</body>

<xml>
  <root>
    <xmlGroup>
      <userId>SPLNXU</userId>
      <firstName></firstName>
      <lastName></lastName>
    </xmlGroup>
  </root>
</xml>
</html>

```

HTML rendered.

User Id:

Result

Czarina Andrada

## Invoke BS Function

This function is used to perform a business service interaction directly from the UI map's HTML. It returns a 'true' or a 'false' depending on whether the invocation encounters an error.

Syntax	Parameters	Comments
<code>oraInvokeBS( )</code>	'BS Name'	
	'XPath' or <code>null</code>	Identifies a group element via XPath. If you specify the word <code>null</code> , then the entire embedded XML object will be passed.

- Example with the statement coded within a JavaScript function.

```

function invokeBS {
  if (!oraInvokeBS('F1-UserSearch', 'xmlGroup')) {
    oraShowErrorAlert();
    return;
  }
}

```

- Example with the statement invoked via onClick.

```

<html>
  <head>
    <title>oraInvokeBS test</title>
  </head>
  <body>
    <table>
      <tr>
        <td>User Id:</td>
        <td>
          <input oraField= "xmlGroup/userId"/>
          <input type="button" value="Search" onClick="oraInvokeBS('F1-
UserSearch', 'xmlGroup');"/>
        </td>
      </tr>
    </table>
  </body>
</html>

```

```

        <tr>
          <td/>
          <td>Search Results</td>
        </tr>
        <tr>
          <td/>
          <td>
            <table oraList="xmlGroup/searchList">
<tr><td><span oraField="userId"></span></td></tr>
              </table>
            </td>
          </tr>
        </table>
      </body>
    </xml>
    <root>
      <xmlGroup>
        <userId/>
        <searchList>
          <userId></userId>
        </searchList>
      </xmlGroup>
    </root>
  </xml>
</html>

```

HTML rendered.

User Id:

Search Results

BBLABY

CBALKAN

CRUPPERT

CTICZON

DSISKA

## Invoke SS Function

This function is used to perform a service script interaction directly from the UI map's HTML. It returns a 'true' or a 'false' depending on whether the invocation encounters an error.

Syntax	Parameters	Comments
<code>oraInvokeSS( )</code>	'Service Script Name'  'XPath' or <b>null</b>	Identifies a group element via XPath. If you specify the word <b>null</b> , then the document belonging to the parent node will be passed. If the parent node is not enough, then the entire document can always be passed using the following syntax:  <code>oraInvokeSS('service script', null, null, {\$SEQUENCEID})</code>

- Example with the statement invoked within a JavaScript function:

```

function invokeSS {
  if (!oraInvokeSS('F1-GetUsers', 'xmlGroup')) {
    oraShowErrorAlert();
    return;
  }
}

```

```
}
```

- Example with the statement invoked within onClick.

```
<html>
  <head>
    <title>oraInvokeSS test</title>
  </head>
  <body>
    <table>
      <tr>
        <td>User Id:</td>
        <td>
          <input oraField= "xmlGroup/userId" />
          <input type="button" value="Search" onClick="oraInvokeSS('F1-
GetUsers', 'xmlGroup');"/>
        </td>
      </tr>
      <tr>
        <td/>
        <td>Search Results</td>
      </tr>
      <tr>
        <td/>
        <td>
          <table oraList="xmlGroup/searchList">
            <tr><td><span oraField="userId"></span></td></tr>
          </table>
        </td>
      </tr>
    </table>
  </body>
<xml>
  <root>
    <xmlGroup>
      <userId/>
      <searchList>
        <userId></userId>
      </searchList>
    </xmlGroup>
  </root>
</xml>
</html>
```

HTML rendered.

User Id:

Search Results

BBLABY  
CBALKAN  
CRUPPERT  
CTICZON  
DSISKA

## Refresh a Rendered Map or Portal Page

### Refresh Map

This function is used to 'Refresh' only the map zone issuing the command.

---

#### Syntax

---

```
oraRefreshMap;
```

---

...

```

<tr>
  <td/>
  <td><input type="button" onclick="oraRefreshMap();" value="Refresh"/></td>
</tr>
...

```

## Refresh Page

This function is used to refresh all zones in the portal.

---

### Syntax

**oraRefreshPage;**

---

```

...
<tr>
  <td/>
  <td><input type="button" onclick="oraRefreshPage();" value="Refresh"/></td>
</tr>
...

```

## Embed Framework Navigation

### Navigate using Navigation Option

This function is used to navigate to another page using the information defined on a navigation option.

---

### Syntax

**oraNavigate( );**

### Parameters

'Navigation Option code'

'Key XPath'

---

**WARNING:** This function is only intended for a UI map defined within a portal zone. It should not be used within a UI map launched by a BPA script.

The following example exhibits two possible uses of this function: as a URL and as a button. Note that the UI Map schema must contain a fkRef attribute. Refer to [FK Reference Formatting](#) for more information.

```

<schema>
  <userId fkRef="CI_USER"/>
</schema>

<html>
<body>
<table summary="" border="1" cellpadding="1" cellspacing="1">
  <tr>
    <td>User Link: </td>
    <td><a href="" onclick="oraNavigate('userMaint','userId'); return false;">
      <span oraField="userId" oraType="fkRef:CI_USER"></span></a>
    </td>
  </tr>
  <tr>
    <td>User Button: </td>
    <td><input type="submit" onclick="oraNavigate('userMaint','userId')"
      value="Go to User"/></td>
  </tr>
</table>
</body>
<xml>
<root>
  <userId>SPLAXT</userId>
</root>
</xml>
</html>

```

HTML rendered.

User Link:	<a href="#">Taranto,Armando</a>
User Button:	<input type="button" value="Go to User"/>

## Launch BPA Script

### Launch BPA Script

Syntax	Parameters	Comments
<code>oraRunScript( );</code>	'BPA script code'.  'XPath Element'	One or more element values may be passed into the BPA where it may be referenced as temporary variables.

**WARNING:** This function is only applicable to UI maps displayed in portal zones. UI maps launched within a running BPA script cannot directly launch another BPA script from the UI map's HTML. Instead, return a value from the UI map and execute a Perform Script or Transfer Control step type.

**NOTE:** It is incumbent on the script author to pull information out of temporary storage in the initial steps of the script.

In the following example, a temporary variable named 'personId' is created with value '1234567890' and the BPA script named 'Edit Address' is launched.

```
<html>
<body>
<table>
  <tr>
    <td>
      <div oraField="address"></div>
      <span oraField="city"></span>
      <span>,</span>
      <span oraField="state"></span>
      <span oraField="zip"></span>
      <span oraField="country"></span>
      <a href="" onClick="oraRunScript('Edit Address','personId');">edit</a>
    </td>
  </tr>
</table>
</body>
<xml>
  <root>
    <personId>1234567890</personId>
    <address>123 Main St</address>
    <city>Alameda</city>
    <state>CA</state>
    <zip>94770</zip>
  </root>
</xml>
</html>
```

HTML rendered.

123 Main St  
Alameda, CA 94770 [edit](#)

## Launch BPA Script With Values

This function is used to launch a BPA, providing name/value pairs to push into temporary storage. Multiple values can be passed. The BPA script can then reference the temporary variables by name.

Syntax	Parameters	Comments
<code>oraRunScriptWithValues( );</code>	'BPA script code'.  'XPath Element Name':value	One or more pairs of element names and values.

**NOTE:** You would use this JavaScript function, instead of `oraRunScript`, if you need to push values to the BPA script that are not located in the UI Map's XML structure.

In the example below, a JavaScript function named 'editUser()' is responsible for launching the BPA script named 'UserEdit'. The temporary variable named 'userId' will be created with value 'CMURRAY'.

```
<html>
<head>
<script type="text/javascript">

function editUser() {
    var values = {'userId': 'CMURRAY'};
    oraRunScriptWithValues('UserEdit', values);
    return;
}

</script>
</head>
<body>
...
</body>
</html>
```

## Exit UI Map with Bound Values

This function is used to exit a UI Map. When you quit the map you can specify a value to return to the script and, in addition, whether to return updated XML.

Syntax	Parameters	Comments
<code>oraSubmitMap( );</code>	'Return Value'  Boolean value	Indicates if the updated XML should be returned. Default is <b>true</b> .

In the following example, the Save button will return updated information, the Cancel button will not.

```
<html>
<body>
<table>
  <tr>
    <td/>
    <td style="padding-bottom:15px;">
      <a href="" onclick="oraShowErrorAlert(); return false;">
        <span oraErrorVar="ERRMSG-TEXT"></span></a>
      </td>
  </tr>
  <tr>
    <td >Address:</td>
    <td><input type="text" oraField="address"/></td>
  </tr>
  <tr>
    <td>City:</td>
```

```

    <td><input type="text" oraField="city"/></td>
  </tr>
  <tr>
    <td>State:</td>
    <td><input type="text" oraField="state"/></td>
  </tr>
  <tr>
    <td>Zip:</td>
    <td><input type="text" oraField="zip"/></td>
  </tr>
  <tr>
    <td/>
    <td style="padding-top:15px;">
      <input type="button" value="Save" onClick="oraSubmitMap('SAVE');"/>
      <input type="button" value="Cancel" onClick="oraSubmitMap('CANCEL',false);"/>
    </td>
  </tr>
</table>
</body>
<xml>
  <root>
    <address>123 Main St</address>
    <city>Alameda</city>
    <state>CA</state>
    <zip>94770</zip>
  </root>
</xml>
</html>

```

Save and Cancel buttons rendered:

## Include a Map Fragment

This function is used to embed a map fragment within another UI map. Note that it is possible to use the include node within a map or a map fragment.

Syntax	Parameters	Comments
<code>&lt;oralInclude map=' ' prefixPath=' '/&gt;</code>	map='UI Map Code' prefixPath='Xpath'	Optionally specify an xpath prefix to be appended onto every included oraField, oraLabel, oraList, oraSelect valuePath and descPath, oraDownloadData, and oraUploadData attribute value defined within the included UI map fragment's HTML.  <b>NOTE:</b> This functionality only applies to XPath attribute values when those values do not appear beneath an oraList attribute. Any XPath value within a table containing

Syntax	Parameters	Comments
		an oraList attribute will not be affected by a prefixPath.

- An example of a map fragment with two buttons, named 'F1-SaveCancelButtons'.

```
<input onClick = "oraSubmitMap('SAVE');" oraMdLabel="SAVE_BTN_LBL" class="oraButton" type="button"/>
<input onClick = "oraSubmitMap('CANCEL',false);" oraMdLabel="CANCEL_LBL" class="oraButton" type="button"/>
```

- An example of a map that includes the map fragment named 'F1-SaveCancelButtons'.

```
...
<tr>
  <td colspan="2" align="center">
<oraInclude map="F1-SaveCancelButtons"/>
  </td>
</tr>
...
```

## Show Schema Default on Add

Default values within in the UI map's schema will be displayed on a UI map's input fields if an embedded <action> node has a value of 'ADD' or blank.

### Syntax

```
<action>ADD</action>
```

```
<action> </action>
```

The schema default for the <description> element will be displayed:

```
<schema>
  <action/>
  <boGroup type="group">
    <key/>
    <description default="enter description here"/>
  </boGroup>
</schema>
```

```
<html>
<body>
<table summary="" border="1" cellpadding="1" cellspacing="1">
  <tr>
    <td>Description </td>
    <td><input oraField="boGroup/description"></td>
  </tr>
</table>
</body>
</html>
<xml>
<root>
  <action>ADD</action>
  <boGroup>
    <key/>
    <description/>
  </boGroup>
</root>
</xml>
</html>
```

HTML rendered.



Description enter description here

## Configure a Chart

The following HTML attributes are used to configure a graphical representation of an XML list. The designer can control the type, size, position, and contents of the chart using the following attributes.

**oraChart="type:pie, stacked, cluster, line, area, combo ;"**

This attribute defines the type of graph to display and its general configuration. The set of configuration parameters available for this attribute are as follows:

Parameter	Values	Description
<b>type:</b>	<b>pie</b>	Defines the type of chart to display.
	<b>stacked</b>	Required
	<b>cluster</b>	
	<b>line</b>	
	<b>area</b>	
	<b>combo</b>	
<b>showLegend</b>	<b>true</b>	Defines if the chart should have a legend displayed.
	<b>false</b>	Optional (default is <b>true</b> )
<b>legendPosition</b>	<b>left</b>	Defines where the legend should appear.
	<b>right</b>	Optional (default is <b>right</b> )
	<b>bottom</b>	Setting position to <b>left</b> or <b>right</b> will automatically render it vertically.
	<b>top</b>	Setting position to <b>top</b> or <b>bottom</b> will automatically render it horizontally.
<b>legendBorder</b>	<b>true</b>	Defines if the legend should display with a border around it.
	<b>false</b>	Optional (default is <b>false</b> )
<b>depth</b>	<b>true</b>	A value of <b>true</b> indicates a 3 dimensional depth for the chart.
	<b>false</b>	Optional (default <b>false</b> , which is a 2 dimensional chart)
<b>animate</b>	<b>true</b>	A value of <b>true</b> indicates that the graph should animate when displayed.
	<b>false</b>	Optional (default is <b>true</b> ). When using large data sets, consider disabling animation.
<b>dataCursor</b>	<b>on</b>	A value of <b>on</b> enables hovering anywhere in the graph.
	<b>off</b>	Optional (default is <b>off</b> ). It is not applicable to pie charts.
<b>orientation</b>	<b>horizontal</b>	Defines the chart orientation. This only applies to bar, line, area, combo charts.

Parameter	Values	Description
		E.g., <b>oraChart="type:cluster; orientation:horizontal"</b> , defines horizontal cluster chart.  Optional (default is vertical).

The **oraChartSeries** attribute defines the source information for the graph. There are 5 of these attributes:

- **oraChartSeries1**
- **oraChartSeries2**
- **oraChartSeries3**
- **oraChartSeries4**
- **oraChartSeries5**

Stacked charts support an unlimited number of series by continuing to add attributes **oraChartSeries6** and above, but beware of performance implications and memory limits when using an excessively high number of series.

All attributes are identical in format and accept the same parameters, as described below.

**NOTE:** All the charts require **oraChartSeries1**. Stacked, Cluster and Line charts may optionally include the additional series attributes (for multiple bars/lines).

If you define multiple series, then data must be provided for all series defined. The data amounts can be 0 (zero) but they have to be present in order for the chart to display correctly.

The set of configuration parameters available for the **oraChartSeriesN** attribute are:

Parameter	Values	Description
<b>list:</b>	XPath value	Defines the XPath to the list in the XML that contains the data to chart.  Required
<b>amount:</b>	XPath value	Defines the XPath to the element in the XML list that contains the amount to chart.  Required
<b>xaxis:</b>	XPath value	Defines the XPath to the element in the XML list that contains the x-axis data.  Required for Stacked, Cluster, Line, Area and Combo charts.
<b>xaxisFormat:</b>	<b>date</b> <b>dateTime</b> <b>time</b> <b>localDate</b> <b>string</b>	Defines the x-axis data format.  If it is <b>date</b> , <b>dateTime</b> or <b>time</b> then the value is presented in the format as defined on the <a href="#">user's</a> display profile.  In case of <b>localDate</b> or <b>string</b> the data is displayed as is with no special formatting.  Optional (Default is <b>date</b> ).
<b>label:</b>	Text value	Defines the label for the amount being charted.  Either this setting or <b>labelPath</b> : must be defined.

Parameter	Values	Description
<b>labelPath:</b>	XPath value	<p>Defines the XPath to the element that provides the label for the amount being charted.</p> <p>Either this setting or <b>label:</b> must be defined.</p>
<b>currency:</b>	A valid Currency code	<p>Defines the currency code for the amount being charted.</p> <p>Optional.</p>
<b>currencyPath:</b>	XPath value	<p>Defines the XPath to the element that provides the currency code for the amount being charted.</p> <p>Optional.</p>
<b>hoverText:</b>	Text value	<p>Defines the hover text for the chart element.</p> <p>Optional (A default hover text is always available.) Ignored if <b>hoverTextPath:</b> is defined.</p> <p>The following substitution variables are available.</p> <ul style="list-style-type: none"> <li>• <b>\$label</b> This will be replaced with the label text as determined by the <b>label:</b> or <b>labelPath:</b> setting.</li> <li>• <b>\$amount</b> This will be replaced with the amount text as specified by the <b>amount:</b> setting.</li> <li>• <b>\$axis</b> This will be replaced with the x-axis text.</li> <li>• <b>\$%</b> This will be replaced by the percentage "slice" of the pie or bar.</li> <li>• <b>\$newline</b> This will be force a line break.</li> </ul> <p>If the hover text defined contains any of the above values, they will be replaced by the equivalent text prior to being displayed.</p> <p>Example:</p> <pre>"hoverText : \$label \$newline \$amount "</pre>
<b>hoverTextPath:</b>	XPath value	<p>Defines the XPath to the element that provides the hover text for the chart element.</p> <p>The hover text in the XML can utilize all the substitution functionality described above in the <b>hoverText:</b> description.</p> <p>Optional.</p>
<b>type:</b>	<b>bar</b> <b>line</b> <b>area</b>	<p>This attribute is used for the <b>combo</b> chart type only. It defines how each series on the <b>combo</b> chart should be presented.</p>

Parameter	Values	Description
		<p>The following example defines a <b>combo</b> chart where one series is rendered as bars and another one as area.</p> <pre>oraChart="type:combo;" oraChartSeries1="list:set; xaxis:date; label:Charge; amount:amount; type:bar" oraChartSeries2="list:set; xaxis:date; label:Balance; amount:balance; type:area"</pre>
<b>navOpt:</b>	A valid Navigation Option code.	<p>Defines a navigation option to be activated when the chart element is clicked.</p> <p>Optional.</p>
<b>navOptPath:</b>	XPath value	<p>Defines the XPath to a navigation option to be activated when the chart element is clicked.</p> <p>Optional</p> <p>Note that both <b>navOpt:</b> and <b>navOptPath:</b> may be configured. The XPath navigation option is processed first. If a value is found it is used, otherwise the value in the <b>navOpt:</b> setting is used. This means that the HTML can define a "default" navigation option and a navigation option present in the XML document will override it.</p>
<b>key:</b>	XPath value	<p>Defines the XPath to an XML element in the series list that contains the key field data to be used in a navigation option.</p> <p>This is required if either <b>navOpt:</b> or <b>navOptPath:</b> is defined.</p> <p><b>NOTE:</b> Only one key field can be configured for a navigation option.</p>
<b>script:</b>	A BPA script name	<p>Defines a BPA script to be activated when the chart element is clicked.</p> <p>Optional</p> <p>When a script is executed, all the elements from that list item will be made available to the script as temporary variables.</p>
<b>scriptPath:</b>	XPath value	<p>Defines the XPath to a BPA script to be activated when the chart element is clicked.</p> <p>Optional</p> <p>Note that both <b>script:</b> and <b>scriptPath:</b> can be configured. The XPath script option is processed first. If a value is found it is used, otherwise the value in the <b>script:</b> setting is used. This means that the HTML can define a default script and a script present in the XML document will override it.</p>
<b>color:</b>	HTML Color code / RGB value	<p>Defines the color for the series. The format is valid HTML color code, e.g. <b>green</b>, <b>red</b> or</p>

Parameter	Values	Description
		<p><b>black</b>. All valid color names are defined in this link: <a href="http://www.w3schools.com/html/html_colornames.asp">http://www.w3schools.com/html/html_colornames.asp</a>.</p> <p>Alternatively an RGB format may be used. (<b>FF0000</b> is red, <b>00FF00</b> is green and <b>0000FF</b> is blue)</p> <p>Optional (default colors applied)</p>
<b>colorPath:</b>	XPath value	<p>Defines the XPath to a color for the series. The valid format as described in the <b>color:</b> setting apply.</p> <p>Optional (default colors applied)</p>
<b>pieColors:</b>	HTML color code / RGB values	<p>Defines the colors for the pie series. Any number of HTML color codes or RGB color values can be specified, separated by spaces.</p> <p>Examples:</p> <pre>pieColors: red green black pieColors: FF0000 00FF00</pre> <p>Optional (default colors applied if the series exceeds the values specified)</p>

### oraChartBroadcast="FIELD\_NAME:XPath;"

A chart configured in a map zone can be set to broadcast portal context. An unlimited number of fields can be broadcast, configured as name/value pairs, as follows:

1. FIELD\_NAME: the name of the portal context field to be broadcast.
2. XPath: the XML schema element from the same list item that corresponds to the user selected chart segment and contains the data value to be broadcast.

### Graph Examples

- Sample of a pie chart configuration:

```
<html>
<head>
<title>Pie Chart</title>
</head>
<body>

<div style="width:100%; height:290px;"
  oraChart="type:pie;"
  oraChartSeries1="list:set; labelPath:date; amount:amount; "
  oraChartBroadcast="BILL_ID:billId;">
</div>

</body>

<xml>
<root>
  <set>
<date>05-02-2003</date>
<amount>163.24</amount>
<billId>592211649441</billId>
  </set>
  <set>
<date>06-02-2003</date>
<amount>97.29</amount>
```

```

<billId>592211649442</billId>
  </set>
  <set>
<date>07-02-2003</date>
<amount>54.38</amount>
<billId>592211649443</billId>
  </set>
</root>
</xml>
</html>

```

- A pie chart rendered for a single series:

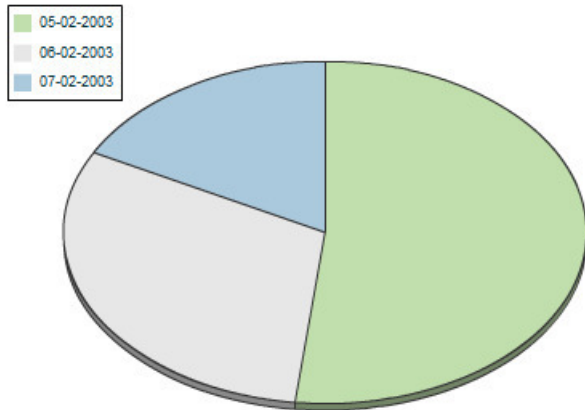

- Sample of a line, cluster, or stacked graph configuration - each with two series:

```

<html>
<head>
<title>Stacked Chart</title>
</head>
<body>

<div style="width:100%; height=300px;"
  oraChart="type:line;"
  oraChartSeries1="list:set; xaxis:date; label:Charge; amount:amount; "
  oraChartSeries2="list:set; xaxis:date; label:Balance; amount:balance; "
  oraChartBroadcast="BILL_ID:billId;">
</div>

<div style="width:100%; height=300px;"
  oraChart="type:cluster;"
  oraChartSeries1="list:set; xaxis:date; label:Charge; amount:amount; "
  oraChartSeries2="list:set; xaxis:date; label:Balance; amount:balance; "
  oraChartBroadcast="BILL_ID:billId;">
</div>

<div style="width:100%; height=300px;"
  oraChart="type:stacked;"
  oraChartSeries1="list:set; xaxis:date; label:Charge; amount:amount; "
  oraChartSeries2="list:set; xaxis:date; label:Balance; amount:balance; "
  oraChartBroadcast="BILL_ID:billId;">
</div>

</body>

<xml>
<root>
  <set>
<date>05-02-2003</date>
<amount>163.24</amount>
<balance>163.24</balance>
<billId>592211649441</billId>
  </set>
  <set>

```

```
<date>06-02-2003</date>
<amount>97.29</amount>
<balance>260.53</balance>
<billId>592211649442</billId>
  </set>
  <set>
<date>07-02-2003</date>
<amount>54.38</amount>
<balance>314.91</balance>
<billId>592211649443</billId>
  </set>
</root>
</xml>
</html>
```

- Three types of chart rendered for two series each: line, cluster, and stacked.

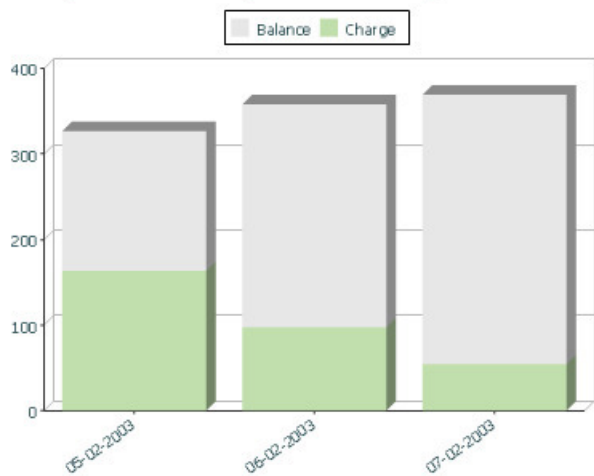
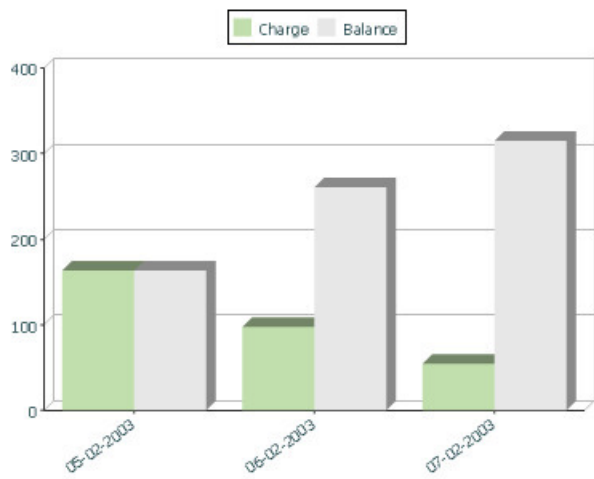
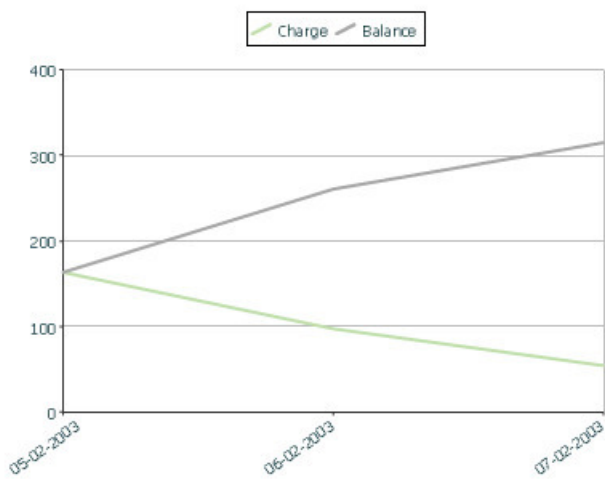

## Upload and Download a CSV File

The following HTML attributes can be used to manage both an upload and a download between a list defined within the map's schema and a CSV (comma separated value) file.

The syntax is `oraUploadData="type:embed;path:list xpath;useLabels:true;showCount:true"`



Upload configuration requires you to name a CSV file to be uploaded, and an XML list as target. By convention, each CSV row will create a separate list instance. Each comma-separated field in the file will be uploaded as a separate element in the list. To embed an upload dialog within a map, the **oraUploadData** attribute must be associated with a container element such as a div, td, or span.

The optional **useLabels:true** value indicates that while parsing the upload CSV file, the headers are expected to be labels

---

**NOTE:** If you do not specify the **useLabels:true** value and the XML target element name is "camelCase" then the corresponding spreadsheet header should be title case with a space between words, e.g.;"Camel Case". Letters and special characters are not considered a different word, for example Address1 must be uploaded into the target XML element address1.

---

Specifying the optional **showCount:true** value will display the number of records uploaded.

---

**CAUTION:** If you are using a grid in conjunction with the **oraUploadData** function, then you must maintain the grid's list with a 'replace' business object action. Refer to [BO Replace Action](#) for more information.

---

Sample of **oraUploadData="embed"** within a div element.

```
<html>
<head>
  <title>File Upload</title>
</head>
<body>

  <div oraUploadData="type:embed;path:myList" > </div>

</body>

<xml>
<root>
  <myList>
<id>838383930</id>
  <name>Janice Smith</name>
  </myList>
  <myList>
<id>737773730</id>
  <name>Bill McCollum</name>
  </myList>
</root>
</xml>
</html>
```

This file upload dialog will be embedded into the body of the page where the oraUploadData is defined.

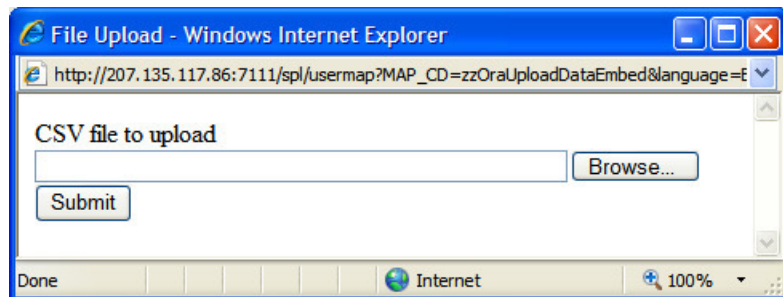

**oraUploadData="type:popup;path:list xpath;useLabels:true;showOk:true;showCount:true"**

Upload configuration requires you to name a CSV file to be uploaded, and an XML list as target. By convention, each CSV row will create a separate list instance. Each comma-separated field in the file will be uploaded as a separate element in the list. To upload a CSV file using a pop-up dialog, the oraUploadData attribute must be associated with an input element such as a button, text link, or image.

The optional useLabels:true value is used to indicate that while parsing the upload CSV file, the headers are expected to be labels

**NOTE:** If you do not specify the useLabels:true value and the XML target element name is "camelCase" then the corresponding spreadsheet header should be title case with a space between words, e.g., "Camel Case". Letters and special characters are not considered a different word, for example Address1 must be uploaded into the target XML element address1.

Specifying the optional showOk:true value will display an "Ok" button once the upload finishes. The popup will stay open until the button is pressed. Additionally, specifying the showCount:true value will display number of records uploaded.

**CAUTION:** If you are using a grid in conjunction with the **oraUploadData** function, then you must maintain the grid's list with a 'replace' business object action. Refer to [BO Replace Action](#) for more information.

Sample of oraUploadData="popup" associated with a button:

```
<html>
<head>
  <title>File Upload</title>
</head>
<body>
  <input type="button" name="submitButton" oraUploadData="type:popup;path:myList;" value='Get Data'>
  <table oraList="myList">
    <tr/>
    <tr>
<td><span oraField="id"/></td>
<td><span oraField="name"/></td>
    </tr>
  </table>
</body>
<xml>
<root>
  <myList>
<id>838383930</id>
  <name>Janice Smith</name>
  </myList>
  <myList>
<id>737773730</id>
  <name>Bill McCollum</name>
  </myList>
</root>
</xml>
</html>
```

HTML Rendered:

838383930 Janice Smith

737773730 Bill McCollum

Pressing the "Get Data" button will launch a standard file upload dialogue (provided by Framework) as shown below.

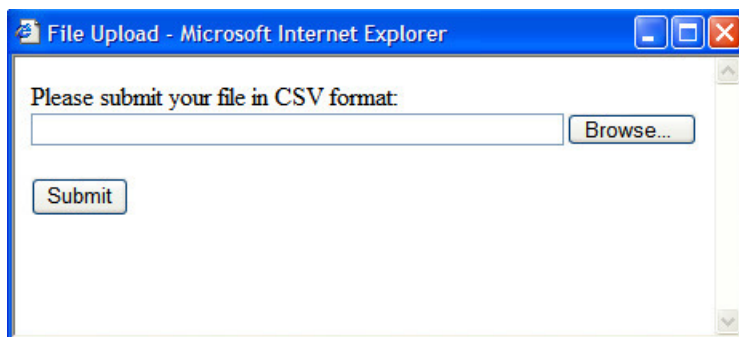

## oraDownloadData="list xpath"

Download configuration requires you to name an XML list to be downloaded. By convention, each list instance will represent a separate row in the created file. By default every element of the list will be comma separated in the file.

---

**NOTE:** The number formatting is based on the user profile setting. For localities where the decimal symbol is a comma, an implementation may configure a property setting (`spl.csv.delimiter.useFromDisplayProfile=true`) to cause the system to use a semicolon as the delimiter that separates the elements rather than a comma.

---

Sample of oraDownloadData.

```
<html>
<head>
<title>File Download</title></head>
<body>
<input type="button" name="downloadButton" oraDownloadData="myList" value="Download" />
</body>
<xml>
<root>
  <myList>
    <id>881-990987</id>
    <name>John Mayweather</name>
  </myList>
  <myList>
    <id>229-765467</id>
    <name>Anna Mayweather</name>
  </myList>
  <myList>
    <id>943-890432</id>
    <name>Andrew Brewster</name>
  </myList>
</root>
</xml>
</html>
```

HTML Rendered:

Download

Pressing the "Download" button will launch a standard file download dialogue (provided by Framework) as shown below.

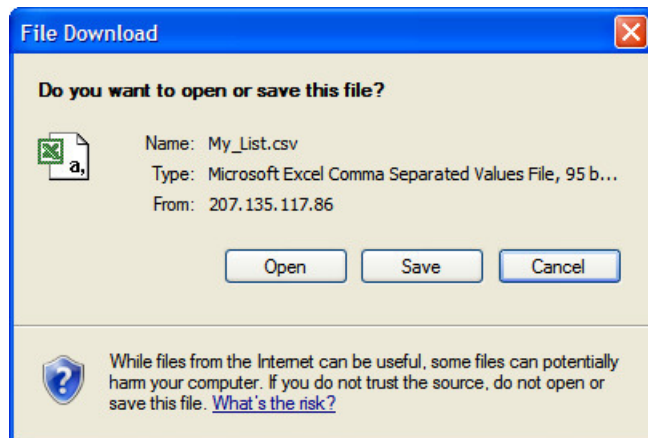

A successful download will result in a CSV file:

	A	B	C
1			
2	Id	Name	
3	881-99098	John Mayweather	
4	229-76546	Anna Mayweather	
5	943-89043	Andrew Brewster	
6			

To download data from a sub list use the attribute `oraDownloadDataInList` instead of `oraDownloadData`. The attribute `oraDownloadDataInList` will have the sub list name. The XPath of the sub list is used to pick data of the specific row from the parent list. Thus only the specific sub list is downloaded.

### **`oraDownloadDataUseLabels="true"`**

The `oraDownloadDataUseLabels` attribute can be used in conjunction with the `oraDownloadData` attribute described above. Specify `oraDownloadDataUseLabels` if you want the generated CSV file to use the element labels for columns headers rather than element names.

## **Construct Portal Zone Map Fragments**

Portal zones can reference a UI map for the zone header and filter area. This UI map is not a complete HTML document, but is instead configured as a UI Map fragment. When constructing a zone map fragment you can reference the following substitution variables. Note that these variables will be dynamically populated at run time with information particular to the map's zone within the portal:

<b>Variable</b>	<b>Replacement Logic</b>
<b>[\$ZONEDESCRIPTION]</b>	Zone's description text.
<b>[\$SEQUENCEID]</b>	Zone's sequence ID.
<b>[\$ZONENAME]</b>	Zone's name.
<b>[\$HELPTEXT]</b>	Zone's help text.
<b>[\$ZONEPARAMNAME]</b>	Zone parameter's value (or blank if it has not been specified).

### **WARNING:**

- Refer to one of the following maps as examples: F1-UIMapHeader and F1-ExplorerHeader.
- These maps make use of the [oraInclude](#) tag to incorporate HTML fragments for the header menu and framework actions. Refer to the zone type parameters for the UI Map fragments you should include in your HTML.
- If you wish to have the "help text" icon appear next to your zone description, you should have `id="title_[$SEQUENCEID]"` on the `<td>` that contains your description.
- If it is necessary to encapsulate JavaScript within a UI Map fragment, it will be necessary to bound the JavaScript within a `![CDATA[ ]]` tag to ensure a valid XML document. Note that the tags themselves may need to be commented out to promote compatibility with older browsers. For example:

```
<script type="text/javascript">
  /*![CDATA[ */
  //
  //javascript
  //
  /*]]> */
</script>
```

**NOTE:** If you wish to preserve the values of a filter input field, within a filter map fragment, for the framework 'Go Back' and 'Go Forward' functionality, you must associate the input field (text box, select, etc.) with a unique HTML id. Input field values associated with a unique id will be captured in the framework's 'memento'. The 'memento' is used to rebuild the input map when the portal zone is navigated to using the 'Go Back' or 'Go Forward' functionality.

**NOTE:** Many specialized functions exist to manipulate zone behavior, for example:

- **oraGetZoneSequence(zoneName).** Uses the zone's code to retrieve its sequence number.
- **oraIsZoneCollapsed(sequenceId).** Uses the zone's sequence to determine if collapsed.
- **oraHandleCollapse(seq).** Collapse a zone.
- **oraHandleExpand(seq,refresh).** Expand and/or refresh a zone.

All of these, and many more functions, are located within the JavaScript library [userMapSupport.js](#) described below.

**NOTE:** When executing oraLoad within a fragment UI map, and you need to execute a JavaScript function during page load (where the function invokes a business object, business service, or service script) you can use the special syntax "oraLoad[\$SEQUENCEID]". Refer to the [Load Page Event](#) section for more information.

Example of oraLoad[\$SEQUENCEID] used within a function:

```
<script type="text/javascript">
function oraLoad[$SEQUENCEID]() {
checkRebateClaimStatus();
}

function checkRebateClaimStatus() {
    var work = id('analyticsFilterText[$SEQUENCEID]',
document).cells[0].innerText.split(' ');
    var rebateClaimId = work[work.length - 3];
    id('rebateClaimId', document).value = rebateClaimId;
oraInvokeSS('C1-CheckRCSt','checkRebateClaimStatus', false);
    var statusIndicator = id('statusInd', document).value;
    if (statusIndicator == 'C1PE' || statusIndicator == 'C1ID') {
        id('addRebateClaimLine', document).style.display = '';
    } else {
id('addRebateClaimLine', document).style.display = 'none';
    }
}
</script>
```

**F1-ExplorerHeader** rendered:

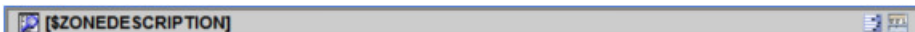

## Invoking a Business Object

The oraInvokeBO function may be used within a portal zone header or zone filter map. It is similar to the command described in [Invoke BO Function](#) which allows for a business object to be invoked within the UI map's HTML. Refer to that section for a description of the first three parameters.

Syntax	Parameters	Comments
oraInvokeBO( )	'BO Name'	
	'XPath' or null	
	'action'	
	null	This must be specified as the fourth argument.
	<b>[\$SEQUENCEID]</b>	This must be specified as the fifth argument.

Syntax	Parameters	Comments
	<b>true   false</b>	Specify <b>true</b> if the fragment is used within a portal zone header. Specify <b>false</b> if the fragment is used with a zone filter map.

Example in a portal zone header:

```
oraInvokeBO('CM-User','xmlGroup','read', null, [SEQUENCEID], true)
```

## Invoking a Business Service

The oraInvokeBS function may be used within a portal zone header or zone filter map. It is similar to the command described in [Invoke BS Function](#) which allows for a business service to be invoked within the UI map's HTML. Refer to that section for a description of the first two parameters.

Syntax	Parameters	Comments
<b>oraInvokeBS( )</b>	'BO Name'	
	'XPath' or <b>null</b>	
	<b>null</b>	This must be specified as the fourth argument.
	<b>[SEQUENCEID]</b>	This must be specified as the fifth argument.
	<b>true   false</b>	Specify <b>true</b> if the fragment is used within a portal zone header. Specify <b>false</b> if the fragment is used with a zone filter map.

Example in a portal zone header:

```
oraInvokeBS('CM-UserSearch','xmlGroup', null, [SEQUENCEID], true)
```

## Invoking a Service Script

The oraInvokeSS function may be used within a portal zone header or zone filter map. It is similar to the command described in [Invoke SS Function](#) which allows for a service script to be invoked within the UI map's HTML. Refer to that section for a description of the first two parameters.

Syntax	Parameters	Comments
<b>oraInvokeSS( )</b>	'Service Script Name'	
	'XPath' or <b>null</b>	
	<b>null</b>	This must be specified as the fourth argument.
	<b>[SEQUENCEID]</b>	This must be specified as the fifth argument.
	<b>true   false</b>	Specify <b>true</b> if the fragment is used within a portal zone header. Specify <b>false</b> if the fragment is used with a zone filter map.

Example in a portal zone header:

```
oraInvokeSS('UserSearch','xmlGroup', null, [SEQUENCEID], true)
```

## Hiding Portal Tabs

The product provides the ability to use JavaScript to hide a tab on the current portal based on some condition using the oraAuthorizeTab JavaScript API. This API accepts a function as a parameter and turns off the tab index indicated.

For example, the UI Map may have a function to turn off one or more tab indexes.:

```
function overrideTabIndex(index){
  if (index == 2) return false;
  if (index == 3) return false;
}
```

The JavaScript is referenced “on load”:

```
<body class="oraZoneMap"
onLoad="oraAuthorizeTabs(overrideTabIndex);">
```

## Required JavaScript Libraries

All of the functionality described in this document depends on a pair of JavaScript libraries. If you are writing and executing your maps entirely within the UI map rendering framework - you do not need to manually insert the following libraries - the framework will insert them for you when the UI Map is rendered.

---

**WARNING:** When executing HTML outside of the framework you must include the following references explicitly within your HTML. In addition, the tool you use to render the HTML must have access to a physical copy of `privateUserMapSupport.js` for bind support.

---

```
src="privateUserMapSupport.js"
```

Your HTML document must reference this library to execute binding in a stand-alone environment.

---

**WARNING:** Referencing functions within this JavaScript library is dangerous - because these functions are owned by framework and they may be changed during version upgrade or via the normal patch process.

---

```
<script type="text/javascript" src="privateUserMapSupport.js"></script>
```

```
src="userMapSupport.js"
```

To take advantage of optional toolset features, you must reference this library.

---

**NOTE:** You can reference the functions within this JavaScript library to write custom functions within the UI map..

---

```
<script type="text/javascript" src="userMapSupport.js"></script>
```

```
onload="oraInitializeUserMap();"
```

To execute binding in a stand-alone environment, you must embed the following onload function into the `<body>` node.

```
<body onload="oraInitializeUserMap();">
```

## UI Map Standards

### Contents

- [Basic UI Map Templates](#)
- [Basic HTML and Styles](#)
- [Grids \(Tables of Data\)](#)
- [Action Buttons](#)
- [Available Styles](#)

### Basic UI Map Templates

All UI Maps share the same basic structure regardless of placement (page area, zone, pop-up) or usage (display only, input).

## Sample XML

All information in this document is based upon the following XML structure.

```
<xml>
  <root>
    <address>123 Main St</address>
    <city>Alameda</city>
    <state>CA</state>
    <zip>94770</zip>
    <contactInformation>
      <type>Home Phone</type>
      <number>510-555-2287</number>
    </contactInformation>
    <contactInformation>
      <type>Cell Phone</type>
      <number>510-555-4285</number>
    </contactInformation>
  </root>
</xml>
```

## Display Only UI Map

```
<html>
<head>
  <title oraMdLabel="ADDRESS_LBL"></title>
  <link rel="stylesheet" type="text/css" href="cisDisabled.css"/>
  <link rel="stylesheet" type="text/css" href="cisEnabled.css"/>
</head>
<body class="oraZoneMap">
<table cellpadding="4" cellspacing="4" width="100%">
  <colgroup>
    <col class="oraLabel oraTableLabel" />
    <col class="oraNormal oraTableData" />
  </colgroup>
  <tr>
    <td oraLabel="address"></td>
    <td oraField="address"></td>
  </tr>
  <tr>
    <td oraLabel="city"></td>
    <td oraField="city"></td>
  </tr>
  <tr>
    <td oraLabel="state"></td>
    <td oraField="state"></td>
  </tr>
  <tr>
    <td class="oraSectionEnd" oraLabel="zip"></td>
    <td class="oraSectionEnd" oraField="zip"></td>
  </tr>
  <tr>
    <td colspan="2" class="oraSectionHeader" oraMdLabel="CONTACT_LBL"></td>
  </tr>
  <tr>
    <td colspan="2" class="oraSectionStart oraEmbeddedTable">
      <table oraList="contactInformation" cellpadding="2">
        <thead >
          <tr>
            <th class="oraGridColumnHeader" nowrap="nowrap">
              <span oraLabel="contactInformation/type"></span>
            </th>
            <th class="oraGridColumnHeader" nowrap="nowrap">
              <span oraLabel="contactInformation/number"></span>
            </th>
          </tr>
        </thead >
        <tbody>
          <tr>
            <td class="oraNormalAlt oraDisplayCell">
              <span oraField="type"></span>
```



```

                </td>
                <td class="oraNormal oraDisplayCell">
                    <span oraField="number"></span>
                </td>
            </tr>
        </tbody>
    </table>
</td>
</tr>
</table>
</body>
</html>
<xml>
    <root>
        <address>123 Main St</address>
        <city>Alameda</city>
        <state>CA</state>
        <zip>94770</zip>
        <contactInformation>
            <type>Home Phone</type>
            <number>510-555-2287</number>
        </contactInformation>
        <contactInformation>
            <type>Cell Phone</type>
            <number>510-555-4285</number>
        </contactInformation>
    </root>
</xml>
</html>

```

## Input UI Map

```

<html>
<head>
    <title oraMdLabel="ADDRESS_LBL"></title>
    <link rel="stylesheet" type="text/css" href="cisDisabled.css"/>
    <link rel="stylesheet" type="text/css" href="cisEnabled.css"/>
</head>
<body>
<table width="100%" cellpadding="12">
    <tr class="oraErrorText">
        <td><a href="" onclick="oraShowErrorAlert(); return false;">
            <span class="oraErrorText" oraErrorVar="ERRMSG-TEXT"></span></a>
        </td>
    </tr>
</table>
<table cellpadding="4" cellspacing="4" width="100%">
    <colgroup>
        <col class="oraLabel oraTableLabel" />
        <col class="oraNormal oraTableData" />
    </colgroup>
    <tr>
        <td oraLabel="address"></td>
        <td><input type="text" oraField="address"/></td>
    </tr>
    <tr>
        <td oraLabel="city"></td>
        <td><input type="text" oraField="city"/></td>
    </tr>
    <tr>
        <td oraLabel="state"></td>
        <td><input type="text" oraField="state"/></td>
    </tr>
    <tr>
        <td oraLabel="zip"></td>
        <td><input type="text" oraField="zip"/></td>
    </tr>
    <tr>
        <td colspan="2" class="oraSectionHeader" oraMdLabel="CONTACT_LBL"></td>
    </tr>
    <tr>
        <td colspan="2" class="oraSectionStart oraEmbeddedTable">
            <table oraList="contactInformation" cellspacing="2">

```

```

        <thead >
            <tr>
                <th class="oraGridColumnHeaderButton"></th>
                <th class="oraGridColumnHeaderButton"></th>
                <th class="oraGridColumnHeader" nowrap="nowrap">
                    <span oraLabel="contactInformation/type"></span>
                </th>
                <th class="oraGridColumnHeader" nowrap="nowrap">
                    <span oraLabel="contactInformation/number"></span>
                </th>
            </tr>
        </thead >
        <tbody>
            <tr>
                <td oraType="addGridRow"></td>
                <td oraType="deleteGridRow"></td>
                <td>
                    <input type="text" oraField="type"/>
                </td>
                <td>
                    <input type="text" oraField="number"/>
                </td>
            </tr>
        </tbody>
    </table>
</td>
</tr>
<tr>
    <td colspan="2" class="oraSectionStart oraEmbeddedTable">
        <table cellspacing="2">
            <tr>
                <td>
                    <input class="oraButton" oraMdLabel="Cl_SAVE_LBL" type="button"
                        onClick="oraSubmitMap('OK');"/>
                </td>
                <td>
                    <input class="oraButton" oraMdLabel="CANCEL_LBL" type="button"
                        onClick="oraSubmitMap('CANCEL',false);"/>
                </td>
            </tr>
        </table>
    </td>
</tr>
</table>
</body>
<xml>
    <root>
        <address>123 Main St</address>
        <city>Alameda</city>
        <state>CA</state>
        <zip>94770</zip>
        <contactInformation>
            <type>Home Phone</type>
            <number>510-555-2287</number>
        </contactInformation>
        <contactInformation>
            <type>Cell Phone</type>
            <number>510-555-4285</number>
        </contactInformation>
    </root>
</xml>
</html>

```

## Basic HTML and Styles

The basic templates introduced the standard HTML and styles used for UI Maps. These standards are described individually in the following sections.

## Stylesheets

The styles to apply the standard look to the maps are all contained in stylesheets. These stylesheets should be included in all UI Maps.

```
...
<link rel="stylesheet" type="text/css" href="cisDisabled.css"/>
<link rel="stylesheet" type="text/css" href="cisEnabled.css"/>
...
```

## Title

Each UI Map should have a <title> tag.

```
...
<title oraMdLabel="ADDRESS_LBL"></title>
...
```

This will give the UI Map a descriptive title.

- If the UI Map is presented in a "pop-up", the title will be in the window title bar.
- If the UI Map is presented in the page area, the title will be added as a <span> tag to the UI Map and will appear at the top of the UI Map.
- If the UI Map is presented as a zone map, it will be ignored. The <title> tag should still be included in the HTML as standard.

## Zone Maps

When the map is presented in a zone as part of a portal, the UI Map should have a border so that the information is "contained" within the zone.

```
...
<body class="oraZoneMap">
...
```

## Page Area Maps vs Pop-Up Maps

The presentation of the UI Maps can vary from design to design. The following standards have been applied to decide when to use a Page Area UI Map and when to use a Pop-Up Map:

- If there are multiple UI Maps in the sequence, always use the Page Area.
- If the UI Map has many input fields, always use a Page Area.
- If the UI Map is a "confirmation" type dialog or only has one or two input fields, use a Pop-Up.

---

**NOTE:** The difference between "just a few input fields" and "many input fields" can be discretionary. The final decision should rest with the dialog designer.

---

## Error Messages

Input maps have a ability to present error messages to the User.

```
...
<table width="100%" cellpadding="12">
  <tr class="oraErrorText">
    <td><a href="" onclick="oraShowErrorAlert(); return false;">
      <span class="oraErrorText" oraErrorVar="ERRMSG-TEXT"></span></a></td>
    </tr>
</table>
...
```

This HTML structure provides the necessary elements and functions to display errors to the User. It should be directly after the <body> tag. When there is no error, nothing will be visible on the UI Map. It will be made visible if

an error occurs and the UI Map is re-presented to the User. Clicking on the link (when visible) will result in a pop-up alert appearing with the long error message text.

## Standard Layout and Styles

The information is presented on the UI Map by using a `<table>` to organize the information in rows and columns.

```
...
<table cellpadding="4" width="100%">
<colgroup>
<col class="oraLabel oraTableLabel" />
  <col class="oraNormal oraTableData" />
</colgroup>
...
```

The `<colgroup>` and `<col>` tags allow for the application of classes to the columns (the label is in the first column and the data is in the second column.). Using these tags mean that the class attribute (to apply styles) does not need to be defined on every `<td>`.

## Grids (Tables of Data)

A UI Map could contain information that is best presented as a grid. These are referred to as "Embedded Tables". The embedded table can be used to display information or input information.

### Example Embedded Table HTML

The embedded table will be included within a row (`<tr>`) of the basic layout:

```
...
<tr>
  <td colspan="2" class="oraEmbeddedTable">
    <table oraList="contactInformation" cellpadding="2">
      <thead >
        <tr>
          <th class="oraGridColumnHeader" nowrap="nowrap">
            <span oraLabel="contactInformation/type"></span>
          </th>
          <th class="oraGridColumnHeader" nowrap="nowrap">
            <span oraLabel="contactInformation/number"></span>
          </th>
        </tr>
      </thead >
      <tbody>
        <tr>
          <td class="oraNormalAlt oraDisplayCell">
            <span oraField="type"></span>
          </td>
          <td class="oraNormal oraDisplayCell">
            <span oraField="number"></span>
          </td>
        </tr>
      </tbody>
    </table>
  </td>
</tr>
...
<xml>
  <root>
    <address> 123 Main St</address>
    <city>Alameda</city>
    <state>CA</state>
    <zip>94770</zip>
    <contactInformation>
      <type>Home Phone</type>
      <number>510-555-2287</number>
    </contactInformation>
    <contactInformation>
      <type>Cell Phone</type>
      <number>510-555-4285</number>
    </contactInformation>
  </root>
</xml>
```

```
</root>  
</xml>
```

## Embedding the Table

The embedded table is included within the overall table structure. The `colspan` attribute ensures that the embedded table can span the standard two columns of the overall layout table.

```
...  
<tr>  
  <td colspan="2" class="oraEmbeddedTable">  
    ...  
    ...  
    ...  
  </td>  
</tr>  
...
```

## Embedded Table Structure

The embedded table is very similar to the basic layout table.

```
...  
<table oraList="contactInformation" cellpadding="2">  
<thead>  
  ...  
  ...  
</thead>  
<tbody>  
  ...  
  ...  
</tbody>  
</table>  
...
```

- The `<table>` tag has a slightly smaller cellpadding and it defines the "list" element contained in the XML that will be used to provide the data.
- The `<thead>` element is used to give the embedded table headings for the columns.
- The `<tbody>` element is the element that will be repeated for each referenced "list" element in the XML. In the previous example, there are two "contactInformation" list elements, so the displayed embedded table will have two rows.

## Column Headings

Embedded tables should have headings for the displayed columns. The `<thead>` tag defines these.

```
...  
<thead>  
  <tr>  
    <th class="oraGridColumnHeader" nowrap="nowrap">  
      <span oraLabel="contactInformation/type"></span>  
    </th>  
    <th class="oraGridColumnHeader" nowrap="nowrap">  
      <span oraLabel="contactInformation/number"></span>  
    </th>  
  </tr>  
</thead>  
...
```

The "nowrap" attribute prevent the column heading from taking multiples lines. If multiples lines are required, the "nowrap" may be removed.

## Input Fields

Embedded tables may be used for input as well as display only. The framework provides a convenient control to assist in the creation of editable embedded tables.

```
...
```

```

<tr>
  <td colspan="2" class="oraEmbeddedTable">
    <table oraList="contactInformation" cellspacing="2">
      <thead >
        <tr>
          <th class="oraGridColumnHeaderButton"></th>
          <th class="oraGridColumnHeaderButton"></th>
          <th class="oraGridColumnHeader" nowrap="nowrap">
            <span oraLabel="contactInformation/type"></span>
          </th>
          <th class="oraGridColumnHeader" nowrap="nowrap">
            <span oraLabel="contactInformation/number"></span>
          </th>
        </tr>
      </thead >
      <tbody>
        <tr>
          <td oraType="addGridRow"></td>
          <td oraType="deleteGridRow"></td>
          <td>
            <input type="text" oraField="type"/>
          </td>
          <td>
            <input type="text" oraField="number"/>
          </td>
        </tr>
      </tbody>
    </table>
  </td>
</tr>
...

```

There are two new columns added to the input embedded table.

- `oraType="addGridRow"` will add a "+" button to the row. This will allow the User to add an additional row to the existing grid.
- `oraType="deleteGridRow"` will add a "-" button to the row. This will allow the User to delete an existing row from the grid.

---

**NOTE:** The `<thead>` tag also requires these two new columns to be added.

---

These controls are, as standard, placed at the beginning of the row in the order shown. Either of the controls may be omitted if required (if, for example, Users are not permitted to delete information).

The presence of either of these controls will activate the "empty list" process. This means that if the XML has no data for the "list" specified, the input grid will display with an empty row ready for the input of new information.

## Action Buttons

### Example Action Button HTML

Action buttons are used to perform some specified function from the UI Map. The actions are as varied as the information being displayed/updated. Below are two common examples:

- **Save.** Normally used on an Input UI Map to allow a User to save any changes they have made.
- **Cancel.** Normally used on an Input UI Map to allow a User to cancel changes in progress.

```

...
<tr>
  <td colspan="2" class=" oraEmbeddedTable">
    <table cellspacing="2">
      <tr>
        <td>
          <input class="oraButton" oraMdLabel="C1_SAVE_LBL" type="button"
            onClick="oraSubmitMap('OK');"/>
        </td>

```

```

        <td>
          <input class="oraButton" oraMdLabel="CANCEL_LBL" type="button"
onClick="oraSubmitMap( 'CANCEL' ,false);"/>
        </td>
      </tr>
    </table>
  </td>
</tr>
...

```

## Button Standards

The following points highlight some standards related to buttons.

- Buttons are included as an embedded table.
- Buttons should be grouped together. They should not be placed in different areas of the UI Map.
- The location of the buttons depends mainly on the type of UI Map.
  - Display Only UI Maps should have a Record Actions section in the upper right section of the UI map.
  - Input UI Maps should have the buttons at the foot of the UI Map (after all input fields).

## Available Styles

Styles are all contained in the referenced CSS stylesheets. They are applied by the HTML "class" attribute. The actual style settings used are not documented here as they may be adjusted. This section only specifies when a particular style should be used.

---

**NOTE:** The "class" attribute may reference more than one style (class="oraLabel oraSectionEnd")

---

Style	Comments	Example
<b>oraButton</b>	Applied to <input> elements where the type is button.	<pre> ... &lt;input class="oraButton" oraMdLabel="CANCEL_LBL" type="button" onClick="oraSubmitMap( 'CANCEL' ,false);"/&gt; ... </pre>
<b>oraDisplayCell</b>	Applied to the <td> tag of an embedded table. It defines how the table cell looks (not the data contained inside the cell).	<pre> ... &lt;td class="oraDisplayCell"&gt;   &lt;span oraField="type"&gt;&lt;/span&gt; &lt;/td&gt; ... </pre>
<b>oraEmbeddedTable</b>	Applied to the <td> tag that will contain the embedded table.	<pre> ... &lt;tr&gt;   &lt;td colspan="2" class=" oraEmbeddedTable"&gt;     &lt;table cellpadding="2"&gt;       ...       ...       ...     &lt;/table&gt;   &lt;/td&gt; &lt;/tr&gt; ... </pre>
<b>oraError</b>	<p>This style is applied to elements that are identified as "error elements". Refer to <a href="#">Display Errors</a> for more information.</p> <p><b>NOTE:</b> This style is not normally applied directly in the UI Map HTML</p>	
<b>oraErrorText</b>	This style is applied to the elements concerned with error messages.	<pre> ... &lt;table width="100%" cellpadding="12"&gt;   &lt;tr class="oraErrorText"&gt; </pre>

Style	Comments	Example
		<pre> &lt;td&gt;&lt;a href=""   onclick="oraShowErrorAlert();   return false;"&gt;   &lt;span class="oraErrorText"     oraErrorVar="ERRMSG-TEXT"&gt;&lt;/span&gt;   &lt;/a&gt; &lt;/td&gt; &lt;/tr&gt; &lt;/table&gt; ... </pre>
<b>oraGridColumnHeader</b>	This style is applied to the <td> tags that define column headers within embedded table.	<pre> ... &lt;thead &gt; &lt;tr&gt; &lt;th class="oraGridColumnHeaderButton"&gt;&lt;/th&gt; &lt;th class="oraGridColumnHeaderButton"&gt;&lt;/th&gt; &lt;th class="oraGridColumnHeader"   nowrap="nowrap"&gt;   &lt;span oraLabel="contactInformation/type"&gt; &lt;/span&gt;&lt;/th&gt; &lt;th class="oraGridColumnHeader"   nowrap="nowrap"&gt;   &lt;span oraLabel="contactInformation/number"&gt; &lt;/span&gt;&lt;/th&gt; &lt;/tr&gt; &lt;/thead &gt; ... </pre>
<b>oraGridColumnHeaderButton</b>	This style is applied to the <td> tags that define the column headers for the "+" and "-" buttons used on editable embedded tables.	<pre> ... &lt;thead &gt; &lt;tr&gt; &lt;th class="oraGridColumnHeaderButton"&gt; &lt;/th&gt; &lt;th class="oraGridColumnHeaderButton"&gt; &lt;/th&gt; &lt;th class="oraGridColumnHeader" nowrap="nowrap"&gt;   &lt;span oraLabel="contactInformation/type"&gt; &lt;/span&gt;&lt;/th&gt; &lt;th class="oraGridColumnHeader"   nowrap="nowrap"&gt;   &lt;span oraLabel="contactInformation/number"&gt; &lt;/span&gt;&lt;/th&gt; &lt;/tr&gt; &lt;/thead &gt; ... </pre>
<b>oraInput</b>	<p>This style is applied to input fields:</p> <ul style="list-style-type: none"> <li>• &lt;input type="text"&gt;</li> <li>• &lt;input type="checkbox"&gt;</li> <li>• &lt;select&gt;</li> <li>• &lt;textarea&gt;</li> </ul> <p><b>NOTE:</b> This can normally be omitted as input styles are applied automatically when oraSchemaDataTypes="true".</p>	<pre> ... &lt;input type="text" class="oraInput"   oraField="address"/&gt; ... </pre>
<b>oraInputMoney</b>	<p>This style is applied to input fields:</p> <ul style="list-style-type: none"> <li>• &lt;input type="text"&gt;</li> <li>• &lt;select&gt; (rare)</li> <li>• &lt;textarea&gt; (not recommended)</li> </ul>	<pre> ... &lt;input type="text" class="oraInputMoney"   oraField="amount"/&gt; ... </pre>



Style	Comments	Example
	<p><b>NOTE:</b> This can normally be omitted as input styles are applied automatically when <code>oraSchemaDataTypes="true"</code>.</p>	
<b>oraInputNumber</b>	<p>This style is applied to input fields:</p> <ul style="list-style-type: none"> <li>• <code>&lt;input type="text"&gt;</code></li> <li>• <code>&lt;select&gt;</code> (rare)</li> <li>• <code>&lt;textarea&gt;</code> (not recommended)</li> </ul> <p><b>NOTE:</b> This can normally be omitted as input styles are applied automatically when <code>oraSchemaDataTypes="true"</code>.</p>	<pre>... &lt;input type="text" class="oraInputNumber"   oraField="count" /&gt; ...</pre>
<b>oraLabel</b>	<p>This style is applied to standard label fields that are right aligned.</p> <p><b>NOTE:</b> This can normally be omitted as it is applied by the <code>&lt;col&gt;</code> tag.</p>	<pre>... &lt;td class="oraLabel"   oraLabel="address"&gt;&lt;/td&gt; ...</pre>
<b>oraLabelAlt</b>	<p>This style is applied to standard label fields only if it is desired to have the label aligned to the left.</p>	<pre>... &lt;td class="oraLabelAlt"   oraLabel="address"&gt;&lt;/td&gt; ...</pre>
<b>oraLabelCenter</b>	<p>This style is applied to standard label fields only if it is desired to have the label aligned in the center of the cell.</p>	<pre>... &lt;td class="oraLabelCenter"   oraLabel="address"&gt;&lt;/td&gt; ...</pre>
<b>oraLink</b>	<p>This style is applied to foreign key references (links). This is automatically added by the UI Map framework but can also be used manually if desired.</p>	<pre>... &lt;td class="oraLabel"&gt;   &lt;a href="www.google.com"     class="oraLink"&gt;Google&lt;/a&gt;&lt;/td&gt; ...</pre>
<b>oraNormal</b>	<p>This style is applied to standard data fields (display only) that are left aligned.</p> <p><b>NOTE:</b> This can normally be omitted as it is applied by the <code>&lt;col&gt;</code> tag.</p>	<pre>... &lt;td class="oraNormal"   oraField="address"&gt;&lt;/td&gt; ...</pre>
<b>oraNormalAlt</b>	<p>This style is applied to standard data fields (display only) only if it is desired to have the data aligned to the right.</p>	<pre>... &lt;td class=" oraNormalAlt"   oraField="address"&gt;&lt;/td&gt; ...</pre>
<b>oraNormalCenter</b>	<p>This style is applied to standard data fields (display only) only if it is desired to have the data aligned in the center of the cell.</p>	<pre>... &lt;td class=" oraNormalCenter"   oraField="address"&gt;&lt;/td&gt; ...</pre>
<b>oraPageTitle</b>	<p>This style is applied to the element that contains the page title.</p> <p><b>NOTE:</b> This style is not normally applied directly in the UI Map HTML. The <code>&lt;span&gt;</code> is created</p>	<pre>... &lt;span class=" oraPageTitle"   oraMdField="PAGE_TITLE_LBL"&gt;&lt;/span&gt; ...</pre>

Style	Comments	Example
	by the UI Map framework when the UI Map is displayed in the page area.	
<b>oraSectionEnd</b>	<p>This style is applied to the &lt;td&gt; tags at the end of a "section" (group of elements). It provides some space to separate the section from the following information.</p> <p><b>NOTE:</b> The style must be applied to both &lt;td&gt; tags or the label may be misaligned with the data/input.</p>	<pre>... &lt;tr&gt;   &lt;td class="oraSectionEnd"     oraLabel="zip"&gt;   &lt;/td&gt;   &lt;td class="oraSectionEnd"     oraField="zip"&gt;   &lt;/td&gt; &lt;/tr&gt; ...</pre>
<b>oraSectionHeader</b>	<p>This style is applied to the &lt;td&gt; tag used to give a heading for a section within the information being displayed. It does not provide spacing before or after itself. The oraSectionStart and oraSectionEnd classes are used for this.</p> <p><b>NOTE:</b> The section header should span both the label column and the data column.</p>	<pre>... &lt;tr&gt;   &lt;td class="oraSectionHeader"     colspan="2"     oraMdField="DATA_SECTION_LBL"&gt;&lt;/td&gt; &lt;/tr&gt; ...</pre>
<b>oraSectionStart</b>	<p>This style is applied to the &lt;td&gt; tags at the start of a "section" (group of elements). It provides some space to separate the section from the previous information (often a section header).</p> <p><b>NOTE:</b> The style must be applied to both &lt;td&gt; tags or the label may be misaligned with the data/input.</p>	<pre>... &lt;tr&gt;   &lt;td class="oraSectionStart"     oraLabel="zip"&gt;&lt;/td&gt;   &lt;td class="oraSectionStart"     oraField="zip"&gt;&lt;/td&gt; &lt;/tr&gt; ...</pre>
<b>oraTableData</b>	<p>This style is applied to the &lt;col&gt; tag for the data column of the main table (second column). It is used to provide a percentage width for the horizontal space to be used for the information.</p>	<pre>... &lt;colgroup&gt;   &lt;col class="oraLabel     oraTableLabel"/&gt;   &lt;col class="oraNormal     oraTableData"/&gt; &lt;/colgroup&gt; ...</pre>
<b>oraTableLabel</b>	<p>This style is applied to the &lt;col&gt; tag for the label column of the main table (first column). It is used to provide a percentage width for the horizontal space to be used for the labels.</p>	<pre>... &lt;colgroup&gt;   &lt;col class="oraLabel     oraTableLabel" /&gt;   &lt;col class="oraNormal oraTableData"/&gt; &lt;/colgroup&gt; ...</pre>
<b>oraTinyText</b>	<p>This style is typically applied directly beneath an &lt;input&gt; tag to provide information or a hint to the user concerning information relevant to the input. For example, name or address format.</p>	<pre>... &lt;tr&gt;   &lt;td oraLabel="address"&gt;&lt;/td&gt;   &lt;td&gt;     &lt;input type="text" oraField="address"/&gt;     &lt;div class="oraTinyText"       oraField="addressFormatHint"&gt;&lt;/div&gt;   &lt;/td&gt; &lt;/tr&gt; ...</pre>
<b>oraZoneMap</b>	<p>This style is used applied when the UI Map is to be displayed as a zone on a portal.</p>	<pre>... &lt;body class="oraZoneMap"&gt; ...</pre>

## Ensuring Unique Element IDs for UI Maps

The following describes how to modify JavaScript code to ensure the proper rendering of unique element IDs for UI Maps. The modification is required only for code that renders HTML using a `getElementById()` (or similar) function to generate list IDs and avoid account verification or related errors.

The following sample snippet contains the necessary modifications:

```
...
function getElementsFromList(namePrefix) {
    var ret = [];
    var elements = document.getElementsByTagName("INPUT");
    for(var i=0;i<elements.length;i++) {
        var elemID = elements[i].id;
        if((id) && (id.startsWith(namePrefix + '_'))) {
            ret.push(elements[i]);
        }
    }
    ...
return ret;
}
```

Since IDs aren't necessarily unique in generated UI Map IDs, the code shown above ensures uniqueness at runtime by appending an underscore and row number (e.g., `myField_1`, `myField_2`) for proper handling by Framework in the rendered HTML, while still allowing you to reference the unmodified IDs contained in the generated UI Map.

A switch in the `spl.properties` file also permits you to disable the generation of unique IDs for elements in a grid (as described below), though, for standards compliance reasons, it is highly recommended that this switch be left at its default value.

```
Property Name: spl.runtime.compatibility.uiMapDisableGenerateUniqueHtmlIDs
File Name: spl.properties (under web project in FW)
Default Value: false
Accepted Values: true or false
Description: This property controls the generation of unique IDs for all input elements inside
a list. When this value is set to true it disables the generation of unique IDs, thus
replicating the old behavior. When this property is set to false or this property is missing
it enables the generation of unique IDs, thus enabling the list to be standards-compliant.
```

## Maintaining Managed Content

The Managed Content maintenance object is used to store content such as XSL files used to create vector charts, JavaScript include files, and CSS files. These files may then be maintained in the same manner as the HTML in UI Maps.

The topics in this section describe the Managed Content portal.

### Managed Content - Main

This page is used to define basic information about the content. Open this page using **Admin > System > Managed Content**.

#### Description of Page

Enter a unique name for the content in the **Managed Content** field.

**Owner** indicates if the content is owned by the base package or by your implementation.

Use **Managed Content Type** to indicate the type of content, for example, XSLT or JavaScript.

Enter a **Description**.

Use the **Detailed Description** to describe in detail how this map is used.

## Managed Content - Schema

This page is used to create and maintain the managed content. Open this page using **Admin > System > Managed Content** and then navigate to the **Schema** tab.

### Description of Page

The General Information zone displays the main attributes of the content. The Editor zone allows you to edit the content.

## Data Areas

The data area has no business purpose other than to provide a common schema location for re-used schema structures. It exists solely to help eliminate redundant element declaration. For example, if you have multiple schemas that share a common structure, you can set up a stand-alone data area schema for the common elements and then include it in each of the other schemas.

Be aware that a stand-alone data area can hold elements that are mapped to true fields. For example, you might have 50 different types of field activities and all might share a common set of elements to identify where and when the activity should take place. It would be wise to declare the elements that are common for all in a stand-alone data area and then include it in the 50 field activity business objects.

It's strongly recommended that you take advantage of stand-alone data areas to avoid redundant data definition!

---

**CAUTION: Dynamic inclusion!** When the system renders a schema, all schemas included within it are expanded real-time. This means that any change you make to a data area will take effect immediately within all schemas it is referenced within.

---

### NOTE:

**Schema Tips.** The data area page includes a special Schema Tips zone that provides a link to launch help topics related to the [Advanced Schema Topics](#) help in one click.

---

Data areas may be included in a business object that does not define a full UI map for display or input. Rather, it is using auto-rendering by defining UI attributes in its schema and via UI hints.

---

**NOTE: View UI Rendering.** A context sensitive "View UI Rendering" zone appears on this page. It may be used for a data area that is part of a business object that is using auto-rendering for the display and input maps. The buttons allow you to view the rendered UI for the segment of the schema that is defined by the data area.

---

## Defining Data Areas

The topics in this section describe how to maintain Data Areas.

### Data Area - Main

Use this page to define basic information about a data area. Open this page using **Admin > System > Data Area**.

#### Description of Page

Enter a unique **Data Area** name and **Description**. Use the **Detailed Description** to describe what this data area defines in detail. **Owner** indicates if the data area is owned by the base package or by your implementation (**Customer Modification**).

---

**CAUTION:** Important! If you introduce a new data area, carefully consider its naming convention. Refer to [System Data Naming Convention](#) for more information.

---

Click the **View Schema** to view the data area's expanded schema definition. Doing this opens the [schema viewer](#) window.

Click the **View XSD** hyperlink to view the business object's expanded schema definition in XSD format.

To extend another data area, reference that data area in the **Extended Data Area** field. By extending a data area you can add additional elements to a base product data area.

Here's an example of an extended data area:

- The product releases with data area A, which contains elements a, b, and c.
- Your implementation creates data area CM-A, which contains element z, and references data area A as the extended data area.
- At run time, everywhere data area A is included it will contain elements a, b, c, and z.

#### Where Used

Follow this link to open the data dictionary to view the tables that reference [FI\\_DATA\\_AREA](#).

## Data Area - Schema

Use this page to maintain a Data Area's schema and to see where the data area is used in the system. Open this page using **Admin > System > Data Area** and then navigate to the **Schema** tab.

#### Description of Page

The contents of this section describe the zones that are available on this portal.

The **General Information** zone displays the main attributes of the data area.

The [Schema Designer](#) zone allows you to edit the data area's schema. The purpose of the schema is to describe the structure and elements of the data area.

---

**FASTPATH:** Refer to [Schema Syntax](#) and [UI Hint syntax](#) for a complete list of the XML nodes and attributes available to you when you construct a schema. Also note that the **Schema Tips** zone in the dashboard provides links to launch these help topics directly.

---

**NOTE: View UI Rendering.** A context sensitive "View UI Rendering" zone is associated with this page. The zone is useful for data areas that are to be included in [business objects that define the user interface detail](#) using schema attributes and UI Hints. The buttons allow you to view the automatically rendered display and input maps.

---

The **Schema Usage Tree** zone summarizes all cross-references to this schema. These may be other schemas, scripts, and web services. For each type of referencing entity, the [tree](#) displays a summary node showing a total count of referencing items. The summary node appears if at least one referencing item exists. Expand the node to list the referencing items and use their description to navigate to their corresponding pages.

## Advanced Schema Topics

The topics in this section describe some advanced information related to schemas used for business objects, business services, service scripts and UI maps.

# Schema Nodes and Attributes

For business object definition, the purpose of the schema is to create a link between the schema and a maintenance object. For business service definition you are specifying the link between the schema and a service (either a general service, search service, or a maintenance object service). For service script definition, you are defining the API for passing information to and from the script. The following documentation is a complete list of the XML nodes and attributes available to you when you construct a schema.

## Contents

- [The Four Element Types](#)
- [The Data Type of a Field Element](#)
- [Referencing Other Elements](#)
- [Standard Time Considerations](#)
- [The Mapping Attributes](#)
- [Descriptive Attributes](#)
- [Schema Constants](#)
- [Defaulting and System Variables](#)
- [The Flattening Nodes and Attributes](#)
- [Search Zone](#)
- [Extend Security for Service Script](#)
- [Overriding Action for a Business Service](#)
- [Specifying searchBy for a Search Service](#)
- [Including Other Schemas](#)
- [Compatibility Attributes](#)

## The Four Element Types

A schema element can be one of four different structure types. Note that there are two classes of element types: the structural nodes group and list, and the data containing nodes of field and raw.

Mnemonic	Valid Values	Description	Examples
type=	"field"	The field type is the default type for any element not explicitly labeled as something other than a field. Therefore, you virtually never have to explicitly label an element as a field. Note that a field element, unlike group or list, will contain information in its nodes - rather than other nodes.	
	"group"	<p>The group element is typically a structural element of the schema only, in which case it has no mapping.</p> <p>Note that when grouping several elements that are all used to map an XML structure of a CLOB / XML field of a business object driven record, the mapping may be at the group level.</p>	<p>Example where a group is used to create a structure</p> <pre>&lt;schema&gt;   &lt;input type="group"     &lt;userId/&gt;   &lt;/input&gt;   &lt;output type="group"&gt;     &lt;firstName/&gt;     &lt;lastName/&gt;   &lt;/output&gt; &lt;/schema&gt;</pre> <p>Example where the group includes the mapping:</p> <pre>&lt;parameters type="group" mapXML="BO_DATA_AREA" mdField=</pre>

Mnemonic	Valid Values	Description	Examples
			<pre>"Fl_TODOSUMEMAIL_PARM_LBL" / &gt; &lt;numberOfDays mdField="Fl_NBR_DAYS" required="true" /&gt; &lt;frequency mdField="Fl_FREQUENCY" / &gt;</pre>
	"list"	The list node is structural node like the group node. The only difference is that the list structure has the ability to repeat multiple times in an XML document.	<p>Example of a schema with a list:</p> <pre>&lt;schema&gt; &lt;statesList type="list"&gt; &lt;state isPrimeKey="true" / &gt; &lt;description/&gt; &lt;/statesList&gt; &lt;/schema&gt;</pre> <p>Example of a schema with a list:</p> <pre>&lt;xml&gt; &lt;statesList&gt; &lt;state&gt;AK&lt;/state&gt; &lt;description&gt;Alaska&lt;/ description&gt; &lt;/statesList&gt; &lt;statesList&gt; &lt;state&gt;AL&lt;/state&gt; &lt;description&gt;Alabama&lt;/ description&gt; &lt;/statesList&gt; ... &lt;/xml&gt;</pre>
	"raw"	The raw data type is used to capture a chunk of raw text that doesn't have any inherent structure associated with it.	<pre>&lt;sendDetail type="raw" /&gt;</pre> <p>Example of an XML instance for the above schema:</p> <pre>&lt;sendDetail&gt; &lt;messageInfo&gt; &lt;senderAddress&gt;123 W. Main St, &lt;/senderAddress&gt; &lt;corpZone&gt;3A&lt;/ corpZone&gt; &lt;/messageInfo&gt; &lt;/sendDetail&gt;</pre>

## The Data Type of a Field Element

Of the four different element types, only a field can have a data type.

Mnemonic	Valid Values	Description	Examples
dataType=	"string"	By default, a field element is a string. Therefore, there is no requirement to specify the string data type.	<pre>&lt;schema&gt; &lt;custName dataType="string" / &gt; &lt;/schema&gt;</pre>
	"number"	<p>Defines an element that is a number.</p> <p><b>NOTE:</b> UI hints include a setting to <a href="#">Suppress Automatic Number Formatting</a>.</p> <p><b>NOTE:</b> Use <b>currencyRef</b> attribute for auto-display</p>	<p>Examples</p> <pre>&lt;schema&gt; &lt;count dataType="number" / &gt; &lt;/schema&gt;</pre> <pre>&lt;schema&gt; &lt;taxRate dataType="number" currencyRef="currency" / &gt; &lt;/schema&gt;</pre>

Mnemonic	Valid Values	Description	Examples
		of currency symbol that is associated with the referenced currency code. The currency decimal positions are ignored by this formatting allowing you to display a currency symbol for a unit rate with many decimals.	
<b>"money"</b>	Optional additional attributes <b>currencyRef</b> ="element name"	Defines an element that represents a monetary amount.  The currency reference is optional and if left blank the installation currency will be used. Automatic formatting and validation to be applied based on the currency. For example, the currency symbol will be shown when auto-rendering. In addition, the number of decimal places must not exceed the valid number defined for the currency.  <b>NOTE:</b> Refer to <a href="#">Referencing Other Elements</a> for supported syntax for referring to other elements.	<pre>&lt;schema&gt;   &lt;currency default="USD"     suppress="true" /&gt;   &lt;balance dataType="money"     currencyRef="currency" / &gt; &lt;/schema&gt;</pre>
<b>"lookup"</b>	Required additional attribute <b>lookup</b> ="field name"	Defines an element that has valid values defined using a lookup.  The lookup field is required.	<pre>&lt;schema&gt;   &lt;status dataType="lookup"     lookup="STATUS_FLG" /&gt; &lt;/schema&gt;</pre>
<b>"lookupBO"</b>	Required additional attribute <b>lookupBO</b> ="bo name"	Defines an element that has valid values defined using an extendable lookup. The extendable lookup's business object is required.	<pre>&lt;schema&gt;   &lt;category dataType="lookupBO"     lookupBO="CM- BusinessCategory" /&gt; &lt;/schema&gt;</pre>
<b>"boolean"</b>		Defines an element that has values of "Y" and "N".	<pre>&lt;schema&gt;   &lt;allowsEdit dataType="boolean" / &gt; &lt;/schema&gt;</pre>
<b>"date"</b>		Defines an element that represents a date.	<pre>&lt;schema&gt;   &lt;startDate dataType="date" / &gt; &lt;/schema&gt;</pre>
<b>"dateTime"</b>		Defines an element that represents a date and time.  <b>NOTE:</b> Refer to <a href="#">Standard Time Considerations</a> for additional configuration available for	<pre>&lt;schema&gt;   &lt;startDateTime     dataType="dateTime" /&gt; &lt;/schema&gt;</pre>



Mnemonic	Valid Values	Description	Examples
		date / time fields that represent standard time.	
	"time"	Defines an element that represents a time.	<pre>&lt;schema&gt;   &lt;startTime dataType="time"/&gt; &lt;/schema&gt;</pre>
	"uri"	Defines an element captures a URI. Elements defined with this type enable the <a href="#">URI Validation and Substitution</a> functionality.	<pre>&lt;schema&gt;   &lt;exportDirectory dataType="uri"/&gt; &lt;/schema&gt;</pre>

## Referencing Other Elements

There are several attributes that allow for a reference to another element in the same schema. The supported syntax of the XPath reference is the same in every case. This section provides examples using the default reference attribute (**defaultRef**).

Reference a sibling element:

```
<schema>
  <id mapField="ACCT_ID" required="true"/>
  <altId defaultRef="id" required="true"/>
</schema>
```

Reference an element in a higher group:

```
<schema>
  <id mapField="ACCT_ID" required="true"/>
  <msgInfo type="group" mapXML="XML_FIELD">
    <altId defaultRef="../id" required="true"/>
  </msgInfo>
</schema>
```

Reference an element in a lower group:

```
<schema>
  <id mapField="ACCT_ID" defaultRef="msgInfo/altId" required="true"/>
  <msgInfo type="group" mapXML="XML_FIELD">
    <altId required="true"/>
  </msgInfo>
</schema>
```

Reference an element in another group:

```
<schema>
  <acctInfo type="group">
    <id mapField="ACCT_ID" required="true"/>
  </acctInfo>
  <msgInfo type="group" mapXML="XML_FIELD">
    <altId defaultRef="../acctInfo/altId" required="true"/>
  </msgInfo>
</schema>
```

## Standard Time Considerations

Most date / time fields represent "legal" time such that if a time zone changes their clocks for winter and summer time, the date / time field captures the current observed time. However, some date / time fields should always be captured in standard time to avoid confusion / ambiguity. A good example is a date and time related to detailed interval data.

When defining an element with **dataType="dateTime"**, you may optionally configure **stdTime="true"** indicating that data captured in the element always represents standard time in the 'base' time zone. The 'base' time zone is specified on the [Installation options](#).

**NOTE:** If an element is mapped to a table / field with a Standard Time Type of **Physical**, then **stdTime="true"** is implied. Refer to [Table / Field](#) for more information.

Example:

```
<schema>
  <startTime dataType="Time" stdTime="true"/>
</schema>
```

If the time zone that represents the date / time field is not the installation time zone, use the optional setting **stdTimeRef="XPath to time zone element"** on a date / time element to indicate that the element represents standard time and indicates the time zone to use. Refer to [Referencing Other Elements](#) for supported syntax for referring to other elements. .

Example:

```
<schema>
  <alternateTimeZone fkRef="F1-TZONE" suppress="true"/>
  <startDateTime dataType="dateTime" stdTimeRef="alternateTimeZone"/>
</schema>
```

**NOTE:** If an element is mapped to a table / field with a Standard Time Type of **Referenced**, then **stdTime="XPath"** is implied. Refer to [Table / Field](#) for more information.

**NOTE:** When schema elements are captured in standard time the UI map supports HTML notation to automatically display the data applying a daylight savings time / summer time correction. Refer to the HTML attribute [oraType="dateTime; stdTime:true"](#) for more information.

There may be cases where the date / time is captured as standard time in one time zone, but should be displayed using a different time zone. In this case, the attribute **displayRef="XPath"** may be used in addition to the appropriate attribute that identifies the time zone that the data is capture in. Refer to [Referencing Other Elements](#) for supported syntax.

```
<schema>
  <displayTimeZone fkRef="F1-TZONE" suppress="true"/>
  <startDateTime dataType="dateTime" stdTime="true" displayRef="displayTimeZone"/>
</schema>
```

## The Mapping Attributes

When constructing your schema, you can choose from one of the following mapping attributes.

Mnemonic	Valid Values	Description	Examples
<b>mapField=</b>	"field name"	In the case of a business object, the <b>mapField</b> attribute is used to identify the database column the element is related to. For business service schemas, the <b>mapField=</b> attribute is used to link a schema element with a service element.	<pre>&lt;schema&gt;   &lt;factId     mapField="FACT_ID"/&gt; &lt;/schema&gt;</pre>
<b>mapChild=</b>	"table name"	The <b>mapChild</b> attribute is used only for business object mapping. It is used in two ways: <ul style="list-style-type: none"> <li>First, to create a list in the business object that corresponds to a child table of an MO.</li> </ul>	<p>Example of a list within a child table in a BO:</p> <pre>&lt;persons type="list"   mapChild="CI_ACCT_PER"   &lt;personId mapField="PER_ID"/   &gt; &lt;/persons&gt;</pre>

Mnemonic	Valid Values	Description	Examples
		<ul style="list-style-type: none"> <li>Second, you can use <b>mapChild</b> to identify the child table a flattened field lives in. For more information on flattening, refer to <a href="#">flattening section</a> below.</li> </ul>	
<b>mapList=</b>	"list name"	<p>The <b>mapList</b> attribute is used only for business service mapping. It is used in two ways:</p> <ul style="list-style-type: none"> <li>First, to create a list in the business service that corresponds to a list in the service.</li> <li>Second, you can use <b>mapList</b> to identify the list that a flattened field lives in. For more information on flattening, refer to <a href="#">flattening section</a> below.</li> </ul>	<p>Example of a list within a business service:</p> <pre>&lt;selectList type="list"   mapList="DE"   &lt;value mapField="COL_VALUE"&gt;     &lt;row mapList="DE_VAL"&gt;       &lt;SEQNO is="2"/&gt;     &lt;/row&gt;   &lt;/value&gt; &lt;/selectList&gt;</pre>
<b>mapXML=</b>	"field name"	<p>The <b>mapXML</b> attribute is typically used to map XML structures into a large character / XML field of the service. Note that when you use <b>mapXML</b> to map either a list or group structure (<b>type="list"</b> or <b>type="group"</b>) you don't have to map all the child elements within the structure. It is also possible to map list elements to a large character field associated with the list child.</p>	<pre>&lt;enrollmentRequest type="group"   mapXML="CASE_CLOB"&gt;   &lt;messageID/&gt;   &lt;sender/&gt; &lt;/enrollmentRequest&gt; &lt;enrollmentKey   mapXML="CASE_CLOB" /&gt; &lt;enrollmentInfo type="list"   mapChild="CI_CASE_CHILD"&gt;   &lt;sequence   mapField="CHILD_SEQ" /&gt;   &lt;name   mapXML="CASE_CHILD_CLOB" /   &gt;   &lt;value   mapXML="CASE_CHILD_CLOB" /   &gt; &lt;/enrollmentInfo&gt;</pre>
<b>isPrimeKey=</b>	"true"	<p>You must specify a primary key for a list defined within a mapped XML element (<b>type="list"</b> <b>mapXML="CLOB"</b>). The primary key is used by the framework to determine whether a list element add, update or delete is required during a business object update.</p> <p><b>NOTE:</b> You do not need to specify the prime key for a business object list mapped to maintenance object list. When a physical list is mapped, the prime key is derived from existing physical meta-data.</p>	<pre>&lt;questionnaire   type="list" mapXML="CASE_CLOB"&gt;   &lt;question   isPrimeKey="true" /&gt;   &lt;answer/&gt; &lt;/questionnaire&gt;</pre>
<b>orderBy=</b>	"XPath asc desc, XPath asc desc"	<p>By default, a list defined within a mapped XML element</p>	<pre>&lt;questionnaire type="list"   orderBy="page/section,   page/sequence"   mapXML="CASE_CLOB"&gt;</pre>

Mnemonic	Valid Values	Description	Examples
		<p>(<b>type="list" mapXML="CLOB"</b>) is sorted by the first element of the list. A different sort order may be specified using the <b>orderBy</b> attribute. The attribute value is a comma separated list of field XPath(s) (relative to the list element) with an optional sort order (ascending is the default).</p> <p><b>NOTE:</b> This is only available for lists mapped as XML within business objects.</p>	<pre>&lt;question isPrimeKey="true"/&gt; &lt;answer/&gt; &lt;page type="group"&gt;   &lt;section/&gt;   &lt;sequence/&gt; &lt;/page&gt; &lt;/questionnaire&gt;</pre>

## Descriptive Attributes

The following attributes can be used to describe a schema element and provide additional configuration related to the element. Typically, these attributes are useful for field elements only.

Mnemonic	Valid Values	Description	Examples
<code>&lt;!-- comment --&gt;</code>		Use this to add a comment to a schema by using special open and close characters: <code>&lt;!--</code> and <code>--&gt;</code> .	<pre>&lt;schema&gt;   &lt;!-- This schema is used to   capture business information   only, please refer to the   'HUMAN' BO for person   information --&gt; &lt;/schema&gt;</pre>
<code>description=</code>	"text"	The description of an element may be used to provide an internal description of the element to help a reader of the schema to understand the business reason for the element.	<pre>&lt;schema&gt;   &lt;active type="boolean"   description="active account"   label="Active"/&gt; &lt;/schema&gt;</pre>
<code>label=</code>	"text"	The label of an element is meant to be a short bit of verbiage that would typically precede the element in a user interface.	<pre>&lt;schema&gt;   &lt;active type="boolean"   description="active account"   label="Active"/&gt; &lt;/schema&gt;</pre>
<code>required=</code>	"true"	Used to require the existence of an element during object interaction.  <b>NOTE:</b> For <a href="#">included</a> schemas, the <code>required="true"</code> attribute is not processed on business object and business service schemas when they are included within a service script schema. This is to support the ability of the service script to populate required elements before an embedded business	<pre>&lt;schema&gt;   &lt;logDate mapField="LOG_DT"   default="%CurrentDate"   required="true"   private="true" &lt;/schema&gt;</pre>

Mnemonic	Valid Values	Description	Examples
		object or business service is invoked from the service script.	
<b>mdField=</b>	"field code"	<p>The meta-data field attribute is used to associate an element with a field's metadata. The field defines data type, as well as its label and help text. If you link an element with a meta-data field, you don't need to specify any of these attributes.</p> <p><b>NOTE:</b> For a business object schema, the mapField attribute is used to derive the data type and label. An mdField attribute may be provided to override these attributes, if needed. If the element is mapped to an XML column, the mdField is needed to provide the appropriate data type and label.</p>	<pre>&lt;schema&gt;   &lt;active mdField="CM_ACTIVE_SW" /&gt; &lt;/schema&gt;</pre>
<b>fkRef=</b>	"FK Reference Code"	<p>If the element is a foreign key, defining its FK Reference will enable framework validation of the element during schema interaction and automatically provide descriptions and navigation capability.</p>	<pre>&lt;schema&gt;   &lt;person fkRef="PER" mapField="CHAR_VAL_FK1"&gt;   &lt;row mapChild="CI_SA_CHAR"&gt;     &lt;CHAR_TYPE_CD is="PER" /   &gt;   &lt;/row&gt; &lt;/person&gt; &lt;/schema&gt;</pre>
<b>private=</b>	"true"	<p>Marking an element as private will prevent it from being exposed in schema interaction.</p> <p><b>NOTE:</b> A private element requires a default.</p>	<pre>&lt;schema&gt;   &lt;type mdField="SA_TYPE_CD" default="E1" private="true" / &gt; &lt;/schema&gt;</pre>
<b>suppress=</b>	"true"	<p>This setting prevents an element from appearing in automatically generated user interfaces.</p> <p><b>NOTE:</b> This attribute can be specified on a group, in which case all elements of the group will be suppressed.</p>	<pre>&lt;schema&gt;   &lt;ls mdField="LIFE_SUPPORT_FLG" default="N" suppress="true" / &lt; &lt;/schema&gt;</pre>
	"blank"	<p>This setting means that automatic UI rendering will hide the element if its value is blank. The element</p>	<pre>&lt;schema&gt;   &lt;email mdField="EMAIL" suppress="blank" /&gt; &lt;/schema&gt;</pre>

Mnemonic	Valid Values	Description	Examples
		will still be modifiable on the input map whether blank or not.	
	"input"	<p>This setting means that automatic UI rendering will suppress the element for input, although it may still be displayed if it is not blank.</p> <p><b>NOTE:</b> Elements marked as <b>suppress="input"</b> will behave as with <b>suppress="blank"</b>. If the value is blank, no value will be displayed on either the display or input map. If the element's value is present, then the element will be displayed on both the display and input map.</p>	<pre>&lt;schema&gt;   &lt;email mdField="EMAIL"     suppress="input" /&gt; &lt;/schema&gt;</pre>
noAudit=	"true"	<p>This setting prevents an element from appearing as a changed element in the business object's audit plug-in spot. If specified on a group or list node it applies to the whole node. You cannot specify it on the schema root node, only on schema elements.</p> <p><b>NOTE:</b> This attribute is only applicable to business object schemas.</p>	<pre>&lt;schema&gt;   ...   &lt;version mapField="VERSION_NBR"     noAudit="true" /&gt;   ...   &lt;workFields type="group"     noAudit="true"     &lt;lastProcessedId/&gt;     &lt;lastProcessedTime/&gt;   &lt;/workFields&gt; &lt;/schema&gt;</pre>

## Schema Constants

There are some product owned schemas where the design warrants a value to be defaulted in the schema, but where the value is implementation specific and therefore cannot be defined by the product. For these situations, the product may use a technique called a schema constant. The design of the schema will include a declared constant. At implementation time, a configuration task will include defining the appropriate value for the constant.

For example, imagine the product delivers an algorithm that will create an outbound message when a certain condition occurs. The outbound message type to use must be configured by the implementation. To use a schema constant to define the outbound message type, the base product will configure the following:

- An option type lookup value for the lookup **F1CN\_OPT\_TYP\_FLG** is defined. For example, **M202 - Activity Completion Outbound Message Type** with a Java Value Name of **outmsgCompletion**
- The base schema that is used to create the "complete activity" outbound message references the schema constant using the Java Value Name of the option type's lookup value

```
...
<outboundMessageType mapField="OUTMSG_TYPE_CD" default="%Constant(outmsgCompletion)"/>
...
```

At implementation time, the administrative users must configure the appropriate outbound message type for "activity completion". Then, navigate to [Feature Configuration](#), choose the **Schema Constants** feature type, choose the option type **Activity Completion Outbound Message Type** and enter the newly created outbound message type in the option value.

Schema constants may also be used in the flattening syntax to define [the row elements required for flattening](#).

## Defaulting and System Variables

The default node can be used to default values into field elements as well as [the row elements required for flattening](#). You can default a field to a constant or to one of several system variables.

### NOTE:

When using the default attribute it is also necessary to specify the **required="true"** attribute, except when the default is used for the flattening syntax.

Mnemonic	Valid Values	Description	Examples
default=	"value"	Use this attribute to default an element to a specified value. The values that are valid depend on the <b>dataType</b> setting.	<pre>&lt;schema&gt;   &lt;perType mapField="PER_OR_BUS_FLG"     default="P" required="true"/ &gt; &lt;/schema&gt;  &lt;schema&gt;   &lt;frequency dataType="number"     default="1" required="true"/ &gt; &lt;/schema&gt;</pre>
	"%CurrentDate"	Used to default the element to the current date. This is only applicable to date elements.	<pre>&lt;schema&gt;   &lt;logDate mapField="LOG_DT"     default="%CurrentDate" required="true"/ &gt; &lt;/schema&gt;</pre>
	"%CurrentDateTime"	Used to default the element to the current date / time. This is only applicable to date / time elements.	<pre>&lt;schema&gt;   &lt;logDateTime mapField="LOG_DTTM"     default="%CurrentDateTime"     required="true"/&gt; &lt;/schema&gt;</pre>
	"%StandardDateTime"	Used to default the standard date and time. The standard date and time is identical to the current date and time, unless daylight savings time / summer time is in effect for the base time zone. This may be used with the <b>stdTime</b> attribute.  <b>NOTE:</b> Refer to <a href="#">Standard Time Considerations</a> for more information.	<pre>&lt;schema&gt;   &lt;startDateTime mapField="START_DTTM"     default="%StandardDateTime"     required="true"/&gt; &lt;/schema&gt;</pre>
	"%ProcessDate"	You can default the process date. The process date differs from the current date because the process date will remain constant throughout the duration of the process being executed. The current date will reflect the actual date of processing. This is similar	<pre>&lt;schema&gt;   &lt;billDate mapField="BILL_DT"     default="%ProcessDate"     required="true"/&gt; &lt;/schema&gt;</pre>

Mnemonic	Valid Values	Description	Examples
		to the batch business date that is a standard <a href="#">batch parameter</a> .	
"%ProcessDateTime"		This is similar to "%ProcessDate" but for date / time fields.	<pre>&lt;schema&gt;   &lt;calcDateTime mapField="CALC_DTTM"     default="%ProcessDateTime"     required="true"/&gt; &lt;/schema&gt;</pre>
"%CurrentUser"		Used to default the element to the current user.	<pre>&lt;schema&gt;   &lt;logUser mapField="LOG_USER"     default="%CurrentUser"     required="true"/&gt; &lt;/schema&gt;</pre>
"%CurrentUserTimeZone"		Used to default the element to the current user's time zone. If the current user's time zone is not found, the installation time zone is used.	<pre>&lt;schema&gt;   &lt;timeZone     default="%CurrentUserTimeZone"     required="true"/&gt; &lt;/schema&gt;</pre>
"%CurrentUserLanguage"		Used to default the element to the current user's language.	<pre>&lt;schema&gt;   &lt;custLanguage mapField="CUST_LANG"     default="%CurrentUserLanguage"     required="true"/&gt; &lt;/schema&gt;</pre>
"%InstallationCurrency"		Used to default the currency from the installation record.	<pre>&lt;schema&gt;   &lt;currency mapField="CURRENCY_CODE"     default="%InstallationCurrency"     required="true"/&gt; &lt;/schema&gt;</pre>
"%InstallationCountry"		You can default the country from installation record.	<pre>&lt;schema&gt;   &lt;country mapField="COUNTRY"     default="%InstallationCountry"     required="true"/&gt; &lt;/schema&gt;</pre>
"%InstallationLanguage"		You can default the language from the installation record.	<pre>&lt;schema&gt;   &lt;language mapField="LANGUAGE"     default="%InstallationLanguage"     required="true"/&gt; &lt;/schema&gt;</pre>
"%Constant( )"		You can default an element value using a <a href="#">schema constant</a> .	<p>The following is an example of a schema constant used as a default value, where the Java Value Name of the Lookup Value is 'customerLanguage'.</p> <pre>&lt;language mapField="CUSTOMER_LANG"   default="%Constant(customerLanguage)"   required="true"/&gt;</pre>
"%Context( )"		<p>You can default a value contained in a context variable.</p> <p><b>WARNING:</b> Context variables must be initialized within a server script before the schema context default can be applied. Refer to <a href="#">Context Variables</a> for more information.</p>	<p>An example of a context variable used as a default value:</p> <pre>&lt;source mapField="PER_ID"   default="%Context(source)"   required="true"/&gt;</pre> <p><b>NOTE:</b> When defining a context variable in scripting, it should be prefixed with <b>\$\$</b>. When referring to the variable</p>



Mnemonic	Valid Values	Description	Examples
			in the <code>%Context( )</code> syntax, the prefix is not included.
<code>defaultRef=</code>	"XPath"	Use this attribute to default the value of one element to the value of another one.	Refer to <a href="#">Referencing Other Elements</a> for supported syntax for referring to other elements.

## The Flattening Nodes and Attributes

The term "flattening" is used to describe the act of defining one or more single elements for a schema that are actually part of a list within the maintenance object. Flattening is possible if there are other attributes of the list that can be defined to uniquely describe the element or elements. A common use case for flattening is a characteristic. Rather than defining the characteristics of an object using a collection where the user must choose the characteristic type and then define the value, the characteristics are defined as actual elements with the appropriate label already displayed. This technique enables the designer of the schema and the user interface to display each separate characteristic in the logical place in the user interface rather than all lumped together.

---

**NOTE:** A flattened element represents a unique row in the database. This row is inserted when the flattened values are created. The row is updated when any of the flattened values are changed. The row is deleted when all the flattened values are removed. The behavior of effective dated elements is slightly different - please see [Flattening an Effective Dated List](#).

---

**NOTE:** The flattening feature can also be used to define a list, see [Flattened List](#).

---

## Identifying the List or Child Table

When flattening a child table, the row node is required to identify the list / child table that the element comes from. Within the row node, at least one element must be defined with an `is=` definition that ensures that the element is a unique row in the database. It may also define elements or fields in the row that are suppressed and are populated using default value configuration.

- For a business object, the row node defines the child table the flattened field belongs to.

The syntax is `<row mapChild="table name">`. This example is for the list of persons for an account in the customer care and billing product. One person may be marked as the "main" person. This illustrates how to define an explicit element for the main person ID to simplify references to that field. It is part of the `CI_ACCT_PER` child table. What makes it unique is that the `MAIN_CUST_SW` is `true` (and only one row may have that value)

```
<custId mapField="PER_ID" mdField="CM-MainCust">
<row mapChild="CI_ACCT_PER">
  <MAIN_CUST_SW is="true" />
  <ACCT_REL_TYPE_CD default="MAIN" />
</row>
</custId>
```

---

**NOTE:** The above example illustrates that the row node may also define elements within the list that are suppressed and assigned a default value. This syntax is never used to identify a particular row. Note that a default value can either be a literal string, or a [system variable](#).

---

- For a business service, the row node identifies the list name the flattened field belongs to.

The syntax is `<row mapList="list name">`. This example shows two entries from a list being flattened to a field value and description.

```
<selectList type="list" mapList="DE">
  <value mapField="COL_VALUE">
```

```

<row mapList="DE_VAL">
  <SEQNO is="2"/>
</row>
</value>
<description mapField="COL_VALUE">
<row mapList="DE_VAL">
  <SEQNO is="3"/>
</row>
</description>
</selectList>

```

## Uniquely Identifying the Flattened Field or List

The `is=` syntax within a row or rowFilter element is used to uniquely identify the row.

Mnemonic	Valid Values	Description	Examples
<code>is=</code>	"value"	Use this attribute to reference a value directly.	<pre> &lt;tdTypeCd   mapField="CHAR_VAL_FK1"&gt;   &lt;row     mapChild="F1_EXT_LOOKUP_VAL_CHAR"&gt;     &lt;CHAR_TYPE_CD       is="CM-TD-TYPE" /&gt;     &lt;/row&gt;   &lt;/tdTypeCd&gt; </pre>
	<code>"%Constant( )"</code>	You can configure a flattened element using a <a href="#">schema constant</a> . During a service interaction the value of the schema constant will be used to identify the flattened element in its child row.	<p>An example of a schema constant used in flattening syntax where the Java Value Name of the Lookup field value is 'cmRate'.</p> <pre> &lt;unitRate mapField="CHAR_VAL"   dataType="number"&gt;   &lt;row mapChild=     "F1_EXT_LOOKUP_VAL_CHAR"&gt;     &lt;CHAR_TYPE is       ="%Constant(cmRate)" /&gt;     &lt;/row&gt;   &lt;/unitRate&gt; </pre>
	<code>"%n"</code>	The <code>%n</code> substitution value is used to reference a relative list instance. A relative list instance is typically used to configure a flattened element for a child table keyed by sequence number. The value of <code>n</code> should be a positive integer value. During a business object read interaction the relative list instance (position) specified by the integer will be returned.	<p>An example with a relative list instance - where the <b>first</b> instance of the row is returned.</p> <pre> &lt;schema&gt;   &lt;mainPhone mapField="PHONE"&gt;     &lt;row mapChild="CI_PER_PHONE"&gt;       &lt;PHONE_TYPE_CD         is="%Constant(mainPhoneType)" /&gt;     &gt;     &lt;SEQ_NUMis="%1" /&gt;   &lt;/row&gt; &lt;/mainPhone&gt; &lt;/schema&gt; </pre>

**FASTPATH:** Additional values for `is=` are used when [Flattening an Effective Dated List](#). Refer to that section for more information.

## Flattening a Pre-defined Characteristic Type

If the flattened field is in a characteristic collection and the characteristic type is a predefined characteristic, automatic UI rendering will generate a dropdown for the list of valid values. For example, the schema below will generate a dropdown for the Usage element showing the valid values of the Status Reason Usage (**F1-SRUSG**) characteristic type.

```

<usage mdField="STATUS_RSN_USAGE" mapField="CHAR_VAL">
  <row mapChild="F1_BUS_OBJ_STATUS_RSN_CHAR">
    <CHAR_TYPE_CD is="F1-SRUSG" />

```

```

    <SEQ_NUM is="1" />
  </row>
</usage>

```

## Defining Multiple Elements from the List

When attempting to include multiple columns from the same list, the system provide shorthand notation for copying the flattening rules defined on another element so that the flattening rules do not need to be repeated. To do this, the row node includes the **rowRef** attribute and it indicates the other element name that defines the mapping information. The following example illustrates flattening the fields Customer ID and Receives Copy of Bill from the same list of Persons for an Account (where the `MAIN_CUST_SW` is `true` ).

```

<custId mapField="PER_ID">
  <row mapChild="CI_ACCT_PER">
    <MAIN_CUST_SW is="true" />
    <ACCT_REL_TYPE_CD default="MAIN" />
  </row>
</custId>
<copyBill mapField="RECEIVE_COPY_SW" rowRef="custId"/>

```

Note that the above notation also illustrates that the **rowRef** may be defined directly in the element's attribute definition.

---

**NOTE:** Refer to [Referencing Other Elements](#) for supported syntax for referring to other elements.

---

## Flattening Two Layers Deep

If your maintenance object or service has nested lists two layers deep, the system supports flattening and element within a flattened element. This technique also uses the **rowRef** attribute. The flattening of the second level refers to the flattened element of the first level. The following example illustrates flattening a characteristic into an element called `legalContact` for the "main" customer. Notice that the `legalContact` element has two row nodes: one to refer to the flattening information for its parent record and one to define its child table

```

<custId mapField="PER_ID">
  <row mapChild="CI_ACCT_PER">
    <MAIN_CUST_SW is="true" />
    <ACCT_REL_TYPE_CD default="MAIN" />
  </row>
</custId>
<legalContact mapField="CHAR_VAL_FK1">
<row rowRef="custId">
  <row mapChild="CI_ACCT_PER_CHAR" >
    <CHAR_TYPE_CD is="LEGAL" />
  </row>
</row>
</legalContact>

```

Note that the above notation also illustrates that the **rowRef** may be defined as an attribute of a row node rather than directly in the element's attribute definition.

## Defining a Flattened List

There are times that a list or child table supports multiple values of the same "type" and these should be presented as a list. To continue with the example above, the list of persons for an account may identify one person as the "main" person. This person has been flattened to a single element (with the account relationship type defaulted and suppressed). To maintain the other persons related to an account, you can define a list where each row captures the Person Id and the Account Relationship Type.

Rather than a row node, the flattened list is configured with a **rowFilter** element. The following schema illustrates the described example. The list node defines the child table. The **rowFilter** includes the criteria that identify the rows within the table to include. The elements of the list are defined within the list node outside the **rowFilter** element.

```

<custId mapField="PER_ID">
  <row mapChild="CI_ACCT_PER">
    <MAIN_CUST_SW is="true" />
    <ACCT_REL_TYPE_CD default="MAIN" />
  </row>

```

```

</custId>
<miscPersons type="list" mapChild="CI_ACCT_PER">
  <rowFilter>
    <MAIN_CUST_SW is="false" />
  </rowFilter>
  <relType mapField="ACCT_REL_TYPE_CD"/>
  <personId mapField="PER_ID"/>
</custId>

```

Note that the system will validate that if a schema contains flattened single elements and flattened lists from the same child table, the criteria that defines what makes them unique must be analogous.

## Flattening an Effective Dated List

There are some lists in the application that are effective dated (and still others that have effective date and time). For example, there are some effective dated characteristic collections. In these collection, the design is to capture a single value for a characteristic type that may change over time. It is not meant to support multiple characteristic values in effect at the same time. The following highlights some information regarding effective dated characteristic functionality:

- The most recent dated row is returned when invoking a BO for read.
- No new row added when all of the values are unchanged on a change to the BO.
- The flattened row value is updated when any of the flattened values are changed and the most recent date is equal to the current date (or the referenced effective date);
- A new row value is inserted when any of the flattened values are changed and the most recent date is different than the current date (or the referenced effective date);

**NOTE:** Refer to [Referencing Other Elements](#) for supported syntax for referring to other elements.

When flattening an effective dated list, the date column must include information regarding the date to use. The following table highlights the possible values.

Mnemonic	Valid Values	Description	Examples
is=	"%effectiveDate"	Use this configuration to indicate that current date should be used for processing. Any value added or updated using this schema will be for the current date. With this option, if the maintenance object allows for the characteristic value to be blank, then setting the flattened value to blank during the BO update will result in updating the existing record with an empty value, or adding a new row with an empty value in case the current date effective dated record is not found.	<pre> &lt;schema&gt;   &lt;price mapField="CHAR_VAL"     dataType="number"&gt;     &lt;row       mapChild="CI_SA_CHAR"&gt;       &lt;CHAR_TYPE is="PRICE"/     &gt;       &lt;EFFDT         is="%effectiveDate"/&gt;     &lt;/row&gt;   &lt;/price&gt; &lt;/schema&gt; </pre>
	"%effectiveDate( )"	Use this configuration to indicate that the date to use the value of another element.  <b>NOTE:</b> Refer to <a href="#">Referencing Other Elements</a> for supported syntax for referring to other elements.	<pre> &lt;schema&gt;   &lt;price mapField="CHAR_VAL"     dataType="number" required="true"&gt;     &lt;row mapChild="CI_SA_CHAR"&gt;       &lt;CHAR_TYPE is="PRICE"/     &gt;       &lt;EFFDT         is="%effectiveDate(priceEdate)" /     &gt;     &lt;/row&gt;   &lt;/price&gt;   &lt;priceEdate mapField="EFFDT" </pre>

Mnemonic	Valid Values	Description	Examples
			<pre>rowRef="price"/&gt; &lt;/schema&gt;</pre>
	<b>"%effectiveDateTime"</b>	Use this configuration to indicate that current date /time should be used for processing. Any value added or updated using this schema will be for the current date / time.	<pre>&lt;schema&gt; &lt;price mapField="CHAR_VAL" dataType="number"&gt; &lt;row mapChild="RATE_CHAR"&gt; &lt;CHAR_TYPE is="PRICE"/ &gt; &lt;EFFDT is="%effectiveDateTime" / &gt; &lt;/row&gt; &lt;/price&gt; &lt;/schema&gt;</pre>
	<b>"%effectiveDateTime( )"</b>	Use this configuration to indicate that the date / time to use the value of another element.  <b>NOTE:</b> Refer to <a href="#">Referencing Other Elements</a> for supported syntax for referring to other elements.	<pre>&lt;schema&gt; &lt;price mapField="CHAR_VAL" dataType="number"&gt; &lt;row mapChild="RATE_CHAR"&gt; &lt;CHAR_TYPE is="PRICE"/ &gt; &lt;EFFDTTM is="%effectiveDateTime(priceEdatetime) &gt; &lt;/row&gt; &lt;/price&gt; &lt;priceEdatetime mapField="EFFDTTM" rowRef="price"/&gt; &lt;/schema&gt;</pre>

## Search Zone

A UI Map schema element can be configured to enable an automatic search dialog when the schema is included within a maintenance UI map.

**NOTE:** Please note that an fkRef can be configured with a search zone. If a schema element has an fkRef but no explicit search attributes (as described here) then the fkRef search information will be used in the UI map. In other words, if the schema element already has an fkRef, then these explicit search attributes in the schema are only used to override the fkRef search information.

**NOTE:** Refer to the [UI Map Attributes and Functions](#) for more information on search zone configuration.

### search="search zone"

The search attribute can be used within a UI map schema and is used to automatically generate the oraSearch UI map attribute. The search zone is an explorer zone configured as a search.

```
<person fkRef="PER" search="C1_PSRCH"/>
```

### searchField="search field:element|'literal';"

The searchField attribute can only be used in conjunction with the search attribute. The searchField attribute is used to build the oraSearchField UI map attribute. The searchField value is used to populate a search zone filter with an initial value when the search zone is launched. The initial value can be a literal also. The searchField value is used to match to the filter mnemonic also named searchField.

Search field: element|'literal'. The search field represents the search zone filter to populate on launch. The element is the map's schema element used to populate the filter. The element is optional, if left blank, it will default to the element that this attribute is specified on. The searchField also takes 'literal' as input value

---

**NOTE:** Multiple filters can be populated within the search zone at launch, but multiple search field pairs must be constructed within the attribute value. The value specified here will be used to directly build the HTML attribute `oraSearchField` within the UI map where this schema is specified.

---

**NOTE:** Note that the element reference is *relative*. Refer to [Referencing Other Elements](#) for supported syntax for referring to other elements.

---

```
<person fkRef="PER" search="C1_PSRCH" searchField="PERSON; PER_TYPE:personType; "/>
```

### **searchOut="search field:element;"**

The `searchOut` attribute can only be used in conjunction with the `search` attribute. The `searchOut` attribute is used to build the `oraSearchOut` UI map attribute. The `searchOut` value is used to capture a selected value from the search zone and move it to a UI map element. The `searchOut` value specified should match the `ELEMENT_NAME` mnemonic within the search result zone parameter.

Search field: element. The search field represents the search zone result brought back to the UI map. The element is the map's schema element to be populated. The element is optional, if left blank, it will default to the element that this attribute is specified on.

---

**NOTE:** Multiple elements can be populated as a result of search zone selection, but multiple search field pairs must be constructed within the attribute value. The value specified here will be used to directly build the HTML attribute `oraSearchOut` within the UI map where this schema is specified.

---

**NOTE:** Note that the element reference is *relative*. Refer to [Referencing Other Elements](#) for supported syntax for referring to other elements.

---

```
<person fkRef="PER" search="C1_PSRCH" searchField="PER_ID"
searchOut="PER_ID;PRIMARY_PHONE:personPhone; "/>
```

## **Extend Security for Service Script**

Application service security will be enforced when either a business object or a service script is invoked from a BPA script or a UI map, but not from a service script. If you want security to be enforced when the business object or a service script is invoked from a service script, you must add the following attribute to the service script's schema.

### **appSecurity="true"**

The `appSecurity` attribute is only available for service script schemas. If specified, any business object or service script directly invoked by the service script will have their application service evaluated for access.

```
<schema appSecurity="true">
  ...
</schema>
```

## **Overriding Action for a Business Service**

If you want to invoke a business service with an action other than 'read', you need to specify the action attribute on the primary node business service schema.

### **pageAction="add, change, delete"**

The action attribute is used to override the default action of read on a business service schema. Valid values are:

- add
- update (only allowed for maintenance object service)
- change (not allowed for maintenance object service)

- delete
- read (this is the default action if no pageAction specified)

Example:

```
<schema pageAction="change">
  <parm type="group">
    <ele1/>
    <ele2/>
  </parm>
</schema>
```

## Specifying searchBy for a Search Service

If you want to invoke a search service then you must explicitly specify the searchBy attribute appropriate for the elements mapped in the schema.

### searchBy="MAIN"

The value values of the searchBy attribute can be found by viewing the XML schema linked to the business service, use the View XML URL. Typical values are:

- MAIN
- ALT
- ALT2
- ALT3
- etc.

```
<schema searchBy="MAIN">
  <AccountID mapField="ACCT_ID" />
  <Results type="list">
    <AccountID mapField="ACCT_ID" />
  </Results>
</schema>
```

## Including Other Schemas

There are no limitations on your ability to include a schema into another schema - all types can be included in all other types. Nested includes are also allowed - and at present there is no limitation on the depth of the nesting.

Including a schema requires two parts:

1. The include node
2. The name attribute

The following table highlights the supported include statements.

Mnemonic	Description	Examples
<includeBO name=""/>	<p>Including a business object schema into another schema is allowed.</p> <p>Note that the mapping rules of a business object or business service schema may or may not make sense in the context of the parent schema. Include other schemas at your own risk. However, a very useful aspect of XML processing is that the framework ignores non-pertinent attributes. In other</p>	<pre>&lt;schema&gt;   &lt;cust type="group"&gt;     &lt;includeBO name="C1-Person"/&gt;   &lt;/cust&gt;   &lt;spouse type="group"&gt;     &lt;includeBO name="C1-Person"/&gt;   &lt;/spouse&gt; &lt;/schema&gt;</pre>

Mnemonic	Description	Examples
	words, it will not hurt to have mapping attributes included into a script schema.	
<code>&lt;includeBS name=" "/&gt;</code>	Used to include a business service schema.	<pre>&lt;schema&gt; &lt;includeBS name="F1-ReadMOLog" /&gt; &lt;/schema&gt;</pre>
<code>&lt;includeDA name=" "/&gt;</code>	Used to include a data area schema.	<pre>&lt;schema&gt; &lt;includeDA   name="F1CommonSchemaFieldData" / &gt; &lt;/schema&gt;</pre>
<code>&lt;includeMP name=" "/&gt;</code>	Used to include a UI map schema.	<pre>&lt;schema&gt; &lt;includeMP   name="F1-DisplayRecordActions" / &gt; &lt;/schema&gt;</pre>
<code>&lt;includeSS name=" "/&gt;</code>	Used to include a service script schema.	<pre>&lt;schema&gt; &lt;includeSS name="F1-ActShowZn" /&gt; &lt;/schema&gt;</pre>

## Compatibility Attributes

These attributes were added as part of upgrades from previous versions of the Framework.

### **fwRel="2"**

This attribute has been added to schemas created in Framework 2 as part of a Framework 4 upgrade. New schemas will not need this attribute. It is not advisable to modify this attribute without understanding the following behavior differences as improper changes could result in errors:

**NOTE:** Schemas created in Framework 2 with the `fwRel="2"` attribute will store any XML mapped fields under groups as top-level XML elements in the `mapXML` field. This means that if two or more fields, in different group structures, were to have the same field name, their storage would conflict with one another resulting in errors. The new behavior, without the `fwRel="2"` attribute, will preserve the group structure and avoid the conflicts.

```
<schema fwRel="2"
  ...
</schema>
```



# UI Hint Syntax

## Contents

- [Working Examples](#)
- [Technical Notes](#)
- [Format an Input Map Title](#)
- [Create a Section](#)
- [Include a Map Fragment](#)
- [Build Dropdown](#)
- [Conditionally Hide Elements](#)
- [Conditionally Protect Elements](#)
- [Trigger Dependent Behavior](#)
- [Control Rendering Target](#)
- [Generate a Text Area](#)
- [Modify FK Reference Defaults](#)
- [Suppress Automatic Number Formatting](#)
- [Auto Capitalize the Input Data](#)

## Working Examples

For working examples of uiHint functionality, refer to the following business objects:

### BOs with User Assigned Keys

The following examples illustrate the patterns used to enable uiHints on an object with a user specified key.

- **F1-OutcomeStyleLookup.** This extendable lookup BO does not require state transition, but does allow duplicate and delete actions.
- **F1-TodoSumEmailTyp.** This request type illustrates the hints required to support state transition on a display map.
- **F1-WebSvc.** This web service BO is a good example for management of complex JavaScript requirements. Both display and input maps have functionality that requires specialized javascript.

### BO with System Generated Key

The following example illustrates the pattern used to enable uiHints on an object with a system generated key.

- **F1-GenericAttachment.** This attachment BO has a system assigned key, which entails the following special handling:
  - **F1-AttachmentMain.** This is the main section data area contains the elements common to all attachments, including the key, bo, and version. Because this data area is used to define the main section of the generated maps, the main section of the map can be extended by an implementation via data area extension functionality.
  - **F1-AttachmentActions.** This record actions map contains the standard actions, Edit and Delete, plus custom actions used only by attachments, View and Upload.
  - **F1-AttachmentIDFrag.** This record information map contains the primary key of the attachment.

### Display Map Service Script

Display map service scripts can be fully supported via dynamic HTML generation. However, to help eliminate the need for a display service script, self-contained uiHint functionality has been developed to write the business object status and determine valid state transitions. So the two most common reasons to craft a display service script have been eliminated.

A typical reason to use a display pre-script is if you have an embedded map fragment that contains a business service schema. The display service script can be used to invoke the business service. Both the map fragment and the display service script must declare the business service schema to support this scenario.

---

**WARNING:** The zone used to display the object's map must have a derivation script, like **F1-GncDsMpDZ** or **F1-GenDss**, that will invoke a display service script for the business object if it has been defined as a BO option - but not require an explicit display map BO option. In addition, the display service script's schema must be enabled for uiHint functionality - as the script's schema will be dynamically rendered by the zone - and not the BO schema.

---

- **F1-ExcelSpreadsheet.** This attachment BO has a display service script used to manipulate the attachment business object before displaying it:
- **F1-AttchDtU.** This display map service script's schema has been defined with the uiHint namespace, and will have a display map generated for it.

### Maintenance Pre-Processing Service Script

Maintenance pre-processing service scripts can be used with uiHints.

- **F1-ExcelSpreadsheet.** This attachment BO has a maintenance pre-processing service script used to manipulate the attachment business object before rendering the maintenance map:
- **F1-AttchPre.** This pre-processing service script's schema mimics a maintenance map schema with embedded boGroup and action elements. It will be invoked before the maintenance map is rendered.

### Maintenance Post-Processing Service Script

Maintenance post-processing service scripts can be used with uiHints.

- **F1-ExcelSpreadsheet.** This attachment BO has a maintenance post-processing service script used to manipulate the attachment business object after rendering the maintenance map:
- **F1-AttchPost.** This post-processing service script's schema mimics a maintenance map schema with embedded boGroup and action elements. It will be invoked after the maintenance map is rendered.

## Technical Notes

The following prerequisites are required to support dynamic HTML generation:

### Schema Requirements

To support automated UI generation, the business object schema must contain the following:

- `<schema xmlns:uiHint="http://oracle.com/ouafUIHints">`. The schema node must name the uiHint namespace.
- `isPrimeKey="true"`. Every element of the business object schema that is part of the primary key must be identified.

### Maintenance Script Requirements

The maintenance script for the MO must be enabled for dynamic generation.

---

**CAUTION:** The business object maintenance BPA script must be declared as an MO Option for uiHint maintenance functionality to work!

---

If the script performs **F1-BOProc** then it is likely no special functionality is needed. However, if the maintenance script contains its own call to **F1-GetValOpt** then the following statement is required prior to that call:

```
move 'false' to "F1-GetBOOpts/input/maintenanceMapRequired";
performScript 'F1-GetValOpt';
```

After the call to **F1-GetValOpt** the following logic must be included to dynamically declare the map schema if the business object does not have a maintenance map of its own:

```
// Perform Main Processing
if ("F1-GetBOOpts/output/maintenanceMap = $BLANK")
  declareBOWithBOGroup "$bo" as 'map_schema';
else
  declareMap "F1-GetBOOpts/output/maintenanceMap" as 'map_schema';
```

end-if;

## Format an Input Map Title

**NOTE:** Throughout this topic the term "field" to refer to both the generic concept of displaying and capturing data in a 'field' as well as referring to the meta-data object supplied in the product to define [Fields](#). When referring to the latter, the term "MD Field" (meta-data Field) is used.

A uiHint element can be used to build a title for a maintenance map. The title will only print on the maintenance map, not on the display map. It will be printed as the first line in the map, centered, with a heading style.

Syntax	Description	Examples
<code>&lt;uiHint:title mdField=" "/&gt;</code>	Displays the label of a referenced MD field as the title.	<pre>&lt;schema xmlns:uiHint="http:// oracle.com/ouafUIHints"&gt; &lt;uiHint:title   mdField="STATUS_RSN_LBL" /&gt;   ... &lt;/schema&gt;</pre>
<code>&lt;uiHint:title text=" "/&gt;</code>	Displays the indicated text as the title. (Do not use this mechanism when multiple languages are supported.)	<pre>&lt;schema xmlns:uiHint="http:// oracle.com/ouafUIHints"&gt; &lt;uiHint:title   text="Status Reason" /&gt;   ... &lt;/schema&gt;</pre>

## Create a Section

The uiHint namespace supports the definition of a UI map section. Note that sections are currently created in generated UI Maps when the schema has a group or list node with a label or mdField. The functionality described here enables the creation of a section without requiring a labeled group or list node within the schema. Every section must be bounded by **startSection** and **endSection** element pair.

Syntax	Supporting Attributes	Description
<code>&lt;uiHint:startSection .../&gt;</code>	<code>sectionColumn="left   right   fullWidth   float"</code>	The default is that the section will be the full width in display maps. To override that setting, specify if you want a half-width section to appear in either the left ( <b>left</b> ) or right ( <b>right</b> ) column or to float ( <b>float</b> ). Sections that are marked as 'float' will display half-width and be aligned according to whether prior sections are displayed or conditionally hidden. For example, if a left-aligned section is followed by a floating section, the floating section will appear in the right column if the left section is populated but will display in the left column if the left section is hidden / collapsed.
	<code>editColumn="left   right   fullWidth   float"</code>	By default a section appears as full width in maintenance maps. To override that setting, specify if you want a half-width section to appear in either the left ( <b>left</b> ) or right ( <b>right</b> ) column or to float ( <b>float</b> ). The behavior is the analogous to the <b>sectionColumn</b> behavior.

Syntax	Supporting Attributes	Description
	sectionOpen="false"	By default a section is open on initial display. Specify this attribute to initially display the section as closed (collapsed).
	mdField=" "	Specify the name of a MD field whose label should be used as the section heading.
	label=" "	Specify the explicit text to use as the section heading.
	visibleOn="displayMap   inputMap"	By default a section appears on both the display and the input maps. Use this attribute to limit the display of the section to either the display map ( <b>displayMap</b> ) or input map ( <b>inputMap</b> ).

The syntax for the end section attribute is `<uiHint:endSection/>`

Examples:

```
<schema xmlns:uiHint="http://oracle.com/ouafUIHints">
  <uiHint:startSection label="Main" sectionColumn="left" />
  ...
  <uiHint:endSection/>
</schema>
```

```
<schema xmlns:uiHint="http://oracle.com/ouafUIHints">
  <uiHint:startSection mdField="F1-ADD-
INFO" sectionColumn="fullWidth" editColumn="float" sectionOpen="false" visibleOn="displayMap" />
  ...
  <uiHint:endSection/>
</schema>
```

**NOTE:** The sectionColumn, editColumn and sectionOpen attributes are available for group and list nodes as well.

## Include a Map Fragment

You can specify a UI map fragment to inject HTML into a generated map using the **includeMap** element name. This allows for you to support more sophisticated behavior on your user interface. For any element that is included for rendering in the map fragment, be sure to suppress the element in its schema definition, otherwise HTML will automatically be generated for the element.

Syntax	Supporting Attributes	Description
<code>&lt;uiHint:includeMap .../&gt;</code>	map=" "	Specify the name of the map.
	visibleOn="displayMap   inputMap"	By default the details from the map fragment appear on both the display and the input maps. Use this attribute to limit the display of the section.

Example:

```
<schema xmlns:uiHint="http://oracle.com/ouafUIHints">
  ...
  <uiHint:includeMap map="StandardActionButtons" visibleOn="displayMap" />
  ...
</schema>
```

**NOTE: Important note on the map fragment schema:** If a map fragment contains a schema, then the fragment schema structure will be injected into the dynamically generated schema when the business object is rendered for input.

Technically, the fragment schema will be inserted after the boGroup structure within the map's schema. This method may be used to support the implementation of maintenance pre and post script processing for a business object and oraInvokeBS function calls within embedded JavaScript.

If JavaScript is required within an XHTML UI Map fragment, it is necessary to bound it within a `![CDATA[ ]]` tag to ensure a valid XML document. Note that the tags themselves may need to be commented out to promote compatibility with older browsers. For example:

```
<script type="text/javascript">
/*  */
//
//javascript
//
/* ]&gt; */
&lt;/script&gt;</pre>
</div>
<div data-bbox="88 273 896 334" data-label="Text">
<p><b>Flush the cache:</b> For performance reasons, the Framework automatically caches business object schemas, data areas, and UI maps. When you update a business object, the cache is automatically flushed. However, if the business object includes either a data area or embedded UI map fragment, the cache must be manually flushed in order for your changes to be recognized. Refer to <a href="#">Server Cache</a> for more information.</p>
</div>
<div data-bbox="88 352 257 370" data-label="Section-Header">
<h2>Build A Dropdown</h2>
</div>
<div data-bbox="88 375 896 404" data-label="Text">
<p>Syntax is provided to build a dropdown list in an edit map. The dropdown may be built using data returned from a service script, a business service or a table.</p>
</div>
<div data-bbox="88 410 906 500" data-label="Table">
<table border="1">
<thead>
<tr>
<th>Syntax</th>
<th>Description</th>
</tr>
</thead>
<tbody>
<tr>
<td>uiHint:select="ss: "</td>
<td>Specify the name of the service script after the colon.</td>
</tr>
<tr>
<td>uiHint:select="bs: "</td>
<td>Specify the name of the business service after the colon.</td>
</tr>
<tr>
<td>uiHint:select="table: "</td>
<td>Specify the name of the table after the colon.</td>
</tr>
</tbody>
</table>
</div>
<div data-bbox="88 513 885 543" data-label="Text">
<p>When specifying a service script or a business service, extra mapping information is needed to pass data to and from the service.</p>
</div>
<div data-bbox="88 550 906 714" data-label="Table">
<table border="1">
<thead>
<tr>
<th>Syntax</th>
<th>Values</th>
<th>Description</th>
</tr>
</thead>
<tbody>
<tr>
<td rowspan="2">uiHint:selectIn=" "</td>
<td>serviceXPath:element</td>
<td>Used to pass the value of another element into the service (mapping to the service's XPath).</td>
</tr>
<tr>
<td>serviceXPath:'Literal'</td>
<td>Used to pass a constant or literal to the service (mapping to the service's XPath).</td>
</tr>
<tr>
<td>uiHint:selectOut="valuePath: ; descPath: "</td>
<td>See examples below.</td>
<td>Used to indicate which element in the service's output holds the values and which one holds the descriptions.</td>
</tr>
</tbody>
</table>
</div>
<div data-bbox="88 729 163 745" data-label="Text">
<p>Examples:</p>
</div>
<div data-bbox="88 751 870 888" data-label="Text">
<pre>&lt;schema xmlns:uiHint="http://oracle.com/ouafUIHints"&gt;
  &lt;boStatus mapField="BO_STATUS_CD" uiHint:select="bs:F1-BOStateReasonList"
    uiHint:selectIn="boStatusBO:boStatusBO" uiHint:selectOut="valuePath:results/status;
    descPath:results/description"/&gt;
  ...
  &lt;algorithm mdField="ALG_CD" uiHint:select="bs:F1-RetrieveSysEvtAlgorithms"
    uiHint:selectIn="algorithmEntity:'F1AA';" uiHint:selectOut="valuePath:results/algorithm;
    descPath:results/description"/&gt;
  ...
  &lt;outboundMsgType mdField="OUTMSG_TYPE_CD" required="true" fkRef="F1-
  OMTYP" uiHint:select="table:F1_OUTMSG_TYPE"/&gt;
&lt;/schema&gt;</pre>
</div>
<div data-bbox="501 942 913 959" data-label="Page-Footer">
<p>Oracle Real-Time Scheduler Administrative User Guide • 253</p>
</div>
```

## Conditionally Hide Elements

The **displayNone** attribute is used to suppress elements on the map based on conditions.

Syntax	Values	Description
uiHint:displayNone=	"XPath','value','!'   '='"	Used to conditionally hide this element based on the value of another element (referenced using its XPath). Enter a value of '' to interrogate a blank value. By default the operator is '='. This may be overridden using '!='.
	"function name, <b>true</b>   <b>false</b> "	Used to indicate a JavaScript function, which must return a Boolean.

### WARNING:

Embedded spaces are not supported within the comma separated string values of this attribute.

This setting may be used on group nodes, list nodes, and elements - except for elements within a list. Elements within a list cannot be hidden conditionally.

The following example illustrates that two elements (currency reference and lookup) that will be hidden or displayed based on the value of the data type element. Note that this example also illustrates [Trigger Dependent Behavior](#) because the data type element's value may change and if it does, the condition for hiding the subsequent elements should be re-evaluated.

```
<schema xmlns:uiHint="http://oracle.com/ouafUIHints">
  ...
  <dataType mdField="F1_SE_DATA_TYPE" dataType="lookup" lookup="F1_SE_DATA_TYPE"
    uiHint:dependents="currencyRef;lookup; "/>
    <currencyRef mdField="F1_SE_CURR_REF_LBL" uiHint:displayNone='dataType','F1MO','!'/'>
    <lookup mdField="F1_SE_LOOKUP_LBL" fkRef="F1-LKUPF" uiHint:displayNone='dataType','F1LP','!'/'>
  ...
</schema>
```

The following example illustrates referring to a function where the function receives parameters:

```
<uiHint:startSection mdField="F1_SE_DEFAULT_SECT"
  uiHint:displayNone="isApplicableForSchemaType(item,'F1MP'),true"/>
```

## Conditionally Protect Elements

The **protect** attribute is used to protect elements on the map based on other factors.

Syntax	Values	Description
uiHint:protect=	"XPath','value','!'   '='"	Used to conditionally protect this element based on the value of another element (referenced using its XPath). Enter a value of '' to interrogate a blank value. By default the operator is '='. This may be overridden using '!='.
	"function name, <b>true</b>   <b>false</b> "	Used to indicate a JavaScript function, which must return a Boolean.
	" <b>action</b> ','A'   'C','!'   '='"	Use the ' <b>action</b> ' setting to protect the element based on the current action. For example, certain elements may only be specified when adding a record. Any subsequent changes to

Syntax	Values	Description
		the record should protect the element from being changed. When using this option, the valid values for the 'value' are <b>A</b> (add) and <b>C</b> (change).

**WARNING:**

Embedded spaces are not supported within the comma separated string values of this attribute.

The protect UI Hint may be used on group nodes, list nodes, and elements - except for elements within a list. Elements within a list cannot be protected conditionally.

The following UI Hint will protect the statistics category when the action is 'C'.

```
<schema xmlns:uiHint="http://oracle.com/ouafUIHints">
...
<statisticsCategory dataType="lookup" mapField="STAT_CATEGORY_FLG"
  lookup="STAT_CATEGORY_FLG" uiHint:protect="'action','C','='"/>
...
</schema>
```

### Trigger Dependent Behavior

The dependents attribute is used to trigger behavior on a child element when a parent element is changed.

Syntax	Values
uiHint:dependents=" "	A list of one or more dependent elements separated by semicolons.

The following example illustrates that the dropdown list of one element is driven by the value of another element. In this example, when the Country changes, the list of States to choose from should change to only show the states for the indicated country.

```
<schema xmlns:uiHint="http://oracle.com/ouafUIHints">
<country label="Country" uiHint:select="table:CI_COUNTRY" uiHint:dependents="state" />
<state label="State" uiHint:select="ss:CM-RetrieveCountryStates"
  uiHint:selectIn="input/country:country;" uiHint:selectOut="valuePath:output/state/stateCode;
  descPath:output/state/stateDesc" />
...
</schema>
```

**NOTE:**

Dependent targets may only name elements, not group or list nodes.

Do not modify the "id" attribute value of dependent and parent element. Data population in dependent is done based on the "id" attribute value.

### Control Rendering Target

By default all elements that are not suppressed are visible on both the display map and the input map. Use the **visibleOn** attribute to limit the inclusion of an element to either the display or input map.

Syntax	Values
uiHint:visibleOn=	"displayMap"
	"inputMap"

```
<schema xmlns:uiHint="http://oracle.com/ouafUIHints">
...
```

```
<uiHint:includeMap map="StandardActionButtons" visibleOn="displayMap"
...
</schema>
```

## Generate a Text Area

By default, a standard text box is rendered in an input map for any string element. If the field is larger and you wish to have a bigger text area (with a scroll bar), use the **textArea** attribute.

---

### Syntax

---

**uiHint:textArea="true"**

---

```
<schema xmlns:uiHint="http://oracle.com/ouafUIHints">
...
<message label="Message" uiHint:textArea="true"/>
...
</schema>
```

## Modify FK Reference Defaults

By default, when an element with **fkRef** is displayed, an info string, context menu, navigation, and search are enabled (if the FK reference has been configured accordingly). Syntax is provided to allow you to selectively turn off any of these features.

---

### Syntax

---

**uiHint:fkRef="info:false;context:false;navigation:false;search:false;"**

---

Only the feature that you wish to turn off needs to be specified. The following example illustrates turning off the navigation capability, meaning the text will not be rendered as hypertext.

```
<schema xmlns:uiHint="http://oracle.com/ouafUIHints">
...
<attachmentID fkRef="F1-
ATTCH" primeKey="true" suppress="input" uiHint:fkRef="navigation:false;"/>
...
</schema>
```

**FASTPATH:** Refer to [FK Reference Formatting](#) in the UI Map Attributes section for more information on each FK reference setting.

## Suppress Automatic Number Formatting

By default numeric fields (**dataType="number"**) are formatted as numeric fields. An attribute is provided to instead apply alphanumeric formatting.

Note: If **dataType** is not specified explicitly, it is derived from **mdField** or **mapField**.

---

### Syntax

---

**uiHint:alphaFormat="true|false"**

---

By default, its value is **false** (and therefore can be left out altogether).

Examples:

```
<schema xmlns:uiHint="http://oracle.com/ouafUIHints">
...
<numberCount mdField="" dataType="number" uiHint:alphaFormat="true"/>
...
</schema>
```



## Auto Capitalize the Input Data

The `uiHint` provides syntax to automatically capitalize input data.

---

### Syntax

---

`uiHint:capitalize="true|false"`

---

---

By default, its value is **false** (and therefore can be left out altogether).

```
<schema xmlns:uiHint="http://oracle.com/ouafUIHints">
  <toDoTypeCd mdField="TD_TYPE_CD" uiHint:capitalize='true' isPrimeKey="true"/>
</schema>
```

**NOTE:** This attribute is ignored if `uiHint:textArea="true"` is configured.

---

The attribute is only available in the schema designer when the `isPrimeKey` is set to **true**. The attribute may be added to any string element when using the source viewer.

## Schema Designer

The Schema Designer is a user-friendly interface for performing the following common schema editing tasks:

- Displaying existing schemas.
- Creating schema elements.
- Moving elements within a schema.
- Adding attribute values.

The designer provides the ability to toggle between **Design View** and **Source View** views by clicking the icons on the **Schema Designer** title bar:



The **Source View** shows the schema elements and their attributes written in the proper syntax.

In the graphical **Design View** mode, the zone is split into two areas. The left pane displays the elements of the schema in a tree-like presentation, while the right pane displays all valid attributes and values for selected schema elements.

The following points highlight some functionality available in the design view.

- If the schema definition refers to another schema using an “include” statement, one can expand that schema in the left panel to view the elements within that schema. Clicking an element in that expanded view shows information about the element’s definition in the right panel. Changes cannot be made to elements in this view.
- To move an existing element within the schema in the left panel, simply drag and drop.
- Right clicking an element in the left panel causes a pop-up to display which offers options based on the position of the element clicked on and based on the type of element.
  - **Add element above | below**
  - **Delete this element**
  - **Move this element up | down**
  - **Add child element**

When adding a new element, you are prompted for the element type. The following lists the possible element types. Most are self explanatory and represent standard schema options.

- **Characteristic.** This is a special type of Flattened Field element that is used to map a single element to the characteristic for a given characteristic type. This element is only applicable for maintenance objects that have one or more characteristic child tables where the primary key is the maintenance object's key, characteristic type and sequence. Effective dated characteristic collections are not supported. The user defines the element name and the characteristic type. The system will configure the remaining flattening information accordingly.
- **Characteristic List.** This is a special type of Flattened List element that is used to map list element that includes a sequence and a characteristic value for a given characteristic type. This element is only applicable for maintenance objects that have one or more characteristic child tables where the primary key is the maintenance object's key, characteristic type and sequence. Effective dated characteristic collections are not supported. The user defines the list name, the characteristic value element name and the characteristic type. The system will configure the remaining flattening information accordingly.
- **Comment.** This adds a comment to the schema.
- **Embedded HTML.** This is specific to a schema enabled for UI Hints. It is used to include a UI map fragment.
- **Field**
- **Flattened Field**
- **Flattened List**
- **Group**
- **Include BO Schema**
- **Include BS Schema**
- **Include DA Schema**
- **Include Map Schema**
- **Include SS Schema**
- **Input Map Title.** This is specific to a schema enabled for UI Hints. It is used to define a title element for the map.
- **List**
- **Nested Flattened Field.** This is a flattened field from a child table.
- **Raw Element.** This element is used to capture text as is. It is typically used to capture an XML structure without any details of the definition of the individual nodes.
- **Section.** This is specific to a schema enabled for UI Hints. It is used to define a section within the map.
- **Simple Field.** This is a special type of Field element that is used to define an element that is mapped to a column that supports data defined in an XML structure. (This is either a column with the character large object data type (CLOB) or the XML data type).

Context-sensitive embedded help is provided for fields and controls in the right pane by clicking the Help icon 

The **Schema Designer** is available by choosing the **Schema** tab on the [Business Object](#), [Data Area](#), [UI Map](#), [Business Service](#), and [Script](#) pages.

## Schema Viewer

The schema viewer shows a tree-view presentation of a schema in its expanded form.

The schema illustrates the structure to be used when communicating with the schema's associated object. The following takes place when a schema is expanded:

- If the schema definition includes references to other schemas, these references are replaced with the corresponding schema definitions.
- Also, if the schema definition contains **private** elements, they are omitted from this view.

Clicking on any node on the tree populates the text box on the top with the node's absolute XPath expression. You will find this feature very useful when writing scripts interacting with schema-based objects. [Scripting](#) often involves referencing elements in a schema-based XML document using their absolute XPath expression. You can use this feature on the schema viewer to obtain the XPath expression for an element and copy it over to your script.

## Business Event Log

Business Event Log may be viewed as a tool designed to capture any type of business event worth noting. You configure business objects to represent the various types of events your application calls for. The following type of details may be captured for each event:

- The business object representing the type of event.
- The date and time the event took place and who initiated it.
- The business entity for which this event is logged.
- Standard application message to describe the event.
- Additional context information that is available at the time of the event and varies for each type of event. The Business Event Log maintenance object supports a standard characteristics collection as well as an XML storage (CLOB) field. The event's business object determines where each piece of information resides. Refer to [Business Objects](#) for more information.

One common type of event may be the audit of changes made to sensitive data, for example, tracking an address change. Whenever an entity associated with a business object is added, changed, or deleted the system summarizes the list of changes that took place in that transaction and hands them over to **Audit** business object algorithms to process. You may design such an algorithm to audit the changes as business event logs. Refer to [a business object may define business rules](#) for more information.

You can also allow users to initiate business event logs to capture important notes about a business entity by exposing a [BPA Script](#) to invoke the event's corresponding business object.

Bottom line is that any process can create a business event log by invoking the business object representing the appropriate type of event.

### Where Used

Follow this link to open the data dictionary where you can view the tables that reference [FI\\_BUS\\_EVT\\_LOG](#).

## Miscellaneous Topics

The following sections describe miscellaneous system wide topics.

## Module Configuration

The system provides the ability to simplify the user interface based on functionality areas practiced by your organization.

Menu items and other user interface elements are associated with function modules. By default, all function modules are accessible. If a function module is not applicable to your business you may turn it off. Refer to [Turn Off A Function Module](#) for more information on how to turn off a module.

If a function module is made non-accessible, i.e. turned off, its related elements are suppressed from the user interface. In addition the system may validate that related functionality is not accessed. This also means that turning off the wrong module may cause any of the following to occur:

- Menu items may not appear. Refer to [Menu Item Suppression](#) to better understand how menu item suppression works.
- Entire menus may not appear. Refer to [Menu Suppression](#) to better understand how menu suppression works.
- Tabs on pages may not appear.
- Fields may not appear.
- The system may return an error message when you attempt to use a function (indicating the function is turned off).

To correct the above situation, simply remove the module from the turned off list thus making it accessible again.

Your module configuration setup is displayed on the [installations](#) record.

## Menu Item Suppression

The following points describe how your module configuration can suppress [menu items](#).

- Menu items that are owned by the base product (as opposed to those your implementation adds) are associated with one or more function modules. If your module configuration has turned off all of the menu item's modules, the menu item is suppressed. If at least one of the modules is accessible, i.e. turned on, the menu item is not suppressed.
- If a menu line doesn't contain any accessible items, the menu line is suppressed.
- If all lines on a menu are suppressed, the menu itself ([Menu](#) or [Admin menu](#)) is suppressed in the application toolbar.

## Menu Suppression

In addition to the above Menu Item Suppression logic, the following points describe how your module configuration can suppress an entire menu.

- Menus that are owned by the base product (as opposed to those your implementation adds) are associated with one or more function modules.
- If your module configuration has turned off all of the menu's modules, the entire menu is suppressed. If at least one of the modules is accessible, i.e. turned on, the menu is not suppressed.

## Turn Off A Function Module

The base package is provided with a **Module Configuration** [Feature Configuration](#) that allows your organization to turn off base package function modules.

To turn off any of the base package function modules add a **Turned Off** option to this feature configuration referencing that module. Refer to the **MODULE\_FLG** lookup field for the complete list of the application's function modules.

Any module not referenced on this feature configuration is considered turned on, i.e. accessible. To turn on a module, simply remove its corresponding **Turned Off** option from this feature configuration.

You may view your module configuration setup on the [installation options](#) page.

---

**NOTE: Only one.** The system expects only one **Module Configuration** feature configuration to be defined.

---

## Global Context Overview

The framework web application provides each product the ability to nominate certain fields to act as a "global context" within the web application. For example, in Oracle Utilities Customer Care and Billing, the global context fields include Account ID, Person ID and Premise ID. The values of these fields may be populated as a result of searching or displaying objects that use these fields in their keys. If you navigate to the Bill page and display a bill, the global context is refreshed with the Account ID associated with that bill. The global context for Person ID and Premise ID are refreshed with data associated with that account.

The fields designated as global context for the product are defined using the lookup **F1\_UI\_CTXT\_FLDS\_FLG**.

Changing the values of the global context typically cause data displayed in zones on the dashboard to be refreshed to show information relevant to the current values of these global context fields.

When the value of one of the global context fields changes, an algorithm plugged into the [installation record](#) is responsible for populating the remaining global context values accordingly. Refer to your specific product for more information about the base algorithm that is provided for that product.

## System Data Naming Convention

There are several maintenance objects in the system that include owner flag in one or more of its tables. We refer to the data in these tables as "system data". Some examples of system data tables include Algorithm Type, Batch Control, Business Object and Script. Implementations may introduce records to the same tables. The owner flag for records created by an implementation is set to **CM** (for customer modification), however the owner flag is not part of the primary key for any of the system data tables. As a result, the base product provides the following guidelines for defining the primary key in system data tables to avoid any naming conflict.

## Base Product System Data

For any table that includes the owner flag, the base product will follow a naming convention for any new data that is owned by the base product. The primary key for records introduced by the product is prefixed with **xn-** where **xn** is the value of the owner flag. For example, if a new background process is introduced to the framework product, the batch code name is prefixed with **F1-**.

---

**NOTE:** There are some cases where the hyphen is not included. For example, portal codes omit the hyphen.

---

For most system data, the remainder of the primary key is all in capital case. An exception is schema oriented records. For business objects, business services, scripts, data areas and UI maps, the product follows the general rule of using CapitalCase after the product owner prefix. For example, **F1-AddToDoEntry** is the name of a base product business service.

---

**NOTE: Data Explorer Business Services.** For business services used to invoke a data explorer zone, it is recommended to name the Business Service the same name as the related zone rather than defining a different CapitalCase name for the business service.

---

Please note that this standard is followed for all new records introduced by the base product. However, there are base product entries in many of these system data tables that were introduced before the naming convention was adopted. That data does not follow the naming convention described above.

---

**NOTE: Schema naming conventions.** A context sensitive "Schema Tips" zone is associated with any page where a schema may be defined. The zone provides recommended naming conventions for elements within a schema along with a complete list of the XML nodes and attributes available to you when you construct a schema.

---

## Implementation System Data

When new system data is introduced for your implementation you must consider the naming convention for the primary key. The product recommends prefixing records with **CM**, which is the value of the owner flag in your environment. This is consistent with the base product naming convention. This convention allows your implementation to use the CM packaging tool in the Software Development Kit as delivered. The extract file provided with the tool selects system data records with an owner flag of **CM** and with a **CM** prefix.

---

**NOTE:** If you choose not to follow the CM naming convention for your records and you want to use the CM packaging tool, your implementation must customize the extract file to define the appropriate selection criteria for the records to be included in the package. Refer to the Software Development Kit documentation for more information.

---

Also note that owner flag may be introduced to an existing table in a new release. When this happens, the CM packaging tool is also updated to include these new system data tables. Your implementation will have existing records in those tables that probably do not follow any naming convention. After an upgrade to such a release, if you want to include this data in the CM packaging tool, you must customize the extract file for the tables in question.

## URI Validation and Substitution

There are some configuration objects that require a reference to a URI, including file path URIs. The system provides the following functionality for fields that capture a URI:

- Validation against a whitelist. Based on a property setting, your implementation may be configured to define a whitelist of URIs. If this setting is enabled, the system will issue an error if the URI is not defined in the whitelist. Consult your system administrator to verify if this setting is enabled or not for your implementation.
- Ability to use substitution variables. Regardless of whether the whitelist property is enabled, fields that reference URIs may support referencing a substitution variable for all or part of the URI definition. This allows the system administrators to define the proper URI locations in a properties file whereas the configuration users only need to know the variable name. For example, when defining a location for an extract file in an extract batch job, instead of typing a file path of `h:\oracle\serverName\1.0.0.0\batch\extract\`, the batch user can enter `@FILE_EXTRACT@`, assuming there is an entry in the substitution variables file with a name of `FILE_EXTRACT`, and a value of `h:\oracle\serverName\1.0.0.0\batch\extract\`. Another example is that the batch user could enter `@BATCH_FILES@\extract\`, assuming that the URI variable for `BATCH_FILES` is defined as `h:\oracle\serverName\1.0.0.0\batch\`.

---

**NOTE:** The product may supply some pre-defined variable names for certain common references. In addition, the 'advanced' menu in the system installation steps may prompt for installers to define the values of these pre-defined variables, if desired. Installations may opt to define additional substitution variables for various URI references. Refer to the *System Administration Guide* for more information.

---

**NOTE:** There is a specific API provided by the system that handles the above functionality. It should be invoked when configuring the URI to check against the whitelist, if applicable and to verify that if a variable is used, an entry is found in the substitution variable list file with that name. For schema elements in a business object that reference a [Field](#) with the **URI** data type or define the element with the **URI** data type configured in the [schema](#) will automatically be validated using this API.

---

## Caching Overview

A great deal of information in the system changes infrequently. In order to avoid accessing the database every time this type of information is required by an end-user or a batch process, the system maintains a cache of static information on the web server and in the batch thread pool worker. These are referred to as the “application caches”. Some examples of application caches include

- System messages
- Field label and other field information
- Security Information

The framework product provides many specific caches for commonly used (and infrequently changed) data. In addition, specific edge applications may introduce additional caches as appropriate.

Information may also be cached on each user's browser.

The following topics highlight information about refreshing the various caches.

## Server Cache

The server cache refers to data that is cached on the web server. An important use of this cache is for users' online access to the application. The caches aid in better performance while navigating throughout the system, allowing for data to be accessed from the cache rather than by always accessing the database. Besides user access to the web server cache, other functionality deployed to the web server uses caches in a similar way. For example, web services are deployed to the web server and access their own version of the cache.

The contents of the cache are cleared whenever the web server is restarted. This means that fresh values are retrieved from the database once users and web services start using the application again.

The product also supplies a flush command that one can issue in the browser's URL to immediately clear the contents of the cache. The command **flushAll.jsp** flushes every cache.

For example, assume the following:

- the web server and port on which you work is called **OU-Production:7500**
- you add a new record to a control table and you want it to be available on the appropriate transactions immediately

You would issue the following command in your browser's address bar: **http://OU-Production:7500/flushAll.jsp**. Notice that the command replaces the typical `cis.jsp` that appears after the port number.

If your system has been configured correctly, the **flushAll** command will submit a request to do a “global” flush of caches (including the web services cache and the thread pool worker cache). This functionality uses a JMS Topic to publish the flush request. Refer to the *Server Administration Guide* for details on how to configure the JMS topic.

## Batch Cache

When submitting a batch job, the batch component uses a Hibernate data cache to cache administrative data that doesn't change very often. The tables whose records are included in this cache are configured using the Caching Regime value of **Cached for Batch**. Refer to [Table - Main](#) for more information. When starting a thread pool worker, data in tables marked as cached is loaded and cached for as long as that thread pool is running.

In addition batch jobs may also access application caches when applicable. When starting a thread pool worker, application data that is cached is loaded and cached for as long as that thread pool is running.

If there is a change in cached data that should be available for the next batch job, the following points highlight how the cache can be refreshed:

- By default the system is configured to automatically refresh the Hibernate cache every 60 seconds. However, an implementation may override the configuration to either change the number of seconds between intervals or to disable the automatic caching altogether. Application caches used by the batch jobs are not impacted by this refresh.
- Restart the thread pool workers.
- Run the **F1-FLUSH** (Flush all Caches) background process. This background process will flush the application data cached for all thread pool workers for all thread pools.
- If your the region has configured the thread pool workers to “listen” to requests for global flush as described in the [Server Cache](#) topic, the thread pool worker caches are also refreshed when a **flushAll** command is issued.

## Client Cache

In addition to the web server's cache, information is also cached on each user's browser. After clearing the cache that's maintained on the web server, you must also clear the cache that's maintained on your client's browser. To do this, follow the following steps:

- Select **Tools** on your browser's menu bar
- Select **Internet Options...** on the menu that appears.
- Click the **Delete Files** button on the pop-up that appears.
- Turn on **Delete all offline content** on the subsequent pop-up that appears and then click **OK**.
- And then enter the standard URL to re-invoke the system.

---

**NOTE: Automatic refresh of the browser's cache.** Each user's cache is automatically refreshed based on the **maxAge** parameter defined in the web.xml document on your web server. We recommend that you set this parameter to **1** second on development / test environments and **28800** seconds (8 hours) on production environments. Please speak to system support if you need to change this value.

---

## Expression Parser

The product provides support for defining expressions that may be of a mathematical or logical/boolean nature. The expression may include variables and functions.

The data explorer [column parameter](#) is an example of where this may be used. That parameter supports the definition of a formula. Edge applications may include support for a formula or expression using this parser as well. For example, several application include a type of ‘rule’ object (calculation rule, form rule or usage rule) that is used for validation or calculation that may support applying a formula.

The following tables highlight what is supported in the expressions that use this parser.

Category	Supported in Expression	Description
Data types	Number	
	String	
	Boolean	
	List	
Literals	Numbers	
	Strings surrounded with either single quote or double quote.	
	<b>NOTE:</b> 'Escaping' special characters is not currently supported.	
	Boolean values: <b>true</b> and <b>false</b> .	



Category	Supported in Expression	Description
Operations	+	Plus
	—	Minus
	/	Division
	*	Multiplication
	^ or **	Power
	%	Modulus
Logical operations	=	Equal
	>	Greater than
	>=	Greater than or equal to
	<	Less than
	<=	Less than or equal to
	!= or <>	Not equal to

This table identifies the functions that are supported. Note that several of the functions are applicable to a list of values. Note that although the functions are listed in lower case, the column parameter syntax in data explorer indicates referencing the functions as all capital letters. The system converts the data explorer column formula to lowercase before being evaluated.

Function	Parameter	Results	Comments
<b>size( )</b>	List element	Number of elements in the list.	
<b>isEmpty( )</b>	List element	Returns true if the list is empty.	
<b>sum( )</b>	List element of type 'number'	Returns the sum of the numbers in the list.	
<b>avg( )</b>	List element of type 'number'	Returns the average of the numbers in the list.	
	One or more numbers separated by commas	Returns the average of the number arguments.	
<b>max( )</b>	List element	Returns the largest value in the list.	
	One or more comparable elements.	Returns the largest value of the number arguments.	
<b>min( )</b>	List element	Returns the smallest value in the list.	
	One or more comparable elements.	Returns the smallest value of the number arguments.	
<b>abs( )</b>	Number	Returns the absolute value.	
<b>ceiling( )</b>	Number	Rounds the number to the ceiling.	
<b>exp10( )</b>	Number	Raises 10 to the number power.	
<b>acos( )</b>	Number	Returns the arc cosine of the number in radians.	The result will lose precision, as it uses double float based functions.
<b>asin( )</b>	Number	Returns the arc sine of the number radians.	The result will lose precision, as it uses double float based functions.
<b>atan( )</b>	Number	Returns the arc tangent of the number radians.	The result will lose precision, as it uses double float based functions.
<b>cos( )</b>	Radian	Returns the cosine of the radian angle input.	The result will lose precision, as it uses double float based functions.
<b>exp( )</b>	Number	Raises e to the number power.	The result will lose precision, as it uses double float based functions.
<b>log10( )</b>	Number	Takes the log, base 10, of the number.	The result will lose precision, as it uses double float based functions.
<b>log( )</b>	Number	Takes the natural log (base e) of the number.	The result will lose precision, as it uses double float based functions.
<b>sin( )</b>	Radian	Returns the sine of the radian angle input.	The result will lose precision, as it uses double float based functions.
<b>sqrt( )</b>	Number	Returns the square root of the number.	The result will lose precision, as it uses double float based functions.
<b>tan( )</b>	Radian	Returns the tangent of the radian angle input.	The result will lose precision, as it uses double float based functions.

Function	Parameter	Results	Comments
<b>floor( )</b>	Number	Rounds the number to the floor.	
<b>round( )</b>	Number	Assumes a scale of 0. The default rounding mode of "round half up" is applied.	
	Number, Scale	The default rounding mode of "round half up" is applied.	
	Number, Scale, Mode	The mode must be set to one of the following: <ul style="list-style-type: none"> <li>• "ROUND_CEILING"</li> <li>• "ROUND_DOWN"</li> <li>• "ROUND_FLOOR"</li> <li>• "ROUND_HALF_DOWN"</li> <li>• "ROUND_HALF_UP"</li> <li>• "ROUND_HALF_EVEN"</li> <li>• "ROUND_UP"</li> <li>• "ROUND_UNNECESSARY"</li> </ul>	
<b>negate( )</b>	Number	Returns the negative value of the number.	Only available in data explorer.

The following are special functions supported in the application for a list of values. In each case, the syntax is *function [ indexVariable in listName | expression using indexVariable ]*, where the *indexVariable* is chosen by the formula writer to represent each entry in the list and the expression used to evaluate each entry must reference that variable.

**NOTE:** The syntax supported for a given use of the formula in a functional area is driven by that particular functional area. For example, in Oracle Public Sector Revenue Management, a formula is supported in the "conditional element validation" form rule. In that form rule all variables including lists are declared in the form rule using letters and the formulas in turn use these letters. In that scenario, the functions below would reference the declared variable letter as the "listName". Other specific functional area that use this expression parser may support different syntax for referencing elements or lists.

Function	Description	Examples
<b>any [ ]</b>	This function returns the value <b>true</b> if any of the entries in list satisfies the expression.	The following returns <b>true</b> if any entry in the Balance list is greater than 0. <code>any [ i in list/Balance   i &gt; 0 ]</code>
<b>all [ ]</b>	This function returns the value <b>true</b> if all of the entries in the list satisfy the expression.	The following returns <b>true</b> if all phone numbers are populated. <code>all [ i in list/phoneNumber   i != ' ' ]</code>
<b>collect [ ]</b>	This function returns a new list of elements from the referenced list where the value of each entry of the new list is the result of the expression applied to each original value.	The following returns a new list with the tax rate applied to each amount. <code>collect [ i in list/amount   i * taxRate ]</code>
<b>select [ ]</b>	This function returns a list of all the values of the original list that satisfy the Boolean expression.	The following returns a new list with only the amounts that are negative numbers. <code>select [ i in list/amount   i &lt; 0 ]</code>
<b>reject [ ]</b>	This function returns a list of all the values of the original list that do not satisfy the Boolean expression.	The following returns a new list with only the amounts that are not negative numbers. <code>reject [ i in list/amount   i &lt; 0 ]</code>

## Debug Mode

Your implementation team can execute the system using a special mode when they are configuring the application. To enable this mode, enter **?debug=true** at the end of the URL that you use to access the application. For example, if the standard URL was **http://CD-Production:7500/cis.jsp**, you'd enter **http://CD-Production:7500/cis.jsp?debug=true** to enable configuration mode.

When in this mode certain debugging oriented tools become available right below the main toolbar.

- **Start Debug** starts a logging session. During this session the processing steps that you perform are logged. For example, the log will show the data areas that are passed in at each step and the data areas returned after the step is processed.
- **Stop Debug** stops the logging session.
- **Show Trace** opens a window that contains the logging session. All of the steps are initially collapsed.
- **Clear Trace** clears your log file.
- **Show User Log** allows you to view your own log entries. The number of "tail" entries to view may be specified in the adjacent **Log Entries** field before clicking the button. Limiting the number of entries to view allows the user to quickly and easily see only the latest log entries without having to manually scroll to the end of the log.
- Checking the **Global Debug** indication starts various tracing options.

Other parts of the system may show additional configuration oriented icons when in this mode. For example, explorer zones may provide additional tools to assist in debugging zone configuration. These icons are described in the context of where they appear.

Also, in debug mode drop down lists in data explorer and UI map zones will contain the code for each item in addition to the item's display string.

---

**NOTE: Show User Log button is secured.** An application service **F1USERLOG** has been provided for this functionality to allow implementations to restrict user access to this button. Such restriction may be called for in production environments.

---

## System Override Date

The system provides a way to override the system date used for online operations. This feature is available if the server administrator has enabled it in the environment properties. For instructions on configuring environment properties see the *Server Administration Guide*. The system date override feature is not recommended for production environments.

Under the **General System Configuration** [Feature Configuration](#), the **System Override Date Option Type** holds the date the application will use as the global system date instead of retrieving the same from the database. This feature can be especially useful in running tests that require the system date to be progressed over a period of time.

The system override date feature is also available at the user level. This is useful when a user wants override the system date to run tests without affecting the system date for other users in the environment. In order to override the system date for the user, open the [User — Characteristics](#) page, add the **System Override Date** characteristic type with a characteristic value set to the desired date in the YYYY-MM-DD format.

If system override dates are defined at both the feature configuration level and the user level, the date set at the user level will take precedence.

## Advanced Search Options

The product supports fuzzy searching in explorer zone types using the Oracle Text CONTAINS operator.

Refer to the DBA guide for details on setting up the database to support fuzzy searching. Note that there are some implementations where fuzzy searching will not be possible. For example, it's only available for implementations using the Oracle database. Additionally, not all languages are supported. Refer to the Oracle Database documentation for more information about fuzzy searching.

For information about the particular syntax to use in the explorer zones, refer to [SQL Statement](#) in the zone parameter details section.

# To Do Lists

---

Certain events that occur within the system will trigger messages describing work that requires attention. For example, if a bill segment has an error, the system generates a To Do message to alert the person responsible for correcting such errors.

Each type of message represents a To Do list. For example, there are To Do lists for bill segment errors, payment errors, customer contact reminder, etc.

We refer to each message as a **To Do Entry**. Each To Do entry is assigned a specific **To Do Role**. The role defines the users who may work on the entry. A To Do entry has a **To Do log** that maintains record of the progress on the To Do entry. For example, the To Do log indicates when the To Do entry was created, when it was assigned to a user and to whom it was assigned, and when and by whom it was completed.

---

**FASTPATH:** Refer to [To Do Processing](#) for a description of end-user queries and tools assisting in reviewing, assigning and processing To Do entries.

---

## The Big Picture of To Do Lists

The topics below provide more information about To Do configuration.

## To Do Entries Reference A To Do Type

Every [To Do entry](#) references a To Do type. The To Do type controls the following functions:

- The To Do list on which the entry appears.
- The page into which a user is taken when they drill down on an entry.
- The message that appears in the user's To Do list. Note this message can be overridden for specific To Do messages by specifying a different message number in the process that creates the specific To Do entry. For example, the process that creates To Do entries associated with bill segments that are in error displays the error message rather than a generic "bill segment is in error" message.
- The To Do list's sort options. Sort options may be used on the To Do list page to sort the entries in a different order. For example, when a user looks at the bill segment error To Do list, they have the option of sorting it in error number order, account name order, or in customer class order. Note the default sort order is also defined on To Do type.
- Whether (and how) the To Do entry is downloaded to an external system (e.g., an email system).
- The roles to which an entry may be reassigned.
- The default priority of the To Do list in respect of other To Do lists.
- The To Do list's usage, which indicates whether a To Do of that type may be created manually by a user.
- The algorithms used to perform To Do list specific business rules.
- The characteristics applicable to the To Do list.

## To Do Entries Reference A Role

Every [To Do entry](#) references a role. The role defines the users who may be assigned to **Open** entries.

The permissible roles that may be assigned to a To Do entry are defined on the entry's To Do type. After an entry is created, its role may be changed to any role defined as valid for the entry's To Do type.

An entry's initial role is assigned by the background process or algorithm that creates the entry. Because you can create your own processes and algorithms, there are an infinite number of ways to default an entry's role. However, the base package processes and algorithms use the following mechanisms to default an entry's role:

- The system checks if an entry's message category / number is suppressed (i.e., not created). If so, the entry is not created. Refer to [To Do Entries Can Be Rerouted Or Suppressed Based On Message Number](#) for more information.
- The system checks if an entry's message category / number is rerouted to a specific role. If so, it defaults this role. Refer to [To Do Entries Can Be Rerouted Or Suppressed Based On Message Number](#) for more information.
- Your specific product may introduce additional criteria for assigning a role, for example perhaps important accounts are assigned to a kind of account management group and the account management group includes configuration for special role for certain To Do types. Refer to [Set Additional Information Before a To Do is Created](#) for more information.
- If a Role wasn't determined in one of the previous steps and a Role is provided by the initiating process, the entry is created with that Role.
- If the entry does not have a role after the above takes place, the entry's To Do type's default role is assigned to the entry.

---

**NOTE:**

At installation time, the system provides a default role assigned to the system To Do types when first installed called **F1\_DFLT**. This is done to allow testing of the system prior to implementing of appropriate To Do roles for your organization. The recommendation is to configure all the To Do Types with appropriate business oriented To Do roles once they are defined.

---

**CAUTION:** Important! Most organizations have the notion of a supervisor who is responsible for all entries assigned to a given role. It's important for this user (or users) to be part of all such roles. Refer to [To Do Supervisor Functions](#) for information about transactions that can be used by supervisors to review and assign work to users.

---

## To Do Entries Can Be Rerouted (Or Suppressed) Based On Message Number

Consider the To Do type used to highlight bill segments that are in error. To Do entries of this type reference the specific bill segment error number so that the error message can be shown when the Bill Segments in Error To Do list is displayed.

---

**NOTE: Message Category / Message Number.** Every error in the system has a unique message category / number combination. Refer to [The Big Picture of System Messages](#) for more information about message categories and numbers.

---

If you want specific types of errors to be routed to specific users, you can indicate such on the To Do type. For example, if certain bill segment errors are always resolved by a given rate specialist, you can indicate such on the To Do type. You do this by updating the [To Do type's message overrides](#). On this page you specify the message category / number of the error and indicate the To Do role of the user(s) who should work on such errors. Once the To Do type is updated, all new To Do entries of this type that reference the message number are routed to the desired role.

---

**NOTE: Reroute versus suppression.** Rather than reroute an entry to a specific role, you can indicate that an entry with a given message number should be suppressed (i.e., not created). You might want to do this if you have a large volume of certain types of errors and you don't want these to clutter your users' To Do lists.

---

Obviously, you would only reroute those To Do types that handle many different types of messages. In other words, if the To Do type already references a specific message category / number rerouting is not applicable.

We do not supply documentation of every possible message that can be handled by a given To Do type. The best way to build each To Do type's reroute list is during the pre-production period when you're testing the system. During this period, compile a list of the messages that should be routed to specific roles and add them to the To Do type.

Keep in mind that if a message number / category is not referenced on a To Do type's reroute information, the entry is routed as described under [To Do Entries Reference A Role](#).

---

**NOTE: Manually created To Do entries cannot be rerouted or suppressed.** The rerouting occurs as part of the batch process or algorithm processing when the To Do is created. The role or user to whom a manual To Do should be assigned is specified when the To Do is created online. A manually created To Do may also be forwarded to another user or role.

---

## The Priority Of A To Do Entry

Some To Do entries may be more urgent to resolve than others. A To Do entry is associated with a priority level representing its relative processing order compared to other entries.

Priority level is initially assigned as follows:

- If a **Calculate Priority** plug-in is defined on the To Do entry's type, the system calls it to determine the entry's priority. You may want to use this method if an entry's priority is based on context or time-based factors. For example, when priority takes into consideration account specific attributes. When applicable, you may design a process that triggers priority recalculation of To Do entries "at will". For example, when priority is reassessed periodically based on factors external to the To Do entry's information. Refer to [To Do Type](#) for more information on priority calculation algorithms.
- If a priority value has not been determined by a plug-in, the system defaults a To Do entry's initial priority to the value specified on its type.

A user may manually override a To Do entry's priority at any time. Notice that once a To Do entry's priority is overridden, **Calculate Priority** plug-ins are no longer called so as to not override the value explicitly set by the user.

---

**NOTE:** The system does not use priority values to control order of assignment nor processing of To Do entries. Priority is available to assist your organization with supporting a business practice that ensures higher priority issues are worked on first.

---

## Working On A To Do Entry

A user can drill down on a To Do entry. When a user drills down on an entry, the user is transferred to the transaction associated with the entry. For example, if a user drills down on a bill segment error entry, the user is taken to the Bill Segment - Main page. Obviously, the page to which the user is taken differs depending on the type of entry.

It is also possible to configure the To Do type to launch a [script](#) when a user drills down on an entry rather than taking the user to a transaction. The script would walk the user through the steps required to resolve the To Do entry. Refer to [Launching Scripts When A To Do Is Selected](#) for more information.

After finishing work on an entry, the user can mark it as **Complete**. Completed entries do not appear on the To Do list queries (but they are retained on the database for audit purposes). If the user cannot resolve the problem, the user can forward the To Do to another user.

## Launching Scripts When A To Do Is Selected

Users can complete many To Do entries without assistance. However, you can set up the system to launch a [script](#) when a user selects a To Do entry. For example, consider a To Do entry that highlights a bill that's in error due to an invalid mailing address. You can set up the system to execute a script when this To Do entry is selected by a user. This script might prompt the user to first correct the customer's default mailing address and then re-complete the bill.

A script is linked to a To Do type based on its message number using the [To Do type's message overrides](#). Refer to [Executing A Script When A To Do Is Selected](#) for more information.

## To Do Entries Have Logs

Each [To Do entry](#) has a To Do log that maintains a record of the To Do's progress in the system. For example, the To Do log indicates when the To Do entry was created, when it was assigned to a user and to whom it was assigned, and when and by whom it was completed. Users can view the log to see who assigned them a particular To Do and whether any work has already been done on the To Do.

A log entry is created for all actions that can be taken on a To Do entry. Log entries are created for the following events:

- A To Do entry is created (either by the system or by a user)
- A To Do entry is completed (either by the system or by a user)
- A user takes an open To Do entry
- A supervisor assigns a To Do entry
- A user forwards an entry to another user or role
- A user sends back a To Do to the user who forwarded it
- A user manually adds a log entry to record details about the To Do's progress
- A user manually overrides the To Do entry's priority

---

**FASTPATH:** For information about the contents of log entries for each of the events, refer to [Log Entry Events](#).

---

## How Are To Do Entries Created?

A To Do Entry may be created in the following ways:

- A [background process](#) can create To Do Entries.
- An [algorithm](#) can create entries of a given type. Because the use of algorithms is entirely dependent on how you configure the control tables, the number of types of such entries is indeterminate.
- A user can create entries of To Do types that have a **Manual** usage. Refer to [To Do Entries Created Manually](#) for information about setting up manual To Do types.

For any base product process that includes logic to create a To Do entry, the system supplies a sample To Do type that may be used. Although the To Do types provided by the product are system data, the following information related to each To Do type may be customized for an implementation and is not overwritten during an upgrade:

- The creation process. If the To Do is created by a background process where the background process is referenced on a To Do type. Refer to [To Do Entries Created By Background Processes](#) for more information.
- The routing process. Refer to [To Do Entries May Be Routed Out of the System](#) for more information.
- The priority. Refer to [To Do Type - Main](#) for more information.
- The [roles](#) that may be associated with the To Do type. Refer to [To Do Entries Reference a Role](#) for more information.
- The [message override](#) information. Refer to [To Do Entries Can Be Rerouted \(Or Suppressed\)](#) and [Launching Scripts When a To Do Is Selected](#) for more information.

## To Do Entries Created By Background Processes

There are different types of To Do entries created by background processes:

- To Do entries created by dedicated To Do background processes
- To Do entries created for object-specific errors detected in certain background processes

- To Do entries created based on a specific condition

## Dedicated To Do Background Processes

There are To Do entries that are created by system background processes whose main purpose is to create To Do entries based on a given condition. For these background processes, the To Do Type indicates the creation background process.

---

**NOTE: If you don't schedule the background process, the entries will not be created!** The To Do entries of this type will only be created if you have scheduled the associated background process. Therefore, if you want the system to produce a given entry, schedule the background process.

---

## To Dos Created for Object-Specific Error Conditions

A system background process may create a To Do entry when an error is detected during object-specific processing. This is applicable for processes that do not have built in error handling, for example where there is an explicit “error” state or where the record has an explicit “exception” record.

For these background processes, the To Do Type must reference the creation background process.

To have the system create To Do entries for some or all of the errors generated by one of these processes, you must do the following:

- If you want the system to generate To Do entries for errors detected by one of the background processes below, go to the appropriate To Do type and populate the creation background process.
- If you want the system to generate To Do entries for some errors for the process, but not for all errors, populate the creation background process and then proceed to the [message overrides](#) tab to [suppress](#) certain messages. To this by indicating the message category and message number you want to suppress. Any error that is suppressed is written to the [batch run tree](#).

The functionality will only create a new To Do entry if there is not already an existing (non-complete) To Do for the same To Do type and drill key. It will also check for an existing To Do for a successfully processed record and complete that To Do.

If you do not populate the creation background process, the errors are written to the [batch run tree](#).

---

**NOTE: Errors received while creating a To Do entry.** If the background process cannot successfully create a To Do entry to report an object-specific error, the error is written to the batch run tree along with the error encountered while attempting to create the To Do entry.

---

---

**NOTE: System errors are not included.** To Do entries are not created for a system error, for example an error related to validation of input parameter. These errors are written to the [batch run tree](#). Refer to [Processing Errors](#) for more information.

---

## To Dos Created by Background Processes for Specific Conditions

There are some system background processes that create a To Do entry when the process detects a specific condition that a user should investigate. For each background process, the To Do type is an input parameter to the process. The system provides To Do types for each base package background process that may create a To Do entry.

---

**NOTE: No Creation Process.** These To Do types do not need (and should not have) a **Creation Process** specified.

---



## To Do Entries Created By Algorithms

There are To Do entries that are created by algorithm types supplied with the base package. The system supplies a To Do Type for each of these To Do entries that you may use.

If you want to take advantage of these types of entries for system algorithm types, you must do the following:

- Create an [algorithm](#):
  - This algorithm must reference the appropriate Algorithm Type.
  - These algorithms have a parameter of the To Do Type to be created. You should specify the To Do Type indicated in the table.
- Plug the algorithm into the respective control table.

## To Do Entries Created Manually

You must set up manual To Do entry types if you want your users to be able to create To Do entries online. Users may create a manual To Do entry as a reminder to themselves to complete a task. Online To Do entries may also be used like electronic help tickets in the system. For example, if a user is having a problem starting service, the user can create a To Do that describes the problem. The To Do can be assigned to a help resolution group that could either resolve the problem or send the To Do back to the initiating user with information describing how to resolve the problem.

If you want to take advantage of manual To Do entries, create a To Do type and specify the following information.

### On the Main tab:

- Set the **To Do Type Usage** flag to **Manual**.
- Set the **Navigation Option** to **toDoEntryMaint** (To Do entry maintenance).
- Set the **Message Category** and **Message Number** to the message you want to be used for To Do entries of this type. The system will populate the message parameter with the Subject. To show only the subject in the To Do's message, use a message with "%1" as its text.

### On the Roles tab:

- Specify the [To Do roles](#) that may be assigned to To Do entries of this type.
- Indicate the To Do role that should be defaulted when you create To Do entries of this type.

### On the Sort Keys tab:

When a user adds a manual To Do entry, the system creates an entry with three sort key values. (Sort keys may be used on the To Do list page to sort the entries in a different order.) The To Do type should be set up to reference the sort keys as follows:

Sequence	Description
1	Created by user ID
2	Created by user name
3	Subject

We recommend that the keys have an **Ascending** sort order and that the Subject is made the default sort key.

**NOTE:** It is possible to define additional sort keys and use a To Do Post Processing algorithm to populate the values. In this case, the base sort keys defined above should still be defined.

### On the Drill Keys tab:

When a user adds a manual To Do entry, it is created with a drill key value equal to the To Do entry's ID. When the user clicks the Go To button next to the message in the To Do list, the system uses the drill down application service (defined on the main tab) and the drill key to display the associated To Do entry.

The To Do type must be set up with a drill key that reference the To Do entry table and the To Do entry ID:

Sequence	Table	Field
1	CI_TD_ENTRY	TD_ENTRY_ID

## The Lifecycle Of A To Do Entry

The following state transition diagram will be useful in understanding the lifecycle of a To Do entry.

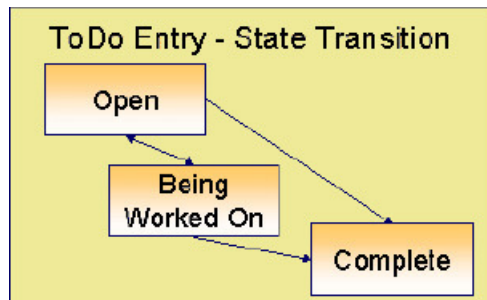

A To Do entry is typically created in the **Open** state. Entries of this type can be viewed by all users belonging to the entry's role. Refer to [How Are To Do Entries Created?](#) for information about how entries are created.

An **Open** entry becomes **Being Worked On** when it is assigned to a specific user or when a user proactively assumes responsibility for the entry. While an entry is **Being Worked On**, it is visible on the To Do Summary page only by the user who is assigned to it.

---

**NOTE:** To Do entries may be created in the **Being Worked On** state. Some To Do background processes may create To Do entries in the **Being Worked On** state. When a user adds a To Do entry online and assigns the To Do to a user (as opposed to a role), the To Do entry is also created in the **Being Worked On** state.

---

A **Being Worked On** entry may be forwarded to a different user or role. If the entry is forwarded to a role, it becomes **Open** again.

When an entry becomes **Complete**, it is no longer visible in the To Do list queries (but it remains on the database for audit purposes). There are two ways an entry can become **Complete**:

- A user can manually indicate it is **Complete** (there are several ways to do this).
- For To Do entries that are logically associated with the state of some object, the system automatically marks the entry **Complete** when the object is no longer in the respective state. For example, an entry that's created when an account doesn't have a bill cycle is completed when the account has a bill cycle.

---

**CAUTION:** Important! The automatic completion of To Do entries occurs when the background process responsible for creating entries of a given type is executed. Therefore, if you only run these processes once per day, these entries remain **Being Worked On** even if the object is no longer in the respective state.

---

## Linking Additional Information To A To Do Entry

Additional information may be linked to a To Do entry using characteristics. For example, when creating a manual To Do entry, a user may define the account related to the To Do.

When creating an automatic To Do entry, the program that generates the To Do may link related data to the To Do using characteristics. Use system [algorithm](#) to link related entities. For manually created To Dos, the valid characteristic types that may be linked to the To Do entry must be defined on the [To Do type](#) for that To Do entry.

If your To Do entries reference characteristics that are related to your global context data, you may want to configure an [Alerts](#) to display an alert if a related entry is **Open** or **Being Worked On**.

## Implementing Additional To Do Entry Business Rules

If your business practice calls for additional validation rules or processing steps to take place after a To Do Entry is created or updated, you may want to take advantage of the **To Do Post Processing** plug-ins defined on [To Do type](#).

For example, you may want to validate that To Do entries are only assigned to users with the proper skill levels needed to resolve them. Refer to [F1-VAL-SKILL](#) for a sample algorithm handling such validation.

## To Do Entries May Be Routed Out Of The System

A To Do type can be configured so that its entries are interfaced to another system.

For example, a given To Do type can be configured to create an email message whenever a new To Do entry is created. The following points describe how to do this:

- Define the name of the background process responsible for interfacing the new To Do entries to another system on the respective To Do type. The base package contains a batch process called [F1-TDEER](#) that can be used for most situations. This batch process invokes the **External Routing algorithms** defined on each entry's To Do type.
- Plug in an appropriate **External Routing** algorithm on the respective To Do type. The logic in this type of algorithm performs the interface efforts for a specific To Do entry. For example, if an email message should be created for a To Do entry, the logic in the algorithm would compose and send the email message(s) for a specific To Do entry.

Click [here](#) to see the algorithm types available for this system event.

## Periodically Purging To Do Entries

**Completed** To Do entries should be periodically purged from the system by executing the [F1-TDPG](#) background process. This background process offers you the following choices:

- You can purge all To Do entries older than a given number of days.
- You can purge To Do entries for a specific list of To Do types that are older than a given number of days.
- You can purge all To Do entries except for a specific list of To Do types that are older than a given number of days.

We want to stress that there is no system constraint as to the number of **Completed** To Do entries that may exist. You can retain these entries for as long as you desire. However, you will eventually end up with a very large number of **Completed** entries and these entries will cause the various To Do background processes to degrade over time. Therefore, you should periodically purge **Completed** To Do entries as they exist only to satisfy auditing and reporting needs.

---

**NOTE: Different retention periods for different types of To Do entries.** Keep in mind that the purge program allows you to retain different types of entries for different periods of time.

---

## Setting Up To Do Options

The topics in this section describe how to set up To Do management options.

## Installation Options

The following section describes configuration setup on the installation options.

### To Do Information May Be Formatted By An Algorithm

A **To Do Information** algorithm may be plugged in on the [installation record](#) to format the standard To Do information that appears throughout the system. This algorithm may be further overridden by a corresponding plug-in on the [To Do Type](#).

### Set Additional Information Before A To Do Is Created

A **To Do Pre-creation** algorithm may be plugged in on the [installation record](#) to set additional information for a To Do entry before it is created. Algorithms of this type are used for two common purposes:

- Linking context specific data to the To Do entry using characteristics. For example, Oracle Utilities Customer Care and Billing provides an algorithm that attempts to link a related person, account, premise, service agreement or service point to a To Do entry based on its drill key value. Note, before you can set up this algorithm, you must define the characteristic types that you'll use to hold each of these entities. Also note that it is not necessary to define these characteristics as valid characteristic types on the To Do type.
- Overriding the Role of a To Do entry based on specific configuration related to the To Do's context data. For example, Oracle Utilities Customer Care and Billing provides an algorithm to determine a To Do role based on overrides related to the account's account management group or division.

## Alerts

If your To Do entries reference characteristics related to your global context data and your product supports dashboard alerts generated by algorithms, you may want configure an algorithm to display an alert if the entry is **Open** or **Being Worked On** for the data currently in context.

Refer to your product's documentation to determine if these types of alerts are supported.

### Next Assignment Algorithm

If your organization opts to use the next assignment feature supported by the Current To Do dashboard zone, you need to plug-in a **Next To Do Assignment** algorithm into the [installation options](#) to determine the next To Do entry the user should work on. Make sure you provide users with security access rights to the zone's next assignment action.

---

**FASTPATH:** Refer to the [Current To Do](#) zone for more information.

---

## Messages

You need only set up new messages if you use algorithms to create To Do entries or prefer different messages than those associated with the base package's To Do types.

## Feature Configuration

The base package is provided with a generic **Activity Queue Management Feature Configuration** type. You may want to set up a feature configuration of this type to define any To Do management related options supporting business rules specific to your organization.

For example, the base package provides the following plug-ins to demonstrate a business practice where To Do entries are only assigned to users with the proper skill levels to work on them.

- The base **To Do Post Processing** To Do Type algorithm **F1-VAL-SKILL** validates that a user has the necessary skill levels required to work on a given To Do entry.
- The base **Next To Do Assignment** installation options algorithm **F1-NEXT-ASSG** only assigns To Do entries to users that have the proper skills to work on them. This plug-in is only applicable if your organization practices **work distribution** "on demand."

You must set up such an **Activity Queue Management** feature configuration if you want to use any of the above base package plug-ins.

The following points describe the various **Option Types** provided with the base package:

- **Skill.** This option provides a reference to a skill category. For example, if you were using characteristics to represent skill categories then you should reference each characteristic type using this option.
- **Override Skill.** This option provides an override skill information reference for a specific message. For example, if you were using a To Do Type characteristic to specify an override skill category and level for a specific message category / number then you would reference this characteristic type using this option.

---

**NOTE: Skill Setup.** Refer to the description of the above base package algorithms for further details on how to setup skill level information.

---

---

**NOTE: More Options.** Your implementation may define additional options types. You do this by add new lookup values to the lookup field **F1QM\_OPT\_TYP\_FLG**.

---

---

**NOTE: Only one.** The system expects only one **Activity Queue Management** feature configuration to be defined.

---

## Defining To Do Roles

This section describes the control table used to maintain To Do roles.

### To Do Role - Main

The **Main** page is used to define basic information about a To Do role.

To maintain this information, select **Admin > General > To Do Role**.

#### Description of Page

Enter a unique **To Do Role** and **Description** for the To Do role.

The grid contains the ID of each **User** that may view and work on entries assigned to this role. The First Name and Last Name associated with the user is displayed adjacent.

---

**NOTE: System Default Role.** The system supplies a default role **F1\_DFLT** linked to each system To Do type. This is done so that To Do functionality may be tested prior to the creation of appropriate business oriented To Do roles.

---

### Where Used

Follow this link to view the tables that reference [CI\\_ROLE](#) in the data dictionary schema viewer.

In addition, various “type” objects or algorithms may reference a To Do role to use when creating a To Do for a given business scenario. This is dependent on your specific product.

## To Do Role - To Do Types

The **To Do Types** page defines the To Do types that may be viewed and worked on by users belonging to a given To Do role.

To maintain this information, select **Admin > To Do Role > Search** and navigate to the **To Do Types** page.

### Description of Page

Enter the ID of each **To Do Type** whose entries may be viewed and worked on by the role.

**Use As Default** is a display-only field that indicates if the role is assigned to newly created entries of this type. You may define the default role for a given To Do type on the To Do Type maintenance page.

---

**CAUTION:** If you remove a To Do type where this role is the default, you must define a new role as the default for the To Do type. You do this on the To Do Type maintenance page.

---

## Defining To Do Types

This section describes the control table used to maintain To Do types.

### To Do Type - Main

The **Main** page is used to define basic information about a To Do type.

---

**FASTPATH:** Refer to [The Big Picture Of To Do Lists](#) for more information about To Do types and To Do lists in general.

---

To maintain this information, select **Admin > General > To Do Type**.

---

**CAUTION:** Important! If you introduce a To Do type, carefully consider its naming convention. Refer to [System Data Naming Convention](#) for more information.

---

### Description of Page

Enter a unique **To Do Type** and **Description** for the To Do type.

**Owner** indicates if this entry is owned by the base package or by your implementation (**Customer Modification**).

Use the **Detailed Description** to provide further details related to the To Do Type.

Enter the default **Priority** of To Do entries of this type in respect of other To Do types. Refer to [The Priority Of A To Do Entry](#) for more information.

For **To Do Type Usage**, select **Automatic** if To Dos of this type are created by the system (i.e., a background process or algorithm). Select **Manual** if a user can create a To Do of this type online.

Define the **Navigation Option** for the page into which the user is transferred when drilling down on a To Do entry of this type.

Use **Creation Process** to define the background process, if any, that is used to manage (i.e., create and perhaps complete) entries of this type. A **Creation Process** need only be specified for those To Do types whose entries are created by a background process. Refer to [To Do Entries Created By Background Processes](#) for more information.

Use **Routing Process** to define the background process that is used to download entries of a given type to an external system, if any. A **Routing Process** need only be specified for those To Do types whose entries are routed to an external system (e.g., an Email system or an auto-dialer). Refer to [To Do Entries May Be Routed Out Of The System](#) for more information.

Use **Message Category** and **Message Number** to define the message associated with this To Do type's entries. Note: this message will only be used if the process that creates the To Do entry does not supply a specific message number. For example, the process that creates To Do entries that highlight bill segments that are in error would not use this message; rather, the entries are marked with the message associated with the bill segment's error.

Use the characteristics collection to define a **Characteristic Type** and **Characteristic Value** common to all To Do entries of this type. You may enter more than one characteristic row for the same characteristic type, each associated with a unique **Sequence** number. If not specified, the system defaults it to the next sequence number for the characteristic type.

#### Where Used

Follow this link to view the tables that reference [CI\\_TD\\_TYPE](#) in the data dictionary schema viewer.

## To Do Type - Roles

The **Roles** page defines the roles who may view and work on entries of a given To Do type.

To maintain this information, select **Admin > To Do Type > Search** and navigate to the **Roles** page.

#### Description of Page

Enter each **To Do Role** that may view and work on entries of a given type. Turn on **Use as Default** if the role should be assigned to newly created entries of this type. Only one role may be defined as the default per To Do type.

---

**FASTPATH:** Refer to [To Do Entries Reference A Role](#) for more information about roles and To Do entries.

---

## To Do Type - Sort Keys

The **Sort Keys** page defines the various ways a To Do list's entries may be sorted. For example, when you look at the bill segment error To Do List, you have the option of sorting the entries in error number order, account name order, or in customer class order.

To maintain this information, select **Admin > To Do Type > Search** and navigate to the **Sort Keys** page.

---

**CAUTION:** Do not change this information unless you are positive that the process / algorithm that creates entries of a given type stores this information on the entries.

---

#### Description of Page

The following fields display for each sort key.

**Sequence** is the unique ID of the sort key.

**Description** is the description of the sort key that appears on the To Do list.

**Use as Default** indicates the default sort key (the one that is initially used when a user opens a To Do list). Only one sort key may be defined as the default per To Do type.

**Sort Order** indicates whether the To Do entries should be sorted in **Ascending** or **Descending** order when this sort key is used.

**Owner** indicates if this entry is owned by the base package or by your implementation (**Customer Modification**).

## To Do Type - Drill Keys

The **Drill Keys** page defines the keys passed to the application service (defined on the Main page) when you drill down on an entry of a given type.

To maintain this information, select **Admin > To Do Type > Search** and navigate to the **Drill Keys** page.

---

**CAUTION:** Do not change this information unless you are positive that the process / algorithm that creates entries of a given type stores this information on the entries.

---

### Description of Page

**Navigation Option** shows the page into which the user is transferred when drilling down on a To Do entry of this type.

The following fields display for each drill key.

**Sequence** is the unique ID of the drill key.

**Table** and **Field** are passed to the application service when you drill down on an entry of a given type.

**Owner** indicates if this entry is owned by the base package or by your implementation (**Customer Modification**).

## To Do Type - Message Overrides

The **Message Overrides** page is used if you want To Do entries that reference a given message category / number to be routed to a specific To Do role (or suppressed altogether) or if you want to associate a script to a given message category / number.

---

**FASTPATH:** Refer to [To Do Entries Reference A Role](#) and [To Do Entries Can Be Rerouted Or Suppressed](#) for more information.

---

To maintain this information, select **Admin > To Do Type > Search** and navigate to the **Message Overrides** page.

### Description of Page

The following fields display for each override.

**Message Category** and **Number** allow the message to be overridden.

**Exclude To Do Entry** indicates if a To Do entry of this type that references the adjacent **Message Category** and **Number** should not be created.

**Override Role** indicates the to do role to which a To Do entry of this type that references the adjacent **Message Category** and **Number** should be addressed. This field is protected if **Exclude To Do Entry** is on.

**Script** indicates the script that should execute when a user drills down on a To Do entry of this type that references the adjacent **Message Category** and **Number**. This field is protected if **Exclude To Do Entry** is on. Refer to [Working On A To Do Entry](#) for more information.

## To Do Type - To Do Characteristics

The **To Do Characteristics** page defines characteristics that can be defined for To Do entries of this type. The characteristic types for characteristics that are linked to the To Do entry as a result of a pre-creation algorithm do not need to be defined here.



To maintain this information, select **Admin > General > To Do Type > Search** and navigate to the **To Do Characteristics** page.

Turn on the **Required** switch if the **Characteristic Type** must be defined on To Do entries of this type.

Enter a **Characteristic Value** to use as the default for a given **Characteristic Type** when the **Default** switch is turned on. Use **Sequence** to control the order in which characteristics are defaulted.

## To Do Type - Algorithms

The **To Do Algorithms** page defines the algorithms that should be executed for a given To Do type.

To maintain this information, select **Admin > To Do Type > Search** and navigate to the **Algorithms** page.

### Description of Page

The grid contains **Algorithms** that control important To Do functions. If you haven't already done so, you must [set up the appropriate algorithms](#) in your system. You must define the following for each algorithm:

- Specify the **System Event** with which the algorithm is associated (see the table that follows for a description of all possible events).
- Specify the **Sequence Number** and **Algorithm** for each system event. You can set the **Sequence Number** to 10 unless you have a **System Event** that has multiple **Algorithms**. In this case, you need to tell the system the **Sequence** in which they should execute.

The following table describes each **System Event**.

System Event	Optional / Required	Description
Calculate Priority	Optional	<p>Algorithms of this type may be used to calculate a To Do entry's priority. They are called initially when a To Do entry is created and each time it gets updated so long as the To Do entry's priority has not been manually overridden. Once overridden, these algorithms are not called anymore.</p> <p>Note that it is not the responsibility of the algorithms to actually update the To Do entry with the calculated priority value but rather only return the calculated value. The system carries out the update as necessary.</p> <p>If more than one algorithm is plugged-in the system calls them one by one until the first to return a calculated priority.</p> <p>Click <a href="#">here</a> to see the algorithm types available for this system event.</p>
External Routing	Optional	<p>Algorithms of this type may be used to route a To Do entry to an external system.</p> <p>The base package <a href="#">F1-TDEER</a> background process invokes the algorithms for every To Do entry that its type references the process as the <b>Routing Process</b> and that the entry was not already routed. The background process marks an entry as routed by updating it with the batch control's current run number.</p> <p>If more than one algorithm is plugged-in the batch process calls them one by one until the first to indicate the To Do entry was routed.</p> <p>Click <a href="#">here</a> to see the algorithm types available for this system event.</p>
To Do Information	Optional	<p>We use the term "To Do information" to describe the basic information that appears throughout the system to describe a To Do entry. The data that appears in "To</p>

System Event	Optional / Required	Description
		<p>Do information" is constructed using this algorithm.</p> <p>Plug an algorithm into this spot to override the "To Do information" algorithm on installation options or the system default "To Do information" if no such algorithm is defined on installation options.</p> <p>Click <a href="#">here</a> to see the algorithm types available for this system event.</p>
To Do Post-Processing	Optional	<p>Algorithms of this type may be used to validate and/or further process a To Do entry that has been added or updated.</p> <p>Click <a href="#">here</a> to see the algorithm types available for this system event.</p>

## List of System To Do Types

The To Do types available to use with the product are found in the To Do Type page. In addition, they may be viewed in the [application viewer's To Do type](#) viewer. If your implementation adds To Do types, you may [regenerate](#) the application viewer to see your additions reflected there.

## Implementing The To Do Entries

To enable the To Do entries visible in the To Do Type page and application viewer, you must configure the system as follows:

- Define the To Do roles associated with each To Do type and link the appropriate users to them. Once you have defined the roles appropriate for your organization's To Do types, remove the reference to this system default role **F1\_DFLT**. Refer to [To Do Entries Reference A Role](#) for more information.
- For any To Do Type that is provided for a specific background process, the To Do simply needs to reference the appropriate Creation Background Process. When the background process is scheduled, To Dos are created based on the logic of the related background process. This applies to [To Dos Created for Object-Specific Error Conditions](#) and [Dedicated To Do Background Processes](#).
- For any To Do Type that is provided for creation by an algorithm or other process, there may be configuration required to populate that To Do type as an algorithm parameter or as an attribute on a control table.

---

**NOTE:** Refer to the description of the To Do type for more information.

---

## Background Processes

This chapter covers various topics related to background processes. Besides providing an overview of background process functionality, the various tools available within the application to define, submit and monitor background processes are covered.

---

**NOTE:** Your specific source application may have additional background process topics. Please refer to the documentation section that applies to your source application for more information.

---

# Understanding Background Processes

This section describes various topics related to the background processes that perform many important functions throughout your product such as:

- Processing To Do Entries
- Monitor processes that select records in a given state to progress them to their next state in their lifecycle
- Processes that purge data
- Processes that extract data
- And many more...

## Background Processing Overview

While the system relies on a scheduler to secure and execute its background processes, there are additional issues that you should be familiar with:

- Batch control records are used for the following purposes:
  - Define the code that executes the logic associated with the background process.
  - For processes that extract information, the batch control record defines the next batch number to be assigned to new records that are eligible for extraction. For example, the batch control record associated with the process that routes To Do entries to an external system defines the next batch number to be assigned to new To Do entries that are configured with this batch control. When this To Do external routing process next runs, it selects all To Do entries marked with the current batch number (and increments the next batch number).
  - The batch control record for each background process organizes audit information about the historical execution of the background process. The system uses this information to control the restart of failed processes. You can use this information to view error messages associated with failed runs.
  - Many processes have been designed to run in parallel in order to speed execution. For example, the process that applies updates for a migration data set import for CMA can be executed so that multiple "threads" are processing a different subset of records (and multiple threads can execute at the same time). Batch control records associated with this type of process organize audit information about each thread in every execution. The system uses this information to control the restart of failed threads. Refer to [Parallel Background Processes](#) for more information.
  - Some processes define extra parameters. These parameters are defined with the batch control. Default values may also be captured for each parameter. They will be used when the [background process is submitted on-line](#).

The following diagram illustrates the relationships that exist for batch control records.

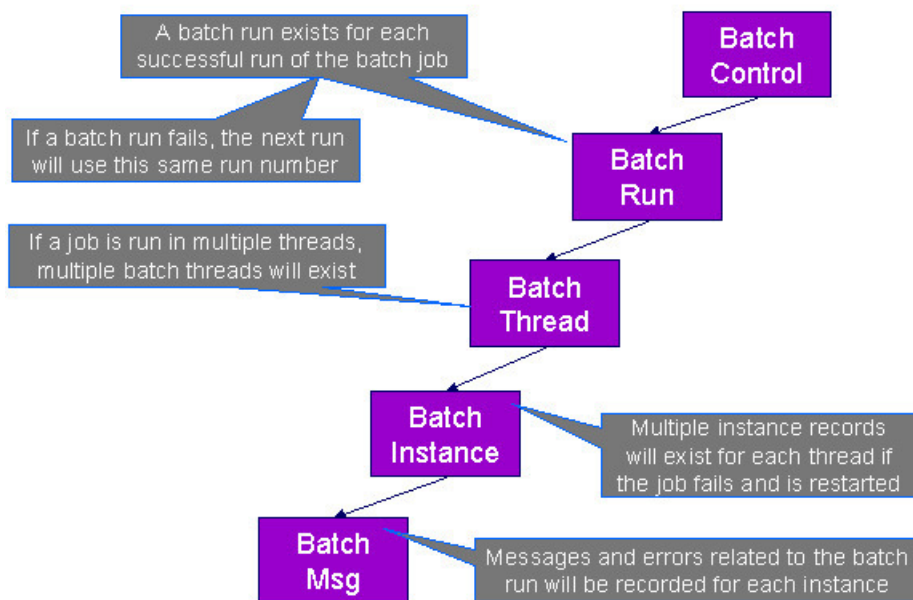

Results of each batch run can be viewed using the [Batch Run Tree](#) page.

Refer to [Batch Scheduler Integration](#) for information about the integration with the Oracle Scheduler.

## Parallel Background Processes

Many processes have been designed to run in parallel in order to speed execution. This is referred to as running the process with multiple “threads”.

The system provides two strategies for distributing the data to the multiple threads.

- **Thread Level SQL Select.** This strategy is sometimes referred to as the “thread iterator” strategy. In this strategy, the batch job uses the primary key to figure out how to evenly distribute key ranges to each thread. Each thread is then responsible for selecting the records. In this strategy, the threads should also re-select the data periodically to release the cursor, which aids in performance. Note that this strategy is preferred but may only be used under the following conditions:
  - The data from only one maintenance object is being processed.
  - The primary key for the maintenance object is a single, numeric system generated key.

---

**NOTE:** Parameters may be used to override the low and high id. Refer to [Parameters Supplied to Background Processes](#) for more information.

---

- **Job Level SQL Select.** This strategy is sometimes referred to as the “standard commit” strategy. In this strategy, the keys for the records to be processed by the batch job are all selected first and stored in a temporary table. The batch job then supplies each thread with a range of keys that it should process. This strategy is used if multiple maintenance objects are being processed by the batch job; if the primary key of the maintenance object has multiple parts or if the primary key is non-numeric.

The multi-threading logic relies on the fact that primary keys for master and transaction data are typically system generated random keys. In addition, if the data is partitioned, it is expected to be partitioned based on the primary key.

---

**NOTE:** The detailed description in the metadata for each batch control provided with the system should indicate if it may be run in parallel. Note that the strategy used is not typically indicated in the detailed description.

---

---

**NOTE: Overriding the thread ranges.** Your implementation has the ability to override the thread ranges if certain data in your system takes longer to process. For example, imagine you have a single account in Oracle Utilities Customer Care and Billing that has thousands of service agreements (maybe the account for a large corporation or a major city). You may want to set up the thread ranges to put this large account into its own thread and distribute the other accounts to the other threads. To do this, you should create the appropriate batch thread records ahead of time in a status of **Thread Ready ( 50)** with the key ranges pre-populated. Note that the base product does not provide the ability to add batch thread records online. If you are interested in more information about this technique, contact Customer Support.

---

## Optimal Thread Count

Running a background process in multiple threads is almost always faster than running it in a single thread. The trick is determining the number of threads that is optimal for each process.

---

**NOTE:** A good rule of thumb is to have one thread for every 100 MHz of application server CPU available. For example if you have four 450 MHz processors available on your application server, you can start with 18 threads to begin your testing:  $(450 * 4) / 100 = 18$ .

---

This is a rule of thumb because each process is different and is dependent on the data in your database. Also, your hardware configuration (i.e., number of processors, speed of your disk drives, speed of the network between the database server and the application server) has an impact on the optimal number of threads. Please follow these guidelines to determine the optimal number of threads for each background process:

- Execute the background process using the number of threads dictated by the rule of thumb (described above). During this execution, monitor the utilization percentage of your application server, database server and network traffic.
- If you find that your database server has hit 100% utilization, but your application server hasn't one of the following is probably occurring:
  - There may be a problematic SQL statement executing during the process. You must capture a database trace to identify the problem SQL.
  - It is also possible that your commit frequency may be too large. Commit frequency is a parameter supplied to every background process. If it is too large, the database's hold queues can start swapping. Refer to [Parameters Supplied to Background Processes](#) for more information about this parameter.
- It is normal if you find that your application server has hit 100% utilization but your database server has not. This is normal because, in general, all processes are CPU bound and not IO bound. At this point, you should decrease the number of threads until just under 100% of the application server utilization is achieved. And this will be the optimal number of threads required for this background process.
- If you find that your application server has not hit 100% utilization, you should increase the number of threads until you achieve just under 100% utilization on the application server. And remember, the application server should achieve 100% utilization before the database server reaches 100% utilization. If this proves not to be true, something is probably wrong with an SQL statement and you must capture an SQL trace to determine the culprit.

Another way to achieve similar results is to start out with a small number of threads and increase the number of threads until you have maximized throughput. The definition of "throughput" may differ for each process but can be generalized as a simple count of the records processed in the batch run tree. For example, in the Billing background process in Oracle Utilities Customer Care and Billing, throughput is the number of bills processed per minute. If you opt to use this method, we recommend you graph a curve of throughput vs. number of threads. The graph should display a curve that is steep at first but then flattens as more threads are added. Eventually adding more threads will cause the throughput to decline. Through this type of analysis you can determine the optimum number of threads to execute for any given process.

## Parameters Supplied To Background Processes

This section describes the various types of parameters that are supplied to background processes.

## General Parameters

The following information is passed to every background process.

- **Batch code.** Batch code is the unique identifier of the background process.
- **Batch thread number.** Thread number is only used for background processes that can be run in multiple parallel threads. It contains the relative thread number of the process. For example, if the billing process has been set up to run in 20 parallel threads, each of the 20 instances receives its relative thread number (1 through 20). Refer to [Optimal Thread Count for Parallel Background Processes](#) for more information.
- **Batch thread count.** Thread count is only used for background processes that can be run in multiple parallel threads. It contains the total number of parallel threads that have been scheduled. For example, if the billing process has been set up to run in 20 parallel threads, each of the 20 instances receives a thread count of 20. Refer to [Optimal Thread Count for Parallel Background Processes](#) for more information.
- **Batch rerun number.** Rerun number is only used for background processes that download information that belongs to given run number. It should only be supplied if you need to download an historical run (rather than the latest run).
- **Batch business date.** Business date is only used for background processes that use the current date in their processing. For example, a billing process may use the business date to determine which bill cycles should be downloaded. If this parameter is left blank, the system date is used. If supplied, this date must be in the format YYYY-MM-DD. Note: this parameter is only used during QA to test how processes behave over time.
- **Override maximum records between commits.** This parameter is optional and overrides each background process's Standard Commit. You would reduce this value, for example, if you were submitting a job during the day and you wanted more frequent commits to release held resources. You might want to increase this value when a background process is executed at night (or weekends) and you have a lot of memory on your servers.
- **Override maximum minutes between cursor re-initiation.** This parameter is optional and overrides each background process's Standard Cursor Re-Initiation Minutes. You would reduce these values, for example, if you were submitting a job during the day and you wanted more frequent commits to release held resources (or more frequent cursor initiations). You might want to increase these values when a background process is executed at night (or weekends) and you have a lot of memory on your servers.
- **User ID.** Please be aware of the following in respect of user ID:
  - Both the user submitting the job and the user ID recorded on the batch submission should have access to the application service for the batch control that secures execution.
  - Any batch process that stamps a user ID on a record it creates or updates uses this user ID in applicable processing.
  - This user ID's [display profile](#) controls how dates and currency values are formatted in messages.
- **Password.** Password is not currently used.
- **Language Code.** Language code is used to access language-specific control table values. For example, error messages are presented in this language code.
- **Trace program at start (Y/N), trace program exit (Y/N), trace SQL (Y/N) and output trace (Y/N).** These switches are only used during QA and benchmarking. If trace program start is set to Y, a message is displayed whenever a program is started. If trace program at exist is set to Y, a message is displayed whenever a program is exited. If trace SQL is set to Y, a message is displayed whenever an SQL statement is executed. If output trace is set to Y, special messages formatted by the background process are written.

---

**NOTE:** The information displayed when the output trace switch is turned on depends on each background process. It is possible that a background process displays no special information for this switch.

---

## Common Additional Parameters

Each batch control supports the definition of additional parameters. There are some additional parameters that are common to all batch processes or common to a specific type of batch process. The batch control should be delivered with the

appropriate additional parameters. However, when new additional parameters are introduced, existing batch controls may not be updated with the new additional parameter.

The following table highlights the common parameters that may be linked to a batch control. Note that for batch parameters, although there is a sequence number that controls the displayed order of the parameter, the batch process does not use the sequence to identify a particular parameter but rather uses the parameter name. In some cases multiple parameter names are supported (a 'camel case' version and an 'all caps' version).

Parameter Name	Description	Additional Comments
<b>MAX-ERRORS / maxErrors</b>	Each of the batch processes has, as part of its run parameters, a preset constant that determines how many errors that batch process may encounter before it is required to abort the run. A user can override that constant using this parameter.	The input value must be an integer that is greater than or equal to zero. The maximum valid value for this parameter is 999,999,999,999,999.
<b>DIST-THD-POOL</b>	Each batch process executes in a thread pool. This parameter is only necessary if the batch process should execute in a different thread pool than the default thread pool.	The default thread pool name is <b>DEFAULT</b> .
<b>emailMode</b>	When the batch job is submitted with an associated email address, the default logic is to send an email when the job completes regardless of success or failure. Use this parameter to limit the email based on the status of the job when it ends.	Valid Values <ul style="list-style-type: none"> <li>• <b>ERROR</b> — send an email only when the job ends in Error status.</li> <li>• <b>SUCCESS</b> — send an email only when the job ends in successfully.</li> <li>• <b>ALL</b> — always send an email only when the job ends. (This is the default.)</li> </ul>

The following parameters are only applicable to jobs that use the **Thread Level SQL Select** method of distributing work to threads as described in [Parallel Background Processes](#).

<b>overrideLowIdValue</b>	Specifies a new low id to use in calculating the range for a thread. The framework by default assumes that the Id is between 0's (e.g. 000000000) and 9's (e.g. 9999999999), but this parameter will override the low value.	The parameter value can be an actual number or it can be set to <b>auto</b> . If <b>auto</b> is configured, it is set to the lowest current value on the database table associated with the background process.
<b>overrideHighIdValue</b>	Specifies a new high id to use in calculating the range for a thread. The framework by default assumes that the Id is between 0's (e.g. 000000000) and 9's (e.g. 9999999999), but this parameter will override the high value.	The parameter value can be an actual number or it can be set to <b>auto</b> . If <b>auto</b> is configured, it is set to the highest current value on the database table associated with the background process.
<b>idRangeOverrideClass</b>	Use this parameter to specify a custom class to do thread range calculation. During batch execution, this override class is instantiated and the setter methods called to initialize the Ids as required. The low and high getter methods are called to retrieve the high and low ids to be used for the run.	The class name specified must implement interface <code>com.splwg.base.api.batch.BatchIdRangeOverride</code> .

The following parameters are only applicable to jobs that perform a single commit, for example for extract batch jobs.

<b>numRecordsToFlush</b>	This parameter defines how frequently to flush the Hibernate cache to prevent high heap consumption and Out Of Memory Errors.	
--------------------------	---	--



## Specific Batch Parameters

Some background processes define additional parameters that are specific to their functionality. When a process receives additional parameters, they are defined and documented in the batch control entry in the application. They are also visible in the [batch control](#) viewer (part of the [application viewer](#)).

## Indicating a File Path

Some of the system background processes use extra parameters to indicate a File Path and/or File Name for an input file or an output file. For example, most extract processes use File Path and File Name parameter to indicate where to place the output file.

When supplying a FILE-PATH variable, the directory specified in the FILE-PATH must already exist and must grant write access to the administrator account for the product. You may need to verify a proper location with your systems administrator.

The syntax of the FILE-PATH depends on the platform used for the product application server. Contact your system administrator for verification. For example, if the platform is UNIX, use forward slashes and be sure to put a trailing slash, for example `/spltemp/filepath/`.

## Processing Errors

When a background process detects an error, the error may or may not be related to a specific object that is being processed. For example, if the program finds an error during batch parameter validation, this error is not object-specific. However, if the program finds an error while processing a specific bill, this error is object-specific. The system reports errors in one of the following ways:

- Errors that are not object-specific are written to the error message log in the [Batch Run Tree](#).
- Some batch processes create entries in an "exception table" for certain object-specific errors. For example, an error detected in the creation of a bill in Oracle Utilities Customer Care and Billing may be written to the bill exception table. If an error is written to an exception table, it does not appear in the batch run tree. For each exception table, there is an associated to do entry process that creates a To Do Entry for each error to allow a user to correct the problem on-line.
- For some background processes, errors that do not result in the creation of an exception record may instead generate a To Do entry directly. For these processes, if you wish the system to directly create a To Do entry, you must configure the To Do type appropriately. Refer to [To Do entry for object-specific errors](#) for information about configuring the To Do type. If the background process detects an object specific error and you have configured the system to create a To Do entry, the error is not written to the batch run tree. If you have configured your To Do type to not create To Do entries for certain errors, these errors are written to the [batch run tree](#).

---

**NOTE: Some processes create exceptions and To Do entries.** It is possible for a background process to create entries in an exception table and create To Do entries directly, depending on the error. Consider batch billing in Oracle Utilities Customer Care and Billing; any conditions that cause a bill or bill segment to be created in **error** status result in a record added to the bill exception table or the bill segment exception table. However, any object-specific error that is not related to a specific bill or bill segment or any error that prevents a bill or bill segment from being created may result in a To Do entry for the object-specific error.

---

## Error Post-Processing Logic

The product supports executing one or more algorithms when a batch process encounters an error that causes execution to stop. This allows for some special processing to occur to handle the failure of the batch job. Algorithms for this plug-in spot receive the batch control, batch run number, batch processing business date, number of threads and the list of the ad hoc parameters of the batch job. The following are some examples of functionality that may be executed when a batch job fails:



- Another object or record that is monitoring the batch job may have its status updated to reflect the batch status.
- An outbound message service may be invoked to perform a task related to the failure.

Note that the units of work for all threads are committed prior to executing the error post-processing logic.

## Post-Processing Logic

The product supports executing one or more algorithms after all the threads of a given batch job have completed. This allows for some special processing to occur at the end of a batch job. Algorithms for this plug-in spot receive the batch control, batch run number, batch processing business date, number of threads and the list of the ad hoc parameters of the batch job. The following are some examples of functionality that may be executed at the end of a batch job:

- Another dependent batch job can be kicked off. Note that this use case is only needed when the multiple dependent jobs are not part of a scheduler (which can also detect the successful end of one batch job so as to submit the next job).
- Statistics for the batch run may be analyzed and based on results, a To Do Entry may be sent to an administrator.
- If the current batch job is processing a large number of child records in multiple threads, a parent record could be updated to a different status or with some other audit information.

Note that the units of work for all threads are committed prior to executing the post-processing logic. The algorithm should perform standard error handling. If an error occurs in one of the post-processing algorithms, the overall batch job's status is set to Error so that it can be re-submitted to retry the logic in the finalize step.

## Timed Batch Processes

Most batch jobs are submitted via a batch scheduler. In the absence of a scheduler, a batch control may be configured as “timed” triggering the framework to monitor and schedule these batch jobs as defined by the timer interval. The timer interval defines the desired interval between starts (in seconds). The system schedules new batch runs at each interval if the last instance of the job has completed.

When configuring a batch control as “timed”, other default information must be provided, including the User ID and Language to use for submitting the job and the email address for notification, if desired.

Timed batch controls also include an Active setting, allowing for an implementation to temporarily stop further executions of the batch job (but retain the other timer settings).

Timed jobs are controlled by the default threadpool and not by a scheduler. When the **DEFAULT** threadpoolworker starts it will start executing any job for a Batch Control configured as **Timed** with the Timer Active set to **Yes**. This is whether the batch daemon or batch server is enabled or not.

## Monitor Background Processes

In many areas of the system, functionality is driven from business object configuration as a BO driven record progresses through its lifecycle. Refer to [Business Object Lifecycle](#) for details. As part of that functionality, it is possible that a background process, called a [monitor batch process](#), is used to execute functionality for the record. A single program is provided for the BO monitor functionality and parameters are used to limit the records processed by maintenance object and other optional parameters that may further limit the records. The product typically provides at least one monitor batch control for each maintenance object that supports a configurable lifecycle on its business object.

This topic highlights the parameters supported by the monitor batch job. Not all parameters are applicable to all maintenance objects and therefore may not be configured on a give base monitor batch control.

Parameter Name	Description	Comments
<code>maintenanceObject</code>	Maintenance Object	For most base delivered batch controls, this parameter is delivered already populated with the value of the maintenance object

Parameter Name	Description	Comments
		value. Note that it is supported to leave this value blank, at which point, the program will determine the maintenance object (objects) to process by looking for an MO that refers to this batch control record as an option.
<b>isRestrictedByBatchCode</b>	Restrict by Batch Code	Set this to <b>true</b> to indicate whether the process should only select records that explicitly refer to this batch control on its current BO state. This is also referred to as “deferred” mode. If set to <b>false</b> , the program includes all records that refer to the current batch control in its BO state and records that don’t refer to any batch control in its current state (but monitor algorithms exist in the current state). This is commonly referred to as “periodic” mode. Note that if the value is not set at all, the program will determine whether to run it as “deferred” or “periodic” based on whether the batch code is configured on the MO option as a <b>State Monitor Process</b> (“deferred”) or a <b>Periodic Monitor Process</b> .
<b>restrictToType</b>	Restrict by Related Type	This parameter is only applicable to maintenance objects that have a related ‘type’ object and the maintenance object has configured an option indicating the field for the related type column. This parameter may be used to limit the processing to records that are in the indicated type.
<b>restrictToBusinessObject</b>	Restrict by Business Object	This parameter may be used to limit the processing to records that are in the indicated business object.
<b>restrictToStatus</b>	Restrict by Status	This parameter may be used to limit the processing to records that are in the indicated status.
<b>sampleRecordNumber</b>	Sample Record Number	This is not a commonly used parameter. It is only applicable when the monitor is used for a business use case that supports processing a subset of the records during a testing phase. For example, if the process is validating a large number of records, it may be an option to only validate every 100 records to determine if there are repeated validation errors that may indicate a common problem that may be solved to fix many errors.

Also note that when submitting a monitor process with multiple [parallel threads](#), the program will use a **Thread Level SQL Select** strategy unless any of the following are true (in which case it will use the **Job Level SQL Select** strategy:

- The input maintenance object is left blank and the program finds more than one maintenance object that refers to this batch control in its options.
- A single MO is applicable but it has a multi-part primary key.
- A single MO is applicable and it has a single primary key, but it is a user defined key instead of a system generated key.
- The sample record number parameter is populated.

## Plug-in Driven Background Processes

Although the product is delivered with a rich library of background processes, implementations may have business requirements that require new processes to be introduced. It is possible for an implementation to write a background process from scratch using a base process as a template. However, the product also provides base background processes that call algorithms to select the records to be processed and to process the records. These are called plug-in driven background processes. The base processes implement standard background process functionality including parallel background process

logic and the ability to create To Do entries for errors. This allows for an implementation to take advantage of the pre-built support and provide plug-ins that include the logic that is unique to the specific use case.

The following sections provide more information about the provided functionality.

## Types of Processes

The system provides the following processes that support plug-ins for selecting and processing the records:

- **Ad-hoc Process.** This background process is provided for implementations that have some custom business logic that needs to be performed on a group of records. The base batch control Plug-in Driven Generic Template ([F1-PDBG](#)) may be used as a template.
- **Extract Process.** This background process is provided for implementations that have extract files to produce for integration with external systems. The process includes parameters to configure the file path and file name for the created file along with other parameters to control how the file is formatted. The base batch control Plug-in Driven Extract Template ([F1-PDBEX](#)) may be used as a template.

## Select Records Algorithm

The first important algorithm to design when implementing a plug-in driven batch process is the Select Records algorithm, plugged in on the [batch control](#) page. This algorithm type must define the first parameter as the SQL. The batch job will directly access the SQL parameter value in the metadata (rather than invoking the algorithm). All other parameters are available for the algorithm to use for its own logic.

In addition, when invoking the algorithm, it must return the strategy to use (**Thread Level SQL Select** or **Job Level SQL Select**). Refer to [parallel background processes](#) for more information about the two strategies and when to use each. When choosing the **Thread Level SQL Select** strategy, the algorithm should return the name of the primary key in the Key Field parameter. In addition, the SQL should include a **BETWEEN** clause that includes the bind variables for the low and high ID for the ranges. See below for the bind variable syntax.

If the SQL statement includes variables that are determined at execution time, it must use bind parameters. Bind parameters are referenced in the SQL statement using a colon and a parameter name (for example **:parameter**). There are some variables provided by the system that are populated by the batch job at execution time. These have **f1.** as its prefix.

The system supports the following pre-defined bind parameters:

- **:f1.lowID** and **:f1.highID** - these should be used in the **BETWEEN** clause for the **Thread Level SQL Select** strategy. The batch job will substitute the appropriate ID range as required.
- **:f1.batchCode** and **:f1.batchNumber** - these are common attributes of the batch control that are referenced on a record for selection purposes. Note that the batch run number is set according to whether the batch job is a re-run of a previous run or not.
- **:f1.businessDate** - the batch job will populate the input batch business date, if populated otherwise the current date.

For any other custom parameters, the Select Records algorithm may return one or more sets of field name / variable name / value where the variable name matches a bind variable in the SQL. The field name provides information about data type and length that assists the SQL binding logic to properly substitute the values. Note that the variable name cannot start with **f1.** as its prefix. The batch job will use the value returned by the algorithm to set the bind parameter in the SQL statement.

The plug in spot receives a list of the ad hoc parameters for the batch job as name / value pairs. If the list includes parameters whose values are to be used in selecting records, your algorithm may be used to identify the relevant batch parameter passed as input and populate the field name and output bind variable appropriately.

The product provides a base algorithm type for this plug-in spot that simply defines a parameter for the SQL. It also includes parameters for the strategy and the key field name. This algorithm type may be used by any custom batch process where the SQL does not rely on any special bind variables that must be determined. Simply create an algorithm for the algorithm type and provide the appropriate SQL. Refer to the algorithm type Select Records by Predefined Query ([F1-PDB-SR](#)) for more information.

## Process Records Algorithm

The other important algorithm to design when implementing a plug-in driven batch process is the Process Record algorithm, plugged in on the [batch control](#) page. This algorithm is called for each record selected for the process. It receives all the information that was selected from the Select Records plug-in.

For the ad-hoc processing batch process, algorithms plugged into this spot are responsible for doing the work for each record based on the desired logic.

For the extract batch process, algorithms plugged into this spot are responsible for returning the data that should be written to the file in one or more XML instances along with the schema name(s) that describes the XML instance(s). For XML output format, the batch process will write the XML instance data as returned by the plug-in. For fixed position or CSV output format, the batch process will convert the XML instance data to the appropriate format and add it to the file.

Also note that algorithms for this plug-in spot will be passed two Booleans, `isFirst` and `isLast`, to indicate if the current work unit is the first and/or last for that thread. This allows for the plug-in to do additional work if needed. Note that the `isFirst` indication is available for both types of batch processes, ad-hoc and extract. However, the `isLast` indication is only applicable for the file extract batch. For the ad-hoc batch process this value will always be set to **false**. Extracts will always execute in a single database transaction. In a single transaction run, any error causes the run to be aborted so that it restarts from the beginning when resubmitted. This is done to avoid partial files being written along with inaccurate setting of the `isLast` element.

The product provides a base algorithm type for this plug-in spot that illustrates the technique to follow when implementing an extract type of plug-in driven background process. Refer to the algorithm type General Process - Sample Process Record Extract ([F1-GENPROCEX](#)) for more information.

## Configuring a New Process

The following points summarize the steps needed to implement a new background process using plug-ins for the specific functionality:

- Verify the SQL that the background process should execute. Keep in mind that all the data selected in the SQL is available to pass to the plug-in that processes the records. If the performance of the background process is important, be sure to consult with a DBA when designing the SQL.
  - If the SQL does not require any custom variables to substitute at runtime, create an algorithm for the base algorithm type [F1-PDB-SR](#) and configure the SQL. In addition, configure the strategy and the primary key name (for the **Thread Level SQL Select** strategy).
  - If the SQL requires custom variables, a new [plug-in script](#) must be designed and coded to populate the variable names and values using the algorithm entity **Batch Control — Select Records**. Besides defining the variables, the algorithm must also indicate the strategy and the primary key name (for the **Thread Level SQL Select** strategy). Define the algorithm type for the newly created script. The first parameter of the algorithm type must be the SQL as illustrated in the base algorithm type. Note that the other parameters are available for use by this algorithm type if needed. Define the algorithm, populating the SQL as appropriate (using the custom variables).
- Design the logic required for each record and create a [plug-in script](#) where the algorithm entity is **Batch Control — Process Record**. Note that the plug-in receives all the information selected in the SQL defined in the Select Records plug-in
  - For an ad-hoc process, the algorithm should perform whatever process is required based on the business use case. Note that the background process is responsible for committing the records.
  - For an extract process, the algorithm is responsible for returning one or more schema instances populated with information that should be written to the file. If an existing schema satisfies the output requirements, it may be used. Otherwise, define a data area to indicate the output format of the records as appropriate.

In either case, define the algorithm type and algorithm for the newly created script.

- Create a batch control by duplicating the appropriate base template as per the type of background process needed. Plug in the algorithms created above and configure the parameters as appropriate. Note that you may configure custom ad

hoc parameters on the batch control if required. Both base and custom batch parameter values are available to the Select Records and Process Records plug in algorithms.

## How to Re-extract Information

If you need to recreate the records associated with an historical execution of an extract process, you can - simply supply the desired batch number when you request the batch process.

## How to Submit Batch Jobs

Most batch jobs are submitted via a batch scheduler. Refer to [Batch Scheduler Integration](#) for information about the integration with the Oracle Scheduler.

Batch jobs may be configured as **Timed**, which means they will automatically be run based on the timer frequency.

In addition, you can manually submit your adhoc background processes or submit a special run for one of your scheduled background processes using the online [batch job submission](#) page.

## How to Track Batch Jobs

You can track batch jobs using the batch process pages, which show the execution status of batch processes. For a specified batch control id and run id, the tree shows each thread, the run-instances of each thread, and any messages (informational, warnings, and errors) that might have occurred during the run.

---

**FASTPATH:** For more information, refer to [Tracking Batch Processes](#).

---

## How to Restart Failed Jobs and Processes

Every process in the system can be easily restarted if it fails (after fixing the cause of the failure). All you have to do is resubmit the failed job; the system handles the restart.

## Assessing Level of Service

For some background processes, an implementation may wish to supply an algorithm that checks some conditions to assess whether or not the process is performing as expected. This algorithm could be simply verifying that the batch process is running as frequently as expected. Or it could be used to check the performance of the job to see if it is running as efficiently as expected. Or it could analyze the data processed by the background process to assess whether there may be some problem with the quality of the data.

The system provides a Level of Service plug-in spot on [batch control](#) to configure the appropriate algorithm for a given background process, if desired. The algorithm is expected to return a value to indicate the 'level of service' determined along with a message indicating the reason for the value. The following Level of Service values are supported:

- **Normal.** Indicates that the algorithm did not detect any issues.
- **Warning.** Indicates that the algorithm found some issues that may or may not indicate a problem.
- **Error.** Indicates that the algorithm found some issues that should be investigated.
- **Disabled.** Indicates that the algorithm could not properly execute the level of service logic.

When viewing a [batch control](#) record, if there is a level of service algorithm configured, its logic is executed and the results are displayed. The level of service is also part of the [Health Check](#) service.

# System Background Processes

---

**NOTE: List of system background processes.** The list of background processes provided in the base product may be viewed in the [application viewer's batch control](#) viewer. In addition if your implementation adds batch control records, you may [regenerate](#) the application viewer to see your additions reflected there.

---

## Defining Batch Controls

The system is delivered with all necessary batch controls. Implementations may define default values for parameters. In addition, implementations may define their own background processes.

To view background processes, open **Admin > System > Batch Control**. Refer to [Background Processing Concepts](#) for more information.

**CAUTION:** Important! If you introduce a new batch process, carefully consider its naming convention. Refer to [System Data Naming Convention](#) for more information.

---

### Description of Page

Enter an easily recognizable **Batch Process** and **Description** for each batch process.

**Owner** indicates if this batch control is owned by the base package or by your implementation (**Customer Modification**). The system sets the owner to **Customer Modification** when you add a batch control. This information is display-only.

Use the **Detailed Description** to describe the functionality of the batch process in detail.

Enter the **Application Service** that is used to provide security for submission requests for the batch control. The application service must have an Access Mode of **Execute**. Refer to [Granting Access To Batch Submission](#) for more information.

Use **Batch Control Type** to define the batch process as either **Timed** or **Not Timed**. A [Timed batch process](#) will be automatically initialized on a regular basis. A Not Timed process needs to be run manually or through a scheduler.

Use **Batch Control Category** to categorize the process for documentation purposes. The base values provided are as follows:

- **Ad Hoc.** Processes of this type are run on an ad hoc basis, only when needed. For example, if there is a process to do a mass cancel / correction of data, it would only be run when a situation occurs requiring this.
- **Extract.** Extract processes extract information that is interfaced out of the system. Processes of this type typically extract records marked with a given run number. If the requester of the process does not supply a specific run number, the system assumes that the latest run number should be extracted. If you need to re-extract an historical batch, you simply supply the respective run number when you request the batch process.
- **ILM.** [Information Lifecycle Management](#) jobs are crawler background processes that are associated with the ILM based storage solution.
- **Monitor.** Processes of this type are processes related to business objects with a lifecycle state that defines [monitor algorithms](#). The monitor process selects records in a given state and executes its algorithms, which may cause the record to transition to another state or may trigger some other logic to occur. Using configuration, the monitor process may target only specific records. Refer to [Monitoring Batch Processes](#) for more information. Note that these types of background processes can be considered a subset of **Process What's Ready**
- **Process What's Ready.** Processes of this type create and update records that are "ready" for processing. The definition of "ready" differs for every process. For example, a payment upload process creates payments for every record that is **pending**. An overdue event monitor activates pending overdue events that have reached their trigger date.
- **Purge.** Processes of this type are used to purge historical records from certain objects that generate a large number of entries and may become unwieldy over time.



- **To Do Entry.** Processes of this type are used to detect a given situation and create or complete a To Do Entry. Refer to [To Do Entries Created by Background Processes](#) for more information.
- The following categories are related to the data conversion / migration processes, which are not applicable to all products:
  - **Conversion.** Processes of this type are dedicated to converting or migrating data from external applications into the product.
  - **Object Validation.** Processes of this type are dedicated to validate data within objects for conversion or migration purposes.
  - **Referential Integrity.** Processes of this type are dedicated to validate referential integrity within objects for conversion or migration purposes.

---

**NOTE:** Additional categories may be introduced by your specific product.

---

If the batch process is Timed, then the following fields are available:

- **Timer Interval** is the number of seconds between batch process submissions. The system will start the next run this many seconds from the start time of the previous run.
- **User ID** is the ID under which the batch process will run.
- **Email Address** is the Email address to be used for notification if the batch process fails.
- **Timer Active** allows you to temporarily switch off the timer while retaining the other settings for the timed job.
- **Batch Language** is the language associated with the batch process.

Use **Program Type** to define if the batch process program is written in **Java** or **Java (Converted)**, meaning that the program has been converted into Java.

---

**NOTE:** **Java (Converted)** program types are not applicable to all products.

---

Use **Program Name** to define the Java class / program associated with your batch process:

---

**NOTE: View the source.** If the program is shipped with the base package, you can use the adjacent button to display the source code of this program in the [Java docs viewer](#).

---

**Level of Service** shows the output of the [level of service](#) algorithm for the batch control. It shows the level of service lookup value along with a message indicating the reason for the output value. Note that if no level of service algorithm is found, then the value **Disabled** is shown with a message indicating that no algorithm is provided for this batch control.

The **Last Update Timestamp**, **Last Update Instance** and **Next Batch Nbr** are used for audit purposes.

Turn on **Accumulate All Instances** to control how this batch control is displayed in the [Batch Run Tree](#). If checked, the run statistics (i.e., "Records Processed" and "Records in Error") for a thread are to be accumulated from all the instances of the thread. This would include the original thread instance, as well as any restarted instances. If this is not turned on, only the ending (last) thread instance's statistics are used as the thread's statistics. This may be preferred for certain types of batch processes where the accumulation would create inaccurate thread statistics, such as those that process flat files and, therefore, always start at the beginning, even in the case of a restart.

The following fields are default values that are used when a batch job is submitted for the batch control:

- Use **Thread Count** to control whether a background process is run single threaded or in multiple parallel threads. This value defines the total number of threads that have been scheduled.
- Select **Trace Program Start** if you want a message to be written whenever a program is started.
- Select **Trace SQL** if you want a message to be written whenever an SQL statement is executed.
- Use **Override Nbr Records to Commit** to define the default number of records to commit. This is used as the default value for timed jobs as well as online submission of jobs that are not timed.

- Select **Trace Program Exit** if you want a message to be written whenever a program is exited.
- Select **Trace Output** if you want a message to be displayed for special information logged by the background process.

For more information about these fields, see [Batch Job Submission - Main](#)

The parameter collection is used to define additional parameters required for a particular background process. The following fields should be defined for each parameter:

**Sequence.** Defines the relative position of the parameter.

**Parameter Name.** The name of the parameter as defined by the background process program.

**Description.** A description of the parameter.

**Detailed Description.** A more detailed description of the parameter.

**Required.** Indicates whether or not this is a required parameter.

**Parameter Value.** The default value, if applicable. Note that an implementation may define a default value for base provided batch controls.

**Security.** Indicates whether the system should **Encrypt** the parameter value or not. A value of **Encrypt** means that the parameter value is stored in the database and written to the log files using encryption. In addition, the parameter is written to the log files with asterisks. The setting applies to values entered here as well as in the online [Batch Submission](#). If there is no need to secure the parameter value, use the default setting of **None**.

**Owner** Indicates if this batch process is owned by the base package or by your implementation (Customer Modification). The system sets the owner to **Customer Modification** when you add a batch process. This information is display-only.

## Batch Control - Algorithms

Use this page to maintain a batch control's algorithms. Open this page using **Admin > System > Batch Control** and then navigate to the **Algorithms** tab.

### Description of Page

The **Algorithms** grid contains algorithms that control important functions for instances of this batch control. You must define the following for each algorithm:

- Specify the **System Event** with which the algorithm is associated (see the table that follows for a description of all possible events).
- Specify the **Sequence Number** and **Algorithm** for each system event. You can set the **Sequence Number** to 10 unless you have a **System Event** that has multiple **Algorithms**. In this case, you need to tell the system the **Sequence** in which they should execute.
- **Owner** indicates if this is owned by the base package or by your implementation (**Customer Modification**).

The following table describes the **System Events**.

System Event	Optional / Required	Description
<b>Error Post-Processing</b>	Optional	Algorithms of this type are called if the batch process fails to complete due to an error. Multiple algorithms are allowed and are executed in sequence order. Refer to <a href="#">Error Post-Processing Logic</a> for more information.  Click <a href="#">here</a> to see the algorithm types available for this system event.
<b>Level of Service</b>	Optional	Algorithms of this type are called to determine the Level of Service provided by a batch control. Note that only one algorithm is allowed. Refer to <a href="#">Assessing Level of Service</a> for more information.



System Event	Optional / Required	Description
		Click <a href="#">here</a> to see the algorithm types available for this system event.
Post-Processing	Optional	Algorithms of this type are called after all threads are complete. Multiple algorithms are allowed and are executed in sequence order. Refer to <a href="#">Post-Processing Logic</a> for more information.  Click <a href="#">here</a> to see the algorithm types available for this system event.
Process Record	Optional	Algorithms of this type are only applicable to <a href="#">plug-in driven background processes</a> and are used to process a specific record.  Click <a href="#">here</a> to see the algorithm types available for this system event.
Select Records	Optional	Algorithms of this type are only applicable to <a href="#">plug-in driven background processes</a> and are used to define the SQL to use to select the records to process. Only one algorithm is allowed.  Click <a href="#">here</a> to see the algorithm types available for this system event.

**NOTE:** You can add new system events. Your implementation may want to add additional batch control oriented system events. To do that, add your new values to the customizable lookup field **F1\_BATCH\_CTRL\_SEVT\_FLG**.

## On-Line Batch Submission

The on-line [batch submission](#) page enables you to request a specific background process to be run. When submitting a background process on-line, you may override standard system parameters and you may be required to supply additional parameters for your specific background process. After submitting your background process, you may use this page to review the status of the submission.

The following topics further describe logic available for on-line submission of background processes.

### Batch Submission Creates a Batch Run

When you request a batch job to be submitted from on-line, the execution of the desired background process will result in the creation of a batch run. Just as with background processes executed through your scheduler, you may use the [Batch Run Tree](#) page to view the status of the run, the status of each thread, the run-instances of each thread, and any messages that might have occurred during the run.

**NOTE:** Your on-line submission record is assigned a status value so that you may know whether your job has been submitted and whether or not it has ended, however, it will not contain any information about the results of the background process itself. You must navigate to the [Batch Run Tree](#) page to view this detail.

### Jobs Submitted in the Background

When you save a record on the batch job submission page, the batch job does not get submitted automatically. Rather, it saves a record in the batch job table. A special background process will periodically check this table for pending records and will execute the batch job. This background process will update the status of the batch job submission record so that a user can determine when their job is complete.

---

**NOTE:** At installation time, your system administrator will set up this special background process to periodically check for pending records in the batch job submission table. Your administrator will define how often the system will look for pending records in this table.

---

It should be noted that this special background process only submits one pending batch job submission record at a time. It submits a job and waits for it to end before submitting the next pending job.

---

**NOTE:** If you request a batch job to be run multi-threaded, the special background process will submit the job as requested. It will wait for all threads to complete before marking the batch job submission record as **ended**. Refer to [Running Multi-threaded Processes](#) for more information.

---

## Email Notification

If you wish the system to inform you when the background process completes, you may supply your email address. The email you receive will contain details related to the batch job's output; similar to the job results you would see from your batch scheduler.

---

**NOTE:** This assumes that during the installation process, your system administrator configured the system to enable email notification. Your administrator may also override the amount of detail included in the email notification.

---

## Running Multi-Threaded Processes

Many of the system background processes may be run multi-threaded. When submitting a background process on-line, you may also run a multi-threaded process or run a single thread of a multi-threaded process. The fields Thread Count and Thread Number on the [batch submission](#) page control the multi-threaded process requests:

- To run a multi-threaded process, indicate the number of threads in **Thread Count** and enter **0** in the **Thread Number**.
- To run a single thread in a multi-threaded process, indicate the number of threads in Thread Count and indicate the Thread Number you would like to run.
- To run a process as a single thread, enter Thread Count = **1** and Thread Number = **1**. This will execute the background process single-threaded.

---

**NOTE:** When running a multi-threaded process, the special background process will wait until all threads are complete before marking the batch job submission record as **Ended**.

---

## Batch Jobs May End in Error

It is possible for your background process to end with an error. When this occurs, your batch job submission record will still be marked as **Ended**. You will need to navigate to the [Batch Run Tree](#) page to determine the status of the batch run.

## Submitting Jobs in the Future

If you wish to request a batch job to be submitted in the future, you may do so when creating your batch job submission record by entering a future submission date. The special background process, which looks for pending records in the batch job submission table, will only submit batch jobs that do not have a future submission date.

## Lifecycle of a Batch Job Submission

The following diagram illustrates the lifecycle of a batch job submission record.

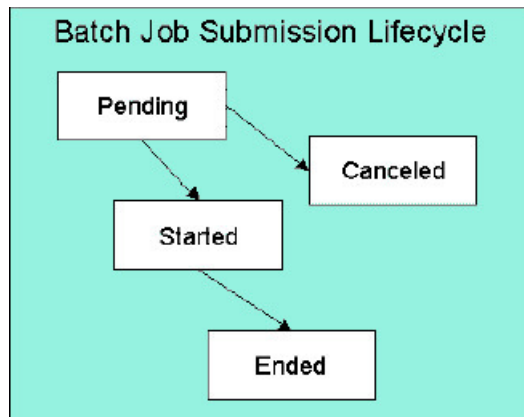

**Pending** — Records are created in **Pending** status. Records in this state are put in a queue to be submitted.

**Canceled**— Users may cancel a pending record to prevent the batch job from being submitted.

**Started**— Once a pending record has been submitted for processing, its status will be changed to **Started**. Records in this status may not be canceled.

**Ended**— When the batch job has finished processing, its status will be changed to **Ended**. Note that records in **Ended** status may have ended in error. Refer to [Batch Jobs May End in Error](#) for more information.

## Granting Access To Batch Submission

Every batch control must reference an [application service](#). When you link a batch control to an application service, you are granting all users in the group the ability to submit the associated batch job for execution.

---

**FASTPATH:** Refer to [The Big Picture Of Application Security](#) for information about granting users access rights to an application service.

---

When the batch control is added to the batch job table, the system checks if both the user submitting the job and the user ID recorded on the batch submission record have access rights. Application security does not apply when viewing a batch control or an associated batch run.

---

**NOTE:** Base batch controls will be associated with base owned application services by default. Implementations will need to ensure the appropriate user groups are linked to these application services.

---

## Batch Job Submission - Main

This page allows you to submit a batch job on-line. Navigate to this page using **Menu > Tools > Batch Job Submission**.

### Description of Page

The **Batch Job ID** is a system generated random number that identifies a particular submission.

To submit a batch job, choose the **Batch Code** for the process you wish to submit.

---

**NOTE: List of system background processes.** The list of background processes provided in the base product may be viewed in the [application viewer's batch control](#) viewer.

---

The following parameters are provided with each background process:

**Thread Number** is used to control whether a background processes is run single threaded or in multiple parallel threads. It contains the relative thread number of the process. For example, if the process has been set up to run in 20 parallel threads, each of the 20 instances receives its relative thread number (1 through 20). Refer to [Running Multi-threaded Processes](#) for more information about populating this field.

**NOTE:** Not all processes may be run multi-threaded. Refer to the description of a batch control to find out if it runs multi-threaded.

---

**Thread Count** is used to control whether a background processes is run single threaded or in multiple parallel threads. It contains the total number of threads that have been scheduled. For example, if the process has been set up to run in 20 parallel threads, each of the 20 instances receives a thread count of 20. Refer to [Running Multi-threaded Processes](#) for more information about populating this field.

**Batch Rerun Number** is only used for background processes that download information that belongs to given run number. It should only be supplied if you need to download an historical run (rather than the latest run).

**Batch Business Date** is only used for background processes that use a date in their processing. In Oracle Utilities Customer Care and Billing, for example, a billing process can use the business date to determine which bill cycles should be downloaded. If this parameter is left blank, the system date is used at the time the background process is executed.

**NOTE:** Saving a record on this page does not submit the batch job immediately. A special background process will run periodically to find pending records and submit them. Depending on how often the special process checks for pending records and depending on how many other pending records are in the 'queue', there may be a slight lag in submission time. If the desired execution date/time is close to midnight, it is possible that your batch job will run on the day after you submit it. If you have left the business date blank in this case, keep in mind that your business date would be set to the day after you submit the job.

---

**Override Nbr Records To Commit** and **Override Max Timeout Minutes**. These parameters are optional and override each background process's Standard Commit Records and Standard Cursor Re-Initiation Minutes. (Each background process's Standard Commit Records / Standard Cursor Re-Initiation Minutes should be documented in the detailed description of the batch control record). Note that Max Timeout Minutes corresponds to the Cursor Re-initiation Minutes.

**FASTPATH:** Refer to [Parameters Supplied to Background Processes](#) for more information.

---

**User ID** is the user ID associated with the run of the background process. Refer to [Parameters Supplied to Background Processes](#) for more information about the significance of the user id.

**NOTE:** This field defaults to the id of the current user.

---

**Password** is not currently used.

**Language Code** is used to access language-specific control table values. For example, error messages are presented in this language code.

If you wish the system to notify you when the batch job is complete, enter your **Email ID**. Refer to [Email Notification](#) for more information.

**NOTE:** This field defaults to the email address for the current user, if populated on the [user](#) record.

---

The **Desired Execution Date/Time** defaults to the current date and time. Override this information if you wish the background process to be executed at some future date and time. Refer to [Submitting Jobs in the Future](#) for more information.

The **Batch Job Status** indicates the current status of the batch job. Refer to [Lifecycle of a Batch Job Submission](#) for more information.

The **Program Name** associated with the batch control code is displayed.

The following trace parameters may also be supplied to a background process and are only used during QA and benchmarking.

- **Trace Program Start** Turn on this switch if you wish a message to be written whenever a program is started.
- **Trace Program Exit** Turn on this switch if you wish a message to be written whenever a program is exited.
- **Trace SQL** Turn on this switch if you wish a message to be written whenever an SQL statement is executed.
- **Trace Output** Turn on this switch if you wish a message to be displayed for special information logged by the background process.

---

**NOTE:** The information displayed when the trace output switch is turned on depends on each background process. It is possible that a background process displays no special information for this switch.

---

---

**NOTE:** The location of the output of this trace information is defined by your system administrator at installation time.

---

If additional parameters have been defined for this background process on the Batch Control page, the **Parameter Name**, **Description**, **Detailed Description** and an indicator of whether or not the parameter is **Required** are displayed.

If a default parameter value is configured on the batch control configuration, that value is shown and may be overridden. Confirm or enter the appropriate **Parameter Value** for each parameter. Note that if the parameter value is configured to be Encrypted on the batch control configuration, the value here will be shown encrypted.

Once you have entered all the desired values, **Save** the record in order to include it in the queue for background processes.

If you wish to duplicate an existing batch job submission record, including all its parameter settings, display the submission record you wish to duplicate and use the **Duplicate and Queue** button. This will create a new Batch Job Submission entry in pending status. The new submission entry will be displayed.

If you wish to cancel a **Pending** batch job submission record use the **Cancel** button. The button is disabled for all other status values.

## Tracking Batch Processes

The batch process pages show the execution status of batch processes. For a specified batch control id and run id, the tree shows each thread, the run-instances of each thread, and any messages (informational, warnings, and errors) that might have occurred during the run. Refer to [Defining Batch Controls](#) for more information on how batch control codes are defined.

## Batch Run Tree - Main

This page allows you to view the status of a specific execution of a batch job. Navigate to this page using **Menu > Tools > Batch Run Tree**.

### Description of Page

Select a **Batch Control** process and **Batch Number** to view information and statistics on the batch run's "threads". The following points should help understand this concept:

- Many batch jobs cannot take advantage of your hardware's processing power when they are run singularly. Rather, you'll find that a large percentage of the CPU and/or disk drives are idle.
- In order to minimize the amount of idle time (and increase the throughput of your batch processes), we allow you to set up your batch processes so that multiple instances of a given batch job are executed at the same time. For example, in Oracle Utilities Customer Care and Billing when you schedule the **billing** process, you can indicate that multiple parallel instances should be executed (rather than just one instance). You'd do this so that the processing burden of creating bills for your customers can be spread over multiple processes.
- We refer to each parallel execution of a batch process as a "thread".
- Statistics and information messages are displayed in respect of each thread. Why? Because each thread is a separate execution and therefore can start and end at different times.

The tree includes a node that displays the total number of records processed for the batch run, the total number of records in error for the batch run and the batch run elapsed time. The elapsed time is the longest elapsed time among the batch thread(s). The message is red if there are any records in error.

If the background process has been enabled to create [To Do entries for object specific errors](#), information about the To Do entries are displayed in the tree. This information is not displayed for each thread, but rather all the To Do entries created for the batch run are grouped together. The To Do entries are grouped by their status.

If the application properties file has been configured with the location of the log files and the log files associated with the batch thread are still available, the links **Download stdout** and (if applicable) **Download stderr** are visible. Clicking either link allows you to view or save the log files.

---

**NOTE: Security Access.** The 'download' hyperlinks are only visible for users that have security access to the **Download** access mode for the batch run tree application service.

---

The messages that appear under a thread always show the start and end times of the execution instance. If errors are detected during the execution of the thread, these error messages may also appear in the tree. Refer to [Processing Errors](#) for information about the types of errors that appear in the batch run tree.

## Batch Run Tree - Run Control

By default, if a batch process fails, it will restart. This tab allows you to modify the restart status of a failed run.

Navigate to this page using **Menu > Tools > Batch Run Tree** search for the desired batch control and then navigate to the **Run Control** page.

### Description of Page

On the main page, you must select a **Batch Control**, **Batch Number**, and **Batch Rerun Number** to view a tree of the batch run. On this page, the following information is displayed:

- **Last Update Timestamp** contains the date and time this batch run last start or last completed.
- **Batch Business Date** is the business date that was supplied to the background process (this date is used as the "system date" by the process).

**Run Status** indicates the status of the batch run. Valid values are: **In Progress**, **Error**, and **Complete**.

If the **Run Status** is **Error**, the system will attempt to restart this run when you attempt to execute the **Batch Control**. In most situations, this is exactly what you want to happen. However, there are rare situations where you do not want the system to execute a given batch run (e.g., if this run is somehow corrupt and you cannot correct the data for whatever reasons). If you want the system to skip the execution of a batch run (and proceed to the next run), turn on **Do Not Attempt Restart**.

## Service Health Check

The system provides a service that returns an overall assessment of the system's health. The overall response is expressed using an HTTP code. The codes supported by the service are defined in the lookup **HEALTH\_RESPONSE\_FLG** and are as follows:

- A value of 500 (One or More Critical Functions Degraded) is returned if there is any critical issue detected by the service.
- A value of 203 (Non-Critical Function Degraded) is returned if no critical issues are found and there is at least one non-critical issue detected by the service.
- Otherwise a value of 200 (All Checks Successful) is returned.

This health check service is accessible through the business service **F1-HealthCheck**. Also note that the system provides an [Inbound Web Service](#) for this business service (also called **F1-HealthCheck**) allowing external systems to use a web service to retrieve this information.

In addition, the product provides a portal that allows a user to view the detailed results of the health check service.

Navigate using **Admin > System > Health Check** to view this portal.

The zone on the portal displays the following:

**Overall Response** is the HTTP response code returned by the business service as described above.

The grid displays the detail of each individual component checked as part of the system health check. See below for more detail about what components are checked.

- **Health Component** indicate the type of health check performed. Currently the system supports **Batch Level of Service** component type.
- **Health Component Details** provides information about the individual entity checked. The information displayed here depends on the type of health component. If supported by the type of component, the column may be hypertext, allowing the user to drill into the entity itself.
- **Status** displays the status returned by the health component check for this individual entity. The information displayed here depends on the type of health component.
- **Status Reason** provides more detail about why the individual entity is in the indicated status. The information displayed here depends on the type of health component.
- **Response** shows the health check response code assigned to this individual entity's health check response. It is mapped based on the status returned by the health component check.

### Health Component Type Details

The details returned by the business service for this portal depends on the health component type. The system supports the **Batch Level of Service** health component type.

This health component type finds all the batch controls that are configured with a [level of service](#) algorithm and invokes the algorithm for each batch control. The business service populates the output for this health service for each batch control as follows:

- The **Health Component Detail** is populated with the Batch Control code and description. In addition, the navigation information for being able to drill into the batch control are provided and used to build the column as hypertext.
- The **Status** is populated with the description of the Level of Service lookup value returned by the level of service algorithm for this batch control.
- The **Status Reason** is populated with the expanded text of the status reason returned by the level of service algorithm for this batch control.



- The **Response** is populated based on the value of the Level of Service status. It is set to **All Checks Successful** (200) when the Level of Service is **Normal** or **Disabled**; **Non-Critical Function Degraded** (203) when the Level of Service is **Warning** and **One or More Critical Functions Degraded** (500) when the Level of Service is **Error**.

## The Big Picture of Requests

Requests enable an implementer to design an ad-hoc batch process using the configuration tools.

An example of such a process might be to send an email to a group of users that summarizes the To Do entries that are assigned to them. This is just one example. The request enables many types of diverse processing.

## Request Type Defines Parameters

For each type of process that your implementation wants, you must configure a request type to capture the appropriate parameters needed by the process.

## Previewing and Submitting a Request

To submit a new request, go to **Menu > Tools > Request** in add mode. You must select the appropriate request type and then enter the desired parameter values, if applicable.

After entering the parameters, the following actions are possible:

- Click **Save** to submit the request.
- Click **Cancel** to cancel the request.
- Click **Preview** to see a sample of records that satisfy the selection criteria for this request. This information is displayed in a separate map. In addition, the map displays the total number of records that will be processed when the request is submitted. From this map you can click **Save** to submit the request, **Back** to adjust the parameters, or **Cancel** to cancel the request.

When a request is saved, the job is not immediately submitted for real time processing. The record is saved with the status **Pending** and a monitor process for this record's business object is responsible for transitioning the record to **Complete**.

As long as the record is still **Pending**, it may be edited to adjust the parameters. The preview logic described above may be repeated when editing a record.

The actual work of the request, such as generating an email, is performed when transitioning to **Complete** (using an enter processing algorithm for the business object).

## To Do Summary Email

The base product includes a sample request process that sends an email to users that have incomplete To Dos older than a specified number of days.

The following configuration tasks are required to use this process:

- Define an Outbound Message Type. The business object usually defined for the Outbound Message Type is **F1-EmailMessage**.
- Define an External System that contains the Outbound Message Type in one of its steps. In the configuration determine if the communication is through SOA, batch, or real-time processing method when sending the email notification. Refer to [Outbound Messages](#) for more information about configuration needed for the different processing methods.
- Create a Request Type that includes the Outbound Message Type and the corresponding External System.
- Create a Request for the created Request Type.



## Exploring Request Data Relationships

Use the following links to open the application viewer where you can explore the physical tables and data relationships behind the request functionality:

- Click [F1-REQ-TYPE](#) to view the request type maintenance object's tables.
- Click [F1-REQ](#) to view the request maintenance object's tables.

## Defining a New Request

To design a new ad-hoc batch job that users can submit via Request, first create a new Request Type business object. The base product BO for request type, **F1-TodoSumEmailTyp**, may be used as a sample.

The business object for the request includes the functionality for selecting the records to process, displaying a preview map for the user to review, and for performing the actual processing. The base product BO for request, **F1-TodoSumEmailReq**, may be used as a sample. The following points highlight the important configuration details for this business object:

- Special BO options are available for request BOs to support the Preview Request functionality.
  - **Request Preview Service Script.** This script retrieves the information that is displayed when a user asks for a preview of a request.
  - **Request Preview Map.** This map displays the preview of a request.
- The enter algorithm plugged into the Complete state is responsible for selecting the records that satisfy the criteria and processing the records accordingly.

## Setting Up Request Types

Use the Request Type portal to define the parameters to capture when submitting a request. Open this page using **Admin > General > Request Type**.

This topic describes the base-package zones that appear on the Request Type portal.

**Request Type List.** The Request Type List zone lists every request type. The following functions are available:

- Click a **broadcast** icon to open other zones that contain more information about the request type.
- Click **Add** in the zone's title bar to add a new request type.

**Request Type.** The Request Type zone contains display-only information about a request type. This zone appears when a request type has been broadcast from the Request Type List zone or if this portal is opened via a drill down from another page. The following functions are available:

- Click **Edit** to start a business process that updates the request type.
- Click **Delete** to start a business process that deletes the request type.
- Click **Deactivate** start a business process that deactivates the request type.
- Click **Duplicate** to start a business process that duplicates the request type.
- State transition buttons are available to transition the request type to an appropriate next state.

Please see the zone's help text for information about this zone's fields.

## Maintaining Requests

Use the Request transaction to view and maintain pending or historic requests.

Open this page using **Menu > Tools > Request > Search**. This topic describes the base-package portals and zones on this page.

**Request Query.** Use the query portal to search for an existing request. Once a request is selected, you are brought to the maintenance portal to view and maintain the selected record.

**Request Portal.** This portal appears when a request has been selected from the Request Query portal. The following base-package zones appear on this portal:

- **Actions.** This is a standard actions zone.
- **Request.** The Request zone contains display-only information about a request. Please see the zone's help text for information about this zone's fields.
- **Request Log.** This is a standard log zone.

## Defining Algorithms

---

In this section, we describe how to set up the user-defined algorithms that perform many important functions including:

- Validating the format of a phone number entered by a user.
- Validating the format of a latitude/longitude geographic code entered by a user.
- In products that support payment and billing:
  - Calculating late payment charges.
  - Calculating the recommended deposit amount.
  - Constructing your GL account during the interface of financial transactions to your GL
- And many other functions...

## The Big Picture Of Algorithms

Many functions in the system are performed using a user-defined algorithm. For example, when a CSR requests a customer's recommended deposit amount, the system calls the deposit recommendation algorithm. This algorithm calculates the recommended deposit amount and returns it to the caller.

---

**NOTE: Algorithm = Plug-in.** We use the terms plug-in and algorithm interchangeably throughout this documentation.

---

So how does the system know which algorithm to call? When you set up the system's control tables, you define which algorithm to use for each component-driven function. You do this on the control table that governs each respective function. For example:

- You define the algorithm used to validate a phone number on your phone types.
- You define the algorithm in Oracle Utilities Customer Care and Billing used to calculate late payment charges on each Service Agreement Type that has late payment charges.
- The list goes on...

The topics in this section provide background information about a variety of algorithm issues.

## Algorithm Type Versus Algorithm

You have to differentiate between the type of algorithm and the algorithm itself.

- An **Algorithm Type** defines the program that is called when an algorithm of this type is executed. It also defines the types of parameters that must be supplied to algorithms of this type.
- An **Algorithm** references an **Algorithm Type**. It also defines the value of each parameter. It is the algorithm that is referenced on the various control tables.

---

**FASTPATH:** Refer to [How to Add A New Algorithm](#) for an example that will further clarify the difference between an algorithm and an algorithm type.

---

## How To Add A New Algorithm

Before you can add a new algorithm, you must determine if you can use one of the sample algorithm types supplied with the system. Refer to [List of Algorithm Types](#) for a complete list of algorithm types.

If you can use one of the sample algorithm types, simply add the algorithm and then reference it on the respective control table. Refer to [Setting Up Algorithms](#) for how to do this.

If you have to add a new algorithm type, you may have to involve a programmer. Let's use an example to help clarify what you can do versus what a programmer must do. Assume that you require an additional geographic type validation algorithm. To create your own algorithm type you must:

- Write a new program to validate geographic type in the appropriate manner. Alternatively, you may configure a plug-in script to implement the validation rules. The advantage of the latter is that it does not require programming. Refer to [plug-in script](#) for more information.
- Create an Algorithm Type called **Our Geographic Format** (or something appropriate). On this algorithm type, you'd define the name of the program (or the plug-in script) that performs the function. You'd also define the various parameters required by this type of algorithm.
- After creating the new Algorithm Type, you can reference it on an Algorithm.
- And finally, you'd reference the new Algorithm on the Geographic Type that requires this validation.

## Minimizing The Impact Of Future Upgrades

The system has been designed to use algorithms so an implementation can introduce their own logic in a way that's 100% upgradeable (without the need to retrofit logic). The following points describe strong recommendations about how to construct new algorithm type programs so that you won't have to make program changes during future upgrades:

- Do not alter an algorithm type's hard parameters. For example, you might be tempted to redefine or initialize parameters defined in an algorithm type's linkage section. Do not do this.
- Follow the naming conventions for the new algorithm type code and your source code, i.e., both the source code and the algorithm type should be prefixed with "CM". The reason for this naming convention is to make it impossible for a new, base-package algorithm type from overwriting your source code or algorithm type meta-data (we will never develop a program or introduce meta-data beginning with CM).
- Avoid using embedded SQL to perform insert/update/delete. Rather, invoke the base-package's object routines or common routines.
- Avoid using base messages (outside of common messages, i.e., those with a message number < 1000) as we may deprecate or change these messages in future releases. The most common problem is caused when an implementation clones a base package algorithm type program because they need to change a few lines of logic. Technically, to be 100% upgradeable, you should add new messages in the "90000" or greater category (i.e., the category reserved for implementation-specific messages) for every message in your new program even though these messages may be duplicates of those in the base package.

# Setting Up Algorithm Types

The system provides many algorithm types to support base product functionality. If you need to introduce a new type of algorithm, open **Admin > System > Algorithm Type**.

---

**FASTPATH:** Refer to [The Big Picture Of Algorithms](#) for more information.

---

**CAUTION:** Important! If you introduce a new algorithm type, carefully consider its naming convention. Refer to [System Data Naming Convention](#) for more information.

---

## Description of Page

Enter an easily recognizable **Algorithm Type** and **Description**.

**Owner** indicates if this algorithm type is owned by the base package or by your implementation (**Customer Modification**). The system sets the owner to **Customer Modification** when you add an algorithm type. This information is display-only.

Enter a **Detailed Description** that describes, in detail, what algorithms of this type do.

Use **Algorithm Entity** to define where algorithms of this type can be "plugged in". If a detailed description about an algorithm entity is available, a small help icon is visible adjacent to the dropdown. Click the icon to view the information.

---

**NOTE:** The values for this field are customizable using the [lookup](#) table. This field name is **ALG\_ENTITY\_FLG**.

---

Use **Program Type** to define if the algorithm's program is written using **Java**, a **Plug-In Script**, or **Java (Converted)**, meaning the program has been converted to Java.

---

**NOTE:** **Java (Converted)** program types are not applicable to all products.

---

Use **Program Name** to define the program to be invoked when algorithms of this type are executed:

- If the Program Type is **Java (Converted)**, enter the name of the converted program.
- If the Program Type is **Java**, enter the Java class name.
- If the Program Type is **Plug-In Script**, enter the plug-in [script](#) name. Only plug-in scripts defined for the algorithm entity may be used.

---

**NOTE: View the source.** If the program is shipped with the base package, you can use the adjacent button to display the source code of this program in the [Java docs viewer](#). For plug-in scripts, drill into the plug-in script to view the details.

---

Use the **Parameter Types** grid to define the types of parameters that algorithms of this type use. The following fields should be defined for each parameter:

- Use **Sequence** to define the relative position of the **Parameter**.
- Use **Parameter** to describe the verbiage that appears adjacent to the parameter on the Algorithm page.
- Indicate whether the parameter is **Required**. This indicator is used when parameters are defined on algorithms that reference this algorithm type.
- **Owner** indicates if the parameter for this algorithm type is owned by the base package or by your implementation (**Customer Modification**). The system sets the owner to **Customer Modification** when you add an algorithm type with parameters. This information is display-only.

---

**NOTE:** When adding a new algorithm type that is for a Java program, the parameters are automatically generated based on the Java code. Once an algorithm type exists, any additional parameters defined in the Java code should be manually added to the algorithm type. For other program types, algorithm type parameters must be manually defined.

---

**NOTE:** When a new algorithm type parameter is added for any program type, existing algorithms for the algorithm type do not automatically get updated with the new parameter. The algorithms must be manually updated.

---

### Where Used

An Algorithm references an Algorithm Type. Refer to [Setting Up Algorithms](#) for more information.

## List of Algorithm Types

The algorithm types available to use with the product may be viewed in the algorithm type page and in the [application viewer's algorithm](#) viewer. If your implementation adds algorithm types or adds algorithms to reference existing algorithm types, you may [regenerate](#) the application viewer to see your additions reflected there.

## Setting Up Algorithms

If you need to introduce a new algorithm, open **Admin > System > Algorithm**. Refer to [The Big Picture Of Algorithms](#) for more information.

### Description of Page

Enter an easily recognizable **Algorithm Code** and **Description** of the algorithm. **Owner** indicates if this algorithm is owned by the base package or by your implementation (**Customer Modification**).

---

**CAUTION:** Important! If you introduce a new algorithm, carefully consider its naming convention. Refer to [System Data Naming Convention](#) for more information.

---

Reference the **Algorithm Type** associated with this algorithm.

---

**FASTPATH:** Refer to [Algorithm Type Versus Algorithm](#) for more information about how an algorithm type controls the type of parameters associated with an algorithm.

---

The parameters available for an algorithm are defined on the algorithm type. The system allows a set of parameter values to change over time. Use the parameter scroll to view parameter values for a given **Effective Date**. The **Owner** of the collection of parameters is displayed. The collection shows the **Parameter** description, the **Sequence** and the **Value** for each parameter.

---

**NOTE:** If the product delivers an algorithm with parameter values defined, an implementation may override the base provided parameter values by adding an additional effective dated collection of parameters.

---

**NOTE:** If an algorithm is defined and subsequently a new parameter is added to the algorithm type, existing algorithms for the algorithm type should be updated as follows: Click the “+” to add a new effective dated entry to the parameter collection. At this point the latest list of parameters for the algorithm type are visible. Configure the parameters accordingly.

---

### Where Used

Algorithms are plugged in on control tables throughout the system. Each algorithm type's Algorithm Entity indicates the name of the control table where it is plugged in. The [algorithm](#) viewer in the application viewer may also be used to see a list of plug-in spots along with their algorithm types and algorithms.

# Defining Script Options

---

We use the term "script" to define processing rules that your implementation sets up to control both front-end and back-end processing:

- Rules that control front-end processing are defined using [Business Process Assistant \(BPA\)](#) scripts. For example, your implementation could set up a BPA script to guide a user through your organization's payment cancellation process.
- Rules that control back-end processing are defined using [Server-based](#) scripts. For example, your implementation could set up a server-based script to control the processing that executes whenever a given type of adjustment is canceled.

The topics in this section describe how to configure your scripts.

## The Big Picture Of Scripts

This section describes features and functions that are shared by both BPA scripts and server-based scripts.

### Scripts Are Business Process-Oriented

To create a script, you must analyze the steps used to implement a given business process. For example, you could create a "stop auto pay" BPA script that:

- Asks the user to select the customer / taxpayer using an appropriate search page
- Asks the user to define the date on which the person would like to stop making automatic payments
- Invokes a server-based script that populates the end-date on the account's latest automatic payment instructions.

After you understand the business process, you can set up a script to mimic these steps. If the business process is straightforward (e.g., users always perform the same steps), the script configuration will be straightforward. If the business process has several logic branches, the composition of the script may be more challenging.

### A Script Is Composed Of Steps

A script contains one or more steps. For example, a "stop auto pay" BPA script might have three steps:

- Ask the user to select the customer / taxpayer using an appropriate search page
- Ask the customer the date on which they'd like to stop making automatic payments (and default the current date)
- Invoke a server-based script that, in turn, updates the account's auto pay options.

Each step references a step type. The step type controls what happens when a step executes. It might be helpful to think of a script as a macro and each step as a "line of code" in the macro. Each step's step type controls the function that is executed when the step is performed.

---

**FASTPATH:** Refer to [How To Set Up Each Step Type](#) for a detailed description of all available step types and how to set them up.

---

### A Script May Declare Data Areas

Both BPA and server-based scripts may have one or more [data areas](#):

- If the script contains steps that exchange XML documents, you must declare a data area for each type of XML document. For example, if a BPA script has a step that invokes a service script, the BPA script must declare a data area that holds the XML document that is used to pass information to and from the service script.
- You can use a data area as a more definitive way to declare your temporary storage. For example, you can describe your script's temporary storage variables using a [stand-alone data area](#) schema and associate it with your script.

Various step types involve referencing the script's data areas as well as support the ability to compare and move data to and from field elements residing in the data areas.

An [Edit Data](#) step supports the syntax to dynamically declare data areas as part of the step itself. This technique eliminates the need to statically declare a data area. Refer to [Edit Data Syntax](#) for more information on edit data commands and examples of the use of dynamic data areas.

---

**NOTE:** Some server based scripts may not use data areas as means of defining or exchanging data, depending on script type and the chosen scripting technique. Refer to [The Big Picture Of Server Based Scripts](#) for an overview of server scripts and their applicable scripting options.

---

## Securing Script Execution

The system supports the ability to secure the execution of scripts by associating the script with an Application Service. Refer to [The Big Picture of Application Security](#) for more information. Application security is optional and applies to service scripts and user-invocable BPA scripts only. If a script is not associated with an application service, all users may execute the script. Otherwise, only users that have **Execute** access to the application service may execute the script.

## The Big Picture Of BPA Scripts

---

**FASTPATH:** Refer to [The Big Picture Of Scripts](#) to better understand the basic concept of scripts.

---

Users may require instructions in order to perform certain tasks. The business process assistant allows you to set up scripts that step a user through your business processes. For example, you might want to create scripts to help users do the following:

- Add a new person to an existing account
- Set up a customer to pay automatically
- Modify a customer who no longer wants to receive marketing information
- Modify a customer's web password
- Record a trouble order
- Merge two accounts into one account
- Fix a bill with an invalid rate
- ... (the list is only limited by your time and imagination)

Users execute these scripts via the [business process assistant](#) (BPA). Users can also define their favorite BPA scripts in their [user preferences](#). By doing this, a user can execute a script by pressing an accelerator key (Ctrl + Shift + a number).

Don't think of these scripts as merely a training tool. BPA scripts can also reduce the time it takes to perform common tasks. For example, you can write a script that reduces the "number of clicks" required to add a new person to an existing account.

---

**CAUTION:** Future upgrade issues. Although we make every effort not to remove fields or tab pages between releases, there may be times when changes made by the base-package will necessitate changes to your scripts. Please refer to the release notes for a list of any removed fields or tab pages.

---

---

**CAUTION:** Scripts are not a substitute for end-user training. Scripts minimize the steps required to perform common tasks. Unusual problems (e.g., a missing meter exchange) may be difficult to script as there are many different ways to resolve such a problem. However, scripts can point a user in the right direction and reduce the need to memorize obscure business processes.

---

The topics in this section describe background topics relevant to BPA scripts.

## How To Invoke Scripts

Refer to [Initiating Scripts](#) for a description of how end-users initiate scripts.

## Developing and Debugging Your BPA Scripts

We recommend considering the approaches outlined below when you construct scripts.

While designing your scripts, determine the most maintainable way to set them up. Rather than creating complex, monolithic scripts, we recommend dividing scripts into smaller sections. For example

- Determine if several scripts have similar steps. If so, set up a script that contains these common steps and invoke it from the main scripts using a **Perform script** step.
- Determine if a large script can be divided into logical sections. If so, set up a small script for each section and create a "master script" to invoke each sub script via a **Transfer control** step.

For debugging purposes, you may find it helpful to categorize the step types into two groups: those that involve some type of activity in the [script area](#), and those that don't. The following step types cause activity in the script area: **Height**, **Display text**, **Prompt user**, **Input data**, **Input Map**, **Set focus to a field**.

The rest of the step types are procedural and involve no user interaction. There are two techniques you can use to assist in debugging these step types.

- You can instruct the system to display text in the script area.
- You can display an entire data area (or a portion thereof) in the script area by entering `%+...+%` where `...` is the name of the node whose element(s) should be displayed.

---

**NOTE: Time saver.** When you develop a new BPA script, change your [user preferences](#) to include the script as your first "favorite". This way, you can press `Ctrl+Shift+1` to invoke the script (eliminating the need to select it from the [script menu](#)).

---

## Launching A Script From A Menu

You can create menu items that launch BPA scripts rather than open a page. To do this, create a [navigation option](#) that references your script and then add a menu item that references the navigation option.

If the navigation option is referenced on a [context menu](#) and the navigation option has a "context field", a temporary storage variable will be created and populated with the unique identifier of the object in context. For example, if you add a "script" navigation option to the bill context menu and this navigation option has a context field of `BILL_ID`, the system will create a temporary storage variable called `BILL_ID` and populate it with the respective bill id when the menu item is selected.

## Launching A Script When Starting The System

You can set the system to launch a script upon startup.



For example, imagine that through an interactive voice response system, a customer has keyed in their account ID and has indicated that they would like to stop an automatic payment. At the point when the IVR system determines that the customer must speak to a user, the interface can be configured to launch the application. When launched it passes the script name and account ID. It can also pass a [navigation option](#) to automatically load the appropriate page (if this information is not part of the script).

To do this, parameters are appended to the standard system URL. The following parameters may be supplied:

- `script=<scriptname>`
- `ACCT_ID=<account id>`
- `location=<navigation option>`

Parameters are added to the standard system URL by appending a question mark (?) to the end and then adding the "key=value" pair. If you require more than one parameter, use an ampersand (&) to separate each key=value pair.

For example, the following URLs are possible ways to launch the **CM-StopAutoPay** script at startup, assuming your standard URL for launching the system is `http://system-server:1234/cis.jsp`:

- `http://system-server:1234/cis.jsp?script=CM-StopAutoPay`
- `http://system-server:1234/cis.jsp?script=CM-StopAutoPay&ACCT_ID=1234512345`
- `Zoneshttp://system-server:1234/cis.jsp?script=CM-StopAutoPay&ACCT_ID=1234512345&location=accountMaint`

It doesn't matter in which order the parameters are provided. The system processes them in the correct order. For example, the following examples are processed by the system in the same way:

- `http://system-server:1234/cis.jsp?ACCT_ID=1234512345&script=CM-StopAutoPay&location=accountMaint`
- `http://system-server:1234/cis.jsp?ACCT_ID=1234512345&location=accountMaint&script=CM-StopAutoPay`

These parameters are kept in a common area accessible by any script for the duration of the session. To use these parameters on a script you may reference the corresponding `%PARM-<name>` [global variables](#). In this example, after the system is launched any script may have access to the above account ID parameter value by means of the `%PARM-ACCT_ID` global variable. Also note, these parameters are also loaded into temporary storage (to continue the example, there'd also be a temporary storage variable called `ACCT_ID` that holds the passed value).

## Determining the Target Navigation in the Script

By default, if a script is provided but the location attribute is not provided, the system navigates to the user's home page prior to executing the script. If the script itself includes a step to navigate to a target page as one of its initial steps, the navigation to the home page is unnecessary and may degrade performance. The system supplies an optional attribute to include in the URL to bypass the home page: `initNav=false`.

---

**NOTE:** The system still requires a page to be launched for technical reasons. A blank portal with no zones is used for this purpose. Users may see this portal (called **Launching Application**) briefly before the navigation initiated by the script. In addition, this is the portal that the user will remain on if there are any errors in the script or if the script does not navigate anywhere.

---

## Navigate to a Given Record's Maintenance Portal

If your use case is to simply navigate to the maintenance page for a given record and display that record, the script **F1-GotoPrtl** (Navigate to portal for an MO and key values) may be used. This script is only applicable to records that are governed by a business object (and define a navigation option as a BO option). It takes the incoming maintenance object code and primary key values, looks up the appropriate portal navigation option from the record's BO, populates keys into the 'page data model' and navigates to the portal.

The script expects the keys to be passed in using variable names `pkValue1` through `pkValue5`. It is also recommended to include the `initNav=false` attribute. This example navigates to the appropriate Migration Data Set portal for the given ID's business object.

- <http://system-server:1234/cis.jsp?script=F1-GotoPrtl&pkValue1=1234512345&mo=F1-MIGRDS&initNav=false>

## Executing A Script When A To Do Entry Is Selected

The system creates [To Do entries](#) to highlight tasks that require attention (e.g., records in error). Users can complete many of these tasks without assistance. However, you can set up the system to automatically launch a script when a user selects a To Do entry. For example, consider a To Do entry that highlights a bill that's in error due to an invalid mailing address. You can set up the system to execute a script when this To Do entry is selected by a user. This script might prompt the user to first correct the customer's default mailing address and then re-complete the bill.

The following points provide background information to help you understand how to implement this functionality:

- Every To Do entry references a [To Do type](#) and a [message category and number](#). The To Do type defines the category of the task (e.g., bill errors). The message number defines the specific issue (e.g., a valid address can't be found.). Refer to [The Big Picture of System Messages](#) for more information about message categories and numbers.
- When a user drills down on a To Do entry, either a script launches OR the user is transferred to the transaction associated with the entry's To Do type. You control what happens by configuring the To Do type accordingly:
  - If you want to launch a script when a user drills down on an entry, you link the script to the [To Do type and message number](#). Keep in mind that you can define a different script for every message (and some To Do types have many different messages).
  - If the system doesn't find a script for an entry's To Do type and message number, it transfers the user to the To Do type's default transaction.

---

**NOTE: How do you find the message numbers?** We do not supply documentation of every To Do type's message numbers (this list would be impossible to maintain and therefore untrustworthy). The best way to determine which message numbers warrant a script is during pre-production when you're testing the system. During this period, To Do entries will be generated. For those entries that warrant a script, simply display the entry on [To Do maintenance](#). On this page, you will find the entry's message number adjacent to the description.

---

- These types of scripts invariably need to access data that resides on the selected To Do entry. Refer to [How To Use To Do Fields](#) for the details.

## The Big Picture Of Script Eligibility Rules

You can configure [eligibility criteria](#) on the scripts to limit the scripts that a user sees in the [script search](#). For example, you could indicate a script should only appear on the script menu if the user belongs to the level 1 customer service representative group. You may also indicate that a script should only appear if the data a user is viewing has certain criteria. For example, if you are using Oracle Utilities Customer Care and Billing, you can indicate that a script should only appear if the current account's customer class is residential. By doing this, you avoid presenting the user with scripts that aren't applicable to the current data in context or the user's role.

The topics in this section describe eligibility rules.

## Script Eligibility Rules Are Not Strictly Enforced

The [script search](#) gives a user a choice of seeing all scripts or only scripts that are eligible (given the current data in context and their user profile). This means that it's possible for a script that isn't eligible for the given context data / user to be executed via this search. In other words, the system does not strictly enforce a script's eligibility rules.

It might be more helpful to think of eligibility rules as "highlight conditions". These "highlight conditions" simply control whether the script appears in the [script search](#) when a user indicates they only want to see eligible scripts.

## You Can Mark A Script As Always Eligible

If you don't want to configure eligibility rules, you don't have to. Simply indicate that the script is always eligible.

## You Can Mark A Script As Never Eligible

If you have scripts that you do not want a user to select from the script menu, indicate that it is never eligible. An example of a script that you wouldn't want a user to select from the menu is one that is [launched when a To Do entry is selected](#). These types of scripts most likely rely on data linked to the selected To Do entry. As a result, a user should only launch scripts of this type from the To Do entry and not from the script menu.

## Criteria Groups versus Eligibility Criteria

Before we provide concrete examples of eligibility criteria, we need to explain two concepts: Criteria Groups and Eligibility Criteria. A script's criteria groups control whether a user is eligible to choose a script. At a high level, it works like this:

- A criteria group has one or more eligibility criteria. A group's criteria control whether the group is considered true or false.
- When you create a group, you define what should happen if the group is true or false. You have the following choices:
  - The user is eligible to choose the script
  - The user is not eligible to choose the script
  - The next group should be checked

We'll use the following example from Oracle Utilities Customer Care and Billing to help illustrate these points. Assume a script is only eligible if:

- The customer has electric service and the user belongs to user group A, B or C
- OR, the customer has gas service and the user belongs to user group X, Y or A

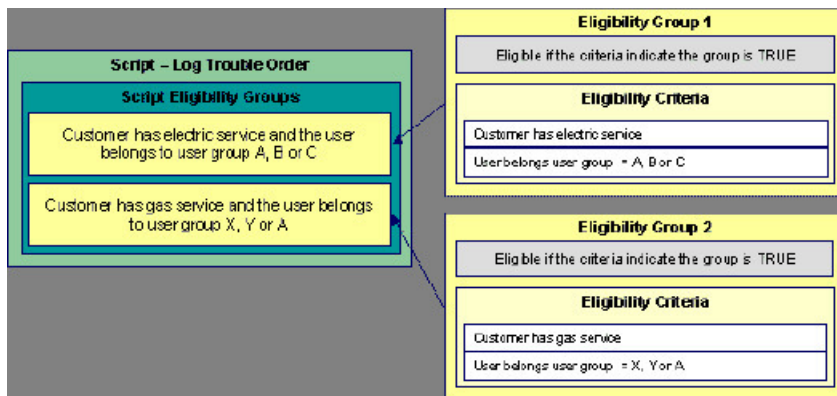

This script requires two eligibility groups because it has two distinct conditions:

- IF (Customer has electric service AND (User belongs to user group A, B or C))
- IF (Customer has gas service AND (User belongs to user group X, Y or A))

If either condition is true, the script is eligible.

You would need to set the following criteria groups in order to support this requirement:

Group No.	Group Description	If Group is True	If Group is False
-----------	-------------------	------------------	-------------------

1	Customer has electric service and the user belongs to user group A, B or C	<b>Eligible</b>	<b>Check next group</b>
2	Customer has gas service and the user belongs to user group X, Y or A	<b>Eligible</b>	<b>Ineligible</b>

The following criteria are required for each of the above groups:

Group 1: Customer has electric service and the user belongs to user group A, B or C				
Seq	Logical Criteria	If Eligibility Criteria is True	If Eligibility Criteria is False	If Insufficient Data
10	Customer has electric service	<b>Check next condition</b>	<b>Group is false</b>	<b>Group is false</b>
20	User belongs to user group A, B or C	<b>Group is true</b>	<b>Group is false</b>	<b>Group is false</b>

Group 2: Customer has gas service and the user belongs to user group X, Y or A				
Seq	Logical Criteria	If Eligibility Criteria is True	If Eligibility Criteria is False	If Insufficient Data
10	Customer has gas service	<b>Check next condition</b>	<b>Group is false</b>	<b>Group is false</b>
20	User belongs to user group X, Y or A	<b>Group is true</b>	<b>Group is false</b>	<b>Group is false</b>

The next section describes how you might configure the specific logical criteria in each of the groups.

## Defining Logical Criteria

When you set up an eligibility criterion, you must define two things:

- The field to be compared
- The comparison method

You have the following choices in respect of identifying the *field to be compared* :

- You can execute an algorithm to retrieve a field value from somewhere else in the system.
- Some products may support choosing a characteristic linked to an appropriate object in the system (such as an account or person).

You have the following choices in respect of identifying the *comparison method*:

- You can choose an operator (e.g., >, <, =, BETWEEN, IN, etc.) and a comparison value.
- You can execute an algorithm that performs the comparison (and returns True, False or Insufficient Data). This is also a very powerful feature, but it's not terribly intuitive. We'll present a few examples later in this section to illustrate the power of this approach.

The [Examples Of Script Eligibility Rules](#) provide examples to help you understand this design.

## Examples Of Script Eligibility Rules

The topics in this section provide examples about how to set up script eligibility rules.

### A Script With A Time Span Comparison

A script that is only eligible for senior citizens has the following eligibility rules:

- Customer class = Residential

- Birth date equates to that of a senior citizen

These rules require only one eligibility group on the script. It would look as follows:

Group No.	Group Description	If Group is True	If Group is False
1	Residential and Senior Citizen	<b>Eligible</b>	<b>Ineligible</b>

The following criteria will be required for this group:

Group 1: Residential, Calif, Senior					
Seq	Field to Compare	Comparison Method	If True	If False	If Insufficient Data
10	Algorithm: retrieve account's customer class	= R	<b>Check next condition</b>	<b>Group is false</b>	<b>Group is false</b>
30	Person characteristic: Date of Birth	Algorithm: True if senior	<b>Group is true</b>	<b>Group is false</b>	<b>Group is false</b>

The first criterion is easy; it calls an algorithm that retrieves a field on the current account. This value, in turn, is compared to a given value. If the comparison results in a True value, the next condition is checked. If the comparison doesn't result in a True value, the **Group is false** (and, the group indicates that if the group is false, the script isn't eligible). Refer to SECF-ACCTFLD in the product documentation for an example of an algorithm type that retrieves a field value from an account.

The last criterion contains a time span comparison. Time span comparisons are used to compare a date to something. In our example, we have to determine the age of the customer based on their birth date. If the resultant age is > 65, they are considered a senior citizen. To pull this off, you can take advantage of a comparison algorithm supplied with the base script as described below.

- Field to Compare. The person characteristic in which the customer's birth date is held is selected.
- Comparison Method. We chose a comparison algorithm that returns a value of **True** if the related field value (the customer's date of birth) is greater than 65 years (refer to [SECC-TIMESPN](#) for an example of this type of algorithm).

You'll notice that if a value of **True** is returned by the **True if senior** algorithm, the group is true (and we've set up the group to indicate a true group means the script is eligible).

**NOTE: The time span algorithm can be used to compare days, weeks, months, etc.** Refer to [SECC-TIMESPN](#) for more information about this algorithm.

## A Script With Service Type Comparison

Imagine a script that is only eligible if the current customer has gas service and the user belongs to user groups A, B or C. This script would need the following eligibility rules:

- Customer has gas service
- User belongs to user group A, B, or C

These rules require only one eligibility group on the script. It would look as follows:

Group No.	Group Description	If Group is True	If Group is False
1	Has gas service and user is part of user group A, B or C	<b>Eligible</b>	<b>Ineligible</b>

The following criteria are required for this group:

Group 1: Has gas service and user is part of user group A, B, or C					
Seq	Field to Compare	Comparison Method	If True	If False	If Insufficient Data
10	Algorithm: check if customer has gas service	= True	<b>Check next condition</b>	<b>Group is false</b>	<b>Group is false</b>

Algorithm: check if  
user belongs to user  
group A, B or C

= True

Group is true

Group is false

Group is false

---

Both criteria are similar - they call an algorithm that performs a logical comparison. These algorithms are a bit counter intuitive (but understanding them provides you with another way to implement complex eligibility criteria):

The first criterion works as follows:

- **Field to Compare.** We chose a "field to compare" algorithm that checks if the current account has service agreements that belong to a given set of service types. It returns a value of **True** if the customer has an active service agreement that matches one of the service types in the algorithm. In our example, the "check if customer has gas service" algorithm returns a value of **True** if the customer has at least one active service agreement whose SA type references the gas service type. The "check if customer has electric service" algorithm is almost identical, only the service type differs.
- **Comparison Method.** We simply compare the value returned by the algorithm to True and indicate the appropriate response.

The second criterion works similarly:

- **Field to Compare.** We chose a "field to compare" algorithm that checks if the user belongs to any user group in a set of user groups. It returns a value of **True** if the user belongs to at least one user group defined in parameters of the algorithm. Refer to [SECF-USRNGRP](#) for an example of this type of algorithm.
- **Comparison Method.** We simply compare the value returned by the algorithm to True and indicate the appropriate response.

---

**NOTE: Bottom line.** The "field to compare" algorithm isn't actually returning a specific field's value. Rather, it's returning a value of **True** or **False**. This value is in turn, compared by the "comparison method" and the group is set to true, false or check next accordingly.

---

## The Big Picture Of Server-Based Scripts

---

**FASTPATH:** Refer to [The Big Picture Of Scripts](#) to better understand the basic concept of scripts.

---

Server-based scripts allow an implementation to configure backend business processes. The system supports three types of server-based scripts, **Plug-In** scripts, **Service** scripts and **Groovy Library** scripts.

- **Plug-in scripts** allow an implementation to develop routines that are executed from the system's various plug-in spots. For example, an implementation could configure a plug-in script that is executed every time an adjustment of a given type is frozen.
- **Service scripts** allow an implementation to develop common routines that are invoked from both front-end and back-end services. For example, an implementation could create a service script that terminates an account's automatic payment preferences. This service script could be invoked from a BPA script initiated by an end-user when a customer asks to stop paying automatically, and it could also be executed from a plug-in script if a customer fails to pay their debt on time. Service scripts are typically written using xpath scripting.
- **Groovy Library scripts** allow an implementation to develop groups of common routines written in the Groovy language which may be invoked from **Groovy Member** step types.

The topics in this section describe background topics relevant to server-based scripts.

## Additional Coding Options For Server Scripts

Server based scripts often perform complex functions best supported by coding in languages with more comprehensive command sets than the base script steps. The system supports two common third-party languages for this purpose.

**XML Path Language** (XPath) is a language for querying and evaluating elements or nodes in an XML document. XPath commands and expressions can be used directly within [Edit Data](#) step types. The script engine version is used to define the applicable XPath version.

**Groovy** is an object-oriented, dynamic language for the Java platform. The framework supports the use of Groovy within server-based scripts to provide restricted and controlled access to Java-like code, particularly for cloud based implementations. The following topic provides more information on how to incorporate Groovy code into scripts.

## Using Groovy Within Scripts

Groovy code can be incorporated in scripts using the step type **Groovy Members**. For each script with Groovy code, there will be a single Groovy class created by concatenating all **Groovy Members** steps.

For security, the product and third party Java classes available for scripting in Groovy will be restricted. The allowable base classes may be viewed via the Groovy JavaDocs feature in the Application Viewer and also via the 'View Groovy Javadocs' link in the context sensitive Script Tips zone. The list of allowable third party classes can be viewed via the 'View third party Groovy whitelist' link in the Script Tips zone.

---

**NOTE:** This system supports the use of Groovy for back end processing purposes. It is not intended for user interfaces. Groovy is also not applicable to BPA scripts.

---

The following describes the two methods for using Groovy.

### Using the Scripting Engine

If the script is configured to use a scripting engine version, it can include a mixture of regular and **Groovy Members** step types. The script step types will define the process to be executed. The **Groovy Members** steps will contain code that can be called from **Edit Data** step types within the script using the **invokeGroovy** command. Only Groovy methods that receive no arguments and return void are supported using this command. Refer to the section on [edit data](#) steps for more details.

For scripts using this option, the framework provides a superclass containing methods that support common scripting actions such as move commands, string evaluation, and methods to invoke business objects, business services and service scripts. Refer to the Groovy specific JavaDocs for details of the supported methods

### Using the Groovy Engine

The system uses an engine version of **Groovy** to indicate that a script is written entirely in Groovy code and can be processed in a similar way to code written in Java. This avoids the need to convert the script to and from XML format and allows the use of code that acts directly on the system objects with consequent performance benefits.

The following script types support the Groovy engine version:

#### Plug In Scripts

Plug-in Scripts can be configured to use the Groovy engine if they contain only **Groovy Members** step types. The system provides an automatically generated superclass that defines the plug-in spot API. Internally, the Groovy code must conform to the system conventions for Java based algorithm types, including the inclusion of an 'invoke' method that is the plug-in entry point, and the definition of 'soft' parameters using annotations.

#### Groovy Library Scripts

Groovy Library Scripts provide the ability to create groups of common routines written in Groovy that can be called from within other scripts. Scripts of this type must include a single step type of **Groovy Library Interface** in which the publicly available methods in the library are listed. The supporting code for those methods is defined in one or more **Groovy Members** step types within the library script. The methods defined in the library can accept arguments and return values of any type. Scripts of this type use the Groovy engine by default and cannot include scripting step types.

Scripts that need to invoke methods from a Groovy library can use the `createLibraryScript` method provided by the system to instantiate the library interface.



## Plug-In Scripts

**NOTE:** This section assumes you are familiar with the notion of plug-in spots (algorithm entities) and plug-ins. See [The Big Picture Of Algorithms](#) for more information.

As an alternative to writing a java program for a plug-in spot, the framework supports creating plug-ins using the defined script steps, Xpath commands, Groovy code or a combination of these three options.

The following topics describe basic concepts related to plug-in scripts.

### A Plug-In Script's API

Like program-based plug-ins, plug-in scripts:

- Run on the application server
- Have their API (input / output interface) defined by the plug-in spot (i.e., plug-in scripts don't get to declare their own API)
- Can only be invoked by the "plug-in spot driver"

For plug-ins configured to use a script engine version, the best way to understand the script's API is to use the **View Script Schema** hyperlink to view its parameters data area schema.

```
<schema>
  <parm type="group">
    <soft type="list">
      <value/>
    </soft>
    <hard type="group">
      <action use="input"/>
      <businessObject type="group" use="input">
        <id/>
      </businessObject>
    </hard>
  </parm>
</schema>
```

Notice the two groups: soft and hard. If you are familiar with plug-in spots, you'll recognize these as the classic soft and hard parameters:

- The **soft** parameters are the values of the parameters defined on the algorithm. Notice they are not named - if you want to reference them in your plug-in script, you must do it by position.
- The **hard** parameters are controlled by the plug-in spot (i.e., the algorithm entity). Notice that this plug-in spot has a single input parameter called "**businessObject/id**". Also notice the **use=** attribute - this shows that this parameter is input-only (i.e., you can't change it in the plug-in script).

**NOTE: XPath.** You can click on an element name to see the XPath used to reference the element in your script.

Plug-ins configured to use the **Groovy** engine version do not use an XML interface for the API and instead are processed in the same way as Java algorithms. The framework supplies a dynamically generated superclass that implements the plug-in spot for Groovy objects. Use the **View Script Superclass** hyperlink to view this superclass and the methods to set and get the hard parameters.



---

**NOTE:** For plug-in scripts using the **Groovy** engine version, soft parameters do not appear in the plug-in spot API as defined by the superclass. Plug-ins using only Groovy code define their soft parameters using annotations, in a similar way to Java algorithms, and fetch those values using methods defined in the algorithm code.

---

## Setting Up Plug-In Scripts

The following points describe how to implement a plug-in script:

- Compose your plug-in [script](#), associating it with the appropriate algorithm entity (plug-in spot).
- Create a new algorithm type for the respective algorithm entity, referencing your plug-in script as the program to carry out the algorithm type's function. Only plug-in scripts associated with the algorithm entity may be referenced on the algorithm type.
- Set up an algorithm for the respective algorithm type and plug it in where applicable. Refer to [Setting Up Algorithm Types](#) for more information.

## Service Scripts

BPA scripts run on the client's browser and guide the end-users through business processes. Service scripts run on the application server and perform server-based processing for [BPA scripts](#), [zones](#) and more. You may want to think of a service script as a common routine that is set up via scripting (rather than programming).

The following topics describe basic concepts related to service scripts.

## A Service Script's API

As with any common routine, a service script must declare its input / output parameters (i.e., its API). A service script's API is defined on its [schema](#).

---

**NOTE:** Refer to [Schema Nodes and Attributes](#) for a complete list of the XML nodes and attributes available to you when you construct a schema.

---

## Invoking Service Scripts

Any type of script configured to use a scripting engine version may [invoke a service script](#):

- A BPA script may invoke a service script to perform server-based processing.
- Plug-in scripts may invoke a service script (like a "common routine").
- A service script may call another service script (like a "common routine").

Map zones may be configured to invoke service scripts to obtain the data to be displayed. Refer to [Map Zones](#) for more information.

[Inbound web services](#) support interaction with service scripts allowing the outside world to interact directly with a service script.

You can also invoke a service script from a Java class.

## Groovy Library Scripts

Just as service scripts can define common routines written in scripting language, Groovy library scripts are used to define groups of common components or methods written in Groovy. Groovy library code runs on the application server and performs server-based processing for scripts that utilize Groovy code.

The following topics describe basic concepts related to Groovy library scripts.

### A Groovy Library Script's API

A Groovy library script's API is composed of one or more public methods whose code is defined in the script's steps. Those methods are defined in a step type of **Groovy Library Interface**. A Groovy library script must have one (and only one) step of this type.

### Invoking Groovy Library Methods

Any type of script that supports the **Groovy Members** step type may invoke common methods defined in Groovy library scripts.

Code within a **Groovy Members** step must create an instance of the Groovy library interface definition to enable the interface methods to be invoked. Refer to the topic [Using Groovy Within Scripts](#) for more information.

## Debugging Server-Based Scripts

The server can create log entries to help you debug your server scripts.

The logs contain a great deal of information including the contents of the referenced data area for **Move data**, **Invoke business object**, **Invoke business service** and **Invoke service script** steps.

Refer to the [Debug Mode](#) topic in the Configuration Tools chapter for details of how to execute the application in debug mode.

## Maintaining Scripts

The script maintenance transaction is used to maintain your scripts. The topics in this section describe how to use this transaction.

---

**FASTPATH:** Refer to [The Big Picture Of Scripts](#) for more information about scripts.

---

## Script - Main

Use this page to define basic information about a script. Open this page using **Admin > System > Script**.

---

**NOTE: Script Tips.** A context sensitive "Script Tips" zone is associated with this page. The zone provides links to [Edit Data Syntax](#) and [Advanced Schema Topics](#) so that users can quickly access those online help topics to aid in constructing scripts. In addition, the zone provides links to view the [Groovy JavaDocs Viewer](#) and the whitelist of third party Groovy classes so that users can verify the restricted list of classes available for Groovy coding in the script.

---

### Description of Page

Enter a unique **Script** code and **Description** for the script. Use the **Detailed Description** to describe the purpose of this script in detail. **Owner** indicates if the script is owned by the base package or by your implementation (**Customer Modification**).

---

**CAUTION:** Important! If you introduce a new script, carefully consider its naming convention. Refer to [System Data Naming Convention](#) for more information.

---

**Script Type** indicates if this is a **BPA Script**, **Plug-In Script**, **Groovy Library Script** or **Service Script**. Refer to [The Big Picture Of BPA Scripts](#) and [The Big Picture Of Server Based Scripts](#) for more information.

**Accessibility Option** appears only for BPA scripts. Set this value to **Accessible from Script Menu** for any script that may be launched as a stand-alone script. Scripts with this configuration may be linked to a navigation option so that they may be invoked from a menu and may be configured by a user as a favorite script. Set this value to **Not Accessible from Script Menu** for any script that cannot be launched on its own. For example, any script that is invoked as a sub-script from another script should have this setting. In addition, any script that is designed to be launched from within a specific portal where certain data is provided to the script should include this setting.

Enter an **Application Service** if the execution of the script should be secured. The application service should include **Execute** as one of its access modes. Refer to [Securing Script Execution](#) for more information. This field does not appear if the script type is **Groovy Library Script**.

**Algorithm Entity** appears only for [plug-in scripts](#). Use this field to define the [algorithm entity](#) into which this script can be plugged in.

**Business Object** appears only for business object related plug-in scripts. Enter the [Business Object](#) whose elements are to be referenced by the plug-in script.

**Script Engine Version** defines key information affecting the context and execution of the script.

- Script engine version values of 1, 2 and 3 define the version of the XML Path Language (XPath) to be used for the script. Versions 2 and 3 use the XPath 2 engine supplied by the XQuery team. This is the same engine used inside the Oracle database. The current script engine version 3 is a modified version that offers performance improvements without impacting existing version 2 scripts.

The default script engine version is 3.0 for plug-in and service scripts. The default version for BPA scripts is 1.0 as higher level versions are not applicable.

There are some additional details to note about script engine version 1.0:

- The XPath library used is Jaxen
- For BPA scripts, it uses the browser's xpath and XML support except for Internet Explorer where the XSD parser is used.
- XPath 1 (and even JavaScript) uses floating point arithmetic, which means that adding a collection of numbers with two decimal places might end up with a value of 10779.079999999998 instead of 10779.08
- A Script Engine Version value of **Groovy** indicates that only **Groovy Members** step types are used in the script and signals to the system that there is no need to convert the data to and from an XML interface. This allows for greater efficiency in script execution. Only plug-in scripts can select the **Groovy** engine version.
- The value **Framework Version 2.1 Compatibility Mode** remains for upgrade purposes. This value should only be applicable to early versions of BPA scripts using syntax that is incompatible with xpath syntax.

---

**NOTE:** The **Script Engine Version** field does not appear for **Groovy Library** scripts. The script engine version for these scripts is set to **Groovy** by default and cannot be changed.

---

Click the **View Script Schema** to view the [script's data areas](#) on the [schema viewer](#) window. This link does not appear if the script engine version is **Groovy**.

Click the **View XSD** hyperlink to view a script's schema definition in XSD format. This link only appears if the script type is **BPA Script** or **Service Script**.

The **View Script Superclass** hyperlink appears only for plug-in scripts using an engine version of **Groovy**. Click this link to view the code of the runtime generated superclass for the related plug-in spot's implementation.

The **View Script As Text** hyperlink appears for server-based scripts only. Click this link to view the internal scripting commands in a separate window.

The [tree](#) summarizes the script's steps. You can use the hyperlink to transfer to the **Step** tab with the corresponding step displayed.

## Script - Step

Use this page to add or update a script's steps. Open this page using **Admin > System > Script** and then navigate to the **Step** tab.

---

**NOTE: Time saver.** You can navigate to a step by clicking on the respective node in the tree on the Main tab.

---

### Description of Page

The **Steps** accordion contains an entry for every step linked to the script. When a script is initially displayed, its steps are collapsed. To see a step's details, simply click on the step's summary bar. You can re-click the bar to collapse the step's details. Please see [accordions](#) for the details of other features you can use to save time.

Select the **Step Type** that corresponds with the step. Refer to [How To Set Up Each Step Type](#) for an overview of the step types.

---

**CAUTION:** The Step Type affects what you can enter on other parts of this page. The remainder of this section is devoted to those fields that can be entered regardless of Step Type. The subtopics that follow describe those fields whose entry is contingent on the Step Type.

---

**Step Sequence** defines the relative position of this step in respect of the other steps. The position is important because it defines the order in which the step is executed. You should only change a Step Sequence if you need to reposition this step. But take care; if you change the Step Sequence and the step is referenced on other steps, you'll have to change all of the referencing steps.

---

**NOTE: Leave gaps in the sequence numbers.** Make sure you leave space between sequence numbers so that you can add new steps between existing ones in the future. If you run out of space, you can use the **Renumber** button to renumber all of the steps. This will renumber the script's steps by 10 and change all related references accordingly.

---

**Display Step** is only enabled on BPA scripts for step types that typically don't cause information to be displayed in the [script area](#) (i.e., step types like **Conditional Branch**, **Go to a step**, **Height**, etc). If you turn on this switch, information about the step is displayed in the script area to help you debug the script.

---

**CAUTION:** Remember to turn this switch off when you're ready to let users use this script.

---

---

**NOTE:** If **Display Step** is turned on and the step has **Text**, this information will be displayed in the script area. If **Display Step** is turned on and the step does not have **Text**, a system-generated messages describing what the step does is displayed in the script area.

---

**Display Icon** controls the [icon](#) that prefixes the **Text** that's displayed in the script area. Using an icon on a step is optional. This field is only applicable to BPA scripts.

**Text** is the information that displays in the [script area](#) when the step executes. You need only define text for steps that cause something to display in the script area.

---

**FASTPATH:** Refer to [How To Substitute Variables In Text](#) for a discussion about how to substitute variables in a text string.

---

**FASTPATH:** Refer to [How To Use HTML Tags And Spans In Text](#) for a discussion about how to format (with colors and fonts) the text that appears in the script area.

---

The other fields on this page are dependent on the **Step Type**. The topics that follow briefly describe each step type's fields and provide additional information about steps.

Click on the **View Script Schema** hyperlink to view the script's data areas. Doing this opens the [schema viewer](#) window.

The **View Script As Text** hyperlink appears for server-based scripts only. Click this link to view the internal scripting commands in a separate window. The presented script syntax is valid within [edit data](#) steps.

## How To Set Up Each Step Type

The contents of this section describe how to set up each type of step.

## Common Step Types To All Script Types

The contents of this section describe common step types applicable to all script types using a scripting language engine version.

## How To Set Up Conditional Branch Steps

**Conditional branch** steps allow you to conditionally jump to a different step based on logical criteria. For example, you could jump to a different step in a script if the customer is residential as opposed to commercial. In addition, several fields are required for **Conditional Branch** steps:

**Compare Field Type** and **Compare Field Name** define the first operand in the comparison. The **Field Type** defines where the field is located. The **Field Name** defines the name of the field. The following points describe each field type:

- **Current To Do Information.** Use this field type when the field being compared resides on the current To Do entry. Refer to [How To Use To Do Fields](#) for instructions on how to define the appropriate **Field Name**.
- **Data Area.** Use this field type when the field being compared is one that you put into one of the scripts data areas in an earlier step. **Field Name** must reference both a data area structure name as well as the field, for example "parm/charType". Refer to [How To Reference Fields In Data Areas](#) for instructions on how to construct the appropriate **Field Name**.
- **Page Data Model.** Use this field type when the field being compared resides on one of the tab pages in the [object display area](#). Refer to [How To Find The Name Of Page Data Model Fields](#) for instructions on how to find the appropriate **Field Name**.
- **Predefined Value.** Use this field type when the field being compared is a [global variable](#).
- **Temporary Storage.** Use this field type when the field being compared is one that you put into temporary storage in an earlier step. The **Field Name** must be the same as defined in an earlier step.
- **User Interface Field.** Use this field type when the field being compared resides on the currently displayed tab page. Refer to [How To Find The Name Of User Interface Fields](#) for instructions on how to find the appropriate **Field Name**.

**Condition** defines the comparison criteria:

- Use >, <, =, >=, <=, <> (not equal) to compare the field using standard logical operators. Enter the comparison value using the following fields.

- Use **IN** to compare the first field to a list of values. Each value is separated by a comma. For example, if a field value must equal **1, 3** or **9**, you would enter a comparison value of **1,3,9**.
- Use **BETWEEN** to compare the field to a range of values. For example, if a field value must be between **1** and **9**, you would enter a comparison value of **1,9**. Note, the comparison is inclusive of the low and high values.

**Comparison Field Type, Comparison Field Name** and **Comparison Value** define what you're comparing the first operand to. The following points describe each field type:

- **Current To Do Information.** Use this field type when the comparison value resides on the current To Do entry. Refer to [How To Use To Do Fields](#) for instructions on how to define the appropriate **Field Name**.
- **Data Area.** Use this field type when the comparison value resides in one of the scripts data areas. **Field Name** must reference both a data area structure name as well as the field, for example "parm/charType". Refer to [How To Reference Fields In Data Areas](#) for instructions on how to construct the appropriate **Field Name**.
- **Page Data Model.** Use this field type when the comparison value resides on one of the tab pages in the [object display area](#). Refer to [How To Find The Name Of Page Data Model Fields](#) for instructions on how to find the appropriate **Field Name**.
- **Predefined Value.** Use this field type when the field being compared is a constant value defined in the script. When this field type is used, use **Comparison Value** to define the constant value. Refer to [How To Use Constants In Scripts](#) for instructions on how to use constants.
- **Temporary Storage.** Use this field type when the comparison value is a field that you put into temporary storage in an earlier step. The **Field Name** must be the same as defined in an earlier step.
- **User Interface Field.** Use this field type when the comparison value resides on the currently displayed tab page. Refer to [How To Find The Name Of User Interface Fields](#) for instructions on how to find the appropriate **Field Name**.

---

**NOTE: Conditional field types.** The field types **Current To Do Information, Page Data Model** and **User Interface Field** are only applicable to BPA scripts.

---

The above fields allow you to perform a comparison that results in a value of **TRUE** or **FALSE**. The remaining fields control the step to which control is passed given the value:

- **If TRUE, Go to** defines the step that is executed if the comparison results in a **TRUE** value.
- **If FALSE, Go to** defines the step that is executed if the comparison results in a **FALSE** value.

---

**NOTE: Numeric Comparison.** Comparison of two values may be numeric or textual (left-to-right). Numeric comparison takes place only when values on both side of the comparison are recognized as numeric by the system. Otherwise, textual comparison is used. Fields for **Current To Do Information, Data Area, Page Data Model,** and **User Interface Field** types are explicitly associated with a data type and therefore can be recognized as numeric or not. This is not the case for fields residing in **Temporary Storage** or those set as **Predefined Values**. A **Temporary Storage** field is considered numeric if it either holds a numeric value moved to it from an explicitly defined numeric value (see above) or it is a resultant field of mathematical operation. A **Predefined Value** field is considered numeric if the other field it is compared to is numeric. For example, if a numeric field is compared to a **Predefined Value** the latter is considered numeric as well resulting in numeric value comparison. However, if the two fields are defined as **Predefined Values** the system assumes their values are text strings and therefore applies textual comparison.

---

## How To Set Up Edit Data Steps

**Edit data** steps provide a free format region where you can specify commands to control your script processing.

In general, the syntax available within edit data mimics the commands available within the explicit step types. However, there are a few commands that are available only within edit data. For example, the two structured commands: **For**, and **If**.

For server-based scripts, you may find it useful to create a few explicit step types and then use the **View Script as Text** hyperlink on the [Script - Step](#) page to better understand the edit data syntax.

---

**NOTE:** Not all BPA step types are supported using the edit data syntax. Refer to the [Edit Data Syntax](#) topic below for more information on edit data commands and examples.

---

Additional field required for **Edit data** steps:

Enter your scripting commands in the **Edit Data Text** field. Click the adjacent icon to open a window providing more space for defining the edit data step.

## Edit Data Syntax

The topics in this section provide detail of the syntax supported in the edit data step type.

### Contents

- [Comments](#)
- [Temporary Variables](#)
- [Context Variables](#)
- [Move Statement](#)
- [Go To Statement](#)
- [Conditional Branch Statement](#)
- [If Statement](#)
- [For Statement](#)
- [List Processing](#)
- [Functions for Processing a List](#)
- [Declare and Invoke Schema Based Objects](#)
- [System and Global Variables](#)
- [Perform Script and Transfer](#)
- [Navigate Statement](#)
- [Invoke Map Statement](#)
- [Declare BO with BO Group](#)
- [Generate Edit Map Statements](#)
- [Terminate Statement](#)
- [Invoking Groovy Code](#)
- [Debugging a BPA Script](#)

### Comments

You can place comments into your script using the double slash notation `//` in the first two characters of the edit data step. Example:

```
//  
// quit with error  
//  
if ("not(customer/securityEnabled)")  
terminate with error (8000, 1001 %1="customer/id" %1='not allowed');  
end-if;
```

### Temporary Variables

Temporary variables can be declared within all types of scripts. They should be referenced by a leading single dollar sign (`$`). However, temporary variables behave differently in the various script types:

- In BPA Scripts temporary variables remain persistent from one BPA script to another (refer to the [Perform Script and Transfer Control statements](#)), which means that you can use temporary variables to communicate between BPA scripts.
- Temporary variables cannot be passed from a BPA script to a service or plug-in script. Only data area elements can be passed between these types of scripts.
- Within service and plug-in scripts, temporary variables remain persistent only for the life of the particular script that declared the variable. This means that temporary variables cannot be passed between plug-in scripts and service scripts, only [global variables](#), [context variables](#) and data area elements can be passed between these types of scripts.

## Declaring / Initializing / Defaulting Temporary Variables

When using a temporary variable, it should be declared or initialized with an appropriate value before using it. A typical method for declaring a variable is to simply move data to it in a move statement, for example.

```
move "0" to $index;
```

---

**FASTPATH:** Refer to [Move to a Temporary Variable](#) for more information on implicit declaration of a temporary variable within a move statement.

---

For BPA scripts, as mentioned above, temporary variables may be passed from one BPA script to another. As such, it is common to reference a temporary variable in a BPA that should have been initialized by a previous BPA. However, if there is any reason that a temporary variable did not get initialized by a previous BPA, a reference to it will cause an error. It is good practice, therefore, to use the **default** statement that will initialize temporary variables that are not already created / initialized.

- The following statement will initialize the temporary variable \$InputAction – but only if the temporary variable has not yet been initialized:

```
default $InputAction;
```

- The following statement will set the value of the temporary variable \$InputAction to 'read' – but only if the variable has not yet been initialized:

```
default $InputAction as 'read';
```

---

**NOTE:** Scripts should take care not to define variables using a reserved keyword. The following table lists the reserved keywords.

---

---

### Keyword

add

as

asError

bpa

branch

data

declareBO

declareBS

declareDA

declareMap

declareSS

default

delete

edit

element

else

end-edit

end-for

end-if

---



**Keyword**

---

**error**

---

**escape**

---

**evaluate**

---

**fastAdd**

---

**fastUpdate**

---

**for**

---

**goto**

---

**if**

---

**in**

---

**invokeBO**

---

**invokeBS**

---

**invokeMap**

---

**invokeSS**

---

**label**

---

**map**

---

**move**

---

**navigate**

---

**navigateAndReloadDashboard**

---

**null**

---

**page**

---

**performScript**

---

**popup**

---

**read**

---

**readWithoutVersion**

---

**replace**

---

**suppress**

---

**target**

---

**terminate**

---

**to**

---

**transferControl**

---

**update**

---

**using**

---

**warn**

---

**with**

---

---

## Context Variables

Context variables are only available within service scripts. The context variable will be available for the duration of the service script and all that it invokes. Therefore, you can use a context variable within a service script to communicate information to a lower level service script or schema. They should be referenced by leading double dollar signs ('\$\$').

**NOTE:** Because context variables are available for lower level scripts, they may sometimes be referred to as global variables or global context variables. But they should not be confused with [global variables](#).

### Declaring / Initializing / Defaulting Context Variables

When using a context variable, it should be declared or initialized with an appropriate value before using it. A typical method for declaring a variable is to simply move data to it in a move statement, for example.

```
move 'context variable' to $$contextVariable;
```

**FASTPATH:** Refer to [Move using a Context Variable](#) for more information.

## Move Statement

The **move** statement copies a source value to a target. The following table highlights various options supported in the move statement.

Statement	Example Description	Example Syntax
Move to Element <b>move "xpath" to "xpath";</b>	Move statement with simple XPath reference.	<pre>move "acct/totalBalance" to "parm/formattedValue";</pre>
<b>NOTE:</b> An XPath expression is surrounded by double quotes.	Move statement with XPath concatenate function.	<pre>move "concat(person/ firstName, ', ', person/lastName) " to "parm/fullName";</pre>
	Move statement with XPath substring-before function.	<pre>move "substring-before(parm/ fullName, ', ')" to "person/firstName";</pre>
	Move statement with XPath substring-after function.	<pre>move "substring-after(parm/ fullName, ', ')" to "person/lastName";</pre>
	Move statement with XPath substring function.	<pre>move "substring(parm/date,1,4)" to "parm/year";</pre>
Move to Element <b>move 'literal' to "xpath";</b>	Move statement using a literal string.	<pre>move 'okay for mailing' to "account/ preferences[type="mail"]/text";</pre>
<b>NOTE:</b> A literal value is surrounded by single quotes.		
Move to Element <b>move 'Boolean' to "xpath";</b>	Move statement with Boolean as literal string.	<pre>if ("account/balance &gt; 0") move 'true' to "account/hasDebitBalance"; end-if;</pre>
	Moving an expression, which results in a Boolean. Note that the filter in the example below is located on a group node.	<pre>&lt;schema&gt; &lt;account&gt; &lt;hasDebitBalance type="boolean"/ &gt; &lt;balance/&gt; &lt;/account&gt; &lt;/schema&gt;  move "boolean(account[balance&gt;0])"</pre>

Statement	Example Description	Example Syntax
		to "account/hasDebitBalance";
Move to Group <b>move "xpath" to "xpath";</b>	Move a set of elements from one group with another – where the element names are valid for the target schema.	<pre>move "account/ custInfo" to "person";</pre> <p>This statement is equivalent to the following statement:</p> <pre>move "account/custInfo/ *" to "person/*";</pre>
Move using a <a href="#">Temporary Variable</a>	When moving to a temporary local variable, it is not surrounded by double quotes. <b>move "xpath" to \$variable;</b>	<pre>move "count(Person/names/ personName) + count(Person/ids/personId)" to \$PersonChildCount;</pre>
	When moving from a temporary variable, the variable is surrounded by double quotes. <b>move "\$variable" to "xpath";</b>	<pre>move "\$AccountBalance" to "parm/formattedValue";</pre>
Move using a <a href="#">Context Variable</a> <b>move "xpath" to \$\$variable;</b> <b>move \$\$variable to "xpath";</b>	Context variables, source or target, are referenced without any double quotes.	<pre>move 'context value' to \$\$contextVariable; // // here, we move from a context variable. move \$\$contextVariable to "MarketMessage/sender";</pre>
Move using a Dynamic Location <b>move "xpath"   'literal' to evaluate("xpath"   \$variable);</b> <b>move evaluate("xpath"   \$variable) to "xpath"   \$variable;</b>	The evaluate statement allows your move source or target location to be dynamically derived from a variable or schema element location.	<pre>move 'literal' to evaluate("schemaLocation"); // move "schemaLocation" to evaluate(\$Variable);  move evaluate("schemaLocation") to \$Variable; // move evaluate(\$Variable) to "schemaLocation";</pre>
Move escape <b>move escape("xpath"   \$variable) to "xpath"   \$variable;</b>	Move escape is only available for service scripts and plug-in scripts. The escape statement scans your source text value for HTML content and escapes it, i.e. replaces any HTML-like characters with special characters that are escaped from HTML rendering. By doing so the text would be displayed as plain text when displayed as part of an HTML element.  <b>NOTE:</b> You should only use this function if the text is to be displayed as part of an HTML element and is suspected to contain HTML-like characters or even malicious HTML that should not be rendered as HTML. If incorrectly displayed using a non HTML element, the special escape characters, if any would be visible as part of your text. Refer to the <a href="#">UI Map Attributes and Functions</a> for more information on how to define an element to display HTML content.	<pre>move escape("schemaLocation") to \$Variable; // move escape(\$Variable) to "schemaLocation";</pre>
Move null <b>move null to "xpath";</b>	You can remove information from the XML instance document through the special syntax of move 'null'. Note that you can specify either	Remove a node and all of its child nodes: <pre>if ("boolean(customer/ securityEnabled)") goto updateInfo;</pre>

Statement	Example Description	Example Syntax
	a node name in the XPath expression or a group name. If you specify a group then the group and all child elements will be eliminated from processing.	<pre>else   move null to "customer"; end-if;</pre> <p>Remove all child nodes of a group node with the suffix '/*'.</p> <pre>if ("boolean(customer/ securityEnabled)")   move null to "customer/*"; end-if;</pre>

## Go To Statement

The edit data step supports functionality analogous to the [Go To](#) step type. The syntax is **goto label;** where the label represents another location within the edit data text field (identified by this label) or represents another step in the script.

The following is an example of going to another location in the same step identified by the label **addSpouse**.

```
if ("string(parm/spouse/name) != $BLANK")
  goto addSpouse;
end-if;
addSpouse: invokeBO 'Person' using "parm/spouse" for add;
```

The following is an example of going to a different step within the same script. The step sequence is the reference used as the label.

```
if ("string(parm/spouse/name) != $BLANK")
  goto 110;
end-if;
.
.
.
110: invokeBO 'Person' using "parm/spouse" for add;
```

## Conditional Branch Statement

The edit data step supports functionality analogous to the [Conditional Branch](#) step type. The syntax is **branch ("xpath") goto label else label;** where:

- The XPath condition in the **branch** statement must evaluate to a Boolean value of True or False.
- The targets for the **goto** and **else** statements are labels that represent another location within the edit data text field (identified by this label) or represent another step in the script.

The following example uses labels for **addSpouse** and **addAccount**

```
branch ("string(parm/spouse/name) != $BLANK") goto addSpouse else addAccount;
```

## If Statement

The **if** statement is similar to the conditional branch statement. Either can be used to structure the logic of your script. This statement may optionally include an **else** statement but it should always end with an **end-if** statement.

**NOTE:** This is an example of a statement that is not represented as a separate step type. It is only available within the edit data text.

The syntax is **if ("xpath") else end-if;**. The XPath condition must evaluate to a Boolean value of True or False. The following are some examples.

Example where the XPath contains a simple logical condition.

```
if ("string(parm/spouse/name) != $BLANK")
  //
  // Create spouse since spouse name present
```

```

    goto addSpouse;
else
    //
    // Create account without spouse
    goto addAccount;
end-if;

```

Example where the XPath contains a complex condition.

```

if ("string(parm/spouse/name) != $BLANK and string(parm/hasSpouse) = true or boolean(parm/requireSpouse)")
    //
    // Create spouse since spouse name present
    goto addSpouse;
end-if;

```

Example of a stacked set of statements used to evaluate multiple possible values of a field.

```

if ("parm/rowCount = 0")
    //
    // no rows found
    goto quit;
end-if;
if ("parm/rowCount = 1")
    //
    // one row found
    goto process;
end-if;
if ("parm/rowCount > 1")
    //
    // more than one row found
    goto quit;
end-if;
quit: terminate;

```

The following XPath shows Boolean based on the existence of the node. In this example, if the node exists in the XML instance document being processed, the statement will evaluate to True. If no element is found, the statement evaluates to false.

---

**NOTE:** When treating XPath nodes as Boolean variables be aware that an empty node evaluates to True. Only a missing node return False.

---

```

if ("boolean(parm/spouse/name)")
    goto addSpouse;
else
    //
    // Create account without spouse
    goto addAccount;
end-if;

if ("not(parm/spouse/name)")
    //
    // Create account without spouse
    goto addAccount;
else
    goto addSpouse;
end-if;

```

## For Statement

The **for** statement creates a list of nodes or values depending on your XPath expression. If you specify a list node then every child node of the list, along with its contents, will be available within the loop. If you specify a child node directly, then a list of values only will be available within the loop.

---

**NOTE:** For more information on creating new entries in a list, please refer to the [creating a new list instance](#) example.

---

---

**NOTE:** This is an example of a statement that is not represented as a separate step type. It is only available within the edit data text.

---

The syntax is **for (\$variable in "xpathList") end-for;**. The XPath condition must evaluate to a Boolean value of True or False.

The following examples are based on this sample schema:

```
<schema>
  <SAList type="list">
    <id/>
    <balance/>
  </SAList>
  <SAContributor type="list">
    <id/>
  </SAContributor>
</schema>
```

Example that specifies the list node in the XPath expression where all child nodes are available for processing.

```
move "0" to $AccountBalance;
move "0" to $index;
for ($SAList in "SAList")
  move "$SAList/balance + $AccountBalance" to $AccountBalance;
  //
  // keep track of each SA contributing to the balance in the SA Contributor list
  move "1 + $index" to $index;
  move "$SAList/id" to "SAContributor[$index]/id";
end-for;
```

Example that specifies a child node within the list node in the XPath expression. Only values of that node are available for processing.

```
move "0" to $AccountBalance;
for ($SABalance in "SAList/balance")
  move "$SABalance + $AccountBalance" to $AccountBalance;
end-for;
```

Example that shows that a filter can be used to limit the rows selected by the **for** loop.

```
move "0" to $AccountDebitBalance;
for ($SAList in "SAList[Balance>0]")
  move "$SAList/balance + $AccountDebitBalance" to $AccountDebitBalance;
end-for;
```

Example that shows the use of a filter when specifying child nodes.

```
move "0" to $AccountCreditBalance;
for ($SABalance in "SAList[Balance<0]/balance")
  move "$SABalance + $AccountCreditBalance" to $AccountCreditBalance;
end-for;
```

## List Processing

This section provides details about processing lists. The examples in this section reference the following schema:

```
<schema>
  <parm type="group">
    <name/>
  </parm>
  <Person type="group">
    <names type="list">
      <type/>
      <name/>
    </names>
  </Person>
</schema>
```

**Referencing a List Element.** You can move a value to a particular list instance by referencing an identifying node in the list within a filter. The syntax is **move "xpath" to "xpathList[filter]/element"**; Example:

```
move "parm/name" to "Person/names[type='main']/name";
```

**Creating a New List Instance.** A special notation can be used within a move target statement to indicate a new list instance should be created. The "+" indicates to the script processor that a new instance of a list should be initiated for the target element. The syntax is **move "xpath" to "+xpathList"**; Example:

```
move "parm/name" to "Person/+names/name";
```

**Deleting a List Instance.** An XML list entry can be deleted from the database by moving an action attribute of 'delete' to the element name. To cause a database delete of a list entry requires an attribute of action="delete" in the target node and a subsequent update BO interaction. The syntax is **move 'delete' to "xpathList@action"**; Example:

```
if ("parm/action = 'd'")
  move "0" to $index;
  for ($CCList in "CCList")
    move "1 + $index" to $index;
    if ("$CCList/id = parm/id")
      move 'delete' to "CCList[$index]@action";
      goto update;
    end-if;
  end-for;
end-if;
```

The following shows the resulting XML.

```
<root>
  <CCList>
    <id>9876538976</id>
    <balance>309.98</balance>
  </CCList>
  <CCList action="delete">
    <id>4321125899</id>
    <balance>87.45</balance>
  </CCList>
</root>
```

**NOTE:** Deleting a list instance through use of the action attribute is risky if iterative BO interactions are required. The XML document that contains the list instance to be deleted will not be altered after a successful BO interaction, which means the document will still contain the list instance even though it no longer exists. To solve this problem, it is essential to re-read the BO after any BO update where the action attribute of 'delete' has been used.

**NOTE:** An alternative to the delete attribute described here, is to use the BO action of [replace](#). Manipulating a list to use the replace action avoids the problem described above concerning stale information in request documents post BO update.

## Functions for Processing a List

XPath provides several functions that are useful to process elements of a list including **count**, **sum** and **last**.

The following examples are based on this sample XML document:

```
<xml>
  <ft>
    <type>bill</type>
    <date>20100101</date>
    <amt>30.30</amt>
    <cat>tax</cat>
  </ft>
  <ft>
    <type>adj</type>
    <date>20100301</date>
    <amt>20.20</amt>
    <cat>int</cat>
  </ft>
```

```
<ft>
  <type>bill</type>
  <date>20100201</date>
  <amt>10.10</amt>
  <cat>tax</cat>
</ft>
</xml>
```

The following is an example of a sum. The syntax is **move "sum(xpathList/element)" to \$variable**; The example sums the total balance.

```
move "sum(ft/amt)" to $TotalBalance;
```

The following is an example of a sum using a filter to get a subtotal. The example sums the balance of the entries that have the 'tax' category.

```
move "sum(ft[cat='tax']/amt)" to $TaxBalance;
```

The following is an example of a count. The syntax is **move "count(xpathList)" to \$variable**; The example finds the count of the number of FT entries in the list.

```
move "count(ft)" to $TranCount;
```

The following is an example of 'last', which is used to locate the last entry. The syntax is **move "last(xpathList)" to \$variable**; The example finds the last amount in the FT list.

```
move "ft[last()]/amt" to $LastAmount;
```

## Declare and Invoke Schema Based Objects

You can invoke a business object, business service or service script within the edit data step. To support the dynamic invoke, a dynamic data area name can be declared.

The schema being declared may be a business object (BO) schema, a business service (BS) schema, a service script (SS) schema, data area (DA) schema or a UI map schema. The declare statement will differ based on the type of schema, but the syntax is analogous.

- **declareBO** 'BO Name' | \$variable | "xpath" as 'DynamicDataArea';
- **declareBS** 'BS Name' | \$variable | "xpath" as 'DynamicDataArea';
- **declareSS** 'SS Name' | \$variable | "xpath" as 'DynamicDataArea';
- **declareDA** 'DA Name' | \$variable | "xpath" as 'DynamicDataArea';
- **declareMap** 'Map Name' | \$variable | "xpath" as 'DynamicDataArea';

When invoking a BO, BS or SS, the name of the object can be specified as a literal or it can be a value contained within an element or a variable. For every Invoke, you must supply an XPath reference to a group name.

- When invoking a business object, an action must be supplied. The syntax is **invokeBO 'BO Name' | \$variable | "xpath" using "xpath" for action**; The valid actions are as follows:
  - **read**. This action reads the current view of the BO data.
  - **add**. This action will add the object and read and return the resulting view of the BO.
  - **fastAdd**. This action will add the object but does not perform a subsequent 'read' to return the resulting view of the BO.
  - **update**. This action will update the object and read and return the resulting view of the BO. This action executes a 'merge' of the information specified in the invoke statement's request XML document with existing BO data. Using this action allows the script to only indicate the elements that are changing.
  - **fastUpdate**. This action will update the object but does not perform a subsequent 'read' to return the resulting view of the BO.
  - **delete**. This action deletes the object.



- **replace.** This action is an alternate to the update action. The replace action completely replaces existing BO data with the information in the request document. Typically, the replace action is used when a BO contains a list because it is easier to simply replace all instances of a list rather than attempt a list merge, which requires special logic to [delete a list instance](#) explicitly.

---

**NOTE:** The replace action must be used when using the UI map functionality to [Upload a CSV File](#).

---

Examples:

```
invokeBO 'BusinessObject' using "dataArea" for fastAdd;
invokeBO $variableBO using "dataArea" for fastUpdate;
invokeBO "daName/boElement" using "dataArea" for replace;
```

- The syntax of the invoke statements for both a business service and service script are similar. The BS / SS is specified along with the XPath reference to the group name:
  - **invokeBS 'BS Name' | \$variable | "xpath" using "xpath";**
  - **invokeSS 'SS Name' | \$variable | "xpath" using "xpath";**

The examples use the **invokeBS** statement but the statements are similar for the **invokeSS** statement.

```
invokeBS 'BusinessService' using "dataArea";
invokeBS $variableBS using "dataArea";
invokeBS "daName/bsElement" using "dataArea";
```

Note that for BPA scripting, the **invoke** statements may also indicate how to handle warnings.

Syntax	Description	Examples
with warn asError	Indicates that a warning should be treated as an error displayed in the UI map. The text <b>asError</b> is optional.	invokeBO 'BusinessObject' using "dataArea" for add; invokeSS 'ServiceScript' using "dataArea" with warn asError;
with warn popup	Indicates that a warning should be presented in the standard framework popup.	invokeBS "daName/bsElement" using "dataArea" with warn popup;
with warn suppress	Indicates that a warning should be suppressed. This is the default if no warning syntax is added to the <b>invoke</b> statement.	invokeBS "daName/bsElement" using "dataArea" with warn suppress; invokeSS 'ServiceScript' using "dataArea";

---

**NOTE:** For service scripts, all objects invoked from the service script will inherit their warning level. Therefore, if the service script is invoked **with warn**, all nested invoke statements will also be invoked **with warn**.

---

For BPA scripts, there should also be logic following the invocation to handle errors and warnings (if desired). The system variables **\$ERROR** and **\$WARNING** are provided to interpret the results. Also note that the product provides a BPA Script **F1-HandleErr** that may be used to display the error. The following is an example of typical error handling logic.

```
invokeBO "F1-DetermineBo/output/bo" using "boSchema" for update with warn popup;
if (" $WARNING")
  terminate;
end-if;
if (" $ERROR")
  transferControl 'F1-HandleErr';
end-if;
```

## System and Global Variables

The following tables highlight system and global variables available for script writing.

### System Variables - All Script Types

The following system variables are available for all script types (service scripts, plug-in scripts, and BPA scripts).

Variable	Description	Example
<b>\$BLANK</b>	Represents an empty node.	<pre>if ("string(parm/spouse/name) ! = \$BLANK")   goto addSpouse; end-if;</pre>
<b>\$CURRENT-DATE</b>	Represents the current date. For BPA scripts, this is the browser date.  For server scripts this is the server date (and is affected by the <a href="#">system date override</a> logic).	<pre>move "\$CURRENT-DATE" to \$tempDate;</pre>
<b>\$CURRENT-STD-DTTM</b>	Represents the current date-time expressed in standard time (meaning without any adjustments for summer time / daylight savings time).	<pre>move "\$CURRENT-STD- DTTM" to \$tempDateTime;</pre>
<b>\$DEVICE-OS</b>	Represents the user's device operating system.	<pre>move "\$DEVICE-OS" to \$tempDeviceOs;</pre>
<b>\$DEVICE-BROWSER</b>	Represents the user's device browser.	<pre>move "\$DEVICE- BROWSER" to \$tempDeviceBrowser;</pre>
<b>\$DEVICE-DISPLAY-TYPE</b>	Represents the user's device screen display type whether it is Desktop size or Medium or Small size. Returned values may be like oraDesktop, oraTablet and oraPhone.	<pre>move "\$DEVICE-DISPLAY- TYPE" to \$tempDeviceDisplayType;</pre>
<b>\$DEVICE-INFO</b>	Provides the combination of all three device properties (DEVICE-OS, DEVICE-BROWSER and DEVICE-DISPLAY-TYPE) and each property value is separated by semi-colon.	<pre>move "\$DEVICE- INFO" to \$tempDeviceInfo;</pre>

### System Variables - BPA Scripts Only

The following system variables are only available / applicable for BPA script types.

Variable	Description	Example
<b>\$DOUBLE_QUOTE</b>	Represents a double quote.	<pre>move "\$DOUBLE_QUOTE" to \$tempField;</pre>
<b>\$SINGLE_QUOTE</b>	Represents an apostrophe.	<pre>move "\$SINGLE_QUOTE" to \$tempField;</pre>
<b>\$SPACE</b>	Contains a single space value.	<pre>move "\$SPACE" to \$tempField;</pre>
<b>\$SYSTEM-DATE</b>	Represents the server date. Note that this date is affected by the <a href="#">system date override</a> logic)	<pre>move "\$SYSTEM-DATE" to \$tempDate;</pre>

### System Variables - Server Scripts Only

The following system variables are only available / applicable for service script and plug-in script types.

Variable	Description	Example
<b>\$ADDITIONAL-IP-INFO</b>	An HTTP request includes an "additional IP address" header field. This may be populated by	<pre>move "\$ADDITIONAL-IP-INFO" to "parm/ request/headerIpAddress";</pre>

Variable	Description	Example
	an implementation if there is some information available on the proxy server or load balancer, such as the originating IP address.	
<b>\$CURRENT-DTTM</b>	Represents the current date-time.	<code>move "\$CURRENT-DTTM" to \$tempDateTime;</code>
<b>\$F1-INSTALLATION-TIMEZONE</b>	Represents the time zone code defined on the <a href="#">installation options</a> .	<code>move "\$F1-INSTALLATION-TIMEZONE" to \$timeZone;</code>
<b>\$LANGUAGE</b>	Represents the language code the script is using. Typically this is the user's default language.	<code>move "\$LANGUAGE" to \$tempLanguage;</code>
<b>\$PROCESS-DATE</b>	Represents the process date. The process date differs from the current date because the process date will remain consistent throughout the duration of the process being executed. For example, if a service script stores several business objects – the process date is initialized at the start of the service script execution and each business object will have the same process date defaulted. The current date, especially the current date time, will reflect the actual time of processing.	<code>move "\$PROCESS-DATE" to \$tempDate;</code>
<b>\$PROCESS-DTTM</b>	Represents the process date-time. Note that the process date and time is initialized at the start of a particular process and will not reflect the exact date and time of an update.	<code>move "\$PROCESS-DTTM" to \$tempDateTime;</code>
<b>\$REQUESTING-IP-ADDRESS</b>	Represents the IP address from the HTTP request. Note that if the request is routed through a proxy server or load balancer, this IP address is be the IP address of the proxy or load balancer, not the IP address of the end user. Refer to the <b>\$ADDITIONAL-IP-INFO</b> variable for information.	<code>move "\$REQUESTING-IP-ADDRESS" to "parm/request/systemIpAddress";</code>
<b>\$USER</b>	Represents the user ID of the user executing the script.	<code>move "\$USER" to \$tempUser;</code>

## Global Variables

BPA scripts and service scripts have access to the values defined in [Global Context](#).

When a BPA script is launched from the user interface, these variables will be automatically initialized. They may be referenced with a single dollar sign in front of the field name. For example if PER\_ID is a supported global variable, then \$PER\_ID can be referenced within the BPA script:

```
move "$PER_ID" to "schema/customerId";
```

For service scripts, global variables may only be referenced if the service script has been invoked directly from a BPA script or a zone on a portal. When a service script is invoked from a BPA script or portal zone, it will have access to the suite of global context variables populated in the UI session. For service scripting, the global fields must be prefixed by two dollar signs (instead of one like in BPA scripting). For example if PER\_ID is a supported global context variable, then \$\$PER\_ID can be referenced within the service script.

```
move $$PER_ID to "schema/customerId";
```

**NOTE:** As described in [Context Variables](#), a service script may declare context variables that use the same two dollar sign syntax.

## Perform Script and Transfer Control Statements

The edit data step supports functionality analogous to the [Perform script](#) step type and the [Transfer Control](#) step type. These are both applicable only to BPA scripts.

Syntax	Valid Values	Comments
performScript	'BPA Script Name'	Script to perform is explicitly provided.
	\$Variable	Script to perform is found in a variable.
	"XPath"	Script to perform is found in an element, referenced by its XPath.
transferControl	Analogous to the <b>performScript</b> statement	

**NOTE:** When the script named in the **performScript** statement has finished, control will be returned to the calling BPA script. When the script named in the **transferControl** statement has finished, you will not be returned to the calling script, complete control will be granted to the transferred to script.

## Navigate Statement

The edit data step supports functionality analogous to the [Navigate to a page](#) step type. This is applicable only to BPA scripts.

Syntax	Valid Values	Comments
navigate	'Navigation Code'	Navigation option is explicitly provided.
	\$Variable	Navigation option is found in a variable.
	"XPath"	Navigation option is found in an element, referenced by its XPath.

In addition, the edit data step supports the ability to indicate that the dashboard should be refreshed when navigating. This is only applicable to BPA scripts.

Syntax	Valid Values
navigateAndReloadDashboard	Analogous to the <b>navigate</b> statement

## Declare BO with BO Group

This statement is specific to BPA scripts that plan to use the base script Main BO Maintenance Processing (**F1–MainProc**) for its Generate Edit Map statements. This script expects that the data used to display in the map is within a **boGroup** tag.

Syntax	Valid Values	Comments
declareBOWithBOGroup	'BO Name'	BO is explicitly provided.
	\$Variable	BO is found in a variable.
	"XPath"	BO is found in an element, referenced by its XPath.

The following table highlights additional syntax for this statement.

Syntax	Valid Values
as	'Dynamic Schema Name'

Examples:

```
declareBOWithBOGroup 'BusinessObject' as 'newMapSchema';
declareBOWithBOGroup $variableBO as 'newMapSchema';
declareBOWithBOGroup "daName/boElement" as 'newMapSchema';
```

## Invoke Map Statement

The edit data step supports functionality analogous to the [Invoke map](#) step type. This is applicable only to BPA scripts.

Syntax	Valid Values	Comments
invokeMap	'Map Name'	UI Map is explicitly provided.
	\$Variable	UI Map is found in a variable.
	"XPath"	UI Map is found in an element, referenced by its XPath.

The following table highlights additional syntax for this statement.

Syntax	Valid Values	Comments
using	"Data Area group name"	Indicates the data area to be passed to and from the server when rendering the HTML form associated with the map.
target	bpa page popup	

Refer to the [Invoke map](#) step type for more information about the **target** values.

If the UI map is configured to return a value, then it can be evaluated using the **\$MAP-VALUE** variable.

```
invokeMap 'UI Map' using "dataArea";
invokeMap $variableMap using "dataArea";
invokeMap "daName/mapElement" using "dataArea" target bpa;

// $MAP-VALUE is a variable returned by the invoked map.
if (" $MAP-VALUE='continue' ")
    goto 300;
else
    terminate;
end if;
```

## Generate Edit Map Statements

The 'generate edit map' statements are used to dynamically generate and launch a UI edit map based on a schema definition. The schema used may be a BO schema, a BS schema, an SS schema or a DA schema. This is applicable only to BPA scripts. The generate statement will differ based on the type of schema, but the syntax is analogous.

### Syntax

```
generateBOEditMap
```

## Syntax

---

generateBSEditMap

---

generateSSEditMap

---

generateDAEditMap

---

---

The BO code / BS code / SS code / DA code may be specified using a literal (surrounded by single quotes), as a temporary variable or by referencing an XPath schema location (surrounded by double quotes).

The following table highlights additional syntax for this statement.

Syntax	Valid Values	Comments
using	"Data Area group name"	Indicates the data area to be passed to and from the server when rendering the HTML form associated with the map.
target	bpa page popup	

The target values indicate where the generated map should be displayed as described in the [Invoke map](#) step type. If the UI map is configured to return a value, then it can be evaluated using the **\$MAP-VALUE** variable.

The examples use the **generateBOEditMap** but the statements are similar for the other schema types.

```
generateBOEditMap 'BO Name' using "dataArea";  
generateBOEditMap $variableMap using "dataArea";  
generateBOEditMap "daName/mapElement" using "dataArea" target bpa;  
  
// $MAP-VALUE is a variable returned by the invoked map.  
if (" $MAP-VALUE='continue' ")  
    goto 300;  
else  
    terminate;  
end if;
```

## Terminate Statement

The edit data step supports functionality analogous to the [Terminate](#) step type.

The following is an example of a simple **terminate** step that will stop the script.

```
if ( "not (parm/spouse/name) " )  
    terminate;  
else  
    goto addSpouse;  
end-if;
```

The **terminate with error** statement is only available in a service script.

Syntax	Attributes	Comments
terminate with error (x, y %n= element=)	'x' represents the message category	Required.
	'y' represents the message number	Required.
	%n="Element XPath" or %n='literal'	Specify the substitution parameters supported by the message using either literal values or XPath references.

Syntax	Attributes	Comments
	element="Element XPath"	Optionally specify an element name within a UI map to highlight as part of the error.

Example:

```
if ("string(customer/lastName) = $BLANK")
  terminate with error (8000, 1001 %1="customer/
lastName" %2='Last name required' element='customer/lastName');
end-if;
```

**FASTPATH:** For more information on presenting errors in a UI map, please refer to [Display Errors](#).

## Invoking Groovy Code

The edit data step supports the ability to invoke Groovy code using the syntax **invokeGroovy 'method'**; where 'method' is the name of a method defined in a **Groovy Members** step within the script . Only methods that do not receive arguments and return void can be invoked in this way. However, the method invoked from the edit data step can be supported by additional Groovy code in other **Groovy Members** step types.

Example Edit Data step:

```
invokeGroovy 'invoke';
```

Example Groovy Members step:

```
void invoke() {
  initParms()
  readBO()
  initConfig()
  retrieve()
  updateBO()
}
```

## Debugging a BPA Script

If a BPA script has height greater than zero, then selected nodes of the script's data area can be displayed at runtime. The XML data is displayed during script execution within the BPA script's display area. Specify the XPath of an XML node from any of the BPA script's data areas, between the paired characters: '%+' and '+%'.

For example, the entire contents of the schema group node named 'input', and the specific contents of the schema element named 'output/status' will be displayed in the BPA script's display area. The debug text must be entered into the BPA script's text area and not within the script's edit data field. Debug text can be declared for any explicit step of the script.

```
display input: %+input+% , and output status: %+output/status+%
```

## Script Engine Version 2 and Above Notes

Scripting using the engine version 2 or above requires some extra syntax to take advantage of XPath 2 functionality. In general, any variable declared will be assumed to be a string. This means, that if you intend to construct a mathematical statement then it is necessary to explicitly declare the data type of variables as integers, numbers, or dates.

**NOTE:** Unless otherwise noted, all XPath examples in this topic are for the Version 1 engine – which means XPath 1. Statements that function using XPath 1 will not necessarily work for XPath 2. This is especially true when executing math, see below for examples.

## Date and Time Arithmetic

XPath date/time and interval data types support arithmetic operations ('+', '-', '\*' etc.) and functions, which can be used for time calculations in the same way as '1 + xs:integer(value)' is used for numeric calculations.

Compare time duration:

```
if ("xs:dateTime(fn:current-dateTime()) - xs:dateTime($updateDateTimeX)
    ge xs:dayTimeDuration(concat('PT', BO/hoursBetweenStatisticsUpdate, 'H'))")
    goto 60;
end-if;
```

Compare one date to another:

```
if ("xs:date(parm/endDate) < xs:date(parm/startDate)")
    terminate with error (11108, 11507 element='endDate');
end-if;
```

Compare a date against today's date:

```
if ("xs:date(parm/startDate) <= xs:date($CURRENT-DATE)")
    terminate with error (11108, 11507 element='endDate');
end-if;
```

Calculate the end of month:

```
// covert to ISO
move "concat($year, '-', $mon2, '-01T00:00:00')" to $monthStart;

// calculate
move "xs:dateTime($monthStart) + xs:yearMonthDuration('P1M') - xs:dayTimeDuration('P0DT1S')."
    to $monthEnd;

// convert from ISO to OUAF
move "concat($year, '-', $mon2, '-', substring(string($monthEnd), 9, 2), '-23.59.59')" to $endDateTime;
```

**NOTE:** XPath date/time/interval formats use the ISO standard, which needs to be converted to/from formats supported in the framework.

## Comparing Date/Times in String Format

Any ISO-like string format for date/time preserves the YYYY MM DD HH MM SS sequence, which is zero-padded. Regardless of separators, this format will remain appropriate for comparison operations. In particular, date/time values in the framework format “YYYY-MM-DD.HH.MM.SS” can be used with “=”, “!=”, as well as “>”, “>=”, “<”, “<=” operators.

```
// retrieve framework date/time value
invokeBS 'CM-MAXMSRMT' using "CM-MAXMSRMT";
move "string(cm-MAXMSRMT/results[1]/measurementDateTime)" to $lastMsmtDT;

// construct another date/time
move "concat($year, '-01-01-00.00.00')" to $startDateTime;

// compare using string operators
if ("{$lastMsmtDT} >= {$startDateTime}")
    move "substring($lastMsmtDT, 1, 4)" to $latestMsmtYear;
```

## Converting Date/Times Between Framework and ISO

Conversion of date/time from framework format to ISO is only necessary for date/time arithmetic. Comparisons can be done with the framework format directly. The only difference between the framework format and ISO date/time formats is in the separators:

Framework: “YYYY-MM-DD.HH.MM.SS”

ISO: “YYYY-MM-DDTHH:MM:SS”

Example of converting from the framework format to ISO:

```
move "concat(substring($ouafDT, 1, 10), 'T', translate(substring($ouafDT, 12), '.', ':'))" to $isoDT;
```

Example of converting from ISO to the framework format:

```
move "concat(substring($isoDT, 1, 10), '.', translate(substring($isoDT, 12), ':', '.'))" to $ouafDT;
```



## Round Money With a Dynamic Currency Scale

Because different currencies support a different number of decimals, the framework provides an API for rounding a monetary amount based on a given currency.

```
move "parm/amount" to $qty;
move "currency/decimals" to $decimals;
move "fn:round(xs:decimal($qty) * math:exp10(xs:double($decimals)))
  div math:exp10(xs:double($decimals))" to "parm/roundedAmount";
```

## Looping through Sequences

In XPath 2 it is possible to organize a for-loop over a sequence of integers, not only a node list.

This example shows a loop over a range of months. This is a sequence-forming construct in XPath. The XPath node list, which we are familiar with, is just another type of sequence.

```
for ($month in "1 to 12")
```

This example shows a loop over a give range of years in descending order:

```
for ($year in "fn:reverse(parm/startYear to parm/endYear)")
  move "concat($year, '-01-01-00.00.00')" to $startDateTime;
  move "concat($year, '-12-31-23.59.59')" to $endDateTime;
  ...
```

This example shows a loop through a node list using 'index', so that other node lists can be accessed:

```
for ($idx in "1 to count(parm/touData/touList)")
  move "parm/touData/touList[$idx]" to $tou; // access any list with this index
```

The above syntax can be used as an elegant alternative to maintaining indices separately, for example instead of the following:

```
move "0" to $idx;
for ($item in "parm/touData/touList")
  move "1 + xs:integer($idx)" to $idx;
```

## String Padding and Decimal Formatting

This is used with specific input formats or output formatting. It is applicable to zero, space and other types of padding.

This example shows prefixing for date/time components, for example producing "2010-01-02" instead of "2010-1-2".

```
move "substring(concat('0',string($month)), string-length(string($month)), 2)" to $mon2;
```

This example shows suffixing for adding decimal zero-padded alignment, for example producing "12.30" and "4.00" instead of "12.3" and "4". The example performs 3 tasks: rounding to 2 decimals, inserting a period if necessary, and zero padding.

```
// round and zero-pad to 2 decimals
move "$item/amount" to $qty;
move "fn:round(xs:double($qty) * 100) div 100" to $qty;
move "string($qty)" to $qty;
move "concat(substring-before(concat($qty, '.'), '.'), '.', substring(concat(substring-
after($qty, '.'), '00'), 1, 2))" to $qty;
```

## Ternary Operation

This makes a choice between values based on a condition, so that it could be used in a single expression instead of an if/else block. It is know in C/C++ as 'cond ? value1 : value2' or in BASIC as 'IFF(cond, value1, value2)'. In XPath the syntax is : "if (cond) then value1 else value2". Note this is not the top-level scripting if-statement block.

In XPath this is an expression, which can be combined with other expressions. In scripting it can be used as:

```
move "if (string(D1-UnitOfMeasure/
measuresPeakQuantity) = 'D1MP') then 'D1MX' else 'D1SM' " to $func;
```

## Pipeline Processing

In scripting, it is not easy to create a simple reusable piece of code as there are no local functions, and a separate script call is a coding overhead and requires packing/unpacking parameters. To avoid copying and pasting the same code block between similar script stages, consider ‘pipelining’, which is breaking the overall process into separate top-level steps, some of which could be shared between alternating paths. This is common for parameter preparation and output formatting. An intermediate result between stages can be stored in a “parm” substructure.

---

Instead of this code:

```
if ("type = A")
  prepare params ...
  call services for A ...
  format output ...
end-if;
if ("type = B")
  prepare params ...
  call services for B ...
  format output ...
end-if;
```

Consider this alternative:

```
prepare params ...
if ("type = A")
  call services for A ...
end-if;
if ("type = B")
  call services for B ...
end-if;
format output ...
```

---

## XPath 2 Functions

Script engine versions 2 and above support XQuery 1.0 Functions and Operators, and the XQuery 1.0 standard itself with some minor limitations. Below are the URLs to both specifications. The first link has the functions/operators available to use from XQuery.

- <http://www.w3.org/TR/xpath-functions/>
- <http://www.w3.org/TR/xquery/>

The following can only access local file systems. (For other protocols like http they will return an empty sequence):

- fn:doc
- fn:collection

## How To Set Up Go To Steps

**Go to** steps allow you to jump to a step other than the next step. Additional fields required for **Go To** steps:

**Next Step** defines the step to which the script should jump.

## How To Set Up Invoke Business Object Steps

**Invoke business object** steps allow you to interact with a [business object](#) in order to obtain or maintain its information.

The following additional fields are required for **Invoke business object** steps:

Use **Warning Level** to indicate whether warnings should be suppressed and if not, how they should be presented to the user. By default, warnings are suppressed. If **Warn As Popup** is used, the warning is displayed using the standard popup dialog. If **Warn As Error** is used processing is directed to the **If Error, Go To** step. This field is only applicable to BPA scripts.

**Group Name** references the [data area](#) to be passed to and from the server when communicating with the **Business Object**. Indicate the **Action** to be performed on the object when invoked. Valid values are **Add, Delete, Fast Add (No Read), Fast Update (No Read), Read, Replace, Update**.

---

**NOTE: Performance note.** The actions **Fast Add** and **Fast Update** should be used when the business object's data area does not need to be re-read subsequent to the **Add** or **Update** action. In other words, the **Add** and **Update** actions are equivalent to **Fast Add + Read** and **Fast Update + Read**.

---

The business object call will either be successful or return an error. The next two fields only appear when the call is issued from a BPA script, to determine the step to which control is passed given the outcome of the call.

**If Success, Go To** defines the step that is executed if the call is successful. This field is only applicable to BPA scripts.

**If Error, Go To** defines the step that is executed if the call returns on error. Please note that the error information is held in [global variables](#). This field is only applicable to BPA scripts.

---

**NOTE: Error technique.** Let's assume a scenario where a business object is invoked from a BPA script and the call returned an error. If the BPA script is configured to communicate with the user using a UI map, you may find it useful to invoke the map again to present the error to the user. Alternatively, you may invoke a step that transfers control to a script that displays the error message information and stops.

---

## How To Set Up Invoke Business Service Steps

**Invoke business service** steps allow you to interact with a [business service](#).

The following additional fields are required for **Invoke business service** steps:

Use **Warning Level** to indicate whether warnings should be suppressed and if not, how they should be presented to the user. By default, warnings are suppressed. If **Warn As Popup** is used, the warning is displayed using the standard popup dialog. If **Warn As Error** is used processing is directed to the **If Error, Go To** step. This field is only applicable to BPA scripts.

**Group Name** references the [data area](#) to be passed to and from the server when the **Business Service** is invoked.

The business service call will either be successful or return an error. The next two fields only appear when the call is issued from a BPA script, to determine the step to which control is passed given the outcome of the call.

**If Success, Go To** defines the step that is executed if the call is successful. This field is only applicable to BPA scripts.

**If Error, Go To** defines the step that is executed if the call returns on error. Please note that the error information is held in [global variables](#). This field is only applicable to BPA scripts.

---

**NOTE: Error technique.** Let's assume a scenario where a business service is invoked from a BPA script and the call returned an error. If the BPA script is configured to communicate with the user using a UI map, you may find it useful to invoke the map again to present the error to the user. Alternatively, you may invoke a step that transfers control to a script that displays the error message information and stops.

---

## How To Set Up Invoke Service Script Steps

**Invoke service script** steps allow you to execute a [service script](#).

The following additional fields are required for **Invoke service script** steps:

Use **Warning Level** to indicate whether warnings should be suppressed and if not, how they should be presented to the user. By default, warnings are suppressed. If **Warn As Popup** is used, the warning is displayed using the standard popup dialog. If **Warn As Error** is used processing is directed to the **If Error, Go To** step. This field is only applicable to BPA scripts.

**Group Name** references the [data area](#) to be passed to and from the server when the **Service Script** is invoked.

The service script call will either be successful or return an error. The next two fields only appear when the call is issued from a BPA script to determine the step to which control is passed given the outcome of the call.

**If Success, Go To** defines the step that is executed if the call is successful. This field is only applicable to BPA scripts.

**If Error, Go To** defines the step that is executed if the call returns on error. Please note that the error information is held in [global variables](#). This field is only applicable to BPA scripts.

---

**NOTE: Error technique.** Let's assume a scenario where a service script is invoked from a BPA script and the call returned an error. If the BPA script is configured to communicate with the user using a UI map, you may find it useful to invoke the map again to present the error to the user. Alternatively, you may invoke a step that transfers control to a script that displays the error message information and stops.

---

## How To Set Up Label Steps

**Label** steps allow you to describe what the next step(s) are doing. Steps of this type are helpful to the script administrators when reviewing or modifying the steps in a script, especially when a script has many steps. When designing a script, the label steps enable you to provide a heading for common steps that belong together. The script tree displays steps of this type in a different color (green) so that they stand out from other steps.

There are no additional fields for **Label** steps.

## How To Set Up Move Data Steps

**Move data** steps allow you to move data (from a source to a destination). The following additional fields are required for **Move data** steps:

**Source Field Type**, **Source Field Name** and **Source Field Value** define what you're moving. The following points describe each field type:

- **Context Variable.** Use this field type in a plug-in or service script if the source value is a variable initiated in a higher level script. This is only applicable to Service Scripts and Plug-in Scripts.
- **Current To Do Information.** Use this field type when the source value resides on the current To Do entry. Refer to [How To Use To Do Fields](#) for instructions on how to define the appropriate **Field Name**. This is only applicable to BPA Scripts.
- **Data Area.** Use this field type when the field being compared is one that you put into one of the script's data areas in an earlier step. **Field Name** must reference both a data area structure name as well as the field, for example "parm/charType". Refer to [How To Reference Fields In Data Areas](#) for instructions on how to construct the appropriate **Field Name**.
- **Global Context.** Use this field type when the source value is a [global context variable](#). This is only applicable to BPA Scripts.
- **Page Data Model.** Use this field type when the source value resides on any of the tab pages in the [object display area](#) (i.e., the source field doesn't have to reside on the currently displayed tab page, it just has to be part of the object that's currently displayed). Refer to [How To Find The Name Of Page Data Model Fields](#) for instructions on how to find the appropriate **Field Name**. This is only applicable to BPA Scripts.
- **Portal Context.** Use this field type when the source value is a variable in the portal context. This is only applicable to BPA Scripts.
- **Predefined Value.** Use this field type when the source value is a constant value defined in the script. When this field type is used, use **Source Field Value** to define the constant value. Refer to [How To Use Constants In Scripts](#) for instructions on how to use constants.

---

**NOTE: Concatenating fields together.** You can also use **Predefined Value** if you want to concatenate two fields together. For example, let's say you have a script that merges two persons into a single person. You might want this script to change the name of the person being merged out of existence to include the ID of the person remaining. In this example, you could enter a **Source Field Value** of **%ONAMEmerged into person %PERID** (where **ONAME** is a field in temporary storage that contains the name of the person being merged out of existence and **PERID** contains the

ID of the person being kept). Refer to [How To Substitute Variables In Text](#) for a description of how you can substitute field values to compose the field value.

---

- **Temporary Storage.** Use this field type when the source value is a field that you put into temporary storage in an earlier step. The **Field Name** must be the same as defined in an earlier step.
- **User Interface Field.** Use this field type when the source value resides on the currently displayed tab page. Refer to [How To Find The Name Of User Interface Fields](#) for instructions on how to find the appropriate **Field Name**. This is only applicable to BPA Scripts.

**Destination Field Type** and **Destination Field Name** define where the source field will be moved. The **Field Type** defines where the field is located. The **Field Name** defines the name of the field. The following points describe each field type:

- **Context Variable.** Use this field type in your plug-in or service script if you use a variable to communicate information to a lower level service script or schema. This is not applicable to BPA Scripts.
- **Data Area.** Use this field type when the destination field resides on one of the scripts data areas. **Field Name** must reference both a data area structure name as well as the field, for example "parm/charType". Refer to [How To Reference Fields In Data Areas](#) for instructions on how to construct the appropriate **Field Name**.
- **Page Data Model.** Use this field type when the destination field resides on any of the tab pages in the [object display area](#) (i.e., the field populated doesn't have to reside on the currently displayed tab page, it just has to be part of the object that's currently displayed). Refer to [How To Find The Name Of Page Data Model Fields](#) for instructions on how to find the appropriate **Field Name**. This is only applicable to BPA Scripts.
- **Portal Context.** Use this field type when the destination to be updated is in the current portal context. This is only applicable to BPA Scripts.
- **Temporary Storage.** Use this field type when the destination field resides in temporary storage. Use **Field Name** to name the field in temporary storage. Use **Field Name** to name the field in temporary storage. Refer to [How To Name Temporary Storage Fields](#) for more information.
- **User Interface Field.** Use this field type when the destination field resides on the currently displayed tab page. Refer to [How To Find The Name Of User Interface Fields](#) for instructions on how to find the appropriate **Field Name**. This is only applicable to BPA Scripts.

---

**NOTE: Conditional field types.** The field types **Current To Do Information**, **Page Data Model** and **User Interface Field** are only applicable to BPA scripts.

---

## How To Set Up Terminate Steps

**Terminate** steps cause a server-based script to end processing successfully or issue an error.

The following additional fields are required for **Terminate** steps:

**Error** indicates whether an error should be thrown or not. If error, **Error Data Text** must be specified, indicating the error message and any message substitution parameters. Refer to [Edit Data Syntax](#) the actual syntax of initiating an error message.

---

**NOTE:** The ability to terminate a step in error is only supported for server-based scripts.

---

## Step Types Applicable to BPA Scripts only

The contents of this section describe step types that are only applicable to BPA scripts.

## How To Set Up Display Text Steps

**Display text** steps cause a text string to be displayed in the script area. Steps of this type can be used to provide the user with guidance when manual actions are necessary. In addition, they can be used to provide confirmation of the completion of tasks.

The information you enter in the **Text** field is displayed in the [script area](#) when the step is executed.

The text string can contain [substitution variables](#) and [HTML formatting commands](#). Also note that for debugging purposes, you can display an entire data area (or a portion thereof) by entering `%+...+%` where ... is the name of the node whose element(s) should be displayed.

---

**NOTE: Conditional step type.** This step type is only applicable to BPA scripts.

---

## How To Set Up Height Steps

**Height** steps are used to change the height of the script area to be larger or smaller than the standard size.

The following additional fields are required for **Height** steps:

**Script Window Height** defines the number of **Pixels** or the **Percentage** (according to the **Height Unit**) that the script window height should be adjusted. The percentage indicates the percentage of the visible screen area that the script area uses. For example, a percentage value of **100** means that the script area will use the entire area.

---

**NOTE: Standard Number of Pixels.** The default number of pixels used by the script area is **75**.

---

**NOTE: Adjust script height in the first step.** If you want to adjust the height of the script area, it is recommendation to define the **height** step type as your first step. Otherwise, the script area will open using the standard height and then readjust, causing the screen to redisplay.

---

**NOTE: Hide script area.** You could use this type of step to set the height to **0** to hide the script area altogether. This is useful if the script does not require any prompting to the user. For example, perhaps you define a script to take a user to a page and with certain data pre-populated and that is all.

---

**NOTE: Automatically close script area.** If you want the script area to close when a script is completed, you could define the final step type with a height of 0.

---

**NOTE: Conditional step type.** This step type is only applicable to BPA scripts.

---

## How To Set Up Input Data Steps

**Input data** steps cause the user to be prompted to populate an input field in the script area. The input value can be saved in a field on a page or in temporary storage. A **Continue** button always appears adjacent to the input field. You may configure steps of this type to display one or more buttons in addition to the **Continue** button. For example, you may want to provide the ability for the user to return to a previous step to fix incorrect information. The user may click on any of these buttons when ready for the script to continue.

The following additional fields are required for **Input Data** steps:

**Destination Field Type** and **Destination Field Name** define where the input field will be saved. The **Field Type** defines where the field is located. The **Field Name** defines the name of the field. The following points describe each field type:

- **Page Data Model.** Use this field type to put the input field into a field that resides on any of the tab pages in the [object display area](#) (i.e., the field populated doesn't have to reside on the currently displayed tab page, it just has to be part of the object that's currently displayed). Refer to [How To Find The Name Of Page Data Model Fields](#) for instructions on how to find the appropriate **Field Name**.
- **Temporary Storage.** Use this field type to put the input field into temporary storage. Use **Field Name** to name the field in temporary storage. Refer to [How To Name Temporary Storage Fields](#) for more information.
- **User Interface Field.** Use this field type to put the input field into a field that resides on the currently displayed tab page. Note, if you want to execute underlying default logic, you must populate a **User Interface Field**. Refer to [How To Find The Name Of User Interface Fields](#) for instructions on how to find the appropriate **Field Name**.

The **Prompt Values** grid may be used to define additional buttons. A separate button is displayed in the script area for each entry in this grid.

- **Prompt Text** is the verbiage to appear on the button. Refer to [How To Substitute Variables In Text](#) for a description of how you can substitute field values into the prompts.
- **Sequence** controls the order of the buttons.
- **Next Script Step** defines the step to execute if the user clicks the button.

---

**NOTE: Conditional step type.** This step type is only applicable to BPA scripts.

---

## How To Set Up Invoke Function Steps

---

**NOTE:** Functions were implemented prior to the introduction of business services (BS), service scripts (SS) and business objects (BO). The functionality is still supported, but the recommendation for implementations going forward is to use a step that invokes one of the above configuration tool objects in a script rather than defining a function.

---

**Invoke function** steps may be used to retrieve or update data independent of the page currently being displayed. For example, if you design a script that takes different paths based on the customer's customer class, you could invoke a function to retrieve the customer's customer class.

---

**FASTPATH:** You must set up a function before it can be referenced in a script. Refer to [Maintaining Functions](#) for the details.

---

The following additional fields are required for **Invoke Function** steps:

**Function** defines the name of the function. The function's **Long Description** is displayed below.

When a function is invoked, it will either be successful or return an error. The next two fields control the step to which control is passed given the outcome of the function call:

- **If Success, Go to** defines the step that is executed if the function is successful.
- **If Error, Go to** defines the step that is executed if the function returns on error. Refer to [How To Use Constants In Scripts](#) for a list of the global variables that are populated when a function returns an error.

---

**NOTE: Error technique.** If a function returns an error, we recommend that you invoke a step that transfers control to a script that displays the error message information and stops (note, the error information is held in [global variables](#)). You would invoke this script via a **Transfer Control**.

---

The **Send Fields** grid defines the fields whose values are sent to the function and whose field value source is not **Defined On The Function**. For example, if the function receives an account ID, you must define the name of the field in the script that holds the account ID.

- **Field** contains a brief description of the field sent to the function.



- **Source Field Type** and **Mapped Field / Value** define the field sent to the function. Refer to the description of Source Field under [How To Set Up Move Data Steps](#) for a description of each field type.
- **Comments** contain information about the field (this is defined on the function).

The **Receive Fields** grid defines the fields that hold the values returned from the function. For example, if the function returns an account's customer class and credit rating, you must set up two fields in this grid.

- **Field** contains a brief description of the field returned from the function.
- **Destination Field Type** and **Mapped Field** define the field returned from the function. Refer to the description of Destination Field under [How To Set Up Move Data Steps](#) for a description of each field type.
- **Comments** contain information about how the field (this is defined on the function).

---

**NOTE: Conditional step type.** This step type is only applicable to BPA scripts.

---

## How To Set Up Invoke Map Steps

**Invoke map** steps are used to invoke a **UI Map** to display, capture and update data using an HTML form. You may configure steps of this type to display one or more buttons in addition to the **Continue** button. For example, you may want to provide the ability for the user to return to a previous step to fix incorrect information. The user may click on any of these buttons when ready for the script to continue.

The following additional fields are required for **Invoke map** steps:

**Group Name** references the **data area** to be passed to and from the server when rendering the HTML form associated with the **Map**.

Use **Target Area** to designate where the map will be presented.

- Select **BPA Zone** if the map should be presented within the **script area**.
- Select **Page Area** if the map should be presented in the **object display area**, i.e. the frame typically used to house a maintenance page.
- Select **Pop-up Window** if the map should be launched in a separate window.

The **Returned Values** grid contains a row for every button defined on the map.

- **Returned Value** is the value returned when the user clicks the button.
- **Use as Default** can only be turned on for one entry in the grid. If this is turned on, this value's Next Script Step will be executed if the returned value does not match any other entry in the grid. For example, if the user closes a pop-up (rather than clicking a button), the default value will be used.
- **Next Script Step** defines the step to execute if the user clicks the button.

---

**NOTE: Conditional step type.** This step type is only applicable to BPA scripts.

---

## How To Set Up Mathematical Operation Steps

**Mathematical operation** steps allow you to perform arithmetic on fields. You can also use this type of step to add and subtract days from dates. For example, you could calculate a date 7 days in the future and then use this value as the customer's next credit review date. The following additional fields are required for **Mathematical Operation** steps:

**Base Field Type** and **Base Field Name** define the field on which the mathematical operation will be performed. The **Field Type** defines where the field is located. The **Field Name** defines the name of the field. The following points describe each field type:

- **Page Data Model.** Use this field type when the field resides on any of the tab pages in the **object display area**. Refer to [How To Find The Name Of Page Data Model Fields](#) for instructions on how to find the appropriate **Field Name**.



- **Temporary Storage.** Use this field type when the field resides in temporary storage. You must initialize the temporary storage field with a Move Data step before performing mathematical operations on the field. Refer to [How To Set Up Move Data Steps](#) for more information.
- **User Interface Field.** Use this field type when the field resides on the currently displayed tab page. Refer to [How To Find The Name Of User Interface Fields](#) for instructions on how to find the appropriate **Field Name**.

**Math Operation** controls the math function to be applied to the **Base Field**. You can specify +, -, /, and \*. Note, if the base field is a date, you can only use + or -.

**Math Field Type**, **Math Field Name** and **Math Field Value** define the field that contains the value to be added, subtracted, divided, or multiplied. The following points describe each field type:

- **Current To Do Information.** Use this field type when the value resides on the current To Do entry. Refer to [How To Use To Do Fields](#) for instructions on how to define the appropriate **Field Name**.
- **Page Data Model.** Use this field type when the value resides on any of the tab pages in the [object display area](#). Refer to [How To Find The Name Of Page Data Model Fields](#) for instructions on how to find the appropriate **Field Name**.
- **Predefined Value.** Use this field type when the value is a constant. When this field type is used, use **Source Field Value** to define the constant value. Refer to [How To Use Constants In Scripts](#) for more information. Note, if you are performing arithmetic on a date, the field value must contain the number and type of **days/ months/ years**. For example, if you want to add 2 years to a date, the source field value would be **2 years**.
- **Temporary Storage.** Use this field type when the value is a field that you put into temporary storage in an earlier step. The **Field Name** must be the same as defined in an earlier step.
- **User Interface Field.** Use this field type when the value resides in a field on the current tab page. Refer to [How To Find The Name Of User Interface Fields](#) for instructions on how to find the appropriate **Field Name**.

---

**NOTE: Conditional step type.** This step type is only applicable to BPA scripts.

---

## How To Set Up Navigate To A Page Steps

**Navigate to a page** steps cause a new page (or tab within the existing page) to be displayed in the object display area. Steps of this type are a precursor to doing anything on the page. The following additional field is required for **Navigate to a page** steps:

**Navigation Option** defines the transaction, tab, access mode (add or change) and any context fields that are passed to the transaction in change mode. For example, if you want a script to navigate to Person - Characteristics for the current person being displayed in the dashboard, you must set up an appropriate navigation option. Refer to [Defining Navigation Options](#) for more information.

---

**NOTE: Navigating to a page in update mode.** Before you can navigate to a page in change mode, the page data model must contain the values to use for the navigation option's context fields. If necessary, you can move values into the page data model using a [Move Data step](#) first. For example, before you can navigate to a page in change mode with an account ID in context, you may need to move the desired account ID into the ACCT\_ID field in the page data model. The actual field name(s) to use are listed as context fields on the [navigation option](#).

---

**NOTE: Conditional step type.** This step type is only applicable to BPA scripts.

---

## How To Set Up Perform Script Steps

**Perform script** steps cause another BPA script to be performed. After the performed script completes, control is returned to the next step in the original script. You might want to think of the scripts referred to on steps of this type as "subroutines". This functionality allows you to encapsulate common logic in reusable BPA scripts that can be called from other BPA scripts. This simplifies maintenance over the long term.

The following additional field is required for **Perform script** steps:

**Script** is the name of the script that is performed.

---

**NOTE: Conditional step type.** This step type is only applicable to BPA scripts.

---

## How To Set Up Press A Button Steps

**Press a button** steps cause a button or link text to be ‘pressed’ in the [object display area](#), the [application toolbar](#) or the [page title area](#). For example, you could use this type of step to add a new row to a person's characteristic (and then you could use a **Move Data** step to populate the newly added row with a given char type and value). The following additional fields are required for **Press a button** steps:

**Button Name** is the name of the button to be pressed. This button must reside on the currently displayed tab page (or in the application toolbar or page actions toolbar). Refer to [How To Find The Name Of A Button](#) for more information.

---

**NOTE: Conditional step type.** This step type is only applicable to BPA scripts.

---

## How To Set Up Prompt User Steps

**Prompt user** steps cause the user to be presented with a menu of options. The options can be presented using either buttons or in the contents of a drop down. You can also use steps of this type to pause a script while the user checks something out (and when the user is ready to continue with the script, they are instructed to click a prompt button). The following additional fields are required for **Prompt User** steps:

**Prompt Type** controls if the prompt shown in the script area is in the form of **Button(s)** or a **Dropdown**. Note, if you use a **Dropdown**, a Continue button appears adjacent to the dropdown in the script area when the step executes. The user clicks the Continue button when they are ready for the script to continue.

The **Prompt Values** grid contains a row for every value that can be selected by a user. Note, if you use a **Prompt Type of Button(s)**, a separate button is displayed in the script area for each entry in this grid.

- **Prompt Text** is the verbiage to appear on the button or in the dropdown entry. Refer to [How To Substitute Variables In Text](#) for a description of how you can substitute field values into the prompts.
- **Sequence** controls the order of the buttons or dropdown entries.
- **Use As Default** can only be turned on for one entry in the grid. If this is turned on for a dropdown entry, this value is defaulted in the grid. If this is turned on for a button, this button becomes the default (and the user should just have to press **Enter** (or **space**) rather than click on it).
- **Next Script Step** defines the step to execute if the user clicks the button or selects the dropdown value.

---

**NOTE: Conditional step type.** This step type is only applicable to BPA scripts.

---

## How To Set Up Set Focus To A Field Steps

**Set focus to a field** steps cause the cursor to be placed in a specific field on a page. A **Continue** button always appears in the script area when this type of step executes. The user may click the **Continue** button when they are ready for the script to continue. You may configure steps of this type to display one or more buttons in addition to the **Continue** button. For example, you may want to provide the ability for the user to return to a previous step to fix incorrect information. The user may click on any of these buttons when ready for the script to continue.

The following additional fields are required for **Set focus to a field** steps:

**Destination Field Name** defines the field on which focus should be placed. This field must reside on the currently displayed tab page. Refer to [How To Find The Name Of User Interface Fields](#) for instructions on how to find the appropriate **Field Name**.

The **Prompt Values** grid may be used to define additional buttons. A separate button is displayed in the script area for each entry in this grid.

- **Prompt Text** is the verbiage to appear on the button. Refer to [How To Substitute Variables In Text](#) for a description of how you can substitute field values into the prompts.
- **Sequence** controls the order of the buttons.
- **Next Script Step** defines the step to execute if the user clicks the button.

---

**NOTE: Conditional step type.** This step type is only applicable to BPA scripts.

---

## How To Set Up Transfer Control Steps

**Transfer control** steps cause the current BPA script to terminate and the control to pass to another BPA script. You might want to construct a BPA script with steps of this type when the script has several potential logic paths and you want to segregate each logic path into a separate BPA script (for ease of maintenance).

The following additional fields are required for **Transfer control** steps:

**Subscript** is the name of the script to which control is transferred.

---

**NOTE: Conditional step type.** This step type is only applicable to BPA scripts.

---

## Step Types Applicable to Server Based Scripts only

The contents of this section describe step types that are only applicable to server based scripts.

### How To Set Up Groovy Member Steps

**Groovy Member** steps provide a free format text area where you can enter Groovy code.

Enter a description of the code block in the **Text** field. Click the adjacent icon to open a window providing more space for entering text.

Enter your code in the **Edit Data Text** field. Click the adjacent icon to open a window providing more space for editing the code.

---

**NOTE:** While it is possible to set up multiple steps of type **Groovy Member** the system treats these steps as a single class for compilation and execution purposes. Refer to the topic [Using Groovy Within Scripts](#) for more information.

---

### How To Set Up Groovy Library Interface Steps

**Groovy Library Interface** steps are only applicable to **Groovy Library Scripts**. They provide a free format text area where you can list the Groovy methods defined within the script that are available for use by other scripts.

Enter a description of the interface step in the **Text** field. Click the adjacent icon to open a window providing more space for entering text.

Enter the list of interface methods in the **Edit Data Text** field. Click the adjacent icon to open a window providing more space for editing the code.

---

**NOTE:** Every **Groovy Library Script** must have one and only one step of type **Groovy Library Interface**. The supporting code for the available methods is defined using one or more **Groovy Member** steps in the same script. Refer to the topic [Using Groovy Within Scripts](#) for more information.

---

## Additional Topics

The contents of this section provide additional information about steps.

### How To Find The Name Of User Interface Fields

Follow these steps to find the name of a field that resides on a page:

- Navigate to the page in question.
- Right click in the body of the page (but not while the pointer is in an input field). Note, if the field in question resides in a grid, you must right click while the pointer is in the section that contains the grid (but not while the pointer is in an input field in the grid) - this is because there's a separate HTML document for each grid on a page.
- Select **View Source** from the pop-up menu to display the source HTML.
- Scroll to the Widget Info section (towards the top of the HTML document). It contains a list of all of the objects on a page. For example, the following is an example from the Account - Main page:

```
widget Info:
widget_ID , Element Type - label info - label
ENTITY_NAME, IL - $ENTITY_NAME - Name
ACCT_ID, IT - $ACCT_ID - Account ID
ACCT_CHECK_DIGIT, IL - $ACCT_CHECK_DIGIT - Account Check Digit
IM_ACCT_ID, IM - $SEARCH_FOR_ACC_LBL - Search for Account
COLL_CL_CD, HD - $COLL_CL_CD - Collection Class
SETUP_DT, IT - $SETUP_DT - Set Up Date
CURRENCY_CD, IS - $CURRENCY_CD - Currency Code
CIS_DIVISION, IS - $CIS_DIVISION - CIS Division
PROTECT_DIV_SW, CB - CI_ACCT$PROTECT_DIV_SW - Protect CIS Division
CUST_CL_CD, IS - $CUST_CL_CD - Customer Class
ACCESS_GRP_CD, IT - $ACCESS_GRP_CD - Access Group
IM_ACCESS_GRP_CD, IM - $SRCH_ACC_GRP_CD - Search for Access Group
ACCESS_DESCR, IL - $DESCR - Description
ACCT_MGMT_GRP_CD, IT - $ACCT_MGMT_GRP_CD - Account Management Group
IM_ACCT_MGMT_GRP_CD, IM - $SEARCH_FOR_TDR_LBL - Search for To Do Role
MGMT_DESCR, IL
ALERT_INFO, IA - $ALERT_INFO - Alert Information
BILL_CYC_CD, IS - $BILL_CYC_CD - Bill Cycle
BILL_AFTER_DT, IT - $BILL_AFTER_DT - Bill After
PROTECT_CYC_SW, CB - $PROTECT_CYC_SW - Protect Bill Cycle
BILL_PRT_INTERCEPT, IT - $BILL_PRT_INTERCEPT - Bill Print Intercept
IM_BILL_PRT_INTERCEPT, IM - $FOR_BILL_PRINT_LBL - Search for User
MAILING_PREM_ID, IT - $MAILING_PREM_ID - Mailing Premise
IM_MAILING_PREM_ID, IM - $SEARCH_FOR_MAI_LBL - Search for Mailing Premise
PREM_INFO, IL
PROTECT_PREM_SW, CB - $PROTECT_PREM_SW - Protect Mailing Premise
dataframe, GD
```

The field names that you'll reference in your scripts are defined on the left side of the HTML (e.g., ENTITY\_NAME, ACCT\_ID, CUST\_CL\_CD, etc.).

The names of fields that reside in scrolls are in a slightly different format. The following is an example of the HTML for the persons scroll that appears on Account - Person. Notice that the fields in the scroll are prefixed with the name of the scroll plus a \$ sign. For example, the person's ID is called **ACCT\_PER\$PER\_ID**.

```

Widget Info:
widget_ID , Element Type - label info - label
ENTITY_NAME, IL - $ENTITY_NAME - Name
PREM_INFO, HD
ACCT_ID, IT - $ACCT_ID - Account ID
ACCT_CHECK_DIGIT, IL - $ACCT_CHECK_DIGIT - Account Check Digit
IM_ACCT_ID, IM - $SEARCH_FOR_ACC_LBL - Search for Account
ACCT_PER$recordCount, SH - $OF_LBL - of
ACCT_PER$PER_ID, IT - $PER_ID - Person ID
IM_ACCT_PER$PER_ID, IM - $FOR_PERSON_LBL - Search for Person
ACCT_PER$ENTITY_NAME, IL - $ENTITY_NAME - Name
ACCT_PER$MAIN_CUST_SW, CB - $MAIN_CUST_SW - Main Customer
ACCT_PER$FIN_RESP_SW, CB - $FIN_RESP_SW - Financially Responsible
ACCT_PER$THRD_PTY_SW, CB - $THRD_PTY_SW - Third Party Guarantor
ACCT_PER$ACCT_REL_TYPE_CD, IS - CI_ACCT_PER$ACCT_REL_TYPE_CD - Relationship Type
ACCT_PER$WEB_ACCESS_FLG, IS - $WEB_ACCESS_FLG - Web Self Service Access Flag
ACCT_PER$PFX_SFX_FLG, IS - $PFX_SFX_FLG - Prefix/Suffix
ACCT_PER$NAME_PFX_SFX, IT - $NAME_PFX_SFX - Pfx/Sfx Name
ACCT_PER$RECEIVE_COPY_SW, CB - $RECEIVE_COPY_SW - Receives Copy of Bill
ACCT_PER$BILL_RTE_TYPE_CD, IS - $BILL_RTE_TYPE_CD - Bill Route Type
ACCT_PER$BILL_RTE_TYPE_INFO, IL
ACCT_PER$BILL_RTG METH_FLG, HD
ACCT_PER$BILL_FORMAT_FLG, IS - $BILL_FORMAT_FLG - Bill Format

```

The names of fields that reside in grids are in a slightly different format. The following is an example of the HTML for the names grid that appears on Person - Main. Notice that the fields in the grid are prefixed with the name of the grid plus a :x\$. For example, the person's name is called **PER\_NAME:x\$ENTITY\_NAME**. When you reference such a field in your script, you have the following choices:

- Substitute **x** with the row in the grid (and keep in mind, the first row in a grid is row **0** (zero); this means the second row is row **1**).
- If you want to reference the "current row" (e.g., the row in which the cursor will be placed), you can keep the **x** notation ( **x** means the "current row").

```

Widget Info:
widget_ID , Element Type - label info - label
PER_NAME:x$NAME_TYPE_FLG, IS - $NAME_TYPE_FLG - Name Type
PER_NAME:x$ENTITY_NAME, IT - CI_PER_NAME$ENTITY_NAME - Person Name

```

## How To Find The Name Of Page Data Model Fields

You find the name of a **Page Data Model** field in the same way described under [How To Find The Name Of User Interface Fields](#). The only restriction is that you cannot refer to hidden / derived fields. However, you can refer to any of the object's fields regardless of the tab page on which they appear. For example, if you position the object display area to the Main tab of the Account transaction, you can reference fields that reside on all of the tab pages.

---

**CAUTION:** If you populate a **Page Data Model** field, none of the underlying default logic takes place. For example, if you populate a customer contact's contact type, none of the characteristics associated with the customer contact type are defaulted onto the customer contact. If you want the underlying defaulting to take place, you must populate a **User Interface Field**.

---

## How To Find The Name Of A Button

If you want a **Press a button** step to press a button or click a link in the application toolbar, use one of the following names:

---

Button Name
IM_GOBACK
IM_HISTORY
IM_GOFORWARD
IM_menuButton
IM_USER_HOME
IM_MY_PREF
IM_helpButton
IM_aboutButton

---

If you want a **Press a button** step to press a button in the page actions toolbar, use one of the following names:

Button Name
IM_SAVE
IM_REFRESH
IM_CLEAR
IM_COPY
IM_DELETE
IM_ScrollBack
IM_ScrollForward

The following buttons are also supported:

Button Name	Comments
IM_TO_DO	
IM_PrevTo Do	This brings you to the <a href="#">To Do Summary</a> page.
IM_NextTo Do	This simulates clicking the <b>Next To Do</b> button in the <a href="#">Current To Do Zone</a> .
IM_CurrentTo Do	This navigates to the <a href="#">To Do Entry</a> page for the user's current To Do. Refer to <a href="#">A User's Current To Do</a> for more information.
IM_MINIMIZE_DASHBOARD	Pressing this will collapse the dashboard.
IM_MAXIMIZE_DASHBOARD	Pressing this will expand the dashboard.

Follow these steps to find the name of other buttons that reside in the object display area:

- Navigate to the page in question.
- Right click in the body of the page (but not while the pointer is in an input field). Note, if the field in question resides in a grid, you must right click while the pointer is in the section that contains the grid (but not while the pointer is in an input field in the grid) - this is because there's a separate HTML document for each grid on a page.
- The option to select may differ based on the browser you are using. For example, for some browsers, the option may be **View Source**. For others, the option may be **This Frame** and then **Frame Source**
- Scroll to the Widget Info section (towards the top of the HTML document). It contains a list of all of the objects on a page, including buttons.
- Iconized buttons (e.g., search buttons) are represented as HTML images and their field names are prefixed with **IM**. The following is an example of the HTML on the To Do Entry - Main page (notice the **IM** fields for the iconized buttons).

```
* Widget Info:
*   Widget_ID , Element Type - label info - label
*   TD_ENTRY_INFO, IL - $TD_ENTRY_INFO - To Do Info
*   TD_ENTRY_ID, IT - CI_TD_ENTRY$TD_ENTRY_ID - To Do ID
*   IM_TD_ENTRY_ID, IM - $TD_ENTRY_ID_SRCH - Search for Entry Id
*   TD_TYPE_CD, IL - $TD_TYPE_CD - To Do Type
*   TYPE_DESCR, IL
*   ROLE_ID, IL
*   ROLE_DESCR2, IL - $DESCR - Description
*   FULL_MSG, PL - $GOTO_TD_ACTION_LBL - Work on To Do
*   IM_EXP_MSG_LONG, IM - $DISPLAY_MESSAG_LBL - Display Message Explanation
```

- Transaction-specific actions buttons (e.g., the buttons use to complete or forward a To Do) are represented as switches. The following is an example of the HTML on the To Do Entry - Main page (notice the **SW** fields for the buttons). Note, if you want to **Set focus** to such a field, you would move a **Predefined Value** of **TRUE** to the switch.

```
*   COMPLETE_SW, BU - $COMPLETE_SW - Complete
*   FORWARD_SW, BU - $FORWARD_SW - Forward
*   SEND_BACK_SW, BU - $SEND_BACK_SW - Send Back
```



## How To Substitute Variables In Text

You can substitute field values into a step's text string. You do this by prefixing the field name whose value should be substituted in the string with a `%`. For example, the message, "On `%COMPLETION_DTTM` this bill was completed, it's ending balance was `%ENDING_BALANCE`" contains two substitution variables (the bill's completion date / time and the bill's ending balance).

To substitute the value of an element from a data area you need to reference its XPath location as follows: `%=XPath=%`. If you want to substitute the whole XML node, not just the value, you need to reference it as follows `%+XPath+%`.

Only fields linked to the [current To Do](#) and fields that reside in [temporary storage](#) and [global variables](#) can be substituted into a text string.

---

**NOTE:** You can substitute fields that reside in the User Interface or Page Data Model by first moving them into temporary storage (using a **Move data** step).

---

You can also substitute field values into the verbiage displayed in [prompts](#) using the same technique.

## How To Use HTML Tags And Spans In Text Strings and Prompts

You can use HTML tags in a step's text string. For example, the word "Continue" will be italicized in the following text string "Press`<i>`Continue`</i>` after you've selected the customer" (the `<i>` and `</i>` are the HTML tags used to indicate that the surrounded text should be italicized).

The following are other useful HTML tags:

- `<br>` causes a line break in a text string. If you use `<br><br>` a blank line will appear.
- `<font color=red>` text `</font>` causes the surrounded text to be colored as specified (in this case, red). You can also use hex codes rather than the color name.

Please refer to an HTML reference manual or website for more examples.

You can also use "spans" to customize the look of the contents of a text string. For example, your text string could be "Press `<span style='font-family:Courier; font-size:large; font-weight:bold;'>`Continue`</span>` after you've selected the customer". This would make the word "Continue" appear as large, bold, Courier text. Please refer to a Cascading Style Sheets (CSS) reference manual or website for more examples.

## How To Use Constants In Scripts

Some steps can reference fields called **Predefined Values**. For example, if you want to compare an input value to the letter "Y", the letter **Y** would be defined as a Predefined Value's field value.

Special constants are used for fields defined as switches. When you move **TRUE** to a switch, it turns it on. When you move **FALSE** to a switch, it turns it off.

You can use a [global variable](#) as a Predefined Value. For example, if you wanted to move the current date to a field, you'd indicate you wanted to move a Predefined Value named `%CURRENT_DATE`.

## How To Use Global Variables

Some explicit steps can reference fields called **Predefined Values**. In addition to referencing an ad hoc constant value (e.g., the letter **Y**), you can also reference a global variable in such a field value. A global variable is used when you want to reference system data.

Note that when using the Edit Data step type, the variable available are slightly different. Refer to [Edit Data Syntax](#) for details.

The following global variables exist for BPA scripts:

Variable Name	Comments
%PARM-<name>	This is the value of a parameter of that name passed in to the application when launched via the standard system URL. Refer to <a href="#">Launching A Script When Starting the System</a> for more information on these parameters.
%PARM-NOT-SET	This is to be used to compare against %PARM-< > parameters to check if the parameter has been set or not when the application was launched. A parameter that has not been set would be considered equal to this global variable. It is recommended to compare parameters against this global variable before using them for the first time.
%BLANK	A constant that contains a blank value (no value).
%SPACE	A constant that contains a single space value.
%CURRENT-DATE	The current date as known by the browser, not the server.
%SYSTEM-DATE	The server date. Note that this date is affected by the <a href="#">system date override</a> logic)
%SAVE-REQUIRED	A flag that contains an indication of whether the data on a page has been changed (and thus requires saving). You may want to interrogate this flag to force a user to save their work before executing subsequent steps. This flag will have a value of <b>TRUE</b> or <b>FALSE</b> .
%NEWLINE	A constant that contains a new line character (carriage return). Upon substitution, a line break is inserted in the resultant text.  <b>NOTE:</b> This constant does not have the desired effect when the resultant text is HTML. For example, a step's text and prompt strings. This is because HTML ignores special characters such as new lines. Refer to <a href="#">How To Use HTML Tags And Spans In Text</a> to learn how to cause a line break in an HTML text.

To refer to a [global context](#) variable, use %FIELD\_NAME. For example, if the field SP\_ID is in the global context, you may reference %SP\_ID to reference the ID of the service point currently in context. In addition, the following special values are supported:

Variable Name	Comments
%CONTEXT-PERSONID	A constant that contains the ID of the current person.
%CONTEXT-ACCOUNTID	A constant that contains the ID of the current account.
%CONTEXT-PREMISEID	A constant that contains the ID of the current premise.

In addition, if the script is invoking something else via one of the various “Invoke” step types and an error is returned, the following global variables contain information about the error:

Variable Name	Comments
%ERRMSG-CATEGORY %ERRMSG-NUMBER	The unique identifier of the error message number.
%ERRMSG-TEXT	The brief description of the error.
%ERRMSG-LONG	The complete description of the error.

## How To Name Temporary Storage Fields

**Input Data** and **Move Data** steps can create fields in temporary storage. You specify the name of the temporary storage field in the step's **Field Name**. The name of the field must not begin with % and must not be named the same as the [global variables](#). Besides this restriction, you can use any **Field Name** that's acceptable to JavaScript (i.e., you can name a field in temporary storage almost anything). Keep in mind that field names are case-sensitive.



## How To Work With Dates

Before we discuss how to work with dates in your scripts, we need to point out that there are two types of date fields: date-only and date-time. Date-only fields only contain a date. Date-time fields contain both a date and a time. The following topics describe how to work with dates on the various step types.

---

**NOTE:** If you're working with a field that resides on the database (as opposed to a temporary storage field), the database field name will tell you what type of date it is: date-only fields are suffixed with **DT**, and date-time fields are suffixed with **DTTM**.

---

### Move Data

If you intend to use a **Move data** step to populate a *date-time* field, please be aware of the following:

- If the destination field resides in the *page data model*, the source field value must be in the format YYYY-MM-DD-HH.MM.SS or YYYY-MM-DD. If the field is in the format YYYY-MM-DD, the time of 12:00 am will be defaulted.
- If the destination field resides in the *user interface*, you must use two steps if you want to populate both date and time. To explain this, we'll assume the field you want to populate is called EXPIRE\_DTTM:
  - First, you populate the date portion of the field. To do this, you'd move a date (this value can be in any valid date format that a user is allowed to enter) to a field called EXPIRE\_DTTM\_FWDDTM\_P1. In other words, you suffix **\_FWDDTM\_P1** to the field name.
  - If you want to populate the time, you'd move the time (again, the field value can be in any format that a user could use to enter a time) to a field called EXPIRE\_DTTM\_FWDTTM\_P2. In other words, you suffix **\_FWDDTM\_P2** to the field name.

If you intend to use a **Move data** step to populate a *date-only* field, please be aware of the following:

- If the destination field resides in the *page data model*, the source field value must be in the format YYYY-MM-DD.
- If the destination field resides in the *user interface*, the source field can be in any valid date format that a user is allowed to enter.

---

**NOTE:** **%CURRENT-DATE**. Keep in mind that the [global variable](#) **%CURRENT-DATE** contains the current date and you can move this to either a page data model, user interface, or temporary storage field. If you move **%CURRENT-DATE** to a temporary storage fields, it is held in the format YYYY-MM-DD.

---

### Mathematical Operation

If you intend to use a **Mathematical operation** step to calculate a date, you can reference both date-only and date-time fields. This is because mathematical operations are only performed against the date portion of date-time fields.

Mathematical operations are limited to adding or subtracting days, months and years to / from a date.

---

**NOTE:** A useful technique to perform date arithmetic using the current date is to move the [global variable](#) **%CURRENT-DATE** to a temporary storage field and then perform the math on this field.

---

### Input Data

If you intend to use an **Input data** step on a *date-time* field, please be aware of the following:

- If the field resides in the *page data model*, the user must enter a value in the format YYYY-MM-DD-HH.MM.SS (and therefore we do not recommend doing this).

- If the field resides in the *user interface*, you must use two steps if you want to populate both date and time. To explain this, we'll assume the field you want to populate is called EXPIRE\_DTTM:
  - First, you populate the date portion of the field. To do this, you'd input the date (this value can be in any valid date format that a user is allowed to enter) in a field called EXPIRE\_DTTM\_FWDDTM\_P1. In other words, you suffix **\_FWDDTM\_P1** to the field name.
  - If you want to populate the time, you'd input the time (again, the field value can be in any format that a user could use to enter a time) in a field called EXPIRE\_DTTM\_FWDTTM\_P2. In other words, you suffix **\_FWDDTM\_P2** to the field name.

If you intend to use an **Input data** step to populate a *date-only* field, please be aware of the following:

- If the field resides in the *page data model*, the user must enter a value in the format YYYY-MM-DD (and therefore we do not recommend doing this).
- If the field resides in the *user interface*, the user can enter any valid date format.

## How To Use To Do Fields

As described under [Executing A Script When A To Do Entry Is Selected](#), you can set up the system to automatically launch a script when a user selects a To Do entry. These types of scripts invariably need to access data that resides on the selected To Do entry. The following points describe the type of information that resides on To Do entries:

- **Sort keys.** These values define the various ways a To Do list's entries may be sorted. For example, when you look at the bill segment error To Do List, you have the option of sorting the entries in error number order, account name order, or in customer class order. There is a sort key value for each of these options.
- **Message parameters.** These values are used when the system finds *%n* notation within the message text. The *%n* notation causes field values to be substituted into a message before it's displayed. For example, the message text **The %1 non-cash deposit for %2 expires on %3** will have the values of three fields merged into it before it is displayed to the user (%1 is the type of non-cash deposit, %2 is the name of the customer, and %3 is the expiration date of the non-cash deposit). Each of these three values is stored as a separate message parameter on the To Do entry.
- **Drill keys.** These values are the keys passed to the page if a user drilled down on the entry (and the system wasn't set up to launch a script). For example, a To Do entry that has been set up to display an account on the account maintenance page has a drill key of the respective account ID.
- **To Do ID.** Every To Do entry has a unique identifier referred to as its To Do ID.

You can access this information in the following types of steps:

- **Move Data** steps can move any of the above to any data area. For example, you might want to move a To Do entry's drill key to the page data model so it can be used to navigate to a specific page.
- **Conditional Branch** steps can perform conditional logic based on any of the above. For example, you can perform conditional logic based on a To Do entry's message number (note, message numbers are frequently held in sort keys).
- **Mathematical Operation** steps can use the above in mathematical operations.

A To Do entry's sort key values are accessed by using a **Field Type** of **Current To Do Information** and a **Field Name** of **SORTKEY[index]**. Note, you can find an entry's potential sort keys by displaying the entry's To Do type and navigating to the [Sort Keys](#) tab. If you want to reference the first sort key, use an index value of **1**. If you want to use the second sort key, use an index value of **2** (and so on).

A To Do entry's drill key values are accessed by using a **Field Type** of **Current To Do Information** and a **Field Name** of **DRILLKEY[index]**. Note, you can find an entry's potential drill keys by displaying the entry's To Do type and navigating to the [Drill Keys](#) tab. If you want to use the first drill key, use an index value of **1**. If you want to use the second drill key, use an index value of **2** (and so on).

A To Do entry's message parameters are accessed by using a **Field Type** of **Current To Do Information** and a **Field Value** of **MSGPARAM[index]**. Note, because a To Do type can have an unlimited number of messages and each message can have different parameters, finding an entry's message parameters requires some digging. The easiest way to determine

these values is to display the To Do entry on [To Do maintenance](#). On this page, you will find the entry's message category/number adjacent to the description. Once you know these values, display the message category/number on [Message Maintenance](#). You'll find the message typically contains one or more %n notations (one for each message parameter). For example, the message text **The %1 non-cash deposit for %2 expires on %3** has three message parameters. You then need to deduce what each of the message parameters are. You do this by comparing the message on the To Do entry with the base message (it should be fairly intuitive as to what each message parameter is). If we continue using our example, %1 is the non-cash deposit type, %2 is the account name, and %3 is the expiration date. You can access these in your scripts by using appropriate index value in `MSGPARAM[index]`.

A To Do entry's unique ID is accessed by using a **Field Type** of **Current To Do Information** and a **Field Value** of **TD\_ENTRY\_ID**.

In addition, any of the above fields can be [substituted into a text string or prompt](#). Simply prefix the To Do field name with a % as you would fields in temporary storage. For example, assume you want your script to display the following text in the script area: "ABC Supply does not have a bill cycle" (where ABC Supply is the account's name). If the first sort key linked to the To Do entry contains the account's name, you'd enter a text string of `%SORTKEY[1] does not have a bill cycle`.

## How To Reference Fields In Data Areas

Various step types involve referencing field elements residing in the [script's data areas](#). To reference an element in a data area you need to provide its absolute XPath notation starting from the data area name. For example, use "CaseLogAdd/caseID" to reference a top-level "caseID" element in a script data area called "CaseLogAdd".

You don't have to type in long XPath notions. Use the **View Script Schema** hyperlink provided on the [Script - Step](#) page to launch the script's data areas schema.

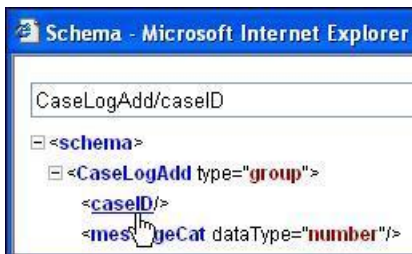

Figure 4: Schema Viewer

Doing this opens the [schema viewer](#) window where you can:

- Click on the field element you want to reference in your script step. The system automatically populates the text box on the top with the element's absolute XPath notation.
- Copy the element's XPath notation from the text box to your script.

You can also use the **View Data Area**, **View Service Script Data Area**, or **View Plug-In Script Data Area** links on [Script - Data Area](#) to the same effect. These open up the schema viewer for a specific data area respectively.

## Script - Data Area

Use this page to define the data areas used to pass information to and from the server or any other data area describing your temporary storage. Open this page using **Admin > System > Script** and then navigate to the **Data Area** tab.

---

**NOTE: Conditional tab page.** This tab page does not appear for [Groovy Library scripts](#) or [plug-in scripts](#) using the [Groovy engine version](#).

---

### Description of Page

The grid contains the script's data areas declaration. For steps that invoke an object that is associated with a schema, you must declare the associated schema as a data area for your script. In addition, if you have defined one or more data areas to

describe the script's temporary storage, you need to declare them too. The following bullets provide a brief description of each field on a script data area:

- **Schema Type** defines the type of schema describing the data area's element structure.
- The data area's schema is the one associated with the referenced **Object**. Only objects of the specified Schema Type may be selected.
- **Data Area Name** uniquely identifies the data area for referencing purposes. By default, the system assigns a data area with the associated object name.
- Click on the **View Data Area** link to view the data area's schema in the [schema viewer](#) window.

The **View Service Script Data Area** link appears for service scripts only. Use this link to view the script's parameters data area schema in the [schema viewer](#) window.

The **View Plug-In Script Data Area** link appears only for plug-in scripts using a script engine version. Use this link to view the script's parameters data area schema in the [schema viewer](#) window.

---

**FASTPATH:** Refer to [A Script May Declare Data Areas](#) for more information on data areas.

---

## Script - Schema

Use this page to define the data elements passed to and from a service script. Open this page using **Admin > System > Script** and then navigate to the **Schema** tab.

---

**NOTE: Conditional tab page.** This tab page only appears for [service scripts](#).

---

### Description of Page

The contents of this section describe the zones that are available on this portal.

The **General Information** zone displays the script name and description.

The [Schema Designer](#) zone allows you to edit the service script's parameters schema. The purpose of the schema is to describe the input and output parameters used when invoking the script.

---

**NOTE:** Refer to [Schema Nodes and Attributes](#) for a complete list of the XML nodes and attributes available to you when you construct a schema.

---

The **Schema Usage Tree** zone summarizes all cross-references to this schema. For each type of referencing entity, the [tree](#) displays a summary node showing a total count of referencing items. The summary node appears if at least one referencing item exists. Expand the node to list the referencing items and use their description to navigate to their corresponding pages.

## Script - Eligibility

Use this page to define a script's eligibility rules. Open this page using **Admin > System > Script** and then navigate to the **Eligibility** tab.

---

**NOTE: Conditional tab page.** This tab page only appears for [BPA scripts](#).

---

### Description of Page

Use the **Eligibility Option** to indicate whether the script is **Always Eligible**, **Never Eligible** or to **Apply Eligibility Criteria**. The remaining fields on the page are only visible if the option is **Apply Eligibility Criteria**.

---

**CAUTION:** The following information is not intuitive; we strongly recommend that you follow the guidelines under [The Big Picture Of Script Eligibility](#) before attempting to define this information.

---

The **Eligibility Criteria Group** scroll contains one entry for each group of eligibility criteria. The following fields may be defined for each group:

- Use **Sort Sequence** to control the relative order in which the group is executed when the system determines if the script should appear in the [script search](#).
- Use **Description** and **Long Description** to describe the criteria group.
- Use **If Group is True** to define what should happen if the eligibility criteria (defined in the following grid) return a value of **True**.
  - Choose **Eligible** if this script should appear.
  - Choose **Ineligible** if this script should not appear.
  - Choose **Check Next Group** if the next criteria group should be checked.
- Use **If Group is False** to define what should happen if the eligibility criteria (defined in the following grid) return a value of **False**.
  - Choose **Eligible** if this script should appear.
  - Choose **Ineligible** if this script should not appear.
  - Choose **Check Next Group** if the next criteria group should be checked.

The grid that follows contains the script's eligibility criteria. Think of each row as an "if statement" that can result in the related eligibility group being true or false. For example, you might have a row that indicates the script is eligible if the current account in context belongs to the residential customer class. The following bullets provide a brief description of each field on an eligibility criterion. Please refer to [Defining Logical Criteria](#) for several examples of how this information can be used.

- Use **Sort Sequence** to control the order in which the criteria are checked.
- Use **Criteria Field** to define the field to compare:
  - Choose **Algorithm** if you want to compare anything other than a characteristic. Push the adjacent search button to select the algorithm that is responsible for retrieving the comparison value. Click [here](#) to see the algorithm types available for this plug-in spot.
  - Some products may also include an option to choose **Characteristic**. Choosing this option displays adjacent fields to define the object on which the characteristic resides and the characteristic type. The objects whose characteristic values may be available to choose from depend on your product.
- Use **Criteria Comparison** to define the method of comparison:
  - Choose **Algorithm** if you want an algorithm to perform the comparison and return a value of True, False or Insufficient Data. Push the adjacent search button to select the algorithm that is responsible for performing the comparison. Click [here](#) to see the algorithm types available for this plug-in spot.
  - Choose any other option if you want to compare the **Criteria Field** using a logical operator. The following options are available:
    - Use **>**, **<**, **=**, **>=**, **<=**, **<>** (not equal) to compare the **Criteria Field** using standard logical operators. Enter the comparison value in the adjacent field.
    - Use **IN** to compare the **Criteria Field** to a list of values. Each value is separated by a comma. For example, if a field value must equal **1**, **3** or **9**, you would enter a comparison value of **1,3,9**.
    - Use **BETWEEN** to compare the **Criteria Field** to a range of values. For example, if a field value must be between **1** and **9**, you would enter a comparison value of **1,9**. Note, the comparison is inclusive of the low and high values.
- The next three fields control whether the related logical criteria cause the eligibility group to be considered true or false:

- Use **If True** to control what happens if the related logical criterion returns a value of True. You have the options of **Group is true**, **Group is false**, or **Check next condition**. If you indicate **Group is true** or **Group is false**, the script is judged **Ineligible** or **Eligible** based on the values defined above in **If Group is False** and **If Group is True**.
- Use **If False** to control what happens if the related logical criterion returns a value of False. You have the options of **Group is true**, **Group is false**, or **Check next condition**. If you indicate **Group is true** or **Group is false**, the script is judged **Ineligible** or **Eligible** based on the values defined above in **If Group is False** and **If Group is True**.
- Use **If Insufficient Data** to control what happens if the related logical criterion returns a value of "Insufficient Data". You have the options of **Group is true**, **Group is false**, or **Check next condition**. If you indicate **Group is true** or **Group is false**, the script is judged **Ineligible** or **Eligible** based on the values defined above in **If Group is False** and **If Group is True**.

## Merging Scripts

Use the Script Merge page to modify an existing script by copying steps from other scripts. The following points summarize the many diverse functions available on the Script Merge transaction:

- You can use this transaction to renumber steps (assign them new sequence numbers).
- You can use this transaction to move a step to a different position within a script. When a step is moved, all references to the step are changed to reflect the new sequence number.
- You can use this transaction to delete a step.
- You can use this transaction to copy steps from other scripts. For example:
  - You may want to create a script that is similar to an existing script. Rather than copying all the information from the existing script and then removing the inapplicable steps, this page may be used to selectively copy steps from the existing script to the new script.
  - You may have scripts that are very similar, but still unique. You can use this transaction to build large scripts from smaller scripts. In this scenario, you may choose to create special 'mini' scripts, one for each of the various options that may make a script unique. Then, you could use the script merge page to select and merge the mini scripts that are applicable for a main script.

**NOTE:** The target script must exist prior to using this page. If you are creating a new script, you must first create the [Script](#) and then navigate to the merge page to copy step information.

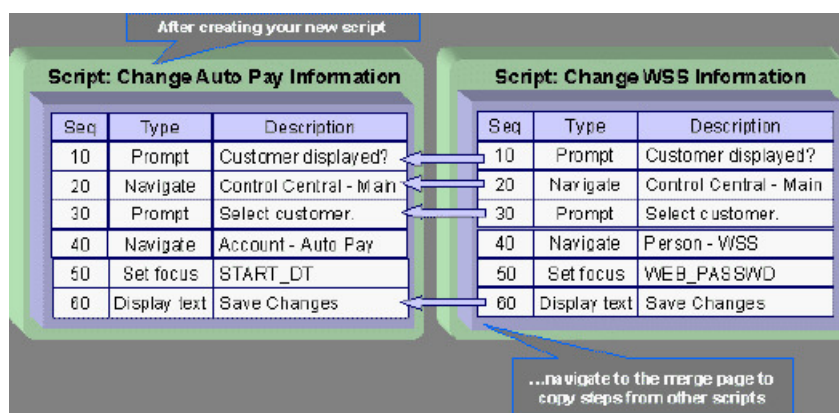

**NOTE:** Duplicate versus Merge. The [Script](#) page itself has [duplication](#) capability. You would duplicate a script if you want to a) create a new script and b) populate it with *all* the steps from an existing script.



## Script Merge

Open **Admin > System > Script Merge** to open this page.

### Description of Page

For **Original Script**, select the target script for merging steps.

For **Merge From Script**, select the template script from which to copy the steps.

---

**NOTE:** You may only copy steps from one Merge From script at a time. If you want to copy steps from more than one script, select the first Merge From script, copy the desired steps, save the original script, and then select the next Merge From script.

---

The left portion of the page displays any existing steps for the **Original Script**. The right portion of the page displays the existing steps for the **Merge From Script**.

You can use the **Copy All** button to copy all the steps from the **Merge From** script to the **Original** script. If you use **Copy All**, the steps are added to the end of the original script.

Each time you save the changes, the system rennumbers the steps in the original script using the **Start From Sequence Number** and **Increment By**.

**Merge Type** indicates **Original** for steps that have already been saved in the original script or **Merge** for steps that have been merged, but not yet saved. The **Sequence**, **Step Type** and **Description** for each step are displayed.

The topics that follow describe how to perform common maintenance tasks:

### Resequencing Steps

If you need to resequence the steps:













- Use the up and down arrows in the Original Script grid to reorder the steps.
- Make any desired changes to the **Start From Sequence Number** or **Increment By**.
- Click Save.

The steps are given new sequence numbers according to their order in the grid.

### Removing a Step from Script

If you want to remove a record linked to the Original script, click the delete button, , to the left of the record.

For example, to remove the **Reset existing bundle XML** step, click the  icon.

		Merge Type	Sequence	Step Type	Description
	 	Original	10	Edit data	Edit data - Check that the BO is an Export Bundle
	 	Original	20	Edit data	Edit data - Read the Bundle
	 	Original	30	Edit data	Edit data - Reset existing bundle XML
	 	Original	40	Edit data	Edit data - Create new bundle XML

After removal, the grid displays:

		Merge Type	Sequence	Step Type	Description
		Original	10	Edit data	Edit data - Check that the BO is an Export Bundle
		Original	20	Edit data	Edit data - Read the Bundle
		Original	40	Edit data	Edit data - Create new bundle XML

**NOTE:** You cannot delete a step that is referenced by other steps unless you also delete the referencing steps, such as **Go to step** or **Prompt** type steps. The system informs you of any missing referenced steps when you attempt to save the original script.

## Adding a Step to a Script

You can move any of the steps from the Merge From script to the Original Script by clicking the left arrow adjacent to the desired step. Once a record is moved it disappears from the Merge From information and appears in the Original information with the word **Merge** in the Merge Type column.

For example, to copy the **Navigate to a page** step, click the left arrow.

Merge Type	Sequence	Step Type	Description

Sequence	Step Type	Description
10	Height	Height - 0%
20	Move data	Move data - Copy 'APP_SVC_ID' to 'APP_SVC_ID'
30	Move data	Move data - Copy 'USR_GRP_ID' to 'USR_GRP_ID'
40	Navigate to a page	Navigate to a page - userGroupAppService
50	Conditional branch	Conditional branch - Compare ACTION with UPDATE
60	Press a button	Press a button - IM_scrollSec_add
70	Move data	Move data - Copy 'APP_SVC_ID' to 'UGP\$APP_SVC_ID'
80	Label	Label - End of Script

The step is moved to the left portion of the page.

		Merge Type	Sequence	Step Type	Description
		Merge	40	Navigate to a page	Navigate to a page - userGroupAppService









  

Sequence	Step Type	Description
10	Height	Height - 0%
20	Move data	Move data - Copy 'APP_SVC_ID' to 'APP_SVC_ID'
30	Move data	Move data - Copy 'USR_GRP_ID' to 'USR_GRP_ID'
50	Conditional branch	Conditional branch - Compare ACTION with UPDATE
60	Press a button	Press a button - IM_scrollSec_add
70	Move data	Move data - Copy 'APP_SVC_ID' to 'UGP\$APP_SVC_ID'
80	Label	Label - End of Script



**NOTE:** If you add a step, such as **Go to step** or **Prompt** type steps, that references other steps, you must also add the referenced steps. The step references are updated to use the new sequence numbers when you save the original script. The system informs you of any referenced steps that haven't been added when you attempt to save the original script.

## Removing an Uncommitted Step from a Script

	Merge Type	Sequence	Step Type	Description
	Merge	40	Navigate to a page	Navigate to userGro
		10	Height	Height - 0%
		20	Move data	Move data - Copy 'APP_SVC_ID' to 'APP_SVC_ID'
		30	Move data	Move data - Copy 'USR_GRP_ID' to 'USR_GRP_ID'
		50	Conditional branch	Conditional branch - Compare ACTION with UPDATE
		60	Press a button	Press a button - IM_scrollSec_add
		70	Move data	Move data - Copy 'APP_SVC_ID' to 'UGP\$APP_SVC_ID'
		80	Label	Label - End of Script

## Maintaining Functions

**NOTE:** Functions were implemented prior to the introduction of business services (BS), service scripts (SS) and business objects (BO). The functionality is still supported, but the recommendation for implementations going forward is to use one of the above configuration tool objects in a script rather than defining a function. The documentation has not been updated throughout this section to highlight where BS, SS or BO could be used to perform the equivalent logic.

**Invoke function** steps may be used to retrieve or update data independent of the page currently being displayed. For example, if you design a script that takes different paths based on the customer's customer class, you could invoke a function to retrieve the customer's customer class. Doing this is much more efficient than the alternative of transferring to the account page and retrieving the customer class from the Main page.

An **Invoke function** step retrieves or updates the relevant data by executing a service (on the server). These types of steps do not refer to the service directly. Rather, they reference a "function" and the function, in turn, references the service.

**NOTE: Functions are abstractions of services.** A function is nothing more than meta-data defining the name of a service and how to send data to it and retrieve data from it. Functions allow you to define a scriptwriter's interface to services. They also allow you to simplify a scriptwriter's set up burden as functions can handle the movement of data into and out of the service's XML document.

The topics in this section describe how to set up a function.

**NOTE: You can retrieve data from all base-package objects.** If you know the name of the base-package "page" service used to inquire upon an object, you can retrieve the value of any of its fields for use in your scripts. To do this, set up a function that sends the unique identifier of the object to the service and retrieves the desired fields from it.

## Function - Main

Use this page to define basic information about a function. Open this page using **Admin > System > Function**.

## Description of Page

Enter a unique **Function** code and **Description** for the function.

Use the **Long Description** to describe, in detail, what the function does.

Define the **Internal Service** that the function invokes.

---

**NOTE:** In this release, only page services can be invoked.

---

Click the **View XML** hyperlink to view the XML document used to pass data to and from the service. Doing this causes the XML document to be displayed in the Application Viewer.

---

**NOTE: XML document may not be viewable.** If you create a new page service and do not regenerate the application viewer, you will not be able to view its XML document.

---

The tree summarizes the following:

- The fields sent to the service. You can use the hyperlink to transfer to the **Send Fields** tab with the corresponding field displayed.
- The fields received from the service. You can use the hyperlink to transfer to the **Receive Fields** tab with the corresponding field displayed.
- Scripts that reference the function. You can use the hyperlink to transfer to the script page.

## Function - Send Fields

Use this page to add or update the fields sent to the service. Open this page using **Admin > System > Function** and then navigate to the **Send Fields** tab.

---

**NOTE: Displaying a specific field.** Rather than scrolling through each field, you can navigate to a field by clicking on the respective node in the tree on the Main tab. Also note, you can use the Alt+right arrow and Alt+left arrow accelerator keys to quickly display the next and previous entry in the scroll.

---

**NOTE: You're defining the service's input fields.** On this tab, you define which fields are populated in the XML document that is sent to the service. Essentially, these are the service's input fields.

---

## Description of Page

Use **Sequence** to define the order of the **Send Fields**.

Enter a unique **Function Field Name** and **Description** for each field sent to the application service. Feel free to enter **Comments** to describe how the field is used by the service.

Use **Field Value Source** to define the source of the field value in the XML document sent to the service:

- If the field's value is the same every time the function is invoked, select **Defined On The Function**. Fields of this type typically are used to support "hard-coded" input values (so that the scriptwriter doesn't have to populate the field every time they invoke the function). Enter the "hard-coded" **Field Value** in the adjacent field.
- If the field's value is supplied by the script, select **Supplied By The Invoker**. For example, if the function retrieves an account's customer class, the script would need to supply the value of the account ID (because a different account ID is passed each time the function is invoked). Turn on **Required** if the invoker must supply the field's value (it's possible to have optional input fields).

Regardless of the Field Value Source, use **XML Population Logic** to define the XPath expression used to populate the field's value in the XML document sent to the service.

---

**NOTE: Usability suggestion.** You populate a field's value in an XML document by specifying the appropriate XPath expression for each field. Rather than referring to an XPath manual, the system can create the XPath expression for you. To do this, click the adjacent **View XML** hyperlink. This will display the XML document used to communicate with the **Service** defined on the Main page. After the XML document is displayed, click the **XPath** hyperlink adjacent to the desired field to see how the XPath expression looks. You can then cut / paste this XPath expression into the **XML Population Logic Field**.

---

## Function - Receive Fields

Use this page to add or update the fields received from the service. Open this page using **Admin > System > Function** and then navigate to the **Receive Fields** tab.

---

**NOTE: Displaying a specific field.** Rather than scrolling through each field, you can navigate to a field by clicking on the respective node in the tree on the Main tab. Also note, you can use the Alt+right arrow and Alt+left arrow accelerator keys to quickly display the next and previous entry in the scroll.

---

**NOTE: You're defining the application service's output fields.** On this tab, you define which fields are populated in the XML document that is received from the service. Essentially, these are the service's output fields.

---

### Description of Page

Use **Sequence** to define the order of the **Receive Fields**.

Enter a unique **Function Field Name** and **Description** for each field received from the service. Feel free to enter **Comments** to describe the potential values returned from the service.

Turn on **Required** if the invoker must use the field.

Regardless of the Field Value Source, use **XML Population Logic** to define the XPath expression used to retrieve the field's value from the XML document received from the service.

---

**NOTE: Usability suggestion.** You retrieve a field's value in an XML document by specifying the appropriate XPath expression for the field. Rather than referring to an XPath manual, the system can create the XPath expression for you. To do this, click the adjacent **View XML** hyperlink. This will display the XML document used to communicate with the **Service** defined on the Main page. After the XML document is displayed, click the **XPath** hyperlink adjacent to the desired field to see how the XPath expression looks. You can then copy / paste this XPath expression into the **XML Population Logic Field**.

---

**NOTE: Fields in multiple lists.** Note that the XPath expression generated in the application viewer refers to lists using a generic "list" reference. If a field within the list is unique across the service, the generic list reference is sufficient for the XML population logic. However, if the field you are trying to reference is in multiple lists, the XPath must include the list name. Adjust the Application Viewer's generated XPath by adding the list name, which can be found in the overview panel in the Service XML viewer. For example, instead of `/pageBody/list/listBody/field[@name='FIELD_NAME']`, the XPath Population Logic must read `/pageBody/list[@name='LIST_NAME']/listBody/field[@name='FIELD_NAME']`.

---

## Attachments

Some implementations may require that attachments be available from the application. These attachments can be stored in the Attachment table and then linked to other objects if applicable.

# Attachment Overview

The following topics provide additional information regarding attachment functionality.

## Attachment Types

The system supports several different attachment content types, for example:

- PDF Document
- Excel Spreadsheet
- Jpeg Image
- Text Document

The attachment data itself may be text or binary. When storing the data in the application however, it is stored as text information only. As a result, the upload of an attachment that is a binary type requires a conversion prior to storing the data. When viewing the attachment, the data is converted again for display.

Each type of attachment is defined using an attachment business object. The business object includes configuration defining the supported file extensions, whether the data is binary or not and the content type that represents the type of data for the attachment.

---

**NOTE:** To view the attachment business objects provided with the base product, navigate using **Admin > Business Object > Search** and search for business objects related to the Maintenance Object for Attachments (**F1-ATCHMT**).

---

## Owned Attachments

Attachments can be either 'owned' or 'common'. An owned attachment is one that is related to a specific record. For example, the specific test results for a given device can be uploaded and linked to that device or to its test records. These types of attachments are typically uploaded and maintained via the object that owns it.

## Common Attachments

Common attachments are ones that are uploaded independent of any transaction in the system. They can be used for general system or company information. Or they can be linked to more than one transaction. For example, instructions for performing a certain type of task can be uploaded as an attachment and linked to a task type where those instructions are relevant. These types of attachments are uploaded and maintained in the central Attachment portal. Objects that may refer to the attachments may link the attachments via characteristics or some other appropriate mechanism.

## Emailing Attachments

The system supports a business service that may be used by system processing to send an email. The business service **F1-EmailService** supports receiving the IDs of one or more attachments as input parameters.

Refer to [Sending Email](#) for more information.

# Configuring Your System for Attachments

In order to link attachments to objects in the system, there may be some configuration or implementation required to support the link. It is possible that one or more objects in your product already support attachments out of the box. Consult the product documentation for the specific object for confirmation. For objects in the system that do not support attachments out of the box, the following sections provide some guidelines for enabling support for attachments. Contact product support for more information.

## Supporting Common Attachments

The attachments themselves are created / uploaded using the attachment portal. Refer to [Maintaining Attachments](#) for more information.

If your implementation has a use case where one or more common attachments may be linked to an object (and the object does not already support this functionality), the object may need to be extended to capture the attachments.

- If the object includes a characteristic collection, this is a recommended way to capture attachments. A characteristic type should be defined for each type of attachment. The characteristic type should be a foreign key type and should reference the Attachment FK reference. The characteristic entity collection should include the object that the common attachment will be linked to.
- Most characteristic collections are sequence based characteristics and would support multiple entries for the same characteristic types, if multiple attachments are applicable.
- If the object to support the attachments is governed by a business object, the implementation must extend the business object to define one or more appropriate elements used to capture the attachments. If only one attachment of a certain type is allowed, a single flattened characteristic may be used. If multiple attachments of a certain type are allowed, the BO schema may define a “flattened list” exposing the sequence and the characteristic type.
- If the object is maintained on a “fixed page” with a generic characteristic collection, no additional configuration is needed to allow users to link attachments to that object.

## Supporting Owned Attachments

When creating an attachment for a specific record, the attachment itself captures the information about the related record, namely its maintenance object code and its primary key. For these types of attachments, no configuration is needed on the related business object to capture the attachments, as was the case with common attachments.

However, it is recommended to configure the user interface of the related object so that the owned attachments can be viewed and maintained from that page. This typically entails the creation of a special zone that retrieves a list of existing attachment records that reference the current record as its foreign key (owner). The zone would include links or buttons to add, upload or view an attachment.

If your product already has support for viewing and maintaining owned attachments on one of the base portals, that may be used as an example to follow. If your product does not have support for owned attachments, contact customer support for more information.

## Defining a New Attachment Type

As mentioned, the product provides support for several content types. If your implementation needs to support attachments for a content type not currently supported, create a new business object copying the configuration of an existing attachment business object.

Configure the following option types for the BO:

- **Binary** indicates whether the attachment data must be converted from binary format. Binary attachments are stored in the database as text, and are then converted back to the original format when retrieved.
- **Content Type** represents the browser's mime type of the attachment.
- **Supported File Extension** specifies the valid file extensions for the content type.

Once the business object is defined, it is ready for use.

## Maintaining Attachments

This section describes the functionality supported for viewing and maintaining attachments.

Navigate using **Admin > General > Attachment**. You are brought to a query portal with options for searching for common attachments.

Once an attachment has been selected, you are brought to the maintenance portal to view and maintain the selected record.

---

**NOTE:** The base search options for the attachments query only support searching for common attachments. Owned attachments may also be viewed on the attachment maintenance portal, but a user may only drill into the attachment maintenance from the maintenance portal of the “owning” entity.

---

The Attachment zone provides basic information about an attachment, including the ability to upload the file and to view an uploaded file.

## Adding Attachments

Common attachments may be added from the attachments portal (or via the standard menu path). In addition, your product may support attachments associated with specific records (“entity owned attachments”) which may also provide the capability to add attachments.

In both cases, when adding an attachment, you are prompted for the file to upload. Once the file is chose, the system determines the appropriate business object to associate with the attachment based on the file extension. Typically one and only one business object is found at which point you are prompted to provide the Attachment Name. (Your specific product may also require additional information at this time). Fill in the details and save.

Please note the following:

- If no business object is found for the uploaded file’s file type, an error is issued. This type of file is not currently supported as an attachment.
- If multiple business objects are found, the user must choose the appropriate one. This should be rare.

## Application Viewer

---

The Application Viewer allows you to explore meta-data driven relationships and other deliverable files online.

---

**NOTE: Running Stand-Alone.** You can also launch the Application Viewer as a stand-alone application (i.e., you do not need to start it from within the system). Refer to [Application Viewer Stand-Alone Operation](#) for more information about running the Application Viewer as a stand-alone application.

---

To open the application viewer from within your application, navigate to **Admin > Implementation Tools > Application Viewer**. The application viewer may also be launched from other locations for example when viewing a section of the online help files that contain hypertext for a table name, clicking on that hypertext brings you to the definition of that table in the data dictionary.

## Application Viewer Toolbar

The Toolbar provides the main controls for using the Application Viewer. Each button is described below.

### Data Dictionary Button



The **Data Dictionary** button switches to the Data Dictionary application.

## Physical and Logical Buttons



The **Physical** button changes the display in the List Panel from a logical name view to a physical name view. Note that the Tables are subsequently sorted by the physical name and therefore may not be in the same order as the logical name view. Once clicked, this button toggles to the Logical button.

The **Logical** button changes the display in the List Panel from a physical name view to a logical name view. Note that the Tables are subsequently sorted by the logical name and therefore may not be in the same order as the physical name view. Once clicked, this button toggles to the Physical button.

These buttons are only available in the Data Dictionary.

## Collapse Button



The **Collapse** button closes any expanded components on the list panel so that the child items are no longer displayed. This button is only available in the Data Dictionary viewer.

## Attributes and Schema Button

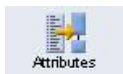

The **Attributes** button changes the display in the Detail Panel from a related tables view to an attribute view. Once clicked, this button toggles to the Schema button.



The **Schema** button changes the display in the Detail Panel from an attribute view to a related tables view. Once clicked, this button toggles to the Attributes button. Note that only tables have this view available. Columns are always displayed in an attribute view.

These buttons are only available in the Data Dictionary.

## Maintenance Object Button



The **Maintenance Object** button switches to the Maintenance Object viewer application.

## Algorithm Button



The **Algorithm** button switches to the Algorithm viewer application.

## Batch Control Button

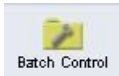

The **Batch Control** button switches to the Batch Control viewer application.

## To Do Type Button



The **To Do Type** button switches to the To Do Type viewer application.

## Description and Code Buttons



The **Description** button changes the display in the List Panel to Description (Code) from Code (Description). Note that the list is subsequently sorted by the description. Once clicked, this button toggles to the Code button.

The **Code** button changes the display in the List Panel to Code (Description) from Description (Code). Note that the list is subsequently sorted by the Code. Once clicked, this button toggles to the Description button.

These buttons are only available in the Batch Control and To Do Type viewers.

## Service XML Button



The **Service XML** button switches to the Service XML viewer. This button is not available when you are already in the Service XML viewer.

You are prompted to enter the name of the service XML file you want to view. The name of the service XML file should be entered without the extension.

A dialog box with a light blue border. It contains a text input field with the label "Service XML Name" to its left. Below the input field are two buttons: "Load" on the left and "Cancel" on the right, both with a yellow background and black text.



## Select Service Button



The **Select Service** button loads another service XML file that you specify. This button is only available in the Service XML viewer.

You are prompted to enter the name of the service XML file you want to view. The name of the service XML file should be entered without the extension.

## Java Docs Button



The **Java Docs** button switches to the Java Docs viewer.

## Groovy Java Docs Button

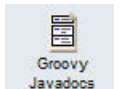

The **Groovy Java Docs** button switches to the Groovy Java Docs viewer.

## Classic Button



This button is only available in the Java Docs viewer.

The **Classic** button launches the classic Javadocs viewer on a separate window. If you are more comfortable with that look you can use this viewer instead.

## Preferences Button



The **Preferences** button allows you to set optional switches used by the Application Viewer. Refer to [Application Viewer Preferences](#) for more information.

## Help Button



The **Help** button opens the Application Viewer help system. You used this button to access this information.

## About Button



The **About** button opens a window that shows when was each Application Viewer data component recently built.

Data for all application viewer components may be regenerated to incorporate up-to-date implementation-specific information. Refer to [Application Viewer Generation](#) for further details.

## Slider Icon



This "slider" icon allows you to resize the list panel and detail panel to your preferred proportions.

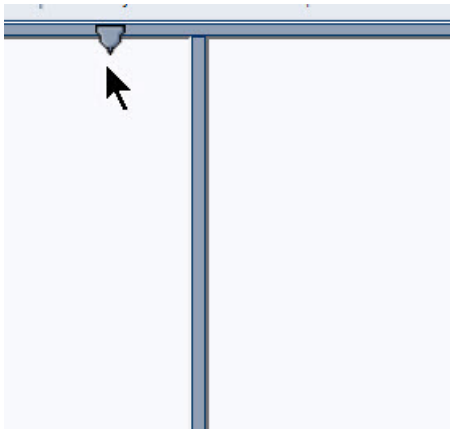

## Data Dictionary

The data dictionary is an interactive tool that allows you to browse the database schema and to graphically view relationships between tables in the system.

To open the data dictionary, click the [Data Dictionary button](#). You can also open the data dictionary by clicking the name of a table in other parts of the application viewer or in the online help documentation.

---

**NOTE: Data Is Generated.** A background process generated the data dictionary information. Refer to [Application Viewer Generation](#) for further details.

---

## Using the Data Dictionary List Panel

The list panel displays a list of tables and their columns. The list panel can list the table names by either their logical names or their physical names. Click the appropriate [button](#) on the toolbar to switch between the two views. The list is displayed in alphabetical order, so the order may not be the same in both views. Both views function in a similar manner.

In the list panel, you can navigate using the following options:

- Click the right arrow icon to expand a table to show its columns.

- Click the down arrow icon to collapse the column list for a table. Optionally, collapse all column lists by using the **Collapse** button.
- Click the column name to display information about the column in the detail panel.
- If the detail panel is in [related table](#) view, click the table name to view its related tables. If the detail panel is in [table detail](#) view, click the table name to display its information.

## Primary And Foreign Keys

The columns in the list panel may display key information as well as the column name:

- A yellow key indicates that the column is a primary key for the table.
- A light blue key indicates that the column is a foreign key to another table. If you hover the cursor over the icon, the tool tip indicates the foreign table.
- A dark blue key indicates that the column is a conditional foreign key. A conditional foreign key represents rare relationships between tables where a single field (or set of fields) may reference multiple primary key constraints of other tables within the application as a foreign key.
- A red key indicates that the column is a logical key field. A logical key represents an alternate unique identifier of a record based on a different set of fields than the primary key.

If you hover your cursor over an icon, the tool tip indicates the key type.

## Field Descriptions Shown

The language-specific, logical name of each field is shown adjacent to the physical column name in the data dictionary. You can enter an override label for a [table / field's](#) to be used throughout the system as the field's logical name. Here too it is the override label that is shown.

---

**NOTE: Regenerate.** You should regenerate the data dictionary after overriding labels. Refer to [Application Viewer Generation](#) for further details.

---

## Using the Data Dictionary Detail Panel

The Data Dictionary detail panel displays the details of the selected item. There are three main displays for the Detail Panel:

- Related tables view
- Table detail view
- Column detail view

## Related Tables View

The Related Tables view displays information about the table's parent tables and child tables. Click the [Schema](#) button in the toolbar to switch to related tables view.

In the related tables view, you can navigate using the following options:

- Click the left arrow and right arrow icons to view the related tables for that linked table. The List Panel is automatically positioned to the selected table.
- Click the maintenance object icon (  ) to view the table's maintenance object.

- If you want to position the [List Panel](#) to view the columns for different table click the name of the table for which you want to view the columns.

## Table Detail View

The table detail view displays information about the selected table. Click [Attributes](#) (in the toolbar) to switch to the table detail view.

In the table detail view, you can navigate using the following options:

- If user documentation is available for the table, click the View User Documentation link to read the user documentation that describes the table's maintenance object.
- If the table has an associated Language Table, click the link to view the Language Table details.
- If there is an associated Maintenance Program, click the link to view the source code for the maintenance program (you are transferred to the [Java Docs Viewer](#)).
- If there is an associated Key Table, click the link to view the Key Table details.

## Column Detail View

Click on a column name in the list panel to switch to the column detail view. The Column Detail view displays information about the selected column.

In the column detail view, you can navigate using the following options:

- If user documentation is available for the column, click the View User Documentation link to read about the column's related maintenance object.
- If the column is a foreign key, click the table name to switch to the Table Detail view for that table.
- If the column has a Value List available (normally only present for a subset of flag and switch fields), click the link to view the source code for the copybook (you are transferred to the [Java Docs Viewer](#)).

## Lookup Values

If the selected column is a lookup field its valid values are also listed. Notice that you can enter an override description for [lookup values](#). In this case the override description is shown.

---

**NOTE: Regenerate.** You should regenerate the data dictionary after overriding lookup value descriptions. Refer to [Application Viewer Generation](#) for further details.

---

## Maintenance Object Viewer

The maintenance object viewer is an interactive tool that allows you to view a schematic diagram of a maintenance object. A maintenance object is a group of tables that are maintained as a unit.

To open the Maintenance Object Viewer, click the [Maint. Object](#) button in the application viewer or click a [maintenance object icon](#) in the Data Dictionary.

---

**NOTE: Data Is Generated.** A background process generated the maintenance object information. Refer to [Application Viewer Generation](#) for further details.

---

## Using the Maintenance Object List Panel

The list panel displays a list of maintenance objects. In the list panel, you can click the maintenance object name to display information about the maintenance object in the detail panel.

## Using the Maintenance Object Detail Panel

The Maintenance Object detail panel displays a schematic of the selected maintenance object.

In the detail panel, you can navigate using the following options:

- Click a table name to transfer to the Data Dictionary [table detail view](#) for a table. (Click the [Maint. Object](#) button in the toolbar to return to the maintenance object.)
- Click the service XML icon () to view the XML file of the Service Program used to maintain the displayed object. (Click the [Maintenance Object](#) button in the toolbar to return to the maintenance object.)

## Algorithm Viewer

The algorithm viewer is an interactive tool that allows you to view algorithm types (grouped by their plug-in spot) and their related algorithms.

To open the Algorithm Viewer, click the [Algorithm](#) button in the application viewer. The Algorithm viewer may also be opened from certain locations in the online help documentation.

---



**NOTE: Data Is Generated.** A background process generates algorithm information. Refer to [Application Viewer Generation](#) for further details.

---

## Using the Algorithm Viewer List Panel

The list panel displays a list of algorithm types and their related algorithms, grouped by their plug-in spot.

In the list panel, you can navigate using the following options:

- Click the algorithm plug-in spot description to display information about the plug-in spot in the detail panel.
- Click the right pointer  icon to expand a plug-in spot and view its algorithm types and their related algorithms.
- Click the down pointer  icon to collapse the list of algorithm types for a plug-in spot.
- Click the algorithm type name to display information about the algorithm type in the detail panel.
- Click the algorithm name to display information about the algorithm in the detail panel.

## Using the Algorithm Plug-In Spot Detail Panel

The Algorithm plug-in spot detail panel displays further information about the selected plug-in spot.

## Using the Algorithm Type Detail Panel

The Algorithm Type detail panel displays further information about the selected algorithm type.

In the Algorithm Type detail panel, you can navigate using the following options:

- Click on the program name to view its source in the Java docs viewer.

## Using the Algorithm Detail Panel

The Algorithm detail panel displays further information about the selected algorithm.

## Batch Control Viewer

The batch control viewer is an interactive tool that allows you to view batch controls.

To open the Batch Control Viewer, click the [Batch Control](#) button in the application viewer. The Batch Control viewer may also be opened from certain locations in the online help documentation.

---

**NOTE: Data Is Generated.** A background process generates batch control information. Refer to [Application Viewer Generation](#) for further details.

---

## Using the Batch Control Viewer List Panel

The list panel displays a list of batch controls. The list panel can display the list of batch controls sorted by their code or sorted by their description. Click the appropriate [button](#) on the toolbar to switch between sorting by the code and description.

In the list panel, you can click the batch control to display information about the batch control in the detail panel.

---

**NOTE: Not All Batch Controls Included.** Note that the insertion and key generation programs for conversion (CIPV\*) are not included.

---

## Using the Batch Control Detail Panel

The batch control detail panel displays further information about the selected batch control.

In the batch control detail panel, you can navigate using the following options:

- Click on the program name to view its source in the Java docs viewer.
- If a To Do type references this batch control as its creation or routing process, click on the To Do type to view its detail in the To Do type viewer.

## To Do Type Viewer

The to do type viewer is an interactive tool that allows you to view to do types defined in the system.

To open the To Do Type Viewer, click the [To Do Type](#) button in the application viewer. The To Do Type viewer may also be opened from certain locations in the online help documentation.

---

**NOTE: Data Is Generated.** A background process generates To Do type information. Refer to [Application Viewer Generation](#) for further details.

---

## Using the To Do Type Viewer List Panel

The list panel displays a list of To Do types. The list panel can display the list of To Do types sorted by their code or sorted by their description. Click the appropriate [button](#) on the toolbar to switch between sorting by the code and description.

In the list panel, you can click the To Do type to display information about the To Do type in the detail panel.

## Using the To Do Type Detail Panel

The To Do type detail panel displays further information about the selected To Do type.

In the To Do type detail panel, you can navigate using the following options:

- If the To Do type references a creation process or a routing process, click on the batch process to view its detail in the batch control viewer.
- Click on the table listed in the drill key section to view its detail in the data dictionary.
- Click on the field(s) listed in the drill key section to view its detail in the data dictionary.

## Service XML Viewer

The service XML viewer is an interactive tool that allows you to browse the XML files of service programs that execute on the application server.

You can access the service XML viewer as follows:

- The maintenance object viewer allows you to view the XML file of the maintenance object's service program. This feature is implemented by viewing the maintenance object and then clicking on the [Service XML icon](#).
- When viewing a maintenance object on the [Maintenance Object](#) page, clicking the **View XML** hyperlink causes the service's XML document to be displayed in the Service XML Viewer.
- When viewing a business service on the [Business Service](#) page, clicking the **View XML** hyperlink causes the service's XML document to be displayed in the Service XML Viewer.
- When setting up a [Function](#), you may want to view the XML document used to pass data to and from the service. Clicking the **View XML** hyperlink causes the XML document to be displayed in the Service XML Viewer.

## Using the Service XML Viewer Overview Panel

The overview panel displays a high level nodes and list names structure of the XML document.

In the overview panel, you can click on any node item to position the detail panel to view that item.

## Using the Service XML Viewer Detail Panel

The detail panel displays nodes and attributes of the selected XML file.

Click the **xpath** button to view the XML path that should be used to reference the selected node in the XML document. The box at the top of the overview panel changes to display this information.

---

**NOTE: Fields in multiple lists.** Note that the generated XPath expression refers to lists using a generic “list” reference. For example: `/pageBody/list/listBody/field[@name='FIELD_NAME']`. If a service has a field that appears in more than one list, the above XPath may not be sufficient for referencing that field. In this case, references to the XPath

should be adjusted to include the list name. The list name is visible in the overview panel. To add the list name, use `[@name='LIST_NAME']`. For example: `/pageBody/list[@name='LIST_NAME']/listBody/field[@name='FIELD_NAME']`.

---

## Java Docs Viewer

The Java Docs viewer is an interactive tool that allows you to browse Java documentation files (Javadocs) for Java classes that execute on the application server.

---

**NOTE:** Proprietary Java Classes. A small number of Java classes have been suppressed due to their proprietary nature.

---

**NOTE: Classic view.** If you are more comfortable using the classic Javadocs viewer you may use the [Classic](#) button.

---

To open the Java Docs viewer from within the application viewer, click the [Java Docs button](#). Additionally, the [algorithm viewer](#) and the [batch control viewer](#) allows you to view the Javadocs of a program written in Java.

## Using the Java Docs Viewer List Panel

The list panel displays a tree of Java packages where each package may be expanded to list the Java interfaces classes it includes.

In the list panel, you can navigate using the following options:

- Click the right arrow icon to expand a Java package to view the Java interfaces and classes it includes.
- Click the down arrow icon to collapse the list for a Java package. Optionally, collapse all lists by using the **Collapse** button.
- Click the Java interface or class name to display information about it in the detail panel.

The list details panel designates the interfaces and the classes as follows:

- A green dot indicates Java interfaces.
- A blue key indicates Java classes.

If you hover the cursor over the icon, the tool tip indicates whether it's an interface or a class.

## Using the Java Package Detail Panel

The package detail panel displays a summary of the various Java classes that are included in the selected Java package.

Click the Java class name to display information about the Java class in the detail panel.

## Using the Java Interface / Class Detail Panel

The detail panel displays Java documentation information about the selected Java interface or class.

You can navigate using hyperlinks to other locations in the current detail panel or to view the details of other Java interfaces / classes.



## Groovy Java Docs Viewer

The Groovy Java Docs viewer is an interactive tool that allows you to browse Java documentation files (Javadocs) for the Java classes that are accessible to Groovy code within scripts.

---

**NOTE:** For system protection, only a subset of the base Java classes are available for use by Groovy code.

---

To open the Groovy Java Docs viewer from within the application viewer, click the [Groovy Java Docs button](#). You can also access the viewer via the 'View Groovy Javadocs' link in the context sensitive Script Tips zone. Refer to the additional topics in the [Java Docs Viewer](#) section for details of how to navigate the viewer panels.

## Application Viewer Preferences

This panel displays the Available Languages and allows you to select the language in which the labels and buttons are displayed. Select your desired language and click OK.

## Application Viewer Stand-Alone Operation

You can run the Application Viewer as a stand-alone application (i.e., you do not need to launch it from the online application environment). To run it as a stand-alone application, you should copy the Application Viewer files (all files in the appViewer directory) and the online help files (all files in the help directory) to the server on which you want to run the Application Viewer.

---

**NOTE:** Online Help. If you do not copy the online help files, online help will not be available for the Application Viewer, nor will you be able to view business descriptions of the tables' maintenance objects.

---

To start the application viewer in stand-alone mode, launch the appViewer.html file (located in the appViewer directory).

## Stand-Alone Configuration Options

You can configure the Application Viewer for stand-alone operation by modifying options in a configuration file. The Application Viewer comes with a default configuration file called config\_default.xml (located in the appViewer\config directory). Create a copy of the default configuration file and rename it to config.xml. Modify the options described in the following table to suit the needs of your installation.

---

**NOTE: Default Configuration.** If you do not create the config.xml file, the Application Viewer launches with its default (internal) configuration.

---

Option	Description
defaultLanguage	The default language used when the application viewer is started. Available values are those marked as language enabled on the language page.
defaultView	The default view then the application viewer is started. Available values include: - Data Dictionary
dataDictionary	Whether the Data Dictionary is available or not: - Y - N

Option	Description
<code>sourceCode</code>	This property is not being used. Simply enter 'N'.
<code>baseHelpLocation</code>	The location of the stand-alone online help in relation to the application viewer. Specify the directory structure relative to the location of the directory in which the Application Viewer files are located. Note that this is the directory in which the language subdirectories for the online help are located. The default location is:  ../help
<code>appViewerHelp</code>	The default help topic that is launched when the Help button is clicked in the Application Viewer. Specify a help file and anchor that is under the appropriate language directory under the <code>baseHelpLocation</code> . The default is:  Framework/Admin/91AppViewer.html#SPLINKApplication_Viewer

## Example Application Viewer Configuration

The following excerpt shows an example Application Viewer configuration.

```
<?xml version="1.0" encoding="UTF-8" ?>
<configuration>
<option id="defaultLanguage">PTB</option>
<option id="defaultView">Data Dictionary</option>
<option id="dataDictionary">Y</option>
<option id="sourceCode">N</option>
<option id="baseHelpLocation">../help</option>
<option id="appViewerHelp">Framework/Admin/91AppViewer.html#SPLINKApplication_Viewer</option>
</configuration>
```

## Application Viewer Generation

The Application Viewer is initially delivered with service XML information only.

The other components of the application viewer are generated on site.

- Use the background process **F1-AVALG** to regenerate algorithm information
- Use the background process **F1-AVBT** to regenerate batch control information.
- Use the background process **F1-AVMO** to regenerate maintenance object information
- Use the background process **F1-AVTBL** to regenerate data dictionary information.
- Use the background process **F1-AVTD** to regenerate To Do type information.

These processes have been introduced so that you can more easily incorporate your implementation-specific information into the application viewer.

To keep the information shown in the application viewer current it is important to execute these background processes after you introduce changes to the corresponding system data.

---

**NOTE: Data Generation Is Not Incremental.** Each new execution of these processes first deletes existing data (if any) in the corresponding folder before it generates new data.

---

**NOTE: Other Extensions.** Service XML may also be extended to include implementation-specific information. The base package is provided with special scripts that handle this type of extension. Refer to the Software Development Kit User Guide for further information on application viewer extensions.

---

---

**NOTE: War File.** If your application is installed in war file format, each generation of application viewer data rebuilds the corresponding war file. The web application server then needs to be "bounced" in order to make the newly generated data available to the application viewer. Please consult your system administrator for assistance.

---

**NOTE: Certain Web Application Servers Are Special.** WebSphere and Oracle Application web application servers require an additional step in order to make the newly generated data available to the application viewer. These web application servers require a rebuild of the application ear file and its redeployment in the web application server. This step is described in the installation document. Please consult your system administrator for further details.

---

## Reporting and Monitoring Tools

---

This chapter describes various tools provided in the product to support reporting and monitoring.

### Reporting Tool Integration

This section describes how to configure your third party reporting tool and how to define your reports in the system to enable users to submit reports online.

### The Big Picture Of Reports

The topics in this section describe the approach for designing and defining your system reports. Note that the product includes an out-of-the-box integration with BI Publisher. However it is possible to use the reporting objects to integrate with a different third party tool.

### Integration with BI Publisher

Your DBMS, your product, and BI Publisher can work together to produce reports. You may choose to use a different reporting tool, but this may not be a trivial effort. This section provides high-level information about some of the business requirements that are being solved with the reporting solution.

### Multi-Language and Localization Support

The integration supports a multi-language implementation and supports different localization settings.:

- All labels, headings and messages are defined using field and message meta-data in the application, which support multiple languages.
- The appropriate font, size, and layout are based on the requested report and the user's language.
- Dates and numbers are formatted as per the user's display profile.
- Currency based numbers are formatted as per the currency definition from the product

### Requesting Reports from The System

Although reports are rendered in your reporting tool, users must be able to request ad-hoc reports from within the system (assuming users have the appropriate security access).

- The prompts for the input parameters must be shown in the user's language
- Users should be able to use the standard search facilities to find parameter values

- Plug-ins can be optionally used to cross-validate input parameters
- Application security must authorize ad-hoc report requests

## Overview of the Data - BI Publisher

The following diagram provides an overview of where data is stored for your reports for integration with BI Publisher.

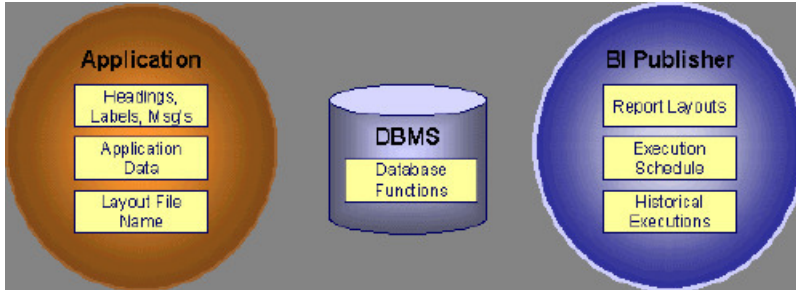

**Figure 5: Application and BI Publisher**

The application contains:

- The application data that appears on your reports.
- The language-specific headings, labels and messages on your reports.
- The layout file name to be used for the report.

BI Publisher contains:

- How your reports look.
- Information about scheduled reports and reports that have already run.

The DBMS contains the SQL used to retrieve the data on your reports (residing in database functions).

---

**NOTE:** BI Publisher can be configured to retrieve data via a service call. Because every business object can be read via a service call, elements that reside in an XML based column can be displayed on reports produced using BI Publisher. See your product's *Installation Guide* or *Optional Products Installation Guide* for information on this configuration.

---

## How To Request Reports

A user may request an ad hoc report from within your product:

- A [report submission](#) page enables a user to choose the desired report and enter the parameter values for the report
- The user must be granted security access to the report
- The request is passed to the reporting tool real time. Refer to [Configure The System to Invoke BI Publisher](#) for more information.
- The reporting tool generates the report and displays it in a new browser window

The reporting tools' scheduler creates reports (as per your schedule). This function is entirely within the reporting tool. No scheduling functions reside within your product.

A user can request an ad-hoc report from within the reporting tool. Note, the user's ID must be supplied as a parameter to the report in order for the user's profile to be used to format dates and numbers

## Viewing Reports

As described above, ad-hoc reports requested from within your product are displayed immediately after they are generated in a new browser window

If your reporting tools supports it, the [Report History](#) page may be configured to open tool's report execution history page and request a view of this report.

---

**NOTE:** The [Report History](#) page currently does not display historical reports for BI Publisher.

---

## Configuring The System To Enable Reports

### Configuring BI Publisher Reports

This section contains topics specific about configuring the product to interoperate with BI Publisher.

### Configure the System to Invoke BI Publisher Real-time

The base product provides an [installation algorithm](#) plug-in spot called Reporting Tool. This plug-in spot should contain an algorithm that invokes the third party reporting tool real-time.

For BI Publisher, the system provides an algorithm type called [F1-BIPR-INV](#), which invokes BI Publisher.

These algorithms rely on information defined in the [Reporting Options](#) table: the reporting server, reporting folder and the user name and password for accessing the reporting tool. The values in the reporting options should have been set up when the system was installed. Contact your system administrator if there are any problems with the values defined on the reporting options.

To use the algorithm types to invoke BI Publisher, perform the following steps:

- Create an [algorithm](#) for the appropriate algorithm type.
- On the [installation options](#), add an entry to the algorithm collection with an algorithm entity of **Reporting Tool** and indicate the algorithm created in the previous step.

### Batch Scheduling in BI Publisher

For many of your reports, you probably want the report to be produced on a regular basis according to a scheduler. The reporting solution relies on the BI Publisher software to provide the batch scheduler functionality. Refer to BI Publisher documentation for details about configuring the batch scheduler.

## Defining Reporting Options

The reporting options are provided as a mechanism for defining information needed by your reporting solution. The base product uses the reporting options to define information needed to access the reporting tool from within the system using the algorithm defined on the installation option.

Navigate to this page using **Admin > Reporting > Reporting Options**.

### Description of page

**Reporting Folder** defines the shared folder where reports are stored.

**Reporting Server** defines the URL of the web application where the reporting tool is installed. For example, using BI Publisher, the format is: `http://<BI Publisher Server>:<port>`.

**Reporting Tool User ID** is not applicable when integrating with BI Publisher.

Other reporting tools may require a user id to use when logging in.

**Reporting Tool Password** is not applicable when integrating with BI Publisher.

Other reporting tools may require a password to use when logging in.

---

**NOTE: Customize Options.** The reporting options are customizable using the Lookup table. This field name is **RPT\_OPT\_FLG**. The reporting options provided with the system are needed to invoke the reporting tool. If your implementation requires other information to be defined as reporting options, use the lookup table to define additional values for the reporting option flag.

---

### Where Used

This information is used by the reporting tool algorithm on the [installation option](#) to invoke the reporting tool software.

Implementations may use reporting options to record other information needed for their reporting tool.

## Defining Report Definitions

For each report supplied by your installation, use the report definition page to define various attributes of the report.

### Report Definition - Main

Navigate to this page using **Admin > Reporting > Report Definition**.

---

**CAUTION:** Important! If you introduce new report definitions, you must prefix the report code with **CM**. If you do not do this, there is a slight possibility that a future release of the application could introduce a new system report with the name you allocated.

---

### Description of page

Enter an easily recognizable **Report Code** and **Description** for each report. Use the **External Reference ID** to define the identifier for this report in your external reporting tool.

Define an [application service](#) to enable users to request submission of this report online or to view report history for this report. Once you define an application service for each report, use [application security](#) to define which users may access this report.

---

**NOTE: Access Mode.** The access mode for application services related to reports must be set to **Submit/View Report**.

---

If you have more than one parameter defined for your report and you wish to perform cross-validation for more than one parameter, provide an appropriate **Validation Algorithm**. Click [here](#) to see the algorithm types available for this system event.

Enter a **Long Description** to more fully describe the functionality of this report. This information is displayed to the user when attempting to submit the report online or when viewing history for this report.

For BI Publisher, if you want to use one of the sample reports provided by the system, but with a different layout, indicate the layout to use for the report in the **Customer Specific Font/ Layout** field and BI Publisher uses this information instead. The name for base report layout is `<report code>_Base`. For example, a base layout for `CI_VACANT` is named `CI_VACANT_Base`.

## Report Definition - Labels

Navigate to this page using **Admin > Reporting > Report Definition** and go to the **Labels** tab.

---

**NOTE: Company name and logo.** Note the company name used as a title in the sample reports is defined as a message on the [installation options](#). For information about installing the company logo, refer to your product's *Installation Guide* or the *Optional Products Installation Guide*.

---

### Description of Page

In order to provide multi-language capability for each report, the labels used for the report must support multiple language definitions. For each label used by your report, indicate a unique **Sequence** and the **Field** used to define the **Label**. The label defined here should be the same label that is defined in your report layout defined in the external reporting tool.

When rendering an image of the report, the external reporting tool retrieves the appropriate label based on the language used for the report.

## Report Definition - Parameters

Navigate to this page using **Admin > Reporting > Report Definition** and go to the **Parameters** tab .

### Description of Page

The **Parameters** scroll contains one entry for every parameter defined for the report. The following fields display:

**Parameter Code** is the identifier of the parameter. This must correspond to the parameter definition in the reporting tool.

**Required** indicates that a value for the parameter must be defined when submitting the report.

**Sort Sequence** must match the parameter order defined in the reporting tool's report. It is also used when displaying the list of parameters on the [report submission](#) page.

**Characteristic Type** indicates the characteristic type used to define this parameter.

**Default Value** is option and if populated is displayed to the user when the report is chosen on the [report submission](#) page.

**Description** is a brief description of the parameter. This description is used when displaying the parameter on the [report submission](#) page.

**Long Description** is a detailed description of the parameter. This description is used on the [report submission](#) page when the user requests more information for a given parameter.

## Sample Reports Supplied with the Product

Depending on your specific product, there may be sample reports provided that your organization may use as they are or as a starting point for creating a [new report](#). The following sections provide an overview of the sample reports along with instructions on how to use one of the sample reports in your implementation environment.

## How to Use a Sample Report Provided with the System

If you would like to use any of the sample reports, you need to perform some steps to be able to execute them in an implementation environment. This section walks you through the steps needed.

## Steps Performed at Installation Time

Refer to the *Installation Guide* or *Optional Products Installation Guide* for instructions for setting up and configuring your product and reporting tool to use the sample reports provided with the system. The following steps are described there.

- Setting up the stored procedures used by the sample reports.
- Defining the company title and logo used by the sample reports. Note the company name used as a title in the sample reports is defined as a message on the [installation options](#).
- Defining a user for integration with your product.
- Publishing the sample reports in BI Publisher.

Contact your system administrator to verify that the above steps have occurred.

## How To Define A New Report

### Use a Sample Report as a Starting Point

- Make a copy of the report and save it in an appropriate directory. Prefix the new report name with **CM**.
- Review the stored procedure(s) used for this report. Refer to the installation guide for information about where the stored procedures should be defined. If you want to change the data that is being accessed, copy the stored procedure, prefixing the new stored procedure with **CM**. Make the appropriate changes in the new version of the stored procedure. Contact your database administrator to find out the procedure for creating a new stored procedure.

---

**NOTE: Performance considerations.** When designing a stored procedure, you must consider the performance of the report when executed. Consult your database administrator when designing your database access to ensure that all issues are considered.

---

**NOTE: Defining Messages.** The stored procedures provided with the system use messages defined in message category 30. If your new stored procedures require new messages, use message category 90000 or greater, which are reserved for implementations.

---

- Review the parameters used by the report. Make appropriate changes to the parameters required by the report. This affects how you define your report. Refer to [Designing Parameters](#) for more information.
- Determine whether or not you require cross validation for your report parameters. If any cross validation is necessary, you should design an appropriate validation algorithm to be executed when requesting a report in your product. Refer to [Designing Validation Algorithms](#) for more information.

---

**NOTE: Cross Validation for On-line Submission Only.** The cross validation algorithm is only executed for ad-hoc report submissions via your product. If you submit this report through your reporting tool, this algorithm is not executed.

---

- Review the labels used by the report. Labels and other verbiage are implemented in the sample reports using a reference to the field table in the system. This enables the report to be rendered in the appropriate language for the user. For any new report label you require, you must define a new field entry. Refer to [Designing Labels](#) for more information.
- Review the layout of the report and make any desired changes based on your business needs.

When you have finished designing and coding your new report in your reporting tool, you must do the following in order for it to be usable:



- Publish the report in BI Publisher. Refer to the documentation for this products for details about publishing a report. Refer to [Publishing Reports in BI Publisher](#) for configuration information specific to publishing a report for integration with your product.
- Define the report. Refer to [Designing Your Report Definition](#) for more information.

## Publishing Reports in BI Publisher

Please refer to the documentation for BI Publisher for more information about publishing a report in this system. The remaining topics in this section provide information about settings needed to ensure that the report is accessible using BI Publisher.

### BI Publisher Database Access

When publishing a report in BI Publisher, you are asked for database logon information. The logon user name and password must be the user name and password that has access to the database functions related to this report in your database.

### Verify BI Publisher User Access Rights

To verify the user's access rights to folders in BI Publisher:

- Open the BI Publisher Enterprise Security Center.
- Check that the role for the user has access to the appropriate report folders.

For more information, refer to the "Understanding Users and Roles" section in the Oracle Business Intelligence Publisher User's Guide.

## Designing Your Report Definition

When adding a new report, you must define it in the system to allow users to request ad-hoc reports from on-line and to take advantage of the multi-language provisions in the system. The following topics illustrate the steps to take to correctly configure your report definition.

### Designing Main Report Definition Values

Refer to field description section of the [report definition](#) main page for information about defining general information about the report.

For the validation algorithm, preliminary steps are required. Refer to [Designing Validation Algorithms](#) for more information.

For the application service, preliminary steps are required. Refer to [Designing Application Services](#) for more information.

### Designing Characteristic Types

The parameter tab on the report definition page uses [characteristic types](#) to define the report parameters. For each report parameter that you plan to use, you must define a characteristic type.

You do not need a unique characteristic type for each report parameter. For example, if Start Date and End Date are parameters your report, only one **Report Date** characteristic type needs to be defined. This characteristic type would be used on both date parameters.

Each characteristic type to be used as a report parameter must indicate a characteristic entity of **Report**.

To illustrate the characteristic type definitions, let's look at the sample report Tax Payables Analysis. It needs the following parameters: From Date, To Date, GL Account Type Characteristic Type and Account Type value.

**NOTE: Account Type Parameters.** The tax payables report must find general ledger entries that have posted to a certain distribution code. In order to find the appropriate distribution code, the report expects each distribution code to be defined with a characteristic indicating its GL account type (for example, **Revenue**, **Asset**, etc.) The report needs to know the characteristic type used to define this entry.

To support the required parameters, the following characteristic types are needed.

Char Type	Description	Type	Valid Values	Char Entities
CI_DATE	Date Parameter	Ad-hoc	(Uses validation algorithm to validate proper date entry)	Report
CI_CHTYP	Characteristic Type	FK Reference	<b>CHAR_TYP</b>	Report
CI_GLTY	GL Account Type	Pre-defined	A- Asset, E- Expense, LM- Liability/miscellaneous, LT- Liability/taxes, R-Revenue	Distribution Code, Report

Highlights for some of the above settings:

- We have defined a characteristic type for defining a characteristic type. This is to allow the user to indicate which Char Type on the Distribution Code is used for the GL account type. This is an FK reference type of characteristic.
- The GL account type characteristic type is referenced on both the Distribution Code entity and the report entity.

## Designing Parameters

Your report definition parameters collection must define a unique parameter entry for each parameter sent to the reporting tool. The sequence of your parameters must match the sequence defined in your reporting tool.

Continuing with the Tax Payables Analysis report as an example, let's look at the parameter definitions.

Parameter Code	Description	Char Type	Default Value
P_FROM_DT	From Date	CI_DATE	N/A
P_TO_DT	To Date	CI_DATE	N/A
P_CHAR_TYPE	Account Type Characteristic	CI_CHTYP	CI_GLTY
P_TAX_ACCTY_CHAR	Account Type Char Value for Tax Related GL Account	CI_GLTY	LT-Liability/taxes

Highlights for some of the above settings:

- The from date and to date parameters use the same characteristic type.
- The characteristic type parameter is defined with a default value pointing to the GL account type characteristic type.
- The GL account type parameter defines the liability/taxes account type as its default value.

**NOTE: User Id.** The sample reports provided by the system pass the user id as the first parameter passed to the reporting tool. It does not need to be defined in the parameter collection for the report.

## Designing Validation Algorithms

When designing your report definition, determine if cross validation should occur for your collection of parameters. In the Tax Payables Analysis report, there are two date parameters. Each date parameter uses the characteristic type validation algorithm to ensure that a valid date is entered. However, perhaps additional validation is needed to ensure that the start date is prior to the end date. To do this, a validation algorithm must be designed and defined on the report definition.

The system provides a sample algorithm [RPTV-DT](#) that validates that two separate date parameters do not overlap. This algorithm should be used by the Tax Payables Analysis report.

If you identify additional validation algorithm, create a new [algorithm type](#). Create an [algorithm](#) for that algorithm type with the appropriate parameter values. Plug in the new validation algorithm to the appropriate report definition.

## Designing Application Services

[Application services](#) are required in order to allow a user to submit a report on-line or to view history for a report. Define an application service for each report and define the user groups that should have submit/view access to this report.

Update [report definition](#) to reference this application service.

## Designing Labels

The system supports the rendering of a report in the language of the user. In order to support a report in multiple languages, the verbiage used in the report must be defined in a table that supports multiple languages. Some examples of verbiage in a report include the title, the labels and column headings and text such as "End of Report".

The system uses the [field](#) table to define its labels.

---

**NOTE: Report Definition.** This section assumes that your new report in the reporting tool has followed the standard followed in the sample reports and uses references to field names for all verbiage rather than hard-coding text in a single language.

---

For each label or other type of verbiage used by your report, define a field to store the text used for the verbiage.

- Navigate to the field page using **Admin > System > Field**.
- Enter a unique **Field Name**. This must correspond to the field name used in your report definition in the reporting tool and it must be prefixed with **CM**.
- Define the **Owner** as **Customer Modification**.
- Define the **Data Type** as **Character**.
- **Precision** is a required field, but is not applicable for your report fields. Enter any value here.
- Use the **Description** to define the text that should appear on the report.
- Check the **Work Field** switch. This indicates to the system that the field does not represent a field in the database.

Update the [report definition](#) to define the fields applicable for this report in the **Labels** tab.

If your installation supports multiple languages, you must define the description applicable for each supported language.

## Measuring Performance

Many implementations need the ability to track and view the performance of key system processes against a defined target level. The framework provides objects to allow an edge product or an implementation to calculate and display performance measures against a desired target for one or more use cases. The topics in this section provide information about what is supplied in the framework and guidelines for implementing a specific use case for batch processes. Your specific product may supply out of the box support for additional use cases. Refer to your product specific documentation for more information.

## About Performance Targets

The following are examples of use cases that would be well suited for tracking as performance targets:

- Track and view the duration of key batch processes, either individually or as a group, and how they relate to a defined target.
- Monitor used and free space on a database against critical levels.
- Check the performance of individual user interface zones against a defined performance expectation
- Compare the number of web service requests made to an application against a threshold where performance may be of concern.

Framework provides functionality to define and categorize performance targets and link them to objects such as business services, zones and portals. This supports the calculation and display of the metrics against desired results.

In addition, Framework supplies out of the box support for batch process performance targets. Individual edge applications may supply more specific functionality for other use cases, if applicable.

Ideally, users should have the ability to view these performance targets on a dashboard that groups related measures. Framework provides the necessary components to achieve this for batch process performance targets.

The following sections highlight functionality supported for performance targets in the framework. Refer to the edge application product documentation for more details of other supported use cases.

## Performance Target Objects Overview

The setup of a performance target involves a unique combination of configuration data and processing logic that calculates and displays a specific measure.

The framework performance target functionality is supported by a combination of inter-related objects, as shown below. Some of these objects will be generic for use in all performance targets while some are specific to a functional area such as batch processes.

- **Maintenance Objects** for capturing performance target types and performance target instances.
- **Extendable Lookups** to define performance target categories and performance target metrics.
- **Business Services** to calculate known metrics for a group of performance targets, such as for batch processes.
- **UI Maps** to interpret the performance calculation results and display them in charts that show the comparison to the target.
- A **Zone** that serves as a template for system duplication to create specific zones related to each performance target. The zone invokes a business service to perform calculations and display performance measures in the related UI map.
- **Business Objects** to capture configuration data for a specific performance target instance and its related objects.
- Functionality to create **Zone instances** for specific performance targets based on the associated template zone.

Each edge application will deliver the following to compliment the objects delivered by the framework:

- **Portals** to group related performance target zones.
- Specific entries for the performance target category **Extendable Lookup** .

The following sections describe the combined use of these objects for performance targets in more detail.

## Calculating and Displaying Performance Targets

Performance targets are intended to be displayed in a portal using an explicit object zone. The zone parameters define both the business service used to calculate the performance metrics and the UI map that displays the results. While an individual performance target needs to reference a zone with a unique configuration that calculates a particular metric, those zones will be based on a template zone which defines the core parameters.

Framework provides a base Batch Performance Target Metric Template zone (**F1-PERFBA**) for batch process performance targets. Refer to this zone and its parameters for more information about the batch performance zone configuration and the related business service and UI map.

## Performance Target Metrics and Metric Types

The framework supports two types of metrics for performance monitoring:

- **Value based metrics** are used to record results against a specific numeric target.
- **Time based metrics** are used to track the results against a specific date and time target.

The list of valid metrics for a given performance target category and its associated performance target types is maintained using an extendable lookup. Framework uses the base business object Batch Performance Target Metric (**F1-BatchPerfTargetMetric**) to define batch process metric values. Refer to this lookup for the supported batch process metrics.

---

**NOTE:** While users are not prevented from adding new values to the lookup, the list is not intended to be extendable as new values will not be recognized by the business service that performs the base batch performance calculation logic.

---

Your edge product or implementation may supply other extendable lookup business objects for additional performance measurement use cases, if applicable.

## Performance Target Categories and Types

There are key configuration details required by all performance targets. These are defined on two related objects.

### Performance Target Categories

Target categories define the template zone and security setting for a group of performance measures. The list of valid categories is maintained using an extendable lookup.

The framework product supplies the business object Performance Target Category (**F1-PerformanceTargetCategory**) for this functionality. Refer to the business object description and configuration for more information.

### Performance Target Types

Target types define the related performance target business object and the display portal for a group of performance measures. In addition, a target type references a target category which defines the associated zone details.

The framework product supplies the business object Performance Target Type (**F1-PerformanceTargetType**) for this functionality. Refer to the business object description and configuration for more information.

The framework does not deliver any standard type or category values for batch processing performance targets. Refer to your specific edge application products to verify if any standard values are delivered for the batch processes within your applications. Edge applications may also supply standard categories and types for additional performance target use cases.

## Performance Targets Define Specific Metrics

Although the types of measures and the business services and UI maps that govern how they are calculated and displayed are defined using separate objects, a **performance target** record defines the additional configuration needed to measure a specific metric and compare the result to a desired value.

There are key configuration details required by all performance target instances. These include a reference to the metric being measured, the desired target value or time, the desired result for the target and the unique zone by which this performance target will be monitored.

---

**NOTE:** The performance target maintenance object has a direct foreign key link to the extendable lookup business object and value that define the performance metric. This is an unusual pattern as extendable lookup values are normally recorded only in an object's schema. The pattern has been adopted to allow the description of the metric to be displayed in the performance target maintenance portal.

---

A given **performance target type** may require additional details for its calculations. For example, the framework batch process performance target defines additional details to restrict the measurement to specific batch processes that have executed within a given time frame. These details are configured on the performance target business object. Refer to the embedded help text on the business objects supplied by the framework and your edge applications for more information.

The **performance target type** also defines the business object to use when creating the resulting performance target record.

## Objects Linked to a Performance Target

Some performance measures such as batch process metrics, derive the data for the calculation from objects within the system. The performance target can be linked to one or more related objects to define the specific data sources included in that target metric. For example, when creating a batch process performance target, the framework supports linking specific batch codes to the performance target to indicate the group of batch processes that are included in the measure.

The performance target business object may be configured to allow only relevant objects types to be linked to a performance target record. Refer to the base Batch Performance Target business object (**F1-BatchPerformanceTarget**) for an example.

## Creating Performance Target Zones

Once a performance target and its objects have been defined, a unique zone needs to be created to display and monitor the specific target.

The framework functionality for batch performance targets implements the zone creation via the related business object lifecycle. When a performance target is added, status enter plug-ins are responsible for generating the new zone using the template zone and prefix configured on the target category (or the override values) and adding the zone to the portal configured on the target type. When a performance target is inactivated, an enter plug in is responsible for removing the zone from the portal.

---

**NOTE:** While the template zone associated with the performance target category may be overridden, the zone generation algorithm makes certain assumptions about the zone type and parameters. In particular, the logic expects to configure a zone parameter that references the performance target code as input to the business service responsible for calculating the metrics.

---

Refer to the base Batch Performance Target business object (**F1-BatchPerformanceTarget**) for details of the lifecycle and the enter plug-ins responsible for performance target zone creation.

## Setting Up Performance Target Configuration

The following topics highlight the general configuration steps required to use performance target functionality. Your particular product or implementation may supply additional functionality to support specific use cases for performance targets. Refer to your product's documentation and the library of business objects supplied for performance target in your system for more information.

## Performance Target Category Lookup

Refer to [About Performance Targets](#) for an overview of performance target functionality.

Each Performance Target Type is associated with a unique Performance Target Category. The categories are defined as an extendable lookup.

Navigate to the [Extendable Lookup](#) portal. Search for and select the **Performance Target Category** business object. Define values that are appropriate to the categories your implementation is assigning for the performance target types in use. In some cases, an edge application may already have delivered the appropriate performance target category for your use

Refer to the embedded help for more information about configuring this object.

## Defining Performance Target Types

Refer to [About Performance Targets](#) for an overview of performance target functionality.

To maintain the performance target types applicable to your product or implementation, open **Admin > Reports > Performance Target Type**.

This is a standard [All-in-One portal](#).

The information captured on the performance target type depends on the business objects supported by your product or implementation. Refer to the embedded help text for more information.

### Where Used

Follow this link to open the data dictionary where you can view the tables that reference [FI\\_PERF\\_TGT\\_TYPE](#).

## Maintaining Performance Targets

This section describes the functionality supported for viewing and maintaining performance targets.

Refer to [About Performance Targets](#) for an overview of performance target functionality.

Navigate using **Main > Reporting > Performance Target**. This is an [All-in-One portal](#) and includes the standard List and display zones for a performance target.

For information about the data defined on the performance target, refer to embedded help.

## Capturing Statistics

The product provides objects to allow for an edge product or an implementation to periodically calculate and capture statistics for one or more use cases. The topics in this section provide information about what is supplied in the framework and guidelines for implementing specific use cases.

## About Statistics

There are two objects that work together to capture the statistics related to a given business use case:

- The statistics control record which defines configuration related to capturing statistics. It also defines a category that is used to group similar types of statistics together.
- The statistics snapshot is the record where the actual calculated statistics are captured.

### Statistics Control

The statistics control record whether or not statistics are automatically calculated and how frequently. In addition, you may control the retention policy of snapshot record. You may indicate that only the most recent snapshot is kept or all snapshot records are kept or that they are retained for a defined number of days.

The system provides a business object for statistics control (**F1-Statistics**) that is expected to be used for most use cases. Its lifecycle includes the support for periodic capturing of statistics snapshot records as well as on demand capture.

## Statistics Snapshot

The statistics snapshot object is the object that is responsible for calculating and capturing the statistics details. A separate business object must be defined for each use case. The schema of the business object defines the details that are captured. In addition, it must include an algorithm as an enter plug-in on the **Complete** state that is responsible for capturing statistics.

The system provides a 'root' business object for statistics snapshot (**F1-SnapshotRoot**) which includes the lifecycle that statistics snapshot business objects should follow. No explicit statistics snapshot use case is provided by the Framework. Your specific product may supply some out of the box support for certain use cases, in which case specific statistics snapshot business objects are provided. Refer to your product specific documentation for more information.

## Viewing / Reporting Statistics

The product provides the mechanism for defining statistics control and statistics snapshot records and viewing the data in basic format. If your product has provided support for specific use cases, there may also be additional portals used to display the statistics in a meaningful format. For example, the statistics snapshot may be capturing data that can be presented in graphical format. Additionally, if multiple historical statistics snapshot records are retained, a zone may be defined to graph changes over time.

## Configuring Your System for Statistics

If your product provides statistics use cases that you are planning to implement, all that you need to do is configure the appropriate statistics control record and define the appropriate configuration for your business requirements. Refer to [Defining and Monitoring Statistics](#) for more information.

If your implementation has identified an additional use case where you would like to capture statistics, the following points highlight the steps needed to configure the system to support the use case.

- Determine whether an additional Statistics Category value is needed. This is captured on the statistics category record. Navigate to the [Lookup](#) page. Search for and select the **STAT\_CATEGORY\_FLG** field. Review the values and determine if additional values are needed.
- Define a new statistics snapshot BO. This should be a child BO of the base delivered BO (**F1-SnapshotRoot**). Its schema should define elements for the specific information that is captured by the statistics calculations. The schema should be designed in conjunction with an appropriate Enter Status algorithm for the **Complete** that calculates the statistics as appropriate for the business requirement.
- Once the snapshot business object is designed and implemented, configure the appropriate statistics control record.

## Defining and Monitoring Statistics

Refer to [About Statistics](#) for an overview of the statistics functionality.

To define and maintain statistics control records and view a list of the current snapshot records, open **Admin > Reporting > Statistics Control**.

This is an [All-in-One portal](#) and includes the standard List and display zones for a statistics control.

For information about the data defined on the statistics control, refer to embedded help.

## Statistics Snapshot

If there are any Statistics Snapshot records for the statistics control, the **Statistics Snapshot List** zone displays a list of the most recent records. A user may drill into any of the records to view more detail. You are brought to a maintenance portal



where you may view details about the calculated statistics. The information captured will be unique to the particular use case. Refer to the embedded help for more information.

## External Messages

---

This section describes mechanisms provided in the product that enable an implementation to configure the system to communicate with an external application.

## Incoming Messages

This section provides information about support for incoming messages.

## Inbound Web Services

Inbound web service functionality is provided to support receiving web service requests from an external system.

### Overview

The following topics provide overview information about inbound web services (IWS).

### Multiple Operations

An inbound web service supports the configuration of one or more operation per web service. Each operation defines the schema-based object to invoke to perform the desired function. An operation may refer to a Business Service, a Business Object, or a Service Script. If the IWS supports multiple operations, each operation can refer to the same or a completely different schema-based object from other operations within the IWS. In addition, each operation may define a transaction type, which is essentially an action that is supported by the schema-based object.

By default, Inbound Web Services uses the Schema Name to dictate the Request and Response for the service. The API can be overridden with custom formats by specifying Request and Response Schemas with the appropriate Request and Response XSL to transform into the relevant schema formats.

For business object based operations, when invoking the web service an action is required. This may be passed into the web service as part of the invocation or alternatively, the action may be defined when configuring the operation using the transaction type.

---

**NOTE:** Using the transaction type **Change** requires all values to be passed in. Using the transaction type **Update** allows the web service to pass only the primary key and the values to be updated. All other elements will retain their existing values.

---

### Annotations Used for Security

When preparing to deploy inbound web services, the security aspects of the service must be decided. The product provides a default security policy that is applied when no other policy is defined: **@Policy(uri="policy:Wssp1.2-2007-Https-BasicAuth.xml", attachToWSDL=true)** which requires HTTP Basic over SSL and a WS-Security Timestamp.

If a different security policy is desired, the following options are available:

- Security policies may be attached to the Inbound Web Service via the Java Enterprise Edition (Java EE) Web Application Server. This allows for multiple policies to be attached as supported by the Java EE Web Application Server. In order to enable this capability, explicit system configuration is required so that the product does not assume the default security policy. See the subsequent bullets for more information.

- Define a system wide security policy using a feature configuration option. Find the [Feature Configuration](#) record for the **External Messages** feature type. (It may need to be defined if it does not exist). Choose the option type **Default security policy** and define an appropriate value. If your implementation wishes for the policies to be attached at the Java EE Web Application Server, define this option type with an option value of **<none>**.
- Attach a security policy to the IWS via a Web Service Annotation. The base product provides annotation types that support the standard WS-Policy (**F1POLICY**) and OWSM Security Policy (**F1-OWSM**). No base annotation is supplied by the product for either annotation type.

If your implementation wishes for the policy of a particular IWS to be attached at the Java EE Web Application Server, define a special annotation for the **F1POLICY** annotation type and configure the **uri** parameter value to **<none>**.

---

**NOTE:** Refer to WebLogic documentation for more information on supported security policies.

---

**NOTE:** In order to use the OWSM Policy, additional system configuration is necessary. Contact your system administrator to confirm if your implementation supports OWSM.

---

## Inbound Web Service Deployment

An Inbound Web Service must be deployed to the Java EE Web Application Server in order for it to be available to the Web Service Clients to access the system. Refer to [Deploying Web Services](#) for more information.

## Deploying XAI Inbound Service via IWS

For implementations using XAI inbound services for external messages, the product recommends moving to the inbound web service mechanism, which uses the Java EE Web Application Server to communicate with the product rather than the XAI servlet.

For XAI inbound services that use the **Business Adapter**, it is straight forward to move to IWS because the configuration is similar. In both cases, the service is configured to reference a business object, business service or service script. The associated WSDL for each record is similar. Changing the interface for the incoming message to use IWS instead of XAI inbound services is similar.

However, for XAI inbound services that use the **Core Adapter**, these services reference an underlying “page service” in the product. For these services, the Request and Response schemas for the XAI inbound service were created using the Schema Editor. In order to support calling an underlying “page service” in IWS, first a [business service](#) must be created to reference the page service (if one doesn’t already exist). However, the resulting schema for the business service is different from the Request and Response schemas related to the XAI inbound service. Moving this functionality to IWS using business services requires changes to the format of the incoming messages.

Moving all incoming messages over to use IWS instead of XAI is the product recommendation. However, to aid in implementations that have many integrations in place using the XAI inbound services that use the **Core Adapter** (or any adapter whose message class is **BASEADA**), the product provides the ability to deploy these types of XAI inbound services to the Java EE Web Application Server along with the Inbound Web Services.

To take advantage of this capability, you must define a feature configuration option. Under the **External Messages** feature configuration type, the **Support XAI Services via IWS** is used to indicate if this feature is supported. Setting the value to **true** turns on the feature. If no option is defined for that option type, it is equivalent to setting the value to **false**.

When the system is configured to support XAI services via IWS, the [Inbound Web Service deployment](#) includes XAI inbound services (that are configured with an Adapter that references the **BASEADA** message class). The deployment portal will also include a zone showing the deployment status of these XAI Inbound Services.

## Configuring Inbound Web Service Options

This topic describes the configuration needed for using inbound web services.

## Technical Configuration

In order to use inbound web services, there are tasks a system administrator must perform.

Refer to the Server Administration Guide for technical details of each of these processes.

## Maintaining Web Service Annotation Types

The product provides some base annotation types. Refer to the metadata for more information. If your implementation wishes to define additional annotation types, use the Web Service Annotation Type portal. Open this page using **Admin > External Message > Web Service Annotation Type**.

You are taken to the query portal where you can search for an existing web service annotation type. Once an annotation type is selected, you are brought to the maintenance portal to view and maintain the selected record.

---

**NOTE:** Use of custom policies should only be considered if the policies supplied by the Java EE Web Application Server are not sufficient for your implementation's needs.

---

The **Web Service Annotation Type** zone provides basic information about the web service annotation type.

Please see the zone's help text for information about this zone's fields.

The system supports the ability for an IWS record to refer to multiple policies. In this situation, the annotation type for the policy should include a reference to a parent annotation type so that the system can properly build the array of annotations.

### Where Used

Follow this link to open the data dictionary where you can view the tables that reference [FI\\_IWS\\_ANN\\_TYPE](#).

## Maintaining Web Service Annotations

If your implementation wishes to define annotations, use the Web Service Annotation portal. Open this page using **Admin > Integration > Web Service Annotation**.

This is a standard [All-in-One portal](#).

### Where Used

Follow this link to open the data dictionary where you can view the tables that reference [FI\\_IWS\\_ANN](#).

## Maintaining Inbound Web Services

[Inbound Web Services](#) are used to define a specific message that your implementation will receive from an external system and provides configuration needed to process the inbound message.

The product provides several inbound web services out of the box. By default, no annotations are defined for the base inbound web services. You may modify the message options or the annotations for any base IWS record. In addition, you may define additional IWS records for other incoming messages supported by your implementation.

To view an inbound web service, navigate using **Admin > Integration > Inbound Web Service**. You are brought to a query portal with options for searching for inbound web services.

Once an inbound web service has been selected, you are brought to the maintenance portal to view and maintain the selected record.

The Inbound Web Service zone displays the configuration information for the record, including its annotations, if applicable and its operations.

## Deploying Web Services

This topic describes the configuration needed for using inbound web services.

Once an Inbound Web Service is defined it is not automatically available to the Web Service Clients to access the system. The Deployment Status and the Active flag (set to true) indicate whether a Web Service is available or not. The last step is to deploy the Inbound Web Services to the Java EE Web Application Server. This deployment phase has a number of steps that are automatically performed when a deployment is initiated:

- The Web Service files are generated and policies are attached.
- The WSDL is generated with appropriate annotations and enumerations.
- The necessary Java stub code to implement the Web Service in the Java EE Web Application Server is generated and compiled.
- The Web Services are built into a valid Web Application Archive (WAR) file.
- Optionally, the newly created Web Services WAR file is deployed to the Java EE Web Application Server. This can also be done manually for clustered deployments, if desired.

There are two methods available for deploying inbound web services:

- Deployment at the command line using the **ivsdeploy[.sh]** command as outlined in the Server Administration Guide. This method is recommended for native installations and production implementations.
- Deployment using the Inbound Web Service Deployment portal. This method is only supported in development (non-production) environments.

### Inbound Web Service Deployment Portal

To use the online Inbound Web Service Deployment portal, navigate using **Admin > Integration > Inbound Web Service Deployment**.

The following sections describe the base zones that are provided on the portal.

#### Deploy Inbound Web Services

The Deploy Inbound Web Services zone provides information about the last deployment. If the region is a development (non-production) region you may use the **Deploy** button to deploy or re-deploy inbound web services. All inbound web services whose Active switch is Yes will be deployed. All whose active switch is No will be undeployed.

---

**NOTE:** When an Inbound Web Service is deployed, the value of its service revision field is captured. Certain changes to configuration will require re-deployment to take effect. When any of the following changes occur, the IWS service revision value is incremented. This will cause the deployment status to show **Needs Deployment**.

- Active switch is changed
- An Annotation is added or removed
- An Operation is added or removed.
- The Operation Name, Schema Type / Schema Name, Request or Response Schema, Request or Response XSL for an Operation is changed.

---

**NOTE:** In addition, if the implementation supports XAI services deployed through IWS, the appropriate XAI inbound services will also be deployed or undeployed as required.

---

#### Deployment Status

The Deployment Status zone displays a list of inbound web services in the product, including the deployment status.

The deployment status is determined by comparing the internal Service Revision field on each IWS against the value captured at the time of deployment.

- **Deployed.** Indicates that the IWS has been deployed and no changes have been detected to the configuration.
- **Needs Deployment.** Indicates that the IWS has never been deployed or has been deployed but in the meantime, changes have been detected to the configuration that require redeployment.
- **Undeployed.** Indicates that the IWS is marked as inactive and the IWS is not found to be deployed at this time.
- **Needs Undeployment.** Indicates that the IWS is marked as inactive but the IWS is found to be deployed at this time.

If the IWS has been deployed, the View column will include a **WSDL** link allowing you to launch a separate window to view the WSDL definition.

Use the broadcast button adjacent to any of the inbound web services listed in the zone to view the details of the IWS record. This causes the **Inbound Web Service** zone to appear. It is the same zone that appears on the [Inbound Web Service](#) maintenance portal.

### XAI Inbound Service Deployment Status

The XAI Inbound Service Deployment Status zone is only visible if the feature configuration option **Support XAI Services via IWS** is configured on the **External Messages** feature type or if the system detects that there are XAI inbound services that have been deployed. (The latter condition is checked for the case where an implementation has XAI inbound services deployed and then chooses to discontinue using this functionality. After changing the feature configuration option to false, one more deployment is required to "undeploy" the XAI services.) The zone displays a list of XAI inbound services in the product that are related to page services. Refer to [Deploying XAI Inbound Service via IWS](#) for more information.

The deployment status is determined by comparing the record's Version field against the value captured at the time of deployment.

- **Deployed.** Indicates that the XAI inbound service has been deployed and no changes have been detected to the configuration.
- **Needs Deployment.** Indicates that the XAI inbound service has not been deployed or has been deployed but in the meantime, changes have been detected to the configuration.
- **Undeployed.** Indicates that the XAI inbound service is marked as inactive or the **Support XAI Services via IWS** is not set to **true** and the XAI inbound service is not found to be deployed at this time.
- **Needs Undeployment.** Indicates that the XAI inbound service is marked as inactive or the **Support XAI Services via IWS** is not set to **true** but the XAI inbound service is found to be deployed at this time.

XAI inbound service does not have the equivalent of a Service Revision field that inbound web service has, which is only incremented when changes are made to the record that impact deployment. For XAI inbound service, the version number on the record is used. This field is incremented when any changes are made, even ones that may not impact deployment. As a result, some XAI Inbound Services may indicate "Needs Deployment" in cases where a redeployment may not be necessary. The recommendation when this occurs is to simply Deploy again to be safe.

If the IWS has been deployed, the View column will include a **WSDL** link allowing you to launch a separate window to view the WSDL definition.

## Guaranteed Delivery

There are alternatives for sending messages to the system besides using inbound web services. An external system may be able to send messages to the system in a generic manner where a new web service does not need to be defined for every new type of message. These types of messages may provide a payload (the message) and the service script or business service to invoke. An example of this type of communication is a message sent from a mobile application using RESTful operations.

The external system may have no mechanism for retrying failed messages. For this situation, the product provides an algorithm that may be used to capture incoming messages that should 'guarantee delivery'. A servlet processing this type of message may invoke the [installation algorithm](#) - Guaranteed Delivery, passing the details of the message and an indication

if a response should be returned. The algorithm is responsible for storing the message information in a table so that it can be subsequently processed.

---

**NOTE:** The framework does not provide a sample algorithm for this plug-in spot. Your specific product may provide an algorithm and additional support for guaranteeing messages. Refer to your product documentation for more information.

---

## Outgoing Messages

"Outgoing messages" is the term used to describe messages that are initiated by our system and sent to an external system. Messages may be sent real time or near real time. The system provides the following mechanisms for communicating messages to external systems.

- **Outbound Messages.** This method allows implementers to use configurable business objects to define the message format and to use scripts to build the message. If sent near real-time the message is posted to the outbound message table waiting for Oracle Service Bus to poll the records, apply the XSL and route the message. If sent real time, the message dispatcher routes the message immediately.
- **Web Service Adapters.** Using a web service adapter, an implementation can consume a WSDL from an external system and create an "adapter" record that references the URL of the external system and creates appropriate request and response data areas to expose the payload information in a format understood by configuration tools. A script may then be written to build the request information and initiate a real-time web service call from within the system.
- **Send Email.** The system supplies a dedicated business service that may be used to send an email real-time from within the application.

All these methods are described in more detail in the following sections.

## Outbound Messages

Outbound messages provide functionality for routing XML messages to an external system real-time or in near real time. In addition the functionality supports collecting related messages into a batch to then be sent to an external system as a consolidate XML message.

For each outbound message that your implementation must initiate you define a [business object](#) for the outbound message maintenance object. Using the business object's schema definition, you define the fields that make up the XML source field. These are the fields that make up the basis for the XML message (prior to any XSL transformation).

Each outbound message requires the definition of its schema by creating a business object whose schema describes the information that is provided to the external system. An XSL transformation may then be performed when routing the message to an external system.

For each external system that may receive this message, you configure the appropriate message XSL and routing information.

Because the outbound message type is associated with a business object, your implementation can easily create outbound message records from a script using the **Invoke business object** script step type. Such a script would do the following:

- Determine the appropriate [outbound message type](#) and [external system](#) based on business rules
- Access the data needed to populate the message detail
- Populate the fields in the schema and use the **Invoke business object** script step type for the outbound message type's business object to store the outbound message.
- The resulting outbound message ID is returned to the script and the scriptwriter may choose to design a subsequent step to store that ID as an audit on the record that initiated this message.

The following topics provide more information about functionality supported by outbound messages.

---

**NOTE:** For implementations that continue to use MPL and XAI, there is additional functionality related to outbound messages. Refer to [Outgoing Messages](#) for more information.

---

## Polling Outbound Messages Using OSB

If the outbound message that needs to be sent to an external system can be sent as an asynchronous message (in ‘near real time’), the process initiating the outbound message should create a record in the outbound message staging table. Oracle Service Bus (OSB), is the recommended tool to use to process outbound messages in near real-time.

Outbound messages that should be processed by OSB should be configured with a processing method defined as **SOA** for the external system / outbound message type. No other information is required for defining outbound message types that are processed by OSB.

For the OSB part of the processing, the product provides a custom transport: OUAF Outbound Message that may be used by an implementation to define messages to process and how to process them.

This section provides an overview of steps required to develop OSB integrations for outbound messages created by your product.

Before developing OSB integrations, a developer should be familiar with OSB development such as creating proxy services, business services, and message flow/routing. These terms are defined as follows:

**Proxy Service:** In OSB, a Proxy Service is the entity that processes a given type of message and routes it to a Business Service. A separate proxy service should be defined for each type of outbound message. If a given outbound message type may be routed to different external systems, it is the responsibility of the proxy service to query the external system defined on the outbound message and invoke the appropriate business service (see below). If any transformation is required prior to routing a message to a business service, it is the proxy service’s responsibility to perform the transformation.

**Business Service:** In OSB, a Business Service is an entity that receives a message from OSB and routes it to the appropriate destination. This should not be confused with the Business Service object provided in the product in the configuration tools.

---

**FASTPATH:** Refer to the whitepaper *OSB Integration* for more information.

---

## Batch Message Processing

Your implementation may be required to send messages to the same destination as a single XML file with multiple messages include. The following points describe this logic:

- The individual messages that should be grouped together must have a processing method of **batch** on the external system / outbound message type record. The appropriate batch code that is responsible for grouping the messages must also be provided.
- A separate "consolidated message" outbound message type should be configured for the external system with a processing method of **SOA**.
- When outbound message records are created for the individual messages, the batch code and current batch run number are stamped on the record.
- When the batch process runs it is responsible for building the XML file that is a collection of the individual messages. This batch process should include the following steps:
  - Format appropriate header information for the collection of messages
  - Apply the individual message XSL to each message before including the message
  - Insert a new outbound message for the external system with the "consolidated message" outbound message type.
- The consolidated message is ready to be processed by Oracle Service Bus.



---

**NOTE: No process provided.** The system does not supply any sample batch job that does the above logic.

---

## Real Time Messages

The system supports the ability to make web service calls, i.e. sending real time messages, to an external system.

The system supports special functionality for sending an Email message real-time. Refer to [Sending Email](#) for more information.

For other types of real-time messages, the system also uses outbound message type and external system configuration to format and route the message. When defining the configuration for real time messages, an additional step is required to define the mechanism for routing the message using a message sender. The system supports routing messages via HTTP and via JMS. Note that for HTTP routing, the system also supports sending the message using a JSON format.

Just like near real-time messages, initiating a real-time outbound message may also be done from a script. When a real time message is added, the system immediately routes it to the external system. If the external system provided a response message back, the system captures the response on the outbound message. If the outbound message type for the external system is associated with a response XSL it is applied to transform the response. In this case the system captures the raw response as well on the outbound message. Note that the outbound message BO should be configured to capture a response XML in its schema.

Any error (that can be trapped) causes the outbound message to be in a state of **Error**. It is the responsibility of the calling process to check upon the state of the outbound message and take a programmatic action. When the outbound message state is changed back to **Pending** the message will be retried.

The base package provides two business services: Outbound Message Dispatcher (**F1-OutmsgDispatcher**) and Outbound Message Mediator (**F1-OutmsgMediator**) that further facilitate making web service calls. Both business services are similar, allowing the calling script to configure the following behavior (with differences noted):

- Whether or not exceptions encountered while sending the message are trapped. Trapping errors allows the calling script to interrogate any errors encountered and take some other programmatic action.
- Whether or not the sent message is persisted as an actual outbound message record. If the message should not be persisted, the two business services handle this differently. The Outbound Message Dispatcher temporarily creates an outbound message record and subsequently deletes it. Because an outbound message is created, all the business object algorithms are executed. However, there is a performance implication. In contrast the Outbound Message Mediator sends a non-persisted message without creating and deleting an outbound message record. It is more efficient, but should only be used if no algorithms on the outbound message BO are needed.

Refer to the descriptions of the two business services for more information.

## Designing the System for Outbound Messages

The following sections describe the setup required when using [outbound messages](#) to communicate with an external system. The configuration walks you through the steps to configure a single external system and all its messages.

### Define the Outbound Message Type

For each outbound message that must be sent to an external system, create a [business object](#) for the outbound message maintenance object. Using the business object's schema definition, your implementation defines the elements that make up the XML Source field (XML\_SOURCE). These are the elements that are the basis for the XML message. XSL transformations may be applied to this XML source to produce the XML message.

If your integration is real-time and a response is expected, the Outbound Message business object should also map to the XML Response field (XML\_RESPONSE).



- You may decide to capture the response as is and define the element as “raw”. For example

```
<responseDetail mapXML="XML_RESPONSE" type="raw"/>
```

In this scenario, a Response XSL may or may not be needed.

- Alternatively, if the details of the response are needed, you may define specific elements for the response. For this option, depending on how the integration is designed, a Response XSL may be needed to transform the response into the expected XML format.

Once you have your business object and schema, define an [outbound message type](#) for each unique outbound message.

## Real-Time Message Configuration

When messages are routed to an external system real-time using the outbound message dispatcher or using the real-time send email business service. The system supports routing messages using HTTP and routing messages using JMS. In addition, there is a special type of message sender used for sending emails. The following sections highlights the supported real-time communication and the configuration needed for each.

### Email Messages

For sending emails, the following configuration is needed:

- Define a [message sender](#) configured for email. Senders of this type should be configured with the **RTEMAILSNDR** class. The sender context is used to configure the connection information for the connecting to the SMTP server.
- This sender may be defined as the default email sender on the [message option](#) table. Alternatively, the message sender can be provided to the business service as input. Refer to [Sending Email](#) for more information.

### Outbound Messages

For other outbound messages that are routed using the real-time outbound message dispatcher, a [message sender](#) must be configured to define how to route the message. The following points highlight more detail related to this configuration.

Determine the communication mechanism prior to configuring the sender.

- When routing the message using JMS, the following configuration must be defined
  - Define an appropriate [JNDI Server](#) that indicates where the JMS resources are located.
  - Define a [JMS Connection](#) to define additional configuration needed for the connection.
  - Define the [JMS Queue](#) or [JMS Topic](#) to define the queue or topic to use.
- When communicating using a JSON format, determine the method to use to convert the XML to JSON. The desired method is driven by how the request should be sent.
  - If choosing the **Base JSON Conversion** method, if XSL transformation needs to be applied prior to the conversion to JSON, then the target XML Request Schema must be defined (using a data area) so that the conversion logic knows the format of the XML it is converting. The XSL is applied to the outbound message’s XML Source, resulting in the defined XML Request Schema, which is then converted to JSON. If XSL transformation is not required, then the outbound message’s XML Source is converted to JSON.
  - If the XML source on the outbound message can be converted to JSON using an XSL, then the **XSL Transformation** method may be chosen.
  - You may also choose to convert the XML Source to JSON via the **Standard API Conversion** method (using a Jettison library). With this method, an XSL may optionally be provided. The conversion will be performed on the transformed XML.
  - For the response, if the outbound message BO defines detailed elements for the XML Response field, then the JSON should be converted to this format. If your conversion method is **Base JSON Conversion**, then if the JSON response cannot be converted directly to the XML Response elements on the outbound message BO, then define a Response

Schema (data area) that represents the results for the base JSON conversion. In addition, define an XSL that can transform the response from the converted XML to the XML format expected on the BO. If the conversion method is **Standard API Conversion** or **XSL Transformation**, the standard API is used to convert JSON to XML. An XSL may be defined to convert the response to the XML Response if needed.

- If the outbound message BO defines a "raw" element to capture the response, then a response schema and XSL are not necessary. In this case, the system will perform a JSON to XML conversion using the **Standard API Conversion** method (regardless of the conversion method defined) and the result is captured in the XML response.
- When using HTTP, no additional configuration is needed prior to configuring the sender.

Define a [message sender](#) configured for each appropriate routing method. The invocation type should be configured as **Real-time**. For routing via HTTP, use the **RTHTTPSNDR** - HTTP sender class. For routing via HTTP with SOAP format automatically applied, use the **SOAPSNDR** - HTTP SOAP sender class. For routing via HTTP using JSON format, use the **RTJSONSNDR** - JSON sender class. For routing via JMS, use the **RTJMSQSNDR** - JMS queue sender class or **RTJMSTSNDR** - JMS topic sender class and configure the JMS Connection and JMS Queue or JMS Topic. Use the sender context to configure the required values for connecting to the appropriate destination.

Configure the [external system](#) / outbound message type collection. The processing method defined for the external system / outbound message type must be **Real-time**.

## Define the External System and Configure the Messages

Define an [external system](#) and configure the valid outgoing messages and their method of communication (processing method). Refer to [Outbound Messages](#) for more information.

## Outbound Message Schema Validation

The outbound messages that are generated by the system should be well formed and valid so that they do not cause any issues in the external system. To ensure this validity you may configure the system to validate messages before they are routed to their destination. Note that the validation is applied just before communication with the sender and therefore after any Request XSL has been applied.

- Define a directory where the valid W3C schemas are located using the Message option **Outbound Message Schema Location**.
- Each [external system](#) message must indicate the appropriate W3C schema to use for validation.

You may turn on or off this validation checking using the Message option **Schema Validation Flag**.

## Configuring the System for Outbound Messages

The following sections describe the setup required when using [outbound messages](#) to communicate with an external system.

### JNDI Server

If using JMS to communicate outbound messages, define a new JNDI Server. Open **Admin > Integration > JNDI Server**.

#### Description of Page

Enter a unique **JNDI Server** and **Description**.

Indicate the Provider URL to indicate the location of the JNDI server. A variable may be used in place of all or part of the URL. The variable must be predefined in the substitution variable property file. The value here should enclose the variable name with @. Refer to [URI Validation and Substitution](#) for more information.

Indicate the **Initial Context Factory**, which is a Java class name used by the JNDI server provider to create JNDI context objects.

### Where Used

Follow this link to open the data dictionary where you can view the tables that reference [CI\\_XAL\\_JNDI\\_SVR](#).

## JMS Connection

To define a JMS Connection, open **Admin > Integration > JMS Connection**.

### Description of Page

Enter a unique **JMS Connection** and **Description**.

Indicate the **JNDI Server** to be used. Refer to [JNDI Server](#) for more information.

Use the **JNDI Connection Factory** to indicate the lookup keyword in the JNDI server used to locate the JMS connection.

### Where Used

Follow this link to open the data dictionary where you can view the tables that reference [CI\\_XAL\\_JMS\\_CON](#).

## JMS Queue

To define your JMS Queue values, open **Admin > Integration > JMS Queue**.

### Description of Page

Enter a unique **JMS Queue** and **Description**.

Enter the **Queue Name** as defined in the JNDI server. This is the JNDI lookup name identifying the queue.

Use the **Target Client Flag** to indicate whether or not the target client is **JMS** or **MQ**.

Select the **JNDI Server** where the queue is defined. Refer to [JNDI Server](#) for more information.

### Where Used

Follow this link to open the data dictionary where you can view the tables that reference [CI\\_XAL\\_JMS\\_Q](#).

## JMS Topic

To define your JMS Topic values, open **Admin > Integration > JMS Topic**.

### Description of Page

Enter a unique **JMS Topic** and **Description**.

Select the **JNDI Server** where the topic is defined. Refer to [JNDI Server](#) for more information.

Enter the **Topic Name** as defined in the JNDI server. This is the JNDI lookup name identifying the topic.

### Where Used

Follow this link to open the data dictionary where you can view the tables that reference [CI\\_XAL\\_JMS\\_TPC](#).

## Message Sender

The topics in this section describe the maintenance of a message sender

### Message Sender - Main

To define a new sender, open **Admin > Integration > Message Sender**.

### Description of Page

Enter a unique **Message Sender** and **Description**.

Set **Invocation Type** to **Real-time**.

---

**NOTE:** The invocation type **MPL** remains in the product for upgrade purposes but is not recommended.

---

Indicate the **Message Class** for this sender, which indicates the method used to route the message. The real-time sender classes are as follows:

Message Class	Description
RTEMAILSNDR	Email sender.
RTHTTPSNDR	HTTP sender.
RTJMSQSNDR	JMS queue sender.
RTJMSTSNDR	JMS topic sender.
RTJSONSNDR	HTTP JSON sender.
SOAPSNDR	HTTP SOAP sender.

The following sender classes are related to MPL processing and remain in the product for upgrade purposes:

Message Class	Description
DWNSTGSNDR	Download Staging sender.
EMAILSENDER	Email sender.
FLATFILESNDR	Flat file sender.
HTTPSNDR	HTTP sender.
JMSSENDER	JMS Queue sender.
OUTMSGSNDR	Outbound Message sender.
STGSENDER	Staging Upload sender.
TPCSNDR	JMS Topic sender.
UPLDERRHNDLR	Upload Error Handler.

Indicate whether or not this sender is currently **Active**.

Indicate whether the **MSG Encoding** is **ANSI message encoding** or **UTF-8 message encoding**.

If the Message Class is one that connects to a JMS Queue or JMS Topic, indicate the appropriate **JMS Connection**

---

**FASTPATH:** Refer to [JMS Connection](#) for more information.

---

If the Message Class is one that connects to a JMS queue, indicate the name of the **JMS Queue** to define where the message is to be sent.

---

**FASTPATH:** Refer to [JMS Queue](#) for more information.

---

If the Message Class is one that connects to a JMS topic, indicate the name of the **JMS Topic** to define where the message is to be sent.

---

**FASTPATH:** Refer to [JMS Topic](#) for more information.

---

The **XAI JDBC Connection** remains for legacy purposes but is not applicable for supported functionality.

## Message Sender - Context

The sender may require context information to define additional information needed by the system to successfully send outgoing messages. Open **Admin > Integration > Message Sender** and navigate to the **Context** page.

### Description of Page

Define the **Context Type** and **Context Value**, which contain parameters for senders when more information is required. See below for the supported context values for different types of senders.

### Where Used

Follow this link to open the data dictionary where you can view the tables that reference [CI\\_XAL\\_SENDER](#).

## Email Sender Context

The email sender is used by the business service that [sends email messages real-time](#).

An email sender must point to the Message Class **RTHTTPSNDR**. In addition, the following context records should be defined for senders of this type.

Context Type	Description
SMTP Host name	The SMTP server host name.
SMTP Username	The user ID used to access the SMTP server.
SMTP Password	The password used to access the SMTP server.
Response Time Out	The amount of time the system should wait for a real time response.

## HTTP Sender

An HTTP sender is one that sends messages to an HTTP server using the HTTP protocol. HTTP senders should reference a Message Class of **RTHTTPSNDR**, **RTJSONSDR** or **SOAPSDR**.

Various parameters are required to establish a session with the target HTTP server. You specify these parameters by defining a collection of context values for the sender. A set of context types related to HTTP variables is provided with the product. The following section describes the context types and where appropriate, indicates valid values.

Before defining the HTTP sender, you need to find out how the HTTP server on the other side expects to receive the request, and in particular, to answer the following questions:

- What is the address of the HTTP server?
- Is the HTTP server using a POST or GET HTTP method?
- If the server is using POST, how are message contents passed? Does it use an HTTP FORM or does it pass the data in the body of an XML message?

Context Type	Description	Values
HTTP URL1 - URL9	Used to construct the URL of the target HTTP server.  Since the URL may be long and complex, you can break it into smaller parts, each defined by a separate context record. The full URL is built by concatenating the values in URL1 through URL9.  You may use substitution variables when entering values for URL parts. Note that the substitution string @XMLMSG@ may be used for <b>GET</b> calls if an XSL has been applied to convert the message into HTTP GET parameters. It is useful if the HTTP Form is not applicable to the type of message.	
HTTP Method	The HTTP method used to send the message.	<b>POST</b> or <b>GET</b>

Context Type	Description	Values
HTTP Proxy Host	<p><b>NOTE:</b> The SOAP sender message class <b>SOAPSNDR</b> only supports the <b>POST</b> method.</p> <p>If connecting to the remote system requires using an HTTP Proxy, then this context field can be used to configure the HTTP Proxy Host. If the Proxy Host is set, the Sender class must use the value specified to connect to the remote system via a proxy.</p>	
HTTP Proxy Port	<p>If connecting to the remote system requires using an HTTP Proxy, then this context field can be used to configure the HTTP Proxy Port. If the Proxy Port is set, the Sender class must use the value specified to connect to the remote system via a proxy. If the HTTP Proxy Host is not set, HTTP Proxy Port is ignored and the connection will be made directly to the remote system.</p>	
HTTP Transport Method	<p>Specifies the type of the message. You can either send the message or send and wait for a response.</p>	<b>Send</b> or <b>sendReceive</b>
HTTP Form Data	<p>Used when the message is in the format of an HTML Form (<code>Content-Type: application/x-www-form-urlencoded</code>).</p> <p>This context specifies the form parameters (data) that should be passed in the HTTP message. Since a form may have multiple parameters, you should add a context record for each form parameter.</p> <p>The value of a form parameter takes the format of <code>x=y</code> where <code>x</code> is the form parameter name and <code>y</code> is its value.</p> <p>If <code>y</code> contains the string <code>@XMLMSG@</code> (case sensitive) then this string is replaced by the content of the service response XML message. The <code>@XMLMSG@</code> string can be used in the HTTP Form Data or in the HTTP URL, but not in both.</p> <p>If a context record of this type is defined for a sender, the sender uses the HTML Form message format to send the message even if <code>@XMLMSG@</code> is not specified in one of the context records.</p> <p>If a context record of this type is not defined for a sender, then the XML is sent with <code>Content-Type: text/plain</code>. When using POST it is put in the HTTP message body.</p>	

Context Type	Description	Values
	<p>Always required when using the GET method.</p> <p>If you are using the GET method and do not specify a Form Data context record, no message is transferred to the HTTP server.</p> <p>The MPL server builds formData by concatenating the individual parts.</p> <p>You may use substitution variables when entering values for Form Data.</p>	
HTTP Login User	<p>The HTTP server may require authentication. Add a context record of this type to specify the login user to use.</p>	
HTTP Login Password	<p>The HTTP server may require authentication. Add a context record of this type to specify the login password to use.</p>	
HTTP Header	<p>Sometimes the HTTP server on the other side may require the addition of HTTP headers to the message.</p> <p>For each HTTP header that has to be specified you should add a context record with a value having the following format <code>x:y</code> where <code>x</code> is the header name and <code>y</code> is the value for the header</p>	
HTTP Time Out	<p>Indicates the amount of time to wait for a connection to be established with the remote system.</p>	
Character Encoding	<p>Indicates if the message should be encoded. The sender will add to the HTTP's content type header the string <code>; charset=x</code> where <code>x</code> is the value of this context and when sending the message it will encode the data in that encoding.</p>	<b>UTF-8 or UTF-16</b>
Response Time Out	<p>The amount of time the system should wait for the remote system to send a response.</p>	

## Real-time HTTP Sender

The following context type is only applicable to senders with the **RTHTTPSNDR** message class.

Context Type	Description
Content Type	<p>Populate a value here to override the <b>Content-Type</b> attribute in the HTTP header, which defaults to <b>text/xml</b>.</p>

## SOAP Sender

A SOAP sender is an HTTP sender that automatically adds support for the SOAP format. For this type of sender (message class of **SOAPSND**), besides the context values listed above, the following context entries may also be supplied.

Context Type	Description	Values
SOAP Insert Timestamp	Indicate whether a timestamp should be added. Default value is 'N'.	Y or N
SOAP Username Security Type	Indicate the desired security type to apply.	<b>BASIC</b> (HTTP Basic), <b>TEXT</b> (Username Token plain text), <b>DIGEST</b> - Username Token Digest
SOAP Expiration Delay (in seconds)	Indicate an expiration delay to add to the timestamp. The default value is 60.	

## JMS Sender

A JMS sender is one that sends messages to a JMS queue or JMS topic. JMS senders should reference a Message Class of **RTJMSQSNDR** or **RTJMSTSNDR**, respectively.

The following parameters are used to connect to the JMS resource.

Context Type	Description	Values
JMS Message Type (Bytes(Y)/Text(N))	Indicates whether the data is sent as a bytes message or as a text message.	Y or N
JMS User Name	Enter the user name to connect to the JMS resource.	
JMS User Password	Enter the password to use to connect to the JMS resource.	
JMS Header	If JMS header values are required for the message, use this context type.  For each JMS header that has to be specified, add a context record with a value having the following format x:y where x is the header name and y is the value.	

## Defining Outbound Message Types

Use this page to define basic information about an outbound message type. Open this page using **Admin > Integration > Outbound Message Type**.

**NOTE:** This page is not available if the **External Message** module is [turned off](#).

### Description of Page

Enter a unique **Outbound Message Type** and **Description**. Use the **Detailed Description** to describe the outbound message type in detail.

Indicate the **Business Object** that defines business rules and the schema for outbound messages of this type.

Indicate the relative **Priority** for processing outbound message records of this type with respect to other types.

This bottom of this page contains a [tree](#) that shows the various objects linked to the outbound message type. You can use this tree to both view high-level information about these objects and to transfer to the respective page in which an object is maintained.

### Where Used



Follow this link to open the data dictionary where you can view the tables that reference [F1\\_OUTMSG\\_TYPE](#).

## External Systems

Use this page to define an external system and define the configuration for communication between your system and the external system.

### External System - Main

Open this page using **Admin > Integration > External System**.

---

**NOTE:** This page is not available if both the **External Message** and the **Open Market Interchange** modules are [turned off](#).

---

#### Description of Page

Enter a unique **External System** and **Description**.

Use the field **Our Name In Their System** to specify the identity of your organization (i.e., your external system identifier) in the external system.

---

**NOTE:** The workflow process profile and notification download profile are only applicable to products that support workflow and notification. They are not visible in the product if the **Open Market Interchange** module is [turned off](#).

---

If this external system sends inbound communications through notification upload staging, the type of workflow process that is created is controlled by the sender's **W/F (Workflow) Process Profile**.

If you send notifications to this external system, select a **Notification DL (download) Profile** that is used to define the configuration of the outgoing messages.

---

**NOTE:** The remaining fields are not visible if the **External Message** module is [turned off](#).

---

Set **Usage** to **Template External System** for external systems whose outbound message type configuration is inherited by other external systems.

If the outbound message type configuration should be inherited from a template external system, define the **Template External System**. If this field is specified, the outbound message type collection displays the data defined for the template system as display-only.

The **Outbound Message Type**[accordion](#) contains an entry for every type of outbound message defined for this external system. For each type of outbound message identify its **Outbound Message Type**.

Define the **Processing Method** for messages of this type. Valid values are **Batch**, **Real-time**, **SOA** and **XAI**.

Define an appropriate **Message Sender** if the processing method is **XAI** or **Real-time**.

Define an appropriate **Batch Control** if the processing method is **Batch**.

If the message sender is one with a message class of **RTJSONSNDR**, indicate the **JSON Conversion Method**. The valid values are **Base JSON Conversion**, **Standard API Conversion** and **XSL Transformation**. Refer to [Real Time Message Configuration](#) for more information about these methods and the additional configuration that may be applicable.

If the **JSON Conversion Method** is **Base JSON Conversion**, the **Request Schema** is enabled. Populate a data area that defines the schema for the XML format to convert the outbound message's BO schema to prior to performing the JSON conversion. Refer to [Real Time Message Configuration](#) for more information.

The **Message XSL** is the schema used to transform information from the format produced by the system to a format understood by the sender, who receives a message of this type. This is not applicable for Processing Method of **SOA**.

Enter the file name of the appropriate **W3C Schema** if you want to validate the message built for outbound messages for this external system / outbound message type prior to being routed to their destination. Refer to [Outbound Message Schema Validation](#) for more information. This is not applicable for Processing Method of **SOA**.

If the **JSON Conversion Method** is **Base JSON Conversion**, the **Response Schema** is enabled. Populate a data area that defines the schema for the XML format that the JSON message is initially converted to. The XML is then converted to BO XML. Refer to [Real Time Message Configuration](#) for more information.

**Response XSL** will have the same search service as is used for the existing Message XSL field. This field will only be displayed when the processing method is **Real-time**. Refer to [Real Time Messages](#) for more information on how it is used.

## External System - Template Use

If you are viewing an external system whose usage is a **Template External System**, use this page to view the other external systems that reference this one. Open this page using **Admin > Integration > External System** and then navigate to the **Template Use** tab.

### Description of Page

The tree shows every external system that references this external system as its template.

## Message Option

The Message Option page defines various system settings used by the system when processing external messages.

To define options for your environment, open **Admin > Integration > Message Option**.

### Description of Page

The following options are supported.

Option	Description	MPL / XAI Option Name
Default Email Sender	This is the default Message Sender used for <a href="#">sending e-mails</a> when no explicit Message Sender is specified.	<b>defaultEmailSender</b>
Default User	The default user is used by XAI to access your product when no other user is explicitly specified. Refer to <a href="#">Server Security</a> for more information. Additionally, the Default User is used for MPL transactions where there is no facility to provide a User ID. For example, no facility exists to provide a user id when reading messages from a JMS Queue. In these messaging scenarios, the system will use the Default User for authorization purposes.	<b>defaultUser</b>
Email Attachment File Location	This is the default location of e-mail attachment files. If not specified, the e-mail service provided with the product assumes a full path is provided with each attachment file.	<b>emailAttachmentFileLocation</b>
Email XSL File Location	This is the default location of e-mail XSL files. If not specified, the e-mail service provided with the product assumes a full path is provided to an XSL file as part of an e-mail request.	<b>emailXSLFileLocation</b>
Messages Language	The default language to use for the messages.	<b>language</b>
Outbound Message Schema Location	Enter the full path of the virtual directory where valid W3C schemas are stored if your implementation wants to <a href="#">validate outbound message schemas</a> . For example: <code>http://localhost/cisxai/schemas</code> .	<b>xaiOuboundSchemaLoc</b>

Option	Description	MPL / XAI Option Name
Schema Validation Flag	Enter <b>Y</b> to turn on <a href="#">schema validation for outbound messages</a> . Enter <b>N</b> to turn this off.	<b>xaiSchemaValidationCheck</b>
To Do Type for Inbound JMS Message Errors	To Do type for inbound JMS message errors. The inbound message processor uses this To Do type when creating To Do entries for inbound JMS messages that cannot be successfully processed. The system provides the To Do type <b>F1-INJMS</b> that may be used here.	<b>toDoTypeforInboundJMSMessageErrors</b>
To Do Type for Outbound Message Errors	To Do type for outbound message errors. The outbound message receiver uses this To Do type when creating To Do entries for outbound messages that cannot be successfully processed. The system provides the To Do type <b>F1-OUTMS</b> that may be used here.	<b>outboundErrorTodo</b>

Note that the following options are only applicable to implementations still using the XAI and MPL servers. The settings here may be overridden by the [AdHoc Parameters section](#) of the XAIParameterInfo.xml or MPLParameterInfo.xml.

Option	Description	MPL / XAI Option Name
Automatically Attempt Resend to Unavailable Sender (Y/N)	Set to <b>Y</b> if you wish to enable <a href="#">Automatic Resend</a> . Set to <b>N</b> if you wish to log errors when the system fails to send an outgoing message.	<b>shouldAutoResend</b>
Default Response Character Encoding	Determines the character encoding to be used when a response is sent. For example, you may specify <b>UTF-8</b> or <b>UTF-16</b> . If no value is specified then the default is <b>UTF-8</b> . If no special encoding should be done, then enter the value <b>none</b> .	<b>defaultResponseEncoding</b>
JDBC Connection Pool Max size	The MPL uses a pool of JDBC connections to connect to the database. This option determines the maximum number of JDBC connections that can be opened in the pool. The default value is 100.	<b>JDBCConnPoolMaxSize</b>
Maximum Errors for a Sender	This value is required if you have enabled <a href="#">Automatic Resend</a> . It defines how many errors you receive from a sender when attempting to send an outgoing message before you mark the sender <b>unavailable</b> .	<b>maxSendingErrors</b>
Messages JDBC Connection	Specifies the JDBC connection that XAI uses to read the text for its messages.	<b>messagesJDBCConnection</b>
MPL Administrator Port	The port number to be used for receiving MPL operator commands.	<b>adminPort</b>
MPL HTTP Server Authentication Method	This setting, along with the MPL HTTP Server User and Password are used to secure commands received by your MPL (such as those issued via <a href="#">XAI Command</a> ) through HTTP. Currently only <b>BASIC</b> authentication is supported.	<b>MPLHTTPAuthMethod</b>
MPL HTTP Server Password	This setting, along with the MPL HTTP Server Authentication Method and User are used to secure commands received by your MPL (such as those issued via <a href="#">XAI Command</a> ) through HTTP. The password should be in encrypted form, using the same encryption that is used for the database password. .	<b>MPLHTTPAuthPassword</b>
MPL HTTP Server User	This setting, along with the MPL HTTP Server Authentication Method and Password are used to secure commands received by your MPL (such as those issued via <a href="#">XAI Command</a> ) through HTTP.	<b>MPLHTTPAuthUser</b>

<b>Option</b>	<b>Description</b>	<b>MPL / XAI Option Name</b>
MPL Log File	The MPL Log File setting is used to specify the name of the file where MPL log information is to be written. The log contains technical information about the operation of the MPL.	<b>MPLLogFile</b>
MPL Trace File	The MPL Trace File setting is used to specify the name of the file where MPL trace information is to be written.	<b>MPLTraceFile</b>
MPL Trace Type	The MPL Trace Type is used to enable or disable tracing of the MPL. The possible values are <b>FULL</b> - All trace messages are written to the log file and <b>NOLOG</b> - No information is written to the log file.	<b>MPLTraceType</b>
Privileged Users	Comma separated list of users that are allowed to specify an effective User or effective User Id via framework custom SOAP Headers.	<b>superUsers</b>
Records MPL Receiver Will Process At a Time	If your implementation has <a href="#">configured multiple MPL servers</a> , indicate the number of records that each MPL receiver should process.	Not currently used
Schema Directory	The full path of the virtual directory where XML schemas are stored. For example: http://localhost/cisxai/schemas. If this option is not specified, the XAI uses the current directory, from where it is being run, to locate schemas.	<b>schemaDir</b>
Send SOAP Fault as HTTP 500	Enter <b>Y</b> to ensure that a SOAP error is reported as an HTTP 500 "internal server error".	<b>sendErrorAsHttp500</b>
Sender Retry Seconds	This value is required if you have enabled <a href="#">Automatic Resend</a> . It defines how many seconds to wait after marking a sender <b>unavailable</b> before you mark the sender <b>available</b> again (and retry sending messages to it).	<b>senderWaitTime</b>
System Error JDBC Connection	When a request fails to execute due to a system error, the MPL retries its execution several times. The MPL registers the system error in a table and uses this table for the retries. This setting specifies the JDBC connection required to access this table. Only enter a value in this field if it is different from the database environment used to read the XAI registry.	<b>systemErrorTableJDBCConnection</b>
System Error Max Retry	When a request fails to execute due to a system error, the MPL retries its execution several times until a maximum number of retries is reached. This option specifies the maximum number of retries.	<b>systemErrorMaxRetries</b>
System Error Retry Interval	When a request fails to execute due to a system error, the MPL retries its execution several times. This option specifies the number of seconds the MPL server waits between retries.	<b>systemErrorRetryInterval</b>
Thread Pool Initial Size	The MPL uses a thread of pools to enhance performance. The MPL starts with a minimum number of threads and grows/shrinks the pool based on the MPL system load. This option specifies the initial number of threads in the thread pool. The minimum number of threads is 12.	<b>threadPoolInitialSize</b>
Thread Pool Max Size	This option specifies the maximum number of threads in the thread pool.	<b>threadPoolMaxSize</b>

Option	Description	MPL / XAI Option Name
Thread Pool Non Activity Time	This option specifies how long a thread in the pool may be inactive before it is timed out and released from the pool.	<b>poolNoneActivityTime</b>
WSDL Service Address Location	Specifies the SOAP address location that XAI uses in creating a WSDL. If no value is present, the XAI's URL is used.	<b>wsdlAddressLocation</b>
XAI Authentication Password	The multi-purpose listener uses this field in combination with the <b>XAI Authentication User</b> when attempting to communicate with the XAI server over HTTP, which is running on a secured servlet and requires authentication.	<b>HTTPBasicAuthPassword</b>
XAI Authentication User	The multi-purpose listener uses this field in combination with the <b>XAI Authentication Password</b> when attempting to communicate with the XAI server over HTTP, which is running on a secured servlet and requires authentication.	<b>HTTPBasicAuthUser</b>
XAI Trace File	The full path name for the file, where the XML messages should be written. For example: c:\inetpub\wwwroot\cisxai\xai.log.	<b>traceFile</b>
XAI Trace Type	Use this option to specify the level of logging. The possible values are <b>FULL</b> - All XML messages are written to the log file and <b>NOLOG</b> - No information is written to the log file.  <b>FASTPATH:</b> Refer to <a href="#">Server Trace</a> for more information about tracing.	<b>traceType</b>
XSD Compliance	XSD does not allow empty elements for xsd:dateTime, xsd:date, and xsd:time. Request documents should specify xsi:nil="true" attribute on dateTime elements with an empty value. Enter xsd:permissive if you wish to enable noncompliant behavior to allow empty elements without xsi:nil="true". Enter xsd:strict if it is desired to enforce strict compliance on dateTime, date, and time elements. The default value is xsd:strict.	<b>xsdCompliance</b>
XSL Directory	The full path of the virtual directory where XSL transformation scripts are located. XSL transformation scripts can be defined for each service. By default, this is the same directory as the schemas directory.	<b>XSLDir</b>

## Managing Outbound Messages

Use this page to view information about outbound messages.

### Outbound Message - Main

Open this page using **Menu > Integration > Outbound Message**.

#### Description of Page

**Outbound Message ID** is the system-assigned unique identifier of the outbound message. These values only appear after the outbound message is added to the database.

The **Processing Method** indicates whether this record will be processed by a **Batch** extract process, through the **XAI** tool or **Real-time**. The value defined on the external system / outbound message type collection populates this value.

When records are created with a processing method of **Batch**, the system sets Extract to **Can Be Extracted**. Change the value to **Not to be extracted** if there is some reason that processing should be held for this record.

For records with a processing method of **Batch**, **Batch Control** indicates the process that will extract this record. This value is populated based on the on the external system / outbound message type's value. **Batch Number** indicates in which batch run this record was extracted or will be extracted.

The **Retry Count** is used by the XAI tool to keep track of how many times the tool tried to process this record and could not process the record, resulting in an error.

The **Creation Date** indicates the date that this record was created.

If the processing method is **XAI**, **Status** defines the state of the outbound message record. Refer to [Lifecycle of Outbound Message](#) for more information.

For messages in **error** status, click **Pending** to change the status back to pending for reprocessing.

For messages in **pending**, **error**, or **in progress** status, click **Cancel** to cancel the message and prevent further processing.

## Outbound Message - Message

Use this page to view the XML source used to build an outbound message. Open this page using **Menu > Integration > Outbound Message** and then navigate to the **Message** tab.

### Description of Page

The **XML Source** is displayed.

If a message XSL is defined on the external system / outbound message type record linked to this outbound message, the **Show XML** button is enabled. Click this button to view the XML that is a result of applying the Message XSL to the XML source.

## Outbound Message - Response

Use this page to display the XML response. Open this page using **Menu > Integration > Outbound Message** and then navigate to the **Response** tab.

### Description of Page

The **XML Response** and optionally the **XML Raw Response** is displayed.

XML Response displays the response data from the system called by the real-time message. If a response XSL is defined on the external system / outbound message type record linked to this outbound message, a transform is performed and the XML Raw Response displays the original, unchanged response.

## Web Service Adapters

The base product provides a configuration object called Web Service Adapter that is used to help build configuration objects to allow for functionality in the system to initiate a web service call from within the system. A Web Service Adapter provides the following functionality:

- WSDL (web service description language) import. An implementer can use the WSDL import functionality to read the details of a WSDL into the system
- Internal API generation. The system generates internal data areas that have two main purposes: they provide the API for custom code to define the appropriate input and they provide output data for the web service call using Oracle Utilities Application Framework schema language. In addition, the web service dispatcher uses element mapping defined in the data areas to transform the internal XML into the structure expected by the external system as described in the WSDL.
- Defines the URL needed to perform the web service call at runtime.

# Understanding Web Service Adapters

The following topics describe the system functionality in more detail.

## Importing a WSDL

Configuring a Web Service Adapter starts by identifying the WSDL (the web service description language document used to define the interface) that will be provided by the external system. The following steps describe the base product functionality provided to allow a user to import a WSDL.

- Navigate to the **Web Service Adapter** page in add mode and select the appropriate base business object.
- Enter a meaningful Web Service Name and appropriate descriptions.
- Provide the URL of the given WSDL.
- Click **Import** to retrieve the details of the WSDL. The system then parses the WSDL details and populates the WSDL Service Name, WSDL Source, WSDL Port, URL and a list of Operations (methods) defined in the WSDL.
- Determine which Operations should be **active** based on the business requirements for invoking this web service. **Active** operations are those that the implementation is planning to invoke from the system. These require appropriate request and response data areas generated for them. The following section provides more information about that.
- Specify the appropriate Security Type to configure the type of security to use when invoking this web service.
- Click Save.

At this point, a web service adapter record is created in pending status. The next step is to generate the request and response data areas for the operations configured as active.

## Generating Request and Response Data Areas

Each **active** operation for the web service adapter requires a pair of data areas, request and response, that represent the request and response XML messages for the operation.

The base product provides steps to generate the data areas as follows:

- As described in the Importing a WSDL section above, the operations listed in the WSDL are generated for the web service adapter and the implementer should indicate which operation to activate.
- After saving the **pending** web service adapter, the display lists all the active operations and for each one includes a **Generate** button.
- After clicking **Generate** for an operation, a window appears where the names of the new Request and Response Data Areas may be defined. Click **Save** to generate the data areas.

The generated data areas provide the API for the implementer to use when implementing the web service call in an appropriate algorithm or service in the system. The data areas contain the appropriate mapping from the elements that the implementer works within the code that invokes the web services and the WSDL definitions.

To facilitate generating the request and response data areas, the base product invokes a special business service used to create the appropriate mapping. The business service is defined as a BO option on the Web Service Adapter business object. This allows an implementation to provide a custom business service to further enhance the request and response mapping where appropriate.

---

### NOTE:

**Generated data areas.** It is possible to edit and modify the generated data areas after they are created. An implementer can change element names or remove unneeded elements if desired. Manually changing the generated data areas must be done only when absolutely necessary. This is because the system is not able to validate manual changes and issues with the data areas would only be detected at run time.

---

## Activating Web Service Adapters

The business objects provided by the base package for web service adapters include a simple lifecycle of **Pending** and **Active**. Configure the web service adapter and its data areas while in **Pending** status and activate it when it is ready to be implemented in the appropriate system functionality.

## Invoking Web Services

To make a call to a web service using a web service adapter, the system has provided a Web Service Dispatcher business service (**F1-InvokeWebService**) to submit a web service call. The calling program is responsible for retrieving all the information to correctly populate the request data required by the web service call before invoking the business service.

---

**NOTE:**

Refer to the detailed description of the business service for more information.

---

## Limitations

The following points highlight limitations associated with the types of web services that the system supports:

- It is possible for one WSDL document to contain definitions for several web services. The system currently supports only one port or service per WSDL document.
- It is possible for a WSDL to support multiple message patterns. The system currently supports only request / response.

## Setting Up Web Service Adapters

Use the Web Service Adapter portal to define the configuration needed to communicate with an external system using a web service call. Open this page using **Admin > Integration > Web Service Adapter**. You are brought to a query portal with options for searching for web service adapters.

Once a web service adapter has been selected, you are brought to the maintenance portal to view and maintain the selected record.

The **Web Service Adapter** zone provides basic information about the web service annotation type.

Please see the zone's help text for information about this zone's fields.

---

**FASTPATH:** Refer to [Understanding Web Service Adapters](#) for information about common web service adapter functionality.

---

## Sending Email

The framework provides the ability to initiate an email from within the system. The following topics highlight the functionality available.

- Sending email “real time” using a specific business service. The framework provides a business service **F1-EmailService** that supports sending an email. The schema supports elements for all the information required to create an email real time. It also supports sending attachments. The SMTP information (host, user name and password) may be provided or may be defined on a message sender, that may be provided as input. In addition, the business service supports using a default message sender defined as a [message option](#). Review the business service schema for information about the input elements.

---

**NOTE:** Validating attachments. If a Validate Email Attachment algorithm is plugged into the [installation record](#), it is called to validate the attachments supplied, if applicable.

---



---

**NOTE: Retry setting.** An option in the system properties file allows your implementation to configure the number of times to retry (if any) if the SMTP server is unavailable. Refer to the server administration guide for more information.

---

- Using an outbound message to send an email. This option allows for different variations as described in [Outbound Messages](#).
- Some emails may be created en masse (for example a large group of emails routed to users for a given set of To Do entries). In this case, the records can be created in the staging table for processing using OSB.
- Messages may still be sent real time using one of two business services described in [Real Time Messages](#). This option is an alternative to the dedicated email service described above when aspects of the outbound message functionality are needed, such as the ability to instantiate a record as an audit or to include additional logic via BO plug-ins as part of sending the email.

## JMS Message Browser

The JMS Message Browser portal allows you to select a JMS queue and view messages currently in the queue.

In order for a JMS queue to be available on the portal, a [message sender](#) must be defined that is configured for the appropriate JMS queue with the credentials to connect to the queue.

- If your organization sends real-time outgoing messages to a JMS queue, this configuration would exist as per the details in [Real-Time Message Configuration](#).
- If inbound web service messages are routed to the system via a JMS queue, no configuration is needed in the system. However, if you would like to view the messages in the queue in the JMS message browser portal, configuration for the JMS queues as described for outgoing messages is required.

Navigate to the portal using **Main > Integration > JMS Message Browser**.

The JMS Senders zone provides a list of configured message senders eligible for selection.

The JMS Message List zone is visible for the JMS Sender broadcast from the first zone. This zone supports selecting one or more records to delete from the queue. Use the message selector to limit the results to messages that satisfy the message selector. This uses standard JMS API message selector functionality. Refer to the zone embedded help for information about the supported syntax.

The JMS Message Details zone displays a message broadcast from the list zone.

## Integration Cloud Service Catalog

Integration Cloud Service (ICS) is an offering that serves as integration infrastructure for Oracle cloud solutions. The product provides an adapter for ICS to streamline integration between your edge application and ICS.

### ICS Adapter

The product provides a web service that ICS can invoke (referred to here as the ICS adapter) to retrieve information about available web services supported by one or more edge products. The information retrieved by the adapter includes the name, the source system, the WSDL location and namespace.

It is possible that not every web service supported by an edge product is managed by ICS. In order to only include the appropriate web services in the ICS adapter, configuration is needed to identify which web services to include.

The web service catalog is used to identify the records that should be retrieved by the adapter:

- For inbound messages, the system supports both the use of [inbound web services](#) and XAI inbound services that are [deployed via IWS](#). Each IWS or XAI inbound service that should be included in the catalog must be flagged. Note that only [deployed](#) services are returned to the catalogue.
- For outbound message, the system requires the creation of an External System that includes each outbound message type that the external system receives. For outbound messages that are integrated through ICS, the external system itself will represent ICS. Rather than identifying each outbound message type to include in the catalog, only the external system needs to be flagged. The ICS adapter will return web service information for all the outbound message types configured for the external system.

---

**FASTPATH:** Refer to [Maintaining the Web Service Catalog](#) for more information.

---

## Master and Subordinate Catalogs

For installations that support multiple edge products, each with their own list of web services, the system includes functionality to allow ICS to make one call to the adapter and receive all the services for all the products. This is handled by nominating one of the edge products as the "master". The "master" receives the ICS adapter request and this product includes configuration for how to connect to the other products to gather their web service catalog information and merge it with its own web services.

## Web Service Catalog Configuration

The topics in this section describe the configuration needed in your edge application to integrate with ICS.

### Web Service Catalog Master Configuration

The **Service Catalog Configuration** ([master configuration](#)) record defines several system wide settings related to integrating with the service catalog.

This includes defining subordinate servers if the current product is considered the "master". The record supports encrypting the subordinate server password. To do this, additional configuration is required. You need to define an entry in the 'encryption' feature configuration referencing **USER\_PASSWORD** in the **field=** setting and **ENCR\_USER\_PASSWORD** in the **encryptedField=** setting. Refer to [Database Encryption and Masking](#) for more information and for additional configuration needed.

For more information about specific fields in the master configuration, refer to the embedded help.

## Maintaining the Web Service Catalog

Refer to [Integration Cloud Service Catalog](#) for an overview of web service catalog functionality.

To add or remove services that are reported to the ICS catalog, navigate to the portal using **Admin > Integration > Web Service Catalog**.

The Catalog zone provides a list of services that are currently in the catalog. Users may use this zone to remove services from the catalog.

The Candidate Services zone provides a list of external systems, inbound web services and XAI inbound services (if applicable) that are not currently linked to the catalog. Users may use this zone to add services to the catalog.

---

**NOTE:** For inbound web services and XAI inbound services, they may be selected for the catalogue at any time. However, only [deployed](#) services are returned to the catalogue by the ICS adapter.

---

# XML Application Integration

This section describes the XML Application Integration (XAI) utility, which enables you to configure your system to receive information from and to send information to external applications using Extensible Markup Language (XML) documents.

---

**NOTE:** The XAI functionality is legacy functionality and not recommended for new implementations. The topics for the functionality outlined in the previous sections describe the recommended features for supporting sending and receiving external messages. The XAI information remains in the documentation for upgrade purposes.

---

## The Big Picture of XAI

The XML Application Integration (XAI) module provides the tools and infrastructure that businesses require for integrating their applications with your product. The integration your product with other systems across organizational boundaries or business is made possible, regardless of the platforms or operating system used. XAI provides an integration platform that enables the following:

- Integrate with Customer Relationship Management (CRM) systems
- Provide information feeds for web based customer portals
- Fit seamlessly with web based applications
- Facilitate fast implementation of batch interfaces
- Integrate with other XML compliant enterprise applications

XAI exposes system business objects as a set of XML based web services. The service can be invoked via different methods, e.g., Hypertext Transfer Protocol (HTTP) or Java Message Service (JMS). Consequently, any application or tool that can send and receive XML documents can now access the rich set of system business objects. Business-to-Business (B2B) or Business-to-Consumer (B2C) integration with other enterprise applications as well as the setup of web portals is made very simple and straightforward.

## XAI Architecture

The XAI architecture contains 3 major components:

- The Core Server Component
- The Multi Purpose Listener (MPL)
- The Client Component

## The Core Server Component

The core server component is responsible for receiving XML requests, executing the service and returning the response to the requester.

The following diagram shows the XAI tool operating on a web server and providing integration between the system business objects and various external applications.

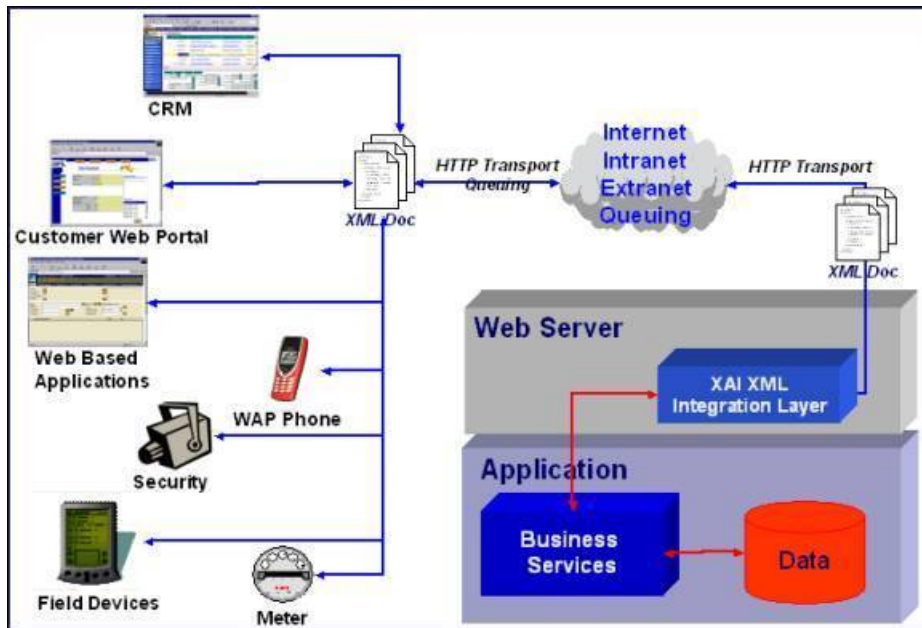

The core is built in Java, using a layered, scalable architecture. The basic transport protocol supported by the core is SOAP/HTTP.

---

**FASTPATH:** Refer to [SOAP](#) for more information.

---

The XAI core server provides a Java servlet to process requests through HTTP. You may also use other messaging mechanisms such as message queuing, publish/subscribe or a staging table. The multi-purpose listener processes the messages.

## The Multi Purpose Listener (MPL)

---

**NOTE:** Multi Purpose Listener functionality is legacy functionality that is not recommended going forward. The Oracle Service Bus (OSB) is the recommended tool. This section remains in place for upgrade purposes.

---

The Multi Purpose Listener (MPL) is a multi-threaded Java server that constantly reads XML requests from various external and internal data sources, such as a Java Message Service (JMS) message queue, a JMS topic or system staging tables.

The MPL can be used to process inbound messages (those sent by an external application to invoke a system service), or outgoing messages (those sent by your product to external applications). The MPL uses different receivers to process messages from different data sources.

A receiver is implemented using 3 distinct layers:

- The Receiving Layer
- The Execution Layer
- The Response Layer

## The Receiving Layer

This layer deals with polling various locations to determine if new records, files or incoming requests exist. The various locations include:

- Staging tables, including [XAI staging control](#), [XAI upload staging](#), notification download staging (certain products only), and [outbound message](#).

- An external directory that contains a file, for example a comma delimited file or an XML file.
- A JMS queue/topic.

A separate receiver is defined to read requests from each of these locations. When the MPL server starts, it looks for all defined active receivers in the [XAI Receiver](#) table, and for each receiver it starts a thread that constantly fetches messages from the message source.

Once a request message is read, it is passed to an execution thread that implements the execution layer. Each receiver references an [Executer](#) that is responsible for executing the request.

## Configuring Multiple MPL Servers

A single MPL server may only run one of each of the above staging table receivers for a given JDBC connection. To enhance the performance of the processing of the staging tables, you may define multiple MPL servers where each one runs the active receivers defined in the receiver table.

To ensure that each staging table receiver processes its own set of records in the staging table, the receiver selects a set number of records (specified as [Message option](#) **Number of Records an MPL Receiver Will Process At a Time**) and marks those records with the IP address and port number of the MPL.

## The Execution Layer

The execution layer sends the XML request to the [XAI core server](#) and waits for a response.

---

**NOTE:** Currently the only type of [executer](#) supported is the XAI servlet running either on an XAI server or locally under the MPL. However the architecture allows for executing a request on other execution environments.

---

The executer is invoked and is passed in an [XAI Inbound Service](#) that specifies an XML request schema and an [adapter](#). Adapters tell XAI what to do with a request. The adapters point to a specific Java class that renders a service.

For example you can configure an Adapter to invoke any published application object (by pointing it to the appropriate java class). This adapter accesses system objects through the page service. You can think of an adapter as a plug-in component.

Once the executer processes the request and a response is received, it is transferred to the next layer, the [response](#) layer.

## The Response Layer

The response layer is responsible for "responding" to the execution. The responses are handled by invoking an appropriate sender defined on the receiver's response information. Each sender defined in the system knows how to process its response. For example:

- The JMS queue sender and the JMS topic sender post responses to the appropriate queue / topic.
- The [staging control sender](#) handles errors received during the execution of the staging control request.
- The [upload staging sender](#) updates the status of the upload staging record based on the success or failure of the staging upload request.
- The download staging sender is a bit unusual because it is helping to build the message being sent (Oracle Customer Care and Billing only).

---

**NOTE:** There are some cases where a response is not applicable. For example, the file scan receiver creates a staging control record to process a file that exists in a directory. There is no "response" applicable for executing this request.

---

## The XAI Client Component

The XAI Client component is the set of online control tables and tools used to manage your XAI environment.

The [Schema Editor](#) is a tool used to create and maintain XAI schemas.

---

**FASTPATH:** Refer to [XAI Schema](#) for more information.

---

The **Registry** is a term used to refer to all the tables required to "register" a service in the system. It includes the [XAI Inbound Service](#) and a set of control tables defining various options.

The [Trace Viewer](#) is installed with your XAI client tools and is used to view traces created on the XAI server.

## XML Background Topics

The following section introduces some background information related to XML.

## XAI Schemas

---

**NOTE: Business Adapter.** The **BusinessAdapter** adapter supports communication to configuration tool objects: [business objects](#), [business services](#) and [service scripts](#) through their own schema API. When communicating to these objects, it is not necessary to create XAI schemas for the schemas associated with the objects. As a result, there is no need to use the XAI schema editor when defining [XAI Inbound Services](#) for this adapter.

---

At the core of XAI are XML web services based on XML schemas. XML schemas define the structure of XML documents and are the infrastructure of e-business solutions. They are used to bridge business applications and enable transaction automation for e-commerce applications. Industry standard schemas document common vocabularies and grammars, enhancing collaboration and standardization. Validating XML processors utilize XML schemas to ensure that the right information is made available to the right user or application.

The system exposes its application objects as XML schemas that define the interface to system services. Every service (e.g., CreatePerson or AccountFinancialHistory) is defined using a pair of schemas: the Request Schema and the Response Schema. The request and response schema can be identical.

The Request Schema defines the XML document structure describing the "inputs" for a service.

The Response Schema defines the XML document structure describing the "outputs" of a service.

## The Schema Editor

---

**CAUTION:** This schema editor is a separate legacy tool that is no longer recommended. The documentation remains for upgrade purposes

---

To facilitate the process of exposing business objects as XML schemas, we use the Schema Editor, a graphical tool to create, import and maintain schemas. The Schema Editor provides automated wizards to import schemas residing in existing data structures and documents. The Schema Editor can import schemas from the following sources: system business objects, ODBC data sources, sequential files.

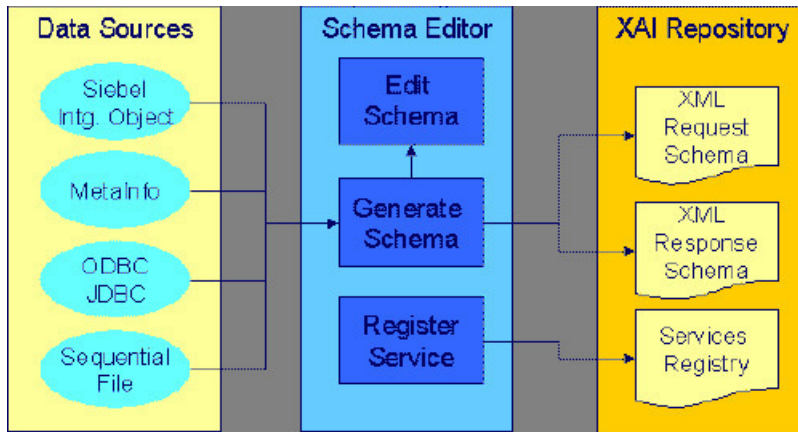

Before the XAI tool can use a service, it must be registered or published.

---

**FASTPATH:** Refer to [Schema Editor](#) for more information.

---

## XSL Transformations

XSL Transformations (XSLT) is a language used to transform an XML document into another XML document or another document format such as HTML. It is part of the Extensible Stylesheet Language (XSL) family of recommendations for defining XML document transformation and presentation. It is defined by the World Wide Web Consortium (W3C) and is widely accepted as the standard for XML transformations. Several tools are available on the market to generate XSLT scripts to transform an XML document defined by a source schema to an XML document defined by a target schema.

In XAI you can use XSL to:

- Transform an inbound message into the structure required by the XAI request schema for that service.
- Transform the response to an inbound message into a format defined by a schema provided by the requesting application.

---

**FASTPATH:** Refer to [XAI Inbound Service](#) for more information.

---

- Transform an outgoing message before it is sent out.

---

**FASTPATH:** Refer to [XAI Route Type](#) for more information.

---

- Transform data from an external source before it is loaded into the staging upload table.

---

**FASTPATH:** Refer to [XAI Inbound Service Staging](#) for more information.

---

## SOAP

SOAP stands for Simple Object Access Protocol. The SOAP "Envelope" is the wrapping element of the whole request document that may be used by messages going through the XAI tool.

The following diagram shows a simple XML request using the SOAP standard.

```

<SOAP-ENV:Envelope>
  <SOAP-ENV:Header>
    <CorrelationID>1234</CorrelationID>
    <SOAPActionVersion>1.2</SOAPActionVersion>
  </SOAP-ENV:Header>
  <SOAP-ENV:Body>
    <CISAccount transactionType='Read'>
      <CISAccountService>
        <CISAccountHeader
          AccountID='1234'
        />
      </CISAccountService>
    </CISAccount>
  </SOAP-ENV:Body>
</SOAP-ENV:Envelope>

```

## XPATH

The XML Path Language (XPath) is an expression language used by XSLT to access or refer to parts of an XML document. It is part of the XSL recommendations maintained by the W3C. XPath provides the syntax for performing basic queries upon your XML document data. It works by utilizing the ability to work with XML documents as hierarchically structured data sets.

In the following XML document, some examples of XPath references are:

- authors/author/name
- authors/\*/name
- authors/author[nationality]/name
- authors/author[nationality='Russian']/name
- authors/author[@period="classical"]

```

<?xml version='1.0'?>
<authors>
  <author period="classical">
    <name>Sophocles</name>
    <nationality>Greek</nationality>
  </author>
  <author>
    <name>Leo Tolstoy</name>
    <nationality>Russian</nationality>
  </author>
  <author period="classical">
    <name>Plato</name>
    <nationality>Greek</nationality>
  </author>
</authors>

```

In the XAI tool, XPath is used to construct outgoing messages.

## Server Security

XAI server security supports the basic HTTP authentication mechanism as well as web service security (WS-Security) to authenticate the user requesting service. When authenticating using WS-Security, the SOAP header contains the authenticating information.

The base package provides two XAI server URLs, one that uses basic HTTP authentication ('/classicxai') and another that supports both methods ('/xaiserver'). Regardless of which authentication method is practiced, it is the latter you should



expose as your main XAI server. The main XAI servlet gathers authentication information from the incoming request (HTTP or SOAP header) and further calls the internal ("classic") servlet for processing.

The "classic" XAI server security uses the basic HTTP authentication mechanism to authenticate the user requesting service. It assumes the requester has been authenticated on the Web server running the XAI servlet using the standard HTTP (or HTTPS) basic authentication mechanism. The authenticated user-id is passed to the application server, which is responsible for enforcing application security. This requires the system administrator to enable basic authentication for the Web server running the XAI servlet. To enable HTTP basic authentication, the XAI server '/classicxai' should be defined as a url-pattern in the web resource collection in the web.xml file. When the XAI server is not enabled for basic authentication, it transfers the user-id specified on the **Default User** [Message Option](#) to the application server.

By default, the system would always attempt to further authenticate using SOAP header information. This is true even if the request has already been authenticated via the Web server. Use the **Enforce SOAP Authentication** [Message Option](#) to override this behavior so that a request that has been authenticated already by the Web server does not require further authentication by the system.

If SOAP authentication information is not provided, the system attempts to authenticate this time using information on the HTTP header. You can force the system to solely use SOAP authentication using the **Attempt Classic Authentication** [Message Option](#).

Currently the system only supports the standard *Username Token Profile* SOAP authentication method where "Username", "Password" and "Encoding" information is used to authenticate the sender's credentials. The following is an example of a *Username Token Profile* in a SOAP header:

```
<SOAP-ENV:Envelope xmlns:SOAP-ENV = "urn:schemas-xmlsoap-org:envelope">
<SOAP-ENV:Header xmlns:wsse="http://www.w3.org/2001/XMLSchema-instance">
<wsse:Security>
<wsse:UsernameToken>
<wsse:Username>MYUSERID</wsse:Username>
<wsse:Password Type="PasswordText">MYPASSWORD</wsse:Password>
</wsse:UsernameToken>
</wsse:Security>
<SOAPActionVersion>2.0.0</SOAPActionVersion>
</SOAP-ENV:Header>
<SOAP-ENV:Body>
...
</SOAP-ENV:Body>
</SOAP-ENV:Envelope>
```

By default both user and password are authenticated. You can use the **System Authentication Profile** [Message Option](#) to change this.

---

**NOTE: Custom authentication.** You can override the base package user credentials authentication logic using the **System Authentication Class** [Message Option](#).

---

## Inbound Messages

Inbound messages are XML messages sent by an external application to invoke a system service. Inbound messages can be sent one at a time or in batches of several messages in a file. Third party integration points can import web services for inbound service calls. The standard method of doing this is by publishing a WSDL (Web Service Definition Language) definition for each exposed service.

## Synchronous Messages

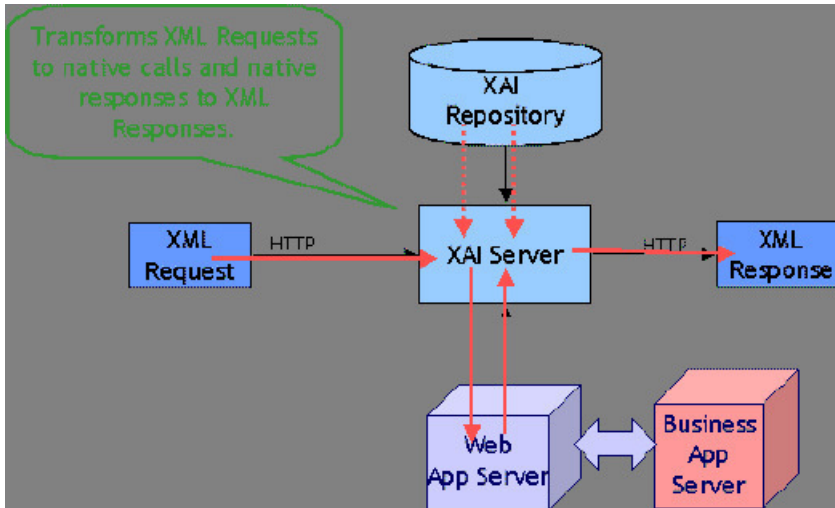

Synchronous service requests are sent using the HTTP protocol to the XAI servlet, which runs under a web application server such as WebLogic.

- The service request XML document must conform to the request schema that defines the service.
- The XAI servlet on the web server receives the service request XML document and based on the service name in the document identifies the appropriate XAI Inbound Service. Once the service is identified, the XAI servlet accesses the XAI Inbound Service record to find out the properties of the service.
- Based on the service properties, the XAI module loads the request and response schemas from the schemas repository (and caches them in memory).
- Based on the Adapter referenced by the service, it calls the appropriate adapter. The adapter performs most of the work to service the request.
  - The adapter connects to the application server, based on the connection information in the registry control tables.
  - It then parses the request document using the request schema.
  - Once the request document has been validated, the adapter converts the XML request document into a call to the application server.
- The response returned by the application server is then converted into a service response XML document, based on the response schema.
- The XML response document is shipped back to the caller over HTTP.

## Using HTTP for Synchronous Service Execution

Invoking a service is not much different from sending a regular HTTP request. Here the HTTP request contains the XML as a parameter. The XAI server handling requests via the HTTP protocol is implemented using a Java servlet running on the web server.

### Microsoft Visual Basic/C Example

Microsoft provides an easy way to send XML requests over HTTP. To send and receive XML data over HTTP, use the Microsoft XMLHTTP object

```
set xmlhttp = createObject("Microsoft.XMLHTTP")
xmlhttp.Open "POST", http://localhost:6000/xaiserver, false
```

```
xmlhttp.Send XMLRequest
```

```
XMLResponse = xmlhttp.ResponseText
```

Here **http://localhost:6000/xaiserver** is the URL of the XAI server. **XMLRequest** contains the XML request to be processed by XAI and **XMLResponse** contains the XML response document created by the XAI runtime.

Java Example

Java provides a very simple way to send a request over HTTP. The following example shows how a request can be sent to XAI from an application running under the same WebLogic server as the one XAI runs. In this example, we use the "dom4j" interface to parse the XML document.

```
import com.splwg.xai.external.*;
import org.dom4j.*;
String xml;
xml = "<XML request>";
XAIHTTPCallForWebLogic httpCall = new XAIHTTPCallForWebLogic();
String httpResponse = httpCall.callXAIServer(xml);
Document document = DocumentHelper.parseText(httpResponse);
```

## Asynchronous Messages

Various types of [receivers](#) running under the MPL server (rather than the XAI server) handle asynchronous inbound messages from several sources.

Requests may be received via the following:

- MQSeries, TIBCO or any JMS compatible messaging system
- The XAI Upload Staging table

The response is returned to the JMS queue/topic or to the staging table.

---

**FASTPATH:** Refer to [Designing XAI Receivers](#) for more information about the different receivers provided by the product for the different data sources.

---

The following diagram shows the flow for asynchronous inbound messages.

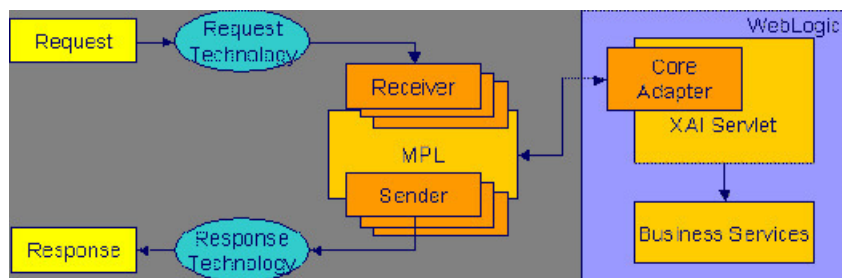

## Using JMS

Java Message Services (JMS) is a standard Java Enterprise Edition (Java EE) protocol to send/receive asynchronous messages using a queue or topic message protocol.

XML messages may be received and sent via JMS using either a JMS Queue or JMS Topic. In order to access a JMS provider such as MQSeries, TIBCO or WebLogic, the MPL must first connect to the appropriate server using a JMS Connection.

The following diagram depicts a message sent and received through a JMS Queue.

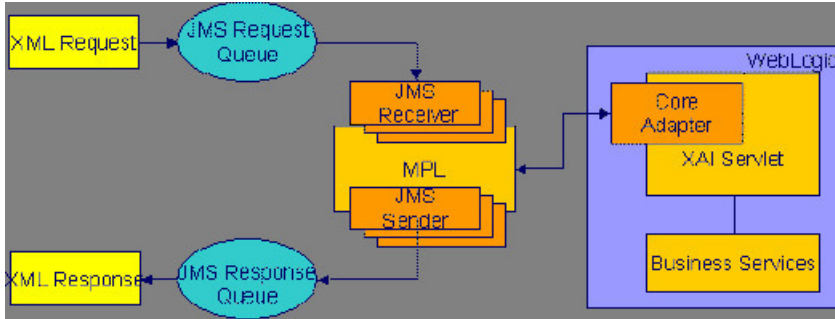

## Using JMS Queues

JMS Queues are used to receive and send messages using the message queue protocol. Products that support this protocol include MQSeries.

The following describes events that take place when a JMS queue is used:

- The requester places the XML request message on a JMS queue. The request contains both the XML message and the name for the *reply queue*.
- The **JMS Queue Receiver** waits for messages on that queue. When the message arrives it is selected from the queue and executed using the adapter for the requested service.
- The XML response message is placed on the reply queue specified in the request. It is the requester's responsibility to fetch the response message from the queue.

The MPL uses a **JNDI server** to locate the queue resource.

## Using JMS Topics

JMS Topics are used to send and receive messages using the publish/subscribe messaging model. Products that support this protocol include TIBCO, MQSeries and WebLogic.

The MPL uses a JNDI server to locate the topic resource.

- Define a **JMS Topic receiver**, listening to a predefined JMS Topic.
- The other application builds an XML message based on the schema defined for that service.
- It sends the XML request to the predefined topic and specifies the reply topic name.
- The MPL reads the message from the Topic, executes the service and returns the response to the reply topic specified in the inbound message.

## Staging Upload

The system provides a staging table, where an interface can store XML requests to perform a service in the system.

Some external systems interfacing with the system are not able to produce XML request messages. Or you may have external systems that produce XML messages but the messages are sent in a batch rather than real time. The system provides the capability to read an external data source containing multiple records, map the data to an XML request and store the request on the **XAI upload staging** table. These records may be in XML requests, sequential input files or database tables.

The XAI upload staging table may be populated in one of the following ways:

- When a collection of messages in a file or database table must be uploaded, a [staging control](#) record should be created for each file/database table. The [Staging Control Receiver](#) processes each file or database table and creates records in the XAI upload staging table for each message.
- The [XML File Receiver](#) creates records directly in the XAI upload staging table. Note, in addition, the XML File Receiver creates a staging control record to group together these records.
- XAI creates records in the XAI upload staging table for [inbound messages in error](#) that are configured to post the error.
- It is possible that when a response to a notification download staging message is received (Oracle Customer Care and Billing only), the response requires some sort of action. If this is the case, the system creates an XAI upload staging record (and an XAI staging control record) for the response.

## Staging Upload Receiver

Once the XML requests are in the staging table, the [Staging Upload Receiver](#) reads the requests from the XAI upload staging table and invokes the XAI server (via the executor) with the appropriate XAI inbound service. Inbound service records typically point to the core [adapter](#) used to invoke system services.

## Staging Upload Sender

The staging upload sender handles "responses" to the execution of the message in XAI upload staging. If the execution is successful, the sender updates the status of the upload staging record to **complete**. If the execution is unsuccessful, the sender updates the status to **error** and creates a record in the [XAI upload exception](#) table.

---

**NOTE: Configuration required.** The above explanation assumes that you have correctly configured your upload staging receiver to reference the upload staging sender. Refer to [Designing Responses for a Receiver](#) for more information.

---

## Staging Control

The [staging control](#) table is used to indicate to XAI that there is a file or table with a collection of records to be uploaded. The special [Staging Control Receiver](#) periodically reads the staging control table to process new records.

The XAI staging control table may be populated in one of the following ways:

- To process a specific sequential input file, manually create a staging control record and indicate the location and name of the file and the XAI inbound service to use for processing. Use this mechanism to process ad-hoc uploads of files.
- If a file is received periodically, you may define a [File Scan Receiver](#), which periodically checks a given file directory for new files. The file scan receiver creates a new staging control record to process this file.
- The [XML File Receiver](#) processes a file containing a collection of XML messages to be uploaded. The XML file receiver creates a staging control record and creates records directly into the XML upload table. The staging control record is automatically set to a status of **Complete** and is used to group together the XML upload records. Refer to [Processing Staging Upload Records for a Staging Control](#) for more information.
- To upload records from a database, manually create a staging control record and indicate an appropriate XAI inbound service, which contains the information needed by the system to access the appropriate table. Use this mechanism to process ad-hoc uploads of files.

---

**NOTE:** To upload records from a database table, you must create a staging control record. There is no receiver that periodically looks for records in a database table.

---

- Whenever an [XAI upload staging](#) record is created, an XAI staging control record is created as well.

---

**FASTPATH:** Refer to [Batch scenarios](#) for more information about configuring the system to populate the staging control with requests from external files.

---

## Staging Control Receiver

The Staging Control [Receiver](#) processes staging control records and invokes XAI (via the executor) to execute the request. The executor uses the appropriate adapter to generate records in the [XAI Upload Staging](#) table - one for each record in the file or table.

The diagram below illustrates the information used by the staging control receiver to load data onto the staging table from a sequential input file.

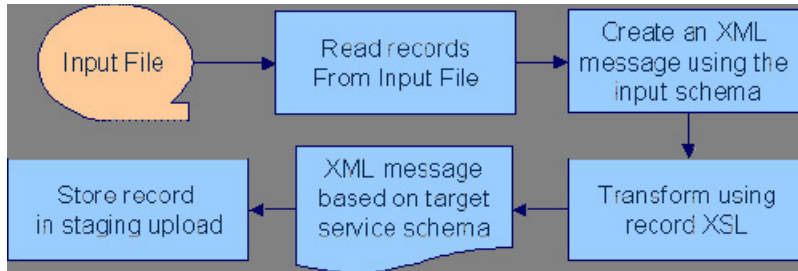

The staging control [adapter](#) does the actual work. It reads the individual records in the input file and applies the XSL transformation script indicated on the XAI inbound service record to the input data to produce an XML request in the XAI upload staging table.

## Processing Staging Upload Records for a Staging Control

In some cases, a process may populate records directly into the XML staging upload table. An example of such a process is the [XML File Receiver](#). In this case, a staging control record is also created and used to group together the staging upload records.

The staging control contains information needed to process a group of staging upload records:

- The user related to these records. This user is for application security purposes. The user indicated here must have the proper rights for the application service and transaction type to be executed by XML upload records processed for this staging control.
- An indication of whether or not the records should be processed [sequentially](#).

## Processing Staging Records in Sequential Order

In some cases, a collection of messages uploaded together in a file must be processed in the order the messages are received. For example, if messages to add a person and add an account for this person are received together, the message to add the person must be processed before the message to add the account.

If messages received in a file must be processed sequentially, turn on the Sequential Execution switch on the [staging control](#) record. When the staging control receiver creates records in the XML upload table, the identifier of each record is built as a concatenation of the staging control record and a sequential number. If your staging control record indicates that the XML upload records should be processed in sequential order, the records are processed in primary ID order.

---

**NOTE: Non-sequential processing.** If your staging control does not indicate that the related XML records should be processed in sequential order, the records are processed by the staging control receiver using a random, multi-threaded mechanism.

---



If you have defined a [receiver](#) to periodically search for files and populate records in the staging control table, you may turn on the Sequential Execution switch on the receiver. This ensures that records processed as a result of this receiver are executed in sequential order.

## Staging Control Parameters

If your staging control accesses the data from a database table, you have the capability of defining the selection criteria. [XAI inbound services](#) that reference the **CISStagingUpload** adapter may contain a collection of fields that are used in an SQL WHERE clause. When adding a new [XAI Staging Control](#) record, you can define the values for the WHERE clause.

For example, imagine that you have a work management system where new premises are defined. Rather than waiting for this system to "push" new data to you, you design the interface to have the system "pull" the new data by looking directly at the "new property" database table.

The Request XML for your XAI service contains SQL statements used to access the data. You could define a Staging Control Parameter of "Add Date". When creating your staging control, you may enter a parameter value of today's date. When this record is processed, it only retrieves new properties from this work management table whose Add Date is today.

The following example shows part of the Request XML schema for an XAI Service that SELECTs premises based on postal code.

```
- <Schema xmlns="urn:schemas-microsoft-com:xml-data" xmlns:dt="urn:schemas-microsoft-com:datatypes" xmlns:d="urn:schemas-microsoft-com:datatypes" xmlns:b="urn:schemas-microsoft-com:BizTalkServer" b:root_reference="TestDuplicatePremise">
- <ElementType name="TestDuplicatePremise" content="eltOnly">
  <b:property name="adapter">CISStagingUpload</b:property>
  <b:property name="stagingUploadType">DB</b:property>
  <element type="Request" />
  <element type="Response" />
</ElementType>
- <ElementType name="Request" content="eltOnly">
  <AttributeType name="Postal" d:type="string" d:maxLength="12" />
  <b:RecordInfo />
  <attribute type="Postal" />
</ElementType>
- <ElementType name="Response" content="eltOnly">
  <b:RecordInfo />
  <element type="Premises" />
</ElementType>
- <ElementType name="Premises">
  <b:RecordInfo />
  <b:property name="SQL">SELECT PREM_TYPE_CD, KEY_SW, OK_TO_ENTER_SW,
TREND_AREA_CD, ADDRESS1, MAIL_ADDR_SW, POSTAL FROM CISADM.CI_PREM WHERE
POSTAL = @TestDuplicatePremise/Request/Postal</b:property>
  <b:property name="tableName">CISADM.CI_PREM</b:property>
- <AttributeType name="PREM_TYPE_CD" d:type="string" d:maxLength="000">
  <b:property name="dataType">string</b:property>
  <b:property name="uniqueId">PREM_TYPE_CD</b:property>
  <b:FieldInfo />
</AttributeType>
- <AttributeType name="KEY_SW" d:type="string" d:maxLength="001">
  <b:property name="dataType">string</b:property>
  <b:property name="uniqueId">KEY_SW</b:property>
```

The postal code value to substitute into the WHERE clause is defined on the individual XML Staging Control records.

---

**FASTPATH:** Refer to [XAI Staging Control](#) for more information.

---

## Staging Control Sender

Before the staging control receiver invokes the executor, it changes its status to **complete**, assuming that there will be no problems. If the executor detects an error condition, the staging control sender updates the status of the staging control record to **error** and removes any XAI upload staging records that may have been created.

---

**NOTE: Configuration required.** The above explanation assumes that you have correctly configured your staging control receiver to reference the staging control sender. Refer to [Designing Responses for a Receiver](#) for more information.

---

## Inbound Message Error Handling

For messages that are processed using the [staging upload](#) table, application errors that prevent XAI from successfully processing the message cause the staging record to be marked in error and highlighted via a To Do entry.

For messages that are not processed via staging upload, your implementation should consider what should happen to application errors. If the origin of the message is able to handle an immediate error returned by XAI, then no special configuration is needed. An example of this is an HTTP call to our system where the originator of the message is waiting for a real-time response.

Otherwise, for messages where errors should not be returned to the originator, but should be highlighted in this system for resolution, be sure to mark the **Post Error** switch on the [XAI inbound service](#). When this switch is turned on and an application error is received by XAI when processing the message an [XAI upload staging](#) record is created (along with a staging control record) and marked in **error**.

For example, if a message is received via a JMS queue, application errors that prevent XAI from processing the message should not be returned to the queue because there is no logic to route the error to the sending system.

## Integration Scenarios

### Integration Using an EAI (or Hub)

It is possible for your various systems to be integrated with each other using a hub. The hub is implemented using an Enterprise Application Integration (EAI) tool provided by a third party vendor. Most hubs support HTTP and/or JMS and can work with XML schemas or document type definitions (DTDs).

- XAI services are presented to the EAI tool as schemas or as DTDs, immediately making the system callable from the hub.
- Integration scripts or workflow processes are defined in the EAI tools.
- At run time the hub uses HTTP or JMS to access the system using inbound messages.
- Outgoing messages are used to notify the hub about events occurring in the system. The messages are sent using HTTP or JMS.

### Batch Scenarios

Messages may be sent in batch files, or may be retrieved from a database. In all cases, the system needs to be able to read the file and identify each individual message in order to create an XML request that can be processed by the XAI server. Once each individual message is identified, a request is stored on the XAI Staging Upload table for later execution.

### XML Message File

It is possible for you to receive a file containing a collection of XML messages. The system identifies each separate message within the file and creates an entry for each message on the XAI upload staging table. It also creates a staging control record to group together each newly created XAI upload record. This staging control is created in **Complete** status and is not processed by the staging control receiver.

Since external applications may send messages in a format unknown to XAI, the system needs a mechanism for identifying the messages and mapping them to an XAI service.



## XAI Groups

First the system associates the entire XML file with an XAI Group. You can think of the XAI Group as a categorization of the collection of messages. For example, you may have a separate XAI Group for each third party who sends you a collection of XML messages.

The system uses an [XPath](#) and XPath value to identify the correct XAI Group for the XML file.

## Attachments and Rules

After identifying the appropriate group to which an XML file belongs, the system takes each message in the file and applies the appropriate XSL transformation to the message to produce a record on the upload staging table.

To process the messages in a file, the system needs to know how to identify each message in a file containing multiple messages. A file may use the same root element for each message or different root elements for different types of messages. For each XAI group, you must indicate the root element(s) that identifies a message by defining one or more attachments. Each attachment defines a root element, which tells the system when a new message begins.

Once the system has identified each separate message in the file, it must determine the correct XSL transformation script to apply. Once again the system uses an [XPath](#) and XPath value to identify the correct XSL to apply. For each XAI group, you define one XAI rule for every possible type of message you may receive in the file. Each XAI rule defines an XPath, XPath value and XSL transformation script.

Note you may assign a priority to each of your rules. The rules for more common messages may be assigned a higher priority. This enhances performance by ensuring that rules for more common messages are processed before rules for less common messages.

---

**NOTE: Include parent elements.** If the XML message includes parent elements (such as a transmission id or a date/time) that are needed for any of the separate child messages that are posted to the upload staging table, you can configure the appropriate attachment to include **parent** elements.

---

---

**FASTPATH:** Refer to [Designing an XML File Receiver](#) for more information about defining receivers that process XML files.

---

## Sequential Input File

You may receive messages in a sequential input file, such as a comma-delimited file.

The following steps should be performed when configuring the system to enable data to be uploaded from an input file into the staging upload table:

1. Create an XML Schema that describes the records in the sequential input file.
2. Create the XSLT transformation that maps a record in the input file to an XML service request in your product.
3. Create an [XAI service](#) representing the batch process that loads the input file into the staging table.
4. If desired, create a new file scan receiver, which waits for an input file to appear in a particular directory. (If you do not take this step, then you need to create a [staging control](#) when you want a file to be processed.)

---

**NOTE: Character Encoding.** If the file is encoded with a specific character encoding, you may indicate the encoding as part of the file name to be uploaded. If the file name ends with **?enc=?x**, where x is the file character encoding, the adapter processes the file accordingly. For example, the file name may be specified as **premiseUpload.csv?enc=?UTF-8**. If the encoding is not specified as part of the file name and the file is in UTF-16 or UTF-8 with byte order mark, then the adapter can recognize the encoding.

---

## Database File

It is possible for you to define an interface where inbound messages are retrieved by reading records in a database table.

The following steps should be performed when configuring the system to enable data to be uploaded from a database table into the staging upload table:

- Create an XML Schema that describes the records in the database table.
- Create the XSLT transformation that maps a record in the database table to an XML service request in your product.
- Create an [XAI service](#) representing the process that loads the records from the database table into the staging table.

## WSDL Catalog

Web Service Definition Language (WSDL) is a language for describing how to interface with XML-based services. It acts as a "user's manual" for Web services, defining how service providers and requesters communicate with each other about Web services.

The base package provides the ability to publish a WSDL definition for each service exposed as an [XAI Inbound Service](#). In addition, it is possible to request a catalog of all the XAI Inbound Services and a link to each WSDL. To view the catalog, launch a new browser session and enter the URL **http://\$host:\$port/XAIApp/xaiserver?WSDL** where \$host and \$port are replaced by the appropriate values for the current environment.

## Outgoing Messages

This section describes outgoing message functionality related to MPL, which is no longer recommended.

- Outbound messages. As described in [Outbound Messages](#), outbound messages are supported for sending outgoing messages. This functionality includes support that is only related to MPL.
- Notification download staging (NDS) messages. This method is only supported by *Oracle Utilities Customer Care and Billing*. Using this method near real-time, a record is written to the NDS staging table referencing only key fields. MPL then polls the records, invokes a service to build the message, applies the XSL and routes the message. If sent real-time, no record is posted to the staging table but rather the message dispatcher routes the message immediately. Refer to Oracle Utilities Customer Care and Billing help, Workflow and Notifications, Notification and XAI for more information.

The following sections describe the outbound messages topics specific to MPL in more detail.

## Outbound Message Receiver

The outbound message [receiver](#) processes records in the outbound message table that have a processing method flag equal to **XAI** and a status of **pending** and changes the status to **in progress**. The receiver then retrieves the message XSL and the message sender defined for the external system / outbound message type.

---

**NOTE: Template external system.** If the outbound message's external system references a template external system, the outbound message type configuration for the template external system is used.

---

It applies the message XSL (if supplied). If the option to [validate outbound message schemas](#) is turned on, the schema validation is performed.

Refer to [Outbound Message Error Handling](#) for information about error handling.

If no errors are received, control is turned over to the [outbound message sender](#) for routing.

---

**NOTE: Initialization of receiver.** During the initialization of this receiver (for example if there is a problem with MPL and it is restarted) any records that are found to be **in progress** are changed to **pending** so that those messages are sent properly.

---

## Lifecycle of Outbound Message

The outbound message receiver processes outbound message records based on their status. The following diagram describes the lifecycle of an **XAI** type outbound message.

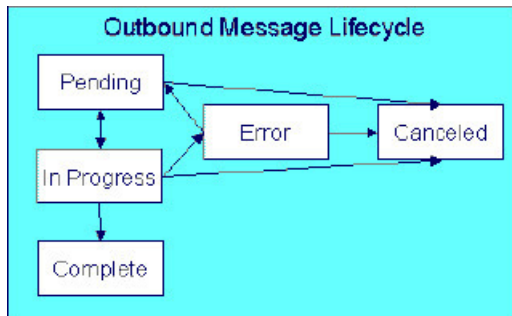

- Records are created in **pending** status.
- The outbound message receiver processes pending records and changes the status to **in progress**.
- If the message is sent successfully the system changes the status to **complete**.
- If there was a problem sending the message the system changes the status to **error**.
- When the user resolves the error they can change the status back to **pending**.
- A user can change the status of a **pending** or **error** record to **anceled**.
- For the rare cases where there is a problem with MPL and a message is left in the status **in progress**, users may manually change the status to **anceled**. In addition the outbound message receiver includes a step at startup to find **in progress** messages and change them to **pending**.

## Outbound Message Sender

The outbound message sender is responsible for routing the message to the [Message sender](#) determined by the receiver. If the routing is successful the outbound message status is marked **complete**. If the routing is unsuccessful, the status is marked in **error**.

Refer to [Outbound Message Error Handling](#) for information about error handling.

---

**NOTE: Automatic Resend.** If you have configured the system for [automatic resend](#) and the system detects that the error is due to the sender being unavailable, the message remains in **pending** status.

---

**NOTE: Configuration required.** The above explanation assumes that you have correctly configured your outbound message receiver to reference the outbound message sender. Refer to [Designing Responses for a Receiver](#) for more information.

---

## Outbound Message Error Handling

If the outbound message receiver or the outbound message sender detects an error while attempting to process the outbound message, it marks the message in **error**, captures the error message and its parameter values and creates a To Do entry using the To Do type specified in the Message option **To Do Type for Outbound Message Errors**.

A separate background process [F1-DTDOM](#) is responsible for completing To Do entries for outbound messages no longer in **Error**.

## Automatic Resend

If a system error is received by the MPL when attempting to route the message to a sender, (using the outbound message method or the NDS message method), the system marks the appropriate table in **error**. This is true even if the reason for the error is that the connection to the sender is unavailable. When the connection is restored, a user must change the status of the appropriate record to **pending** (for outbound messages) or **retry** (for NDS messages) in order for the message to be resent.

Alternatively, you can configure your system to attempt to automatically resend the message. This section describes the logic available for auto resend. To enable automatic resend, you must set the flag **Automatically Attempt Resending to Unavailable Senders** on [Message option](#) appropriately.

If an error is received by the MPL when it attempts to invoke a sender and the auto resend option is on, the system does not mark the record in **error**. It continues to attempt sending messages to the sender until the number of errors has reached a predefined maximum error number (defined as an [Message option](#)). When the maximum is reached, the sender is marked as **unavailable** and an MPL log entry is created. The MPL ignores messages for **unavailable** senders.

The system tries to resend messages to this sender the moment the sender is reset to be **available**. The following points describe how a sender becomes **available**:

- MPL attempts to retry sending messages to unavailable senders every X minutes, where X is defined on [Message option](#).
- On MPL startup all senders are marked as **available**
- A user may navigate to the [XAI Command](#) page and issue a command **MPL Refresh Sender** to refresh the cached information for a particular sender

## Designing Your XAI Environment

This section guides you through the steps required to design the tables that control your XAI processing.

### Installation

The XAI server is installed with default configuration. This section describes how you may customize the XAI server configuration.

Startup parameters are defined in two parameters files

- The XAIParameterInfo.xml file is used by the XAI HTTP server. This file is found within the XAI directory in the path (...\\splapp\\xai).
- The MPLParameterInfo.xml file is used by the MPL server. This file is found within the XAI directory in the path (...\\splapp\\mpl).

Both files store the parameters as XML files with the following elements (sections):

- Source
- ParameterVariables
- AdHocParameters

### The XAI Source Section

The XAI tool accesses XAI [registry](#) information through the standard system programs. The <Source> section in the XAIParameterInfo.xml file tells XAI the user ID for accessing the registry information. It contains the following attributes:

Attribute Name	Description
Source Type	This should be set to <b>CorDaptix</b> , which tells XAI to access the registry through the standard access to system programs.
CorDaptixUser	The user ID to use when accessing the registry data.

## The MPL Source Section

The `<Source>` section in the `MPLParameterInfo.xml` file defines the database connection information used to connect to the database storing the XAI table information. It contains the following attributes:

Attribute Name	Description
Source Type	Defines the source of the data, for example <b>ORACLE</b> or <b>DB2</b> .
jdbcURL	The URL used to connect to the product database. For example: <b>jdbc:oracle:thin:@//server-name:1234/DBNAME</b>
databaseUser	The Oracle User Id used to connect to the database.
databaseUserPassword	The Oracle password used to connect to the database.

## The Parameter Variables Section

When defining values for fields in certain control tables in the registry, you may reference substitution variables that point to the `<ParameterVariables>` section of the installation files. Substitution variables provide for dynamic substitution of values based on parameters provided at server startup.

To specify a substitution parameter in a string value you enter the name of the substitution parameter enclosed with @.

For example if you have a field in the XAI control tables that should contain the URL for the XAI HTTP servlet, you could enter the value in the following way: **http://@HOST@:@PORT@/xaiserver**.

In the parameters section, define the appropriate values for these parameters, for example:

```
<ParameterVariables>
<ParameterVariable name="HOST" value="localhost" />
<ParameterVariable name="PORT" value="8001" />
</ParameterVariables>
```

At run time, the system builds the URL as `http://localhost:8001/xaiserver`.

Every substitution parameter is defined using an `<ParameterVariable>` element with the following attributes:

Attribute Name	Description
Name	The name of the substitution parameter
Value	The value to replace an occurrence of the substitution parameter in an XAI control table field

**NOTE:** Substitution parameters can only be used for string fields, and not for fields that are foreign keys to other objects.

## The AdHoc Parameters Section

The `<AdHocParameters>` section is used to provide registry definitions that override the existing ones. Unlike the `<ParameterVariables>` section, a whole registry object definition can be specified in this section. When the XAI server starts, it first reads the registry definitions from the database and then it reads the `<AdhocParameters>` section. If it finds an object definition in this section, it uses it to replace the one read from the database.

Attribute Name	Description
----------------	-------------

Object Name	The object name may be one of the following objects: Option Receiver Sender
Object Attributes	The attributes of the object. Each object type has its own set of attributes:
'Option' object attributes	
name	The option flag. Must be defined in the OPTION_FLG table
value	The value for that option
'Receiver' object attributes	
name	The receiver ID
Class	The JMS provider. May be 'MQ'
TargetClient	The client type writing/reading to the JMS queue/topic. May be 'JMS' or 'MQ'. Only relevant for interfacing with MQSeries
JMSProvider	The JMS provider. May be 'MQ'
TargetClient	The client type writing/reading to the JMS queue/topic. May be 'JMS' or 'MQ'. Only relevant for interfacing with MQSeries
Executer	The XAI Executer ID for this receiver
'Sender' object attributes	
Class	The JMS provider. May be 'MQ'
JMSProvider	The JMS provider. May be 'MQ'
TargetClient	The client type writing/reading to the JMS queue/topic. May be 'JMS' or 'MQ'. Only relevant for interfacing with MQSeries

## Designing XAI Inbound Services

When designing your XAI environment, you should first identify the services that you would like to perform. Determining your services facilitates your design for the other registry options.

The following points highlight how to design your inbound services:

- Determine each service that needs to be performed
- Determine the correct [adapter](#) that is needed by your service.
- Determine the required layout of the request and response messages and specify the request [schema](#) and response [schema](#).
- If a transformation of the data is required, you need to design the appropriate request XSL and response [XSL transformation](#) scripts.
- If the service references the staging upload adapter, determine the staging file type and design the record XSL transformation script. In addition, determine if you want to enter an input file name and interface name. Finally, determine whether or not you need to indicate a special [JDBC connection](#).
- As new releases of the system are installed, it may be necessary to modify your service for the new release. If this is the case, you need to design separate versions of the inbound service.

---

**FASTPATH:** Refer to [XAI Inbound Services](#) for more information.

---

## Designing XML Schemas

You need XML schemas for the services you designed in [Designing XAI Inbound Services](#).

For each message, identify what service you need to invoke and what action you need to perform. If you have multiple actions that you may need to perform for the same service, you may choose to create a single generic XML schema or you may choose to create multiple schemas, which are more specific. For generic messages, the transaction type, indicating the action to perform would be passed in on the XML request document to indicate what must be done. For more specific messages, you may be able to indicate the transaction type directly on the schema and it would not need to be overwritten at run time.

You need to create a response schema for each request schema. It is possible for you to use the same schema for both functions.

---

**FASTPATH:** Refer to [Schema Editor](#) for more information.

---

## Designing XSL Transformations

You need an XSL transformation script for each service you designed in [Designing XAI Inbound Services](#), where you determined a transformation is necessary. In addition, you need XSLT scripts for your outgoing messages. Each sender, which receives a message, probably requires a transformation of the message into a local format. Refer to [Outgoing Messages](#) for more information.

For each message requiring transformation, determine the format used by the external system. In most cases, it is not the same format recognized by the system. For each case, you must create an XSL transformation, which maps the message format from the external format to one expected by your product or from your product format to one expected by the external system.

When identifying the required XSL transformations, remember to take into consideration the data that is processed by the staging control table. This service reads data stored in a file or database table and uses the Record XSL to map the individual records to an individual service request.

---

**FASTPATH:** Refer to [XAI Inbound Service](#) for more information.

---

## Designing Your Registry Options

The XAI registry is a set of control tables that is used to store service definitions as well as various system information required by the XAI and MPL servers. The following sections describe each table in the registry.

## Designing XAI JDBC Connections

If you need to access a database table to process your messages, XAI needs to know the location of the database and how to access it. If the tables are located in the same database used for the system (defined in your [Installation](#)), then you do not need to enter any extra JDBC Connections. If you need to access data that lives in another database, design the additional JDBC Connections and determine the type of connection and connection information.

---

**FASTPATH:** Refer to [XAI JDBC Connections](#) for more information about defining XAI JDBC Connections.

---

## Designing XAI Formats

The Formats section of the registry is used to define data formats. Data formats can be used in schema definitions to specify data transformations. To determine what data formats you need to define for your XAI environment, you must review the expected format of data that you will be exchanging and determine whether or not data transformation is required.

The following sections describe the four different types of formats and some guidelines in their use.

## Date Formats

Date formats may be specified using any valid Java format supported by the `java.text.SimpleDateFormat` class.

To specify the time format use a time pattern string. For patterns, all ASCII letters are reserved. The following usage is defined:

Symbol	Meaning	Presentation	Example
G	era designator	Text	AD
y	year	Number	1996
M	month in year	Text & Number	July & 07
d	day in month	Number	10
h	hour in am/pm (1-12)	Number	12
H	hour in day (0-23)	Number	0
m	minute in hour	Number	30
s	second in minute	Number	55
S	millisecond	Number	978
E	day in week	Text	Tuesday
D	day in year	Number	189
F	day of week in month	Number	2 (2nd Wed in July)
w	week in year	Number	27
W	week in month	Number	2
a	marker for am/pm	Text	PM
k	hour in day (1-24)	Number	24
K	hour in am/pm (0-11)	Number	0
z	time zone	Text	Pacific Standard Time
'	escape for text	Delimiter	
"	single quote	Literal	'

## Currency Formats

Currency formats are used to specify formatting for elements representing currencies. They may include the following:

Symbol	Meaning
#	Number place holder
,	Thousands separator
.	Decimal point
\$	Currency sign

For example to define the currency format for US dollar, indicate: `$$,#.00`

## Phone Formats

Phone formats can be used to specify formats for telephone numbers. The supported format specification is limited to the following format characters:

Symbol	Meaning
0	number place holder
\0	0



Any other character appearing in the formatting expression is a placeholder for that character. To specify the '0' character, use '\0'.

**Phone Format Example:** (000) 000-0000

## Text Formats

Text formats are used to specify formats for character string attributes. The following expressions are supported:

Symbol	Meaning
\cUpperCase	Translate the string to upper case.
\cLowerCase	Translate the string to lower case.
\cProperCase	Translate the string to proper case. The first character of every word is translated to uppercase. The remaining characters are translated to lowercase.

---

**FASTPATH:** Refer to [XAI Format](#) to define your XAI Formats.

---

## Designing XAI Adapters

The product provides a set of adapters to process your XML requests. The adapters point to a specific Java class that renders a service. If you find that you need to use a protocol, which is not supported by the adapters provided, you will need to add a new Message Class (which points to a Java class) and a new XAI Adapter. It is recommended that your implementers contact customer support. The following adapter classes are provided.

- **BUSINESSADA:** This is the adapter class that provides access to schema-based objects. This adapter accesses [business objects](#), [business services](#) and [service scripts](#) through their schema API. Services with this adapter need to indicate the schema of the object, which should be invoked. When communicating to these objects, it is not necessary to create XAI schemas for the schemas associated with the objects. XAI is able to directly communicate with these objects using their existing schema definitions. As a result, there is no need to use the XAI schema editor when defining XAI Inbound Services for this adapter.
- **BASEADA:** This is the core adapter class that provides access to any published system service. This adapter accesses system objects through the page server. Services with this adapter need to indicate the object (application service), which should be invoked.
- **STGUPADA:** This staging upload adapter class is used when an extra step is required prior to using a service with the core adapter. For example, perhaps you need to read a file, which is not in XML format, and convert it to an XML format recognized by the system. Services with this type of adapter do not need to indicate an application service but must indicate information about the file to be converted. Refer to [XAI Staging Control](#) for more information.
- **XAICMNDADA:** This is an internal adapter. It is used to send commands to the XAI Server.
- **SIEBELADA:** This adapter is no longer supported.

## Designing XAI Executors

The executor is responsible for executing messages received through a message receiver. The product provides an executor, which uses the XAI server; however the architecture allows for implementing additional execution classes. If you require a different executor and therefore a different execution class, it is recommended that your implementers contact customer support.

---

**FASTPATH:** Refer to [XAI Executor](#) for more information.

---

## Designing Message Senders

This section only describes message sender functionality that is only related to the XAI/MPL processing. Refer to [message sender](#) for details about other types of senders that are supported independent of XAI/MPL.

Message senders are responsible for define outgoing message destinations and for " [responding](#)" to the XAI executer.

- For NDS messages, the sender to use is defined on the [XAI route type](#) for the notification download profile.
- For outbound messages, the sender to use is defined on the [external system](#) / outbound message type collection.
- For responding to the XAI executer, the sender to use is defined on the [receiver](#).

For each sender, you must reference an appropriate Message Class. The information in this section describes the sender classes that are provided with the system.

You must create senders to "respond" to the various staging table receivers in the system.

- Create a sender to be used for "responses" to messages processed by the staging control receiver. You should create one sender, which points to the Message Class **UPLDERRHNDLR**. Refer to [Staging Control Sender](#) for more information about this sender.
- Create a sender to be used for "responses" to messages processed by the upload staging receiver. You should create one sender, which points to the Message Class **STGSENDER**. Refer to [Staging Upload Sender](#) for more information about this sender.
- Create a sender to be used for messages processed by the download staging receiver. You should create one sender, which points to the Message Class **DWNSTGSNDR**. (DWNSTGSNDR is not supported in all products.)
- Create a sender to be used for messages processed by the outbound message receiver. You should create one sender, which points to the Message Class **OUTMSGSNDR**. Refer to [Outbound Message Sender](#) for more information about this sender.

Next, design the senders for "responses" to other receivers, for example the JMS queue receiver or JMS topic receiver. The system provides message classes to use for these senders. Use the class **JMSENDER** for a JMS queue sender and **TPCSNDR** for a JMS topic sender.

Finally, review all your [outgoing messages](#) and determine the mechanism for communicating with the target system for each message.

- For all senders that are used for [real time messages](#), define a context entry with a context type of **Response Time Out** to define the amount of time the system should wait for a real time response.
- An HTTP sender is one that sends messages to an HTTP server using the HTTP protocol. For an HTTP sender, reference a message class of **HTTPSNDR**. In addition, the context described in [Message Sender — Context](#) for the **RTHTTPSNDR** apply to this sender as well.
- An email sender allows for XML messages to be sent as email messages through an SMTP server. It can be used in notification download processes to send a response as an email message. The email sender supports standard email functionality such as "CCs" and attachments. The content of the email message is controlled by the XSL script defined in the [XAI route type](#) of the NDS message. The XSL script has access to all context records of the NDS message as well as the input XAI message that was created by processing the NDS. Reference a message class of **EMAILSENDER**. In addition, the context described in [Message Sender — Context](#) for the **RTHTTPSNDR** apply to this sender as well.
- If you want XML messages to be written to a flat file, use a flat file sender. For example, it can be used in the notification download process to write a response message to a flat file. Flat file senders should reference a Message Class of **FLATFILESNDR**. In addition, the following context records should be defined for senders of this type.

Context Type	Description	Values
Flat file output directory	Directory in the file system where to write the file	

Context Type	Description	Values
Flat file filename pattern	The name of the output file. The file name may be a literal constant, or generated dynamically.  To create a dynamic filename use <file name>\$\$ID, where \$\$ID is replaced at run time by the ID of the NDS message that triggered the response message. If no file name is defined for the sender, the XAI server generates a file name with the following format 'XAI\$\$ID.xai'.	
Append data to file	This parameter controls whether the content of the response message is appended to an existing file, or a new file is created (possibly replacing an existing one).	<b>YES or NO</b>
Character Encoding	Indicates if the message should be sent with character encoding. The sender will write the content of the file with encoding specified in the context value. If no value is specified, the sender uses the default Java system encoding, which is determined according to the operating system locale.	<b>UTF-8 or UTF-16</b>

## Designing XAI Groups

XAI groups are used by the system to process an XML file containing multiple messages to be uploaded into the system. One or more groups may be defined for an [XML file receiver](#).

**FASTPATH:** Refer to [XML Message File](#) for more information about how groups are used to process an XML file.

When setting up your XAI environment, identify the interfaces that require uploading an XML file containing multiple XML messages into the system through XAI.

First you need to categorize the XML files that you may receive. Define an XAI Group for each logical categorization. For example, you may want to define a separate XAI Group for each third party who may send you a collection of XML messages. Or, if all third party service providers send direct access messages in a standard format, you may want to define a single XAI Group for direct access messages.

For each group, you need to identify the root elements that indicate when a new message is starting. This collection of unique root elements for a group is called the attachments.

For each group, you must identify every possible message that may be sent. For every message, define an XAI Rule. The rule indicates the XSL transformation script to be executed along with the XPath and XPath value that the system uses to identify each message.

**FASTPATH:** Refer to [XAI Group](#) to define groups, their attachments and their rules.

## Designing XAI Receivers

Receivers define small pieces of code that wait for requests to be received through various sources. Each receiver references a Message Class where the small piece of code is defined. The following receiver classes are provided:

Class	Description
STGRCVR	Polls the XAI upload staging table for new inbound requests.
STGCTLR	Polls the XAI staging control table for new upload processes.

Class	Description
<b>DWNSTGRCVR</b>	Polls the notification download staging table (NDS) for new messages. (Not available in all products).
<b>OUTMSGRCVR</b>	Polls the outbound message table for new messages.
<b>JMSRCVR</b>	Receives requests through a message queue that supports the JMS Queue interface, such as IBM MQSeries.
<b>TPCRCVR</b>	Receives requests through a publish/subscribe model, such as TIBCO, or any system supporting the JMS Topic interface.
<b>FILESCANRCVR</b>	Polls a given directory for files with a given file name pattern.
<b>XMLFILERCVR</b>	Polls a given directory for XML files with a given file name pattern.

Multiple receivers may be defined for these receiver classes. For example, the XML file receiver defines the scan directory. If you have multiple directories that contain files to be uploaded, define a receiver for each directory.

All types of receivers reference a Message Class and XAI Executer. If you require a new Message Class or Executer because you use a protocol that is not currently supported, it is recommended that your implementers contact customer support.

## Designing Responses for a Receiver

Once a request has been sent for execution to the XAI server (via the executer), [the response layer](#) processes the response. For some receivers, a response may not be applicable. For example, a file scan receiver reads flat files in a given directory and posts records to the XAI staging control table. Responses are not applicable for this type of receiver.

The response may be conditional on the outcome of the request and may be sent to more than one destination (sender). To design your receiver responses, determine the conditions under which a response should be sent for each request processed by each receiver:

- Never send a response
- Send a response if the request was successful
- Send a response if the request was unsuccessful due to a system error
- Send a response if the request was unsuccessful due to an application error

Once you determine when to send a response, you must determine where to send the response. Responses for different conditions may be sent to different Message Senders or to the same Message Sender.

## Designing Receivers that Poll Staging Tables

The following receivers are needed to poll the various system staging tables.

- Create a [staging upload receiver](#) that references the Message Class **STGRCVR**. For responses, **All Events** should reference the [staging upload sender](#).
- Create a [staging control receiver](#) that references the Message Class **STGCTLR**. For responses, **All Events** should reference the [staging control sender](#).
- If your implementation uses the NDS message method of communicating outgoing messages, create a staging download receiver that references the Message Class **DWNSTGRCVR**. For responses, **All Events** should reference the download staging sender. NDS messaging is not supported in all products.
- If your implementation uses the [outbound message](#) method of communicating outgoing messages, create an [outbound message receiver](#) that references the Message Class **OUTMSGRCVR**. For responses, **All Events** should reference the [outbound message sender](#).

For all the above receivers, if you need to access multiple environments, simply create receivers for each JDBC connection. Note that you should not add more than one of each of the above receivers pointing to the same JDBC connection. To improve performance for a single JDBC connection you may [configure multiple MPL servers](#).

---

**NOTE: Sample Data for Initial Install.** When first installing the system, records for each of the above receivers are provided. Your implementation may use these records or remove them and create your own.

---

## Designing a JMS Queue Receiver

If you need to receive messages through a JMS compatible queue, you need to define a JMS Queue receiver. When designing a JMS Queue receiver you first need to design a JMS Connection and a JMS Queue.

If you would like to post [responses](#) back to the JMS queue, you may create a [message sender](#) to send the response to the JMS queue.

## Designing a JMS Topic Receiver

If you need to receive messages through a JMS Topic using the publish/subscribe model, you need to define a JMS Topic receiver, which receives messages published under a specific topic. When designing a JMS Topic receiver you first need to design a JMS Connection and a JMS Topic.

If you would like to post [responses](#) through a JMS Topic using the publish/subscribe model, you may create a [message sender](#) to send the response to the JMS topic.

## Designing a File Scan Receiver

The file scan receiver constantly looks in a given directory for files with a given pattern. When it finds a matching file, it creates a record in the [staging control](#) table to upload the contents of the file into the [upload staging](#) table.

When setting up your XAI environment, identify the interfaces that require uploading a file from a directory into the system through XAI. For each unique file, define a file scan receiver. For each receiver record, indicate the Scan Directory, where new files will be placed, the Scan File, which is the naming pattern to look for and the XAI Inbound Service to use for mapping the data into a system service.

In addition, if you want to specify a character encoding, the following Context record should be defined.

Context Type	Description	Values
Character Encoding	Indicates that the message is character encoded. When the receiver creates a staging control entry for a file, it will add ?enc=?x to the name of the file in the table where x is the value of this parameter. Refer to <a href="#">Sequential Input File</a> for more information.	<b>UTF-8 or UTF-16</b>

## Designing an XML File Receiver

The XML file receiver constantly looks in a given directory for XML files with a given pattern. When it finds a matching file, it goes through steps to identify each separate message in the file, determine the appropriate XSL transformation and create a record in the staging upload table.

---

**FASTPATH:** Refer to [XML Message File](#) for more information.

---

When setting up your XAI environment, identify the interfaces, which require uploading an XML file containing multiple XML messages into the system through XAI. For each unique file, define an XML file receiver. For each receiver record, indicate the Scan Directory, where new files will be placed, the Scan File, which is the naming pattern to look for and the collection of XAI groups. XAI groups are used by the system to identify each separate message in the file and to determine the appropriate XSL transformation for each message.

---

**FASTPATH:** Refer to [Designing XAI Groups](#) for more information.

---

## Configuring the System for NDS Messages

Refer to the documentation for your product to find out if NDS messaging is supported.

## Schema Editor

---

**CAUTION:** This schema editor is a separate legacy tool that is no longer recommended. The documentation remains for upgrade purposes

---

The Schema Editor is a Graphical User Interface (GUI) tool to create XML schemas. The tool provides wizards to generate schemas from various sources.

## Opening the Schema Editor

After launching the schema editor, you are asked to connect to a database. On the Connect dialog:

- Select an ODBC data source pointing to the desired database.
- Enter the data source, user ID, password and database owner required to log on to that database.
- Click **Connect**.

After connecting, the schema editor appears.

Use the File/Open dialogue to select a schema from the schema directory. Refer to [The Options Menu](#) for information about setting the default schema directory.

---

**NOTE:** When opening a schema, the schema editor validates the schema and any errors are displayed. Refer to [Validating a schema](#) for more information.

---

## Schema Editor Window

---

**CAUTION:** This schema editor is a separate legacy tool that is no longer recommended. The documentation remains for upgrade purposes

---

The schema editor allows you to modify individual elements and attributes of a given schema.

### Description of Page

Refer to [System Wide Functions for Schema Editor](#) for information about the various menu options available for the schema editor.

**Service Name** Enter the name of the service to be created in the service name text box. This is the name of the first element under the Body element in the XML document.

---

**CAUTION:** Important! When adding new schemas, carefully consider the naming convention for the Service Name. Refer to [System Data Naming Convention](#) for more information.

---

**Adapter** The adapter used to process services using this schema.

**Internal Service Name** If the schema is for an adapter that should invoke a system service, this is the internal name of the service.

**Transaction Type** Select the transaction type performed by the service. The available values are **Read, Add, Change, Update, Delete, List** and **Search**.

---

**NOTE:** The difference between Change and Update is that for Change, all field values must be passed in with the request. Field values that are not passed in to the request are set to null. For Update, you need only pass the primary key field values and the values of the fields to be updated. All other fields retain their existing values.

---

### Left Panel

The left panel of the schema editor displays a tree view of the hierarchical elements in the schema. The (+) expands a node, the (-) collapses a node.

### Right Panel

The following attributes appear on the right panel of the Schema Editor. Some fields cannot be modified in the schema editor. The field description indicates when the field is protected.

**Tag Name** The XML element tag name. This field is protected, but you may modify this attribute to give the element a self-explanatory name by right-clicking on the element name in the left tree-view.

**MetaInfo Name** Maps the element to a fully qualified field name in the service, for example PER\_ID. This field is protected.

**Internal Type** This property is populated automatically when you generate the schema from your product. The values further define elements and attributes. The values are **page, pageBody, list, listHeader, listBody, searchHeader, codeTableDesc, Private**. The values of **codeTableDesc** and **Private** are used to define special types of attributes.

**Private attribute** A field that does not exist on the server side, but one that you still want to have in the schema.

**Description** A description of this field.

**Content** The element type. This field is only available for elements. Possible values are **eltOnly**- element may contain only other elements and no text, **TextOnly**- element may only contain text.

**Search Type** Services, which perform a Search, may allow searching based on different criteria. The values are taken from the system meta information when the schema is generated. The possible values are **Main, Alternate1, Alternate2, Alternate3, Alternate4, Alternate5** and **Alternate6**.

---

**NOTE:** You would not typically modify this value because it corresponds to a value in the meta information. However, the value is modifiable to accommodate the rare case in which a service may change in a new release. In this scenario, you may prefer to update the schema manually rather than regenerate a new schema for the new version.

---

**Is Part of Primary Key** Used to indicate to the XAI server whether or not this field makes up part of the primary key of the record. The values are taken from the metadata information when the schema is generated. Value may be **true** or **false**.

---

**NOTE:** Typically you would not modify this value because it corresponds to a value in the meta data information. However, the value is modifiable to accommodate the rare case where a service may change in a new release. In this scenario, you may prefer to update the schema manually rather than regenerate a new schema for the new version.

---

**Min Occurs** This field is available for elements only and is used for repeating elements. It defines the minimum number of occurrences for an element. Value may be 0 or 1.

**Schema Max Occurs** This field is available for elements only and is used for repeating elements. It defines the maximum number of occurrences for an element. Value may be 0, 1 or \*.

**Limit Number of occurrences** This field is available for elements only and is used for repeating elements. If the **Schema Max Occurs** field has been set to '\*', define the number of max occurrences here.

**XML Data Type** The data type for the attribute. Possible values are **number, string, decimal, date, dateTime**, and **boolean**.

**Server Data Type** Indicates the data type of this attribute on the server. This field is protected.

**Service Format** The format expected by the service. At runtime, XAI converts the Tag format to the Service Format before executing the request. Formats are defined in [XAI Format](#).

**Tag Format** The format used to format an element/attribute in the schemas. Formats are defined in [XAI Format](#).

**Min Length** Use this property to define the minimum length of the attribute, if applicable.

**Max Length** Use this property to define the maximum length of the attribute, if applicable.

**Precision** This is used for decimal attributes to define the maximum number of digits.

**Scale** This field is used for decimal attributes to define the number of digits at the right of the decimal point.

**Required** A value of **Y** indicates that the element must appear in XML document. A value of **N** indicates that the element is optional.

**Default value** Default value to be used for Request schema, when the element is not supplied as part of the XML request document.

**Fixed Value** Fixed value to be used for Request schema. This value is used regardless of the value supplied in the request document.

**Code Table Field** This property is used for attributes that are descriptions of a code table, where the description is not automatically returned by the system service. Use this property to indicate the code whose description should be retrieved by the XAI server.

**Code Table Program** This property is used for attributes that are descriptions of a code table, where the description is not automatically returned by the system service. Use this field to indicate the program that XAI should call to access the description for the **Code Table Field**.

### Creating a Schema

Usually you do not create schemas from scratch; rather you use Schema Creation Wizards to import existing data structure definitions from a variety of data sources:

- System services
- Comma Delimited Files
- Database Extract
- Any XML document

Once a schema is created based on the existing data structure, it is displayed in a TreeView on the left panel. Once the imported schema has been edited, it serves as the basis for creating the request and response schemas. When imported, the schema exposes all fields defined in the service. You may want to remove some attributes/elements from the request or response schema.

---

**NOTE:** Although the main purpose of the editing process in the creation of the request and response schemas is the elimination of elements, which makes the schema shorter and more understandable, it is not required for processing purposes. Therefore, if you don't mind that you have not used elements in your schemas, you could stay with one schema, which serves as both the request and response schema.

---

1. Save the Schema as a Request schema with an appropriate name, for example PersonInfoRequestSchema.xml
2. To create the Response schema, which is identical to the request schema, use the Save As Response menu option. This renames the top element of the schema to ServiceNameResponse, for example PersonInfoResponse and save the schema under a different name i.e. PersonInfoResponseSchema.xml. Note that if the request and response schemas are identical then one schema may be used for both and there is no need to create separate schemas.
3. Read in the Request Schema (File/Open) and modify its structure. Depending on the service type, you'll have to modify the contents of the Request Schema. This is usually required when the service is an "Info" service, which requires very few input elements. In such cases you'll delete most of the elements on the schema and only leave the necessary elements required to invoke the service. For example: in the PersonInfo request, you only need the PersonId and the Company elements in the request schema.



4. Read in the Response Schema (File/Open) and Modify its structure. Depending on the service type, you'll want to modify the contents of the Response Schema. This is usually required when the service is an "Add" or "Delete" service, which returns very few input elements. In such cases you'll delete most of the elements on the response schema and only leaves the necessary elements required by the requester of the service.

### Adding an Element/Attribute

Usually, you won't have to add element or attributes to a schema. However if the schema already exists and you want to add an element/attribute, you can follow this procedure. Be aware that any element/attribute added here must also exist on the xml metainfo.

- Select the element's node on the TreeView.
- Right click on it and select the 'Add Element' or 'Add Attribute' option in the pop-up menu
- Enter the element/attribute name in the prompt dialog box and click OK.

### Removing Elements/Attributes

When generating a schema using one of the wizards, the generated schema may contain information that you do not want to publish as part of the service, or is not required for a particular service. You can remove elements/attributes from the schema, and though these elements/attributes may still exist on the service they are not seen by the XAI service using this schema. To remove an element or attribute:

- Select the node to be removed.
- Right click and select "Delete" from the popup menu.

### Renaming an Element

To rename an element:

- Select the element's node on the TreeView.
- Right click it and select the Rename option in the pop-up menu
- Enter the new name in the prompt dialog box and click OK.

---

**NOTE:** The information in this table is cached by the XAI server and by the MPL server. Changes to values in this table do not affect the runtime copy of these servers. Refer to [XAI Command](#) for information about refreshing a schema.

---

## Validating a Schema

---

**CAUTION:** This schema validation is part of a separate legacy tool that is no longer recommended. The documentation remains for upgrade purposes

---

Although a schema is validated against the metainfo XML file when it is read into the editor or before it is saved, you can perform the validation at any time while the schema is being edited. To validate a schema, click on the toolbar "Validate" button . If the schema fails to validate the schema errors dialog is displayed.

When the editor fails to validate a schema against the xml metainfo file, it pops up a dialog that lists the errors found in the schema definition. These errors may be of two types:

- An element or attribute in the schema could not be found in the xml metainfo file. You can click **Remove** to remove the element from the schema.
- The data type of an attribute does not match the one defined in the metainfo file. You can click **Correct**, and the editor fixes the data type so it does match.

The **Correct All** button can be used to correct all fields that have data types that do not match the one in the XML metainfo file.

---

**NOTE:** Correcting errors does not save the schema definition into a file. You have to save it manually.

---

If you **Exit** without correcting the errors, the schema displays with the mismatch information highlighted in red.

## Registering a Service

Before a service can be used it must be defined in the [XAI Inbound Service](#) table in the XAI registry. A service can be registered in the XAI registry directly from the schema editor. Go to the menu item 'Register Service' in the 'Schemas' menu. The Register service UI page appears. Fill in the required fields.

---

**NOTE:** The registry entry for the service can be later modified using the [XAI Inbound Service](#) page.

---

## Testing a Schema

The XAI schema editor provides a testing option.

---

**NOTE: Testing in your product.** You may also test your schemas and your services using [XAI Submission](#).

---

## System Wide Functions for Schema Editor

Because the schema editor is in an application outside of the standard products, this section introduces some general functions related to the application.

### Application Standards

- The schema editor is a Multiple Document Interface (MDI) windows application. It may contain multiple active windows. You may jump from one window to the other using the Window menu option.
- The Editor window is always active. Closing the schema editor window quits the application.
- In the Editor window, a splitter bar is available to resize the schema tree view horizontally.
- Actions may be performed using menu items or by clicking on toolbar buttons.
- All messages are displayed on a status bar at the bottom of the screen. Some may also be displayed using message boxes.

### The File Menu

Use the File menu to open existing schemas and to save a schema to a file.

**Connect** — Connects to the database.

**Open** — Loading an existing schema into the editor

You can read an existing schema into the editor.

1. Click on the Open toolbar button or select the File/Open menu option.
2. A file selection dialog is shown. Select the schema file name.
3. The editor first validates the schema against the xml metainfo file. If it fails to validate it shows the Schema Validation Errors dialog. Refer to [Validating a schema](#) for more information.

**Save** — Save the current schema to a file. Using the current file name.

To save a Schema, click on the Save toolbar button, or select the File/Save menu option. When you save a schema, the editor first attempts to validate the schema. If it fails to validate it against the XML Metainfo file, you are prompted to save it with inconsistency errors or to return to the editor.

**Save As** — Save the current schema to a file. Use a different file name.

**Save As Response** Save a copy of the current schema to a file as a response schema. Use a different file name.

## The View Menu

Use the view menu to perform actions on the Tree View nodes or to view errors. The following menu options are available:

**Expand All** — Expand all nodes in the Tree View

**Collapse All** — Collapse all nodes in the Tree View

**Expand Branch** — Expand the selected node and all the node's children

**Search** (Ctrl+F) — Find a node with a node name containing a given string

**Search Again** (F3) — Find the next node with containing the search string

**View Schema Errors** — Display the Schema Validation Errors dialog.

**Web Browser** — Display the current schema definition on a web browser page

## The Schemas Menu

Use the Schemas menu to create, test, validate and register schemas.

- To create schemas from various sources use the **Create menu**.
- To [validate a schema](#) select the **Validate** option (Ctrl+V).
- To create a sample instance and test the schema, select the **Test** option (Ctrl+T).
- To create an entry in the service registry for a service represented by the current schema, select the **Register Service** option (Ctrl+R). Refer to [Registering a Service](#) for more information.

## The Options Menu

**Always Save As W3C** — Turn on this option to save schemas in W3C format by default instead of XDR format.

**Always Save As DTD** — Turn on this option to save schemas in DTD format by default instead of XDR format.

### Preferences

The following options may be set on the preferences dialog (Select Options and then Preferences):

- The Default Date Time Format - used for schema date fields
- The default Schema Directory - used to read/save schemas
- The default Metainfo Directory - used to create/validate schemas
- The XAI Servlet URL - used when executing requests from the test schema dialog.
- The Default Account Id - used when generating sample instances of a schema
- Language - used to access language specific data

## The Tools Menu

Schemas tools can be invoked from the **Schema Editor Tools** menu.

**Converting Schemas to a W3C compatible schema** — Schemas generated in the Microsoft BizTalk-compatible format (XDR format) may be saved in a format compatible with the *October 2000, W3C XML* schema standard. To save a schema in a W3C format:

- Select **Convert to W3C** from the **Tools** menu. The **Convert to W3C** dialog box appears.
- Select the schema(s) to be converted. Multiple schemas may be converted in a single step.
- The name of the W3C schema is the same name as the schema but with an ".xsd" file extension, and is saved to the same directory as the original schema.
- Click **Convert**.

**Converting Schemas to a DTD** — Schemas generated in the Microsoft BizTalk-compatible format (XDR format) may be saved as a DTD.

- Select the **Convert to DTD** option from the **Tools** menu. The **convert DTD** dialog box appears.
- Select the schema(s) to be converted. Note that multiple schemas may be converted in a single step.
- The name of the W3C schema is the same name as the schema but with a ".dtd" file extension, and is saved to the same directory as the original schema.
- Click **Convert**.

**Validating multiple schemas** — The schema validation tool can be used to validate the correctness of an XAI schema when compared to the metainfo xml definition used to generate the schema. For each validated schema, the validation tool scans the list of elements/attributes and compares them with those defined in the XML metainfo file. Select **Validate Schemas** in the **Tools** menu.

- The **Validate Schema** dialog box appears.
- The left list box is used to select the directory where the schemas to be validated are stored. By default this is the **Schema Directory** as defined in the preferences.
- On the right, the list of schemas is displayed on a grid.
- Multiple schemas may be validated in a single step.
- To select a schema click on the left button (the first column in the row).
- To select multiple schemas, hold the `Ctrl` key and select the required schemas.
- Click `Validate Schemas`.
- The schema grid is updated. When an attribute defined in the schema is missing from the metainfo file or when the properties of the element do not match defined in the metainfo, a button is displayed at the right of the schema name. Clicking on the **edit** button loads the schema into the editor and displays the Schema Validation Errors dialog for that schema. You can correct the schema and save it. Refer to [Validating a schema](#) for more information.

## Setting Up Your XAI Environment

This section describes the control tables available to administer your XAI environment.

### Message Class

The Message Classes are references to actual Java classes. The Message Class defines the Java class used to implement Receivers, Senders, Adapters and Executors. This information is provided with the system and does not need to be modified for a specific installation.

To view a Message Class, open **Admin > XAI > Message Class**.

#### Description of Page

The **Message Class** and **Description** are unique identifiers of the Message Class. The **Class Definition** indicates the Java class, implementing the adapter, receiver, sender or executor.

**Owner** indicates if this Message Class is owned by the base package or by your implementation ( **Customer Modification**). The system sets the owner to **Customer Modification** when you add a Message Class. This information is display-only.

#### Where Used

Follow this link to open the data dictionary where you can view the tables that reference [CI\\_XAI\\_CLASS](#).

## XAI Envelope Handler

To view your envelope handlers, open **Admin > XAI > XAI Envelope Handler**. This information is provided with the system and does not need to be modified for a specific installation.

#### Description of Page

Enter a unique **XAI Envelope Handler ID** and **Description**.

Indicate whether the **Envelope Type** is **Custom SOAP Envelope**, **Default** (no SOAP environment) or **SOAP Envelope**. Note that the values of **Siebel Integration Message** and **Siebel VBC** are not supported.

When the envelope type is **SOAP Envelope**, indicate the **Envelope URI**.

**Owner** indicates if this XAI envelope handler is owned by the base package or by your implementation (**Customer Modification**). The system sets the owner to **Customer Modification** when you add an XAI envelope handler. This information is display-only.

## Setting Up Your Registry

The following section describes the control tables that are logically considered part of the XAI Registry.

### XAI JDBC Connection

To view an XAI JDBC Connection, open **Admin > XAI > XAI JDBC Connection**.

#### Description of Page

Enter a unique **XAI JDBC Connection** and **Description**.

Use the **Connection Type** to indicate how the JDBC connects to a database. The following connection types are valid:

- **Oracle Defined Connection** indicates the connection is to an Oracle database through a JNDI entry.
- **DB2 Defined Connection** indicates the connection is to a DB2 database through a JNDI entry.
- **JNDI Defined Connection** indicates the connection is using the MQ series classes implementing JMS.
- **Determined by parameter file** indicates that the connection information should be determined by looking at the parameters defined at [Installation](#).

For connection types of **Oracle** or **DB2**, use the **JDBC URL** to indicate URL of the database connection to be initialized at XAI/MPL startup time. Indicate the **Database User** and **Database Password** required for accessing the database. The JDBC connection URL can either be a Type 2 or a Type 4. For example:

- Type 2: jdbc:oracle:oci8:@CD200ODV
- Type 4: jdbc:oracle:thin:@myhost:1521/ CD200ODV

For a connection type of **Determined by parameter file**, indicate the parameter substitutions, which should be accessed from the parameter file for the JDBC URL, database user and database password, for example, @JDBCURL@, @DBUSER@ and @DBENCPASS@.

When the connection type is **JNDI**, indicate the **JNDI Server** and the **JNDI Data Source** name as defined in the JNDI.

#### Where Used

Follow this link to open the data dictionary where you can view the tables that reference [CI\\_XAI\\_JDBC\\_CON](#).

## XAI Format

Open **Admin > XAI > XAI Format** to define the various formats.

#### Description of Page

For each new format, specify a unique **XAI Format** name and **Description**.

Indicate whether the Format Type is a **Currency formatting string**, a **Date/Time formatting string**, a **Phone formatting string** or a **Text formatting string**.

Finally, indicate the **Format Expression**, which defines the formatting pattern to be applied.

**Owner** indicates if this format is owned by the base package or by your implementation ( **Customer Modification**). The system sets the owner to **Customer Modification** when you add an XAI format. This information is display-only.

#### Where Used

Follow this link to open the data dictionary where you can view the tables that reference [CI\\_XAI\\_FORMAT](#).

## XAI Adapter

To define a new adapter, open **Admin > XAI > XAI Adapter**.

#### Description of Page

Indicate a unique **Adapter Name** and **Description**.

Indicate the **Message Class**, which is the name of the Java class, implementing the adapter. The class should be one that is defined for an adapter. The adapter classes provided with the product are **BASEADA**- Core Adapter, **BUSINESSADA**- Business Requests Adapter and **XAICMNDADA**- XAI Command Adapter. Note that the values **SIEBELADA** and **STGUPADA** are no longer supported.

---

**FASTPATH:** Refer to [Message Class](#) for more information.

---

The following fields are not applicable for the **BusinessAdapter** adapter.

Use the **JNDI Server** to indicate the name of the WebLogic JNDI server running your product. Refer to [JNDI Server](#) for more information.

Indicate the **Default User** to be passed to your product server when this adapter is executed.

---

**NOTE:** If the XML request is sent over an HTTP connection, which has been authenticated, the authenticated User Id is passed to your product.

---

The **Default Date** format and the **Default DTTM** (date / time) **Format** specify date and date/time [formats](#) to use when a schema does not explicitly indicate formats.

**Owner** indicates if this XAI adapter is owned by the base package or by your implementation (**Customer Modification**). The system sets the owner to **Customer Modification** when you add an XAI adapter. This information is display-only.

#### Where Used

Follow this link to open the data dictionary where you can view the tables that reference [CI\\_XAI\\_ADAPTER](#).

## XAI Executer

To define a new Executer, open **Admin > XAI > XAI Executer**.

### Description of Page

Enter a unique **Executer ID** and **Description**.

Indicate the **Message Class** for this executer. The class should be one that is defined for an executer. The executer class provided with the product is **XAIURLEXEC**- XAI Executer.

Indicate the appropriate **Executer URL**.

**Owner** indicates if this XAI executer is owned by the base package or by your implementation ( **Customer Modification**). The system sets the owner to **Customer Modification** when you add an XAI executer. This information is display-only.

### Where Used

Follow this link to open the data dictionary where you can view the tables that reference [CI\\_XAI\\_EXECUTER](#).

## XAI Group

XAI groups are used to process XML files, which contain a collection of [XML messages](#) to be uploaded in batch.

### XAI Group - Main

To define your XAI groups, open **Admin > XAI > XAI Group**.

#### Description of Page

Enter a unique **Group** and **Description** for the XAI Group.

Indicate the **Parser** used for this group. Possible values are **Dom Parser** and **StAX Parser**.

---

**NOTE:** **Dom Parser** reads the full XML document into memory and therefore is not ideal for larger XML documents.

---

Indicate the **XPath** and **XPath Value**, which an XML file receiver uses to identify which group a given XML file belongs to.

- For **StAX Parsers** the XPath is limited to the root element.
- For **Dom Parsers**, the XPath supports defining elements at a lower level than the root element.

### XAI Group - Attachments

Open **Admin > XAI > XAI Group** and navigate to the **Attachments** tab to define attachments for your group.

#### Description of Page

For each entry in the attachments collection, indicate the **Sequence** and the **Root Element**. Use **Include Elements** to indicate if **Parent** elements should be included along with the current element when applying the XAI rules.

---

**FASTPATH:** Refer to [XML Message File](#) for more information about how this is used.

---

### XAI Group - Rules

Open **Admin > XAI > XAI Group** and navigate to the **Rules** tab to define rules for your group.

#### Description of Page

For each entry in the rules collection, indicate the **Sequence**, the **Priority**, the **XPath** name and **XPath Value** and the **XSL File Name**.

---

**NOTE: Include Parent.** If your attachment indicates that **Parent** elements should be included, be sure that the parent element is included in the XPath defined here.

---

**FASTPATH:** Refer to [XML Message File](#) for more information about how this is used.

---

## Where Used

Follow this link to open the data dictionary where you can view the tables that reference [CI\\_XAI\\_RGRP](#).

## XAI Receivers

### XAI Receiver - Main

To define your XAI receivers, open **Admin > XAI > XAI Receiver**.

#### Description of Page

Enter a unique **Receiver ID** and **Description** for the XAI Receiver.

Indicate the **Message Class** for this receiver. The class should be one that is defined for a receiver. The receiver classes are **DWNSTGRCVR**- Download Staging receiver, **FILESCANRCVR**- Upload Files from a directory, **JMSRCVR**- JMS Queue receiver, **OUTMSGRCVR**- Outbound Message receiver, **STGCTLRRCVR**- Staging Control receiver, **STGRCVR**- Staging Upload Receiver and **TPCRCVR**- JMS Topic receiver, **XMLFILERCVR**- XML File receiver.

---

**FASTPATH:** For more information, refer to [Designing XAI Receivers](#) about different types of receivers.

---

Indicate whether or not this receiver is currently **Active**.

Identify the **Executor ID**. Select the XAILOCAL executor if the Message Class for this receiver is STGCTLRRCVR. Select the BYPASSXAI executor if the Message Class for this receiver is OUTMSGRCVR. For all other receivers select the XAIURL executor. For more information, refer to [XAI Executor](#).

Indicate whether the **MSG Encoding** is **ANSI message encoding** or **UTF-8 message encoding**.

The **Read Interval** indicates the number of seconds between read cycles.

**Start At Time** and **Duration** are not currently in use.

If the Message Class for this receiver is **FILESCANRCVR**, **STGRCVR**, **STGCTLRRCVR** or **XMLFILERCVR**, indicate the **XAI JDBC Connection**.

---

**FASTPATH:** Refer to [XAI JDBC Connection](#) for more information.

---

Turn on **Sequential Execution** if the received requests should be processed in [sequential order](#) (instead of multithreaded). If this value is turned on then XAI staging control records created by this receiver are marked for sequential execution.

#### JMS Information

The following information is only available if the Message Class is **JMSRCVR** or **TPCRCVR**.

Indicate the appropriate **JMS Connection**

---

**FASTPATH:** Refer to [JMS Connection](#) for more information.

---

Indicate the appropriate **JMS Queue**.



---

**FASTPATH:** Refer to [JMS Queue](#) for more information.

---

Indicate the appropriate and **JMS Topic**.

---

**FASTPATH:** Refer to [JMS Topic](#) for more information.

---

#### File Information

The following information is only available if the Message Class is **FILESCANRCVR** or **XMLFILERCVR**.

Use the **Scan Directory** to indicate where to look for new files.

In **Scan File**, indicate the file pattern. All files with names matching the pattern are uploaded into the staging upload table. For each file found, a record in the staging control table is created.

---

**CAUTION:** WARNING. MPL expects all files conforming to the Scan File pattern to be complete. If a file is in the process of being copied into the scan directory and its name conforms to the naming pattern, MPL still attempts to process it and may issue an error for the incomplete file. It is suggested that files first be copied into the scan directory with a different name that does not conform to the naming pattern, for example filename.xml.inprocess. Once the file copy/transfer is complete, rename the file to one that conforms to the naming pattern, for example, filename.xml.

---

The following information is only available if the Message Class is **FILESCANRCVR**.

Use the **XAI In Service Name** to indicate how the records in the file are mapped and how they are transformed to match a system service request structure.

## XAI Receiver - Context

Open **Admin > XAI > XAI Receiver** and navigate to the **Context** tab to define context for your receiver.

### Description of Page

The Context collection enables you to define a collection of **Context Types** and **Context Values** defining. Use this collection when you need to store an attribute of a receiver that is not catered for in the current table.

---

**NOTE:** The values for the Context Type field are customizable using the Lookup table. This field name is RCVR\_CTXT\_FLG.

---

## XAI Receiver - Response

Open **Admin > XAI > XAI Receiver** and navigate to the **Response** tab to define where to send responses to requests made by this receiver. Refer to [Designing Responses for a Receiver](#) for more information.

### Description of Page

The response collection enables you to define the destination (**Message Sender**) where responses to a request may be sent under various circumstances (**Event**). The events currently defined with the product are **All events**, **Message executed OK**, **Application Error**, **System Error**.

---

**NOTE:** The values for this field are customizable using the Lookup table. This field name is ON\_EVENT\_FLG.

---

## XAI Receiver - Groups

Open **Admin > XAI > XAI Receiver** and navigate to the **Groups** tab to the valid XAI groups for an XML file receiver.

### Description of Page

This collection is only available if the Message Class is **XMLFILERCVR**.

For each entry in the Group collection, indicate the **Priority** and the **Group**. Refer to [XAI Groups](#) for more information about defining groups.

### Where Used

Receivers are used by the XAI server and by the MPL server to process messages sent to the system from various sources.

## XAI Inbound Services

The XAI Inbound Services section in the registry is the main section of the registry. It is used to define the service characteristics. Basically, a service is defined by an Adapter responsible for executing the service, a pair of XML schemas and connection attributes. The Adapter defines the interface with the target application server, while the schemas define the structure of the request XML document expected by the service and the structure of the response XML document generated by the service.

### XAI Inbound Service - Main

To update an inbound service, open **Admin > XAI > XAI Inbound Service**.

---

**CAUTION:** Important! When adding new inbound services, carefully consider the naming convention of the XAI In Service Name. Refer to [System Data Naming Convention](#) for more information.

---

#### Description of Page

Define a unique **XAI In Service Name**. This information is used in the system to identify the service. The service name is also the first XML element after the <Body> element in the XML request/response document. The system generates a unique **XAI Service ID**, which serves as the primary key.

**Owner** indicates if this XAI inbound service is owned by the base package or by your implementation ( **Customer Modification**). The system sets the owner to **Customer Modification** when you add an XAI inbound service. This information is display-only.

Indicate the **Adapter**, which defines the interface with the target application server.

---

**FASTPATH:** Refer to [XAI Adapter](#) for more information.

---

If adapter for this service should invoke a system service, then indicate the appropriate **Service Name**.

---

**FASTPATH:** Refer to [Service Program](#) for more information about defining services.

---

If adapter is the base package **Business Adapter** then **Service Name** does not appear. Instead, use **Schema Type** to indicate the type of object this service invokes and **Schema Name** to reference the object to invoke. Using this adapter, you may set up service to invoke [business objects](#), [business services](#) and [service scripts](#).

---

**FASTPATH:** Refer to [Designing XAI Adapters](#) for more information about the **Business Adapter**.

---

Use the **Description** and **Long Description** to describe the service.

Check the **Active** switch if this service is enabled and available for execution. If this switch is unchecked, then the service is defined in the registry, but not yet available for public use.

Check the **Post Error** switch to support [inbound message error handling](#) for messages that are not processed via the staging upload table.

Check the **Trace** switch if you would like the trace to be on for this particular service. If the general trace option is not activated, you can force a trace for a particular service.

---

**FASTPATH:** Refer to [Server Trace](#) for more information about trace functionality.

---

When the **Debug** switch is checked, debug information is generated on the XAI console when this service is executed. The debug information can be useful to resolve problems.

### Schema Definitions

**NOTE:** Request Schema and Response Schema are not applicable to services invoking schema-based objects. They do not appear when the **Business Adapter** is used.

---

The next two properties define the request and response XML schemas. The schemas were created using the [Schema Editor](#) and are SOAP compatible. The schema XML files are expected to be stored in the Schemas Directory on the Web server running the XAI server.

The **Request Schema** is the XML schema defining the service request. The request sent to the server must adhere to the schema definition.

The **Response Schema** is the XML schema defining the service response. The response generated by the XAI server corresponds to the response schema definition.

The same service may perform several actions on a business object. Use the **Transaction Type** to define the default action performed by a service. The transaction type can be provided when invoking a service, by dynamically specifying a transaction type attribute on the Service element of the XML request. This field may take the following values: **Read, Add, Change, Update, Delete, List** and **Search**.

**NOTE:** The difference between **Change** and **Update** is that for **Change**, all field values must be passed in with the request. Field values that are not passed in to the request are set to null. For **Update**, you need only pass the primary key field values and the values of the fields to be updated. All other fields retain their existing values.

---

Services, which perform a Search, may allow searching based on different criteria. When the Transaction Type value is **Search**, use the **Search Type** to define the default search criteria. The possible values are **Main, Alternate1, Alternate2, Alternate3, Alternate4, Alternate5** and **Alternate6**.

**NOTE:** This is a default definition only and it may be overridden at run time when the service is invoked. To override the search type at run time, you should specify the searchType attribute on the Service element of the XML request.

---

### XSL Transformation Definitions

Sometimes, the XML request document does not conform to the request schema, or the response document expected by the service requestor is not the one generated by the adapter. In such cases the request and/or the response documents must be transformed. The XAI server supports transformation through XSL transformation scripts. Transformation scripts may be applied to the request before it is passed to the adapter or applied to the response document before it is sent to the service requestor.

The **Request XSL** is the name of the XSL transformation to be applied to the request document before processing it. The transformation is usually required when the incoming document does not correspond to the XAI service request schema therefore it has to be transformed before it can be processed by the adapter.

The **Response XSL** is the name of the XSL transformation to be applied to the response document when the requester of the service expects the response to have a different XML document structure than the one defined by the response schema for the service.

Click the **WSDL URL** hyperlink to launch a separate window that contains the WSDL definition for the inbound service. Note that the server name and port number for the URL are built using a setting in the common properties file using the XAI HTTP Caller URL setting.

**NOTE:** Refer to [WSDL Catalog](#) for information on how to obtain the WSDL catalog for all XAI Inbound Services.

---

## XAI Inbound Service - Staging

The staging tab is used to define parameters for services that use the Staging Upload adapter.

---

**FASTPATH:** Refer to [XAI Upload Staging](#) for more information.

---

Open **Admin > XAI > XAI Inbound Service** and navigate to the **Staging** page to define attributes for your upload staging adapters.

### Description of Page

Indicate the **Staging File Type** to be processed by the staging upload service. Possible values are **Comma Delimited file**, **Database Extract** and **Sequential file**.

The format of the records in the input file are not in an XML format and do not correspond to an XAI service schema. As a result, the input record must be transformed into an XML message that conforms to an XAI service request schema. Enter the **Record XSL**, which indicates the XSL transformation script used to transform the input record into the appropriate XML message.

For **sequential files** and **Comma delimited files**, indicate the **Input File Name** to be processed.

---

**NOTE:** This parameter can be overridden in the **Staging Control** table when a request to execute such a service is made.

---

When the service takes its input from a **Database extract**, indicate the **JDBC Connection** used to connect to the database that contains the input data.

---

**NOTE:** If this value is not populated XAI uses the default JDBC connection, which is the current product database.

---

---

**FASTPATH:** Refer to [XAI JDBC Connection](#) for more information about defining these values.

---

Use the **Interface Name** to provide a description of the interface being implemented through this service.

## XAI Inbound Service - Parameters

This tab enables you to define parameters that are used as selection criteria by the DB Extract staging upload service.

Open **Admin > XAI > XAI Inbound Service** and navigate to the **Parameters** page.

### Description of Page

The **Parameters** that were defined under the Request element in the schema are displayed here. They are used to drive the extraction process. This tab only displays the list of parameters. The values for these parameters can later be entered when the control record to invoke this service is created.

---

**FASTPATH:** Refer to [Staging Control Parameters](#) for more information.

---

**Owner** indicates if this XAI inbound service is owned by the base package or by your implementation ( **Customer Modification**). The system sets the owner to **Customer Modification** when you add an XAI inbound service. This information is display-only.

### Where Used

Follow this link to open the data dictionary where you can view the tables that reference [CI\\_XAI\\_IN\\_SVC](#).

---

**NOTE:** The information in this table is cached by the XAI server and by the MPL server. Changes to values in this table do not affect the runtime copy of these servers. Refer to [XAI Command](#) for information about refreshing a service.

---

## XAI Route Type

Refer to the documentation for your product to find out if XAI Route Type is supported.

## Running Your XAI Environment

---

**NOTE:** The XAI functionality is legacy functionality and not recommended for new implementations. This information remains in the documentation for upgrade purposes. Refer to [Incoming Messages](#) and [Outgoing Messages](#) for information about the recommended features for supporting sending and receiving external messages.

---

The [XML Application Integration](#) (XAI) module provides the tools and infrastructure that businesses require for integrating their third-party systems with the application.

This section describes the pages used to manage incoming and outgoing information via the XAI tool.

## XAI Staging Control

Refer to [Staging Control](#) for more information about the purpose and functionality of this page.

Navigate to this page using **Menu > Integration > XAI Staging Control**.

### Description of Page

The **XAI Staging Control ID** is a system generated unique identifier of this record.

The **XAI Staging Control Status** indicates the current state of this record.

**Pending** This status indicates that this record needs to be processed.

**In Progress** This status indicates that the background process, which uploads the staging records, is currently processing this record.

**Error** This status indicates that the background process found a problem with this record. When the data related to this record has been fixed, change the status back to **Pending** so that it will be processed again.

**Complete** This status indicates that this record has been processed.

The **Number of Uploaded Records** indicates how many XAI staging records related to this staging control record were uploaded.

The **Run Date Time** indicates the date and time this record was processed by the upload process.

The **User**, who created this staging control record, is captured.

If the data to be uploaded is found in a file, indicate the **Upload File Name**, which should include the directory path and file name.

---

**NOTE: Character Encoding.** Refer to [Sequential Input File](#) for information about specifying character encoding for a file.

---

---

**NOTE: Complete File.** MPL expects this file to be complete. If the file is in the process of being copied into the directory, MPL still attempts to process it and may issue an error for the incomplete file. The staging control record should only be created once the complete file is ready for upload.

---

Enter a description of the **XAI Interface Name**. This is simply information and is not used by the system.

Turn on **Sequential Execution** if you want the XAI upload staging records related to the staging control record to be processed in [sequential order](#) (instead of multithreaded).

The **XAI Service ID** tells the system how to create the XML related to the XAI upload staging record to be created. In Oracle Utilities Customer Care and Billing, for example, XAI Services with an adapter type of **CISStagingUpload** may be indicated here.

---

**FASTPATH:** For more information about XAI services, refer to [XAI Inbound Service](#).

---

Use the **Comments** to provide free format information related to this staging control record.

The collection of staging control parameters is used to define selection criteria when the staging control is accessing data from a database table. The **Staging Control Parameter** defines the field used in the WHERE clause and **XAI Staging Control Parm Value** defines the value to be used in the WHERE clause.

Refer to [Staging Control Parameters](#) for more information.

The **Message** collection displays any completion messages for XML requests related to the staging control record.

## XAI Upload Staging

The XAI upload page allows you to view the details or to fix errors for a request in the Staging Upload table. This page displays the text of the XML request document linked to the upload.

### XAI Upload Staging - Main

To view or modify an XAI upload document, navigate to **Menu > Integration > XAI Upload Staging** and navigate to the main tab.

#### Description of Page

The **XAI Upload Staging ID** is a system assigned identifier of the XAI upload staging record.

The **Application Service** identifies the internal system service called by the XAI tool to load/update the system data.

---

**NOTE:** The upload process does not use this. Rather, the application service is part of the XML Request. This field is used to help in searching for XAI Upload records.

---

The **XAI Staging Control ID** related to this XAI upload staging record is displayed.

The status of the upload is indicated by the **XAI Upload Staging Status**. Values are **Pending**, **In Progress**, **Complete**, and **Error**. If the record is in error, an error is written to the [XAI Upload Exception](#) table.

**Create Date/Time** indicates when the record was posted.

**Completion Date/Time** indicates when the work was completed.

If this XAI upload staging record is a response to an **XAI Download Staging** record, information about the related download staging record is displayed.

If there is an error with this record, you will see the error **Message** associated with this record. The message area is suppressed if there are no problems with the record.

Click the adjacent button to view the long explanation. The long explanation provides information about the cause of the error (and how to fix it).

The upload staging data appears in the **XML Request** text box.

## XAI Upload Staging - Response

To view the response to a completed XAI upload staging document, navigate to **Menu > Integration > XAI Upload Staging** and go to the **Response** page.

### Description of Page

The **XAI Upload Staging ID** is a system assigned identifier of the XAI upload staging record.

The system's response to the upload XML appears in the **XML Response** text box.

## Uploading XAI Staging Records

### Staging Control Layout

In order to load XML requests from flat sequential files, comma separated value (CSV) files and from database tables, you need to create a staging control record. The name of this table is **CI\_XML\_STG\_CTL**. The following table describes each column on this table.

Column Name	Length	Required	Data Type	Comments
XML_STG_CTL_ID	10	Y	N	This is the unique identifier of the record. This value does not have to be a random number, but it does need to be unique.
RUN_DTTM	26	N	Date/Time	Date and time this record was executed.
XAI_IN_SVC_ID	10	Y	A/N	This is the XAI service associated with this record. This service should have an adapter of <b>CISStagingUpload</b> .
XML_STG_FILE_NAME	250	N	A/N	This is the location and name of the file containing the data to be uploaded. This is used for comma delimited files and flat sequential files.
XML_INTFC_NAME	30	N	A/N	The name of the interface used to populate this table. This is simply information and is not used by the system.
XML_STG_STATUS_FLG	2	Y	A/N	Must be set to <b>P (Pending)</b> .
NT_XID_CD	30	N	A/N	This field is not in use.
NT_UP_XTYPE_CD	30	N	A/N	This field is not in use.
USER_ID	8	Y	A/N	The ID of the user who created this record.
COMMENTS	254	N	A/N	Use the free format comments, if necessary.
NBR_RECORD_UPLD	10	N	A/N	Leave this blank. This will be populated by the process which creates upload staging records for this control record.

## Staging Control Parameters Layout

If your staging control record should read a database table, the XAI service may include selection criteria in its WHERE clause. If that is the case, then your staging control record should populate the selection criteria. The name of this table is **CI\_XML\_STGCTL\_P**. The following table describes each column on this table.

Column Name	Length	Req'd	Data Type	Comments
XML_STG_CTL_ID	10	Y	N	The unique identifier of the staging control record.
XML_STG_CTL_PARM	18	Y	A/N	Indicate the element in the WHERE clause whose value will limit the selection of records.
XML_STG_CTL_PVAL	250	Y	A/N	Use this to indicate the value used to limit selection of records.

## Upload Staging Layout

You create an XAI upload staging record directly for each XML request you wish to make. The name of this table is **CI\_XML\_STGUP**. The following table describes each column on this table.

Column Name	Length	Required	Data Type	Comments
XML_STGUP_ID	15	Y	N	This is the unique identifier of the record. This value does not have to be a random number, but it does need to be unique.
APP_SVC_ID	20	Y	A/N	This is the foreign key to the application service table, and identifies the application service that is being requested.
COMPLETE_DTTM	26	N	Date/Time	Completion date and time.
CRE_DTTM	26	Y	Date/Time	Creation date and time.
RETRY_COUNT	3	Y	N	Number of retries to process the request.
XML_REQUEST	30,000	Y	A/N	The XML request document.
XML_RESPONSE	30,000	Y	A/N	The XML response document.
XML_STG_CTL_ID	10	Y	A/N	The id of the staging control record linked to this record.
XML_STG_STATUS_FLG	2	Y	A/N	Must be set to <b>P (Pending)</b> .

## XMLUP-PR - Purge XAI Upload Objects

**Completed** XAI upload staging objects should be periodically purged from the system by executing the **XMLUP-PR** background process. This background process allows you to purge all **Completed** XAI upload staging objects older than a given number of days.



We want to stress that there is no system constraint as to the number of **Completed** XAI upload staging objects that may exist. You can retain these objects for as long as you desire. However we recommend that you periodically purge **Completed** XAI upload staging objects as they exist only to satisfy auditing and reporting needs.

## XAI Upload Exception

A record is written to the XAI upload exception table for every XAI upload staging record that is in error.

To view the messages associated with the exception records, schedule the **TD-XAIUP** background process. This process generates a To Do entry for every record in the XAI upload exception table.

After correcting the cause of the error, drill into the [XAI Upload Staging](#) page and change the status from **Error** to **Pending** and the system will attempt to process the record again.

## XAI Download Staging

### XAI Download Staging - Main

To view individual XAI download staging records associated with a notification download staging record, open **Menu > Integration > XAI Download Staging**.

#### Description of Page

**XAI Download Staging** displays information about the record.

The **Download Staging ID** and **XAI Route Type** are the primary identifiers for this record.

The **XAI Download Status** is displayed. The values are **Pending**, **Complete**, **Canceled** or **Error**. When a record is in **Error**, it is displayed on the [XAI Download Exception](#) table.

Values from the NDS record associated with this XAI download staging record are displayed including **Service Provider**, **Notification Download Type**, **NT Download Status Flag**, **Retry Count** and the **Context** collection.

### XAI Download Staging - Request

To display the XAI Request built by the download staging receiver, open **Menu > Integration > XAI Download Staging**.

#### Description of Page

The **XML Request** built by the download staging receiver is displayed.

### XAI Download Staging - Response

To display the Response to this request, open **Menu > Integration > XAI Download Staging**.

#### Description of Page

The **XML Response** to this message is displayed.

## XAI Download Exception

A record is written to the XAI download exception table for every XAI download staging record that is in error.

To view the messages associated with the exception records, schedule the **TD-XAIDN** background process. This process generates a To Do entry for every record in the XAI download exception table.

## Maintaining Your XAI Environment

This section describes various tools provided to enable your XAI administrators to more easily maintain your XAI environment.

### XAI Submission

This page exists for testing purposes. It allows you to create an XML request document and submit it to the system, to ensure that the XML has been built correctly.

#### XAI Submission - Main

To submit an XML document for testing, navigate to **Admin > XAI > XAI Submission** and navigate to the main tab.

##### Description of Page

This page is used to test XML schemas, which are defined for the XAI tool. Enter an appropriate XML document in the **XML Request** field. Typically, you define the XML schema using the schema editor in the XAI application. Then you would copy and paste the document here, then modify the schema to enter actual data for testing purposes.

When you have entered the document, choose **Save** to submit this document to the system. Note that this request information is not saved anywhere. It simply calls the system with the appropriate service name and executes the XML request.

Navigate to the **Response** tab to view the response.

#### XAI Submission - Response

To view the response to a XML document for testing, navigate to the response tab.

##### Description of Page

After choosing **Save** on the main tab to submit a test for an XML request, the response to your request is displayed in the **XML Response** text box.

### Additional XAI Tools

This section introduces some additional tools to help you maintain your XAI environment.

#### XAI Service Export

The service export page allows you to export the definition of an XAI Inbound Service to a file. This function may be helpful if you need to copy the definition of this service to a separate environment. To export a service, open **Admin > XAI > XAI Service Export**.

##### Description of Page

Upon entry into this page, you are provided with the current list of **XAI In bound Services** and their **Description** s. Use the **XAI In Service Name** search field to find the XAI service that you would like to export.

Use the **Export?** column to indicate which XAI service(s) you would like to export. Once you have selected your services, choose **Save**.

---

**NOTE:** If multiple services are selected, they are exported together into the same output file.

---

You are presented with the standard File Download dialogue where you can open or save the file.

## XAI Service Import

The service import page allows you to import the definition of an XAI Inbound Service from a file into the XAI service table. This function may be helpful if you need to copy in the definition of this service from a separate environment. To import a service, open **Admin > XAI > XAI Service Import**.

### Description of Page

Upon initial entry into this page, you are provided with an input field, where you can enter the file name to import. Click **Browse** to search for the desired file in a directory.

Once the file is identified, click **Read File**, to read in the contents of the file.

---

**NOTE:** The format of the file must include tags indicating the column names for XAI Inbound Service table along with the values of the columns. For an example of how the format should be, simply go to the [XAI Service Export](#) page, export a Service and view the format of the resulting file.

---

Once the file has been read in, the list of XAI services found defined within the file is displayed in the Import grid, identified by their **XAI In Service Name** and **Description**. In the **Import?** column, indicate which services to import.

If a service with this service name already exists in the table, you must check the **Overwrite Existing** switch in order to indicate that the imported file information should replace the current service. An [XAI Inbound Service](#) that is provided as part of the system (i.e., with an owner of **Base Product**) may not be overwritten.

Click Save to proceed with the import. If any problems are found, information is displayed in the **Message Text** column.

## XAI Command

Use the XAI Command page to send commands to the XAI and MPL server. To execute a command, open **Admin > XAI > XAI Command**.

### Description of Page

The following operator commands may be sent to the XAI server. For each of these commands, you may check **Also Sent to MPL URL**, in which case, the command is also sent to the MPL server. You need to indicate the URL of the MPL server.

**Display Registry** Use this command to display the current registry information that the XAI instance is running with.

**Refresh Code and Description** This is related to an attribute in the schema editor where you may indicate that the description of a control table code should be returned along with the code itself. This information is kept in cache memory in the server. As a result, changes made to descriptions have no effect on the runtime server. This command clears the cache of control table codes and descriptions accessed by the server.

**Refresh Registry** The registry contents are kept in cache memory in the server. As a result, making changes to the registry control tables has no effect on the runtime server. Use this command to refresh the contents of the registry cache with the new values in the registry control tables. The command reloads all registry control table data into the server.

**Refresh Schema** Schema definitions are stored in cache memory on the XAI server. As a result, modifying a schema definition has no effect on the runtime server. To refresh schema definitions, use the Refresh Schemas command.

**Refresh Service** Service definitions are stored in cache memory on the XAI server. As a result, modifying an XAI inbound service definition has no effect on the runtime server. To refresh service definitions, use the Refresh Service command. You are prompted to indicate which service to refresh.

**Refresh XSL** XSL Transformation script definitions are stored in cache memory on the XAI server. As a result, modifying an XSL transformation definition has no effect on the runtime server. To refresh XSL transformation definitions, use the Refresh XSL command.

**Trace On** Use this command to start the XAI server trace.

**Trace Off** Use this command to stop the XAI server trace.

**XAI Trace Clear** Use this command to clear the contents of the trace file.

**XAI Trace Swap** Use this command to rename the current trace file by appending the date and time to the end. A new trace file is then created with the name as defined in the [Message option](#) page.

The following operator commands can be sent to the MPL server. You must set the URL of the MPL server first.

**MPL Refresh Executer** Executer definitions are stored in cache memory. As a result, adding or modifying executer definitions has no effect on the runtime server. Use this command to refresh executer definitions. You are prompted to indicate the executer to refresh.

**MPL Refresh Receiver** Receiver definitions are stored in cache memory. As a result, adding or modifying receiver definitions has no effect on the runtime server. Use this command to refresh receiver definitions. You are prompted to indicate the receiver to refresh.

**MPL Refresh Sender** Sender definitions are stored in cache memory. As a result, adding or modifying sender definitions has no effect on the runtime server. Use this command to refresh sender definitions. You are prompted to indicate the sender to refresh.

**MPL Start Receiver** Use this command to start a particular receiver. You are prompted to indicate the receiver to start.

**MPL Stop** Use this command to stop all MPL activity. It stops all receivers and waits for all executers and senders to complete.

**MPL Stop Receiver** Use this command to stop a particular receiver. You are prompted to indicate the receiver to stop.

**MPL Trace On** Use this command to start the MPL server trace.

**MPL Trace Off** Use this command to stop the MPL server trace.

When you have chosen the appropriate command and indicated any extra information, click **Send Command** to send the command to the server(s).

If you have sent a command to the XAI Server, then the bottom portion of the screen displays the response in the **XAI Response**. If you have sent a command to the MPL Server, then the bottom portion of the screen displays the response in the **MPL Response**. If you have sent a command to both servers, the bottom portion of the screen displays both responses.

## MPL Exception

The MPL Exception table is used by the MPL to keep information about requests that resulted in a system error. These are errors that occurred inside the MPL. For example, if the MPL fails to send a request to XAI (maybe WebLogic is down), this is a system error, which would be logged in the MPL exception table.

There are errors that are defined recoverable. This means that the MPL will retry the action that failed, according to the parameters it received.

## Server Trace

The XAI server traces every request and response. The requests/responses are written to a trace file on the server. The trace file may be viewed using the [Trace Viewer](#).

## Starting the Trace

The log starts automatically based on definitions in the [Message Options](#) in the traceType and traceFile options. To manually start the trace:

- Navigate to **Admin > XAI > XAI Command**.
- Select the **Start Trace** command from the command dropdown
- Click **Send Command**

## Stopping the Trace

- Navigate to **Admin > XAI > XAI Command**.
- Select the **Stop Trace** command from the command dropdown
- Click **Send Command**

## Trace Viewer

Use the Trace Viewer utility to view the log file. The Trace Viewer is installed when you install the XAI client tools. It can be found in the XAI program group under Start/Programs.

## Main Page

When the Trace Viewer starts, select a trace file to view. A trace file may be opened in one of two ways:

- To open a trace file directly from its location on the web application server, use the **File, Open HTTP** menu item and provide the appropriate URL.
- To open a trace file on the local/network file system use the **File, Open** menu item

### Description of Page

Once a trace file is opened, it displays a list of all the requests on the left side including the **Service Name**, the **Start Time** and the **End Time**.

To display the XML contained in the request and response entries for a displayed request, select a request entry.

### Filtering Options

Since the trace file may contain a very large number of messages, the trace viewer limits the number of messages that can be displayed. It does that by displaying messages traced within the last x number of **Minutes**, **Hours** or **Days**.

Use the **Max Messages** to limit the number of messages displayed.

---

**NOTE: Default Note.** By default, the Trace viewer displays the first **200** messages in the trace file.

---

To view only errors in the trace, check the **Show only Errors** option.

---

**NOTE: Refresh Display.** After changing any of the above filtering options, click the refresh button  in order to redisplay the request entries based on the new options.

---

The **First Message Found** field indicates the date and time of the earliest entry in the trace file.

Viewing as Text

To view the trace file as text rather than viewing each entry in its XML format, use the **View, As Text** menu option. The contents of the trace file are displayed in text format in a separate window.

## Statistics Page

Use the **View, Statistics** menu item to view the statistic page, which displays performance statistics about the XAI services that were executed in the XAI trace file.

For each type of XAI Service and transaction type, it displays the following information based on the requests traced in the XAI trace file:

- The **Service Name** with the transaction type in parentheses
- The **Number of calls** for this service in the listed trace records
- The **Average duration Time** (in seconds)
- The **Max imum duration Time** (in seconds)
- The **Min imum duration Time** (in seconds)

---

**NOTE: Requests Included in Statistics.** Only requests falling in the time selection criteria and listed on the main log viewer are processed for calculating the statistics.

---

To display a Duration Chart for a particular service, check the Service. A chart such as the one below is displayed.

## Integrations

---

This chapter provides high level information about product integrations supported for all products that use Oracle Utilities Application Framework.

### LDAP Integration

Organizations commonly use a Lightweight Directory Access Protocol (LDAP) security repository as a source of security credentials. The system provides support for importing users and groups from an external LDAP repository into the product to populate Users and User Groups in the system. Once imported, all user and group functions are available. You can resynchronize your LDAP users and groups at any time.

---

**NOTE: Import only.** The system currently supports importing LDAP information. Exporting users and groups from the system to LDAP is not provided.

---

**NOTE:** Additional configuration. When importing new users and / or groups, additional configuration is needed in the base product. For example, after importing a new user group and its users, the user group configuration should be updated to define the valid application services for the user group. After importing a new user, additional configuration may be needed on the user such as valid To Do Roles, valid Home Page, etc.

---

**FASTPATH:** Refer to [Defining Security and User Options](#) for more information about the application security and what it controls.

---

This section the functionality provided in the framework application that supports LDAP. Refer to the *LDAP Integration* white paper for more information about typical steps related to the full integration.

## LDAP Integration Overview

This topic provides a high level overview of the integration process.

At a high level, the base product provides a process to import user group and / or user definitions from and LDAP repository. This is a one way integration.

- When importing a user, if it is not already found in the system, it will be added; otherwise its attributes will be updated according to the imported information.
- When importing a user group, if it is not already found in the system, it will be added; otherwise its attributes will be updated according to the imported information.
- When importing a user, its user group links will be updated as per the information in the import file. In addition, if there are any user groups linked to the user that are not found system, they will be added (however, the other users linked to that group in the LDAP repository will not be added as part of this step).
- When importing a user group, its user links will be updated as per the information in the import file. In addition, if there are any users linked to the user group that are not found system, they will be added (however, the other user groups linked to that user in the LDAP repository will not be added as part of this step).
- The import will not cause any deletions of the User or User Group to occur.

### A Batch Process Initiates the Import

A batch process is used to initiate the import of information from the LDAP repository. **F1-LDAP** may be submitted ad hoc or may be set up in a scheduler to periodically re-sync the information from the LDAP repository into the application.

The batch process uses parameters to define how to connect to the LDAP repository. In addition, parameters are used to indicate which user or group is being imported.

### Adjusting Data to Import

The system provides several mechanisms for adjusting data that is being added to the system:

- There is an **LDAP Import Preprocess** algorithm plug-in spot on the [installation](#) record. Algorithms plugged in here are called by the batch process prior to the add or update of any records. It may be used to make adjustments to the data before doing updates in the application.
- Specifically for creating or updating Users, the **F1-IDMUser** business object is used to add and create the user. The standard BO Preprocessing algorithm plug-in spot may be used to adjust data prior to creation.
- The LDAP mapping file supports some attributes to perform simple modifications to data.
  - The **transform** attribute supports values to truncate values or to convert data to upper case.
  - The **autoGenerate** attribute is specific to the User ID field. Setting this to true will trigger code that will automatically populate the User ID based on the user's name. Refer to [LDAP Mapping](#) for more information.

### Performing Additional Processing After Import

The system provides a plug-in spot on the [installation](#) record called **LDAP Import**. Algorithms plugged into this spot are called after users or user groups have been added or updated. It may be used to perform any extra processing that may need to be executed.

In addition, for any additional processing related to the creation or update of a User, the standard [Business Object plug-ins](#) may be used for the **F1-IDMUser** business object which the LDAP batch process uses to create or update users.

## Configuring LDAP Integration

To interface the LDAP based security repository with the authorization component of the Oracle Utilities Application Framework product the following must be performed:

- The location and port number of the LDAP based security repository must be defined to in the JNDI Server.
- • The LDAP based security repository must be mapped to the Oracle Utilities Application Framework security model. This mapping is expressed as an XML file containing the LDAP query, rules and defaults used in the transformation.
- • The mapping file must be configured on the **F1-LDAP** batch job.

### Define the JNDI Server

The first step in the configuration process is to define the location of the LDAP based security repository server so that the interface can connect to the physical attributes of the interface. This is done by creating a [JNDI Server](#).

---

**NOTE:** The LDAP server is strictly not a JNDI source but is treated as a JNDI source for the integration.

---

Enter a reasonable JNDI Server name and description.

Populate the **Provider URL** using the format **ldap://<hostname>:<portnumber>** where **<hostname>** is the host of the LDAP server and **<portnumber>** is the port used for the interface.

For the **Initial Context Factory**, the interface uses the standard **com.sun.jndi.ldap.LdapCtxFactory** provided with java for the LDAP interface. If your vendor supplies a custom context factory it may be used. Refer to the documentation provided with your LDAP based security repository for further information.

### Define Mapping

The critical component of the interface is a file that describes the mapping between the LDAP based security repository and the system's security model. This file contains the mapping, rules and queries used by the LDAP batch program to provide the interface. The LDAP batch job includes the reference to the mapping file as a parameter. Refer to [LDAP Mapping](#) for more information on defining the mapping file.

### Configure LDAP Batch Process

At this point, many parameters for the **F1-LDAP batch control** can be updated with system wide configuration.

- JNDI Server, User and Password may all be configured appropriately. Note that it is recommended that the **Security** setting for the Password be set to **Encrypt**.
- The **LDAP Configuration File** should be populated with the name and location of the LDAP Mapping file.
- If the LDAP service has any limitation to the number of objects that may be imported, configure the **LDAP Query Page Size** parameter to enable querying.

---

**NOTE: Group and User Parameters.** The assumption is that the Group or User input parameters are specific to a given import request and as such would not be populated as part of a configuration step.

---

**NOTE: L2 Cache.** The LDAP Import batch process requires the L2 Cache to be disabled since it needs to perform some updates in the outside of the worker threads. Any environment using LDAP Import must set **spl.runtime.batch.L2CacheMode=OFF** in the **threadpoolworker.properties** file. It is recommended to run the LDAP import in its own dedicated threadpoolworker.

---



## LDAP Mapping

An LDAP repository consists of multiple entries. Each entry represents an object in the directory that is identified by a Distinguished Name (DN) and may contain one or more attributes. In a typical LDAP repository there is usually an entry for users and an entry for groups. The connection between users and groups may be implemented in two different ways:

- The users belonging to a group are defined in a special multiple-value attribute on the Group entry.
- The groups to which a user belongs are defined in a special multiple-value attribute on the User entry.

The mapping between LDAP security objects and base security objects is stored in an XML document that can be processed by the LDAP import batch job. As part of setting up your system for LDAP import, you need to define this mapping. The base package provides a sample mapping file called **ldapdef.xml** that can be used as a starting point and changed per your business requirements and your particular LDAP repository.

Once you have defined the mapping XML document, this is configured as a parameter in the **F1-LDAP** batch job.

The XML structure:

- The **LDAPEntry** element maps the LDAP entries to system objects (User or Group). The mapping file must contain one and only one LDAPEntry element for User and one for Group.
- The **LDAPCDXAttrMapping** element within the LDAPEntry element maps attributes in the LDAP entry to attributes in the system object.
- The **LDAPEntryLinks** element describes objects linked to the LDAP entry. When mapping the user entity you need to describe how the groups the user belongs to are retrieved. When mapping the group entity you need to describe how the users contained in the group are retrieved.

The following table describes the attributes to define for each element.

Element	Attribute	Description
LDAPEntry	name	The name of the LDAP entry: - <b>Group</b> - <b>User</b>
	baseDN	The base distinguished name in LDAP for this entry.
	cdxEntity	The name of the base product entity to which the LDAP entry is mapped: - <b>Group</b> - <b>User</b>
	searchFilter	An LDAP search filter that is used to locate LDAP entries. A %searchParm % string in that filter is replaced by the value from the user or group parameter from the <b>F1-LDAP</b> batch job submission.
	Scope	Sets the scope of the search. Valid values are: - onelevel (the value normally used) - subtree
LDAPCDXAttrMapping	ldapAttr	The name of the LDAP attribute to be mapped. Note that this may be referenced more than once to allow one LDAP element to map to multiple base product elements. For example, if an email address should be used both for the Login ID and the Email Address.
	cdxName	The name of the base product attribute to be mapped. For User, this is the element within the F1-IDMUser business object. For Group, this is either the 'group' or the 'description'.
	default	The default value that will be assigned to the element referenced in the cdxName attribute when one of the following occurs: - The LDAP attribute contains a null or empty value - The LDAP attribute does not exist or is not specified. Default values are applied only when creating a new entity and are not applied to updated entities.

Element	Attribute	Description
	autoGenerate	Set this to <b>true</b> in order to turn on auto generation of the user ID. If this is true, the system will define the user id as <first initial of first name>+<last name> all uppercase, to a maximum of 8 digits. If an existing user is found for the generated ID, a number will replace the eight digit (or be appended to the end). The system will increment the number until a unique ID is found.
	transform	Use this attribute to indicate if a transformation of the data should occur. Valid values: <b>uppercase truncate</b> . Note that this attribute should not be used in conjunction with the autoGenerate attribute.
LDAPEntryLink	linkedToLDAPEntity	The name of the linked entity ( <b>User</b> or <b>Group</b> ). Use User when describing the Group entity. Use Group when describing the User entity.
	linkingLDAPAttr	The multiple-value attribute name on the LDAP entity that contains the linked entity.
	linkingSearchFilter	The search filter to be applied to retrieve the list of linked objects, for example:  (&!(objectClass=group)(memberOf=%attr%))  The search filter may contain the string % attr % that acts as a substitution string and is replaced at run time by the value of the attribute named "attr" of the imported entity. If the LDAP entry you are describing is a Group and the string is %name%, it is replaced by the value of the "name" attribute of the group you are importing. If the LDAP entry you are describing is a User and the string is %dn%, it is replaced by the "dn" attribute of the User you are importing.
	linkingSearchScope	Sets the scope of the search. Valid values are: - <b>onelevel</b> (the value normally used) - <b>subtree</b>

## Sample Mapping

The following XML describes a sample mapping. The example makes the following assumptions:

- The base product attribute **displayProfileCode** is defaulted to "NORTHAM" when adding a new user.
- The LDAP Group entry contains the list of users belonging to the group in the **departmentNumber** attribute.
- The groups to which a user belongs are retrieved by applying a search filter.

```
<LDAPEntries>
  <LDAPEntry name=" User" baseDN="ou=people,dc=example,dc=com" cdxEntity="
    user" searchFilter=" (&!(objectClass=inetOrgPerson)(uid=%searchParm%)) ">
    <LDAPCDXAttrMappings>
      <LDAPCDXAttrMapping ldapAttr="uid" cdxName=" user" />
      <LDAPCDXAttrMapping ldapAttr="cn" cdxName="externalUserId" />
      <LDAPCDXAttrMapping cdxName="language" default=" ENG" />
      <LDAPCDXAttrMapping ldapAttr="givenName" cdxName="firstName" />
      <LDAPCDXAttrMapping ldapAttr="sn" cdxName=" lastName" />
      <LDAPCDXAttrMapping cdxName="displayProfileCode" default="NORTHAM" />
      <LDAPCDXAttrMapping cdxName="toDoEntriesAge1" default="30" />
      <LDAPCDXAttrMapping cdxName="toDoEntriesAge2" default="90" />
      <LDAPCDXAttrMapping cdxName="userEnable" default="ENBL" />
    </LDAPCDXAttrMappings>
    <LDAPEntryLinks>
      <LDAPEntryLink linkedToLDAPEntity="Group" linkingLDAPAttr="departmentNumber" />
    </LDAPEntryLinks>
  </LDAPEntry>
  <LDAPEntry name="Group" baseDN="ou=people,dc=example,dc=com" cdxEntity="
    Group" searchFilter=" (&!(objectClass=organizationalUnit)(ou=%searchParm%)) ">
    <LDAPCDXAttrMappings>
      <LDAPCDXAttrMapping ldapAttr="name" cdxName="Group" />
      <LDAPCDXAttrMapping ldapAttr="description" cdxName=" Description" default="Unknown" />
    </LDAPCDXAttrMappings>
    <LDAPEntryLinks>
      <LDAPEntryLink linkedToLDAPEntity="User" linkingSearchFilter="
        (&!(objectClass=inetOrgPerson)(departmentNumber=%distinguishedName%)) "
        linkingSearchScope="onelevel" />
    </LDAPEntryLinks>
  </LDAPEntry>
</LDAPEntries>
```

```
</LDAPEntryLinks>
</LDAPEntry>
</LDAPEntries>
```

## Oracle Identity Manager Integration

The *Oracle Identity Manager* product allows a site to centralize their user definitions and password rules to manage and deploy across the enterprise set of products. When an employee joins an organization, changes their name or departs an organization their security presence across an enterprise must be appropriately managed. Oracle Identity Manager allows for users to be provision and managed in a central location.

An integration is provided to allow the ability to create, maintain and remove users in the identity management product and sync those changes to the users defined in the application. The following sections provide additional details about the integration with respect to configuration steps required in an Oracle Utilities Application Framework based product. For more information about the configuration required in the identity management product, refer to the *Identity Management Suite Integration* white paper.

### Template User Functionality

The user object in this product captures configuration used to control access but also preferences. The identify management product allows for extending the configuration to capture user configuration that is specific to this product. However, it does not support providing searches or dropdowns to select valid values. For example, to define the user's Home Page requires the reference to a navigation option. To set up your business process such that the home page is configured when defining the user in the identity management product dictates that the security user types in the correct navigation option reference.

On the other hand, to define a minimal amount of user information in the identity management product may result in a two step process for defining users: first define them in the identity management product with the basic authentication details and setting system defaults for some important fields, then after submitting the new user to be added to this product, navigate to the [user](#) page in this product and fill in all the configuration that is specific to this product.

The product provides support for defining a template user that can facilitate the definition of users and reduce some of the challenges listed above. The concept is as follows:

- Define a template user for each broad category of users in the system. For example, Oracle Utilities Mobile Workforce Management may define the following template users: Dispatcher, Mobile Worker, System Administrator and Contractor. Each user would define the typical configuration for users of that type including the home page, the user groups, the To Do roles, the portal preferences, etc.
- When extending the configuration in the identity manager product, simply map the information that is unique to a user and in addition, define a field for the template user. For example, you may choose to only capture the Name (first and last), Email address and User IDs for the user along with its Template User (which is mapped to a user characteristic). Additional fields may be included for capture in the identity management product when defining new users as per an implementation's business needs. For example, if the organization covers multiple time zones, perhaps it is easier to define the user's time zone when defining the user in the identity management product.
- When the new user is uploaded to the system, the interface uses the user BO **F1-IDMUser** to create the user. The BO includes a preprocessing algorithm that looks for the existence of a template user (sent as a characteristic of type **F1-TMUSR**). All the information from the template user will be copied onto the new user record except for the information passed in from the identity manager. The template user is captured on the newly created user via a characteristic for information / audit purposes.
- Once the new user is created, its configuration can now be adjusted, if applicable. Note that the template user is only a tool used when adding a user. Updates to the template user will not "ripple" to all the other users that were created based on this template.

## Configuring Template Users

Before configuring template users, all the administrative control tables that are part of User configuration must be defined, including time zones, display profiles, To Do roles, data access roles and user groups.

The next step is to define the user configuration for your system users. During this exercise, you will find that you have broad categories of users. But you will also see that within a given category of user there may be variations in the user privileges and preferences. For example, perhaps there are supervisors within the Mobile Worker role that have more security privileges than a typical Mobile Worker. In addition, there may be variations based on the attributes of the users themselves. For example, maybe your organization exists in multiple time zones and some of your workers are in one time zone and some are in the other.

At this point your security users that are designing their user provisioning procedures must decide the following:

- What information about a new user will be captured in the identity system (besides the expected information like Name, Email and the User IDs)? For example, for the case of multiple time zones, maybe the best solution is to capture the time zone when defining the user.

What information is defined on the template user and how many template users should be created to reduce the need for manual steps or additional data captured in the identity management system? In the case of multiple time zones, proliferating the template users to have one set for one time zone and another set for the other time zone may not make sense since this is one field that is different. However it may be reasonable to create additional templates in the case of variations in the levels of privileges for workers of a different category. So rather than template users for Dispatcher, Mobile Worker, System Administrator and Contractor, your organization may have template users for Dispatcher, Mobile Worker, Mobile Worker (Supervisor), System Administrator, Contractor (Short Term) and Contractor (Long Term).

What information is must be configured on the User record in the application after the user is added? If only a small number of users have a variation from other users, it may be that the easiest way to deal with those variations is to simply update those user records manually. Using the above examples:

- If your organization covers 2 time zones but only a small group of people work in one of the time zones whereas the bulk of the users are in the other time zone, the simplest procedure may be to define the template users for the main time zone and use that for the creation of all users. Then for the small group of users in the separate time zone, navigate to the User page to adjust the time zone after the record is added.
- If only a small number of Mobile Workers are supervisors with separate privileges, rather than defining a special template user for those type of workers, the simpler procedure may be to use the Mobile Worker template and then navigate to the User page to add the additional privileges to the supervisor users after the record is added.

To create a template user, navigate using **Admin > Security > User** .

- Define a User ID that will become the template user reference in the identity management system.
- Be sure to choose a **User Type** of **Template User**.
- Define all the information that should be copied onto a new user that references this user as a template user. Note that **Bookmarks** are not included in the data that is copied from a template user.

---

**NOTE:** There is configuration needed in Oracle Identity Management to capture the template user and any other information that the implementation has chosen to define in the identity management product when provisioning a new user. Refer to the *Identity Management Suite Integration* white paper for more information.

---

## Batch Scheduler Integration

The Oracle Database includes an enterprise wide scheduler to simplify the scheduling of background processes. The scheduler is implemented by the *DBMS\_SCHEDULER* package. The product provides an integration with the Oracle Scheduler to facilitate scheduling background processes shipped with the product.

At a high level, the integration with the Oracle DBMS Scheduler supports the following entities:

- **DBMS Program.** A program should be defined for each Batch Control that needs to be scheduled by the DBMS scheduler. A program would typically invoke a batch job, but it could be configured to set certain options instead.
- **DBMS Chain.** A Chain defines a series of steps with dependency rules between them. A step references a program, with the program performing the actual work for that step. A rule is attached to each step to identify its dependent steps and the condition for when that step should be executed. For example, in a chain consisting of STEP\_A and STEP\_B, where STEP\_B can only start if STEP\_A was successful, the rule for STEP\_B to start would specify a condition of "STEP\_A SUCCEEDED".
- **DBMS Schedule.** A predefined frequency for jobs that need to be run periodically, for example, nightly jobs.
- **DBMS Job.** Defines a plan to perform a specific program or a chain periodically on a specific schedule or ad-hoc.

The product provides a set of business services to maintain these entities as well as submit jobs, manage submissions and report on past submissions. Refer to business services that start with the prefix "F1-DBMS" for more information.

---

**NOTE:** For details on the integration, refer to the *Server Administration Guide* which contains the API. In addition, refer to the white paper *Oracle Scheduler Integration* that provides guidelines for using this integration.

---

## Data Synchronization

Your implementation may need to communicate certain data to external systems. This may be part of a data warehousing requirement or an integration effort. The synchronization process has two main parts. First, the change to the data must be detected and captured. Once that is accomplished, the next step is to manage the communication of that change to the external systems involved. The changes must be captured in chronological order so as to avoid systems going out of sync.

## About Data Synchronization

The following sections describe general supported functionality in more detail using the logic supplied in the base business object **F1-SyncRequest**. Note that each edge application delivers an appropriate child business object for this BO for each specific synch scenario supported in that product. Some of the functionality below is accomplished using configuration on the parent BO delivered by the framework while other functionality may be delivered by the child BO. In addition, there may be more complex use cases supported by your specific product integration. Refer to your specific application's library of Sync Request business object along with the documentation related to your specific product integration for more information.

### Capturing the Change

The base product uses the **Audit** plug-in spot on the maintenance object to allow for logic to be performed by the system when a change is detected to a record for that MO. The framework calls the algorithm defined on this plug-in spot in the event a change to the MO has been detected. Refer to the description of the plug-in spot on [Maintenance Object — Algorithms](#) for more information about when this plug-in is called.

The base product provides an change data capture algorithm **F1-GCHG-CDCP** that may be used by maintenance objects. This algorithm creates a Sync Request record for each changed record, capturing the MO code and the primary key, if it doesn't find an existing sync request for the same record (and the same business object) in the initial state. The sync request business object used is the one defined in the **Sync Request BO** option on the MO for the record that was changed.

Your specific product may also introduce additional Audit algorithms to cater for more sophisticated examples. Click [here](#) to see the algorithm types available for this system event.

When creating the sync request record, typically the Sync Request BO will have a pre-processing plug-in that captures a snapshot of the record's data prior to its change. This will be used in subsequent steps to verify that the external system needs to be notified of the change.

## Confirming that a Sync is Needed

Once a sync request is captured, there are several steps performed prior to any information being sent to the external system.

---

**NOTE:** This section only highlights key steps. Please refer to the business object configuration, its lifecycle and algorithms for a thorough picture of the full functionality..

---

- When a Sync Request record is created, its initial state (**Pending**) is configured to be processed by a batch monitor. That way, records are added to the sync request table added throughout the day but all are processed together. The MO audit algorithm ensures that a new sync request is not created if a Pending record already exists for a given MO / PK combination (for the same business object). However, it is possible that a record for that MO / PK exists in a subsequent “non-final” (such as **Awaiting Acknowledgement**). This state includes a monitor algorithm to check for that condition and to skip transitioning if another record exists. This is done to ensure that the existing record is fully processed before this new record is processed.
- The next state of the lifecycle is **Determine if Sync Needed**. This step uses an algorithm to take a snapshot (called the ‘final snapshot’) of the data and compare it against the initial snapshot taken when the record was created. Based on the logic of the algorithm, it may decide to proceed (transition to **Send Request** or to discontinue (transition to **Discarded**.

## Communicating to the External System

Once it is confirmed that the sync should occur, a message must be sent to the external system. The following points highlight the basic functionality.

- An algorithm linked to the **Send Request** state. The expectation is that this algorithm creates an outbound message that routes the information to the external system appropriately. The algorithm must determine the external system and outbound message type to use. Business objects for Sync Request support BO options to define the external system and outbound message type to use for this algorithm.
- Once the outbound message is triggered, the record transitions to the **Awaiting Acknowledgement** status. This state is used to hold the sync request from further state transitions until an acknowledgement is received from the external system. Note that this step relies on implementation of a response mechanism from the external system. It is recommended to implement a response as this helps control the chronological flow of information. The product supplies the business service **F1-UpdateSyncRequest** that transitions the sync request to either the next default state (in this case the **Synchronized** state) if a positive acknowledgement is received; or the state associated with the Rejection transition condition (in this case the **Error** state) if a negative acknowledgement is received. In addition, this state may be configured with a monitor algorithm that detects that a timeout limit has been reached.
- For records that enter the **Error** state, it is recommended to configure an algorithm that creates a To Do entry to alert someone of the problem. Refer to the integration documentation for more information. The state is already preconfigured with an algorithm to complete To Dos when exiting the state.
- The final state **Synchronized** is used to mark the successful synchronizations. However, for more complicated use cases, this state may be used to trigger some additional action. Refer to the documentation for your specific product integration for more information.

## Maintaining Sync Requests

The system provides a Sync Request portal that is used to view the in progress or completed sync request records.

The menu location of the portal depends on your specific edge product. It may be in a Data Synchronization menu or perhaps in the Batch menu. You are brought to a query portal with options for searching. The options may differ based on your specific product.

Once a sync request has been selected, you are brought to the maintenance portal to view and maintain the selected record.

An **Actions** zone may appear to display specific actions. Alternatively, the actions may be displayed directly in the display area of the **Sync Request** zone.

The **Sync Request** zone provides basic information about the sync request record.

Depending on your specific product additional zones may appear.

## Analytics Integration

The framework provides several building blocks and tools that the edge applications may use to implement integration with the Oracle Utilities Analytics product (referred to in this section as the analytics product). The following sections provide more information about this functionality.

### About Analytics Integration

The following sections describe the type of configuration supported in your product to integrate with the analytics product. Refer to the Oracle Utilities Analytics documentation for more information.

#### Master Configuration

Edge applications that include an integration to the analytics product typically include a master configuration record that captures information needed for the extract, load and transformation step, such as extract parameters. These records are provided by the specific edge products and may be viewed and maintained on the [master configuration](#) portal.

Note that your specific edge application may deliver an **Analytics Configuration** portal that displays the information from the master configuration record along with other analytics related configuration.

#### Bucket Configuration

The analytics product provides support for defining a set of ranges, each representing a bucket for which extracted measures can be grouped and classified under the relevant bucket. The framework product provides support for viewing and defining the buckets. Refer to [Bucket Configuration](#) for more information.

#### Characteristic Mapping

The product provides objects to allow mapping configuration of characteristics in the product to user defined fields on dimensions in the analytics product. Refer to ETL Mapping Control for more information.

#### Change Data Capture Using Sync Request

Depending on the specific edge application and version you are using, there may be components of the integration that use Sync Request for the change data capture step. If that functionality applies to your implementation, the following points highlight how to get more information:

- Refer to the administration guide for Oracle Utilities Analytics to confirm if your product integration is using Sync Request for any change data capture functionality.
- Review the Sync Request Business Objects provided by your product for analytics integration.
- Refer to [Data Synchronization](#) for a high level understanding of the process.

### Maintaining Bucket Configurations

Several key performance indicators in the analytics product look at measurement values (for example: the age of an asset or the age of debt) classified into a number of pre-defined groups also known as buckets. The overall metric can then be reported by the different buckets and allow various analyses.

For example, the age of an asset can be classified into the following buckets:

- Less than 6 Months

- 6-12 Months
- One Year and Older

The age of debt, also known as arrears can be classified onto the following buckets:

- 0-30 Days
- 30-60 Days
- 60-90 Days
- 90+ Days

The definition of the buckets is extracted to the Business Intelligence data warehouse, to be used as dimensions.

## Bucket Definition Considerations

Each type of bucket is defined using a bucket configuration Business Object. The bucket definition considerations and/or rules will vary based on the bucket configuration business object used. The business objects available are driven by your specific product. For a list of available bucket configurations business objects, navigate to the business object page and view the business objects for the Bucket Configuration maintenance object.

## Setting Up Bucket Configurations

To maintain the bucket ranges for the bucket configuration(s) applicable to your product, open **Admin > Analytics Configuration > Bucket Configuration**.

You are taken to the query portal where you can search for an existing bucket configuration. Once a record is selected, you are brought to the maintenance portal to view and maintain the selected record.

---

**NOTE:** Your specific product may also include an Analytics Configuration portal that displays the list of existing and potential bucket configuration records, allowing you to drill into this page to view the record in detail.

---

The **Bucket Configuration** zone provides basic information about the bucket configuration.

For more information about the elements supported refer to the zone's help or to the relevant analytics integration documentation for your product.

## ETL Mapping Control

If your implementation would like to map characteristic data in your application to user defined fields on dimensions in the analytics product, the ETL mapping control provides configuration to support this.

ETL mapping control relies on configuration in the Allowed Target Dimensions [extendable lookup](#). The extendable lookup is used to define each Target Table in the analytics product that has one or more user defined fields that may be populated with characteristic values. It also defines the valid characteristic entities that may act as the source for the characteristic data.

---

**NOTE:** The framework does not provide any values in this lookup, but edge products that support mapping provide values in this lookup. Please refer to your specific product's integration chapter and refer to the Oracle Utilities Analytics documentation for more information.

---

## Setting up ETL Mapping Control

Use the ETL mapping control to define how to populate each target table (dimension) and target column (user defined field) by indicating the characteristic entity, characteristic type and for sequence-based characteristic, the sequence number.



---

**NOTE:** For sequence based characteristics, if the source entity captures multiple characteristic values for a given characteristic type, each characteristic type and sequence combination must be mapped to a specific target table and target column.

---

**NOTE:** Only **Adhoc** and **Pre-defined** characteristic types are supported.

---

To maintain the ETL mapping control records, open **Admin > Analytics Configuration > ETL Mapping Control**.

This is a standard [All-in-One portal](#).

Refer to the embedded help text for more information.

## Business Flags

It is possible that information detected in one product may be useful or even critical to share with another product. The framework provides functionality for receiving information from an external system that acts as a type of flag or alert that may need investigation. This allows any system to store detected business flags in a common way and share that information with one or more other systems.

### About Business Flags

The following is an example of a use case for business flags. Imagine that DataRaker highlights potential theft of service at a certain location. That product may initiate a business flag alert to various products owned by the implementation with a recognized "standard name" for the business flag, such as "TAMPER".

- If Oracle Utilities Meter Data Management receives this business flag, it may initiate a service investigation monitor.
- If Oracle Utilities Mobile Workflow Management receives this business flag, it may initiate a service investigation activity.
- If Oracle Utilities Customer Care and Billing receives this business flag, it may initiate a hold on billing for that location.

Note that the framework product supplies basic functionality to support logic that is common to all edge applications that implement business flag functionality. However it is the individual edge applications that supply more specific functionality (business objects and algorithms) for specific use cases, if applicable.

The following sections highlight functionality supported for business flags in the framework. Refer to the edge application product documentation for more details for supported use cases.

### Standard Name

To ensure that Business Flags are universally understood across all edge applications and to simplify integration each Business Flag will have a Standard Name. This is a name that is used by all the products when sending information to each other. That way, if DataRaker product sends Oracle Utilities Meter Data Management a "TAMPER" business flag, it should result in the same functionality as when Utilities Customer Care and Billing sends a "TAMPER" business flag.

Business Flag Standard Names are defined using an extendable lookup. In addition to standard extendable lookup fields, the standard name also references a category. In addition, the lookup supports defining one or more external names, for cases where information is communicated from an external system that does not send the expected Standard Name.

The framework does not deliver any standard names or category values. Refer to your specific edge application products to verify if any standard names or categories are delivered. Your implementation may configure appropriate standard names and categories based on your business rules.

## Business Flag Type Defines Behavior for a Standard Name

Although the definition of the business flag standard names should be universally understood by the various integrated products that support them, each individual product defines what should occur when a business flag with a given standard name is created. This is configured using a business flag type. Only one active business flag type may exist for a given standard name. Business flags that are received from an external system will define the standard name, but will not have knowledge of the specific business flag types defined. The business flag type is determined based on the standard name.

The business flag type defines the business object to use when creating the resulting business flag record. The business object defines the lifecycle of a resulting business flag record.

## Business Flag Type Algorithms

The business flag type includes support for algorithms. This allows for an implementation to define a common business object that may be used for different business flag types (if a common lifecycle is followed) but allow for different functionality to kick in depending on the business flag type.

The product supplies a plug-in spot for **Additional Processing** that may be invoked by a business flag that enters the Additional Processing state. Refer to your product's library of business objects to determine if there is an Additional Processing state that supports calling algorithms on the business flag type.

Click [here](#) to see the algorithm types available for this system event.

## Objects Linked to a Business Flag

There are two types of links between an object in the system and a given business flag.

### Affected Entity

Each business flag is associated with a single record in the system that is considered the “affected entity” or the entity that the business flag is associated with. The affected entity is defined by the specific business objects designed for the use cases supported by your edge product. For example, many utility base products may configure service point as the affected entity for its business flag use cases. Each business flag created is linked to a specific service point. Linking a specific entity to each business flag allows for algorithms to trigger functionality for that entity such as an investigation order. In addition, algorithms may be implemented in other business process areas that look for the existence of a business flag and act accordingly.

### Related Objects

The business flag supports linking one or more related objects to a business flag to make it easier to trigger functionality or for impacted business processes to look for business flags. For example, when creating a business flag for a given service point, it may be useful to link all the accounts that are currently linked to the service point. Then, if an account oriented process should check for a business flag, it can look directly for a business flag linked to the account in its related object.

## Impacted Business Process

The product supplies support for associating one or more impacted business processes to a business flag type. This configuration is used when functionality for that business process is impacted in some way based on the existence of a business flag of a given type. For example, maybe some process is put on hold when a certain type of business flag exists.

Note that configuring a business process on business flag type is not enough to trigger any impact on that business process when a business flag exists. There must also be some logic implemented in the business process functionality itself that knows to look for a business flag for a given record that is configured to impact the business process.

The definition of the business process is at the discretion of the edge application that supplies functionality to support this. For example, the business process could be defined as something broad such as “billing” or could be something more granular such as “billing estimation”. The system supplies an extendable lookup to use for configuring the supported business processes. Refer to the values of the business process extendable lookup in your edge application or to the edge application specific Business Flag documentation for more information about supported business processes.

## Dates

A business flag supports two dates: a Business Flag Date/Time and a Business Flag **End** Date/Time

- The business flag date / time is required for all business flags. For some types of business flags only one date is needed.
- For business flags that have a start and end period, the business flag date/time acts as the start date and the other field is the end date.

For a business flag that has a date range, it may be important for functionality implemented for [impacted business processes](#). How the process treats the date will depend on its functionality.

- For some processes, the business flag is essentially expired after the end date has passed. This applies to impacted processes that are only looking at the current status of data in the system. For example, collection processing could be held if there is a business flag currently in effect (where the current date is within the date range). It would never look at historical business flags.
- For some processes where historical data may be relevant, a business flag effective during that same historical period may impact the process. For example if a business flag denotes an outage event for a given time period, perhaps estimated consumption should never be calculated for that time period.

Note that because business flags have a status, the design for the lifecycle of the business objects for the above effective dated use cases must carefully consider the states. For business flags that are considered expired after the end date passes, the BO lifecycle may be designed to transition to a final state after that date such that the record is no longer included in active processing. For business flags that continue to impact processing for a historic period, the BO lifecycle may be designed to remain in a non-final state such that it is clear that the record is still applicable.

## Creating Business Flags

Business flags may be created in a system for one of the following reasons:

- A message is received from an external system that initiates the creation of a business flag. In this case, logic in the external system has detected some situation that this product is being alerted about.
- Business logic in this product detects a situation that should be investigated or should act as a flag. In this scenario, there may not be any integration needed depending on the business rules.
- Business logic in this product detects a situation that another integrated product should be alerted about. In this scenario, the business flag record is used to send out information to the integrated product.
- A user manually creates a business flag based on knowledge of the affected entity. For example, a customer service representative may create a business flag as a result of contact with the customer.

### Creating a Business Flag from a Web Service

The system supplies an inbound web service Business Flag Sync Driver (**F1-BusinessFlagSync**) that may be used for an external system to initiate (or update) a business flag. It references a service script whose ultimate responsibility is to determine the appropriate Business Flag Type, based on the standard name or external standard name, and therefore the appropriate business object for the new business flag. Because different products may have different logic related to creating a business flag, the service script calls another service script linked to the maintenance object using the Business Flag Sync MO option.

The framework does not supply a Business Flag Sync service script, however individual edge applications supply a service script based on the use cases it supports out of the box.

---

**NOTE:** For products that are continuing to use XAI for external messages, the product also includes an XAI inbound service for the same Business Flag Sync Driver service script. Note that the product recommendation is to discontinue use of XAI and use [inbound web services](#) instead.

---

## Error Handling

If there is a problem in trying to create a business flag based on incoming information, the Business Flag Sync Driver service script creates a special business flag record using the Business Flag Error Business Object. This is also configured on the maintenance object as an option. The framework product supplies the business object Business Flag Error (**F1-BusinessFlagError**) for this functionality. Refer to the business object description and configuration for more information.

## Confidence

There may be use cases where a condition is suspected, but not confirmed. The originating system should be able to assign a "confidence" level to the business flag.

For example, DataRaker through aggregating and analyzing large amounts of data identifies potential revenue protection issues that need investigation. It triggers business flags with a **Suspected** confidence.

An application receiving this business flag may adjust the confidence to either **Confirmed** or **Rejected**. That update can be communicated to the other products that received the same business flag.

Note that the application that receives a business flag is responsible for acting on the value based on business rules.

Because a utility implementation may have multiple applications installed that support business flags, the following guidelines are suggested for designing where the confidence flag should be updated.

- If Oracle Utilities Service Order Management is implemented, it has the responsibility of updating the confidence flag and communicating the update to other products.
- Otherwise, the assumption is that Oracle Utilities Customer Care and Billing owns field work orchestration and that it will have the responsibility for updating the confidence flag and communicating the update to other products.

No product logic is provided to enforce the above suggestions, however, the business objects supplied by the different edge applications will support the recommended implementation.

## Business Flag Updates from External System

When the product that is responsible for updating the Confidence flag makes a change, it should initiate an outbound message to alert other products. On the receiving side, the same inbound web service and Business Flag Sync service script is responsible for the update. Refer to [Creating Business Flags](#) for more information.

## Setting Up Business Flag Configuration

The following topics highlight the general configuration steps required to use business flag functionality. Your specific product may supply additional functionality to support specific use cases for business flags. Refer to your specific product's documentation and the library of business objects supplied for Business Flag in your product for more information.

## Standard Name Category Characteristic Type

Define one or more categories for grouping your standard names into logical business groupings.

Navigate to the [Characteristic Type](#) page. Search for and select the Business Flag Category characteristic type (**F1-BUSFC**).

Define desired category values and descriptions to be used for the standard names.

## Business Flag Standard Name Lookup

Navigate to the [Extendable Lookup](#) portal. Search for and select the **Business Flag Standard Name** business object.

Define values that are recognized in the external systems that your implementation is receiving business flag details from.

Define a **Category** for the standard name that is appropriate for your product. Note that the category does not have to be in sync with standard name definitions in external products.

Refer to the embedded help for more information about configuring this object.

## Business Process Lookup

If your specific product supports configuring business processes that may be impacted by the existence of a business flag, they are defined as an extendable lookup.

Navigate to the [Extendable Lookup](#) portal. Search for and select the **Business Process** business object.

## Integration Configuration

The following points highlight configuration required to support receiving business flag information from an external source:

- Define a record for each [External System](#) that the product may be receiving business flag records from. This should be a value known by the external system and provided when new business flags are sent to this product.

When this product should initiate business flag information to be sent to an external system, configure one or more [Outbound Message Type](#) records. For each one, update the External System to configure how each outbound message type is communicated to the external system.

## Defining Business Flag Types

Refer to [About Business Flags](#) for an overview of business flag functionality.

To maintain the business flag types applicable to your product, open **Admin > Integration > Business Flag Type**.

This is a standard [All-in-One portal](#).

The information captured on the business flag type depends on the business objects supported by your product. Refer to the embedded help text for more information.

### Where Used

Follow this link to open the data dictionary where you can view the tables that reference [FI\\_BUS\\_FLG\\_TYPE](#).

## Maintaining Business Flags

This section describes the functionality supported for viewing and maintaining business flags.

Refer to [About Business Flags](#) for an overview of business flag functionality.

Navigate using **Main > Integration > Business Flags**. You are brought to a query portal with options for searching for business flags.

Once a business flag record has been selected, you are brought to the maintenance portal to view and maintain the selected record.

The **Business Flag** zone provides basic information about a business flag. Refer to the embedded help for more information.

## Configuration Migration Assistant (CMA)

---

This chapter describes the Configuration Migration Assistant (CMA), a facility to enable the export of customer-owned configuration data from one environment to another.

**CAUTION:** This chapter is intended for users responsible for testing configuration data and performing "what if" analysis in non-production databases.

---

### Understanding CMA

The Configuration Migration Assistant (CMA) provides implementers with a flexible, extensible facility for migrating configuration data from one environment to another (e.g., from a development environment to a production environment). Data is exported from the source system to a file. The file can then be checked in to a version control system for reuse, or can be immediately imported into the target system and applied.

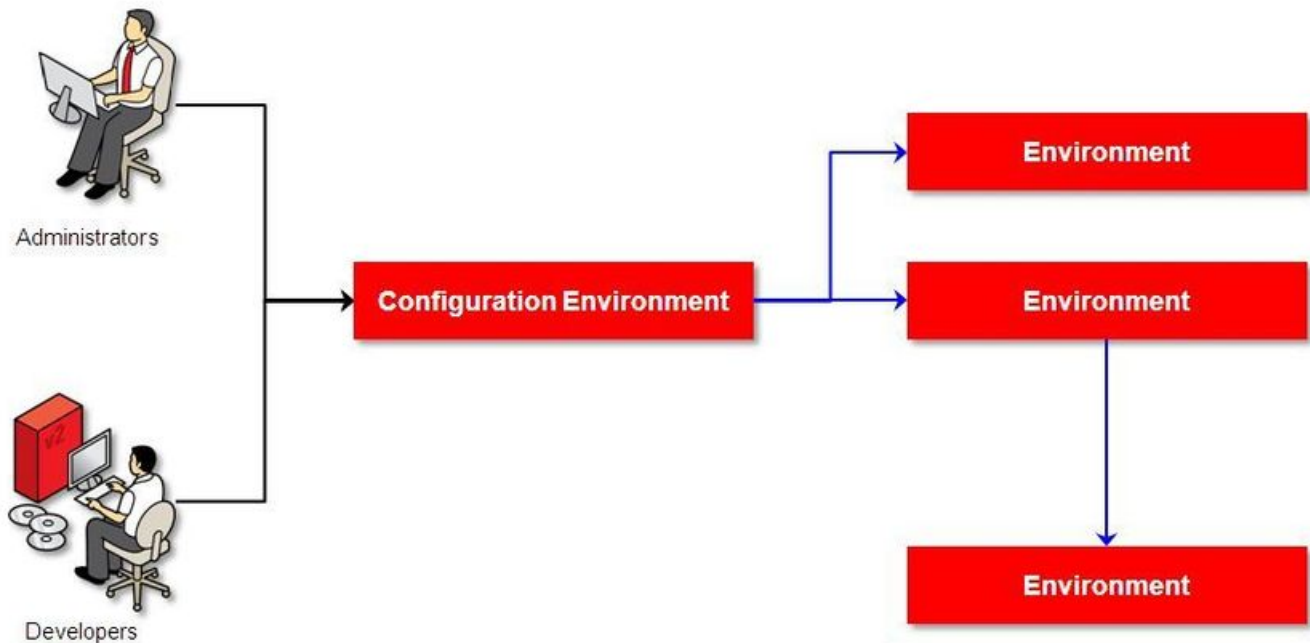

**NOTE:** As used in this chapter, *source* systems are those on which export-related activities are conducted and *target* systems are those on which migration updates are to occur. The two system preparation tasks described in [Migration Assistant Configuration](#) must be performed on both source and target systems.

---

## The CMA Process Flow

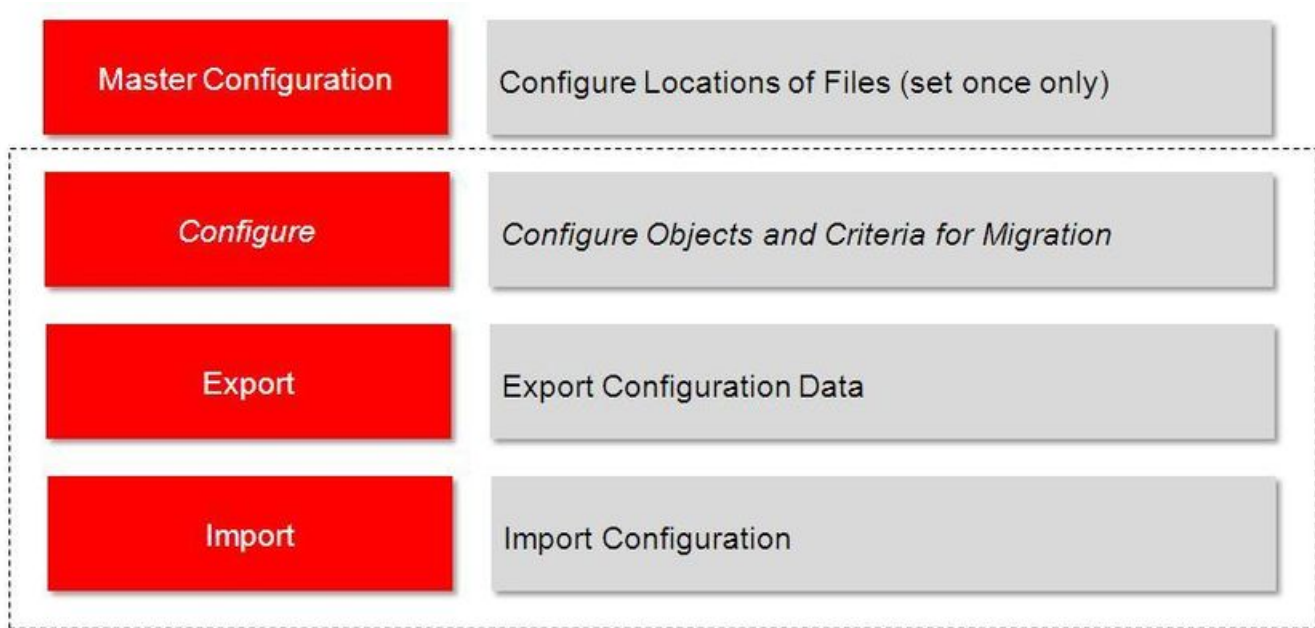

The high-level CMA process comprises the following tasks and flows. Each is described in more detail later in this section.

- **Configuration** steps are used to define the data to migrate. This task is performed on the source system and may be defined at any time. Note that the products provide base delivered configuration that may be used as is or used as a template for building more specific configuration for a given implementation.
  - Specify the source and target paths and a file extension for import and export data files in the **Migration Assistant Configuration** master configuration record.
  - Each type of record that may be copied requires a **Migration Plan**. The migration plan is used to identify the maintenance object (MO) for the record (using a business object) and allows for instructions to specify related records that may be included in the migration. Multiple migration plans may exist for a given maintenance object if there are different requirements for migrating records in that MO under different circumstances.
    - The primary instruction in the migration plan could define the physical BO of the record. This signals to CMA that all records for the MO are eligible to be migrated.
    - The primary instruction may define a specific BO, in which case only records that reference that BO in its parental hierarchy are considered.

---

**NOTE:** Refer to [Understanding the BO Filtering Process](#) for more information.

---

- Subsequent instructions may include references to related records. There may be some circumstances where a migration should include subsequent records and some circumstances where they shouldn't based on requirements.
- A **Migration Request** is used to define the data to include in a given migration. There are several types of migration requests:
  - Criteria-based. This type of migration request defines a set of migration plans to be logically included together as part of a migration. For each migration plan, selection criteria may be defined to limit the migration to a subset of data for each MO. Selection may be defined using SQL, an algorithm or explicit primary key values.



- **Entity List.** This type of migration request allows the user to choose explicit MO / prime keys. It is meant for a targeted migration of specific objects. Note that although the user views and maintains MO / PK values when configuring this type of migration request, a migration plan is still used internally for the CMA migration processing.
- **Group.** This type of migration request points to other migration requests. This allows you to define separate migration requests that represent logical groupings of migration plan instructions for ease of maintenance, but to combine all the separate migration requests into a single "grouped" migration request for streamlined export / import purposes.

---

**FASTPATH:** For more information, refer to [CMA Configuration](#).

---

- The **Export** process includes all the steps needed to select records to be exported from the source environment and create the export file.
  - A **Migration Data Set Export** object is created for a specific migration request.
  - The lifecycle of the Migration Data Set Export business object includes algorithms that select the appropriate records according to the migration request, determine dependencies between records to build groupings of related objects and create the export file.
  - Because there may be a large volume of data in the export, many of the steps in the lifecycle of the migration data set export are executed via the **Migration Data Set Export Monitor**.

---

**FASTPATH:** For more information, refer to [Exporting a Migration](#).

---

- The file created by the export, which is a BINARY file, needs to be transferred from the export directory to the import directory. The transfer needs to be done in such a way as to preserve the file structure. Refer to [Migration Assumptions, Restrictions and Recommendations](#) for more information.
- The **Import** processes include all the steps needed to read an imported file, compare the data in the file to the data in the target, review the proposed changes and apply the updates. The following is a high level overview of the process.
  - A **Migration Data Set Import** object is created for a given file to import.
  - The next step reads the import file and creates **Migration Transactions** and **Migration Objects** based on the information in the import file. A migration object is created for every maintenance object record to potentially be created or updated. The migration transaction is a grouping record that groups together related migration objects.
  - The next step is for the objects to **Compare** the data being imported against the data for that record in the target environment. If it is found that the migration object is new or represents a change to the existing record in the target environment, appropriate SQLs are generated. If no changes are found, the object is marked "unchanged" and doesn't progress.
  - Once all the objects are compared, the user may review the objects for acceptance or rejection.
  - When the migration objects are all accepted or rejected, the next step is to apply the objects and update the target environment.

---

**FASTPATH:** For more information, refer to [Importing and Applying a Migration](#).

---

## Migration Assumptions, Restrictions and Recommendations

The following sections describe miscellaneous topics that are important to learn with respect to CMA.



## Type of Data Migrated

CMA is designed to migrate configuration data.

The comparison step of the import process will generate appropriate insert or update SQL statements for the following data found in the export:

- Configuration data in a maintenance object with no owner flag. This is purely implementation data.
- Configuration data in a maintenance object with owner flag, where the owner is **Customer Modification**. For example, implementer-specific business objects.
- Configuration data in a maintenance object with owner flag, where the main record is owned by the product but where a child record exists with an owner of **Customer Modification**. For example, implementer-specific algorithms added to a base owned business object.
- Customizable fields in a record that is owned by the product. For example, the priority of a based owned To Do type.

## Data with System Generated Primary Keys

The tool provides support for administrative data with system-generated primary keys. The logic relies on the maintenance object to use a method that looks at other attributes of the record (considered a “logical key”) to detect whether the record being migrated already exists in the target region or not. The examples in this section will use the Attachment maintenance object as an example. Common attachments are considered administrative data. The attachment MO uses the file name and the creation date as the “logical key”.

Imagine a common attachment for the "standard rate codes" file exists in a source region with the key 123456789. The table below highlights possible situations at the target region and actions supported in CMA.

Scenario	Target Situation	Action	Comments
1	No matching record	Record can be added with key 123456789.	
2	Record exists with key 123456789 and logic confirms that it is also the "standard rate codes" attachment.	Record can be updated.	
3	Record exists with key 123456789, but logic detects that it is not the "standard rate codes" attachment.	Record is not updated. An error is issued.	The system cannot update this record because it's not the right attachment record.
4	The system detects that another attachment record exists for the "standard rate codes" attachment with a different ID.	Record is not updated. An error is issued.	Assumption is that the record was created directly in the target or was copied from a different source.

The use cases described in scenarios 3 and 4 above would require key mapping to keep track of the id from the source to the id in the target so that any other records from the source that reference this key as a foreign key would be updated as part of the migration. This functionality is not supported.

Scenarios 1 and 2 above are supported for maintenance objects that use the method to detect the logical key.

**NOTE:** If a maintenance object with a system generated key does not supply a method to detect the logical key, CMA will update an existing record with the same ID. For maintenance objects in the framework that provide this method, refer to [Framework Provided Migration Configuration](#). For your specific edge application, refer to the CMA addendum for information about support for admin data with system generated keys.

The product recommends that an implementation establishes a migration strategy such that administrative records with system generated keys are always created in the same region and always follow a standard migration path for promoting the data from this source region to other regions. Following this strategy, you would minimize or eliminate the possibility that

a record for the same logical key is created in multiple places such that different IDs would be generated as described by scenario 4 above.

## MOs with a Mixture of Administration and Non-Administration Data

There are some MOs that contain a mixture of master or transaction data and administrative data. The Attachment is an example of this. The product supports common attachments and owned attachments. Owned attachments are records that are specific to its owner. The owner could be master or transaction data and its attachments are therefore considered master or transaction data. Owned attachments are not candidates for migration using CMA. Common attachments on the other hand are considered administrative data and may be candidates for migration using CMA. For these use cases, an implementation may follow the suggested strategy of only creating the administrative data in one region so that IDs for common attachments are not reused. However, it is reasonable and expected that owned attachments are being created in the target region and may receive a system generated key that matches the key of a common attachment from the source region.

To try to minimize this issue, the system includes special logic to be used by any MO that may contain administrative data mixed in with master or transaction data. This special logic generates the key of an administrative record with a zero (0) in the middle of the key and ensures that the keys for master and transaction data do not include a zero in this spot. For maintenance objects in the framework that use this method, refer to [Framework Provided Migration Configuration](#). For your specific edge application, refer to the CMA addendum for information about additional maintenance objects that may be in this category.

## No Record Deletion

The CMA process allows users to define records to copy from a source environment to a target environment. In that way, the import process for the migrated records is able to identify objects to add and objects to change. There is no mechanism for indicating that records in the target environment should be deleted. The absence of those records in the import is not enough because the migration may be only importing a subset to add or update. If data on the target system must be deleted, users must delete the records in the target accordingly.

Note that CMA does support the deletion of child rows of an object as a result of a comparison. This is only applicable to child records that are owned by the implementation.

## File Transfer Considerations

When moving the export file between systems, use the binary transfer option of whatever tool you use to move the file so that line-end characters are not converted from Linux-style to Windows-style or vice versa.

It is recommended to avoid using 'txt' for the export file's extension (defined in the [master configuration](#)). That file extension by default implies a non-binary file and tools that perform file transfer may treat this as a non-binary file unless explicitly stated. The recommendation is to define 'cma' as the extension. This is not a recognized file extension and most file transfer tools will transfer the file as is.

Note that if the file gets converted, there are two likely outcomes - either a numeric conversion error, or a buffer under-run error may be received when attempting to import the file.

## Multi-Language Environment Considerations

If your implementation uses a language other than English, it means that migrated objects may have multiple language rows (because English is always enabled). There are some important points with respect to multiple languages and CMA:

- As described in [User Language](#), there are steps to follow when supporting an additional language. The steps outlined in that topic highlight that for system data, translation of the strings may be provided via a language pack provided by the product or may be the responsibility of your implementation. In either case, this effort is non-trivial and will have its own established plan. The expectation is that the translation of the system data is applied for each region at your implementation site. CMA should not be used to create a new language in a target region.
- For administrative / control data that your implementation develops as part of your project, the expectation is that descriptions for your supported language are entered in the region that is considered the source region used to promote

changes to regions in the “chain”. For example, control data is entered in a development region and promoted to a test with the supported language enabled in both regions.

- What if you export data from a region with more languages enabled than your target? This scenario is perhaps a case where the source region is a type of test or playpen region where the additional language is enabled for other purposes. In this case, if the language code does exist at all in the target region, the import will produce an error given that the code is invalid. If the language code exists but is not enabled, this will cause the extra language rows to be inserted in the target region, but will not cause any issues. They are simply ignored.
- What if you export data from a region with fewer languages enabled than your target? In this situation, the import process will only create language rows for the languages that were copied from the source. It will not automatically create language rows in the target as part of the import. For this situation, the recommendation is to run the **New Language** batch program ([F1-LANG](#)) that creates any missing language entries.

## CMA Configuration

The following sections describe tasks required for CMA configuration.

### Master Configuration - Migration Assistant

In both the source environment and the target environment, the system needs to know the location of the export directory and the import directory along with the expected file suffix. Implementations may define the information explicitly for each region using the **Migration Assistant Configuration** [master configuration](#) record.

For more information about specific fields in the master configuration, refer to the embedded help.

---

**NOTE:** This record can be updated at any time to change details. The new configuration takes effect on all subsequent exports and imports.

---

Implementations may also rely on the system defaults. If no Migration Assistant Configuration record is found, the system assumes that there is an entry defined in the system's substitution variable list for **F1\_CMA\_FILES**. Further it defaults the values as follows:

- Export directory is the value for this variable plus "**\export**".
- Import directory is the value of this variable plus "**\import**".
- File suffix is set to **cma**

Refer to [URI Validation and Substitution](#) for more information about the substitution variable list.

## Migration Plans

A migration plan defines one or more types of objects that are eligible for migration. It is essentially a set of instructions describing how the data to be exported is structured, allowing objects to be migrated together as a logical unit to ensure consistency and completeness.

The following topics describe defining a migration plan as well as other topics for a migration plan.

### Defining a Migration Plan

To view or define a migration plan, navigate using **Admin > Implementation Tools > Migration Plan**.

Use the **Migration Plan Query** portal to search for an existing migration plan. Once a migration plan is selected, you are brought to the maintenance portal to view and maintain the selected record.

---

**CAUTION:** Important! If you introduce a new migration plan, carefully consider its naming convention. Refer to [System Data Naming Convention](#) for more information.

---

The following points provide information about defining **Instructions** for a migration plan.

The **Instruction Sequence** uniquely identifies the instruction. The recommendation is to use increments of 10 to allow insertion of other instructions in the future.

Select **Primary** for the first **Instruction Type**. All migration plans must contain one and only one primary instruction. All subsequent instructions require a **Subordinate** instruction type. In this case, the **Parent Instruction Sequence** must be entered. This number, used to maintain the defined relationships in the exported data, must match an instruction sequence number at a higher level in the hierarchy.

The instruction **Description** provides a business description of the instruction.

Select a **Business Object (BO)** to define the type of object from which data will be derived.

---

**NOTE:** Though BOs are specified in each instruction, it's important to understand that each BO is used only for filtering purposes. The migrated data set comprises the complete contents of the *maintenance object* that the business object structure is defined against. For a more detailed explanation of this, see [Understanding the BO Filtering Process](#).

---

**NOTE:** Refer to [Identifying Tables to Exclude From Migrations](#) for information about defining child tables to always exclude from a migration.

---

**Traversal Criteria** is used to define the relationship between each of the objects in a migration plan. The system provides three options to define how the child object is connected to the parent object so the system knows how to traverse from one object to another. **Traversal Criteria Type** options are **Constraint**, **SQL** and **XPath**. The following points explain each option:

- **Constraint** allows you to select a table constraint that represents a given record's relationship to another record in the system via a foreign key constraint defined in the meta-data. If **Constraint** is selected, the following additional fields are enabled:
  - **Constraint ID** is a unique identifier for the constraint. The search will show the valid table constraints for the MO of the instruction's BO and the MO of the parent instruction's BO.
  - **Constraint Owner** is used to define the owner of the constraint. This is populated automatically when selecting a constraint from the search.
- **SQL** lets you specify SQL join criteria between the parent instruction's object and the child object in the **SQL Traversal Criteria**. The syntax of the the traversal criteria is a WHERE clause (without including the word WHERE). When referring to a field on the parent instruction's object, use the syntax `#PARENT.TABLE_NAME.FIELD_NAME`. When referring to a field on the current instruction's object, use the syntax `#THIS.TABLE_NAME.FIELD_NAME`. For example, the following statement is used on a migration plan for Business Object, where the parent instruction is the BO and the subordinate instruction is used to reference the UI Map that is referred to as a BO option with the option type "F1DU":

```
#PARENT.F1_BUS_OBJ_OPT.BUS_OBJ_OPT_FLG = 'F1DU' AND @trim(#THIS.F1_MAP.MAP_CD) = @trim(#PARENT.F1_BUS_OBJ_OPT.BUS_OBJ_OPT_VAL).
```
- The **XPath** option lets you apply syntax in an XPath expression referencing elements in the instructions' referenced business objects. This is entered in the **XPath Traversal Criteria**. For example, the display map collection statement in the SQL example noted above would be written as follows in XPath: `#this/mapCd = #parent/businessObjectOption/businessObjectOptionValue AND #parent/businessObjectOption/businessObjectOptionType = 'F1DU'`. This technique allows foreign key references that are mapped inside an XML column to be referenced.

---

**NOTE:** The #parent expressions may access elements that are stored in an XML column and described using mapXML and mdField. However, the #this expressions must refer to fields available in the business object using the mapField reference.

---

Defining **Next Migration Plan** provides the ability to indicate that in addition to copying the object defined in the instruction, any additional instructions included in that referenced migration plan will also be included in an export.

The **Algorithms** grid contains algorithms associated with each instruction. You must define the following for each algorithm:

- Specify the **System Event** with which the algorithm is associated (see the table that follows for a description of all possible events).
- Specify the **Sequence** and **Algorithm** for each system event. You can set the **Sequence** to 10 unless you have a **System Event** that has multiple **Algorithms**. In this case, you need to tell the system the Sequence in which they should execute.

System Event	Optional / Required	Description
Pre-Compare	Optional	Algorithms of this type may be used to adjust the data after it is moved to the target system. These may only be defined on the primary instruction.  Refer to <a href="#">Adjusting Imported Data</a> for more information.  Click <a href="#">here</a> to see the algorithm types available for this system event.
Import	Optional	Algorithms of this type are no longer supported.

#### Where Used

Follow this link to open the data dictionary where you can view the tables that reference [F1\\_MIGR\\_PLAN](#).

## Understanding the BO Filtering Process

Migration plan instructions require the definition of a business object to provide CMA with information about the record related to the instruction.

If the business object is the physical business object for the maintenance object, then CMA assumes that the instruction applies to all records that satisfy the traversal criteria. CMA recognizes the physical BO by comparing the BO to the value defined in the maintenance object option. If the business object defined is not the physical BO, then CMA will limit the records in the instruction to those that explicitly reference this BO or reference a child of this BO as its **identifying BO** value. (In other words, this BO must be in the parentage hierarchy of the records to be included in the instruction.)

---

**NOTE:** Unlike Bundling, CMA does not use the BO schema to drive what data is copied for a given record. The BO is only used as a filtering mechanism for selecting records. Refer to [Identifying Tables to Exclude from Migration](#) for information about how to ensure a child table is not included in a migration.

---

For example, if you define a migration plan for Master Configuration and use the physical business object for the instruction (**F1-MstCfgPhysicalBO**) then all master configuration records are considered for the instruction. If instead the business object you define is Migration Assistant Configuration (**F1-MigrationAssistantConfig**) then only the record related to this business object is included in the instruction.

## Migration Plans for Objects with XML-Embedded Links

When migrating objects where foreign key references are captured in the object's XML based field, subordinate instructions are needed to define the foreign key references in order for CMA to understand the relationships. This is in contrast to direct

foreign keys where CMA can determine the relationships using constraints. The instructions provide two purposes. For wholesale migrations, where all data (or a large amount of data) is being migrated, the instructions allow CMA to group related objects into transactions. This helps in the apply process at import time to ensure that related objects are grouped together. However, the apply process includes iterative steps to try to overcome dependencies like this so defining the instructions is not critical for this type of migration. For targeted migrations, defining instructions ensures that the related objects are included in the migration, if appropriate.

The following are options for creating migration plans with XML-embedded links:

- One option is to use the specific logical (business) BO in the primary instruction to define the object you are copying. With this option, the subordinate instructions may use XPath criteria to define the related foreign key. When this approach is used, a separate Migration Plan must be created for each logical BO. (Refer to [Understanding the BO Filtering Process](#) for more information.) This option would only be used in isolated cases.
- Another option is to create a migration plan that uses the Physical BO as the primary instruction, and then include a subordinate instruction for the real logical BO, using SQL Traversal to join the object to itself by its primary key. Note that with this technique, the records that reference the logical BO will still only be included in the export file once. At this point further subordinate instructions may use XPath notation to define the foreign key data. Using the physical BO as the primary instruction ensures that all records in the MO are considered. The subordinate instructions with the logical BO and XPath notations will only apply to the records that are applicable to that BO. This option is useful for MOs that have a small number of logical business objects with disparate foreign keys.
- Another option is to use the physical BO in the primary instruction and use raw SQLs in the subordinate instruction's traversal criteria to identify the foreign keys using substring commands. A separate Subordinate Instruction is needed for each SQL corresponding to each element occurrence. Using this technique has the same advantages of the previous in that all records for the MO are included in the migration. However, this technique may be useful for maintenance objects with a larger number of business objects expected where each has one or more foreign keys. It's especially useful if many business objects reference the same foreign key. Then only one instruction is required for that foreign key. Note that a single migration plan may use this technique and the XPath technique for different elements.

A migration request may have multiple migration plans for the same maintenance object. That allows for some flexibility and long term maintainability in that the above techniques may be used in multiple migration plans. Consider the following example:

- A product provides base business objects with foreign keys defined in the XML field and provides the appropriate migration plan with instructions. An implementation extends this business object or perhaps creates their own business object for the same maintenance object and includes different additional foreign keys in the XML. Rather than duplicating the base migration plan and adding additional instructions for the additional foreign keys, the implementation can create a second migration plan for the MO with the additional foreign keys defined. A migration request should be defined to include both migration plans. In this case if the implementation has only one custom BO, they can choose to use the custom BO as the primary instruction as described above in the first option.

## Defining a Migration Request

Migration Requests are used to define the data to be included in a migration. To view or define a migration request, navigate using **Admin > Implementation Tools > Migration Request**.

Use the **Migration Request Query** portal to search for an existing migration request. Once a migration plan is selected, you are brought to the maintenance portal to view and maintain the selected record.

There are three types or classes of migration request. The system provides a base business object for each along with a migration request class, which matches the business object. The subsequent sections provide more information about each class of migration request.

Note that all migration requests support defining a Category, which allows implementers to categorize the migration request.

In addition, all classes of migration request include the following zones:



- **Migration Request** This zone contains display-only information about the selected record. Please see the zone's help text for information about this zone's fields.
- **Referencing Migration Requests** This zone is only visible if the displayed migration request is included in a Group migration request. It lists each group migration request that includes it.

Other zones may appear for specific classes of migration requests. See the following sections for more information.

### Where Used

Follow this link to open the data dictionary where you can view the tables that reference [FI\\_MIGR\\_REQ](#).

## Criteria-based

This type of migration request defines a set of migration plans to be logically included together as part of a migration. For each migration plan, selection criteria is defined to indicate which records for each MO should be included. Selection may be defined using SQL, an algorithm or explicit primary key values.

- For selection using SQL Statement, refer to the embedded help for examples.
- For selection using Algorithm, the algorithms that are eligible to be plugged in here are those valid for the **Migration Request - Select** system event. Click [here](#) to see the algorithm types available for this system event.
- For selection using Specific Keys, the primary key (1 through 5) must be explicitly specified. Multiple rows are allowed.

## Entity List

This type of migration request allows the user to choose explicit MO / prime keys. The MOs that are eligible are those that are configured with a **Default Migration Plan** option. Although the user is managing MO / PKs, the migration instructions are still defined with a migration plan. The system maps the migration instructions in a similar way to a **Criteria-based** migration requests that use a Specific Key selection type. Note however that it will create a separate migration instruction for each MO / PK combination. It does not try to group all PKs for the same MO / migration under one migration instruction.

For this type of migration request, a user adds a migration request record with its description and other main information. Then, a special zone **Add Entities** is provided to find and select records based on a selected maintenance object and add to the migration request. The user is prompted to provide a reference and comments, if desired. If the category selected is one that requires a reference, then this will be validated.

When maintaining a migration request with existing entities, they are visible in the zone **Migration Request Entities** . This zone allows a user to remove the entity from the list.

## Group

This type of migration request points to other migration requests. This allows you to define separate migration requests that represent logical groupings of migration plan instructions for ease of maintenance, but to combine all the separate migration requests into a single "grouped" migration request for streamlined export / import purposes.

The CMA export process will build an extract that includes the union of all the objects that qualify for the export and group them together based on their relationships.

## Wholesale and Targeted Migrations

The Configuration Migration Assistant is used for two general types of migrations: wholesale and targeted. The following sections provide some additional information about these concepts.

## Wholesale Migrations

Wholesale migrations are used when migrating all the configuration and/or administrative data from one environment to another. For example, a wholesale migration might be used when migrating administrative data from a development or test environment to a production environment.

A wholesale migration may be comprised of one or more migration requests that in total include all the administrative data to move. With the ability to group migration requests, the expectation is that implementations follow these guidelines:

- Multiple migration requests using the Criteria-based or Entity List migration request classes are used to group information logically together to allow for more reuse.
- A Group migration request is used for the export. This allows for one data set to export and one data set on the import side, simplifying the process. Note that depending on the amount of data, this may be a large import set to process. An implementation may find it easier to create multiple migration requests that break down the process into several steps.

You should consider that the framework product provides base migration requests and your specific edge product may provide base migration requests as well that may or may not include framework migration plans. Using the product provided migration requests is beneficial with respect to maintenance. As features are added to the product (including new administrative maintenance objects), any impact on CMA should be included in the product owned migration requests. If your implementation introduces new custom administrative maintenance objects that should be included in CMA, then custom migration plans and a custom migration request should be added. Your implementation can build a Group migration request that includes the base migration request and your custom migration requests to have a consolidated export.

Migration plans used in wholesale migrations may be designed to omit subordinate instructions related to explicit foreign keys that are identified through constraints as they are not needed, assuming that the data they are referring to will also be included in the migration.

---

**NOTE:** Refer to [Framework Provided Migration Objects](#) for information about migration requests provided in the framework product. Refer to your specific product's documentation for information about addition base provided migration requests.

---

## Targeted Migrations

A targeted migration refers to migrating a specific subset of data from one environment to another. Examples of targeted migrations include:

- Migration of a new Business objects with its options and algorithms.
- Migration of a new maintenance portal, its zones, and its application service.
- Migration of all outbound message types.

It is expected that the Entity List migration request is used for these types of migrations.

## Identifying Tables to Exclude From Migrations

Some maintenance objects that are eligible to be migrated may include child tables that should not be included in the migration. For example, if an object includes log tables, the entries in the log should reflect the actions on the object in that system, and will be different between the source system and the target system. If you have a custom Maintenance Object that includes tables you don't wish to migrate (such as a log table), use the **Non-Migrated Table** option on the MO to specify this table. All child records for this table will also be ignored during migration.

Another use case to consider is a child "many-to-many" table that connects two administrative objects and exists in the maintenance object of both tables. The child table may be in both MOs for convenience sake, but it may be that one MO is considered more of a "driver" object and the other more of a subordinate. If you are doing a targeted migration where you



want to copy a subset of objects, you may want to only copy the driver object and its children and their data but not their children. For example, in Oracle Public Sector Revenue Management, a Form Type includes a collection of valid Form Change Reasons and in turn the Form Change Reason refers to its Form Types. If an implementation wants to do a targeted migration of a form type and include all its related information, including form rules and form change reasons, it does not want the migration of a form change reason to in turn copy all its form types (and their data).

---

**NOTE:** The MO option must be set in both the Source and Target systems for a given MO.

---

## Configuring Custom Objects for Migration

During the implementation and extension of the product, new custom administrative maintenance objects may be introduced. If your implementation would like to migrate records in those maintenance objects using the Configuration Migration Assistant, additional steps must be performed, which are highlighted in the following sections.

### Physical Business Object

As described in [Understanding the BO Filtering Process](#), the migration plan requires a business object for its instruction. The business object is used to identify the records eligible for inclusion in the migration. Assuming your custom tables use one or more “logical” business objects for their processing, your implementation must decide if these business objects are appropriate for use by the migration plans, or if a physical BO is warranted. If so, create an appropriate physical BO.

### Review MO Option Configuration

The following points highlight maintenance object (MO) configuration that should be reviewed or updated to support CMA:

- If a physical BO was created (above), link it to the MO as an option using the appropriate option type.
- Be sure that your MO defines an appropriate [FK Reference](#) and includes an Option on the MO that identifies the FK Reference. This is used by various portals and zones for CMA when showing detail about records being imported into the target region. Also be sure that this FK reference defines an Information program.
- As described in [Identifying Tables to Exclude From Migrations](#), an MO option is used to identify child tables for an MO that should never be included in a migration. If your custom maintenance object includes a standard Log table, then the recommendation is to list that table as an excluded table. Depending on the specific design of the maintenance object, there may be other child tables to define.

### Characteristic Type Configuration

The CMA import process will attempt to create a log record for any administrative object that includes a log table. If your implementation has introduced any custom administrative tables that you plan to include in a migration request and it includes a log table, you must, to ensure that the log creation is successful, add your log table as a valid characteristic entity to the characteristic type **F1-MGO** (Migration Object).

Navigate to [Characteristic Type](#) and select the characteristic type **F1-MGO**. Navigate to the **Characteristic Entity** tab and add a row to include the characteristic entity for your custom maintenance object's log table.

### Standard CMA Configuration

Create one or more migration plans for the new object, depending on the type of data in the maintenance object and the types of migrations you envision:

- If you have implemented only one "logical" business object used to define the data in the MO, then a single migration plan that references the this BO (or the maybe the MO's physical BO) is appropriate.
- If you have implemented more than one "logical" business object, would the data for multiple business objects get copied together? Then perhaps a single migration plan that references the MO's physical BO is appropriate.

- Are there additional foreign keys defined using mapXML in the business object(s) for the MO? If so, then it is recommended to include sub-instructions to define the links. At this point, if multiple "logical" BOs exist, your implementation may choose to define all the additional elements in the same migration plan or choose to define separate migration plans for each logical BO.
- Your implementation may decide to define more than one migration plan for the same type of record based on the types of migrations you plan to include. For example, you may decide to include a migration plan that copies only the records in this maintenance object. You may decide to define another migration plan that copies the records in this MO along with related records in another MO (for a special type of migration). Having said that, be sure to design the migration plan with reuse in mind to minimize maintenance efforts.

In order to support **Entity List** migration request, a default migration plan must be defined as an option on the maintenance object. This should be a single migration plan that supports all types of business objects for the MO.

If your implementation has a template migration request to use for targeted or wholesale migrations, include the new migration plan(s) as appropriate.

---

**CAUTION:** Important! New migration plans and migration requests should follow naming conventions. Refer to [System Data Naming Convention](#) for more information.

---

## The CMA Execution Process

The following diagram illustrates a high-level view of the Configuration Migration Assistant execution process. The subprocesses illustrated here are described in more detail in the following sections.

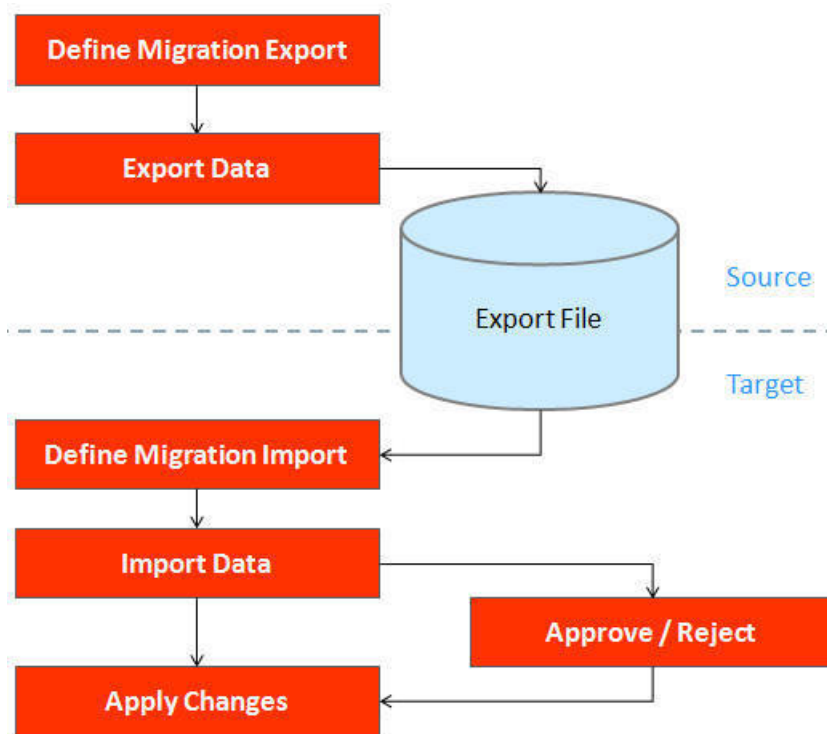

## Exporting a Migration

The migration export process begins in the source environment by defining a **Migration Data Set Export**, which specifies a defined **Migration Request** and provides a file name and description for the export file. After the data set is defined and saved, the **Migration Data Set Export Monitor** batch job can be submitted generate the export file.

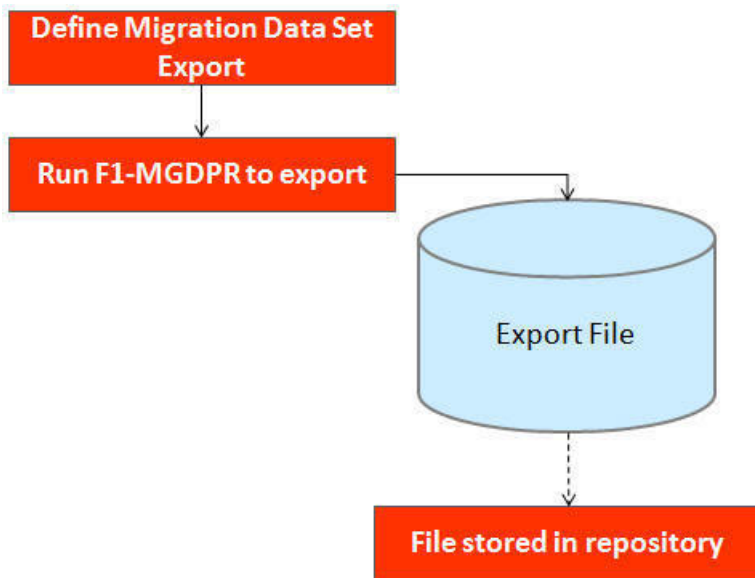

The following topics provide more detail about this process.

## Migration Data Set Export

To migrate data from one region to another, define a **Migration Data Set Export**. This establishes the export file name and identifies the migration request.

To view an existing migration data set export, navigate using **Admin > Implementation Tools > Migration Data Set Export**. Use the query criteria to locate the desired data set.

Note that you can also initiate the creation of an export data set from the [Migration Request](#) portal using the **Export** button.

The export requires the name of an existing **Migration Request**.

Enter a unique **File Name** for the export. Do not use spaces in the name, and do not enter the file extension or a path. The output location and file extension of the intended export file, which should appear in the **Export Directory** and **File Suffix** labels, are defined as described in the topic [Migration Assistant Configuration](#).

Enter an **Export Description** to provide information about the purpose of the export. Note that this field is not language enabled.

The **Source Environment Reference** is for information purposes. It should be populated with text that provides a meaningful description of the source environment. The default value is the URL of the source environment.

## Export Lifecycle

The following diagram describes the lifecycle of a Migration Data Set Export (data set).

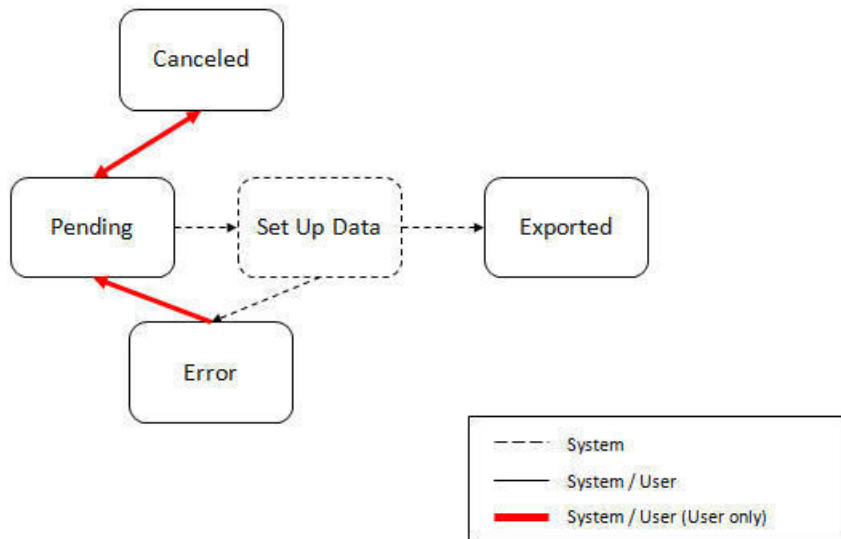

The following points describe the lifecycle.

- The data set is created in **Pending** status.
- A user may choose to temporarily **Cancel** a pending data set to prevent it from being processed. The user can later return it to the Pending state when desired.
- The record remains in Pending until its monitor batch job is submitted. The **Migration Data Set Export Monitor** (F1-MGDPR) selects pending records and transitions them to **Set up data**. Refer to [Running Batch Jobs](#) for more information.
- Set up data is a transitory state that includes the algorithm that does the work of determining the objects to include in the export and group related objects together into a transaction. If everything is successful, the export file is written to the appropriate file location and the record transitions to **Exported**. If an error is detected, the process stops and the record transitions to **Error**.
- If a record is in error and it is possible to correct the error, the record may be transitioned back to Pending to try again.

When the process is marked as **Exported**, the export file can be imported into the target system.

---

**NOTE:** The export process creates a file, providing the benefits of having a standalone file. It can be stored in a version control system for audit purposes or provided to others for import purposes.

---

**CAUTION:** Under no circumstances should exported data files be edited manually. Doing so could cause data corruption when the file content is applied to the target environment.

---

**NOTE:** The export functionality is supported using the business object **Migration Data Set Export** (F1-MigrDataSetExport). The expectation is that implementations will use the delivered base business object and its logic and will have no reason to implement a custom business object for the CMA export process.

---

## Importing and Applying a Migration

The import process is broken down into four general steps: Import, Compare, Approve, Apply. The following points provide an overview of the steps.

- **Import.** The first step covers importing the file and creating appropriate Migration Import records in the target environment to facilitate the subsequent steps.

- **Compare.** The compare step reviews each object that is in the import file and compares the object in the import against the equivalent record in the target environment. The comparison step results in noting which objects are unchanged, which are new (and the appropriate SQL to insert them) and which objects are changed (and the appropriate SQL to update them). Based on user configuration at import time, the objects that qualify for the import may be in a state that requires review or may be pre-approved.
- **Approve.** Once the comparison is complete, the user should review the results. There may be records marked for review. All of these records must be approved or rejected before the import can proceed. When the user is satisfied with the results of the comparison and has completed the review, the import is marked to proceed to the Apply step. Optionally, a migration import may be configured to automatically apply.
- **Apply.** This is the final step and is the step where the records in the target environment are added or updated. Because of potential high volumes of data and because of possible dependencies between records, this step supports two levels of attempting to apply the records. There is an apply step at the object level and an apply step at the transaction level. This will be described in more detail below.

## Import Step

The import process starts with verifying the import directory configured as described in the following topic [Master Configuration - Migration Assistant](#) and ensuring that the exported file is located in that directory. Then, in the target environment, a **Migration Data Set Import** record should be created. The user indicates the file name.

In addition, the user decides what the default status should be for resulting objects.

- The **Default Status for Add** sets the default status for objects that are determined to be *new* during the import comparison process. The default is to automatically set new objects to **Approved** status. Other options are to set any new objects to **Rejected** or **Needs Review** status.
- The **Default Status for Change** sets the default status for objects that are determined to be *changed* during the import comparison process. As with new objects, the default for changed objects is **Approved**, with **Rejected** or **Needs Review** options available.

The user may also configure the **Automatically Apply** flag to **Yes**. This allows for use cases where the migration is repetitive and has been tested and the user feels that there is no need for manual approval. Note that when configuring this setting, neither of the Default Status values may be set to **Needs Review** and at least one must be set to **Approved**.

The file to import contains a list of all the objects included in the export. Any objects that the export step determined to be related have been grouped into “transactions”. Once the Migration Data Set Import is created, the next step is for the system to read in the file and create Migration Transactions and Migration Objects.

The following is a portion of the Migration Data Set Import lifecycle as it pertains to the import step.

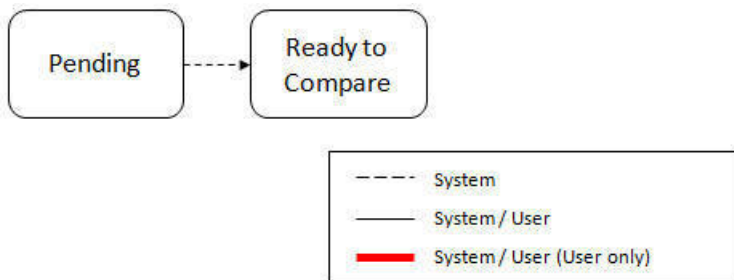

The following points describe the lifecycle.

- The data set is created in **Pending** status.
- The record remains in Pending until its monitor batch job is submitted. The **Migration Data Set Import Monitor** (F1–MGDIM) selects pending records and transitions them to **Ready to Compare**. Refer to [Import Process Summary](#) and [Running Batch Jobs](#) for more information.

The Ready to Compare state has an algorithm that is responsible for reading the related import file and creating the migration transactions and migration objects. The data set remains in this state until the comparison step is complete.

---

**NOTE:** A user may choose to **Cancel** a data set. Refer to [Cancelling a Data Set](#) for more information.

---

The following diagram highlights the relationships of the resulting migration import records.

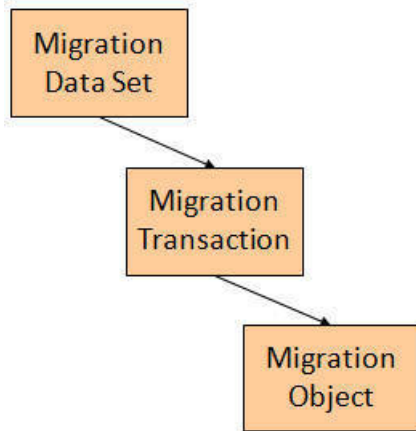

The migration transaction and migration object each have their own lifecycle that will help manage the subsequent compare and apply steps. At the end of the import step, the status values of the three types of records are as follows:

- Migration Data Set Import is in the **Ready to Compare** state.
- Migration Transaction is in the **Pending** state.
- Migration Object is in the **Pending** state.

---

**NOTE:** The import functionality is supported using business objects supplied by the base product. The expectation is that implementations will use the delivered base business objects and their logic and will have no reason to implement a custom business objects for the CMA import process. The base business objects are **Migration Data Set Import** (F1-MigrObjectImport), **Migration Transaction** (F1-MigrTransactionImport) and **Migration Object** (F1-MigrObjectImport).

---

## Compare Step

The import step results in the creation of one or more migration objects, one for each record selected in the export based on the export's migration request and its configuration. Related objects are grouped together in migration transactions. The next step in the import process is the Comparison step. In this step, the data captured by the import file for each object is compared to the view of that object in the target environment.

To cater for a possible large volume of objects, the comparison is done via a batch monitor. To aide in performance of the process, the monitor is performed on the migration objects so that it can be run multi-threaded. Once the objects are finished with the comparison, the migration transactions and the migration data set should be updated with an appropriate overall status before continuing to the next step. As a result, the comparison actually requires three steps: Migration Object Comparison, Migration Transaction Status Update and Migration Data Set Export Status Update. The steps are explained in detail in the following sections.

---

**NOTE:** Refer to [Running Batch Jobs](#) for more information about streamlining the various steps in the process.

---

## Migration Object Compare

This is the main step of the comparison. The **Migration Object Monitor** (F1-MGOPR) selects pending migration object records and transitions them to **Comparing**. This is a transitory state that includes the algorithm that does the work of

comparing. There are various possible outcomes that could occur based on the logic in the algorithm. The following diagram illustrates a portion of the migration object lifecycle that pertains to comparison.

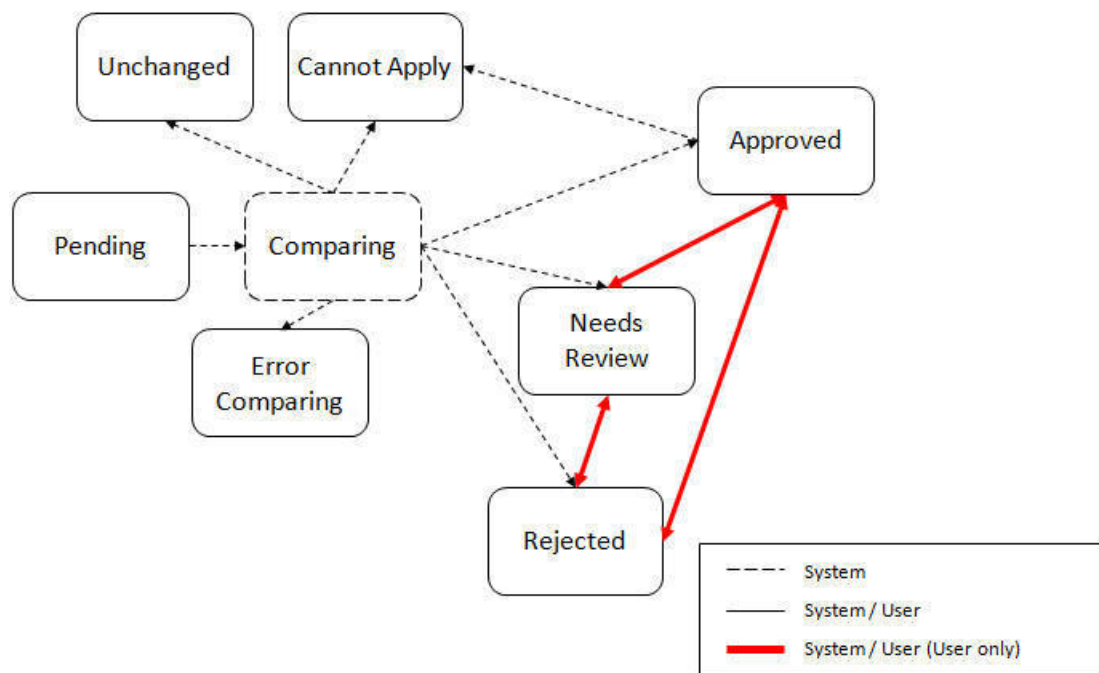

The following points describe the lifecycle.

- When **Pending** records are selected by the monitor batch job, it transitions to **Comparing**. If the migration object refers to one or more pre-compare algorithms, they are executed to [adjust the data prior to comparison](#). Then algorithm will determine the appropriate next state by comparing the source data to the target data.
- If the record in the migration object is found in the target environment and the data is exactly the same, the record transitions to **Unchanged** (with the object action value also set to **Unchanged**).
- If the record in the migration object is found in the target environment and the data is different, the algorithm sets the object action value to **Change** and generates the appropriate SQL to be used later in the Apply step to update the record. It then transitions to **Approved**, **Needs Review** or **Rejected** based on the Default Status For Change setting captured on the Data Set.
- If the record in the migration object is not found in the target environment, the algorithm sets the object action value to **Add** and generates the appropriate SQL to be used later in the Apply step to insert the record. It then transitions to **Approved**, **Needs Review** or **Rejected** based on the Default Status For Add setting captured on the Data Set.
- If there is any issue with attempting to parse the object data from the import, the record transitions to **Error Comparing**.
- If there is any reason that the imported object is not valid for import, the record transitions to **Cannot Apply**. The log will be updated with the error that caused the record to transition to this state. An example is that perhaps the record was exported in a different version of the product and has additional elements that are not recognized in this version.

---

**NOTE:** Refer to [Cancelling a Data Set](#) for information about cancelling a data set and its impact on its related objects.

---

## Migration Transaction Status Update

After the import step, the migration transaction remains in the Pending state until all its objects have completed the comparison step. At that point, the status of the transactions should be updated based on the results of their objects. The **Migration Transaction Monitor** (F1-MGTPR) selects pending migration transaction records and runs its monitor algorithms. There are various possible outcomes that could occur based on the logic in the algorithms. The following diagram illustrates a portion of the migration transaction lifecycle that pertains to comparison.



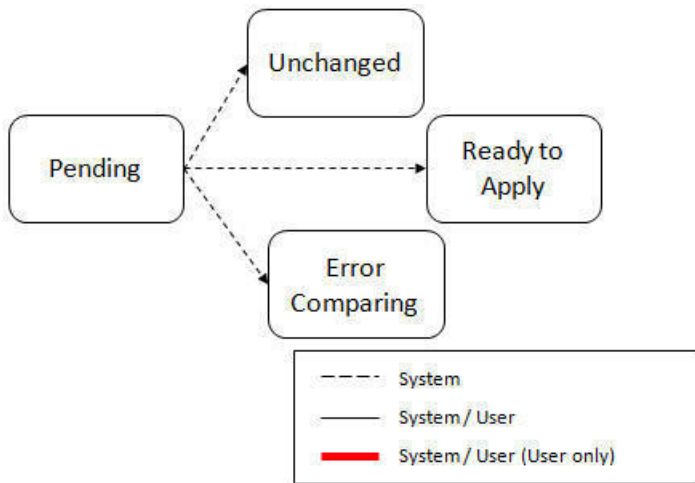

The following points describe the lifecycle possible next states after Pending.

- If any related migration object is in the Error Comparing state, the transaction transitions to **Error Comparing**.
- If all related migration objects are in the Unchanged state, the transaction transitions to **Unchanged**.
- Otherwise, the transaction transitions to **Ready to Apply**. This means that at least one object is in an “apply-able” state.

The transaction remains in the **Ready to Apply** state until a user has approved the data set to move to the Apply step and the transaction’s related objects have attempted to apply themselves. This is described in more detail below.

---

**NOTE:** Refer to [Cancelling a Data Set](#) for information about cancelling a data set and its impact on its related objects.

---

### Migration Data Set Import Status Update

Once all the objects and all transactions have been updated via the previous two steps, the migration data set export must be updated based on the results of their transactions. The **Migration Data Set Import Monitor** (F1-MGDIM) selects Ready to Compare data sets and runs its monitor algorithms. Note that this is the same monitor process that is used to select Pending data sets. There are various possible outcomes that could occur based on the logic in the algorithms. The following diagram illustrates the portion of the migration transaction lifecycle that pertains to comparison.

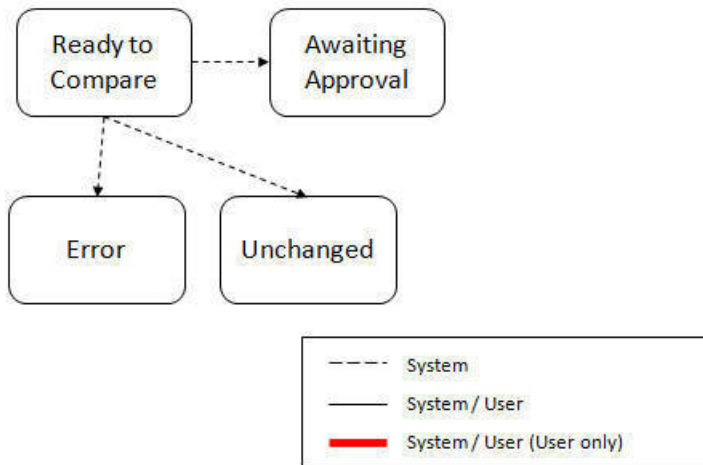

The following points describe the lifecycle possible next states after Ready to Compare.

- If any related migration transactions is in the Error Comparing state, the data set transitions to **Error**.
- If all related migration transactions are in the Unchanged state, the data set transitions to **Unchanged**.



- Otherwise, the transaction transitions to **Awaiting Approval**. This means that there are no errors and at least one object is in an “apply-able” state.

The data set remains in the **Awaiting Approval** state until a user decides that the data set and all its records are ready to progress to the Apply step.

---

**NOTE:** A user can choose to cancel a data set at any time while it is in progress. Refer to [Cancelling a Data Set](#) for more information.

---

## Approval Step

Once the comparison is complete and the data set transitions to the Awaiting Approval state, a user needs to progress the data set to **Apply Objects** to trigger the Apply step. The following points describe steps a user may take during the approval step.

- If the data set configuration for the Default State for Add and Change was set to **Approved**, then any migration object that is determined to be eligible for the Apply step will be in the Approved state. In this situation, a user may want to review the data set and its transactions and objects to see verify that the results make sense. At that time, the user is able to move an object to Needs Review or Rejected as appropriate.
- If the data set configuration for the Default State for Add and Change was set to **Needs Review** for either option, then each migration object in the Needs Review state must be reviewed and the user must either Reject or Approve each object before moving to the Apply step.
- If the data set configuration for the Default State for Add and Change was set to **Rejected** for either option, the assumption is that the rejected records don’t need to be reviewed. But if a user finds a rejected record that shouldn’t be rejected, it may be transitioned to Approved (or Needs Review) as appropriate.

Once the user is comfortable with the data set’s results and no more objects are in the Needs Review state, the user should transition the record to **Apply Objects**. This will initiate the Apply step.

Alternatively, if the Automatically Apply flag was set to **Yes** when creating the import record, the import data set will progress from **Awaiting Approval** to **Apply Objects**. Refer to [Import Process Summary](#) for more information.

---

**NOTE:** Refer to [Maintaining Import Data](#) for details about the pages provided to help the user review a data set and its transactions and objects to help in the approval step.

---

---

**NOTE:** A user can choose to cancel a data set at any time while it is in progress.

---

## Apply Step

The apply step is the step where records in the target environment are added or updated. Like the comparison step, the apply step is actually multiple steps to optimally handle high volume and dependencies between records as smoothly as possible.

---

**NOTE:** Refer to [Running Batch Jobs](#) for more information about streamlining the various steps in the process.

---

Before explaining the apply steps in detail, the following points highlight the type of data that may be included in a given data set.

1. Records that have no foreign keys and therefore no dependencies on other records. Examples: Message, Display Profile.
2. Records that have foreign keys that may already be in the target. Examples: Algorithms for existing algorithm types, To Do Roles for existing To Do Types.
3. Records that have foreign keys that are new records but also part of the migration. CMA detected the relationship at export time and grouped the objects in the same transaction. Example: Script-based Algorithm Type where the script is also in the migration.

4. Records that have foreign keys that are new records but also part of the migration. CMA did not detect the relationship. This may occur if the reference the foreign key is in a XML or parameter column and the migration plan did not include an instruction to explicitly define the relationship. Example, a Zone that references a visibility script.
5. Records that have circular references where both records are new and are part of the migration. CMA detected the relationship at export time and grouped the objects in the same transaction. Example: plug-in Script for a BO plug-in spot. The script references the BO and the BO references an algorithm for the script's algorithm type.

To handle high volume data, the first step in the apply process is to perform the apply logic at the migration object level via a multi-threaded batch job. This should result in all records in categories 1 and 2 above being applied successfully.

For records in categories 3 and 4 above, if a record with a foreign key is added or updated before its related record, the validation will fail. However, if the related record is added first and then the record referring to it is added, validation will pass. Because the migration objects are not ordered, the multi-threaded batch process may not process records in the desired order. To overcome this potential issue, the Apply step has special functionality, described in detail below.

For records in category 5 above, the circular reference will mean that the apply process at the object level will not successfully add or update these records. The apply process at the transaction level will cover these records. This is described in detail below.

## Apply Objects

Once the Data Set is in the state of **Apply Objects**, the **Migration Object Monitor - Apply** process (F1-MGOAP) runs to attempt to apply the objects. The background process in conjunction with the Apply algorithm have special functionality to ensure records in categories 3 and 4 (above) successfully apply during this step:

- The **Migration Object Monitor - Apply** process is a special one that continually re-selects records in the **Approved** state until there are no more eligible records to process.
- When an error is received in the Apply Object algorithm, the algorithm increments an "iteration count" on the migration object record. If the iteration count does not exceed a maximum count (noted in the algorithm), the object remains in the **Approved** state and is eligible to be picked up for processing again. If the iteration count exceeds the maximum defined in the algorithm, the record transitions to the **Error Applying** state.

---

**NOTE:** When submitting this Apply batch job, be sure to set the number of threads to a number that does not exceed the number of threads supported by the thread pool worker. Doing this will cause the 'excess' threads to wait for the supported number of threads to finish.

---

The following diagram is the portion of the migration object lifecycle that pertains to the Apply step.

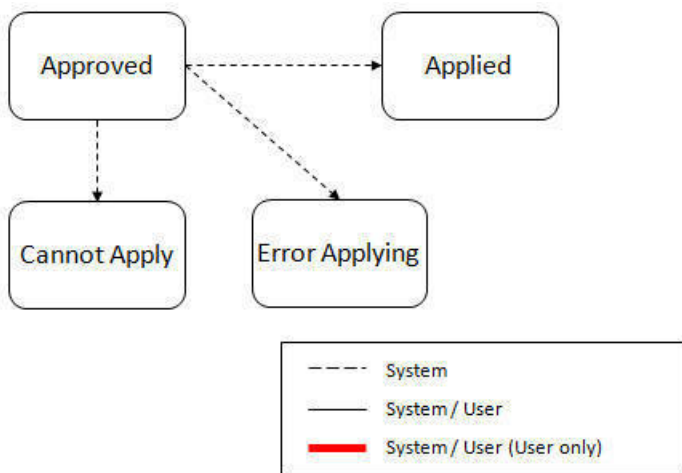

At the completion of the Apply monitor process, typically the objects will be in the **Applied** state or the **Error Applying** state. The records in the Error Applying state are in that state for one of two reasons.

- They are in category 5 described above where the records have a circular reference with another record. For this scenario, the Apply Transactions step described below should successfully apply the records.
- There is some other error that is unrelated to the records in the current migration. In this case, manual intervention may be required. Refer to the [Resolving Errors](#) section below for more information.

As shown in the diagram, the Apply Objects algorithm may also detect a reason that the object cannot be applied. This may occur if the object in the target environment has been updated since the comparison step, making the SQL captured at that point no longer applicable. If this occurs, after the current migration is fully applied, the original file may be imported again, and new comparisons can be generated and applied.

## Apply Transactions

Ideally, after the Apply Objects step, all the objects are **Applied** or are in **Error Applying** due to the "circular reference" situation. The typical next step is to turn over responsibility to the transactions. The migration transactions can then attempt to apply their objects in bulk.

In order to ensure that multiple background processes are not trying to select migration objects to run the Apply step, the Transactions are only eligible to attempt to "apply my objects" if the Data Set is in the **Apply Transactions** state.

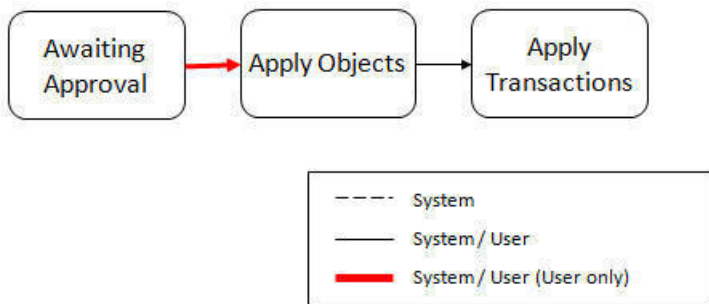

A monitor algorithm (executed by the data set monitor batch process) on the Apply Objects state checks to see if all migration objects are no longer **Approved** or the count of records in **Error Applying** does not exceed a configured limit. If so, it automatically transitions the record to the **Apply Transactions** state.

If the number of objects in **Error Applying** exceeds a configured limit, the monitor algorithm does not automatically transition the record. In that case, a user must determine if the large number of errors can be resolved or manually transition to **Apply Transactions** (despite the large number of errors). The [Resolving Errors](#) section below describes alternative steps that the user may take if there are errors.

Once the Data Set is in the state of **Apply Transactions**, the **Migration Transaction Monitor - Apply** process (F1-MGTAP) runs. It attempts to apply the transaction's objects. If no migration objects are in error, the migration transaction simply transitions to **Applied**. If any of the migration objects are in **Error Applying**, the background process and the Apply algorithm have special functionality to try to overcome dependencies in migrated objects:

- The Apply algorithm selects all migration objects in error and performs all their SQL, then validates all the records. If there are objects in the transaction with circular references, they should pass validation at this point.
- Because there may still be some dependencies across transactions, similar error handling described in the Apply Objects step occurs here. When an error is received in the Apply Transaction's Object algorithm for any of the objects in the transaction, the algorithm increments an "iteration count" on the migration transaction record. If the iteration count does not exceed a maximum count (noted in the algorithm), the transaction remains in the **Ready to Apply** state and is eligible to be picked up for processing again. If the iteration count exceeds the maximum, the record transitions to the **Error Applying** state. Note that if any objects in the transaction are in error, none of the objects are applied. They all remain in error.
- The **Migration Transaction Monitor - Apply** process is a special one that continually re-selects records in the **Ready to Apply** state until there are no more eligible records to process.

---

**NOTE:** When submitting this Apply batch job, be sure to set the number of threads to a number that does not exceed the number of threads supported by the thread pool worker. Doing this will cause the 'excess' threads to wait for the supported number of threads to finish, erasing the benefit of the iteration processing.

---

The following diagram is the portion of the migration transaction lifecycle that pertains to the Apply step illustrating the points above.

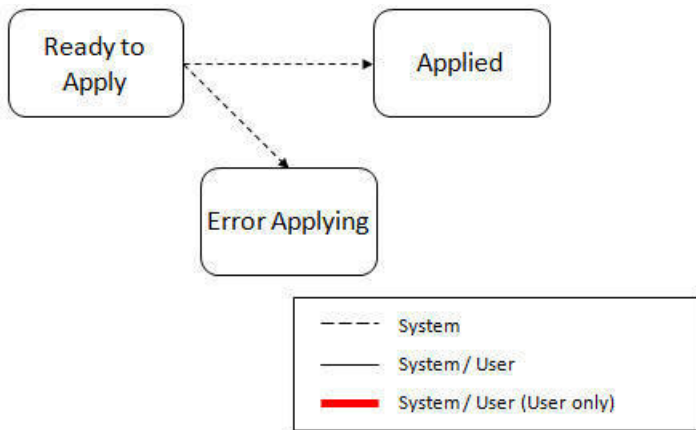

If at the end of the transaction level Apply process there are transactions in error (and therefore there are still objects in error), a user must review the errors and determine how to fix them. Refer to the [Resolving Errors](#) section below for more information.

## Resolving Errors

As mentioned in the previous sections, errors may be received after the Apply Objects process runs. If the number of records in error is below a certain limit (and the data set monitor batch job is submitted to execute the monitor algorithms) the system will automatically transition the data set to the **Apply Transactions**. If the monitor batch job is not run or if the number of objects in error exceeds a certain limit, a user must make the decision after viewing the errors in the Objects in Error zone on the [Migration Data Set Import](#) portal.

- If the errors appear to be dependency related, the user can decide to let the "transactions apply their objects" and transition the data set to **Apply Transactions**, described above.
- If the errors appear to be related to an outside issue that can be manually resolved, the user may choose to fix the issue and redo the Apply Objects step.
- The user may also decide to reject one or more objects to remove them from the migration.

After the Apply Transactions step, if there are still errors, a user must review the records and determine how to proceed. Errors are visible in the **Transactions in Error** zone on the [Migration Data Set Import](#) portal.

- The user may decide to reject one or more objects to remove them from the migration.
- The user may manually resolve an issue external to the migration and then decide to do one of the following:
  - Redo the **Apply Objects** step. This is recommended if there are a large number of Objects still in error and not a large number of dependencies expected. The benefits of running the Apply Objects multi-threaded will ensure that the process runs efficiently.
  - Redo the **Apply Transactions** step.

Because the objects and transactions are in Error Applying, in order to "retry" the Apply step after manually fixing an error, the system needs to move the records back to the state that allows them to be picked up by the appropriate Apply process. For migration objects, records need to be moved back to **Approved**. For migration transactions, records need to be moved back to **Ready to Apply**. The following points describe the Retry logic for migration objects.

- If a user decides to **Retry Objects** (using an action button on the Migration Data Set Import page), the data set transitions to the **Retry Objects** state. At this point the Migration Object monitor must be run.
- The monitor on the **Error Applying** state for the objects detects that the data set is in the state of **Retry Objects** and that triggers the transition back to **Approved**.
- The next step is to transition the data set from **Retry Objects** to **Apply Objects**. This may be done manually or by running the Migration Data Set Import monitor process.
- Now the objects are eligible to be picked up by the object level Apply process.

Analogous logic exists for the migration transactions.

- If a user decides to **Retry Transactions** (using an action button on the Migration Data Set Import page), the data set transitions to the **Retry Transactions** state. At this point the Migration Transaction monitor must be run.
- The monitor on the **Error Applying** state for the transactions detects that the data set is in the state of **Retry Transactions** and that triggers the transition back to **Ready to Apply**.
- The next step is to transition the data set from **Retry Transactions** to **Apply Transactions**. This may be done manually or by running the Migration Data Set Import monitor process.
- Now the transactions are eligible to be picked up by the transaction level Apply process.

The retry logic may also occur when transitioning between the Apply Objects and Apply Transactions depending on whether or not there are errors. The following scenario highlights this point.

- After the **Apply Objects** step there are objects in **Error Applying**. The data set transitions to **Apply Transactions** and the Apply step is done at the transaction level.
- After the **Apply Transactions** step there are transactions in **Error Applying**.
- User chooses to try to apply objects again (by clicking **Retry Objects**). The steps outlined above for retrying objects are followed at this point.
- After the apply objects, user may choose to retry objects again (after fixing errors if applicable).
- At some point the user will transition to **Apply Transactions** again. If there are transactions in **Error Applying**, the system will automatically transition the data set to **Retry Transactions** and the steps outlined above for retry transactions are followed.

## Finalize Apply Step

Once all the migration objects for a migration transaction are in a final state (**Applied**, **Rejected** or **Cannot Apply**), the migration transaction transitions to the **Applied** state. Once all the migration transactions are in the **Applied** state, the Migration Data Set record transitions to the **Completed** and the import is complete.

---

**NOTE:** To review the full lifecycle for each record, refer to the Business Object - Summary tab in the application metadata for the base business objects **Migration Data Set Import** (F1-MigrObjectImport), **Migration Transaction** (F1-MigrTransactionImport) and **Migration Object** (F1-MigrObjectImport).

---

## Adjusting Data Prior to Comparing

Some records may have data that is specific to the environment it is in and won't apply in the target environment. In such cases, an algorithm plugged into the [migration plan](#) primary instruction may be used to adjust the data when importing. This algorithm is executed by the comparison algorithm before any comparison is performed. Algorithms of this system event receive the view of the source record (being imported) and the view of the existing record in the target region, if it exists. The data is provided using the physical BO of the migration plan's maintenance object. The algorithm may make changes and pass a new view of the record that should be used for the comparison. This system event supports multiple algorithms that are executed in sequence. Each algorithm receives the original record's data, the target record's data (if applicable) and the 'new' view of the data (as populated by previous algorithms, if any). The final 'new' view of the data is used for the object comparison.

---

**FASTPATH:** Refer to [Base Business Objects](#) for more information about physical BOs.

---

Some examples of records that may require import algorithms.

- Batch Control references its next batch sequence number along with snapshot information like the last run date / time. This information is only relevant with respect to its environment. The instruction for a batch control can include an algorithm to not overwrite the batch sequence number when copying a batch control.
- Some products include administrative objects that reference a master data object. Master data objects are not copied as part of CMA. An import algorithm may be used to adjust the referenced master data foreign key when importing, for example to reset it (or not overwrite when updating). If the algorithm knows how to find the appropriate master data record to link, that may also be included.

Note that it is possible to use the algorithm to "reset" the source data as a way of indicating that the record should not be imported. For these situations, the migration object comparison step will transition the record to **Unchanged** and will use an object action value of **Canceled**. (Note that object action is a simple lookup value. The record is not transitioned to the **Canceled** BO state as to reserve that status for user initiated cancellations of the object or one of its parent records). This technique not expected to be used often because ideally using appropriate selection criteria at export time should ensure that the only records exported are those that should be imported.

---

**NOTE: Legacy 'Import' system event.** The system originally provided an Import system event / plug-in spot. The purpose of algorithms for this plug-in spot were similar in that they were meant to adjust imported data prior to adding or updating. The algorithms were executed in the Apply step. The logic does not allow for easily interacting with the record using a BO. This makes it difficult to use a plug-in script as the plug-in type. In addition, it is difficult to update elements in an XML column. The support for the plug-in spot will be removed in a future release. Algorithms to adjust the data should be using the pre-compare system event.

---

## Import Process Summary

The following table summarizes the steps required to complete the import process from start to finish. Note that this section **only a summary** and assumes that you are familiar with the details described in the previous sections. It highlights what steps are manual and what steps are performed by a batch monitor process. For each step, the table highlights the Next Action sequence that would occur. For the Apply steps, there are two parts where multiple next actions are possible based on whether there are errors and the user's decision on how to resolve the error. Refer to [Resolving Errors](#) for more information. The possible next actions have the same sequence with a letter following the sequence highlighting the action to take based on the results of the previous step.

---

**NOTE:** When running the Apply batch jobs, be sure to set the number of threads to a number that does not exceed the number of threads supported by the thread pool worker.

---

Also note that a sequence and action marked in bold is considered the "normal path".

Step	Seq	Action	Manual / Batch	Portal - Action	Batch Control	Record Impacted - Resulting Status	Next Action Sequence
Import	<b>10</b>	<b>Create Import record</b>	Manual	Migration Data Set Import - Add		Migration Data Set Import - Pending	11
	<b>11</b>	<b>Import file</b>	Batch		F1-MGDIM - Migration Data Set Import Monitor	Migration Data Set Import - Ready to Compare Migration Transaction - Pending	20

Step	Seq	Action	Manual / Batch	Portal - Action	Batch Control	Record Impacted - Resulting Status	Next Action Sequence
						Migration Object - Pending	
Compare	20	<b>Migration Object Compare</b>	Batch		F1-MGOPR - Migration Object Monitor	Migration Object - Approved, Needs Review, Rejected, Unchanged or Error Comparing	21
	21	<b>Migration Transaction status update</b>	Batch		F1-MGTPR - Migration Transaction Monitor	Migration Transaction - Ready to Apply, Unchanged or Error Comparing	22
	22	<b>Migration Data Set Import status update</b>	Batch		F1-MGDIM - Migration Data Set Import Monitor	Migration Data Set Import - Awaiting Approval, Apply Objects (if configured for Automatic Apply), Unchanged or Error	30
Approval	30	<b>Review comparison results, approve / reject as needed</b>  (This step is skipped if the data set is configured for Automatic Apply)	Manual	Migration Data Set Import, drill in to the Transactions / Objects as necessary.		Migration Object - Approved or Rejected (no records should be in Needs Review)  Migration Data Set Import - Apply Objects	40
Apply	40	<b>Apply Objects</b>	Batch		F1-MGOAP - Migration Object Monitor - Apply	Migration Object - Applied or Error Applying	41 Appropriate next action is based on error review, if applicable.
	41a	Migration Data Set Import status update - auto transition to Apply Transactions.  Only applicable if the number of migration objects in Error Applying is below a threshold	Batch		F1-MGDIM - Migration Data Set Import Monitor	Migration Data Set Import - Apply Transactions	42
	41b	<b>Migration Data Set Import status update - manual transition</b>	Manual	Migration Data Set Import - click Apply Transactions			

Step	Seq	Action	Manual / Batch	Portal - Action	Batch Control	Record Impacted - Resulting Status	Next Action Sequence
		<p><b>to Apply Transactions.</b></p> <p>Occurs if user reviews errors and determines that they may be resolved in the Apply Transaction step.</p>					
		System detects that all the transactions are in the Ready to Apply state and proceeds to the Apply Transactions state.				Migration Data Set Import - Apply Transactions	42
		System detects that there are transactions in the Error Applying state and transitions instead to the Retry Transactions state.				Migration Data Set Import - Retry Transactions	45
41c		<p>Migration Data Set Import status update - manual transition to Retry Objects.</p> <p>Occurs if user reviews errors and decides to fix an external error and wants to try the batch level Apply again at the object level.</p>	Manual	Migration Data Set Import - click Retry Objects		Migration Data Set Import - Retry Objects	44
42		<b>Apply Transactions</b>	Batch		F1-MGTAP - Migration Transaction Monitor - Apply	Migration Transaction - Applied or Error Applying Migration Object - Applied or Error Applying	43 Appropriate next action is based on error review, if applicable.
43a		<p><b>Migration Data Set Import status update - auto transition to Completed</b></p> <p>Applicable if all transactions are Applied</p>	Batch		F1-MGDIM - Migration Data Set Import Monitor	Migration Data Set Import - Completed.	N/A



Step	Seq	Action	Manual / Batch	Portal - Action	Batch Control	Record Impacted - Resulting Status	Next Action Sequence
	43b	Migration Data Set Import status update - manual transition to Retry Objects. Occurs if user reviews errors and decides to fix an external error and wants to try the batch level Apply again at the Object level.	Manual	Migration Data Set Import - click Retry Objects		Migration Data Set Import - Retry Objects	44
	43c	Migration Data Set Import status update - manual transition to Retry Transactions. Occurs if user reviews errors and decides to fix an external error and wants to try the batch level Apply again at the Transaction level.	Manual	Migration Data Set Import - click Retry Transactions		Migration Data Set Import - Retry Transactions	45
	44	Migration Objects status update from Error Applying back to Approved. Occurs if user chose to Retry Objects.	Batch		F1-MGOPR - Migration Object Monitor	Migration Object - Approved	
		Migration Data Set Import status update from Retry Objects to Apply Objects	Batch		F1-MGDIM - Migration Data Set Import Monitor	Migration Data Set Import - Apply Objects	40
	45	Migration Transactions status update from Error Applying back to Ready to Apply. Occurs if user chose to Retry Transactions or if the user transitions to Apply Transactions and the system detects that	Batch		F1-MGTPR - Migration Transaction Monitor	Migration Transaction - Ready to Apply	42

Step	Seq	Action	Manual / Batch	Portal - Action	Batch Control	Record Impacted - Resulting Status	Next Action Sequence
		there are Transactions in the Error Applying state.					
		Migration Data Set Import status update from Retry Objects to Apply Objects	Batch		F1-MGDIM - Migration Data Set Import Monitor	Migration Data Set Import - Apply Transactions	42

The following table summarizes the batch monitor jobs that are used in the import process. You can see that there are special monitor processes for the Apply step for both the Object and Transaction. However, for all other states that have monitor logic, the standard monitor process for that MO is used.

Batch Control	Description	Comments
F1-MGDIM	Migration Data Set Import Monitor	Processes data set records in the following states: <ul style="list-style-type: none"> <li>• Pending</li> <li>• Ready to Compare</li> <li>• Apply Objects</li> <li>• Retry Objects</li> <li>• Apply Transactions</li> <li>• Retry Transactions</li> </ul>
F1-MGTPR	Migration Transaction Monitor (Deferred)	Processes transaction records in the following states: <ul style="list-style-type: none"> <li>• Pending</li> <li>• Error Applying</li> </ul>
F1-MGTAP	Migration Transaction Monitor - Apply	Processes transaction records in the Ready to Apply state where the data set is in the Apply Transactions or Canceled state. <p><b>NOTE:</b> Be sure to set the number of threads to a number that does not exceed the number of threads supported by the thread pool worker.</p>
F1-MGOPR	Migration Object Monitor	Processes object records in the following states: <ul style="list-style-type: none"> <li>• Pending</li> <li>• Needs Review (check for Data Set cancellation)</li> <li>• Rejected (check for Data Set cancellation)</li> <li>• Error Applying</li> </ul>
F1-MGOAP	Migration Object Monitor - Apply	Processes object records in the Approved state where the data set is in the Apply Objects or Canceled state. <p><b>NOTE:</b> Be sure to set the number of threads to a number that does not exceed the number of threads supported by the thread pool worker.</p>

Refer to [Running Batch Jobs](#) for more information about managing the batch jobs, including ways to automate the above steps.

## Canceling a Data Set

A user may choose to **Cancel** a data set to prevent it from being processed at any point during the process.

If related migration transactions or migration objects have already been created, they will not be canceled as part of the data set getting canceled (due to possible high volumes of related records). They will be canceled the next time an appropriate monitor batch process runs. The child records checks to see if the data set has been canceled prior to any state transition.

## Additional Note Regarding Imports

The following points describe miscellaneous comments related to Migration Import.

- CMA relies on the fact that database referential integrity constraints are not in place, and that the SQL statements can be run in any order within the transaction. Any archiving solution that requires referential integrity constraints (such as Information Lifecycle Management) would not be possible on this data. Given that CMA migrations comprise administrative data and not transactional data, this should be a reasonable exception.
- The validation that is performed is only via the **Page Validate** service. BO validation algorithms are not executed. Page validation does not include validation of the business object against the schema (for example, for required fields, field sizes, etc.).
- If multiple migration requests are exported at the same time, on the import side, you should consider importing, reviewing, and applying an entire file/data set before moving on to the next one. The reason is that if objects are included in more than one file, two sets of "inserts" will be generated, but only the first will succeed. The second will cause the object to transition to "Cannot Apply". If instead you wait until the first file is completed before importing the second, the second data set will not generate any SQL for the object, since it has already been inserted. It's a matter of efficiency: If you first import all files and then try to apply all, you'll have to identify the duplicated object as an error and then mark the object as rejected before applying the transaction. This may also be avoided by using a Group migration request to include all objects in one file rather than multiple files.

## Caching Considerations

Because CMA updates administrative data that is usually read from a cache, after a successful migration, the target region now has new administrative data which needs to be part of various caches. It is recommended to flush the server cache (which will trigger a 'global' flush of the cache). If the thread pool workers in the target region are configured to refresh their caches when a global flush is requested, then this is the only step required. If not, then the **F1-FLUSH** batch job should also be submitted to refresh the caches used in batch processing.

---

**FASTPATH:** Refer to [Caching Overview](#) for more information.

---

## Maintaining Import Data

This section describes the portals provided to add, view and maintain migration import data.

### Migration Data Set Import

Use the Migration Data Set Import portal to view and maintain migration data set import records. Refer to [Importing and Applying a Migration](#) for an overview of the import process.

Navigate using **Admin > Implementation Tools > Migration Data Set Import**. You are brought to a query portal with options for searching for import data sets. In addition, the query provides an option to specifically search for data sets that have either objects in error or transactions in error.

Once a data set has been selected, you are brought to the maintenance portal to view and maintain the selected record. The following zones are visible on the main tab:

- **Migration Data Set Import.** This zone contains display-only information about the selected record. Please see the zone's help text for information about this zone's fields.
- **Migration Data Set Transactions.** This zone is visible once the [Import Step](#) has occurred and lists all the transactions that are related to the data set. To see more information about a specific migration transaction, click the hypertext for its ID. This brings you to the [Migration Transaction](#) portal.
- **Migration Data Set Impacted Object Summary.** This zone is visible once the [Import Step](#) has occurred and lists the objects that are related to the data set. To see more information about a specific migration object, click the hypertext for its ID. This brings you to the [Migration Object](#) portal. A user may choose to update the status of one or more records by checking the records and clicking **Approve**, **Reject** or **Needs Review** accordingly.
- **Migration Data Set Objects in Error.** This zone is only visible if there are objects for this data set in a non-final status that have errors. It indicates the error for each object. A user may use this zone to review errors after the monitor batch job to apply objects completes. Using the error information shown, the user can choose to drill into the record to transition it to **Error Applying** or choose to manually fix the cause of the errors and click **Retry Objects**. The user may also choose to select one or more records to **Reject**.

---

**NOTE:** Refer to [Apply Step](#) for more information about resolving errors.

---

- **Migration Data Set Transactions in Error.** This zone is only visible if there are transactions for this data set in a non-final state that have errors. It indicates the error for each transaction. A user may use this zone to review errors after the monitor batch job to apply transactions completes. The errors received when attempting to apply objects at the transaction level may differ from those received when attempting to apply objects at the object level. A transaction log is created for each object error received and these exceptions are shown in this zone.

---

**NOTE:** Refer to [Apply Step](#) for more information about resolving errors.

---

## Migration Transaction Portal

This page appears after drilling into a specific migration transaction from the migration data set portal or from the migration object portal.

Refer to [Importing and Applying a Migration](#) for an overview of the import process.

The following zones are visible on the main tab:

- **Migration Transaction.** This zone contains display-only information about the selected record. Please see the zone's help text for information about this zone's fields.
- **Migration Transaction Objects.** This zone lists the objects that are related to the data set. To see more information about a specific migration object, click the hypertext for its ID. This brings you to the [Migration Object](#) portal. A user may choose to update the status of one or more records by checking the records and clicking **Approve**, **Reject** or **Needs Review** accordingly.

## Migration Object Portal

This page appears after drilling into a specific migration object from the migration data set portal or from the migration transaction portal.

Refer to [Importing and Applying a Migration](#) for an overview of the import process.

The **Migration Object** zone contains display-only information about the selected record. Please see the zone's help text for information about this zone's fields.

## Running Batch Jobs

There are several batch jobs that are part of the CMA process, especially the import step (which are highlighted in [Import Process Summary](#)). And in some cases, a single batch jobs may process multiple states in the same business object lifecycle. Implementations must decide the best way to manage the batch job submission depending on how they plan to work.

- **Batch scheduler.** If an implementation wishes to put these batch jobs in the batch scheduler, a given job may need to be included several times to manage progressing the records to completion.
- **Timed Batches.** The batch controls can be configured as timed batches so that they run every N minutes based on the setting. This allows for the batch jobs to run periodically and process whatever is ready. A user doesn't have to manually submit a batch request. Navigate to the [Batch Control](#) page and select the appropriate batch controls. For each one, change the Batch Control Type to **Timed**. Fill in the additional information that appears for timed batches.
- **Event Driven.** The system provides BO enter plug-in algorithms and batch control post processing plug-in algorithms that automatically submit the appropriate next batch job for that step in the process. This allows for as much automation as possible for the steps that don't require user input. Note that configuration is required because the BOs / batch controls are not configured for this scenario by default. The following table highlights the BO and status where an algorithm may be plugged in and the name of the algorithm to use.

Business Object	Status	Algorithm
Migration Data Set Export	Pending	F1-MGDPR-SJ (Submit Migration Data Set Export Monitor).
Migration Data Set Import	Pending	F1-MGDIM-SJ (Submit Migration Data Set Import Monitor).
	Ready To Compare, Retry Objects	F1-MGOPR-SJ (Submit Migration Object Monitor).
	Apply Objects	F1-MGOAP-SJ (Submit Migration Object Apply Monitor).
	Apply Transactions	F1-MGTAP-SJ (Submit Migration Transaction Apply Monitor).
	Retry Transactions	F1-MGTPR-SJ (Submit Migration Transaction Monitor).

The following table highlights the batch controls where an algorithm may be plugged in and the name of the algorithm to use.

Batch Control	Algorithm
F1-MGTPR (Migration Transaction Monitor)	F1-MGDIM-NJ (Submit Migration Data Set Import Monitor).
F1-MGTAP (Migration Transaction Monitor - Apply)	F1-MGDIM-NJ (Submit Migration Data Set Import Monitor).
F1-MGOAP (Migration Object Monitor - Apply)	F1-MGDIM-NJ (Submit Migration Data Set Import Monitor).
F1-MGOPR (Migration Object Monitor)	F1-MGTPR-NJ (Submit Migration Transaction Monitor).

- **Manual submission.** The user managing the CMA import process submits the appropriate batch jobs on demand when a particular step is ready. Navigate to [Batch Job Submission](#), select the appropriate batch control and fill in the parameters as needed.

Note that after successfully applying the migrated data, the L2 cache of all thread pools must be refreshed. For more information, see [Caching Considerations](#).

**CAUTION:** Be sure that the Thread Count set when submitting the batch job does not exceed the number supported by the thread pool. Otherwise the extra threads will wait until the supported number of threads are finished, possibly resulting in a large number of errors in the Apply steps.

Refer to the parameter descriptions in the batch control metadata for more information about filling in the parameters.

For additional details on submission controls, refer to the topic [Batch Job Submission - Main](#) in the Batch Jobs section.

## CMA Reference

This section provides additional reference information.

### Framework-Provided Migration Configuration

This topic describes special information relating to migration objects provided for use by CMA in the product. Additional objects may be provided by your specific product. Any special information for objects is provided separately in each product's documentation.

The following points highlight some information about Framework-provided migration requests. Navigate to the migration request page in the application to view the details of all provided objects.

- Several base migration requests are supplied to logically group system and administrative tables. For example, there is a migration request for Framework System Configuration **F1-SystemConfig** where most system configuration objects are included. There is another one provided for CMA related configuration objects.
- There are several different security related migration requests that include different combinations of migration plans to support multiple possible business requirements related to security migration.
- The system supplies a group migration request **F1-FrameworkConfig** (Framework Configuration), which includes several other migration requests. The expectation is that this migration request includes all the typical objects that are included in a wholesale migration. Your specific product may include this migration request into its own group migration request to support a wholesale migration of all the framework and product administrative tables. An implementation may choose to build a custom group migration request. In this case, review the various migration requests provided by base to see if any may be included as components for the custom migration request. Then any new migration plans added to the base migration request in future releases are automatically included in future migrations.

---

**NOTE:** Refer to your specific product's CMA documentation for its recommendation on which migration requests to use for a full migration of framework and product administrative tables.

---

The following points highlight some information about the Framework-provided migration plans. Navigate to the migration plan page in the application to view the details of all provided objects.

- Fields and characteristic types are not migrated with an object (like a business object or a data area) unless specifically indicated.
- The **Application Service** used by an object is migrated only if it is CM-owned.
- The **Batch Control** object optionally references a User. If this user does not exist on the target system, CMA cannot apply the requested changes. Also note that when running a batch job, snapshot information is captured on the batch control. Updates like this increment the version number. If a batch control record is part of the migration and the comparison step has detected a change to the batch control, the Apply step will error out for this batch control if a batch job is submitted between the compare and apply step.

---

**NOTE:** CMA batch controls that are part of the import step are executing and as such, the system does not include these records in a migration. If your implementation changes default parameters for any of the batch controls, the recommendation is to manually make those changes to the target region.

---

- The base migration plans for MO and BO include instructions to copy option types that use foreign key references to refer to other objects. Note that the data stored in the options are not validated, so defining these instructions is not required when doing wholesale migrations. However, including subordinate instructions for foreign key references is useful for targeted migrations to ensure that the related data is included in the migration. If you add additional MO or BO option types that use foreign keys and you want to support targeted migrations, you must create custom migration plans

and requests for MO and BO, respectively to include these referenced objects in the migration plan. Note that you do not need to duplicate the instructions in the base migration plans. You may define the additional migration plans to only have the additional custom option types. When submitting a migration request for MO or BO you must include both the base migration plans and the custom migration plans in the request.

- For scripts, schema-based objects and zones, the migration plans provided by the product migrate, through constraints, some of the typical associated data with them. However, data specified through alternate formats (such as through **Edit Data** steps in scripts, referenced in schemas for schema-based objects, or data from mnemonics in zone parameters, etc.) are not identified and combined in the same transaction. The iterative processing functionality of the import step should resolve any timing issues that may result in validation errors for these types of objects.
- There are two migration plans for **Scripts**. The migration plan **F1-ScriptOnly** migrates just the script and its **Application Service** (provided the Application Service is CM-owned). The migration plan **F1-Script** includes most related objects, but does not migrate any objects referenced in the edit data area steps. It does not move the **Function** maintenance object. It may be included in any appropriate custom targeted migration request where scripts and related data should be migrated.
- If your implementation includes a **Feature Configuration** setting for the **F1\_DBCONINFO** entry that will be included in a migration request, be sure that the import user on the target region has the appropriate security rights to this entry (**Administrator** access mode for the Feature Configuration application service (**CILTWSDP**)).
- The common attachments in the Attachment maintenance object may be considered administrative data to include in a migration. Because this MO has a system generated key, as described in [Migration Assumptions, Restrictions and Recommendations](#), it uses a logical key of the file name and the creation date to determine if the record exists in the target environment. In addition, this MO contains admin data (common attachments) and non-admin data (owned attachments). To try to minimize the possibility of key “collision”, new common attachments receive a generated key that includes a zero in the middle whereas owned attachments receive a generated key that does not have a zero in the middle.
- The Menu maintenance object has a user defined key, however, its menu lines and menu items have system generated keys. To avoid the possibility of overriding a menu line or menu item incorrectly, the menu MO will check the menu line’s menu name in the source and target to be sure they match and will check the menu item’s menu line in the source and target to be sure they match otherwise an error will be issued in the comparison step.
- For the system messages, the product provides three different migration plans.
  - Message Category and its Messages (F1-MessageCategory). This migration plan is included in the **F1-SystemConfig** migration request.
  - Message Category (F1-MessageCategoryOnly). This migration plan is provided to support a targeted migration where an implementation has created a custom message category and wants to move it but doesn’t want to move all its messages.
  - Message (F1-Message). This migration plan is provided to support a targeted migration where only specific messages within a message category should be migrated.
- For lookup values, the product provides two different migration plans.
  - Lookup Field and its Values (F1-Lookup). This migration plan is included in the **F1-SystemConfig** migration request.
  - Lookup Value (F1-LookupValue). This migration plan is provided to support a targeted migration where only specific lookup values within a lookup field should be migrated.
- There are some system data objects where no information in a base delivered record may be modified by an implementation. For these records, the base delivered migration requests include selection criteria to only select CM-owned records (because the base records will always exist in the target region assuming both regions have the same release). An example is Algorithm Type. The **F1-SystemConfig** migration request only includes CM-owned algorithm types. However, many system data objects support custom changes to one or more fields, for example the Zone object allows an implementation to override the zone text or certain parameters. Other system data objects support custom additions to a collection. For example, the Maintenance Object allows an implementation to add algorithms or options. For the migration plans related to these system data objects, all records are included in the base delivered migration

requests to allow for any customized configuration to be migrated. It means that during the Import / Compare step many base delivered objects that are not customized will be marked **Unchanged**.

- Many of the integration related maintenance objects that include references to environment-specific data, such as Message Senders. This data should be migrated with extreme care. When appropriate, consider taking advantage of [URI Substitution](#).

## Configuring Facts

---

Fact is an optional configuration tool for simple workflow-type business messages or tasks. The base package does not provide a dedicated Fact user interface because fact is generic by design. Implementations configure their own user interface to visualize the desired custom business process. The topics in this section describe the generic Fact entity and how it can be customized.

### Fact Is A Generic Entity

The Fact maintenance object is a generic entity that can be configured to represent custom entities and support automated workflows for a variety of applications. Each fact references a business object to describe the type of entity it is. A status column on the fact may be used to capture its current state in the processing lifecycle controlled by its business object.

The maintenance object also supports a standard characteristic collection as well as a CLOB element to capture additional information.

#### Where Used

Follow this link to open the data dictionary where you can view the tables that reference [F1\\_FACT](#)

### Fact's Business Object Controls Everything

A fact's business object controls its contents, lifecycle and various other business rules:

- Its schema defines where each piece of information resides on the physical Fact maintenance object.
- It may define a lifecycle for all fact instances of this type to follow. Each fact must exist in a valid state as per its business object's lifecycle definition.
- It may define validation and other business rules to control the behavior of facts of this type.

---

**FASTPATH:** For more information about business objects, refer to [The Big Picture of Business Objects](#).

---

### Fact Supports A Log

The Fact maintenance object supports a log. Any significant event related to a Fact may be recorded on its log. The system automatically records a log record when the fact is created and when it transitions into a new state. In addition, any custom process or manual user activity can add log entries.

---

**FASTPATH:**

---

Refer to [State Transitions Are Audited](#) for more information on logging.



# Cloud Service Foundation

---

This chapter provides information on how to administer features associated with Oracle Utilities Cloud Service Foundation functionality.

---

**NOTE:** This chapter does not apply to all implementations. Contact your system administrator to confirm if your implementation includes Oracle Utilities Cloud Service Foundation.

---

## Process Automation Tool

---

**NOTE:** This section does not apply to all implementations. Contact your system administrator to confirm if your implementation includes Oracle Utilities Cloud Service Foundation and the Process Automation Tool.

---

The Process Automation Tool allows customers and implementers to orchestrate and automate a set of infrastructure related multi-step processes. The tool provides the ability to monitor the progress of such process and each of the steps. The tool also supports user actions at the process and step level.

The process automation tool is made out of the following system entities:

- Infrastructure Process - a Business Object of the Service Task MO.
- Infrastructure Process Step - a Business Object of the Service Task MO.
- Infrastructure Process Type - a Business Object of the Service Task Type MO.
- Infrastructure Process Step Type - a Business Object of the Service Task Type MO.

An Infrastructure Process references a type that includes the steps that are a part of that process. The steps are executed one by one according to their sequence as long as the previous step ended successfully. When a step in a process fails, the process will stop and wait for a user to take further actions.

An Infrastructure Process can span up to two product environments. This means that it can invoke and monitor steps in two systems. This, for example, allows it to orchestrate a configuration migration (using the [Configuration Migration Assistant](#)) from one product environment to another. Such a migration can include steps to create the export data on the **source** environment, move the export file to the **target** environment and execute all the import tasks on the target environment, all as a single Infrastructure Process. In this case the Infrastructure Process will be created on the **target** environment and will pull the configuration from the **source** environment.

---

**NOTE:**

This is done in order to ensure that only application users with sufficient security privileges in any system environment can create Infrastructure Processes that can update that environment.

The rule is that when an Infrastructure Process is created to run processes on two systems, the process will always be created on the **environment with the higher security requirements**. For example, if you need to run processes on the Development and Test environments, the infrastructure process will be created and executed from the Test environment (assuming that the Test environment has higher security requirements than the Development environment).

---

The steps that make an Infrastructure Process reference a step type that governs their behavior. A comprehensive set of process and step types is provided with the product. This set can be extended by implementers as needed.

## Creating an Infrastructure Process

To create a new process, navigate using **Admin > Implementation Tools > Infrastructure Process**. Use the Infrastructure Process Query to search for an existing process. Once an Infrastructure Process is selected, you are brought to the maintenance portal to view and maintain the selected record.

The following points provide information about creating a new Infrastructure Process.

Infrastructure Process references an **Infrastructure Process Type**. When creating a new process you need to select the type that the process will be based on.

The **Name** of the process is used for tracking purposes. The name doesn't have to be unique in the system.

The **Process Steps** list is read-only and represents the steps that were configured on the Infrastructure Process Type.

---

**NOTE:**

Changing information on the Infrastructure Process Type, including the steps, will not affect existing Infrastructure Process records.

---

The **Process Details** section represents additional information that is required according to the corresponding process type definition.

## Executing an Infrastructure Process

### Infrastructure Process Lifecycle

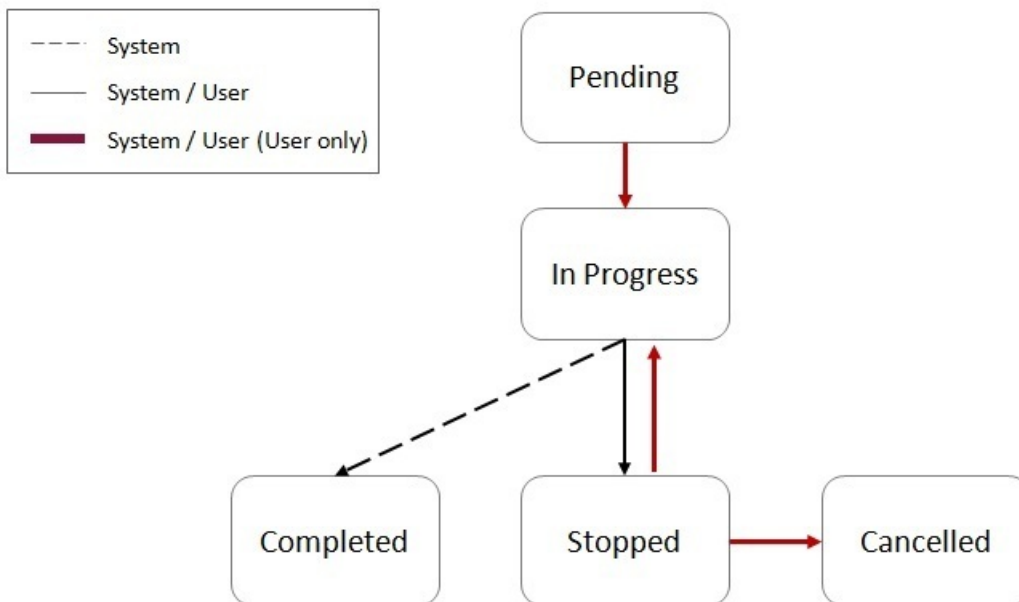

New processes are created in a Pending status. While in this status the Infrastructure Process record can be modified, deleted or duplicated.

---

**NOTE:** Once an Infrastructure Process record is created, its type cannot be changed. To change the type, you can delete the process that was created with the wrong type (if it is still in Pending status) and create a new process with the correct type.

---

Use the **Start** action, on the maintenance portal to begin the process execution. The process status will change to **In Progress**.

---

**NOTE:** While the Infrastructure Process is in **Pending** status, the steps will not have a status or any available actions. When the process transitions to **In Progress** status the process step records are created. From that point on they have a status and actions according to the step that and status.

---

While the process is **In Progress** the steps of the process will execute one by one according to their sequence. The process can be stopped using the **Stop** action. In this case the current step that is in progress will continue but the next step will not be executed. If any of the steps fail, the process will also transition into **Stopped** status and will not execute the next step.

When the process is in **Stopped** status it can be resumed by selecting the **Resume** action, or it can be cancelled by selecting the **Cancel** action.

### Infrastructure Process Step Lifecycle

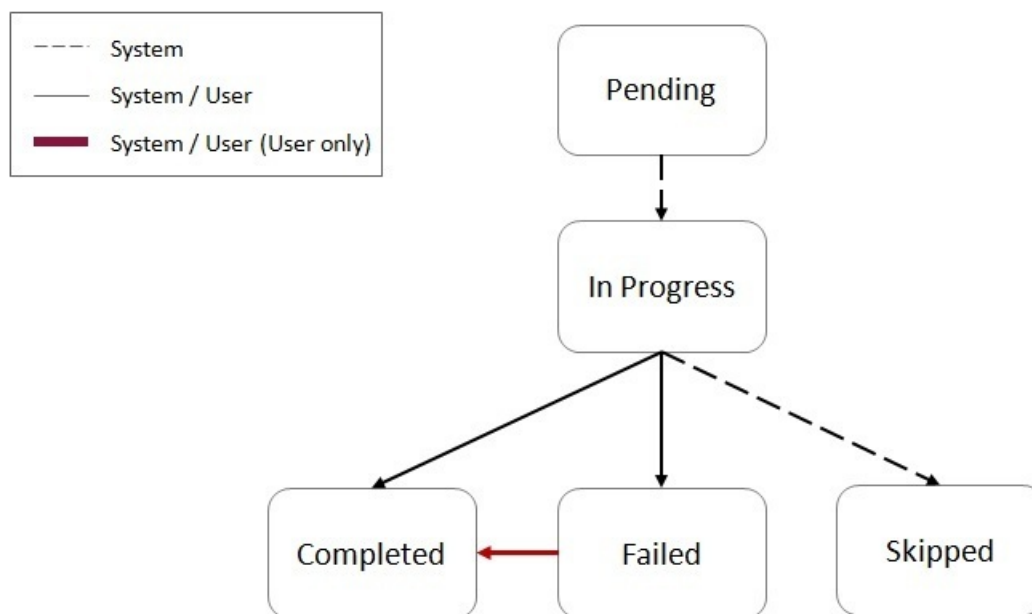

A process steps is created in **Pending** status and is transitioned to **In Progress** by the process logic when its turn to execute arrives.

When a step is **In Progress**, the following transitions are possible:

- Transition the step into **Completed** status upon successful completion of the step's work or by selecting the **Complete** action.
- Transition the step into **Failed** status when an error was detected during the step's work or by selecting the **Fail** action.
- Steps may include logic that will transition the step into **Skipped** status if that logic determines that the step should not be executed.

When the step is **In Progress**, selecting the **Job Status** action will display information about the job running status (if it is a batch job type of step).

---

**NOTE:** Manually changing the step status to **Completed** or **Failed** while the step is **In Progress** should be carefully considered. This should only be done when step stays **In Progress** status for a long time and upon investigation it is clear that some manual intervention is required.

---

When a step is in **Failed** status it is still possible to manually transition the step into **Completed** status.

---

**NOTE:** Transitioning the step from **Failed** to **Completed** status should only be done if it is clear that the step was able to successfully accomplish its task. This will likely be established after some investigation.

---

## Monitoring Infrastructure Process Progress

### Infrastructure Process Control

The Infrastructure Process Control portal provides an overview of Infrastructure Processes that are active (i.e. in **Pending** or **In Progress** status) or processes that did not complete (i.e. in **Stopped** status) within the last X days.

Navigate to Infrastructure Process Control portal, using **Admin > Implementation Tools > Infrastructure Process Control**.

Available actions on this portal are:

- **New Process** - creates a new Infrastructure Process
- **Environment Setup** - directs the user to the master configuration related to the process automation tool

Select any of the processes from the portal lists for more information.

### Monitoring a Running Infrastructure Process

When a process is running (in **In Progress** status), you can monitor its progress by refreshing the page. To configure automatic page refresh, refer to the User Portal Preferences for this portal.

The Infrastructure Process maintenance portal provides information about the status of the overall process as well as each of the steps.

You can also view the details of each individual step including their log for more information or to investigate exceptions.

### Dealing with Exceptions

Infrastructure Process steps can be divided into two main categories:

- Steps that start a batch process (job)
- Steps that are not batch process related

In addition, steps can be local or remote. Local steps execute on the same product environment that the process is executing while remote steps are executed on a different product environment.

### Batch Job Step Exceptions

Batch job steps start a batch job either locally or on a different product environment.

#### Batch job step in Failed status as a result of a batch job error

When a batch process (local or remote) ends with an error, the process step is automatically transitioned to **Failed** status.

In this case, you should:

1. Ascertain the cause of the job failure (in the local or remote environment).

2. If the issue is temporary or can be fixed, fix it and then rerun the batch job manually using the Batch Job Submission page (in the local or remote environment). If the resubmitted job ended successfully, you can transition the process step to the **Completed** status and use the **Resume** action at the process level to continue the process execution.

If the issue cannot be resolved, further investigation is required. In this case the process should remain in **Stopped** status.

### **Batch job step in In Progress status while batch job ended with an error**

When an Infrastructure Process Step that is associated with a batch job stays in **In Progress** status while the batch job ended with an error, further investigation is required. One possible cause for that situation could be an error that causes the job to fail and at the same time also prevents the job from communicating its status back to the originating process step.

In this case you should manually transition the step into **Failed** status and continue your investigation.

---

**NOTE:** If you decide to stop the Infrastructure Process altogether (as a result of the exception), it is a good idea to mark the batch job that failed as “Do Not Attempt Restart” in the Batch Run Control for that batch run. This will ensure that the next time the Infrastructure Processes runs, when it gets to that batch process step it will not attempt to resume the execution that ended with an exception, possibly causing a repeat of the exception.

---

### **Batch job step in In Progress status while batch job ended successfully**

When an Infrastructure Process Step that is associated with a batch job stays in **In Progress** status while the batch job ended successfully, further investigation is required. In this case, once you ascertained that the job did actually end successfully, you can manually transition the process step into **Completed** status and use the **Resume** action at the process level to continue its execution.

## **Non-Batch Step Exceptions**

Infrastructure Process Steps that are not associated with batch jobs can experience errors as well and therefore can fail. As a reminder, the logic for these steps can experience local or remote errors. When such a step fails, information about the failure can be found in the process step log.

## **Process Automation Tool Setup**

The process automation tool requires the setup of the following components:

- Master Configuration
- External Systems
- Message Senders

In addition, a security setup is required.

The setup itself is done automatically as part of the environment provisioning process. The information in this section is provided for reference and in case changes in existing setup are required.

## **Security Setup**

Before the process automation tool can be used, the security credentials of the Message Senders, used by the process automation tool, must be updated.

In order to execute the security setup, navigate using **Admin > Implementation Tools > Process Automation Security Setup**.

The setup script will ask you to provide a User ID, a Password and to indicate whether or not to override the existing security setup.

**Please contact your system or security administrator for more information about what User ID should be used for this setup.**

You should select to override existing security setup when you need to update the User ID or the Password on the existing Messages Senders, used by the process automation tool. A common use case will be mandatory periodic password rotation for the user account that was selected for the setup.

---

**NOTE:** At the end of the process, you will be asked to flush all the system cache. This is required in order for the information update to take effect.

---

## Master Configuration Setup

The process automation tool relies on master configuration settings in order to identify all the product environments that are available to it. The Master Configuration is automatically setup as part of the system provisioning process.

This section describes the setup options in case manual changes are needed.

To access the configuration for the process automation tool, navigate using **Admin > General > Master Configuration** and look for Process Automation Configuration.

The Main section includes the definition of the **Current Environment** code and the **default file extension** for CMA export files.

The Current Environment code is a **unique** code that is given to each product environment.

The Environment List section describes all the existing product environments and integration (SOA) environment that the process automation tool need to interact with, for example, in order to run a process that moves integration configuration from one environment to another.

The environment in the list includes the following details:

- **Environment:** the environment code.
- **Product:** defined in the Process Automation Product extendable lookup.
- **Domain:** defined in the Process Automation Domain extendable lookup.
- **Migration Source:** select “Yes” if you can migrate configuration data from this environment.

---

**NOTE:** You should not allow automated migration of configuration from your development environment directly to your production environment but you would allow migrating from the development to test environments.

---

- **External System:** reference to the External System definition that will support communication with the row’s environment.
- **SFTP Alias:** this is a name of the SSH file that will be used to support file transfer capabilities between system environment directories.

## External Systems and Message Senders

The process automation tool communicates with other product environments (including SOA environments) through Outbound Messages.

The automated setup for the process automation tool creates a set of Message Senders and External Systems to support communication with other product environments.

Each product environment which is defined on the Process Automation Configuration has a corresponding unique External System. Each External System contains the details of all the message types that it supports, the message sender for each message type and additional data if required (for example, message or response XSLs).

## Configuring New Infrastructure Processes

The process automation tool configuration is essentially a collection of process types and step types that support the automation of various multi-step processes. A set of Infrastructure Process Types and Infrastructure Process Step Types is provided with the base product. Customers and implementers can create new process and step types.

This section describes the actions required to configure new Infrastructure Process Type and Infrastructure Process Step Type.

### Configuring a New Infrastructure Process Step Type

In order to configure a new step type, navigate using **Admin > Implementation Tools > Infrastructure Process Step Type**. Use the Infrastructure Process Step Type Query to view existing step types.

---

**CAUTION:** Base product step type names start with “K1” and should not be change. Changing these step types can break the process and step types that are provided with the product.

---

The following points provide information about creating a new Infrastructure Process Step Type.

When creating a new step type, a business object has to be selected first. The Infrastructure Process Step Type BO contains the information necessary for the Infrastructure Process Step that references that step type. For example, a batch process step type BO contains information related to the batch code that should be submitted and the parameters that will be passed to it. You can use existing Infrastructure Process Step Type BOs or create new BOs according to your business requirements.

The **Related Transaction BO** references the Infrastructure Process Step BO. The step BO contains the business logic associated with the step. For example, a batch process step BO is responsible to submit a batch job with to the information from the step type. You can use existing Infrastructure Process Step BOs or create new BOs according to your business requirements.

The **Process Step Type Details** section represents additional information that is required for this specific step type BO.

### Configuring a New Infrastructure Process Type

In order to configure a new process type, navigate using **Admin > Implementation Tools > Infrastructure Process Type**. Use the Infrastructure Process Step all-in-one portal to view existing process types.

---

**CAUTION:** Base product process type names start with “K1” and should not be change. Changing these process types can break the base product process types that are provided with the product.

---

The following points provide information about creating a new Infrastructure Process Type.

When creating a new process type, a business object has to be selected first. The Infrastructure Process Type BO contains information necessary for the Infrastructure Process that references that process type. You can use existing Infrastructure Process Type BOs or create new BOs according to your business requirements.

The **Related Transaction BO** references the Infrastructure Process BO. The process BO contains the business logic associated with the process. This includes the orchestration of the process steps. The process BO also contains information that is shared by step business logic during the process. For example, a process BO that handles migration of data between product environments can have a buffer that will hold the information pulled from the source environment using one step so that another step can use it to push that to the target environment. You can use existing Infrastructure Process BOs or create new BOs according to your business requirements.

The **Process Type Steps** section includes a collection of step types. The sequence of steps has to be unique and this will be sequence of execution.

---

**CAUTION:** When selecting step types for a process type you need to consider the fact that not all step types can be used on all process types. For example, some steps need to get or save information in the process itself so it can be used by other steps of that process. These types of steps can only work with a certain type of process. Please refer to the detailed description in each of the base product provided Infrastructure Process Step Types to see what process types they can be referenced on.

---

The **Infrastructure Process Type Details** section represents additional information that is required for the specific process type BO.

## CMA Migration Infrastructure Process Types

The following Infrastructure Process Types are provided to support the following configuration migration use cases:

- CMA Accelerator Load - import an exported file created by the Configuration Migration Assistant export process.
- CMA Migration - a wholesale or piecemeal configuration migration (using the Configuration Migration Assistant), exporting configuration from a source environment and importing it to a target environment.

### CMA Accelerator Load (K1-CMA-LOAD)

The K1-CMA-LOAD Infrastructure Process Type supports importing of an exported CMA file.

K1-CMA-LOAD is based on K1-CMAMigrationProcessType Infrastructure Process Type BO and uses the K1-CMAMigration as the Infrastructure Process BO.

The CMA Accelerator Load process type includes all the necessary steps to download an exported CMA file (that was uploaded to the system via FTP) into the environment that the process is running on (via FTP) and to run all the batch processes that are a part of the CMA import.

---

**NOTE:** This process type does not include a step for a manual user review. It is assumed that when loading an accelerator, there shouldn't be anything to review and the new configuration content is expected to be new for the most part or OK to override existing configuration.

---

### Using the CMA Accelerator Load Infrastructure Process Type

In order to import a CMA export file (e.g. an accelerator), you need to:

- Upload the file to the system via FTP.
- Create a new infrastructure process with the K1-CMA-LOAD Infrastructure Process Type and provide the following additional details:
  - **Name.**
  - The **Process Steps** list is for reference only.
  - **Export filename:** specify the CMA export file name that was uploaded to the system. You should specify the full name including the file extension name.
  - **User Review Needed:** select “Yes” only if you are expecting the CMA file to include data that already exists in the system and need to be reviewed before changes are applied.
  - **Default Status For Add, Default Status For Update** are relevant in case you selected to have a user review. In this case define the default status of migration data items when imported into the target environment.
- Once the process is saved, you can start it by selecting the Start action.



## CMA Migration (K1-CMA-MIGRATE)

The K1-CMA-MIGRATE Infrastructure Process Type supports a full or partial migration of configuration data, from a remote environment (the source) to the environment that the process is running on (the target).

---

**NOTE:** The configuration migration process is done as a PULL (running on the target environment and pulling data from the source environment) to make sure that users without security privileges to make changes in a product environment “A” won’t be able to run a process from a remote environment “B” that will force changes into “A”.

---

K1-CMA-MIGRATE is based on K1-CMAMigrationProcessType Infrastructure Process Type BO and uses the K1-CMAMigration as the Infrastructure Process BO.

This configuration migration process type includes all the necessary steps to create an export CMA file from a migration request on the source environment, move the file into the target environment (via FTP) and to run all the import batch processes on the target environment to process the file. This process type also includes a step for a manual user review of the imported data if needed.

### Using the CMA Migration Infrastructure Process Type

In order to migrate configuration data from a remote environment (the source environment) to the current environment (the target environment) you need to:

- Create a new infrastructure process with the K1-CMA-MIGRATE Infrastructure Process Type and provide the following additional details:
  - **Name.**
  - **From Environment:** select the source environment from which the data will be migrated to the target environment (the current environment). The list of valid environments to choose from is taken from the Process Automation Master Configuration. The target environment is always the current environment - the one that this process is created on.
  - The **Process Steps** list is for reference only.
  - **Migration Request:** specify the CMA Migration Request ID that will be used for the migration process. The migration request should exist on the source environment and will be validated against that environment.
  - **Export filename:** specify the CMA export file name that will be used for the export and import process. You should specify the full name including the file extension name. If you leave this field empty, the system will default the file name according to the migration request ID and the default file extension name.
  - **User Review Needed:** select “Yes” only if you are expecting the CMA file to include data that already exists in the system and need to be reviewed before changes are applied.
  - **Default Status For Add, Default Status For Update** are relevant in case you selected to have a user review. In this case define the default status of migration data items when imported into the target environment.
- Once the process is saved, you can start it by selecting the Start action.

## Integration Configuration (SOA) Infrastructure Process Types

The K1-INTEG-CONFIG-MIGR Infrastructure Process Type supports the migration of integration configuration data from a source to a target environment for the following configuration types:

- DVM data
- Integration Configuration Properties

The migration is done by using REST APIs that are provided by the integration infrastructure to get and post data. Migration of integration configuration will include a step to get the data from the source environment and then post it to the target environment.

## Integration Configuration Migration (K1-INTEG-CONFIG-MIGR)

K1-INTEG-CONFIG-MIGR is based on K1-IntegConfigMigProcessType Infrastructure Process Type BO and uses the K1-IntegrationConfigMigration as the Infrastructure Process BO.

This migration process type includes all the steps to migrate DVM and Integration Configuration Properties.

### Using the Integration Configuration Migration Infrastructure Process Type

In order to migrate integration configuration data from a remote environment (the source) to the current environment (the target) you need to:

- Create a new infrastructure process with the K1-INTEG-CONFIG-MIGR Infrastructure Process Type and provide the following additional details:
  - **Name.**
  - **Product:** select the integration product whose configuration you wish to migrate.
  - **From Environment:** select the source environment to migrate the configuration from. The environment should be one of environments of the product that was selected. The list of valid environments to choose from is taken from the Process Automation Master Configuration according to the product that was selected.
    - The target environment is set to the current domain of the product that was selected. For example, if you are creating a process in the Test environment and you select an integration product “A”, then the target environment will be the “A”-Test environment.
  - **Migrate DVM:** select Yes to migrate DVM data. Selecting No will cause the process to skip this step.
  - **Migrate Configuration File:** select Yes to migrate the integration configuration properties file. Selecting No will cause the process to skip this step.
- Once the process is saved, you can start it by selecting the Start action.

## Data Conversion Support for Cloud Implementations

This chapter provides information and requirements on data conversion in support of Oracle Utilities Cloud implementations.

---

**NOTE:** This section does not apply to all implementations. Contact your system administrator to confirm if your implementation includes Oracle Utilities Cloud Service Foundation and Data Conversion Support for cloud implementations.

---

## Data Conversion Overview

The ability to convert customer data from legacy systems to OUAF based products is critical for every implementation. The following chapter describes the overall process, tools and considerations for customer data conversion to SaaS OUAF based product on Oracle Cloud.

## Conversion Steps

In general data conversion effort in the cloud is divided into the following steps:

- Prepare for conversion
- Create conversion data files
- Upload conversion data files to the cloud
- Process conversion data files
- Process converted data in cloud application
- Approve converted data for production mode

---

**NOTE:**

It is important to note that the conversion process is a highly iterative process. All the steps above are likely to be done (completely or partially) multiple times during the conversion process.

For example, customer typically start with a small set of data to convert, they fix issues discovered with that data and then re-create new data files and proceed to convert them. This can happen many times, each time with either a different data sample or bigger and bigger data conversion sets until all the required data has gone through the conversion process.

---

## Prepare for Conversion

Preparing for conversion will typically include the following actions:

- Identify the OUAF product entities (Maintenance Objects) for which data will be converted. Refer the specific OUAF product documentation for information about converted entities for that product. Each of the product converted entities will have a set of conversion staging tables that will receive the data from your legacy system before they get processed into the system.
- Generate the conversion artifacts for the product entities you plan to convert data for. This will include, for example, a set of data specification files that describe the format of data required for each file.
- Identify your various sources of data and extraction methods.

## Create Conversion Data Files

In this step you create the set of data conversion files that were identified for the conversion process. You can choose to generate data files for each staging table or create a smaller set for each converted Maintenance Object.

The data conversion files typically do not include all the data to begin with but start small and grow with every iteration of the conversion process until they reach their maximum size at the end.

---

**NOTE:** When performing data conversion in the cloud, customers don't have access to the database staging tables. Data scrubbing and transformation activities has to take place before the data files are generated (in each conversion iteration) so the result of these activities is reflected on the data files that are moved to the cloud to be loaded into the staging tables.

---

## Upload Data Conversion Files to the Cloud

Since data conversion files are created locally they have to be uploaded to the cloud environment in order to be processed and loaded into the conversion staging tables.

In this step you can use any sFTP client with the account credentials that were provided at provisioning time to upload all the files via FTP to the cloud environment.

For more details refer to [Input Data Files](#) .

## Process Conversion Data Files

After uploading the files to the cloud, you should run a set of batch processes that will process the data files using Oracle SQL Loader and insert the data to the product conversion staging tables.

The staging table load process also produces output files that provide feedback on the load process.

You can download these output files for review using the same sFTP client you used to upload the data file.

---

**NOTE:** The process that imports the data in the files to the staging tables, using Oracle SQL Loader, is using the artifacts that were generated in the “Prepare for Conversion” step.

---

For more details refer to [Understanding Load Data Process](#) .

## Process Converted Data in Cloud Application

When the data intended for conversion (for a conversion iteration) is loaded into the appropriate conversion staging tables, the OUAF application in the cloud can process that data according to the product’s data model, technical and business rules.

Refer to the OUAF product specific documentation for further guidelines and information on the specific processes and guidelines related to data conversion.

---

**NOTE:**

This is one step of the overall iterative process but it is also includes many internal steps, for example:

1. Validation of the data in the conversion staging tables.
2. Generation of the system assigned keys for the converted entities.
3. Migration of the converted data from the staging tables into the actual system tables.

When the processing of the converted data in this iteration is completed, information from the system is used to identify changes necessary to source data, the extraction process or other activities involved in producing the data to be converted.

The process can then start over by loading a new set of data into data conversion files, load them to the staging tables in the cloud and process them once more to get more feedback.

---

## Approve Converted Data for Production Mode

When the quality and scope of data converted has reached its target, the process can stop. Once the overall data has been approved for production mode the conversion process comes to an end. The process of approving the data includes many activities, for example:

- Running various reports to compare converted data with legacy data to verify the quantity and quality of the data.
- Running reports and tests in the new application to verify the data and the system’s behavior using that data.
- Manual review of random and key data in the system.

## SQL Loader

Loading the data in the data conversion files into the product conversion staging tables is done using Oracle SQL Loader.

Oracle SQL Loader is an Oracle Database Tool that enables mass upload of data from various sources into database tables in a fast and safe way.

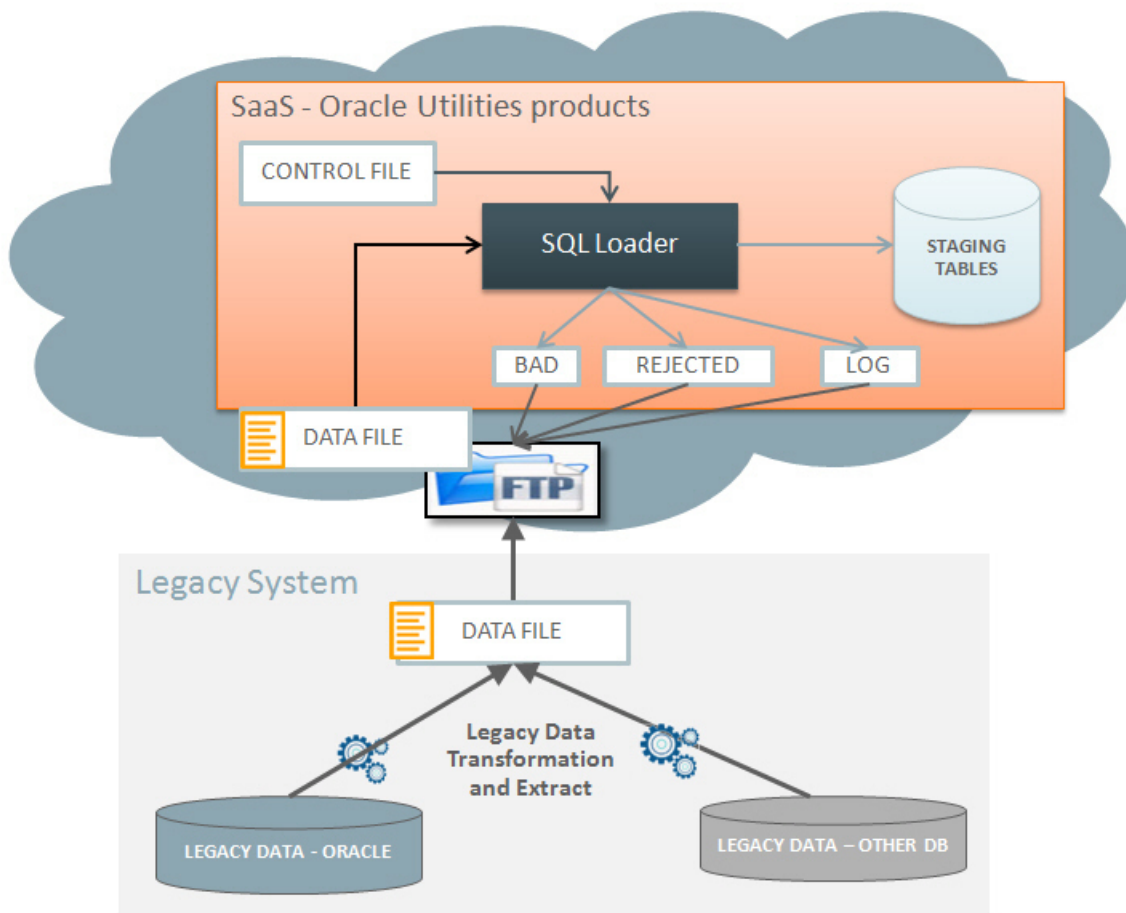

SQL Loader processing is determined by Control Files. The control files for the data conversion process are provided for each of the product conversion staging tables as part of the artifact generation which is a part of the preparations activities before starting the conversion process.

The Control Files typically define:

- The location of input files to load.
- The character set of the input data.
- The target table(s) for the load and how to insert the data (e.g. append to or override).
- How to map the data in the input file to tables and fields.
- The location of the output files (e.g. log, bad or rejected records).
- Options for parallel processing and load balancing.

The control files that are generated for the product include all the parameters necessary to load the product conversion staging tables. There are some customization options for these files that are discussed later.

After loading the control files, SQL Loader reads the records in the input data file(s), converts the input into database tables and columns that are inserted into the database.

SQL Loader has 2 modes of operation:

- **Conventional Path Load** – data is inserted to the database by using database SQL INSERT statements.
- **Direct Path Load** – data is inserted into the database using data blocks that are written directly to the database. This method is much faster and therefore is the method selected for the data conversion process.

SQL Loader has the ability to deal with multiple data files mapped to multiple tables as well as loading data into CLOB fields.

## Using SQL Loader When Processing Conversion Data Files

Processing of uploaded conversion data files is done via a Batch Process (for each staging table or MO) that does the following:

- Prepare parameters for invoking SQL Loader.
- Invoke SQL Loader for loading one staging table or one MO, using the data files that was uploaded to the cloud (using sFTP). The data file is processed directly from the sFTP server and is NOT copied to a local directory on the server.
- Archive the input file(s) and upload the results output files to the sFTP server so they can be subsequently downloaded by the customer for review.

## Conversion Artifacts

The base product includes a set of artifacts that support the conversion process. These artifacts are provided on demand (generated as a result of a user request in the system).

The available artifacts are:

- Input Data Specifications
- SQL Loader Control Files

## Conversion Input Data Specifications

The system will generate a text file with data specification instructions for each of the conversion tables that are supported by the base product.

The specification files are for reference ONLY and are not used by the system at run time. These files describe the data format for each table so that the data specified can be loaded correctly with the Control File that is also generated by the system.

For more details refer to [Conversion Artifact Generator](#) .

## SQL Loader Control Files

The control files are for internal use and are generated for each of the conversion tables that are supported by the product. These files are used by SQL Loader to interpret and load the data that is provided in the conversion data files.

The control file contains:

- General load parameters and options
- Data field specifications and table-specific load instructions

For more details refer to [Conversion Artifact Generator](#) .

## Configuring Conversion

The following sections describe the settings and configurations used by various conversion processes.

## Conversion Master Configuration

The Conversion Master Configuration controls generic aspects of legacy data load process. It stores:

- **Conversion Task Types.** The task types define load parameters for individual tables or maintenance objects. The Master Configuration captures default Conversion Task Types for both table and maintenance object-level loads. It also allows to setup **Override Instructions** for tables and maintenance objects that require special processing or data formatting
- Conversion Artifacts storage options. You can indicate that the snapshot of the generated file(s) should be **Stored as an Attachment**. If the indicator is set to **Y**, the Business Object to use for the Attachment has to be specified, otherwise, it is not required.

## Conversion Task Types

To configure a new conversion task type, navigate using Admin → Conversion Support → Conversion Task Type.

The definitions on the conversion task type control the parameters of the data load for the target object: table or maintenance object.

For the input data files, Conversion Task Types defines:

- Strings to use as data delimiters and enclosing characters. These attributes are referencing the Extendable Lookup values for K1-ConvFileDelimiterLookup and K1-ConvFileEnclosingCharLookup
- Date and DateTime fields' formats. These attributes are referencing the Extendable Lookup values for K1-ConvLoadDateFormatLookup and K1-ConvLoadDateTimeFmtLookup
- CLOB data extract rules: indicates whether the CLOB data is supplied as part of the input data file or as a separate, secondary file
- Control File Header - a fragment of the control file that contains general load parameters. This is a Foreign Key reference to the Managed Context entry.

Conversion Task Type also defines the transactional business object for Conversion Task. The algorithms linked to the transactional business object are responsible for the generation of the Conversion Artifacts: control files and input data specifications.

The following Conversion Task Types are pre-configured in the product:

- **K1-CNV-TABLE** - meant to be used for a single table load. It is referencing a Transactional Conversion Task Business Object whose algorithms generate Table Conversion Artifacts
- **K1-CNV-MO** - meant to be used for a single maintenance object load. It is referencing a Transactional Conversion Task Business Object whose algorithms generate Maintenance Object Conversion Artifacts
- **K1-CNV-KEY-TABLE** – meant to be used for the Key Tables. Key Tables are index-organized tables (IOT) and as such cannot be loaded in multiple concurrent sessions of SQL loader. This Task Type is referencing a Control File Header (Managed Content) where *Parallel Load* parameter is set to *false*

## Conversion Artifact Generator

Conversion Artifacts is a set of supporting files used for data upload with SQL Loader. The artifacts are generated based on the table and maintenance object metadata and the definitions from [Conversion Master Configuration](#) and [Configuration Task Types](#). Conversion artifacts include SQL Loader control files and input data file specifications.

Input data file specifications provide detailed field-by-field description of the expected data type and format, field order and other instructions. Your implementation may use these specifications to create the legacy data extract.

The generator reads [Conversion Master Configuration](#) in order to determine the conversion task type associated with the table or maintenance object.

You can choose to generate artifacts for table-level and/or maintenance object-level load, or for the entire system or for specific Table or Maintenance Object:

- Navigate to **Admin** —> **Conversion Support** —> **Generate Conversion Artifacts**.
- Select one of the options:
  - **Generate All** – performs a complete refresh of the conversion artifacts. It deletes existing and creates new Conversion Tasks for every table that is marked for conversion in the metadata. It also creates Conversion Task for every Maintenance Object that includes tables marked for conversion.
  - **Include All Tables** – recreates artifacts for all Tables that are marked for conversion in the metadata
  - **Table search** allows you to select specific target table
  - **Include All maintenance Objects** – recreates artifacts for all Maintenance Objects whose tables are marked for conversion in the metadata
  - **Maintenance Object search** allows you to select specific target Maintenance Object.

---

**NOTE:** The process overrides all previously generated artifacts and replaces existing files.

---

The generator creates **Conversion Tasks**, one instance per table and/or per maintenance object and creates attachment that stores the input data file specifications file. The attachment is linked to the Conversion Task as a Related Object.

The regeneration is necessary each time the metadata or conversion configurations are amended.

Conversion Tasks query is provided with the base product.

## Accessing the Artifacts

In order to make the generated input data file specifications available for download, submit the batch process [K1-CNVUS](#).

After successful batch completion, locate the files under corresponding folder. Refer to [Input and Output File Location](#) for more details. You can also view the individual specifications by searching for a Conversion Task and exploring the linked attachment.

---

**NOTE:**

- The specification file name for the table is composed as *<table name>\_spec.txt*
  - The specification file name for the maintenance object is composed as *<maintenance object code>\_spec.txt*
- 

## Conversion Tasks

The following sections provide information about Conversion Tasks and generated conversion artifacts.

### Conversion Task Query

Conversion Task query allows to search by variety of criteria:

- Creating User, Conversion Task Type and Status
- Linked Object – Table or Maintenance Object
- Exact Conversion Task ID



## Conversion Task

The purpose of the **Conversion Task** is to maintain the conversion artifacts for Table or Maintenance Object. Please consider the following with respect to conversion tasks.

- The business object lifecycle supports multiple attempts to re-generate the artifacts.
- The re-generation could be triggered either manually or by the Conversion Artifact Generator. Only one set of the artifacts is relevant at any point of time, hence only one Conversion Task at the time can exist for a given Table or Maintenance Object.
- Typically, Conversion Tasks are created by [Conversion Artifact Generator](#). However, it can also be created manually by navigating to **Admin**—> **Conversion Support** —> **Conversion Task**.
- Use the Conversion Task Query to search for an existing entry. Select the entry from the search results to navigate to the maintenance portal to view and maintain the selected record.
- Conversion Task references a Conversion Task Type and contains standard business object record information, including the creation date/time, status update date/time and creating user.
- The task references the object – **Table or Maintenance Object** – for which the artifacts are generated.
- The collection of task's **Related Objects** store references to the Attachments that store a snapshot of the generated files. A new attachment is created after each generation run and linked to the Conversion Task for audit purposes.

## Conversion Batch Controls

The following batch controls are delivered with base product:

---

**NOTE:**

Batch processes that interact with sFTP server include **Source Host Alias** parameter (required). This parameter should be populated with SSH configuration file name of the sFTP account.

The value will be different for each of the OUAF-based products; the file is generated upon service subscription. Contact your security administrator to obtain the file name.

---

Batch Control	Description
K1-CNVLD	Conversion - Load Data using SQL Loader. This process facilitates the legacy data extract upload using SQL Loader. The input data files are expected to be compressed using <b>gzip</b> and uploaded to the sFTP site. One run uploads the data into a target Table or Maintenance Object. The process is multi-threaded.
K1-CNVDS	Conversion - Disable Conversion This process resets the environment indicators and prevents further conversion activities. Once conversion is disabled, the following actions are blocked: <ul style="list-style-type: none"><li>• Switching between Conversion and Production</li><li>• Table truncation</li><li>• Disable Indexes and Rebuilding the Statistics</li><li>• Data insertion into Production</li><li>• Data upload into staging</li></ul>
K1-CNVEN	Conversion - Enable Conversion This process resets the environment indicators and enables it for conversion activities. It should be executed at the start of the Conversion project.
K1-CNVUS	Conversion - Upload Specification Files

	This process is copying the input data specification files into sFTP location and makes them available for the download
K1-DRPIN	<p>Conversion - Disable Indexes on Production Tables</p> <p>This process can be used in two modes:</p> <ul style="list-style-type: none"> <li>• Populate Table or Maintenance Object batch parameter to process specific object</li> <li>• If no specific target is populated, the process disables indexes on all converted tables in Production schema</li> </ul>
K1-SDSIN	<p>Conversion - Disable Indexes on Staging Tables</p> <p>This process can be used in two modes:</p> <ul style="list-style-type: none"> <li>• Populate Table or Maintenance Object batch parameter to process specific object</li> <li>• If no specific target is populated, the process disables indexes on all converted tables in Staging schema</li> </ul>
K1-RIUSP	<p>Conversion - Rebuild Indexes and Update Statistics in Production</p> <p>This process can be used in two modes:</p> <ul style="list-style-type: none"> <li>• Populate Table or Maintenance Object batch parameter to process specific object</li> <li>• If no specific target is populated, the process rebuilds indexes and updates statistics on all converted tables in Production schema</li> </ul>
K1-RIUSS	<p>Conversion - Rebuild Indexes and Update Statistics in Staging</p> <p>This process can be used in two modes:</p> <ul style="list-style-type: none"> <li>• Populate Table or Maintenance Object batch parameter to process specific object</li> <li>• If no specific target is populated, the process rebuilds indexes and updates statistics on all converted tables in Staging schema</li> </ul>
K1-CLNTB	<p>Conversion - Truncate Tables in Production</p> <p>This process can be used in two modes:</p> <ul style="list-style-type: none"> <li>• Populate Table or Maintenance Object batch parameter to process specific object</li> <li>• If no specific target is populated, the truncates all converted tables in Production schema</li> </ul>
K1-SCLTB	<p>Conversion - Truncate Tables in Staging</p> <p>This process can be used in two modes:</p> <ul style="list-style-type: none"> <li>• Populate Table or Maintenance Object batch parameter to process specific object</li> <li>• If no specific target is populated, the truncates all converted tables in Staging schema</li> </ul>
K1-CLNKY	<p>Conversion - Truncate Key Reference Tables</p> <p>This process can be used in two modes:</p> <ul style="list-style-type: none"> <li>• Populate Table or Maintenance Object batch parameter to process specific object</li> <li>• If no specific target is populated, the truncates all Key Reference tables in Staging schema</li> </ul>

## Configuring Data Load Batch Controls for Conversion Project

The generic batch process [K1-CNVLD](#) performs the load of the input data file(s) into a target table or maintenance object, specified as one of the batch parameters.

Consider creating individual batch controls per object (table or maintenance object).

It allows leverage the parallel processing capacity of the system; the data load processes for all objects can be submitted near-simultaneously, thus minimizing the time needed for the legacy data upload, which is only an initial step in the overall data conversion process.

Use batch control [K1-CNVLD](#) for rehearsal load batch run for various tables and/or maintenance objects and determine the optimal load strategy:

- Whether the data should be extracted and loaded as single Tables and/or Maintenance Objects
- Whether and how to split the data files and the number of threads for the batch
- Potential log file size and the feasible logging level

Configure data load Batch Controls for each individual Table or Maintenance Object. Pattern the configuration after [K1-CNVLD](#) and set the default parameter values:

- Target Table or Maintenance Object:
  - File Extension
  - Log Level
  - Retain Input
  - Max Number of Errors

Configure single-threaded batch controls for Key Tables.

## Input Data Files

This section provides information on inputting data files for data conversion.

### Overview

This section provides information on the requirements and details for file upload, loading table, maintenance object, CLOB, layout, data formatting, and so on related to inputting data files for data conversion.

### File Creation and Upload

The extract data is expected to be uploaded in compressed form. Use `gzip` to create compressed input data files.

#### File Creation

Use your sFTP account to retrieve input data specifications from **conversion/reference** directory. Create the data extract text file, using field delimiters, enclosing characters and data formatting according to the specifications.

If the files were created under Windows operating system, it is recommended to remove the carriage return character prior to compression (not applicable for secondary files with CLOB data).

#### File Compression with `gzip`

Use `gzip` utility to compress the file.

- For Windows operating system, download and install `gzip` utility for Windows. Run the following:

```
# Navigate to the gzip folder
cd C:\gzip-1.3.12-1-bin\bin
# Run gzip.
# New file will be created in the same directory as the original the input file
gzip -k <full path to the input data file>
# Sample command for the file TABLE_NAME.txt located under
# C/myDataDirectory/:
gzip -k C/myDataDirectory/TABLE_NAME.txt
```

- For Unix/Linux operating systems, run the following command:

```
gzip < <inputFile name> > <outputFile name with .gz suffix>
# Sample command for the file TABLE_NAME.txt
```

```
gzip < TABLE_NAME.txt > TABLE_NAME.txt.gz
```

## Loading Table or Maintenance Object

The conversion data upload supports two types of the extract:

- Data extract that contains the data for a single target staging table.  
In this case, the upload process inserts records into a single staging table. The input data file consists of similar records, each represents a row in the target table.
- Data extract that contains the data for the group of target staging tables that represent a Maintenance Object.  
In this case, the upload process populates all the tables that belong to a maintenance object. The input data file contains multiple types of records that are inserted into various tables. Each record is prefixed with the table name that is used as record type indicator.

## Multiple Data Files

The large volume of the converted data may require the extract to be split into multiple parts.

In this case the multi-part extract for a target staging Table or Maintenance Object is loaded with a multi-threaded batch run.

### Sample scenario:

10M of the Person records are being converted. The extract file is split into 10 files, PERSON1, PERSON2 PERSON3 etc., each file contains 1M records. All 10 files are uploaded to sFTP.

Batch process 'Load Person data' is submitted with 5 threads; each thread picks up 2 files and uploads the data into staging tables.

## Loading CLOB Data

The CLOB data can be loaded in two ways:

- Extracted as part of the main data file. This method is suitable for the relatively small CLOB data size. Refer to [Limitations](#) for more details.
- Extracted into a separate file. This method is suitable for larger CLOB data sizes and also for large volume tables or maintenance objects. In this scenario, the secondary file has to be uploaded at the same time as the primary data file.

## Notes on Secondary Data Files (CLOB Data)

Secondary data file is loaded simultaneously with the primary data file. The CLOB data extract should contain exactly the same number of records as a primary file.

---

### NOTE:

When splitting the extract into multiple data files, make sure that the numbers of extracted records in the primary and secondary files are matching.

It is applicable for both table-level and maintenance-object level load.

---

### Sample Scenario:

Table CI\_PER includes CLOB column C1\_PER\_DATA\_AREA. The CLOB field is used to store customer's resume.

The legacy table contain 10K records and the CLOB data is available for some of the records

The primary data file, CI\_PREM.csv contains 10K lines, one line per record

The secondary data file, CI\_PREM\_CLOB, contains 10K records too. The records with the empty CLOB are represented by CLOB delimiter.

<b>Primary File – Regular Data Fields</b>	<b>Secondary File - CLOB</b>
12345678,John,Doe,.....	John's resume <endclob>
45165609,Smith,Mary,.....	Mary Smith resume<endclob>
33336733,Brand,Brent,.....	<endclob>
06737482,Sunshine,Julie,.....	Julie Sunshine resume<endclob>

### Splitting single table data extract with CLOB

The following example illustrates how to split the single table large volume extract correctly if the CLOB data is supplied in the secondary file:

Assuming the table has 10K records, split into two equal parts. The following files should be created:

- Primary File 1 with 5K records
- Secondary File 1 with 5K CLOB entries
- Primary File 2 with 5K records
- Secondary File 2 with 5K CLOB entries

### Splitting maintenance object data extract with CLOB

The following example illustrates how to split the maintenance object large volume extract correctly if the CLOB data is supplied in the secondary file:

Assuming the maintenance object has two tables, one of the tables includes CLOB column and the primary table has 10K records. The data supposed to be split into two equal parts. The following files should be created:

- Primary File 1 with 5K records for the primary table and corresponding records for the child table
- Secondary File 1 with CLOB entries corresponding to the table in the Primary File 1
- Primary File 2 with 5K records for the primary table and corresponding records for the child table
- Secondary File 2 with CLOB entries corresponding to the table in the Primary File 2

---

**NOTE:**

For Maintenance Object-level load consider supplying CLOB data in the primary file, to avoid complicated logic of data splitting.

Refer to [CLOB Data - XML](#) for limitations concerning XML CLOB data

---

## File Layout and Data Formatting

The input data specifications for each table or maintenance object that are subject to conversion specification files are available for download. Refer to [Input and Output File Location](#) for details.

Specifications are generated based on the metadata and conversion configurations. Configurations control delimiters and enclosing characters and define CLOB data processing rules.

The data extract file is expected to contain one record per each target table row. The data field order in the record has to be exactly the same as it is listed in the specification file.

The specifications contain field-by-field data formatting rules for:

- Data type and size
- Date, DateTime and Time formatting
- Special notes on CLOB fields

The fields in the record are expected to be separated by a delimiter character (or string).

The CLOB data in the main record has to be enclosed in the CLOB Delimiter string, for example `<clobend>some clob data<clobend>`

For the not-nullable columns with no data, a single space enclosed in the enclosing character (or string) has to be supplied, for example “ “

Enclosing character (or string) can also be used to encapsulate data that includes a field delimiter, for example “*Hello, World*”

## Defining Custom Data Delimiters and Enclosing Characters

The default configurations are delivered with the base product.

Your entire legacy data or a specific table may require use of a different data delimiter and/or enclosing characters.

- Define new data delimiter string, CLOB delimiter string and/or enclosing string
- Configure Conversion Task Type using newly created delimiters
- Amend Conversion Master Configuration, setting default (for all tables or maintenance objects) or override (for specific table or maintenance Object) instructions.
- Regenerate Conversion Artifacts

Now you can create data extract according to the newly generated specifications.

## Input Data for a Staging Table

The extract for a single table contains delimited data records. Depending on the conversion configuration, the CLOB data should be supplied either inline or in a separate, secondary file.

### Input Data File Names

Input data file names has to follow the rules described in this chapter. The names are key-sensitive.

File Type	File Name
Single data file per table, no CLOB	File name equal target table name, i.e. CI_PREM
Single data file per table, CLOB data in secondary file	Primary file name equal target table name, i.e. CI_PREM Secondary file name composed as target table name concatenated with '_CLOB', i.e. CI_PREM_CLOB
Multiple data file per table, no CLOB	File name is composed as target table name concatenated with file number, i.e. CI_PREM1, CI_PREM2 etc
Multiple data file per table, CLOB data in secondary file	Primary file name is composed as target table name concatenated with numeric file number, i.e. CI_PREM1, CI_PREM2 etc Secondary file name composed as target table name concatenated with '_CLOB' and file number, i.e. CI_PREM_CLOB1, CI_PREM_CLOB2 etc

## Input Data for Maintenance Object

The extract for a maintenance object contains delimited data records for all tables included in the maintenance object. Depending on the conversion configuration, the CLOB data should be supplied either inline or in a separate, secondary files,

one file per table containing CLOB. Refer to [Notes on Secondary Data Files \(CLOB Data\)](#) for limitations concerning XML CLOB data and more details.

### Input Data File Names

Input data file names has to follow the rules described in this chapter. The names are key-sensitive.

File names for Maintenance Object contain Maintenance Object Code. If the code includes spaces or special characters, it should be replaced with '\_', for example:

*For actual MO Code: SP/MTR HIST, in the file name, use SP\_MTR\_HST*

File Type	File Name
Single data file per Maintenance Object, no CLOB	File name equal target maintenance object name, i.e. PREMISE
Single data file per Maintenance Object, CLOB data in secondary file	Primary file name equal maintenance object name, i.e. PREMISE Secondary files name composed as maintenance object name concatenated with table name concatenated with '_CLOB'. For example, if CI_PREM table contains CLOB, the secondary file name is. PREMISE_CI_PREM_CLOB
Multiple data file per Maintenance Object, no CLOB	File name is composed as target maintenance object name concatenated with file number, i.e. PREMISE1, PREMISE 2 etc
Multiple data file per Maintenance Object, CLOB data in secondary file	Primary file name is composed as target maintenance object name concatenated with file number, i.e. PREMISE1, PREMISE 2 etc Secondary files name composed as maintenance object name concatenated with table name concatenated with '_CLOB' concatenated with file number. For example, if CI_PREM table contains CLOB, the secondary file name is. PREMISE_CI_PREM_CLOB1, PREMISE_CI_PREM_CLOB2, etc

## Limitations for Input Data

### Key Tables

Due to the technical limitations, the Key tables cannot be loaded in the multi-threaded mode. If you decided to create input data files using the Maintenance Object method, consider the following:

- Created data extract(s) for a Maintenance Object data, but exclude the Key table(s) and run data upload in the multi-threaded batches
- Create separate extract for the Key table(s) only and upload them in the single threaded batches.

### CLOB Data Size

The maximum size of the CLOB data included in the main data file is 10K. If you converted CLOB data size is expected to be larger than 10K, create secondary data file.

### CLOB Data - XML

The XML data formatted using new line character cannot be uploaded as part of the primary data file. If your CLOB data includes formatted XML, you should create secondary data file(s) for CLOB columns.

## Conversion Orchestration

This section provides information on orchestrating a data conversion.

## Input and Output File Location

Locations for conversion input and output files on the sFTP server:

- Upload input data files: **conversion/upload**
- Download the process output: logs, discard and bad files: **conversion/download**
- Download archived (processed) input data files: **conversion/archive**
- Download input data specifications: **conversion/reference**

## Understanding Load Data Process

The setup of the batch controls that is necessary to support data conversion and legacy data extract upload is described in [Data Load Batch Controls](#) .

The following sections explain the process of legacy data extract upload with SQL loader.

### Load Data Batch Run Parameters

The data upload batch is processing single target object – Table or Maintenance Object. The data extract may be supplied in one or multiple files, created and named according to the Input File instructions for [a Staging Table](#) and [Maintenance Object](#) .

The process is multi-threaded and optimized for the parallel load.

Using the batch parameters you can control:

- Level of logging
- Data extract retention
- Maximum number of load errors

### Multi-Threading

The process is threading by dividing the multiple data files between the threads. Each thread in turn, is processing its files one by one.

The exception is Key Tables. They are index-organized tables and have to be loaded in the single thread, due to the SQL Loader restrictions.

### Load Outcome – Log, Bad and Rejected Files

SQL Loader output files are available for download after each run . Refer to [Input and Output File Location](#) for details. To ensure file name uniqueness, the output file names are concatenated with the current timestamp.

- **Log file** contains the information about the run, including number of record processed, errors encountered and other useful information. The level of logging is controlled by the batch parameter *log* .
- **Bad and Rejected** files contains the records that were rejected by either the SQL Loader or the database.



## Interrupted Load

The data load process can be re-started. Once SQL Loader reached the maximum number of errors allowed for the run, it records the position of the last record in error in the log. The restarted load begins pulling the data from the file after skipping certain number of records.

In order to continue processing interrupted load, perform the following steps:

- Retrieve the log file. Find statement '*Specify SKIP=*n* when continuing the load.*' in the log file.
- Re-upload the input data file to the server
- Submit the batch once again, this time specifying the *n* as a *skip* batch parameter

## Tables Cleanup and Index Maintenance

The SQL Loader is running in parallel mode in order to maximize the performance. Therefore the target tables are not emptied prior to the data insertion and it has to be done implicitly, by running corresponding batch jobs.

Indexes are disabled during the data upload. The product provides batch processes that support index disabling/re-building and statistics update.

- User batch control *KI-SCLTB* to truncate tables in **Staging** area and batch control *KI-CLNTB* to truncate tables in **Production**
- Use batch control *KI-SDSIN* to disable indexes in **Staging** area and batch control *KI-DRPIN* to disable indexes in **Production**
- Use batch control *KI-CLNKY* to truncate **Key Reference** tables in **Staging** area

The supported scenarios are:

- **Truncate Specific Table or Maintenance Object:** In order to truncate the specific table, submit the corresponding batch job, specifying *table* parameter. In order to truncate the data that stored in a specific Maintenance Object, submit the corresponding batch job, specifying *maintenanceObject* parameter. The process will also disable indexes in the truncated tables.

---

**NOTE:** If the truncated table's metadata defines a Key table, the Key table gets truncated too.

---

- **Truncate all Converted Tables:** In order to truncate all converted tables run the corresponding batch job without specifying *table* or *maintenanceObject* parameters. The process will disable indexes and truncate all tables marked for conversion in the metadata.
- **Truncate Key Reference Tables for Specific Table or Maintenance Object:** In order to truncate Key Reference table linked to a staging table, submit the corresponding batch job, specifying *table* parameter. In order to truncate Key Reference tables for a specific Maintenance Object, submit the corresponding batch job, specifying *maintenanceObject* parameter.
- **Truncate all Key Reference Tables:** Submit the corresponding batch job without specifying *table* or *maintenanceObject* parameters to truncate all Key Reference tables.
- **Disable Indexes for Specific Table or Maintenance Object:** In order to disable indexes for the specific table, submit the corresponding batch job, specifying *table* parameter. In order to disable indexes for the specific Maintenance Object's tables, submit the corresponding batch job, specifying *maintenanceObject* parameter.
- **Disable Indexes for all converted Tables:** In order to disable indexes on all converted tables run the corresponding batch job without specifying *table* or *maintenanceObject* parameters. The process will disable indexes and truncate all tables marked for conversion in the metadata.

## Load Performance Tuning

The data specifics – volumes, structure and other aspects – may justify customizing the default configurations for all or some tables.

The SQL Loader is processing data according to the Control File. The fragment that contains general load parameters is stored as Managed Content that is referenced on the Conversion Task Type.

You can create new Managed Content, configure the Conversion Task Type and specify the new settings on Conversion Master Configuration, for all or specific Tables or Maintenance Objects.

## Understanding the Conversion Orchestration Process

The following sections provide information on general aspects of conversion orchestration.

### Enabling Conversion

Conversion activities are possible as long as conversion is enabled in the environment. The authorized Conversion Administrator may run the corresponding batch job to enable conversion.

### Switching between Staging and Production Schema

In the environment enabled for conversion, the online application is running against the database schema that contains synonyms pointing to either Staging or Production tables.

The synonyms could be switched by running the corresponding batch job.

The switching is possible only while Conversion is Enabled

Navigate to **Admin** → **Conversion Support** → **Switch Schema** to perform the action.

### Preparing for Conversion

The preparation steps include evaluating initial conversion configurations provided by the product, customizing the configurations if needed, and finally, generating conversion artifacts.

The preparation should be done when the environment is running against Production schema

### Conversion Development

The creation of the legacy data extract and rehearsal of the data load and subsequent conversion data processing is done while the environment is running against Staging schema.

Consider creating and scheduling the sequence of the batch processes for both data load and following validation and insertion.

Include table truncation, index maintenance and statistic updates into batch chains.

### Conversion Run

For the mock-up, or dress rehearsal or the actual go-live conversion run you may choose to amend data load batch controls for tables/maintenance objects to improve performance:

- Reduce the logging level – set **log** batch parameter to NOLOG
- Do not retain input data – set **retaininput** batch parameter to PURGE

### Disabling Conversion

After conversion is completed, the various activities such as table truncation and index maintenance should not be allowed.

Upon conversion project completion, switch the schema to Production and request that the authorized Conversion Administrator run the corresponding batch job to disable Conversion in the environment.

## Security Setup for Conversion

The services associated with data conversion are combined into the following user groups

- **Conversion Administrators** includes the services linked to the most sensitive database operations: enable/disable conversion and switching database synonyms between production and staging schema
- **Conversion Development** includes the services associated with conversion-related configurations
- **Conversion Operations** provides access to services associated with data load batch processes. This group could be extended to include services associated with specific table(s) or maintenance object data loads

These user groups are included in the base product. Your implementation may chose to use it as is or create a different setup.

## Conversion Reconciliation Reports

Your cloud service subscription includes an access to the BI Publisher instance that can be used to create and run data reports against both production and staging tables. Contact your Security Administrator for access information.

# Chapter 2

---

## Real-Time Scheduler Administrative User Guide

---

### General Options

---

#### Defining Installation Options

This section provides additional setup information related to your installation options record.

Refer to [Framework installation options](#) section for more information.

#### Base Time Zone

To support businesses spanning across multiple time zones, the system stores all date and time information in a single common time zone known as the base time zone or the server time zone. Furthermore, date and time information is stored in standard time (i.e. independent of any seasonal time shifting adjustments, if applicable, in that time zone).

The system also allows data to be entered and displayed in a different time zone in legal time ( i.e. adjusted for seasonal time shifting, managing the conversion back and forth between the data entry and the storage time zones).

Entities associated with a geographic location such as activities, crew shifts and meetings, are entered and displayed in the specific time zone where they occur, the entity time zone. The rest of the application uses the user's preferred time zone to display date and time information.

The CDI portal displays data according to the user time zone; however, users have the ability to toggle time zones as needed.

Crews using the mobile application work their schedule using their local device time zone. The system handles the conversion of the data to and from the server time zone.

---

**NOTE:** The server time zone must be correctly specified on the installation options record for the system to work properly.

---

## Formatted Address

Throughout the system address information is formatted for display based on standard address constituents.

---

**NOTE:** Logic to format an address resides in an "Address Information" algorithm on the installation options. Click [here](#) to see the algorithm types available for this system event. The system requires such algorithm to be plugged in.

---

## Address Geocoding

The scheduler has to be provided with the geocode of any location that may be included on crew's route. These include locations of tasks, service centers, depots, mobile worker home addresses if they start or end their shifts from home, etc.

Unless a geocode is provided, algorithms on the various business entities that capture an address attempt to geocode the address when the entity is added or when the address changes.

The minimum match quality level for address geocoding is configurable. By default, the base system requires an exact match, which is the maximum quality level. You can control the quality level of geocoding for any entity that has an address by overriding the match quality parameter of the algorithms on each entity with a different minimum quality level, based on your business needs.

---

**NOTE:** Logic to geocode an address resides in an "Address Geocoding" algorithm on the installations options. Click [here](#) to see the algorithm types available for this system event.

---

## Defining Locations

This portal is used to define your company's facility locations such as service centers, business offices, depots, etc. These may be used as locations where crews may start and end their shift, attend meetings, etc.

You can access the portal from the **Admin Menu > Resource Management > Location**.

A location's physical address must be geocoded so the scheduler can direct crews to and from that location. Unless explicitly provided, the system attempts to geocode the address using the geocoding service defined on the installation options, expecting an exact match.

---

**NOTE:** Logic to geocode the home address resides in an algorithm associated with the location's business object. Review this algorithms and adjust its match quality parameter as needed.

---

The following zones may appear as part of the portal's **Main** tab page

- **Location List.** This zone lists all locations. Broadcast a record to display the details of the selected record.
- **Location.** This zone provides information about the selected location.

### Where Used

Follow this link to open the data dictionary where you can view the tables that reference [MI\\_LOCATION](#).

## Configuring Mapping Options

The CDI map as well as other zones showing items on a geographic map require that you set up options on a feature configuration record.

Find the [Feature Configuration](#) record for the **Map Server Configuration** feature type and define the various options as needed. (It may need to be defined if it does not exist).

## Defining Geographic Areas

A geographic areas defines the boundary of an area in your territory.

Using a geographic area, you can represent regions such as the entire company territory, and certain dense population areas to be displayed as custom layers in the CDI map similar to alert areas. Refer to [CDI Map](#) for more information.

You can also define speed profile areas that allows, the scheduler to calculate more accurate travel times by adjusting the average travel speeds within a specific area. Refer to [Understanding Speed Profiles](#) for more information.

You can access the Location portal from the **Admin Menu > Service Management > Geographic Area**.

The following zones may appear as part of the portal's **Main** tab page

- **Geographic AreaList.** This zone lists all geographic areas. Broadcast a record to display the details of the selected record.
- **Geographic Area.** This zone provides information about the selected area.
- **Overrides.** This zone lists speed overrides for specific dates that apply to this area. The zone is only visible for speed profile areas.

Use the **Geographic Area Map** zone on the portal's **Map** tab page to define the map boundaries of the area.

### Where Used

Follow this link to open the data dictionary where you can view the tables that reference [MI\\_GEOGRAPHIC\\_AREA](#).

## Setting Up Global Configuration

Many aspects of the application relies on setting up the **Global Configuration** master configuration record.

Refer to [Framework master configuration portal](#) for more information.

## Service Areas

---

### Understanding Service Areas

Typically, not all crews are allocated to do work in the whole territory and not all dispatchers monitor the whole territory. Service areas represent a division of your company's service territory into more manageable smaller areas. These areas may represent geographic regions, business units, or any other breakdown that is meaningful for your organization.

Examples of where service areas are used may be as follows:

- An activity is associated with a single service area that covers its location and the type of work requested.

- Crews on specific shifts may be allowed to work in specific service areas.
- Dispatchers may be responsible for monitoring specific service areas.
- A particular scheduler may cover one or more service areas.

This section describes concepts related to service areas.

## Different Service Areas For Different Service Types

If multiple types of services are provided and the service territory is divided differently for each type of service, each service area must be associated with a corresponding service type. In the same way activity types need to be associated with the corresponding service type. For example, your company's electric service areas and activities differ from your gas service areas and activities. Service areas of the same service type cannot overlap geographically.

This information is used by the system when it [determines the service area for an activity](#). The system finds the service area that geographically includes the activity location and that belongs to the same service type associated with the activity's type.

## Geographic Boundaries

The actual geographic boundaries of a service area may be captured as part of the service area record. While optional, there are benefits in capturing the service area's boundary when possible.

When this information is available, the system [determines the service area for an activity](#) by looking for a service area that its geographical boundaries includes the geocode of the activity's location.

Another benefit for recording the boundaries of service areas is that they can be displayed on geographic maps. The CDI map shows service areas as additional layer information available for dispatchers. The service areas covered by a scheduler's area are shown on the scheduler area portal.

If service areas follow postal code boundaries, their boundaries can be composed within the application under the following conditions:

- Your organization has a license to use Oracle Spatial.
- Postal code boundary data obtained from an external source is uploaded to a designated table.

Refer to [Prepare Postal Code Boundary Data](#) for more information.

Alternatively, geographic boundaries for a service area may be drawn in an external Geographic Information System (GIS) tool and the resulting ordinates (comma delimited latitude and longitudes) can then be copied and uploaded to the system.

## Service Area Hierarchy

Service areas may be organized in tree-like hierarchy levels representing broader territories, regions, offices, etc. For example, your service territory may be organized in "Division", "District", and "County" levels where each service area belongs to a "County".

Setting up a service area hierarchy is optional and mainly used for reporting purposes and advanced searching in the CDI Gantt and other key online queries. When hierarchy information is available, these queries allow the user to also filter by levels higher than the service area.

The meaning of each hierarchy level is entirely dependent upon your business practices. You can define up to 3 levels with level 1 being the highest, level 2 below level 1, and level 3 below level 2. Refer to [Define Service Area Hierarchy Levels](#) for more information.

Using the "Service Area Hierarchy" portal to set up the entire hierarchy structure via manual entry or by uploading a spreadsheet.

You must define the entire service area hierarchy before you can associate service areas with it.

---

**NOTE:** Service areas must all belong to the lowest level defined in the hierarchy. For example, if the hierarchy uses 2 levels only, all service areas must reference a level 2 node in the hierarchical structure.

---

## Configuring Service Areas

Design the boundaries of your service areas as well as the hierarchical structure above them. When ready, follow the steps in the order they are described in this section to configure the service areas.

### Defining Service Area Hierarchy Levels

Enable each applicable service area hierarchy level by populating its corresponding override description on the **M1\_SER\_ARE\_HIR\_LEV\_FLG** lookup to describe its role in your business structure.

### Defining Service Area Hierarchy

This portal is used to define the various nodes in a service area hierarchy.

Refer to [Service Area Hierarchy](#) for more information.

You can access this portal from the **Admin Menu > Service Management > Service Area Hierarchy**.

The following zones may appear as part of the portal's **Main** tab page

- **Service Area Hierarchy List.** This zone lists all service area hierarchy nodes. Broadcast a record to display the details of the selected record. You may also use this zone to download and upload hierarchies to and from an Excel spreadsheet.
- **Hierarchy Node.** This zone provides information about the selected service area hierarchy node.
- **Hierarchy Tree.** This zone provides a tree view of the entire service area hierarchy.
- **Service Areas In Hierarchy.** This zone lists service areas associated with the hierarchy.
- **Service Areas Not In Hierarchy.** This zone lists service areas yet to be associated with the hierarchy.

#### Where Used

Follow this link to open the data dictionary where you can view the tables that reference [M1\\_HIERARCHY](#).

### Prepare Postal Code Boundary Data

If service areas follow postal code boundaries, the following steps must be done:

- Find the [Feature Configuration](#) record for the **Map Server Configuration** feature type. (It may need to be defined if it does not exist). Choose the option type **Oracle Spatial Licensed** and define a value of Y.
- Postal code boundary data has been obtained from an external source and uploaded to the **M1\_POSTAL\_CODE\_BOUNDARY** table.

Refer to [Geographic Boundaries](#) for more information.

### Defining Service Areas

This portal is used to maintain service areas which define boundaries of areas in your territory.

Refer to [Understanding Service Areas](#) for more information.



You can access this portal from the **Admin Menu > Service Management > Service Area**.

The following zones may appear as part of the portal's **Main** tab page

- **Service AreaList**. This zone lists all service areas. Broadcast a record to display the details of the selected record.
- **Service Area**. This zone provides information about the selected service area.
- **Covering Schedulers**. This zone lists schedulers covering the selected service area.

The **Service Territory** zone on the portal's **Map** tab page is used to upload and view the geographic boundaries of the service area as well as view all other service areas in the territory for the same service type, if any. Use the **Edit Text** button and enter in the "Polygon Definition" the boundary definition of the area. This may be the resulting ordinates from drawing the geographic boundaries in an external Geographic Information System (GIS) tool, or if applicable, the list of postal codes defining this service area.

#### Where Used

Follow this link to open the data dictionary where you can view the tables that reference [MI\\_SVC\\_AREA](#).

## Postal Code to Service Area Mappings

If service areas follow postal code boundaries but you cannot capture the geographic boundaries of your service areas for any reason, the base product's **Determine Service Area** algorithm uses the **Postal Code to Service Area Mapping (M1-ServiceAreaLookup)** extendable lookup to map a postal code to a service area.

For easier setup, you may use the **Upload Postal Codes for Service Territory (M1-UpPostCd)** BPA script to upload these mapping records from an Excel spreadsheet.

If multiple types of services are provided and the service territory is divided differently for each type of service, you will need to use a separate extendable lookup for each service type as follows:

- Subclass the base extendable lookup for each service type supported.
- Specify the service type as a business object option.
- Use a separate Excel spreadsheet for each service type.
- When using the upload BPA script, select the appropriate extendable lookup for the service type mapping you are currently uploading.

If boundary data is not available and your implementation relies on the base product logic to [determine the service area for an activity](#) based on postal code, set up mapping between each postal code and the service area that covers it. Refer to [Postal Code to Service Area Mappings](#) for more information.

---

**NOTE:** If previously your organization has set up the extendable lookup and now you have the ability to capture service area boundaries, you may use the **Convert Postal Codes to Service Area Boundary (M1-CnvPosCd)** BPA script to convert your existing mapping data into service area boundaries. You no longer need to maintain the extendable lookup mapping.

---

## Capabilities

---

### Understanding Capabilities

A capability is a skill, equipment, or other attribute of a crew which makes the crew qualified to perform work.

Refer to [Resource Capabilities](#) for more information.

This section describes how capabilities are used to achieve compatibility between work requirements and resources.

## Worker Capabilities

This section describes key concepts related to worker capacities and how they are used.

### Skill

Skills define an ability or talent needed to perform certain types of work and as such, may support different level of expertise for the same skill set.

### Skill Levels

A skill set defines relationships between skills where each represents a specific level of expertise.

In the following example, the listed skills represent levels of expertise within a skill set. They are grouped together by referencing the same set number:

- Level 1 - Novice Inspector
- Level 2 - Standard Inspector
- Level 3 - Expert Inspector

Skill levels are used to make sure that skilled resources are being used as efficiently as possible. The scheduler can assign a crew to an activity based on their level of skill so as not to waste more experienced resources on a simple task, or to be sure to have a worker with a high level of skill where needed.

In this example, if an activity requires a "Novice Inspector" skill, the scheduler would first look for novice inspector crews before considering standard or expert inspectors.

Skill levels are optional. You don't need to specify level information if the skill does not require levels.

Skill preference can also be requested at the skill level. For example, an activity may require a novice level electrician, but would prefer an intermediate level electrician.

### Skill Efficiency

A skill level can also specify an efficiency, or numerical value which quantifies the relative speed or competency of the skill level. For example a worker at "expert" skill level probably works faster than a worker at "novice" level. The higher the number, the more efficient the worker. The skill efficiency value affects how the scheduler determines the scheduled duration for activities where skill requirements are specified.

The activity specifies the estimated amount of time it should take the work to be completed by a resource possessing the required skills. This estimated work duration represents the amount of time allotted for the activity on the schedule.

For an activity that requires a single minimum skill level and a skill efficiency is associated with each level, the scheduler adjusts the scheduled duration based on the assigned resource's skill level relative to the level that is required by the activity. As a result, if a more efficient resource is assigned, work may be completed faster. The percentage of the scheduled duration that is impacted by skill efficiency might also be specified on the activity type.

For example, an activity specifies an estimated duration of 60 minutes and at minimum requires an electrician of intermediate skill level. Assume that 30 minutes of the duration time is required for set up and clean up, and 30 minutes is required for electrical work if performed by a worker with intermediate electrical skills. This means that the efficiency duration impact percentage defined on the activity type would be set at 50% (only half of the 60 minutes requires skilled work).

With the skill efficiency set at 2 on the expert level skill, it is assumed that the expert only needs 15 minutes for the electrical work portion of the activity. Depending on the worker, the activity's scheduled duration would be calculated as follows:

- Intermediate worker = 60 minutes scheduled duration

- Expert worker = 45 minutes scheduled duration

If this value is not populated, the value is assumed to be 100% meaning that the skill efficiency impacts the entire scheduled duration.

---

**NOTE:** Skill Efficiency only applies to skills representing skill levels. Also, this functionality is ignored when the activity references more than one required skill as well as when multi person crews are used. This is not supported for complex activities.

---

## Attribute

An attribute defines a condition that is true about the mobile worker or an item they need to possess to perform certain types of work. For example, having a security clearance, building access, drug testing, permits, language proficiency, etc.

## Vehicle Equipment

Equipment is any device or apparatus used to perform certain types of work.

---

**NOTE:** This is a generic reference to a type of item and not a reference to a specific item.

---

## Limited Time

Some capabilities may be limited in time. For example, a skill that requires a license that must be renewed every year or an attribute representing a security clearance that is effective for a limited period of time. In the same way a vehicle may be associated with a certain type of equipment for a specific period of time only.

When you set up a mobile worker or a vehicle with such capability, you would be asked to provide the applicable effective period.

## Load Category

Delivery, pickup and depot replenishment activities request to transfer goods from and to depots. Different types of goods may impose specific scheduling requirements around the vehicle that carries them as well as the bay at the depot handling them. A load category describes a type of product or service that involve these requirements and capabilities, examples might include diesel, premium unleaded, and regular unleaded for fuels; electronics, appliances, and lighting for retail delivery.

For example, if an activity is used to deliver a certain type of fuel that can only be serviced at certain bays of a depot. A load category may be defined to describe this type of fuel. The activity would reference that load category to describe the requested goods and the appropriate bays at the depot would list this load category to indicate they can handle it.

Refer to [Load Compatibility](#) for more information on how this capability is used.

## Defining Worker Capabilities

This portal is used to define worker skills and attributes.

Refer to [Worker Capabilities](#) for more information.

You can access the Location portal from the **Admin Menu > Resource Management > Worker Capability**.

The following zones may appear as part of the portal's **Main** tab page

- **Skill List.** This zone lists all skills. Broadcast a record to display the details of the selected skill.

- **Attribute List.** This zone lists all attributes. Broadcast a record to display the details of the selected attribute.
- **Worker Capability.** This zone provides information about the selected capability.

Adding a new skill level to an existing skill set is achieved by duplicating an existing skill level of the skill set.

#### Where Used

Follow this link to open the data dictionary where you can view the tables that reference [M1\\_CAP\\_TYPE](#).

## Defining Equipment

This portal is used to define equipment needed to perform certain types of work.

Refer to [Vehicle Equipment](#) for more information.

You can access the Location portal from the **Admin Menu > Resource Management > Equipment**.

The following zones may appear as part of the portal's **Main** tab page

- **Equipment List.** This zone lists all equipment. Broadcast a record to display the details of the selected equipment.
- **Equipment.** This zone provides information about the selected equipment.

#### Where Used

Follow this link to open the data dictionary where you can view the tables that reference [M1\\_CAP\\_TYPE](#).

## Defining Load Categories

This portal is used to define load categories. A load category describes the good requested by activities, handled by a vehicle and serviced at a depot.

Refer to [Load Category](#) for more information.

You can access the Load Category portal from the **Admin Menu > Resource Management > Load Category**.

The following zones may appear as part of the portal's **Main** tab page

- **Load Category List.** This zone lists all load categories. Broadcast a record to display the details of the selected load category.
- **Load Category.** This zone provides information about the selected load category.

#### Where Used

Follow this link to open the data dictionary where you can view the tables that reference [M1\\_CAP\\_TYPE](#).

## Tasks

---

## Understanding Activity Types

This section describes various features controlled by activity type configuration.

Refer to [About Activities](#) for more information.

## Activity Business Object Controls Everything

Different types of activities involve different details and rules and as such, they are implemented using different activity business objects. It is important that you reference the appropriate activity business object when defining an activity type.

The base product provides various activity business objects to handle common types of work. Your implementation may introduce more custom business objects to adequately represent the data and business rules associated with a particular type of work. Refer to [Designing Activity Types](#) for more information.

## The Activity's Host System

The activity type record describes work that may be requested from a specific host system. As such, it is required that the activity type references the external system record set up for the specific host system and thus the same activity type cannot be used for multiple host systems.

The corresponding identifier of the activity type in the host system may optionally be specified on the activity type. This may be used to default a new activity's type from its host's activity type when applicable.

All outbound messages to the host system related to activities of this type are directed to the external system defined for the host system.

Refer to [Host External System Configuration](#) for more information.

## Service Type

If your company provides multiple service types and divides your service territory into different service areas for the different service types, you should state the service type associated with each activity type.

Refer to [Different Service Areas For Different Service Types](#) for more information.

## Service Category

An activity's type may be associated with one service category. A service category represents a broad category for work that is used in Oracle Utilities Analytics as a filter and to group activities on the Activities Dashboard.

## Default Resource Capabilities

The activity type may define worker and vehicle capabilities needed to perform activities of this type. This information may be extended or overridden on the activity.

Refer to [Resource Capabilities](#) for more information.

## When Can Work Be Performed

This section describes options that may be used to control when activities of this type can be scheduled.

### Cutoff Time

Certain types of work may only be scheduled on the same day they are sent in as long as they arrive before a specified cutoff time. If they arrive past the cutoff time they may only be scheduled starting the following day.

You may specify a cutoff time on the activity type as the business day cut off for activities of this type. An Arrival Time Window (ATW) is not generated for an activity's time window that starts on the activity's creation date but is passed the business day cut off time.

## Default Due Date

When the host system sends in an activity without a due date, the system can default it if such option is configured on the activity type. The activity type may state a number of days or hours within which the activity should be completed. Days and hours may refer to calendar or business days and hours, respectively.

You must specify a [work profile](#) if choosing to default due date by business days or business hours. This is because the system relies on the work profile definition of business days and hours for this type of work.

For example,

- A work profile is created specifying that work can be performed between 9 AM and 4 PM Monday through Thursday and 9 AM and 1 PM on Friday.
- An activity type references this work profile and also indicates that work must be performed within 24 business hours.
- If an activity of this type comes in from the host with a time window that starts on a Thursday at 3 PM with no end time window, the default due date and time is set to the following Wednesday at 2 PM (1 hour on Thursday, 4 hours on Friday, 7 hours on Monday and Tuesday, and 5 hours on Wednesday).

On the work profile you may also designate a "Minimum Business Day" value to establish the minimum duration that can be considered as a business day when defaulting an activity's due date by business days. This ensures that only time windows that are long enough are considered.

For example, if this is set at 5 hours and the activity must be completed within 3 business days on the activity type, but one of the days is a 4 hour day, that day will not be considered a full business day for the purpose of defaulting the activity due date.

---

**NOTE:** When determining an activity's due date [public holidays](#) are considered but time window overrides are not. Refer to [Override Time Windows](#) for more information on such events. Logic to determining an activity's due date resides in a "Update Time Windows" algorithm on the activity's business object. Click [here](#) to see the algorithm types available for this system event.

---

## Work Calendar

An activity type may reference a work calendar that defines public holidays during which work of this type should not be scheduled.

## Work Profile

Certain types of work may only be performed on specific days and business hours. For example, cutting a meter for non-payment is not allowed on weekends or hydrant flushes can only be performed during the graveyard shift.

A work profile describes the business hours during which work is allowed to be performed and may be referenced on one or more activity types that follow this profile.

Typically work profiles represent a regulatory restriction that does not allow an activity to be scheduled outside of these windows. You should configure work profiles as appropriate to typical work patterns and to restrict activity types according to regulatory requirements or other requirements. With a work profile properly defined for the activity type, the system ensures that the activity is not scheduled outside of the established time window.

The system uses this information when it generates arrival time windows (ATW) for an activity.

Refer to [When Can The Activity Be Actually Scheduled?](#) for more information.

You can also define a "Maximum Late Time" to establish the maximum duration, in minutes, that activities associated with this profile can be scheduled late. When specified, the scheduler will not schedule the activity if it can only start or

complete (depending on the value of the Time Window Mode set on the activity) later than the time window end time by this maximum number of minutes.

Setting this to zero indicates that no lateness is allowed. If this value is not specified, lateness is not restricted, allowing late cost scheduling rules to determine the activity's schedule as normal.

---

**NOTE:** Changes to work profiles after they have been established and added to activity types do not impact existing activities, only activities created after the change.

---

## Default Appointment Booking Group

When the system receives an appointment booking request from the host, it uses the appointment booking group specified on the request to identify the actual time windows during which appointments are allowed to be scheduled. If no appointment booking group is supplied by the host, the system uses the activity type's default appointment booking group.

You may specify an appointment group as well as a [work profile](#). In this situation, the scheduler would offer appointment times available considering both the work profile and the appointment booking group. For example, if the work profile specifies that work can only be performed Friday mornings, appointments for Friday afternoon will not be offered.

Refer to [Appointment Booking](#) for more information about the web service.

## Determine Activity Priority

Typically the host system does not set the activity's scheduling priority but rather lets the system determine it based on activity type configuration as well as an optional activity business priority number.

For example, collection activities can be prioritized highest overdue amount first. The host system would include a business priority number equal to the amount overdue. Given this, the activity type logic would derive the scheduling priority based on stepped ranges of amounts overdue:

- Up to \$100 set scheduling priority to 1
- Up to \$1000 set scheduling priority to 5
- etc.

Another example may be for the host to provide a business priority number equal to the number of customers impacted so that the activity that impacts the most customers is prioritized higher.

Using stepped ranges allows you to set same type of work activities with different scheduling priorities based on business needs. If a scheduling priority cannot be determined based on a business priority number, the default priority specified on the activity type is used.

If your organization needs to maintain the concept of priority based on activity type but allow activities of same type to prioritize differently, it is important to keep scheduling priority ranges allocated to specific types of work and let the stepped list be a further list of ranges within the range designated for the activity type. This way the scheduling priority will represent the preference between one type of work to other types as well as the preference within activities of one type of work.

## Taking a Break While On Site

By default, breaks are planned to be taken in between activities. However, some activities may require the crew to remain on site for a long time. In this situation the crew may be entitled to a planned break on site. The activity type indicates whether breaks may be scheduled to be taken while the crew is on site or not.

If the activity type is set up to allow breaks to be planned while on site, the scheduler plans such breaks accordingly. The crew is provided with a visual cue on the mobile application's task list as to whether an activity is scheduled with some break time while on site.

Complex activity types always allow breaks to be scheduled while on site.

## Advance Allocation

Certain types of work might need to be locked to their currently assigned crew at some time before the planned start time of the shift. When allocation is done in advance, dispatchers and planners can know in advance which crew is slated to perform the work. This information can be useful for planning purposes as per your business needs.

## Activity Time Tracking

The system tracks important events such as status updates on the assignment log. This information can be used to summarize how much time was spent by the crew on travel, actual work, taking breaks on site, and whether there was any wait time on site.

Refer to [Crew Time](#) for more information.

You can configure the activity type to summarize that information and present it to the crew at activity completion time so they can review and adjust their time as needed.

---

**NOTE:** This feature is independent from timesheet functionality; however, if the crew has made adjustments to reported times on an activity, they are included in the timesheet total adjusted times summary.

---

This feature is automatically enabled for complex activity types as they tend to be long tasks during which a crew may have taken breaks on site and it is very important to keep track of an accurately reported work time to be subtracted from the overall complex activity.

## Handling Expired Activities

If an activity has not been worked by its due date, the scheduler stops attempting to schedule it.

Depending on your configuration and business practices, activities of certain types may be configured to handle the situation as follows:

- Enable automatic extensions so that the scheduler will continue to try and schedule expired activities beyond the original effective time window by a set number of days or hours.

---

**CAUTION:** The purpose of automatic time window extension is to allow a few more attempts to complete an expired activity. Having too many time windows for an activity may incur an overall performance degradation. Defining small and numerous extensions are often used incorrectly to influence activity prioritization. This technique places an unnecessary burden on the scheduler and does not achieve the proper scheduling results. Priority profiles along with task type scheduling priority configuration should be used instead. Refer to [Activity Priority](#) for more information.

---

- Cancel the activity.
- Create a To Do for a user to review and make the necessary changes.

---

**NOTE:** Logic to handle the business rules associated with expired activities resides in an "Activity Expiration" algorithm on the activity's business object. Click [here](#) to see the algorithm types available for this system event.

---

## Assist Activity Types

The activity type indicates whether this type of activity may be created for the purpose of assisting another crew with their work.



Refer to [Assist Activities](#) for more information.

It is recommended that your organization set up assist activities to require manual acknowledgment by the assisting crew. This serves as notification that they are aware of the fact that they have been assigned to assist another crew.

## Creating Activities By The Crew

As per your business practices, crews may or may not be allowed to create activities in the field.

Activity type configuration supports the following options:

- The crew may be allowed or not allowed to create an activity of this type. For example, you may set up connects or disconnects such that they can be worked when dispatched as part of the shift schedule but never created in the field.
- The crew may be allowed or not allowed to create related activities while working an activity of this type. A related activity is an activity worked at the same location. If they are allowed to do so, you may optionally restrict the list of activity types they may use to create related activities.

## Contracting Work

By default, work can only be performed by company resources. However, certain types of work can be allowed to be performed by contractors.

The activity type indicates whether activities are allowed to be performed by company crews only, any resource (including contractors), or restricted to shift-based crews (which can be composed of internal resources and/or contractors). This information can be overridden on the activity.

Refer to [About Contractors](#) for more information.

## Understanding Service Classes

A service class is a broad categorization of activity types, allowing an activity type to belong to more than one service class. Each activity type must belong to at least one service class.

Examples of service classes include an electricity service class for all activities associated with electricity service, a gas service class for all activities associated with gas service, and a collections service class for all activities associated with collection, non-payment, and cutting off services.

Some of the main usages of service classes are as follows:

- Crews may not be allowed to perform certain classes of work on specific shifts. Activities of the types included in these service classes would not be assigned by the scheduler to these shifts.
- The primary function of a crew on a specific shift is defined using a service class. The scheduler is encouraged to prefer activities of the types included in the service class over others when assigning work to the crew on the shift.
- Crew shifts may be configured to reserve certain percentage of their capacity to activities of certain types using a service class.
- Dispatchers may monitor certain classes of work.

The scheduler uses this classification when scheduling work to shifts, based on their primary function and the type of work they are allowed to perform. Dispatchers also use this classification when they choose to monitor work by their service class association.

Review your activity types and group them to various service classes to meet your business requirements.

## Designing Activity Types

The product can be used by many different types of businesses and can support a diverse set of activities ranging from field service orders, to installations and inspections, and even home deliveries.

The underlying processes of scheduling, routing, and data transfer are quite similar; the primary differences are in the details, such as the activity information received from the host, the necessary completion information to be captured and sent back to the host, and how that data should be validated and processed.

The base package provides a standard activity business object that serves as the foundation for all other activity specific business objects. This business object provides the basic logic to manage the activity lifecycle, handle scheduling and routing, and transfer data between the host and the mobile devices.

On top of this strong foundation, each implementation can build custom business objects by extending what is in the base system rather than creating them from scratch. The customization process should begin with an analysis of what already exists in the base system, followed by a thoughtful design phase that identifies exactly what additional information and processes are needed. Only when the design phase is complete should an implementer begin using system configuration tools to create or customize system entities.

This section discusses topics related to customizing and extending the base activity functionality.

## The Lifecycle Business Objects

The base system provides lifecycle activity and assignment business objects that handle core functionality common to all types of activities. Additional subclass business objects are provided to support specific types of activities.

Activity and assignment business objects are unique in that they typically require some amount of customization to adequately represent the data and business rules associated with a particular type of work.

As a rule, custom activity and assignment business objects should always be a subclass of the corresponding base lifecycle business objects so that core functionality remains upgradable and consistent across of types of activities.

---

**NOTE:** Never clone the lifecycle activity or assignment business objects.

---

## Activity And Assignment Business Objects Are Related

As part of the dispatch process, activity rules spawn an assignment record for the assigned resource using the **Assignment Business Object** option defined on the activity business object.

The activity business object defines the details received from the host system for an activity. An assignment is a copy of the activity record made available to the assigned resource, and where they also enter completion information. As such, the assignment structure includes a copy of key activity details as well as completion details.

When the assignment is created, key details are copied from the activity onto the assignment record. Details to copy are those specified in the data area referenced by the **Dispatched Details** option defined on the assignment business object.

When these details are changed on the activity, an audit rule on the activity business object makes the same changes onto the current assignment for the activity so as to keep it up to date with latest activity details. In the same way, an audit rule on the assignment business object sends an updated copy of the assignment to the crew's mobile device (or to the assigned contractor company) so as to keep their copy of the assignment up to date.

## Extending Existing Business Objects

You should not need to create a new custom business object to achieve the following:

- Enforce additional custom rules. Your implementation can plug-in additional custom algorithms to existing business objects.
- Inactivate base algorithms. Though should be exercised with caution, your implementation can turn off the execution of a base algorithm using designated BO options.
- Use an alternate User Interface for the business object. Your implementation can override the base user interface used to display and maintain a business object, both on the server and on the mobile applications. Refer to the corresponding configuration techniques supported by the server and mobile applications.

If your implementation needs to perform more customization than that, subclass the corresponding lifecycle business object to introduce a new custom business object. Refer to [Custom Activity Business Objects](#) for more information.

## Custom Activity Business Objects

Below is a high-level summary of the steps required to create custom activity and assignment business objects to support the various types of work performed by your business.

### Analyze The Types Of Work

Identify all custom types of activities required for your implementation.

You will need to create a different activity business object for each type of work that requires different details to be sent from the host, completion details to be sent to the host, or validation logic. For example, one type of work might require that payment history is available to the crew as part of the activity details, while another might send a prior service record. Similarly, one type of work might require that the crew captures a particular kind of measurement or device reading, while another might capture customer satisfaction ratings; both types would require custom logic to validate the captured data.

For each activity type you identified above, do the following:

- Identify all data to be received from and sent back to the host.
- Design the UI maps to be used to display and capture data. You will need to design screens for the server application and, if MDTs are used in the fields, the mobile application as well.
- Identify all rules needed to extend the base business object for this type of activity, including algorithms that will be needed to handle validation of any data to be captured, monitor processes, etc. Make a list of these items so you can be sure to address all of them in the development process.
- Identify the data that needs to be synchronized to the crew. Do not include any data the crew does not need to know in order to perform their work.

### Configure The Custom Business Objects

The following describes the high-level steps needed to configure custom activity business objects that handle the necessary data and rules to support such activities:

- Set up the custom activity business object as follows:
- If applicable, define the details that may be received from the host system in a custom data area.
- The details should not include completion details.
- Make sure to leverage [UI Hints](#) to automatically render these details as part of the activity's user interface on the server application.
- Use this data area to extend the base data areas that describe activity details that may be sent in from the host system and dispatched to the crew. If the lifecycle business object is M1 owned, extend the "Extended Activity Data Details (M1-DataDetails)" data area. If M2 owned, extend the "Extended Utility Data Details (M2-DataDetails)" data area.
- Create a custom activity business object as a child of the base activity lifecycle business object; thus, all events associated with the parent business object are automatically supported for the custom business object.

- The custom business object's schema must include the base activity business object schema as well as the custom activity details data area, if any.
- Finally, associate with the custom business object any custom algorithms and service scripts required to display or capture the additional activity data, validate it, or handle any other custom business processes.
- Set up the custom assignment business object as follows:
- If applicable, define in a custom data area the completion details relevant to this type of activity to be captured by the crew and sent to the host system.
- Make sure to leverage [UI Hints](#) to automatically render these details as part of the assignment's user interface on the server application.
- Use this data area to extend the base data areas that describe activity completion details that may be sent to the host system. If the lifecycle business object is M1 owned, extend the "Extended Utility Completion Details (M1-CompletionDetails)" data area. If M2 owned, extend the "Extended Utility Completion Details (M2-CompletionDetails)" data area.
- Create a custom assignment business object as a child of the base assignment lifecycle business object; thus, all events associated with the parent business object are automatically supported for the custom business object.
- The custom business object's schema must include the base assignment business object schema as well as the custom activity completion details data area, if any.
- Finally, associate with the custom business object any custom algorithms and service scripts required to display or capture the additional activity completion data, validate it, or handle any other custom business processes.
- Reference the custom assignment business object as the **Assignment Business Object** option on the custom activity business object.
- Define an activity type record referencing your custom activity business object; it already knows the assignment business object to use via the business object option. Refer to [Defining Task Types](#) for more information.
- Add your activity type to an appropriate service class.
- If your implementation uses the mobile application to work such activities, extend it as follows:
- Add business rules to the mobile application to validate and process the completion data as needed.
- Design and implement the mobile user interface sections. This includes the sections used to display the additional activity information sent from the host system as well as those used by the crew to capture the additional completion information.
- Add the new activity type, the custom business objects and all the necessary items needed to support them to your designated custom deployment parts.
- Create and activate a new deployment.

---

**NOTE:** Refer to the mobile application training material for a more detailed instruction on how to extend and customize the mobile application.

---

## Configuring Activity Options

Follow the steps described in this section to configure various activity related options.

## Defining Site ID Configuration

When an activity does not reference an explicit site ID for site grouping purposes the system, by default, combines all site address elements to compose the site ID before it sends the activity to the scheduler.

Refer to [Site Identifier](#) for more information.

If your business requires a subset of the site address elements to be used, find the [Feature Configuration](#) record for the **Site Id Configuration** feature type (It may need to be defined if it does not exist), and add options to list the relevant fields to use instead.

---

**NOTE:** If your data is such that it does not allow you to use a subset of the site address elements, but rather you need to parse your address elements and use custom rules to compose a site ID, this feature configuration would not be useful. For this situation, it is recommended that you either correct the data in the host system when possible, or add custom parsing rules to compose the site ID in the host system and send it along with the activity. Alternatively, you can add custom activity post processing business object rules that set the site ID on the activity when it is added or when the address changes.

---

## Host External System Configuration

Outbound messages to an activity's host system are directed to the external system defined for the host system on the activity type. The kind of messages supported by each host system depend on the type of integration implemented.

Refer to [Crew May Be Managed Externally](#) for learn more about the type of integrations supported.

Set up an [External System](#) record that handles all the outbound messages supported by the host system.

Refer to [Configuring Outbound Messages](#) for more information.

## Defining Remark Types

This portal is used to maintain remark types. Standard remarks define common indications that can be entered when an activity is completed and are sent to the host system as part of the completion details. The activity type defines the types of remarks valid for this type of work.

You can access this portal from the **Admin Menu > Service Management > Remark Type**.

The following zones may appear as part of the portal's **Main** tab page

- **Remark TypeList.** This zone lists all remark types. Broadcast a record to display the details of the selected record.
- **Remark Type.** This zone provides information about the selected remark type.

### Where Used

Follow this link to open the data dictionary where you can view the tables that reference [M1\\_RMK\\_TYPE](#).

## Defining Priority Profiles

This portal is used to maintain priority profiles. The scheduler applies a factor onto the activity's scheduling priority to calculate its priority over time. This factor is defined by a "Priority Profile" as a function over the activity's broad time window. The priority profile also defines whether activities associated with this profile are considered [mandatory or optional](#). An activity is associated with the priority profile referenced on its activity type.

You can access this portal from the **Admin Menu > Service Management > Priority Profile**.

The following zones may appear as part of the portal's **Main** tab page

- **Priority Profile List.** This zone lists all priority profiles. Broadcast a record to display the details of the selected record.
- **Priority Profile.** This zone provides information about the selected priority profile.

### Where Used

Follow this link to open the data dictionary where you can view the tables that reference [M1\\_PRI\\_PROF](#).

## Defining Work Profiles

Work profiles define operational time windows and other time restrictions regarding when certain types of work can be performed. An activity is associated with a work profile referenced on its activity type.

Refer to [Work Profile](#) for more information.

This portal is used to maintain work profiles.

You can access this portal from the **Admin Menu > Service Management > Work Profile**.

The following zones may appear as part of the portal's **Main** tab page

- **Work Profile List.** This zone lists all work profiles. Broadcast a record to display the details of the selected record.
- **Work Profile.** This zone provides information about the selected work profile.

### Where Used

Follow this link to open the data dictionary where you can view the tables that reference [M1\\_APPT\\_BOOK\\_GRP](#).

## Defining Appointment Booking Groups

Appointment booking groups define valid appointment time windows. Different types of work may be associated with different appointment times. .

Refer to [Appointment Booking Group](#) for more information.

This portal is used to maintain appointment booking groups.

You can access this portal from the **Admin Menu > Service Management > Appointment Booking Group**.

The following zones may appear as part of the portal's **Main** tab page

- **Appointment Booking Group List.** This zone lists all appointment booking groups. Broadcast a record to display the details of the selected record.
- **Appointment Booking Group.** This zone provides information about the selected appointment booking group.

### Where Used

Follow this link to open the data dictionary where you can view the tables that reference [M1\\_APPT\\_BOOK\\_GRP](#).

## Uploading Common Attachments

Create common attachments for supporting documents needed to be available for the crew when they work specific activity types. Refer to [Attachments Related To The Type Of Work](#) for more information.

Refer to [Defining Task Types](#) to set up activity types.

## Defining Activity Types

Set up an activity type for each type of work handled by your business.

Refer to [Defining Task Types](#) to set up activity types.

## Defining Service Classes

This portal is used to maintain service classes.

Refer to [Designing Activity Types](#) for more information.

You can access this portal from the **Admin Menu > Service Management > Service Class**.

The following zones may appear as part of the portal's **Main** tab page

- **Service Class List.** This zone lists all service classes. Broadcast a record to display the details of the selected record.
- **Service Class.** This zone provides information about the selected service class.

#### Where Used

Follow this link to open the data dictionary where you can view the tables that reference [MI\\_SVC\\_CLS](#).

## Defining Task Types

Anything the crew needs to perform or spend time on is represented as task to be incorporated as part of the crew's shift schedule. Most tasks are activities the crew needs to perform but they can also be to attend meetings, replenish stock, handle goods at the depot, or take a planned break.

A task type defines default attributes for all tasks of a particular type.

The system supports the following classes of task types:

- **Activity Types.** You may define different activity types to describe the various types of work your business handles. Refer to [Understanding Activity Types](#) for more information.
- **Break Types.** You may define different types of breaks crews are entitled to take during their shift. Refer to [Breaks](#) for more information.
- **Non Productive Task (NPT) Types.** You may define different types of administrative tasks a crew may perform during their shift. Refer to [Non-Productive Tasks \(NPTs\)](#) for more information.
- **Depot Task Types.** You may define different depot task types for different depot records. Refer to [Depot Task](#) for more information.
- **Period of Unavailability (POU) Task Types.** You may define different types of meetings or events a crew may attend. Refer to [Meetings](#) for more information.

This portal is used to maintain all classes of task types.

You can access this portal from the **Admin Menu > Service Management > Task Type**.

The following zones may appear as part of the portal's **Main** tab page

- **Task TypeList.** This zone lists all task types. Broadcast a record to display the details of the selected record.
- **Task Type.** This zone provides information about the selected task type.
- **Service Classes.** This zone lists the service classes that include the selected task type. This zone is only visible for activity types.
- **Attachments.** This zone is used to maintain the list of common attachments associated with the selected task type. Refer to [Attachments Related To The Type Of Work](#) for more information. The zone is only visible for activity types.

#### Where Used

Follow this link to open the data dictionary where you can view the tables that reference [MI\\_TASK\\_TYPE](#).

## Crews

---

## Understanding Crew Hierarchies

Crews may be organized in tree-like hierarchy levels representing the business units they are associated with. For example, your business practices may require crew hierarchy levels of "Business Unit", "Department", and "Office" levels where each crew belongs to an "Office".

Setting up a crew hierarchy is optional and mainly used for reporting purposes and advanced searching in the CDI Gantt and other key online queries. When hierarchy information is available, these queries allow the user to also filter by levels higher than crew.

The meaning of each hierarchy level is entirely dependent upon your business practices. You can define up to 3 levels with level 1 being the highest, level 2 below level 1, and level 3 below level 2. Refer to [Define Crew Hierarchy Levels](#) for more information.

Using the "Crew Hierarchy" portal to set up the entire hierarchy structure via manual entry or by uploading an Excel spreadsheet.

You must define the entire crew hierarchy before you can associate crews with it.

---

**NOTE:** Crews must all belong to the lowest level defined in the hierarchy. For example, if the hierarchy uses 2 levels only, all crews must reference a level 2 node in the hierarchical structure.

---

## Configuring Crew Hierarchy

Design the crew hierarchical structure and when ready, follow the steps in the order they are described in this section to configure the hierarchy.

### Defining Crew Hierarchy Levels

Enable each applicable crew hierarchy level by populating its corresponding override description on the **M1\_CREW\_HIR\_LEV\_FLG** lookup to describe its role in your business structure.

Refer to [Understanding Crew Hierarchies](#) for more information.

### Defining Crew Hierarchy

This portal is used to define the various nodes in a crew hierarchy.

Refer to [Understanding Crew Hierarchies](#) for more information.

You can access this portal from the **Admin Menu > Resource Management > Crew Hierarchy**.

The following zones may appear as part of the portal's **Main** tab page

- **CrewHierarchy List.** This zone lists all crew hierarchy nodes. Broadcast a record to display the details of the selected record. You may also use this zone to download and upload hierarchies to and from an Excel spreadsheet.
- **Hierarchy Node.** This zone provides information about the selected crew hierarchy node.
- **Hierarchy Tree.** This zone provides a tree view of the entire crew hierarchy.
- **Crews In Hierarchy.** This zone lists crews associated with the hierarchy.
- **Crews Not In Hierarchy.** This zone lists crews yet to be associated with the hierarchy.

**Where Used**



Follow this link to open the data dictionary where you can view the tables that reference [MI\\_HIERARCHY](#).

## Configuring Crew Options

Follow the steps in the order they are described in this section to configure crew related options.

### Defining Mobile Worker Types

A mobile worker type defines attributes of a mobile worker's job description. For example, a mobile worker type can define the assumed skills or attributes of all mobile workers of that type.

Refer to [Mobile Workers](#) for more information.

This portal is used to maintain mobile worker types.

You can access this portal from the **Admin Menu > Resource Management > Mobile Worker Type**.

The following zones may appear as part of the portal's **Main** tab page

- **Mobile Worker Type List.** This zone lists all mobile worker types. Broadcast a record to display the details of the selected record.
- **Mobile Worker Type.** This zone provides information about the selected mobile worker type.

#### Where Used

Follow this link to open the data dictionary where you can view the tables that reference [MI\\_RESRC\\_TYPE](#).

### Defining Vehicle Types

A vehicle is associated with a vehicle type that defines attributes common to all vehicles of that type. For example, it can define the assumed equipment of all vehicles of that type.

Refer to [Vehicles](#) for more information.

This portal is used to maintain vehicle types.

You can access this portal from the **Admin Menu > Resource Management > Vehicle Type**.

The following zones may appear as part of the portal's **Main** tab page

- **Vehicle Type List.** This zone lists all mobile worker types. Broadcast a record to display the details of the selected record.
- **Vehicle Type.** This zone provides information about the selected mobile worker type.

#### Where Used

Follow this link to open the data dictionary where you can view the tables that reference [MI\\_RESRC\\_TYPE](#).

### Defining Crew Types

A crew type record defines a particular type of crew, such as a one-person crew or a multi-person crew, etc.

Refer to [About Crews](#) for more information.

This portal is used to maintain crew types.

You can access this portal from the **Admin Menu > Resource Management > Crew Type**.

The following zones may appear as part of the portal's **Main** tab page

- **Crew Type List.** This zone lists all crew types. Broadcast a record to display the details of the selected record.
- **Crew Type.** This zone provides information about the selected crew type.

#### Where Used

Follow this link to open the data dictionary where you can view the tables that reference [M1\\_RESRC\\_TYPE](#).

## Configuring Crew Shift Options

Follow the steps in the order they are described in this section to configure crew shift related options.

### Defining Shift Types

A crew shift type is closer to the common meaning of the term 'shift' which typically refers to the time of day during which a crew performs work, such as first shift or second shift. A shift type defines attributes common to all crew shifts and shift templates of this type, such as their typical start and end times, duration, etc.

Refer to [About Crew Shifts](#) for more information.

This portal is used to maintain shift types.

You can access this portal from the **Admin Menu > Resource Management > Shift Type**.

The following zones may appear as part of the portal's **Main** tab page

- **Shift Type List.** This zone lists all shift types. Broadcast a record to display the details of the selected record.
- **Shift Type.** This zone provides information about the selected shift type.

#### Where Used

Follow this link to open the data dictionary where you can view the tables that reference [M1\\_CREW\\_SHFT\\_TYPE](#).

### Defining Shift Cost Profiles

Global and shift-based costs are used by the scheduler to evaluate and compare possible schedule solutions. A less costly schedule is preferred over a more costly one. Shift cost profiles are predefined shift-based cost factors that are used as multipliers against global costs. You can assign a shift cost profile to one or more shift templates or to individual shifts.

For example, a shift-based overtime cost of 3 means that overtime for all crew shifts associated with this profile is three times more than the overtime cost defined globally.

---

**NOTE:** Before you define shift cost profiles, study your organization's cost requirements and how they relate to specific service areas and/or service classes. Small changes to shift-based factors may result in significant schedule changes.

---

The shift cost profile record may also include a list of relevant service areas and/or service classes. These associations do not restrict the use of the shift cost profile in any way; you can associate any shift cost profile to any shift. Rather, the system uses these associations to recommend appropriate shift cost profiles when you are defining crew shifts.

Refer to [About Crew Shifts](#) for more information.

This portal is used to maintain shift cost profiles.

You can access this portal from the **Admin Menu > Resource Management > Shift Cost Profile**.

The following zones may appear as part of the portal's **Main** tab page

- **Shift Cost Profile List.** This zone lists all cost profiles. Broadcast a record to display the details of the selected record.
- **Shift Cost Profile.** This zone provides information about the selected cost profile.

## Where Used

Follow this link to open the data dictionary where you can view the tables that reference [M1\\_SHFT\\_COPRF](#).

## Defining Shift Related Task Types

Shift configuration may include planning of breaks and Non Productive Tasks (NPT).

Refer to [Defining Task Types](#) to set up Break and NPT types.

## Periods of Unavailability (POUs)

---

### Understanding POU Configuration

A period of unavailability (POU) is a specific period of time during which one or more resources are not available to perform work; for example, meetings or training sessions crews attend as part of their shift, a mobile worker's vacation leave, a vehicle's planned maintenance time, etc.

A POU type defines basic characteristics of all POUs of a particular type, for example:

- A POU type specifies whether or not POUs of that type can be recurring and if so, specifies the POU template business object used to create recurring POUs of that type.
- A POU type also identifies the class of resource (crew, mobile worker, vehicle, etc.) that can be associated with POUs of that type.

Refer to [About Periods of Unavailability \(POUs\)](#) for more information.

### Defining Period of Unavailability Task Types

For crew meeting POUs, a POU task is automatically created by the system for each invited crew in order to incorporate the meeting as a task into their schedule.

The system uses the task type defined on the POU type to create the POU Task. If not specified, the default task type specified on the global master configuration record is used.

Refer to [Defining Task Types](#) to set up POU task types.

### Defining Period of Unavailability Types

This portal is used to maintain POU types.

You can access this portal from the **Admin Menu > Resource Management > Period of UnavailabilityType**.

The following zones may appear as part of the portal's **Main** tab page

- **Period of UnavailabilityType List.** This zone lists all POU types. Broadcast a record to display the details of the selected record.
- **Period of UnavailabilityType.** This zone provides information about the selected POU type.

## Where Used

Follow this link to open the data dictionary where you can view the tables that reference [M1\\_POU\\_TYPE](#).

# Dispatchers

---

## Understanding Dispatch Areas

When dispatchers log on to start their shift, they select dispatch areas they will monitor during that shift. A dispatch area includes one or more [service areas](#) as well as one or more [service classes](#), indicating the type of work the dispatcher monitors in the specified areas.

The system considers crews on specific shifts, contractor capacities, and activities to match the criteria defined by a dispatch area as follows:

- The crew shift covers at least one of the service areas defined by the dispatch area, and the crew is allowed to perform work associated with at least one of the service classes defined by the dispatch area.
- The activity's service area is included in the list of service areas defined by the dispatch area and its activity type is included in at least one of the service classes defined by the dispatch area.
- If your organization uses contracted work capacities, then similar to crew shifts, a contractor capacity has to cover at least one of the service areas defined by the dispatch area as well as cover at least one service class defined by the dispatch area. If the capacity is defined for a specific activity type only, that activity type has to belong to a service class covered by the dispatch area.

Refer to [Managing Crews And Activities](#) for more information.

## Defining Dispatcher Types

A dispatcher type record defines a particular type of dispatcher.

Refer to [About Dispatchers](#) for more information.

This portal is used to maintain dispatcher types.

You can access this portal from the **Admin Menu > Resource Management > Dispatcher Type**.

The following zones may appear as part of the portal's **Main** tab page

- **Dispatcher Type List.** This zone lists all dispatcher types. Broadcast a record to display the details of the selected record.
- **Dispatcher Type.** This zone provides information about the selected dispatcher type.

### Where Used

Follow this link to open the data dictionary where you can view the tables that reference [MI\\_RESRC\\_TYPE](#).

## Defining Dispatch Areas

This portal is used to maintain dispatch areas. A dispatch area is a predefined set of service areas and service classes that can be monitored by one or more dispatchers.

Refer to [Understanding Dispatch Areas](#) for more information.

You can access this portal from the **Admin Menu > Service Management > Dispatch Area**.

The following zones may appear as part of the portal's **Main** tab page

- **Dispatch Area List.** This zone lists all dispatch areas. Broadcast a record to display the details of the selected record.
- **Dispatch Area.** This zone provides information about the selected dispatch area.

### Where Used

Follow this link to open the data dictionary where you can view the tables that reference [M1\\_DISP\\_AREA](#).

## Customizing The CDI Portal

Being the primary point of user interaction for dispatchers, the CDI portal is highly customizable. This section describes various customization options your implementation can use.

Refer to [About CDI](#) for more information.

## Gantt Customizations

The following section describes the various areas in which the scheduling Gantt may be customized to meet your business needs.

### General Gantt Configuration

Like with all CDI portal zones, the crews listed in the Gantt's left pane are restricted to those in the [dispatcher's scope](#) of currently monitored crew shifts. If the dispatcher has applied a [filter](#) then the list is temporarily narrowed down based on the filtering criteria. For each crew, one or more of their shifts are displayed in the right pane along with their schedule of tasks.

The system automatically refreshes the information being displayed to ensure an up to date picture of the schedule is presented to the dispatcher.

---

**NOTE:** Logic to provide the Gantt with the list of crew shifts and their scheduled tasks, as well as all the necessary information and visual cues it needs in order to present them, resides in a plug-in. Click [here](#) to see the algorithm types available for this system event.

---

Similarly, when the Gantt view is toggled to present the tasks scheduled for a single shift (Task View), the system lists the shift's tasks in the left pane and their schedule and available time windows in a time line in the right pane.

---

**NOTE:** Logic to provide the Gantt with all the necessary information and visual cues it needs to present the schedule of a single shift in "Tasks View" resides in a plug-in. Click [here](#) to see the algorithm types available for this system event.

---

If your business involves depot related work, the Gantt view may be toggled to present the tasks scheduled to one of the depots managed by the dispatcher as well as those scheduled to a specific depot bay.

---

**NOTE:** Logic to provide the Gantt with all the necessary information and visual cues it needs to present the schedule of a single depot or bay resides in a plug-in. Click [here](#) to see the algorithm types available for this system event.

---

These algorithms and more are provided as part of a default configuration that controls various aspects of the Gantt functionality as well as its visual appearance.

You may override these settings as per your company's preferences; for example you can

- Provide custom icons and choose different colors instead of those used by default
- Choose more columns (from a predefined list) to appear by default on the "List of Crews" pane
- State whether your company prefers the Gantt's main timeline view to list individual shifts on the left pane instead of the default option to group them by crew
- and more

---

**NOTE:** The default configuration used by the CDI Gantt, as well as other Gantt zones, is defined in the **Gantt Configuration (M1-GanttConfiguration)** extendable lookup. Review and adjust these settings for all or some of the Gantt zones.

---

## Frequent Data Refresh

Key operational zones are set up to frequently refresh their data to reflect the most recent updates.

Ensure the automatic refresh interval is properly set up for the following zones:

- KPI Summary
- Alert Queue dashboard zone
- Backup Alert queue dashboard zone

The refresh interval for these zones is defined on their maintenance portals. Individual users can override these settings in the zone refresh parameter in user preferences.

---

**NOTE:** It is recommended to set up the "Activity Search" zone to not automatically refresh. This zone is assumed to be used to find specific activities as needed.

---

## Right-Click Context Menus

You can add custom menu options to the context menu that appears when a user right-clicks a task or shift in the [Scheduling Gantt](#) zone.

The system supports several customizable context menus:

- M1-GANTT-ACTIVITY. This menu is used for a single activity that is not completed.
- M1-GANTT-ACTIVITY-MULTI. This menu is used for multiple activities that are not completed.
- M1-GANTT-BREAK. This menu is used for a break task.
- M1-GANTT-DEPOT-BAY. This menu is used for a depot bay.
- M1-GANTT-DEPOT-TASK. This menu is used for a depot task.
- M1-GANTT-DEPOT-TASKMULTI. This menu is used for multiple depot tasks.
- M1-GANTT-POU. This menu is used for a POU task.
- M1-GANTT-SHIFT. This menu is used for a single shift in CDI scheduling Gantt.
- M1-GANTT-SHIFTSHIFT\_PORTAL. This menu is used for a single shift on Crew Shift portal Gantt.
- M1-GANTT-TASK. This menu is used for any other single task.
- M1-GANTT-TRANSFER. This menu is used for depot transfer activity.

---

**NOTE:** Menu lines added to these context menus must invoke a BPA script to perform the work, and the BPA script must follow a specific schema. Each context menu provided with the base package contains at least one item that serves as an example of how to implement such a menu item.

---

## Gantt Filters

The **CDI Gantt Filters (M1-GanttFilters)** extendable lookup defines filters provided by the base product that your implementation may choose to customize.

Refer to [Filter The List of Crews](#) for more information.

To inactivate a base filter, set the corresponding record in the extendable lookup as inactive.

You can introduce additional custom filters as needed to meet your business requirements. Follow the steps below to set up a new Gantt filter:

- Create a data explorer query zone that returns a list of shift identifiers based on your business requirement. The zone must contain only the shift id as an output column.
- Create a data explorer (FWLZDEXP) Business Service for your zone. The Business Service must map the zone's returned Shift ID column to an element named 'shiftId'. If you wish to default any input parameters, you may do so by using the standard schema standards (e.g. default = "xyz").
- Add your business service to the CDI Gantt Filters extendable lookup.

---

**NOTE:** It is your responsibility to ensure that the SQL is efficient and references the dispatcher's data scope. The Gantt algorithm does not validate that the returned shifts are indeed relevant to the dispatcher. Refer to the base filters for examples.

---

## Hover Text

The text displayed when hovering over a task on the scheduling Gantt may be different from the task's standard information throughout the system.

---

**NOTE:** Logic to format the detailed description displayed on the Gantt for a task resides in an "Task Detailed Information" algorithm on the task business object. Click [here](#) to see the algorithm types available for this system event.

---

In the same way, the text displayed when hovering over a shift on the scheduling Gantt may be different from the shift's standard information throughout the system.

---

**NOTE:** Logic to format the detailed description displayed on the Gantt for a shift resides in an "Shift Detailed Information" algorithm on the shift business object. Click [here](#) to see the algorithm types available for this system event.

---

## Visual Cues

Many of the visual cues associated with shifts and tasks are controlled by predefined styles in the **Gantt Style (M1-GanttStyle)** extendable lookup.

Your implementation may configure the system to show a custom icon in the task bar for certain types of activities and POU's. To do so, perform the following:

- Register the custom icon on the [Display Icon Reference](#) portal.
- Select the icon reference name on the activity type or POU task type.

Showing an icon in the task bar for activities is optional. Note that even when an icon is specified on the activity type, the dispatcher may opt to not display it as their preference. Refer to [Customize Your Gantt Display](#) for more information.

For POU tasks though, an icon is always shown in the task bar to distinguish these tasks from other classes of tasks. The base icon is shown by default if a specific icon is not defined on the POU task type.

## Task Coloring Rules

By default, a task bar's background color is determined based on the class and state of the task.

Your implementation may introduce additional color rules for the dispatchers to use. For example, color tasks based on their activity type, how close the activity is to its due date, its service area, etc. Dispatchers can toggle between the color rules and set a color rule as their default.

Use the **Gantt Color Rule (M1-ColorRuleSet)** extendable lookup to define more color rules as needed.

## CDI Map Customizations

The following section describes the various areas in which the CDI Map may be customized to meet your business needs.

## CDI Map Layers

Map layers are defined by the "CDI Map Layer" extendable lookup. Each map layer definition indicates whether the layer should be loaded and displayed when the CDI Map is initially loaded. You can override the default indication as needed.

You can add to the extendable lookup custom layers of the following types:

- A custom layer may reference a MapViewer theme name you have predefined in the MapViewer repository. Note that this theme must not assume any context, i.e. it is called without any input from the CDI map.
- The system allows you to define geographic areas for various usages. Refer to [Defining Geographic Areas](#) for more information on how to set up these areas. Once defined, a custom layer may be added to show all active geographic areas of a specific usage. For example, if you have defined a geographic hazard area that crews should not enter, that area can be shown on the CDI map.

## Hover Text

The system calls the service script configured on the map layer entry in the extendable lookup to format the information displayed when the user hovers over an icon in that layer. You can use a custom service script as needed, so long as it includes the base script schema as part of its schema to ensure upgradability.

The text displayed when hovering over a task or a shift on the map may be different from the task's standard information throughout the system.

---

**NOTE:** The logic used to display detailed information about a related shift or task resides in the same algorithms used to format the task and shift [Gantt hover text](#). The algorithms are designed to compose a different hover texts when called from the Gantt and another when called from the map.

---

# Alerts

---

## Understanding Alert Types

An alert type controls the business rules associated with raising and evaluating alerts for a certain situation meaningful to your business.

Refer to [About Alerts](#) for more information.

This section describes various features controlled by alert type configuration.

## Alert Business Object Controls Everything

The base product provides various alert business objects to handle most types of alerts. It is important that you reference the appropriate alert business object when defining an alert type.

Below are some examples of alerts supported by the base product. Review their logic and define corresponding alert types for those relevant to your implementation.

- **Missed appointment** alerts are generated when an appointment has been missed.
- **Unacknowledged emergency** alerts are created when a crew does not acknowledge an emergency alert within a specified period of time. Refer to [Unacknowledged Emergency Alert](#) for more information.
- **Underscheduled Complex Activity** alerts are generated for complex activities that cannot be scheduled beyond a specified threshold.



- **Synchronization** alerts are created when the crew does not receive a dispatched activity's assignment from the server within a specified period of time. Refer to [Synchronization Alert](#) for more information.
- **Cancel Activity** alerts are created on an attempt, typically initiated by the host system, to cancel an activity that has been dispatched to the crew. Refer to [Activity Cancellation By Host](#) for more information.
- **Crew Idle** alerts are generated when the crew shift is idle for a specified period of time.
- **Crew Taking Too Long** alerts are generated when the crew has been on site for some predefined minutes since the estimated completion time of an activity.
- **Hazard Area** alerts are generated when crews enter a hazard area. Refer to [Hazard Areas](#) for more information.
- **Vehicle Leave Area** alerts are generated when vehicles leave a certain geographic area. Refer to [Vehicle Leave Areas](#) for more information.
- **Panic** alerts are created when a crew in distress presses the "Panic" button on their mobile device. Refer to [Request For Help](#) for more information.
- **Timed Event** alerts are created when a crew has created an event with an expiration date and time to indicate that the dispatcher should check on them if the event expires. Refer to [Request For Help](#) for more information.

Your implementation may extend or customize the base business objects or introduce custom business objects as needed. Refer to [Designing Alert Types](#) for more information.

## Alert Creation

Most alerts are generated in the background. The system frequently checks for the condition associated with each active alert type and raises alerts for each situation that meets the criteria.

Alerts created by base product rules explicitly exclude offline crews from being checked for alerts related to their work progress. Refer to [Offline Mode](#) for more information.

---

**NOTE:** Logic to create alerts of a given alert type resides in an "Alert Creation Algorithm" defined on the alert type. Click [here](#) to see the algorithm types available for this system event. The **Alert Type Monitor** background process calls this algorithm for each active alert type. The batch process needs to run frequently to create alerts in a timely manner. Refer to [MI-ATMTR](#) batch control for more information.

---

A creation algorithm is not required if there is another mechanism that raises alerts of this type. Some types of alerts may be raised on demand by a user or by other business rules throughout the application. For example, a crew may raise a "Panic" alert from the field to request immediate help. This type of alert is created right way upon the crew's request. This type of alert does not need to reference any creation algorithm on the alert type record. Refer to [Request For Help](#) for more information.

## Alert Creation Threshold

The creation algorithm is typically designed to use some sort of a threshold that is taken into account, amongst other criteria, when determining whether an alert of this type should be raised or not. The threshold is set on the alert type and its meaning is only known to the logic creating the alert. For example, a crew idle alert is raised if a crew is idle more than the amount of minutes specified in the creation threshold.

## Valid Activity Types

For activity related alerts, you may specify a restricted list of activity types for which this type of alert would be raised. If no activity types are specified, alerts of this type are raised for any type of activity.

## Alert Distribution

An alert reports a problem related to an activity, a crew on a specific shift, or a resource at a specific location.

The system attempts to assign the alert to a logged on dispatcher that is currently monitoring the activity or crew, or covers the location associated with the alert. If no dispatcher is currently monitoring the subject of the alert, the system further looks for a logged on dispatcher that is eligible to watch it based on their dispatcher record settings, but did not elect to monitor the area or service class on today's dispatcher shift.

As a last resort the system attempts to assign the alert to any logged on dispatcher, if this is allowed by configuration.

When multiple candidate dispatchers are available to receive the alert, the system balances the load by preferring the one with the least number of open alerts.

An email is sent to the email address specified on the alert type to notify a supervisor in case the alert could not be assigned to any dispatcher.

---

**NOTE:** Logic to assign an alert to a dispatcher resides in an algorithm on the alert's business object. These rules can be customized during implementation to meet your organization's business requirements.

---

## Alert Priority

Some alerts may need to be addressed before others. You can specify a priority on the alert type to represent the priority of alerts of this type relative to other alerts. The priority dictates the order by which alerts are presented to dispatchers in their alert queue.

You can also specify on the alert type whether or not alerts of this type should make a sound when they appear in the alert queue to help get the attention of the dispatcher. The sound file to use as well as other parameters need to be populated on the [global configuration](#) record for alert sound to be enabled.

## Alert Evaluation

The system automatically closes an alert if the underlying condition no longer exists or is no longer relevant. For example, an alert related to a crew being idle would automatically close when the crew is no longer idle or if the crew's shift is completed. Similarly, a missed appointment alert should be automatically closed if the activity is subsequently canceled.

---

**NOTE:** Logic to evaluate an existing alert and close it if it is no longer valid resides in an "Alert Evaluation Algorithm" defined on the alert type. Click [here](#) to see the algorithm types available for this system event. The **Alert Monitor** background process calls this algorithm for each open alert. The batch process must run frequently to properly evaluate and close existing alerts. Refer to [MI-ALMTR](#) batch control for more information.

---

However, alerts that were raised by a user on demand like a crew's panic alert, can only be manually closed by a dispatcher after they contact the crew and make sure they are no longer in danger.

---

**NOTE:** When applicable, it is important to associate alert types with an evaluation algorithm to ensure that alerts do not remain in any dispatcher's queue when the underlying issue has already been resolved.

---

## Snoozing Options

The system supports a snooze feature, similar to the snooze on an alarm clock. You can configure alerts of a given type to snooze for a configurable amount of minutes after the dispatcher acknowledges the alert. When such alert is acknowledged,

the alert is dropped from the dispatcher 's alert queue while the dispatcher tries to address the issue, and reappears after that amount of time, if the conditions are still true for the alert.

As a general rule, you should allow an alert to snooze if it is important that the alert be closed only when the underlying issue has been resolved, and you want to allow the dispatcher for more time to resolve it. When the snooze time expires, the system evaluates the underlying condition and closes the alert if the condition no longer exists.

For some types of alerts, you may want to allow the dispatcher to adjust the snooze time themselves when they acknowledge the alert.

---

**NOTE:** If the alert type does not support snoozing, alerts of this type are automatically closed once a dispatcher acknowledges them irrespective of whether the underlying issue is resolved or not.

---

## Can A Dispatcher Manually Close Alerts?

Typically alerts should be closed when the underlying condition is resolved and as such, should not allow a user to manually close it. However, some types of alerts may be designed to allow such user intervention.

---

**NOTE:** The logic that creates the alerts has to be designed to handle manual closure so that it does not recreate the alert again once closed. Refer to the description of the algorithm that creates the alerts to better understand if it handles manual closure of alerts.

---

## Should The Alert Expire?

You can configure alerts of given type to automatically expire and close after some predefined amount of time, irrespective of whether the underlying condition is resolved or not.

## Should The Alert Recycle?

Recycling an alert refers to the process of reassigning it to another dispatcher. You can configure alerts of given type to recycle if the assigned dispatcher doesn't acknowledge the alert within a configurable amount of time. If a recycle time is not specified on the alert type, alerts of this type are never recycled based on time; however, they will still be recycled when the assigned dispatcher logs off.

## Designing Alert Types

The product can be used to raise many different types of alerts related to crews and activities.

The underlying processes of assigning the alert to a dispatcher, waiting for the user to act upon the alert, and managing the closure of an alert are quite similar; the primary differences may be the conditions under which the alert is raised and closed as well as unique actions a user may take to address it. The base package provides several alert business object that demonstrates typical alert handling use cases.

This section discusses topics to consider when designing custom types of alerts.

## When Should The Alert Be Raised?

Understand the business conditions for which to raise alerts of this type.

## Event Driven Alerts

If alerts are to be raised upon a specific event, you need to design an algorithm that will be triggered by the event to create an alert. Refer to [Request For Help](#) for an example.

Typically alerts are raised for conditions that have already been met so they are in effect from the time of their creation. However, critical alerts may be raised in advance to ensure a dispatcher is notified of the situation in a timely manner. Refer to [Unacknowledged Emergency Alert](#) for an example.

## Monitored Situations

Many alerts are not event-driven, but rather are raised based on a situation that is determined by frequent analysis of the data. For such alerts, an [Alert Creation](#) algorithm needs to be developed based on your business requirements. Consider the following when designing such algorithm:

- Is there a configurable [threshold](#) to be applied before creating an alert?
- Can the alert be [manually closed](#)? If you have to allow manual closure, please be sure to build this logic into the alert creation algorithm to avoid raising repeated alerts for same issue.

## When Should The Alert Be Closed?

Understand the business rules that allow the system to automatically close alerts of this type. When applicable, design a corresponding [Alert Evaluation](#) algorithm and specify it on the alert type.

## Use The Base Business Objects

You should be able to use the base alert business objects to implement most of your custom alerts. Implement your custom creation and evaluation algorithms and reference them on the alert type.

If you need more details to be captured on an alert or leverage a different lifecycle, your implementation would need to design a new custom alert business object to handle these requirements.

## Defining Alert Types

This portal is used to maintain alert types.

You can access this portal from the **Admin Menu > Service Management > Alert Type**.

The following zones may appear as part of the portal's **Main** tab page

- **Alert Type List.** This zone lists all alert types. Broadcast a record to display the details of the selected record.
- **Alert Type.** This zone provides information about the selected alert type.

### Where Used

Follow this link to open the data dictionary where you can view the tables that reference [M1\\_ALERT\\_TYPE](#).

## Key Performance Indicators (KPIs)

---

# Understanding Key Performance Indicators (KPIs)

Key performance indicators (KPIs) are quantifiable measurements related to crews and activities a dispatcher currently monitors. For example, a KPI might measure the number of idle crews or the number of missed appointments.

Refer to [KPIs](#) for more information.

This section describes various features controlled by KPI configuration.

## Calculation Algorithm

A KPI record defines what is being measured and how to measure it. A KPI is either crew shift-oriented (for example, the number of idle crews) or activity-oriented (for example, the number of appointments missed).

---

**NOTE:** Logic to calculate the KPI measurement and provide the necessary information associated with it resides in a "Calculation Algorithm" defined on the KPI record. Click [here](#) to see the algorithm types available for this system event.

---

The calculation algorithm may be designed to use some sort of a threshold that is taken into account, amongst other criteria, when determining the KPI value. The threshold is set on the KPI record and its meaning is only known to the calculation algorithm.

If a KPI is actionable, the KPI value appears as a link on the KPI Summary zone on the CDI portal. This allows the dispatcher to drill in to the KPI specific CDI portal where actions can be taken to address the underlying condition. If a KPI is not actionable, the KPI appears as plain text for information purposes only.

Refer to [Monitoring KPIs](#) for more information.

The KPI calculation plug-in spot supports two modes, **Summary** or **List**. If called in **Summary** mode, the algorithm returns the calculated value of the KPI as well as an indication as to whether it is actionable or not. If called in **List** mode, it returns the list of activities and/or shifts that contributed to the KPI value.

The system calls the KPI calculation algorithm in **Summary** mode for each KPI monitored by a dispatcher and displays the KPI value in the KPI Summary zone on the CDI portal. When the dispatcher navigates to the KPI Specific CDI portal for a selected KPI, the system calls the KPI's calculation algorithm in **List** mode, narrowing the information displayed on the portal accordingly.

## Alert Based KPIs

Some KPIs may measure the same underlying conditions as some of the alerts raised by your implementation. For those KPIs, the base product provides a KPI calculation algorithm that counts the number of open alerts of a specific type that are related to activities or crews monitored by the dispatcher.

Note that alerts are considered regardless of whether or not they are assigned to the dispatcher. For example, if there are multiple dispatchers covering the same dispatch area, the KPI counts would appear for all of these dispatchers even though the alerts are distributed between them.

## Severity Thresholds

The KPI record defines the normal, warning, and severe thresholds values for the measurement. If the KPI value is less than the normal threshold, the KPI will not be presented to the dispatcher, even if it is actionable.

## Designing Your KPIs

The following is a high-level summary of the steps involved in designing KPIs for your organization:

- Determine what the KPI measures and identify whether the KPI is related to activities or to crews.
- Determine whether there is an existing alert type that measures the underlying condition. If so, you can use the KPI calculation algorithm provided with the base package. If not, you must create an algorithm to calculate the KPI that you would later on reference on the KPI record.
- Identify the beginning of the normal, warning, and severe ranges for the KPI.
- Define the KPI Record. Refer to [Defining KPIs](#) for more information.

## Defining KPIs

This portal is used to define a Key Performance Indicator (KPI) record.

You can access this portal from the **Admin Menu > Service Management > KPI**.

The following zones may appear as part of the portal's **Main** tab page

- **KPI List.** This zone lists all KPIs. Broadcast a record to display the details of the selected record.
- **KPI Type.** This zone provides information about the selected KPI.

### Where Used

Follow this link to open the data dictionary where you can view the tables that reference [M1\\_KPI](#).

## Procedures

---

### Understanding Procedure Types

Procedure types represent the type of forms a crew is required to fill out as part of working their shifts.

Refer to [About Procedures](#) for more information.

This section describes various features controlled by procedure type configuration.

### Related Entity

On the procedure type you specify whether it is related to an activity type, a vehicle type, or a primary function. Once defined, the procedure types may be referenced on the corresponding entities.

**Primary Function** procedure types referenced on service classes determine the procedures required when a crew takes on a certain primary function role defined by this service class. This may be at shift start time or when there is a change in primary function mid shift.

**Vehicle Type** procedure types may be referenced on vehicle types to determine the procedures required when a vehicle of this type is used or changed on a shift.

**Activity Type** procedure types may be referenced on activity types to determine the procedures required before the crew can start work on the activity.

## Questionnaire

Typically, procedures consist of simple questionnaires with predetermined expected answers (yes/no, text, a number, etc). The base product is shipped with business objects to supports this type of procedure but you may customize your procedure business object to meet your business needs.

The base product business objects implement a simple questionnaire form that allows you to define the specific questions or steps that need to be followed to complete the procedure. These can be in the form of yes or no questions, text or numerical values that must be entered, valid ranges, etc.

Message categories are used for the text messages for all steps in the procedure. It is recommended that you designate one or more message categories for procedure related messages. For example, you may have a message category for vehicle inspection or activity safety checklist.

---

**NOTE:** All custom message categories must be numbered 90000 and above.

---

Procedure message categories need to be included as part of your deployment type configuration. When adding or changing step messages, you need to create and activate a new mobile application deployment to reflect your recent changes. Refer to [Creating a Deployment](#) for more information.

## Effective Dated Procedures

Some types of procedures may only be required at certain periods. If you specify an effective period on the procedure type, the system would only enforce it during that time.

## Attendance

You can set the procedure type to require that the crew takes attendance of who was present during completion of the procedure. All of the mobile workers assigned to the crew shift are listed for the crew leader to indicate whether or not they were present.

## Override Results

The system does not allow the business activity to commence until all required procedures are passed. If procedure override is allowed, the crew can bypass a failed procedure so it is considered as passed.

Depending on your business practices, the procedure type may or may not be configured to allow the crew to override or bypass a failed procedure as necessary.

## Designing Procedure Types

Analyze your procedures and procedure forms to determine how they can be transformed to be used with this feature.

Plan your procedure type configuration as follows:

Classify your procedure forms as being related to activity types, vehicle types, or service classes.

Determine whether crews are allowed to override and proceed the requested change to the shift or activity if the questions are not answered correctly, or if the procedure fails and requires remediation by the crew before the shift or activity can continue.

Determine whether taking attendance is required..

- Review the actual steps to complete the procedure and determine whether the base questionnaire business object may be used or if a custom business object is needed. If using the base questionnaire business object, create message categories to define procedure steps.
- Use the Procedure Type portal to define your procedure types, referencing the procedure business object base or a custom one. Refer to [Defining Procedure Types](#) for more information.
- Associate the procedure types with activity types, vehicle types, and service classes as needed.

## Defining Procedure Types

This portal is used to display and maintain a procedure type.

You can access the portal from the **Main Menu > Resource Management > Procedure Type**. You are brought to a query portal with options for searching for a specific procedure type. Once a procedure type has been selected you are brought to the maintenance portal to view and maintain the selected record.

The **Procedure Type** zone on the portal's **Main** tab page provides information about the procedure type.

### Where Used

Follow this link to open the data dictionary where you can view the tables that reference [M1\\_PROCEDURE\\_TYPE](#).

## Timesheet

---

### Understanding Timesheet Configuration

This section describes various features controlled by timesheet configuration.

Refer to [About Timesheets](#) for more information.

### Timesheet Business Objects Control Everything

The base product handles the process of preparing timesheet records for all mobile workers that worked as a crew using the "Crew Timesheet Process" business object. The crew process timesheet record is created using the **Timesheet Process Typeglobal configuration** parameter.

The crew process business object initiates the individual timesheet records for each mobile worker using the "Resource Timesheet" business object. These timesheet records are created using the **Timesheet Typeglobal configuration** parameter.

If these timesheet types are not specified on the Global Configuration record, timesheet functionality is not enabled for your organization.

Your implementation may extend or customize the base business objects or introduce custom business objects as needed. Refer to [Designing Timesheet Types](#) for more information.

### Work And Travel Time 'Buckets'

You may track travel time as well as time working on a task using different "buckets" for different task types.



## Designing Timesheet Types

Timesheet functionality allows your organization to more easily use the time information which is collected within the application as shifts are completed. Analyze how timesheet information is used by your organization and design customizations as needed.

This section discusses topics related to customizing and extending the base timesheet functionality.

## Integration with Timekeeping Systems

Timesheet information can be exported to external timekeeping systems or other applications as needed. The actual process to interface a timesheet record to an external system is not provided out of the box and has to be customized.

A timesheet record in the processed state is ready for extract to an external system. Depending on how your system integrates with the external timekeeping system, you can create a custom algorithm that on entry to the processed state, sends a message to the external system.

Alternatively the external system may poll for processed timesheet records.

## Approval

The "Resource Timesheet" business object assumes no further approval is necessary once the mobile worker accepts their timesheet record and marks it reviewed. Once reviewed, the timesheet record is considered processed and ready to be interfaced to an external system, if such custom process has been implemented.

You may introduce custom logic to require manager approval as follows:

- Set up a custom algorithm to automatically transition a reviewed timesheet record to the **Pending Approval** state instead of the **Processed** state. The algorithm should be based on the **Generic Business Object Status Monitor (F1-GEN-BOMON)** algorithm type.
- Plug your custom algorithm on the **Reviewed** state before the base algorithm.
- A user would need to approve or reject the timesheet record as needed.

## Configuring Timesheet Options

Follow the steps in the order they are described in this section to configure timesheet options.

## Defining Timesheet Types

This portal is used to display and maintain a timesheet type.

You can access the portal from the **Main Menu > Resource Management > Timesheet Type**.

The following zones may appear as part of the portal's **Main** tab page

- **Timesheet Type List.** This zone lists all timesheet types. Broadcast a record to display the details of the selected record.
- **Timesheet Type.** This zone provides information about the selected timesheet type.

### Where Used

Follow this link to open the data dictionary where you can view the tables that reference [M1\\_TIMESHEET\\_TYPE](#).

## Defining Custom Timesheet Time Types

By default travel and work time is summarized across all task types. If your business requires that travel and work are summarized separately for specific types of work you may introduce new timesheet time types in the **Timesheet Time Type (M1-TimeSheetTimeType)** extendable lookup and reference them on the corresponding task types. The timesheet time types should be set up to conform to your external timekeeping system. For example, you may want all meter work to be grouped into one timesheet time type and all collections work in another

## Enable Timesheet Functionality

To enable timesheet functionality, reference the timesheet types for the crew process and for the mobile worker in the [Global Configuration](#) record.

This is also where you state whether or not mobile workers are allowed to adjust the timesheet times as calculated by the system at the end of their shift.

Also, ensure that the **Timesheet Monitor** batch process is run periodically. The batch is mainly needed to handle situations where timesheet calculation is waiting for some task completion errors to be resolved. Refer to [M1-TIMSHT](#) batch control for more information.

## Mail

---

### Defining Mailing Lists

This portal is used to maintain mailing lists.

Refer to [About Mail](#) for more information.

You can access this portal from the **Admin Menu > Mail Management > Mailing List**.

The following zones may appear as part of the portal's **Main** tab page

- **Mailing Lists.** This zone lists all mailing lists. Broadcast a record to display the details of the selected record.
- **Mailing List.** This zone provides information about the selected mailing list.
- **Mailing List Users.** This zone allows you to view users currently in the selected mailing list as well as remove users from the list.
- **Add Users.** This zone allows you to add more users to the selected mailing list

#### Where Used

Follow this link to open the data dictionary where you can view the tables that reference [M1\\_MAILING\\_LIST](#).

### Defining Mail Templates

This portal is used to maintain mail templates.

Refer to [About Mail](#) for more information.

You can access this portal from the **Admin Menu > Mail Management > Mail Template**.

The following zones may appear as part of the portal's **Main** tab page

- **Mailing Lists.** This zone lists all mailing lists. Broadcast a record to display the details of the selected record.
- **Mailing List.** This zone provides information about the selected mailing list.
- **Mailing List Users.** This zone allows you to view users currently in the selected mailing list as well as remove users from the list.
- **Add Users.** This zone allows you to add more users to the selected mailing list

#### Where Used

Follow this link to open the data dictionary where you can view the tables that reference [M1\\_MAIL](#).

## Transfer of Goods

---

### Understanding Transfer of Goods

This section describes topics related to configuring transfer of goods options.

Refer to [About Transfer of Goods](#) for more information.

### Depot Related Business Objects

The following entities may need to be defined using designated depot related business objects:

- **Activity Types.** Depot based activities involve either loading goods at a depot center and delivering them to a customer location or, collecting goods from a customer location and returning them to a depot center. Whether the activity is picking up goods or dropping them off is defined on the activity's type. The activity type needs to be defined using the depot based business object.
- **Activities.** Depot related activities specify depot information and other goods related information. These activities and their assignments need to be managed by depot related business objects.
- **Depot Transfer Activity Types.** Depot transfer jobs are used to transfer goods between depots. Each job consists of a pair of depot transfer activities, one activity loads the goods from a source depot and the other unloads them at the destination depot. Whether the transfer activity is picking up goods or dropping them off is defined on the activity's type. The activity type needs to be defined using the depot based business object.
- **Depot Transfer Activities.** Depot transfer activities specify depot information and other goods related information. These activities and their assignments need to be managed by depot transfer business objects.
- **Break Types.** If breaks need to be taken at the depot, their break type should be defined using the depot related business object.
- **Vehicle Types.** If your business leverages maximum [load capacity limits](#) of vehicles, these are defined on the vehicle type. To specify these limits on a vehicle type your implementation must use the capacity related vehicle type business object that supports vehicle capacities.
- **Crews.** For single person crews that need to be restricted to specific depots use the depot related crew business object.
- **Crew Shifts.** If your business leverages maximum [load capacity limits](#), these may be overridden on a specific shift for exception handling. This functionality requires that you use the depot based shift business object.

### Depot Task Types

The scheduler generates depot tasks as needed when planning depot runs to and from depot centers.

The system uses the depot task type specified on the depot or depot profile level and, if not specified, it uses the depot task type referenced on the [global configuration](#), to generate the depot tasks.

---

**NOTE:** If a depot task type cannot be determined for a depot, the scheduler disables the scheduling of all activities associated with the depot.

---

## Using Capacity Limits

Using load capacity limits as a scheduling consideration is optional. If this functionality is needed, you may specify up to 5 types of capacity limits on designated lookup fields.

The types of load capacity limits to consider such as weight, volume, size etc must be configured before they can be used to describe the load on the activity, the maximum load a vehicle can carry, as well as the maximum load a depot can handle during a time windows.

Refer to [Defining Types Of Load Capacity](#) for more information.

## Configuring Transfer of Goods

The following guidelines provide a basis for transfer of goods configuration.

### Defining Types Of Load Capacity

If you are using cumulative capacities to describe goods, such as weight, volume etc, override the descriptions of up to 5 capacity types defined in the lookup *MI\_CUMULATIVE\_CAPACITY\_FLG* to enable them.

---

**NOTE:** The system supports a way to calculate the amount of time it takes to transfer goods at a depot's bay as a function of the bay's service rate and the quantity of goods specified on an activity. If this functionality is applicable to your operations make sure to define the first cumulative capacity to describe quantity of goods being transferred. Refer to [Handling Various Categories of Load](#) for more information.

---

If you are using non cumulative capacities to describe goods, such as size, override the descriptions of up to 5 capacity types defined in the lookup *MI\_NONCUM\_CAPACITY\_FLG* to enable them.

If you are using maximum cumulative capacities to describe maximum load, such as maximum weight, maximum volume etc, override the descriptions of up to 5 maximum capacity types defined in the lookup *MI\_MAX\_CAPACITY\_FLG* to enable them.

If you are using maximum non cumulative capacities to describe maximum load, such as maximum size, override the descriptions of up to 5 maximum capacity types defined in the lookup *MI\_MAX\_NONCUM\_CAPACITY\_FLG* to enable them.

Set up corresponding scheduler configuration costs for applicable cumulative and noncumulative capacity types. For example, if you defined "cumulative capacity 1" as "weight" then make sure you provide the cost for weight in the "cumulative capacity cost 1" parameter.

### Defining Depot Related Task Types

The following task types need to be set up to handle depot related work:

- Define depot task types as needed. Refer to [Depot Task Types](#) for more information.
  - If the crew handles the loading of process of goods at the depot based on a detailed list of items provided by the host system use the **Depot Task Items (M1-DepotTaskItems)** business object.

- If the crew does not handle an itemized load, use the **Depot Task (M1-DepotTask)** business object.
- Define depot related activity types.
  - Use the **Depot Related Activity Type (M1-DepotRelatedActivityType)** business object to define types of activities that involve distribution or collection of goods.
  - Reference the **Depot Related Activity (M1-DepotRelatedActivity)** business object on these types of activities.
  - If you are using only this business object to define activity types, you may want to update the other activity business objects to not allow new instances.
- Define depot transfer activity types. This is only applicable if your company uses the [depot replenishment](#) functionality.
  - Use the **Depot Transfer Activity Type (M1-DepotTransferActivityType)** business object to define the types of activities used for the loading step in a depot transfer job. Their depot activity class should be set to **Pick Up**.
  - Reference the **Depot Transfer Activity Load (M1-DepotTransferActivityLoad)** business object on these types of activities.
  - Use the **Depot Transfer Activity Type (M1-DepotTransferActivityType)** business object to define the types of activities used for the unloading step in a depot transfer job. Their depot activity class should be set to **Drop Off**.
  - Reference the **Depot Transfer Activity Unload (M1-DepotTransferActivityUnload)** business object on these types of activities.
- If breaks should be scheduled at the depot, define depot break types.
  - Use the **Depot Break Type (M1-DepotBreakType)** business object to define break types that should be scheduled at the depot.
  - If you are using only this business object to define break types you may want to update the other base break type business object to not allow new instances.

Refer to [Defining Task Types](#) to set up all these task types.

## Defining Depot Related Vehicle Types

If your implementation needs the ability to specify maximum load capacities on vehicle types, use the **Vehicle Type with Capacities (M1-VehicleTypeWithCapacity)** business object.

If you are using only this business object to define vehicle types you may want to update the other base vehicle type business object to not allow new instances.

Refer to [Defining Vehicle Types](#) to set up vehicle types.

## Defining Depot Related Crew Types

For single person crews that should be restricted to specific depots, use the **Depot Related Single Person Crew (M1-DepotSinglePersonCrew)** business object. Reference this business object when defining crew types.

If you are using only this business object to define crews you may want to update the other base crew business object to not allow new instances.

Refer to [Defining Crew Types](#) to set up vehicle types.

## Defining Depot Related Shift Types

If your implementation needs the ability to specify override maximum load capacities on a specific shift and other depot restrictions, use the **Depot Related Shift (M1-DepotRelatedShift)** business object. Reference this business object when defining shift types.

If you are using only this business object to define crew shifts, you may want to update the other base crew shift business object to not allow new instances.

---

**NOTE:** Depot related information is only applicable for actual shifts and not templates. The standard shift template business object should be used on the shift type even for depot related shifts.

---

## Defining Depot Transfer Shift Type

This section is only applicable if your company uses the [depot replenishment](#) functionality.

The system creates a new transfer shift when notified by the host system that a driver has arrived to the depot to start a transfer. The shift is created using the shift type specified on a feature configuration.

Define a transfer shift type as follows:

- Use the *Depot Transfer Shift Type (MI-DepotTransferShiftType)* business object to define the transfer shift type to use when creating [depot transfer shifts](#).
- Reference the *Depot Transfer Shift (MI-DepotTransferShift)* business object on this shift type.
- Find the [Feature Configuration](#) record for the *Schema Constants* feature type and populate the transfer shift type you created on the corresponding option. (It may need to be defined if it does not exist).

## Defining Depots

This portal is used to maintain depots and depot profiles.

Refer to [About Depots](#) for more information.

You can access this portal from the **Admin Menu > Resource Management > Depot**. You are brought to a query portal with options for searching for a specific depot. Once a depot has been selected you are brought to the maintenance portal to view and maintain the selected record.

The following zones may appear as part of the portal's **Main** tab page

- **Depot.** This zone provides information about the selected depot.
- **Override Time Windows.** This zone lists any override time windows for the depot. You can also use this zone to add a new override time window.
- **Cutoffs.** This zone shows a history of cutoff requests for the depot. The zone is only visible for a distribution depot.

The following zones may appear as part of the portal's **Schedule** tab page

- **Depot Gantt.** This zone displays a graphical representation of the tasks scheduled to this depot's bays on a time line. The Gantt works in a similar way as the dispatcher's scheduling Gantt on the CDI portal when toggled to view a single depot. Refer to [Using the Scheduling Gantt](#) for more information.
- **Scheduled Tasks.** This zone displays the list of tasks scheduled to this depot.

### Where Used

Follow this link to open the data dictionary where you can view the tables that reference [MI\\_DEPOT](#).

## Defining Bays

This portal is used to maintain a depot's bay.

Refer to [About Depots](#) for more information.

You can access the portal from the Bays zone on the Depot maintenance portal.

The following zones may appear as part of the portal's **Main** tab page

- **Bay.** This zone provides information about the bay.
- **Override Time Windows.** This zone lists any override time windows for the bay. You can also use this zone to add a new override time window.

The following zones may appear as part of the portal's **Schedule** tab page

- **Bay Gantt.** This zone displays a graphical representation of the tasks scheduled to this bay on a time line. The Gantt works in a similar way as the dispatcher's scheduling Gantt on the CDI portal when toggle to view a single bay. Refer to [Using the Scheduling Gantt](#) for more information.
- **Scheduled Tasks.** This zone displays the list of tasks scheduled to this depot.

## Contractor Management

---

### Understanding Contractor Configuration

This section describes concepts related to contractor management administration. This is only applicable if your company utilizes the contractor functionality.

Review your contractor agreements to determine which contracting model it follows and configure the system accordingly.

Refer to [About Contractors](#) for more information.

### Contractor Users

Irrespective of the contacting model used, any contractors that require access to the application must be set up as users and their user record must reference the resource group of their company. This is defined on the **Miscellaneous** tab of the User portal.

The system also supports the following method of associating contractor users with their company records:

- Mark the user as a contractor without specifying the specific company they work for. This is also defined on the **Miscellaneous** tab of the User portal.
- When done setting contractor users, go to the Resource Group record for each contractor company and associate the corresponding users to it.

---

**NOTE:** If not associated with a contractor's resource group users are considered company users. As such, they are allowed access to entire data.

---

Contractor users must only be allowed access to the certified application components for contractor users to ensure they have access to data related to their company only. Refer to [Shift Based Model Security](#) and [Capacity Based Model Security](#) for more information.

### Shift Based Model Security

In the shift based model only mobile workers need to have access to the system. All other user roles are assumed to be company users.

The base product secures the following portals to ensure the data accessed by a contractor mobile worker is restricted to their data only:

- Activity Search. All base query options are secured.

- Activity
- Assignment
- Crew Shift Search. All base query options are secured.
- Crew Shift
- Break / Non Productive Task
- POU
- Depot Task
- My Calendar portal

Contractor mobile workers must be associated with their contractor company on the user record and belong to a user group that provides limited access to these transactions.

---

**NOTE:** Do not provide access to any transaction that is not in the secured list.

---

**NOTE:** It is recommended to define a designated shift based mobile worker user group as well as a template record that belongs to that user group. Use the template to set up shift based contractor users. Refer to the **Accelerator** environment provided with the product for a recommended user and user group configuration.

---

## Capacity Based Model Security

---

**NOTE:** If your company integrates with the contractor company's system via web services, there is no need to grant access to any contractor user.

---

When applicable, part of your business practice might be to provide contractor users access to the Contractor Work Management portal or the contractor mobile application to manage work committed to their company. Any individual who will need to access these parts of the application needs to be set up as a contractor user.

Refer to [Managing Committed Work](#) for more information.

The base product secures the following portals to ensure the data accessed by a capacity based contractor users is restricted to their data only:

- Contractor Work Management
- Activity Search. All base query options are secured.
- Activity
- Assignment
- Capacity Search. All base query options are secured.
- Capacity

Contractor users must be associated with their contractor company on the user record and belong to a user group that provides limited access to these transactions.

---

**NOTE:** Do not provide access to any transaction that is not in the secured list.

---

**NOTE:** It is recommended to define designated capacity based manager and worker user groups as well as template records that belongs to these user groups respectively. Use the appropriate template to set up contractor managers and workers as needed. Refer to the **Accelerator** environment provided with the product for a recommended user and user group configuration.

---



## Contracting Work

Settings on the activity type indicate whether the activity should be worked by company crews only, any resource (including contractors), or restricted to shift-based crews (which can be composed of internal resources and/or contractors).

Review your activity types to determine which types of activities can be worked by contractors.

## Configuring Shift Based Contractors

Plan your shift based contractor configuration as follows:

- Define a Resource Group Type for shift based contractors. Refer to [Defining Resource Group Types](#) for more information.

For each shift based contractor company, complete the following set up:

Set up a resource group for the contractor company based on the shift based resource group type.

- Set up their mobile workers as contractor users in the system, associating the user records with the contractor company's resource group. Refer to [Contractor Users](#) for more information.

Set up their mobile workers, vehicles, and crews referencing the contractor company they belong to.

Create crew specific shift templates or subscribe these crews to common templates to generate their shifts just as you would for company crews.

Set up MDTs as needed if these crews would be using the mobile application.

---

**NOTE:** Only mobile workers should be provided with user access to the system. All other roles are assumed to be company employees. Your organization should define contractor users based on user groups that provide them with access only to the certified transactions that apply data security.

---

## Configuring Capacity Based Contractors

Plan your capacity based contractor configuration as follows:

- Define a Resource Group Type for capacity based contractors. Refer to [Defining Resource Group Types](#) for more information.

For each capacity based contractor company, complete the following set up:

- Set up a resource group for the contractor company based on the capacity based resource group type. Review the contractual agreements with the contractor company to properly reflect expectations around notification lead time, approval time, and service area coverage.
- When applicable, set up their users as contractor users in the system, associating the user records with the contractor company's resource group. Refer to [Contractor Users](#) for more information.
- Create capacity weekly templates to generate their capacities as per contractual agreements.
- If the contractor company integrates with your system via web services, you need to customize the message exchange between their services and the base product services. Refer to the [Contractor Management](#) integration section for more information.

## Defining Resource Group Types

This portal is used to maintain resource group types. Resource group types define classifications for various types of contractor companies doing work with your organization.

Refer to [Resource Groups](#) for more information.

You can access this portal from the **Admin Menu > Resource Management > Resource Group Type**.

The following zones may appear as part of the portal's **Main** tab page

- **Resource Group Type List.** This zone lists all resource group types. Broadcast a record to display the details of the selected record.
- **Resource Group Type.** This zone provides information about the selected resource group type.

### Where Used

Follow this link to open the data dictionary where you can view the tables that reference [M1\\_RESRC\\_TYPE](#).

## Configuring Capacity Model Options

This section describes topics related to configuring capacity based contractors options.

## Defining Capacity Types

Capacities represent an external contracting company's agreement to take on a certain amount of work of a certain type in specific service areas for a period of time. Capacities can be defined by number of hours or number of activities, as defined on their capacity type.

This portal is used to maintain capacity types.

You can access this portal from the **Admin Menu > Resource Management > Capacity Type**.

The following zones may appear as part of the portal's **Main** tab page

- **Capacity Type List.** This zone lists all capacity types. Broadcast a record to display the details of the selected record.
- **Capacity Type.** This zone provides information about the selected capacity type.

### Where Used

Follow this link to open the data dictionary where you can view the tables that reference [M1\\_CREW\\_SHFT\\_TYPE](#).

## Integration with Contractor Systems

This step is only relevant if you need to integrate with the contractor company's system.

When an activity is committed to a capacity contractor, the system sends the activity details to the contractor. Such message is also sent when key activity details have changed or the activity has been recalled from the contractor company.

Outbound messages to a contractor company's system are directed to the external system referenced on their resource group record. Set up an [External System](#) record to support such communication.

Refer to [Managing Committed Work](#) for more information.

The kind of messages supported are configured in an extendable lookup. Add a record to the **External System Messages (M1-ExternalSystemMessages)** extendable lookup that matches the external system code you have set up for the contractor company's system. Populate the appropriate message information to enable it or mark it as not applicable.

Refer to [Configuring Outbound Messages](#) for more information.

## Mobile Application

---

### Understanding Mobile Devices

Mobile devices such as laptops, cellular phones, tablets, and other mobile devices may be used to interface with the system via the supported mobile applications. The mobile application and data reside locally on the mobile device allowing the crew to work offline as needed.

This section describes concepts related to device management administration.

### Mobile Platform

The mobile solution consists of a thin runtime installed on the device, the mobile application files, and metadata. The mobile applications are built using HTML5 and JavaScript on top of the Oracle Utilities Mobile Library (OUML) platform. The application communicates with the server via RESTful Services exposed by the main application.

The mobile applications require metadata (such as lookups, business object definitions and more ) to function. All files for all mobile application reside in a shared location on the server. It is the metadata that controls the behavior and functionality unique to each mobile application. The metadata package for each mobile application is also known as a deployment.

The URL entered at application startup is the URL used for both communication with the server and locating the mobile application HTML5 and JavaScript files. The deployment is downloaded once the user selects which mobile application they will be using.

Refer to [Understanding Deployments](#) for more information.

This approach makes it easier to push out applications changes to crews without having to reinstall the application on the device. The footprint on the device is kept to the minimal allowing the rest to be downloaded at start time from the server. The thin runtime can be downloaded from the application store and is assumed to be rarely updated. Customers can make as many changes as they like to the application HTML5 and JavaScript files without having to physically reinstall anything on the device.

---

**NOTE:** This section does not apply to mobile applications implemented using the legacy Java based mobile communication platform. These applications are still supported in this release for existing customers only. Support for such applications will be dropped in the next release. Refer to [Understanding Mobile Application Files](#) as well as [Understanding The Legacy Mobile Platform](#) for more information.

---

### Mobile Device Terminals (MDT)

You must create an MDT record for each physical device that will use a mobile application to communicate with the main server application. The MDT record has to be uniquely identified by a device tag.

The product provides a replicator tool on the MDT portal that may be used to create many MDT records that share the same device tag prefix.

An MDT Type defines attributes common to mobile devices of a certain type such as the [mobile platform](#) applicable to that type, logging, ports, attachment maximum size, and so on.

---

**NOTE:** You should only use the **Restful Service Device** mobile platform to take advantage of the base products mobile applications. All other mobile platforms represent various options of the legacy Java based mobile communication platform that will be dropped in the next release.

---

## Registration

The first time a mobile user runs the mobile application, they will be required to register their mobile device.

The system will ask for the MDT Tag and the URL of the server application. The MDT Tag is a unique, user-defined identifier that is assigned to the device when the MDT record is created on the server application.

As part of the registration process, the system posts the device's unique ID on the MDT record on the server. Various mobile platforms like iOS, Android, and Windows provide a system level API to get the device's unique hardware ID which is used as the device's unique ID.

Once the device is registered, the mobile user will be able to log on to the application from that device without further prompting.

All the platforms return the same ID consistently, except for iOS that assigns a unique ID for the application when it is installed. This means that for iOS, the MDT's unique ID changes each time the application is uninstalled and installed again. In this situation, you would need to reset the unique ID stamped on the MDT record after reinstalling the application. Use the **Reset Registration** action on the MDT portal to do so.

## Sending GPS Data

The MDT Type specifies whether the device has GPS capability, the GPS port, how frequently to poll the device, and how frequently to send data to the server. Whether or not GPS data is sent to the server is controlled by the mobile application.

When this functionality is enabled, the mobile application sends batches of GPS data to the server in the frequency configured on the MDT type. The GPS data is associated with the crew using the device.

Refer to [Sending Current Location](#) for more information.

## Managing Attachments

The MDT Type may set a limit for the total size for attachments on mobile devices of that type. When a user attempts to download an attachment, the system validates that the total size of the download plus what is already on the mobile device will not exceed the maximum for the mobile device. The total size specified should take into account common attachments that are included as part of the mobile application [deployment part](#) configuration. These are automatically downloaded along with the mobile application.

When using the Hybrid mobile application you may also limit the size of individual attachments captured in the field by different device types by setting an attachment size restriction on the MDT type.

## Data Encryption

You have the option of enabling or disabling data encryption globally as well as for specific devices.

Use the **Data Encryption**[global configuration](#) parameter to either turn it on or off globally.

Each MDT has a data encryption setting which you can set to either use the global default, or turn it on or off for this device.

# Understanding Mobile Application Files

The mobile application consists of the Oracle Utilities Mobile library and application layers responsible for specific business functionality. It uses HTML5 and JavaScript to implement business logic, render the user interface and interact with mobile device services. RESTful services facilitate communication between the mobile application and the application server.

The following diagram illustrates the mobile application architecture in a high level.

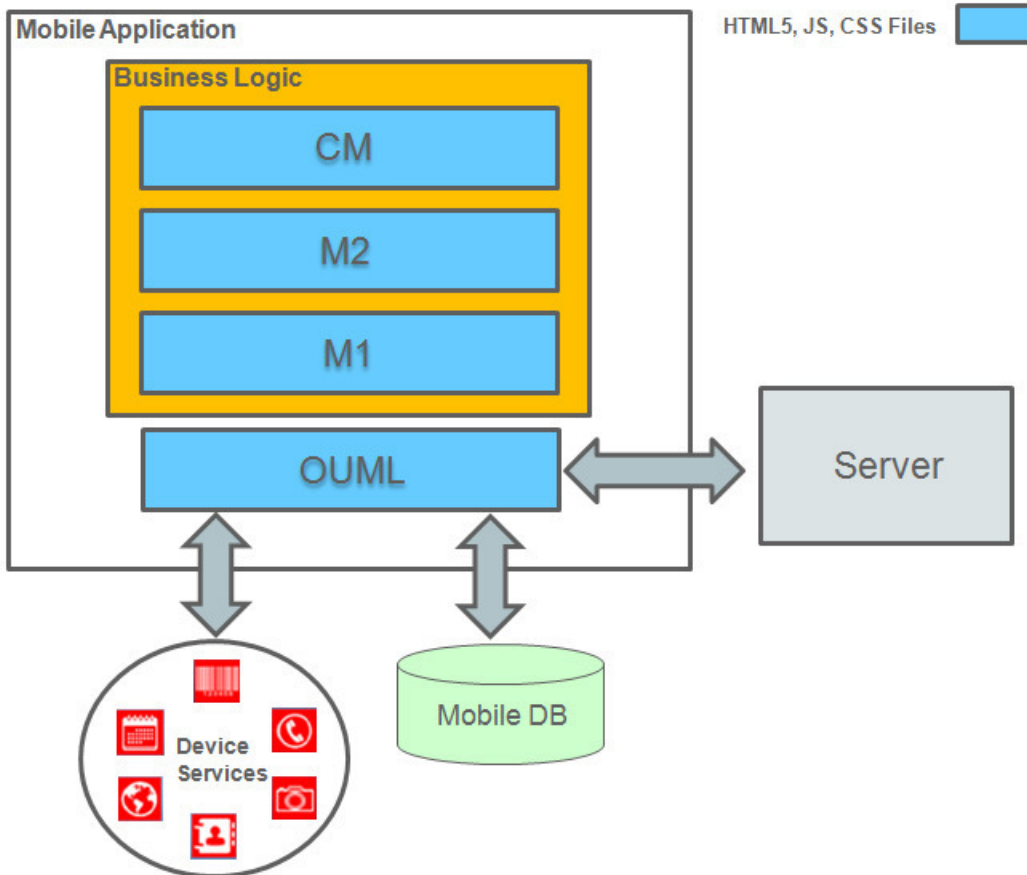

Figure 6: Mobile Application Architecture

The following sections describe concepts related to the mobile application solution as well as how your implementation may extend it to meet your mobile application requirements.

## Oracle Utilities Mobile Library (OUML)

The Oracle Utilities Mobile Library provides a foundation layer and APIs for application development including offline storage, encryption, communication, logging, configuration, UI rendering, navigation, customization, deployment and so on.

The library of APIs is optimized to work with Oracle Utilities Application Framework (OUAF) based services, configurations and metadata mainly around supporting the notion of business objects.

Inbound and outbound communication between the mobile application and server is based on RESTful services and JSON payload. Messages to the server are stored in the device's local database and then forwarded to the server. In situations

where device is offline at the time of making an outbound request the communication module of the mobile application ensures the delivery of the message when device is back online and communication with server is reestablished.

## Business Logic Resides in Mobile Components

Business logic supporting the various types of mobile application deployments is implemented in the form of mobile components of the following types:

- Standalone pages. For example Task List.
- Business objects. For example the crew's shift, tasks they need to perform and so on.
- Shared components include:
  - **Business Object Status Enter and Post Processing** plug-ins. These implement business rules triggered when a business object transitions to a new state in its lifecycle or updated respectively. The same plug-in may be associated with multiple business objects.
  - Services. A service implements an independent function that can be called from various places in the application.
  - UI Sections. These model reusable form sections that can be references on multiple pages.
- A library of common functions. Implements a library of functions that can be shared across the application.
- Inbound Messages. Implements an inbound message from the server.
- Product Configuration. Defines global settings for the mobile application.
- Themes. Defines swatches and styles for the mobile application.

The following sections describe how mobile components are implemented and used.

### Mobile Component Ownership

Mobile components are system-owned records stored in a designated maintenance object. The base product is released with all the necessary mobile components needed to support its mobile applications.

You may implement new custom mobile components to meet your organization's mobile application requirements.

As a rule, only the component's owner is allowed to change and delete it. However, some types of components allow custom extensions where custom content may be added to base components. For example, you may customize a base owned business object mobile component to add more plug-ins when it transitions to a specific state, etc.

### Mobile Component Editor

Mobile components are implemented using a browser-based editor. Use the Mobile Component portal to author custom mobile components as well as extend the content of base components.

## Packaged by a Batch Process

The source of mobile components is stored in the database and as such can be migrated from one environment to another using standard tools such as Bundling and CMA.

The mobile application requires this content (HTML, JavaScript and CSS etc) to be available in the form of files. The **Build Mobile Component Package** batch process needs to run to generate files based on mobile component content and package them into an application bundle file on a shared location on the server. The bundle is downloaded when the application is launched from the mobile device.

The following illustration shows how mobile components are converted to files and packaged along with the OUML files as the mobile application bundle.

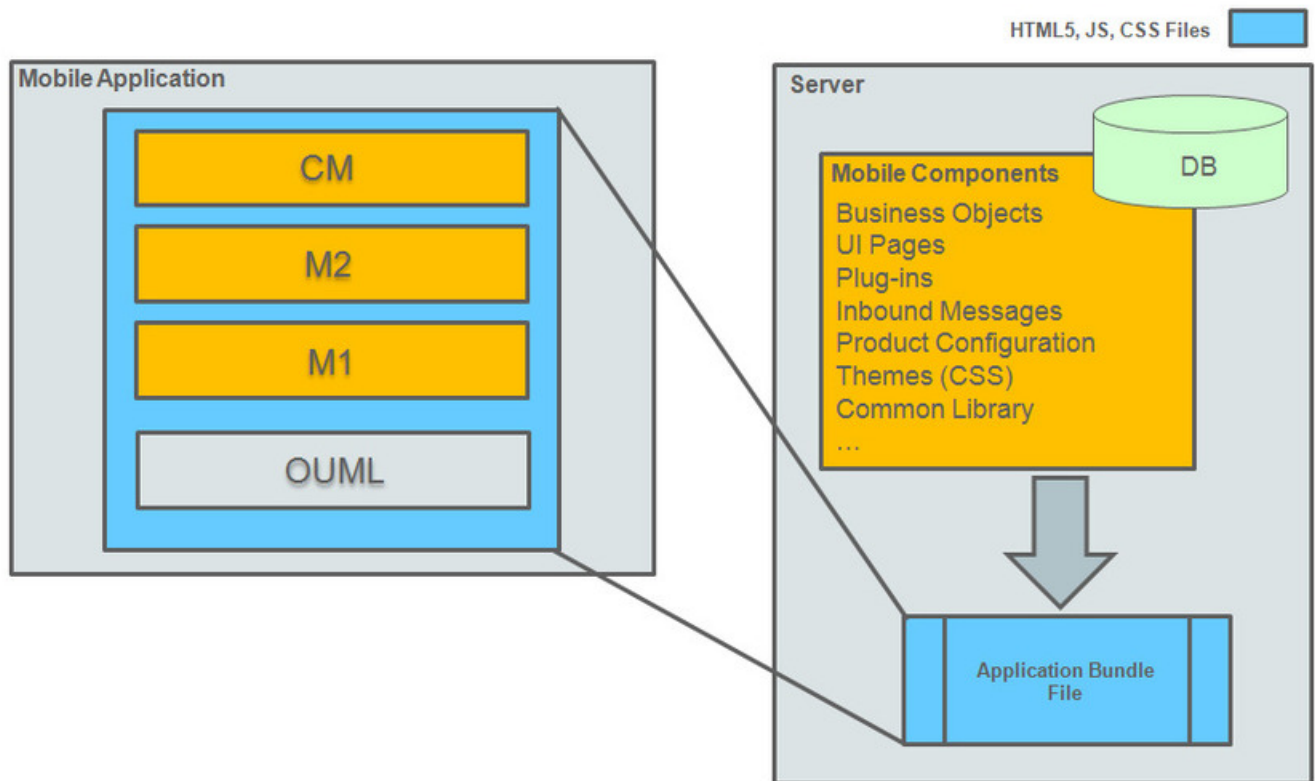

Figure 7: Mobile Application Bundle

**NOTE:** The **Build Mobile Component Package** batch process should run on demand to package the mobile application bundle as a zip file. Refer to [M1-BMCOM](#) batch control for more information.

## Testing

The mobile application is packaged and deployed as a client application in the format native to the supported runtime platforms. The files in the mobile application bundle are downloaded to the mobile device when the client application is launched.

The following illustration describes how to test the mobile application on a mobile device.

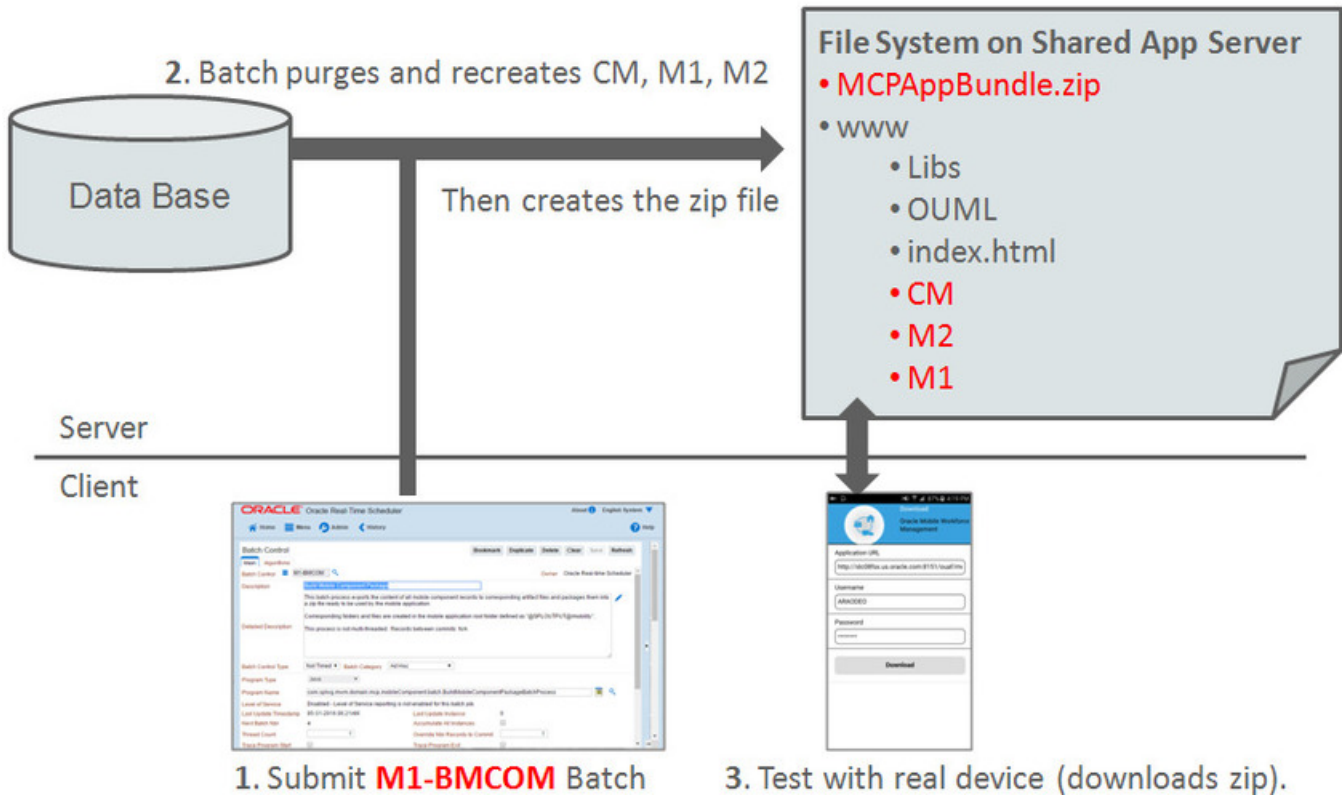

Figure 8: Mobile Device Testing Illustration

For testing and development purposes, the mobile application files be directly accessed as a web application using Chrome browser. This approach does not require the files to be bundled.

To simplify browser-based testing in a shared application server, content changes made via the mobile component editor are also automatically synced to the corresponding file in the shared file system. You do not need to run the packaging batch process when testing this way.

The following illustration describes this process.



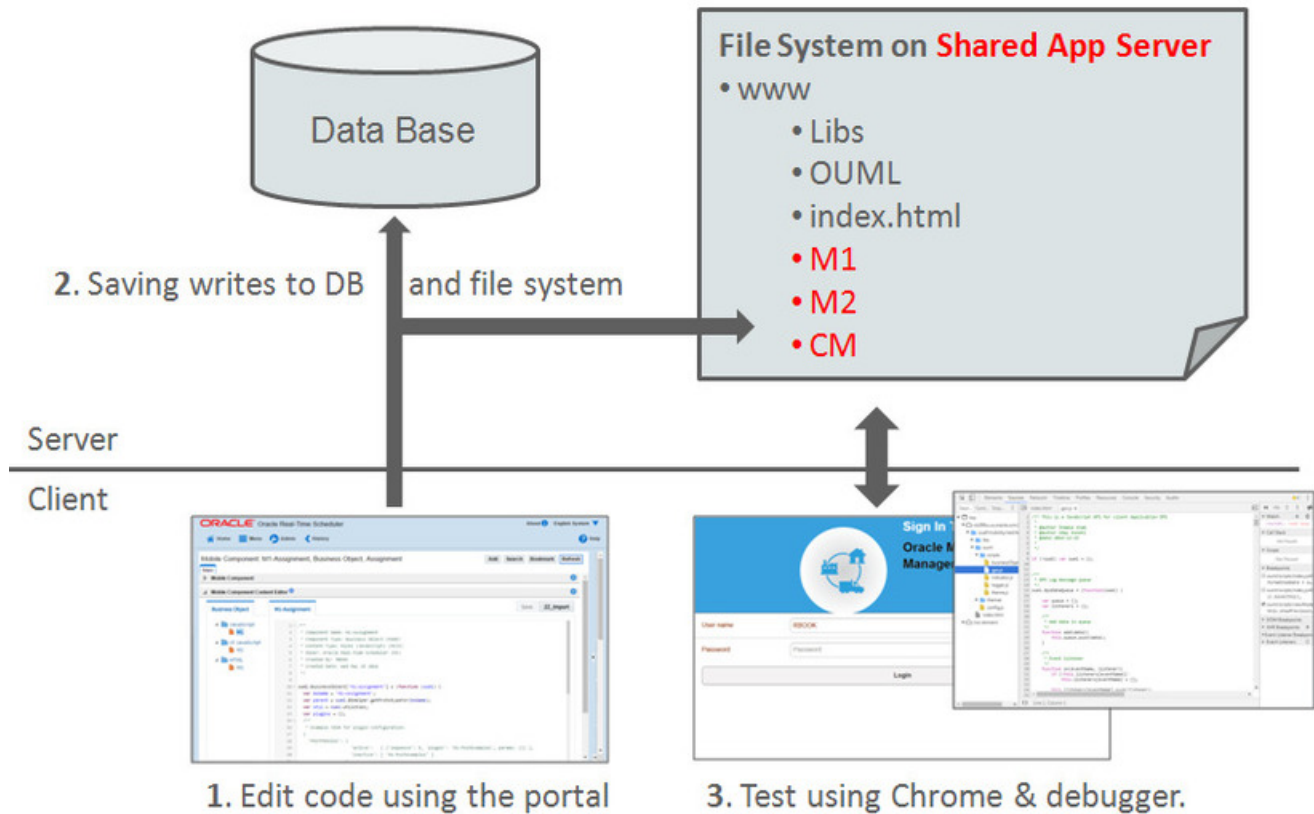

Figure 9: Shared Development/Testing Illustration

Use these steps to test the application using Chrome:

- If not already installed, install the Google Chrome desktop browser.
- Create a shortcut to the executable on your desktop.
- Right-click the shortcut and choose Properties, then append the following to the Target property to disable cross-domain JavaScript security:

```
--user-data-dir="C:/Chrome dev session" --disable-web-security --allow-file-access-from-files --allow-file-access
```

- Start Chrome via the shortcut and load the mobile application at: `http://server:port/ouaf/mobility/rest/test/www/index.html`

Note that certain device specific features, such as barcoding, capturing a picture, etc., are not available when the application is accessed this way. Testing these features must be done using the native application.

**WARNING:** Chrome must NOT be used in a production environment. It is only certified to be used for development and debugging purposes.

## Understanding Deployments

A deployment refers to a specific cut of application metadata and control records needed to support a mobile application of a specific type and language. The deployment is downloaded to the mobile device terminal (MDT) by the corresponding mobile application.

This section describes topics related to managing mobile application deployments.

## Deployment Types

A deployment type represents the configuration needed to support an application of a given type. You can configure multiple types of applications by setting up a deployment type for each.

A deployment type configuration defines the following aspect of the mobile application:

- The application items included in the application, by referencing deployment parts.
- The initial function that starts the business flow on the device when the application is launched.
- The MDT Types compatible to run this type of application.
- The authorized user groups that are allowed to use the mobile application.
- The application message categories used by the mobile application.

## Deployment Parts

Deployment parts provide a way to create reusable groups of application items. A deployment part is a collection of application components, such as business objects, lookups, task types, and many more that are needed to support the mobile application.

The base product provides preconfigured deployment parts that include the base mobile application components. You only need to configure parts to include your custom entities. If you need to add custom deployment items, it is strongly recommended that you include them in designated custom deployment parts and not directly add them to base product deployment parts. Make sure to include your custom deployment parts as part of your deployment type setup.

Create deployment parts to represent subsets of your custom deployment items based on their type or usage. You should share deployment parts across deployment types when applicable to prevent redundancy and improve management of deployment configuration. For example, use a designated deployment part for control data, another for items that are common across platforms, another with user interface items for a specific platform etc.

To simplify the collection of items in a deployment part it is recommended that you create an export bundle per deployment part so that implementers can add their new or changed items directly to the corresponding bundle using the dashboard zone. Once items are collected, the bundle can be uploaded to the deployment part. You can always maintain items manually on a deployment part.

Consider where attachments must be automatically pushed to crew and add them to your deployment parts.

## Deployment

A deployment can only be created using the **Create Deployment (M1-DPLOY)** batch process. Once your deployment type setup is complete, submit the batch to create a new deployment for your deployment type for a specific language.

By default, once the batch job runs and the deployment has been created, it has to be manually activated on the deployment portal before it can be deployed to any devices. Alternatively, you may set a batch parameter to automatically activate the new deployment.

---

**NOTE:** The **Create Deployment** batch process should run on demand or periodically based on your business needs to avoid situations where out of dates deployments are being used. Refer to [M1-DPLOY](#) batch control for more information.

---

## Out of Date Deployments

Deployments become out of date when a new mobile application version is released, the deployment type configuration changes, or any underlying application component that is part of the configuration changes.

Mobile users are warned at login to their mobile device that they are using an out of date deployment. The user is allowed to continue, but is advised to contact their administrator to synchronize their deployment. Refer to [Downloading Deployments](#) for more information.

The product provides a batch process that evaluates existing active deployment records and marks those that are out of date if it detects any metadata changes. The background process also purges out of date deployments that are older than a specified number of days.

---

**NOTE:** The **Deployment Evaluation and Purge** batch process should run on demand or periodically based on your business needs to avoid situations where out of dates deployments are being used. Refer to [MI-DPUTD](#) batch control for more information.

---

Also note that as part of accepting a new product release, all existing deployments are marked as out of date. New deployments are required to be created and activated.

When an active deployment is marked out of date, the system creates a To Do entry in order for a user to create a new deployment as needed. Creating a new deployment for the same deployment type and language automatically closes any remaining To Do entries reported for out of date deployments for the same configuration.

## Downloading Deployments

Once a deployment has been activated, it is available for download to mobile devices. When the mobile user logs on to the mobile application, the system looks for the most recent version of all active, qualified deployments based on the user's user group, language, and MDT type.

If no deployments are found, the system displays an authorization error message and prevents the user from continuing.

If only one deployment is found and it is the same as the one currently deployed, then the deployment is not downloaded.

If only one deployment is found and it is newer than the one currently deployed or there is none currently deployed, then the deployment is downloaded to the mobile device.

If more than one deployment is found, the user can select the one they want to download.

---

**NOTE:** A new deployment will not be downloaded if unprocessed data from a previous shift still exist on the device. The system warns that user of the situation. If the user is authorized to use the deployment currently on the device, it will be used; otherwise, an authorization error will be displayed

---

## Mobile Application Versioning

The mobile application communication architecture involves both client side and server side elements. These must be compatible or else errors will occur. To enforce compatibility, the system validates the mobile application version as follows:

- When the mobile device attempts to connect to the server, the system versioning check validates whether or not the mobile application version on the mobile device is compatible with the mobile application version on the server. If the versions are not compatible, the device is not allowed to work online and no communication is sent to and from the server.

- In this situation, the mobile device must be upgraded to the correct version before it can work online again. If there was data on the mobile device, the user can continue offline and manually collect any data they need before the mobile device is upgraded.
- When a deployment is created on the server, it is marked with the version number of the server side mobile application components that created it. Then when a mobile device logs on to download a deployment, only deployments with compatible mobile application versions can be downloaded. This prevents the incompatible version situation described above.

---

**NOTE:** Before the server is upgraded, all crews using the mobile application must be allowed to end their shift successfully from their mobile devices and logoff. This will prevent the need for manual data copying. Use the crew shift search query option to find such shifts and coordinate their successful completion before server side upgrade.

---

**NOTE:** Also note that, with each new product version, existing deployments stamped with the older version are marked as out of date.

---

The **About** screen on the mobile device shows the mobile application version number. This version is also marked on the MDT record on the online mobile device screen. Deployments show the mobile application version as well on the online user interface.

## Setting Up Deployments

This section summarizes steps involved in configuring your deployment types:

- Review the various types of devices your crews would be using and set up corresponding MDT types.
- Define MDT records for each mobile device.
- Create deployment parts to represent subsets of your custom deployment items based on their type or usage.
- Set up a deployment type for each type of application you need to support. For example, the product supports a mobile application for a crew to work their schedule, and another application for a contractor worker.
- Associate deployment parts to appropriate deployment types.
- Associate MDT Types to appropriate deployment types.
- Identify the user groups authorized to use each type of mobile application and associate them with appropriate deployment types.
- Associate MDT Types to appropriate deployment types.
- When you have finished defining each deployment type, you must run a batch process to create a deployment for it and each language supported by your company.
- Activate each deployment, if not already activated by the batch process.

## Understanding The Legacy Mobile Platform

This section provides information relating to the Mobile Communications Platform (MCP).

---

**NOTE:** Custom mobile applications implemented using the legacy Java based mobile communication platform are still supported in this release for existing customers only. Support for applications implemented on the legacy platform will be dropped in the next release.

---

# Mobile Application Connection Modes

The mobile application can be used in a disconnected or connected mode.

## Disconnected Mode

In disconnected mode the mobile application and data reside locally on the mobile device allowing the crew to work offline as needed. This means the physical device has to be compatible with the mobile application requirements it runs locally.

You must create an MDT record for each physical device that will communicate with the main server application.

Refer to [Understanding Mobile Devices](#) for more information..

## Connected Mode

In connected mode neither data nor the mobile application reside locally on the accessing mobile device. Instead the data and mobile application reside on the server and the user must be connected to the server at all times using their standard browser to access the mobile application. This should not be confused with the server application. This is the mobile application presented in a regular internet browser.

The actual physical device used to access the mobile application in a connected mode is irrelevant since the application is not run locally and therefore registering the specific device in the system is not needed. The system however, still needs an MDT record for the mobile application to work properly, but it is not related to the physical accessing device.

To access the mobile application in connected mode, the user needs to reference your organization's mobility server URL in a browser, as they would any website, and enter their username and password. After the user is authenticated, the system allocates an MDT record of a connected platform MDT Type from a pool of available records to the user. If all connected mobile devices are already in use by other users, the system duplicates an existing connected MDT record to create a new MDT record and allocates it to the user.

It is possible to log on with the same user from multiple devices. The first login is considered the "primary" user, has read/write abilities and receives any alerts or notifications delivered during login. All other logins with that same user can also edit and update data but do not receive notifications and alerts. Since all data is shared on the server in connected mode, all users have access to the same data. An icon on the navigation bar allows users to take over as the primary user as needed on a given device.

In connected mode, the system ignores the display option value configured on the MDT Type for the mobile device and instead dynamically changes the display option based on the available screen resolution (once per login). This means that for iPads and newer Android devices, which typically use 1024x768, the system recognizes them as X VGA (laptop). This is important when you are selecting a deployment; for these devices, they should select a laptop deployment.

Once allocated to a user, the mobile device is stamped with that user and is not available to another user. The system generates new MDT records upon request but it requires at least one to be defined manually. To speed up the mobile device allocation process it is recommended to define a pool of connected MDT records in advance for as many crews that access in that mode daily.

Regardless of the connection mode, when a mobile worker starts a shift from the mobile application, the mobile device they have used is stamped on the started shift. If connected mode was used and the user closes the browser and logs in again, the system re-assigns the same mobile device stamped on the started shift to which the user belongs. Moreover, any user that is part of that started shift and uses connected mode to access the mobile application would be assigned the same mobile device so they can all share data associated with working their shift.

When the shift is completed and all messages are processed, transactional data is cleared from the connected mobile device data store on the server and the mobile device it is made available to all.

As with all mobile device specific data, log files are also stored on the server and uniquely identified by mobile device.

The following functionality is not supported when accessing the mobile application in connected mode: GPS data is not captured or sent to the server, encryption, attachments, capture picture and capture sound functionality.

---

**NOTE:** Logic to generate and assign a virtual MDT when using the mobile application resides in a "Determine Connected Device" algorithm on the installation options record. This algorithm is only required if your organization uses the connected mode. Click [here](#) to see the algorithm types available for this system event.

---

## Configuration Tools

Standard framework configuration tools, such as business objects, scripts, UI maps, algorithms, etc., are used to create, extend and customize the mobile application.

It is important to note that the mobile framework is a slightly scaled-down version of the Oracle Utilities Application Framework.

### Business Objects

Entity maintenance is only performed via interaction with business objects. The business object layer does not interact with an underlying maintenance object layer, but rather is based on a completely different data model architecture. This means that all business rules to be performed on the mobile application need to be defined as business object rules.

The business object framework is limited as follows:

- Automatic state transition is not supported.
- Transitory states are not supported.
- Only two plug-in spots are supported.
- MCP Enter
- MCP Post Processing
- BO invocation for read, add, replace, and delete actions is supported.

The same business object definition that governs an entity on the server application also governs it on the mobile application; however, different business rules apply. On the mobile, entity-specific business logic must be triggered by these MCP-specific business object plug-in spots only.

These MCP Business Object algorithms are modeled after the server concept of the corresponding algorithms, but apply only to the mobile device and have a different hard parameter interface. Unlike the server framework, when these MCP algorithms are called the entity in the local database still reflects the unchanged version, while the changed entity is provided in memory as an input hard parameter. Further changes to the entity should be made to the input copy, not directly.

Scripting is the only supported programming language for these plug-in spots and java scripting for user interface rules. Service scripts and plug-in scripts are limited to XPATH version 1.0.

As mentioned earlier, the data model architecture is completely different from the server framework. Instead of individual maintenance objects, the mobile framework is based on a single XML data storage for business object instances. This also means direct access to tables for query purposes is not possible. All queries need to be performed by calling the MCP Query mobile framework business service. Refer to that business service for more information.

### User Interface

There is no notion of portals, zones or BPA scripts on the mobile device. Service scripting syntax in the mobile framework supports a "Terminate with Map" command that allows user interface interaction. This is the only means of presenting data to and obtaining data from a user.

Different devices may call for a different UI map to maintain and display an entity's details. For example, a handheld device has less real estate than a laptop. To accommodate differences in screen size, the MDT type record provides a display option attribute, which specifies the type of display (such as Windows Mobile VGA or Windows XVGA). Further, each business object that is maintained by the mobile application, like task and shift business objects, has an option where you can specify the mobile script to use for each supported device display option.

## Navigating Back to a Previous Map

When navigating to a UI Map with this tag, the tag tells the MCP to push the previous UI Map name and data onto the stack of backable maps. This is in case users execute a "back" at some point. In this case the MCP displays the UI Map name and data from the stack and navigates to it.

If this tag is not on the UI Map being navigated to, then the backable map stack is cleared.

For example:

```
<!DOCTYPE HTML PUBLIC "-//W3C//DTD HTML 4.01//EN" "http://www.w3.org/
TR/html4/strict.dtd">
<html >
<body oraMCPSupportsBack="true">
...
...
</body>
</html>
```

## Clickable Phone Numbers

You can use the oraPhone and oraPhoneContact attributes to identify phone numbers on UI Maps.

For example:

```
<td oraPhone="true" oraPhoneContact="boGroup/customerInformation/
contactName" oraField="boGroup/customerInformation/mainPhone"></td>
```

## Device Vs. Server Time Zones

The mobile framework supports the user working in the local time zone for their device while at the same time managing the conversion to and from the base time zone when communicating data to and from the server.

## Mobile Application Testing

The system provides tools to help implementations test their mobile application. This provides improved efficiency in building mobile UI maps and other mobile application components to help reduce implementation time lines.

The **Base Quick UI Map (M1-MCPDevTools)** deployment part has to be included in the deployment type being tested for the tools to be enabled. During implementation, the development tools deployment part can be included in any deployment type to enable testing.

---

**NOTE:** When ready for production, the deployment part should be removed from the deployment types to disable the developer features.

---

## UI Map Testing

This tool allows a user to quickly test their mobile UI map on the device without going through the entire mobile application data setup.

For the purpose of this tool you need to launch a mobile application on any MDT. The deployment may be based on your actual deployment type or it can be a standalone deployment type that only includes the **Base Quick UI Map (M1-MCPDevTools)** deployment part. If using a testing deployment type you need to use the service script **Developer App Initial Service Script (M1-MCPIUITST)** as its Initial Service Script.

Follow these steps to test a UI map:

- Launch your mobile application.

- Access the UI Map portal and make the necessary edits. You may also provide test data as part of the UI map XML element, just like you do when testing server UI maps.
- Enter your MDT Tag in the **Mobile Map** zone on the dashboard, and click the **Test** button. If you typically use the same MDT ID for testing you can reference it as a characteristic on your user record and the zone would default it when displayed .

A new window opens to display the changes on the MDT using test data if defined on the UI map. When this is initially launched, the MDT needs to have already downloaded a deployment and be displaying an application screen (not one of the initial MCP screens such as Register, Logon, or Deployment). This will allow you to logon to the MDT and the device will be ready to receive RSI messages from the server to test UI Maps.

This feature is not supported for the Connected MCP platform.

## Refresh the Mobile Application

This tool allows a user to refresh all items in the deployment currently used by their MDT.

Follow these steps to test a UI map:

- Launch your mobile application.
- Change a mobile application item, for example a UI map.
- Click the **Refresh** button on the mobile application. This process rebuilds the deployment and sends it to the mobile device. It does not create a new deployment but rather update an existing deployment capturing the time it was updated.

This one click approach can be used instead of re-creating the deployment on the server each time there are metadata changes done. This will re-generate the deployment on the server and replace the deployment already present on the MDT.

## Navigation and Display

This section describes configurable aspects of the mobile application work flow and display.

### Everything Starts with the Initial Script

When a user logs on to the mobile application, the mobile framework invokes the Initial Script defined for the specific deployment on the device.

The base package Initial Script demonstrates how a crew obtains their shift for the day, starts the shift, and then is presented with their tasks for the day. The crew can work each task and use other actions to manage their shift.

As mentioned earlier, the maintenance user interface associated with each task and shift business object can easily be replaced with your custom user interface, as these are defined as business object options. If you need to customize common parts of the mobile application that are not business object specific, you can do that by cloning the Initial Script and adjusting it as needed.

### Indicator Bar

The user interface on mobile devices includes an indicator bar which shows various indicators such as new email and connectivity. You can introduce your own indications by doing the following::

- Add the special icons to the **Mobile Device Indicator Bar (M1-MCPIndicator)** extendable lookup.
- Add custom logic to the mobile application to properly add or remove the indication from the bar as needed. To do this you will need to call the "MCP Indicator Bar" Manager business service.



## The Tool Bar

The mobile application displays a toolbar below the application indicator bar. The toolbar is available from every application screen, but the buttons that are displayed at any time vary depending on the current application screen you are viewing.

## General Actions Menu

The Task List user interface supports an actions icon that when clicked presents the user with a list of actions a crew can take during their shift, for example changing their primary function, changing crew allocation, going offline, completing their shift etc.

To add more custom actions

- Copy the base actions script and UI map to create your custom script and map. Make sure that you to include the base script as your custom script's schema for upgradability reasons.
- Enhance them to support your custom actions.
- Copy the base initial script and set it to call your custom actions script.
- Use your custom initial script in your deployments.

## Task Actions Menu

When on a task related user interface a menu actions icon appears if configured on the task business object. The base activity business objects are configured with a BO option to manage activity related actions such as creating a new activity for the same location, capturing contents for this activity etc.

To add more task related custom actions

- Copy the base actions script and UI map to create your custom script and map. Make sure that you to include the base script as your custom script's schema for upgradability reasons.
- Specify your actions script as a BO option with a higher sequence number than the base actions script.

## Remote Script Invocation

Data and updates sent to the crew, as well as updates and completion data received from the crew, rely on the Remote Script Invocation (RSI) mechanism supported by the mobile framework.

Data exchange is achieved by calling a framework business service to place an asynchronous request to invoke a service script and its corresponding data on a remote application. The system provides both server and mobile device versions of this service. The server version places the request to be performed on a specific MDT, whereas the mobile device version places the request on the server. A synchronous RSI call to the server is also supported.

---

**NOTE:** Logic to process remote messages sent from the mobile device resides in a "Remote Script Invocation" algorithm on the installation options record. Click [here](#) to see the algorithm types available for this system event.

---

## Messages Sent to the Crew

Various algorithms implement logic to send messages to the crew's mobile device. For example, the Task Synchronization algorithm is responsible to dispatch tasks and send updates to dispatched tasks.

A call back notification functionality is supported for RSI messages issued from the server only.

With this functionality, the process posting the RSI message to the crew may request to be notified if delivery of the message to the crew takes too long. For example, this may be used to raise an alert when an activity takes too long to dispatch to a crew.

## Messages Received from the Crew

A synchronous form of an RSI call may be issued from the mobile device only, such as when the crew request and start their shift for the day.

On the server, messages sent from the crew are processed by the Remote Script Invocation installation plug-in. This allows a better handling when an application error occurs. The base algorithm persists the message as a crew message business object and if an error is encountered while processing the message a To Do Entry is raised for a user to correct the issue and reprocess the message.

Remote messages in an error state are periodically retried by the remote message monitor batch process.

## Device Capabilities

The capabilities section on the MDT Type allows you to define the various features or functions supported by mobile devices of this type, such as capturing photo or sound, attaching supporting documents or launching a geographic map.

If a capability is not explicitly enabled on the MDT Type, the corresponding function is not available on the device. Review your device types to ensure their platform is supported and enable functions to represent true device capabilities.

## Mobile Data Cleanup

The system uses a background process to purge old RSI records as well as cleanup unused data related to Connected MCP transactions.

---

**NOTE:** Set the parameters of the **Stale MDT and RSI Cleanup** batch process to clean up this data as required by your business practices. Refer to [MI-CLMDT](#) batch control for more information.

---

## Configuring Mobile Devices

The following section describes mobile device configuration options.

### Defining MDT Types

This portal is used to maintain MDT types.

Refer to [Understanding Mobile Devices](#) for more information.

You can access the portal from the **Admin Menu > Device Management > MDT Type**.

The following zones may appear as part of the portal's **Main** tab page

- **MDT Type List.** This zone lists all MDT types. Broadcast a record to display the details of the selected deployment part.
- **MDT Type.** This zone provides information about the selected MDT type.

#### Where Used

Follow this link to open the data dictionary where you can view the tables that reference [MI\\_MDT\\_TYPE](#).

## Defining MDTs

This portal is used to display and maintain a mobile data terminal (MDT). You need to define a mobile data terminal (MDT) record for each mobile device that needs to communicate with the system to send and receive work using the mobile application.

You can access the portal from the **Main Menu > Device Management > MDT**. You are brought to a query portal with options for searching for a specific MDT. Once an MDT has been selected you are brought to the maintenance portal to view and maintain the selected record.

Refer to [Understanding Mobile Devices](#) for more information.

The **MDT** zone on the portal's **Main** tab page provides information about the mobile device.

The following zones may appear as part of the portal's **Log Files** tab page:

- **Mobile Log Files Search.** This zone allows you to search for log files that may have been sent in from the mobile device to a designated location on the sever.
- **Mobile Log.** This zone shows server logging information related to communications made using this mobile device, if this feature is enabled from the mobile device. The zone is only applicable to devices using the **Connected MCP** or the **RESTful Services** mobile platforms.

## Replicate MDTs

You may use the **Replicate** button set up a bulk of MDT records based on the details of the current MDT. This function sets the device tag for each new MDT to the prefix text you provide and a running sequence number.

## Getting the MDT Log Files

Log files are not sent to the server automatically; they are only sent on demand, usually for debugging or tracing purposes. Use the **Get Log Files** button to send a message to the device to send log files to the server. When the device sends the files, you may use the **Log Files** tab to view their content.

## Changing the Mobile Device Log Level

Click the **Set Log Level** button to send a request to the device to change the logging level used by the mobile application. Once the mobile device is updated, it sends a response back to the server to update the current log level on the MDT record to reflect the change.

## Reset Registration

If this MDT is used by an iOS device and the mobile application was reinstalled on the device, the unique ID has to be reset before the MDT can be used again. Click the Reset Registration button to do so.

Refer to [Registration](#) for more information.

## Configuring Deployment Options

The following section describes mobile device configuration options.

## Defining Deployment Parts

This portal is used to maintain deployment parts. You may upload a predefined bundle when adding or updating a deployment part.

Refer to [Understanding Deployments](#) for more information.

You can access the portal from the **Admin Menu > Device Management > Deployment Part**.

The following zones may appear as part of the portal's **Main** tab page

- **Deployment Part List.** This zone lists all deployment parts. Broadcast a record to display the details of the selected deployment part.
- **Deployment Part.** This zone provides information about the selected deployment part.
- **Deployment Items.** This zone lists the application items included in this deployment part.
- **Referenced By Deployment Types.** This zone lists the deployment types referencing this deployment part.

#### Where Used

Follow this link to open the data dictionary where you can view the tables that reference [MI\\_DEPLOYMENT\\_PART](#).

## Defining Deployment Types

A deployment type represents a specific type of mobile application. This portal is used to maintain deployment types.

Refer to [Understanding Deployments](#) for more information.

You can access the portal from the **Admin Menu > Device Management > Deployment Type**.

The following zones may appear as part of the portal's **Main** tab page

- **Deployment Type List.** This zone lists all deployment types. Broadcast a record to display the details of the selected deployment type.
- **Deployment Type.** This zone provides information about the selected deployment type. You may use the **New Deployment** link to submit the batch process to create a new deployment.

#### Where Used

Follow this link to open the data dictionary where you can view the tables that reference [MI\\_DEPLOYMENT\\_TYPE](#).

## Maintaining Deployments

This portal is used to view existing deployments and change their status.

---

**NOTE:** A deployment has to be activated before it can be downloaded to mobile devices. You can also inactivate a deployment so that it can no longer be deployed.

---

Refer to [Understanding Deployments](#) for more information.

You can access the portal from the **Main Menu > Device Management > Deployment**. You are brought to a query portal with options for searching for a specific deployment. Once a deployment has been selected you are brought to the maintenance portal to view and maintain the selected record.

The **Deployment** zone on the portal's **Main** tab page provides information about the mobile device.

The following zones may appear as part of the portal's **Main** tab page

- **Deployment.** This zone provides information about the selected deployment.
- **Out of Date Items.** This zone lists items that have changed and caused the deployment to become out of date. Expand the zone to request the system to evaluate the deployment now. If the deployment is out of date, it is marked as such and the zone lists the out of date items information.

## Defining Mobile Components

This portal is used to maintain mobile components. You may use this portal to review the base components as well as extend them or implement new custom mobile components to support your mobile application requirements.

---

**NOTE:** You need to run the **Build Mobile Component Package** background process to include your custom mobile component content as part of the application bundle that is downloaded when the mobile application is launched from a mobile device. Refer to [MI-BMCOM](#) batch control for more information.

---

Refer [Understanding Mobile Components](#) for more information.

You can access the portal from the **Admin Menu > Device Management > Mobile Component**.

The following zones may appear as part of the portal's **Main** tab page:

- **Mobile Component.** This zone provides general information about the selected mobile component.
- **Mobile Component Content Editor.** This zone is used to maintain the various contents associated with the selected mobile component.

### Where Used

Follow this link to open the data dictionary where you can view the tables that reference [MI\\_MOBILE\\_COMPONENT](#).

## Schedulers

---

### Understanding Schedulers

The scheduling process automatically assigns tasks to crew shifts, matching field work requirements to crew capabilities and optimizing the routes traveled by crews. The goal of the scheduling process is to produce the most cost-effective schedule.

The following sections provide a high level understanding on how the scheduler works and what components requires configuration.

### The Scheduling Process

The scheduling process has the following basic inputs:

- **Tasks.** Tasks represent the types of "things" the crew might have to do during their shift. They can be any one of the following, all of which are incorporated into the schedule as needed.
  - Activities indicate the type of work, required skills, task duration, service location, time windows, and task-based cost factors.
  - If using depot functionality, the scheduler inserts visits to the depot as depot tasks.
  - Periods of Unavailability tasks (POUs) indicate a fixed period of time as well as a location where the crew must attend to some task unrelated to shift work, such as a meeting.
  - Non productive tasks (NPTs) indicate a window of time after the shift has started as well as location where the crew must attend to some task unrelated to shift work.
  - Breaks indicate a broad window during which the crew may take their break, as well as the allowed break duration.

- **Crew Shifts.** Shift data includes crew capabilities, covered service areas and service classes, logon and logoff location, and shift-based cost factors.
- **Contractor Capacities.** Capacity data includes covered service areas and service classes, as well as a capacity amount which may be defined in number of activities or number of hours. This is only applicable if you are using capacity contractors. Refer to [About Capacities](#) for more information.
- **Depots.** If you are using depot functionality, the scheduler can manage shifts which include the location where the crew picks up and drops off goods.
- **Map Data:** All locations within the service territory are represented in the map data.
- **Static Control Data:** This includes scheduler parameters and appointment booking groups information.

The scheduling process assigns each task a scheduled date/time on a particular shift of a crew, or a contractor capacity if using the contractor functionality. As part of the optimization process, a task may be assigned, unassigned, and reassigned any number of times until the task is dispatched.

Refer to [Scheduling An Activity](#) for more information.

Depot transfer activities are scheduled to bays and not to crew shifts. The scheduling process assigns each transfer activity to a scheduled date/time for a particular bay of a depot.

Refer to [Depot Replenishment](#) for more information.

## Multiple Schedulers

The term scheduler refers to the system component that manages a single scheduling process. An implementation typically runs at least two schedulers to provide for backup, but may run additional sets of schedulers if required for scalability.

Refer to [Using Multiple Schedulers to Scale the Scheduling Process](#) for more information.

Each uniquely named scheduler record is associated with:

- A single scheduling process it manages. Refer to [Schedules Are Continuously Running Batch Processes](#) for more information.
- A scheduler configuration that defines the scheduling parameters to be used during the scheduling process. Refer to [Understanding Scheduler Parameters](#) for more information.
- A specific geographic area called a scheduling area it covers. Refer to [Understanding Scheduler Areas](#) for more information.

## Scheduler Process Types

A scheduling process may have the following responsibilities:

- Optimization
- Request Handler Only
- Optimization and Request Handler
- Holding

Optimization refers to the main responsibility of the scheduling process, i.e. to schedule tasks to shifts (or capacities).

A request handler scheduler responds to various types of ad-hoc requests, such as an appointment booking request etc. Refer to [Request Types](#) for more information.

A scheduler can be configured to handle optimizations and requests, or just one of these roles.

A holding scheduler does not schedule shifts or tasks. It is designed to capture tasks and shifts that cannot be assigned to any online scheduler. One and only one holding scheduler should exist. Any task or shift attached to a holding scheduler is evidence of a scheduling error.

## Request Types

A scheduler that handles requests can handle the following request types:

- **Chooser.** Returns a list of recommended shifts or contractor capacities for an activity.
- **Appointment booking.** Returns a list of valid possible appointments for an activity. Appointment booking refers to how the system handles requests from the host system for appointments and how it responds with available appointment windows. Refer to the [Appointment Booking Groups](#) for more information.
- **Conditional booking.** Confirms the schedule of an activity when it is interfaced to the system. Refer to [Conditional Booking](#) for more information.
- **Route and Directions.** Returns the street level route as well as driving directions for an ordered list of locations.

## Schedules are Continuously Running Batch Processes

Each scheduler record must reference a unique batch control that manages and handles the execution of the scheduler and is designed to run continuously without interruption.

The Batch Control's **Batch Category** needs to be set to **Scheduler** to identify it as used for a scheduler.

At run time, the batch process determines the scheduler record associated with its batch control and handles operations requested on behalf of the scheduler. If the record is marked **Online**, the batch process starts the corresponding scheduler, and if requested to be **Offline**, it instructs the scheduler to properly terminate. If necessary, a scheduler can be brought online or offline by using the **Boot** or **Shut Down** buttons, respectively, on the [Scheduler](#) portal.

As standard batch processes, scheduler batch processes may be visible by an enterprise management console as well as started and monitored by an enterprise batch scheduler.

Refer to [Monitoring Schedulers](#) for more information.

## Auto-Dispatching

Dispatching is an action that locks a task's schedule so no further optimization takes place and marks it as ready to be sent to the assigned resource (crew on a specific shift or a contracting company). If it is currently assigned to a crew's shift, dispatching locks the task's sequence in the shift schedule.

Automatic dispatching refers to the process in which the scheduler initiates the dispatching of tasks.

You can enable or disable automatic dispatching for activities as follows:

- **Globally.** Use the "Enable Auto Dispatch" scheduler parameter to enable or disable auto dispatching for activities globally. If enabled, it can still be disabled at the shift or activity level.
- **By Shift.** Refer to [Controlling Auto-Dispatching](#) for more information.
- **By Activity.** Refer to [Disabling Auto Dispatch](#) for more information.

The following are additional [scheduler configuration](#) parameters that affect auto dispatch:

- Break Dispatch Mode
- POU Dispatch Mode
- Non Productive Task Dispatch Mode

- Auto Dispatch Stability Period
- Auto Dispatch Interval
- Auto Dispatch On Completion
- Auto Dispatch Time Horizon
- Emergency Dispatch Mode
- 

## The Scheduler Registry

The scheduler registry contains a record for each task, shift, capacity, appointment booking group, and scheduler configuration managed by a scheduler. It is via the registry mechanism that entity updates are sent to the scheduling process.

For example, when the scheduler acquires an activity, it adds it to its registry and gets its scheduling related information. If the activity is later on changed, the registry record for the activity is marked as being changed which triggers the scheduler to read the activity's latest information.

This section describes topics related to the scheduler registry.

### Registry Objects

The scheduler acquires entities within its short and long scheduling horizons as follows:

- An activity is registered with all schedulers that cover its geographic location or at least its service area. A scheduler that uses optimization areas acquires activities that their location's geocode is within its optimization areas. If the scheduler's area is defined using service areas only, it registers all activities within these service areas.
- A shift is registered with all schedulers that cover any of its service areas.
- A break is registered with all schedulers that register its shift.
- A POU task is registered with all schedulers that register any shifts for the invited crews, and cover any of the POU services areas, if any.
- Every appointment booking group is registered with all schedulers.
- A scheduler configuration and its cost profile are registered with all schedulers using them.

Details about each entity are kept within the in memory data store of the scheduler. The scheduler manager batch process reads the scheduling details of a registered object and forwards the information to the scheduler.

---

**NOTE:** Logic to prepare details to be sent to the scheduler resides in a "Scheduler Read" algorithm on the entity's business object.

---



---

**NOTE:** Click [here](#) to see the task related algorithm types available for this system event.

---



---

**NOTE:** Click [here](#) to see the shift / capacity related algorithm types available for this system event.

---



---

**NOTE:** Click [here](#) to see the depot related algorithm types available for this system event.

---



---

**NOTE:** Click [here](#) to see the scheduler configuration related algorithm types available for this system event.

---



---

**NOTE:** Click [here](#) to see the appointment booking group related algorithm types available for this system event.

---



The scheduler manager batch process keeps the scheduler's registry up to date, removing entities that should no longer be managed by the scheduler, and acquiring new entities as needed.

You can configure the system to provide advanced users with the ability to search for and locate schedulers that are handling a particular task or shift. The **Navigate To Scheduler Registry(M1-NavScReg)** BPA script can be added to your user's favorites through preferences. This script locates the related scheduler registry, if any, for the task or shift being displayed and navigates to the scheduler registry portal.

## Notifying The Scheduler Of Updates To Entities

The system notifies scheduler managers about a change that was made to an entity they have registered by posting a change action onto each scheduler's registry record for the entity. Each scheduler manager then communicates this information to its scheduler process.

Posting actions in the registry include:

- **Send.** An entity has changed and the entire entity needs to be sent to the scheduler.
- **Send Status.** An entity's state has changed and state-related details for the entity, rather than the entire entity, need to be sent to the scheduler.
- **Send Schedule.** Another scheduler manager has made a schedule change to an entity and schedule-related details need to be sent to the scheduler.
- **Processed.** The update conveyed via the registry posting action has been processed by the scheduler.
- **Remove.** The system has deleted or cancelled an entity (or changed it so that it is no longer relevant to the scheduler) and the entity needs to be removed from the scheduling process (that is, it should no longer be considered for scheduling). After removing the object, the scheduler deletes the registry entry.

---

**NOTE:** It is the responsibility of an audit algorithm associated with the entity's business object to post the scheduler registry update when changes are made to that entity.

---

## Notifying The Entity Of A Schedule Change

The scheduler manager notifies the system when it automatically dispatches a task as well as when key information about a dispatched task's schedule has changed.

This allows the system to perform business rules related to dispatching as well as communicate schedule changes to crews for tasks already dispatched to them.

---

**NOTE:** Logic to process changes in scheduler post dispatch resides a "Post Dispatch" algorithm on the task business object. Click [here](#) to see the algorithm types available for this system event.

---

## Errors

If any errors or warnings resulted from the posting action, they appear in the registry record.

In addition, the registry records for a **Holding** scheduler represent entities that should have been covered by online schedulers, but are not.

Some scheduling errors may resolve on their own when the problem is temporary, while other errors may require user intervention. The system generates To Do entries for all registry related errors in batch and closes these To Do entries when the issue is resolved.

---

**NOTE:** To Do entries for scheduling errors are created by the **Scheduler Monitor** batch process. You need to ensure the batch runs frequently enough to match your business requirements of reporting these errors. Refer to [M1-SCHED](#) batch control for more information.

---

## Current Crew Location

The current location of the crew at any point in time is key information to the scheduling process. The scheduler estimates the crew's current location based on its last known location. GPS data is not required, but when it is available, estimating the crew's current location is more accurate.

The mobile application may be enabled to frequently send GPS reports of the crew's location. Refer to [Sending Current Location](#) for more information.

Vehicles equipped with an external GPS system may also be configured to transmit GPS data independently. Refer to [Add GPS Coordinates For Resource](#) for more information.

When determining the location of a crew working on a specific shift, the system first looks for GPS records associated with the crew and if none are found, it looks for GPS data associated with any of the vehicles the crew utilizes on that shift.

## Monitoring Schedulers

The application provides the ability to monitor schedulers using standard batch controls. This allows you to use third party enterprise management tools, if desired, to monitor schedulers as you would with any other batch process.

You can monitor schedulers using standard processing:

- Use an enterprise scheduler which shows if any scheduler submissions have failed. These can typically restart the scheduler using the tool's console.
- JMX monitoring is also available for enterprise management consoles such as Oracle Enterprise Manager or via simple JMX clients.
- View diagnostics in the [Batch Control Global View](#) portal. The scheduler periodically reports various statistical measurements related to its current operation such as total number of activities and shifts it manages, average cycle time, etc. You may view these statistics on the [Scheduler](#) portal. If the **Level Of Service** algorithm is enabled on the scheduler's batch control, the system uses this information to evaluate how well the scheduler currently works and rate its level of service accordingly.

## Understanding Scheduler Areas

A scheduler area defines a geographic area to be scheduled by a number of cooperating schedulers, where each scheduler covers one scheduler area.

Refer to the inline help for instructions on creating and maintaining scheduler area records. The following sections provide conceptual information to help you design your scheduler areas before entering them into the system.

## Multiple Service Areas within a Scheduler Area

A scheduler area may comprise one or more service areas.

A scheduler is limited to scheduling tasks within its scheduler area. Thus, the set of service areas comprising a scheduler area must at least match the most complex set of service areas covered by any given shift.

Consider a territory with eight service areas: N, E, S, W, NE, SE, NW, SW. Shifts scheduled during the day typically operate in just two service areas, while shifts scheduled during the night can be routed to any of the eight service areas:

- Day Shift (N): N, NE
- Day Shift (E): E, SE

- Day Shift (S): S, SW
- Day Shift (W): W, NW
- Night Shift: N, E, S, W, NE, SE, NW, SW

Since the scheduler area must cover the most complex set of shift service areas, the Night shift is used to model the scheduler area: N, E, S, W, NE, SE, NW, SW.

## Using Optimization Areas

If a scheduler area has too many tasks for a single scheduler to manage (typically over 20,000), the system should be configured to run multiple schedulers in parallel and each scheduler should handle a segment of the total scheduling area. The segments, called optimization areas, should overlap each other. The overlap promotes task/shift migration between schedulers and thus achieves optimal shift routing.

### Determining the Best Optimization Area Shape

Every route that crosses an optimization area boundary represents additional workload for the scheduler. The scheduler must acquire all tasks of every shift it schedules so it is most efficient if every scheduler has most of its shifts wholly within its own optimization area. Thus, the best shape for an optimization area is the one least likely to have routes exiting and entering the area.

Optimization area shapes must be complementary. Optimization areas of different sets should not share common boundaries and should overlap as much as possible to promote optimum routing.

The diagram below illustrates how a pair of complementary optimization areas may be insufficient for optimal routing at specific points on the map. This simple diagram shows two optimization sets, each with two optimization areas. Each of the four optimization areas shown has its own scheduler - for simplicity, only partial sets are illustrated. The black and orange lines represent four different shifts.

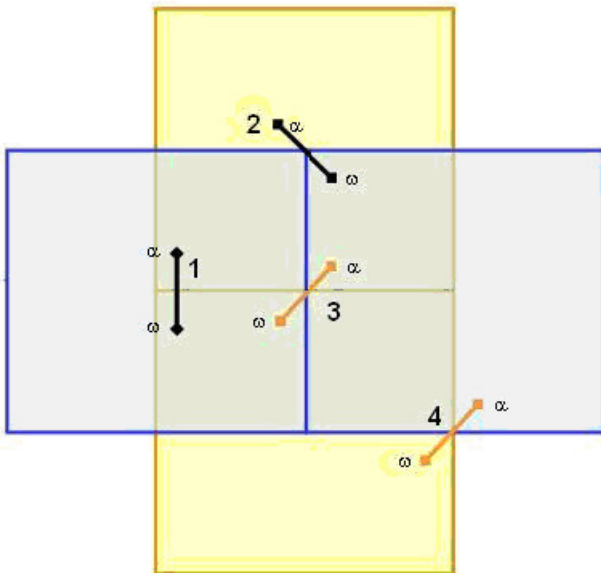

**Figure 10: Inefficient Optimal Routing**

Shifts 1 and 2 can be adequately covered in this configuration, because each one lies entirely within at least one scheduler. Shifts 3 and 4, however, cannot, because no single scheduler contains all the tasks of the shift. This is referred to as the corner problem, which occurs wherever the boundaries of two different optimization areas intersect and the two areas belong to different optimization sets.

Adding a third optimization set, as shown in the following diagram, solves the corner problem. All shifts can be covered as shown, because each one lies entirely within at least one scheduler.

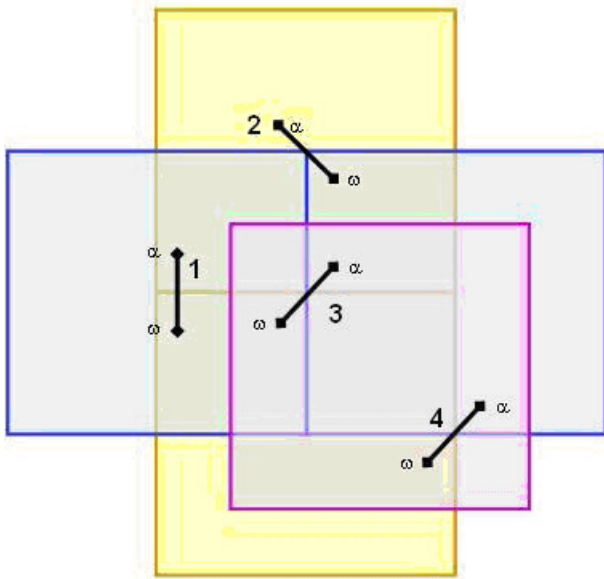

**Figure 11: Efficient Optimal Routing**

In general, corner problems caused by optimization area overlap must be covered by a third set of optimization areas. If no corner problems exist, only two optimization sets are required.

Follow these general steps when designing optimization sets:

- Design a set of optimization areas to cover the scheduler area, where each optimization area is as large as possible (the number of tasks bounded by any area should not exceed the Scheduler Areas maximum scheduling load plus a growth factor) but still fits into a single scheduler. For best results, always try to use the least number of optimization areas possible and assign only one optimization area to a scheduler (though multiple optimization areas can be assigned to a single scheduler).
- Design a second set of optimization areas where the optimization area boundaries are as far as possible from the first set's optimization area boundaries.
- Design a third set of optimization areas to cover any 'corner problems' caused by the overlap of the first two sets.

### Example

The following image illustrates a scheduler area, named 'City', that contains more tasks than the physical limit for a single scheduler. Therefore, the scheduler area will require three sets of optimization areas.

# City



Figure 12: City Geographic Area

Define the first optimization set with coordinates: (40.9, -75.1 NW) to (40.2, -74.0 SE). The optimization set will have two optimization areas:

- Optimization area 1: (40.9, -75.1 NW) to (40.6, -74.0 SE).
- Optimization area 2: (40.6, -75.1 NW) to (40.2, -74.0 SE).



Figure 13: Optimization Set 1

Define the second optimization set with coordinates: (40.9, -75.1 NW) to (40.2, -74.0 SE). The optimization set will have two optimization areas:

- Optimization area 1: (40.9, -75.1 NW) to (40.2, -74.5 SE).

- Optimization area 2: (40.9, -74.5 NW) to (40.2, -74.0 SE).

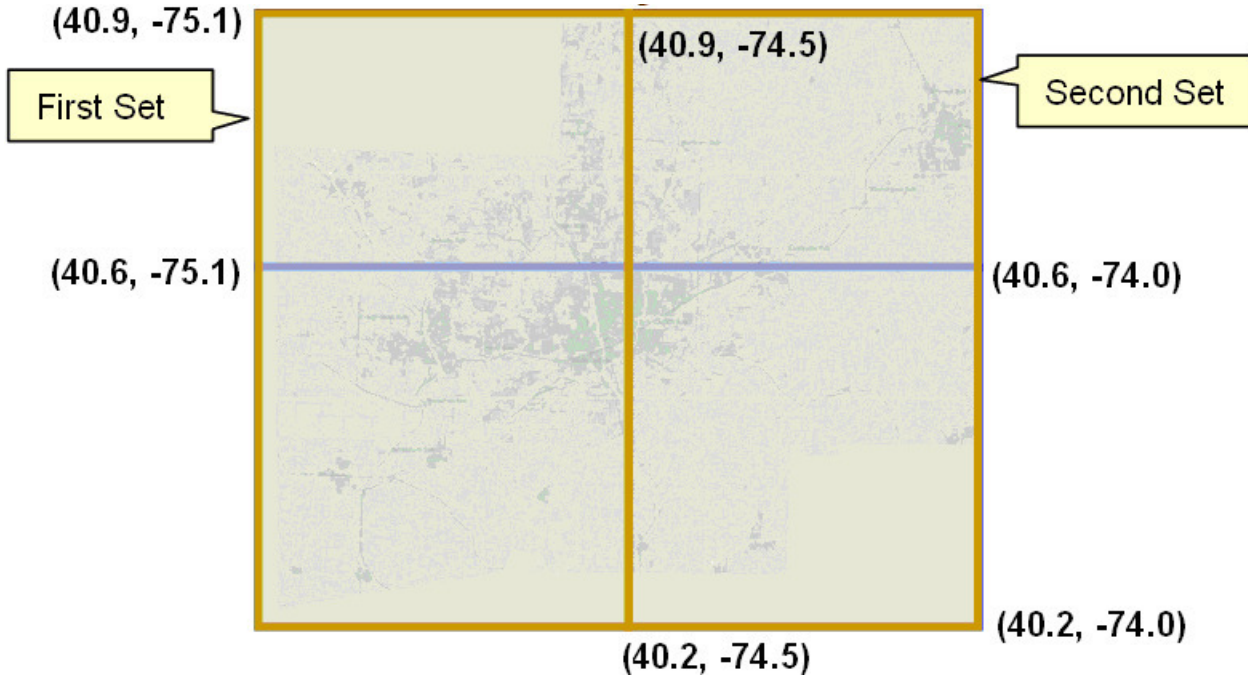

Figure 14: Optimization Set 2

Define the third optimization set with coordinates: (40.7, -74.7 NW) to (40.5, -74.4 SE). The optimization set will have one optimization area:

- Optimization area 1: (40.7, -74.7 NW) to (40.5, -74.4 SE).

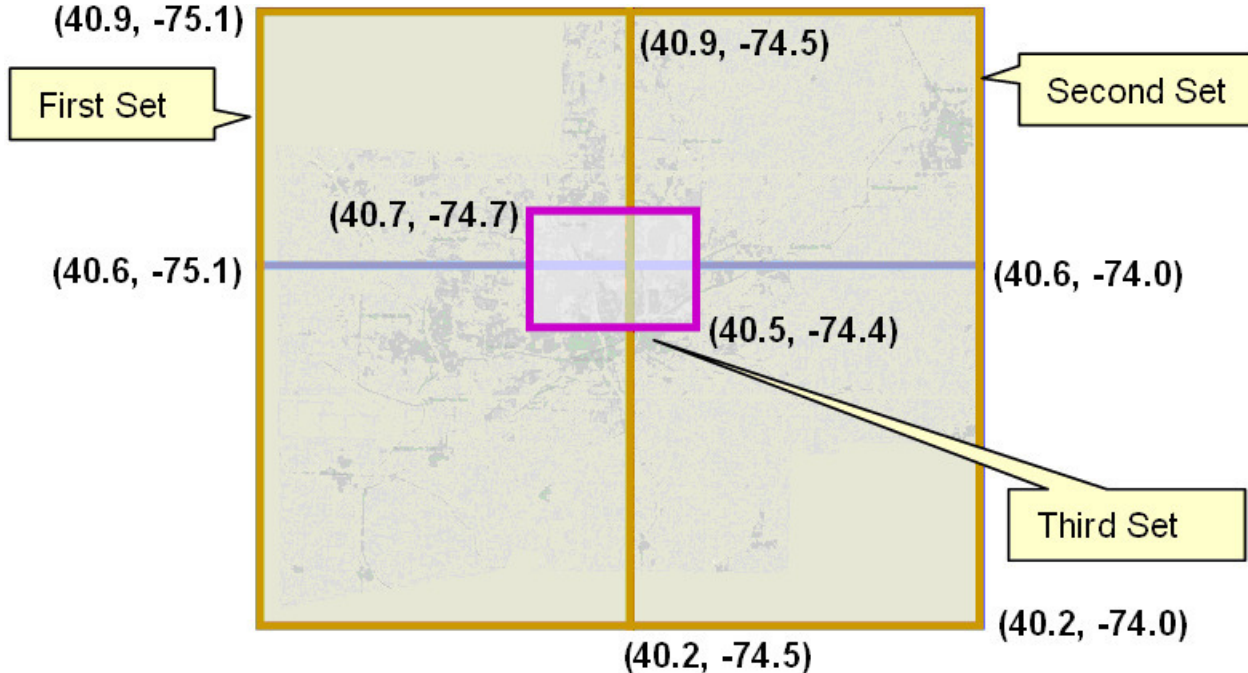

Figure 15: Optimization Set 3



## Scheduler Map Files

A scheduler uses a map file that consists of geographic locations, referred to as nodes, and inter-node links for which the direction, distance, and travel time are known. The MapEditor tool allows you to create map files used by the scheduler to obtain travel information and to display places and travel paths in a particular geographical region.

When new map updates are sent from HERE maps (formerly Nokia / NAVTEQ), they can sometimes overlay the existing maps and overwrite any edits made by your implementation via the Map Editor tool. If your system is properly configured, edited maps can be reapplied onto an updated version of HERE maps.

By default the scheduler assumes road speeds are the same for all days of the week and times of day when it computes travel estimates. If your company has licensed the HERE "Historic Traffic Patterns" product you may use the MapEditor to apply it as part of the scheduler map file and update it annually. The scheduler then consults this information and bases travel estimates and routes on historical road-speeds for the day of week, time of day, and direction.

---

**NOTE:** The additional traffic patterns product requires additional license.

---

The additional "Historic Traffic Patterns" product is provided in a .csv or relational database format and represents 3 years of history of average road speeds. In addition, a Holiday Appendix is provided to list a country's major holidays and surrounding days where the traffic patterns are impacted (for example, Memorial day in the US is the last Monday in May and there is less traffic due to the absence of work-day commuting, but more traffic due to recreational travel).

For performance reasons up to 5 traffic patterns can be defined as a template; Each template is constructed by averaging the 15 minutes interval road-speeds over a user specified period of time on a specific day. The templates are then associated with specific dates and times at which they apply. The following is an example of traffic pattern templates:

Template	Days	Dates	Time	Description
Weekday Morning Peak	Monday-Friday		07:00-09:00,	Traffic jam during morning peak hours.
Weekday Afternoon Peak	Monday-Friday		16:00-19:00	Traffic jam during afternoon peak hours.
Sunday Market Hours	Sunday		10:00-13:00	Closed for cars traffic area.
Christmas Shopping Time		December 22-24	19:00-22:00	Slow Traffic due to extended shopping hours and increased traffic.

---

**NOTE:** Documentation for this tool is provided in a separate guide. Refer to the Oracle Map Editor User Guide for more information.

---

If your company has not licensed the traffic patterns product the [Speed Profiles](#) functionality may be used to adjust travel speed for a broad geographic area, as opposed to specific roads, by day of week, time of day as well as specific dates.

By default the scheduler assumes the Speed Profiles approach is used. When historical traffic patterns are available a scheduler configuration parameter states which option should be used.

## Understanding Scheduler Parameters

The goal of the scheduling process is to produce the most cost-effective schedule or the most efficient schedule, while considering a large number of configurable factors to arrive at the optimum schedule.

The scheduler is heavily parameterized with the ability to support a myriad of operational use cases and scenarios. Every individual implementation will utilize a unique combination of these parameters to deliver the final operational solution.

Scheduler parameters control how a particular scheduler will schedule tasks, optimize routes, and dispatch activities to crews to achieve this goal. Descriptions of the scheduler parameters are provided in [Parameter Definition](#) portal. In general these parameters should only be modified with the guidance of your Oracle representative.

This section describes in a high level the various types of parameters used by the scheduler.

## Parameter Types

Scheduler parameters can be broadly categorized as follows:

- **Cost Control.** These parameters provide detailed scheduling goals and policies. They control the day today flexibility and "tuning" of the scheduler solution.
- **Entity.** These parameters are defined as part of other entities in the system, such as shifts or activity types, and serve as factors over corresponding cost control parameters.
- All other types of parameters control general operating and administrative behavior of the scheduler.

Values for all but entity parameters are associated with a [scheduler configuration](#) record that may be shared by multiple schedulers.

Refer to the [Parameter Definition](#) portal for the complete list of scheduler parameters, their description and default values. .

## Scheduler Configurations

Each scheduler is associated with a scheduler configuration. A scheduler configuration is a predefined set of parameters and settings that control scheduler behavior; a scheduler configuration may be used by multiple schedulers.

Scheduler configuration settings differ for each implementation depending upon the type of key operations managed by an organization.

This section describes topics related to scheduler configurations.

### Scheduling Horizon

The scheduler uses a scheduling horizon to determine the number of days into the future to consider when scheduling work.

Appointments set outside of the scheduling horizon are considered by the scheduler as "long term" appointments. A scheduler configured to handle requests may be restricted to handle short term requests only (i.e. those set within the scheduling horizon), long term requests only, or both.

The scheduler uses a long term horizon to determine the number of days into the future to consider for long term requests. The long term horizon must be the same or larger than the scheduling horizon.

A scheduler configured to handle requests can also be restricted to handle short term requests only (i.e. those set within the scheduling horizon), long term requests only, or both.

### Plan Consistency

To ensure consistency in decision making between schedulers, all schedulers that their scheduler areas cover the same service area must use the same scheduler configuration. If they manage the same entities, they must share the same scheduling goals and restrictions.

### Cost Profiles

A cost profile is a type of scheduler configuration that establishes a pre-defined set of cost control parameters which can be referenced on multiple scheduler configurations.

Refer to [Cost Control Parameters](#) for more information.



Cost profiles can be defined to handle different situations, users can actively switch between cost profiles without shutting down the scheduler. Example situations which may cause you to switch cost profiles include:

- Time of year - winter work, summer work, etc.
- Strong thunderstorms - where different types of work may be preferred
- Sudden drop in temperature - where regulations prohibit turning off power to customers for non-pay
- Sudden high temperatures - where regulations prohibit turning off water to customers for non-pay
- A large backlog of certain types of work, where it has been determined it is ok to work more overtime
- and so on.

Switching cost profiles is done by changing the cost profile referenced on the scheduler configuration. When the cost profile is changed, the scheduler responds immediately by optimizing work according to the changed cost profile. The same applies to changing the parameters defined on a cost profile that is currently used by online schedulers; the schedulers are notified and acquire the new cost profile values automatically.

---

**NOTE:** There is no need to restart the schedulers to reflect cost control changes.

---

## Working With Scheduler Configurations

Only complete configurations can be associated with online schedulers. If you are setting up a new scheduler configuration, mark it complete before you reference it on scheduler records.

Changing cost profile parameters or switching a scheduler configuration to use another cost profile takes effect automatically without the need to stop and restart the scheduler.

For all other scheduler configuration changes, you would need to stop and restart the schedulers for the changes to take effect.

## Cost Control Parameters

Applying cost controls allows the system to produce the most cost-effective schedule while adhering to your business rules and processes. A scheduler is associated with cost control parameters via the cost profile referenced on its scheduler configuration.

Refer to [Business Drivers Related to Cost Control Settings](#) for high level guidelines on how cost control parameters are used to achieved different business goals.

This section discusses cost control and entity parameters which can be modified to best suit your business practices when configuring the system.

### Cost Parameter Types

Cost parameters are of two types.

#### Relative

Cost factors that work as multipliers against global costs. For example, consider that an organization has fulltime crews and contractors that may be called on to handle excess work. In order to encourage the system to schedule work to contractors only when no full-time crew is available, you could apply a relative cost of 10 to contractor shifts, indicating that these shifts would cost ten times as much to use in the schedule as a full-time crew shift.

Examples of relative cost parameters are Relative Shift Cost, Relative Late Cost. Relative costs factors default to a value of 1.0.

## Global

Costs that are applied globally at a base level within the schedule.

Examples of global cost settings are Late Cost, Shift Cost, Travel Time Cost, and Travel Distance Cost.

## Global Cost Parameter Types

Global costs can be of various types.

### Flat

Costs that are applied once when the object is activated, and removed when the object is no longer being used. These are also known as "Standing Costs". The cost for using this object does not go up over time but stays at a standard or flat cost.

For example, the global Shift Cost is the flat cost of utilizing a shift. The Relative Shift Cost parameter can be used as a multiplier against the flat cost. Other examples of flat costs include: Shift cost, cost of a run, cost of goods, hauling costs, site costs, etc.

### Variable

Costs that increase linearly based on a measurable variable. These are also known as "Running Costs" or "Variable Costs". For example, travel time costs may be expressed as dollars per minute or dollars per hour, and travel distance costs expressed as dollars per mile or dollars per kilometer. Other examples of rate costs include: idle time costs, access window costs, pick up or drop off services, allocation costs, site separation costs, product depot costs, etc.

### Complex

Costs that increase exponentially and are nonlinear in nature. The Late Cost parameter, which defines the global cost of late arrival to an activity, is a function of the number of seconds late for arrival. For example, late cost is incurred beginning with the first second the crew is late for arrival. However, the exponential function can be defined so that the late cost is insignificant for the first ten minutes, but starts to ramp up quickly thereafter. This cost pattern models the idea that the customer will accept a crew being 5-10 minutes late, but will be increasingly displeased with any further delays.

Examples of complex costs include: resource arriving late at a task, overtime, volume, weight, reserve capacity, etc.

The following figure illustrates the type of curve represented by a complex cost:

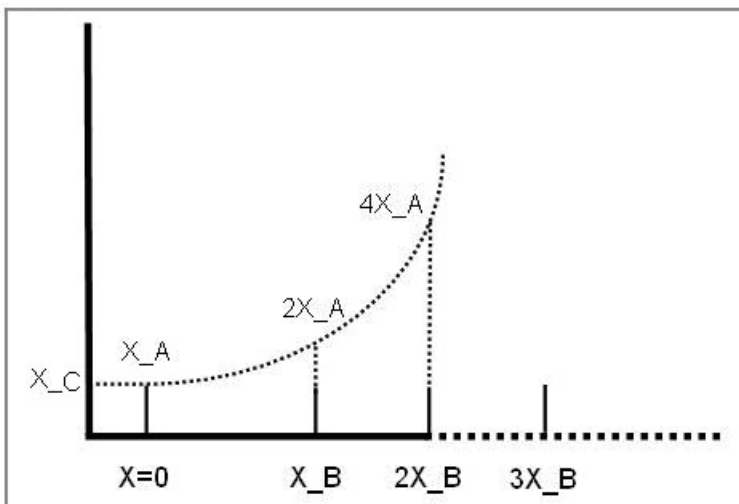

Figure 16: Complex Cost Curve

Complex costs are determined by mathematical functions controlled by a group of three cost control parameters:

- **Cost Value A** represents the initial slope for  $x \geq 0$  (at  $x=0$ ).
- **Cost Value B** represents the doubling rate (the slope of the function doubles every  $x_B$ ).
- **Cost Value C** represents a flat additional cost, creating an initial step.

## Time-Dependent

Factors that adjust shift-based costs based on when a shift begins. For example, when the system is scheduling activities several days into the future, the goal is to combine activities to produce the best route for each day. As a result, some shifts may appear under-utilized or even empty. However, when scheduling activities for the current day, the main objective is to add as many activities as possible to fully utilize the crew's time. Time-dependent cost (TDC) factors allow the scheduler to produce the most cost-effective schedule considering these time factors.

To configure time-dependent costs, you must define three distinct curves.

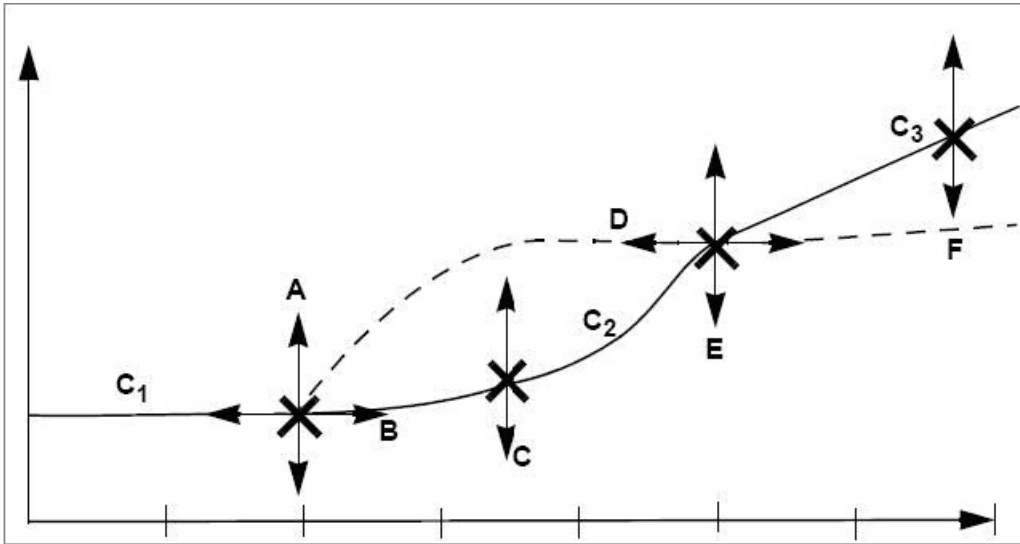

Figure 17: Time Dependent Curve

In the diagram above, the horizontal axis is time, in day increments (Day 0, Day 1, Day 2, etc.). The initial curve is always flat. The second curve is either convex or concave. The final curve is always a straight line into infinity.

Six independent variables (TDC Values A-F) are required to define this shape:

- **TDC Value A.** Initial value for the time-dependent cost factor, which is flat from day 0 to TDC Value B. This value must be greater than or equal to zero.
- **TDC Value B.** Controls how long the initial TDC Value A applies, in hours. For example, if the initial factor should apply for all of the first day, then this should be set to 24 (hours).
- **TDC Value C.** Controls the shape of the curve between the initial value and the final slope, referred to as the transition curve. The valid range is 0.1 to 10. A value of 4 produces a curve similar to the solid line in the previous diagram. A value of 0.2 produces a curve similar to the dashed line in the previous diagram. A value of 1 produces a straight, linear gradient between the initial and final slope, and is a good starting point.
- **TDC Value D.** Number of hours after which the function changes from curved to linear. This value controls the width of the transition curve. This value must be greater than TDC Value B.
- **TDC Value E.** Factor at the point at which the function changes from curved to linear. (This the final factor for the transition curve and the initial factor for the final curve.) This value must be greater than or equal to zero.
- **TDC Value F.** Controls the gradient of the final slope (units/hour).

Thus, the three curves are defined as follows:

- **Initial curve:**  $C1(x:0..B) = A$
- **Second curve:**  $C2(x:B..D) = ((x - B) / (D - B))C * (E - A) + A$
- **Final curve:**  $C3(x:D..) = (x - D) * F + E$

### Example 1: TDC Applied to Late Cost

Time-dependent costs can be applied to the **Late Cost** parameter to address a situation where cost should remain the same for the first two days, then rise rapidly 1 cost unit per day over the next two days and then increase by 0.2 units for all the remaining days. In this example, TDC variables would be set as follows:

A = 1

B = 48 (hours)

C = 1

D = 48 (hours)

E = 3

F = 0.0083 (0.2 / 24)

Assuming that 5 minutes of late time is costed at 100 units to begin with, applying these time dependent costs would result in the following:

For a shift on day 1, the cost is 100

For a shift on day 2, the cost is 100

For a shift on day 3, the cost is 200

For a shift on day 4, the cost is 300

For a shift on day 5, the cost is 320

For a shift on day 6, the cost is 340

For a shift on day 7, the cost is 360

### Example 2: TDC Applied to Shift Promotion Cost

Time-dependent costs can be applied to the **Shift Promotion Cost** parameter to promote early completion of activities. The scheduler has no innate preference for activities to be completed as early as possible. Until other constraints are breached, the scheduler is mainly distance driven.

Thus, it may schedule an activity for day 5, even though there is capacity on day 1, if it results in less travel. Time-dependent costing can be applied to the Shift Promotion Cost to bias against distance in favor of ensuring that no transport capacity is wasted for day 1. Ideally, costing is set so that day 1 fills up just before it becomes day 0. If costing is too weak, capacity is wasted; if too strong, days fill up well in advance, and the quality of routes suffers.

### Example 3: TDC Applied to Reserve Capacity Cost

Time-dependent costs can also be applied to the **Reserve Capacity Cost** parameter to limit the area covered for individual routes when providing appointments. This is done by invoking an additional cost when a vehicle exceeds a certain percentage (such as 50%) of its available time.

Thus, the first appointment determines the general direction of that day's run, with the distance travelled for subsequent appointments being restricted through the reserve capacity cost. The more distance is being covered, the stronger the restriction, causing activities that introduce excessive travel to be deferred to another day. Time-dependent costing is required to gradually relax the Reserve Capacity Cost, enabling the system to fill day 0, day 1 and so on, in case the reserve capacity cost turns out to be too restrictive.

## Understanding Speed Profiles

In regions where traffic issues have a significant impact on crew travel times and schedules, it is beneficial for the scheduler to be able to factor in these traffic patterns when scheduling shifts and calculating travel.

Your implementation can set up speed profile templates that define specific days and times where travel speeds are impacted. For example, the speed profile for weekday rush hour would indicate slower speeds than the profile for a week day at mid day or on the weekends.

This section describes topics related to speed profile configuration.

## Speed Profile Is Made Of Daily Templates

Speed profiles define a collection of daily templates which delineate 24 hour speed factors that are associated with a type of day (default, rush hour on a weekday, holiday, weekend, and so on). Note that these are indications of relative speeds, not time. This information improves the scheduler's travel time estimates by taking into account traffic patterns based on day of the week and time of day.

Once the speed profiles are defined, you can draw the related geographic areas to show the specific regions where the speed profiles apply.

## Speed Profile Area

Speed profile geographic areas represent the specific region on the map that is impacted by a speed profile.

Configuring these geographic areas allows the scheduler to calculate more accurate travel times by adjusting the average travel speeds within the map area. The scheduler factors in the speed areas that overlap the scheduler area.

The speed profile does not impact which road or route the scheduler selects or adjust the travel speeds in real time based on the geographic area of the destination. Rather, it allows the scheduler to make a more precise travel time calculation with the expected traffic conditions taken into account.

## Speed Profile Overrides

On any speed profile geographic area, you have the option to override the speed profile on a specific date. For example, if you know that there is a major event which will slow down traffic during a time frame which would normally be considered off hours, you can apply an override and either enter the speed factors manually or use a daily template to define the override.

## Designing Your Schedulers

This section provides high level guidelines and recommendation around scheduler administration.

## Using Multiple Schedulers to Scale the Scheduling Process

The scheduling process is very complex and has high memory requirements that increase dramatically as the number of tasks being scheduled increases. Memory requirements also increase as the scheduling horizon (the number of days into the future that must be scheduled) increases.

To achieve optimum performance without sacrificing scheduling efficiency, the system can be configured to use multiple schedulers at once and limit the number of tasks and shifts for which each scheduler is responsible.

Oracle provides general guidelines for calculating the optimum number of schedulers required for a particular installation:

- Define a variable, **L**, to be the maximum task load that can be scheduled by a single scheduler. 20,000 is the typical maximum.
- Determine the total number of tasks, of unique location, to be scheduled in a given scheduler area within the scheduling horizon.
- If the task count is less than **L**, then a single scheduler can cover the entire area. One extra scheduler will be required for backup.
- If the task count is greater than **L**, then the scheduler area must be covered by multiple schedulers working in parallel, and the area must be divided into smaller segments called optimization areas. Each scheduler is typically configured with a single optimization area.
- To calculate the number of optimization areas (schedulers) required for a large task count, use the following guidelines:
- Though the typical maximum load (**L**) for a scheduler is about 20,000, schedulers configured with an optimization area should be designed for a smaller average load, typically 62.5% of **L**, which we call *oL*.
- The total number of schedulers required for the scheduler area can be estimated as follows, where *n* is equal to the expected maximum task count:  $((n/oL \text{ rounded up to the next whole number}) * 3) - 1$

The result is multiplied by 3 because three sets of optimization areas are typically required to manage a scheduler area with a large task count. Subtract 1 because the third optimization set can typically have fewer optimization areas than the first two sets.

Please note that these rules are guidelines only; greater or fewer schedulers may be required depending on local geographies and particular scheduling requirements.

The table below shows an approximate number of schedulers required for various task counts, assuming the following base values:

Maximum task count for a single scheduler:  $L = 20,000$

Maximum task count for a single scheduler linked to an optimization area:  $oL = 12,500$  (62.5% of **L**)

*n* = Task Count

Task Count (n) Low	Task Count (n) High	Scheduler Count	Explanation
0	20,000	2	If the load is less than the maximum task count, then one scheduler can handle the entire load, with an additional scheduler for backup
20,000	25,000	5	$n = 25,000$ $n/oL (25,000 / 12,500)$ rounded up = 2 $2 * 3 - 1 = 5$
25,000	37,000	8	$n = 37,500$ $n/oL$ rounded up = 3 $3 * 3 - 1 = 8$
37,500	50,000	11	$n = 50,000$ $n/oL$ rounded up = 4 $4 * 3 - 1 = 11$

Thus, every physical location of an area must be covered by at least two schedulers for small task counts (typically under 20,000) or three schedulers for large task counts (typically over 20,000).

**NOTE:** The actual number of schedulers necessary may vary due to geographic constraints or particular scheduling requirements. Some geographic areas may be too large for a single scheduler to process. Determining the appropriate number of schedulers and defining optimum scheduling areas are essential to achieve maximum scheduling efficiency.

## Failover and Load Balancing

Each scheduler is controlled by a designated batch process. The batch infrastructure provides flexibility around failover and load balancing. Distributed Thread Pools allow a pool of schedulers to be associated to a pool of threads across multiple JVMs on multiple machines.

Load balancing among batch nodes assigns a thread to a JVM with the lowest percentage thread utilization for the requested thread pool. This enables active load balancing where schedulers are spread out among servers.

The following diagram illustrates scheduler distribution between thread pools and machines:

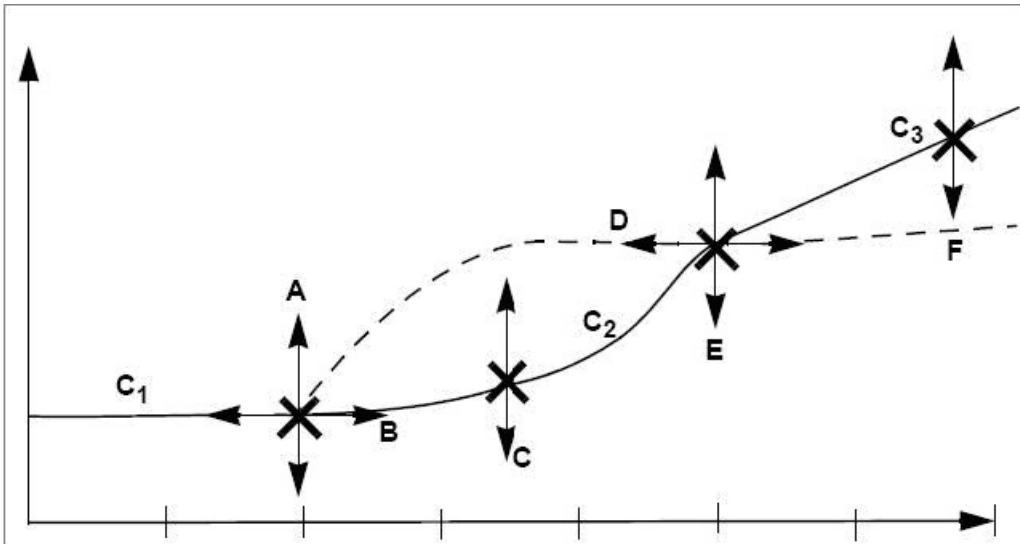

The following diagram illustrates how machine failure causes automatic migration to other machines offering threads to the same thread pool:

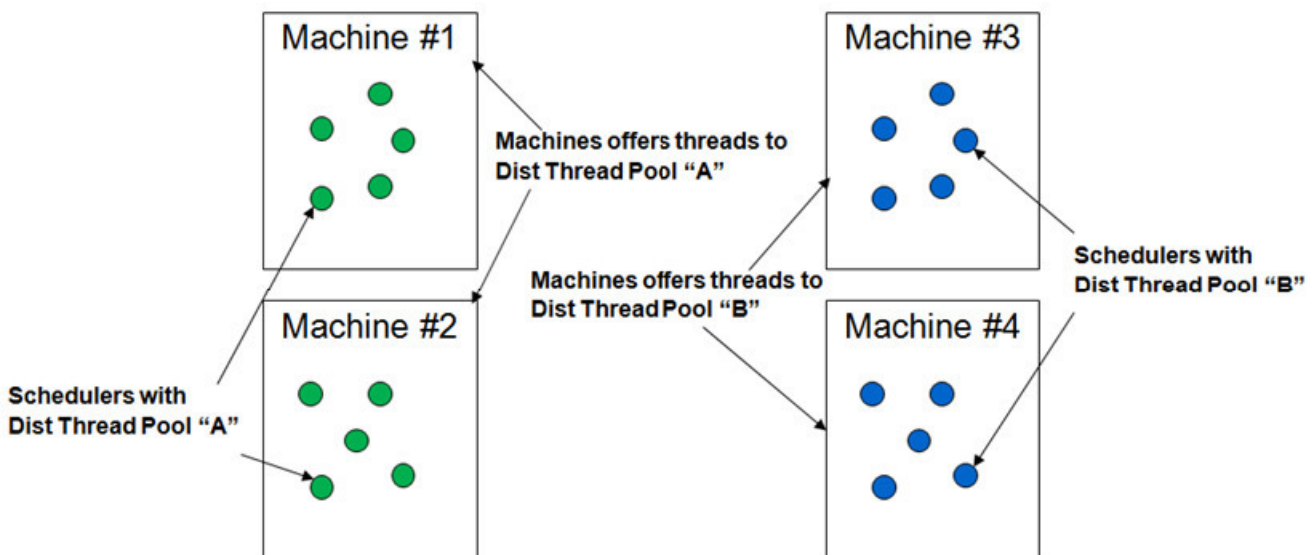

## Business Drivers Related to Cost Control Settings

Typically, two major business drivers will guide your configuration of cost control parameters. These business drivers are generally tied to the areas of field service vs. transportation operations. Of course, any implementation may mix and match these business goals.

---

**NOTE:** It is best not to change the Travel Distance and Travel Time costs from their default settings. These act as a reference for all other cost-controls.

---

### Field Service Based Operations

Businesses with field service based operations typically require that a person in the field make a visit to the customer site. Electric, gas, and water utility companies usually fall into this categorization.

Organizations with operations based mainly in the field might focus on the following considerations:

- More responsive to customer requests
- More assurance of timely / complete response

### SLA Adherence

Operations that have service level contracts to customers, generally known as service level agreements (SLA), must adhere to certain standards when making service calls. Failure to meet these standards can result in costly penalties and legal consequences.

Cost controls to configure include any lateness and time cost rules such as:

- Arrival Costs
- Late Cost
- Relative Late Cost (Entity Parameter)
- Resource Attribute Cost
- SLA
- SLA Flexibility (Entity Parameter)
- Preferred Time Factor (Entity Parameter)

### Days to Serve

Organizations that do not have formal customer service level contracts but that maintain internal targets to offer service within a certain number of days of a customer placing a work order, offer incentives to meet these service goals.

Cost controls to configure include any time dependent cost rules, resource, shift, travel, time and shift promotion rules such as:

- Late Cost
- Shift Promotion Cost
- Preferred Time Factor
- Complex Activity Span Cost



## Balance Planned and Reactive Work Orders

Some scheduler rules can help to balance situations where pre-existing planned work (such as preventative maintenance) must be superseded by higher priority reactive work order types (emergency or reconnects or credit restores). The planned work must still be completed to meet service level commitments, while the organization completes the reactive work tasks.

When planned work orders come into the system, they usually come in bulk. Reactive work only comes when it occurs, so the scheduler needs to be automated to factor in reactive work. It moves planned work out to make space for reactive work while also factoring in the cost for these changes.

Cost controls to configure include any priority allocation settings, cost rules and time window automatic extension settings, such as:

- Shift Promotion Cost
- Stop Promotion Factor
- Preferred Time Factor
- Late Cost

## Lowest Resource Schedule

In organizations where the efficiency of the operation is measured primarily on the utilization of the fewest number of available resources, shift cost and resource rules become very important. When the scheduler is set to consider the lowest number of resources, it attempts to use fewer crews and better resources (such as varying skill levels).

Cost controls to configure include any resource (including contractors), overtime or shift cost rules, such as:

- Resource Attribute Cost
- Overtime Cost
- Shift Cost
- Cost for a Non-Preferred Contractor. This mainly applies for shift based contractors. Organizations employing a number of sub-contractors with different agreements may want the scheduler to prioritize one sub-contractor over another, depending on the activity. A ranked list of preferred contractors is specified on the activity; any contractor company not specified is deemed to be ranked last.
- Cost for a Non-Preferred Shift Class. This only applies for organizations employing capacity based contractors. The same considerations apply as for shift based contractors (as described above); however, organizations employing both types of contractors must also configure a "Non Preferred Shift Class" cost.

Complex activities require additional configuration to control the elapsed time between the first and last visit, and the duration of visits themselves.

- Complex Activity Span Cost
- Under Scheduled Visit Cost
- Maximum Overlap Between Visits

## Transportation Based Operations

Business focused on transportation based operations tend to place a high value on making appointment times and minimizing traveling distances.

Organizations with operations mainly based around transportation might focus on the following considerations:

- Better Leverage of workforce skills
- Reduction of time lags / travel waste

## Appointment Compliance

In organizations where appointments are offered to ensure that deliveries and collections are made according to the appointment commitments, lateness time and distance become important factors in the scheduler configuration.

Cost controls to configure include any lateness, time or distance cost rules, such as:

- Late Cost

## Maximum Density of Appointments

Most organizations will need to configure the scheduler to ensure that appointments are not scheduled too close together and that there is enough time to complete work in between appointments.

Cost controls to configure include any time or distance cost rules, such as:

- Late Cost
- Apply Minimum Travel Time to All Tasks (Optimizer Behavior Parameter)
- Task Grouping Travel Time (Optimizer Performance)
- Shift Promotion Cost (to promote appointments/fill gaps in earlier shifts)

## Zero Over Capacity Schedule

In situations where the work load puts resources over capacity, parameters must be in place to enforce alternate scheduling policies and contingent plans to reallocate priorities.

Cost controls to configure include any weight, volume, capacity, lateness or overtime cost rules, such as:

- Cumulative Capacity 1- 5 Cost
- Depot SLA Window
- Depot Late
- Depot Window Capacity 1 - 5
- Late Cost
- Overtime Cost

## Lowest Mileage Schedule

Some organizations place the most value on achieving the highest efficiency in their operations by measuring the economy of scheduled routes. The scheduler should be configured to plot the shortest route possible and within the shortest amount of time.

Cost controls to configure include any time or distance cost rules, such as:

- Late Cost
- Task Grouping Travel Time (Optimizer Performance)

## Lowest Resource Schedule

Some organizations place the most value on achieving the highest efficiency in their operations by measuring the utilization of resources. The scheduler should be configured to use the fewest number and least expensive resources.

Cost controls to configure include any resource, shift or overtime cost rules, such as:

- Resource Attribute Cost
- Shift Costs. Any parameters related to maximizing shift efficiency.

- Overtime Cost
- Service Class Cost
- Shift Promotion Cost

## Configuring Schedulers

This section provides a high-level summary of the steps required to set up schedulers and scheduling entities for your organization.

- Use the MapEditor to build map files used by the scheduler to create and optimize routes, and calculate travel times and distances. Refer to the MapEditor User's Guide for details.
- Analyze the geographic areas requiring scheduling. Refer to [Understanding Scheduler Areas](#) for more information.
- Review the scheduler parameter definitions and adjust the global default values as necessary.
- Define various cost profiles and scheduler configurations to support various circumstances as needed.
- Identify each scheduler you will be using.
- Analyze scheduler distribution over servers, as well as the necessary thread pools you would need to support load balancing and failover.
- Set up an appropriate batch control record for each scheduler and schedule it to run continuously.
- Create a scheduler record for each scheduler and associate it with its batch control, a scheduler configuration, a scheduler area, and an optimization area as needed.

## Configuring Scheduler Options

Follow the steps described in this section to configure scheduler options.

### Defining Parameter Definitions

This portal allows you to adjust the minimum, maximum, and default values for each scheduler parameter as needed.

Refer to [Understanding Scheduler Parameters](#) for more information.

You can access this portal from the **Admin Menu > Scheduler > Parameter Definition**.

The following zones may appear as part of the portal's **Main** tab page

- **Parameter Definition List.** This zone lists all parameter definitions. Broadcast a record to display the details of the selected parameter definition.
- **Parameter Definition.** This zone provides information about the selected parameter definition.

#### Where Used

Follow this link to open the data dictionary where you can view the tables that reference [MI\\_PARM\\_DEF](#).

### Defining Scheduler Areas

This portal is used to maintain scheduler areas. A scheduler area defines a geographic areas to be scheduled by one or more cooperating schedulers.

Refer to [Understanding Scheduler Areas](#) for more information.

You can access this portal from the **Admin Menu > Scheduler > Scheduler Area**.

The following zones may appear as part of the portal's **Main** tab page

- **Scheduler AreaList.** This zone lists all scheduler areas. Broadcast a record to display the details of the selected record.
- **Scheduler Area.** This zone provides information about the selected scheduler area.
- **Scheduler Area Tree.** This zone displays a tree view the service areas included in the scheduler area.

The **Scheduler Area Map** zone on the portal's **Map** tab page displays the territory covered by the scheduler area as well as all the optimization sets if any are associated with area.

#### Where Used

Follow this link to open the data dictionary where you can view the tables that reference [MI\\_SCHED\\_AREA](#).

## Defining Scheduler Configurations

This portal is used to maintain scheduler configurations as well as cost profiles.

Refer to [Scheduler Configurations](#) for more information.

You can access this portal from the **Admin Menu > Scheduler > Scheduler Configuration**.

The following zones may appear as part of the portal's **Main** tab page

- **Scheduler Configuration List.** This zone lists all scheduler configurations. Broadcast a record to display the details of the selected record.
- **Scheduler Configuration.** This zone provides information about the selected scheduler configuration.
- **Schedulers Using This Configuration.** This zone lists all schedulers using this scheduler configuration.

#### Where Used

Follow this link to open the data dictionary where you can view the tables that reference [MI\\_SCHED\\_CONFIG](#).

## Cost Control Changes

If you need to change cost control parameters for an online scheduler you may do so in either of these ways:

- Directly change the parameters on the cost profile being used
- Switch the cost profile currently used on the scheduler's scheduler configuration with another cost profile.

---

**NOTE:** There is no need to restart the schedulers to reflect cost control changes. All impacted schedulers are notified of the change and acquire the new cost control values automatically.

---

## Scheduler Configuration Changes

If you need to change scheduler configuration parameters for an online scheduler you may do so in either of these ways:

- Directly change the parameters on the scheduler configuration being used. Next, shutdown and boot all online schedulers for the changes to take effect.
- If you wish to keep the current configuration intact, create and adjust a copy of it and publish the new configuration to all schedulers using the original scheduler configuration record, such that they use the new configuration instead of the original. Use these steps to publish a scheduler configuration:
  - Make a copy of the configuration you want to replace using the **Duplicate** action. When prompted, enter a name for the new configuration.
  - Enter your changes to the new configuration, save and complete it.
  - Broadcast the original configuration (the one you are replacing).

- Broadcast the new configuration.
- Click **Publish**. When prompted, select the original configuration you want to replace. The new configuration will now be linked to every offline scheduler the old scheduler configuration was previously linked to.

## Setting Up Scheduler Batch Controls

For each scheduler, create a new batch control by duplicating the **Scheduler Manager Batch Job (M1-SM)** sample batch control. Refer to [M1-SM](#) batch control for more information. This batch control should be referenced on the corresponding scheduler record.

Scheduler manager batch processes must be run continuously for the schedulers to work properly. As standard batch processes, scheduler batch processes may be visible by an enterprise management console as well as started and monitored by an enterprise batch scheduler.

If your organization does not use a third party software to trigger and monitor batches processes periodically, you may configure these batch controls to be timed with a 60 seconds interval.

You may also want configure these batch controls to run on designated thread pool workers for load balancing purposes. Refer to [Failover and Load Balancing](#) for more information.

## Defining Schedulers

This portal is used to manage a scheduler's state and configuration.

If necessary, a scheduler can be brought on or offline by using the **Boot** or **Shut Down** buttons, respectively.

---

**NOTE:** This does not cancel or start the scheduler's batch process but rather guides the batch process to start or terminate its associated scheduler process. If you no longer need to use a certain scheduler, you need to shut it down and contact your system administrator to terminate the corresponding batch process and ensure it is not automatically started again.

---

Refer to [Understanding Schedulers](#) for more information.

You can access this portal from the **Admin Menu > Scheduler > Scheduler**.

The following zones may appear as part of the portal's **Main** tab page

- **Scheduler List.** This zone lists all scheduler definitions. Broadcast a record to display the details of the selected scheduler definition.
- **Scheduler.** This zone provides information about the selected scheduler definition.
- **Scheduler Runtime Details.** This zone provides run time information about the scheduling process managed by this scheduler as well as any statistics it has recently posted.

### Where Used

Follow this link to open the data dictionary where you can view the tables that reference [M1\\_SCHEDULER](#).

## Defining Speed Profiles

This portal is used to maintain daily and template speed profiles.

You need to create daily speed templates first, then these can be referenced on your speed profile templates. Next, you can navigate to the [Geographic Area](#) portal to define the region on the map to which the speed profile template applies.

Refer to [Understanding Speed Profiles](#) for more information.

You can access this portal from the **Admin Menu > Scheduler > Speed Profile**.

The following zones may appear as part of the portal's **Main** tab page

- **Speed Profile List.** This zone lists all daily and template speed profiles. Broadcast a record to display the details of the selected record.
- **Speed Profile.** This zone provides information about the selected speed profile.

#### Where Used

Follow this link to open the data dictionary where you can view the tables that reference [M1\\_SPEED\\_PROFILE](#).

## Viewing the Scheduler Registry

This portal is used to display the scheduler registry record for an entity managed by a specific scheduler.

Refer to [The Scheduler Registry](#) for more information.

You can access the portal from the **Main Menu > Scheduler > Scheduler Registry**. You are brought to a query portal with options for searching for a specific scheduler registry records. Once a scheduler registry record has been selected, you are brought to this portal to view the selected record.

The following zones may appear as part of the portal's **Main** tab page

- **Scheduler Registry.** This zone provides information about the registered entity.
- **Scheduler Read.** This zone displays the details that would be sent to the scheduler for this entity. This information varies depending on the type of registry object.

## Integrations

---

### Understanding Web Services

This section provides a high level description of web services and outbound messages provided by the product to support various types of integrations.

Refer to the [Inbound Web Service](#) portal for more information about each inbound service.

Refer to the appropriate Oracle Utilities Integration documentation for information about specific integrations.

### Appointment Booking

The host system uses this service to request a list of available appointment time windows for an activity prior to sending it to the application for scheduling. Requests from the host specify key activity details and the time periods for which the scheduler should return a list of available appointment windows.

The system processes an appointment booking request from the host as follows:

- Using the appointment booking group specified on the request, identify the actual time windows during which appointments can be scheduled. If no appointment booking group is supplied by the host, the system uses the activity type's default appointment booking group.
- Geocode the proposed activity's site address.
- Determine the activity service area. This is done by invoking the Determine Service Area algorithm associated with the activity business object defined on the proposed activity's type.

- Calculate its arrival time window (ATW) and service time windows (STW) based on the requested Effective Time Windows (ETW) and preferred time windows (PTW). This is Activity Maintenance By Host done by invoking the Update Time Windows algorithm associated with the activity business object defined on the proposed activity's type.
- If scheduling priority is not provided, default it from activity type and business priority number if any.
- Default contractor eligibility and preferences based on activity type and service area.
- The information gathered above is sent to scheduler(s) responsible for appointment booking.
- Appointment information is returned. If there are multiple schedulers handling appointment booking requests, the first response is used.

Refer to [Appointments](#) for more information on how appointments are managed.

## Activity Maintenance By Host

The host system uses the following inbound services to interface activities to be scheduled, sending updates to activity information, as well as inquiring as to the current status of an activity.

### Maintain Activity By Host

The host system uses this service to interface a single activity and to update the activity information as needed. This service does not accept update requests to an activity that is already completed or canceled.

The following are important notes about this service:

- The system cannot evaluate which change warrants a recall and which does not. The host system should explicitly cancel an activity to request a recall. Refer to [External System Activity Cancellation](#) service for more information on the cancellation process.
- The host may indicate that the new activity, or changes to an existing activity, should only be accepted if it can be scheduled as requested by sending the request as a **conditional booking** request.
- If the activity is already dispatched and a change is requested as a conditional booking, the system is requested to ensure the "new" booking details can be scheduled as requested, if and when the crew returns their assignment. Depending on the type of work requested, it may be important to only accept the "new" booking if the "existing" booking can be guaranteed to be canceled. In other words, only accept the new if it can replace the existing.
- If an activity is already dispatched, the system cannot guarantee that the work will not be performed because the crew may not be connected to receive the latest status of the activity. If it is important to only accept a new booking as a replacement of an existing booking, the host should also indicate that the request is a **guaranteed rebooking**, in which case the system will error and not accept the change.
- If it is acceptable that rebooking is not guaranteed, the host system should send in a request to cancel the existing activity and add a new activity with the new details using the [Maintain Activities \(Job\) By Host](#) service. This way the two bookings are kept independent.

### Maintain Activities (Job) By Host

The host system uses this service to interface multiple activity as well as update their information once interfaced.

This service is useful in the following situations:

- When interfacing a set of activities that should be scheduled as a job
- When interfacing a set of activities that should be scheduled as a chain
- When sending in a rebooking request that cancels one activity and adds another to replace it as a single transaction.

Note that you can still add each activity, even if it is part of a job or a chain dependency, using the single activity service. Using this service though enables the system to validate the set of activities and either accept or reject all in a single transaction.

If conditional booking is requested but it should not be a guaranteed rebooking the host should send the request as a cancellation of the existing activity and a request to create a new activity with the new booking details. The system will confirm the new details with the scheduler and if can be scheduled the system will attempt to recall the activity from its currently assigned crew by calling the [External System Activity Cancellation](#) service. Refer to this service for more information.

If the crew has not performed the work and is connected then the recall would be successful and the existing activity would eventually be canceled for which a cancellation message is sent to the host as usual. If however the crew has completed the work the completion information would be sent to the host and it is the host's responsibility to cancel the new activity.

## External System Activity Cancellation

The host system uses this service to cancel an activity. If the activity is not yet dispatched, it is canceled right away and a successful response is sent to the host system. If the activity is already canceled or completed, an error is issued.

Once an activity is dispatched, the system can only request a recall, but cannot guarantee the work would not be performed as the crew may not be connected to get notification of the latest status of the activity. The system responds with an indication that it will attempt to cancel the activity and has alerted a dispatcher of the situation.

Refer to [Activity Cancellation By Host](#) for more information.

## Retrieve Activity and Assignment Details

The host system uses this service to inquire upon the current status and details of an activity.

## Activity Completion To Host

In an integration where activity completion information is entered into the system by crews or external capacity contractors, the system forwards this information to the host system requesting the work.

The system initiates an **Activity Completion** synchronization request to send activity completion information to the host system when an activity is canceled or completed. If the host has initiated the cancellation or completion, no synchronization request is sent back to the host system.

## Activity Status Update To Host

In an integration where crews utilize the application to work their schedule and provide status updates about activities they perform, the system may be configured to forward this information to the host system requesting the work. The current state of the activity at the time of processing the message is sent to the host system. If a previous status update message was not yet sent a new message would therefore not be added.

This is not necessary if the host system is designed to request a status update on demand using the [Retrieve Activity and Assignment Details](#) inbound service.

If enabled on the external system's messages extendable lookup, the system initiates an **Activity Status Update** synchronization request to notify the host system of interim activity status updates once the activity is dispatched.

## New Activities to Host

Any activity created in the system has to be communicated back to the host system associated with the activity type. This typically occurs when a mobile worker discovers an issue in the field that needs to be acted upon. It may also occur when a dispatcher creates an activity for a crew to assist another crew.



The system initiates a **New Activity** synchronization request to send the details of a new activity to the host system when it is created.

## Contractor Management

The following section describes message exchanges with a capacity contractor company's system.

### Activity to Contractor

All outbound messages to the contractor's system are sent to the external system referenced on the contractor's resource group record.

The system initiates an **Activity to Contractor** synchronization request to send activity details to the contractor's system when an activity is committed to that contractor. The same type of message is also sent when activity details change, as well as when the commitment is recalled.

### Activity Commitment By Contractor

The contractor system uses this inbound service to approve or reject an activity committed to them.

If the contractor company does not approve an activity committed to them in a timely manner, i.e. within the agreed upon approval time, the system automatically assumes they have rejected the commitment and excludes this contractor from the activity, allowing it to be rescheduled as needed.

### Activity Completion By Contractor

The contractor system uses this inbound service to send in completion information for an activity.

## Crews Managed By Host

This section is relevant to an integration where crews are managed by the host system, and communicate status and completion information directly to the host system. In this type of integration, the system is mainly used for planning, scheduling, and dispatching purposes, but not to capture completion information.

All resource information contributing to establishing mobile workers, crews and shift templates, and exceptions are defined in the host system and synchronized with the system. This is then used to generate corresponding entities and shifts needed for scheduling.

The system sends generated shifts to the host system as well as any updates made to shift information.

The host system then notifies the system when shifts start which causes work to be dispatched back to the host system. The system notifies the host system of each dispatched task and in return, it is informed of task and shift status changes, but not completion information.

All messages to the host system are sent to the external system referenced on the crew record.

### Maintain a Common Location

The host system uses this inbound service to synchronize common location information.

### Maintain Service Area

The host system uses this inbound service to synchronize service area information.

### Maintain Shift Weekly Template

The host system uses this inbound service to synchronize shift weekly template information.

## Maintain Work Calendar

The host system uses this inbound service to synchronize work calendar information.

## Process Employee Sync Requests

The host system uses this inbound service to synchronize an employee's information.

## Update Shift Status

The host system uses this inbound service to notify the system of shift status changes.

## Update Task Status

The host system uses this inbound service to notify the system of task status changes.

## Dispatching A Task

The system initiates an **Activity Dispatched** synchronization request to notify the host system that an activity has been dispatched or advance dispatched prior to shift start.

## Crew Shift Synchronization

The system initiates a **Crew Shift Synchronization** request to notify the host system of a new shift or a change to an existing shift.

This process relies on the resource monitor batch process to review and detect shift information changes associated with externally managed crews.

---

**NOTE:** It is important that you schedule the **Resource** is batch process to run frequently to meet your business requirements. Refer to [M1-RESRC](#) batch control for more information.

---

## Activity ETA Update

The host system may use this inbound service to notify the system when the crew currently working an activity is estimated to arrive at the activity location.

## Depot Management

### Request Depot Cutoff

A depot cutoff request closes all distribution depot runs that are planned to depart from the depot before a cutoff time.

Refer to [About Depot Cutoff](#) for more information.

### Request Manifest Details

The host system may use this web service to request scheduling manifest details for one or more shifts by various selection criteria.

Refer to [Scheduling Manifest](#) for more information.

### Request Depot Transfers Manifest

The host system may use this web service to request a scheduling manifest for a distribution depot's upcoming transfer activities where their schedule time has been locked in advance.

Refer to [Depot Replenishment](#) for more information.

## Start Depot Transfer Job

The host system uses this web service to start a depot transfer job when the assigned driver arrives at the loading depot.

Refer to [Depot Replenishment](#) for more information.

## Task Bay Inquiry

The host system uses this web service to poll for the confirmed bay schedule information for a depot task or a transfer activity.

Refer to [Bays](#) for more information.

## Miscellaneous

### Add GPS Coordinates For Resource

If crews are using the product's mobile application over devices that support GSP data capture, you can configure their shifts to allow the collection and sending of GPS data to the server.

If however the source of your GPS data is different, you may use this inbound service to interface GPS data from an external system. GPS data records have to be associated with either a crew or a vehicle known to the system. Make sure you reference a crew's name or a vehicle's tag respectively in the external identifier of each GPS data record sent in using this service.

### Geocode an Address

An external system may use this inbound service to geocode an address. The service returns multiple addresses if more than one is found to match the request.

### Send Mail Notification

The host system may use this web service to send a mail message related to an activity to the mobile device of the crew working the activity. If the activity is not yet dispatched to any crew or the crew does not use a mobile device the message is not sent.

### Get Latest Location for Started Crews

The host system may use this web service to request for the latest GPS coordinates for crews that have already started their shift and their location has changed as of a specified time.

### System Is Available

This web service allows an external system to know if this system is up and running.

## Web Service Statistics

This portal provides a statistical analysis of key inbound web service calls made during a specific period of time.

You can access the portal from the **Main Menu > Dashboard > Web Service Statistics**.

The following zones may appear as part of the portal's **Main** tab page

- **Appointment Requests.** This zone provides statistical information related to appointment booking web service calls.
- **Interface Activities.** This zone provides statistical information related to web services that interface single activities or a set of activities on each service call.

By default the last seven days are considered but you may change the date range and additional parameters using the **Edit Parameters** action on each zone header.

Refer to [Integrations](#) for more information about these web services.

## Configuring Outbound Messages

You would need to configure an [External System](#) record for each system your company sends messages to, as well as set up an outbound message type for each type of message handled by these systems.

Refer to [External System](#) for more information.

The application creates a synchronization request to manage the sending of an outbound message to an external system. The synchronization requests create the appropriate outbound messages based on outbound message types specified on a feature configuration. Find the [Feature Configuration](#) record for the **Schema Constants** feature type and populate the outbound message types you created on the corresponding message type options as needed. (It may need to be defined if it does not exist).

The system determines which synchronization request business object associated to use for each type of outbound message based on an extendable lookup configured for each external system.

For each external system record, add a corresponding record with same name, to the **External System Messages (M1-ExternalSystemMessages)** extendable lookup. Populate the list of messages with the appropriate information to either enable it or mark it as not applicable.

Synchronization request records are processed by the synch request monitor batch process, and it is at that time that the actual outbound message is prepared and sent to the external system.

---

**NOTE:** It is important that you schedule the **Sync Request** batch process to run as frequently as needed to meet your business requirements. Refer to [F1-SYNRQ](#) batch control for more information.

---

## Configuration Options

---

### Batch Control Global View

This portal provides an "at a glance" view of the current running state of batch processes. Use the portal to find out if a batch process currently runs and how well it runs.

---

**NOTE:** Monitor batch processes as well as scheduler batch processes are configured to use a "Level of Service" algorithm defined on their batch control record to assess how well the process currently runs. Click [here](#) to see the algorithm types available for this system event.

---

When these algorithms are used with batch processes, they can answer the question of whether or not the batch process is running as expected. The diagnostics provide additional supporting information so that users can troubleshoot and otherwise monitor the processes. For example, slow running processes and job failures are highlighted.

You can access the portal from the **Main Menu > Batch > Batch Control Global View**.

Refer to [Batch Control](#) for more information.

The following zones may appear as part of the portal's **Main** tab page

- **Batch Controls.** This zone allows you to filter the list of batch controls to view.
- **Current State.** This zone displays information about the currently running process for a selected batch control.

## Configuration Migration Assistant (CMA)

The Configuration Migration Assistant (CMA) provides customers with a flexible, extensible facility for migrating their configuration data from one environment to another e.g., from a development environment to a production environment.

Refer to CMA for more information.

This section describes CMA related topics that are specific to this product.

### Executing Wholesale Migrations

Process the **MWM Configuration (M1-MWMConfig)** to migrate all administrative data for this product:

Process any of the other delivered migration requests as needed.

### Data that Cannot be Migrated Using CMA

Configuration Migration Assistant does not currently support migration of objects with system generated IDs. The following maintenance objects are therefore not supported by CMA:

- Shift Weekly Template that are not common templates, such as crew-specific templates, subscriptions to common templates, as well as contractor templates.
- Alert areas that reference excluded resources cannot be migrated because IDs for resources are system generated.

### BI Configuration

This portal provides a bird's eye view of the configuration information for Oracle Utilities Analytics. It provides links and guidelines for the areas that need configuration to successfully run the extract transfer and load processes from Oracle Utilities Analytics.

Refer to the Oracle Utilities Analytics Administration Guide for more information.

You can access the portal from the **Admin Menu > BI Configuration > BI Configuration**.

The following zones may appear as part of the portal's **Main** tab page

- **Bucket Configuration List.** This zone lists bucket configurations to set up.
- **BI-Related Business Objects Information.** This zone lists additional control entities to set up.

The following zones may appear as part of the portal's **OWB-Based ETL** tab page

- **Outbound Sync BOs and Algorithm List.** This zone lists business objects and algorithms involved in the extract process.
- **BI-Oriented Extendable Lookup.** This zone lists extendable lookups to set.
- **External Data Source Indicators List.** This zone lists the external identifiers of the various sources for your analytics data.

## Table Setup Sequence

---

## Control Data Setup

This section lists the control data entities in the order they should be defined.

Level	Entity	Comment
1	<a href="#">Defining Installation Options</a>	
1	<a href="#">Configuring Mapping Options</a>	
1	<a href="#">Configuring Outbound Messages</a>	This step should be performed for each external system your system is to integrate with.
1	<a href="#">Defining Locations</a>	
1	<a href="#">Configuring Service Areas</a>	
1	<a href="#">Defining Worker Capabilities</a>	
1	<a href="#">Defining Equipment</a>	
1	<a href="#">Defining Procedure Types</a>	
1	<a href="#">Defining Shift Types</a>	
1	<a href="#">Configuring Timesheet Options</a>	
1	<a href="#">Configuring Crew Hierarchy</a>	
1	<a href="#">Defining Crew Types</a>	
1	<a href="#">Defining Dispatcher Types</a>	
1	<a href="#">Configuring Mobile Devices</a>	
1	<a href="#">Defining Mailing Lists</a>	
1	<a href="#">Defining Break Types</a>	
1	<a href="#">Defining Non Productive Task Types</a>	
1	<a href="#">Defining POU Task Types</a>	
2	<a href="#">Defining Period of Unavailability Types</a>	
2	<a href="#">Configuring Activity Options</a>	
2	<a href="#">Defining Mobile Worker Types</a>	
2	<a href="#">Defining Vehicle Types</a>	If your implementation utilizes loading capacities on vehicles refer to the <a href="#">Transfer of Goods Setup</a> instead.
2	<a href="#">Configuring Scheduler Options</a>	
2	<a href="#">Defining Mail Templates</a>	
3	<a href="#">Defining Alert Types</a>	
3	<a href="#">Defining Service Classes</a>	
4	<a href="#">Defining KPIs</a>	
4	<a href="#">Defining Dispatch Areas</a>	
4	<a href="#">Defining Shift Cost Profiles</a>	
5	<a href="#">Setting Up Global Configuration</a>	
6	<a href="#">Configuring Deployment Options</a>	

## Resource Setup

This section lists resource related entities in the order they should be defined.

Level	Entity	Comment
1	<a href="#">Maintaining Alert Areas</a>	
1	<a href="#">Maintaining Dispatchers</a>	

1	<a href="#">Maintaining Mobile Workers</a>	You would need to set up the contractor company before you can set up contractor mobile workers,
1	<a href="#">Maintaining Vehicles</a>	You would need to set up the contractor company before you can set up contractor vehicles,
2	<a href="#">Maintaining Crews</a>	You would need to set up the contractor company before you can set up contractor crews,
3	<a href="#">Maintaining Periods Of Unavailability</a>	
3	<a href="#">Maintaining Shift Weekly Templates</a>	

## Transfer of Goods Setup

This section lists entities related to transfer of goods functionality in the order they should be defined.

Level	Entity	Comment
1	<a href="#">Configuring Transfer of Goods</a>	

## Contractor Management Setup

This section lists entities related to contractor management functionality in the order they should be defined.

Level	Entity	Comment
1	<a href="#">Defining Resource Group Types</a>	
1	<a href="#">Configuring Capacity Model Options</a>	
2	<a href="#">Maintaining Resource Groups</a>	
3	<a href="#">Maintaining Capacity Weekly Templates</a>	
3	<a href="#">Maintaining Contractor Eligibility</a>	

## BI Setup

Refer to the Oracle Utilities Analytics Administration Guide for more information.