

EAGLE

Database Administration - SS7 User's Guide

Release 46.6

E93318 Revision 1

March 2018

Copyright © 1993, 2018, Oracle and/or its affiliates. All rights reserved.

This software and related documentation are provided under a license agreement containing restrictions on use and disclosure and are protected by intellectual property laws. Except as expressly permitted in your license agreement or allowed by law, you may not use, copy, reproduce, translate, broadcast, modify, license, transmit, distribute, exhibit, perform, publish, or display any part, in any form, or by any means. Reverse engineering, disassembly, or decompilation of this software, unless required by law for interoperability, is prohibited.

The information contained herein is subject to change without notice and is not warranted to be error-free. If you find any errors, please report them to us in writing.

If this is software or related documentation that is delivered to the U.S. Government or anyone licensing it on behalf of the U.S. Government, then the following notice is applicable:

U.S. GOVERNMENT END USERS: Oracle programs, including any operating system, integrated software, any programs installed on the hardware, and/or documentation, delivered to U.S. Government end users are "commercial computer software" pursuant to the applicable Federal Acquisition Regulation and agency-specific supplemental regulations. As such, use, duplication, disclosure, modification, and adaptation of the programs, including any operating system, integrated software, any programs installed on the hardware, and/or documentation, shall be subject to license terms and license restrictions applicable to the programs. No other rights are granted to the U.S. Government.

This software or hardware is developed for general use in a variety of information management applications. It is not developed or intended for use in any inherently dangerous applications, including applications that may create a risk of personal injury. If you use this software or hardware in dangerous applications, then you shall be responsible to take all appropriate fail-safe, backup, redundancy, and other measures to ensure its safe use. Oracle Corporation and its affiliates disclaim any liability for any damages caused by use of this software or hardware in dangerous applications.

Oracle and Java are registered trademarks of Oracle and/or its affiliates. Other names may be trademarks of their respective owners.

Intel and Intel Xeon are trademarks or registered trademarks of Intel Corporation. All SPARC trademarks are used under license and are trademarks or registered trademarks of SPARC International, Inc. AMD, Opteron, the AMD logo, and the AMD Opteron logo are trademarks or registered trademarks of Advanced Micro Devices. UNIX is a registered trademark of The Open Group.

This software or hardware and documentation may provide access to or information about content, products, and services from third parties. Oracle Corporation and its affiliates are not responsible for and expressly disclaim all warranties of any kind with respect to third-party content, products, and services unless otherwise set forth in an applicable agreement between you and Oracle. Oracle Corporation and its affiliates will not be responsible for any loss, costs, or damages incurred due to your access to or use of third-party content, products, or services, except as set forth in an applicable agreement between you and Oracle.

This documentation is in preproduction status and is intended for demonstration and preliminary use only. It may not be specific to the hardware on which you are using the software. Oracle Corporation and its affiliates are not responsible for and expressly disclaim all warranties of any kind with respect to this documentation and will not be responsible for any loss, costs, or damages incurred due to the use of this documentation.

The information contained in this document is for informational sharing purposes only and should be considered in your capacity as a customer advisory board member or pursuant to your beta trial agreement only. It is not a commitment to deliver any material, code, or functionality, and should not be relied upon in making purchasing decisions. The development, release, and timing of any features or functionality described in this document remains at the sole discretion of Oracle.

This document in any form, software or printed matter, contains proprietary information that is the exclusive property of Oracle. Your access to and use of this confidential material is subject to the terms and conditions of your Oracle Master Agreement, Oracle License and Services Agreement, Oracle PartnerNetwork Agreement, Oracle distribution agreement, or other license agreement which has been executed by you and Oracle and with which you agree to comply. This document and information contained herein may not be disclosed, copied, reproduced, or distributed to anyone outside Oracle without prior written consent of Oracle. This document is not part of your license agreement nor can it be incorporated into any contractual agreement with Oracle or its subsidiaries or affiliates.

Contents

1 Introduction

Overview	1-1
Scope and Audience	1-1
Documentation Admonishments	1-1
Manual Organization	1-2
My Oracle Support (MOS).....	1-3
Emergency Response.....	1-3
Related Publications	1-4
Customer Training	1-4
Locate Product Documentation on the Oracle Help Center Site	1-4
Maintenance and Administration Subsystem	1-4
EAGLE Database Partitions	1-5

2 Configuring Destination Tables

Introduction	2-1
Point Code Formats	2-2
14-Bit ITU National Point Code Formats	2-8
ITU National Duplicate Point Codes	2-13
Proxy Point Codes	2-19
Changing the Proxy Point Code Quantity	2-21
Changing the DPC Quantity	2-31
Activating the ITU National and International Spare Point Code Support Feature.....	2-55
Spare Point Code Feature Migration Plan.....	2-65
Multiple Point Code Support.....	2-73
Adding a Secondary Point Code	2-79
Removing a Secondary Point Code.....	2-90
Adding a Point Code to the Self-Identification of the EAGLE.....	2-96
Changing the Self-Identification of the EAGLE	2-106
Cluster Routing and Management Diversity (CRMD).....	2-150
Nested Cluster Routing.....	2-161
Adding a Cluster Point Code	2-168
Changing the Attributes of a Cluster Point Code	2-193

Network Routing	2-211
Adding a Network Routing Point Code.....	2-216
Adding a Destination Point Code	2-232
Removing a Destination Point Code.....	2-261
Changing a Destination Point Code.....	2-283
Changing the Group Code Assigned to a 14-Bit ITU National Point Code.....	2-309

3 SS7 Configuration

Introduction	3-1
Enabling the Large System # Links Controlled Feature.....	3-2
Adding an SS7 Linkset.....	3-19
ITU SLS Enhancement.....	3-46
ITU TFR Procedures	3-52
Per-Linkset Random SLS	3-53
Verifying the Gateway Screening Configuration for a Linkset.....	3-55
Configuring the MTP Restart Feature.....	3-63
Configuring the 5-Bit to 8-Bit SLS Conversion Feature.....	3-69
Using Proxy Point Codes and Secondary Point Codes when Adding a Linkset	3-76
Activating the SLS Bit Rotation by Incoming Linkset Feature.....	3-96
Configuring the RSL8 Value for ANSI Linksets.....	3-107
Removing a Linkset Containing SS7 Signaling Links	3-111
Changing an SS7 Linkset	3-138
Verifying the New Adjacent Point Code or New Secondary Point Code for a Linkset	3-165
Using the MULTGC Parameter when Changing the Attributes of a Linkset	3-190
Configuring an ITU Linkset with a Secondary Adjacent Point Code (SAPC).....	3-200
Adding an SS7 Signaling Link	3-221
Removing an SS7 Signaling Link.....	3-235
Adding a Route Containing an SS7 DPC	3-245
Adding a Route Containing a Cluster Point Code.....	3-270
Adding a Route Containing an IPGWx Linkset.....	3-281
Removing a Route.....	3-296
Changing a Route	3-328
Changing Level 2 Timers	3-354
Changing Level 3 Timers	3-361
Changing a Signaling Link Test Message.....	3-367
Configuring Circular Route Detection.....	3-370
Configuring the TFA/TFR Pacing Rate.....	3-374
Configuring the Frequency of RST Messages on Low Priority Routes	3-377
Adding Remote Loopback Points.....	3-381
Removing Remote Loopback Points	3-386
Changing Remote Loopback Points.....	3-389
Configuring the System for Random SLS Generation.....	3-393
Configuring the Options for the TDM Global Timing Interface.....	3-407

Configuring the Restricted Linkset Option.....	3-415
Configuring the Options for Handling TFCs on ITU-I and ITU-N Networks	3-422
Changing the High-Capacity Card Temperature Alarm Thresholds.....	3-426
Activating the Origin-Based MTP Routing Feature	3-431
Configuring the Origin-Based MTP Routing SCCP OPC Option	3-447
Adding an Exception Route Entry	3-451
Removing a Route Exception Entry	3-497
Changing a Route Exception Entry	3-514
Activating the Circular Route Auto-Recovery Feature	3-541
Turning Off the Circular Route Auto-Recovery Feature	3-550
Activating the Enhanced Far-End Loopback Detection Feature.....	3-553
Turning Off the Enhanced Far-End Loopback Detection Feature	3-562
Activating the Multiple Linksets to Single Adjacent PC (MLS) Feature	3-565
Configuring the ITU Linkset NI Mapping Options.....	3-577
Configuring the Option for Handling Message Priorities for Messages Crossing into ITU-I and ITU-N Networks.....	3-583
Activating the 6-Way Loadsharing on Routesets Feature.....	3-586

4 Point Code and CIC Translation Configuration

Introduction	4-1
Changing the Point Code and CIC Translation Quantity	4-2
Adding a Point Code and CIC Translation Entry	4-10
Removing a Point Code and CIC Translation Entry.....	4-25
Configuring the Point Code and CIC Translation STP Option	4-28
Configuring the Point Code and CIC Translation Linkset Option.....	4-31

A E1 Interface

Introduction	A-1
Determining the Configuration	A-6
E1 Interface Configuration Procedures.....	A-9
Adding a LIM-E1 Card	A-10
Removing a LIM-E1 Card	A-23
Adding Channelized and non-Channel Bridged E1 Ports	A-26
Adding Channel Bridged E1 Ports.....	A-45
Adding Unchannelized E1 Ports	A-63
Removing the E1 Interface Parameters.....	A-91
Changing the Attributes of a Channelized E1 Port	A-94
Changing the Attributes of an Unchannelized E1 Port.....	A-107
Making a Channel Bridged E1 Port from a Channelized E1 Port.....	A-114
Making a Non-Channel Bridged E1 Port from a Channel Bridged E1 Port.....	A-134
Adding an E1 Signaling Link	A-142

B T1 Interface

Introduction	B-1
Determining the Configuration	B-5
T1 Interface Configuration Procedures.....	B-8
Adding a LIM-T1 Card	B-8
Removing a LIM-T1 Card.....	B-20
Adding Channelized and non-Channel Bridged T1 Ports	B-23
Adding Channel Bridged T1 Ports.....	B-42
Adding Unchannelized T1 Ports	B-59
Removing the T1 Interface Parameters.....	B-83
Changing the Attributes of a Channelized T1 Port	B-86
Changing the Attributes of an Unchannelized T1 Port.....	B-98
Making a Channel Bridged T1 Port from a Channelized T1 Port.....	B-105
Making a Non-Channel Bridged T1 Port from a Channel Bridged T1 Port.....	B-126
Adding a T1 Signaling Link	B-133

C ATM Signaling Link Configuration

Introduction	C-1
Overview of the ATM High-Speed Signaling Link LIM Operation.....	C-6
ATM High-Speed Signaling Link Testing Capability	C-14
Large MSUs.....	C-22
Unsolicited Messages	C-22
ATM High-Speed Signaling Link Configuration	C-25
Adding an ATM High-Speed LIM	C-26
Changing the Three Links per E5-ATM-B Card Quantity	C-34
Adding an ATM High-Speed Signaling Link	C-45
Changing an ATM High-Speed Signaling Link Parameter Set.....	C-91

D Reference Information

Requirements for EAGLEs Containing more than 1200 Signaling Links.....	D-1
Determining the Number of High-Speed and Low-Speed Signaling Links	D-1

List of Figures

1-1	EAGLE Database Partitions (E5-Based Control Cards).....	1-6
2-1	Mixed Network with ANSI, ITU-I, and ITU-N Nodes.....	2-1
2-2	Changing the Format of an ITU National Point Code.....	2-11
2-3	Network Example #1.....	2-14
2-4	Network Example #2.....	2-16
2-5	Network for Conversion.....	2-18
2-6	Context of the Proxy Point Code in the Network.....	2-19
2-7	Changing the Proxy Point Code Quantity.....	2-26
2-8	Changing the DPC Quantity.....	2-45
2-9	Activating the ITU National and International Spare Point Code Support Feature.....	2-60
2-10	Example of an Existing Network that is not using the ITU National and International Spare Point Code Support Feature.....	2-67
2-11	Stage One - ITU National and International Spare Point Code Support Feature Provisioned on All Nodes.....	2-69
2-12	Stage Two - All Traffic Merged onto a Third Linkset.....	2-72
2-13	Stage Three - All Traffic Merged onto Linkset LS9.....	2-73
2-14	Replacing the First STP Pair.....	2-75
2-15	Replacing a Second STP Pair.....	2-76
2-16	Multiple Linkset Example.....	2-77
2-17	Adding a Secondary Point Code.....	2-87
2-18	Removing a Secondary Point Code.....	2-95
2-19	Adding a Point Code to the Self-Identification of the EAGLE.....	2-101
2-20	Changing the Self-Identification of the EAGLE.....	2-130
2-21	Cluster Routing and Management Diversity.....	2-150
2-22	Cluster Management.....	2-157
2-23	Home Cluster Example.....	2-159
2-24	Nested Cluster Routing Sample Configuration.....	2-165
2-25	Adding a Cluster Point Code.....	2-184
2-26	Changing the Attributes of a Cluster Point Code.....	2-204
2-27	Example of Network Routing Reliability.....	2-212
2-28	Potential Routing Network Failure.....	2-213
2-29	Adding a Network Routing Point Code.....	2-225
2-30	Adding a Destination Point Code.....	2-252
2-31	Removing a Destination Point Code.....	2-274
2-32	Changing a Destination Point Code.....	2-302
2-33	Changing the Group Code Assigned to a 14-Bit ITU National Point Code.....	2-312
3-1	Adding a SS7 Linkset.....	3-43
3-2	ITU ISUP Routing Label with CIC.....	3-46
3-3	Example of Bit Rotation.....	3-48
3-4	SLS creation Using "Other CIC Bit".....	3-49
3-5	Verifying the Gateway Screening Configuration for a Linkset.....	3-60
3-6	Configuring the MTP Restart Feature.....	3-68
3-7	Configuring the 5-Bit to 8-Bit SLS Conversion Feature.....	3-73
3-8	Using Proxy Point Codes and Secondary Point Codes when Adding a Linkset.....	3-83
3-9	Activating the SLS Bit Rotation by Incoming Linkset Feature.....	3-100
3-10	Configuring the RSL8 Value for ANSI Linksets.....	3-110
3-11	Removing a Linkset Containing SS7 Signaling Links.....	3-125
3-12	Changing an SS7 Linkset.....	3-160
3-13	Verifying the New Adjacent Point Code or New Secondary Point Code for a Linkset.....	3-175
3-14	Using the MULTGC Parameter when Changing the Attributes of a Linkset.....	3-195
3-15	Configuring an ITU Linkset with a Secondary Adjacent Point Code (SAPC).....	3-210

3-16	Adding an SS7 Signaling Link.....	3-230
3-17	Removing an SS7 Signaling Link.....	3-242
3-18	Adding a Route Containing an SS7 DPC.....	3-257
3-19	Adding a Route Containing a Cluster Point Code.....	3-276
3-20	Adding a Route Containing an IPGWx Linkset.....	3-289
3-21	Removing a Route.....	3-313
3-22	Changing a Route.....	3-339
3-23	Changing Level 2 Timers.....	3-360
3-24	Changing Level 3 Timers.....	3-366
3-25	Changing a Signaling Link Test Message.....	3-369
3-26	Configuring Circular Route Detection.....	3-373
3-27	Configuring the TFA/TFR Pacing Rate.....	3-376
3-28	Configuring the Frequency of RST Messages on Low Priority Routes.....	3-380
3-29	Adding Remote Loopback Points.....	3-385
3-30	Removing Remote Loopback Points.....	3-388
3-31	Changing Remote Loopback Points.....	3-392
3-32	Random SLS Mapping to a Combined Linkset.....	3-396
3-33	Random SLS Mapping to a Single Linkset.....	3-396
3-34	Configuring the System for Random SLS Generation.....	3-402
3-35	Configuring the Options for the TDM Global Timing Interface.....	3-412
3-36	Configuring the Restricted Linkset Option.....	3-419
3-37	Configuring the Options for Handling TFCs on ITU-I and ITU-N Networks.....	3-425
3-38	Changing the High-Capacity Card Temperature Alarm Thresholds.....	3-430
3-39	ISDN User Part Message Parts.....	3-433
3-40	Activating the Origin-Based MTP Routing Feature.....	3-440
3-41	Configuring the Origin-Based MTP Routing SCCP OPC Option.....	3-450
3-42	Adding an Exception Route Entry.....	3-473
3-43	Removing a Route Exception Entry.....	3-505
3-44	Changing a Route Exception Entry.....	3-526
3-45	Activating the Circular Route Auto-Recovery Feature.....	3-545
3-46	Turning Off the Circular Route Auto-Recovery Feature	3-552
3-47	Activating the Enhanced Far-End Loopback Detection Feature.....	3-557
3-48	Turning Off the Enhanced Far-End Loopback Detection Feature	3-564
3-49	Activating the Multiple Linksets to Single Adjacent PC (MLS) Feature.....	3-570
3-50	Configuring the ITU Linkset NI Mapping Options.....	3-582
3-51	Configuring the Option for Handling Message Priorities for Messages Crossing into ITU-I and ITU-N Networks.....	3-585
3-52	Activating the 6-Way Loadsharing on Routesets Feature.....	3-591
4-1	Changing the Point Code and CIC Translation Quantity.....	4-7
4-2	Adding a Point Code and CIC Translation Entry.....	4-19
4-3	Removing a Point Code and CIC Translation Entry.....	4-27
4-4	Configuring the Point Code and CIC Translation STP Option.....	4-30
4-5	Configuring the Point Code and CIC Translation Linkset Option.....	4-35
A-1	E1/T1 MIM Block Diagram.....	A-2
A-2	E5-E1T1-B Block Diagram.....	A-3
A-3	Channel Bridging.....	A-5
A-4	Adding a LIM-E1 Card.....	A-16
A-5	Removing a LIM-E1 Card.....	A-25
A-6	Adding Channelized and non-Channel Bridged E1 Ports.....	A-32
A-7	Adding Channel Bridged E1 Ports.....	A-52
A-8	Adding Unchannelized E1 Ports.....	A-72
A-9	Removing the E1 Interface Parameters.....	A-93
A-10	Changing the Attributes of a Channelized E1 Port.....	A-100
A-11	Changing the Attributes of an Unchannelized E1 Port.....	A-111

A-12	Making a Channel Bridged E1 Port from a Channelized E1 Port.....	A-123
A-13	Making a Non-Channel Bridged E1 Port from a Channel Bridged E1 Port.....	A-139
A-14	Adding an E1 Signaling Link.....	A-157
B-1	E1/T1 MIM Block Diagram.....	B-2
B-2	HC MIM or E5-E1T1 Block Diagram.....	B-3
B-3	Channel Bridging.....	B-4
B-4	Adding a LIM-T1 Card.....	B-13
B-5	Removing a LIM-T1 Card.....	B-22
B-6	Adding Channelized and non-Channel Bridged T1 Ports.....	B-29
B-7	Adding Channel Bridged T1 Ports.....	B-48
B-8	Adding Unchannelized T1 Ports.....	B-66
B-9	Removing the T1 Interface Parameters.....	B-85
B-10	Changing the Attributes of a Channelized T1 Port.....	B-91
B-11	Changing the Attributes of an Unchannelized T1 Port.....	B-102
B-12	Making a Channel Bridged T1 Port from a Channelized T1 Port.....	B-115
B-13	Making a Non-Channel Bridged T1 Port from a Channel Bridged T1 Port.....	B-130
B-14	Adding a T1 Signaling Link.....	B-144
C-1	High-Speed Link Protocol Model for CCS Network Elements.....	C-2
C-2	ATM High-Speed Signaling Link Protocol Stack vs. Oracle Implementation in the EAGLE.....	C-3
C-3	Frame Formats for High-Speed and Low-Speed Signaling Link Protocol Stacks.....	C-4
C-4	ATM Protocol Encapsulation.....	C-5
C-5	Functional Block Diagram of ATM High-Speed Signaling Link.....	C-6
C-6	E1 Frame Structure.....	C-9
C-7	CRC-4 Multiframe Structure.....	C-10
C-8	ATM Cell Mapping into E1 Frames.....	C-11
C-9	ANSI ATM High-Speed Signaling Link Loopback Support.....	C-17
C-10	E1 ATM High-Speed Signaling Link Loopback Support.....	C-18
C-11	Adding an ATM High-Speed LIM.....	C-31
C-12	Changing the Three Links per E5-ATM Card Quantity.....	C-40
C-13	Adding an ATM High-Speed Signaling Link.....	C-72
C-14	Changing an ATM High-Speed Signaling Link Parameter Set.....	C-97

List of Tables

1-1	Admonishments.....	1-2
2-1	Point Code Format.....	2-8
2-2	14-Bit ITU National Point Code Values.....	2-9
2-3	Proxy Point Code Quantities and Part Numbers.....	2-20
2-4	Proxy Point Code Quantities and Part Numbers.....	2-21
2-5	Maximum Point Code Quantities.....	2-151
2-6	Maximum Alias Point Code Quantities.....	2-152
2-7	Example Cluster Routing Information.....	2-157
2-8	Home Cluster Routing Information.....	2-159
2-9	Routing Models	2-162
2-10	Routing Table for Nested Cluster 5-5-*.	2-165
2-11	Routing Table for Full Point Code Member 5-5-1.....	2-165
2-12	Example of Nested Cluster Routing Failure and Recovery Actions	2-166
2-13	Reception of an RSx Message.....	2-215
2-14	Reception of an RCx Message.....	2-215
2-15	Destination Point Code Type and Alias Point Code Type Combinations.....	2-236
2-16	Maximum Alias Point Code Quantities.....	2-238
2-17	Destination Point Code Type and Alias Point Code Type Combinations.....	2-287
2-18	Maximum Alias Point Code Quantities.....	2-289
3-1	Linkset Parameters.....	3-19
3-2	Actions of the National Spare for Network Indicator Feature.....	3-22
3-3	Adding a Linkset Parameter Combinations.....	3-33
3-4	ITU SLS Bit Rotation.....	3-49
3-5	ANSI Linkset Incoming Bit Rotation Rules.....	3-50
3-6	ANSI SLS Bit Rotation.....	3-51
3-7	Route Management Messages Sent on Status Transition.....	3-53
3-8	MTP Restart Signaling Link Alignment Delay.....	3-63
3-9	Signaling Link Selector (SLS) Conversion (ANSI Linksets Only).....	3-70
3-10	Linkset Parameters.....	3-138
3-11	Actions of the National Spare for Network Indicator Feature.....	3-141
3-12	Changing a Linkset Parameter Combinations.....	3-153
3-13	Secondary Adjacent Point Code Configuration Table.....	3-201
3-14	Signaling Link Parameters.....	3-221
3-15	SS7 Signaling Link Parameter Combinations.....	3-222
3-16	Level 2 Timer Sets.....	3-354
3-17	Level 2 Timer Values - Low-Speed ANSI Signaling Links.....	3-354
3-18	Level 2 Timer Values - Low-Speed ITU Signaling Links.....	3-355
3-19	Level 2 Timer Values - ITU-N High-Speed Signaling Links for China.....	3-356
3-20	Level 2 Timer Values - ITU-N High-Speed Signaling Links for Areas other than China	3-357
3-21	Level 2 Timer Values - Unchannelized T1 High-Speed Signaling Links.....	3-357
3-22	Loopback Point Configuration Table.....	3-382
3-23	ITU Random SLS Rules.....	3-394
3-24	ANSI Random SLS Rules.....	3-394
3-25	Failure Scenarios for a 32-Link Combined Linkset.....	3-398
3-26	High Capacity Thermal Limits.....	3-427
3-27	Add Exception Route Parameter Combinations.....	3-462
3-28	Remove Exception Route Parameter Combinations.....	3-499
3-29	Change Exception Route Parameter Combinations.....	3-521
3-30	Network Indicator Mapping Rules.....	3-578
4-1	PCT Quantities and Part Numbers.....	4-3

4-2	ENT-PCT Parameters.....	4-10
A-1	Functional Overview of the E1 and Channel Card.....	A-3
A-2	Channel Bridging E1 Port Pairing.....	A-5
A-3	E1 Signaling Link Configuration Form.....	A-8
A-4	E1 Card Part Numbers.....	A-10
A-5	HC-MIM Card Locations.....	A-10
A-6	Card Removal Procedures	A-12
A-7	Maximum Number of E1 Ports.....	A-28
A-8	E1 Interface Parameter Combinations.....	A-30
A-9	Channel Bridging Ports.....	A-46
A-10	Channel Bridged E1 Port Combinations.....	A-49
A-11	SE-HSL SLK QuantityPart Numbers.....	A-67
A-12	Unchannelized E1 Port Parameter Combinations.....	A-70
A-13	E1 Interface Parameter Combinations	A-97
A-14	Unchannelized E1 Port Parameter Combinations	A-109
A-15	Channel Bridging Ports.....	A-115
A-16	Channel Bridged E1 Port Parameter Combinations	A-121
A-17	Non-Channel Bridged E1 Port Parameter Combinations	A-136
A-18	E1 Signaling Link Configuration Table.....	A-145
A-19	E1 Signaling Link Parameter Combinations.....	A-151
B-1	Functional Overview of the T1 and Channel Card.....	B-3
B-2	Channel Bridging T1 Port Pairing.....	B-5
B-3	T1 Signaling Link Configuration Form.....	B-7
B-4	T1 Card Part Numbers.....	B-8
B-5	HC-MIM Card Locations.....	B-9
B-6	Card Removal Procedures.....	B-10
B-7	Maximum Number of T1 Ports.....	B-24
B-8	T1 Interface Parameter Combinations.....	B-26
B-9	Channel Bridging Ports.....	B-42
B-10	Channel Bridged T1 Port Combinations.....	B-46
B-11	ST-HSL-A SLK Quantity Part Numbers.....	B-63
B-12	Unchannelized T1 Port Parameter Combinations.....	B-64
B-13	T1 Interface Parameter Combinations	B-89
B-14	Unchannelized T1 Port Parameter Combinations	B-100
B-15	Channel Bridging Ports.....	B-106
B-16	Channel Bridged T1 Port Parameter Combinations	B-112
B-17	Non-Channel Bridged T1 Port Parameter Combinations	B-128
B-18	T1 Signaling Link Parameter Combinations.....	B-140
C-1	Link Proving Differences Between ITU and ANSI.....	C-13
C-2	ATM High-Speed Signaling Link Loopback Support.....	C-15
C-3	High-Speed Signaling Link vs. Low-Speed Signaling Link Unavailability Reasons by Priority	C-19
C-4	High-Speed Signaling Link State Transition Alignment Events.....	C-20
C-5	High-Speed Signaling Link Transmitted/Received Alignment PDUs.....	C-21
C-6	High-Speed Signaling Link Special Level 1 Alignment Events.....	C-22
C-7	Signaling Link Unsolicited Alarm Messages.....	C-23
C-8	Loopback Test UIMs.....	C-25
C-9	ATM High-Speed LIM Card Type and Card Application Combinations.....	C-26
C-10	Example Card Configuration.....	C-27
C-11	3 Links per E5-ATM-B Card Quantities and Part Numbers.....	C-34
C-12	ATM Signaling Link Cable Lengths.....	C-46
C-13	ATM High-Speed Signaling Link Parameter Combinations.....	C-47

Introduction

Chapter 1, Introduction, contains general information about the database and the organization of this manual.

Overview

The *Database Administration – SS7 User’s Guide* describes the procedures used to configure the EAGLE and its database to implement the **SS7** protocol.

Note: Database administration privileges are password restricted. Only those persons with access to the command class “Database Administration” can execute the administrative functions. Other command classes and the commands allowed by those classes are listed in *Commands User’s Guide*.

As of Release 46.6, throughout this manual, these terms are used to refer to either the EPM-B version or other replacement version of the card unless one of the card types is specifically required.

- E5-ENET - the E5-ENET-B card
- E5-E1T1 - the E5-E1T1-B card
- E5-ATM - the E5-ATM-B card
- E5-IPSM - the E5-ENET-B card that is running the IPSHC GPL
- E5-SM4G - the E5-SM8G-B card (not an EPM-B card)
- MCPM - the original MCPM or the E5-MCPM-B card





Scope and Audience

This user’s guide is intended for database administration personnel or translations personnel responsible for configuring the **EAGLE** and its database to implement the **SS7** protocol.

Documentation Admonishments

Admonishments are icons and text throughout this manual that alert the reader to assure personal safety, to minimize possible service interruptions, and to warn of the potential for equipment damage.

Table 1-1 Admonishments

Icon	Description
 DANGER	Danger: (This icon and text indicate the possibility of <i>personal injury</i> .)
 WARNING	Warning: (This icon and text indicate the possibility of <i>equipment damage</i> .)
 CAUTION	Caution: (This icon and text indicate the possibility of <i>service interruption</i> .)
 TOPPLE	Topple: (This icon and text indicate the possibility of <i>personal injury and equipment damage</i> .)

Manual Organization

Throughout this document, the terms database and system software are used. Database refers to all data that can be administered by the user, including shelves, cards, links, routes, global title translation tables, and gateway screening tables. System software refers to data that cannot be administered by the user, including generic program loads (GPLs).

This document is organized into these sections:

[Introduction](#) contains general information about the database and the organization of this user's guide.

[Configuring Destination Tables](#) describes the methods for configuring destination point codes (DPCs) in the database of the EAGLE. The cluster routing and management diversity feature is also discussed in this section.

[SS7 Configuration](#) describes the procedures necessary to configure the EAGLE to support the SS7 network.

[Point Code and CIC Translation Configuration](#) describes the procedures necessary to configure the Point Code and CIC Translation feature.

[E1 Interface](#) contains general information about the E1 interface and how to provision it.

[T1 Interface](#) contains general information about the T1 interface and how to provision it.

[ATM Signaling Link Configuration](#) contains general information about the ATM high-speed signaling links and how to provision them.

[Reference Information](#) contains the following information that is used by more than one procedure in this user's guide:

- [Requirements for EAGLEs Containing more than 1200 Signaling Links](#)

- [Determining the Number of High-Speed and Low-Speed Signaling Links](#)

My Oracle Support (MOS)

MOS (<https://support.oracle.com>) is your initial point of contact for all product support and training needs. A representative at Customer Access Support (CAS) can assist you with MOS registration.

Call the CAS main number at 1-800-223-1711 (toll-free in the US), or call the Oracle Support hotline for your local country from the list at <http://www.oracle.com/us/support/contact/index.html>. When calling, make the selections in the sequence shown below on the Support telephone menu:

1. Select 2 for New Service Request
2. Select 3 for Hardware, Networking and Solaris Operating System Support
3. Select one of the following options:
 - For Technical issues such as creating a new Service Request (SR), Select 1
 - For Non-technical issues such as registration or assistance with MOS, Select 2

You will be connected to a live agent who can assist you with MOS registration and opening a support ticket.

MOS is available 24 hours a day, 7 days a week, 365 days a year.

Emergency Response

In the event of a critical service situation, emergency response is offered by the Customer Access Support (CAS) main number at 1-800-223-1711 (toll-free in the US), or by calling the Oracle Support hotline for your local country from the list at <http://www.oracle.com/us/support/contact/index.html>. The emergency response provides immediate coverage, automatic escalation, and other features to ensure that the critical situation is resolved as rapidly as possible.

A critical situation is defined as a problem with the installed equipment that severely affects service, traffic, or maintenance capabilities, and requires immediate corrective action. Critical situations affect service and/or system operation resulting in one or several of these situations:

- A total system failure that results in loss of all transaction processing capability
- Significant reduction in system capacity or traffic handling capability
- Loss of the system's ability to perform automatic system reconfiguration
- Inability to restart a processor or the system
- Corruption of system databases that requires service affecting corrective actions
- Loss of access for maintenance or recovery operations
- Loss of the system ability to provide any required critical or major trouble notification

Any other problem severely affecting service, capacity/traffic, billing, and maintenance capabilities may be defined as critical by prior discussion and agreement with Oracle.

Related Publications

For information about additional publications related to this document, refer to the Oracle Help Center site. See [Locate Product Documentation on the Oracle Help Center Site](#) for more information on related product publications.

Customer Training

Oracle University offers training for service providers and enterprises. Visit our web site to view, and register for, Oracle Communications training:

<http://education.oracle.com/communication>

To obtain contact phone numbers for countries or regions, visit the Oracle University Education web site:

www.oracle.com/education/contacts

Locate Product Documentation on the Oracle Help Center Site

Oracle Communications customer documentation is available on the web at the Oracle Help Center (OHC) site, <http://docs.oracle.com>. You do not have to register to access these documents. Viewing these files requires Adobe Acrobat Reader, which can be downloaded at <http://www.adobe.com>.

1. Access the Oracle Help Center site at <http://docs.oracle.com>.
2. Click `Industries`.
3. Under the Oracle Communications subheading, click the `Oracle Communications documentation` link.

The Communications Documentation page appears. Most products covered by these documentation sets will appear under the headings "Network Session Delivery and Control Infrastructure" or "Platforms."

4. Click on your Product and then the Release Number.

A list of the entire documentation set for the selected product and release appears.

5. To download a file to your location, right-click the PDF link, select `Save target as` (or similar command based on your browser), and save to a local folder.

Maintenance and Administration Subsystem

The Maintenance and Administration Subsystem (MAS) is the central management point for the EAGLE. The **MAS** provides user interface, maintenance communication, peripheral services, alarm processing, system disk interface, and measurements. Management and redundancy are provided by use of two separate subsystem processors.

The MAS resides on two separate sets of Maintenance and Administration Subsystem Processor (**MASP**) cards and a Maintenance Disk and Alarm card (collectively referred to as **control cards**). The control cards are located in slots 1113 through 1118 of the EAGLE control shelf. The control cards must be E5-based cards.

E5-based Control Cards

The E5-based set of EAGLE control cards consists of the following cards:

- Two Maintenance and Administration Subsystem Processor cards (E5-MASP) cards. Each dual-slot **E5-MASP card** is made up of the following two modules:
 - Maintenance Communication Application Processor (E5-MCAP) card
 - Terminal Disk Module (E5-TDM) card
- One Maintenance Disk and Alarm card (E5-MDAL card)

Maintenance Communication Application Processor (E5-MCAP) Card

The **E5-MCAP card** contains the Communications Processor and Applications Processor and provides connections to the IMT bus. The card controls the maintenance and database administration activity and performs both application and communication processing. E5-MCAP cards are located in slots 1113 and 1115 of the control shelf.

Each E5-MCAP card contains two **USB ports**. One **latched USB port** is used with removable flash media (“thumb drives”), and one **flush-mounted USB port** is used with a plug-in flash drive. The **removable media** drive in the latched USB port is used to install and back up customer data. The flush-mounted USB port is used for upgrade and could be used for disaster recovery.

Terminal Disk Module (E5-TDM) Card

The **E5-TDM card** provides the Terminal Processor for the 16 I/O ports, and interfaces to the Maintenance Disk and Alarm (E5-MDAL) card and fixed disk storage. The E5-TDM card also distributes Composite Clocks and High Speed Master clocks throughout the EAGLE, and distributes Shelf ID to the EAGLE. Each E5-TDM card contains one fixed SATA drive that is used to store primary and backup system databases, measurements, and Generic Program Loads (GPLs). E5-TDM cards are located in slots 1114 and 1116 of the control shelf.

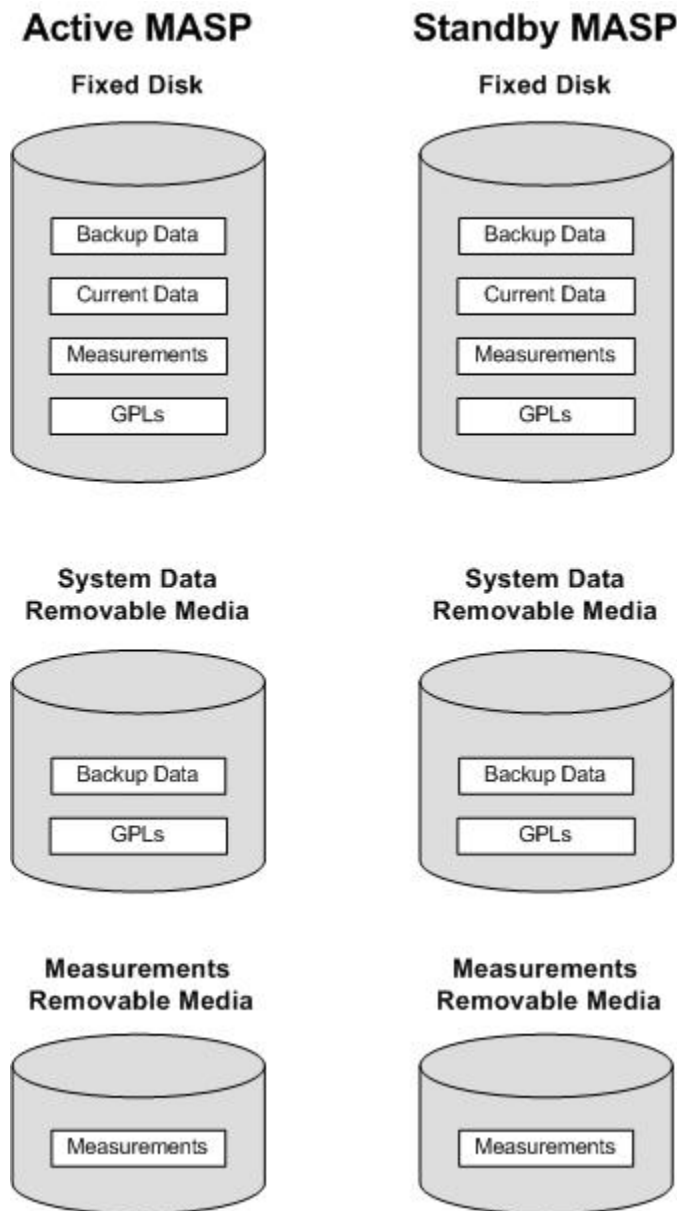
Maintenance Disk and Alarm (E5-MDAL) Card

The **E5-MDAL card** processes alarm requests and provides fan control. There is only one E5-MDAL card in a control card set. Critical, major, and minor system alarms are provided for up to 6 individual frames. In addition to the 3 system alarms, the E5-MDAL card provides the system audible alarm. The E5-MDAL card provides control of fans on a per-frame basis, and allows for each fan relay to be set individually. The E5-MDAL card is located in slots 1117 and 1118 of the control shelf.

EAGLE Database Partitions

The data that the **EAGLE** uses to perform its functions are stored in two separate areas: the fixed disk drives, and the removable media. The following sections describe these areas and data that is stored on them. These areas and their partitions are shown in [Figure 1-1](#).

Figure 1-1 EAGLE Database Partitions (E5-Based Control Cards)



Fixed Disk Drive

There are two fixed disk drives on the **EAGLE**. The fixed disk drives contain the “master” set of data and programs for the **EAGLE**. The two fixed disk drives are located on the terminal disk modules (**E5-TDMs**). Both disks have the same files. The data stored on the fixed disks is partially replicated on the various cards in the **EAGLE**. Changes made during database administration sessions are sent to the appropriate cards.

The data on the fixed disks can be viewed as four partitions.

- Current partition
- Backup partition
- Measurements partition

- Generic program loads (**GPLs**) partition

The data which can be administered by users is stored in two partitions on the fixed disk, a current database partition which has the tables which are changed by on-line administration, and a backup database partition which is a user-controlled copy of the current partition.

All of the on-line data administration commands affect the data in the current partition. The purpose of the backup partition is to provide the users with a means of rapidly restoring the database to a known good state if there has been a problem while changing the current partition.

A full set of **GPLs** is stored on the fixed disk, in the **GPL** partition. There is an approved **GPL** and a trial **GPL** for each type of **GPL** in this set and a utility **GPL**, which has only an approved version. Copies of these **GPLs** are downloaded to the **EAGLE** cards. The **GPL** provides each card with its functionality. For example, the `ss7ansi` **GPL** provides **MTP** functionality for link interface modules (**LIMs**).

Measurement tables are organized as a single partition on the fixed disk. These tables are used as holding areas for the measurement counts.

Removable Media

The removable media is used with the E5-MCAP card portion of the E5-MASP in card locations 1113 and 1115.

The removable media is used for two purposes.

- To hold an off-line backup copy of the administered data and system **GPLs**
- To hold a copy of the measurement tables

Because of the size of the data stored on the fixed disk drives on the **E5-TDMs**, a single removable media cannot store all of the data in the database, **GPL** and measurements partitions.

To use a removable media to hold the system data, it must be formatted for system data. To use a removable media to hold measurements data, it must be formatted for measurements data. The **EAGLE** provides the user the ability to format a removable media for either of these purposes. A removable media can be formatted on the **EAGLE** by using the `format-disk` command. More information on the `format-disk` command can be found in *Commands User's Guide*. More information on the removable media drives can be found in *Hardware Guide*.

Additional and preformatted removable media are available from the [My Oracle Support \(MOS\)](#).

Configuring Destination Tables

Chapter 2, *Configuring Destination Tables*, describes the methods for configuring destination point codes (DPCs) in the database of the EAGLE. The cluster routing and management diversity feature is also discussed in this section.

Introduction

The **SS7** network configuration for the **EAGLE** requires linksets and routes. These entities use point codes, and these point codes must be defined in the destination point code table of the database. A destination is a node in any network that is uniquely identified by a point code in conjunction with a network indicator. The destination is always the node's true point code.

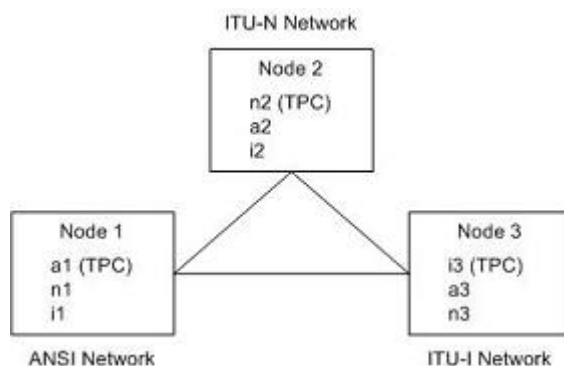
The **EAGLE** supports three types of networks and nodes to carry **SS7** traffic, using **TCP/IP** technology:

- **ANSI**
- **ITU International (ITU-I)**
- **ITU National (ITU-N)**

When nodes in different networks wish to communicate, each node must have its own true point code and an alternate point code for each of the network types involved. For example, if node 1 in an **ANSI** network, node 2 in an **ITU-N** network, and node 3 in an **ITU-I** network wish to communicate with each other, node 1 must have an **ANSI** true point code and one alternate point code each for the **ITU-N** and **ITU-I** network. Node 2 must have an **ITU-N** true point code and one alternate point code each for the **ANSI** and **ITU-I** network. Node 3 must have an **ITU-I** true point code and one alternate point code each for the **ANSI** and **ITU-N** network.

[Figure 2-1](#) shows an example of a mixed network with **ANSI**, **ITU-I**, and **ITU-N** nodes. Each node has one true point code and two alternate point codes.

Figure 2-1 Mixed Network with ANSI, ITU-I, and ITU-N Nodes



The node's true point code is also called the destination point code.

This chapter discusses the method for configuring destination point codes (**DPCs**) in the database of the **EAGLE**. **Destination** point codes can be one of five types:

- Full point codes used for **SS7** routing. A full point code is a point code containing numbers in each portion of the point code, for example, 111-011-100. The full point code can be in one of three formats, **ANSI**, **ITU** international, or **ITU** national. See the [Point Code Formats](#) section for more information on the point code formats. The **EAGLE** must have a full point code for each network type (**ANSI**, **ITU-N**, **ITU-I**) it is connected to.
- Secondary point codes, used by the **Multiple Point Code** Support feature. A secondary point code is a point code assigned to a full point code and used as if they were the actual **EAGLE** point code. Secondary point codes can be in one of three formats: **ANSI**, **ITU** international, or **ITU** national. The format of the secondary point code must be the same as the format of the full destination point code. See the [Multiple Point Code Support](#) section for more information on secondary point codes.
- Cluster destination point codes, used by the cluster routing and management (**CRMD**) feature and nested cluster routing feature. A cluster point code is an **ANSI** point code containing numbers in the network identifier and network cluster portions of the point code, and an asterisk (*) in the network cluster member field of the point code, for example, 111-011-*. See the [Cluster Routing and Management Diversity \(CRMD\)](#) section and the [Nested Cluster Routing](#) section for more information on cluster point codes.
- Network routing point codes, used by the network routing feature. A network routing point code is an **ANSI** point code containing a number in the network identifier portion of the point code, and asterisks (*) in the network cluster and network cluster member portions of the point code, for example, 111-*-*. See the [Network Routing](#) section for information on network routing point codes.
- Proxy point codes, used by the Proxy Point Code feature. A proxy point code is a point code that assumes the point code of another node in order to ease the migration of deploying an STP in a network with direct-connect links into other networks. See the [Proxy Point Codes](#) section for more information about proxy point codes.

The **Cluster** Routing and Management Diversity (**CRMD**) feature, the nested cluster routing feature, the multiple point code support feature, and the network routing features are also discussed in this section.

In order to complete the definition of linksets and routes, destination point codes are required to be in the database. Even though linksets use adjacent point codes, the adjacent point code of a linkset must be defined in the destination point code table of the database.

The procedures shown in this chapter use a variety of commands. If more information on these commands is needed, go to *Commands User's Guide* to find the required information.

Point Code Formats

The **EAGLE** supports three different point code formats:

- **ANSI** point codes

- ITU International point codes
- ITU National point codes (both 14-bit ITU-N point codes and 24-bit ITU-N point codes).

ANSI Point Codes

ANSI point codes are made up of three groups of digits called the network indicator (NI), network cluster (NC), and network cluster member (NCM). The values for ANSI point codes depends on the value of the `pctype` parameter of the `chg-sid` command, either `ansi` or `other`. If the `pctype` parameter is set to `ansi`, the ANSI rules for the ANSI point code are used to define the point code. The range of values for an ANSI point code with the `pctype=ansi` parameter are:

- NI – 001-255
- NC – 001-255 (if ni = 001-005) or 000-255, * (if ni = 006-255)
- NCM – 000-255, *

The `pctype=other` parameter specifies that the ANSI point codes do not meet ANSI standards. The range of values for ANSI point codes with the `pctype=other` parameter are:

- NI – 000-255
- NC – 000-255, *
- NCM – 000-255, *

The asterisk (*) point code value indicates a single cluster address for a cluster point code (for example, 20-2-*) or a network routing destination (21-*-*). For more information on cluster point codes, see the [Cluster Routing and Management Diversity \(CRMD\)](#) section. For more information on network routing point codes, see the [Network Routing](#) section.

A double asterisk (**) and triple asterisk (***) can also be used for the NC and NCM fields of the ANSI point code, but for only the `rtrv-dstn`, `rept-stat-dstn`, `rtrv-rte`, and `rept-stat-rte` commands.

A double asterisk in the NCM field of a point code (for example, 20-2-**) produces a summary report that shows all point code destinations or routes residing in the given cluster (20-2). This does not include the cluster point code, if the cluster point code (for example, 20-2-*) is provisioned. The following examples (`rtrv-dstn` and `rtrv-rte`) are reports generated using two asterisks in the NCM field of a point code.

```
rtrv-dstn:dpca=20-2-**
```

```
rlghncxa03w 09-05-28 21:16:37 GMT EAGLE5 41.0.0
  DPCA          CLLI          BEI  ELEI  ALIASI          ALIASN/N24  DMN
  020-002-045   rlghncbb100 no  ---  -----  -----  SS7
  020-002-050   rlghncbb100 no  ---  -----  -----  SS7
```

```
Destination table is (11 of 2000) 1% full
```

```
Alias table is (5 of 8000) 1% full
```

```
rtrv-rte:dpca=20-2-**
```

```
rlghncxa03w 07-05-28 21:16:37 GMT EAGLE5 37.0.0
  DPCA          ALIASI          ALIASN/N24  LSN          RC  APCA
```

```

020-002-045 ----- lsn1      15    020-002-045
                    lsn2      20    020-003-036
                    lsn3      25    001-001-002
                    RTX:No  CLLI=-----
020-002-050 ----- lsn4      15    020-002-050
                    lsn3      20    001-001-002
                    lsn2      25    020-003-036
                    RTX:No  CLLI=-----

```

A double asterisk in the **NC** field of a network routing point code (for example, 21-**-*) produces a summary report that shows all point code destinations or routes that are members of the given network (network 21). This does not include the specified network routing point code (for example, 21-**-*). The following examples (rtrv-dstn and rtrv-rte) are reports using two asterisks in the **NC** field of a network routing point code.

rtrv-dstn:dpca=21-**-*

```

rlghncxa03w 09-05-28 21:16:37 GMT EAGLE5 41.0.0
  DPCA          CLLI          BEI  ELEI  ALIASI          ALIASN/N24  DMN
  021-002-045  rlghncbb101 no  --- -----  -----  SS7
  021-002-050  rlghncbb101 no  --- -----  -----  SS7

```

Destination table is (11 of 2000) 1% full
 Alias table is (5 of 8000) 1% full

rtrv-rte:dpca=21-**-*

```

rlghncxa03w 07-05-28 21:16:37 GMT EAGLE5 37.0.0
  DPCA          ALIASI          ALIASN/N24  LSN      RC    APCA
  021-002-045  -----  -----  lsn10    15    021-002-045
                    lsn20    20    021-003-036
                    lsn30    25    010-001-002
                    RTX:No  CLLI=-----
  021-002-050  -----  -----  lsn40    15    021-002-050
                    lsn30    20    010-001-002
                    lsn20    25    021-003-036
                    RTX:No  CLLI=-----
  021-005-*    -----  -----  lsn40    15    021-002-050
                    lsn30    20    010-001-002
                    lsn20    25    021-003-036
                    RTX:No  CLLI=-----

```

Three asterisks in the **NCM** field of a point code produces a summary report that shows all point code destinations or routes residing in the given network cluster along with the specified cluster point code, if the cluster point code (for example, 20-2-**) is provisioned. The following examples (rtrv-dstn and rtrv-rte) are reports using three asterisks in the **NCM** field of a point code.

rtrv-dstn:dpca=20-2-***

```

rlghncxa03w 09-05-17 16:00:32 GMT EAGLE5 41.0.0
  DPCA          CLLI          BEI  ELEI  ALIASI          ALIASN/N24  DMN
  020-002-*    rlghncbb000 no  --- -----  -----  SS7
  020-002-045  rlghncbb100 no  --- -----  -----  SS7
  020-002-050  rlghncbb100 no  --- -----  -----  SS7

```

Destination table is (11 of 2000) 1% full
 Alias table is (5 of 8000) 1% full

rtrv-rte:dpca=20-2-***

rlghncxa03w 07-05-28 21:16:37 GMT EAGLE5 37.0.0

DPCA	ALIASI	ALIASN/N24	LSN	RC	APCA
020-002-045	-----	-----	lsn1	15	020-002-045
			lsn2	20	020-003-036
			lsn3	25	001-001-002
			RTX:No	CLLI=-----	
020-002-050	-----	-----	lsn4	15	020-002-050
			lsn3	20	001-001-002
			lsn2	25	020-003-036
			RTX:No	CLLI=-----	
020-002-*	-----	-----	lsn4	15	020-002-050
			lsn3	20	001-001-002
			lsn2	25	020-003-036
			RTX:No	CLLI=-----	

Three asterisks in the NC field of the point code produces a summary report that shows all point code destinations or routes residing in the given network along with the specified network routing point code. The following examples (rtrv-dstn and rtrv-rte) are reports using three asterisks in the NC field of a network routing point code.

rtrv-dstn:dpca=21-***-*

rlghncxa03w 09-05-17 16:00:32 GMT EAGLE5 41.0.0

DPCA	CLLI	BEI	ELEI	ALIASI	ALIASN/N24	DMN
021-***	rlghncbb001	yes	yes	-----	-----	SS7
021-002-045	rlghncbb101	no	---	-----	-----	SS7
021-002-050	rlghncbb101	no	---	-----	-----	SS7

Destination table is (11 of 2000) 1% full
 Alias table is (5 of 8000) 1% full

rtrv-rte:dpca=21-***-*

rlghncxa03w 07-05-28 21:16:37 GMT EAGLE5 37.0.0

DPCA	ALIASI	ALIASN/N24	LSN	RC	APCA
021-002-045	-----	-----	lsn10	15	021-002-045
			lsn20	20	021-003-036
			lsn30	25	010-001-002
			RTX:No	CLLI=-----	
021-002-050	-----	-----	lsn40	15	021-002-050
			lsn30	20	010-001-002
			lsn20	25	021-003-036
			RTX:No	CLLI=-----	
021-005-*	-----	-----	lsn40	15	021-002-050
			lsn30	20	010-001-002
			lsn20	25	021-003-036
			RTX:No	CLLI=-----	
021-***	-----	-----	lsn30	20	010-001-002
			lsn20	25	021-003-036
			lsn40	35	021-002-050
			RTX:No	CLLI=-----	

The following rules apply to provisioning **ANSI** point code if the `pctype=ansi` parameter is specified with the `chg-sid` command:

- The **NI** value of 0 is not allowed (for example, `dpc=0-1-1` and `dpc=0-0-0` are not valid point codes).
- If the **NI** value is 1, 2, 3, 4, or 5, then the **nc** value cannot be 0 (for example, `dpc=5-0-1` is rejected).
- If the **NI** value is 1, 2, 3, 4, or 5, then network routing point codes are not allowed (for example, `dpc=4-*-*` is rejected).

The following rules apply to provisioning **ANSI** point code if the `pctype=other` parameter is specified with the `chg-sid` command:

- The **NI** value of 0 is allowed, however `dpc=0-0-0` is rejected (for example, `dpc=0-1-1` is accepted).
- The **NC** value can be 0 for all values of **NI** (for example, `dpc=5-0-1` is accepted).
- Network routing point codes are allowed for all values of **ni** (for example, `dpc=4-*-*` is accepted).

An **ANSI** point code containing all zeros is not a valid point code and cannot be entered into the database.

ITU International Point Codes

The **ITU** international point codes are made up of three groups of digits called zone, area, and id. The range of values for **ITU** International point codes are:

- **ZONE** – 0-7
- **AREA** – 000-255
- **ID** – 0-7

An **ITU** international point code containing all zeros is not a valid point code and cannot be entered into the database.

14-Bit ITU National Point Codes

The 14-bit **ITU** national point code is either a 1- to 5-digit number, or 2, 3, or 4 numbers separated by dashes. 14-bit **ITU** national point codes can also have group codes assigned to them if the **ITU** National Duplicate **Point Code** feature is on. The group code is a two-character field ranging from **AA** to **ZZ** that is entered as the last subfield of a 14-bit **ITU** national point code and is separated by a dash from the rest of the point code. If the **ITU** National Duplicate **Point Code** feature is on, the format of a 14-bit **ITU** national point code is either a 1- to 5-digit number with a group code (for example, 11567-aa), or 2, 3, or 4 numbers separated by dashes with a group code (for example, 5-15-10-3-aa).

For more information on the format of 14-bit **ITU** national point code formats, see the [14-Bit ITU National Point Code Formats](#) section.

For more information on the **ITU** National Duplicate **Point Code** feature and group codes, see the [ITU National Duplicate Point Codes](#) section.

24-Bit ITU National Point Codes

A 24-bit ITU national point code is made up of three segments separated by dashes. Each segment contains three digits and corresponds to 8 bits of the point code. The range of values for 24-bit ITU national point codes are:

- Main Signaling Area (MSA) – 000-255
- Sub Signaling Area (SSA) – 000-255
- Signaling Point (SP) – 000-255

A 24-bit ITU international point code containing all zeros is not a valid point code and cannot be entered into the database.

Spare Point Codes

The provisioning of spare point codes allows the **EAGLE** to process messages that contain either the International Spare or National Spare network indicator values. Spare point codes can be provisioned only if the ITU National and International **Spare Point Code (PC)** Support feature is enabled. Only ITU-I and 14-bit ITU-N point codes can be provisioned as spare point codes.

Spare point codes are shown with the prefix “s-” with the point code value. This allows the destination point code table to contain two point code entries with the same value, one a spare point code and one a non-spare point code. For example, the destination point code table contains these point code entries, 2-034-5 and s-2-034-5. Point code 2-034-5 is a non-spare ITU-I point code and point code s-2-034-5 is a spare ITU-I point code.

Private Point Codes

Private point codes are used for internal routing in the **EAGLE 5 ISS**. Private point codes can be used for internal point codes for the End Office feature, and for adjacent point codes for **IPGWx** linksets.

Private point codes are shown with the prefix “p-” with the point code value. This allows the destination point code table to contain two point code entries with the same value, one private and one not private. For example, the destination point code table contains these point code entries, 002-002-002 and p-002-002-002. Point code 002-002-002 is a non-private point code that is used for configuring linksets and routes from the **EAGLE 5 ISS** to external nodes in the network. Point code p-002-002-002 is a private point code and is not known to the external nodes in the network.

By using private point codes for internal routing, these point code values are not known outside of the **EAGLE 5 ISS** and do not use a point code value for network configuration.

There can be private point codes for all point code types: **ANSI**, ITU-I, ITU-I Spare, 14-bit ITU-N, 14-bit ITU-N Spare, and 24-bit ITU-N.

Point Code Usage

The **ANSI** are used in **ANSI** networks. The ITU international point codes are used in ITU international networks. The ITU national point codes are used in ITU national networks. ITU national point codes can be either 14-bit ITU national point codes, or 24-bit ITU national point codes. [Table 2-1](#) shows a sample destination point code for each type of network.

Table 2-1 Point Code Format

Network Type	Point Code Format
ANSI	001-002-003
ITU International	7-255-7
14-bit ITU National	See "14-Bit ITU National Point Code Formats"
24-bit ITU National	001-002-003

To enter an **ITU** international point code, a 14-bit **ITU** national point code or a 24-bit **ITU** national point code, either as a **DPC** or as an alias point code, the self **ID** of the **EAGLE** must be defined for these networks. Verify this with the `rtrv-sid` command. If point code values are shown in the `PCI` field of the output of the `rtrv-sid` command, then **ITU** international point codes can be entered. If point code values are shown in the `PCN` field of the output of the `rtrv-sid` command, then the 14-bit **ITU** national point codes can be entered. If point code values are shown in the `PCN24` field of the output of the `rtrv-sid` command, then 24-bit **ITU** national point codes can be entered. If a value is shown in the `PCN` field, then a value cannot be entered in the `PCN24` field. If a value is shown in the `PCN24` field, then a value cannot be entered in the `PCN` field.

A destination is defined with a mandatory true point code of one format, and two optional alias point codes that are of the other two formats. Alias point codes are used to provide alternate point codes for a particular destination. The true point code must be of the same format as the point code used for the self **ID** of the **EAGLE** and must match the format of the point code used for the destination node. For example, if the destination node uses an **ANSI** point code, then the true point code must be an **ANSI** point code.

A destination can have up to two alias point codes. A destination alias point code type must not match that destination's true point code type. If both alias point codes are defined, the point code types of the aliases must not match.

The point code type (**ANSI**, **ITU** international, **ITU** national) is specified by different parameters. A letter that indicates the point code type is appended to the parameter that specifies the point codes. The appended letters are as follows.

"A" – indicates an **ANSI** point code, for example, `dpcA`

"I" – indicates an **ITU** international point code, for example, `dpcI`

"N" – indicates a 14-bit **ITU** national point code, for example, `dpcN`

"N24" – indicates a 24-bit **ITU** national point code, for example, `dpcN24`

The **ANSI** point codes can also be specified by a point code parameter without the letter "A" appended to it, for example, `dpc`.

14-Bit ITU National Point Code Formats

The format of a 14-bit **ITU** national point code is defined by the `npcfmtI` parameter of the `chg-stpopts` command. This parameter defines how the 14-bit **ITU** national point code is entered into the database, and how it is displayed in any **EAGLE** outputs (command outputs or unsolicited outputs).

The 14-bit ITU national point code can be either a single number, up to five digits, or two, three, or four numbers separated by dashes. The 14-bit ITU national point code is a 14-bit integer. The values used by the `npcfmt i` parameter of the `chg-stpopts` command defines the number of bits that make up each part of the point code format, if the 14-bit ITU national point code is made up of two, three, or four numbers.

If the 14-bit ITU national point code format has less than four numbers, the parts of the point code format not being used must be specified as zero (0). All four parts of the point code format must be specified with the `npcfmt i` parameter, no matter how many numbers the point code format will contain, and the sum of the values of all four parts of the point code format must be 14 (for example, `NPCFMTI=7-7-0-0`, `NPCFMTI=0-6-8-0`, `NPCFMTI=0-0-4-10`, `NPCFMTI=3-8-3-0`, `NPCFMTI=14-0-0-0`).

If the database contains 14-bit ITU national point codes of a particular format, and the format is changed with the `npcfmt i` parameter of the `chg-stpopts` command, the format of the 14-bit ITU national point codes in the database will be changed to the new format.

The values of the parts of the 14-bit ITU national point code are defined in [Table 2-2](#).

Table 2-2 14-Bit ITU National Point Code Values

NPCFMTI Parameter Values	0	1	2	3	4
Range of Values	The segment is not used.	0-1	0-3	0-7	0-15
NPCFMTI Parameter Values	5	6	7	8	9
Range of Values	0-31	0-63	0-127	0-255	0-511
NPCFMTI Parameter Values	10	11	12	13	14
Range of Values	0-1023	0-2047	0-4095	0-8191	0-16383

A 14-bit ITU national point code containing all zeros is a valid point code and can be entered into the database.

When the **EAGLE** is delivered to the user, the format of the 14-bit ITU national point code is set to 14-0-0-0 (a single number containing up to five digits). If the 14-bit ITU national point code is a single number, the value of the point code is from 1 to 16383.

To change the format of a 14-bit ITU national point code, perform [Changing the Format of 14-Bit ITU National Point Codes](#). The example used in this procedure changes the format of the 14-bit ITU national point code from 14-0-0-0 to 4-4-4-2.

Changing the Format of 14-Bit ITU National Point Codes

Caution: Changing the formats of the 14-bit ITU national point codes will change how any existing 14-bit ITU national point codes are displayed in the database.

1. Display the existing values for the `npcfmt i` parameter by entering the `rtrv-stpopts` command. The value for the `npcfmt i` parameter is shown in the `NPCFMTI` field. This is an example of the possible output.

```
rlghncxa03w 07-05-17 16:02:05 GMT EAGLE5 37.0.0
STP OPTIONS
-----
NPCFMTI      14-0-0-0
```

Note: The `rtrv-stpopts` command output contains other fields that are not used by this procedure. If you wish to see all the fields displayed by the `rtrv-stpopts` command, see the `rtrv-stpopts` command description in *Commands User's Guide*.

2. Change the value of the `npcfmt i` parameter. For this example, enter this command.

```
chg-stpopts:npcfmt i=4-4-4-2
```

When this command has successfully completed, this message should appear.

```
rlghncxa03w 07-05-07 00:22:57 GMT EAGLE5 37.0.0
CHG-STPOPTS: MASP A - COMPLTD
```

Note: The parameters of the `chg-stpopts` command are optional. For any parameters not specified with the `chg-stpopts` command, the values for these parameters are not changed.

3. Verify the changes using the `rtrv-stpopts` command. This is an example of the possible output.

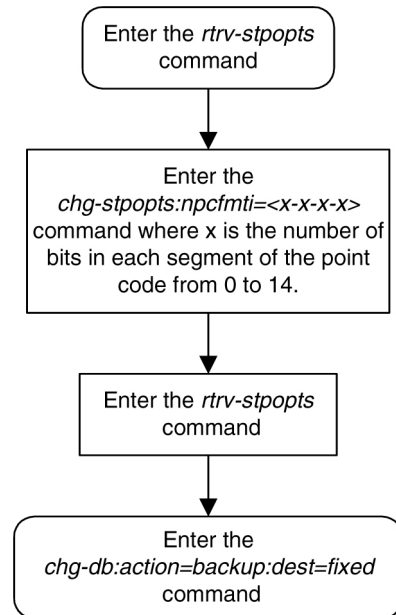
```
rlghncxa03w 07-05-17 16:02:05 GMT EAGLE5 37.0.0
STP OPTIONS
-----
NPCFMTI      4-4-4-2
```

Note: The `rtrv-stpopts` command output contains other fields that are not used by this procedure. If you wish to see all the fields displayed by the `rtrv-stpopts` command, see the `rtrv-stpopts` command description in *Commands User's Guide*.

4. Back up the new changes, using the `chg-db:action=backup:dest=fixed` command. These messages should appear; the active **Maintenance and Administration Subsystem Processor (MASP)** appears first.

BACKUP (FIXED) : MASP A - Backup starts on active MASP.
 BACKUP (FIXED) : MASP A - Backup on active MASP to fixed disk complete.
 BACKUP (FIXED) : MASP A - Backup starts on standby MASP.
 BACKUP (FIXED) : MASP A - Backup on standby MASP to fixed disk complete.

Figure 2-2 Changing the Format of an ITU National Point Code



Examples of Different 14-Bit ITU National Point Code Formats

A 14-bit ITU national point code whose format is 3-8-3-0, results in a point code containing three numbers separated by dashes. Because the fourth part of the format is zero, the point code format contains only three numbers. Using [Table 2-2](#) as a guide, the range of values for this point code format are from 0-000-1 to 7-255-7.

A 14-bit ITU national point code whose format is 2-8-3-1, results in a point code containing four numbers separated by dashes. Using [Table 2-2](#) as a guide, the range of values for this point code format are from 0-000-0-1 to 3-255-7-1.

A 14-bit ITU national point code whose format is 7-0-7-0 results in a point code containing two numbers separated by dashes. Because the second and fourth parts of the format are zero, the point code format contains only two numbers. Using [Table 2-2](#) as a guide, the range of values for this point code format are from 000-001 to 127-127.

A 14-bit ITU national point code whose format is 14-0-0-0 results in a point code containing a single number, containing up to five digits. Using [Table 2-2](#) as a guide, the range of values for this point code format are from 1 to 16383.

Exception

The format defined by the `npcfnti` parameter of the `chg-stpopts` command applies to all database entities that use 14-bit ITU national point codes, except gateway screening. Gateway screening allows the 14-bit ITU national point code to be displayed and entered in the database only as a single number. If the **EAGLE 5 ISS** is using a format for the 14-bit ITU national point code other than a single number, the point code will have to be converted from its current format to a single number in order to be used by gateway screening.

Converting Single Number 14-Bit ITU National Point Codes

To convert a single number **ITU** national point code to a multiple part **ITU** national point code, perform these steps. For this example, the 14-bit **ITU** national point codes 14781 and 695 are converted to point codes using the 3-8-3-0 format.

1. The point code is converted to a binary number. This can be done with most scientific calculators.
 - The number 14781 converts to the binary number 11100110111101.
 - The number 695 converts to the binary number 1010110111.

Note: Make sure the binary number contains 14 digits. If it does not, add leading zeros to the binary number to bring the total number of digits in the number to 14.

In this example, the binary equivalent for the decimal number 695 (1010110111) contains 10 digits, so four zeros must be added to the beginning of the binary number. The resulting binary number is now 00001010110111.

2. Divide the binary number into the number of parts required by the format of the 14-bit **ITU** national point code. For this example, the format is 3-8-3-0. Since the last part of the point code format is 0, the point code format contains only three parts. Divide the point code into three parts: the first part of the point code contains the first three digits of the 14-digit binary number, the second part of the point code contains the next eight digits of the 14-digit binary number, and the third part of the point code contains the last three digits of the 14-digit binary number.

For this example, the binary numbers would be divided like this:

- 11100110111101 = 111 00110111 101
 - 00001010110111 = 000 01010110 111
3. Convert each part of the point code into a decimal number, using the same scientific calculator used in step 1, and separate each part of the point code with dashes. The results are as follows.
 - 111 00110111 101 = 7-55-5
 - 000 01010110 111 = 0-86-7

When the 14-bit **ITU** national point codes are converted from single numbers to multiple-part point codes, the resulting value of the multiple-part point code depends on the point code format specified by the `npcfmt.i` parameter of the `chg-stpopts` command. When converting the single-number point code 14781 to the point code format 3-8-3-0, the resulting point code value is 7-55-5. If point code 14781 is converted to the point code format 4-4-4-2, the resulting point code value is 14-6-15-1.

Converting Multiple-Part 14-Bit ITU National Point Codes

To convert multiple-part 14-bit **ITU** national point codes to a single number, perform these steps. For this example, the 14-bit **ITU** national point codes 7-55-5 and 0-86-7, using the 3-8-3-0 point code format, are converted into a single number.

1. Convert each part of the point code into a binary number using a scientific calculator. The results are as follows.

- 7-55-5 = 111 00110111 101
 - 0-86-7 = 000 01010110 111
2. Combine each part of the point code into a single binary number as follows.
- 111 00110111 101 = 11100110111101
 - 000 01010110 111 = 00001010110111

Note: If the binary number has any zeros at the beginning of the number, remove these zeros, as they are not necessary.

In this example, the binary equivalent for the point code 0-86-7 (00001010110111) contains four zeros at the beginning of the binary number. When the leading zeros are removed from the binary number, the resulting binary number is now 1010110111.

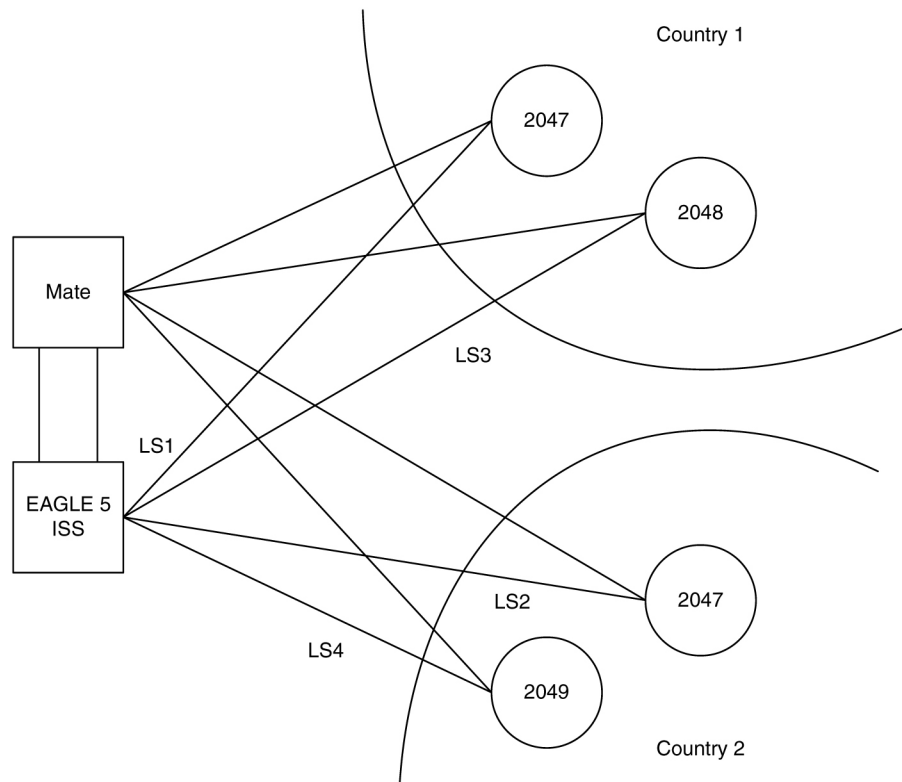
3. Convert the binary number to a decimal number using the same scientific calculator used in step 1.
- The binary number 11100110111101 converts to the decimal number 14781.
 - The binary number 1010110111 converts to the decimal number 695.

ITU National Duplicate Point Codes

Note:

This feature applies only to 14-bit ITU national spare and non-spare point codes.

This feature allows an **EAGLE** mated pair to route traffic for two or more countries that may have overlapping point code values. For example, in the network shown in [Figure 2-3](#), both Country 1 and Country 2 have **SSPs** with a **PC** value of 2047.

Figure 2-3 Network Example #1

Group Codes

Users must divide their ITU-National destinations into groups. These groups will likely be based on Country. However, one group could have multiple countries within it, or a single country could be divided into multiple groups. The requirements for these groups are:

- No duplicate point codes are allowed within a group.
- ITU-National traffic from a group must be destined for a PC within the same group.
- The user must assign a unique two-letter group code to each group.

For example, in the network shown in [Figure 2-4](#), Country 1 can only have 1 point code with a value of 2047. Traffic coming from SSP 2047 in Country 1 can only be destined to other nodes within Country 1. In this example, the user assigns a group code of 1 to Country 1, and a group code of 2 to Country 2.

When the user enters an ITU-National point code, they must also enter the group code, using the format "point code - group code". This group code must be used for any command that uses an ITU-N point code.

For example, to provision the EAGLE for the network shown in [Figure 2-4](#), the user would enter these commands:

```
ent-dstn:dpcn=2047-aa
ent-dstn:dpcn=2048-aa
ent-dstn:dpcn=2047-ab
ent-dstn:dpcn=2049-ab
```

```
ent-ls:lsn=LS1:apcn=2047-aa
```

```
ent-ls:lsn=LS2:apcn=2047-ab
```

```
ent-ls:lsn=LS3:apcn=2048-aa
```

```
ent-ls:lsn=LS4:apcn=2049-ab
```

Group Code aa

The following special rules apply to group code aa:

- ITU-N MSUs received on an ITU-I linkset are assigned group code of aa.
- ITU-N destinations entered before this feature is turned on are assigned group code of aa when the ITUDUPPC feature bit is turned on.

Normal Operation

When an ITU-N message arrives at the **EAGLE**, the **EAGLE** creates an internal point code based on the 14 bit **PC** in the message, and the group code assigned to the incoming linkset.

For example, when a message arrives on **LS3** with **DPC** of 2047, the **EAGLE** maps that to an internal point code of 2047-aa, because **LS3** has a group code of aa. The **EAGLE** then routes the message to **LS1**, which is the route for 2047-aa.

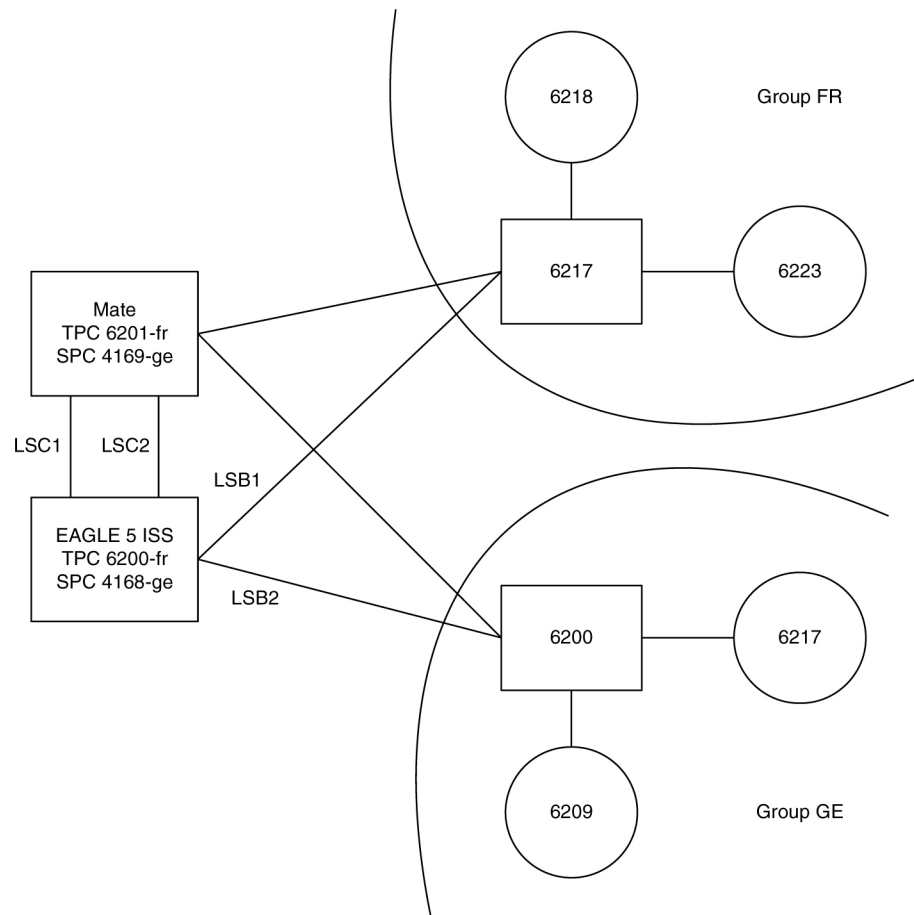
When a message arrives on **LS4** with **DPC** of 2047, the **EAGLE** maps that to an internal point code of 2047-ab, because **LS4** uses group code ab. The **EAGLE** then routes the message to **LS2**, which is the route for 2047-ab.

C Linksets

For each group defined, a separate C-linkset must be defined. This C-linkset is used as the alternate route for point codes in the group.

For example, in [Figure 2-4](#), LSC1 is used for point codes in Group fr. Its adjacent point code is 6201-fr, and is used as the alternate route for 6217-fr, 6218-fr, and 6223-fr.

LSC2 is used for point codes in Group ge. Its adjacent point code is group 4169-ge, and is used as the alternate route for 6200-ge, 6209-ge, and 6217-ge.

Figure 2-4 Network Example #2

For example, to provision the **EAGLE** for the network shown in [Figure 2-5](#), the user would enter these commands:

```
ent-dstn:dpcn=6201-fr (Mate's true PC)
ent-dstn:dpcn=4169-ge (Mate's secondary PC)
ent-dstn:dpcn=6217-fr (Group fr destinations)
ent-dstn:dpcn=6218-fr
ent-dstn:dpcn=6223-fr
ent-dstn:dpcn=6200-ge (Group ge destinations)
ent-dstn:dpcn=6217-ge
ent-dstn:dpcn=6209-ge

ent-ls:lsn=LSC1:apcn=6201-fr:lsc=C (C linkset used by Group fr)
ent-ls:lsn=LSC2:apcn=4169-ge:lsc=C (C linkset used by Group ge)
ent-ls:lsn=LSB1:apcn=6217-fr:lsc=B
ent-ls:lsn=LSB2:apcn=6200-ge:lsc=B

ent-rte:dpcn=6217-fr:lsn=LSB1:rc=10 (primary route for a Group fr
destination)
```


ent-rte:dpcn=6217-fr:lsn=LSC1:rc=20 (alternate route for a Group fr destination)

ent-rte:dpcn=6217-ge:lsn=LSB2:rc=10 (primary route for a Group ge destination)

ent-rte:dpcn=6217-ge:lsn=LSC2:rc=20 (alternate route for a Group ge destination)

Receiving an ITU-National MSU on an ITU-International Linkset

It is possible for the **EAGLE** to receive **ITU-National MSUs** on an **ITU-International linkset**. A linkset is considered an **ITU-International linkset** if its adjacent point code is an **ITU-International PC**. An **MSU** is **ITU-National** if it is received on an **ITU linkset** (National or International), and the **NIC** field in the **SIO** is set to 2 (National).

ITU-International linksets do not have a group code. **ITU-National MSUs** received on **ITU-International linksets** will be assigned a group code of **aa**.

Existing ITU National Destinations

Any **ITU-National destinations** that were entered before Release 26.05 or before the **ITU National Duplicate Point Codes** feature was turned on will be assigned the group code of **aa**.

Interaction with Other Features

Gateway Screening

For example, in the network in [Figure 2-4](#), if the user wanted to screen out **MSU** coming from 6217 in Group **ge**, but allow **MSUs** coming from 6217 in Group **fr**, he or she could assign different screensets to **LSB1** and **LSB2**. The screenset assigned to **LSB1** would allow **MSUs** from **OPC 6217**. The screenset assigned to **LSB2** would block **MSUs** from **OPC 6217**.

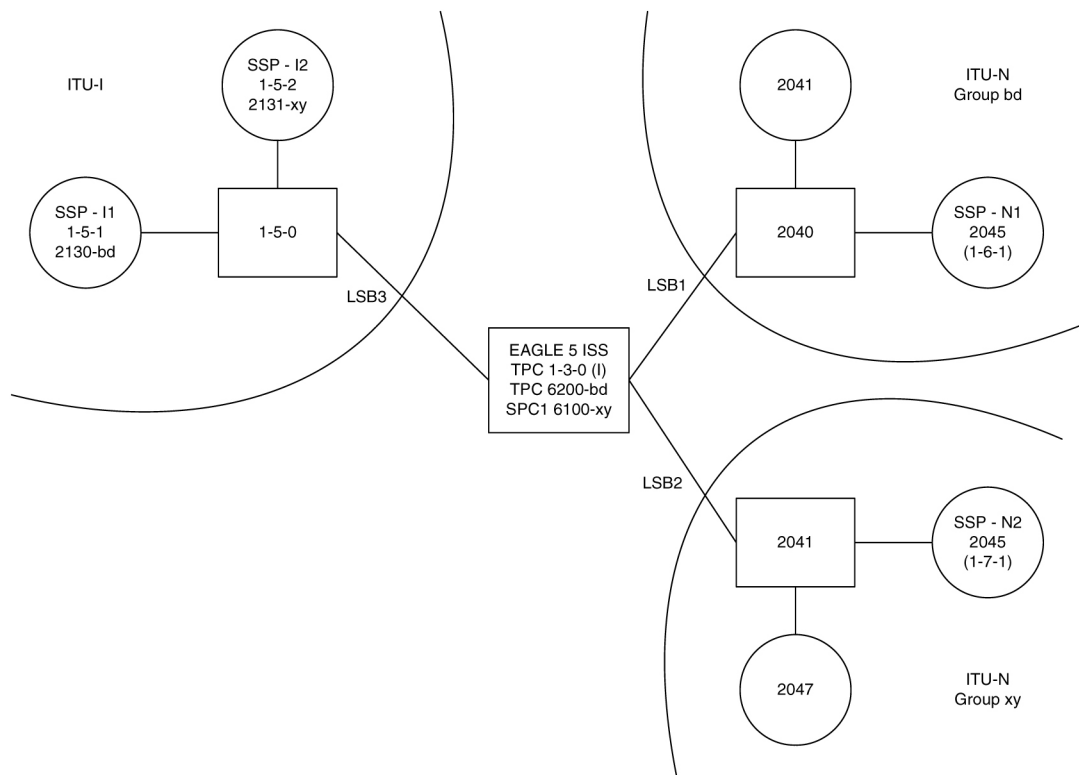
Multiple Point Codes

The Multiple Point Codes feature (see [“Multiple Point Code Support”](#)) must be on in order to turn on the **ITU National Duplicate Point Codes** feature. For every group that is used, the user must provision either a **True PC** or **Secondary Point Code**, using the **chg-sid** command.

For example, in the network in [Figure 2-4](#), two groups are used having group codes of **fr** and **ge**. An **ITU-National True Point Code** is entered for group **fr**, and an **ITU-National Secondary Point code** is entered for group **ge**.

Conversion between ITU-N and ITU-I or ANSI

Each **ITU-N destination** and group code can have its own **ITU-I or ANSI alias PC**. Each **ITU-I or ANSI node** can be assigned one **ITU-N destination**. For conversion from **ITU-I or ANSI** to **ITU-N** to succeed, the **ITU-N alias** of the sending node must have the same group code as the destination's group code. So each **ITU-I or ANSI node** can only send and receive messages from one **ITU-N group**.

Figure 2-5 Network for Conversion

In [Figure 2-5](#), **SSP-N1** (2045-bd) is assigned **ITU-I** alias 1-6-1, and **SSP-N2** (2045-xy) is assigned **ITU-I** alias 1-7-1. **SSP-I1** is assigned **ITU-N** alias 2130-bd and **SSP-I2** is assigned **ITU-N** alias 2131-xy. In this example, **SSP-I1** can exchange traffic with nodes in group bd, but not nodes in group xy. **SSP-I2** can exchange traffic with nodes in group xy, but not nodes in group bd.

SSP-I1 (1-5-1) can send to **SSP-N1** by using the **ITU-I** alias 1-6-1, But if **SSP-I1** tries to send to 2045-xy by using the **ITU-I** alias 1-7-1, conversion will fail, and the **EAGLE** will generate **UIM 1091** (Indicating **OPC** conversion failed).

SSP-N1 can send traffic to **SSP-I1**, but **SSP-N2** cannot send traffic to **SSP-I1**. **SSP-N1** sends an **ITU-N MSU** with **DPC** set to 2130. The **EAGLE** assigns a group code of bd to the **MSU** based on the incoming linkset. The **EAGLE** then looks up 2130-bd, determines that this is an alias for **ITU-I** 1-5-1, and routes the **MSU** to **SSP-I1**.

If **SSP-N2** sends an **ITU-N MSU** with **DPC** set to 2130, the **EAGLE** assigns a group code of xy to the **MSU** based on the incoming linkset. The **EAGLE** then looks up 2130-xy, does not find a match, and discards the **MSU**.

To provision the **SSP-N1**, **SSP-N2**, **SSP-I1**, and **SSP-I2** in the network shown in [Figure 2-5](#), the following commands are used:

```
ent-dstn:dpcn=2045-bd:aliasi=1-6-1
ent-dstn:dpcn=2045-xy:aliasi=1-7-1
ent-dstn:dpci=1-5-1:aliasn=2130-bd
ent-dstn:dpci=1-5-2:aliasn=2131-xy
ent-rte:dpcn=2045-bd:lsn=LSB1:rc=10
ent-rte:dpcn=2045-xy:lsn=LSB2:rc=10
```

```
ent-rte:dpci=1-5-1:lsn=LSB3:rc=10
```

```
ent-rte:dpci=1-5-2:lsn=LSB3:rc=10
```

Limitations

The ITU National Duplicate **Point Code** feature has the following limitations:

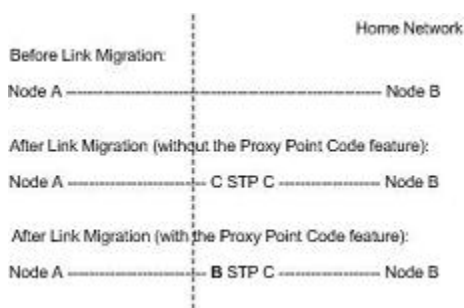
- Duplicate Point Codes are only supported for ITU-National Destinations.
- ITU-National traffic from a group must be destined for a PC within the same group.
- No duplicate point codes are allowed within a group.
- For each group that is provisioned, a separate ITU-N C-linkset must be provisioned.
- It is not possible to change a destination's group code. If the user wants to move a destination from one group to another, the user must provision a new destination that uses the new group code and delete the old destination.
- If conversion between ITU-N and ITU-I or ANSI is used, only 1 ITU-N group can send traffic to a specific ANSI or ITU-I node.

Proxy Point Codes

The Proxy Point Code feature allows the EAGLE to assume the point codes of other nodes in order to ease the migration of deploying an STP in a network with direct-connect links into other networks. For example, if a foreign network SS7 node is directly connected to an SS7 node in the home network, an EAGLE can be deployed so that the transition is transparent to the foreign node. The foreign node can still behave as if it is connected to the original node in the home network. EAGLE will provide routing connectivity in the home network to the foreign node and will allow the foreign node to connect to the home network.

In the examples in [Figure 2-6](#), foreign network Node A connects to home network Node B. Normally, STP C would connect between them, requiring both Node A and Node B to use STP C as the APC. With this feature, Node A does not require any modifications, as STP C provides a proxy point code B. The configuration in this example assume that the self point code of the STP is C.

Figure 2-6 Context of the Proxy Point Code in the Network



A proxy point code can be any of these types of point codes:

- ANSI
- ITU-I

- ITU-I Spare
- 14-bit ITU-N
- 14-bit ITU-N Spare
- 24-bit ITU-N

A proxy point code must be a full point code and cannot be a cluster point code or a network routing point code. Private point codes and secondary point codes cannot be used as a proxy point code.

The following types of signaling links can be assigned to a linkset whose adjacent point code is a proxy point code:

- LSL
- ATM-HSL (LIM-ATM and E1-ATM are supported)
- SE-HSL
- M2PA.

Feature Provisioning Requirements

The EAGLE can contain a maximum of 100 proxy point codes. The proxy point code quantity is enabled in groups of 10 proxy point codes with the `enable-ctrl-feat` command and these part numbers shown in [Table 2-3](#).

Table 2-3 Proxy Point Code Quantities and Part Numbers

Part Number	Proxy Point Code Quantity
893-0187-01	10
893-0187-02	20
893-0187-03	30
893-0187-04	40
893-0187-05	50
893-0187-06	60
893-0187-07	70
893-0187-08	80
893-0187-09	90
893-0187-10	100

Once a proxy point code quantity has been enable, the quantity cannot be decreased.

A temporary feature access key cannot be used to enabled a proxy point code quantity.

Once a proxy point code quantity has been enabled, the proxy point codes are provisioned in the database with the `ent-dstn` command and the `prx` parameter. Other point codes can use a proxy point code that is already provisioned in the database. These point codes are provisioned with the `ent-dstn` command and the `ppc` parameter.

After the proxy point code has been provisioned in the database, a linkset using the proxy point code can be provisioned in the database. This linkset, referred to as a

proxy linkset, is provisioned using the `ent-ls` command with the adjacent point code of the linkset, the `lst=prx` parameter, and the `ppc` parameter. The `ppc` parameter value is the proxy point code provisioned with the `ent-dstn` command.

A proxy linkset has the same characteristics as an A linkset.

A proxy point code can be assigned to a maximum of 10 linksets.

Secondary adjacent point codes are not supported on a proxy linkset.

A proxy point code cannot be used as the adjacent point code of an IPGWx linkset.

To provision the Proxy Point Code feature, perform these procedures.

1. Enable a proxy point code quantity using the `enable-ctrl-feat` command. Perform [Changing the Proxy Point Code Quantity](#). Once a proxy point code quantity is enabled, the Proxy Point Code feature is enabled and turned on. The `chg-ctrl-feat` command cannot be used to turn the Proxy Point Code feature on.
2. Provision the proxy point code using the `ent-dstn` command with the `prx` and `ppc` parameters. Perform [Adding a Destination Point Code](#).
3. Provision the proxy linkset using the `ent-ls` command with the `lst=prx` and `ppc` parameters. Perform [Adding an SS7 Linkset](#).

Changing the Proxy Point Code Quantity

This procedure is used to increase the number of **proxy point codes** that are allowed in the EAGLE. The EAGLE can contain a maximum of 100 proxy point codes.

The `enable-ctrl-feat` command enables the proxy point code quantity, in groups of 10 proxy point codes, by specifying the part number for the proxy point code quantity and the proxy point code quantity's feature access key with these parameters:

Note: As of Release 46.3, the `fak` parameter is no longer required. This parameter is only used for backward compatibility.

`:fak` – The feature access key supplied by Oracle. The feature access key contains 13 alphanumeric characters and is not case sensitive. If you do not have the feature access key for the proxy point code quantity you wish to enable, contact your Oracle Sales Representative or Account Representative.

`:partnum` – The Oracle-issued part number for the proxy point code quantity shown in the following table:

Table 2-4 Proxy Point Code Quantities and Part Numbers

Part Number	Proxy Point Code Quantity
893018701	10
893018702	20
893018703	30
893018704	40
893018705	50

Table 2-4 (Cont.) Proxy Point Code Quantities and Part Numbers

Part Number	Proxy Point Code Quantity
893018706	60
893018707	70
893018708	80
893018709	90
893018710	100

The `enable-ctrl-feat` command requires a valid serial number for the **EAGLE** to be configured in the database, and that this serial number is locked. This can be verified with the `rtrv-serial-num` command. The **EAGLE** is shipped with a serial number in the database, but the serial number is not locked. The serial number can be changed, if necessary, and locked once the **EAGLE** is on-site, by using the `ent-serial-num` command. The `ent-serial-num` command uses these parameters.

`:serial` - The serial number assigned to the **EAGLE**. The serial number is not case sensitive.

`:lock` - Specifies whether or not the serial number is locked. This parameter has only one value, `yes`, which locks the serial number. Once the serial number is locked, it cannot be changed.

Note: To enter and lock the **EAGLE**'s serial number, the `ent-serial-num` command must be entered twice, once to add the correct serial number to the database with the `serial` parameter, then again with the `serial` and the `lock=yes` parameters to lock the serial number. You should verify that the serial number in the database is correct before locking the serial number. The serial number can be found on a label affixed to the control shelf (shelf 1100).

Once the proxy point code quantity is enabled with the `enable-ctrl-feat` command, the proxy point code is also turned on. The `chg-ctrl-feat` command is not necessary to turn on the proxy point code quantity.

1. Display the features that are enabled by entering the `rtrv-ctrl-feat` command.

The following is an example of the possible output.

```
rlghncxa03w 07-05-28 21:15:37 GMT EAGLE5 37.0.0
The following features have been permanently enabled:
```

Feature Name	Partnum	Status	Quantity
Command Class Management	893005801	on	----
LNP Short Message Service	893006601	on	----
Intermed GTT Load Sharing	893006901	on	----
XGTT Table Expansion	893006101	on	4000000
XMAP Table Expansion	893007710	on	3000
Large System # Links	893005901	on	1500
Routesets	893006401	on	6000
HC-MIM SLK Capacity	893012707	on	64

The following features have been temporarily enabled:

```
Feature Name          Partnum  Status  Quantity  Trial Period Left
Zero entries found.
```

The following features have expired temporary keys:

```
Feature Name          Partnum
Zero entries found.
```

If a proxy point code quantity is shown in the `rtrv-ctrl-feat` output, continue the procedure with [Oracle](#).

If the `rtrv-ctrl-feat` output in [1](#) shows any controlled features, continue the procedure with [Oracle](#). If the `rtrv-ctrl-feat` output shows only the HC-MIM SLK Capacity feature with a quantity of 64, [2](#) through [5](#) must be performed.

If a proxy point code quantity is not shown in the `rtrv-ctrl-feat` output, continue the procedure with [2](#).

2. Display the serial number in the database with the `rtrv-serial-num` command.

This is an example of the possible output.

```
rlghncxa03w 07-05-28 21:15:37 GMT EAGLE5 37.0.0
System serial number = nt00001231
System serial number is not locked.
rlghncxa03w 07-10-28 21:15:37 GMT EAGLE5 37.0.0
Command Completed
```

Note: If the serial number is correct and locked, continue the procedure with [Oracle](#). If the serial number is correct but not locked, continue the procedure with [5](#). If the serial number is not correct, but is locked, a proxy point code quantity cannot be enabled and the remainder of this procedure cannot be performed. Contact the Customer Care Center to get an incorrect and locked serial number changed. Refer to [My Oracle Support \(MOS\)](#) for the contact information. The serial number can be found on a label affixed to the control shelf (shelf 1100).

3. Enter the correct serial number into the database using the `ent-serial-num` command with the `serial` parameter.

For this example, enter this command.

```
ent-serial-num:serial=<EAGLE's correct serial number>
```

When this command has successfully completed, the following message should appear.

```
rlghncxa03w 07-05-28 21:15:37 GMT EAGLE5 37.0.0
ENT-SERIAL-NUM:  MASP A - COMPLTD
```

4. Verify that the serial number entered into [3](#) was entered correctly using the `rtrv-serial-num` command.

This is an example of the possible output.

```
rlghncxa03w 07-05-28 21:15:37 GMT EAGLE5 37.0.0
System serial number = nt00001231
```

```
System serial number is not locked.
rlghncxa03w 07-05-28 21:15:37 GMT EAGLE5 37.0.0
Command Completed
```

If the serial number was not entered correctly, repeat [3](#) and [4](#) and re-enter the correct serial number.

5. Lock the serial number in the database by entering the `ent-serial-num` command with the serial number shown in [2](#), if the serial number shown in [2](#) is correct, or with the serial number shown in [4](#), if the serial number was changed in [3](#), and with the `lock=yes` parameter.

For this example, enter this command.

```
ent-serial-num:serial=<EAGLE's serial number>;lock=yes
```

When this command has successfully completed, the following message should appear.

```
rlghncxa03w 07-05-28 21:15:37 GMT EAGLE5 37.0.0
ENT-SERIAL-NUM: MASP A - COMPLTD
```

6. Enable a proxy point code quantity with the `enable-ctrl-feat` command specifying the part number for the proxy point code quantity and the feature access key.

For this example, enter this command.

```
enable-ctrl-feat:partnum=893018703:fak=<30 proxy point codes
feature access key>
```

Note: A temporary feature access key cannot be specified to enable the proxy point code quantity.

Note: The values for the feature access key (the `fak` parameter) are provided by Oracle. If you do not have the feature access key for the proxy point code quantity you wish to enable, contact your Oracle Sales Representative or Account Representative.

When the `enable-ctrl-feat` command has successfully completed, this message should appear.

```
rlghncxa03w 07-05-28 21:15:37 GMT EAGLE5 37.0.0
ENABLE-CTRL-FEAT: MASP B - COMPLTD
```

7. Verify the changes by entering the `rtrv-ctrl-feat` command with the proxy point code quantity part number specified in [Oracle](#).

For this example, enter this command.

```
rtrv-ctrl-feat:partnum=893018703
```

The following is an example of the possible output.

```
rlghncxa03w 07-05-28 21:15:37 GMT EAGLE5 37.0.0
The following features have been permanently enabled:
```

Feature Name	Partnum	Status	Quantity
Proxy Point Code	893018703	on	30

The following features have been temporarily enabled:

Feature Name	Partnum	Status	Quantity	Trial Period Left
Zero entries found.				

The following features have expired temporary keys:

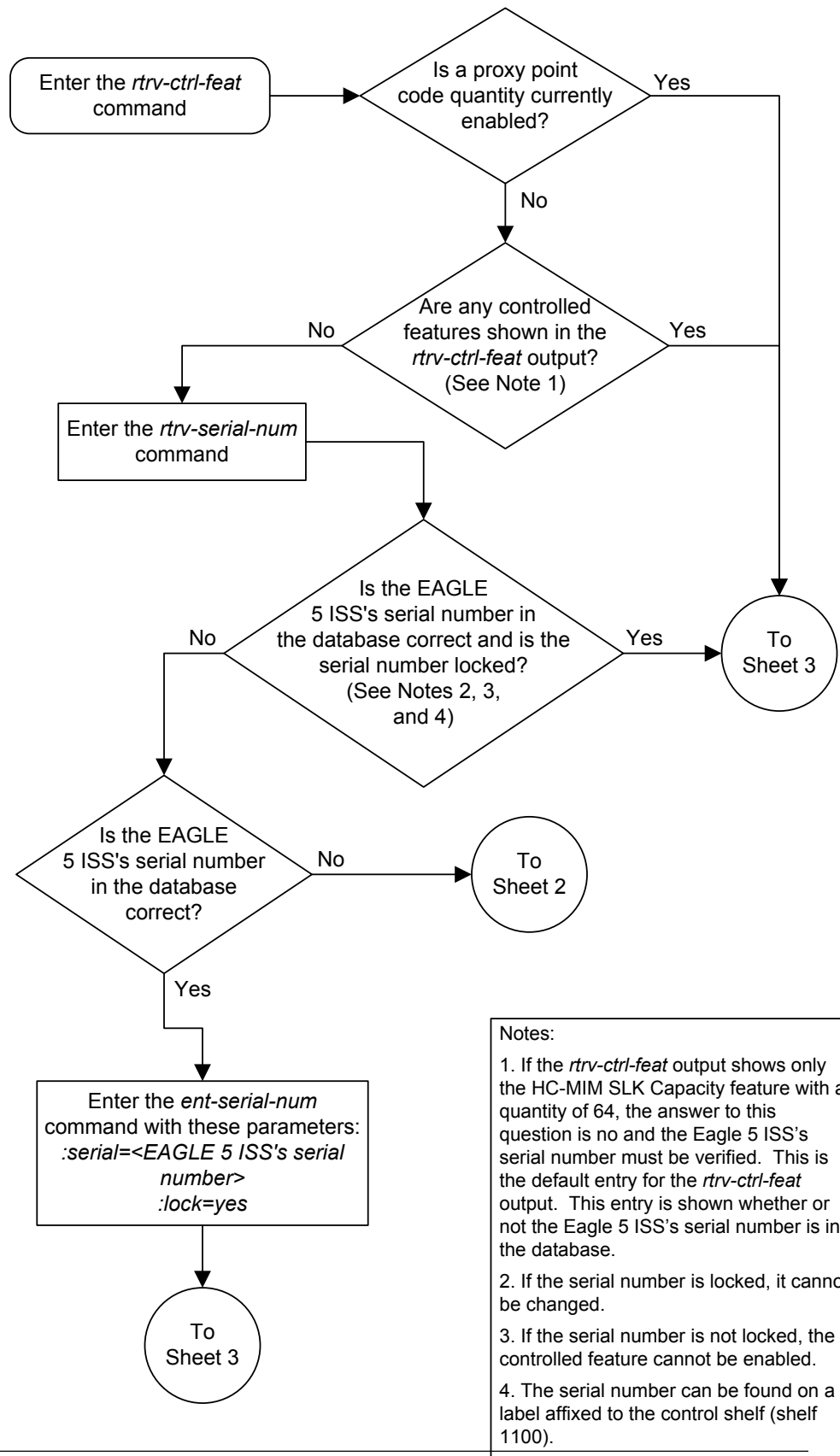
Feature Name	Partnum
Zero entries found.	

8. Back up the new changes, using the `chg-db:action=backup:dest=fixed` command.

These messages should appear; the active **Maintenance and Administration Subsystem Processor (MASP)** appears first.

```
BACKUP (FIXED): MASP A - Backup starts on active MASP.  
BACKUP (FIXED): MASP A - Backup on active MASP to fixed disk complete.  
BACKUP (FIXED): MASP A - Backup starts on standby MASP.  
BACKUP (FIXED): MASP A - Backup on standby MASP to fixed disk complete.
```

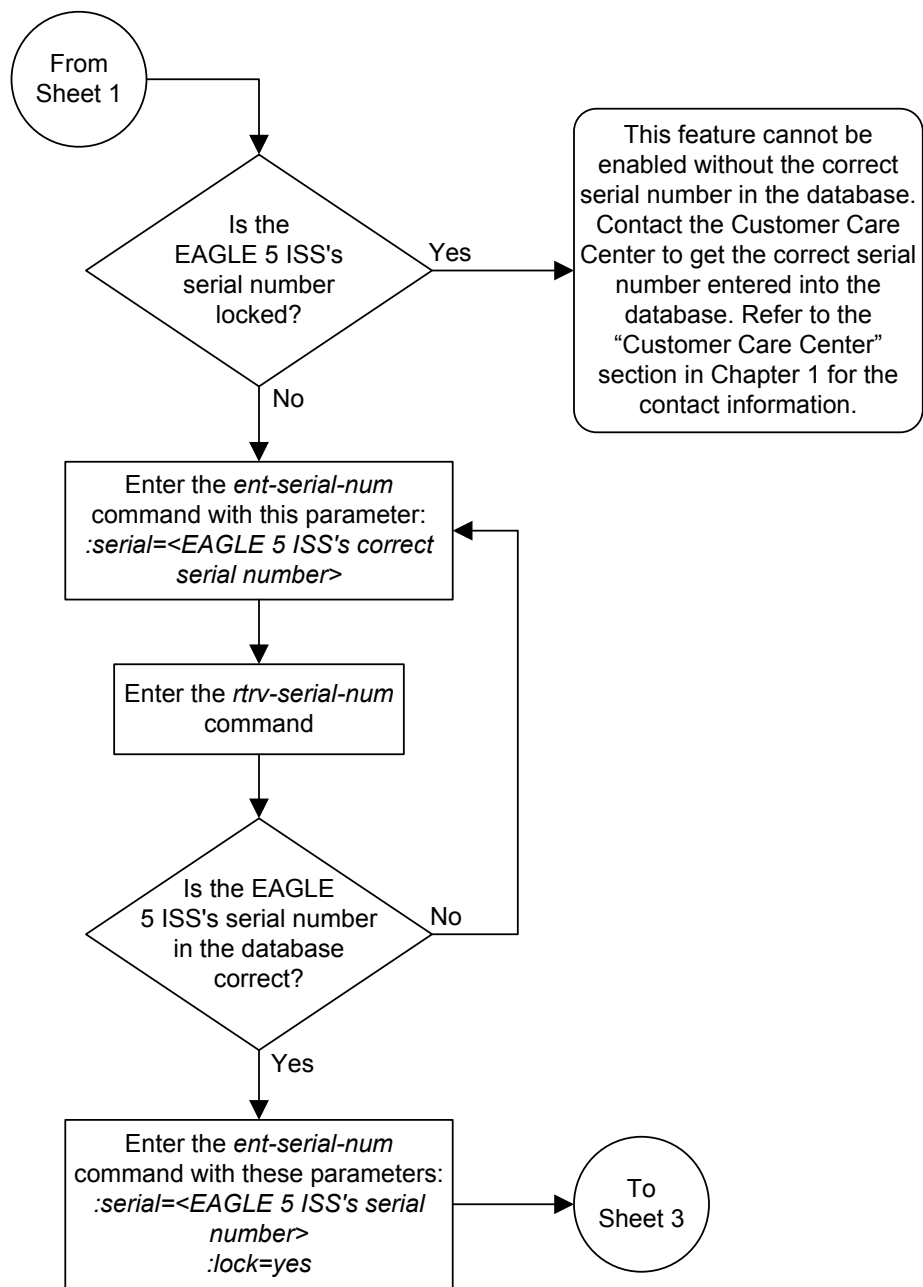
Figure 2-7 Changing the Proxy Point Code Quantity



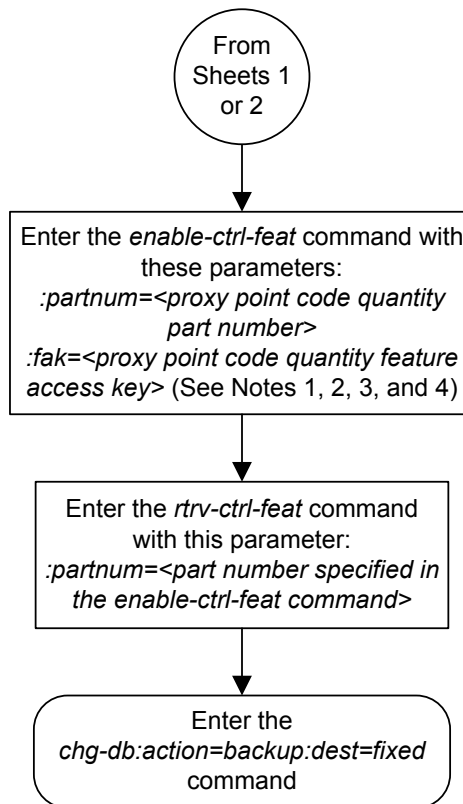
Notes:

1. If the *rtrv-ctrl-feat* output shows only the HC-MIM SLK Capacity feature with a quantity of 64, the answer to this question is no and the Eagle 5 ISS's serial number must be verified. This is the default entry for the *rtrv-ctrl-feat* output. This entry is shown whether or not the Eagle 5 ISS's serial number is in the database.
2. If the serial number is locked, it cannot be changed.
3. If the serial number is not locked, the controlled feature cannot be enabled.
4. The serial number can be found on a label affixed to the control shelf (shelf 1100).

Sheet 1 of 3



Sheet 2 of 3



Notes:

1. The following are the part numbers for the proxy point code quantity being enabled.

Part Number	Proxy Point Code Quantity
893018701	10
893018702	20
893018703	30
893018704	40
893018705	50
893018706	60
893018707	70
893018708	80
893018709	90
893018710	100

2. A proxy point code quantity cannot be decreased.

3. A proxy point code quantity cannot be enabled with a temporary feature access key.

4. If you do not have the feature access key for the proxy point code quantity you wish to enable, contact your Tekelec Sales Representative or Account Representative.

Changing the DPC Quantity

This procedure is used to increase the number of **DPCs** that are allowed in the EAGLE beyond what is currently shown in the `ent-dstn`, `dlt-dstn`, `chg-dstn`, and `rtrv-dstn` outputs. The EAGLE can contain a maximum of one of these quantities: 2000 (system default), 5000, 6000, 7000, 8000, or 10,000 DPCs.

To have more than 2000 DPCs in the EAGLE, the 5000 Routes feature must be turned on using the `chg-feat` command. Turning on the 5000 Routes features allows the EAGLE to contain a maximum of 5000 DPCs. To have more than 5000 DPCs in the EAGLE, either 6000, 7000, or 8000, or 10,000 routesets must be enabled using the `enable-ctrl-feat` command, in addition to having the 5000 Routes feature turned on. Enabling 6000, 7000, 8000, or 10,000 routesets allows the EAGLE to contain a maximum of 6000, 7000, 8000, or 10,000 DPCs. The `rtrv-ctrl-feat` command shows whether or not 6000, 7000, 8000, or 10,000 routesets are enabled. The `rtrv-feat` command shows whether or not the 5000 Routes feature is turned on.

Note: Once the 5000 Routes feature is turned on with the `chg-feat` command, it cannot be turned off.

The 5000 Routes feature must be purchased before you turn this feature on with the `chg-feat` command. If you are not sure if you have purchased the 5000 Routes feature, contact your Oracle Sales Representative or Account Representative.

Once the maximum **DPC** quantity is set, the actual number of DPCs allowed in the EAGLE is configured using the `mtpdpcq` parameter of the `chg-stpopts` command. The `rtrv-stpopts` command output, as well as the outputs of the `ent-dstn`, `dlt-dstn`, `chg-dstn`, and `rtrv-dstn` commands, shows the actual number of DPCs allowed in the EAGLE.

If the **Cluster Routing and Management Diversity** feature is turned on, (shown by the entry `CRMD = on` in the `rtrv-feat` output) the `mtpxlq` parameter is also shown in the `rtrv-stpopts` output. The `mtpxlq` parameter defines the maximum number of entries that the exception list (x-list) for the Cluster Routing and Management Diversity feature can contain. The value of the `mtpxlq` parameter of the `chg-stpopts` command can also be changed to more than 2000 destination point codes. For more information on exception lists, see the "Exception Lists (X-lists)" in the [Cluster Routing and Management Diversity \(CRMD\)](#) section.

The `enable-ctrl-feat` command enables 6000, 7000, 8000, or 10,000 routesets by inputting the part number for the routeset quantity and the routeset quantity's feature access key with these parameters.

:partnum – The Oracle-issued part number for the routeset quantity:

- For 6000 routesets - 893006401
- For 7000 routesets - 893006402
- For 8000 routesets - 893006403
- For 10,000 routesets - 893006405

:*fak* – The feature access key supplied by Oracle. The feature access key contains 13 alphanumeric characters and is not case sensitive.

Note: The values for the feature access key (the *fak* parameter) are provided by Oracle. If you do not have the feature access key for the routeset quantity you wish to enable, contact your Oracle Sales Representative or Account Representative.

The *enable-ctrl-feat* command requires a valid serial number for the EAGLE to be configured in the database, and that this serial number is locked. This can be verified with the *rtrv-serial-num* command. The EAGLE is shipped with a serial number in the database, but the serial number is not locked. The serial number can be changed, if necessary, and locked once the EAGLE is on-site, by using the *ent-serial-num* command. The *ent-serial-num* command uses these parameters.

:*serial* – The serial number assigned to the EAGLE. The serial number is not case sensitive.

:*lock* – Specifies whether or not the serial number is locked. This parameter has only one value, *yes*, which locks the serial number. Once the serial number is locked, it cannot be changed.

Note: To enter and lock the EAGLE's serial number, the *ent-serial-num* command must be entered twice, once to add the correct serial number to the database with the *serial* parameter, then again with the *serial* and the *lock=yes* parameters to lock the serial number. You should verify that the serial number in the database is correct before locking the serial number. The serial number can be found on a label affixed to the control shelf (shelf 1100).

To enable 7000 or 8000 routesets, the DPC table can contain no more than 8000 alias point codes. To enable 10,000 routesets, the DPC table can contain no more than 10,000 alias point codes. The number of alias point codes configured in the EAGLE is shown in the output of the *ent-dstn*, *dlt-dstn*, *chg-dstn*, and *rtrv-dstn* command outputs in one of two ways, depending on whether or not the Cluster Routing and Management Diversity feature is on or off.

If the Cluster Routing and Management Diversity feature is off.

```
rlghncxa03w 07-05-17 16:02:05 GMT EAGLE5 37.0.0
Destination table is (10 of 8000) 1% full
Alias table is (8 of 8000) 1% full
RTRV-DSTN: MASP A - COMPLTD
```

If the Cluster Routing and Management Diversity feature is on.

```
rlghncxa03w 07-05-17 16:02:05 GMT EAGLE5 37.0.0
DESTINATION ENTRIES ALLOCATED: 8000
  FULL DPC(s): 9
  EXCEPTION DPC(s): 0
  NETWORK DPC(s): 0
  CLUSTER DPC(s): 1
  TOTAL DPC(s): 10
  CAPACITY (% FULL): 1%
ALIASES ALLOCATED: 8000
ALIASES USED: 8
```



```

CAPACITY (% FULL):          1%
X-LIST ENTRIES ALLOCATED:   500
RTRV-DSTN: MASP A - COMPLTD

```

To set the alias point code quantity below 8000 if 7000 or 8000 routesets will be enabled, or 10,000 if 10,000 routesets will be enabled, perform the [Changing a Destination Point Code](#) procedure. The alias point codes are removed using this procedure.

The routeset quantities (6000, 7000, 8000, or 10,000) cannot be temporarily enabled (with a temporary feature access key) and cannot be disabled with the `chg-ctrl-feat` command and the `status=off` parameter. The routeset quantity cannot be decreased to a smaller quantity once a quantity is enabled. For example, if the current routeset quantity of the EAGLE is 7000 routesets, the quantity cannot be reduced to 6000 routesets.

Once any of these routeset quantities are enabled with the `enable-ctrl-feat` command, they are also activated. The `chg-ctrl-feat` command is not necessary to activate these routeset quantities.

To enable 10,000 routesets, the EAGLE can contain only E5-based control cards. Refer to [Maintenance and Administration Subsystem](#) for more information about the control cards.

1. Display the DPC quantity currently allowed in the EAGLE by entering the `rtrv-stpopts` command.

The DPC quantity is displayed in the `MTPDPCQ` field of the output. This is an example of the possible output.

```

rlghncxa03w 07-05-17 16:02:05 GMT  EAGLE5 37.0.0
STP OPTIONS
-----
MTPDPCQ          1750

```

Note: The `rtrv-stpopts` command output contains other fields that are not used by this procedure. If you wish to see all the fields displayed by the `rtrv-stpopts` command, see the `rtrv-stpopts` command description in *Commands User's Guide*.

The `MTPDPCQ` value cannot exceed one of these totals depending on the features that are enabled or turned on.

- 2000 – if the 5000 Routes feature is not on, and 6000, 7000, 8000, or 10,000 routesets are not enabled.
- 5000 – if the 5000 Routes feature is on, and 6000, 7000, 8000, or 10,000 routesets are not enabled.
- 6000 – if 6000 routesets are enabled.
- 7000 – if 7000 routesets are enabled.
- 8000 – if 8000 routesets are enabled.
- 10,000 – if 10,000 routesets are enabled.

If the Cluster Routing and Management Diversity feature is on, the `MTPXLQ` field will be shown in the `rtrv-stpopts` command output. The `MTPXLQ` field shows the maximum number of entries the exception list (x-list) can contain. The sum of the `MTPDPCQ` and `MTPXLQ` values cannot exceed one of these totals depending on the features that are enabled or turned on.

- 2500 – if the 5000 Routes feature is not on, and 6000, 7000, 8000, or 10,000 routesets are not enabled.
- 5500 – if the 5000 Routes feature is on, and 6000, 7000, 8000, or 10,000 routesets are not enabled.
- 6500 – if 6000 routesets are enabled.
- 7500 – if 7000 routesets are enabled.
- 8500 – if 8000 routesets are enabled.
- 10,500 – if 10,000 routesets are enabled.

For more information on the Cluster Routing and Management Diversity feature, see the [Cluster Routing and Management Diversity \(CRMD\)](#) section.

Perform one of the following steps based on the `MTPDPCQ` value (or `MTPDPCQ` and `MTPXLQ` values) shown in the `rtrv-stpopts` output. The values shown in parentheses are the sum of the `MTPDPCQ` and `MTPXLQ` values.

- 8001 - 10,000 (8501 - 10,500) – 10,000 routesets are enabled. The only action that can be performed is to change the DPC quantity using the `chg-stpopts` command. This is the maximum number of routesets the EAGLE can have. Continue the procedure with [14](#) to change the DPC quantity. If you do not wish to change the DPC quantity, this procedure is finished.
- 7001 - 8000 (7501 - 8500) – 8000 routesets are enabled. To enable the 10,000 routeset quantity, continue the procedure with [11](#). If you wish to change the DPC quantity and not enable 10,000 routesets, continue the procedure with [14](#). If you do not wish to enable 10,000 routesets or change the DPC quantity, this procedure is finished.
- 6001 - 7000 (6501 - 7500) – 7000 routesets are enabled. To enable the 8000 routeset quantity, continue the procedure with [Oracle](#). To enable the 10,000 routeset quantity, continue the procedure with [11](#). If you wish to change the DPC quantity and not enable 8000 or 10,000 routesets, continue the procedure with [14](#). If you do not wish to enable 8000 or 10,000 routesets or change the DPC quantity, this procedure is finished.
- 5001 - 6000 (5501 - 6500) – 6000 routesets are enabled. To enable 7000, or 8000, 10,000 routesets, continue the procedure with [10](#). To enable the 10,000 routeset quantity, continue the procedure with [11](#). If you wish to change the DPC quantity and not enable 7000, 8000, or 10,000 routesets, continue the procedure with [14](#). If you do not wish to enable 7000, 8000, or 10,000 routesets or change the DPC quantity, this procedure is finished.
- 2001 - 5000 (2501 - 5500) – The 5000 Routes feature is on. To enable 6000, 7000, 8000, or 10,000 routesets, perform [2](#). If you wish to change the DPC quantity and not enable 6000, 7000, 8000, or 10,000 routesets, continue the procedure with [14](#). If you do not wish to enable 6000, 7000, 8000, or 10,000 routesets or change the DPC quantity, this procedure is finished.

- 2000 or less (2500 or less) – Continue the procedure with [2](#).
2. Verify that 6000, 7000, 8000, or 10,000 routesets are enabled by entering the `rtrv-ctrl-feat` command.

The following is an example of the possible output.

```
rlghncxa03w 07-05-28 21:15:37 GMT EAGLE5 37.0.0
The following features have been permanently enabled:
```

Feature Name	Partnum	Status	Quantity
Command Class Management	893005801	on	----
LNP Short Message Service	893006601	on	----
Intermed GTT Load Sharing	893006901	on	----
XGTT Table Expansion	893006101	on	4000000
XMAP Table Expansion	893007710	on	3000
Large System # Links	893005901	on	1500
Routesets	893006401	on	6000
HC-MIM SLK Capacity	893012707	on	64

The following features have been temporarily enabled:

Feature Name	Partnum	Status	Quantity	Trial Period Left
Zero entries found.				

The following features have expired temporary keys:

Feature Name	Partnum
Zero entries found.	

If 10,000 routesets are enabled, the `Routesets` row appears in the `rtrv-ctrl-feat` output with a quantity of 10,000. The only action that can be performed is to change the DPC quantity using the `chg-stpopts` command. This is the maximum number of routesets the EAGLE can have. Continue the procedure with [14](#) to change the DPC quantity. If you do not wish to change the DPC quantity, this procedure is finished.

If 8000 routesets are enabled, the `Routesets` row appears in the `rtrv-ctrl-feat` output with a quantity of 8000. To enable 10,000 routesets, continue the procedure with [11](#). If you wish to change the DPC quantity and not enable 10,000 routesets, continue the procedure with [14](#). If you do not wish to enable 10,000 routesets or change the DPC quantity, this procedure is finished.

If 7000 routesets are enabled, the `Routesets` row appears in the `rtrv-ctrl-feat` output with a quantity of 7000. To enable 8000 routesets, continue the procedure with [Oracle](#). To enable 10,000 routesets, continue the procedure with [11](#). If you wish to change the DPC quantity and not enable 8000 or 10,000 routesets, continue the procedure with [14](#). If you do not wish to enable 8000 or 10,000 routesets or change the DPC quantity, this procedure is finished.

If 6000 routesets are enabled, the `Routesets` row appears in the `rtrv-ctrl-feat` output with a quantity of 6000. To enable 7000 or 8000, 8000, or 10,000 routesets, continue the procedure with [10](#). To enable 10,000 routesets, continue the procedure with [11](#). If you wish to change the DPC quantity and not enable 7000, 8000, or 10,000 routesets, continue the procedure with [14](#). If you do not wish to enable 7000, 8000, or 10,000 routesets or change the DPC quantity, this procedure is finished.

If 6000, 7000, 8000, or 10,000 routesets are not enabled, continue the procedure with [3](#).

3. Enter the `rtrv-feat` command to verify that the 5000 Routes feature is turned on.

If the 5000 Routes feature is on, the `DSTN5000 = on` entry appears in the output.

Note: The `rtrv-feat` command output contains other fields that are not used by this procedure. If you wish to see all the fields displayed by the `rtrv-feat` command, see the `rtrv-feat` command description in the *Commands Manual*.

If the 5000 Routes feature is not on, and you do not wish to turn the 5000 Routes feature on, or enable 6000, 7000, 8000, or 10,000 routesets, the only action that can be performed is to change the DPC quantity using the `chg-stpopts` command. However the DPC quantity can be no greater than 2000 DPCs (2500 DPCs if the `rtrv-stpopts` output in [1](#) contains the `MTPDPCQ` and `MTPXLQ` parameters). Continue the procedure with [14](#) to change the DPC quantity. If you do not wish to change the DPC quantity, this procedure is finished.

If the 5000 Routes feature is not on, and you wish to turn the 5000 Routes feature on, or enable 6000, 7000, 8000, or 10,000 routesets, continue the procedure with [4](#).

If the 5000 Routes feature is on, continue the procedure with [6](#).

4. Turn the 5000 Routes feature on by entering this command.

```
chg-feat :DSTN5000=on
```

Note: Once the 5000 Routes feature is turned on with the `chg-feat` command, it cannot be turned off.

The 5000 Routes feature must be purchased before you turn this feature on with the `chg-feat` command. If you are not sure if you have purchased the 5000 Routes feature, contact your Oracle Sales Representative or Account Representative.

When the `chg-feat` has successfully completed, this message appears.

```
rlghncxa03w 07-05-28 11:43:04 GMT EAGLE5 37.0.0  
CHG-FEAT: MASP A - COMPLTD
```

5. Verify that the 5000 Routes feature is turned on, by entering the `rtrv-feat` command.

If the 5000 Routes feature is on, the `DSTN5000 = on` appears in the command output.

Note: The `rtrv-feat` command output contains other fields that are not used by this procedure. If you wish to see all the fields displayed by the `rtrv-feat` command, see the `rtrv-feat` command description in *Commands User's Guide*.

If 6000, 7000, 8000, or 10,000 routesets are not being enabled, the only action that can be performed is to change the DPC quantity. If you wish to change the DPC quantity and not enable 6000, 7000, 8000, or 10,000 routesets, continue the procedure with [14](#). If you do not wish to enable 6000, 7000, 8000, or 10,000 routesets or change the DPC quantity, this procedure is finished.

If 6000, 7000, 8000, or 10,000 routesets are being enabled, go to [6](#).

Note: If the `rtrv-ctrl-feat` output in [1](#) shows any controlled features, continue the procedure [10](#). If the `rtrv-ctrl-feat` output shows only the HC-MIM SLK Capacity feature with a quantity of 64, [6](#) through [9](#) must be performed.

If 6000, 7000, 8000, or 10,000 routesets are being enabled, the serial number of the EAGLE must be in the database and the serial number must be locked. If the `rtrv-ctrl-feat` output in [2](#) shows any features in addition to the HC-MIM SLK Capacity feature with a quantity of 64, the serial number is in the database and it is locked. Continue the procedure by performing one of these steps.

- If 6000 routesets are being enabled, continue the procedure with [Oracle](#).
- If 7000, 8000, or 10,000 routesets are being enabled, continue the procedure with [10](#).

The HC-MIM SLK Capacity feature with a quantity of 64 is shown in the `rtrv-ctrl-feat` output in [2](#) whether or not the serial number of the EAGLE is in the database or whether or not the serial number is locked. If the `rtrv-ctrl-feat` output shows only the HC-MIM SLK Capacity feature with a quantity of 64, the status of the serial number must be verified. Continue the procedure with [6](#).

6. Display the serial number in the database with the `rtrv-serial-num` command.

This is an example of the possible output.

```
rlghncxa03w 07-05-28 21:15:37 GMT EAGLE5 37.0.0
System serial number = nt00001231
System serial number is not locked.
rlghncxa03w 07-10-28 21:15:37 GMT EAGLE5 37.0.0
Command Completed
```

Note: If the serial number is correct and locked, continue the procedure with [Oracle](#) if 6000 routesets are being enabled. Continue the procedure with [10](#) if 7000, 8000, or 10,000 routesets are being enabled. If the serial number is correct but not locked, continue the procedure with [9](#). If the serial number is not correct, but is locked, 6000, 7000, 8000, or 10,000 routesets cannot be enabled and the remainder of this procedure cannot be performed. Contact the Customer Care Center to get an incorrect and locked serial number changed. Refer to the [My Oracle Support \(MOS\)](#) section for the contact information. The serial number can be found on a label affixed to the control shelf (shelf 1100).

7. Enter the correct serial number into the database using the `ent-serial-num` command with the `serial` parameter.

For this example, enter this command.

```
ent-serial-num:serial=<EAGLE's correct serial number>
```

When this command has successfully completed, the following message should appear.

```
rlghncxa03w 07-05-28 21:15:37 GMT EAGLE5 37.0.0
ENT-SERIAL-NUM: MASP A - COMPLTD
```

8. Verify that the serial number entered in 7 was entered correctly using the `rtrv-serial-num` command.

This is an example of the possible output.

```
rlghncxa03w 07-05-28 21:15:37 GMT EAGLE5 37.0.0
System serial number = nt00001231
System serial number is not locked.
rlghncxa03w 07-05-28 21:15:37 GMT EAGLE5 37.0.0
Command Completed
```

If the serial number was not entered correctly, repeat 7 and 8 and re-enter the correct serial number.

9. Lock the serial number in the database by entering the `ent-serial-num` command with the serial number shown in 6, if the serial number shown in 6 is correct, or with the serial number shown in 8, if the serial number was changed in 7, and with the `lock=yes` parameter.

For this example, enter this command.

```
ent-serial-num:serial=<EAGLE's serial number>:lock=yes
```

When this command has successfully completed, the following message should appear.

```
rlghncxa03w 07-05-28 21:15:37 GMT EAGLE5 37.0.0
ENT-SERIAL-NUM: MASP A - COMPLTD
```

If 6000 routesets are not being enabled, continue the procedure with [Oracle](#).

If 7000, 8000, or 10,000 routesets are not being enabled, continue the procedure with [Oracle](#).

If 7000 routesets are currently enabled, and 8000 or 10,000 routesets are being enabled, continue the procedure with [Oracle](#).

If 5000 or 6000 routesets are currently enabled and 7000, 8000, or 10,000 routesets are being enabled, continue the procedure with [10](#).

10. Verify the number of alias point codes configured in the EAGLE by entering the `rtrv-dstn` command with the `msar=only` parameter.

To enable 7000 or 8000 routesets, the EAGLE can have no more than 8000 alias point codes.

To enable 10,000 routesets, the EAGLE can have no more than 10,000 alias point codes.

The `msar=only` parameter displays only the maximum numbers of different types of point codes the EAGLE can have and the actual numbers of the different types of point codes that are configured in the EAGLE.

```
rtrv-dstn:msar=only
```

One of two types of outputs are displayed, depending on whether or not the Cluster Routing and Management Diversity feature is on or off.

If the Cluster Routing and Management Diversity feature is off:

```
rlghncxa03w 07-05-17 16:02:05 GMT EAGLE5 37.0.0
Destination table is (10 of 8000) 1% full
Alias table is (8 of 8000) 1% full
RTRV-DSTN: MASP A - COMPLTD
```

If the Cluster Routing and Management Diversity feature is on:

```
rlghncxa03w 07-05-17 16:02:05 GMT EAGLE5 37.0.0
DESTINATION ENTRIES ALLOCATED: 8000
  FULL DPC(s): 9
  EXCEPTION DPC(s): 0
  NETWORK DPC(s): 0
  CLUSTER DPC(s): 1
  TOTAL DPC(s): 10
  CAPACITY (% FULL): 1%
ALIASES ALLOCATED: 8000
  ALIASES USED: 8
  CAPACITY (% FULL): 1%
X-LIST ENTRIES ALLOCATED: 500
RTRV-DSTN: MASP A - COMPLTD
```

If 7000 or 8000 routesets are being enabled and the EAGLE contains more than 8000 alias point codes, perform the [Changing a Destination Point Code](#) procedure to reduce the number of alias point codes to an amount below 8000.

If 10,000 routesets are being enabled and the EAGLE contains more than 10,000 alias point codes, perform the [Changing a Destination Point Code](#) procedure to reduce the number of alias point codes to an amount below 10,000.

When this step has been completed, continue the procedure by performing one of these steps.

- If 7000 or 8000 routesets are being enabled, continue the procedure with [Oracle](#).
- If 10,000 routesets are being enabled, continue the procedure with [11](#).

11. Display the control cards in the EAGLE by entering this command.

```
rtrv-stp:gpl=oamhc
```

This is an example of the possible output.

```
rlghncxa03w 10-12-01 16:07:48 GMT EAGLE5 43.0.0

Card  Part Number  Rev  Serial Number  Type      DB      APPL      GPL Version
----  -
1113  870-2903-01  C    10206255064    E5MCAP    1024M  OAMHC    132-018-000
1115  870-2903-01  C    10206255165    E5MCAP    1024M  OAMHC    132-018-000
```

Command Completed.

To enable 10,000 routesets, E5-MCAP cards must be installed in card locations 1113 and 1115. If E5-MCAP cards are not shown in either card location 1113 or 1115,

install the E5-MCAP cards in card locations 1113 or 1115 as required. Contact the Customer Care Center before installing the E5-MCAP cards. Refer to the [My Oracle Support \(MOS\)](#) section for the contact information.

After the E5-MCAP cards have been installed, or if E5-MCAP cards are shown in card locations 1113 and 1115 in the `rtrv-stp` output, continue the procedure with [Oracle](#).

12. Enable the routeset quantity with the `enable-ctrl-feat` command specifying the part number for the routeset quantity and the feature access key.

- To enable 6000 routesets, enter this command.

```
enable-ctrl-feat:partnum=893006401:fak=<6000 Routesets
feature access key>
```

- To enable 7000 routesets, enter this command.

```
enable-ctrl-feat:partnum=893006402:fak=<7000 Routesets
feature access key>
```

- To enable 8000 routesets, enter this command.

```
enable-ctrl-feat:partnum=893006403:fak=<8000 Routesets
feature access key>
```

- To enable 10,000 routesets, enter this command.

```
enable-ctrl-feat:partnum=893006405:fak=<10,000 Routesets
feature access key>
```

Note: A temporary feature access key cannot be specified to enable the routeset quantity.

Note: The values for the feature access key (the `fak` parameter) are provided by Oracle. If you do not have the feature access key for the routeset quantity you wish to enable, contact your Oracle Sales Representative or Account Representative.

When the `enable-ctrl-feat` command has successfully completed, this message should appear.

```
rlghncxa03w 07-05-28 21:15:37 GMT EAGLE5 37.0.0
ENABLE-CTRL-FEAT: MASP B - COMPLTD
```

13. Verify the changes by entering the `rtrv-ctrl-feat` command with the routeset quantity part number specified in [Oracle](#).

- If 6000 routesets was enabled, enter this command.

```
rtrv-ctrl-feat:partnum=893006401
```

The following is an example of the possible output.

```
rlghncxa03w 07-05-28 21:15:37 GMT EAGLE5 37.0.0
The following features have been permanently enabled:
```


Feature Name	Partnum	Status	Quantity
Routesets	893006401	on	6000

The following features have been temporarily enabled:

Feature Name	Partnum	Status	Quantity	Trial Period
Left				

Zero entries found.

The following features have expired temporary keys:

Feature Name	Partnum

Zero entries found.

- If 7000 routesets was enabled, enter this command.

```
rtrv-ctrl-feat:partnum=893006402
```

The following is an example of the possible output.

```
rlghncxa03w 07-05-28 21:15:37 GMT EAGLE5 37.0.0
```

The following features have been permanently enabled:

Feature Name	Partnum	Status	Quantity
Routesets	893006402	on	7000

The following features have been temporarily enabled:

Feature Name	Partnum	Status	Quantity	Trial Period
Left				

Zero entries found.

The following features have expired temporary keys:

Feature Name	Partnum

Zero entries found.

- If 8000 routesets was enabled, enter this command.

```
rtrv-ctrl-feat:partnum=893006403
```

The following is an example of the possible output.

```
rlghncxa03w 07-05-28 21:15:37 GMT EAGLE5 37.0.0
```

The following features have been permanently enabled:

Feature Name	Partnum	Status	Quantity
Routesets	893006403	on	8000

The following features have been temporarily enabled:

Feature Name	Partnum	Status	Quantity	Trial Period
Left				

Zero entries found.

The following features have expired temporary keys:

Feature Name	Partnum

Zero entries found.

- If 10,000 routesets was enabled, enter this command.

```
rtrv-ctrl-feat:partnum=893006405
```

The following is an example of the possible output.

```
rlghncxa03w 10-12-28 21:15:37 GMT EAGLE5 42.0.0
The following features have been permanently enabled:
```

Feature Name	Partnum	Status	Quantity
Routesets	893006405	on	10000

The following features have been temporarily enabled:

Feature Name	Partnum	Status	Quantity	Trial Period
Left				
Zero entries found.				

The following features have expired temporary keys:

Feature Name	Partnum
Zero entries found.	

Continue the procedure by performing one of these steps.

- If the DPC quantity or exception list quantity are not being changed, continue the procedure with [16](#).
- If the DPC quantity or exception list quantity are being changed, continue the procedure with [14](#).

14. Change the maximum number of destination point codes that the EAGLE can contain by entering the `chg-stpopts` command with the `mtpdpcq` parameter.

The values that can be specified with the `mtpdpcq` parameter is shown in the following list.

- 500 to 2000 – if the 5000 Routes feature is not on, and 6000, 7000, 8000, or 10,000 routesets are not enabled.
- 500 to 5000 – if the 5000 Routes feature is on, and 6000, 7000, 8000, or 10,000 routesets are not enabled.
- 500 to 6000 – if 6000 routesets are enabled.
- 500 to 7000 – if 7000 routesets are enabled.
- 500 to 8000 – if 8000 routesets are enabled.
- 500 to 10000 – if 10000 routesets are enabled.

For this example, enter this command.

```
chg-stpopts:mtpdpcq=7350
```

When this command has successfully completed, this message should appear.

```
rlghncxa03w 07-05-07 00:22:57 GMT EAGLE5 37.0.0
CHG-STPOPTS: MASP A - COMPLTD
```

If the `MTPXLQ` field (the exception list quantity) is shown in the `rtrv-stpopts` output in [1](#), and you wish to change only the `MTPXLQ` value, enter the `chg-`

`stpopts` command with the `mtpxlq` parameter. For example, if you wish to change the exception list quantity to 1000 point codes, enter this command.
`chg-stpopts:mtpxlq=1000.`

Both the exception list quantity and the maximum of destination point codes can be changed, by entering the `chg-stpopts` command with both the `mtpdpcq` and `mtpxlq` parameters. For example, if you wish to change the exception list quantity to 1000 point codes and the maximum number of point codes to 6200, enter this command.

```
chg-stpopts:mtpxlq=1000:mtpdpcq=6750
```

When specifying the `mtpxlq` parameter with the `chg-stpopts` command, the resulting sum of the `MTPDPCQ` and `MTPXLQ` values cannot be greater than the values shown in the following list.

- 2500 – if the 5000 Routes feature is not on, and 6000, 7000, 8000, or 10,000 routesets are not enabled. The range of values for the `mtpdpcq` and `mtpxlq` parameters is from 500 to 2000.
- 5500 – if the 5000 Routes feature is on, and 6000, 7000, 8000, or 10,000 routesets are not enabled. The range of values for the `mtpdpcq` and `mtpxlq` parameters is from 500 to 5000.
- 6500 – if 6000 routesets are enabled. The range of values for the `mtpdpcq` and `mtpxlq` parameters is from 500 to 6000.
- 7500 – if 7000 routesets are enabled. The range of values for the `mtpdpcq` parameter is from 500 to 7000. The range of values for the `mtpxlq` parameters is from 500 to 6000.
- 8500 – if 8000 routesets are enabled. The range of values for the `mtpdpcq` parameter is from 500 to 8000. The range of values for the `mtpxlq` parameters is from 500 to 6000.
- 10500500 to 10500 – if 10000 routesets are enabled. The range of values for the `mtpdpcq` and `mtpxlq` parameters is from 500 to 10,000.

15. Verify the changes using the `rtrv-stpopts` command.

This is an example of the possible output.

```
rlghncxa03w 07-05-17 16:02:05 GMT EAGLE5 37.0.0
STP OPTIONS
-----
MTPDPCQ          7350
```

Note: The `rtrv-stpopts` command output contains other fields that are not used by this procedure. If you wish to see all the fields displayed by the `rtrv-stpopts` command, see the `rtrv-stpopts` command description in the *Commands Manual*.

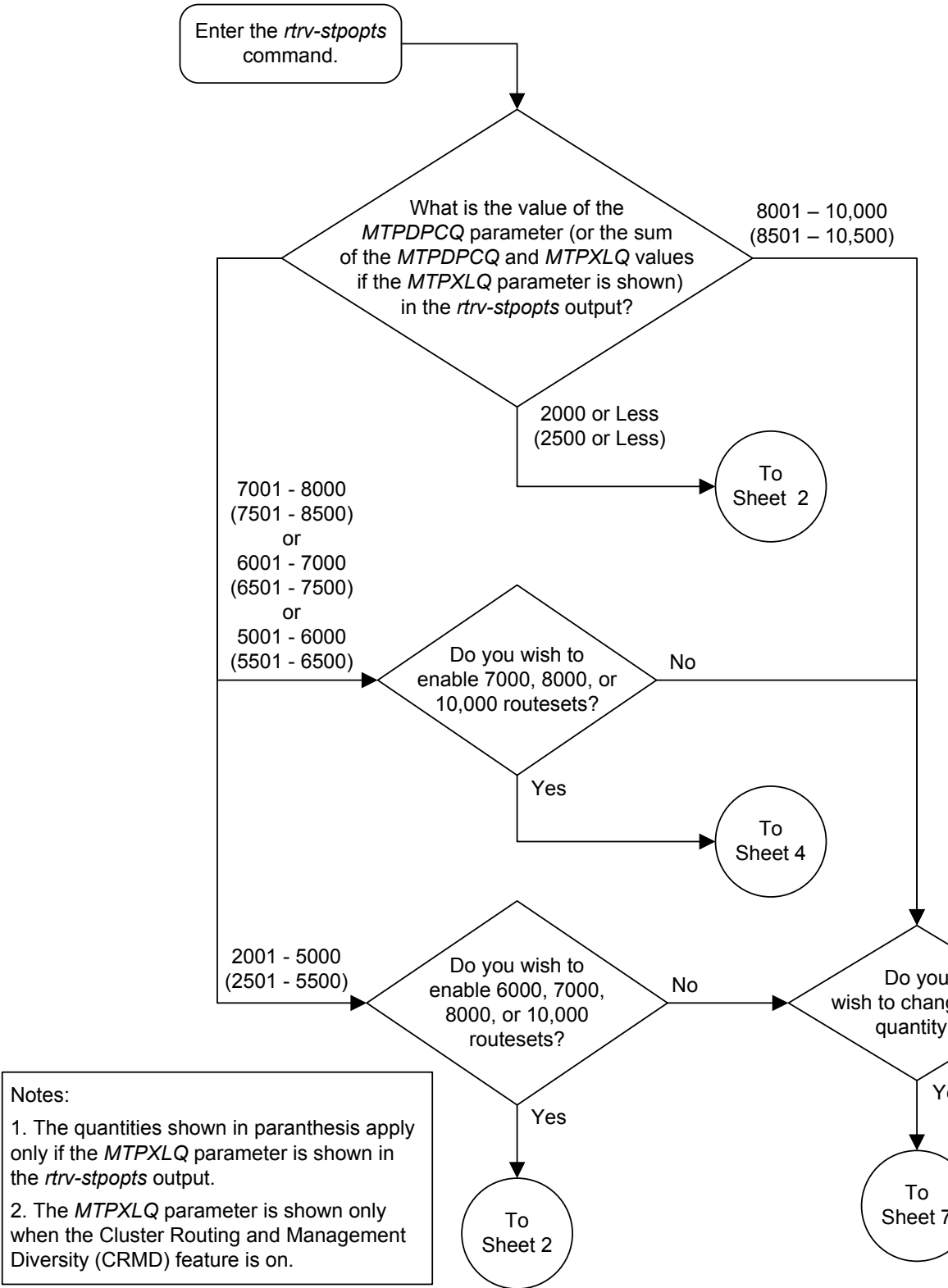
If the `mtpxlq` parameter was specified in [14](#), the `mtpxlq` parameter value will be shown in the `MTPXLQ` field of the `rtrv-stpopts` command output.

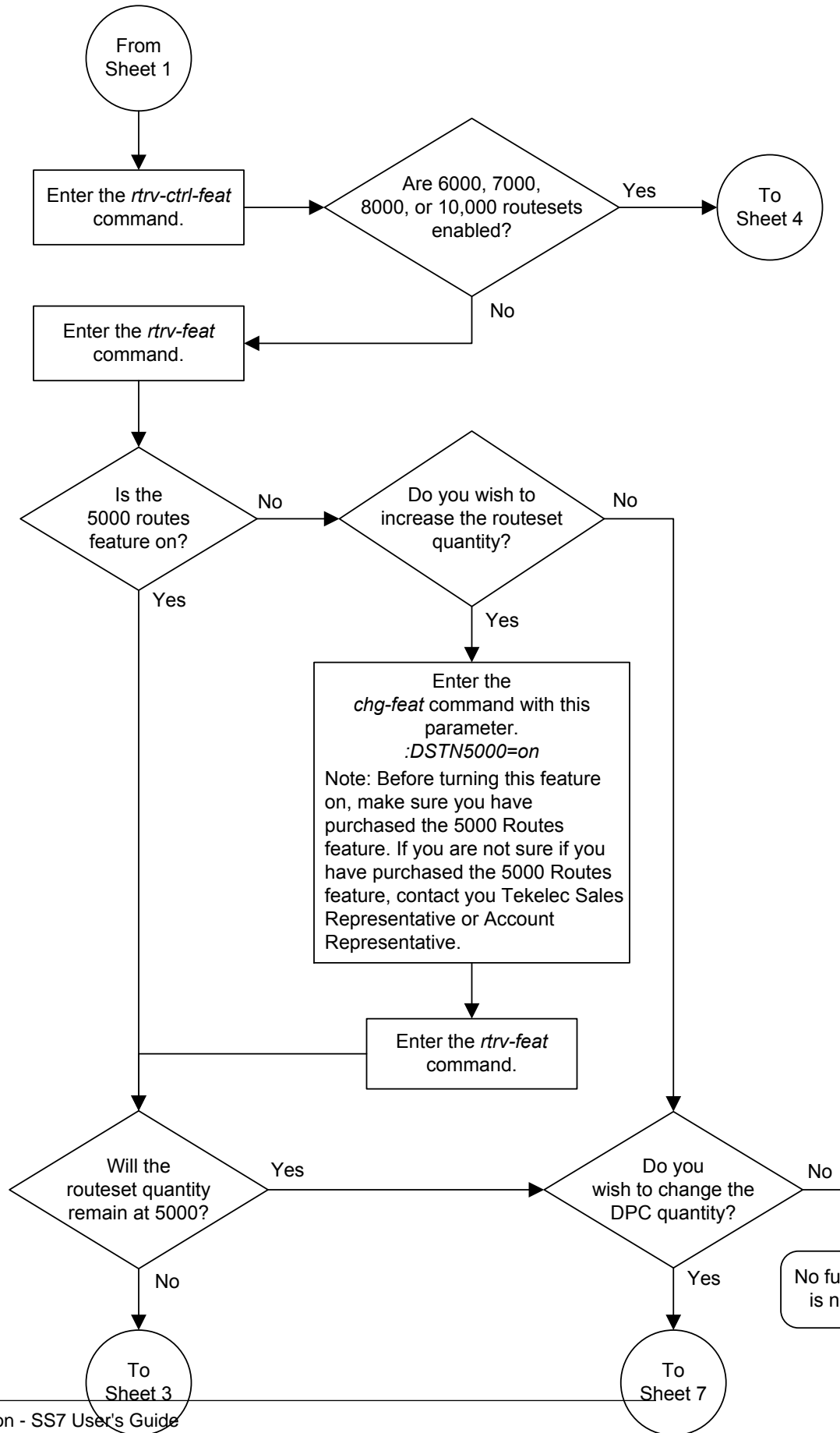
16. Back up the new changes, using the `chg-db:action=backup:dest=fixed` command.

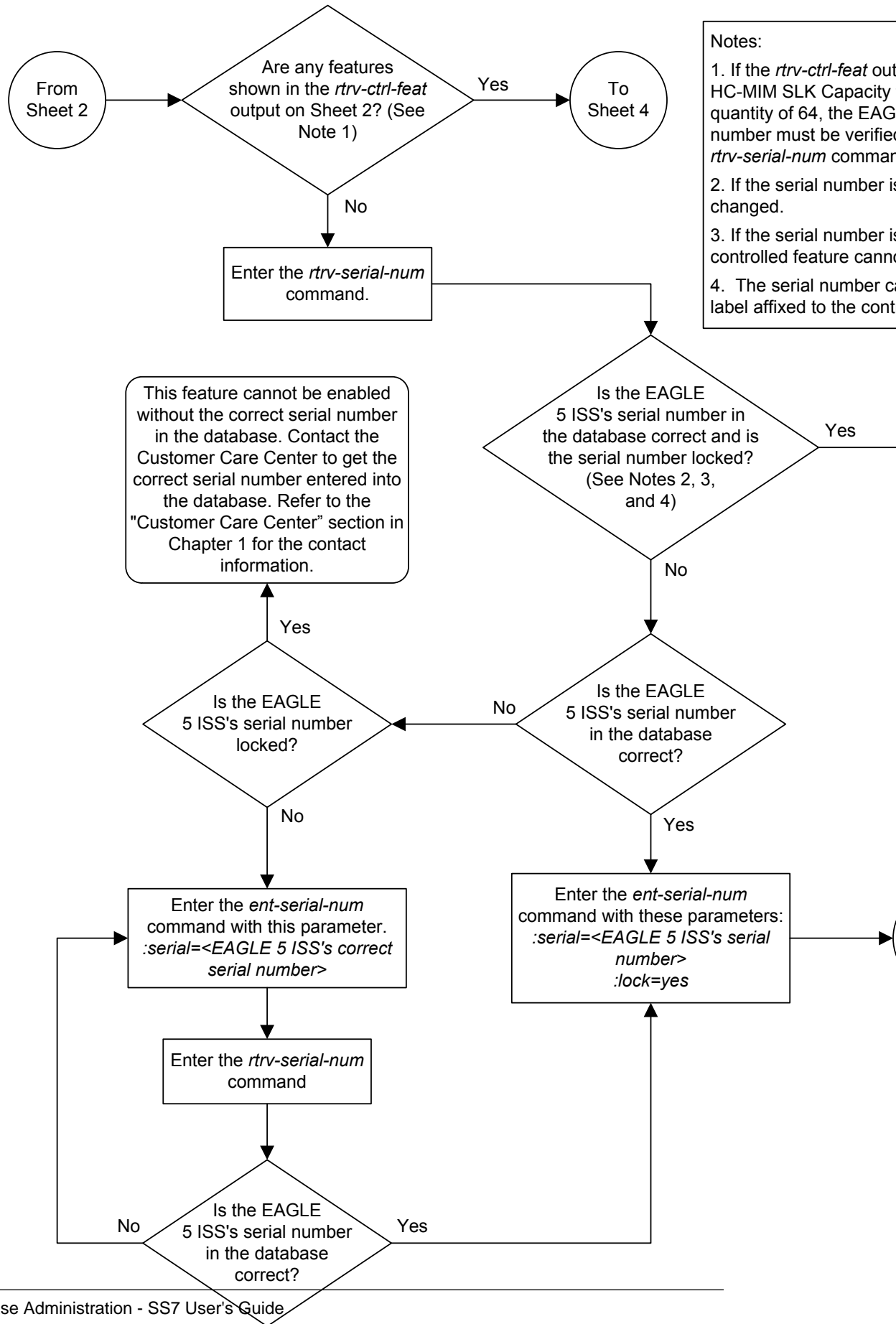
These messages should appear; the active **Maintenance and Administration Subsystem Processor (MASP)** appears first.

```
BACKUP (FIXED): MASP A - Backup starts on active MASP.  
BACKUP (FIXED): MASP A - Backup on active MASP to fixed disk complete.  
BACKUP (FIXED): MASP A - Backup starts on standby MASP.  
BACKUP (FIXED): MASP A - Backup on standby MASP to fixed disk complete.
```

Figure 2-8 Changing the DPC Quantity

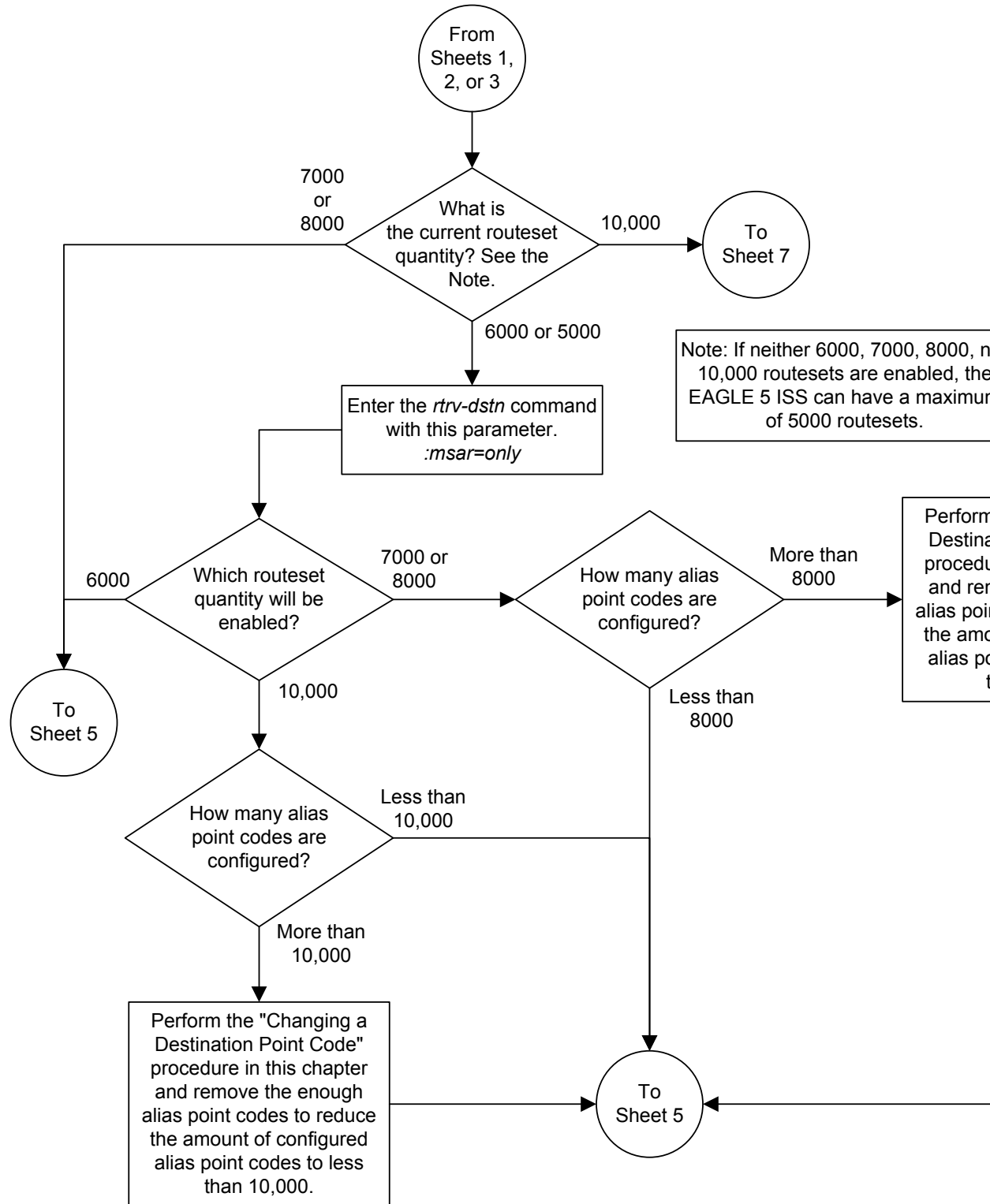


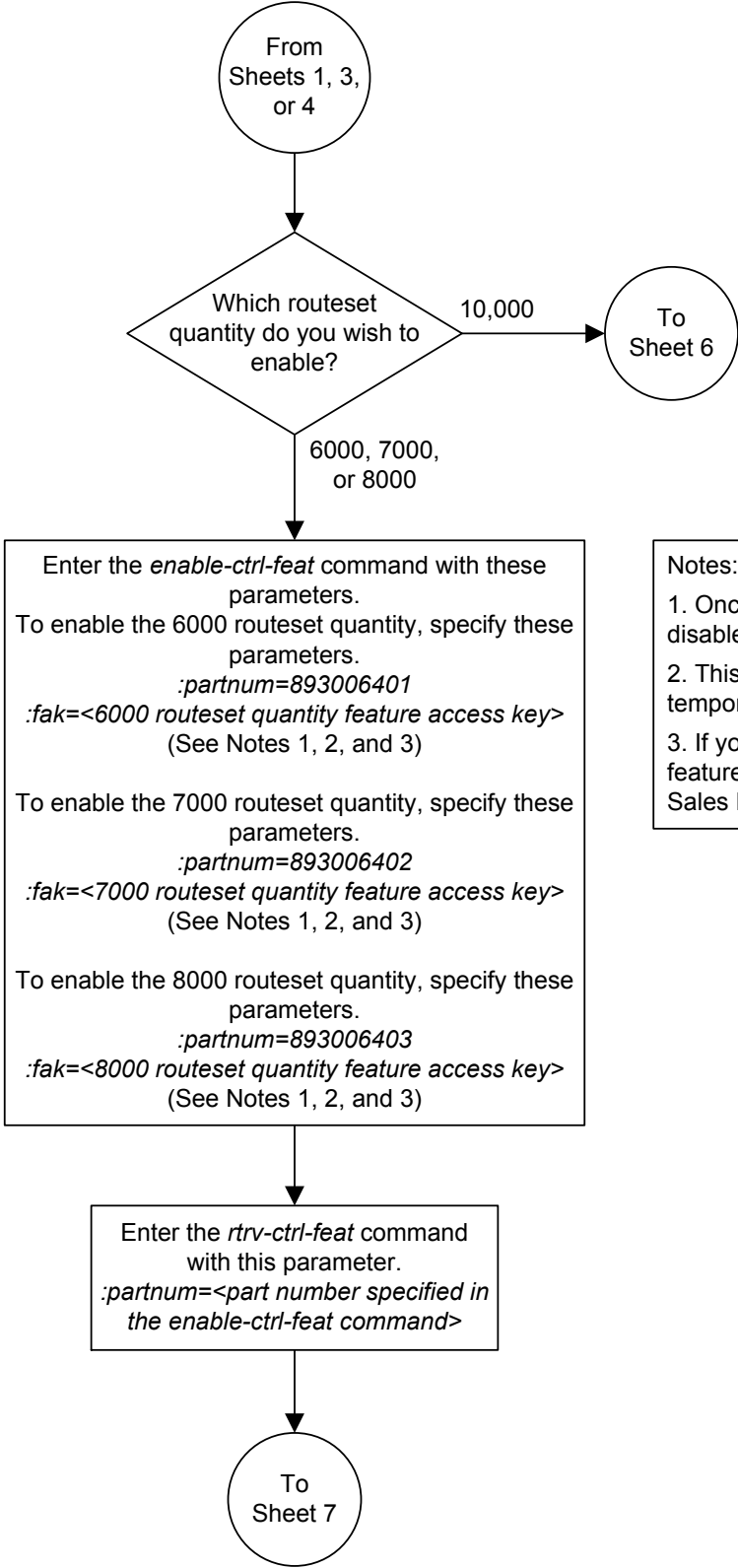




Notes:

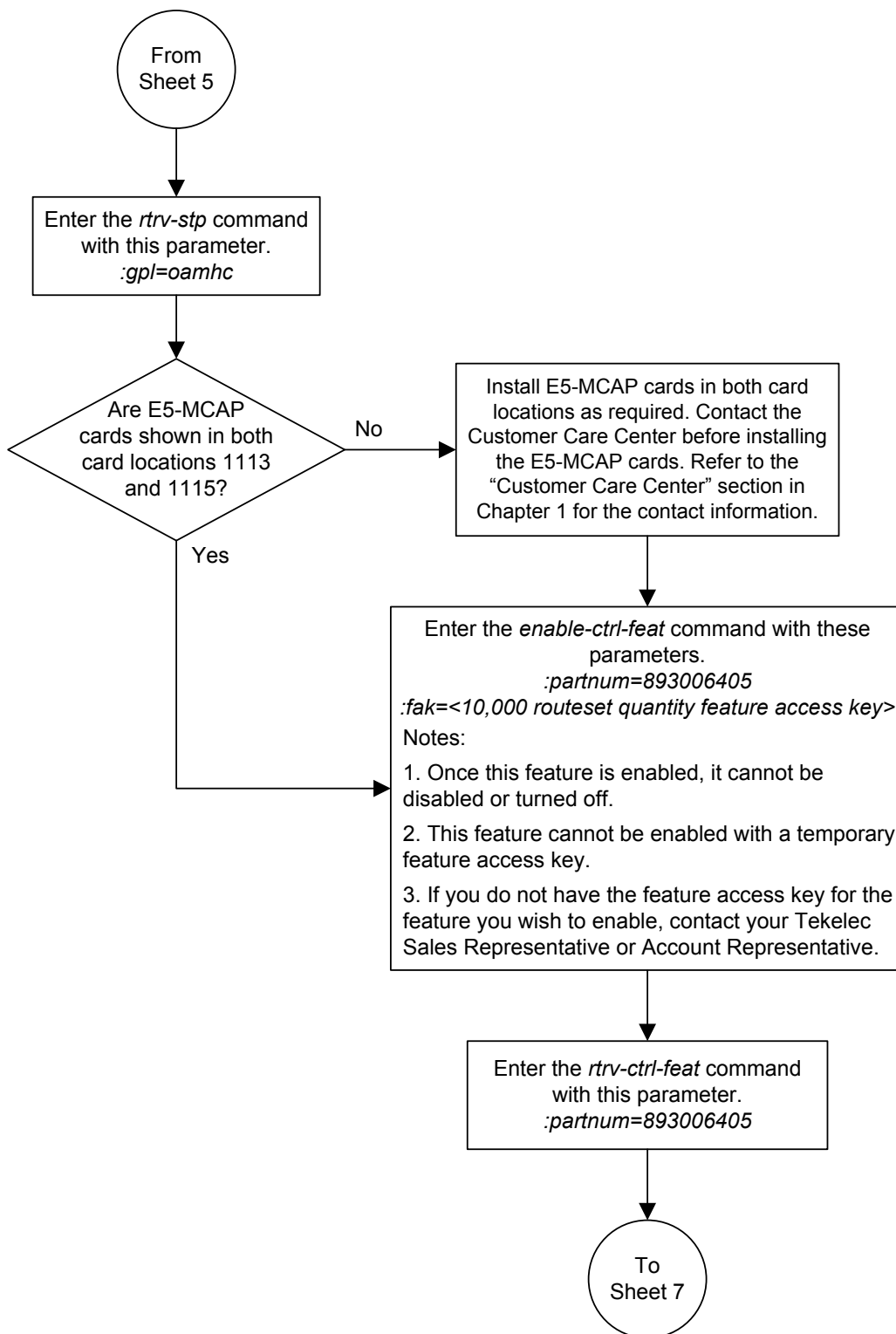
1. If the *rtrv-ctrl-feat* output shows HC-MIM SLK Capacity quantity of 64, the EAGLE 5 ISS's serial number must be verified using the *rtrv-serial-num* command.
2. If the serial number is incorrect, it must be changed.
3. If the serial number is incorrect and the feature is a controlled feature, it cannot be enabled.
4. The serial number cannot be changed if a label is affixed to the controller.

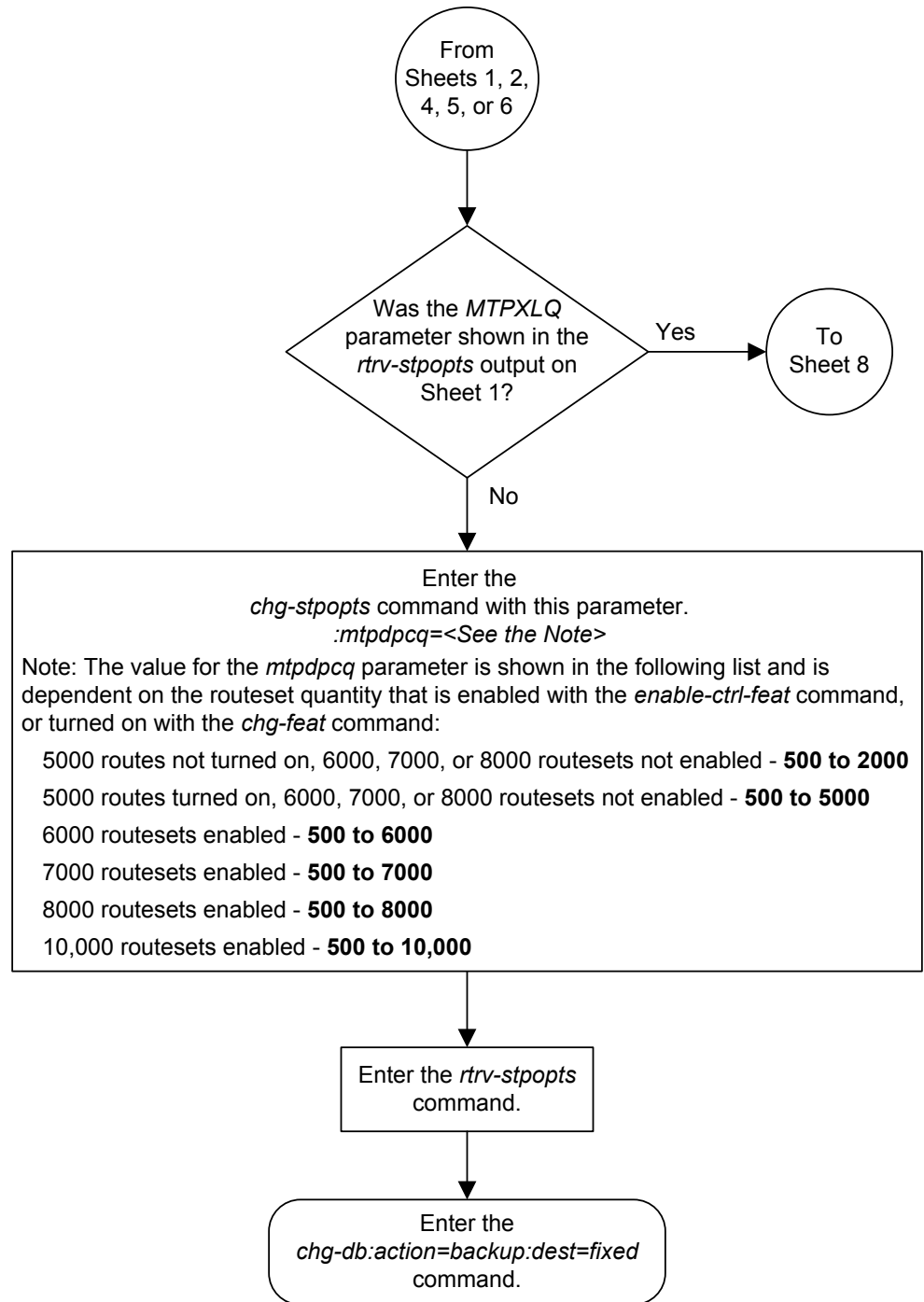


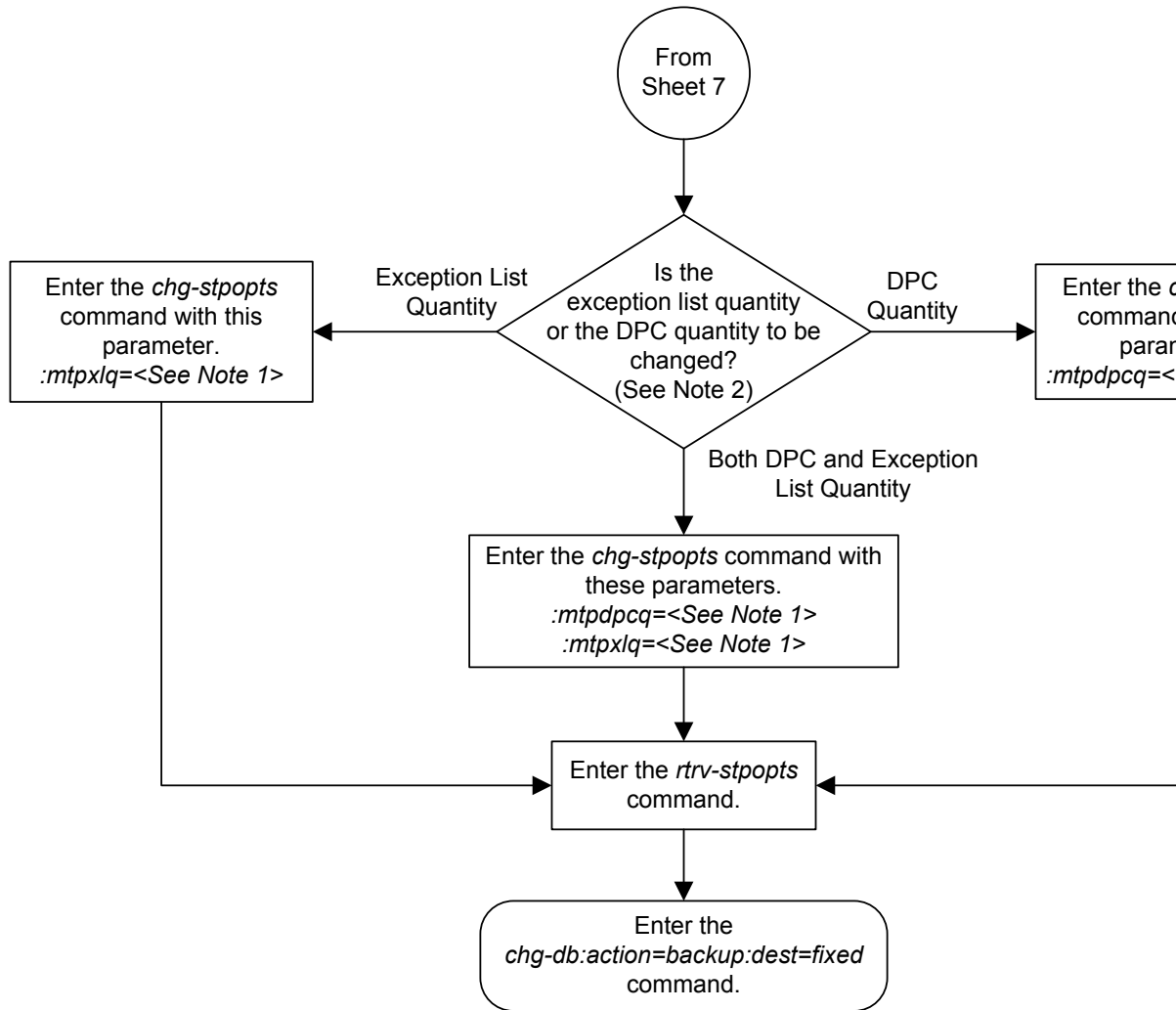


Notes:

1. Once this feature is enabled, it cannot be disabled or turned off.
2. This feature cannot be enabled without a temporary feature access key.
3. If you do not have the feature access key, contact your Sales Representative or Account Manager.







Notes:

1. The sum of the values for the *mtpdpcq* and *mtpxlq* parameters cannot exceed these values, depending on which routeset quantity has been enabled with the *enable-ctrl-feat* command, or turned on with the *chg-ctrl-feat* command:

5000 routes not turned on, 6000, 7000, 8000, or 10,000 routesets not enabled - **2500**. The range of values for the *mtpdpcq* and *mtpxlq* parameters is 500 to 2000.

5000 routes turned on, 6000, 7000, 8000, or 10,000 routesets not enabled - **5500**. The range of values for the *mtpdpcq* and *mtpxlq* parameters is 500 to 5000.

6000 routesets enabled - **6500**. The range of values for the *mtpdpcq* and *mtpxlq* parameters is 500 to 6000.

7000 routesets enabled - **7500**. The range of values for the *mtpdpcq* parameter is 500 to 7000. The range of values for the *mtpxlq* parameter is 500 to 6000.

8000 routesets enabled - **8500**. The range of values for the *mtpdpcq* parameter is 500 to 8000. The range of values for the *mtpxlq* parameter is 500 to 6000.

10,000 routesets enabled - **10,500**. The range of values for the *mtpdpcq* parameter is 500 to 10,000. The range of values for the *mtpxlq* parameter is 500 to 10,000.

2. If the DPC quantity or the exception list quantity is being changed, both the *mtpdpcq* and *mtpxlq* parameters do not have to be specified unless the resulting sum of the *mtpdpcq* and *mtpxlq* parameters would exceed the totals shown in Note 1.

For example, the current *mtpdpcq* value is 4000 and the current *mtpxlq* value is 1500, resulting in a sum of 5500, and only the 5000 Routes feature is on. To increase either value, both parameters must be specified and the sum of the new values cannot exceed 5500. If either value is being decreased, the other parameter can be specified as long as the sum of the values does not exceed 5500.

Activating the ITU National and International Spare Point Code Support Feature

This feature allows **ITU** international (**ITU-I**) and 14-bit **ITU** national (**ITU-N**) spare point codes to be provisioned in the database. To provision these point codes, the **ITU National and International Spare Point Code Support** feature must be enabled with the `enable-ctrl-feat` command. Turning this feature on with the `chg-ctrl-feat` command allows the **EAGLE** to route messages using **ITU-I** and 14-bit **ITU-N** spare point codes.

The `enable-ctrl-feat` command enables the **ITU National and International Spare Point Code Support** feature by inputting the feature's access key and the feature's part number with these parameters:

`: fak` – The feature access key provided by Oracle. The feature access key contains 13 alphanumeric characters and is not case sensitive.

`: partnum` – The Oracle-issued part number of the **ITU National and International Spare Point Code Support** feature, 893013601.

Once this feature is enabled, it is permanently enabled. This feature cannot be enabled with a temporary feature access key.

The `enable-ctrl-feat` command requires that the database contain a valid serial number for the **EAGLE**, and that this serial number is locked. This can be verified with the `rtrv-serial-num` command. The **EAGLE** is shipped with a serial number in the database, but the serial number is not locked. The serial number can be changed, if necessary, and locked once the **EAGLE** is on-site, with the `ent-serial-num` command. The `ent-serial-num` command uses these parameters.

`: serial` – The serial number assigned to the **EAGLE**. The serial number is not case sensitive.

`: lock` – Specifies whether or not the serial number is locked. This parameter has only one value, `yes`, which locks the serial number. Once the serial number is locked, it cannot be changed.

Note: To enter and lock the **EAGLE**'s serial number, the `ent-serial-num` command must be entered twice, once to add the correct serial number to the database with the `serial` parameter, then again with the `serial` and the `lock=yes` parameters to lock the serial number. You should verify that the serial number in the database is correct before locking the serial number. The serial number can be found on a label affixed to the control shelf (shelf 1100).

The `chg-ctrl-feat` command uses these parameters:

`: partnum` – The Oracle-issued part number of the **ITU National and International Spare Point Code Support** feature, 893013601.

`: status=on` – used to turn the **ITU National and International Spare Point Code Support** on.

The status of the controlled features in the **EAGLE** is shown with the `rtrv-ctrl-feat` command.

Once the **ITU National and International Spare Point Code Support** is enabled, **ITU-I** or 14-bit **ITU-N** spare point codes can be added to the **EAGLE**. To do this, perform these procedures to provision these database entities.

- To add spare point codes to the self identification of the **EAGLE** - [Adding a Point Code to the Self-Identification of the EAGLE](#) procedure
 - To change the self identification of the **EAGLE** to include spare point codes - [Changing the Self-Identification of the EAGLE](#) procedure.
 - To add spare point codes to the **DPC** table - [Adding a Destination Point Code](#) procedure.
 - To use spare point codes as the adjacent point code of a linkset - [Adding an SS7 Linkset](#) .
 - To add signaling links to the linkset - [Adding an SS7 Signaling Link](#) procedure.
 - To use spare point codes as the **DPC** of a route - Perform one of the “Adding a **Route**” procedures in [SS7 Configuration](#).
1. Display the controlled features in the database by entering the `rtrv-ctrl-feat` command.

This is an example of the possible output.

```
rlghncxa03w 07-05-28 11:43:04 GMT EAGLE5 37.0.0
The following features have been permanently enabled:
```

Feature Name	Partnum	Status	Quantity
SCCP Conversion	893012001	on	----
EIR	893012301	on	----
GSM Map Screening (GMS)	893013201	on	----
HC-MIM SLK Capacity	893012707	on	64

```
The following features have been temporarily enabled:
```

Feature Name	Partnum	Status	Quantity	Trial Period Left
Zero entries found.				

```
The following features have expired temporary keys:
```

Feature Name	Partnum
Zero entries found.	

If the **ITU National and International Spare Point Code Support** feature is enabled, the entry `Spare Point Code Support` is shown in the permanently enabled section of the `rtrv-ctrl-feat` output. If the status of the **ITU National and International Spare Point Code Support** feature is on, no further action can be performed.

If the **ITU National and International Spare Point Code Support** is enabled but not turned on (shown by the entry `off` in the `Status` column), continue the procedure with [7](#).

If the **ITU National and International Spare Point Code Support** is not enabled, continue the procedure with [2](#) .

2. Display the serial number in the database with the `rtrv-serial-num` command.

Note: If the `rtrv-ctrl-feat` output in 1 shows any controlled features, continue the procedure with 6. If the `rtrv-ctrl-feat` output shows only the **HC-MIMSLK Capacity** feature with a quantity of 64, 2 through 5 must be performed.

This is an example of the possible output.

```
rlghncxa03w 07-05-28 21:15:37 GMT EAGLE5 37.0.0
System serial number = nt00001231
```

System serial number is not locked.

```
rlghncxa03w 07-05-28 21:15:37 GMT EAGLE5 37.0.0
Command Completed
```

Note: If the serial number is correct and locked, continue the procedure with 6. If the serial number is correct but not locked, continue the procedure with 5. If the serial number is not correct, but is locked, this feature cannot be enabled and the remainder of this procedure cannot be performed. Contact the Customer Care Center to get an incorrect and locked serial number changed. Refer to [My Oracle Support \(MOS\)](#) for the contact information. The serial number can be found on a label affixed to the control shelf (shelf 1100).

3. Enter the correct serial number into the database using the `ent-serial-num` command with the `serial` parameter.

For this example, enter this command.

```
ent-serial-num:serial=<EAGLE's correct serial number>
```

When this command has successfully completed, the following message should appear.

```
rlghncxa03w 07-05-28 21:15:37 GMT EAGLE5 37.0.0
ENT-SERIAL-NUM: MASP A - COMPLTD
```

4. Verify that the serial number entered into 3 was entered correctly using the `rtrv-serial-num` command.

This is an example of the possible output.

```
rlghncxa03w 07-05-28 21:15:37 GMT EAGLE5 37.0.0
System serial number = nt00001231
```

System serial number is not locked.

```
rlghncxa03w 07-05-28 21:15:37 GMT EAGLE5 37.0.0
Command Completed
```

If the serial number was not entered correctly, repeat 3 and 4 and re-enter the correct serial number.

5. Lock the serial number in the database by entering the `ent-serial-num` command with the serial number shown in 2, if the serial number shown in 2 is

correct, or with the serial number shown in 4, if the serial number was changed in 3, and with the `lock=yes` parameter.

For this example, enter this command.

```
ent-serial-num:serial=<EAGLE's serial number>:lock=yes
```

When this command has successfully completed, the following message should appear.

```
rlghncxa03w 07-05-28 21:15:37 GMT EAGLE5 37.0.0
ENT-SERIAL-NUM: MASP A - COMPLTD
```

6. Enable the **ITU National and International Spare Point Code Support** feature by entering the `enable-ctrl-feat` command.

For this example, enter this command.

```
enable-ctrl-feat:partnum=893013601:fak=<ITU National and
International Spare Point Code Support feature access key>
```

Note: The values for the feature access key (the `fak` parameter) are provided by Oracle. If you do not have the feature access key for the **ITU National and International Spare Point Code Support** feature, contact your Oracle Sales Representative or Account Representative.

When the `enable-ctrl-feat` command has successfully completed, this message should appear.

```
rlghncxa03w 07-05-28 21:15:37 GMT EAGLE5 37.0.0
ENABLE-CTRL-FEAT: MASP A - COMPLTD
```

7. Turn the **ITU National and International Spare Point Code Support** feature on by entering the `chg-ctrl-feat` command with the part number used in 6 and the `status=on` parameter.

Caution: Once the **ITU National and International Spare Point Code Support** feature is turned on, it cannot be turned off.

For this example, enter this command.

```
chg-ctrl-feat:partnum=893013601:status=on
```

When this command has successfully completed, the following message should appear.

```
rlghncxa03w 07-05-28 21:15:37 GMT EAGLE5 37.0.0
CHG-CTRL-FEAT: MASP A - COMPLTD
```

8. Verify the changes by entering the `rtrv-ctrl-feat` command.

This is an example of the possible output.

```
rlghncxa03w 07-05-28 21:15:37 GMT EAGLE5 37.0.0
The following features have been permanently enabled:
```

```

Feature Name          Partnum  Status Quantity
Spare Point Code Support  893013601 on    ----
    
```

The following features have been temporarily enabled:

```

Feature Name          Partnum  Status Quantity  Trial Period Left
Zero entries found.
    
```

The following features have expired temporary keys:

```

Feature Name          Partnum
Zero entries found.
    
```

9. Back up the new changes, using the `chg-db:action=backup:dest=fixed` command.

These messages should appear; the active **Maintenance and Administration Subsystem Processor (MASP)** appears first.

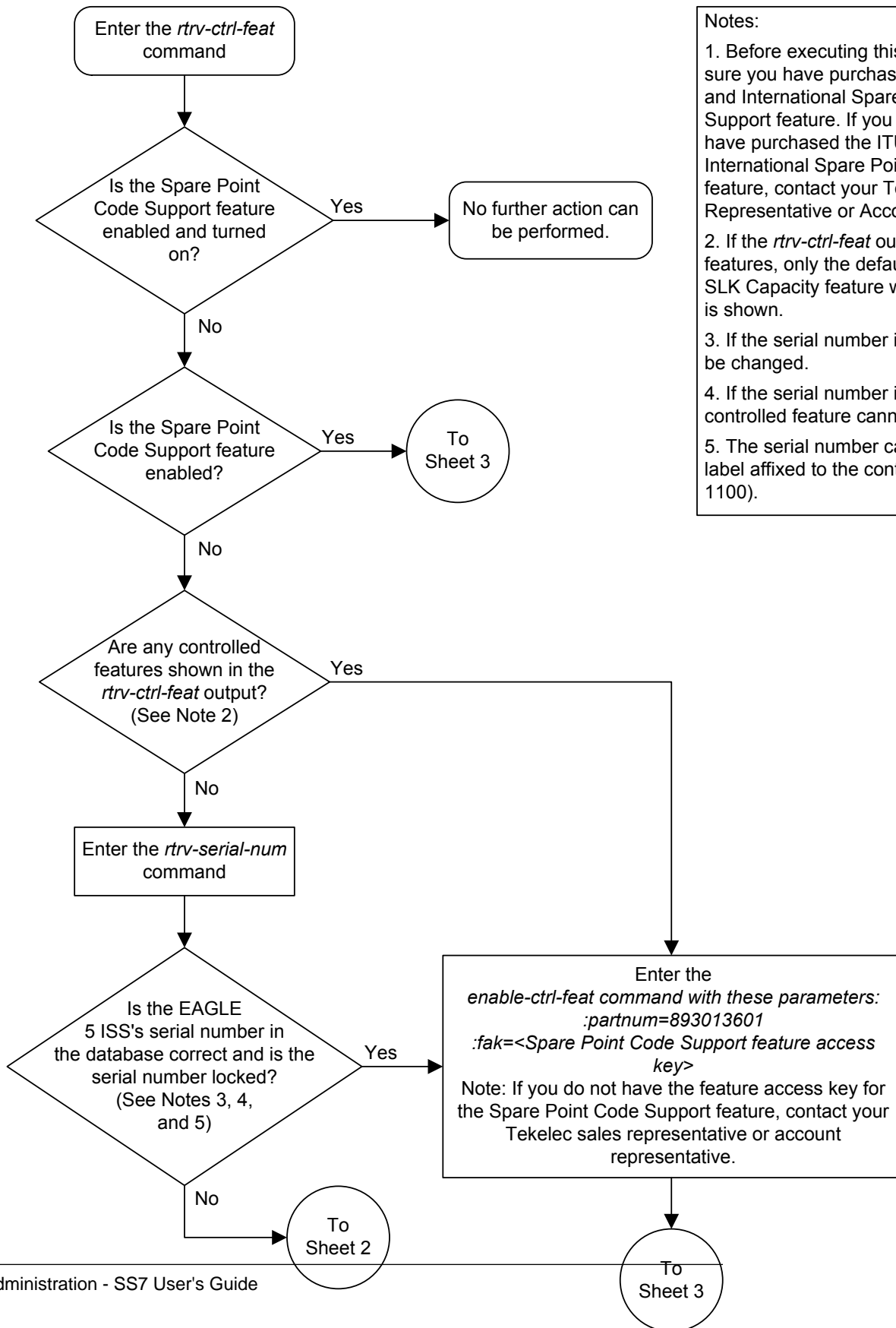
```

BACKUP (FIXED): MASP A - Backup starts on active MASP.
BACKUP (FIXED): MASP A - Backup on active MASP to fixed disk complete.
BACKUP (FIXED): MASP A - Backup starts on standby MASP.
BACKUP (FIXED): MASP A - Backup on standby MASP to fixed disk complete.
    
```

10. To begin adding ITU-I or 14-bit ITU-N spare point codes, perform the [Adding a Point Code to the Self-Identification of the EAGLE](#) procedure.

Note: Before executing this procedure, make sure you have purchased the ITU National and International Spare Point Code Support feature. If you are not sure if you have purchased the ITU National and International Spare Point Code Support feature, contact your Oracle Sales Representative or Account Representative.

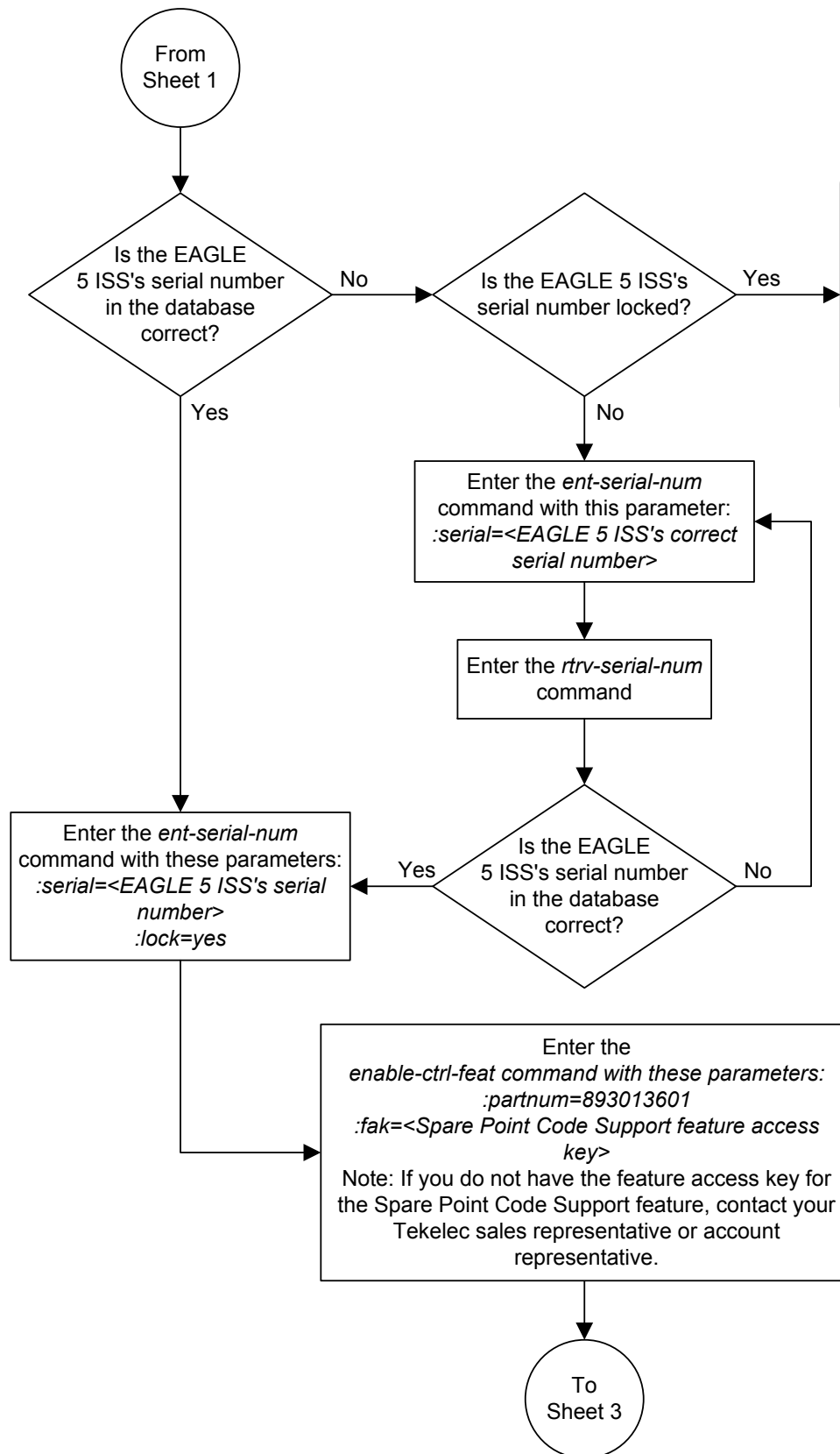
Figure 2-9 Activating the ITU National and International Spare Point Code Support Feature



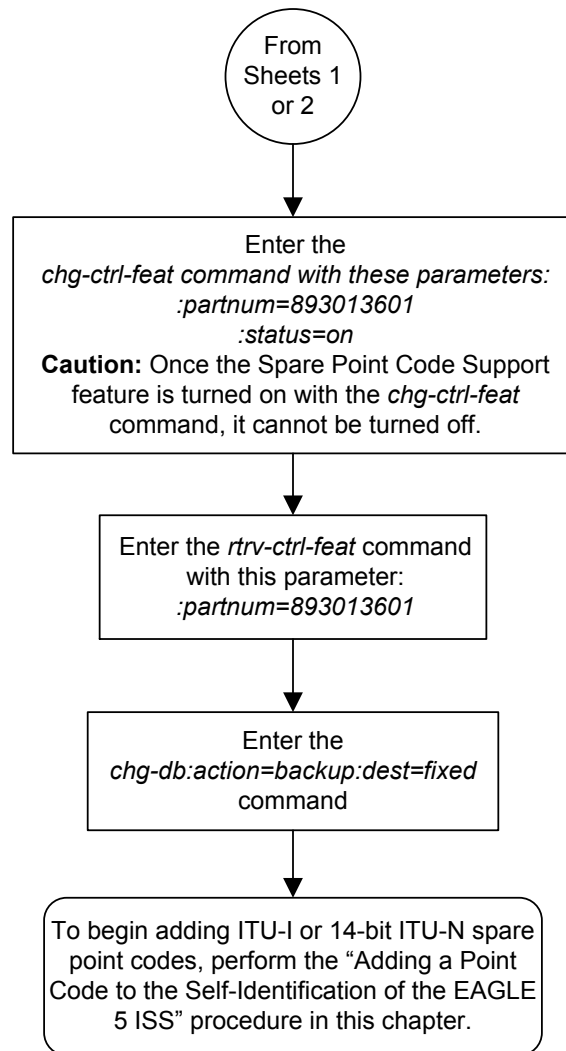
Notes:

1. Before executing this procedure, ensure you have purchased the ITU National and International Spare Point Code Support feature. If you have not purchased the ITU National and International Spare Point Code Support feature, contact your Tekelec sales representative or account representative.
2. If the *rtv-ctrl-feat* output shows any controlled features, only the default SLK Capacity feature will be shown.
3. If the serial number is incorrect, it must be changed.
4. If the serial number is a controlled feature, it cannot be changed.
5. The serial number can be found on the label affixed to the controller (part number 1100).

Sheet 1 of 3



Sheet 2 of 3



Spare Point Code Feature Migration Plan

This section describes how to migrate a signaling network that uses the Duplicate Point Code feature to support a National Spare network to a signaling network that uses the ITU National and International Spare Point Code Support feature to support a National Spare network

Terminology

The term “enabled” refers to entering the `enable-ctrl-feat` command to provision the ITU National and International Spare Point Code Support feature.

The term “turn on” refers to entering the `chg-ctrl-feat` command to change the ITU National and International Spare Point Code Support feature status to on. After this feature is turned on, all MSU processing is performed using the ITU National and International Spare Point Code Support feature rules.

APC refers to the adjacent point code of a linkset. The APC is the point code of the adjacent node to which messages are routed. The APC can be one of these types of point codes:

- ANSI point code
- ITU-International point code
- ITU-International spare point code
- 14-bit ITU-National point code
- 14-bit ITU-National spare point code
- 24-bit ITU-National point code.

For more information on these point code types, see the [Point Code Formats](#) section.

SAPC refers to the secondary adjacent point code that is assigned to a linkset. For more information on secondary adjacent point codes, see the [Configuring an ITU Linkset with a Secondary Adjacent Point Code \(SAPC\)](#) procedure.

National traffic refers to traffic whose messages contain the national network indicator value 2 ($NI=10_{\text{binary}}$).

National Spare traffic refers to traffic whose messages contain the national spare network indicator value 3 ($NI=11_{\text{binary}}$).

Assumptions

The examples used to illustrate the migration process use these assumptions.

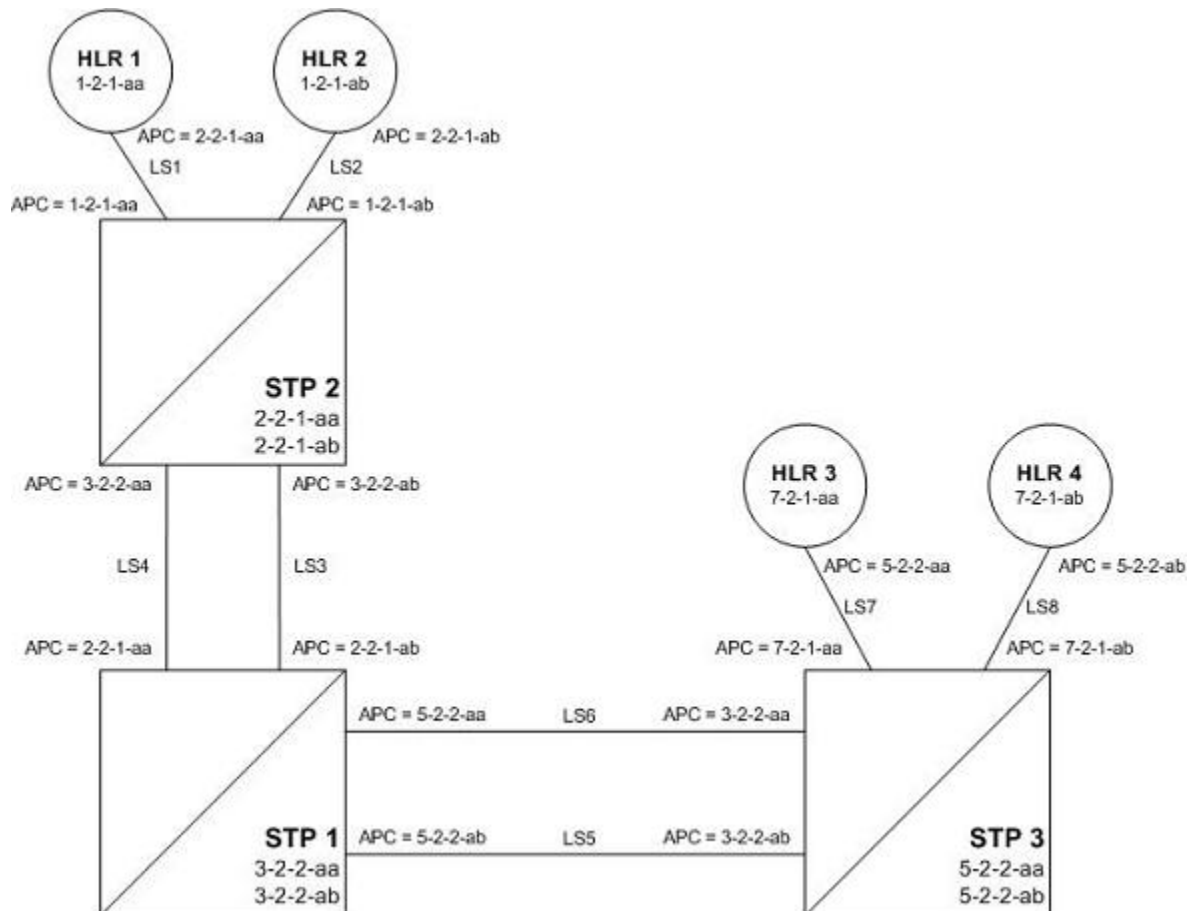
- The group code aa is assigned to the point codes that are assigned to the nodes handling messages that contain the national network indicator value 2 ($NI=10_{\text{binary}}$).
- The group code ab is assigned to the point codes that are assigned to the nodes handling messages that contain the national spare network indicator value 3 ($NI=11_{\text{binary}}$).
- Only two nodes support the duplicate point code feature: STP 1 and STP 2.

- Between pairs of nodes, separate linksets exist for group aa and group ab. In this case, separate linksets exist between STP 1 and STP 2.
- The nodes are migrated to the ITU National and International Spare Point Code Support feature, one at a time, in three stages.
 - Stage one involves upgrading all the nodes to the new software load, enabling the ITU National and International Spare Point Code Support feature for provisioning, and provisioning each node with the required point codes and routes.
 - Stage two involves turning on the ITU National and International Spare Point Code Support feature on an adjacent pair of EAGLEs, one pair of nodes at a time, and changing the routing between these EAGLEs to use a single linkset.
 - Stage three removes the components that are no longer needed after the migration has been completed.
- After the migration process is complete, a single linkset will remain between pairs of nodes. Each linkset will carry both National and National Spare traffic.
- A third linkset containing high-speed signaling links will be created to support both the National and National Spare traffic. The other two linksets will be removed later.
- Prior to merging both National and National Spare traffic for an adjacent pair of nodes onto a single linkset, the customer and Oracle will need to determine whether more links must be added to the linkset to support the higher traffic volume. If the linkset has already reached its limit of 16 links, and more links are required, the customer and Oracle will decide whether the customer must deploy high-speed signaling links.
- The `nis` parameter value for all linksets whose point code suffix is ab is set to on.
- After an EAGLE has been upgraded to the ITU National and International Spare Point Code Support feature, the point codes that will be assigned to these nodes will have to be provisioned with the same group codes that are currently assigned to these nodes.
- The routes for the National Spare traffic must be provisioned before the ITU National and International Spare Point Code Support feature is turned on for a node.
- The customer should not lose any traffic during the migration.

Figure 2-10 shows an example network that is not using the ITU National and International Spare Point Code Support feature.

Note: For the figures shown in this section, a point code that is prefaced with “s” indicates a spare point code, and a point code that is not prefaced with an “s” indicates a non-spare point code. If a linkset includes an APC (adjacent point code) or SAPC that is prefaced with “s,” the linkset supports traffic to and from ITU-National spare point codes. If the linkset includes an APC or SAPC that is not prefaced with “s,” the linkset supports traffic to and from ITU-National point codes. A linkset that includes both ITU-National and ITU-National spare APC and SAPCs supports both national and national spare traffic. Point codes that are labeled within the STP nodes represent true and secondary EAGLE point codes.

Figure 2-10 Example of an Existing Network that is not using the ITU National and International Spare Point Code Support Feature



Stage One

Figure 2-11 shows an example network. The items shown in bold are items that are added during this stage of the migration procedure.

The following steps are performed for each node shown in Figure 2-11, one at a time, as part of this stage of the migration procedure.

1. Upgrade each EAGLE shown in Figure 2-11 to the software release that contains the ITU National and International Spare Point Code Support feature by performing the appropriate upgrade procedure.

2. Enable the ITU National and International Spare Point Code Support feature on each EAGLE shown in [Figure 2-11](#), by performing the [Activating the ITU National and International Spare Point Code Support Feature](#) procedure. Do not turn the feature on at this time.

Note: Provisioning for the ITU National and International Spare Point Code Support feature can be performed once the feature is enabled. Message processing based on this feature is not performed until the feature is turned on.

3. Add a new true ITU-National spare point code in the self identification table of each EAGLE by performing the [Adding a Point Code to the Self-Identification of the EAGLE](#) procedure at each EAGLE. For example, add these point codes:
 - Point code s-3-2-2-ab to STP 1
 - Point code s-2-2-1-ab to STP 2
 - Point code s-5-2-2-ab to STP 3.
4. Add one secondary ITU-National spare point code to each EAGLE by performing the [Adding a Secondary Point Code](#) procedure. For example, add these point codes:
 - Point code s-0-0-1-ab to STP 2
 - Point code s-0-0-2-ab to STP 1
 - Point code s-0-0-3-ab to STP 3.
5. Add a secondary adjacent ITU-National spare point code (SAPC) to the linksets whose APCs have the “ab” suffix by performing the [Configuring an ITU Linkset with a Secondary Adjacent Point Code \(SAPC\)](#) procedure. For example, add these secondary adjacent point codes:
 - SAPC s-0-0-1-ab for linkset LS3 in STP 1
 - SAPC s-0-0-2-ab for linkset LS3 in STP 2
 - SAPC s-5-2-2-ab for linkset LS5 in STP 1
 - SAPC s-3-2-2-ab for linkset LS5 in STP 3
 - SAPC s-1-2-1-ab for linkset LS2 in STP 2
 - SAPC s-7-2-1-ab for linkset LS8 in STP 3.

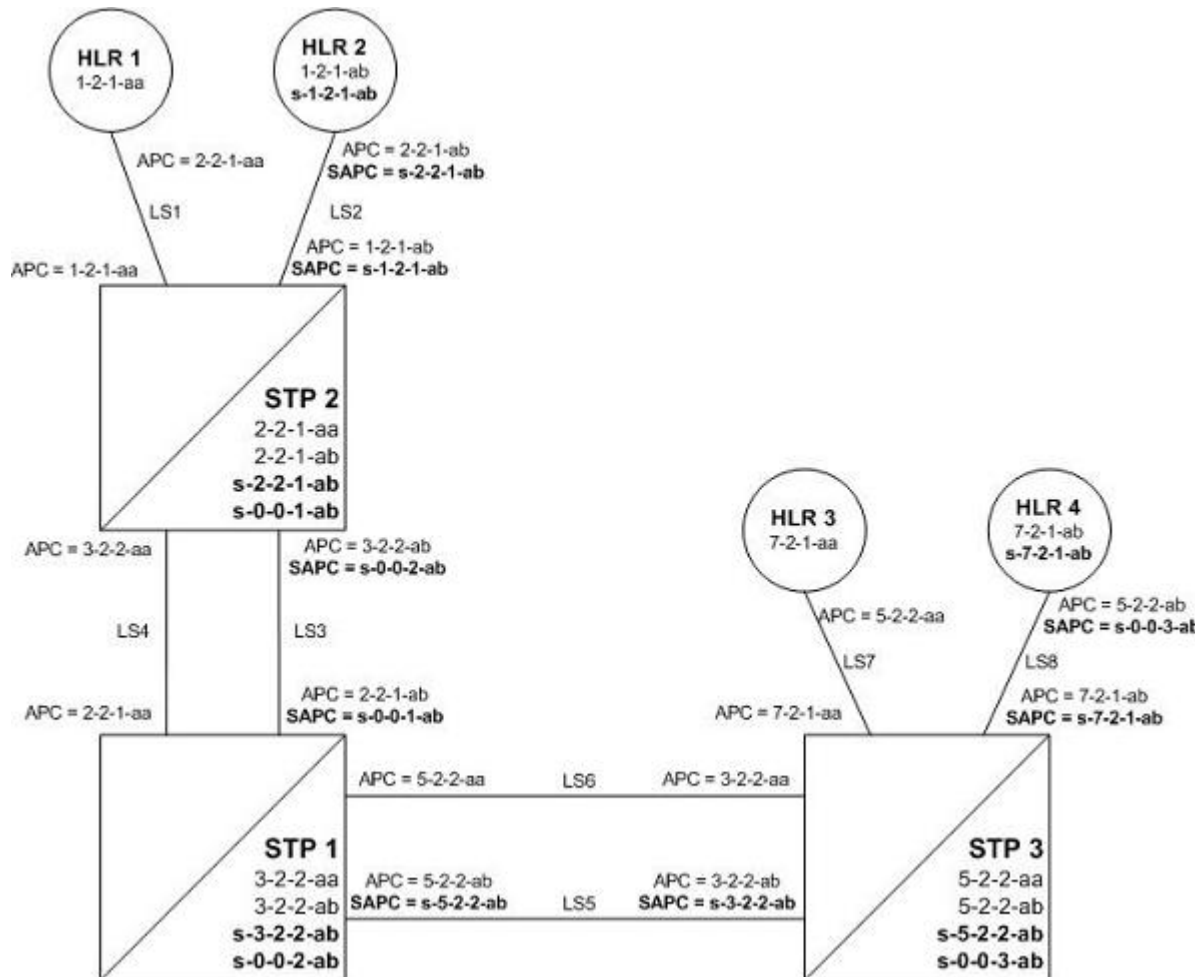
This provisioning must be done before National Spare traffic can be routed over the linksets whose APCs have the “ab” suffix using the ITU National and International Spare Point Code Support feature. As a result of this provisioning, linksets LS2, LS3, LS5, and LS8 can support traffic to and from ITU-National spare point codes as well as ITU-National point codes.

6. Provision the routes for the ITU-National spare point codes provisioned in step 5 by performing one of these procedures as required.
 - [Adding a Route Containing an SS7 DPC](#)

- [Adding a Route Containing an IPGWx Linkset](#)

For example, provision a route to point code s-1-2-1-ab on LS3 at STP 1.

Figure 2-11 Stage One - ITU National and International Spare Point Code Support Feature Provisioned on All Nodes



After Stage One has been completed, as indicated in [Figure 2-11](#), linksets LS2, LS3, LS5, and LS8 are capable of supporting traffic to and from both ITU-National and ITU-National spare point codes. Routing decisions, however, are still made using the Duplicate Point Code rules, as the ITU National and International Spare Point Code Support feature has not been turned on.

Stage Two

After stage one is completed for all nodes, the network continues to have the same linksets that it had before this process was started. The same messages are routed over the same linksets, except the new feature is used for routing on select adjacent nodes (STP 1 and STP 2 in this example). This is shown in [Figure 2-12](#) when the feature is turned on for STP 1 and STP 2. Items in bold are added during this stage.

1. Turn on MSU processing on STP 1 by turning on the ITU National and International Spare Point Code Support feature. Perform the [Activating the ITU National and International Spare Point Code Support Feature](#) procedure on STP 1 to turn the spare point code feature on.

At this point, messages arriving at STP 1 with the DPC 1-2-1-aa that contain the national spare network indicator value 3 (NI=11_{binary}) are routed using linkset LS3 with the new route provisioned in step 6 of Stage One of this procedure (point code s-1-2-1-ab on LS3 at STP 1).

Messages arriving with DPC 1-2-1-ab that contain the national network indicator value 2 (NI=10_{binary}) will continue to be routed using linkset LS4.

Since the ITU National and International Spare Point Code Support feature has not been turned on for STP 2 and STP 3, these nodes continue to route traffic according to the Duplicate Point Code feature rules.

2. Turn on MSU processing on STP 2 by turning on the ITU National and International Spare Point Code Support feature. Perform the [Activating the ITU National and International Spare Point Code Support Feature](#) procedure on STP 2 to turn the spare point code feature on.

At this point, messages arriving at STP 2 with DPC 7-2-1-ab that contain the national spare network indicator value 3 (NI=11_{binary}) are routed using linkset LS5 with the new route provisioned in step 6 of Stage One of this procedure (point code s-7-2-1-ab on LS5 at STP 2).

Messages arriving with DPC 7-2-1-aa that contain the national network indicator value 2 (NI=10_{binary}) will continue to be routed using linkset LS6.

3. Set the `nis` parameter value for linkset LS3 to `off` by performing [Changing an SS7 Linkset](#).
4. Create secondary ITU-National point code 2-2-2-aa on STP 2 and secondary ITU-National point code 3-2-3-aa on STP 1 by performing the [Adding a Secondary Point Code](#) procedure on STP 1 and STP 2.
5. Create a third linkset, LS9, that contains high-speed signaling links with these APC and SAPC values:
 - The APC for linkset LS9 on STP 2 is 3-2-3-aa
 - The APC for linkset LS9 on STP 1 is 2-2-2-aa
 - The SAPC for linkset LS9 on STP 2 is s-3-2-2-ab
 - The SAPC for linkset LS9 on STP 1 is s-2-2-1-ab.

Create linkset LS9 by performing one of these procedures as required:

- [Adding an SS7 Linkset](#)
- "Configuring an IPGWx Linkset" in *Database Administration - IP7 User's Guide*.
- "Adding an IPSG M2PA Linkset" in *Database Administration - IP7 User's Guide*.
- "Adding an IPSG M3UA Linkset" in *Database Administration - IP7 User's Guide*.

The traffic from linksets LS3 and LS4 will be merged onto linkset LS9. Linkset LS9 will be the only linkset that will remain between STP 1 and STP 2 after the migration is complete.

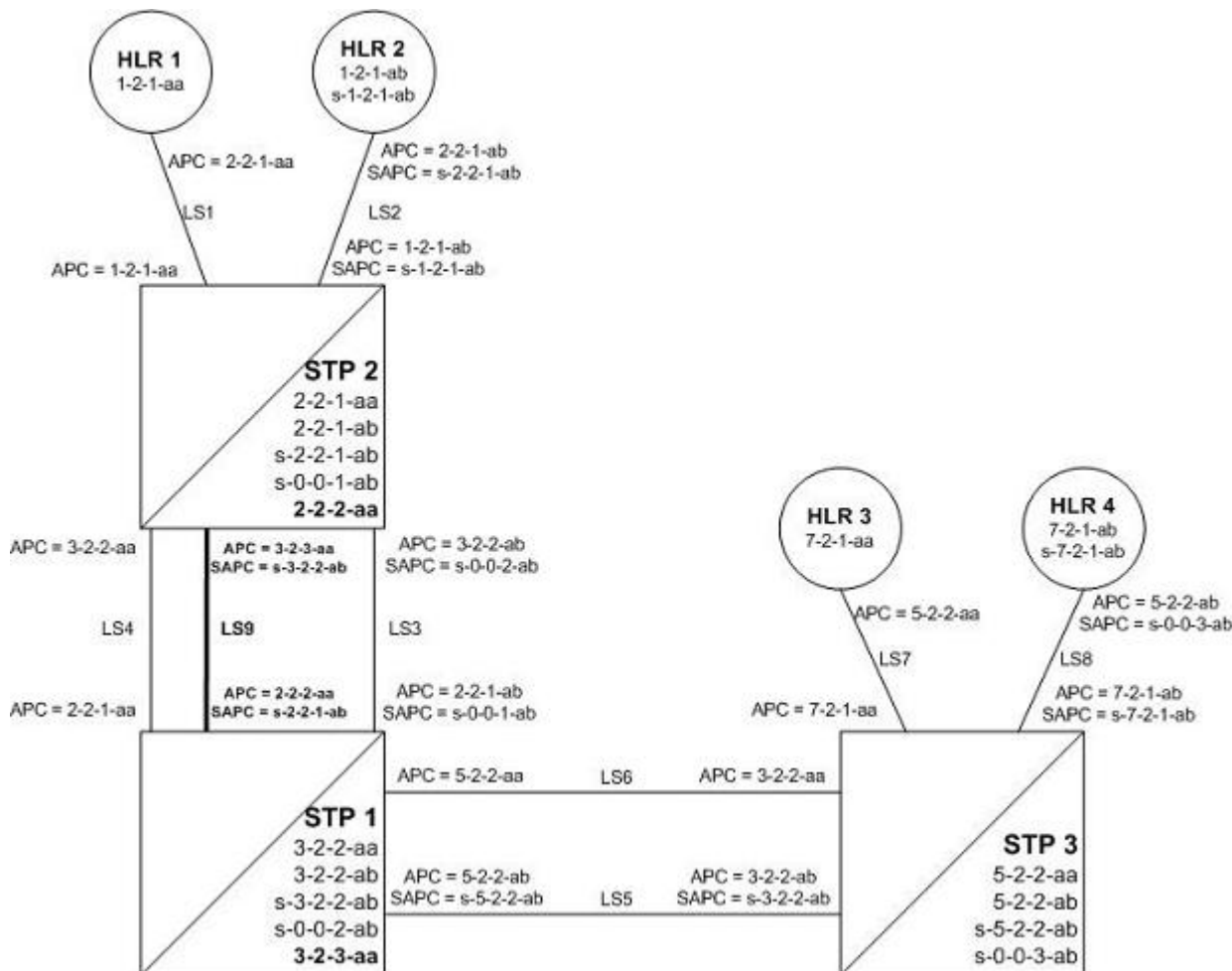
6. Provision linkset LS9 to use high-speed signaling links by performing one of these procedures as required:
 - [Adding an ATM High-Speed Signaling Link](#)

- "Adding an IPLIMx Signaling Link" procedure in *Database Administration - IP7 User's Guide*
- "Adding an IPGWx Signaling Link procedure in *Database Administration - IP7 User's Guide*
- "Adding an IPGS M2PA Signaling Link" in *Database Administration - IP7 User's Guide*.
- "Adding an IPGS M3UA Signaling Link" in *Database Administration - IP7 User's Guide*.

Make sure that enough slots are available to support these cards.

7. Change the routes on STP 1 to s-1-2-1-ab and 1-2-1-aa so that all National and National Spare traffic uses linkset LS9 by performing the [Changing a Route](#) procedure. At this point, incoming National Spare traffic to STP 1 still uses linkset LS3, and incoming National Spare traffic to STP 1 still uses linkset LS4 until the routes on STP 2 are changed so that all National and National Spare traffic uses linkset LS9.
8. Provision routes on the adjacent nodes to include the new true and secondary point codes that were added to STP 1 and STP 2. Perform one of these procedures as required.
 - [Adding a Route Containing an SS7 DPC](#)
 - [Adding a Route Containing an IPGWx Linkset](#).

All traffic (National and National Spare) should now be flowing on linkset LS9.

Figure 2-12 Stage Two - All Traffic Merged onto a Third Linkset

In Figure 2-12, all traffic between STP 1 and STP 2 is routed over linkset LS9, using the national spare network indicator value 3 (NI=11_{binary}) and the national network indicator value 2 (NI=10_{binary}) to select the route. Note that linkset LS3 and linkset LS4 are not being used.

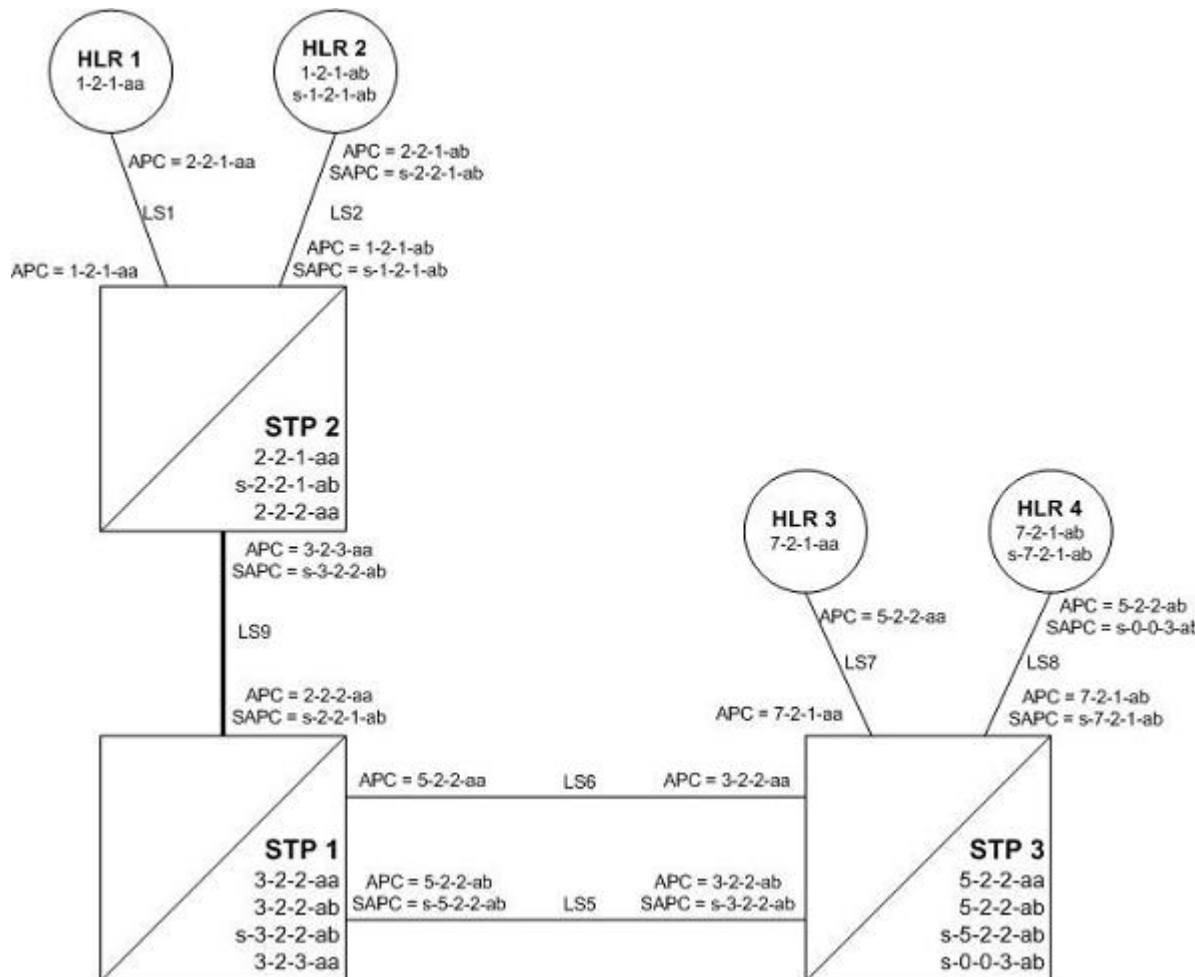
Stage Three - Removing Unused Components

The unused components that resulted from the migration need to be removed.

1. Perform the [Removing a Linkset Containing SS7 Signaling Links](#) procedure to remove the unused linksets. For this example, remove linksets LS3 and LS4.
2. Perform the [Removing a Destination Point Code](#) procedure to remove the point codes that were the APCs of the unused linksets. For this example, remove point codes 3-2-2-aa and 3-2-2-ab from STP 2, and 2-2-1-aa and 2-2-1-ab from STP 1.
3. Perform the [Removing a Secondary Point Code](#) procedure to remove the unused secondary point codes. For this example, remove secondary point codes s-0-0-1-ab from STP 2 and s-0-0-2-ab from STP 1.
4. Perform the [Changing the Self-Identification of the EAGLE](#) procedure to remove any unused true point codes. For this example, remove point code 2-2-1-ab from STP 2.

At this point, after all affected linksets have been merged, the situation looks like [Figure 2-13](#). Both National and National Spare traffic between STP 2 and STP 1 are sent over linkset LS9. Traffic between STP 1 and STP 3 continues to route over linkset LS6 for ITU-National point code/group code aa and over linkset LS5 for ITU-National spare point code/group code ab. This is because the ITU National and International Spare Point Code Support feature has been turned on for STP 1 but not for STP 3, so the routes have not been changed between STP 1 and STP 3.

Figure 2-13 Stage Three - All Traffic Merged onto Linkset LS9



Multiple Point Code Support

Currently, the EAGLE supports six true point codes:

- ANSI point code
- ITU international point code
- ITU international spare point code
- 14-bit ITU national point code
- 14-bit ITU national spare point code
- 24-bit ITU national point code.

Note: The ITU national point code can be either 14-bit ITU national - spare and non-spare - or 24-bit ITU national. Both 14-bit ITU national and 24-bit national point codes cannot be present in the **EAGLE** at the same time.

In addition, the **EAGLE** supports up to 96 capability point codes, each of which can be designated as either **ANSI**, **ITU-I** (spare and non-spare), 14-bit **ITU-N** (spare and non-spare), or 24-bit **ITU-N**. Each capability point code defined on an **EAGLE** node can be used for routing messages to that node. For various reasons, customers might need the **EAGLE** to support more than one true point code in a particular domain.

There are three main reasons driving this feature:

- Some customers desire to collapse multiple existing **STP**'s into one **EAGLE**. This can present problems in that end offices and other nodes may not be controlled by the carrier making reprovisioning of these network elements difficult. **Multiple Point Code (MPC)** support is designed to allow the **EAGLE** to assume more than one point code for **SS7** routing. **MPC** support is different in concept from capability point codes in that provisioning and routing will use secondary point codes as if they were the actual point code of the **EAGLE**.
- Several customers in the international market want to deploy a single **STP** pair in multiple national (**ITU-N**) networks. This may not be possible without the **MPC** feature, as these operators are often forced to use a unique point code assigned by each national regulator of these target countries.
- Customers may require additional links between two nodes beyond the number of links permitted by the protocol. For example, the maximum number of links between two nodes in an **ITU** network is 16. The **MPC** feature can allow for additional linksets between these nodes, increasing the number of links that can be used.

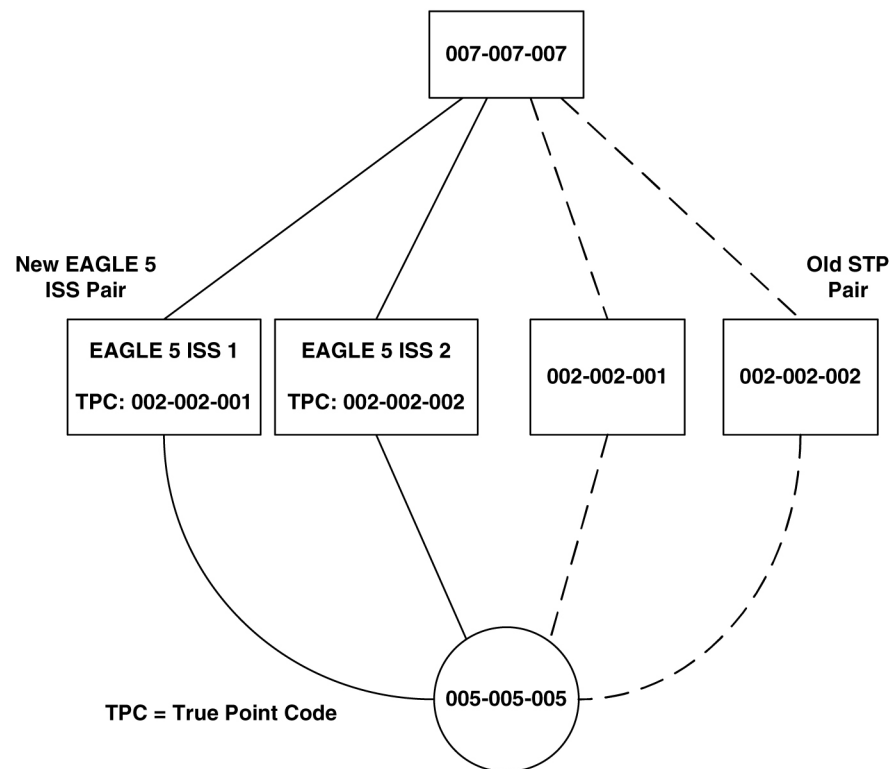
This feature adds the ability to support Secondary Point Codes (**SPCs**) in addition to the true point codes used by the **EAGLE** in any of the three domains **ANSI**, **ITU-N** (14-bit or 24-bit) and **ITU-I**. Secondary point codes are used by provisioning and routing as if they are the true point code of the **EAGLE**. **SPCs** are supported for any type of link (A, B, C, D, etc.). There is no effect on provisioning capability point codes as a result of this feature.

In addition to the one **True Point Code (TPC)** already supported for each of the **ANSI**, **ITU-N** (14-bit or 24-bit) and **ITU-I** domains, the **EAGLE** support a pool of 40 Secondary Point Codes (**SPC**), each of which may be assigned as either **ANSI**, **ITU-I**, 14-bit **ITU-N**, or 24-bit **ITU-N** (not to exceed a total of 40 in one **EAGLE**). **SPCs** can be used in the same ways that true **PCs** are used.

Replacing Two STP Pairs with One Pair

The following example shows how an **EAGLE** pair can replace two existing **STP** pairs. In this example, each **EAGLE** in the pair uses one true point code and one secondary point code.

As shown in [Figure 2-14](#), a new **EAGLE** first replaces one existing **STP** pair. In this case, **EAGLE**'s true point code is set to the true point code of the old **STP**. The adjacent nodes are cut over to the **EAGLE** pair. The adjacent nodes do not need to be reconfigured.

Figure 2-14 Replacing the First STP Pair

Next, a second **STP** pair is replaced with the **EAGLE** pair. As shown in [Figure 2-15](#), an **SSP** and an **STP** are being “re-homed” from an old **STP** pair to a new **EAGLE** pair. In this example, the **STP** (003-003-003) is reconfigured with new routes to recognize that it is now connected to **EAGLE** 1 and **EAGLE** 2 instead of 001-001-001 and 001-001-002. **STP** 003-003-003, if not an **EAGLE** with Multiple Point Codes, may not be able to support more than one linkset to the same point code. See [Multiple Linksets between Two Nodes](#) section for a description of this capability. The interconnecting device (**STP** or **SSP**) can use either the **TPC** or **SPC** as the device requires.

At **EAGLE** 1, the user would configure the secondary point code 001-001-001, using the `ent-spc` command. The user would also configure a route to 001-001-002 over the C-linkset. The user would then configure point code 004-004-004 in the **EAGLE**'s database to indicate that this point code uses the secondary point code 001-001-001, instead of the **EAGLE**'s true point code (`chg-dstn:dpc=004-004-004:spc=001-001-001`). This last step would be repeated for all other adjacent **SSPs** and **SCPs** that are re-homed from the old **STP** Pair to the new **EAGLE** Pair.

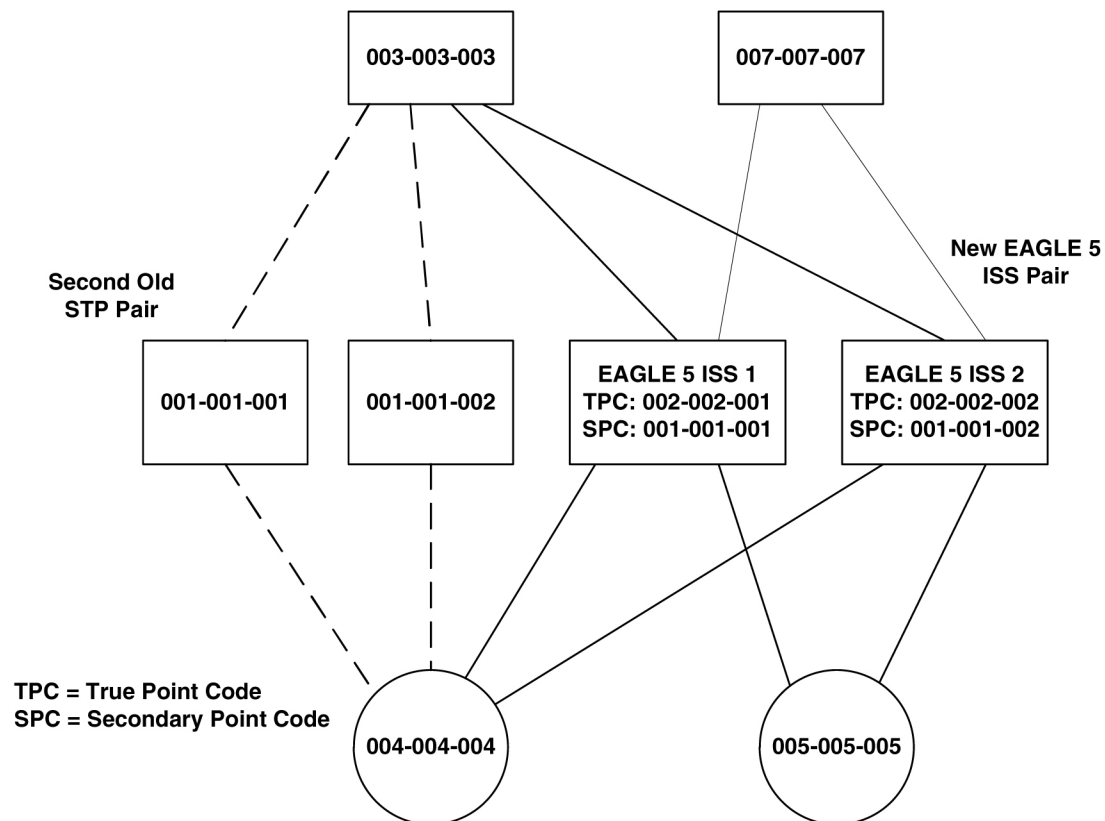
Similarly, at **EAGLE** 2, the user would configure the secondary point code 001-001-002, and configure a route over the C-link to 001-001-001. The user would also configure point code 004-004-004 in **EAGLE** 2's database to indicate that this point code uses the secondary point code 001-001-002, instead of the **EAGLE**'s true point code.

When **EAGLE** 1 receives a message from the **SSP** destined for 001-001-001, the **EAGLE** 5 **ISS** processes the message as if the message was sent to the **EAGLE**'s true point code.

When **EAGLE** 1 generates a message (for example, network management, link test messages, or **GTT** messages) that is destined for 004-004-004, **EAGLE** 1 puts the **OPC** 001-001-001 in the message. When **EAGLE** 5 **ISS** 1 generates a message that is destined for 003-003-003 or 005-005-005, it puts the **OPC** 002-002-001 in the message. When

EAGLE 1 generates **GTT** and **SCMG** messages that are destined for non-adjacent point codes, it includes the **OPC 002-002-001** in the message.

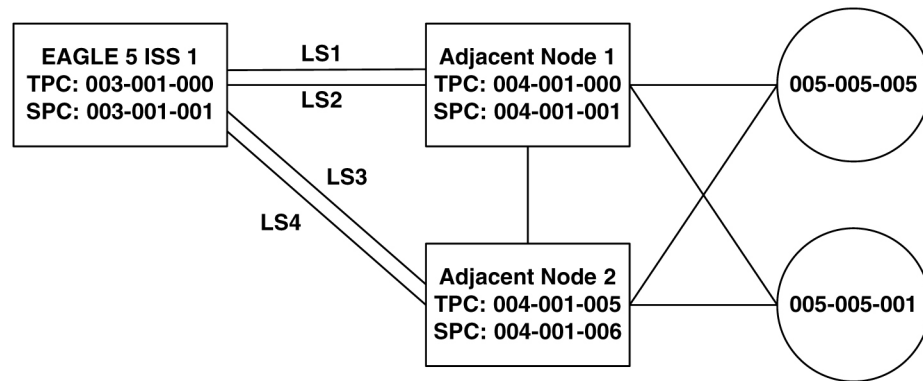
Figure 2-15 Replacing a Second STP Pair



Multiple Linksets between Two Nodes

With this feature, it is possible to configure multiple linksets between two nodes, if the adjacent node also supports Multiple Point Codes. The EAGLE continues to enforce the rule that each linkset must have a different adjacent point code.

One reason for provisioning multiple linksets between two nodes is to increase the number of links that can be configured between STP pairs. For example, in [Figure 2-16](#), the EAGLE is connected to an STP pair that supports multiple point codes. Without this feature, only 16 ITU links can be configured between the EAGLE and the STP pair (8 links in LS1 and 8 links in LS2). In this example, two linksets are added, increasing the number of links to 32 (8 links in each of LS1, LS2, LS3, and LS4).

Figure 2-16 Multiple Linkset Example

In this example, the adjacent point code (APC) for **LS1** is 4-1-0 and the APC for **LS2** is 4-1-1. 4-1-1 is assigned an **SPC** of 3-1-1. So adjacent, Adj Node1 sees **LS1** as having an **APC** of 3-1-0, and **LS2** as having an **APC** of 3-1-1.

To load balance over these 4 linksets, half the destinations that use the **STP** pair can be assigned **LS1** and **LS3** as a combined linkset. The other half of the destinations can be assigned **LS2** and **LS4** as a combined linkset.

The commands to provision **EAGLE1** for the network shown in [Figure 2-16](#) are:

```

chg-sid:pc=3-1-0
ent-spc=3-1-1
ent-dstn:dpc=4-1-0
ent-dstn:dpc=4-1-1:spc=3-1-1
ent-dstn:dpc=4-1-5
ent-dstn:dpc=4-1-6:spc=3-1-1
ent-dstn:dpc=5-5-1
ent-dstn:dpc=5-5-5
ent-ls:lsn=ls1:apc=4-1-0
ent-ls:lsn=ls2:apc=4-1-1
ent-ls:lsn=ls3:apc=4-1-5
ent-ls:lsn=ls4:apc=4-1-6
ent-rte:dpc=4-1-0:lsn=ls1:rc=10
ent-rte:dpc=4-1-1:lsn=ls2:rc=10
ent-rte:dpc=4-1-5:lsn=ls3:rc=10
ent-rte:dpc=4-1-6:lsn=ls4:rc=10
ent-rte:dpc=5-5-1:lsn=ls1:rc=10
ent-rte:dpc=5-5-1:lsn=ls3:rc=10
ent-rte:dpc=5-5-5:lsn=ls2:rc=10
ent-rte:dpc=5-5-5:lsn=ls4:rc=10
  
```

Local Number Portability

Note: Local number portability supports only **ANSI** point codes.

The **EAGLE** allows only the true point code to be entered into the mated application table. Also, the **EAGLE** continues to allow the user to enter translations to the true point code. However, the **EAGLE** does not allow the user to enter translation to a secondary point code.

If a node sends a `rt-on-gt` query, the node should set the query's **DPC** to the **EAGLE**'s capability point code. If a node sends an `rt-on-ssn` query, the node should set the query's **DPC** to the true point code or secondary point code used by that node. If the node has a secondary point code, then the query's **DPC** is set to the secondary point code. If the node does not have a secondary point code, then the query's **DPC** is set to the true point code.

rt-on-gt Queries from a Node That Uses Secondary Point Codes

Nodes that send `rt-on-gt` queries should use the capability point code, regardless of whether these nodes use a true or a secondary point code.

1. The node sends a query containing this information:
 - The **DPC** is the capability point code of the **EAGLE**'s **LNP** subsystem.
 - The routing indicator in the called party address is **GT**.
 - The point code in the calling party address is the node's point code.
2. The result of the translation contains this information:
 - The **DPC** is the **EAGLE**'s true point code.
 - The routing indicator in the called party address is **SSN**.
 - The subsystem number in the calling party address is the **LNP** subsystem number.
3. The **LNP** subsystem sends a reply with this information:
 - The **DPC** is the calling party address' point code.
 - The **OPC** is the **EAGLE**'s secondary point code.
 - The routing indicator in the called party address is **SSN**.

In this case, if the local subsystem fails or is taken offline, the **EAGLE** sends a response method **TFP** containing this information:

- The **DPC** is the node's point code.
- The **OPC** is the **EAGLE**'s secondary point code.
- The concerned point code is the **EAGLE**'s capability point code.

This **TFP** causes the node to divert traffic to the mate.

If a node sends an `rt-on-gt` query to either the **EAGLE**'s true point code or a secondary point code, the **EAGLE** cannot divert traffic to the mate. In this case, the

EAGLE does not send a **TFP** concerning the secondary point code or the true point code, so the node will not divert traffic to the mate.

rt-on-ssn queries from a Node That Uses Secondary Point Codes

It is possible that nodes using a secondary point code will send `rt-on-ssn` queries. In this case, these nodes should send the queries to the secondary point code. The **EAGLE** will accept `rt-on-ssn` queries from these nodes if the **DPC** is the true point code or a secondary point code. However, **SCCP** management will not work correctly if the `rt-on-ssn` queries do not use the true point code or a secondary point code associated with the sending node.

1. Nodes send queries to the **EAGLE** with this information:
 - The **DPC** is the **EAGLE**'s secondary point code.
 - The routing indicator in the called party address is **SSN**.
 - The subsystem number in the called party address is the **LNP** subsystem number.
 - The subsystem number is the **LNP** subsystem number.
 - The point code in the calling party address is the node's point code.
2. The **LNP** subsystem sends a reply with this information:
 - The **DPC** is the point code in the calling party address.
 - The **OPC** is the secondary point code.
 - The routing indicator in the called party address is **SSN**.
 - The point code in the calling party address is the secondary point code.

In this case, if the **EAGLE**'s **LNP** subsystem fails or is taken offline, the **EAGLE** broadcasts an **SSP** (assuming that the node is in the concerned point code group) with this information:

- The **DPC** is the node's point code.
- The **OPC** is the secondary point code.
- The affected point code is the secondary point code.
- The affected subsystem number is the **LNP** subsystem number.

Limitations

The same adjacent point code cannot be used for two different links.

Local **EAGLE** subsystems (for example, **LNP**) must use the **True Point Code**.

Adding a Secondary Point Code

This procedure is used to add a secondary point code to the database using the `ent-spc` command.

The `ent-spc` command uses only one parameter: `spc/spca/spci/spcn/spcn24` – the secondary point code.

Note: See [Point Code Formats](#) for a definition of the point code types that are used on the **EAGLE** and for a definition of the different formats that can be used for **ITU** national point codes.

The secondary point code must be a full point code. **Cluster** and network routing point codes cannot be specified as a secondary point code.

The **Multiple Point Code** Support feature must be on to configure secondary point codes in the database. This can be verified with the entry `MPC = on` in the `rtrv-feat` command output. If the **Multiple Point Code** Support feature is not turned on, enter the `chg-feat:mpc=on` command.

Note: Once the **Multiple Point Code** Support feature is turned on with the `chg-feat` command, it cannot be turned off.

The **Multiple Point Code** Support feature must be purchased before you turn this feature on with the `chg-feat` command. If you are not sure if you have purchased the **Multiple Point Code** Support feature, contact your Oracle Sales Representative or Account Representative.

The database can contain up to 40 secondary point codes.

The secondary point code cannot be defined in the database as the true point code of the **EAGLE**, a capability point code, a destination point code, or an alias point code. The true point code and capability point codes are shown in the `rtrv-sid` command output. The destination point codes and alias point codes are shown in the `rtrv-dstn` command output.

The secondary point code cannot be shown in the `rtrv-pct` output as an EPC (emulated point code) value.

For the examples in this procedure, these secondary point codes are being added to the database:

ANSI secondary point code = 010-100-010

ITU secondary international point code = 4-100-1

14-bit ITU secondary national point code = 14-15-12-1

The format of the 14-bit ITU national point codes used in these examples is 4-4-4-2.

Canceling the RTRV-DSTN Command

Because the `rtrv-dstn` command used in this procedure can output information for a long period of time, the `rtrv-dstn` commands can be canceled and the output to the terminal stopped. There are three ways that the `rtrv-dstn` command can be canceled:

- Press the F9 function key on the keyboard at the terminal where the `rtrv-dstn` command was entered.
- Enter the `canc-cmd` without the `trm` parameter at the terminal where the `rtrv-dstn` command was entered.
- Enter the `canc-cmd:trm=<xx>`, where `<xx>` is the terminal where the `rtrv-dstn` command was entered, from another terminal other than the terminal where the `rtrv-dstn` command was entered. To enter the `canc-cmd:trm=<xx>`

command, the terminal must allow Security Administration commands to be entered from it and the user must be allowed to enter Security Administration commands. The terminal's permissions can be verified with the `rtrv-secu-trm` command. The user's permissions can be verified with the `rtrv-user` or `rtrv-secu-user` commands.

For more information about the `canc-cmd` command, refer to *Commands User's Guide*.

1. Display the current secondary point codes, using the `rtrv-spc` command.

This is an example of the possible output.

```
rlghncxa03w 07-05-17 16:02:05 GMT EAGLE5 37.0.0
SPC (Secondary Point Codes)

SPCA
    001-010-010
    002-010-010
    003-010-010

SPC-I
    1-253-5
    2-254-6
    3-255-7

SPC-N
    10-01-11-1
    13-02-12-0

SPC-N24

none

Secondary Point Code table is (8 of 40) 20% full
```

If the secondary point code table is full, shown by the entry `Secondary Point Code table is (40 of 40) 100% full`, go to the [Removing a Secondary Point Code](#) procedure and remove a secondary point code from the database.

If error message `E3867 Cmd Rej: MPC feature must be enabled` is displayed, the **EAGLE** has detected that the multiple point code support feature is off and the `rtrv-spc` command will not display any data. Continue the procedure with [2](#) to verify that the multiple point code support feature is off.

2. Verify whether or not the multiple point code support feature is on, by entering the `rtrv-feat` command.

If the multiple point code support feature is on, the `MPC` field should be set to `on`. For this example, the multiple point code support feature is off.

Note: The `rtrv-feat` command output contains other fields that are not used by this procedure. If you wish to see all the fields displayed by the `rtrv-feat` command, see the `rtrv-feat` command description in *Commands User's Guide*.

If the multiple point code support feature is on, continue the procedure with [4](#).

If the `rtrv-feat` command output shows that the multiple point code support feature is on, but error message E3867 was displayed when the `rtrv-spc` command was entered, contact the Customer Care Center. Refer to [My Oracle Support \(MOS\)](#) for the contact information.

If group codes are to be assigned to the ITU-N secondary point code, and none are currently displayed in the `rtrv-spc` command output, the ITU National Duplicate **Point Code** feature must be on. This is shown by the entry `ITUDUPPC = on` in the `rtrv-feat` command output.

3. Turn the multiple point code support feature on by entering this command.

```
chg-feat:mpc=on
```

Note: Once the multiple point code support feature is turned on with the `chg-feat` command, it cannot be turned off.

The multiple point code support feature must be purchased before you turn this feature on with the `chg-feat` command. If you are not sure if you have purchased the multiple point code support feature, contact your Oracle Sales Representative or Account Representative.

When the `chg-feat` has successfully completed, this message should appear.

```
rlghncxa03w 07-05-07 00:57:31 GMT EAGLE5 37.0.0  
CHG-FEAT: MASP A - COMPLTD
```

Note: If group codes are shown for the 14-bit ITU-N secondary point codes in the `rtrv-spc` command output, if 24-bit ITU-N secondary point codes are being configured, or the ITU National Duplicate **Point Code** feature is on, continue the procedure with [5](#).

4. Turn the ITU National Duplicate **Point Code** feature on by entering this command.

```
chg-feat:ituduppc=on
```

Note: Once the ITU National Duplicate **Point Code** feature is turned on with the `chg-feat` command, it cannot be turned off.

The ITU National Duplicate **Point Code** feature must be purchased before you turn this feature on with the `chg-feat` command. If you are not sure if you have purchased the ITU National Duplicate **Point Code** feature, contact your Oracle Sales Representative or Account Representative.

When the `chg-feat` has successfully completed, this message should appear.

```
rlghncxa03w 07-05-07 00:57:31 GMT EAGLE5 37.0.0  
CHG-FEAT: MASP A - COMPLTD
```

5. Display the self-identification of the **EAGLE** using the `rtrv-sid` command to verify the point code values in the self-identification of the **EAGLE**, and to verify the point code types defined in the **EAGLE**.

This is an example of the possible output.

```

rlghncxa03w 07-05-10 11:43:04 GMT EAGLE5 37.0.0
PCA          PCI          PCN          CLLI          PCTYPE
100-100-100  3-75-7          7-9-8-1     rlghncxa03w  OTHER

CPCA
002-002-002      002-002-003      002-002-004      002-002-005
002-002-006      002-002-007      002-002-008      002-002-009
004-002-001      004-003-003      050-060-070

CPCA (LNP)
005-005-002      005-005-004      005-005-005

CPCI
1-002-1          1-002-2          1-002-3          1-002-4
2-001-1          7-222-7

CPCN
2-0-10-3        2-0-11-0        2-0-11-2        2-0-12-1
2-2-3-3        2-2-4-0        10-14-10-1

```

To enter an **ANSI** secondary code with the `ent-spc` command, a point code must be shown in the `PCA` field of the `rtrv-sid` command output.

To enter an **ITU-I** secondary point code with the `ent-spc` command, a point code must be shown in the `PCI` field of the `rtrv-sid` command output.

To enter a 14-bit **ITU-N** secondary point code with the `ent-spc` command, a point code must be shown in the `PCN` field of the `rtrv-sid` command output.

To enter a 24-bit **ITU-N** secondary point code with the `ent-spc` command, a point code must be shown in the `PCN24` field of the `rtrv-sid` command output.

If the required type of point code is shown in the `rtrv-spc` output in [1](#) or is shown in the `rtrv-sid` output in this step, continue the procedure with [6](#).

If the required type of point code is not shown in the `PCA`, `PCI`, `PCN`, or `PCN24` fields of the `rtrv-sid` command output, go to the [Adding a Point Code to the Self-Identification of the EAGLE](#) procedure and add the required point codes.

6. Display the current destination point codes using the `rtrv-dstn` command.

This is an example of the possible output.

```

rlghncxa03w 10-12-10 11:43:04 GMT EAGLE5 43.0.0
Extended Processing Time may be Required

DPCA          CLLI          BEI  ELEI  ALIASI          ALIASN/N24  DMN
030-045-*    rlghncbb010  yes  yes  -----        -----        SS7
111-011-*    rlghncbb000  yes  yes  -----        -----        SS7
240-012-004  rlghncbb001  yes  ---  1-111-1        10-13-9-3      SS7
240-012-005  rlghncbb002  yes  ---  1-112-2        10-13-10-0     SS7
240-012-006  rlghncbb003  yes  ---  1-112-3        10-13-10-1     SS7
240-012-008  -----      yes  ---  1-113-5        10-13-10-2     SS7

DPCI          CLLI          BEI  ELEI  ALIASA          ALIASN/N24  DMN
2-131-1      rlghncbb023  no   ---  222-210-000    11-11-8-1     SS7
2-131-2      -----      no   ---  222-211-001    11-11-8-2     SS7
2-131-3      -----      no   ---  222-211-002    11-11-8-3     SS7

```

```

DPCN          CLLI          BEI ELEI  ALIASA          ALIASI          DMN
10-15-2-3     rlghncbb013 no ---  222-200-200    2-121-1        SS7
10-15-3-0     rlghncbb013 no ---  222-200-201    2-121-2        SS7

DESTINATION ENTRIES ALLOCATED:  2000
FULL DPC(s):                    9
EXCEPTION DPC(s):               0
NETWORK DPC(s):                 0
CLUSTER DPC(s):                 2
TOTAL DPC(s):                   11
CAPACITY (% FULL):              1%
ALIASES ALLOCATED:              8000
ALIASES USED:                    18
CAPACITY (% FULL):              1%
X-LIST ENTRIES ALLOCATED:       500
RTRV-DSTN: MASP A - COMPLTD

```

Note: If the `spcn` parameter is not being used in this procedure, continue the procedure with 9.

7. Display the PCT entries by entering the `rtrv-pct` command.

This is an example of the possible output.

```

rlghncxa03w 10-12-17 16:02:05 GMT  EAGLE5 43.0.0

EPCA          FILTPCA          REALPCA      SI  SSN  RELCAUSE
001-001-001   *                          240-012-006  5  ---  10

ECICS = 10      ECICE = 20
RCICS = 30      RCICE = 40

EPCI          FILTPCI          REALPCI      SI  SSN  RELCAUSE
1-001-2       2-131-2          2-131-3     3   10  ---

ECICS = ----- ECICE = -----
RCICS = ----- RCICE = -----

EPCN          FILTPCN          REALPCN      SI  SSN  RELCAUSE
13-11-14-1   *                          10-15-2-3   *  ---  ---

ECICS = ----- ECICE = -----
RCICS = ----- RCICE = -----

Unique EPC      is 3 of 250
Unique RealPC  is 3 of 250

PCT table is (3 of 1000) 1% full.

```

Note: If the `spcn` parameter is not being used in this procedure, continue the procedure with 9.

8. Display the existing values for the `npcfmt.i` parameter by entering the `rtrv-stpopts` command.

The value for the `npcfmt i` parameter is shown in the `NPCFMTI` field. This is an example of the possible output.

```
rlghncxa03w 07-05-17 16:02:05 GMT EAGLE5 37.0.0
STP OPTIONS
-----
NPCFMTI          4-4-4-2
```

Note: The `rtrv-stpopts` command output contains other fields that are not used by this procedure. If you wish to see all the fields displayed by the `rtrv-stpopts` command, see the `rtrv-stpopts` command description in *Commands User's Guide*.

If you wish to change the format of the 14-bit ITU national point codes, go to the [14-Bit ITU National Point Code Formats](#) section. Changing the formats of the 14-bit ITU national point codes will change how any existing 14-bit ITU national point codes are displayed in the database.

9. Add the secondary point code, using the `ent-spc` command.

The secondary point code being added in this procedure cannot match any of the point code values shown in the `rtrv-sid` output in [5](#), and any of the **DPC** or alias point code values shown in the `rtrv-dstn` output in [6](#).

The secondary point code being added in this procedure cannot match the EPC (emulated point code) value shown in the `rtrv-pct` output in [7](#).

For this example, enter these commands.

```
ent-spc:spca=010-100-010
ent-spc:spci=4-100-1
ent-spc:spcn=14-15-12-1
```

When each of these commands has successfully completed, this is an example of the message that should appear.

```
rlghncxa03w 07-05-17 15:35:05 GMT EAGLE5 37.0.0
Destination table is (11 of 40) 28% full
ENT-SPC: MASP A - COMPLTD
```

10. Verify the changes using the `rtrv-spc` command.

This is an example of the possible output.

```
rlghncxa03w 07-05-17 16:02:05 GMT EAGLE5 37.0.0
SPC (Secondary Point Codes)

SPCA
    001-010-010
    002-010-010
    003-010-010
    010-100-010

SPC-I
    1-253-5
    2-254-6
```

3-255-7
4-100-1

SPC-N
10-01-11-1
13-02-12-0
14-15-12-1

SPC-N24

none

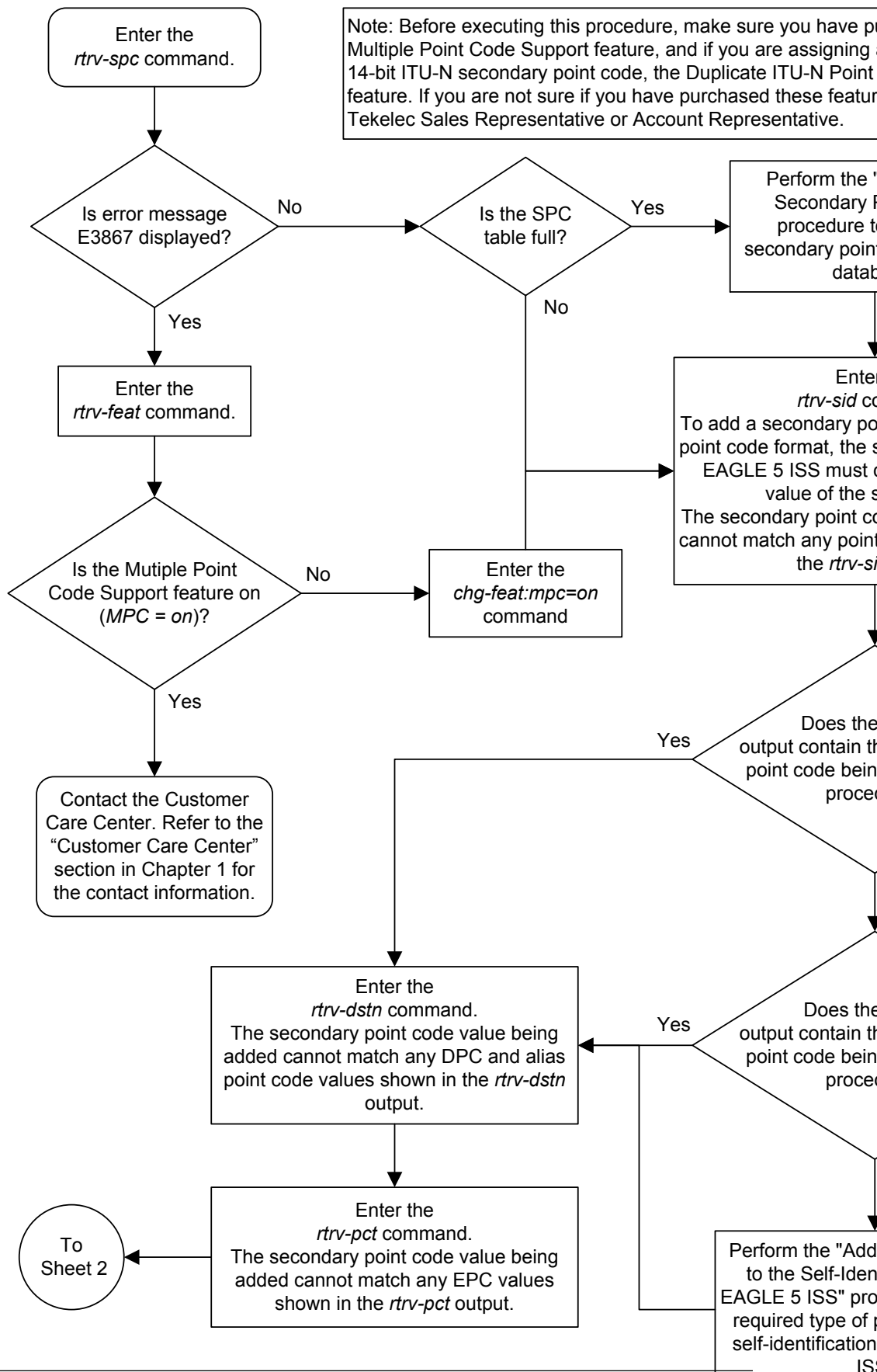
Secondary Point Code table is (11 of 40) 28% full

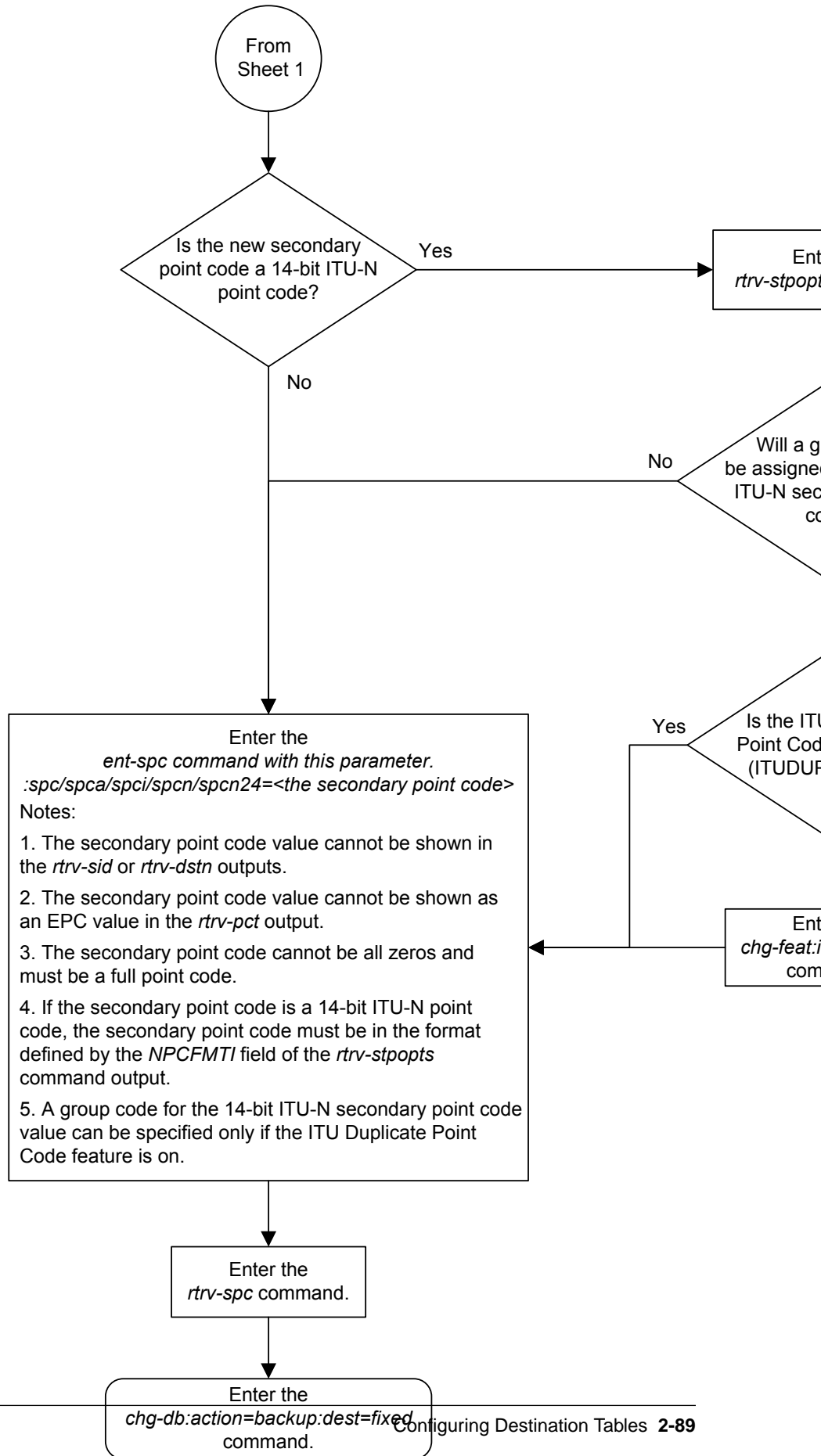
11. Back up the new changes, using the `chg-db:action=backup:dest=fixed` command.

These messages should appear; the active **Maintenance and Administration Subsystem Processor (MASP)** appears first.

```
BACKUP (FIXED) : MASP A - Backup starts on active MASP.  
BACKUP (FIXED) : MASP A - Backup on active MASP to fixed disk complete.  
BACKUP (FIXED) : MASP A - Backup starts on standby MASP.  
BACKUP (FIXED) : MASP A - Backup on standby MASP to fixed disk complete.
```

Figure 2-17 Adding a Secondary Point Code





Removing a Secondary Point Code

This procedure is used to remove a secondary point code from the database using the `dlt-spc` command.

The `dlt-spc` command uses only one parameter: `spc/spca/spci/spcn/spcn24` – the secondary point code.

Note: See [Point Code Formats](#) for a definition of the point code types that are used on the EAGLE and for a definition of the different formats that can be used for ITU national point codes.

The secondary point code being removed from the database must be in the database, but cannot be referenced by any destination point codes or by any linksets. Entering the `rtrv-dstn` command with either the `spca`, `spci`, `spcn`, or `spcn24`, depending on the point code type of the secondary point code being removed from the database, shows the destination point codes that are referencing the secondary point code being removed from the database.

Entering the `rtrv-ls` command with either the `spca`, `spci`, `spcn`, or `spcn24`, depending on the point code type of the secondary point code being removed from the database, shows the linksets that are referencing the secondary point code being removed from the database.

For the example in this procedure, secondary point code 010-100-010 is being removed from the database.

Canceling the RTRV-DSTN Command

Because the `rtrv-dstn` command used in this procedure can output information for a long period of time, the `rtrv-dstn` commands can be canceled and the output to the terminal stopped. There are three ways that the `rtrv-dstn` command can be canceled:

- Press the F9 function key on the keyboard at the terminal where the `rtrv-dstn` command was entered.
- Enter the `canc-cmd` without the `trm` parameter at the terminal where the `rtrv-dstn` command was entered.
- Enter the `canc-cmd:trm=<xx>`, where `<xx>` is the terminal where the `rtrv-dstn` command was entered, from another terminal other than the terminal where the `rtrv-dstn` command was entered. To enter the `canc-cmd:trm=<xx>` command, the terminal must allow Security Administration commands to be entered from it and the user must be allowed to enter Security Administration commands. The terminal's permissions can be verified with the `rtrv-secu-trm` command. The user's permissions can be verified with the `rtrv-user` or `rtrv-secu-user` commands.

For more information about the `canc-cmd` command, refer to *Commands User's Guide*.

1. Display the secondary point codes in the database, using the `rtrv-spc` command. This is an example of the possible output.

```
rlghncxa03w 07-05-17 16:02:05 GMT EAGLE5 37.0.0
```

SPC (Secondary Point Codes)

SPCA

```
001-010-010
002-010-010
003-010-010
010-100-010
```

SPC-I

```
1-253-5
2-254-6
3-255-7
4-100-1
```

SPC-N

```
10-01-11-1
13-02-12-0
14-15-12-1
```

SPC-N24

none

Secondary Point Code table is (11 of 40) 28% full

2. Display the destination point codes that reference the secondary point code being removed from the database using the `rtrv-dstn` command with either the `spca`, `spci`, or `spcn` parameters.

For this example, enter this command.

```
rtrv-dstn:spca=010-100-010
```

This is an example of the possible output.

```
rlghncxa03w 09-05-17 16:02:05 GMT EAGLE5 41.0.0
```

```
SPCA = 010-100-010
```

DPCA	CLLI	BEI	ELEI	ALIASI	ALIASN/N24	DMN
240-012-004	rlghncbb001	yes	---	1-111-1	10-13-9-3	SS7
240-012-005	rlghncbb002	yes	---	1-112-2	10-13-10-0	SS7

Destination table is (16 of 2000) 1% full

Alias table is (9 of 8000) 1% full

RTRV-DSTN: MASP A - COMPLTD

- If no DPCs are shown in this step, skip step 3 and go to step 4.
 - If DPCs are shown in this step, continue the procedure with step 3.
3. Remove the reference to the secondary point code using the `chg-dstn` command and specifying the destination point codes shown in step 2 with either the `dpca`, `dpci`, or `dpcn` parameters, and with either the `spca=none`, `spci=none`, or `spcn=none` parameters, depending on the type of point codes being used. For this example, enter these commands.

```
chg-dstn:dpca=240-012-004:spca=none
```

```
chg-dstn:dpca=240-012-005:spca=none
```

When this command has successfully completed, and the cluster routing and management diversity feature is turned off (CRMD = off in the `rtrv-feat` command output), this message should appear.

```
rlghncxa03w 07-05-17 15:35:05 GMT EAGLE5 37.0.0
Destination table is (16 of 2000) 1% full
CHG-DSTN: MASP A - COMPLTD
```

If the cluster routing and management diversity feature is turned on (CRMD = on in the `rtrv-feat` command output), this message should appear when each command has successfully completed.

```
rlghncxa03w 07-5-17 15:35:05 GMT EAGLE5 37.0.0
DESTINATION ENTRIES ALLOCATED: 2000
  FULL DPC(s): 14
  EXCEPTION DPC(s): 0
  NETWORK DPC(s): 0
  CLUSTER DPC(s): 2
  TOTAL DPC(s): 16
  CAPACITY (% FULL): 1%
ALIASES ALLOCATED: 8000
  ALIASES USED: 8
  CAPACITY (% FULL): 1%
X-LIST ENTRIES ALLOCATED: 500
CHG-DSTN: MASP A - COMPLTD
```

After this step has been performed, skip steps 4 and 5 and go to step 6.

4. Display the status of the Multiple Linksets to Single APC feature by entering this command.

```
rtrv-ctrl-feat:partnum=893019701
```

This is an example of the possible output.

```
rlghncxa03w 07-05-28 21:15:37 GMT EAGLE5 37.0.0
The following features have been permanently enabled:
```

Feature Name	Partnum	Status	Quantity
Multiple Linkset to APC	893019701	on	----

The following features have been temporarily enabled:

Feature Name	Partnum	Status	Quantity	Trial Period Left
Zero entries found.				

The following features have expired temporary keys:

Feature Name	Partnum
Zero entries found.	

If the Multiple Linksets to Single APC feature is enabled and turned on, continue the procedure with step 5.

If the Multiple Linksets to Single APC feature is not enabled or turned on, skip step 5 and go to step 6.

5. Display the linksets that reference the secondary point code that is being removed by entering the `rtrv-ls` command with the secondary point code value.

For this example, enter this command.

```
rtrv-ls:spca=010-100-010
```

This is an example of the possible output.

```
rlghncxa03w 07-05-28 21:15:37 GMT EAGLE5 37.0.0
```

```
SPCA = 010-100-010
```

LSN	APCA (SS7)	SCRN	L3T SLT			BEI	LST	LNKS	GWS GWS GWS			SLSCI	NIS
			SET	SET					ACT	MES	DIS		
lsn1	002-002-002	none	1	1	no	A	2	off	off	off	no	off	
lsn2	003-003-003	none	1	1	no	A	3	off	off	off	no	off	

Link set table is (12 of 1024) 1% full.

If linksets are shown in this step, these linksets must be removed before the secondary point code can be removed. Perform the [Removing a Linkset Containing SS7 Signaling Links](#) procedure to remove the linksets. After the linksets have been removed, continue the procedure with step 6.

If no linksets are shown in this step, continue the procedure with step 6.

- Remove the secondary point code, using the `dlt-spc` command. For this example, enter this command.

```
dlt-spc:spca=010-100-010
```

When this command has successfully completed, this is an example of the message that should appear.

```
rlghncxa03w 07-05-17 15:35:05 GMT EAGLE5 37.0.0
Destination table is (10 of 40) 25% full
DLT-SPC: MASP A - COMPLTD
```

- Verify the changes using the `rtrv-spc` command specifying the secondary point code specified in step 6.

For this example, enter this command.

```
rtrv-spc:spca=010-100-010
```

When this command has successfully completed, this is an example of the message that should appear.

```
rlghncxa03w 07-05-17 16:02:05 GMT EAGLE5 37.0.0
SPC (Secondary Point Codes)
```

```
Secondary Point Code specified is not provisioned
```

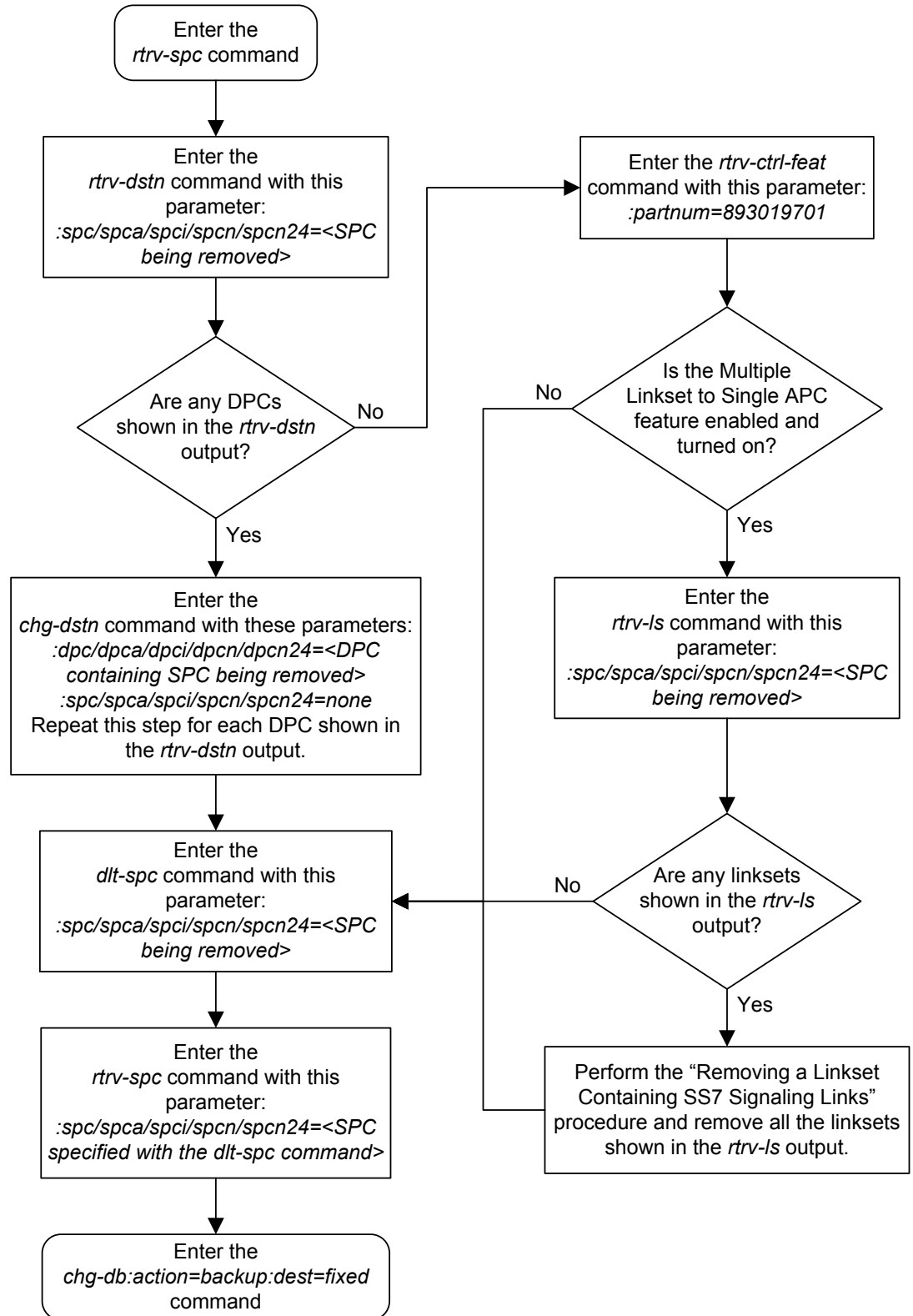
```
Secondary Point Code table is (10 of 40) 25% full
```

- Back up the new changes, using the `chg-db:action=backup:dest=fixed` command. These messages should appear; the active **Maintenance and Administration Subsystem Processor (MASP)** appears first.

```
BACKUP (FIXED) : MASP A - Backup starts on active MASP.
BACKUP (FIXED) : MASP A - Backup on active MASP to fixed disk complete.
```

```
BACKUP (FIXED) : MASP A - Backup starts on standby MASP.  
BACKUP (FIXED) : MASP A - Backup on standby MASP to fixed disk complete.
```

Figure 2-18 Removing a Secondary Point Code



Adding a Point Code to the Self-Identification of the EAGLE

This procedure is used to add a true point code to the self-identification of the **EAGLE** using the `ent-sid` command. Adding the point code using this procedure instead of the [Changing the Self-Identification of the EAGLE](#) procedure does not require the **EAGLE** to be re-initialized after the point code is added.

However, if you wish to add a capability point code, change an existing true point code, change the **CLLI** value, or the `pctype` parameter value in the self-identification, the [Changing the Self-Identification of the EAGLE](#) procedure must be used.

The `ent-sid` command uses these parameters:

`:pc/pca` – ANSI point code
`:pci` – ITU-I or ITU-I spare point code
`:pcn` – 14-bit ITU-N or 14-bit ITU-N spare point code
`:pcn24` – 24-bit ITU-N point code

Note: See [Point Code Formats](#) for a definition of the point code types that are used on the **EAGLE** and for a definition of the different formats that can be used for **ITU** national point codes.

The network type of the point code being added in this procedure cannot be the same as the network type of any point codes shown in `PCA`, `PCI`, `PCN`, or `PCN24` columns in the `rtrv-sid` output. For example, if an **ANSI** point code is shown in the `rtrv-sid` output (a point code in the `PCA` column), then the `pc/pca` parameter cannot be specified in this procedure.

However, the self-identification can contain both spare and non-spare point codes for the `PCI` and `PCN` values. If the `rtrv-sid` output contains an **ITU-I** point code, but does not contain an **ITU-I** spare point code, the `pci` parameter can be specified with an **ITU-I** spare point code value. If spare and non-spare point codes are shown for the `PCI` value, then the `pci` parameter cannot be specified in this procedure. This is also true for 14-bit **ITU-N** and 14-bit **ITU-N** spare point codes.

The point code of the **EAGLE** cannot match the capability point codes of the **EAGLE** or any destination point codes or alias point codes. Capability point codes are shown in the `rtrv-sid` output. Destination point codes and alias point codes are shown in the `rtrv-dstn` output.

The point code of the **EAGLE** must be a full point code and cannot be a cluster point code. The point code containing all zeros cannot be used as a value for these parameters.

The point code value for the `pcn` parameter (either 14-bit **ITU-N** or 14-bit **ITU-N** spare point code) must match the format defined by the `NPCFMTI` parameter of the `rtrv-stpopts` output. If group codes are shown for the 14-bit **ITU-N** point codes in the `rtrv-sid` output, then a group code must be specified with the `pcn` parameter value. The group code must match the group codes shown in the `rtrv-sid` or `rtrv-spc` outputs.

1. Display the self-identification of the **EAGLE** using the `rtrv-sid` command.

This is an example of the possible output.


```

rlghncxa03w 07-05-10 11:43:04 GMT EAGLE5 37.0.0
PCA          PCI          PCN          CLLI          PCTYPE
001-001-001  1-200-6        10-13-9-3    rlghncxa03w  OTHER

CPCA
002-002-002  002-002-003   002-002-004   002-002-005
002-002-006  002-002-007   002-002-008   002-002-009
004-002-001  004-003-003   050-060-070
CPCA (LNP)
005-005-002  005-005-004   005-005-005

CPCI
1-002-1      1-002-2        1-002-3        1-002-4
2-001-1      7-222-7

CPCN
2-0-10-3     2-0-11-0       2-0-11-2       2-0-12-1
2-2-3-3     2-2-4-0        10-14-10-1

```

If the network type of the point code being added in this procedure matches the network types of the point codes shown in the PCA, PCI, PCN, or PCN24 columns, this procedure cannot be performed. Perform the [Changing the Self-Identification of the EAGLE](#) procedure to change the point codes shown in these columns.

Note: If an ITU-I or 14-bit ITU-N spare point code is displayed in the `rtrv-sid` output in step 1, or if an ITU-I or 14-bit ITU-N spare point code is not being added in this procedure, skip step 2 and go to step 3.

2. Verify whether or not the **ITU National and International Spare Point Code Support** feature is enabled by entering the `rtrv-ctrl-feat` command with the part number of this feature.

Enter this command.

```
rtrv-ctrl-feat:partnum=893013601
```

This is an example of the possible output.

```

rlghncxa03w 07-05-28 21:15:37 GMT EAGLE5 37.0.0
The following features have been permanently enabled:

```

Feature Name	Partnum	Status	Quantity
Spare Point Code Support	893013601	on	----

The following features have been temporarily enabled:

Feature Name	Partnum	Status	Quantity	Trial Period Left
Zero entries found.				

The following features have expired temporary keys:

Feature Name	Partnum
Zero entries found.	

If the **ITU National and International Spare Point Code Support** feature is not enabled, perform the [Activating the ITU National and International Spare Point](#)

[Code Support Feature](#) procedure to enable the ITU National and International Spare Point Code Support feature.

Note: If the `pcn` parameter is not being used in this procedure, skip this step and step 4, and go to step 5.

3. Display the existing values for the `npcfmt i` parameter, by entering the `rtrv-stpopts` command.

The value for the `npcfmt i` parameter is shown in the `NPCFMTI` field. This is an example of the possible output.

```
rlghncxa03w 07-05-17 16:02:05 GMT EAGLE5 37.0.0
STP OPTIONS
-----
NPCFMTI          4-4-4-2
```

Note: The `rtrv-stpopts` command output contains other fields that are not used by this procedure. If you wish to see all the fields displayed by the `rtrv-stpopts` command, see the `rtrv-stpopts` command description in *Commands User's Guide*.

Note: If the `rtrv-sid` output in step 1 shows group codes assigned to the 14-bit ITU-N point codes, then a group code must be assigned to the `pcn` parameter value specified in this procedure. This group code must be shown in either the `rtrv-sid` output or the `rtrv-spc` output. If the group code being assigned to the `pcn` parameter value is shown in the `rtrv-sid` output, skip step 4 and go to step 5.

4. Display the secondary point codes in the database, using the `rtrv-spc` command.

This is an example of the possible output.

```
rlghncxa03w 07-05-07 11:43:04 GMT EAGLE5 37.0.0
SPC (Secondary Point Codes)

SPCA
    001-010-010
    002-010-010
    003-010-010
    010-100-010

SPC-I
    1-253-5
    2-254-6
    3-255-7
    4-100-1

SPC-N
    10-01-11-1
    13-02-12-0
    14-15-12-1

SPC-N24
```

none

5. Verify whether or not the point code being added in this procedure is a **DPC** value in the **DPC** table by entering the `rtrv-dstn` command and specifying the point code value that is being added in this procedure. For this example, enter these commands.

```
rtrv-dstn:dpci=s-3-75-7
```

```
rtrv-dstn:dpcn=s-7-9-8-1
```

When each of these commands have been executed, the following output is displayed showing that the specified point code is not in the **DPC** table.

```
rlghncxa03w 09-05-28 21:16:37 GMT EAGLE5 41.0.0
```

```
No destinations meeting the requested criteria were found
```

```
Destination table is (22 of 2000) 1% full
```

```
Alias table is (18 of 8000) 1% full
```

6. Verify whether or not the point code being added in this procedure is an alias point code in the **DPC** table by entering the `rtrv-dstn` command and specifying the point code value that is being added in this procedure. For this example, enter these commands.

```
rtrv-dstn:aliasi=s-3-75-7
```

```
rtrv-dstn:aliasn=s-7-9-8-1
```

When each of these commands have been executed, the following output is displayed showing that the specified point code is not an alias point code in the **DPC** table.

```
rlghncxa03w 09-05-28 21:16:37 GMT EAGLE5 41.0.0
```

```
No destinations meeting the requested criteria were found
```

```
Destination table is (22 of 2000) 1% full
```

```
Alias table is (18 of 8000) 1% full
```

If the point code specified in steps 5 and 6 is shown in the **DPC** table, choose another point code to add to the self-identification and repeat steps 5 and 6.

If the point code specified in steps 5 and 6 is not shown in the **DPC** table, go to step 7.

7. Add the point code to the self-identification of the **EAGLE** using the `ent-sid` command with the `pca`, `pci`, `pcn`, or `pcn24` parameters and according to these rules.
 - If the `pcn` parameter is specified with the `ent-sid` command, the `pcn24` parameter cannot be specified.
 - If the `pcn24` parameter is specified with the `ent-sid` command, the `pcn` parameter cannot be specified.
 - For `pcn` parameter values, the format of the point code must match the format defined by the `NPCFMTI` parameter of the `rtrv-stpopts` output. If group

codes are shown in the `rtrv-sid` output in step 1, a group code must be assigned to the `pcn` parameter value being added in this procedure. This group code must be shown either in the `rtrv-sid` or `rtrv-spc` output.

- The point code values must be full point codes.
- The ITU National and International **Spare Point Code** Support feature must be enabled to specify an ITU-I or 14-bit ITU-N spare point code.
- The point code specified in this procedure cannot be defined as a capability point code.
- See "ANSI Point Codes" in the [Point Code Formats](#) section for information about entering ANSI point codes.

For this example, enter this command.

```
ent-sid:pci=s-3-75-7:pcn=s-7-9-8-1
```

When this command has successfully completed, this message should appear.

```
rlghncxa03w 07-05-07 09:17:40 GMT EAGLE5 37.0.0
ENT-SID: MASP A - COMPLTD
```

8. Verify the changes using the `rtrv-sid` command.

This is an example of the possible output.

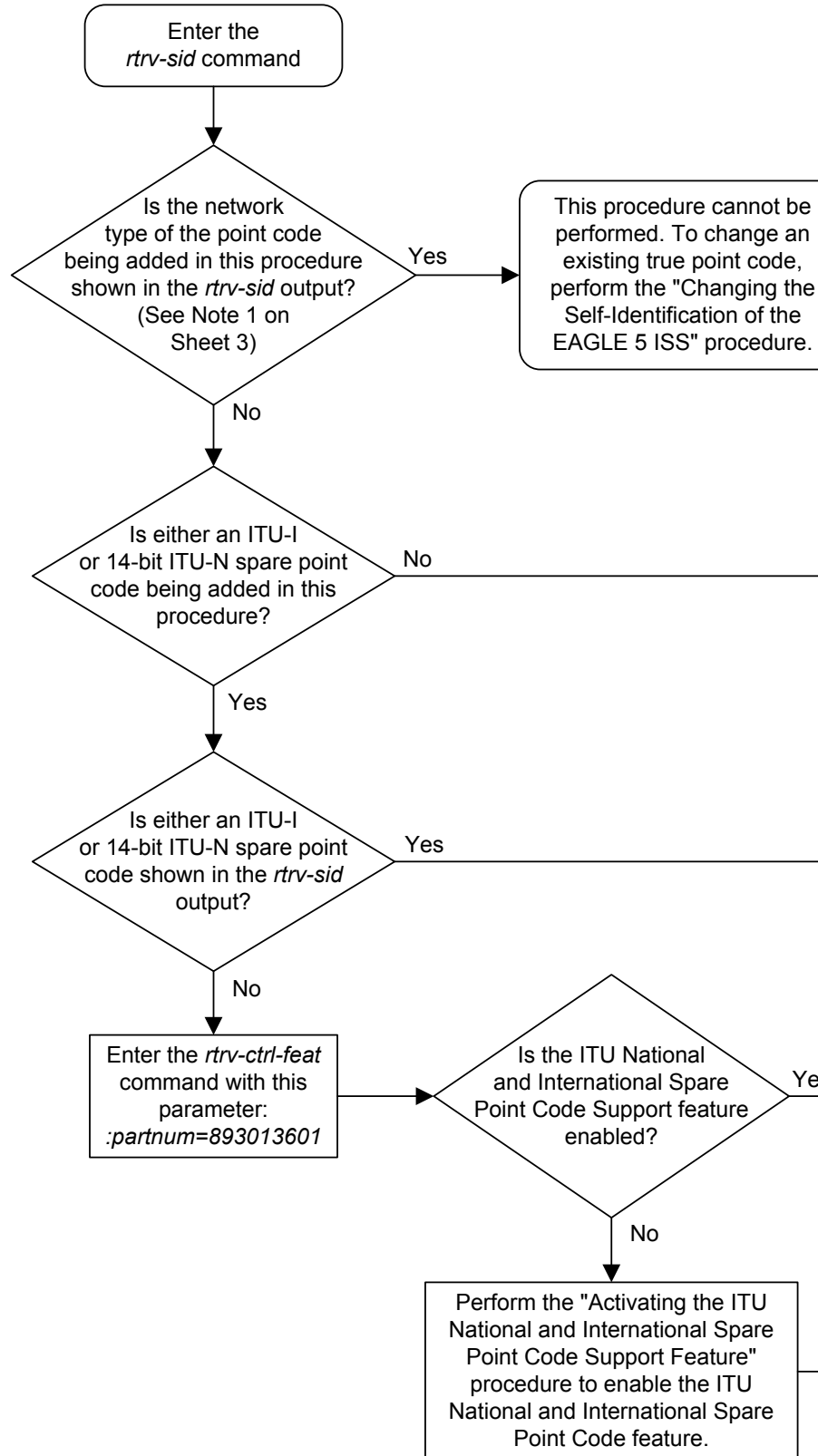
```
rlghncxa03w 07-05-10 11:43:04 GMT EAGLE5 37.0.0
PCA          PCI          PCN          CLLI          PCTYPE
001-001-001  1-200-6        10-13-9-3   rlghncxa03w  OTHER
              s-3-75-7        s-7-9-8-1
CPCA
002-002-002  002-002-003   002-002-004 002-002-005
002-002-006  002-002-007   002-002-008 002-002-009
004-002-001  004-003-003   050-060-070
CPCA (LNP)
005-005-002  005-005-004   005-005-005 006-006-006
CPCI
1-002-1      1-002-2        1-002-3      1-002-4
2-001-1      7-222-7
CPCN
2-0-10-3     2-0-11-0       2-0-11-2     2-0-12-1
2-2-3-3     2-2-4-0        10-14-10-1
```

9. Back up the new changes, using the `chg-db:action=backup:dest=fixed` command.

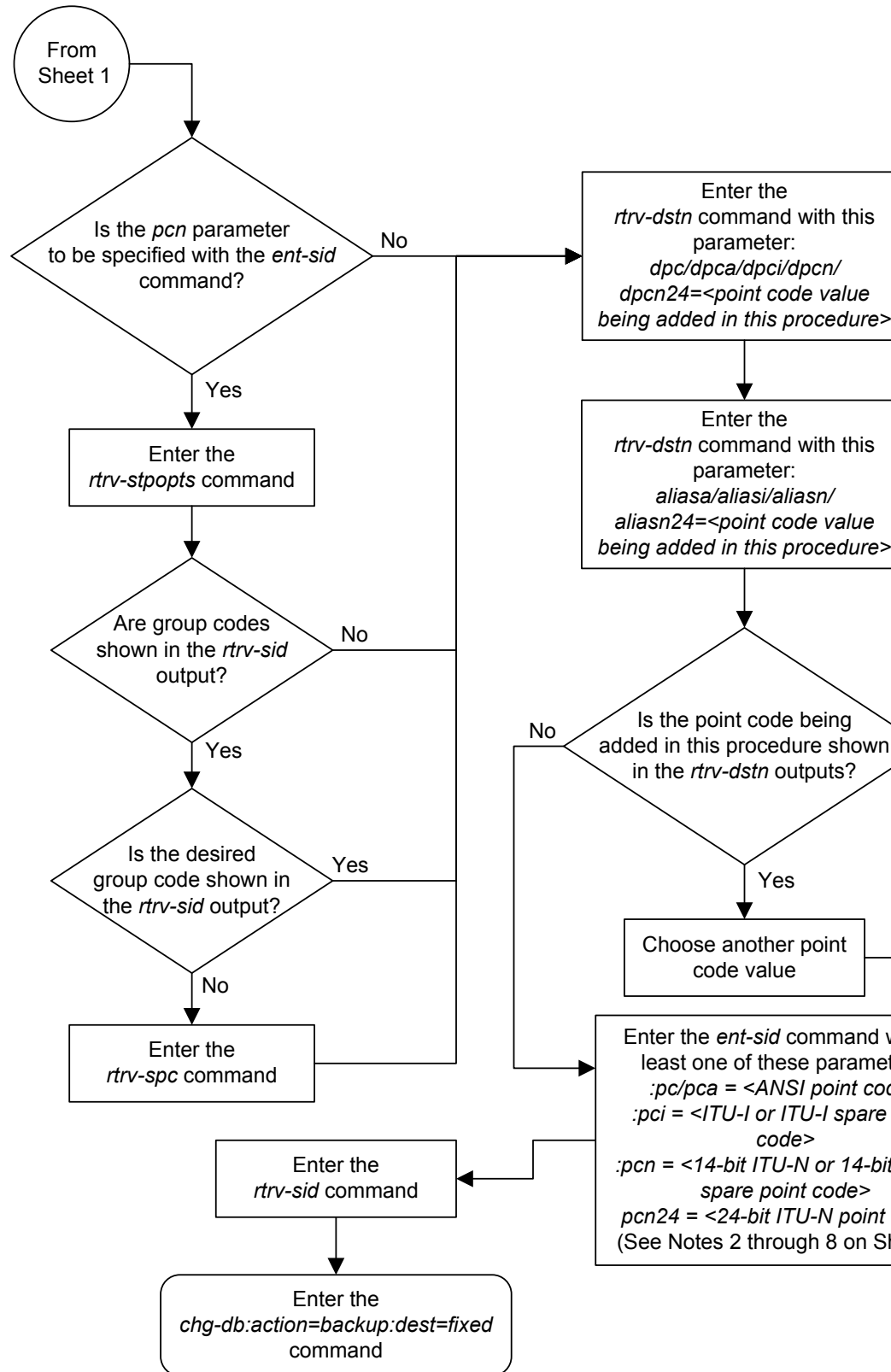
These messages should appear; the active **Maintenance and Administration Subsystem Processor (MASP)** appears first.

```
BACKUP (FIXED) : MASP A - Backup starts on active MASP.
BACKUP (FIXED) : MASP A - Backup on active MASP to fixed disk complete.
BACKUP (FIXED) : MASP A - Backup starts on standby MASP.
BACKUP (FIXED) : MASP A - Backup on standby MASP to fixed disk complete.
```

Figure 2-19 Adding a Point Code to the Self-Identification of the EAGLE



Sheet 1 of 3



Sheet 2 of 3

Notes:

1. The self-identification can contain these types of point codes:

ANSI - shown in the *PCA* column

ITU-I - shown in the *PCI* column

14-bit ITU-N - shown in the *PCN* column

24-bit ITU-N - shown in the *PCN24* column.

The *PCI* column can also contain an ITU-I spare point code in addition to the ITU-I point code.

The *PCN* column can also contain a 14-bit ITU-N spare point code in addition to the ITU-N point code.

If any of these point code types, including spare point codes, are shown in the *rtrv-sid* output, the type of point code cannot be specified in this procedure.

2. If the the *pcn* parameter is specified with the *ent-sid* command, the *pcn24* parameter cannot be specified.
3. If the the *pcn24* parameter is specified with the *ent-sid* command, the *pcn* parameter cannot be specified.
4. For 14-bit ITU-N point code values, the format of the point code must match the format defined by the *NPCFMTI* parameter of the *rtrv-stpopts* output.
5. The point code values must be full point codes.
6. The ITU National and International Spare Point Code Support feature must be enabled to support ITU-I or 14-bit ITU-N spare point code.
7. The point code specified in this procedure cannot be defined as a capability point code.
8. See the "ANSI Point Codes" section in the *Database Administration Manual – SS7* for information on entering ANSI point codes.

Changing the Self-Identification of the EAGLE

This procedure is used to change the self-identification of the **EAGLE** using the `chg-sid` command. The self-identification of the **EAGLE** is a set of point codes made up of a true point code (**PC**) and a capability point code (**CPC**) for each network type to which the **EAGLE** is connected. A capability point code identifies a group of nodes that have similar capabilities, for example, global title translation.

Caution: Use this procedure only during periods of low traffic. If the **EAGLE**'s point code, defined by the `pc/pca/pci/pcn/pcn24` parameter, is changed with the procedure, the **EAGLE** must be reinitialized with the `init-sys` command. The `init-sys` command reboots the entire **EAGLE** and reloads all cards with the updated self-identification information.

The `strdev` value of the `chg-stpopts` command can be used to turn on the Persistent Device States (**PDS**) feature. If **PDS** is on, the current device states for cards, signaling links, and terminals are restored after the `init-sys` command has executed. Refer to the `chg-stpopts` command description in *Commands User's Guide* for more information about **PDS**.

Note: If the `PCA`, `PCI`, `PCN`, or `PCN24` fields in the `rtrv-sid` output do not contain any values, and you only wish to add these values, it is recommended that the ["Adding a Point Code to the Self-Identification of the EAGLE" procedure](#) be used to add these values instead of using this procedure as the ["Adding a Point Code to the Self-Identification of the EAGLE" procedure](#) does not require the **EAGLE** to be re-initialized after the point code value is added.

The `chg-sid` command uses these parameters:

`:pc/pca/pci/pcn/pcn24` – The point code used to uniquely identify the **EAGLE** or, with the value `none`, the point code is defined by the `pc/pca/pcn24` parameter is removed from the database. Removing the `pci` or `pcn` value should be done by using the `npci` or `npcn` parameters.

`:cpc/cpca/cpci/cpcn/cpcn24` – The point code used to identify a group of functionally related nodes in the signaling network to which the **EAGLE** belongs. This point code is called the capability point code.

`:npc/npc/npci/npcn/npcn24` – The new capability point code that replaces an existing capability point code in the database or, with the value `none`, removes an existing capability point code from the database.

`:npci/npcn` – The new **ITU-I** (`npci`) or 14-bit **ITU-N** (`npcn`) point code used to uniquely identify the **EAGLE** that replaces an existing `pci` or `pcn` parameter value, with the value `none`, removes an existing `pci` or `pcn` parameter value from the database. The `npci/npcn` parameter values cannot be equal to any `cpc` or `pc` parameter values. The `pci` parameter must be specified if the `npci` parameter is specified. The `pcn` parameter must be specified if the `npcn` parameter is specified. The new **ITU-I** or 14-bit **ITU-N** point code values (`npci/npcn`) must be the same type as the `pci/pcn` parameter value. For example, if the `pci` value is a non-spare point code,

the `npci` value must be a non-spare point code. If the `pci` value is a spare point code, the `npci` value must be a spare point code.

Note: See [Point Code Formats](#) for a definition of the point code types that are used on the **EAGLE** and for a definition of the different formats that can be used for ITU national point codes.

`:clli` – The **Common Language Location Identifier** assigned to the **EAGLE**

`:pctype` – Point code type, either `ansi` or `other`.

`:cpctype` – the type of capability point code: `STP`, `LNP`, `INP`, `EIR`, `GPORT`, `GFLEX`, `MNP`, `VFLEX`, `ATINPQ`, `AIQ`.

The self-identification of the **EAGLE** can consist of an **ANSI** point code, an **ITU** international non-spare point code, an **ITU** international spare point code, a 14-bit **ITU** national non-spare point code, a 14-bit **ITU** national spare point code, or a 24-bit **ITU** national point code, or combinations of these types of point codes. The self-identification of the **EAGLE** cannot have both a 14-bit **ITU-N** point code (spare or non-spare) and a 24-bit **ITU-N** point code.

The self-identification of the **EAGLE** must contain point codes whose formats match the network the **EAGLE** is connected to. For example, if the **EAGLE** is connected to an **ANSI** network, the self-identification of the **EAGLE** must contain an **ANSI** point code. If the **EAGLE** is connected to an **ITU** international network, the self-identification of the **EAGLE** must contain an **ITU** international point code. If the **EAGLE** is connected to an **ITU** national network, the self-identification of the **EAGLE** must contain either a 14-bit or a 24-bit **ITU** national point code.

The self-identification of the **EAGLE** can contain capability point codes. A capability point code is used by the **SS7** protocol to identify a group of functionally related nodes in the signaling network. The self-identification of the **EAGLE** can contain up to 96 capability point codes which can be all one point code network type, or a mixture of all three point code network types.

The **EAGLE** can contain an **ANSI** capability point code, an **ITU** national capability point code (spare or non-spare), and either a 14-bit (spare or non-spare) or a 24-bit **ITU-N** capability point code.

Note: The self-identification of the **EAGLE** cannot contain private point codes, and private point codes cannot be assigned as capability point codes.

ITU international and 14-bit **ITU** national spare point codes can be specified only if the **ITU National and International Spare Point Code Support** feature is enabled. The status of this feature can be verified by entering the `rtrv-ctrl-feat` command. If the **ITU National and International Spare Point Code Support** feature is not enabled, perform the [Activating the ITU National and International Spare Point Code Support Feature](#) to enable the **ITU National and International Spare Point Code Support** feature.

The self-identification of the **EAGLE** can also contain a **CLLI**, the common language location identifier of the **EAGLE**.

The **CLLI** of the **EAGLE** cannot match the **CLLI** of any destination point code. Use the `rtrv-dstn` command to verify the **CLLIs** of the destination point codes in the database.

If the CLLI of the Eagle is changed and the SEAS over IP feature is enabled and turned on, the **CCSMR** configuration must be updated with the new CLLI. Perform the procedures in the "SEAS over IP Configuration Procedures" chapter in the *Database Administration - System Management User's Guide* to update the CCSMR configuration.

If the **CLLI** of the **EAGLE** is to be changed, and the Eagle Support for **Integrated Sentinel (E5IS)** feature is on, the **EISCOPY** option must be off before the `chg-sid` command is executed. The value of the **EISCOPY** option can be verified with the `rtrv-eisopts` command. After the `chg-sid` command is executed, the **EISCOPY** option must be changed back to on.

Capability point codes are specified with the `cpctype` parameter with the capability point code parameters, `cpc/cpca/cpci/cpcn/cpcn24`, or the new capability point code parameters, `ncpc/ncpca/ncpci/ncpcn/ncpcn24`. The EAGLE supports these types of capability point codes.

- STP capability point codes are specified with the `cpctype=stp` parameter. **STP** capability point codes can be any point code type. **STP** capability point codes can be specified regardless of which features are enabled or turned on.
- LNP capability point codes are specified with the `cpctype=lnp` parameter. LNP capability point codes can be only ANSI point codes, specified with either the `cpc`, `cpca`, `ncpc`, or `ncpca` parameters. The LNP feature must be enabled to specify the `cpctype=lnp` parameter. This can be verified with the `rtrv-ctrl-feat` command. If the LNP feature is enabled, the entry LNP TNs is shown in the `rtrv-ctrl-feat` command output with a quantity greater than zero.

If any of these capability point codes are shown in the `rtrv-sid` output: INP, EIR, G-Port, G-Flex, MNP, V-Flex, ATINPQ; then LNP capability point codes cannot be provisioned. If any of these features are enabled, and turned on if required: INP, ANSI-41 INP Query, EIR, G-Port, A-Port, G-Flex, IS41 GSM Migration, V-Flex, ATINP; then LNP capability point codes cannot be provisioned. If the LNP feature is not enabled, perform the procedures in *ELAP Administration and LNP Feature Activation User's Guide* to enable the LNP feature.

- INP capability point codes are specified with the `cpctype=inp` parameter. **INP** capability point codes can be either an ITU-I, 14-bit ITU-N, or 24-bit ITU-N point code, specified with either the `cpci`, `cpcn`, `cpcn24`, `ncpci`, `ncpcn`, or `ncpcn24` parameters. The INP or ANSI-41 INP Query feature must be enabled and turned on to specify the `cpctype=inp` parameter. Enter the `rtrv-ctrl-feat` command to verify whether or not the INP or ANSI-41 INP Query feature is enabled and turned on.

If LNP capability point codes are shown in the `rtrv-sid` output, or the LNP feature is enabled, INP capability point codes cannot be provisioned. If either the INP or ANSI-41 INP Query feature is not enabled or turned on, perform the procedures in the *INP/AINPQ User's Guide* to enable and turn on the INP or ANSI-41 INP Query feature.

- EIR capability point codes are specified with the `cpctype=eir` parameter. **EIR** capability point codes can be either an ITU-I, 14-bit ITU-N, or 24-bit ITU-N point code, specified with either the `cpci`, `cpcn`, `cpcn24`, `ncpci`, `ncpcn`, or `ncpcn24` parameters. The **EIR** feature must be enabled and turned on to specify the `cpctype=eir` parameter. Enter the `rtrv-ctrl-feat` command to verify whether or not the **EIR** feature is enabled and turned on.

If LNP capability point codes are shown in the `rtrv-sid` output, or the LNP feature is enabled, **EIR** capability point codes cannot be provisioned. If the **EIR**

feature is not enabled or turned on, perform the procedures in *EIR User's Guide* to enable and turn on the **EIR** feature.

- G-Flex capability point codes are specified with the `cpctype=gflex` parameter. G-Flex capability point codes can be any point code type. The G-Flex feature must be enabled and turned on to specify the `cpctype=gflex` parameter. Enter the `rtrv-ctrl-feat` command to verify whether or not the G-Flex feature is enabled and turned on. If LNP capability point codes are shown in the `rtrv-sid` output, or if the LNP feature is enabled, G-Flex capability point codes cannot be provisioned. If the G-Flex feature is not enabled or turned on, perform the procedures in *G-Flex User's Guide* to enable and turn the G-Flex feature on.
- G-Port capability point codes are specified with the `cpctype=gport` parameter. **G-Port** capability point codes can be any point code type. The **G-Port** feature must be enabled to specify the `cpctype=gport` parameter. Enter the `rtrv-ctrl-feat` command to verify whether or not the **G-Port** feature is enabled. If **LNP** or **MNP** capability point codes are shown in the `rtrv-sid` output, or the LNP, A-Port, or IS41 GSM Migration features are enabled, **G-Port** capability point codes cannot be provisioned. If the **G-Port** feature is not enabled, perform the procedures in *G-Port User's Guide* to enable the **G-Port** feature.
- MNP capability point codes are specified with the `cpctype=mnnp` parameter. **MNP** capability point codes can be any point code type. The **A-Port** feature or **IS41 GSM Migration** feature must be enabled to specify the `cpctype=mnnp` parameter. Enter the `rtrv-ctrl-feat` command to verify whether or not the **A-Port** feature or **IS41 GSM Migration** feature is enabled. If **LNP** or **G-Port** capability point codes are shown in the `rtrv-sid` output, or the LNP or G-Port features are enabled, **MNP** capability point codes cannot be provisioned. If the **A-Port** feature is not enabled, perform the procedures in *A-Port User's Guide* to enable the **A-Port** feature. If the **IS41 GSM Migration** feature is not enabled, perform the procedures in *IS41 GSM Migration User's Guide* to enable the **IS41 GSM Migration** feature.
- V-Flex capability point codes are specified with the `cpctype=vflex` parameter. **V-Flex** capability point codes can be any point code type. The V-Flex feature must be enabled and turned on to specify the `cpctype=vflex` parameter. Enter the `rtrv-ctrl-feat` command to verify whether or not the V-Flex feature enabled and turned on. If LNP capability point codes are shown in the `rtrv-sid` output, or the LNP feature is enabled, V-Flex capability point codes cannot be provisioned. If the V-Flex feature is not enabled or turned on, perform the procedures in *V-Flex User's Guide* to enable and turn on the V-Flex feature.
- ATINPQ capability point codes are specified with the `cpctype=atinpq` parameter. **ATINPQ** capability point codes can be either an ANSI, ITU-I, or 14-bit ITU-N point code, specified with either the `cpc/cpca`, `cpci`, `cpcn`, `ncpc/ncpca`, `ncpci`, or `ncpcn` parameters.
The **ATINP** feature must be enabled to specify the `cpctype=atinpq` parameter. Enter the `rtrv-ctrl-feat` command to verify whether or not the **ATINP** feature is enabled. If **LNP** capability point codes are shown in the `rtrv-sid` output, or the LNP feature is enabled, **ATINPQ** capability point codes cannot be provisioned. If the **ATINP** feature is not enabled, perform the procedures in *ATINP User's Guide* to enable the **ATINP** feature.
- AIQ capability point codes are specified with the `cpctype=aiq` parameter. **AIQ** capability point codes can be either an ANSI, ITU-I, or 14-bit ITU-N point code,

specified with either the `cpc/cpca`, `pci`, `cpcn`, `ncpc/ncpca`, `ncpci`, or `ncpcn` parameters.

The **ANSI41 AIQ** feature must be enabled to specify the `cpctype=aiq` parameter. Enter the `rtrv-ctrl-feat` command to verify whether or not the **ANSI41 AIQ** feature is enabled. **AIQ** capability point codes can be specified regardless of which features, other than the **ANSI41 AIQ** feature, are enabled or turned on. If the **ANSI41 AIQ** feature is not enabled, perform the procedures in the *Analyzed Information Features User's guide* to enable the **ANSI41 AIQ** feature.

The `pctype` parameter of the `chg-sid` command determines the format of point codes (but not the **ITU** international or **ITU** national point codes) that can be used on the **EAGLE**, `ansi` and `other`. The value `ansi` means the **EAGLE** supports point codes that meet the **ANSI** standard. The value `other` means that the **EAGLE** supports point codes that do not meet the **ANSI** standard. The `pctype` parameter does not apply to **ITU** international or **ITU** national point codes. See the “**ANSI Point Codes**” in the [Point Code Formats](#) section for more information about **ANSI** point codes.

This procedure causes a change in the routing information for this node. Make sure that all other nodes that route messages to this node are notified of these changes.

The point code of the **EAGLE** cannot match the capability point codes of the **EAGLE**. The point code of the **EAGLE** and the capability point codes of the **EAGLE** are shown in 1.

The point code and capability point codes of the **EAGLE** cannot match any destination point codes. Use the `rtrv-dstn` command to display the destination point codes in the database.

The point code and capability point codes of the **EAGLE** cannot be defined as a destination point code of a route. Use the `rtrv-rte` command to display the destination point codes of the routes in the database.

The point code and capability point codes of the **EAGLE** cannot match any emulated point code (EPC) values that are shown in the `rtrv-pct` output

The point code of the **EAGLE** or the capability point codes, specified by the `pc/pca/pci/pcn/pcn24`, `cpc/cpca/cpci/cpcn/cpcn24` or `ncpc/ncpca/ncpci/ncpcn/ncpcn24` parameters, must be a full point code and cannot be a cluster point code. A point code containing all zeros cannot be used as a value for **ANSI** (`pc/pca`, `cpc/cpca`, `ncpc/ncpca`) and **ITU-I** (`pci`, `cpci`, `ncpci`) parameters. A point code containing all zeros can be used as a value for 14-bit **ITU-N** (`pcn`, `cpcn`, `ncpcn`) and 24-bit **ITU-N** (`pcn24`, `cpcn24`, `ncpcn24`) parameters.

If either the `cpctype` parameter or the capability point code parameter (`cpc/cpca/cpci/cpcn/cpcn24`) are specified, the other parameter must be specified.

If the new capability point code parameter (`ncpc/ncpca/ncpci/ncpcn/ncpcn24`) is specified, the capability point code parameter (`cpc/cpca/cpci/cpcn/cpcn24`) and the `cpctype` parameters must be specified.

Only one of the new capability point code parameters (`ncpc/ncpca/ncpci/ncpcn/ncpcn24`) can be specified with the `chg-sid` command.

The new capability point code (`ncpc/ncpca/ncpci/ncpcn/ncpcn24`) must be of the same point code type as the capability point code (`cpc/cpca/cpci/cpcn/cpcn24`) specified in the command. For example, if an **ITU** international capability point code (`cpci`) is being replaced, then only the `ncpci` parameter can be specified.

The point code of the **EAGLE** cannot be changed if it is referenced in the mated application table. Enter the `rtrv-map` command to verify if the **EAGLE**'s point code

is being referenced in the mated application table. The **EAGLE's** point code would be shown in the `PCA`, `PCI`, `PCN`, `PCN24`, `MPCA`, `MPCI`, `MPCN`, or `MPCN24` fields of the `rtrv-map` command output. If the **EAGLE's** point code is referenced by the mated application table, perform the Removing a Mated Application procedure in *Database Administration - GTT User's Guide*, and remove the mated applications that reference the **EAGLE's** point code.

The destination point codes and alias point codes are shown in the `DPCA`, `DPCI`, `DPCN`, `DPCN24`, `ALIASA`, `ALIASI`, `ALIASN`, and `ALIASN24` fields in the `rtrv-dstn` command output. Secondary point codes are shown in the `SPCA`, `SPCI`, `SPCN`, and `SPCN24` fields in the `rtrv-spc` command output. The **EAGLE's** point code and capability point codes are displayed in the `PCA`, `PCI`, `PCN`, `PCN24`, `CPCA`, `CPCI`, `CPCN`, and `CPCN24` fields in the `rtrv-sid` command output. The **EAGLE's** true point code and capability point codes cannot be shown in either the `rtrv-dstn` or `rtrv-spc` command outputs.

To assign group codes to a 14-bit **ITU-N** point code, the **ITU** duplicate point code and multiple point code support features must be on. If the **ITU** National Duplicate **Point Code** feature is on, the entry `ITUDUPPC = on` is shown in the `rtrv-feat` command output. If the multiple point code support feature is on, the entry `MPC = on` is shown in the `rtrv-feat` command output. For more information on using group codes with 14-bit **ITU-N** point codes, see the [ITU National Duplicate Point Codes](#) section.

Note: Once the **ITU** duplicate point code and multiple point code support features are turned on with the `chg-feat` command, they cannot be turned off.

The **ITU** duplicate point code and multiple point code support features must be purchased before you turn this feature on with the `chg-feat` command. If you are not sure if you have purchased the **ITU** duplicate point code and multiple point code support features, contact your Oracle Sales Representative or Account Representative.

If you wish to specify the `pcn24` parameter with the `chg-sid` command and the `rtrv-sid` output shows the `PCN` field, the 14-bit **ITU-N** point code value, shown in the `PCN` field must be removed with the `npcn=none` parameter before the `pcn24` parameter value can be specified by the `chg-sid` command. If the `PCN` field contains both spare and non-spare point code values, both the spare and non-spare 14-bit **ITU-N** point code values must be removed before the `pcn24` parameter can be specified. If no value is shown in the `PCN` field, specifying the `npcn=none` parameter is not necessary.

If you wish to specify the `pcn` parameter with the `chg-sid` command and the `rtrv-sid` output shows the `PCN24` field, the 24-bit **ITU-N** point code value, shown in the `PCN24` field must be removed with the `pcn24=none` parameter before the `pcn` parameter value can be specified by the `chg-sid` command. If no value is shown in the `PCN24` field, specifying the `pcn24=none` parameter is not necessary.

When the **EAGLE** is initially installed, the self-identification of the **EAGLE** must be configured before any destination point codes can be configured in the database.

For the examples in this procedure, the self-identification of the **EAGLE** is being changed to these values:

ANSI point code = 100-100-100

ITU international point code = 3-75-7

14-bit ITU national point code = 7-9-8-1

LNP capability point code = 006-006-006

The format of the 14-bit ITU national point codes used in these examples is 4-4-4-2.

Canceling the RTRV-DSTN, RTRV-MAP, and RTRV-RTE Commands

Because the `rtrv-dstn`, `rtrv-map`, and `rtrv-rte` commands used in this procedure can output information for a long period of time, the `rtrv-dstn`, `rtrv-map`, and `rtrv-rte` commands can be canceled and the output to the terminal stopped. There are three ways that the `rtrv-dstn`, `rtrv-map`, and `rtrv-rte` commands can be canceled:

- Press the F9 function key on the keyboard at the terminal where the `rtrv-dstn`, `rtrv-map`, or `rtrv-rte` command was entered.
- Enter the `canc-cmd` without the `trm` parameter at the terminal where the `rtrv-dstn`, `rtrv-map`, or `rtrv-rte` command was entered.
- Enter the `canc-cmd:trm=<xx>`, where `<xx>` is the terminal where the `rtrv-dstn`, `rtrv-map`, or `rtrv-rte` command was entered, from another terminal other than the terminal where the `rtrv-dstn`, `rtrv-map`, and `rtrv-rte` commands were entered. To enter the `canc-cmd:trm=<xx>` command, the terminal must allow Security Administration commands to be entered from it and the user must be allowed to enter Security Administration commands. The terminal's permissions can be verified with the `rtrv-secu-trm` command. The user's permissions can be verified with the `rtrv-user` or `rtrv-secu-user` commands.

For more information about the `canc-cmd` command, refer to *Commands User's Guide*.

1. Display the self-identification of the **EAGLE** using the `rtrv-sid` command.

This is an example of the possible output.

```
rlghncxa03w 08-09-10 11:43:04 GMT EAGLE5 39.2.0
PCA          PCI          PCN          CLLI          PCTYPE
001-001-001  1-200-6       10-13-9-3   rlghncxa03w  OTHER

CPCA
002-002-002  002-002-003  002-002-004  002-002-005
002-002-006  002-002-007  002-002-008  002-002-009
004-002-001  004-003-003  050-060-070

CPCA (LNP)
005-005-002  005-005-004  005-005-005

CPCI
1-002-1      1-002-2      1-002-3      1-002-4
2-001-1      7-222-7

CPCN
2-0-10-3    2-0-11-0    2-0-11-2    2-0-12-1
2-2-3-3    2-2-4-0    10-14-10-1
```

Continue the procedure by performing one of these steps.

- If only the CLLI or CLLI and PCTYPE values are being changed, continue the procedure with [11](#).

- If only the `PCTYPE` value is being changed, continue the procedure with [19](#).
 - If point codes will be specified in this procedure, continue the procedure by performing one of these steps.
 - If 14-bit or 24-bit ITU-N point codes will be specified, continue the procedure with [2](#).
 - If 14-bit or 24-bit ITU-N point codes will not be specified, continue the procedure with [5](#).
2. If you wish to specify the `pcn24` parameter with the `chg-sid` command and the `rtrv-sid` output shows the `PCN` field, the 14-bit ITU-N point code value, shown in the `PCN` field must be removed with the `npcn=none` parameter before the `pcn24` parameter value can be specified by the `chg-sid` command.

Before the `npcn=none` parameter can be specified, any ITU-N point codes shown in the `rtrv-dstn` output must be removed. If no value is shown in the `PCN` field, then performing this step is not necessary. If the `PCN` field contains a point code, perform the [Removing a Destination Point Code](#) procedure to remove the ITU-N point codes. After the ITU-N point codes have been removed, enter this command.

```
chg-sid:pcn=<current PCN value>:npcn=none
```

If the `PCN` field contains both spare and non-spare point code values, both the spare and non-spare 14-bit ITU-N point code values must be removed from the `rtrv-dstn` and `rtrv-sid` outputs before the `pcn24` parameter can be specified.

After the `PCN` value has been removed, continue the procedure with [6](#).

If you wish to specify the `pcn` parameter with the `chg-sid` command and the `rtrv-sid` output shows the `PCN24` field, the 24-bit ITU-N point code value, shown in the `PCN24` field must be removed with the `pcn24=none` parameter before the `pcn` parameter value can be specified by the `chg-sid` command.

Before the `pcn24=none` parameter can be specified, any ITU-N24 point codes shown in the `rtrv-dstn` output must be removed. If no value is shown in the `PCN24` field, then performing this step is not necessary. If the `PCN24` field contains a point code, perform the [Removing a Destination Point Code](#) procedure to remove the ITU-N24 point codes. After the ITU-N24 point codes have been removed, enter this command.

```
chg-sid:pcn24=none
```

After the `PCN24` value has been removed, continue the procedure with [3](#).

When the `chg-sid` command has successfully completed, this message should appear.

```
rlghncxa03w 06-05-07 09:17:40 GMT EAGLE5 39.2.0
CHG-SID: MASP A - COMPLTD
```

A caution message is displayed indicating that the **EAGLE** needs to be reinitialized.

```
CAUTION: SYSTEM SITE ID HAS BEEN CHANGED, MANUAL RE-INITIALIZATION IS NEEDED
```

3. Display the existing values for the `npcfmt i` parameter, by entering the `rtrv-stopts` command.

The value for the `npcfmt i` parameter is shown in the `NPCFMTI` field. This is an example of the possible output.

```
rlghncxa03w 08-09-17 16:02:05 GMT EAGLE5 39.2.0
STP OPTIONS
-----
NPCFMTI          4-4-4-2
```

Note: The `rtrv-stpopts` command output contains other fields that are not used by this procedure. If you wish to see all the fields displayed by the `rtrv-stpopts` command, see the `rtrv-stpopts` command description in *Commands User's Guide*.

If you wish to change the format of the 14-bit ITU national point codes, go to the [14-Bit ITU National Point Code Formats](#) section. Changing the formats of the 14-bit ITU national point codes will change how any existing 14-bit ITU national point codes are displayed in the database.

After this step has been performed, continue the procedure by performing one of these steps.

- If group codes are shown in the `rtrv-sid` output, continue the procedure with [5](#).
 - If group codes are not shown in the `rtrv-sid` output, and group codes will not be specified with the 14-bit ITU-N point codes, continue the procedure with [5](#).
 - If group codes are not shown in the `rtrv-sid` output, and group codes will be specified with the 14-bit ITU-N point codes, continue the procedure with [4](#).
4. Enter the `rtrv-feat` command to verify that the **Multiple Point Code Support** and **ITU Duplicate Point Code Support** features are on.

If the **Multiple Point Code Support** feature is on, the `MPC` field should be set to on. If the **ITU Duplicate Point Code Support** feature is on, the `ITUDUPPC` field should be set to on. For this example, these features are off.

Note: The `rtrv-feat` command output contains other fields that are not used by this procedure. If you wish to see all the fields displayed by the `rtrv-feat` command, see the `rtrv-feat` command description in *Commands User's Guide*.

If the **ITU Duplicate Point Code Support** feature is off and the **Multiple Point Code** feature is on, enter this command.

```
chg-feat:ituduppc=on
```

If both features are off, enter this command.

```
chg-feat:mpc=on:ituduppc=on
```

When the `chg-feat` has successfully completed, this message should appear.

```
rlghncxa03w 08-09-07 00:57:31 GMT EAGLE5 39.2.0
CHG-FEAT: MASP A - COMPLTD
```

- If spare point codes are being specified in this procedure, the **ITU National and International Spare Point Code Support** feature must be enabled.

Note: If an ITU-I or 14-bit ITU-N spare point code is displayed in the `rtrv-sid` output in 1, or if an ITU-I or 14-bit ITU-N spare point code is not being specified in this procedure, continue the procedure with 6. The `rtrv-ctrl-feat` command shows the status of the ITU National and International Spare Point Code Support feature.

Enter the `rtrv-ctrl-feat` command with the part number of this feature.

Enter this command.

```
rtrv-ctrl-feat:partnum=893013601
```

This is an example of the possible output.

```
rlghncxa03w 08-09-28 21:15:37 GMT EAGLE5 39.2.0
The following features have been permanently enabled:
```

Feature Name	Partnum	Status	Quantity
Spare Point Code Support	893013601	on	----

The following features have been temporarily enabled:

Feature Name	Partnum	Status	Quantity	Trial Period Left
Zero entries found.				

The following features have expired temporary keys:

Feature Name	Partnum
Zero entries found.	

If the **ITU National and International Spare Point Code Support** feature is not enabled, perform the [Activating the ITU National and International Spare Point Code Support Feature](#) procedure to enable the **ITU National and International Spare Point Code Support** feature.

- The point codes specified in this procedure cannot be shown in the `rtrv-dstn` command output.

Display the point codes in the destination point code table by using the `rtrv-dstn` command. This is an example of the possible output.

```
rlghncxa03w 10-12-10 11:43:04 GMT EAGLE5 43.0.0
Extended Processing Time may be Required
```

DPCA	CLLI	BEI	ELEI	ALIASI	ALIASN/N24	DMN
001-002-003	ls04clli	yes	---	-----	-----	SS7
002-002-002	ls01clli	no	---	-----	-----	SS7
002-007-008	ls06clli	yes	---	-----	-----	SS7
003-003-003	ls03clli	yes	---	-----	-----	SS7
004-004-004	ls02clli	yes	---	-----	-----	SS7
179-100-087	-----	yes	---	-----	-----	SS7

200-050-176	-----	yes	---	-----	-----	SS7
240-007-000	-----	yes	---	-----	-----	SS7
240-012-004	rlghncbb001	yes	---	1-111-1	10-13-9-3	SS7
240-012-005	rlghncbb002	yes	---	1-112-2	10-13-10-0	SS7
240-012-006	rlghncbb003	yes	---	1-112-3	10-13-10-1	SS7
240-012-008	-----	yes	---	1-113-5	10-13-10-2	SS7
DPCI	CLLI	BEI	ELEI	ALIASA	ALIASN/N24	DMN
2-131-1	rlghncbb023	no	---	222-210-000	11-11-8-1	SS7
2-131-2	-----	no	---	222-211-001	11-11-8-2	SS7
2-131-3	-----	no	---	222-211-002	11-11-8-3	SS7
3-150-4	lsi7clli	yes	---	-----	-----	SS7
DPCN	CLLI	BEI	ELEI	ALIASA	ALIASI	DMN
10-6-15-1	lsn5clli	yes	---	-----	-----	SS7
10-15-2-3	rlghncbb013	no	---	222-200-200	2-121-1	SS7
10-15-3-0	rlghncbb013	no	---	222-200-201	2-121-2	SS7

Destination table is (19 of 2000) 1% full

Alias table is (18 of 8000) 1% full

Continue the procedure by performing one of these steps.

- If the `pc/pca/pci/pcn/pcn24` parameter value is not being changed, continue the procedure with [10](#).
 - If the `pc/pca/pci/pcn/pcn24` parameter value is being changed to another point code value, continue the procedure with [9](#).
 - If the `pc/pca/pci/pcn/pcn24` parameter value is being removed, continue the procedure with [8](#).
7. The point codes specified in this procedure cannot be shown in the `rtrv-pct` output as an emulated point code (EPC). Display the PCT entries by entering the `rtrv-pct` command.

This is an example of the possible output.

```
rlghncxa03w 10-12-17 16:02:05 GMT EAGLE5 43.0.0
```

```

EPCA          FILTPCA          REALPCA      SI  SSN  RELCAUSE
001-001-001   *                240-012-006  5  ---  10

```

```

ECICS = 10          ECICE = 20
RCICS = 30          RCICE = 40

```

```

EPCI          FILTPCI          REALPCI      SI  SSN  RELCAUSE
1-001-2       2-131-2          2-131-3      3  10  ---

```

```

ECICS = -----  ECICE = -----
RCICS = -----  RCICE = -----

```

```

EPCN          FILTPCN          REALPCN      SI  SSN  RELCAUSE
13-11-14-1   *                10-15-2-3    *  ---  ---

```

```

ECICS = -----  ECICE = -----
RCICS = -----  RCICE = -----

```

Unique EPC is 3 of 250

Unique RealPC is 3 of 250

PCT table is (3 of 1000) 1% full.

Continue the procedure by performing one of these steps.

- If the `pc/pca/pci/pcn/pcn24` parameter value is not being changed, continue the procedure with 10.
 - If the `pc/pca/pci/pcn/pcn24` parameter value is being changed to another point code value, continue the procedure with 9.
 - If the `pc/pca/pci/pcn/pcn24` parameter value is being removed, continue the procedure with 8.
8. For the **EAGLE** to have point codes of a particular network type (**ANSI**, **ITU-I**, or **ITU-N**), a point code of that same type must be defined by the `pc/pca/pci/pcn/pcn24` parameter of the `chg-sid` command.

To remove a point code defined by the `pc/pca/pci/pcn/pcn24` parameter, all point codes of the same network type as the point code being removed in this procedure must be removed from the database.

If the `rtrv-dstn` output in 6 shows that there are no point codes of the same network type as the point code being removed, continue the procedure with 11.

If the `rtrv-dstn` output in 6 shows that there are point codes of the same network type as the point code being removed, perform the [Removing a Destination Point Code](#) procedure and remove the point codes shown in the `rtrv-dstn` output in 6 that are the same network type as the point code being removed in this procedure.

After this step is performed, continue the procedure with 11.

9. Display the mated applications in the database, using the `rtrv-map` command.

This is an example of the possible output.

```
rlghncxa03w 09-07-07 00:34:31 GMT EAGLE5 41.1.0

PCA          Mate PCA          SSN RC MULT SRM MRC GRP NAME SSO
255-001-000          250 10 SOL *N *N GRP01  ON
255-001-000          251 10 SHR *Y *Y GRP01  OFF
253-001-002          254 10 SHR *Y *Y GRP01  OFF
255-001-000          252 10 SOL *Y *Y GRP01  ON
255-001-000          253 10 SHR *N *N GRP01  OFF
253-001-004          254 10 SHR *N *N GRP01  OFF
255-001-001          255 10 DOM YES YES GRP01  ON
253-001-005          254 20 DOM YES YES GRP01  ON
255-001-001          250 10 DOM YES YES GRP01  OFF
253-001-001          254 20 DOM YES YES GRP01  OFF
255-001-002          251 10 SHR *Y *Y GRP01  OFF
255-001-002          254 10 SHR *Y *Y GRP01  OFF
255-001-002          252 10 DOM YES YES GRP01  ON
```

```

                255-001-003  254 20  DOM YES YES GRP01  ON
255-001-002
                253 10  SHR *Y *Y GRP01  ON
                255-001-004  254 10  SHR *Y *Y GRP01  ON

PCI             Mate PCI      SSN RC MULT SRM MRC GRP NAME SSO
2-001-2        2-001-1        255 10  DOM NO  NO  GRP03  OFF
                254 20  DOM NO  NO  GRP03  OFF

PCN             Mate PCN      SSN RC MULT SRM MRC GRP NAME SSO
0-5-6-3       1-5-10-3       253 10  SHR NO  *Y  GRP05  OFF
                254 10  SHR NO  *N  GRP05  OFF

```

MAP TABLE IS (20 of 1024) 2 % FULL

If the **EAGLE's** point code is shown in the `rtrv-map` command output (in the `PCA`, `PCI`, `PCN`, `PCN24`, `MPCA`, `MPCI`, `MCPN`, or `MPCN24` fields), perform the Removing a Mated Application procedure in the *Database Administration - GTT User's Guide*, and remove the **EAGLE's** point code from the mated application table.

10. Display the secondary point codes in the database, using the `rtrv-spc` command.

This is an example of the possible output.

```

rlghncxa03w 08-09-07 11:43:04 GMT  EAGLE5 39.2.0
SPC (Secondary Point Codes)
SPCA
    001-010-010
    002-010-010
    003-010-010
    010-100-010
SPC-I
    1-253-5
    2-254-6
    3-255-7
    4-100-1
SPC-N
    10-01-11-1
    13-02-12-0
    14-15-12-1
SPC-N24
none
Secondary Point Code table is (11 of 40) 28% full

```

If the **EAGLE's** point code or capability point code that is being configured in this procedure is shown in [6](#) or [10](#), choose another point code to configure with this procedure.

Continue the procedure by performing one of these steps.

- If the `clli` parameter value is not being changed, continue the procedure with [15](#).
- If the `clli` parameter value is being changed, continue the procedure with [11](#).

11. Enter the `rtrv-feat` command, or examine the `rtrv-feat` output in [4](#), if [4](#) was performed, to verify that the Eagle Support for **Integrated Sentinel** feature is on.

If the Eagle Support for **Integrated Sentinel** feature is on, the E5IS field should be set to on.

Note: The `rtrv-feat` command output contains other fields that are not used by this procedure. If you wish to see all the fields displayed by the `rtrv-feat` command, see the `rtrv-feat` command description in *Commands User's Guide*.

Continue the procedure by performing one of these steps.

- If the Eagle Support for **Integrated Sentinel** feature is not on, continue the procedure with [15](#).
- If the Eagle Support for **Integrated Sentinel** feature is on, continue the procedure with [12](#).

12. Display the **EISCOPY** option by entering the `rtrv-eisopts` command.

This is an example of the possible output.

```
rlghncxa03w 10-07-07 11:43:04 GMT EAGLE5 42.0.0
EIS OPTIONS
-----
EISCOPY = ON

FAST COPY OPTIONS
-----
FCGPL = IPSG          FCMODE = FCOPY
FCGPL = IPGHC         FCMODE = FCOPY
-----
```

Continue the procedure by performing one of these steps.

- If the **EISCOPY** option is off, continue the procedure with [15](#).
- If the **EISCOPY** option is on, continue the procedure by performing one of these steps..
 - If the **FCMODE** value for all the GPLs shown in the `rtrv-eisopts` output is OFF, continue the procedure with [15](#).
 - If the **FCMODE** value for any of the GPLs shown in the `rtrv-eisopts` output is STC or FCOPY, continue the procedure with [13](#).

13. Change the **FCMODE** values for all the GPLs shown in [12](#) to OFF by entering this command.

```
chg-eisopts:fcmode=off:fcgpl=all
```

When the `chg-eisopts` has successfully completed, this message should appear.

```
rlghncxa03w 10-07-07 11:43:04 GMT EAGLE5 42.0.0
CHG-EISOPTS: MASP A - COMPLTD
```

14. Turn the **EISCOPY** option off by entering the `chg-eisopts` command with the `eiscopy=off` parameter.

Caution: Changing the `EISCOPY` option to `off` will disable the Eagle Support for **Integrated Sentinel** feature.

When the `chg-eisopts` has successfully completed, this message should appear.

```
rlghncxa03w 08-09-07 11:43:04 GMT EAGLE5 39.2.0
CHG-EISOPTS: MASP A - COMPLTD
```

Continue the procedure by performing one of these steps.

- If capability point codes will not be provisioned in this procedure, continue the procedure with [19](#).
 - If capability point codes will be provisioned in this procedure, continue the procedure with [15](#).
15. To add a particular type of **CPC**, only one **CPC** type (the `cpctype` parameter) can be specified with the `chg-sid` command, and the feature corresponding to the **CPC** type must be enabled or turned on.

The EAGLE supports these types of CPCs.

- **STP CPCs** - no feature is required to be enabled or turned on to specify STP CPCs. If you wish to add an STP CPC, continue the procedure with [19](#).
- **LNPCPCs** - If you wish to add an LNP CPC and LNP CPCs are shown in the `rtrv-sid` output in [1](#), continue the procedure with [19](#). If only STP CPCs are shown in the `rtrv-sid` output in [1](#), continue the procedure with [18](#). If any of these CPCs are shown in the `rtrv-sid` output in [1](#): INP, G-Port, G-Flex, EIR, MNP, V-Flex, ATINPQ, LNP CPCs cannot be added.
- **INP CPCs** - If you wish to add an INP CPC and INP CPCs are shown in the `rtrv-sid` output in [1](#), continue the procedure with [19](#). If INP and LNP CPCs are not shown in the `rtrv-sid` output in [1](#), continue the procedure with [16](#). If LNP CPCs are shown in the `rtrv-sid` output in [1](#), INP CPCs cannot be added.
- **G-Flex CPCs** - If you wish to add a G-Flex CPC and G-Flex CPCs are shown in the `rtrv-sid` output in [1](#), continue the procedure with [19](#). If G-Flex and LNP CPCs are not shown in the `rtrv-sid` output in [1](#), continue the procedure with [16](#). If LNP CPCs are shown in the `rtrv-sid` output in [1](#), G-Flex CPCs cannot be added.
- **MNP CPCs** - If you wish to add an MNP CPC and MNP CPCs are shown in the `rtrv-sid` output in [1](#), continue the procedure with [19](#). If MNP and LNP CPCs are not shown in the `rtrv-sid` output in [1](#), continue the procedure with [16](#). If LNP CPCs are shown in the `rtrv-sid` output in [1](#), MNP CPCs cannot be added.
- **EIR CPCs** - If you wish to add an EIR CPC and EIR CPCs are shown in the `rtrv-sid` output in [1](#), continue the procedure with [19](#). If EIR and LNP CPCs are not shown in the `rtrv-sid` output in [1](#), continue the procedure with [16](#). If LNP CPCs are shown in the `rtrv-sid` output in [1](#), EIR CPCs cannot be added.

- **V-Flex CPCs** - If you wish to add a V-Flex CPC and V-Flex CPCs are shown in the `rtrv-sid` output in 1, continue the procedure with 19. If V-Flex and LNP CPCs are not shown in the `rtrv-sid` output in 1, continue the procedure with 16. If LNP CPCs are shown in the `rtrv-sid` output in 1, V-Flex CPCs cannot be added.
 - **ATINPQ CPCs** - If you wish to add an ATINPQ CPC and ATINPQ CPCs are shown in the `rtrv-sid` output in 1, continue the procedure with 19. If ATINPQ and LNP CPCs are not shown in the `rtrv-sid` output in 1, continue the procedure with 16. If LNP CPCs are shown in the `rtrv-sid` output in 1, ATINPQ CPCs cannot be added.
 - **G-Port CPCs** - If you wish to add a G-Port CPC and G-Port CPCs are shown in the `rtrv-sid` output in 1, continue the procedure with 19. If G-Port, MNP, and LNP CPCs are not shown in the `rtrv-sid` output in 1, continue the procedure with 17. If LNP or MNP CPCs are shown in the `rtrv-sid` output in 1, G-Port CPCs cannot be added.
 - **AIQ CPCs** - If you wish to add an AIQ CPC and AIQ CPCs are shown in the `rtrv-sid` output in 1, continue the procedure with 19. If AIQ CPCs are not shown in the `rtrv-sid` output in 1, continue the procedure with 16.
16. To specify these types of CPCs: INP, G-Flex, MNP, EIR, V-Flex, ATINPQ, AIQ, the following features must be enabled, and turned on if necessary.
- INP CPCs - the INP or ANSI-41 INP Query features must be enabled and turned on.
 - G-Flex CPCs - the G-Flex feature must be enabled and turned on.
 - EIR CPCs - the EIR feature must be enabled and turned on.
 - MNP CPCs - the A-Port or IS41 GSM Migration features must be enabled.
 - V-Flex CPCs - the V-Flex feature must be enabled and turned on.
 - ATINPQ CPCs - the ATINP feature must be enabled.
 - AIQ CPCs - the ANSI41 AIQ feature must be enabled.

Enter the `rtrv-ctrl-feat` command to verify the status of the feature required for the CPC that is being added. This is an example of the possible output.

```
rlghncxa03w 08-09-28 21:15:37 GMT EAGLE5 39.2.0
The following features have been permanently enabled:
```

Feature Name	Partnum	Status	Quantity
Command Class Management	893005801	on	----
Intermed GTT Load Sharing	893006901	on	----
XGTT Table Expansion	893006101	on	4000000
XMAP Table Expansion	893007710	on	3000
Large System # Links	893005901	on	1500
Routesets	893006401	on	6000
HC-MIM SLK Capacity	893012707	on	64

```
The following features have been temporarily enabled:
```

Feature Name	Partnum	Status	Quantity	Trial Period Left
Zero entries found.				

The following features have expired temporary keys:

Feature Name	Partnum
Zero entries found.	

If the LNP feature is enabled, LNP, AIQ, or STP CPCs can be specified in this procedure. If an AIQ CPC will be provisioned, continue with this step. If an LNP or STP CPC will be provisioned, continue the procedure with 19.

If the feature that is required for the CPC that is being added is enabled, and turned on if required, continue the procedure with 19.

If the feature that is required for the CPC that is being added is not enabled, or turned on if required, perform the procedures in one of the following manuals to enable, and turn on if required, the feature required to support the CPC that is being added.

- INP CPCs - *INP/AINPQ User's Guide* – to enable and turn on the INP or ANSI-41 INP Query features.
- G-Flex CPCs - *G-Flex User's Guide* – to enable and turn on the G-Flex feature.
- EIR CPCs - *EIR User's Guide* – to enable and turn on the EIR feature.
- MNP CPCs - *A-Port User's Guide* to enable the A-Port feature, or *IS41 GSM Migration User's Guide* – to enable the IS41 GSM Migration feature.

Note: If G-Port CPCs are shown in the `rtrv-sid` output, when the A-Port or IS41 GSM Migration features are enabled, the G-Port CPCs are changed to MNP CPCs.

- V-Flex CPCs - *V-Flex User's Guide* – to enable and turn on the V-Flex Feature.
- ATINPQ CPCs - *ATINP User's Guide* – to enable the ATINP feature.
- AIQ CPCs - *Analyzed Information Features User's Guide* – to enable the ANSI41 AIQ feature.

After the required feature has been enabled, and turned on if required, continue the procedure with 19.

17. To provision G-Port CPCs, the G-Port feature must be enabled. Verify that the G-Port feature is enabled by entering the `rtrv-ctrl-feat` command. This is an example of the possible output.

```
rlghncxa03w 08-09-28 21:15:37 GMT EAGLE5 39.2.0
The following features have been permanently enabled:
```

Feature Name	Partnum	Status	Quantity
Command Class Management	893005801	on	----
Intermed GTT Load Sharing	893006901	on	----
XGTT Table Expansion	893006101	on	4000000
XMAP Table Expansion	893007710	on	3000
Large System # Links	893005901	on	1500
Routesets	893006401	on	6000
HC-MIM SLK Capacity	893012707	on	64

The following features have been temporarily enabled:

```
Feature Name          Partnum  Status  Quantity  Trial Period Left
Zero entries found.
```

The following features have expired temporary keys:

```
Feature Name          Partnum
Zero entries found.
```

If G-Port feature is enabled, continue the procedure with [19](#).

If the G-Port feature is not enabled, perform the procedures in the *G-Port User's Guide* to enable the G-Port feature. After the G-Port feature has been enabled, continue the procedure with [19](#).

If the LNP feature is enabled, LNP, AIQ, or STP CPCs can be specified in this procedure. If an AIQ CPC will be provisioned, continue the procedure with [16](#). If an LNP or STP CPC will be provisioned, continue the procedure with [19](#).

If either the A-Port or IS41 GSM Migration features are enabled, G-Port CPCs cannot be provisioned. If you wish to provision other types of CPCs, go back to [15](#) and select another type of CPC to provision. If you do not wish to provision other CPCs, continue the procedure with [19](#) to provision the self identification without provisioning CPCs.

- 18.** To provision LNP CPCs, the LNP feature must be enabled. Verify that the LNP feature is enabled by entering the `rtrv-ctrl-feat` command. This is an example of the possible output.

```
rlghncxa03w 08-09-28 21:15:37 GMT EAGLE5 39.2.0
The following features have been permanently enabled:
```

```
Feature Name          Partnum  Status  Quantity
Command Class Management  893005801  on      ----
LNP Short Message Service  893006601  on      ----
Intermed GTT Load Sharing  893006901  on      ----
XGTT Table Expansion      893006101  on      4000000
XMAP Table Expansion       893007710  on      3000
Large System # Links       893005901  on      1500
Routesets                 893006401  on      6000
HC-MIM SLK Capacity       893012707  on      64
```

The following features have been temporarily enabled:

```
Feature Name          Partnum  Status  Quantity  Trial Period Left
Zero entries found.
```

The following features have expired temporary keys:

```
Feature Name          Partnum
Zero entries found.
```

If the LNP feature is enabled, continue the procedure with [19](#).

If the LNP feature is not enabled and none of the features shown in [16](#) or [17](#) are enabled, except ANSI41 AIQ, and turned on if required, perform the procedures in *ELAP Administration and LNP Feature Activation User's Guide* to enable the LNP feature. After the LNP feature has been enabled, continue the procedure with [19](#). AIQ CPCs can be provisioned regardless of which features are enabled or turned on. The ANSI41 AIQ feature must be enabled to provision AIQ CPCs.

If any of the features shown in [16](#) or [17](#) are enabled, and turned on if required, except ANSI41 AIQ, LNP CPCs cannot be specified. If you wish to provision CPCs for the features that are enabled, and turned on if required, go back to [15](#) and select another type of CPC to provision. If you do not wish to provision other CPCs, continue the procedure with [19](#) to provision the self identification without provisioning CPCs.

19. Change the value of the self-identification of the **EAGLE**, using the `chg-sid` command.

For this example, the point code of the **EAGLE** is being changed to these values:

- ANSI point code = 100-100-100
- ITU international point code = 3-75-7
- ITU national point code = 7-9-8-1
- LNP capability point code = 006-006-006

To make these changes, enter this command.

```
chg-  
sid:pca=100-100-100:pci=3-75-7:pcn=7-9-8-1 :cpca=006-006-006:  
cpctype=lnp
```

If you wish to configure network routing point codes using the network indicator values 1 through 5, the `pctype` parameter value must be other. For more information on network routing point codes, see the [Network Routing](#) section.

When this command has successfully completed, this message should appear.

```
rlghncxa03w 08-09-07 09:17:40 GMT EAGLE5 39.2.0  
CHG-SID: MASP A - COMPLTD
```

If any of the `pc/pca/pci/pcn/pcn24` parameters are changed, the **EAGLE** needs to be reinitialized. A caution message is displayed indicating that the **EAGLE** needs to be reinitialized.

```
CAUTION: SYSTEM SITE ID HAS BEEN CHANGED, MANUAL RE-INITIALIZATION IS NEEDED
```

If the CLLI value has been changed, and the SEAS over IP feature is enabled and turned on, shown in the `rtrv-ctrl-feat` output, this caution messages appears.

```
CAUTION: System CLLI has changed, CCSMR re-configuration required
```

If the gateway screening redirect function's DPC is the `pc/pca/pci/pcn/pcn24` parameter value and this parameter value was changed in this step, this caution message appears.

```
CAUTION: SYSTEM SITE ID WAS REFERENCED BY THE REDIRECT FUNCTION'S DPC
```

Continue the procedure by performing one of these steps.

- If the `pc/pca/pci/pcn/pcn24` and `clli` parameters were not changed, continue the procedure with [27](#).

- If the `clli` parameter was changed, but the `pc/pca/pci/pcn/pcn24` was not changed, continue the procedure by performing one of these steps.
 - If this caution message, `CAUTION: System CLLI has changed, CCSMR re-configuration required`, appeared after the `chg-sid` command was performed, continue the procedure with [23](#).
 - If the caution message did not appear after the `chg-sid` command was performed, continue the procedure with one of these steps.
 - If the `EISCOPY` option was changed in [14](#), continue the procedure with [24](#).
 - If the `EISCOPY` option was not changed in [14](#), continue the procedure with [27](#).
- If the `pc/pca/pci/pcn/pcn24` parameter was changed, continue the procedure by performing one of these steps.
 - If you wish to change the `RSTRDEV STP` option, continue the procedure with [20](#).
 - If you do not wish to change the `RSTRDEV STP` option, continue the procedure with [21](#).

20. Enter the `rtrv-stpopts` command to display the setting of the `rstrdev` parameter.

[21](#) instructs you to enter the `init-sys` command.

If you do not want the **EAGLE** to restore previous device states after the `init-sys` command has executed and `RSTRDEV` value is `on` in the `rtrv-stpopts` output, enter the `chg-stpopts:off=rstrdev` command.

If you want the **EAGLE** to restore previous device states after the `init-sys` command has executed, and `RSTRDEV` value is `off` in the `rtrv-stpopts` output, enter the `chg-stpopts:on=rstrdev` command.

Continue with [21](#).

Caution: The `init-sys` command causes a complete EAGLE reload, and should only be used during periods of low traffic. Using this command ensures the updated self-identification information is loaded onto all cards, but will interrupt service.

Caution: The `rstrdev` value of the `chg-stpopts` command can be used to turn on the Persistent Device States (**PDS**) feature. When PDS is turned off and the `init-sys` command executes, the EAGLE does not retain the manually initiated state (for example, OOS-MT-DSBLD) for the signaling links, cards, or terminals. After the command executes, the EAGLE attempts to bring all provisioned signaling links, cards, and terminals on-line, including those that were previously out of service. You will need to manually put each device back into its previous state after the EAGLE is back on-line. It is, therefore, advisable to print or electronically capture the output of the `rept-stat-slk`, `rept-stat-card`, and `rept-stat-trm` commands for reference prior to issuing the `init-sys` command. To restore a device to its previous state, issue the appropriate inhibit/deactivate command listed in *Commands User's Guide* in the Related Commands section for each of the above `rept-stat` commands. When **PDS** is turned on using the `chg-stpopts:on=rstrdev` command, the EAGLE restores the previous device states of signaling links, terminals, and cards after the `init-sys` command has executed.

21. Reinitialize the **EAGLE** by entering the `init-sys` command.

Note: The `init-sys` command must be entered twice within 30 seconds for the EAGLE to be re-initialized. If the `init-sys` command is not executed twice within 30 seconds, the attempt to re-initialize the EAGLE is aborted.

When the `init-sys` command is first entered, this message should appear.

```
rlghncxa03w 08-09-28 07:05:01 GMT EAGLE5 39.2.0
CAUTION: This command causes a complete system reload, and
will result in traffic loss.
Re-enter command within 30 seconds to confirm.
```

When the `init-sys` command is re-entered within the 30 second time limit, this message should appear.

```
rlghncxa03w 08-09-28 07:05:17 GMT EAGLE5 39.2.0
Init System command issued at terminal #3
```

From the time that the `init-sys` command is accepted, you must wait approximately two minutes before you can perform [22](#) (logging onto the **EAGLE**). If the **EAGLE** terminal is in the **VT-100/VT-320** mode, the terminal display will be refreshed with non-zero alarm counts. During this 2-minute interval, an intermediate screen refresh is caused by the **MASPs** role change from active to standby, and from standby to active. This screen refresh is typically a partial refresh, and the alarm indicators are set to zero.

If you are logged into the EAGLE in the **KSR** mode, the only response you will receive indicating that you are now able to log into the EAGLE is **UAM 0009**, **MASP** became active. **UAM 0009** could be issued twice due to possible transient **MASP** role change (switching from active to standby).

Following the execution of the `init-sys` command, the **MASP** that was active before the `init-sys` command was entered will be the active **MASP** when the EAGLE has finished reinitializing.

22. Log into the EAGLE using the login command (or the act-user command).

This is an example of the messages that appear when the login session has successfully completed.

```
NOTICE: This is a private computer system.
Unauthorized access or use may lead to prosecution.
0 LOGIN failures since last successful LOGIN
Last successful LOGIN was on port 4 on 04-06-02 @ 09:34:56
```

If the `clli` parameter was not changed in 19, continue the procedure by performing one of these steps.

- If the CAUTION: SYSTEM SITE ID WAS REFERENCED BY THE REDIRECT FUNCTION'S DPC message was displayed in 19, continue the procedure with 26.
- If the CAUTION: SYSTEM SITE ID WAS REFERENCED BY THE REDIRECT FUNCTION'S DPC message was not displayed in 19, continue the procedure with 27.

If this caution message, CAUTION: System CLI has changed, CCSMR re-configuration required, appeared in 19, continue the procedure with 23. If the caution message did not appear in 19, continue the procedure by performing one of these steps.

- If the EISCOPY option was changed in 14, continue the procedure with 24.
- If the EISCOPY option was not changed in 14, continue the procedure by performing one of these steps.
 - If the CAUTION: SYSTEM SITE ID WAS REFERENCED BY THE REDIRECT FUNCTION'S DPC message was displayed in 19, continue the procedure with 26.
 - If the CAUTION: SYSTEM SITE ID WAS REFERENCED BY THE REDIRECT FUNCTION'S DPC message was not displayed in 19, continue the procedure with 27.

23. Perform the procedures in the "SEAS Over IP Configuration Procedures" chapter in *Database Administration - System Management User's Guide* to re-configure the CCSMRs with the new CLI information.

After the CCSMRs have been re-configured, continue the procedure by performing one of these steps.

- If the EISCOPY option was changed in 14, continue the procedure with 24.
- If the EISCOPY option was not changed in 14, continue the procedure by performing one of these steps.
 - If the CAUTION: SYSTEM SITE ID WAS REFERENCED BY THE REDIRECT FUNCTION'S DPC message was displayed in 19, continue the procedure with 26.
 - If the CAUTION: SYSTEM SITE ID WAS REFERENCED BY THE REDIRECT FUNCTION'S DPC message was not displayed in 19, continue the procedure with 27.

24. Turn the **EISCOPY** option on by entering the `chg-eisopts` command with the `eiscopy=on` parameter.

Caution: The Eagle Support for the **Integrated Sentinel** feature will be disabled if this step is not performed.

When the `chg-eisopts` has successfully completed, this message should appear.

```
rlghncxa03w 08-09-28 07:05:01 GMT EAGLE5 39.2.0
CHG-EISOPTS: MASP A - COMPLTD
```

After the **EISCOPY** option has been changed, continue the procedure by performing one of these steps.

- If the **FCMODE** value was changed in 13, continue the procedure with 25.
- If 13 was not performed, continue the procedure by performing one of these steps.
 - If the **CAUTION: SYSTEM SITE ID WAS REFERENCED BY THE REDIRECT FUNCTION'S DPC** message was displayed in 19, continue the procedure with 26.
 - If the **CAUTION: SYSTEM SITE ID WAS REFERENCED BY THE REDIRECT FUNCTION'S DPC** message was not displayed in 19, continue the procedure with 27.

25. Change the **FCMODE** values that were changed in 13 to the values that were displayed in 12 by entering the `chg-eisopts` command with the `fcmode` and `fcgpl` parameter values that were displayed in 12. If all the **GPL** values were changed in 13, the `gpl=all` parameter can be specified with the `chg-eisopts` command.

For this example, enter this command.

```
chg-eisopts:fcmode=fcopy:fcgpl=all
```

When the `chg-eisopts` has successfully completed, this message should appear.

```
rlghncxa03w 10-07-28 07:05:01 GMT EAGLE5 42.0.0
CHG-EISOPTS: MASP A - COMPLTD
```

Continue the procedure by performing one of these steps.

- If the **CAUTION: SYSTEM SITE ID WAS REFERENCED BY THE REDIRECT FUNCTION'S DPC** message was displayed in 19, continue the procedure with 26.
 - If the **CAUTION: SYSTEM SITE ID WAS REFERENCED BY THE REDIRECT FUNCTION'S DPC** message was not displayed in 19, continue the procedure with 27.
26. If the point code of the **EAGLE** or capability point code is referenced by the gateway screening redirect function and the gateway screening redirect function is enabled, the gateway screening redirect function's **DPC** must be changed to reference the new **EAGLE's** point code.

Use the `chg-gws-redirect` command to change the gateway screening redirect function's **DPC**. Perform the Changing the Gateway Screening Redirect Parameters procedure in the *Database Administration - Features User's Guide* to change the gateway screening redirect function's **DPC**.

27. Verify the changes using the `rtrv-sid` command.

This is an example of the possible output.

```
rlghncxa03w 08-09-10 11:43:04 GMT EAGLE5 39.2.0
PCA          PCI          PCN          CLLI          PCTYPE
100-100-100  3-75-7         7-9-8-1     rlghncxa03w  OTHER

CPCA
002-002-002  002-002-003   002-002-004 002-002-005
002-002-006  002-002-007   002-002-008 002-002-009
004-002-001  004-003-003   050-060-070

CPCA (LNP)
005-005-002  005-005-004   005-005-005 006-006-006

CPCI
1-002-1      1-002-2       1-002-3      1-002-4
2-001-1      7-222-7

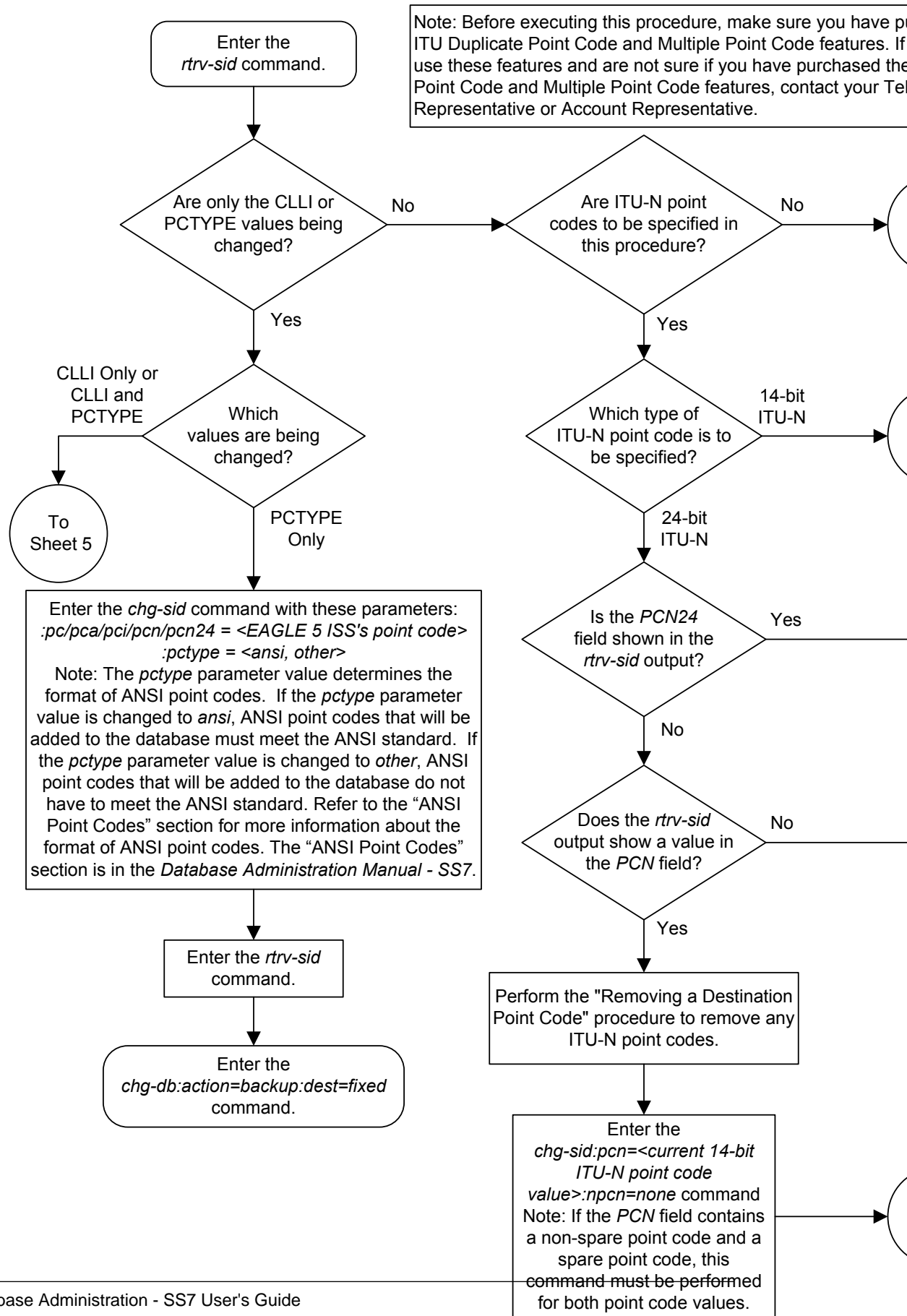
CPCN
2-0-10-3    2-0-11-0      2-0-11-2     2-0-12-1
2-2-3-3     2-2-4-0       10-14-10-1
```

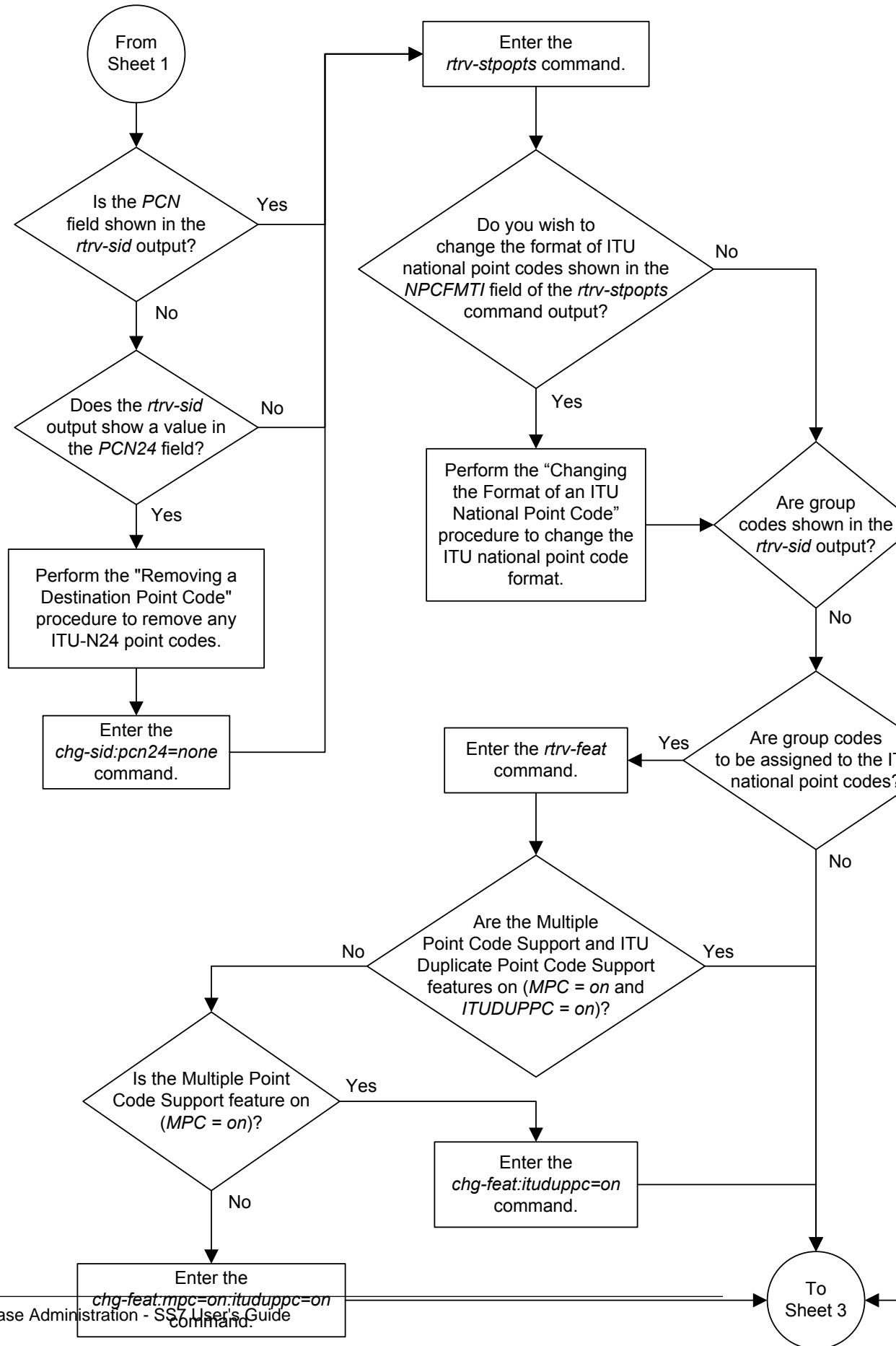
28. Back up the new changes, using the `chg-db:action=backup:dest=fixed` command.

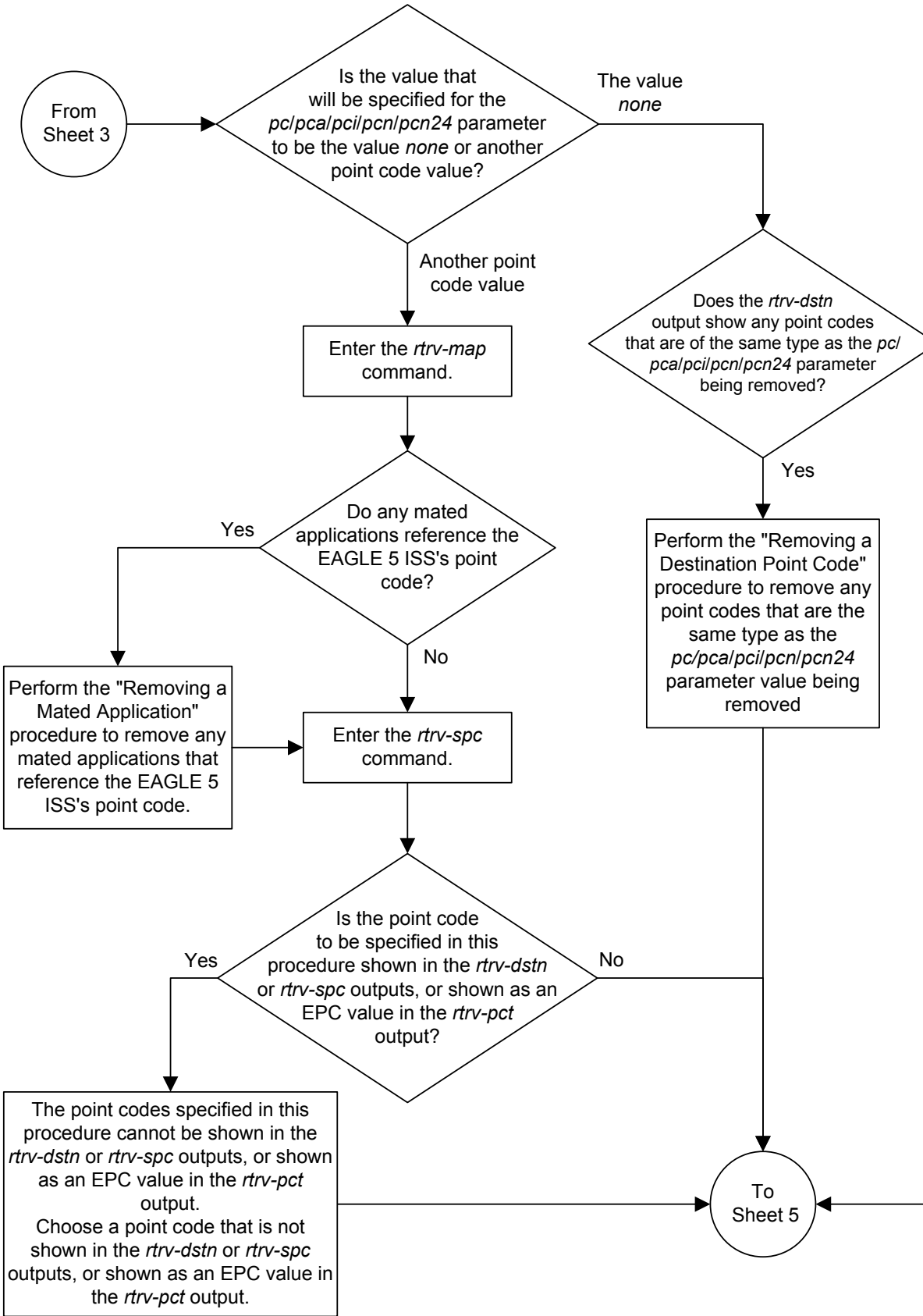
These messages should appear; the active **Maintenance and Administration Subsystem Processor (MASP)** appears first.

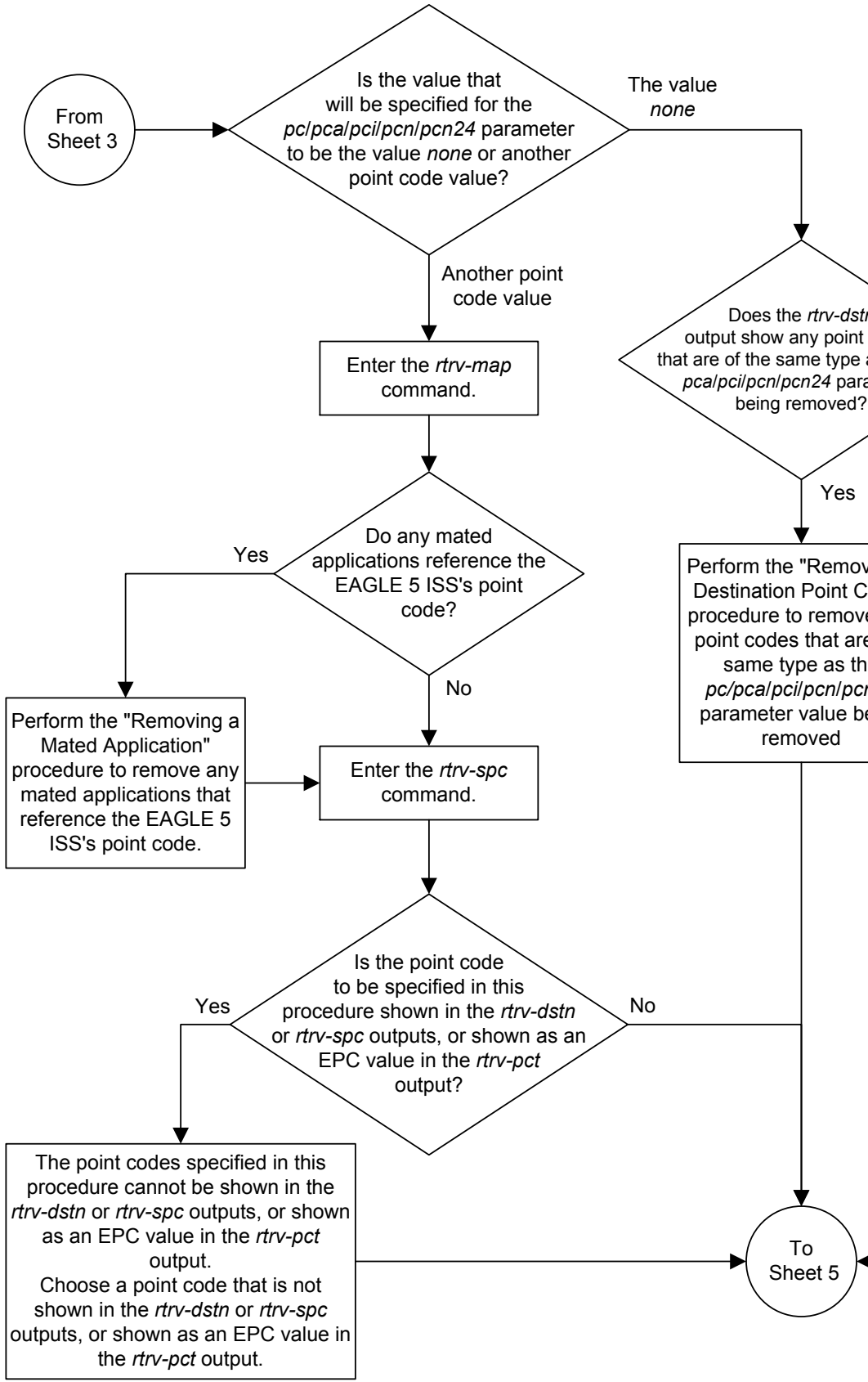
```
BACKUP (FIXED) : MASP A - Backup starts on active MASP.
BACKUP (FIXED) : MASP A - Backup on active MASP to fixed disk complete.
BACKUP (FIXED) : MASP A - Backup starts on standby MASP.
BACKUP (FIXED) : MASP A - Backup on standby MASP to fixed disk complete.
```

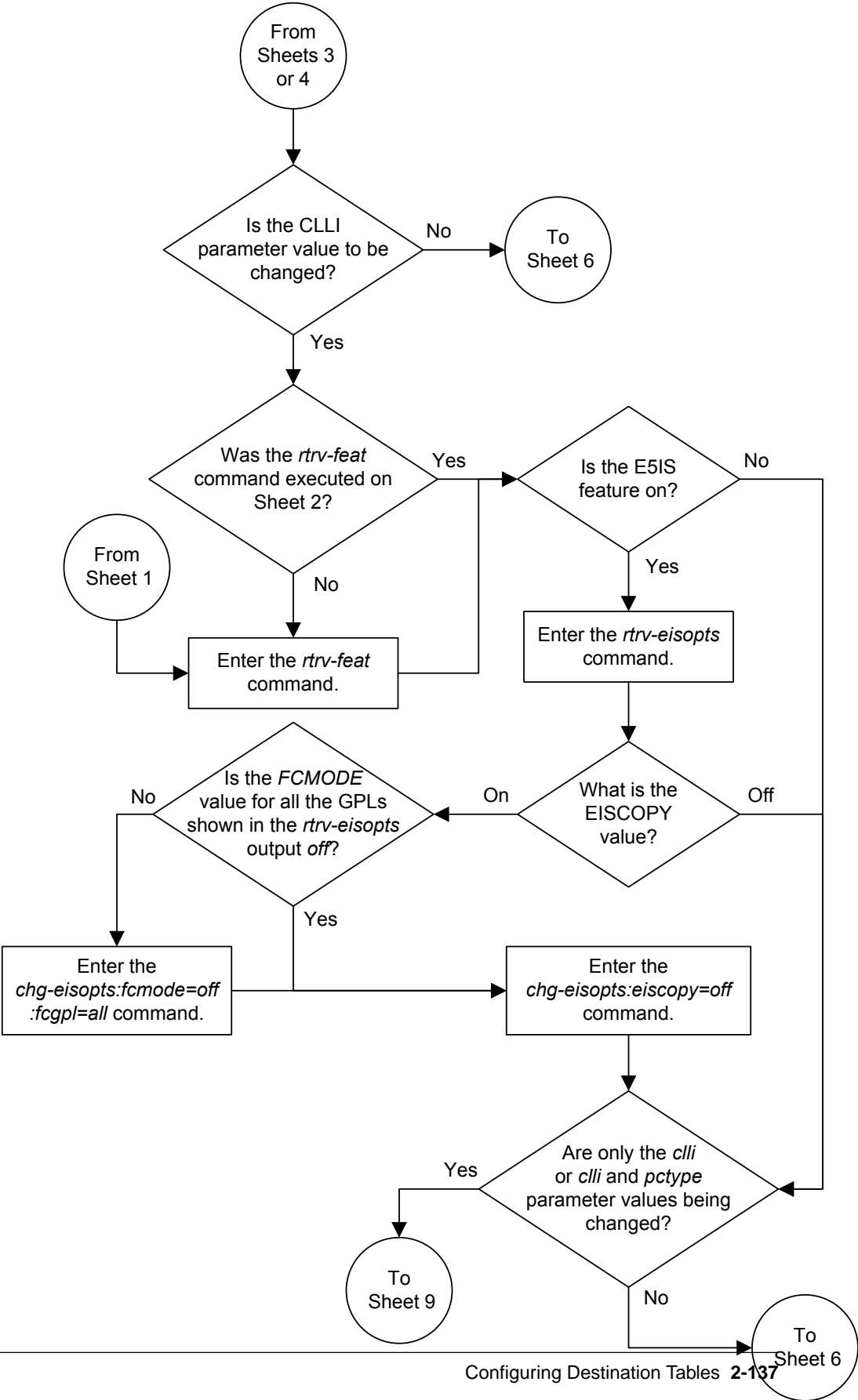
Figure 2-20 Changing the Self-Identification of the EAGLE

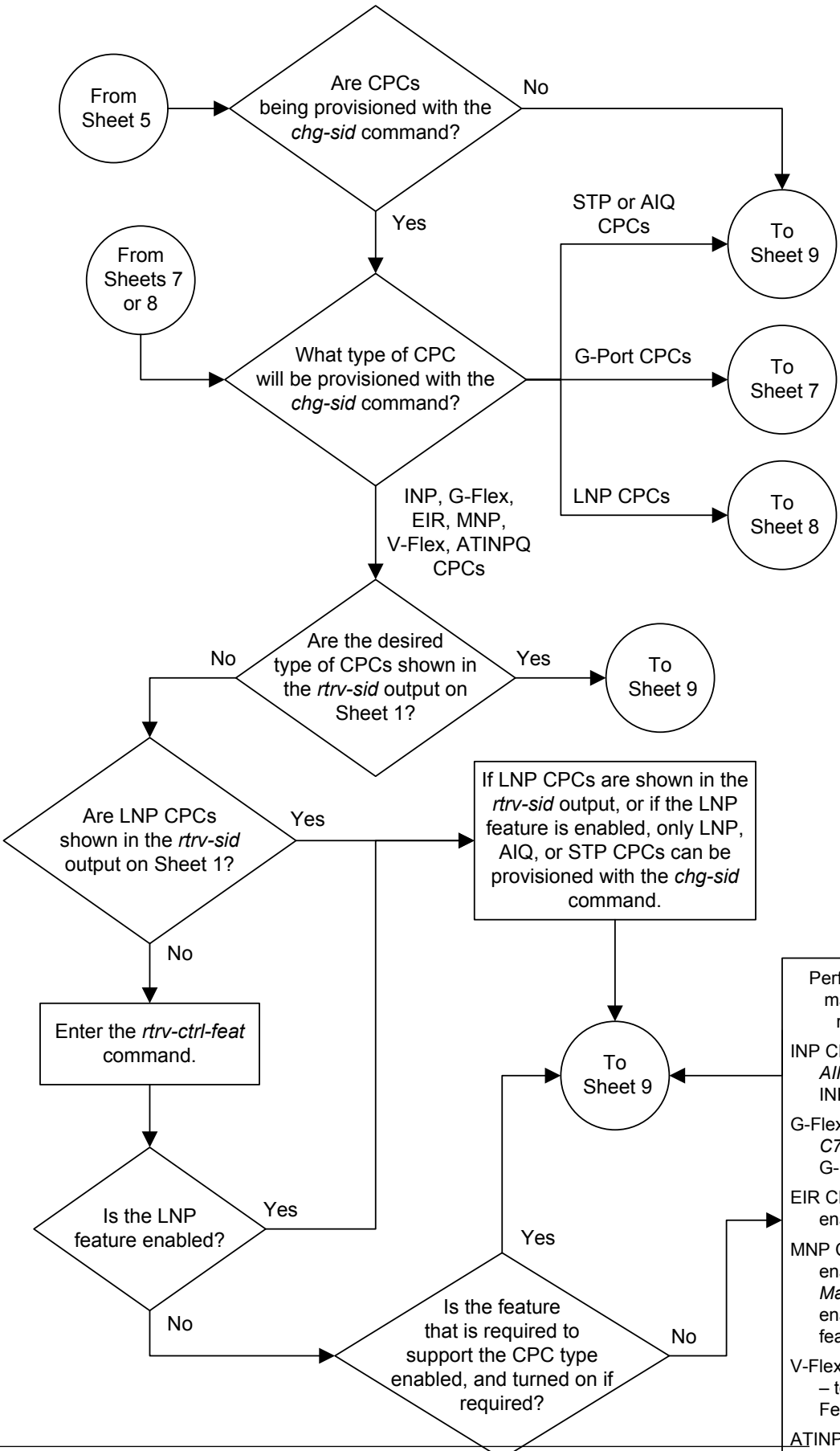


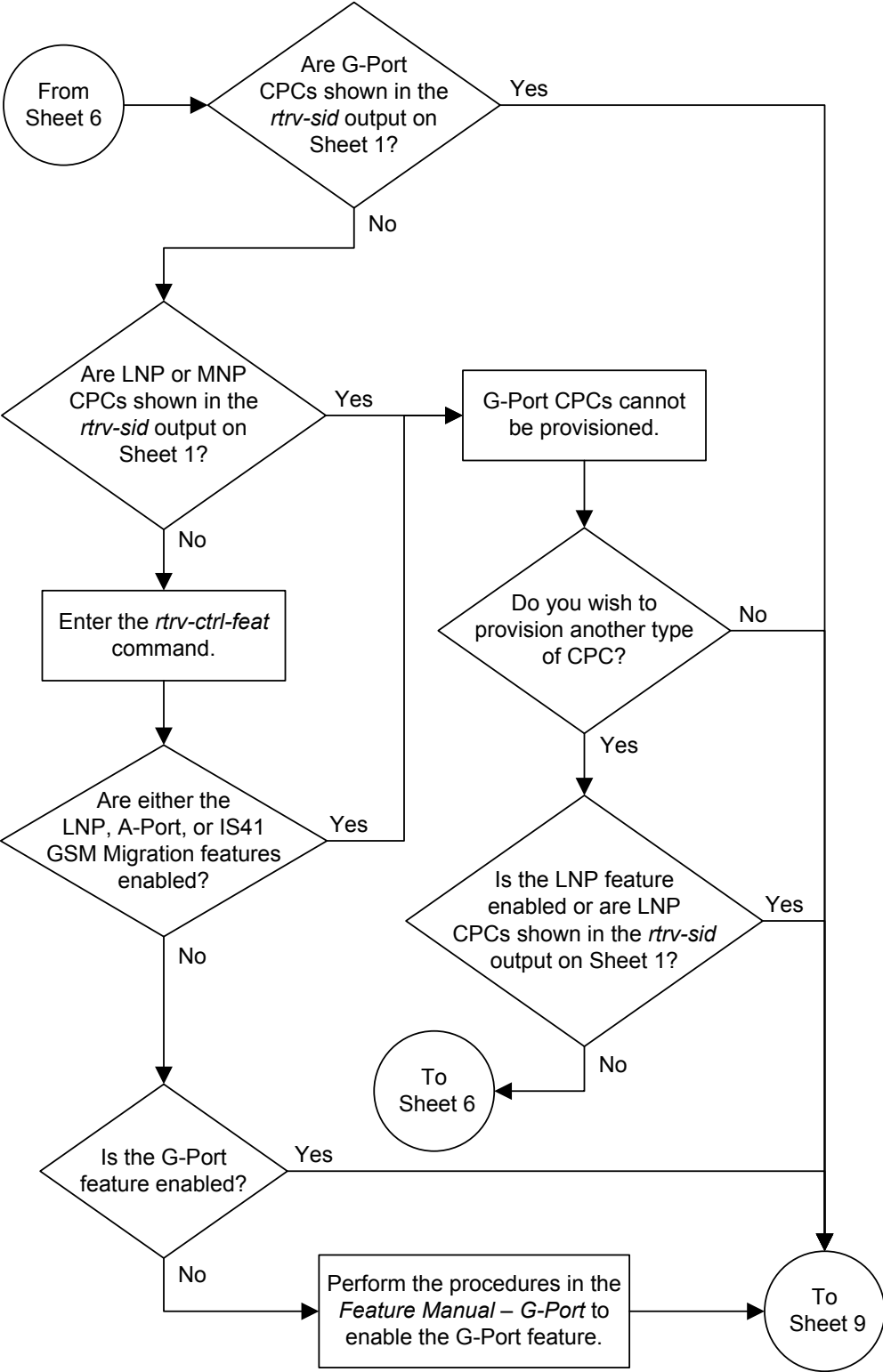


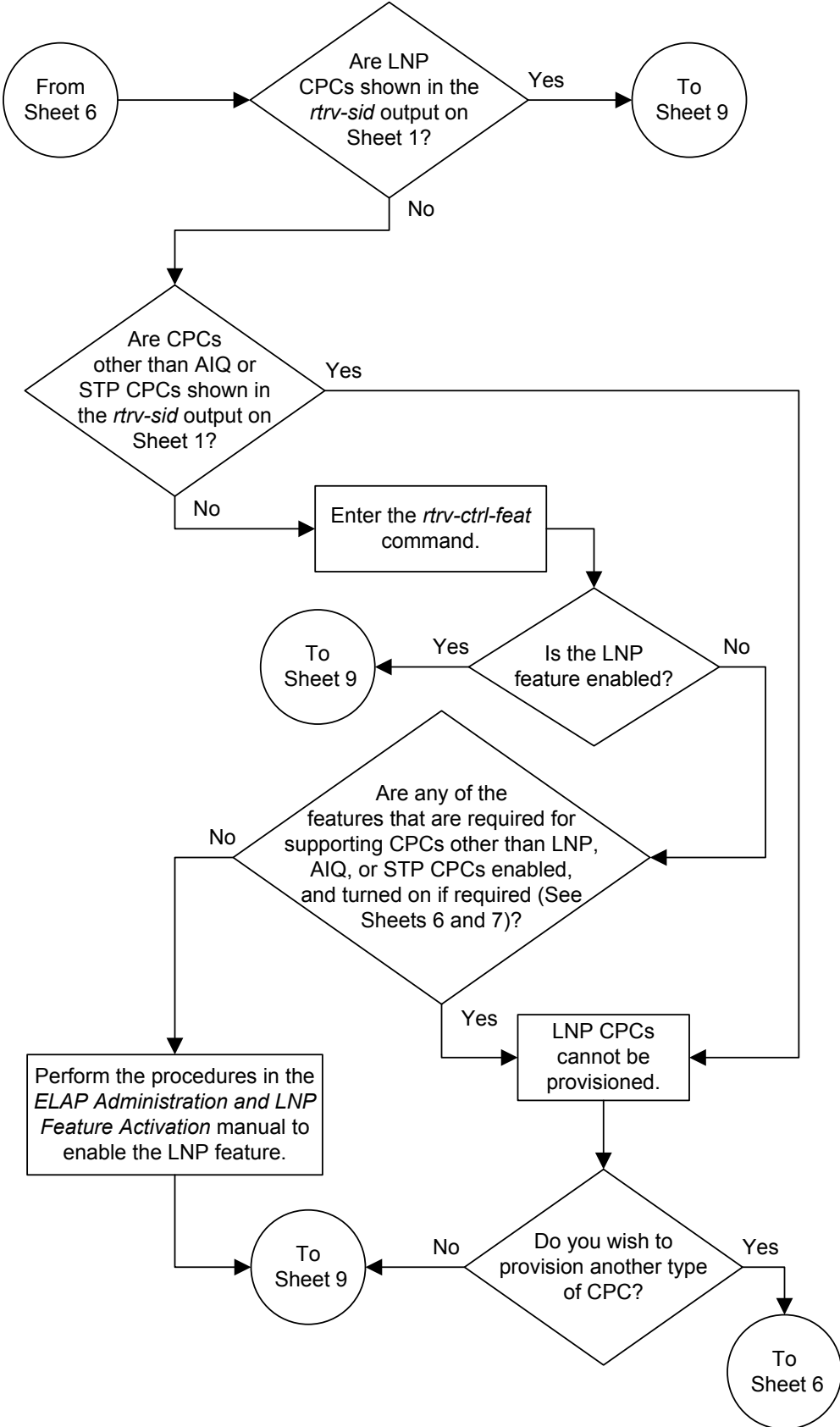


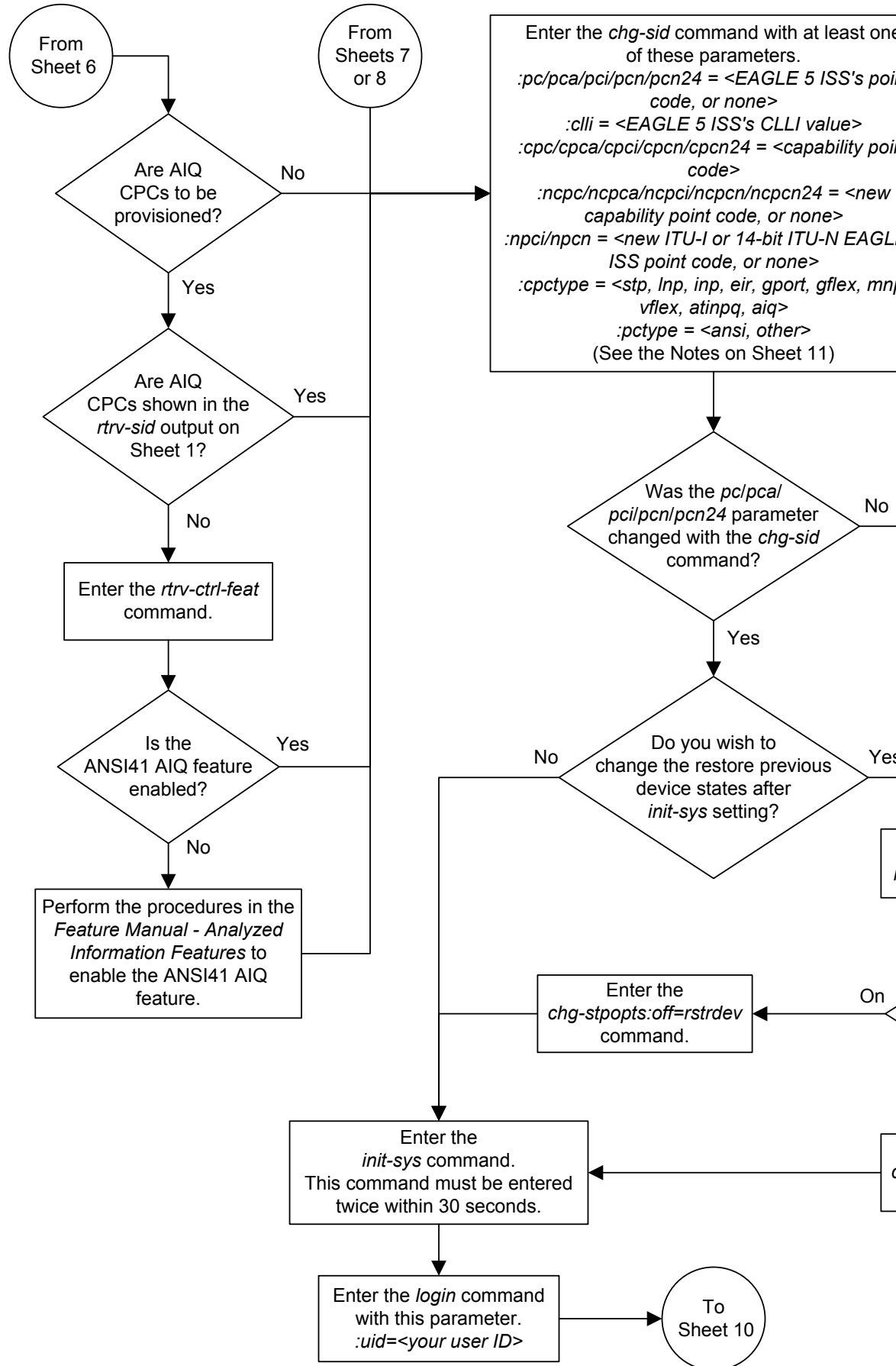


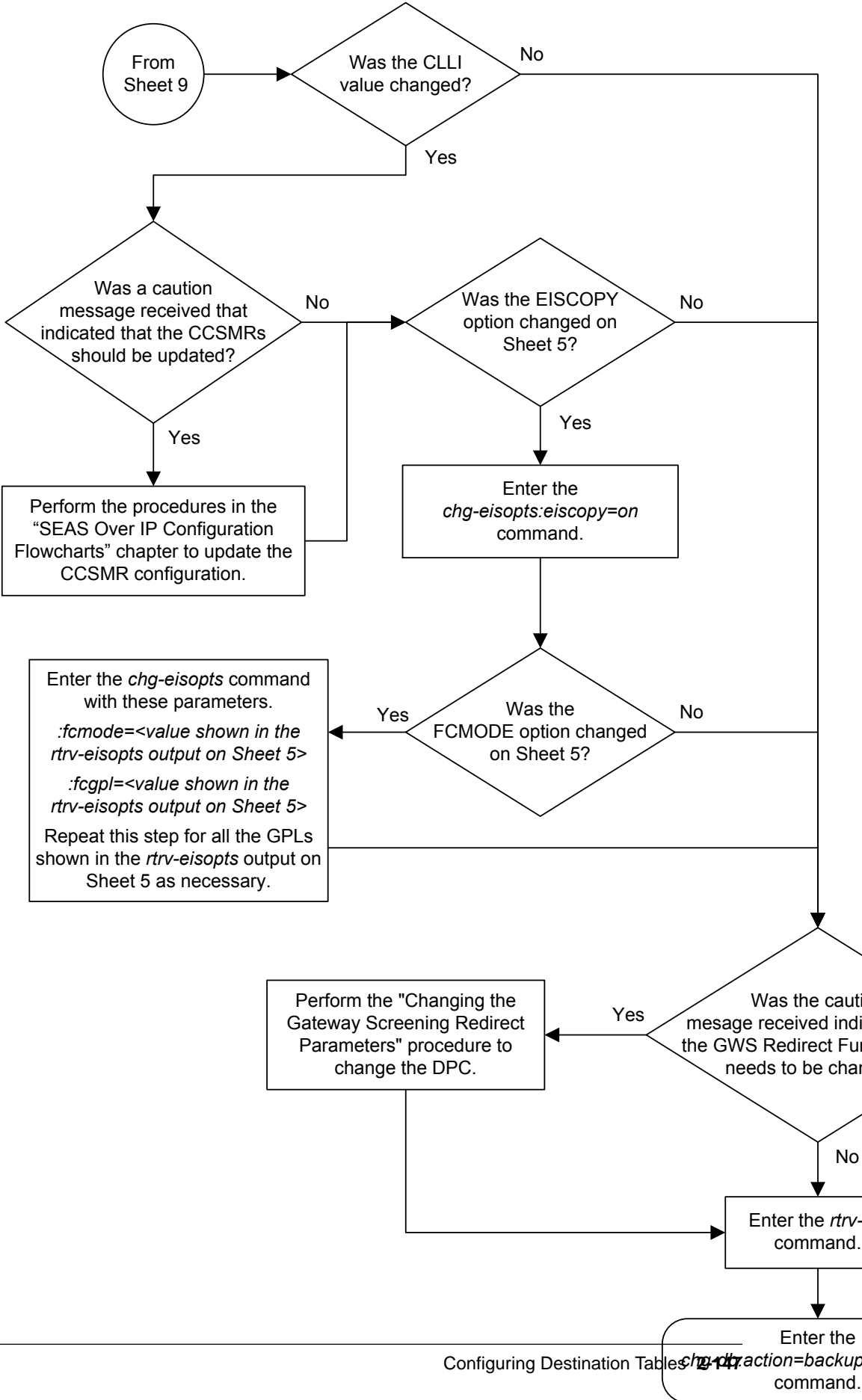












Notes:

1. The parameters *pc/pca*, *cpc/cpca*, and *ncpc/ncpca* require ANSI point code values.
2. The parameters *pci*, *npci*, *cpci*, and *npci* require ITU-I point code values.
3. The parameters *pcn*, *ncpn*, *cpcn*, and *ncpcn* require 14-bit ITU-N point code values.
4. The parameters *pcn24*, *cpcn24*, and *ncpcn24* require 24-bit ITU-N point code values.
5. The EAGLE 5 ISS can contain 14-bit ITU-N point codes or 24-bit ITU-N point codes, but not both at the same time.
6. For 14-bit ITU-N point code values, the format of the point code must match the format defined by the *rtv-stpopts* output.
7. The point code values must be full point codes.
8. The *cpc* parameter must be specified with the *ncpc* parameter and the point code type of both parameters must be the same.
9. Either the *cpc* or *ncpc* parameter must be specified with the *cpctype* parameter.
10. The *ncpc* parameter value cannot be equal to the *cpc* or *pc* parameter values.
11. The *cli* parameter value cannot be *none* or assigned to a route.
12. If the *cpctype* parameter value is *inp*, the point code values must be ANSI point codes.
13. If the *cpctype* parameter value is *inp*, the point code values must be either ITU-I, 14-bit ITU-N, or 24-bit ITU-N point codes.
14. If the *cpctype* parameter value is *eir*, the point code values must be either ITU-I, 14-bit ITU-N, or 24-bit ITU-N point codes.
15. If the *cpctype* parameter value is *gflex*, the point code values can be any point code type.
16. If the *cpctype* parameter value is *gport*, the point code values can be any point code type.
17. If the *cpctype* parameter value is *stp*, the point code values can be any point code type.
18. The EAGLE 5 ISS can contain a maximum of 96 capability point codes.
19. The *ncpc=none* parameter removes the specified capability point code.
20. The *ncpc=<point code value>* replaces the specified capability point code.
21. The *pc=none* parameter removes the point code of the specified point code type. This parameter only applies to routes that have DPCs of the point code type specified by the *pc=none* parameter.
22. The *pctype* parameter specifies whether or not the ANSI point codes used by the EAGLE 5 ISS must be ANSI point codes (*pctype=ansi*) or not (*pctype=other*). This parameter does not apply to ITU international or ITU national point codes. For more information, see the "ANSI Point Codes" section in this chapter for information about entering ANSI point codes.
23. If you wish to specify the *pcn24* parameter with the *chg-sid* command and the *rtv-sid* output shows a 14-bit ITU-N point code value, shown in the *PCN* field must be removed with the *pcn=none* parameter before the *pcn24* parameter value can be specified by the *chg-sid* command. Enter the *chg-sid* command with the *pcn=none* parameter, then re-enter the *chg-sid* command with the *pcn24* parameter. If no value is shown in the *PCN* field, specifying the *pcn=none* parameter is not necessary.
24. If you wish to specify the *pcn* parameter with the *chg-sid* command and the *rtv-sid* output shows a 24-bit ITU-N point code value, shown in the *PCN24* field must be removed with the *pcn24=none* parameter before the *pcn* parameter value can be specified by the *chg-sid* command. Enter the *chg-sid* command with the *pcn24=none* parameter, then re-enter the *chg-sid* command with the *pcn* parameter. If no value is shown in the *PCN24* field, specifying the *pcn24=none* parameter is not necessary.
25. The *npci=none* parameter removes the specified ITU-I point code.
26. The *npcn=none* parameter removes the specified 14-bit ITU-N point code.
27. The *npci=<point code value>* replaces the specified ITU-I point code.
28. The *npcn=<point code value>* replaces the specified 14-bit ITU-N point code.
29. The *npci/npcn* parameter values cannot be equal to any *cpc* or *pc* parameter values.
30. The *pci* parameter must be specified if the *npci* parameter is specified.
31. The *pcn* parameter must be specified if the *npcn* parameter is specified.
32. The new ITU-I or 14-bit ITU-N point code values (*npci/npcn*) must be the same type as the *pci/pcn* parameter values. For example, if the *pci* value is a non-spare point code, the *npci* value must be a non-spare point code. If the *pci* value is a spare point code, the *npci* value must be a spare point code.
33. If the *cpctype* parameter value is *mnp*, the point code values can be any point code type.
34. If the *cpctype* parameter value is *vflex*, the point code values can be any point code type.
35. If the *cpctype* parameter value is *atinpq* or *aiq*, the point code values must be either ANSI, ITU-I, or ITU-N point codes.

Cluster Routing and Management Diversity (CRMD)

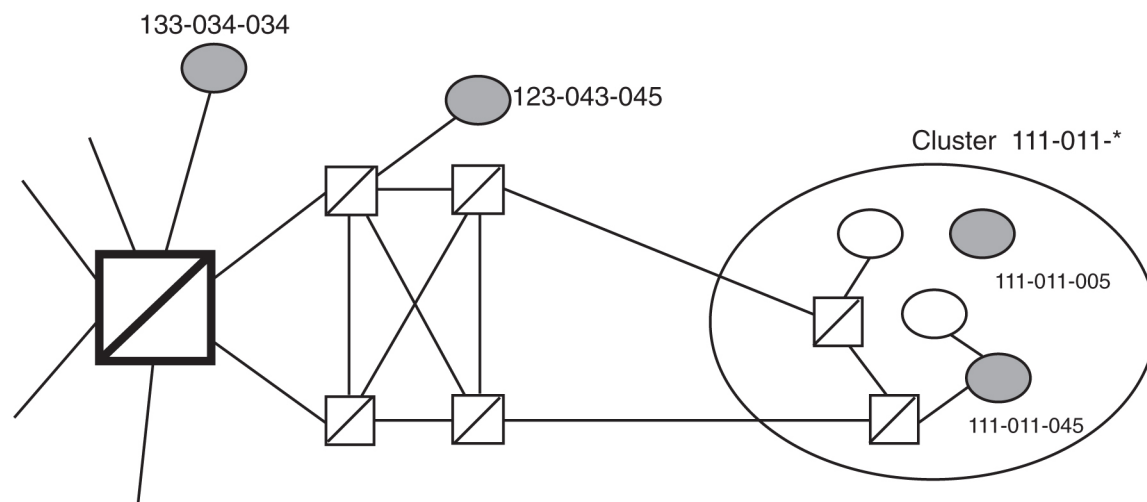
The Cluster Routing and Management Diversity feature eliminates the need for a full point code entry in the routing table to route to every signaling point in every network. The **Cluster** Routing and Management Diversity feature allows the EAGLE to configure one routeset to a entire cluster of destinations. This feature also allows the EAGLE to manage and switch traffic to more end nodes.

A cluster is defined as a group of signaling points whose point codes have identical values for the network and cluster fields of the point codes. A cluster entry in the routing table is shown with an asterisk (*) in the member field of the point code, for example, 111-011-*. With this feature, **ANSI** destination point codes can be specified as either a full point code, for example, 123-043-045, or as a cluster of signaling point codes, for example, 111-011-*.

Note: Cluster entries can only be provisioned as ANSI destination point codes. Cluster entries cannot be provisioned for **ITU** international or ITU national destination point codes. The ANSI alias point code for an ITU international or ITU national destination point code must be a full point code.

The Cluster Routing and Management Diversity feature allows provisioning of clusters, as well as of full point codes that belong to the same cluster as destination point codes (Figure 2-21). The point codes 111-011-*, 111-011-005 and 111-011-045 entries can be provisioned. In Figure 2-21, the cluster destination point code 111-011-* represents all the point codes of the cluster except for point codes 111-011-005 and 111-011-045. Cluster entries in the destination point code table can also be used as a **DPC** for a route. A group of such routes with varying relative cost forms a routeset to a cluster, just like a routeset to a full point code.

Figure 2-21 Cluster Routing and Management Diversity



Exception Lists (X-lists)

An exception list for a cluster is a list of point codes in a cluster whose routes are more restricted than other routes to that cluster. The term “more restricted” is used when comparing the route status of a cluster member to the route status of the cluster. A

PROHIBITED status is more restrictive than a RESTRICTED status, and a RESTRICTED status is more restrictive than an ALLOWED status.

This list contains point codes that are not assigned to any individual routeset, and the only routeset to that node is through a cluster routeset. The exception list is a dynamic list that changes when the status of the cluster routesets changes.

The EAGLE allows users to specify whether exception list entries need to be created on a per cluster basis. For each cluster, the user can specify an exception list exclusion indicator (ELEI) when configuring the cluster point code with the `ent-dstn` command. When the ELEI is `yes`, the EAGLE does not create exception list entries or remove any existing exception list entries for the given cluster. When the ELEI is `no`, the EAGLE creates and removes exception list entries. When the ELEI is `no`, it is not guaranteed that there will be space available to create each and every possible exception list entry for provisioned cluster entries. All such exception list entries must compete for available exception list space.

Exception list entries are stored as an extension of the Destination Point Code table. The Destination Point Code table can contain a maximum number of entries, as shown in [Table 2-5](#). The EAGLE allows the user to specify the number of entries reserved for the exception list. [Table 2-5](#) also shows the number of entries that can be reserved for the exception list and the number of entries that are reserved for configured destinations (the full, cluster point codes, and network routing point codes).

Table 2-5 Maximum Point Code Quantities

Feature Status	Maximum DPC Quantity	Number of Entries Reserved for the Exception List	Maximum Number of Full, Cluster, and Network Routing Point Codes
The 5000 Routes feature is off and 6000, 7000, 8000, or 10,000 routesets are not enabled	2500	500 - 2000	2500 minus the number of entries reserved for the exception list.
The 5000 Routes feature is on and 6000, 7000, 8000, or 10,000 routesets are not enabled	5500	500 - 5000	5500 minus the number of entries reserved for the exception list.
6000 routesets are enabled	6500	500 - 6000	6500 minus the number of entries reserved for the exception list.
7000 routesets are enabled	7500	500 - 6000	7500 minus the number of entries reserved for the exception list.
8000 routesets are enabled	8500	500 - 6000	8500 minus the number of entries reserved for the exception list.

Table 2-5 (Cont.) Maximum Point Code Quantities

Feature Status	Maximum DPC Quantity	Number of Entries Reserved for the Exception List	Maximum Number of Full, Cluster, and Network Routing Point Codes
10,000 routesets are enabled	10500	500 - 10000	10500 minus the number of entries reserved for the exception list.

The outputs of the `ent-dstn`, `dlt-dstn`, `chg-dstn`, and `rtrv-dstn` commands display this destination point code usage information.

- The number of configured full point codes
- The number of configured cluster point codes
- The number of configured network routing point codes
- The sum of configured destinations (full, network routing, and cluster point codes)
- The number of DPCs the EAGLE may contain (full, network routing, and cluster point codes). This number is the value of the `chg-stpopts` command's `mtpdpcq` parameter. The `mtpdpcq` parameter value is not always the maximum number of entries minus the number reserved for the exception list. This calculation determines the maximum number of DPCs the EAGLE may contain. The `mtpdpcq` parameter value of the `chg-stpopts` command determines the actual number of DPCs the EAGLE can have, and can be set to an amount less than the maximum.
- The number of entries reserved for exception list. This number is the value of the `chg-stpopts` command's `mtpxlq` parameter.
- The maximum number of alias point codes that can be in the EAGLE. The EAGLE can contain the quantities of alias point codes shown in [Table 2-6](#) depending the features that are enabled or turned on.

Table 2-6 Maximum Alias Point Code Quantities

Feature Status	Maximum Alias Point Code Quantity
The 5000 Routes feature is off and 6000, 7000, 8000, or 10,000 routesets are not enabled	12000
The 5000 Routes feature is on and 6000, 7000, 8000, or 10,000 routesets are not enabled	12000
6000 routesets are enabled	12000
7000 routesets are enabled	8000
8000 routesets are enabled	8000

Table 2-6 (Cont.) Maximum Alias Point Code Quantities

Feature Status	Maximum Alias Point Code Quantity
10,000 route sets are enabled	10000

- The number of alias point codes configured in the EAGLE.

Exception list entries have an expiration timer. There is a single EAGLE-wide expiration timer value for exception list entries. The exception list expiration timer, the size of the exception list, and the percentage of occupancy that generates a minor alarm can be configured with the `chg-stpopts` command. The values are shown in these fields of the `rtrv-stpopts` command output:

MTPXLQ = the maximum number of entries the exception list (x-list) can contain.

MTPXLET = the maximum amount of time the EAGLE will maintain an unreferenced exception list (x-list) entry

MTPXLOT = the exception list (x-list) occupancy threshold (in terms of percentage of space available). If this threshold is exceeded, the EAGLE raises a minor alarm. The percentage of occupancy refers to the number of exception list entries as compared to the maximum number of entries the exception list can hold. For example, if there are 1500 entries configured for the exception list and the exception list contains 1000 entries, the percentage of the exception list space being used is 66%. If this threshold is exceeded, the EAGLE raises a minor alarm.

The EAGLE raises a major alarm when the exception list becomes completely full and the EAGLE fails to create any more exception list entries.

MTPDPCQ = the maximum number of destination point codes that can be configured in the EAGLE.

The sum of the MTPDPCQ and MTPXLQ values (the maximum DPC quantity) cannot exceed the totals shown in [Table 2-5](#) depending on the features that are enabled or turned on.

An exception list entry's timer is restarted when an exception list entry gets created, updated, or used for routing. This expiration timer (the `mtpxlet` parameter in the `chg-stpopts` command) can be set from a minimum of 20 minutes to a maximum of 24 hours. The default value for the expiration timer upon EAGLE start-up is 60 minutes. If the timer expires before it is restarted, the exception list entry is removed. The expiration timer allows the EAGLE to save resources, if the exception list entry is sitting idle for a long time.

An exception list entry can be created for three distinct set of conditions.

1. The first set of conditions creates exception list entries based on the status of the route (allowed, restricted, or prohibited), and these entries are marked as "exception list due to routing."
2. The EAGLE creates an exception list entry to maintain the congestion status of a non-provisioned, cluster-routed destination point code. These entries are marked "exception list due to congestion."
3. The EAGLE also creates an exception list to prohibit routing to a member of a cluster when circular routing to that member is detected. These exception list entries are marked "exception list due to circular routing."

An exception list entry for a particular cluster can be removed from the exception list when these conditions are met.

1. The status of all routes to the specified point code changes to a status that is less or equally restrictive than the corresponding status of the cluster's routes. This can happen for two reasons.
 - A `dact-rstst` command was issued.
 - A network management message (**TFA** or **TFR**) was received indicating the new status of the route to the specified point code.
2. The expiration timer for the exception list entry expires.
3. When a `chg-dstn` command is issued and changes the **ELEI** to **yes** for the cluster, and the EAGLE removes all exception list entries created for that cluster.
4. The `chg-stpopts` command was issued with the `mtpxlet` parameter, and the new value for the `mtpxlet` parameter was smaller than the original value. This command can change the allocation of routing table entries for the exception list. If the size of the exception list is reduced and the number of entries in the exception list is now greater than the new value of the `mtpxlet` parameter, the EAGLE will remove excess exception list entries at random.
5. When the user allows a circular routed "exception list due to circular routing" entry.
6. When congestion abates for an "exception list due to routing" entry.

Cluster Routing

When the EAGLE receives an **MSU** to route, the routing function looks for the MSU's destination point code as a full point code entry in the routing table. If found, the full point code entry is used to find the corresponding routeset and the outgoing route. If a full point code entry is not found, the routing function uses the destination point code's network and cluster values to find a cluster entry to which the destination point code belongs. If found, the cluster entry is used to find the corresponding routeset and the outgoing route. If neither a full point code entry or cluster point code entry is found, the EAGLE generates **UAM 1004**, "MTP rcvd unknown DPC."

Compatibility with Non-Cluster Routing Nodes

It is possible that not all of the nodes in the network that the EAGLE is operating in are cluster routing nodes. In such a situation, those nodes not doing cluster routing will interpret **TCx** messages, and apply them to each individual point code belonging to the concerned cluster. This may cause an inconsistency in the status records for exception-listed point codes in different nodes. In order to avoid this situation, the EAGLE takes these steps:

1. After broadcasting a **TCR** message for a cluster, the EAGLE stops any level 3 T8 timers running for exception-listed members of the cluster, and enables TFPs for the cluster's exception-listed (prohibited) member point codes by stopping the level 3 T8 timer. This allows TFPs to be sent for prohibited members immediately after a TCR is broadcast.
2. After broadcasting a **TCA** message for a cluster, the EAGLE enables a one-time **TFR** for the cluster's exception-listed (restricted) member point codes by stopping the level 3 T18 timer, and enables the TFPs for the cluster's exception-listed (prohibited) member point codes by stopping the level 3 T8 timer. This allows TFPs to be sent for prohibited members, and TFRs for restricted members, immediately after a TCA is broadcast.

Cluster Management and the ITU Network

ITU SS7 networks do not use the concepts of clusters of point codes and cluster network management messages. The EAGLE does not generate TCx messages toward ITU nodes. When the EAGLE is acting as gateway between an ITU network and an ANSI network, during the broadcast phase of TCx messages, the EAGLE does not send TCx messages to adjacent ITU point codes. It is possible that messages may be lost in such a case. In order to reduce message loss and quickly notify the sending ITU node about the status, the EAGLE enables TFPs or TFRs immediately (with the level 3 T8 or T18 timers stopped) and relies on the TFPs or TFRs to convey the status information.

While sending response method network management messages in response to a received MSU, the EAGLE checks the MSU's originating point code. If the MSU's originating point code is an ITU point code, a TFX message is returned.

Cluster Management When the Cluster Routing Feature is Turned Off

The Cluster Routing and Management Diversity feature is an optional feature that is turned off by default. To use the Cluster Routing and Management Diversity feature, it must be turned on by entering the appropriate command. Once this feature is turned on, it cannot be turned off. If this feature is turned off, the EAGLE does not send any cluster management messages or allow cluster destination point codes to be added to the destination point code table. The EAGLE is capable of processing incoming cluster management messages, even though the feature is turned off. When a cluster management message is received, the EAGLE treats this message as though network management messages were received for each full point code, configured in the destination point code table, that belongs to that cluster.

Cluster Routing and Management Diversity Rules

These rules apply to the Cluster Routing and Management Diversity feature.

- If the provisioned number of exception list entries are already created, the EAGLE will not create any more exception list entries. The EAGLE raises an alarm in advance of such an occurrence, and pegs each occurrence of failure-to-create an exception list entry.
- All adjacent point codes for linksets must be full point codes.
- All entries in the remote point code table must be a full point code.
- The EAGLE maintains the congestion status of only 100 destinations, including full point codes and point codes to which cluster routing is performed.
- When the cluster routing feature is turned on, and the EAGLE receives an MSU and does not find a route with a full point code, a cluster route, or any other full point code route belonging to the cluster, the EAGLE will generate a TCP response.
- When the cluster routing feature is turned off, and the EAGLE receives an MSU and does not find a route with a full point code, the EAGLE will generate a TFP response.

When the EAGLE is used as an ITU-ANSI gateway STP.

- The EAGLE does not broadcast TCx messages toward the ITU nodes. Messages could be lost until the response method is initiated. It is recommended that the cluster routing feature not be turned on when the EAGLE is an ITU gateway STP.

- Cluster destination point codes cannot have ITU alias point codes.

All ANSI alias point codes specified for real ITU point codes are required to be full point codes.

The point code specified in the `ent-map` command must use a full point code, and that full point code must be in the routing table.

The point code specified in the `ent-gtt` and `ent-cspc` commands can use either a full point code or a cluster point code, but these point codes must be in the routing table.

The EAGLE allows cluster routing for subsequent global title (GTT) messages. The EAGLE also sends subsystem status messages to concerned point codes using a cluster route. The EAGLE does not generate MTP status messages for point codes that the EAGLE is routing clusters to, so all point codes in the mated application table must be full point codes.

Gateway screening verifies the concerned point code in TFX/RSx messages received by the EAGLE. Gateway screening passes a TFX/RSx message through the MTP-affected destination test, if the concerned point code has either a full point code route or a cluster route.

Gateway screening verifies the concerned point code in TCx/RCx messages received by the EAGLE. Gateway screening passes a TCx/RCx message through the MTP-affected destination test, if the concerned point code has either a cluster route for a concerned cluster or a member route for any of the members of the concerned cluster.

If a point code is in the routing table as an exception-listed point code and the user enters a command (`ent-dstn`) to configure that same point code as a full point code, the exception-listed point code attribute is changed to a full point code attribute, and the exception-list related information from the cluster entry is updated.

When a cluster destination point code is removed from the EAGLE's database, all related exception-listed point codes of that cluster are removed.

The EAGLE implements these protocol features that are non-preferred options.

- The EAGLE broadcasts a TFP, when a full point code is prohibited and these conditions apply.
 - The corresponding cluster is not provisioned.
 - All other full point codes belonging to the same cluster are prohibited on the same route.
- The EAGLE responds with a TFP, when a message is received for an inaccessible point code and the corresponding cluster does not exist.
- Upon receiving a TCR message for a cluster that is not configured, the EAGLE marks all individually configured members of that cluster as restricted, and starts the RSR procedure for them.
- Upon receiving a TCP message for a cluster that is not provisioned, the EAGLE marks all individually configured members of that cluster as prohibited, and starts the RSP procedure for them.
- The EAGLE stops the level 3 T8 and T18 timers, after broadcasting a TCA for prohibited and restricted members of the clusters. These members can be exception-listed point codes or full point codes.

- The EAGLE stops the level 3 T8 timers after broadcasting a TCR for prohibited members of the clusters. These members can be exception-listed point codes or full point codes.

The route assigned to a full point code DPC cannot be removed from the database if that DPC is a member of a cluster point code in the database.

If a route assigned to a cluster point code is removed from the database, all routes to any members of that cluster are also removed from the database.

Cluster Routing and Management Diversity Example

This section shows an example of the Cluster Routing and Management Diversity feature, and lists the network events affecting the EAGLE. This example is based on [Figure 2-22](#) and [Table 2-7](#).

Figure 2-22 Cluster Management

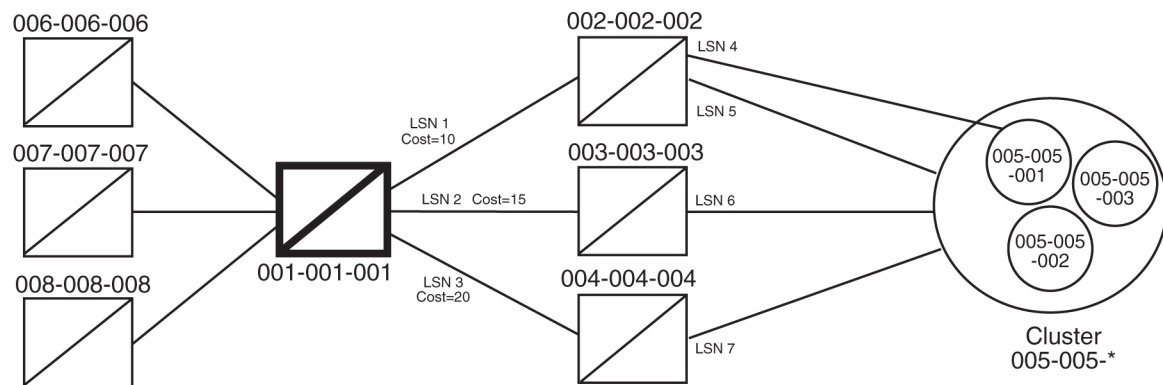


Table 2-7 Example Cluster Routing Information

	Route Table for Destination 005-005-001	Route Table for Cluster 005-005-*
1	LSN 1, Cost=10	LSN 1, Cost=10
2	LSN 2, Cost=15	LSN 2, Cost=15
3	LSN 3, Cost=20	LSN 3, Cost=20

When the normal routes, linksets LSN 1 and LSN 2, become available, the EAGLE sends a preventive TFP for destination 005-005-001 and a preventive TCP for cluster 005-005-* to node 002-002-002, and starts routing messages to destination 005-005-001 and cluster 005-005-* using linkset LSN 1. The EAGLE broadcasts TFAs about destination 005-005-001 and TCAs about cluster 005-005-* to all other adjacent nodes.

1. When linkset LSN 4 fails, node 002-002-002 sends a TFP for destination 005-005-001 to the EAGLE. Linkset LSN 4 is prohibited from carrying traffic from the EAGLE to destination 005-005-001. The EAGLE stops using linkset LSN 1 to send traffic to destination 005-005-001, performs forced rerouting, starts level 3 timer T11 for destination 005-005-001, and starts using linkset LSN 2 to send messages to destination 005-005-001. The EAGLE generates preventive TFPs about destination 005-005-001 to node 002-002-003. The preventive TCP for cluster 005-005-* sent to node 002-002-002 remains in effect.

When the level 3 timer T11 for destination 005-005-001 expires, TFRs are broadcast for destination 005-005-001 to nodes 004-004-004, 006-006-006, 007-007-007, and 008-008-008. Destination 005-005-001 is restricted.

2. When linkset LSN 5 fails, node 002-002-002 sends a TCP for cluster 005-005-* to the EAGLE. Linkset LSN 5 is prohibited from carrying traffic from the EAGLE to cluster 005-005-*. The EAGLE stops using linkset LSN 1 to send traffic to cluster 005-005-*, performs forced rerouting, starts the level 3 timer T11 for cluster 005-005-*, and starts using linkset LSN 2 to send messages to cluster 005-005-*. The EAGLE sends preventive TCPs for cluster 005-005-* on linkset LSN 2. The EAGLE sends a TCR for cluster 005-005-* on linkset LSN 1, to allow cluster 005-005-* and destination 005-005-001 to send messages back to the EAGLE on linkset LSN 1. When the level 3 timer T11 for cluster 005-005-* expires, the EAGLE sends a TCR for cluster 005-005-* to nodes 004-004-004, 006-006-006, 007-007-007, and 008-008-008. Cluster 005-005-* is restricted.
3. When linkset LSN 6 fails, node 003-003-003 sends a TCP for cluster 005-005-* to the EAGLE. The EAGLE performs forced rerouting, sends a preventive TFP for destination 005-005-001 and a TCP for destination 005-005-001 to node 004-004-004, and starts using linkset LSN 3 for sending messages to destination 005-005-001 and cluster 005-005-*.
4. When linkset LSN 7 fails, node 004-004-004 sends a TCP for cluster 005-005-* to EAGLE. The EAGLE cannot send traffic to either destination 005-005-001 or cluster 005-005-*. The EAGLE broadcasts TCPs for cluster 005-005-* to nodes 002-002-002, 003-003-003, 004-004-004, 006-006-006, 007-007-007, and 008-008-008. Cluster 005-005-* and destination 005-005-001 are inaccessible.
5. When linkset LSN 7 recovers, node 004-004-004 sends a TCA for cluster 005-005-* to the EAGLE. The EAGLE sends a preventive TCP for cluster 005-005-* to node 004-004-004, and starts using linkset LSN 3 to send traffic to cluster 005-005-*. The EAGLE sends a TCR for cluster 005-005-* to node 002-002-002. This allows cluster 005-005-* to send messages back to the EAGLE on linkset LSN 3. The EAGLE sends a preventive TCP for cluster 005-005-* to nodes 003-003-003 and 004-004-004. The EAGLE sends a TCR for cluster 005-005-* to nodes 006-006-006, 007-007-007, and 008-008-008. The EAGLE enables response method for destination 005-005-001, and starts a routeset test for destination 005-005-001 on linkset LSN 3. Cluster 005-005-* is restricted.
6. When linkset LSN 6 recovers, node 003-003-003 sends a TCA for cluster 005-005-* to the EAGLE. The EAGLE performs controlled rerouting on cluster 005-005-*, sends a preventive TCP for cluster 005-005-* to node 003-003-003, and starts using linkset LSN 2 to send traffic to cluster 005-005-*. The EAGLE sends a TCR for cluster 005-005-* to node 004-004-004. The EAGLE starts a routeset test for destination 005-005-001 on linkset LSN 2.
7. When linkset LSN 5 recovers, node 002-002-002 sends a TCA for cluster 005-005-* to the EAGLE. The EAGLE performs controlled rerouting, and starts using linkset LSN 1 to send traffic to cluster 005-005-*. The EAGLE sends a preventive TCP for cluster 005-005-* to node 002-002-002. The EAGLE broadcasts a TCA for cluster 005-005-* to nodes 003-003-003, 004-004-004, 006-006-006, 007-007-007, and 008-008-008. The EAGLE enables response method for destination 005-005-001, and starts a routeset test for destination 005-005-001 on linkset LSN 1. Cluster 005-005-* is allowed.
8. In response to the routeset test, node 004-004-004 sends a TFA for destination 005-005-001 to the EAGLE. The EAGLE performs controlled rerouting, and starts

using linkset LSN 3 to send traffic to destination 005-005-001. The EAGLE sends a preventive TFP for destination 005-005-001 to nodes 003-003-003 and 004-004-004. The EAGLE sends a TFR for destination 005-005-001 to node 002-002-002 that allows destination 005-005-001 to send messages back to the EAGLE on linkset LSN 1. The EAGLE broadcasts a TFR for destination 005-005-001 to nodes 006-006-006, 007-007-007, and 008-008-008. Destination 005-005-001 is restricted.

9. In response to the routeset test, node 003-003-003 sends a TFA for destination 005-005-001 to the EAGLE. The EAGLE performs controlled rerouting and starts using linkset LSN 2 to send traffic to destination 005-005-001. The EAGLE sends a preventive TFP for destination 005-005-001 to node 003-003-003. The EAGLE sends a TFR for destination 005-005-001 to node 004-004-004.
10. In response to the routeset test, node 002-002-002 sends a TFA for destination 005-005-001 to the EAGLE. The EAGLE performs controlled rerouting, and starts using linkset LSN 1 to send traffic to destination 005-005-001. The EAGLE sends a preventive TFP for destination 005-005-001 to node 002-002-002. The EAGLE sends a TFA for destination 005-005-001 to nodes 003-003-003, 004-004-004, 006-006-006, 007-007-007, and 008-008-008. Destination 005-005-001 is allowed.

Home Cluster Example

Figure 2-23 Home Cluster Example

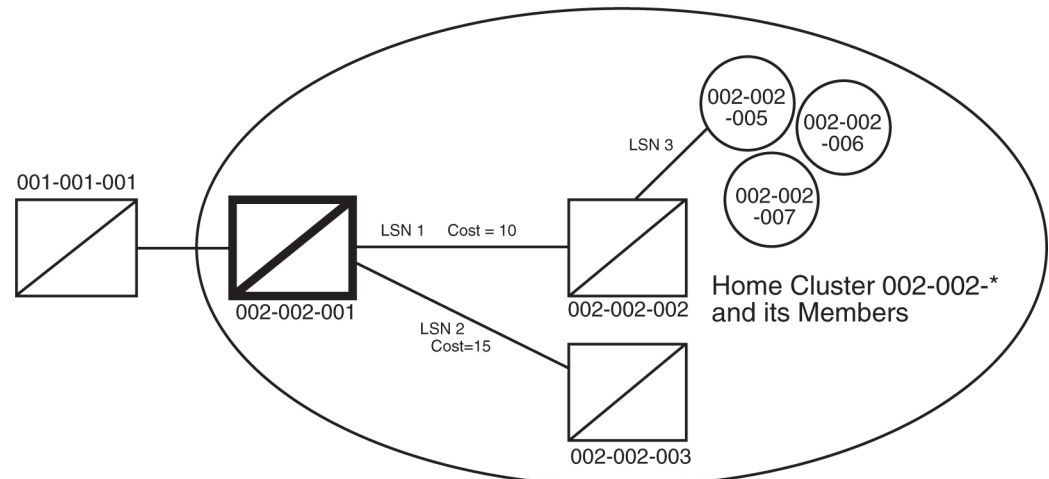


Table 2-8 Home Cluster Routing Information

	Route table for Destination 002-002-005	Route table for cluster 002-002-*
1	LSN 1, Cost=10	LSN 1, Cost=10
2	LSN 2, Cost=15	LSN 2, Cost=15

A home cluster is a cluster point code that contains either the true point code or any capability point code of the EAGLE. For example, if the EAGLE's true point code or any capability point code is 002-002-001 and a cluster 002-002-* is configured, then the cluster 002-002-* is a home cluster.

Provisioning a home cluster causes a profound impact on network management, regarding the home cluster as well as members of the cluster. These impacts are:

- Because the EAGLE is one of the accessible members of the home cluster, the EAGLE never transmits TCP or TCR messages regarding the home cluster, except for these:
 - Preventive TCP – when starting to route to the cluster through an adjacent node
 - Broadcast TCR – when the EAGLE starts routing on an alternate route for the entire cluster
 - Back Routing TCR – to allow adjacent nodes on normal routes to route through the EAGLE, when the cluster is not accessible on the normal route
 - Broadcast TCP – when the cluster (except the EAGLE itself) becomes inaccessible
- If individual members are provisioned for the home cluster, the EAGLE properly generates network management messages for these nodes, except that no TFRs can be sent from those members being routed on the alternate route to the EAGLE.
- Network management replies to the routeset test, and the response method generates the correct network management messages for the home cluster, its members, and unprovisioned member point codes.
- When the entire home cluster is being routed on the alternate route, the EAGLE generates a full point code response method TFR reply. In such a case, the EAGLE generates only one TFR for the very first member of the cluster for which MSU is received on each signaling link to that cluster.
- When the home cluster is inaccessible, the EAGLE generates one response TFP, at an interval equal to the value of the level 3 timer T8 for the members of the home cluster. If the EAGLE keeps receiving traffic for the home cluster, the EAGLE sends response TFPs for all members of the cluster.

This makes network management unreliable for the home cluster and its members.

When the normal routes, linksets LSN 1 and LSN 2, become available, the EAGLE sends a preventive TFP for destination 002-002-005 to node 002-002-002, and starts sending messages to destination 002-002-005 and cluster 002-002-* using linkset LSN 1. No preventive messages are sent for cluster 002-002-*. The EAGLE broadcasts a TFA for destination 002-002-005 and a TCA for cluster 002-002-* to all other adjacent nodes.

1. Node 002-002-002 sends an MSU containing the destination point code 002-002-006 on linkset LSN 1. The EAGLE responds with a response preventive TFP for destination 002-002-006 to node 002-002-002.
2. When linkset LSN 3 fails, node 002-002-002 sends a TFP for destination 002-002-005 to the EAGLE. The EAGLE stops using linkset LSN 1 to send traffic to destination 002-002-005, performs forced rerouting, starts the level 3 timer T11 for destination 002-002-005, and starts using linkset LSN 2 to send traffic to destination 002-002-005. The EAGLE generates a preventive TFP for destination 002-002-005 to node 002-002-003. When the level 3 timer T11 for destination 002-002-005 expires, TFRs for destination 002-002-005 are broadcast to nodes 002-002-003 and 001-001-001. Destination 002-002-005 is restricted.
3. Node 002-002-002 sends an MSU containing the destination point code 002-002-005 on linkset LSN 1. The EAGLE responds with a response preventive

- TFP for destination 002-002-005 to node 002-002-002, because no member of a home cluster is allowed to route messages back to the EAGLE.
4. When linkset LSN 1 fails, the EAGLE stops using linkset LSN 1 to send traffic to cluster 002-002-*, performs forced rerouting, starts the level 3 timer T11 for cluster 002-002-*, and starts using linkset LSN 2 to send traffic to cluster 002-002-*. Cluster 002-002-* is restricted. No preventive or broadcast messages are sent, and no member of the cluster is allowed to send messages back to the EAGLE.
 5. Node 001-001-001 sends an MSU containing the destination point code 002-002-006. The EAGLE responds with a response TFR for destination 002-002-006 to node 001-001-001. The MSU is routed on linkset LSN 2.
 6. Node 001-001-001 sends an MSU containing the destination point code 002-002-005. The EAGLE responds with a response TFR for destination 002-002-005 to node 001-001-001. The MSU is routed on linkset LSN 2.
 7. Node 001-001-001 sends an MSU containing the destination point code 002-002-007 and receives no response. The MSU is routed on linkset LSN 2.
 8. When linkset LSN 2 fails, destination 002-002-005 and cluster 002-002-* are prohibited. The EAGLE broadcasts a TFP for destination 002-002-005 to node 001-001-001.
 9. Node 001-001-001 sends an MSU containing the destination point code 002-002-007. The EAGLE responds with a TFP for destination 002-002-007 to node 001-001-001, and starts the level 3 timer T8 for cluster 002-002-*.
 10. Node 001-001-001 sends an MSU containing the destination point code 002-002-006, and receives no response until the level 3 timer T8 expires.
 11. Node 001-001-001 sends an MSU containing the destination point code 002-002-005. The EAGLE responds with a TFP for destination 002-002-005 to node 001-001-001, and starts the level 3 timer T8 for destination 002-002-005.
 12. Node 001-001-001 sends an MSU containing the destination point code 002-002-006. After the level 3 timer T8 for cluster 002-002-* expires, the EAGLE responds with a TFP for destination 002-002-006 to node 001-001-001, and starts the level 3 timer T8 for cluster 002-002-*.

Nested Cluster Routing

When a node is switching traffic to remote (non-adjacent) nodes, it is possible that an **STP** is using at least one route that is different from the other members of a cluster. Typically, this occurs when the node is directly connected to the member of a cluster, such as when an **STP** has A-links or E-links that are connected to a member. The nested cluster routing feature provides a mechanism that allows both cluster and member routes to be provisioned in the same cluster.

Nested Clusters and Cluster Members

The cluster routing and management feature requires that routes to a cluster and members of that cluster be in the same routeset. With the nested cluster routing feature, however, users can have certain members of the provisioned cluster with different full point code routesets. This different routeset may be totally different, partially different, or exactly the same.

With the nested cluster routing feature, routes to these members can be changed, deleted, or added. Deletion of a full point code route entry within a cluster will result

in the member using the cluster entry for routing. Deletion of a cluster route entry will not delete the full point code route entry. This holds true even if the full point code entry and the cluster have the same route.

The **EAGLE** sends cluster network management messages (**TCA**, **TCR**, **TCP**) based on the least restrictive of the cluster's routeset status, and the routeset status of any full point code entries within the cluster.

The nested cluster routing feature provides a new routing model. The **EAGLE** allows several routing models. [Table 2-9](#) describes coupling between the cluster and its members. Coupling describes the relationship between the cluster and member routes.

Table 2-9 Routing Models

System Routing Model	Characteristics	Issues and Resolution
Full Point Code Routing (FPR) No coupling	The EAGLE behaves as a full point code router when the Cluster Routing and Management Diversity feature is off. Only full point code destinations are provisioned. The EAGLE never generates TCx messages concerning clusters of provisioned members. Received TCx messages are applied to all members of the concerned cluster.	No issues. There is no coupling between cluster status and member statuses due to the lack of clusters.
Cluster Routing (CR) No coupling NCAI=No	With the Cluster Routing and Management Diversity feature on, the EAGLE allows the provisioning of cluster destinations. For cluster destinations, only cluster destinations are provisioned. The EAGLE generates TCx messages only for provisioned cluster destinations. All received TCx messages are applied to concerned cluster entry, if it exists. Otherwise, it is applied to all individual members.	No issues. There is no coupling between cluster status and member status due to the lack of members belonging to provisioned cluster.

Table 2-9 (Cont.) Routing Models

System Routing Model	Characteristics	Issues and Resolution
Cluster Routing and Management Diversity (CRMD) Full coupling NCAI=No	In this mode, the EAGLE allows provisioning of clusters as well as members of same clusters. Here cluster and member have the same routeset, and they are fully coupled. All TCx messages are applied to members, and TCx messages generated by the EAGLE reflect member status. In this mode, the member status cannot be less restrictive than the cluster.	No issues regarding network management message generation and processing. Cluster and members cannot have a different routeset, and thus E-links cannot be provisioned for members of a cluster.
Nested Cluster Routing No coupling NCAI=Yes	In this mode, if the <code>ncai</code> parameter is <code>yes</code> (provided both the nested cluster routing and the Cluster Routing and Management Diversity features are on), the user can enter a cluster routeset, then enter a different routeset for a member of that cluster. In this case, member routeset status can be less restricted than cluster routeset status.	There is an issue regarding broadcasting network management messages. Because members can be less restricted than the cluster, the broadcast of cluster messages (TCA , TCR , TCP) is based on the least restrictive of the following: <ul style="list-style-type: none"> • The cluster's routeset status. • The routeset status of any full point code entries within the cluster. • Also, when the <code>ncai</code> parameter is <code>yes</code>, the EAGLE does not generate preventive TCP messages.

Administration

The nested cluster routing feature is provisioned using the `ncai` parameter of either the `ent-dstn` or `chg-dstn` commands. The `ncai` parameter can only be specified for cluster point codes.

In order to specify the `ncai` parameter, both the **Cluster Routing and Management Diversity** and the nested cluster routing features must be on. If the `ncai` parameter is `yes`, the **EAGLE** allows certain members of the provisioned cluster to have a different full point code routeset.

If the `ncai` parameter is `no`, standard command-handler rules apply (any full point code routeset within a cluster must have the same routeset as the cluster). If `ncai` parameter is `yes`, new command-handler rules apply (full point code routeset can be

different from the cluster routeset). [Figure 2-24](#) provides an example of provisioning a nested cluster and its associated members.

Nested Cluster Routing Rules of Operations

The following rules apply to nested clusters (cluster entries with the `ncai` parameter set to `yes`):

1. The **EAGLE** allows the user to enter a full point code routeset entry even if the point code is a member of a cluster that has a different routeset. For example, in [Figure 2-24](#), the provisioned member 5-5-1 has a different routeset than the cluster's routeset.
2. When the **EAGLE** broadcasts network management messages relating to the cluster, the **EAGLE** uses the least restricted of the following to determine which cluster message (**TCA**, **TCR**, **TCP**) to send:
 - The cluster's routeset status
 - The routeset status of any full point code entries within the cluster

For example, in [Figure 2-24](#), if linkset **LSB** fails, a **TCP** message for cluster 5-5-* is not broadcast because the least restrictive status of provisioned member 5-5-1 is allowed.
3. The **EAGLE** does not send preventive **TCPs** when it begins routing toward a nested cluster. The **EAGLE** sends response-method preventive **TFPs** if it receives an **MSU** and there is danger of circular routing. For example, in [Figure 2-24](#), the **EAGLE** does not send a preventive **TCP** for cluster 5-5-* when routing to cluster 5-5-* over linkset **LSB**. However, if the **EAGLE** receives an **MSU** on linkset **LSB** destined for node 5-5-2, the **EAGLE** discards the **MSU** and sends a **TFP** to node B concerning node 5-5-2.

Note: The **EAGLE** will still send preventive **TFPs** when it starts routing toward a full point code member of a nested cluster.

4. The **EAGLE** replies to **RCx** cluster routeset test messages, using the less restrictive routeset status as indicated in rule #2.
5. The **EAGLE** replies to **RSx** full point code routeset messages, using the full point code's routeset status and the danger of circular routing.
6. Response method **TFP** or **TFR** is used when the cluster destination is more restrictive than a full point code member. The modified **TFP** response method will send no more than one **TFP** per cluster member during the time period defined by the level 3 T8 timer. The modified **TFR** response method sends no more than one response **TFR** per cluster member.

Nested Cluster Routing Example

[Figure 2-24](#) provide an example of nested cluster routing. [Table 2-10](#) and [Table 2-11](#) show the routing tables for the cluster point code and one of the members of the cluster point code. [Table 2-12](#) shows what actions the **EAGLE** takes when the linksets in a nested cluster configuration fail and recover. The actions in [Table 2-12](#) are based on the example nested cluster routing configuration shown in [Figure 2-24](#).

Figure 2-24 Nested Cluster Routing Sample Configuration

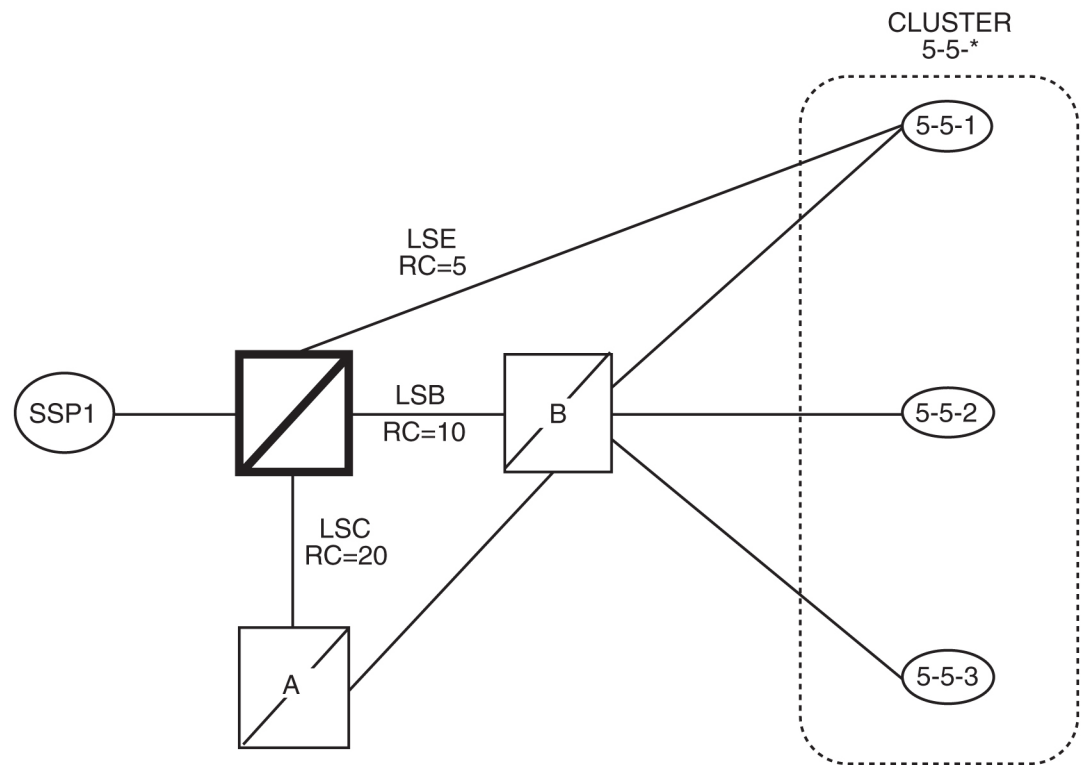


Table 2-10 Routing Table for Nested Cluster 5-5-*

Linkset Name	Route DPC	Cost Value of the Route
LSB	5-5-*	10
LSC	5-5-*	20

Table 2-11 Routing Table for Full Point Code Member 5-5-1

Linkset Name	Route DPC	Cost Value of the Route
LSE	5-5-1	5
LSB	5-5-1	10
LSC	5-5-1	20

Table 2-12 Example of Nested Cluster Routing Failure and Recovery Actions

Event	Action
All linksets are up and all routes are available.	The EAGLE does not send a preventive TCP for cluster 5-5-* to node B because cluster 5-5-* is a nested cluster. Messages are routed to SSP 5-5-1 using linkset LSE and to cluster 5-5-* using linkset LSB . The EAGLE broadcasts TCAs concerning cluster 5-5-* to nodes SSP1 , SSP 5-5-1 , node A, and node B.
The linkset between node B and SSP 5-5-2 fails. Node B sends a TFP concerning SSP 5-5-2 .	The EAGLE creates an x-list entry for point code 5-5-2 and marks it prohibited on linkset LSB . The EAGLE broadcasts TFPs to SSP1 , SSP 5-5-1 and node A and sends response method TFP concerning point code 5-5-2. The EAGLE starts an RSP for SSP 5-5-2 on linkset LSB .
The linkset between node B and SSP 5-5-1 fails. Node B sends a TFP for SSP 5-5-1 to the EAGLE .	The EAGLE marks full point code 5-5-1 as prohibited on linkset LSB . The EAGLE routes the traffic to SSP 5-5-1 using linkset LSE . The EAGLE starts an RSP for SSP 5-5-1 on linkset LSB .
The linkset between node B and SSP 5-5-2 recovers, and node B sends a TFA for SSP 5-5-2 to the EAGLE .	The EAGLE removes point code 5-5-2 from the exception list. The status of linkset LSB is changed from prohibited to allowed. Traffic is routed to SSP 5-5-2 using linkset LSB . The EAGLE broadcasts a TFA concerning SSP 5-5-2 to SSP1 , SSP 5-5-1 and node A. The EAGLE sends a preventive TFP concerning SSP 5-5-2 to node B.
The linkset between node B and SSP 5-5-1 recovers, and node B sends a TFA concerning SSP 5-5-1 to the EAGLE .	The EAGLE marks full point code 5-5-1 as allowed on linkset LSB .
Linkset LSB fails.	The EAGLE stops using linkset LSB to send traffic to cluster 5-5-*. Linkset LSB is marked prohibited, forced rerouting is performed, level 3 timer T11 for cluster 5-5-* is started, and starts using linkset LSC to send traffic to cluster 5-5-*. The EAGLE marks cluster 5-5-* restricted on linkset LSC for all members of cluster 5-5-* except full point code 5-5-1. When level 3 timer T11 expires, a TFR response method is sent for all members of cluster 5-5-* except full point code 5-5-1.

Table 2-12 (Cont.) Example of Nested Cluster Routing Failure and Recovery Actions

Event	Action
SSP1 sends an MSU with DPC=5-5-2.	The EAGLE responds with TFR concerning SSP 5-5-2 to SSP1. The MSU is routed on linkset LSC.
SSP1 sends an MSU with DPC=5-5-1.	The EAGLE routes the MSU to SSP 5-5-1 using linkset LSE.
Linkset LSB recovers.	The EAGLE stops using linkset LSC to send traffic to cluster 5-5-*, performs controlling rerouting on cluster 5-5-*, marks cluster 5-5-* as allowed on linkset LSB, and starts routing traffic to cluster 5-5-* using linkset LSB.
The SSP sends a routeset test (RSR) concerning SSP 5-5-2 to the EAGLE.	The EAGLE responds with a TFA concerning SSP 5-5-2.
Linkset LSC fails.	The EAGLE stops using linkset LSC to send traffic to cluster 5-5-* or full point code 5-5-1, and marks cluster 5-5-* and full point code 5-5-1 as prohibited on linkset LSC.
Linkset LSC recovers.	The EAGLE marks cluster 5-5-* and full point code 5-5-1 as allowed on linkset LSC.
Linkset LSE fails.	The EAGLE stops using linkset LSE to send traffic to SSP-5-5-1, marks SSP 5-5-1 as prohibited on linkset LSE, performs forced rerouting, starts level 3 timer T11 concerning SSP 5-5-1, sends preventive TFP concerning SSP 5-5-1 to node B, and starts using linkset LSB to send traffic to full point code 5-5-1. The EAGLE marks full point code 5-5-1 as restricted on linkset LSB. When level 3 timer T11 expires, a TFR concerning SSP 5-5-1 is sent to SSP1 and node A.
SSP1 sends an MSU with the DPC 5-5-2.	The EAGLE routes the MSU to SSP 5-5-2 using linkset LSB.
SSP1 sends an MSU with the DPC 5-5-1.	The EAGLE responds with a TFR concerning SSP 5-5-1 to SSP1. The MSU is routed to SSP 5-5-1 using linkset LSB.

Table 2-12 (Cont.) Example of Nested Cluster Routing Failure and Recovery Actions

Event	Action
Linkset LSE recovers.	The EAGLE stops using linkset LSB to send traffic to SSP 5-5-1 , performs controlling rerouting on full point code 5-5-1, marks full point code 5-5-1 as allowed on linkset LSE , and starts routing traffic to full point code 5-5-1 using linkset LSE . The EAGLE broadcasts a TFA for SSP 5-5-1 to SSP1 , node A, and node B.

Limitations of the Nested Cluster Routing Feature

The **EAGLE** only supports a maximum of 200 nested cluster destinations. This limit does not apply to non-nested clusters (clusters with the `ncai` parameter set to `no`).

If a cluster is more restricted than a member, the **EAGLE** broadcasts the status of the least restricted member, and relies on response method for members of the cluster that do not have a full point code entry.

The **EAGLE** does not broadcast preventive **TCPs** for nested cluster destinations. Because the **EAGLE** does not send preventive **TCPs** when it begins routing toward a nested cluster, circular routing can occur. The **EAGLE** sends response method **TFPs** if it receives an **MSU** when there is a danger of circular routing.

Adding a Cluster Point Code

This procedure is used to add a cluster point code for the **Cluster Routing and Management Diversity (CRMD)** feature, and nested cluster point codes for the nested cluster routing feature to the database, using the `ent-dstn` command.

To change the attributes of an existing cluster point code, go to the [Changing the Attributes of a Cluster Point Code](#) procedure.

Note: Cluster entries can only be provisioned as ANSI destination point codes. Cluster entries cannot be provisioned for ITU international or ITU national destination point codes, and cannot be provisioned as a proxy point code. The ANSI alias point code for an ITU international or ITU national destination point code must be a full point code. An ANSI private point code must be a full point code.

To remove a cluster point code from the database, go to the [Removing a Destination Point Code](#) procedure.

The Cluster Routing and Management Diversity feature must be turned on.

The `ent-dstn` command uses these parameters:

`:dpc/dpca` – The destination point code being added to the database.

Note: See [Point Code Formats](#) for a definition of the point code types that are used on the **EAGLE**.

Note: Alias point codes (`aliasi/aliasn/aliasn24`) and secondary point codes (`spc/spca`) cannot be specified for a cluster point code.

`:clli` – The **Common Language Location Identifier** assigned to this point code.

`:domain` – The network in which the destination entity or node exists, SS7.

Note: Specifying `:domain=ss7` is the only valid entry for cluster destinations.

`:bei` – Broadcast exception indicator that indicates whether transfer-prohibited (**TFP**) messages will be broadcast from this node. The `bei=yes` parameter means **TFPs** will not be broadcast. The `bei=no` parameter means **TFPs** will be broadcast.

`:ipgwapc`– (ANSI networks only)**IP Gateway Adjacent Point Code** indicator. Specify `ipgwapc=yes` to provide **SS7** linkset definition compatibility for gateway connections to **IP-SCPs**. The default is `ipgwapc=no`.

`:elei` – For cluster point codes only. Specifies whether or not the EAGLE maintains a dynamic status exception list for each cluster route that may be used to reach the member signaling points making up the cluster. The `elei=yes` parameter means the EAGLE does not maintain an exception list for the cluster point code specified by the `dpc` parameter. The `elei=no` parameter means the EAGLE does maintain an exception list for the cluster point code specified by the `dpc` parameter. The default value for the `elei` parameter is `no`.

`:ncai` – The nested-cluster-allowed indicator specifies whether or not the route to the cluster point code can be different from the route to a point code that is a member of the cluster point code. A point code is a member of a cluster point code if it has the same network identifier (**NI**) and network cluster (**NC**) values as the cluster point code. This parameter can be specified only for cluster point codes.

If the `ncai` parameter value is `yes`, the cluster point code is a nested cluster point code. Point codes that are members of this cluster point code can be assigned to routesets that are different from the routeset assigned to the cluster point code.

If the `ncai` parameter value is `no`, the cluster point code is not a nested cluster point code. Point codes that are members of this cluster point code must be assigned to the same routeset assigned to the cluster point code.

The default value for the `ncai` parameter is `no`.

See the [Nested Cluster Routing](#) section for more information on the nested cluster routing feature.

`:nprst` - NM bits reset. This parameter specifies whether the NM bits in an ITU IAM message should be set to 00. This parameter has two values.

- `off` - Do not set NM bits to 00 in an ITU IAM message if the `nptype` option value in the `rtrv-tifopts` output is `nm`.
- `on` - Set the NM bits to 00 in an ITU IAM message if the `nptype` option value in the `rtrv-tifopts` output is `nm`.

The default value for this parameter is `off`.

`:rcause` - Release cause. This parameter specifies the condition that triggers the sending of a Release message. This parameter has these values.

- 0 - 127
- none - use the values specified for the `rcausenp` and `rcausepfx` parameters in the `rtrv-tifopts` output.

The default value for this parameter is none.

If the `rlcopc` parameter value in the `rtrv-tifopts` output is on and a value of 0-127 is specified for the `rcause` parameter, then the `rcause` parameter value overrides the values specified for the `rcausenp` and `rcausepfx` parameters in the `rtrv-tifopts` output.

`:splitiam` - This parameter specifies how and when to split an ITU IAM message into one IAM message and one SAM message. This parameter has these values.

- 15-31 - The maximum number of CdPN digits allowed in the IAM message before the splitting occurs. The remaining digits, up to a total of 32, are encoded in the SAM message.
- none - the value specified for the `splitiam` parameter in the `rtrv-tifopts` output is used to determine when to split the IAM message.

The default value for this parameter is none.

To specify the `nprst` or `rcause` parameters, the TIF Number Portability feature, part number 893018901, must be enabled. To specify the `splitiam` parameter, at least one of these features must be enabled.

- TIF Number Portability - part number 893018901
- TIF SCS Forwarding - part number 893022201
- TIF Simple Number Substitution - part number 893024001
- TIF Additional Subscriber Data - part number 893024501
- TIF Generic Routing Number - part number 893025501
- TIF Selective Screening - part number 893040201

The status of these features is shown in the `rtrv-ctrl-feat` output. Perform the procedures in *TIF User's Guide* to enable these features.

`:sccpmsgcnv` - The `sccpmsgcnv` parameter controls SCCP UDT(S)/XUDT(S) message conversion for the specified destination. This parameter can be specified only if the XUDT UDT Conversion feature is enabled and turned on. The `rtrv-ctrl-feat` output shows the status of the XUDT UDT Conversion feature. If the XUDT UDT Conversion feature is not enabled or turned on, perform the "Activating the XUDT UDT Conversion Feature" procedure in *Database Administration - GTT User's Guide* to enable and turn on the XUDT UDT Conversion feature. This parameter contains these values.

- none - SCCP UDT(S)/XUDT(S) message conversion is not required on messages for the destination. This value is the default value for this parameter.
- udt2xudt - All UDT(S) messages for the destination are converted to XUDT(S) messages.
- xudt2udt - All non-segmented XUDT(S) messages for the destination are converted to UDT(S) messages. Segmented XUDT(S) messages for the destination are not converted to UDT(S) messages.

- `sxudt2udt` - All segmented and non-segmented XUdT(S) messages for the destination are converted to UDT(S) messages.

The `ent-dstn` command also contains the `homescp` and `homesmsc` parameters. The values for these parameters are `yes` and `no`. The value `no` is the default value for these parameters. The value `yes` for these parameters cannot be specified for a cluster point code. To specify the value `yes` for these parameters, perform the [Adding a Destination Point Code](#) or [Changing a Destination Point Code](#) procedures.

To add a cluster point code to the database, the Cluster Routing and Management Diversity feature must be on. The `ncai` parameter can be specified for the cluster point code only if both the Cluster Routing and Management Diversity and nested cluster routing features are on. This is shown by the entries `CRMD = on` (for the Cluster Routing and Management Diversity feature) and `NCR = on` (for the nested cluster routing feature) in the `rtrv-feat` command output.

The domain of the cluster point code must be SS7 (`domain=ss7`).

To enter an ANSI point code, an ANSI self ID for the EAGLE must be defined. This can be verified with the `rtrv-sid` command. The ANSI self ID is shown in the `PCA` field in the `rtrv-sid` command output. If no values are shown in the `PCA` field of the `rtrv-sid` command output, go to [Changing the Self-Identification of the EAGLE](#) procedure to add the ANSI Self ID of the EAGLE.

The actual number of destination point codes that can be configured in the database is set by the `mtpdpcq` parameter of the `chg-stpopts` command, and is shown in the `MTPDPCQ` field in the `rtrv-stpopts` command output. See [13](#).

If the 5000 Routes feature is not on, and 6000, 7000, 8000, or 10,000 routesets are not enabled, the sum of the `mtpdpcq` and `mtpxlq` parameters cannot exceed 2500. The range of values for the `mtpdpcq` and `mtpxlq` parameters is 500 to 2000.

If the 5000 Routes feature is on, and 6000, 7000, 8000, or 10,000 routesets are not enabled the sum of the `mtpdpcq` and `mtpxlq` parameters cannot exceed 5500. The range of values for the `mtpdpcq` and `mtpxlq` parameters is 500 to 5000.

If 6000 routesets are enabled, the sum of the `mtpdpcq` and `mtpxlq` parameters cannot exceed 6500. The range of values for the `mtpdpcq` and `mtpxlq` parameters is 500 to 6000.

If 7000 routesets are enabled, the sum of the `mtpdpcq` and `mtpxlq` parameters cannot exceed 7500. The range of values for the `mtpdpcq` parameter is 500 to 7000. The range of values for the `mtpxlq` parameter is 500 to 6000.

If 8000 routesets are enabled, the sum of the `mtpdpcq` and `mtpxlq` parameters cannot exceed 8500. The range of values for the `mtpdpcq` parameter is 500 to 8000. The range of values for the `mtpxlq` parameter is 500 to 6000.

If 10,000 routesets are enabled, the sum of the `mtpdpcq` and `mtpxlq` parameters cannot exceed 10500. The range of values for the `mtpdpcq` and `mtpxlq` parameters is 500 to 10,000.

Note: For more information on the destination point code quantities, go to the [Changing the DPC Quantity](#) procedure.

If the `ncai` parameter value is `yes`, the EAGLE can have a maximum of 200 nested cluster point codes in the database.

The value of the `clli` parameter cannot be in the `DPC` table and cannot match the `CLLI` of the EAGLE. Verify this by entering the `rtrv-dstn` and the `rtrv-sid`

commands, shown in 3 and 4. If the value of the `clli` parameter matches any CLI values in either of these outputs, choose another value for the `clli` parameter that does not match any CLIs shown in either of these command outputs.

If the `PCTYPE` field of the `rtrv-sid` command output contains the entry `ANSI`, and the network value of the destination point codes specified by the `ent-dstn` command, is from 0 to 5, the cluster value of that point code must be from 1 to 255. If the network value of that point code is from 6 to 255, the cluster value of that point code must be from 0 to 255.

To add a cluster point code to the database when the database contains point codes that are members of the cluster, the linkset type used by the routes to the member point codes must be either B, C, or D. For example, you wish to add the cluster point code `004-004-*` and the database contains point codes `004-004-001` and `004-004-002`. When cluster point code is added, point codes `004-004-001` and `004-004-002` would become members of the cluster point code `004-004-*`. If point codes `004-004-001` or `004-004-002` are the destination point codes of routes, and the linkset type of these routes are either A or E, the cluster point code `004-004-*` cannot be added to the database. The linkset type of these routes must be changed to either B, C, or D to add cluster point code `004-004-*` to the database. To change the linkset type of a linkset, perform the [Changing an SS7 Linkset](#) procedure.

The examples in this procedure are used to enter the cluster point code `111-011-*` and the nested cluster point code `030-045-*`.

Canceling the RTRV-DSTN Command

Because the `rtrv-dstn` command used in this procedure can output information for a long period of time, the `rtrv-dstn` command can be canceled and the output to the terminal stopped. There are three ways that the `rtrv-dstn` command can be canceled:

- Press the F9 function key on the keyboard at the terminal where the `rtrv-dstn` command was entered.
- Enter the `canc-cmd` without the `trm` parameter at the terminal where the `rtrv-dstn` command was entered.
- Enter the `canc-cmd:trm=<xx>`, where `<xx>` is the terminal where the `rtrv-dstn` command was entered, from another terminal other than the terminal where the `rtrv-dstn` command was entered. To enter the `canc-cmd:trm=<xx>` command, the terminal must allow Security Administration commands to be entered from it and the user must be allowed to enter Security Administration commands. The terminal's permissions can be verified with the `rtrv-secu-trm` command. The user's permissions can be verified with the `rtrv-user` or `rtrv-secu-user` commands.

For more information about the `canc-cmd` command, refer to *Commands User's Guide*.

1. Display the current destination point codes in the database, using the `rtrv-dstn` command.

This is an example of the possible output.

```
rlghncxa03w 10-12-10 11:43:04 GMT EAGLE5 43.0.0
Extended Processing Time may be Required

      DPCA          CLLI          BEI  ELEI    ALIASI          ALIASN/N24    DMN
      002-002-002  ----- no   --- -----          -----          SS7
      020-002-045  rlghncbb100 no   --- -----          -----          SS7
```

```

020-002-050  rlghncbb100 no --- ----- SS7
030-045-001  ----- yes --- ----- SS7
111-011-001  ----- yes --- ----- SS7
240-012-005  rlghncbb002 yes --- 1-112-2 11112 SS7
240-012-006  rlghncbb003 yes --- 1-112-3 11113 SS7

DPCI        CLLI        BEI  ELEI  ALIASA        ALIASN/N24  DMN
2-131-1     rlghncbb023 no --- 222-210-000 12001      SS7
2-131-2     ----- no --- 222-211-001 12002      SS7

DPCN        CLLI        BEI  ELEI  ALIASA        ALIASI       DMN
11211      rlghncbb013 no --- 222-200-200 2-121-1    SS7
11212      rlghncbb013 no --- 222-200-201 2-121-2    SS7

```

```

DESTINATION ENTRIES ALLOCATED: 2000
FULL DPC(s):                    11
EXCEPTION DPC(s):                0
NETWORK DPC(s):                  0
CLUSTER DPC(s):                  0
TOTAL DPC(s):                    11
CAPACITY (% FULL):               1%
ALIASES ALLOCATED:               8000
ALIASES USED:                    12
CAPACITY (% FULL):               1%
X-LIST ENTRIES ALLOCATED:        500
RTRV-DSTN: MASP A - COMPLTD

```

If the addition of the cluster point code will not exceed the current DPC capacity shown in the `rtrv-dstn` output, continue the procedure with [2](#).

If the addition of the cluster point code will exceed the current DPC capacity, and the current capacity is less than 10,000 (or 10,500 if the `DESTINATION ENTRIES ALLOCATED` and `X-LIST ENTRIES ALLOCATED` fields are shown in the `rtrv-dstn` output), perform the [Changing the DPC Quantity](#) procedure to change the DPC quantity. Continue the procedure with [2](#).

If the addition of the cluster point code will exceed the current DPC capacity, and the current capacity is 10,000 (or 10,500 if the `DESTINATION ENTRIES ALLOCATED` and `X-LIST ENTRIES ALLOCATED` fields are shown in the `rtrv-dstn` output), perform the [Removing a Destination Point Code](#) procedure to remove a DPC or perform the [Removing a Route Exception Entry](#) procedure to remove an exception route. Continue the procedure with [2](#).

Note: If the `rtrv-dstn` output in [1](#) shows any cluster point codes, and nested cluster point codes are not being configured in this procedure, continue the procedure with [3](#).

Note: If cluster point codes are not shown in the `rtrv-dstn` output in [1](#), but ANSI point codes are shown in [1](#), continue the procedure with [3](#).

2. Display the self-identification of the EAGLE using the `rtrv-sid` command. This is an example of the possible output..

```

rlghncxa03w 07-05-10 11:43:04 GMT EAGLE5 37.0.0
PCA          PCI          PCN          CLLI          PCTYPE
010-020-030 0-123-1      12-0-14-1   rlghncxa03w  OTHER

```

CPCA			
002-002-002	002-002-003	002-002-004	002-002-005
002-002-006	002-002-007	002-002-008	002-002-009
004-002-001	004-003-003	050-060-070	
CPCI			
1-001-1	1-001-2	1-001-3	1-001-4
1-002-1	1-002-2	1-002-3	1-002-4
2-001-1	7-222-7		
CPCN			
2-0-10-3	2-0-11-0	2-0-11-2	2-0-12-1
2-2-3-3	2-2-4-0	10-14-10-1	

If the **PCA** field does not contain an entry, perform the [Changing the Self-Identification of the EAGLE](#) procedure and add an ANSI point code to the self identification of the EAGLE.

Note: If the `DESTINATION ENTRIES ALLOCATED` and `X-LIST ENTRIES ALLOCATED` fields are shown in the `trv-dstn` output in [1](#), and nested cluster point codes are not being configured in this procedure, continue the procedure with [6](#).

- Verify that the Cluster Routing and Management Diversity feature is turned on, by entering the `trv-feat` command. If nested cluster point codes are to be configured in the database, the nested cluster routing feature must be turned on. If the Cluster Routing and Management Diversity feature is turned on, the `CRMD` field should be set to on. If the nested cluster routing feature is turned on, the `NCR` field should be set to on. In this example, both features are off.

Note: The `trv-feat` command output contains other fields that are not used by this procedure. If you wish to see all the fields displayed by the `trv-feat` command, see the `trv-feat` command description in *Commands User's Guide*.

- Turn the Cluster Routing and Management Diversity feature on by entering this command.

```
chg-feat:crmd=on
```

Note: If the Cluster Routing and Management Diversity feature is on, shown by the `CRMD = on` entry in the `trv-feat` command output in [3](#), continue the procedure with [5](#).

Note: Once the Cluster Routing and Management Diversity feature is turned on with the `chg-feat` command, it cannot be turned off.

The Cluster Routing and Management Diversity feature must be purchased before you turn this feature on with the `chg-feat` command. If you are not sure if you have purchased the Cluster Routing and Management Diversity feature, contact your Sales Representative or Account Representative.

When this command has successfully completed, this message should appear.

```
rlghncxa03w 07-05-10 11:43:04 GMT EAGLE5 37.0.0
CHG-FEAT: MASP A - COMPLTD
```

If nested cluster point codes are being added to the database or the `ncai` parameter is specified for the cluster point code and the nested cluster routing feature is on, shown by the `NCR = on` entry in the `rtrv-feat` command output in 3, and DPCs are shown in the `rtrv-dstn` output that are members of the cluster point code that is being added, continue the procedure with 6. If the `rtrv-dstn` output does not show any DPCs that are members of the cluster point code being added, continue the procedure with 9.

If nested cluster point codes are being added to the database or the `ncai` parameter is specified for the cluster point code and the nested cluster routing feature is off, continue the procedure with 5.

- Turn the nested cluster routing feature on by entering this command.

```
chg-feat:ncr=on
```

Note: Once the nested cluster routing feature is turned on with the `chg-feat` command, it cannot be turned off.

The nested cluster routing feature must be purchased before you turn this feature on with the `chg-feat` command. If you are not sure if you have purchased the nested cluster routing feature, contact your Sales Representative or Account Representative.

When this command has successfully completed, this message should appear.

```
rlghncxa03w 07-05-10 11:43:04 GMT EAGLE5 37.0.0
CHG-FEAT: MASP A - COMPLTD
```

Note: If the `rtrv-dstn` output does not show any DPCs that are members of the cluster point code being added in this procedure, continue the procedure with 9.

- The cluster point code cannot be added to the database if the database contains member point codes assigned to routes that are assigned to linksets whose linkset type is either A or E.

Enter the `rtrv-rte` command with one of the DPCs that is a member of the cluster point code being added in this procedure. For this example, enter these commands.

```
rtrv-rte:dpca=111-011-001
```

This is an example of the possible output.

```
rlghncxa03w 07-05-17 15:35:05 GMT EAGLE5 37.0.0
DPCA          ALIASI          ALIASN/N24      LSN           RC           APCA
111-011-001   -----          -----          lsn2          10          111-011-001
RTX:No       CLI=-----
```

```
rtrv-rte:dpca=030-045-001
```

This is an example of the possible output.

```
rlghncxa03w 07-05-17 15:35:05 GMT EAGLE5 37.0.0
  DPCA          ALIASI      ALIASN/N24    LSN          RC      APCA
  030-045-001  -----      -----      lsn3         10     030-045-001
                                     RTX:No  CLLI=-----
```

If the DPC specified in this step is the DPC of a route, continue the procedure with [7](#).

If the DPC specified in this step is not the DPC of a route, repeat this step for other DPCs, shown in the `rtrv-dstn` output, that are members of the cluster point code being added in this procedure.

If all the DPCs that are members of the cluster point code being added have been displayed, and none of these DPCs are DPCs of routes, continue the procedure with [9](#).

7. Enter the `rtrv-ls` command with the linkset name shown in the `rtrv-rte` output in [6](#).

The linkset name is shown in the LSN column of the `rtrv-rte` output. For this example, enter these commands.

```
rtrv-ls:lsn=lsn2
```

This is an example of the possible output.

```
rlghncxa03w 09-05-17 15:35:05 GMT EAGLE5 41.0.0

LSN          APCA  (SS7)  L3T SLT          GWS GWS GWS
lsn2         111-011-001  none 1  1  no  B  2  off off off no  off

CLLI          TFATCABMLQ MTPRSE ASL8
-----      1          ---  no

RANDSLS
off

IPSG  IPGWAPC  GTTMODE          CGGTMOD
no    no      CdPA          no

LOC  LINK  SLC  TYPE          L2T          PCR  PCR
1103 A    0  LIMDS0  1  56000  BASIC  ---  -----
1104 A    1  LIMDS0  1  56000  BASIC  ---  -----
```

Link set table is (6 of 1024) 1% full.

```
rtrv-ls:lsn=lsn3
```

This is an example of the possible output.

```
rlghncxa03w 09-05-17 15:35:05 GMT EAGLE5 41.0.0

LSN          APCA  (SS7)  L3T SLT          GWS GWS GWS
lsn3         111-011-001  none 1  1  no  B  2  off off off no  off

CLLI          TFATCABMLQ MTPRSE ASL8
-----      1          ---  no

RANDSLS
off

IPSG  IPGWAPC  GTTMODE          CGGTMOD
no    no      CdPA          no

LOC  LINK  SLC  TYPE          L2T          PCR  PCR
1103 A    0  LIMDS0  1  56000  BASIC  ---  -----
1104 A    1  LIMDS0  1  56000  BASIC  ---  -----
```



```

lsn3          030-045-001  none 1  1  no  B  2  off off off no  off

CLLI          TFATCABMLQ MTPRSE ASL8
----- 1          ---  no

RANDSLS
off

IPSG  IPGWAPC  GTTMODE          CGGTMOD
no    no      CdPA          no

          L2T          PCR PCR
LOC  LINK  SLC  TYPE  SET  BPS  ECM  N1  N2
1103 B    0  LIMDS0  1   56000 BASIC ---  -----
1104 B    1  LIMDS0  1   56000 BASIC ---  -----

```

Link set table is (6 of 1024) 1% full.

If the linkset type of the linkset is either A or E, perform [Changing an SS7 Linkset](#) to change the linkset type to B, C, or D.

If all the DPCs that are members of the cluster point code being added have not been displayed in 6, repeat 6 and 7.

After all the linksets whose APCs are members of the cluster point code that is being added, and the linkset type of these linksets shown in this step is B, C, or D, or the linkset type was changed, continue the procedure by performing one of these steps.

- If the `nprst`, `rcause`, or `splitiam` parameters will not be specified for the cluster point code, continue the procedure with 9.
 - If the `nprst`, `rcause`, or `splitiam` parameters will be specified for the cluster point code, continue the procedure with 8.
8. Display the features that are enabled by entering the `rtrv-ctrl-feat` command. This is an example of the possible output.

```

rlghncxa03w 10-12-17 15:35:05 GMT  EAGLE5 43.0.0
The following features have been permanently enabled:

```

Feature Name	Partnum	Status	Quantity
HC-MIM SLK Capacity	893012707	on	64
TIF Number Portability	893018901	off	----
XUDT UDT Conversion	893035301	on	----

The following features have been temporarily enabled:

Feature Name	Partnum	Status	Quantity	Trial Period Left
Zero entries found.				

The following features have expired temporary keys:

Feature Name	Partnum
Zero entries found.	

To specify the `nprst` or `rcause` parameters, the TIF Number Portability feature, part number 893018901, must be enabled. To specify the `splitiam` parameter, at least one of these features must be enabled.

- TIF Number Portability - part number 893018901
- TIF SCS Forwarding - part number 893022201
- TIF Simple Number Substitution - part number 893024001
- TIF Additional Subscriber Data - part number 893024501
- TIF Generic Routing Number - part number 893025501

Perform the procedures in *TIF User's Guide* to enable these features as required.

9. Continue the procedure by performing one of these steps.

- Continue the procedure with [11](#) if any of these conditions are present.
 - The `sccpmsgcnv` parameter will not be specified for the cluster point code.
 - The `sccpmsgcnv` parameter will be specified for the cluster point code and the `rtrv-ctrl-feat` output in this step shows that the XUDT UDT Conversion feature is enabled and turned on. If the `rtrv-ctrl-feat` output in this step shows that the XUDT UDT Conversion feature is not enabled or turned on, perform the "Activating the XUDT UDT Conversion Feature" procedure in *Database Administration - GTT User's Guide* to enable and turn on the XUDT UDT Conversion feature.
- Continue the procedure with [10](#) if the `sccpmsgcnv` parameter will be specified for the cluster point code and [8](#) was not performed.

10. Enter this command to verify the status of the XUDT UDT Conversion feature.

```
rtrv-ctrl-feat:partnum=893035301
```

This is an example of the possible output.

```
rlghncxa03w 10-12-17 15:35:05 GMT EAGLE5 43.0.0
The following features have been permanently enabled:
```

Feature Name	Partnum	Status	Quantity
XUDT UDT Conversion	893035301	on	----

The following features have been temporarily enabled:

Feature Name	Partnum	Status	Quantity	Trial Period Left
Zero entries found.				

The following features have expired temporary keys:

Feature Name	Partnum
Zero entries found.	

If the XUDT UDT Conversion feature is not enabled or turned on, perform the "Activating the XUDT UDT Conversion Feature" procedure in *Database*

Administration - GTT User's Guide to enable and turn on the XUDT UDT Conversion feature.

If the XUDT UDT Conversion feature is enabled and turned on, or the "Activating the XUDT UDT Conversion Feature" procedure was performed in this step, continue the procedure with [11](#).

11. Add the cluster point code to the database, by using the `ent-dstn` command.

For this example, enter these commands.

```
ent-dstn:dpca=111-011-
*:clli=rlghncbb000:bei=yes:elei=yes:domain=ss7

ent-dstn:dpca=030-045-
*:clli=rlghncbb010:bei=yes:elei=yes :domain=ss7:ncai=yes

ent-dstn:dpca=100-075-
*:bei=yes:elei=yes:ncai=yes:nprst=on:rcause=15 :splitiam=10:s
ccpmsgcnv=udt2xudt
```

When these commands have successfully completed, this message should appear.

```
rlghncxa03w 09-05-17 15:35:05 GMT EAGLE5 41.0.0
DESTINATION ENTRIES ALLOCATED: 2000
  FULL DPC(s): 12
  EXCEPTION DPC(s): 0
  NETWORK DPC(s): 0
  CLUSTER DPC(s): 3
  TOTAL DPC(s): 15
  CAPACITY (% FULL): 1%
ALIASES ALLOCATED: 8000
  ALIASES USED: 12
  CAPACITY (% FULL): 1%
X-LIST ENTRIES ALLOCATED: 500
ENT-DSTN: MASP A - COMPLTD
```

12. Verify the changes using the `rtrv-dstn` command and specifying the DPC that was entered in [11](#).

For this example, enter these commands.

```
rtrv-dstn:dpca=111-011-*
```

This is an example of the possible output.

```
rlghncxa03w 10-12-28 21:16:37 GMT EAGLE5 43.0.0

  DPCA          CLLI          BEI ELEI  ALIASI          ALIASN/N24  DMN
  111-011-*     rlghncbb000 yes yes  -----      -----      SS7

  SPCA          NCAI          RCAUSE NPRST SPLITIAM HMSMSC HMSCP  SCCPMSGCNV
  -----      no           none  off  none      no      no      none

DESTINATION ENTRIES ALLOCATED: 2000
  FULL DPC(s): 12
  EXCEPTION DPC(s): 0
  NETWORK DPC(s): 0
  CLUSTER DPC(s): 3
  TOTAL DPC(s): 15
  CAPACITY (% FULL): 1%
```

```
ALIASES ALLOCATED:          8000
  ALIASES USED:              12
  CAPACITY (% FULL):        1%
X-LIST ENTRIES ALLOCATED:  500
RTRV-DSTN: MASP A - COMPLTD
```

```
rtrv-dstn:dpca=030-045-*
```

This is an example of the possible output.

```
rlghncxa03w 10-12-28 21:16:37 GMT EAGLE5 43.0.0
```

DPCA	CLLI	BEI	ELEI	ALIASI	ALIASN/N24	DMN
030-045-*	rlghncbb010	yes	yes	-----	-----	SS7

SPCA	NCAI	RCAUSE	NPRST	SPLITIAM	HMSMSC	HMSCP	SCCPMSGCNV
-----	no	none	off	none	no	no	none

```
DESTINATION ENTRIES ALLOCATED:  2000
  FULL DPC(s):                    12
  EXCEPTION DPC(s):                0
  NETWORK DPC(s):                  0
  CLUSTER DPC(s):                  3
  TOTAL DPC(s):                    15
  CAPACITY (% FULL):              1%
ALIASES ALLOCATED:                8000
  ALIASES USED:                    12
  CAPACITY (% FULL):              1%
X-LIST ENTRIES ALLOCATED:        500
RTRV-DSTN: MASP A - COMPLTD
```

```
rtrv-dstn:dpca=100-075-*
```

```
rlghncxa03w 10-12-28 21:16:37 GMT EAGLE5 43.0.0
```

DPCA	CLLI	BEI	ELEI	ALIASI	ALIASN/N24	DMN
100-075-*	-----	yes	yes	-----	-----	SS7

SPCA	NCAI	RCAUSE	NPRST	SPLITIAM	HMSMSC	HMSCP	SCCPMSGCNV
-----	yes	15	on	10	no	no	udt2xudt

```
DESTINATION ENTRIES ALLOCATED:  2000
  FULL DPC(s):                    12
  EXCEPTION DPC(s):                0
  NETWORK DPC(s):                  0
  CLUSTER DPC(s):                  3
  TOTAL DPC(s):                    15
  CAPACITY (% FULL):              1%
ALIASES ALLOCATED:                8000
  ALIASES USED:                    12
  CAPACITY (% FULL):              1%
X-LIST ENTRIES ALLOCATED:        500
RTRV-DSTN: MASP A - COMPLTD
```

Note: If you do not wish to change the exception list parameters for the Cluster Routing and Management Diversity feature, continue the procedure with [16](#).

13. The parameters for the exception list for the Cluster Routing and Management Diversity feature can be changed from the default settings by using the `chg-stpopts` command. The parameters of the `chg-stpopts` command that control the exception point-code list are:

`mtpxlq` = the maximum number of entries the exception list (x-list) can contain

`mtpxlet` = the maximum amount of time the **EAGLE** will maintain an unreferenced exception list (x-list) entry, expressed in the format `hhmm`, where `hh` is the number of hours, and `mm` is the number of minutes.

`mtpxlot` = the exception list (x-list) occupancy threshold (in terms of percentage of space available). If this threshold is exceeded, the **EAGLE** raises a minor alarm.

`mtpdpcq` = the maximum number of destination point codes that can be configured on the **EAGLE**.

Note: The sum of the `MTPDPCQ` and `MTPXLQ` value's cannot exceed one of these totals depending on the features that are enabled or turned on:

- 2500 – if the 5000 Routes feature is not on, and 6000, 7000, or 8000 routesets are not enabled. The range of values for the `mtpdpcq` and `mtpxlq` parameters is 500 to 2000.
 - 5500 – if the 5000 Routes feature is on, but 6000, 7000, or 8000 routesets are not enabled. The range of values for the `mtpdpcq` and `mtpxlq` parameters is 500 to 5000.
 - 6500 – if 6000 routesets are enabled. The range of values for the `mtpdpcq` and `mtpxlq` parameters is 500 to 6000.
 - 7500 – if 7000 routesets are enabled. The range of values for the `mtpdpcq` parameter is 500 to 7000. The range of values for the `mtpxlq` parameter is 500 to 6000.
 - 8500 – if 8000 routesets are enabled. The range of values for the `mtpdpcq` parameter is 500 to 8000. The range of values for the `mtpxlq` parameter is 500 to 6000.
 - 10,500 – if 10,000 routesets are enabled. The range of values for the `mtpdpcq` and `mtpxlq` parameters is 500 to 10,000.
-

Display the existing values for the exception list parameters, by entering the `rtrv-stpopts` command. This is an example of the possible output.

```
rlghncxa03w 07-05-17 16:02:05 GMT EAGLE5 37.0.0
STP OPTIONS
-----
MTPXLQ          500
MTPXLET        0100
MTPXLOT         90%
MTPDPCQ        2000
```

Note: The `thertrv-stpopts` command output contains other fields that are not used by this procedure. If you wish to see all the fields displayed by the `thertrv-stpopts` command, see the `thertrv-stpopts` command description in *Commands User's Guide*.

Note: If the Cluster Routing and Management Diversity was turned on in this procedure, the `MTPXLQ`, `MTPXLET`, and `MTPXLOT` parameters are shown with these default values.

- `MTPXLQ` – 500
- `MTPXLET` – 0100
- `MTPXLOT` – 90%

The `MTPDPCQ` value is not changed when the **Cluster Routing and Management Diversity** is turned on.

14. If you wish to change the exception list parameters or the `mtpdpcq` value, enter the `chg-stpopts` command.

Note: If the DPC quantity or the exception list quantity is being changed in this step, both the `mtpdpcq` and `mtpxlq` parameters do have to be specified in this step unless the resulting sum of the `mtpdpcq` and `mtpxlq` parameters would exceed the totals shown in 12. For example, the current `mtpdpcq` value is 4000 and the current `mtpxlq` value is 1500, resulting in a sum of 5500, and only the 5000 Routes feature is on. To change either value, both parameters must be specified and the sum of the new values cannot exceed 5500. If in this example, the current `mtpdpcq` value is 3000 and the current `mtpxlq` value is 1500, resulting in a sum of 4500, either parameter value can be changed without specifying the other parameter as long as the sum of the values does not exceed 5500.

For this example, change the DPC quantity value to 1750, the exception list size to 750, the exception list timer to 1 hour and 30 minutes (90 minutes), and the exception list occupancy threshold to 75%. Enter this command.

```
chg-stpopts:mtpdpcq=1750:mtpxlq=750:mtpxlet=0130:mtpxlot=75
```

When this command has successfully completed, this message should appear.

```
rlghncxa03w 07-05-17 15:35:05 GMT EAGLE5 37.0.0
CHG-STPOPTS: MASP A - COMPLTD
```

15. Verify the changes using the `rtrv-stpopts` command.

This is an example of the possible output.

```
rlghncxa03w 07-05-17 16:02:05 GMT EAGLE5 37.0.0
STP OPTIONS
-----
MTPXLQ           750
MTPXLET          0130
```

MTPXLOT	75%
MTPDPCQ	1750

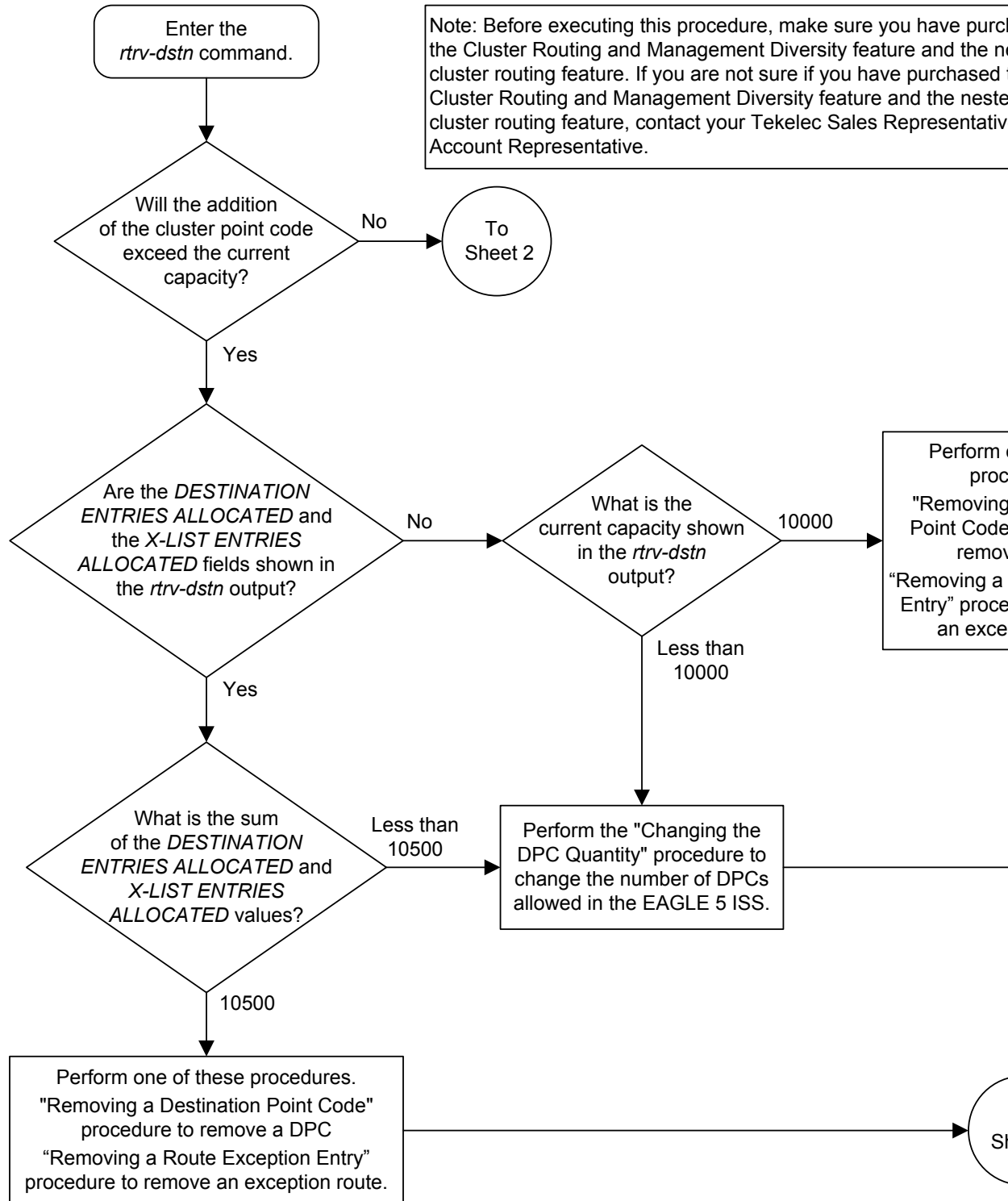
Note: Thertrv-stpopts command output contains other fields that are not used by this procedure. If you wish to see all the fields displayed by thertrv-stpopts command, see thertrv-stpopts command description in *Commands User's Guide*.

16. Back up the new changes, using the `chg-db:action=backup:dest=fixed` command.

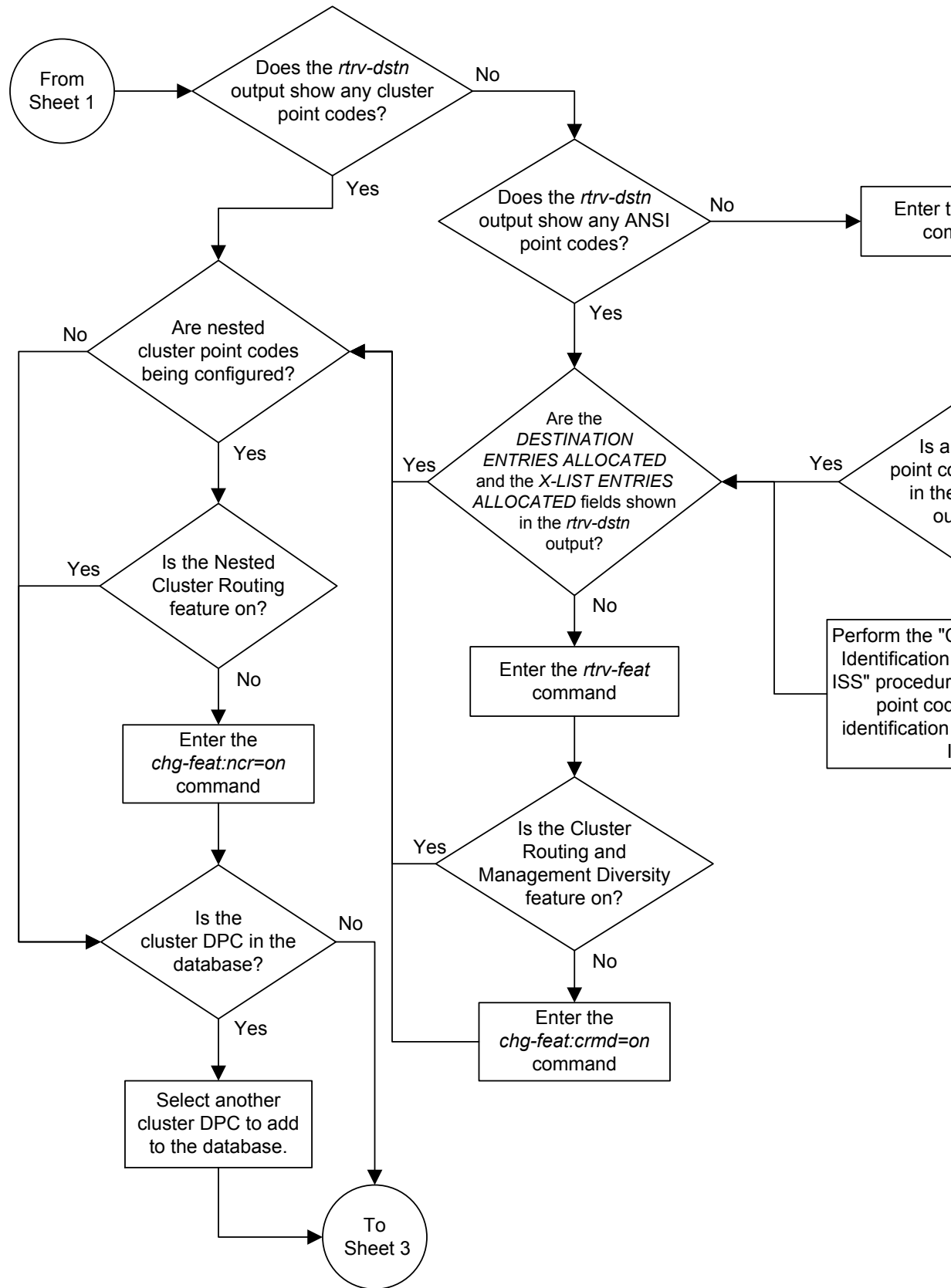
These messages should appear; the active **Maintenance and Administration Subsystem Processor (MASP)** appears first.

```
BACKUP (FIXED) : MASP A - Backup starts on active MASP.  
BACKUP (FIXED) : MASP A - Backup on active MASP to fixed disk complete.  
BACKUP (FIXED) : MASP A - Backup starts on standby MASP.  
BACKUP (FIXED) : MASP A - Backup on standby MASP to fixed disk complete.
```

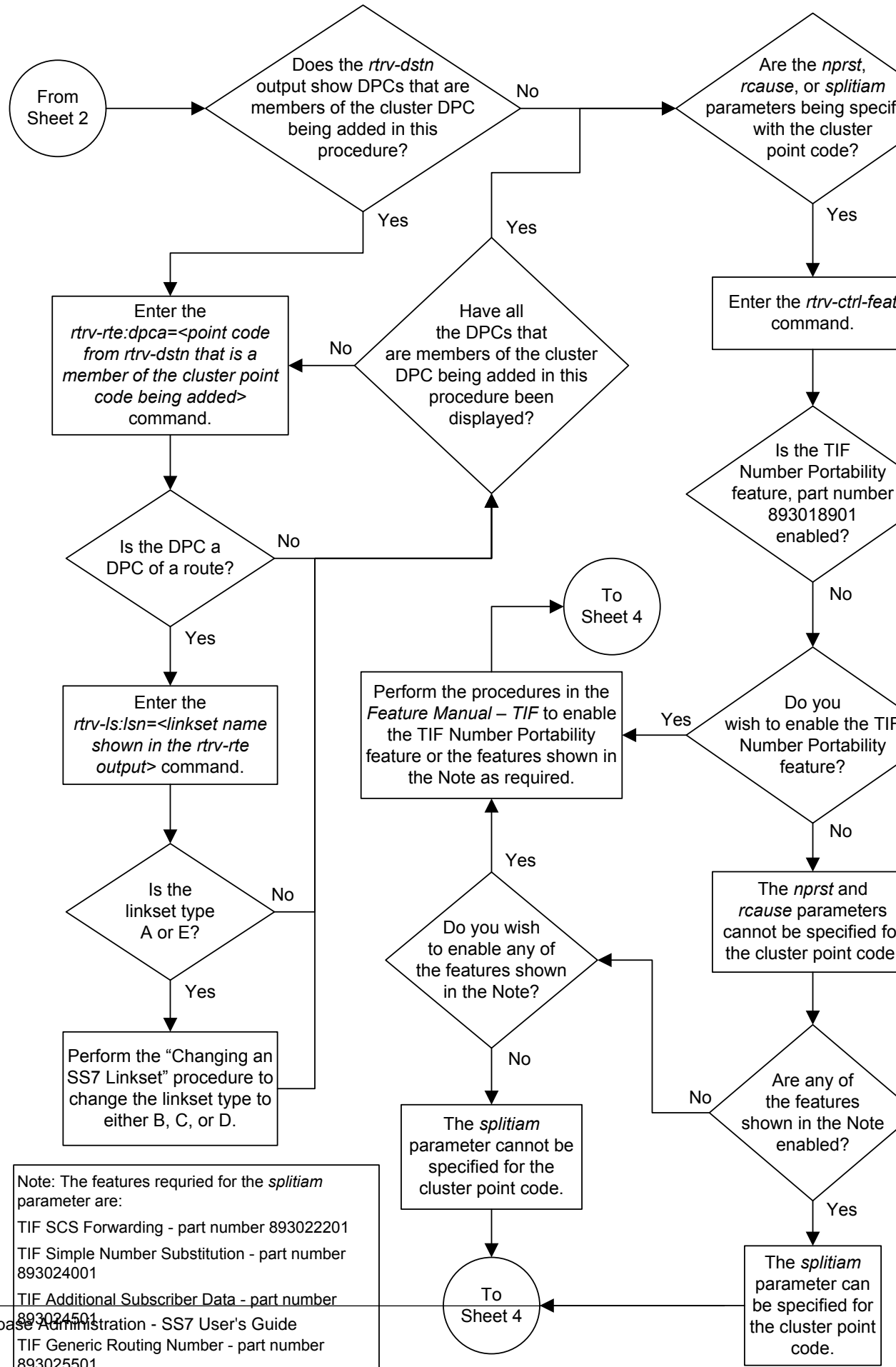
Figure 2-25 Adding a Cluster Point Code



Sheet 1 of 5

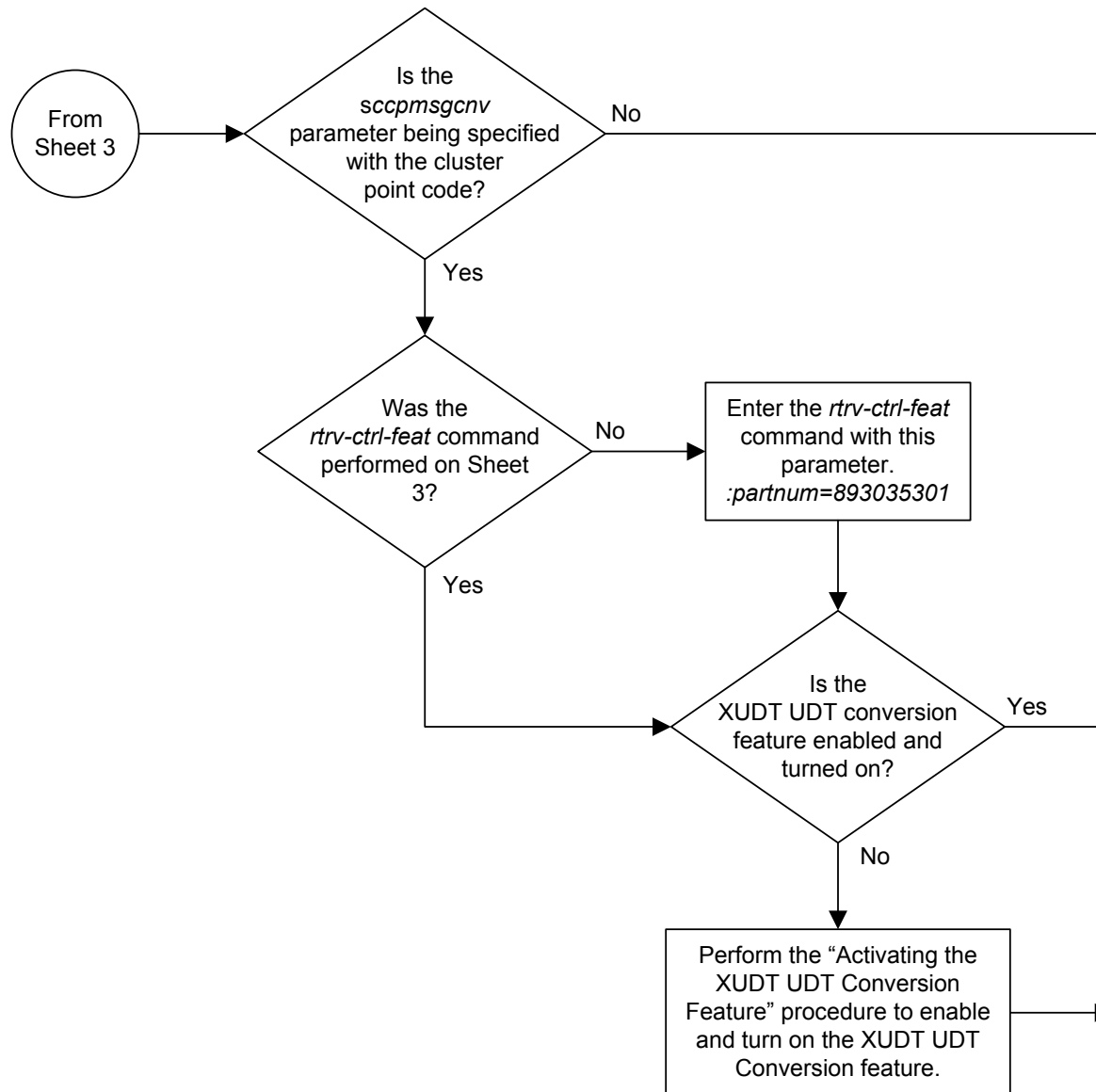


Sheet 2 of 5

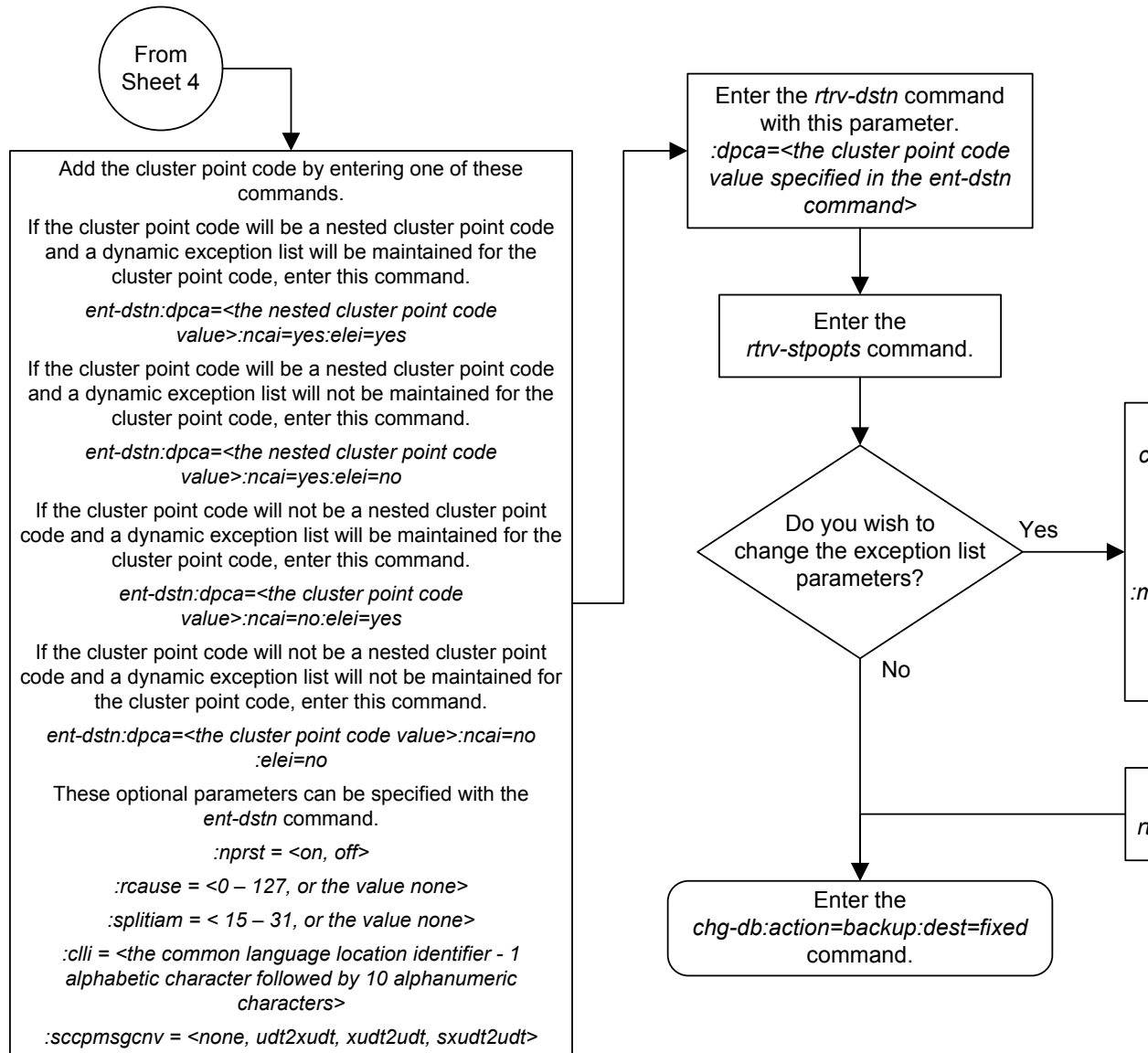


Note: The features required for the *splitiam* parameter are:
 TIF SCS Forwarding - part number 893022201
 TIF Simple Number Substitution - part number 893024001
 TIF Additional Subscriber Data - part number 893024501
 TIF Generic Routing Number - part number 893025501

Sheet 3 of 5



Sheet 4 of 5



Notes:

- The sum of the values for the *mtpdpcq* and *mtpxlq* parameters cannot exceed these values, depending which routeset quantity is enabled with the *enable-ctrl-feat* command, or turned on with the *chg-feat* command:
 - 5000 routes not turned on, 6000, 7000, or 8000 routesets not enabled - **2500**. The range of values for the *mtpdpcq* and *mtpxlq* parameters is 500 to 2000.
 - 5000 routes turned on, 6000, 7000, or 8000 routesets not enabled - **5500**. The range of values for the *mtpdpcq* and *mtpxlq* parameters is 500 to 5000.
 - 6000 routesets enabled - **6500**. The range of values for the *mtpdpcq* and *mtpxlq* parameters is 500 to 6000.
 - 7000 routesets enabled - **7500**. The range of values for the *mtpdpcq* parameter is 500 to 7000. The range of values for the *mtpxlq* parameter is 500 to 6000.
 - 8000 routesets enabled - **8500**. The range of values for the *mtpdpcq* parameter is 500 to 8000. The range of values for the *mtpxlq* parameter is 500 to 6000.
 - 10000 routesets enabled - **10500**. The range of values for the *mtpdpcq* and *mtpxlq* parameters is 500 to 10000.
- If the DPC quantity or the exception list quantity is being changed in this step, both the *mtpdpcq* and *mtpxlq* parameters must be specified in this step unless the resulting sum of the *mtpdpcq* and *mtpxlq* parameters would exceed the totals shown in Note 1. If the quantity is being decreased, the other parameter can be specified as long as the sum of the values does not exceed 5500. For example, the current *mtpdpcq* value is 4000 and the current *mtpxlq* value is 1500, resulting in a sum of 5500, and only the *enable-ctrl-feat* feature is on. To increase either value, both parameters must be specified and the sum of the new values cannot exceed 5500. If in this example, the current *mtpdpcq* value is 3000 and the current *mtpxlq* value is 1500, resulting in a sum of 4500, either parameter can be changed without specifying the other parameter as long as the sum of the values does not exceed 5500.

Changing the Attributes of a Cluster Point Code

This procedure is used to change the attributes of a cluster point code in the database, using the `chg-dstn` command.

Note: Cluster entries can be provisioned only as ANSI destination point codes. Cluster entries cannot be provisioned for ITU international or ITU national destination point codes, and cannot be provisioned as a proxy point code. The ANSI alias point code for an ITU international or ITU national destination point code must be a full point code. An ANSI private point code must be a full point code.

To add a new cluster point code to the database, perform the [Adding a Cluster Point Code](#) procedure.

To remove a cluster point code from the database, perform the [Removing a Destination Point Code](#) procedure.

The cluster point code to be changed must be in the database.

The `chg-dstn` command uses these parameters:

:dpc/dpca – The destination point code in the database being changed

Note: See [Point Code Formats](#) for a definition of the point code types that are used on the EAGLE.

Note: Alias point codes (`aliasi/aliasn/aliasn24`) and secondary point codes (`spc/spca`) cannot be specified for a cluster point code.

:clli – The **Common Language Location Identifier** assigned to this point code

:domain – The network in which the destination entity or node exists- SS7.

:bei – Broadcast exception indicator that indicates whether transfer-prohibited (TFP) messages will be broadcast from this node. The `bei=yes` parameter means TFPs will not be broadcast. The `bei=no` parameter means TFPs will be broadcast.

:ipgwapc – (ANSI networks only) **IP Gateway Adjacent Point Code** indicator. Specify `ipgwapc=yes` to provide SS7 linkset definition compatibility for gateway connections to IP-SCPs. The default is `ipgwapc=no`.

:elei – For cluster point codes only. Specifies whether or not the EAGLE maintains a dynamic status exception list for each cluster route that may be used to reach the member signaling points making up the cluster. The `elei=yes` parameter means the EAGLE does not maintain an exception list for the cluster point code specified by the `dpc` parameter. The `elei=no` parameter means the EAGLE does maintain an exception list for the cluster point code specified by the `dpc` parameter.

:ncai – The nested-cluster-allowed indicator specifies whether or not the route to the cluster point code can be different from the route to a point code that is a member of the cluster point code. A point code is a member of a cluster point code if it has the same network identifier (NI) and network cluster (NC) values as the cluster point code. This parameter can be specified only for cluster point codes.

If the `ncai` parameter value is `yes`, the cluster point code is a nested cluster point code. Point codes that are members of this cluster point code can be assigned to routesets that are different from the routeset assigned to the cluster point code.

If the `ncai` parameter value is `no`, the cluster point code is not a nested cluster point code. Point codes that are members of this cluster point code must be assigned to the same routeset assigned to the cluster point code.

Refer to the [Nested Cluster Routing](#) section for more information on the nested cluster routing feature.

`:nprst` - NM bits reset. This parameter specifies whether the NM bits in an ITU IAM message should be set to 00. This parameter has two values.

- `off` - Do not set NM bits to 00 in an ITU IAM message if the `nptype` option value in the `rtrv-tifopts` output is `nm`.
- `on` - Set the NM bits to 00 in an ITU IAM message if the `nptype` option value in the `rtrv-tifopts` output is `nm`.

The default value for this parameter is `off`.

`:rcause` - Release cause. This parameter specifies the condition that triggers the sending of a Release message. This parameter has these values.

- 0 - 127
- `none` - use the values specified for the `rcausenp` and `rcausepfx` parameters in the `rtrv-tifopts` output.

The default value for this parameter is `none`.

If the `rlcopc` parameter value in the `rtrv-tifopts` output is `on` and a value of 0-127 is specified for the `rcause` parameter, then the `rcause` parameter value overrides the values specified for the `rcausenp` and `rcausepfx` parameters in the `rtrv-tifopts` output.

`:splitiam` - This parameter specifies how and when to split an ITU IAM message into one IAM message and one SAM message. This parameter has these values.

- 15-31 - The maximum number of CdPN digits allowed in the IAM message before the splitting occurs. The remaining digits, up to a total of 32, are encoded in the SAM message.
- `none` - the value specified for the `splitiam` parameter in the `rtrv-tifopts` output is used to determine when to split the IAM message.

The default value for this parameter is `none`.

To specify the `nprst` or `rcause` parameters, the TIF Number Portability feature, part number 893018901, must be enabled. To specify the `splitiam` parameter, at least one of these features must be enabled.

- TIF Number Portability - part number 893018901
- TIF SCS Forwarding - part number 893022201
- TIF Simple Number Substitution - part number 893024001
- TIF Additional Subscriber Data - part number 893024501
- TIF Generic Routing Number - part number 893025501

The status of these features is shown in the `rtrv-ctrl-feat` output. Perform the procedures in *TIF User's Guide* to enable these features.

`:sccpmsgcnv` - The `sccpmsgcnv` parameter controls SCCP UDT(S)/XUDT(S) message conversion for the specified destination. This parameter can be specified only if the XUDT UDT Conversion feature is enabled and turned on. The `rtrv-ctrl-feat` output shows the status of the XUDT UDT Conversion feature. If the XUDT UDT Conversion feature is not enabled or turned on, perform the "Activating the XUDT UDT Conversion Feature" procedure in *Database Administration - GTT User's Guide* to enable and turn on the XUDT UDT Conversion feature. This parameter contains these values.

- none - SCCP UDT(S)/XUDT(S) message conversion is not performed on messages for the destination.
- udt2xudt - All UDT(S) messages for the destination are converted to XUDT(S) messages.
- xudt2udt - All non-segmented XUDT(S) messages for the destination are converted to UDT(S) messages. Segmented XUDT(S) messages for the destination are not converted to UDT(S) messages.
- sxudt2udt - All segmented and non-segmented XUDT(S) messages for the destination are converted to UDT(S) messages.

The `chg-dstn` command also contains the `homescp` and `homesmsc` parameters. The values for these parameters are `yes` and `no`. The value `no` is the system default value for these parameters. The value `yes` for these parameters cannot be specified for a cluster point code. To specify the value `yes` for these parameters, perform the [Adding a Destination Point Code](#) or [Changing a Destination Point Code](#) procedures.

The value of the `clli` parameter cannot be in the **DPC** table and cannot match the **CLLI** of the EAGLE. Verify this by entering the `rtrv-dstn` and the `rtrv-sid` commands, shown in [1](#) and [3](#). If the value of the `clli` parameter matches any CLLI values in either of these outputs, choose another value for the `clli` parameter that does not match any CLLIs shown in either of these command outputs.

If a nested cluster point code is changed to a non-nested cluster point code (the value of the `ncai` parameter is changed from `yes` to `no`), any point codes that are members of this point code must be assigned to the same routeset as the cluster point code.

The `elei` (exception list exclusion indicator) parameter can be specified only for a cluster destination point code. Cluster destination point codes and the `elei` parameter can be specified only if the Cluster Routing and Management Diversity feature is turned on. Verify this with the `rtrv-feat` command. If the Cluster Routing and Management Diversity feature is turned on, the `CRMD` field should be set to `on`. If the Cluster Routing and Management Diversity feature is not turned on, enter the `chg-feat:crmd=on` command. For more information on the Cluster Routing and Management Diversity feature, refer to the [Cluster Routing and Management Diversity \(CRMD\)](#) section.

The `ncai` parameter can be specified only if the Nested Cluster Routing feature is on. This can be verified with the entry `NCR = on` in the `rtrv-feat` command output. If the nested cluster routing feature is not turned on, enter the `chg-feat:ncr=on` command. For more information on the nested cluster routing feature, refer to the [Nested Cluster Routing](#) section.

Note: Once the Cluster Routing and Management Diversity and nested cluster routing features are turned on with the `chg-feat` command, they cannot be turned off.

The Cluster Routing and Management Diversity and nested cluster routing features must be purchased before you turn these features on with the `chg-feat` command. If you are not sure if you have purchased the Cluster Routing and Management Diversity and nested cluster routing features, contact your Sales Representative or Account Representative.

The examples in this procedure are used to change the attributes of the cluster point code 030-003-*

Canceling the `RTRV-DSTN` and `RTRV-RTE` Commands

Because the `rtrv-dstn` and `rtrv-rte` commands used in this procedure can output information for a long period of time, the `rtrv-dstn` and `rtrv-rte` commands can be canceled and the output to the terminal stopped. There are three ways that the `rtrv-dstn` and `rtrv-rte` commands can be canceled:

- Press the F9 function key on the keyboard at the terminal where the `rtrv-dstn` or `rtrv-rte` command was entered.
- Enter the `canc-cmd` without the `trm` parameter at the terminal where the `rtrv-dstn` or `rtrv-rte` command was entered.
- Enter the `canc-cmd:trm=<xx>`, where `<xx>` is the terminal where the `rtrv-dstn` or `rtrv-rte` command was entered, from another terminal other than the terminal where the `rtrv-dstn` or `rtrv-rte` command was entered. To enter the `canc-cmd:trm=<xx>` command, the terminal must allow Security Administration commands to be entered from it and the user must be allowed to enter Security Administration commands. The terminal's permissions can be verified with the `rtrv-secu-trm` command. The user's permissions can be verified with the `rtrv-user` or `rtrv-secu-user` commands.

For more information about the `canc-cmd` command, refer to *Commands User's Guide*.

1. Display the current destination point codes, using the `rtrv-dstn` command.

This is an example of the possible output.

```
rlghncxa03w 10-12-10 11:43:04 GMT EAGLE5 43.0.0
Extended Processing Time may be Required
```

DPCA	CLLI	BEI	ELEI	ALIASI	ALIASN/N24	DMN
020-002-*	rlghncbb000	yes	yes	-----	-----	SS7
240-012-004	rlghncbb001	yes	---	1-111-1	10-13-9-3	SS7
240-012-005	rlghncbb002	yes	---	1-112-2	10-13-10-0	SS7
240-012-006	rlghncbb003	yes	---	1-112-3	10-13-10-1	SS7
240-012-007	-----	yes	---	1-117-3	10-13-11-1	SS7
240-012-008	-----	yes	---	1-113-5	10-13-10-2	SS7
030-003-*	rlghncbb333	yes	yes	-----	-----	SS7
030-003-100	rlghncbb334	yes	---	1-112-3	10-13-10-1	SS7
030-003-200	rlghncbb335	yes	---	1-117-3	10-13-11-1	SS7
030-003-225	rlghncbb336	yes	---	-----	-----	SS7
DPCI	CLLI	BEI	ELEI	ALIASA	ALIASN/N24	DMN
2-131-1	rlghncbb023	no	---	222-210-000	11-11-8-1	SS7

2-131-2	-----	no	---	222-211-001	11-11-8-2	SS7
2-131-3	-----	no	---	222-211-002	11-11-8-3	SS7
4-163-5	-----	no	---	250-200-007	15-11-5-1	SS7
DPCN	CLLI	BEI	ELEI	ALIASA	ALIASI	DMN
7-9-10-1	-----	no	---	210-090-100	1-75-6	SS7
10-15-2-3	rlghncbb013	no	---	222-200-200	2-121-1	SS7
10-15-3-0	rlghncbb013	no	---	222-200-201	2-121-2	SS7

```

DESTINATION ENTRIES ALLOCATED: 2000
  FULL DPC(s):                  20
  EXCEPTION DPC(s):             0
  NETWORK DPC(s):               0
  CLUSTER DPC(s):              2
  TOTAL DPC(s):                 22
  CAPACITY (% FULL):            1%
ALIASES ALLOCATED:              8000
  ALIASES USED:                 28
  CAPACITY (% FULL):            1%
X-LIST ENTRIES ALLOCATED:      500
RTRV-DSTN: MASP A - COMPLTD

```

If the CLLI value for the cluster point code is not being changed in this procedure, continue the procedure with [3](#).

If the CLLI value for the cluster point code is being changed in this procedure, continue the procedure with [2](#).

2. Display the self-identification of the EAGLE using the `rtrv-sid` command.

This is an example of the possible output.

```

rlghncxa03w 07-05-10 11:43:04 GMT EAGLE5 37.0.0
  PCA          PCI          PCN          CLLI          PCTYPE
  010-020-030  0-123-1      12-0-14-1    rlghncxa03w   OTHER
  CPCA
  002-002-002  002-002-003  002-002-004  002-002-005
  002-002-006  002-002-007  002-002-008  002-002-009
  004-002-001  004-003-003  050-060-070
  CPCI
  1-001-1      1-001-2      1-001-3      1-001-4
  1-002-1      1-002-2      1-002-3      1-002-4
  2-001-1      7-222-7
  CPCN
  2-0-10-3     2-0-11-0     2-0-11-2     2-0-12-1
  2-2-3-3     2-2-4-0     10-14-10-1

```

If the CLLI value for the cluster point code is being changed in this procedure, that CLLI value cannot be shown in the CLLI fields of either the `rtrv-dstn` ([1](#)) or the `rtrv-sid` command outputs.

3. Display the attributes of the cluster point code being changed, by entering the `rtrv-dstn` command and specifying the cluster point code that is being changed.

For this example, enter this command.

```
rtrv-dstn:dpca=030-003-*
```

This is an example of the possible output.

```
rlghncxa03w 10-12-28 21:16:37 GMT EAGLE5 43.0.0

DPCA          CLLI          BEI ELEI  ALIASI          ALIASN/N24  DMN
030-003-*     rlghncbb333 yes yes  -----          -----          SS7

SPCA          NCAI          RCAUSE NPRST SPLITIAM HMSMSC HMSCP SCCPMSGCNV
-----      yes          none  off  none      no      no      none

DESTINATION ENTRIES ALLOCATED:  2000
FULL DPC(s):                    20
EXCEPTION DPC(s):                0
NETWORK DPC(s):                  0
CLUSTER DPC(s):                  2
TOTAL DPC(s):                    22
CAPACITY (% FULL):               1%
ALIASES ALLOCATED:                8000
ALIASES USED:                     28
CAPACITY (% FULL):               1%
X-LIST ENTRIES ALLOCATED:         500
RTRV-DSTN: MASP A - COMPLTD
```

Continue the procedure by performing one of these steps.

- If the `nprst`, `rcause`, `splitiam`, `sccpmsgcnv`, or `ncai` parameter values will not be changed, continue the procedure with [10](#).
 - If only the `ncai` parameter value will be changed, continue the procedure by performing one of these steps.
 - If the current `ncai` parameter value is `no`, continue the procedure with [8](#).
 - If the current `ncai` parameter value is `yes`, continue the procedure with [6](#).
 - If the `sccpmsgcnv` parameter value will be changed and the `nprst`, `rcause`, or `splitiam` parameter values will not be changed, continue the procedure with [5](#).
 - If the `nprst`, `rcause`, or `splitiam` parameter value will be changed, continue the procedure with [4](#).
4. Display the features that are enabled by entering the `rtrv-ctrl-feat` command. This is an example of the possible output.

```
rlghncxa03w 10-12-17 15:35:05 GMT EAGLE5 43.0.0
The following features have been permanently enabled:
```

Feature Name	Partnum	Status	Quantity
HC-MIM SLK Capacity	893012707	on	64
TIF Number Portability	893018901	off	----
XUDT UDT Conversion	893035301	on	----

The following features have been temporarily enabled:

Feature Name	Partnum	Status	Quantity	Trial Period Left
--------------	---------	--------	----------	-------------------

Zero entries found.

The following features have expired temporary keys:

Feature Name	Partnum
Zero entries found.	

To specify the `nprst` or `rcause` parameters, the TIF Number Portability feature, part number 893018901, must be enabled. To specify the `splitiam` parameter, at least one of these features must be enabled.

- TIF Number Portability - part number 893018901
- TIF SCS Forwarding - part number 893022201
- TIF Simple Number Substitution - part number 893024001
- TIF Additional Subscriber Data - part number 893024501
- TIF Generic Routing Number - part number 893025501

Perform the procedures in *TIF User's Guide* to enable these features as required.

Continue the procedure by performing one of these steps.

- If the `sccpmsgcnv` or `ncai` parameter values will not be changed, continue the procedure with 10.
 - If only the `ncai` parameter value will be changed, continue the procedure by performing one of these steps.
 - If the current `ncai` parameter value is `no`, continue the procedure with 8.
 - If the current `ncai` parameter value is `yes`, continue the procedure with 6.
 - If the `sccpmsgcnv` parameter value will be changed, continue the procedure with 5.
5. To specify the `sccpmsgcnv` parameter the XUDT UDT Conversion feature must be enabled and turned on.

If 4 was performed and the `rtrv-ctrl-feat` output in 4 shows that the XUDT UDT Conversion feature is enabled and turned on, continue the procedure by performing one of these steps.

- If the `ncai` parameter values will not be changed, continue the procedure with 10.
- If the `ncai` parameter value will be changed, continue the procedure by performing one of these steps.
 - If the current `ncai` parameter value is `no`, continue the procedure with 8.
 - If the current `ncai` parameter value is `yes`, continue the procedure with 6.

If 4 was performed and the `rtrv-ctrl-feat` output in 4 shows that the XUDT UDT Conversion feature is not enabled and turned on, perform the "Activating the XUDT UDT Conversion Feature" procedure in *Database Administration - GTT User's Guide* to enable and turn on the XUDT UDT Conversion feature.

If [4](#) was not performed, enter this command to verify the status of the XUDT UDT Conversion feature.

```
rtrv-ctrl-feat:partnum=893035301
```

This is an example of the possible output.

```
rlghncxa03w 10-12-17 15:35:05 GMT EAGLE5 43.0.0
The following features have been permanently enabled:
```

Feature Name	Partnum	Status	Quantity
XUDT UDT Conversion	893035301	on	----

The following features have been temporarily enabled:

Feature Name	Partnum	Status	Quantity	Trial Period Left
Zero entries found.				

The following features have expired temporary keys:

Feature Name	Partnum
Zero entries found.	

If the `rtrv-ctrl-feat` output in this step shows that the XUDT UDT Conversion feature is not enabled or turned on, perform the "Activating the XUDT UDT Conversion Feature" procedure in *Database Administration - GTT User's Guide* to enable and turn on the XUDT UDT Conversion feature.

If the `rtrv-ctrl-feat` output in this step shows that the XUDT UDT Conversion feature is enabled and turned on, or the "Activating the XUDT UDT Conversion Feature" procedure was performed in this step, continue the procedure by performing one of these steps.

- If the `ncai` parameter values will not be changed, continue the procedure with [10](#).
 - If the `ncai` parameter value will be changed, continue the procedure by performing one of these steps.
 - If the current `ncai` parameter value is `no`, continue the procedure with [8](#).
 - If the current `ncai` parameter value is `yes`, continue the procedure with [6](#).
- 6.** Enter the `rtrv-dstn` command with the cluster point code being changed, but with three asterisks for the network-cluster member value of the cluster point code instead of one asterisk.

For this example, enter this command.

```
rtrv-dstn:dpca=030-003-***
```

This is an example of the possible output.

```
rlghncxa03w 09-05-28 21:16:37 GMT EAGLE5 41.0.0
```

DPCA	CLLI	BEI	ELEI	ALIASI	ALIASN/N24	DMN
030-003-*	rlghncbb333	yes	yes	-----	-----	SS7
030-003-100	rlghncbb334	yes	no	1-112-3	10-13-10-1	SS7


```

030-003-200  rlghncbb335 yes no    1-117-3      10-13-11-1  SS7
030-003-225  rlghncbb336 yes no    -----      -----      SS7

```

```

Destination table is (20 of 2000) 1% full
Alias table is (28 of 8000) 1% full
RTRV-DSTN: MASP A - COMPLTD

```

If the cluster point code does not have any member point codes in the database, continue the procedure with [8](#).

If the cluster point code has member point codes in the database, continue the procedure with [7](#).

7. Display the routes to the members of the cluster point code, shown in [6](#), in the database using the `rtrv-rte` command with the DPC values shown in [6](#) for the members of the cluster point code.

For this example, enter these commands.

```
rtrv-rte:dPCA=030-003-100
```

This is an example of the possible output.

```

rlghncxa03w 07-05-07 11:43:04 GMT  EAGLE5 37.0.0

DPCA          ALIASI          ALIASN/N24    LSN           RC           APCA
030-003-100   1-112-3         10-13-10-1   1s000300     10          030-003-100

RTX:No  CLLI=rlghncbb334

```

```
rtrv-rte:dPCA=030-003-200
```

This is an example of the possible output.

```

rlghncxa03w 07-05-07 11:43:04 GMT  EAGLE5 37.0.0

DPCA          ALIASI          ALIASN/N24    LSN           RC           APCA
030-003-200   1-117-3         10-13-11-1   1s000301     10          10 030-003-200

RTX:No  CLLI=rlghncbb335

```

```
rtrv-rte:dPCA=030-003-225
```

This is an example of the possible output.

```

rlghncxa03w 07-05-07 11:43:04 GMT  EAGLE5 37.0.0

DPCA          ALIASI          ALIASN/N24    LSN           RC           APCA
030-003-225   -----         -----         1s000301     10          030-003-300

RTX:No  CLLI=rlghncbb336

```

If the NCAI parameter is being changed from YES to NO, the routes to the point codes that are members of the cluster point code being changed must be removed from the database. Perform the [Removing a Route](#) procedure to remove these routes from the database. For this example, the routes to point codes 030-003-100, 030-003-200, and 030-003-225 must be removed. Continue the procedure with [10](#).

8. Verify that the nested cluster routing feature is on with the `rtrv-feat` command.

If the nested cluster routing feature is turned on, the NCR field should be set to on. In this example, the nested cluster routing feature is off.

Note: Thertrv-feat command output contains other fields that are not used by this procedure. If you wish to see all the fields displayed by thertrv-feat command, see thertrv-feat command description in *Commands User's Guide*.

If the nested cluster routing feature is on, continue the procedure with 10.

If the nested cluster routing feature is off, continue the procedure with 9.

9. Turn the nested cluster routing feature on by entering this command.

```
chg-feat:ncr=on
```

Note: Once the nested cluster routing feature is turned on with thechg-feat command, it cannot be turned off

The nested cluster routing feature must be purchased before you turn this feature on with the chg-feat command. If you are not sure if you have purchased the nested cluster routing features, contact your Sales Representative or Account Representative.

When this command has successfully completed, this message should appear.

```
rlghncxa03w 07-05-10 11:43:04 GMT EAGLE5 37.0.0
CHG-FEAT: MASP A - COMPLTD
```

10. Change the attributes of the cluster point code, using the chg-dstn command.

If the rcause, nprst, and splitiam parameters will be specified for the cluster point code, one or more of the features shown in 4 must be enabled.

If the sccpmsgcnv parameter will be specified for the cluster point code, the XUDT UDT Conversion feature, shown in the rtrv-ctrl-feat output in either 4 or 5, must be enabled.

For this example, enter this command.

```
chg-dstn:dpca=030-003-
*:clli=ls09clli:ncai=no:elei=no:nprst=on:rcause=5 :splitiam=2
0:sccpmsgcnv=xudt2udt
```

When this command has successfully completed, this message should appear.

```
rlghncxa03w 07-05-17 15:35:05 GMT EAGLE5 37.0.0

DESTINATION ENTRIES ALLOCATED:    2000
  FULL DPC(s):                    20
  EXCEPTION DPC(s):                0
  NETWORK DPC(s):                  0
  CLUSTER DPC(s):                  2
  TOTAL DPC(s):                    22
  CAPACITY (% FULL):               1%
ALIASES ALLOCATED:                8000
```

```

ALIASES USED:                28
CAPACITY (% FULL):          1%
X-LIST ENTRIES ALLOCATED:   500
CHG-DSTN: MASP A - COMPLTD

```

11. Verify the changes using the `rtrv-dstn` command, and specifying the cluster point code that was entered in 10 with the `dpca` parameter.

For this example, enter this command.

```
rtrv-dstn:dpca=030-003-*
```

This is an example of the possible output.

```
rlghncxa03w 10-12-28 21:16:37 GMT EAGLE5 43.0.0
```

```

DPCA          CLLI          BEI ELEI  ALIASI          ALIASN/N24  DMN
030-003-*     1s09clli     yes no  -----

```

SPCA	NCAI	RCAUSE	NPRST	SPLITIAM	HMSMSC	HMSCP	SCCPMSGCNV
-----	no	5	on	20	no	no	xudt2udt

```

DESTINATION ENTRIES ALLOCATED:  2000
FULL DPC(s):                    20
EXCEPTION DPC(s):               0
NETWORK DPC(s):                 0
CLUSTER DPC(s):                 2
TOTAL DPC(s):                   22
CAPACITY (% FULL):              1%
ALIASES ALLOCATED:              8000
ALIASES USED:                   28
CAPACITY (% FULL):              1%
X-LIST ENTRIES ALLOCATED:       500
RTRV-DSTN: MASP A - COMPLTD

```

12. Back up the new changes, using the `chg-db:action=backup:dest=fixed` command.

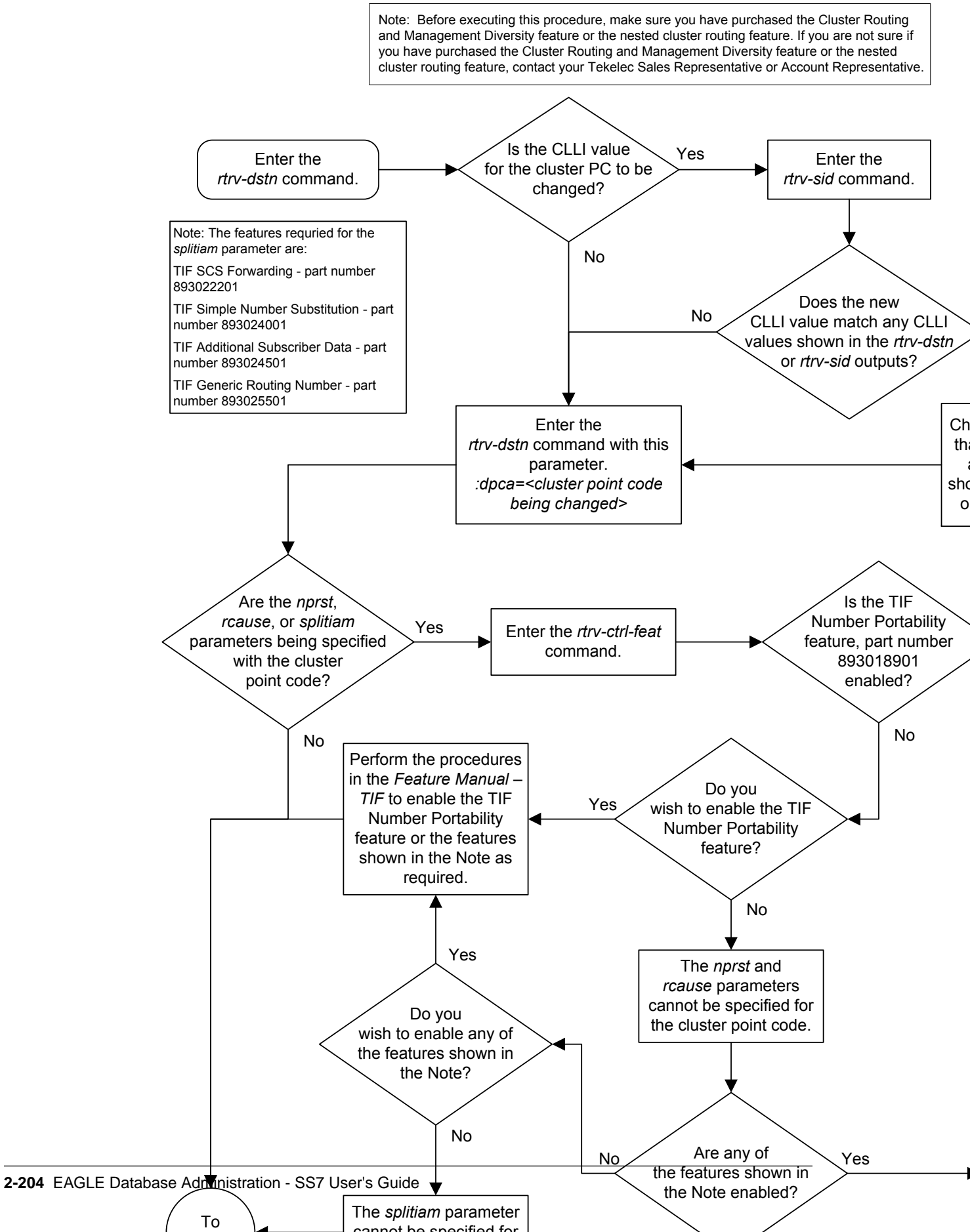
These messages should appear; the active **Maintenance and Administration Subsystem Processor (MASP)** appears first.

```

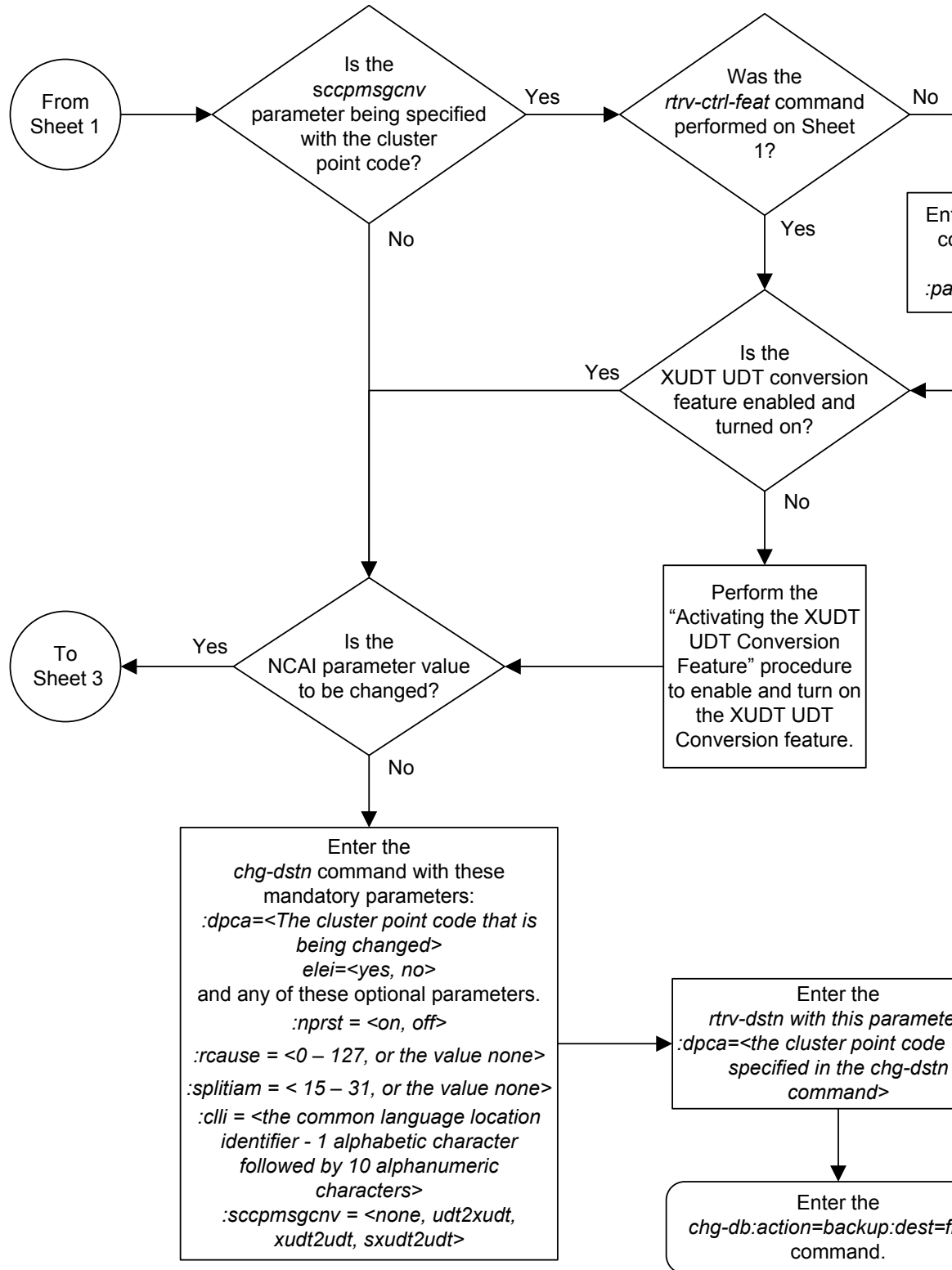
BACKUP (FIXED) : MASP A - Backup starts on active MASP.
BACKUP (FIXED) : MASP A - Backup on active MASP to fixed disk complete.
BACKUP (FIXED) : MASP A - Backup starts on standby MASP.
BACKUP (FIXED) : MASP A - Backup on standby MASP to fixed disk complete.

```

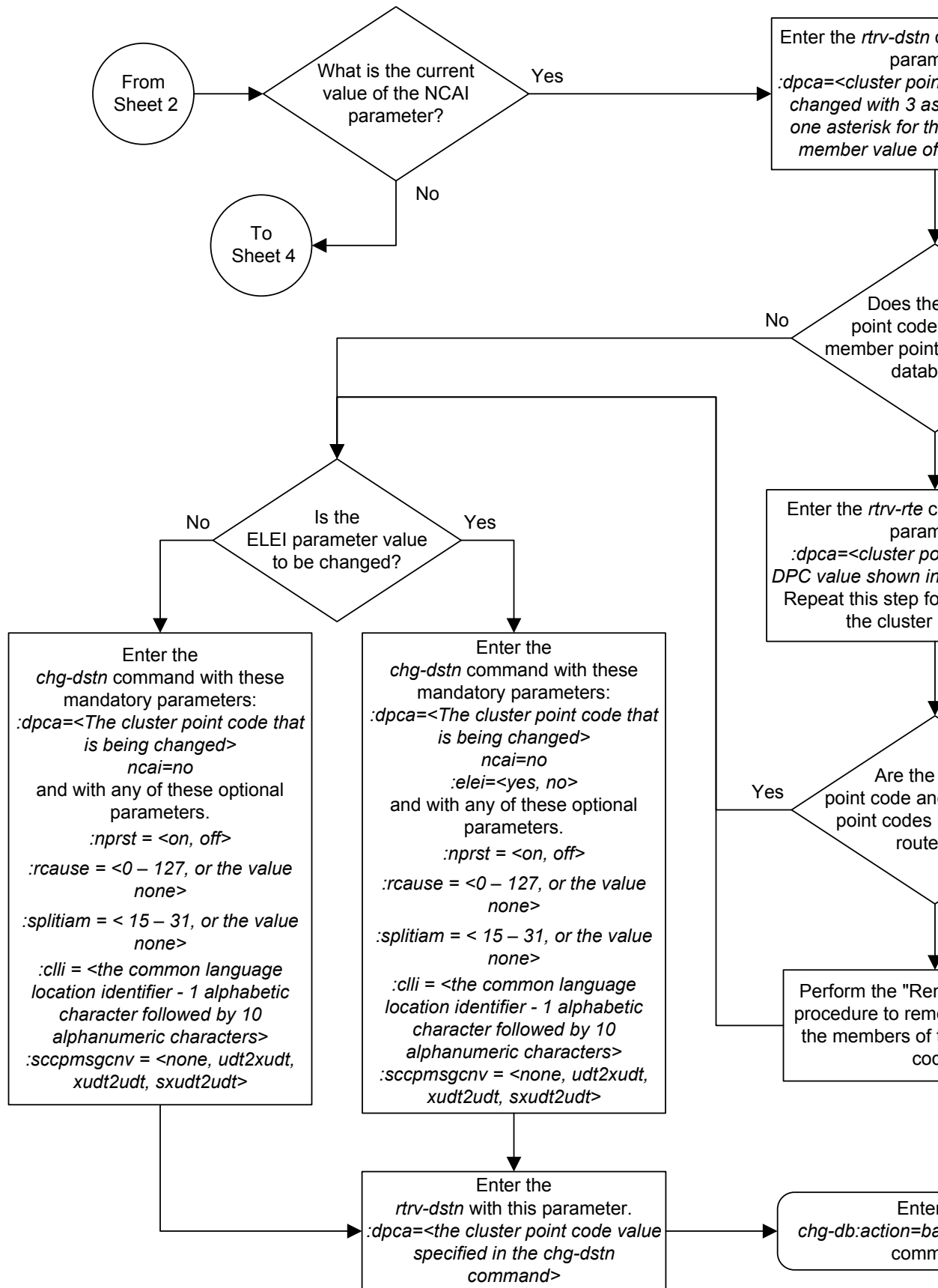
Figure 2-26 Changing the Attributes of a Cluster Point Code



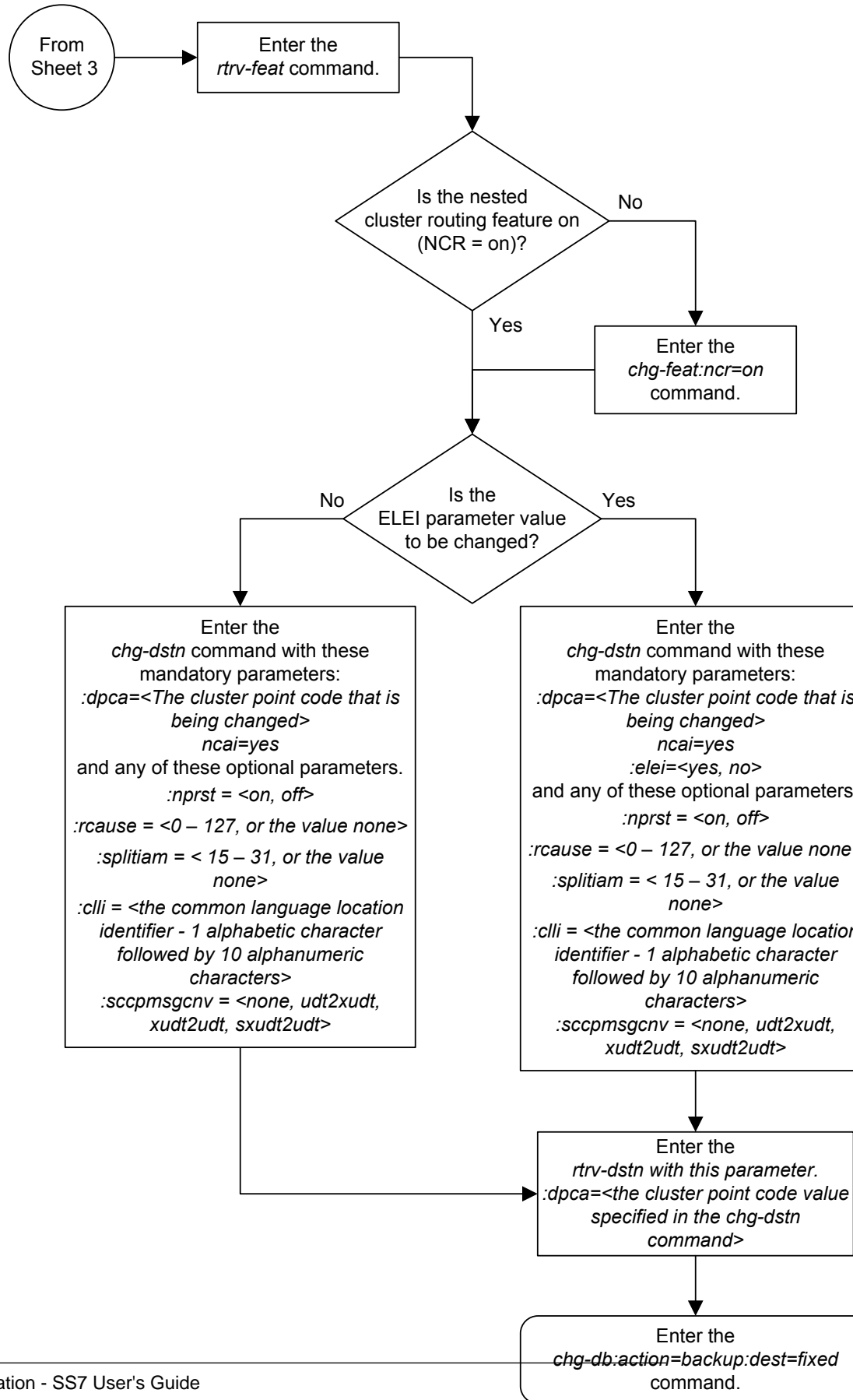
Sheet 1 of 4



Sheet 2 of 4



Sheet 3 of 4



Network Routing

Network routing allows the user to provision a single routeset that can be used for all **MSUs** destined to members of that network. The advantages of network routing are:

- Reduces the number of entries in the route table
- Allows routing to members of a network without having to add those members to the route table

A **EAGLE** user can connect to a remote network by provisioning a single route table element. As the remote network grows, the **EAGLE** user does not have to add new route table entries for each new point code in the remote network.

Note: Network routing can be used only with **ANSI** point codes. A network routing point code cannot be provisioned as a proxy point code.

Types of Routing Strategies Available

The **EAGLE** currently allows a user to provision two types of routing strategies:

- Full point code routing
- Network/cluster routing (also called cluster routing)

This feature allows the user to provision a third type of routing strategy, network routing.

It is possible to provision full point code entries, cluster entries, and network entries for members of the same network. Any overlaps in the routing strategies are handled by a specific searching hierarchy.

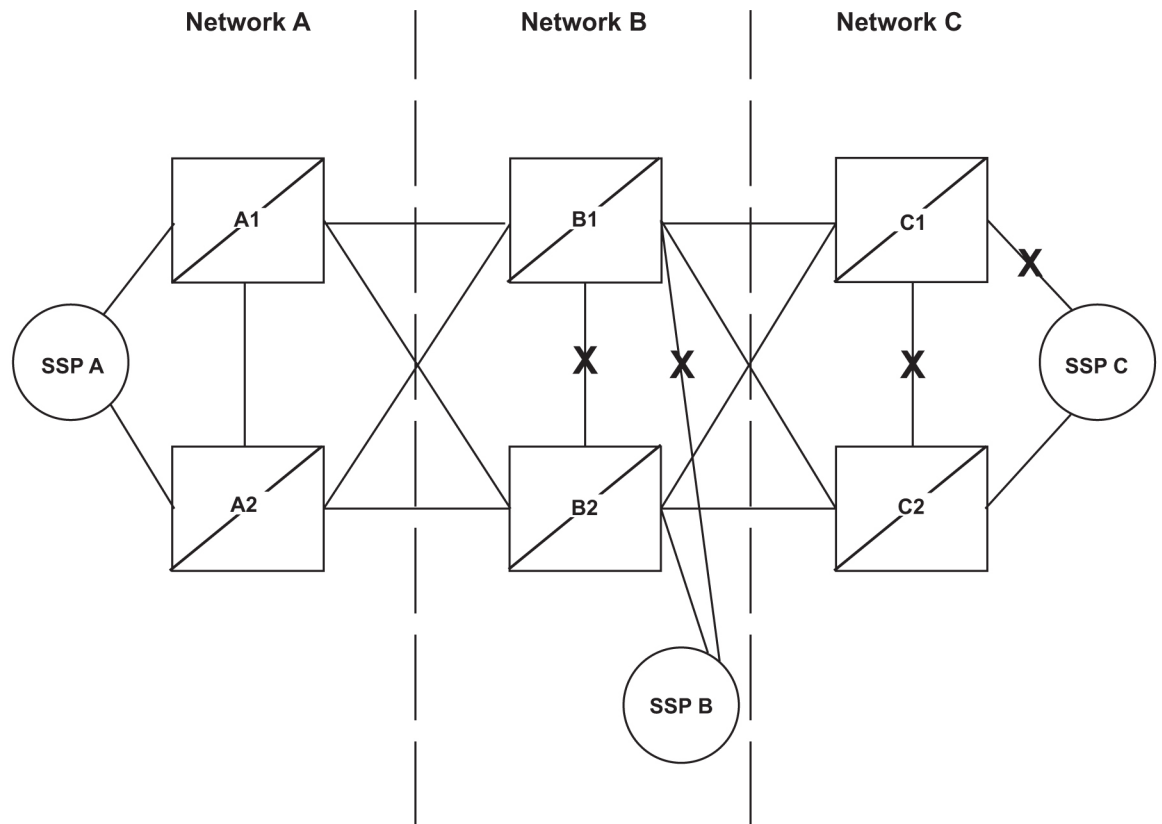
All of these route table entries can coexist:

- 8-1-1 – A full point code entry
- 8-1-* – A cluster entry
- 8-*. * – A network entry

The searching hierarchy tries to match against a full point code entry first, followed by a cluster entry, and finally a network entry. In the preceding example, when the **EAGLE** routes an **MSU** destined for 8-1-1, it uses the full point code entry; when the **EAGLE** routes an **MSU** destined for 8-1-2 it uses the cluster entry; and when the **EAGLE** routes an **MSU** destined for 8-2-2, it uses the network entry.

Applications

Network routing is very useful when the destination node is very far away from the source node. The reliability of network routing increases when the destination is further away. Notice that in [Figure 2-27](#), routing from network A is more reliable to nodes in network C than to nodes in network B.

Figure 2-27 Example of Network Routing Reliability

If the nodes in network A use network routing for network C, network A can still route traffic to **SSP C**, even if two linksets fail. In this example, one of the A-linksets to **SSP C** and the C-linkset between node C1 and node C2 fail. In this case, the **EAGLE** in network A continues to route half its traffic to node B1, and half to node B2. Node B1 and node B2 (which do not use network routing) route all traffic for **SSP C** through node C2.

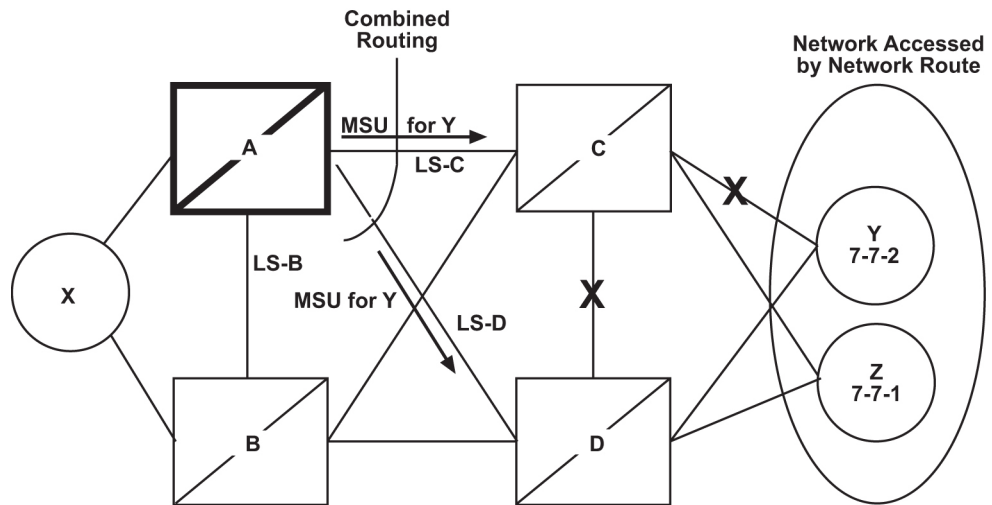
If the nodes in network A use network routing for network B, traffic going to **SSP B** may be lost if two linksets fail. In this example, one of the A-linksets to **SSP B** and the C-linkset between node B1 and node B2 fail. In this case, the **EAGLE** in network A continues to route half its traffic to node B1, and half to node B2. Traffic for **SSP B** routed through node B1 is discarded, resulting in message loss.

Route Availability

A route is one path to a destination. A routeset is a list of paths to a destination. **Route** availability consists of two parts:

- Local availability
- Remote availability

Remote availability is affected by **TFx** network management messages. Local availability is affected by linkset failures and recoveries. **TFx** messages do not affect point codes accessed by network route entries. Therefore, for network route entries, route availability consists of only local availability. The highest priority linkset available for traffic is used for routing **MSUs**, regardless of the remote availability of that route.

Figure 2-28 Potential Routing Network Failure

In the example in [Figure 2-28](#), linksets LS-C and LS-D form a combined route to network route 7-7-*. Because 7-7-* is a network route, the **EAGLE** always considers the non-adjacent status of the routes to be allowed. In the example shown, the **EAGLE** routes traffic destined to 7-7-1 over LS-C and LS-D. The **EAGLE** ignores **TFPs** concerning 7-7-1 or **TCPs** concerning 7-7-*.

Point Code Availability

A point code that is accessed by a network route entry is considered available if there is any linkset in the routeset that is available for traffic.

Local Link Congestion

This feature has no impact on the generation of **TFC** messages. A **TFC** is generated concerning point code X-Y-Z, even if X-Y-Z is routed using a network route entry.

Remote Congestion

Because the **EAGLE** has global title capabilities, it is possible for the **EAGLE** to receive a **TFC** concerning a point code that is accessed by a network route entry. Network route entries are not affected by **TFC** messages.

Broadcast Transfer Messages

The **EAGLE** does not broadcast **TFx** messages for network route entries.

Response Method Transfer Messages

The **EAGLE** sends response method **TFx** messages for network routes as follows:

- Prohibited Network Routes

If the **EAGLE** receives an **MSU** that is accessed by a network route entry, and that network route is Prohibited, the **EAGLE** sends a response method **TFP** or **TCP** message, as follows:

- If there is a full point code defined in the same cluster as the **MSU** (for example, 8-7-* and 8-7-1 are defined in the **EAGLE**'s routing table, and **MSU** is destined for 8-7-2), the **EAGLE** sends a **TFP** with concerned point code set to the **MSU**'s **DPC**.
- Otherwise, the **EAGLE** sends a **TCP** with concerned point code set to the cluster of the **MSU**'s **DPC**.

The **EAGLE** sends response method **TCPs** or **TFPs** at a rate of one **TCP** or **TFP** per signaling link during the level 3 T8 timer period for each network route.

For example, in [Figure 2-28](#), the network route for 7-*- becomes Prohibited due to the failure of **LS-B**, **LS-C**, and **LS-D**. When the **EAGLE** receives an **MSU** from **X** destined for 7-7-1, the **EAGLE** sends a response method **TCP** concerning 7-7-*. When the **EAGLE** receives an **MSU** from **X** destined for 7-8-2, the **EAGLE** sends a response method **TCP** concerning 7-8-*.

- **System Detects Danger of Circular Routing**

If the **EAGLE** receives an **MSU** that is accessed by a network route entry, and the **EAGLE** detects danger of circular routing, the **EAGLE** sends a response method **TFP** or **TCP** message, as follows:

- If there is a full point code defined in the same cluster as the **MSU** (for example, 8-*- and 8-1-1 are defined in the **EAGLE**'s routing table, and the **MSU** is destined for 8-1-2), the **EAGLE** sends a **TFP** with concerned point code set to the **MSU**'s **DPC**.
- Otherwise, the **EAGLE** sends a **TCP** with concerned point code set to the cluster of the **MSU**'s **DPC**.

The **EAGLE** sends response method **TCPs** at a rate of one **TCP** per signaling link during the level 3 T8 timer period for each network route.

For example, in [Figure 2-28](#), all linksets are available. If the **EAGLE** receives an **MSU** from node **C** destined for 7-7-1, the **EAGLE** detects danger of circular routing, and sends a response method **TCP** concerning 7-7-*. The **EAGLE** also discards the **MSU**.

- **Restricted Network Routes**

If the **EAGLE** receives an **MSU** that is accessed by a network route entry, and that network route is **Restricted**, the **EAGLE** sends a one-time response method **TFR** or **TCR** message, as follows:

- If there is a full point code defined in the same cluster as the **MSU** (for example, 8-*- and 8-1-1 are defined in the **EAGLE**'s routing table, and **MSU** is destined for 8-1-2), the **EAGLE** sends a **TFR** with concerned point code set to the **MSU**'s **DPC**.
- Otherwise, the **EAGLE** sends a **TCR** with concerned point code set to the cluster of the **MSU**'s **DPC**.

For example, in [Figure 2-28](#), the network route for 7-*- becomes **Restricted** due to the failure of **LS-C** and **LS-D**. When the **EAGLE** receives an **MSU** from **X** destined for 7-7-1, the **EAGLE** sends a response method **TCR** concerning 7-7-*, then routes the **MSU** over **LS-B**. When the **EAGLE** next receives an **MSU** from **X** destined for 7-8-2, the **EAGLE** does not send a response, and routes the **MSU** over **LS-B**.

Reception of Transfer Messages

The **EAGLE** does not apply received transfer messages to a network route.

For example, in [Figure 2-28](#), if the **EAGLE** receives a **TFP** concerning 7-7-1, it has no effect on the routing status of 7-*-*. The **EAGLE** continues to send **MSUs** destined to 7-*-*, including **MSUs** destined to 7-7-1, on **LS-C**.

As another example, if the **EAGLE** receives a **TCP** concerning 7-8-*, it has no effect on the routing status of 7-*-*. The **EAGLE** continues to send **MSUs** destined to 7-*-*, including **MSUs** destined to 7-8-2, on **LS-C**.

Reception of an RSx Message

If a routeset test (**RSP** or **RSR**) is received, a full point code reply (**TFx**) is generated. The responses to **RSP/RSR** have been changed according to [Table 2-13](#). Note that the searching hierarchy applies.

Table 2-13 Reception of an RSx Message

Concerned Point Code is:	Result
Found by a full point code match	No change to existing rules.
Found by a cluster match	No change to existing rules.
Found by a network match	Send a TFx message based on the current routeset status. <ul style="list-style-type: none"> Send a TFP if danger of circular routing. Otherwise: <ul style="list-style-type: none"> Send a TFA if the network route is Allowed. Send a TFR if the network route is Restricted. Send a TFP if the network route is Prohibited.
Not found	No change to existing rules. Send a TFP .

Reception of an RCx Message

If a routeset cluster test (**RCP** or **RCR**) is received, a cluster reply (**TCx**) is generated. The responses to **RCP/RCR** have been changed according to [Table 2-14](#). Note that the searching hierarchy applies.

Table 2-14 Reception of an RCx Message

Concerned Point Code is:	Result
Found by a cluster match	No change to existing rules.
Found by a network match	Send a TCx message based on the current routeset status. <ul style="list-style-type: none"> Send a TCP if danger of circular routing. Otherwise: <ul style="list-style-type: none"> Send a TCA if the network route is Allowed. Send a TCR if the network route is Restricted. Send a TCP if the network route is Prohibited.
Not found	No change to existing rules. Send a TCP .

Administration

The network routing feature must be on, before a network routing point code can be provisioned in the database. This can be verified with the entry `NRT = on` in the output of the `rtrv-feat` command. If the network routing feature is not on, `NRT = off`, it must be turned on with the `chg-feat` command using the `nrt=on` parameter. Once the network routing feature is on, the network routing point code can be provisioned in the database like any other destination point code. Routes can then be assigned to the network routing point code like any other destination point code. For more information on provisioning network routing point codes, see the [Adding a Network Routing Point Code](#) procedure.

Note: Once the network routing feature is turned on using the `chg-feat` command, it cannot be turned off. When using the network routing feature, limited network management is provided for point codes not covered by full point code routing, cluster routing, or nested cluster routing.

The network routing feature must be purchased before you turn this feature on with the `chg-feat` command. If you are not sure if you have purchased the network routing feature, contact your Oracle Sales Representative or Account Representative.

Adding a Network Routing Point Code

This procedure is used to add a destination point code to the database, using the `ent-dstn` command.

To change the attributes of an existing network routing point code, perform the [Changing a Destination Point Code](#) procedure.

To remove a network routing point code from the database, perform the [Removing a Destination Point Code](#) procedure.

The `ent-dstn` command uses these parameters.

`:dpc/dpca` – The destination point code being added to the database

Note: See [Point Code Formats](#) for a definition of the point code types that are used on the EAGLE. Alias point codes (`aliasi/aliasn/aliasn24`) and secondary point codes (`spc/spca`) cannot be specified for a network routing point code. An ANSIprivate point code must be a full point code.

`:clli` – The **Common Language Location Identifier** assigned to this point code.

`:domain` – The network in which the destination entity or node exists, SS7.

The network routing point code must be in the SS7 domain (`domain=ss7`) and can only be an ANSI point code. ITU point codes cannot be specified as network routing point codes.

`:nprst` - NM bits reset. This parameter specifies whether the NM bits in an ITU IAM message should be set to 00. This parameter has two values.

- `off` - Do not set NM bits to 00 in an ITU IAM message if the `nptype` option value in the `rtrv-tifopts` output is `nm`.

- `on` - Set the NM bits to 00 in an ITU IAM message if the `nptype` option value in the `rtrv-tifopts` output is `nm`.

The default value for this parameter is `off`.

`:rcause` - Release cause. This parameter specifies the condition that triggers the sending of a Release message. This parameter has these values.

- `0 - 127`
- `none` - use the values specified for the `rcausenp` and `rcausepfx` parameters in the `rtrv-tifopts` output.

The default value for this parameter is `none`.

If the `rlcopc` parameter value in the `rtrv-tifopts` output is `on` and a value of 0-127 is specified for the `rcause` parameter, then the `rcause` parameter value overrides the values specified for the `rcausenp` and `rcausepfx` parameters in the `rtrv-tifopts` output.

`:splitiam` - This parameter specifies how and when to split an ITU IAM message into one IAM message and one SAM message. This parameter has these values.

- `15-31` - The maximum number of CdPN digits allowed in the IAM message before the splitting occurs. The remaining digits, up to a total of 32, are encoded in the SAM message.
- `none` - the value specified for the `splitiam` parameter in the `rtrv-tifopts` output is used to determine when to split the IAM message.

The default value for this parameter is `none`.

To specify the `nprst` or `rcause` parameters, the TIF Number Portability feature, part number 893018901, must be enabled. To specify the `splitiam` parameter, at least one of these features must be enabled.

- TIF Number Portability - part number 893018901
- TIF SCS Forwarding - part number 893022201
- TIF Simple Number Substitution - part number 893024001
- TIF Additional Subscriber Data - part number 893024501
- TIF Generic Routing Number - part number 893025501

The status of these features is shown in the `rtrv-ctrl-feat` output. Perform the procedures in *TIF User's Guide* to enable these features.

`:sccpmsgcnv` - The `sccpmsgcnv` parameter controls SCCP UDT(S)/XUDT(S) message conversion for the specified destination. This parameter can be specified only if the XUDT UDT Conversion feature is enabled and turned on. The `rtrv-ctrl-feat` output shows the status of the XUDT UDT Conversion feature. If the XUDT UDT Conversion feature is not enabled or turned on, perform the "Activating the XUDT UDT Conversion Feature" procedure in *Database Administration - GTT User's Guide* to enable and turn on the XUDT UDT Conversion feature. This parameter contains these values.

- `none` - SCCP UDT(S)/XUDT(S) message conversion is not required on messages for the destination. This value is the default value for this parameter.

- `udt2xudt` - All UDT(S) messages for the destination are converted to XUDT(S) messages.
- `xudt2udt` - All non-segmented XUDT(S) messages for the destination are converted to UDT(S) messages. Segmented XUDT(S) messages for the destination are not converted to UDT(S) messages.
- `sxudt2udt` - All segmented and non-segmented XUDT(S) messages for the destination are converted to UDT(S) messages.

These parameters cannot be specified with a network routing point code.

<code>ncai</code>	<code>spc</code>	<code>elei</code>	<code>bei</code>	<code>ipgwapc</code>	<code>ppc</code>	<code>prx</code>
-------------------	------------------	-------------------	------------------	----------------------	------------------	------------------

The `ent-dstn` command also contains the `homescp` and `homesmsc` parameters. The values for these parameters are `yes` and `no`. The value `no` is the default value for these parameters. The value `yes` for these parameters cannot be specified for a network routing point code. To specify the value `yes` for these parameters, perform the [Adding a Destination Point Code](#) or [Changing a Destination Point Code](#) procedures.

The value of the `clli` parameter cannot be in the DPC table and cannot match the CLLI of the EAGLE. Verify this by entering the `rtrv-dstn` and the `rtrv-sid` commands, shown in 1 and 2. If the value of the `clli` parameter matches any CLLI values in either of these outputs, choose another value for the `clli` parameter that does not match any CLLIs shown in either of these command outputs.

To enter the `dpc/dpca` parameter with the `ent-dstn` command, a point code must be defined in the `PCA` field of the self ID of the EAGLE. Verify this with the `rtrv-sid` command.

If no value is shown in the `PCA` field in the `rtrv-sid` command output, the self-identification of the EAGLE must be updated with an ANSI point code. Go to [Changing the Self-Identification of the EAGLE](#) procedure to change the self-identification of the EAGLE.

Note: To enter a network routing point code with the network indicator values 1 through 5, the `pctype` parameter value of the `chg-sid` command must be set to `other`. If you attempt to add a network routing point code with the network indicator values 1 through 5 and the `pctype` parameter value is `ansi`, the `ent-dstn` command will be rejected with this error message.

E2169 Cmd Rej: Point code out of range

Destination point codes must be unique in the database.

The actual number of destination point codes that can be configured in the database is set by the `mtpdpcq` parameter of the `chg-stpopts` command, and is shown in the `MTPDPCQ` field in the `rtrv-stpopts` command output.

If the 5000 Routes feature is not on, and 6000, 7000, 8000, or 10,000 routesets are not enabled, a maximum of 2000 destination point codes can be configured in the database.

If the 5000 Routes feature is on, and 6000, 7000, 8000, or 10,000 routesets are not enabled, a maximum of 5000 destination point codes can be configured in the database.

If 6000 routesets are enabled, a maximum of 6000 destination point codes can be configured in the database.

If 7000 routesets are enabled, a maximum of 7000 destination point codes can be configured in the database.

If 8000 routesets are enabled, a maximum of 8000 destination point codes can be configured in the database.

If 10,000 routesets are enabled, a maximum of 10,000 destination point codes can be configured in the database.

Note: For more information on the destination point code quantities, refer to the [Changing the DPC Quantity](#) procedure.

The examples in this procedure are used to add the network routing point code 007-*-* to the database.

Canceling the RTRV-DSTN Command

Because the `rtrv-dstn` command used in this procedure can output information for a long period of time, the `rtrv-dstn` command can be canceled and the output to the terminal stopped. There are three ways that the `rtrv-dstn` command can be canceled:

- Press the F9 function key on the keyboard at the terminal where the `rtrv-dstn` command was entered.
- Enter the `canc-cmd` without the `trm` parameter at the terminal where the `rtrv-dstn` command was entered.
- Enter the `canc-cmd:trm=<xx>`, where `<xx>` is the terminal where the `rtrv-dstn` command was entered, from another terminal other than the terminal where the `rtrv-dstn` command was entered. To enter the `canc-cmd:trm=<xx>` command, the terminal must allow Security Administration commands to be entered from it and the user must be allowed to enter Security Administration commands. The terminal's permissions can be verified with the `rtrv-secu-trm` command. The user's permissions can be verified with the `rtrv-user` or `rtrv-secu-user` commands.

For more information about the `canc-cmd` command, refer to *Commands User's Guide*.

1. Display the current destination point codes using the `rtrv-dstn` command.

This is an example of the possible output.

```
rlghncxa03w 10-12-10 11:43:04 GMT EAGLE5 43.0.0
Extended Processing Time may be Required

DPCA          CLI          BEI  ELEI  ALIASI          ALIASN/N24  DMN
001-002-003   ls04cli      yes  ---  -----          -----  SS7
030-045-*     rlghncbb010 yes  yes  -----          -----  SS7
111-011-*     rlghncbb000 yes  yes  -----          -----  SS7
240-012-004   rlghncbb001 yes  ---  1-111-1          10-13-9-3  SS7
240-012-005   rlghncbb002 yes  ---  1-112-2          10-13-10-0 SS7
240-012-006   rlghncbb003 yes  ---  1-112-3          10-13-10-1 SS7
240-012-008   -----     yes  ---  1-113-5          10-13-10-2 SS7

DPCI          CLI          BEI  ELEI  ALIASA          ALIASN/N24  DMN
```

```

2-131-1      rlghncbb023 no --- 222-210-000 11-11-8-1  SS7
2-131-2      ----- no --- 222-211-001 11-11-8-2  SS7
2-131-3      ----- no --- 222-211-002 11-11-8-3  SS7

DPCN        CLLI          BEI  ELEI  ALIASA        ALIASI        DMN
10-15-2-3   rlghncbb013 no --- 222-200-200 2-121-1      SS7
10-15-3-0   rlghncbb013 no --- 222-200-201 2-121-2      SS7

```

```

DESTINATION ENTRIES ALLOCATED: 6000
FULL DPC(s):                   14
EXCEPTION DPC(s):              0
NETWORK DPC(s):                0
CLUSTER DPC(s):                2
TOTAL DPC(s):                  16
CAPACITY (% FULL):             1%
ALIASES ALLOCATED:             8000
ALIASES USED:                  18
CAPACITY (% FULL):             1%
X-LIST ENTRIES ALLOCATED:      500
RTRV-DSTN: MASP A - COMPLTD

```

If the addition of the network routing point code will not exceed the current DPC capacity shown in the `rtrv-dstn` output, continue the procedure with [2](#).

If the addition of the network routing point code will exceed the current DPC capacity, and the current capacity is less than 10,000 (or 10,500 if the `DESTINATION ENTRIES ALLOCATED` and `X-LIST ENTRIES ALLOCATED` fields are shown in the `rtrv-dstn` output), perform the [Changing the DPC Quantity](#) procedure to change the DPC quantity. Continue the procedure with [2](#).

If the addition of the network routing point code will exceed the current DPC capacity, and the current capacity is 10,000 (or 10,500 if the `DESTINATION ENTRIES ALLOCATED` and `X-LIST ENTRIES ALLOCATED` fields are shown in the `rtrv-dstn` output), perform the [Removing a Destination Point Code](#) procedure to remove a DPC or perform the [Removing a Route Exception Entry](#) procedure to remove an exception route. Continue the procedure with [2](#).

2. Verify that the network routing feature is on, by entering the `rtrv-feat` command.

If the network routing feature is on, the `NRT` field should be set to `on`. For this example, the network routing feature is off.

Note: The `rtrv-feat` command output contains other fields that are not used by this procedure. If you wish to see all the fields displayed by the `rtrv-feat` command, see the `rtrv-feat` command description in *Commands User's Guide*.

If the network routing feature is on, continue the procedure with [4](#).

3. If the network routing feature is not on, shown by the `NRT = off` entry in the `rtrv-feat` command output of [2](#), turn the network routing feature on by entering this command.

```
chg-feat:nrt=on
```

Note: Once the network routing feature is turned on with the `chg-feat` command, it cannot be turned off.

The network routing feature must be purchased before you turn this feature on with the `chg-feat` command. If you are not sure if you have purchased the network routing feature, contact your Oracle Sales Representative or Account Representative.

When the `chg-feat` has successfully completed, this message should appear.

```
rlghncxa03w 07-05-07 00:57:31 GMT EAGLE5 37.0.0
CHG-FEAT: MASP A - COMPLTD
```

Continue the procedure by performing one of these steps.

- If you wish to enter a network routing point code with the network indicator values 1 through 5, and the network indicator values 1 through 5 are not shown in the `rtrv-dstn` output in 1, perform 4 to verify the `pctype` value.
 - If ANSI point codes are not shown in the `rtrv-dstn` output in 1, perform 4 to verify that an ANSI point code is assigned to the self-identification of the EAGLE.
 - If the `rtrv-dstn` output in 1 shows ANSI point codes or shows ANSI point codes that contain the network indicator values 1 through 5, or you do not wish to provision a network routing point code with the network indicator values 1 through 5, continue the procedure by performing one of these steps.
 - If the `nprst`, `rcause`, or `splitiam` parameters will not be specified for the cluster point code, continue the procedure with 6.
 - If the `nprst`, `rcause`, or `splitiam` parameters will be specified for the cluster point code, continue the procedure with 5.
4. Display the self-identification of the EAGLE using the `rtrv-sid` command.

This is an example of the possible output.

```
rlghncxa03w 07-05-10 11:43:04 GMT EAGLE5 37.0.0

PCA          PCI          PCN          CLLI          PCTYPE
100-100-100  3-75-7       7-9-8-1     rlghncxa03w  OTHER

CPCA
002-002-002  002-002-003  002-002-004  002-002-005
002-002-006  002-002-007  002-002-008  002-002-009
004-002-001  004-003-003  050-060-070

CPCA (LNP)
005-005-002  005-005-004  005-005-005

CPCI
1-002-1      1-002-2      1-002-3      1-002-4
2-001-1      7-222-7

CPCN
```

2-0-10-3	2-0-11-0	2-0-11-2	2-0-12-1
2-2-3-3	2-2-4-0	10-14-10-1	

To enter an ANSI destination point code with the `ent-dstn` command, a point code must be shown in the `PCA` field of the `rtrv-sid` command output.

If the required point code is not shown in the `PCA` field of the `rtrv-sid` command output, perform the [Changing the Self-Identification of the EAGLE](#) procedure to configure the required point codes.

To enter a network routing point code with the network indicator values 1 through 5, the `pctype` parameter value of the `chg-sid` command must be set to `other`. If you wish to enter a network routing point code with a network indicator value 1 through 5, and the `pctype` parameter value is `ansi`, perform the [Changing the Self-Identification of the EAGLE](#) procedure to change the `pctype` value to `other`.

Continue the procedure by performing one of these steps.

- If the `nprst`, `rcause`, or `splitiam` parameters will not be specified for the cluster point code, continue the procedure with 6.
 - If the `nprst`, `rcause`, or `splitiam` parameters will be specified for the cluster point code, continue the procedure with 5.
5. Display the features that are enabled by entering the `rtrv-ctrl-feat` command. This is an example of the possible output.

```
rlghncxa03w 09-05-17 15:35:05 GMT EAGLE5 41.0.0
The following features have been permanently enabled:
```

Feature Name	Partnum	Status	Quantity
HC-MIM SLK Capacity	893012707	on	64
TIF Number Portability	893018901	off	----

The following features have been temporarily enabled:

Feature Name	Partnum	Status	Quantity	Trial Period Left
Zero entries found.				

The following features have expired temporary keys:

Feature Name	Partnum
Zero entries found.	

To specify the `nprst` or `rcause` parameters, the TIF Number Portability feature, part number 893018901, must be enabled. To specify the `splitiam` parameter, at least one of these features must be enabled.

- TIF Number Portability - part number 893018901
- TIF SCS Forwarding - part number 893022201
- TIF Simple Number Substitution - part number 893024001
- TIF Additional Subscriber Data - part number 893024501
- TIF Generic Routing Number - part number 893025501

Perform the procedures in *TIF User's Guide* to enable these features as required.

6. Continue the procedure by performing one of these steps.
 - Continue the procedure with 8 if any of these conditions are present.
 - The `sccpmsgcnv` parameter will not be specified for the cluster point code.
 - The `sccpmsgcnv` parameter will be specified for the cluster point code and the `rtrv-ctrl-feat` output in this step shows that the XUDT UDT Conversion feature is enabled and turned on. If the `rtrv-ctrl-feat` output in this step shows that the XUDT UDT Conversion feature is not enabled or turned on, perform the "Activating the XUDT UDT Conversion Feature" procedure in *Database Administration - GTT* to enable and turn on the XUDT UDT Conversion feature.
 - Continue the procedure with 7 if the `sccpmsgcnv` parameter will be specified for the cluster point code and 5 was not performed.
7. Enter this command to verify the status of the XUDT UDT Conversion feature.

```
rtrv-ctrl-feat:partnum=893035301
```

This is an example of the possible output.

```
rlghncxa03w 10-12-17 15:35:05 GMT EAGLE5 43.0.0
The following features have been permanently enabled:
```

Feature Name	Partnum	Status	Quantity
XUDT UDT Conversion	893035301	on	----

The following features have been temporarily enabled:

Feature Name	Partnum	Status	Quantity	Trial Period Left
Zero entries found.				

The following features have expired temporary keys:

Feature Name	Partnum
Zero entries found.	

If the XUDT UDT Conversion feature is not enabled or turned on, perform the "Activating the XUDT UDT Conversion Feature" procedure in *Database Administration - GTT User's Guide* to enable and turn on the XUDT UDT Conversion feature.

If the XUDT UDT Conversion feature is enabled and turned on, or the "Activating the XUDT UDT Conversion Feature" procedure was performed in this step, continue the procedure with 8.

8. Add the network routing destination point code, using the `ent-dstn` command.

For this example, enter this command.

```
ent-dstn:dpca=007-*
*:rcause=50:nprst=on:splitiam=25:sccpmsgcnv=sxudt2udt
```

When this command has successfully completed, and the Cluster Routing and Management Diversity feature is turned off (shown with the `CRMD = off` entry in the `rtrv-feat` command output), this message should appear.

```
rlghncxa03w 07-05-17 15:35:05 GMT EAGLE5 37.0.0
Destination table is (17 of 2000) 1% full
ENT-DSTN: MASP A - COMPLTD
```

If the Cluster Routing and Management Diversity feature is turned on (`CRMD = on` in the `rtrv-feat` command output), this message should appear when each command has successfully completed.

```
rlghncxa03w 07-05-17 15:35:05 GMT EAGLE5 37.0.0
DESTINATION ENTRIES ALLOCATED: 6000
  FULL DPC(s): 14
  EXCEPTION DPC(s): 0
  NETWORK DPC(s): 1
  CLUSTER DPC(s): 2
  TOTAL DPC(s): 17
  CAPACITY (% FULL): 1%
ALIASES ALLOCATED: 8000
  ALIASES USED: 18
  CAPACITY (% FULL): 1%
X-LIST ENTRIES ALLOCATED: 500
ENT-DSTN: MASP A - COMPLTD
```

9. Verify the changes using the `rtrv-dstn` command and specifying the DPC that was entered in 8.

For this example, enter this command.

```
rtrv-dstn:dpca=007-*-*
```

This is an example of the possible output.

```
rlghncxa03w 10-12-28 21:16:37 GMT EAGLE5 43.0.0

  DPCA          CLLI          BEI ELEI  ALIASI          ALIASN/N24  DMN
  007-*-*      -----  yes --- -----  -----  SS7

  SPCA          NCAI          RCAUSE NPRST SPLITIAM HMSMSC HMSSCP SCCPMSGCNV
  -----  ----          50    on    25          no    no    sxudt2udt

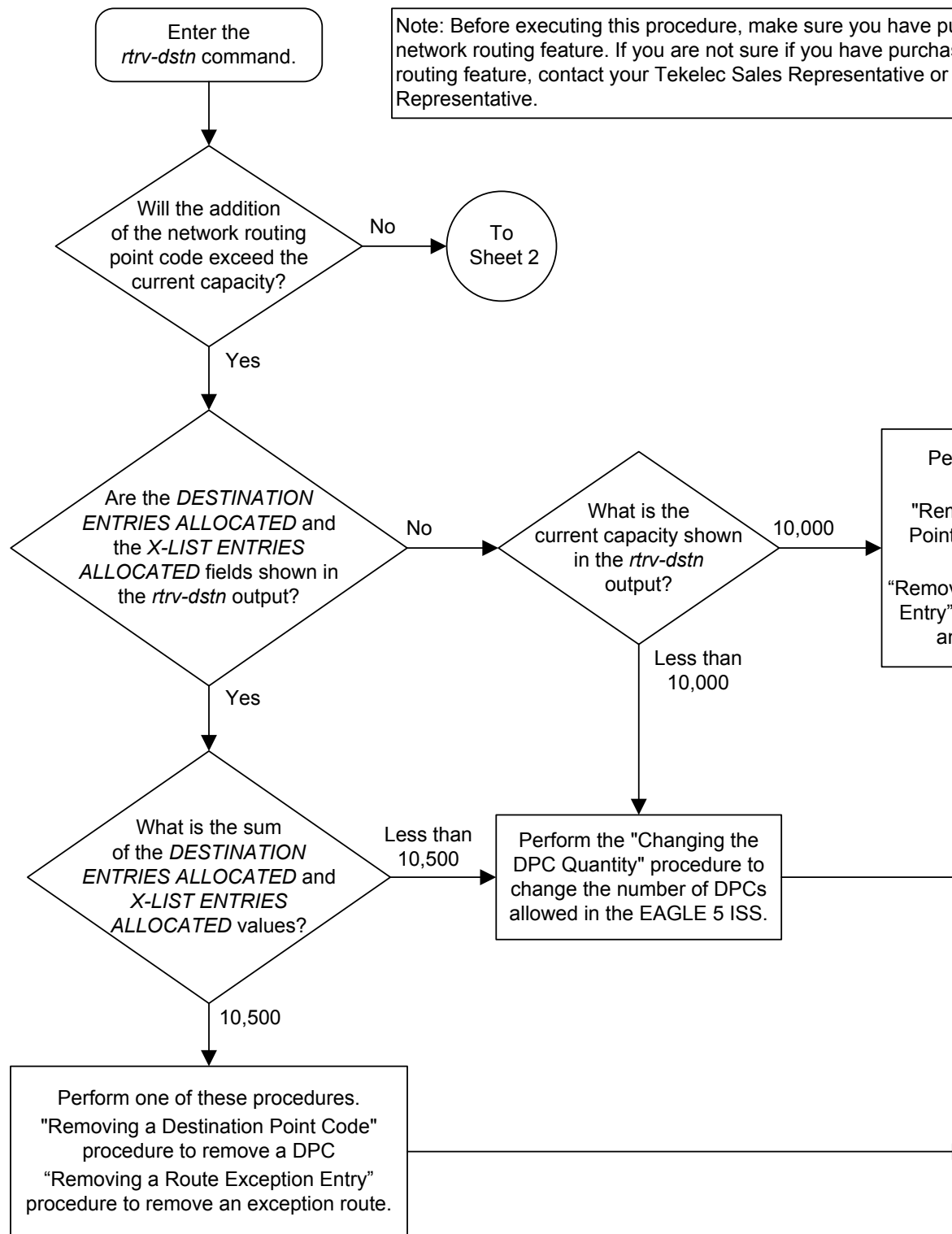
Destination table is (14 of 2000) 1% full
Alias table is (18 of 8000) 1% full
```

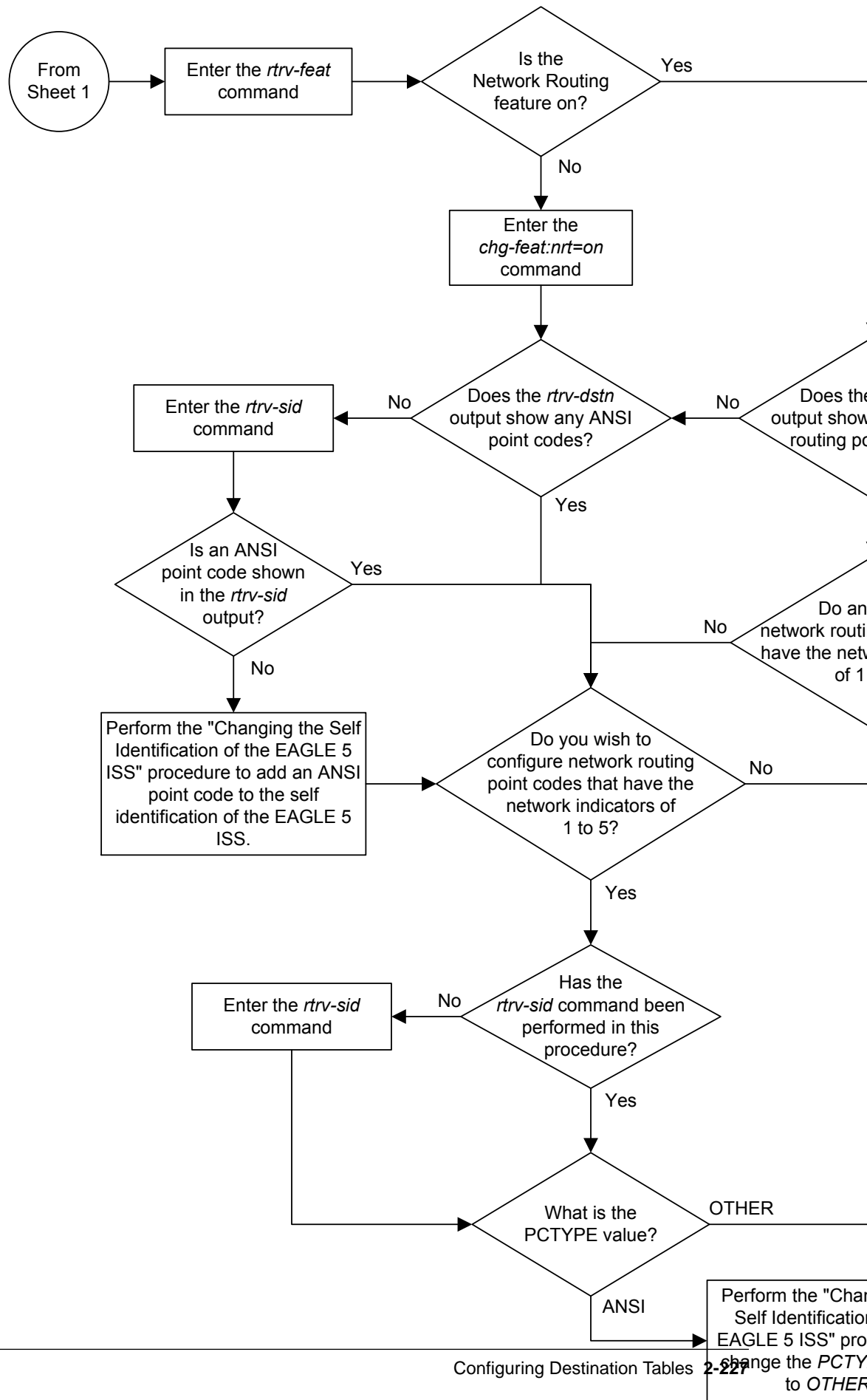
10. Back up the new changes, using the `chg-db:action=backup:dest=fixed` command.

These messages should appear; the active **Maintenance and Administration Subsystem Processor (MASP)** appears first.

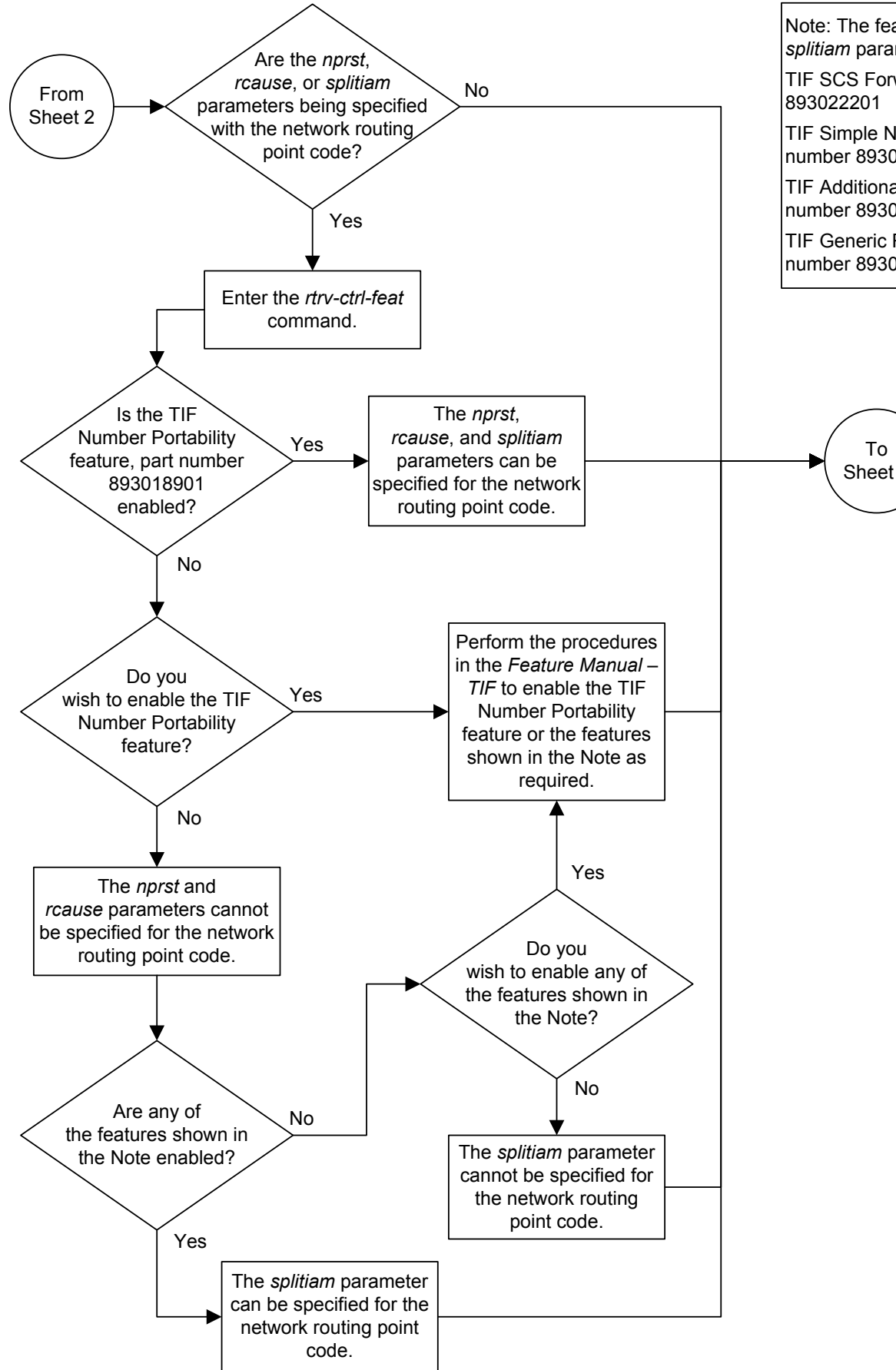
```
BACKUP (FIXED) : MASP A - Backup starts on active MASP.
BACKUP (FIXED) : MASP A - Backup on active MASP to fixed disk complete.
BACKUP (FIXED) : MASP A - Backup starts on standby MASP.
BACKUP (FIXED) : MASP A - Backup on standby MASP to fixed disk complete.
```


Figure 2-29 Adding a Network Routing Point Code

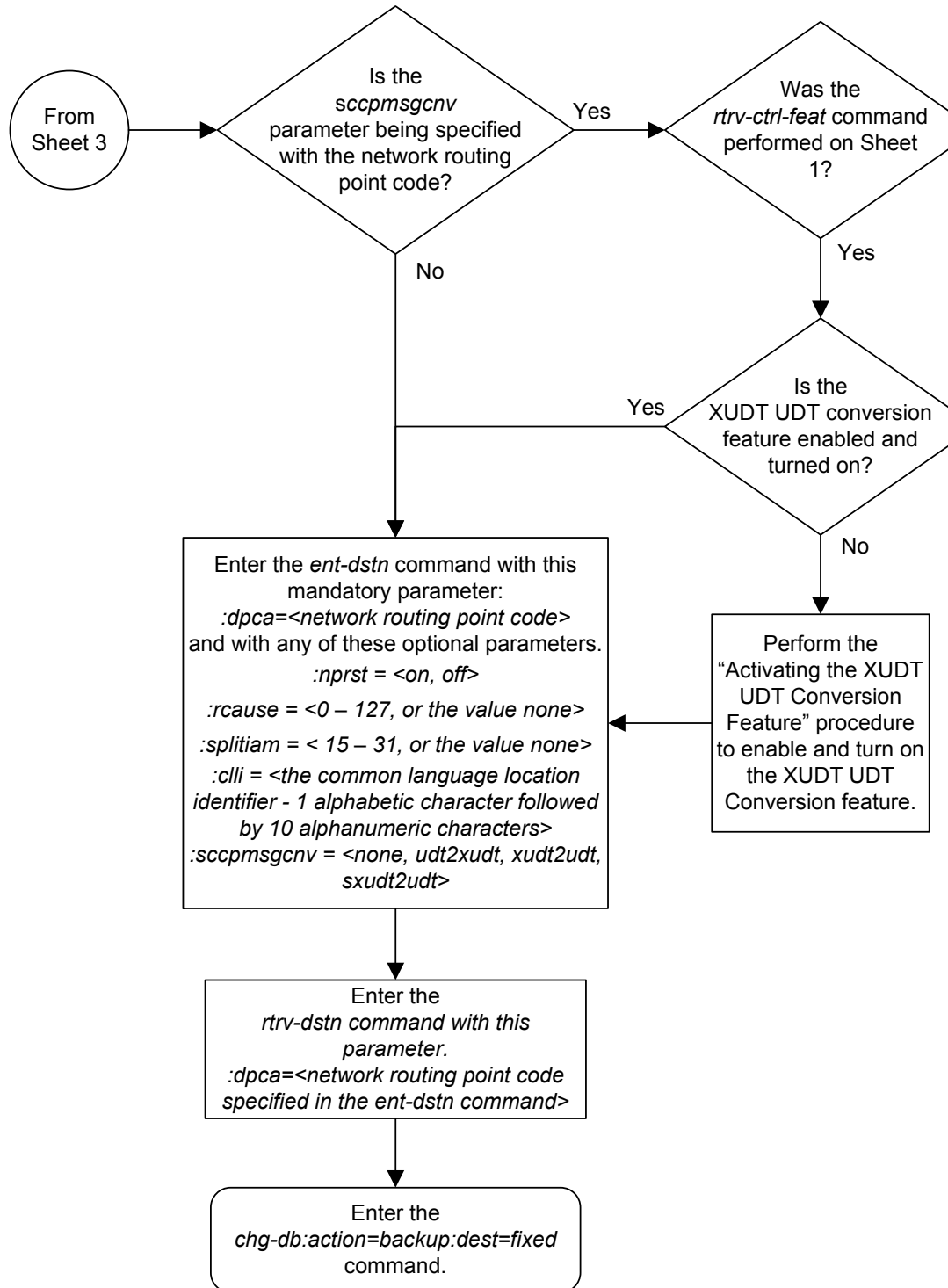




Perform the "Changing the Self Identification of the EAGLE 5 ISS" procedure to add an ANSI point code to the self identification of the EAGLE 5 ISS.



Note: The features *splitiam* parameter, TIF SCS Form number 893022201, TIF Simple Number number 8930, TIF Additional number 8930, and TIF Generic number 8930.



Adding a Destination Point Code

This procedure is used to add a destination point code to the database, using the `ent-dstn` command.

The `ent-dstn` command uses these parameters:

`:dpc/dpca/dpci/dpcn/dpcn24` – The destination point code being added to the database

`:aliasa/aliasi/aliasn/aliasn24` – The alternate destination point code. Two optional alias addresses can be defined.

`:ppc/ppca/ppci/ppcn/ppcn24` – The proxy point code that is assigned to the destination point code.

Note: See [Point Code Formats](#) for a definition of the point code types that are used on the EAGLE and for a definition of the different formats that can be used for ITU national point codes. A private point code cannot be used as an alias point code.

`:clli` – The **Common Language Location Identifier** assigned to this point code

`:domain` – The network in which the destination entity or node exists, SS7.

`:ipgwapc` – **IP Gateway Adjacent Point Code** indicator. Specify `ipgwapc=yes` to provide SS7 linkset definition compatibility for gateway connections to IP-SCPs. The default is `ipgwapc=no`.

`:bei` – Broadcast exception indicator that indicates whether transfer-prohibited (**TFP**) messages will be broadcast from this node. The `bei=yes` parameter means TFPs will not be broadcast. The `bei=no` parameter means TFPs will be broadcast.

`:spc/spca/spci/spcn/spcn24` – The secondary point code as defined by the `ent-spc` command. The secondary point code allows the EAGLE to use another point code in addition to the one defined by the `dpc`, `dpca`, `dpci`, `dpcn`, or `dpcn24` parameters of the `ent-dstn` command for SS7 routing purposes. Refer to the [Multiple Point Code Support](#) section for more information on secondary point codes. A private point code cannot be used as a secondary point code.

`:prx` – This parameter specified whether or not the destination point code is proxy point code. This parameter has two values, `yes` or `no`. If the `prx` parameter value is `yes`, the destination point code is a proxy point code. If the `prx` parameter value is `no`, the destination point code is not a proxy point code.

The `ppc` and `prx` parameters can be specified only if a quantity of proxy point codes is enabled. Proxy point code quantities are enabled in groups of 10. The enabled quantity of proxy point codes is shown in the `rtrv-ctrl-feat` output. If no proxy point code quantity is shown in the `rtrv-ctrl-feat` output, or the proxy point code quantity needs to be increased, up to a maximum quantity of 100 proxy point codes, perform the [Changing the Proxy Point Code Quantity](#) procedure.

The `ppc` parameter assigns a proxy point code to a destination point code. The proxy point code value must be provisioned in the database. The destination point code must be a full point code, in the SS7 domain, and cannot be a private point code. The destination point code cannot have the `ipgwapc=yes` parameter value assigned. The destination point code and proxy point code must be the same network type. For

example, if the destination point code is an ANSI point code, the proxy point code must be an ANSI point code. If the destination point code and proxy point code are 14-bit ITU-N point codes with a group code, the group code values for both the destination point code and the proxy point code must be the same. The `spc` and `ppc` parameters cannot be specified together in the same `ent-dstn` command line.

The `prx` parameter specifies whether or not the destination point code specified with the `ent-dstn` command is a proxy point code. The destination point code value must be a full point code, in the SS7 domain, and cannot be a private point code. The destination point code value cannot have the `ipgwapc=yes` parameter value assigned.

`:nprst` - NM bits reset. This parameter specifies whether the NM bits in an ITU IAM message should be set to 00. This parameter has two values.

- `off` - Do not set NM bits to 00 in an ITU IAM message if the `nptype` option value in the `rtrv-tifopts` output is `nm`.
- `on` - Set the NM bits to 00 in an ITU IAM message if the `nptype` option value in the `rtrv-tifopts` output is `nm`.

The default value for this parameter is `off`.

`:rcause` - Release cause. This parameter specifies the condition that triggers the sending of a Release message. This parameter has these values.

- `0-127`
- `none` - use the values specified for the `rcausenp` and `rcausepfx` parameters in the `rtrv-tifopts` output.

The default value for this parameter is `none`.

If the `rlcopc` parameter value in the `rtrv-tifopts` output is `on` and a value of 0-127 is specified for the `rcause` parameter, then the `rcause` parameter value overrides the values specified for the `rcausenp` and `rcausepfx` parameters in the `rtrv-tifopts` output.

`:splitiam` - This parameter specifies how and when to split an ITU IAM message into one IAM message and one SAM message. This parameter has these values.

- `15-31` - The maximum number of CDPN digits allowed in the IAM message before the splitting occurs. The remaining digits, up to a total of 32, are encoded in the SAM message.
- `none` - the value specified for the `splitiam` parameter in the `rtrv-tifopts` output is used to determine when to split the IAM message.

The default value for this parameter is `none`.

To specify the `nprst` or `rcause` parameters, the TIF Number Portability feature, part number 893018901, must be enabled. To specify the `splitiam` parameter, at least one of these features must be enabled.

- TIF Number Portability - part number 893018901
- TIF SCS Forwarding - part number 893022201
- TIF Simple Number Substitution - part number 893024001
- TIF Additional Subscriber Data - part number 893024501

- TIF Generic Routing Number - part number 893025501

The status of these features is shown in the `rtrv-ctrl-feat` output. Perform the procedures in *TIF User's Guide* to enable these features.

`:homescp` - This parameter specifies whether the destination point code should be considered a home **SCP** when performing SCCP processing for messages that have no global title address digits (the global title indicator (GTI) is set to zero). This parameter cannot be specified for a cluster point code or a network routing point code. These are the values for this parameter.

- `yes` - the specified DPC is considered a home SCP.
- `no` - the specified DPC is not considered a home SCP. This is the default value.

`:homesmsc` - This parameter specifies whether the destination point code (DPC) should be considered a home **SMSC** when performing SCCP processing for messages that have no global title address digits (the global title indicator (GTI) is set to zero). This parameter cannot be specified for a cluster point code or a network routing point code. These are the values for this parameter.

- `yes` - the specified DPC is considered a home SMSC.
- `no` - the specified DPC is not considered a home SMSC. This is the default value.

`:sccpmsgcnv` - The `sccpmsgcnv` parameter controls SCCP UDT(S)/XUDT(S) message conversion for the specified destination. This parameter can be specified only if the XUDT UDT Conversion feature is enabled and turned on. The `rtrv-ctrl-feat` output shows the status of the XUDT UDT Conversion feature. If the XUDT UDT Conversion feature is not enabled or turned on, perform the "Activating the XUDT UDT Conversion Feature" procedure in *Database Administration - GTT User's Guide* to enable and turn on the XUDT UDT Conversion feature. This parameter contains these values.

- `none` - SCCP UDT(S)/XUDT(S) message conversion is not required on messages for the destination. This value is the default value for this parameter.
- `udt2xudt` - All UDT(S) messages for the destination are converted to XUDT(S) messages.
- `xudt2udt` - All non-segmented XUDT(S) messages for the destination are converted to UDT(S) messages. Segmented XUDT(S) messages for the destination are not converted to UDT(S) messages.
- `sxudt2udt` - All segmented and non-segmented XUDT(S) messages for the destination are converted to UDT(S) messages.

The `elei` and `ncai` parameters cannot be specified in this procedure. To use these parameters to provision a destination point code, perform the [Adding a Cluster Point Code](#) procedure.

Secondary point codes must be a full point code. A secondary point code can only be assigned to a full point code. The network type of the secondary point code must match the network type of the **DPC**. The secondary point code used in this procedure must be configured in the database with the `ent-spc` command. The secondary point codes are shown in the `SPCA`, `SPC-I`, `SPC-N`, and `SPC-N24` fields of the `rtrv-spc` command output. If the desired secondary point code is not shown in the output of the `rtrv-spc` command, perform the [Adding a Secondary Point Code](#) procedure to configure the desired point code as a secondary point code.

The value of the `clli` parameter cannot be in the **DPC** table and cannot match the **CLLI** of the EAGLE. Verify this by entering the `rtrv-dstn` and the `rtrv-sid` commands, shown in steps 1 and 5 of the procedure that follows. If the value of the `clli` parameter matches any CLLI values in either of these outputs, choose another value for the `clli` parameter that does not match any CLLIs shown in either of these command outputs.

To enter point codes of any network type (**ANSI**, ITU-I, 14-bit ITU-N, or 24-bit ITU-N) into the database with the `ent-dstn` command, the self **ID** of the EAGLE must be defined for these networks. Verify this with the `rtrv-sid` command.

If a point code value is shown in the **PCA** column of the `rtrv-sid` command, then ANSI point codes can be specified with the `ent-dstn` command.

If a point code value is shown in the **PCI** column of the output of the `rtrv-sid` command, then ITU-I point codes can be specified with the `ent-dstn` command. The **PCI** column of the `rtrv-sid` output can contain spare and non-spare point code values. To provision ITU-I non-spare point codes in this procedure, the `rtrv-sid` output must contain an ITU-I non-spare point code in the **PCI** column. To provision ITU-I spare point codes in this procedure, the `rtrv-sid` output must contain an ITU-I spare point code in the **PCI** column.

If a point code value is shown in the **PCN** column of the output of the `rtrv-sid` command, then 14-bit ITU-N point codes can be specified with the `ent-dstn` command. The **PCN** column of the `rtrv-sid` output can contain spare and non-spare point code values. To provision 14-bit ITU-N non-spare point codes in this procedure, the `rtrv-sid` output must contain a 14-bit ITU-N non-spare point code in the **PCN** column. To provision 14-bit ITU-N spare point codes in this procedure, the `rtrv-sid` output must contain a 14-bit ITU-N spare point code in the **PCN** column.

If a point code value is shown in the **PCN24** column of the output of the `rtrv-sid` command, then 24-bit ITU-N point codes can be specified with the `ent-dstn` command.

If no values are shown in the **PCA**, **PCI**, **PCN**, or **PCN24** columns in the `rtrv-sid` command output, the self-identification of the EAGLE must be updated with an ANSI point code, ITU international point code, 14-bit ITU national point code, or a 24-bit ITU national point code. Perform the [Adding a Point Code to the Self-Identification of the EAGLE](#) procedure to add the necessary point codes to the self-identification of the EAGLE.

Note: The EAGLE can contain 14-bit ITU national point codes or 24-bit ITU national point codes, but both at the same time.

Private point codes cannot be specified in the self-identification of the EAGLE, therefore, private point codes can be added as long as the self identification of the EAGLE contains a point code with the same network type as the private point code being added in this procedure. The ITU National and International **Spare Point Code** Support feature does not have to be enabled to add a private point code. A proxy point code cannot be used as a value when specifying a private point code.

The type of alias point code that can be provisioned with the `ent-dstn` command is dependent on the type of DPC that is being provisioned. [Table 2-15](#) shows the DPC and alias point type combinations that can be used with the `ent-dstn` command.

Table 2-15 Destination Point Code Type and Alias Point Code Type Combinations

DPC Type	Alias Point Code Type (See Notes 1 - 4)	Alias Point Code Type (See Notes 1 - 4)	DPC TYPE	Alias Point Code Type (See Notes 1 - 4)	Alias Point Code Type (See Notes 1 - 4)		
ANSI	no alias specified	no alias specified	ITU-I	no alias specified	no alias specified		
	ITU-I	no alias specified		ANSI	no alias specified		
	ITU-I	ITU-N		ANSI	ITU-N		
	ITU-I	ITU-N Spare		ANSI	ITU-N Spare		
	ITU-I	ITU-N24		ANSI	ITU-N24		
	ITU-I Spare	no alias specified		ITU-I Spare	no alias specified		
	ITU-I Spare	ITU-N		ITU-I Spare	ITU-N		
	ITU-I Spare	ITU-N Spare		ITU-I Spare	ITU-N Spare		
	ITU-I Spare	ITU-N24		ITU-I Spare	ITU-N24		
	ITU-N	no alias specified		ITU-N	no alias specified		
	ITU-N Spare	no alias specified		ITU-N (Note 6)	ITU-N Spare (Note 6)		
	ITU-N24	no alias specified		ITU-N Spare	no alias specified		
	ITU-I Spare	no alias specified		no alias specified	ITU-N	ITU-N24	no alias specified
		ANSI		no alias specified		no alias specified	no alias specified
ANSI		ITU-N	ANSI	no alias specified			
ANSI		ITU-N Spare	ANSI	ITU-I			
ANSI		ITU-N24	ANSI	ITU-I Spare			
ITU-I		no alias specified	ITU-I	no alias specified			
ITU-I		ITU-N	ITU-I (Note 5)	ITU-I Spare (Note 5)			
ITU-I		ITU-N Spare	ITU-I Spare	no alias specified			
ITU-I	ITU-N24	ITU-N Spare	no alias specified				

Table 2-15 (Cont.) Destination Point Code Type and Alias Point Code Type Combinations

DPC Type	Alias Point Code Type (See Notes 1 - 4)	Alias Point Code Type (See Notes 1 - 4)	DPC TYPE	Alias Point Code Type (See Notes 1 - 4)	Alias Point Code Type (See Notes 1 - 4)
	ITU-N	no alias specified		ITU-N Spare	ITU-I
	ITU-N (Note 6)	ITU-N Spare (Note 6)		ITU-N Spare	ITU-I Spare
	ITU-N Spare	no alias specified	ITU-N24	no alias specified	no alias specified
	ITU-N24	no alias specified		ANSI	no alias specified
ITU-N Spare	no alias specified	no alias specified		ANSI	ITU-I
	ANSI	no alias specified		ANSI	ITU-I Spare
	ANSI	ITU-I		ITU-I	no alias specified
	ANSI	ITU-I Spare		ITU-I Spare	no alias specified
	ITU-I	no alias specified			
	ITU-I (Note 5)	ITU-I Spare (Note 5)			
	ITU-I Spare	no alias specified			
	ITU-N	no alias specified			
	ITU-N	ITU-I			
	ITU-N	ITU-I Spare			

Table 2-15 (Cont.) Destination Point Code Type and Alias Point Code Type Combinations

DPC Type	Alias Point Code Type (See Notes 1 - 4)	Alias Point Code Type (See Notes 1 - 4)	DPC TYPE	Alias Point Code Type (See Notes 1 - 4)	Alias Point Code Type (See Notes 1 - 4)
Notes:					
1. ANSI alias point codes are specified with the <code>aliasa</code> parameter.					
2. ITU-I and ITU-I Spare alias point codes are specified with the <code>aliasi</code> parameter.					
3. ITU-N and ITU-N Spare alias point codes are specified with the <code>aliasn</code> parameter.					
4. ITU-N24 alias point codes are specified with the <code>aliasn24</code> parameter.					
5. To specify the ITU-I and ITU-I Spare alias point codes for the DPC, both point code values are specified with the <code>aliasi</code> parameter and the values are separated by a comma. For example, to specify the alias point codes 2-005-7 and s-3-002-1, the <code>aliasi</code> parameter is specified like this; <code>aliasi=2-005-7,s-3-002-1</code> . The <code>aliasa</code> and <code>aliasn</code> parameters cannot be specified for the DPC.					
6. To specify the ITU-N and ITU-N Spare alias point codes for the DPC, both point code values are specified with the <code>aliasn</code> parameter and the values are separated by a comma. For example, to specify the alias point codes 00010 and s-00020, the <code>aliasn</code> parameter is specified like this; <code>aliasn=00010,s-00020</code> . The <code>aliasa</code> and <code>aliasi</code> parameters cannot be specified for the DPC.					

Alias point codes can only be specified for full point code entries, and must be full point codes.

ANSI alias point codes cannot be a member of a cluster point code that is already in the database. A point code is a member of a cluster point code if it has the same network identifier (NI) and network cluster (NC) values as the cluster point code.

The EAGLE can contain the quantities of alias point codes shown in [Table 2-16](#) depending the features that are enabled or turned on.

Table 2-16 Maximum Alias Point Code Quantities

Feature Status	Maximum Alias Point Code Quantity
The 5000 Routes feature is off and 6000, 7000, 8000, or 10,000 routesets are not enabled	12000
The 5000 Routes feature is on and 6000, 7000, 8000, or 10,000 routesets are not enabled	12000
6000 routesets are enabled	12000
7000 routesets are enabled	8000
8000 routesets are enabled	8000
10,000 routesets are enabled	10000

Destination point codes and alias point codes must be unique in the database. A point code can be defined as a true destination point code, an alias point code, the self ID of the EAGLE, or the capability point code of the EAGLE. The self IDs and capability point codes of the EAGLE can be verified with the `rtrv-sid` command.

If the `PCTYPE` field of the `rtrv-sid` command output contains the entry `ANSI`, and the network value of the destination point code specified by the `ent-dstn` command is from 0 to 5, the cluster value of that point code must be from 1 to 255. If the network value of that point code is from 6 to 255, the cluster value of that point code must be from 0 to 255.

The actual number of destination point codes that can be configured in the database is set by the `mtpdpcq` parameter of the `chg-stpopts` command, and is shown in the `MTPDPCQ` field in the `rtrv-stpopts` command output.

If the 5000 Routes feature is not on, and 6000, 7000, 8000, or 10,000 routesets are not enabled, a maximum of 2000 destination point codes can be configured in the database.

If the 5000 Routes feature is on, and 6000, 7000, 8000, or 10,000 routesets are not enabled, a maximum of 5000 destination point codes can be configured in the database.

If 6000 routesets are enabled, a maximum of 6000 destination point codes can be configured in the database.

If 7000 routesets are enabled, a maximum of 7000 destination point codes can be configured in the database.

If 8000 routesets are enabled, a maximum of 8000 destination point codes can be configured in the database.

If 10,000 routesets are enabled, a maximum of 10,000 destination point codes can be configured in the database.

Note: For more information on the destination point code quantities, refer to the [Changing the DPC Quantity](#) procedure.

If ITU-N point codes are specified with the `ent-dstn` command, the format of the point code values must match the format shown in the `NPCFMTI` field of the `rtrv-stpopts` command output. For more information, refer to the [14-Bit ITU National Point Code Formats](#) section.

Canceling the RTRV-DSTN Command

Because the `rtrv-dstn` command used in this procedure can output information for a long period of time, the `rtrv-dstn` command can be canceled and the output to the terminal stopped. There are three ways that the `rtrv-dstn` command can be canceled:

- Press the F9 function key on the keyboard at the terminal where the `rtrv-dstn` command was entered
- Enter the `canc-cmd` without the `trm` parameter at the terminal where the `rtrv-dstn` command was entered
- Enter the `canc-cmd:trm=<xx>`, where `<xx>` is the terminal where the `rtrv-dstn` command was entered, from another terminal other than the terminal where the `rtrv-dstn` command was entered. To enter the `canc-cmd:trm=<xx>`

command, the terminal must allow Security Administration commands to be entered from it and the user must be allowed to enter Security Administration commands. The terminal's permissions can be verified with the `rtrv-secu-trm` command. The user's permissions can be verified with the `rtrv-user` or `rtrv-secu-user` commands.

For more information about the `canc-cmd` command, refer to *Commands User's Guide*.

1. Display the current destination point codes, using the `rtrv-dstn` command.

This is an example of the possible output.

```
rlghncxa03w 10-12-10 11:43:04 GMT EAGLE5 43.0.0
Extended Processing Time may be Required

DPCA          CLLI          BEI  ELEI   ALIASI          ALIASN/N24    DMN
001-002-003   ls04clli     yes  ---   -----        -----        SS7
030-045-*     rlghncbb010 yes  yes   -----        -----        SS7
111-011-*     rlghncbb000 yes  yes   -----        -----        SS7
240-012-004   rlghncbb001 yes  ---   1-111-1        10-13-9-3-fr  SS7
240-012-005   rlghncbb002 yes  ---   1-112-2        10-13-10-0-ge SS7
240-012-006   rlghncbb003 yes  ---   1-112-3        10-13-10-1-fr SS7
240-012-008   -----     yes  ---   1-113-5        10-13-10-2-ge SS7

DPCI          CLLI          BEI  ELEI   ALIASA          ALIASN/N24    DMN
2-131-1       rlghncbb023 no   ---   222-210-000    11-11-8-1-ge  SS7
2-131-2       -----     no   ---   222-211-001    11-11-8-2-fr  SS7
2-131-3       -----     no   ---   222-211-002    11-11-8-3-ge  SS7

DPCN          CLLI          BEI  ELEI   ALIASA          ALIASI         DMN
10-15-2-3-fr  rlghncbb013 no   ---   222-200-200    2-121-1        SS7
10-15-2-3-ge  rlghncbb013 no   ---   222-100-200    2-100-1        SS7
10-15-3-0-fr  rlghncbb013 no   ---   222-200-201    2-121-2        SS7
10-15-3-0-ge  rlghncbb013 no   ---   222-100-201    2-100-2        SS7

DESTINATION ENTRIES ALLOCATED:  2000
  FULL DPC(s):                   18
  EXCEPTION DPC(s):              0
  NETWORK DPC(s):                0
  CLUSTER DPC(s):                2
  TOTAL DPC(s):                  20
  CAPACITY (% FULL):             1%
ALIASES ALLOCATED:               8000
  ALIASES USED:                   22
  CAPACITY (% FULL):             1%
X-LIST ENTRIES ALLOCATED:        500
RTRV-DSTN: MASP A - COMPLTD
```

If a quantity of proxy point codes is enabled, the number of proxy point codes that are provisioned in the database are shown at the end of the `rtrv-dstn` output as shown in this example.

```
DESTINATION ENTRIES ALLOCATED:  2000
  FULL DPC(s):                   18
  EXCEPTION DPC(s):              0
  NETWORK DPC(s):                0
  CLUSTER DPC(s):                2
  Proxy DPC (s):                  1
  TOTAL DPC(s):                  20
  CAPACITY (% FULL):             1%
ALIASES ALLOCATED:               8000
```



```

ALIASES USED:                22
CAPACITY (% FULL):          1%
X-LIST ENTRIES ALLOCATED:    500
RTRV-DSTN: MASP A - COMPLTD

```

- To add the new DPC, these entities must be checked depending on how the DPC will be provisioned.

Perform the commands and procedures as required depending on how the DPC will be provisioned.

The addition of the new DPC cannot exceed the current capacity shown in the `DESTINATION ENTRIES ALLOCATED` or the `Destination` table row of the `rtrv-dstn` output. If the current capacity will be exceeded by adding the new DPC, and the maximum capacity is shown in the `rtrv-dstn` output: 10,000 if the `DESTINATION ENTRIES ALLOCATED` and `X-LIST ENTRIES ALLOCATED` rows are not shown in the `rtrv-dstn` output, or 10,500 if the `DESTINATION ENTRIES ALLOCATED` and `X-LIST ENTRIES ALLOCATED` rows are shown in the `rtrv-dstn` output, perform [Removing a Destination Point Code](#) or [Removing a Route Exception Entry](#) to remove an existing DPC or exception route entry.

If the maximum capacity is not shown in the `rtrv-dstn` output, perform [Changing the DPC Quantity](#) to increase the number of DPCs that can be in the database.

The type of point code being added, ANSI, ITU-I, ITU-N, ITU-N24 must be shown in the `rtrv-dstn` output or the `rtrv-sid` output. If the point code type is not shown in the `rtrv-dstn` output, perform the `rtrv-sid` command in [3](#). If the point code type is not shown in `rtrv-dstn` and `rtrv-sid`, perform [Adding a Point Code to the Self-Identification of the EAGLE](#) to add a point code of the desired point code type.

If the new DPC will be a 14-bit ITU-N point code, and a group code will be assigned to the point code, the group code must be defined in `rtrv-sid` output in [3](#), `rtrv-dstn` output in [1](#), or `rtrv-spc` output in [4](#). If the group code is not shown in either of these outputs, perform [Adding a Point Code to the Self-Identification of the EAGLE](#) to add an entry with the desired group code. If the group code will be different from the ones shown in the `rtrv-sid` or `rtrv-dstn` outputs, perform [Adding a Secondary Point Code](#) to add a secondary point code with the desired group code.

If a secondary point code will be specified with the DPC, the secondary point code must be shown in the `rtrv-spc` output in [4](#). If the secondary point code is not shown in the `rtrv-spc` output, perform [Adding a Secondary Point Code](#) to add the desired secondary point code.

If the `clli` parameter will be specified with the DPC, the `clli` parameter value cannot be shown in the `rtrv-sid` or `rtrv-dstn` outputs. Enter the `rtrv-sid` command in [3](#) to verify the CLLI value in the self-identification of the EAGLE.

The format of a 14-bit ITU-N DPC must match the format defined by the `NPCFMTI` value in the `rtrv-stpopts` output. Enter the `rtrv-stpopts` in [5](#) to verify the `NPCFMTI` value. If you wish to change the format, perform [14-Bit ITU National Point Code Formats](#).

To specify an alias point code with the DPC, adding the new alias point code cannot exceed the maximum alias point code quantity shown in the `ALIASES ALLOCATED:` or the `Alias` table row in the `rtrv-dstn` output. If the maximum alias point code quantity will be exceeded, perform [Changing a Destination Point](#)

[Code](#) to remove enough alias point codes to allow the new alias point code to be added.

If the `nprst` or `rcause` parameters will be specified with the DPC, the TIF Number Portability feature must be enabled. Enter the `rtrv-ctrl-feat` command in [6](#) to verify that the feature is enabled. If the feature is not enabled, perform the procedures in *TIF User's Guide* to enable the TIF Number Portability feature.

If the `splitiam` parameter will be specified with the DPC, at least one of these features must be enabled.

- TIF Number Portability
- TIF SCS Forwarding
- TIF Simple Number Substitution
- TIF Additional Subscriber Data
- TIF Generic Routing Number

Enter the `rtrv-ctrl-feat` command in [6](#) to verify if any of these features are enabled.

If none of these features are enabled, perform the procedures in *TIF User's Guide* to enable one or more of these features.

If the `prx=yes` or `ppc` parameters will be specified with the DPC, the Proxy Point Code feature must be enabled. The addition of the proxy point code with the `prx=yes` parameter cannot exceed the enabled proxy point code quantity, shown in the `PPC` table or `PROXY DPC(s)` row of the `rtrv-dstn` output. Enter the `rtrv-ctrl-feat` command in [6](#) to verify if a proxy point code quantity is enabled. If a proxy point code quantity is enabled, the Proxy Point Code feature is enabled. To enable the Proxy Point Code feature or increase the proxy point code quantity, perform [Changing the Proxy Point Code Quantity](#). If the enabled quantity is 100, and 100 proxy point codes are in the database, no more proxy point codes can be added.

The `ppc` parameter assigns an existing proxy point code to the DPC. Enter the `rtrv-dstn:prx=yes` command in [7](#) to verify that the proxy point code is in the database.

The `sccpmsgcnv` parameter specifies the kind of conversion performed on messages for the specified destination. This parameter can be specified only if the XUDT UDT Conversion feature is enabled and turned on. Enter the `rtrv-ctrl-feat` command in [6](#) to verify that the XUDT UDT Conversion feature is enabled and turned on. If the XUDT UDT Conversion feature is not enabled or turned on, perform the "Activating the XUDT UDT Conversion Feature" procedure in *Database Administration - GTT User's Guide* to enable and turn on the XUDT UDT Conversion feature.

After the required entities have been verified and provisioned, continue the procedure with [8](#).

3. Display the self-identification of the EAGLE using the `rtrv-sid` command.

This is an example of the possible output.

```
rlghncxa03w 06-10-10 11:43:04 GMT EAGLE5 36.0.0
```

PCA	PCI	PCN	CLLI	PCTYPE
100-100-100	3-75-7	7-9-8-1-fr	rlghncxa03w	OTHER
CPCA				
002-002-002	002-002-003	002-002-004	002-002-005	
002-002-006	002-002-007	002-002-008	002-002-009	
004-002-001	004-003-003	050-060-070		
CPCA (LNP)				
005-005-002	005-005-004	005-005-005		
CPCI				
1-002-1	1-002-2	1-002-3	1-002-4	
2-001-1	7-222-7			
CPCN				
2-0-10-3-fr	2-0-11-0-fr	2-0-11-2-fr	2-0-12-1-fr	
2-2-3-3-fr	2-2-4-0-fr	10-14-10-1-fr		

4. Display the secondary point codes in the database with the `rtvr-spc` command.

This is an example of the possible output.

```
rlghncxa03w 06-10-17 16:02:05 GMT EAGLE5 36.0.0
SPC (Secondary Point Codes)
SPCA
    001-010-010
    002-010-010
    003-010-010
    010-100-010
SPC-I
    1-253-5
    2-254-6
    3-255-7
    4-100-1
SPC-N
    10-1-11-1-ge
    13-2-12-0-ge
    14-15-12-1-ge
SPC-N24
none
Secondary Point Code table is (11 of 40) 28% full
```

5. Display the existing values for the `npcfmt i` parameter by entering the `rtvr-stpopts` command.

The value for the `npcfmt i` parameter is shown in the `NPCFMTI` field. This is an example of the possible output.

```
rlghncxa03w 06-10-17 16:02:05 GMT EAGLE5 36.0.0
STP OPTIONS
-----
NPCFMTI      4-4-4-2
```

Note: The `rtvr-stpopts` command output contains other fields that are not used by this procedure. If you wish to see all the fields displayed by the `rtvr-stpopts` command, see the `rtvr-stpopts` command description in *Commands User's Guide*.

6. Display the features that are enabled by entering the `rtrv-ctrl-feat` command..

The following is an example of the possible output.

```
rlghncxa03w 06-10-28 21:15:37 GMT EAGLE5 36.0.0
The following features have been permanently enabled:
```

Feature Name	Partnum	Status	Quantity
Command Class Management	893005801	on	----
LNP Short Message Service	893006601	on	----
Intermed GTT Load Sharing	893006901	on	----
XGTT Table Expansion	893006101	on	4000000
XMAP Table Expansion	893007710	on	3000
Large System # Links	893005901	on	1500
Routesets	893006401	on	6000
HC-MIM SLK Capacity	893012707	on	64

The following features have been temporarily enabled:

Feature Name	Partnum	Status	Quantity	Trial Period Left
Zero entries found.				

The following features have expired temporary keys:

Feature Name	Partnum
Zero entries found.	

7. Display the proxy point codes in the database by entering this command.

```
rtrv-dstn:prx=yes
```

This is an example of the possible output.

```
rlghncxa03w 09-05-28 21:15:37 GMT EAGLE5 41.0.0
```

```
PRX = yes
```

DPCA	CLLI	BEI	ELEI	ALIASI	ALIASN/N24	DMN
002-002-002	-----	no	---	-----	-----	SS7

```
Destination table is (18 of 2000) 1% full
Alias table is (22 of 8000) 1% full
PPC table is (1 of 10) 10% full
```

If the desired proxy point code is shown in the `rtrv-dstn` output, perform [8.c of 8](#) to assign the proxy point code to the destination point code with the `ppc` parameter.

If the desired proxy point code is not shown in the `rtrv-dstn` output, add the proxy point code by performing [8.b of 8](#) with the `prx=yes` parameter. After the new proxy point code has been added, perform [8.c of 8](#) again to assign the proxy point code to the destination point code with the `ppc` parameter.

8. Add the destination point code, using the `ent-dstn` command.

- If proxy point codes are not being provisioned in this procedure, perform [8.a](#).
- If a new proxy point code is being provisioned with the `prx=yes` parameter, perform [8.b](#).

- If a proxy point code is being assigned to a destination point code, perform [8.c](#).
- a. Add the destination point code to the database without specifying the `prx` or `ppc` parameters. If alias point codes will be assigned to the DPC, [Table 2-15](#) shows the DPC and alias point type combinations that can be used with the `ent-dstn` command.

```
ent-
dstn:dpca=240-012-007:bei=yes:aliasi=1-117-3:aliasn=10-13-1
1-1-
fr :spca=001-010-010:homescp=yes:homesmsc=yes:sccpmsgcnv=xu
dt2udt

ent-dstn:dpca=240-012-006:spca=002-010-010

ent-
dstn:dpci=4-163-5:bei=no:aliasa=250-200-007:domain=ss7:spci
=2-254-6

ent-dstn:dpcn=7-9-10-1-
fr:bei=no:aliasa=210-090-100 :aliasi=1-75-6:domain=ss7

ent-dstn:dpcn=7-9-10-1-
ge:bei=no:aliasa=210-100-100:aliasi=2-175-6 :domain=ss7:spc
n=13-02-12-0-ge

ent-dstn:dpci=3-002-1:aliasn=9-12-2-1-fr,s-8-11-3-0-ge

ent-dstn:dpcn=10-11-1-3-fr:aliasi=3-125-0,s-4-135-3

ent-dstn:dpcn=6-10-7-9-
ge:bei=no:aliasa=211-100-100:aliasi=3-175-6 :spcn=13-02-12-
1-ge:rcause=15:nprst=on:splitiam=20
```

- b. To add a new proxy point code to the database, specify the `ent-dstn` command with the `prx=yes` parameter.

For this example, enter this command.

```
ent-dstn:dpca=003-003-003:prx=yes
```

Note: The point code being added as a proxy point code must be a full point code, in the SS7 domain, and cannot be a private point code. The point code cannot have the `ipgwapc=yes` parameter value assigned.

- c. To assign a proxy point code to a destination point code, specify the `ent-dstn` command with the `ppc` parameter.

For this example, enter this command.

```
ent-dstn:dpca=004-004-004:ppca=003-003-003
```

The following rules apply to assigning proxy point codes to destination point codes.

- The destination point code must be a full point code and cannot be a private point code.
- The destination point code cannot have the `ipgwapc=yes` parameter value assigned.

- The destination point code and proxy point code must be the same network type. For example, if the destination point code is an ANSI point code, the proxy point code must be an ANSI point code.
- If the destination point code and proxy point code are 14-bit ITU-N point codes with a group code, the group code values for both the destination point code and the proxy point code must be the same.

When the `ent-dstn` command has successfully completed, and the Cluster Routing and Management Diversity feature is turned off (shown with the `CRMD = off` entry in the `rtrv-feat` command output), and no proxy point code quantity is enabled, this message should appear.

```
rlghncxa03w 09-05-17 15:35:05 GMT EAGLE5 41.0.0
Destination table is (27 of 2000) 1% full
Alias table is (27 of 12000) 1% full
ENT-DSTN: MASP A - COMPLTD
```

If the Cluster Routing and Management Diversity feature is turned on (`CRMD = on` in the `rtrv-feat` command output), and no proxy point code quantity is enabled, this message should appear.

```
rlghncxa03w 09-05-17 15:35:05 GMT EAGLE5 41.0.0
DESTINATION ENTRIES ALLOCATED: 2000
  FULL DPC(s): 27
  EXCEPTION DPC(s): 0
  NETWORK DPC(s): 0
  CLUSTER DPC(s): 2
  TOTAL DPC(s): 29
  CAPACITY (% FULL): 1%
ALIASES ALLOCATED: 8000
  ALIASES USED: 31
  CAPACITY (% FULL): 1%
X-LIST ENTRIES ALLOCATED: 500
ENT-DSTN: MASP A - COMPLTD
```

If a proxy point code quantity is enabled and the Cluster Routing and Management Diversity feature is turned off (shown with the `CRMD = off` entry in the `rtrv-feat` command output), this message should appear.

```
rlghncxa03w 09-05-17 15:35:05 GMT EAGLE5 41.0.0
Destination table is (29 of 2000) 1% full
Alias table is (27 of 12000) 1% full
PPC table is (2 of 10) 20% full
ENT-DSTN: MASP A - COMPLTD
```

If the Cluster Routing and Management Diversity feature is turned on (`CRMD = on` in the `rtrv-feat` command output), and a proxy point code quantity is enabled, this message should appear.

```
rlghncxa03w 09-05-17 15:35:05 GMT EAGLE5 41.0.0
DESTINATION ENTRIES ALLOCATED: 2000
  FULL DPC(s): 25
  EXCEPTION DPC(s): 0
  NETWORK DPC(s): 0
  CLUSTER DPC(s): 2
  Proxy DPC(s): 2
```

```

TOTAL DPC(s):          29
CAPACITY (% FULL):    1%
ALIASES ALLOCATED:    8000
ALIASES USED:         27
CAPACITY (% FULL):    1%
X-LIST ENTRIES ALLOCATED: 500
ENT-DSTN: MASP A - COMPLTD

```

9. Verify the changes using the `rtrv-dstn` command with the DPC that was entered in 8.

For this example, enter these commands.

```
rtrv-dstn:dpca=240-012-007
```

This is an example of the possible output.

```
rlghncxa03w 10-12-28 21:16:37 GMT EAGLE5 43.0.0
```

```

DPCA      CLI      BEI ELEI  ALIASI      ALIASN/N24  DMN
240-012-007  ----- yes ---  1-117-3      10-13-11-1-fr SS7

```

```

SPCA      NCAI PRX      RCAUSE NPRST SPLITIAM HMSMSC HMSCP SCCPMSGCNV
001-010-010 ---- no      none  off  none      yes   yes   xudt2udt

```

```

DESTINATION ENTRIES ALLOCATED:  2000
FULL DPC(s):                    25
EXCEPTION DPC(s):                0
NETWORK DPC(s):                  0
CLUSTER DPC(s):                  2
Proxy DPC(s):                    2
TOTAL DPC(s):                    29
CAPACITY (% FULL):                1%
ALIASES ALLOCATED:                8000
ALIASES USED:                     27
CAPACITY (% FULL):                1%
X-LIST ENTRIES ALLOCATED:         500
RTRV-DSTN: MASP A - COMPLTD

```

```
rtrv-dstn:dpca=240-012-006
```

This is an example of the possible output.

```
rlghncxa03w 10-12-28 21:16:37 GMT EAGLE5 43.0.0
```

```

DPCA      CLI      BEI ELEI  ALIASI      ALIASN/N24  DMN
240-012-006  rlghncbb003 yes ---  1-112-3      10-13-10-1-fr SS7

```

```

SPCA      NCAI PRX      RCAUSE NPRST SPLITIAM HMSMSC HMSCP SCCPMSGCNV
002-010-010 ---- no      none  off  none      no    no    none

```

```

DESTINATION ENTRIES ALLOCATED:  2000
FULL DPC(s):                    25
EXCEPTION DPC(s):                0
NETWORK DPC(s):                  0
CLUSTER DPC(s):                  2
Proxy DPC(s):                    2
TOTAL DPC(s):                    29
CAPACITY (% FULL):                1%
ALIASES ALLOCATED:                8000
ALIASES USED:                     27

```

```

CAPACITY (% FULL):          1%
X-LIST ENTRIES ALLOCATED:   500
RTRV-DSTN: MASP A - COMPLTD

```

rtrv-dstn:dpci=4-163-5

This is an example of the possible output.

rlghncxa03w 10-12-28 21:16:37 GMT EAGLE5 43.0.0

DPCI	CLLI	BEI	ELEI	ALIASA	ALIASN/N24	DMN
4-163-5	-----	no	---	250-200-007	-----	SS7

SPCI	NCAI	PRX	RCAUSE	NPRST	SPLITIAM	HMSMSC	HMSCP	SCCPMSGCNV
2-154-6	----	no	none	off	none	no	no	none

```

DESTINATION ENTRIES ALLOCATED:  2000
FULL DPC(s):                     25
EXCEPTION DPC(s):                 0
NETWORK DPC(s):                   0
CLUSTER DPC(s):                   2
Proxy DPC(s):                     2
TOTAL DPC(s):                     29
CAPACITY (% FULL):                1%
ALIASES ALLOCATED:                8000
ALIASES USED:                     27
CAPACITY (% FULL):                1%
X-LIST ENTRIES ALLOCATED:         500
RTRV-DSTN: MASP A - COMPLTD

```

rtrv-dstn:dpcn=7-9-10-1-fr

This is an example of the possible output.

rlghncxa03w 10-12-28 21:16:37 GMT EAGLE5 43.0.0

DPCN	CLLI	BEI	ELEI	ALIASA	ALIASI	DMN
7-9-10-1-fr	-----	no	---	210-090-100	1-75-6	SS7

SPCN	NCAI	PRX	RCAUSE	NPRST	SPLITIAM	HMSMSC	HMSCP	SCCPMSGCNV
-----	----	no	none	off	none	no	no	none

```

DESTINATION ENTRIES ALLOCATED:  2000
FULL DPC(s):                     25
EXCEPTION DPC(s):                 0
NETWORK DPC(s):                   0
CLUSTER DPC(s):                   2
Proxy DPC(s):                     2
TOTAL DPC(s):                     29
CAPACITY (% FULL):                1%
ALIASES ALLOCATED:                8000
ALIASES USED:                     27
CAPACITY (% FULL):                1%
X-LIST ENTRIES ALLOCATED:         500
RTRV-DSTN: MASP A - COMPLTD

```

rtrv-dstn:dpcn=7-9-10-1-ge

This is an example of the possible output.

rlghncxa03w 10-12-28 21:16:37 GMT EAGLE5 43.0.0

DPCN	CLLI	BEI	ELEI	ALIASA	ALIASI	DMN
7-9-10-1-ge	-----	no	---	210-100-100	2-175-6	SS7

SPCN	NCAI	PRX	RCAUSE	NPRST	SPLITIAM	HMSMSC	HMSCP	SCCPMSGCNV
13-02-12-0-ge	----	no	none	off	none	no	no	none

DESTINATION ENTRIES ALLOCATED: 2000
 FULL DPC(s): 25
 EXCEPTION DPC(s): 0
 NETWORK DPC(s): 0
 CLUSTER DPC(s): 2
 Proxy DPC(s): 2
 TOTAL DPC(s): 29
 CAPACITY (% FULL): 1%
 ALIASES ALLOCATED: 8000
 ALIASES USED: 27
 CAPACITY (% FULL): 1%
 X-LIST ENTRIES ALLOCATED: 500
 RTRV-DSTN: MASP A - COMPLTD

rtrv-dstn:dpca=003-003-003

This is an example of the possible output.

rlghncxa03w 10-12-28 21:16:37 GMT EAGLE5 43.0.0

DPCA	CLLI	BEI	ELEI	ALIASI	ALIASN/N24	DMN
003-003-003	-----	no	---	-----	-----	SS7

SPCA	NCAI	PRX	RCAUSE	NPRST	SPLITIAM	HMSMSC	HMSCP	SCCPMSGCNV
-----	----	yes, 1	none	off	none	no	no	none

DESTINATION ENTRIES ALLOCATED: 2000
 FULL DPC(s): 25
 EXCEPTION DPC(s): 0
 NETWORK DPC(s): 0
 CLUSTER DPC(s): 2
 Proxy DPC(s): 2
 TOTAL DPC(s): 29
 CAPACITY (% FULL): 1%
 ALIASES ALLOCATED: 8000
 ALIASES USED: 27
 CAPACITY (% FULL): 1%
 X-LIST ENTRIES ALLOCATED: 500
 RTRV-DSTN: MASP A - COMPLTD

rtrv-dstn:dpca=004-004-004

This is an example of the possible output.

rlghncxa03w 10-12-28 21:16:37 GMT EAGLE5 43.0.0

DPCA	CLLI	BEI	ELEI	ALIASI	ALIASN/N24	DMN
004-004-004	-----	no	---	-----	-----	SS7

PPCA	NCAI	PRX	RCAUSE	NPRST	SPLITIAM	HMSMSC	HMSCP	SCCPMSGCNV
003-003-003	----	no	none	off	none	no	no	none

```

DESTINATION ENTRIES ALLOCATED: 2000
  FULL DPC(s): 25
  EXCEPTION DPC(s): 0
  NETWORK DPC(s): 0
  CLUSTER DPC(s): 2
  Proxy DPC(s): 2
  TOTAL DPC(s): 29
  CAPACITY (% FULL): 1%
ALIASES ALLOCATED: 8000
  ALIASES USED: 27
  CAPACITY (% FULL): 1%
X-LIST ENTRIES ALLOCATED: 500
RTRV-DSTN: MASP A - COMPLTD

```

rtrv-dstn:dpci=3-002-1

This is an example of the possible output.

rlghncxa03w 10-12-28 21:16:37 GMT EAGLE5 43.0.0

DPCI	CLLI	BEI	ELEI	ALIASN	ALIASN	DMN		
3-002-1	-----	no	---	9-12-2-1-fr	s-8-11-3-0-ge	SS7		
SPCI	NCAI PRX	RCAUSE	NPRST	SPLITIAM	HMSMSC	HMSCP	SCCPMSGCNV	
-----	----	no	none	off	none	no	no	none

```

DESTINATION ENTRIES ALLOCATED: 2000
  FULL DPC(s): 25
  EXCEPTION DPC(s): 0
  NETWORK DPC(s): 0
  CLUSTER DPC(s): 2
  Proxy DPC(s): 2
  TOTAL DPC(s): 29
  CAPACITY (% FULL): 1%
ALIASES ALLOCATED: 8000
  ALIASES USED: 27
  CAPACITY (% FULL): 1%
X-LIST ENTRIES ALLOCATED: 500
RTRV-DSTN: MASP A - COMPLTD

```

rtrv-dstn:dpcn=10-11-1-3-fr

This is an example of the possible output.

rlghncxa03w 10-12-28 21:16:37 GMT EAGLE5 43.0.0

DPCN	CLLI	BEI	ELEI	ALIASI	ALIASI	DMN		
10-11-1-3-fr	-----	no	---	3-125-0	s-4-135-3	SS7		
SPCN	NCAI PRX	RCAUSE	NPRST	SPLITIAM	HMSMSC	HMSCP	SCCPMSGCNV	
-----	----	no	none	off	none	no	no	none

```

DESTINATION ENTRIES ALLOCATED: 2000
  FULL DPC(s): 25
  EXCEPTION DPC(s): 0
  NETWORK DPC(s): 0
  CLUSTER DPC(s): 2
  Proxy DPC(s): 2

```

```

TOTAL DPC(s):                29
CAPACITY (% FULL):           1%
ALIASES ALLOCATED:           8000
ALIASES USED:                 27
CAPACITY (% FULL):           1%
X-LIST ENTRIES ALLOCATED:    500
RTRV-DSTN: MASP A - COMPLTD

```

```
rtrv-dstn:dpcn=6-10-7-9-ge
```

This is an example of the possible output.

```
rlghncxa03w 10-12-28 21:16:37 GMT EAGLE5 43.0.0
```

```

DPCN          CLLI          BEI  ELEI  ALIASA          ALIASI          DMN
6-10-7-9-ge  ----- no   ---  211-100-100    3-175-6        SS7

```

```

SPCN          NCAI PRX          RCAUSE NPRST SPLITIAM HMSMSC HMSCP SCCPMSGCNV
13-02-12-1-ge ---- no          15     on   20         no     no     none

```

```

DESTINATION ENTRIES ALLOCATED:  2000
FULL DPC(s):                    25
EXCEPTION DPC(s):               0
NETWORK DPC(s):                 0
CLUSTER DPC(s):                 2
Proxy DPC(s):                   2
TOTAL DPC(s):                   29
CAPACITY (% FULL):              1%
ALIASES ALLOCATED:              8000
ALIASES USED:                    27
CAPACITY (% FULL):              1%
X-LIST ENTRIES ALLOCATED:       500
RTRV-DSTN: MASP A - COMPLTD

```

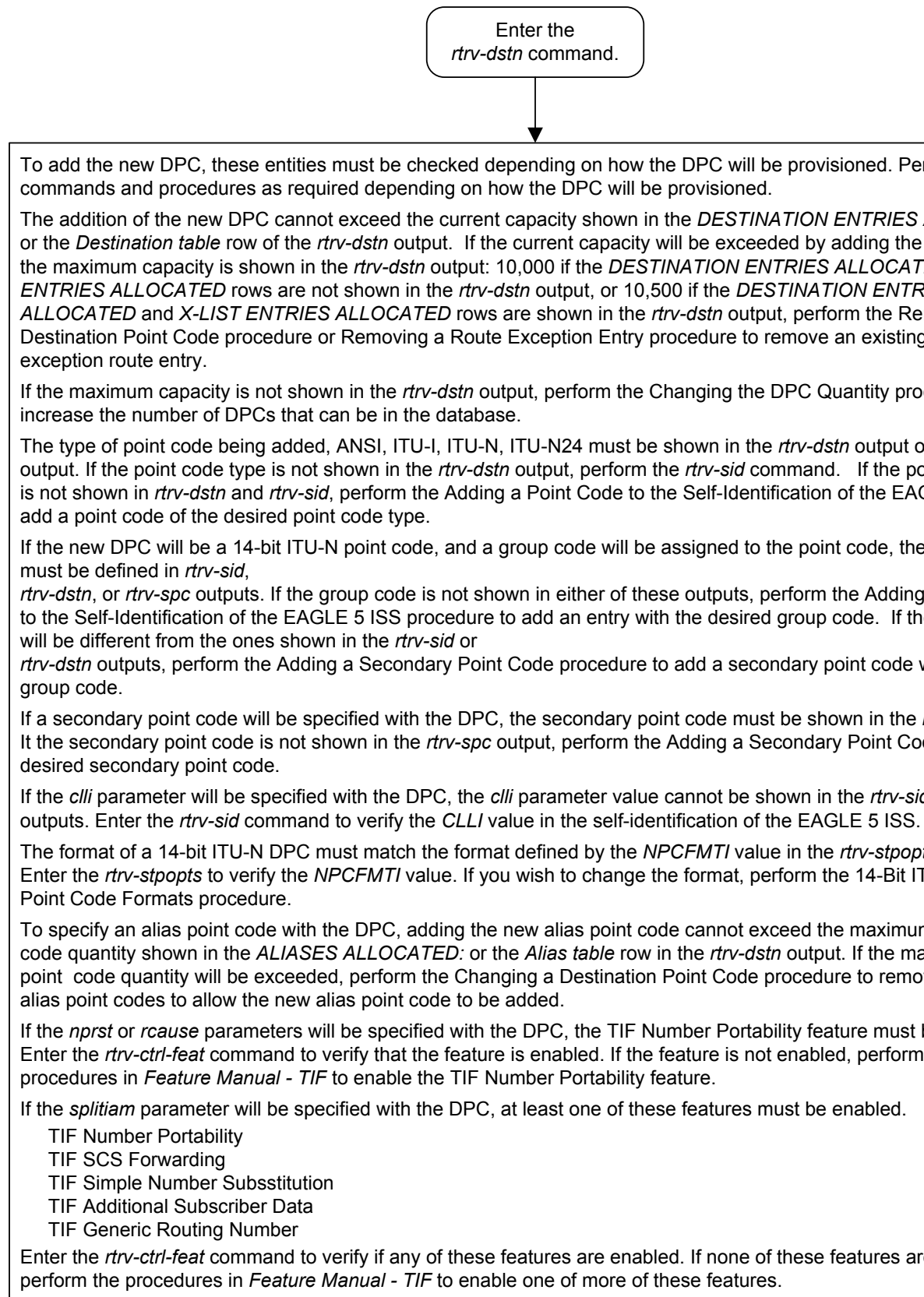
10. Back up the new changes, using the `chg-db:action=backup:dest=fixed` command.

These messages should appear; the active **Maintenance and Administration Subsystem Processor (MASP)** appears first.

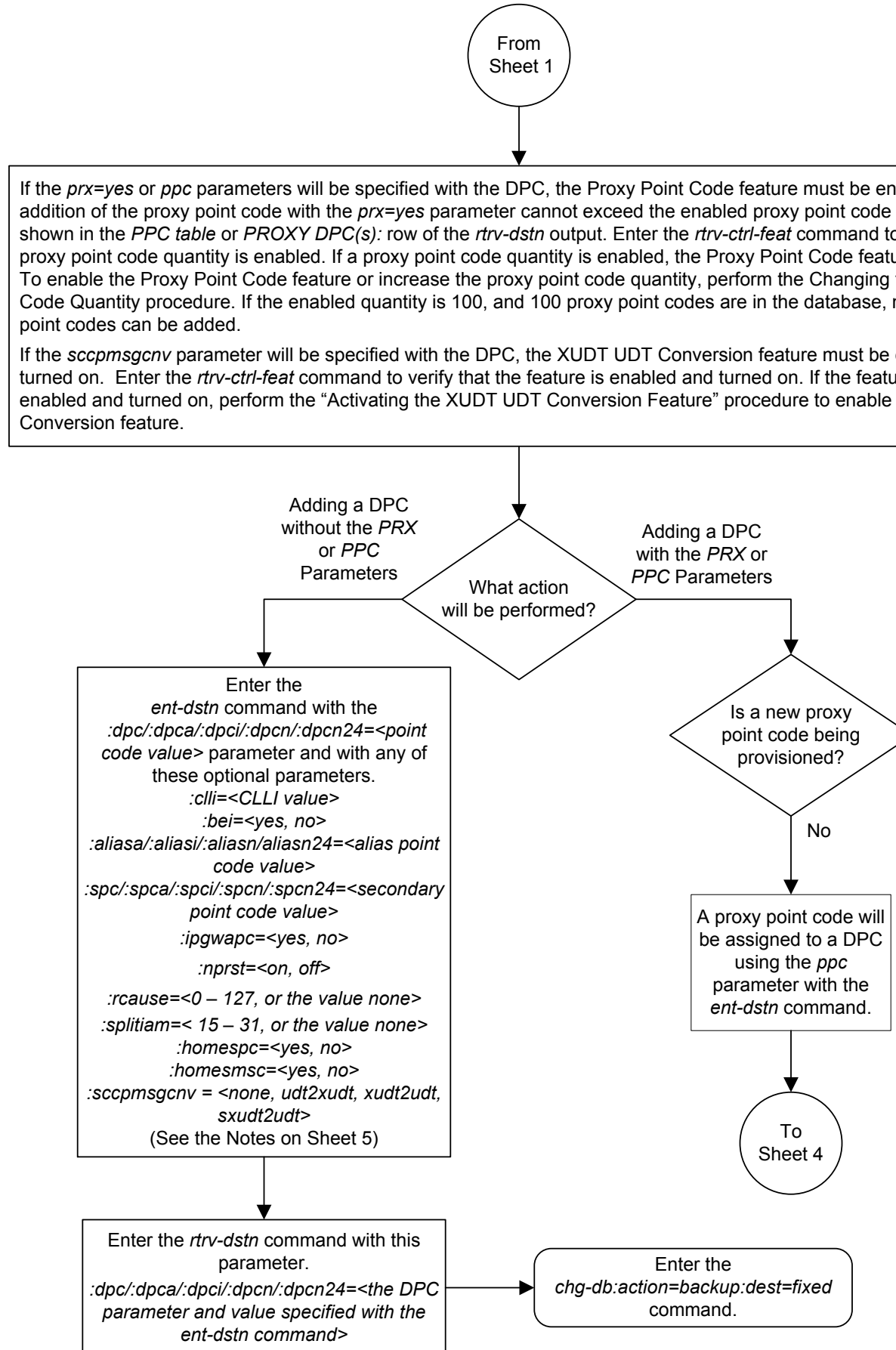
```

BACKUP (FIXED) : MASP A - Backup starts on active MASP.
BACKUP (FIXED) : MASP A - Backup on active MASP to fixed disk complete.
BACKUP (FIXED) : MASP A - Backup starts on standby MASP.
BACKUP (FIXED) : MASP A - Backup on standby MASP to fixed disk complete.

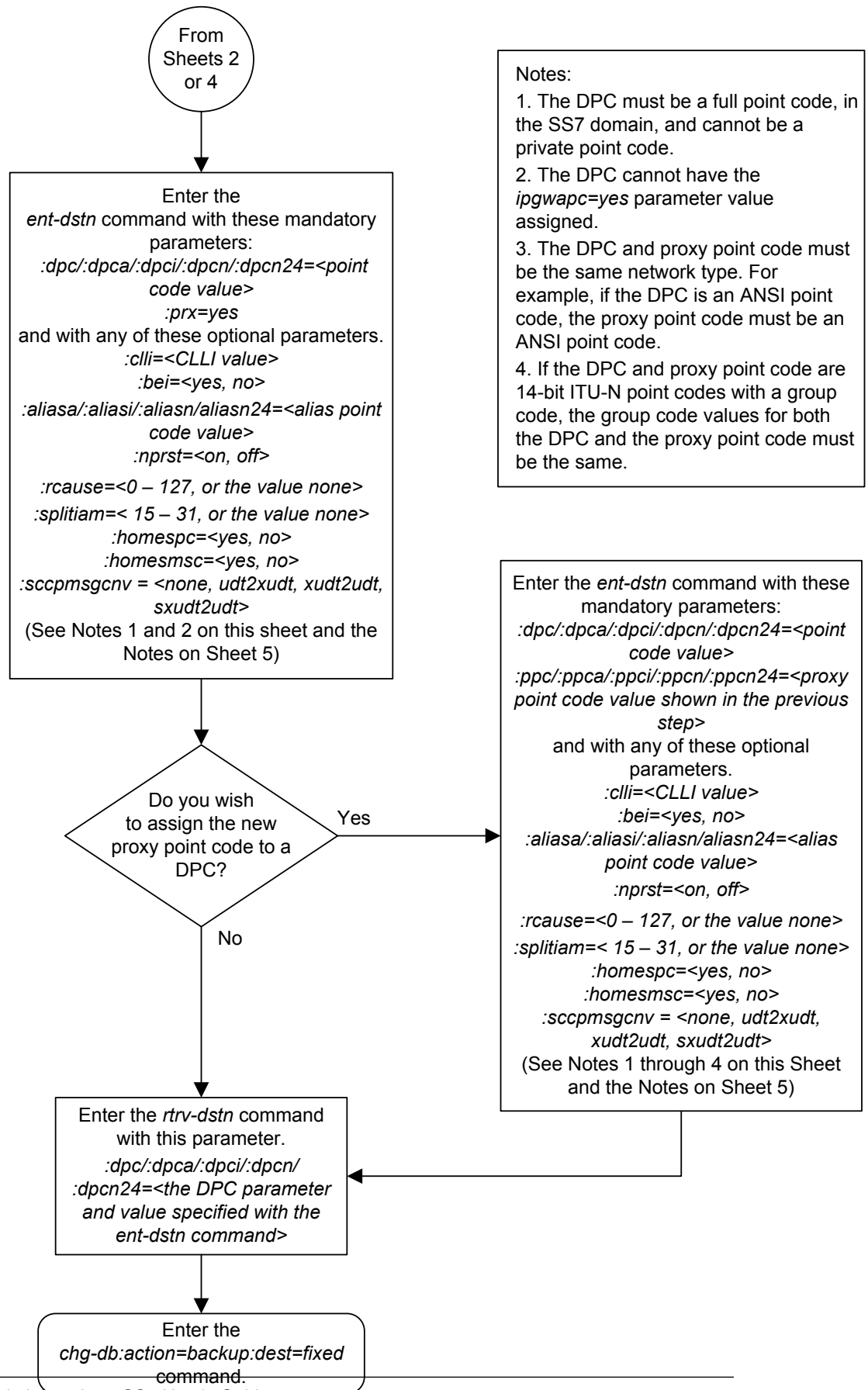
```

Figure 2-30 Adding a Destination Point Code

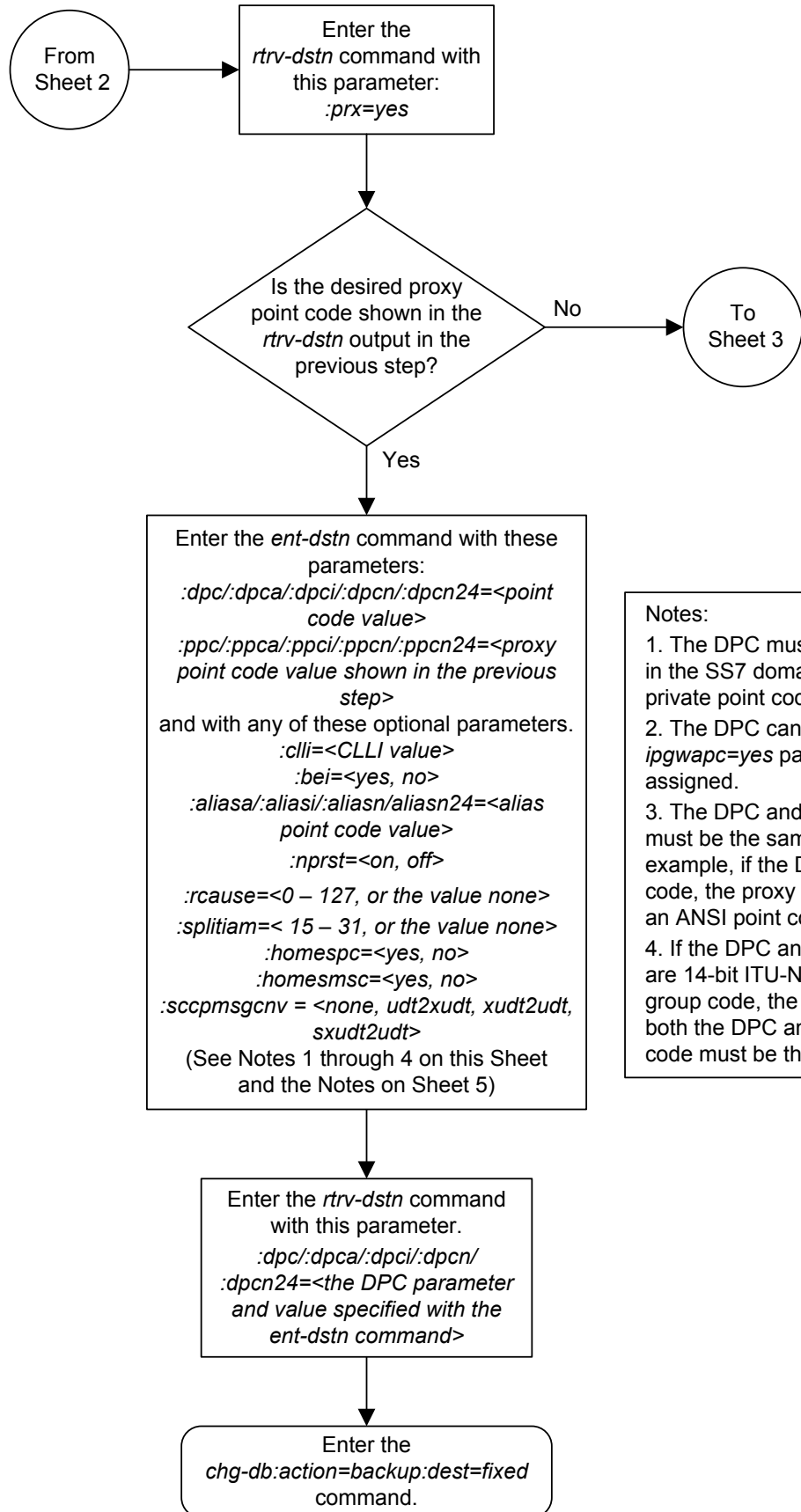
Sheet 1 of 5



Sheet 2 of 5



Sheet 3 of 5



- Notes:
1. The DPC must be a full point code in the SS7 domain, and cannot be a private point code.
 2. The DPC cannot have the *ipgwapc=yes* parameter value assigned.
 3. The DPC and proxy point code must be the same network type. For example, if the DPC is an ANSI point code, the proxy point code must also be an ANSI point code.
 4. If the DPC and proxy point code are 14-bit ITU-N point codes with a group code, the group code value for both the DPC and the proxy point code must be the same.

Sheet 4 of 5

Notes:

1. The *PCI* and *PCN* columns of the *rtv-sid* output can contain spare and non-spare point code values. To provision ITU-N non-spare point codes in this procedure, the *rtv-sid* output must contain non-spare point codes (ITU-I non-spare point code in the *PCI* column and 14-bit ITU-N non-spare point code in the *PCN* column). To provision ITU-I or 14-bit ITU-N spare point codes in this procedure, the *rtv-sid* output must contain spare point codes (ITU-I spare point code in the *PCI* column and 14-bit ITU-N spare point code in the *PCN* column).
2. The *:dpc/:dpcal/:dpcil/:dpcn/:dpcn24*, *:aliasal/:aliasil/:aliasn/:aliasn24*, *:spcl/:spcal/:spcil/:spcn/:spcn24* and *:ppc/:ppcal/:ppcn24* parameters are used to provision either ANSI, ITU-I, 14-bit ITU-N, or 24-bit ITU-N point codes.
 - :dpc/:dpcal/:spcl/:spcal/:aliasal/:ppcal* = ANSI DPC, private ANSI DPC, SPC, alias point code, proxy point code
 - :dpcil/:spcil/:aliasil/:ppcil* = ITU-I DPC (non-spare point code, spare point code, private point code, private spare point code), SPC (non-spare or spare point code), alias point code (non-spare or spare point code), proxy point code
 - :dpcn/:spcn/:aliasn/:ppcn* = 14-bit ITU-N DPC (non-spare point code, spare point code, private point code, private spare point code), SPC (non-spare or spare point code), alias point code (non-spare or spare point code), proxy point code
 - :dpcn24/:spcn24/:aliasn24/:ppcn24* = 24-bit ITU-N DPC, private 24-bit ITU-N DPC, SPC, alias point code, proxy point code
3. The network type of alias point codes cannot be the same as the network type of the DPC.
 - If the DPC is ANSI, then either ITU-I or ITU-N (14-bit or 24-bit) alias point codes can be assigned.
 - If the DPC is ITU-I, then either ANSI or ITU-N (14-bit or 24-bit) alias point codes can be assigned.
 - If the DPC is either a 14-bit or a 24-bit ITU-N, then either ITU-I or ANSI alias point codes can be assigned.
4. The system can contain 14-bit ITU-N point codes or 24-bit ITU-N point codes, but not both at the same time.
5. The network type of an SPC must be the same as the network type of the DPC.
6. The alias point code and SPC value must be full point codes.
7. The alias point code value cannot be shown in the *rtv-dstn* output.
8. The NI and NC values of an ANSI point code cannot be the same as the NI and NC values of any cluster point code shown in the *rtv-dstn* output.
9. The *rtv-sid* output must show values in the *PCA*, *PCI*, *PCN*, or *PCN24* fields before a DPC of the network type code is added. These fields can be added.
10. The DPC or CLLI value being added cannot be shown in the *rtv-sid* output.
11. The DPC being added cannot be an alias point code.
12. The SPC value must be shown in the *rtv-spc* output.
13. If a 14-bit ITU-N DPC is being added and the ITU Duplicate Point Code feature is on, and no SPC are being assigned, the group code assigned to the DPC must be the same as the group code value shown in the *PCN* field of the *rtv-sid* output.
14. If a 14-bit ITU-N DPC is being added and the ITU Duplicate Point Code feature is on, and an SPC is being assigned, the group code assigned to the DPC must be the same as the group code assigned to the SPC.
15. The format of 14-bit ITU-N point codes must match the format defined by the *NPCFMTI* value of the *rtv-stpopts* output.
16. The *ipgwpc* parameter can be used only for ANSI DPCs that will be used to define the IP gateway APC of a link.
17. The default value for the *domain* parameter is *ss7*, and the default value for the *bei* parameter is *no*.
18. The EAGLE 5 ISS can contain these quantities of alias point codes depending on the features that are enabled or turned on:
 - 5000 routes is not turned on, 6000, 7000, 8000, or 10,000 routesets is not enabled – 12,000 alias point codes
 - 5000 routes is turned on, 6000, 7000, 8000, or 10,000 routesets is not enabled – 12,000 alias point codes
 - 6000 routesets are enabled – 12,000 alias point codes
 - 7000 routesets are enabled – 8000 alias point codes
 - 8000 routeset are enabled – 8000 alias point codes
 - 10,000 routesets are enabled – 10,000 alias point codes
 The number of alias point codes is shown in the *ent-dstn* and *rtv-dstn* outputs.
19. The type of alias point code that can be provisioned is dependent on the type of DPC that is being provisioned. Refer to the Destination Point Code and Alias Point Code Type Combinations table in the “Adding a Destination Point Code” procedure in the *Database Administration Manual – SS7* for the alias point code parameter combinations.
20. The default value for the *sccpmsgcnv* parameter is *none*.

Removing a Destination Point Code

This procedure is used to remove a destination point code from the database, using the `dlt-dstn` command.

The `dlt-dstn` command uses this parameter:

`:dpc/dpca/dpci/dpcn/dpcn24` – The destination point code being removed from the database

Note: See [Point Code Formats](#) for a definition of the point code types that are used on the EAGLE and for a definition of the different formats that can be used for ITU national point codes.

The destination point code to be removed must exist in the database, but cannot be assigned to any routes. Enter the `rtrv-rte` command to see if the destination point code to be removed is assigned to any routes. If the destination point code is assigned to any routes, perform [Removing a Route](#) to remove these routes.

The destination point code cannot be defined as an adjacent point code for a linkset. Enter the `rtrv-ls` to see if the destination point code to be removed is defined as an adjacent point code for a linkset. If the destination point code is defined as an adjacent point code for a linkset, perform [Removing a Linkset Containing SS7 Signaling Links](#).

The destination point code cannot be removed if all of these conditions are present:

- The destination point code is a member of a cluster point code. This is shown by entering the `rtrv-dstn` command and specifying the destination point code with three asterisks (***) for the network cluster member value of the destination point code instead of the actual network cluster value of the destination point code.
- The NCAI value of the cluster point code is no. This is shown by entering the `rtrv-dstn` command and specifying the cluster point code.
- The destination point code is the DPC of an exception route. This is shown by entering the `rtrv-rtx` command and specifying the destination point code that is being removed.

If the destination point code meets these conditions, perform the [Removing a Route Exception Entry](#) procedure to remove the exception route entries that reference the DPC that is being removed.

The destination point code cannot be in the mated relay node (MRN) table. Verify this by entering the `rtrv-mrn` command, specifying the destination point code being removed from the database. If the destination point code is shown in the `rtrv-mrn` command output, remove the point code from the MRN table, by performing the [Removing an MRN Group or MRN Group Entry](#) procedure in *Database Administration - GTT User's Guide*.

The destination point code cannot be in the mated application (MAP) table. Verify this by entering the `rtrv-map` command, specifying the destination point code being removed from the database. If the destination point code is shown in the `rtrv-map` command output, remove the point code from the MAP table, by performing the [Removing a Mated Application](#) procedure in *Database Administration - GTT User's Guide*.

The destination point code cannot be defined as an end office internal point code. Verify this by entering the `rtrv-rmt-appl` command. If the destination point code is shown in the `rtrv-rmt-appl` command output, perform the “Removing an End Node Internal **Point Code**” procedure in *Database Administration - IP7 User's Guide* to remove the internal point code.

If the point code being removed in this procedure is a proxy point code, the proxy point code cannot be removed if the proxy point code is assigned to a destination point code or assigned to a linkset. Proxy point codes are shown in the `rtrv-dstn:dpc=<DPC value>` output with the entry `PRX=yes`. To verify if the proxy point code is assigned to a destination point code, enter the `rtrv-dstn` command with the `ppc` parameter equal to the proxy point code value. This will display all the destination point codes that reference the proxy point code. These destination point codes must be removed before the proxy point code can be removed.

To verify if the proxy point code is assigned to a linkset, enter the `rtrv-ls` command with the `ppc` parameter equal to the proxy point code value. This will display all the linksets that reference the proxy point code. These linksets must be removed before the proxy point code can be removed.

Canceling the RTRV-DSTN and RTRV-LS Commands

Because the `rtrv-dstn` and `rtrv-ls` commands used in this procedure can output information for a long period of time, the `rtrv-dstn` and `rtrv-ls` commands can be canceled and the output to the terminal stopped. There are three ways that the `rtrv-dstn` and `rtrv-ls` commands can be canceled:

- Press the F9 function key on the keyboard at the terminal where the `rtrv-dstn` or `rtrv-ls` command was entered
- Enter the `canc-cmd` without the `trm` parameter at the terminal where the `rtrv-dstn` or `rtrv-ls` command was entered
- Enter the `canc-cmd:trm=<xx>`, where `<xx>` is the terminal where the `rtrv-dstn` or `rtrv-ls` command was entered, from another terminal other than the terminal where the `rtrv-dstn` or `rtrv-ls` command was entered. To enter the `canc-cmd:trm=<xx>` command, the terminal must allow Security Administration commands to be entered from it and the user must be allowed to enter Security Administration commands. The terminal's permissions can be verified with the `rtrv-secu-trm` command. The user's permissions can be verified with the `rtrv-user` or `rtrv-secu-user` commands.

For more information about the `canc-cmd` command, go to *Commands User's Guide*.

1. Display the current destination point codes, using the `rtrv-dstn` command.

This is an example of the possible output.

```
rlghncxa03w 10-12-17 16:02:05 GMT EAGLE5 43.0.0
Extended Processing Time may be Required

DPCA          CLLI          BEI ELEI     ALIASI          ALIASN/N24     DMN
000-005-000   ----- yes --- -----             -----      SS7
000-007-000   ----- yes --- -----             -----      SS7
001-001-001   ----- yes --- -----             -----      SS7
001-001-002   ----- yes --- -----             -----      SS7
001-207-000   ----- yes --- -----             -----      SS7
002-002-002   ----- yes --- -----             -----      SS7
002-004-100   ----- yes --- -----             -----      SS7
003-003-003   ----- yes --- -----             -----      SS7
```

```

004-004-004 ----- yes --- ----- SS7
007-*-* ----- yes --- ----- SS7
007-007-007 ----- yes --- ----- SS7
008-001-001 ----- yes --- ----- SS7
008-001-003 ----- yes --- ----- SS7
008-001-004 ----- yes --- ----- SS7
008-001-005 ----- yes --- ----- SS7
008-001-006 ----- yes --- ----- SS7
008-001-007 ----- yes --- ----- SS7
008-001-008 ----- yes --- ----- SS7
030-045-* rlgghncbb010 yes yes ----- SS7
111-011-* rlgghncbb000 yes yes ----- SS7
240-012-* rlgghncbb000 yes yes ----- SS7
240-012-004 rlgghncbb001 yes --- 1-111-1 10-13-9-3-fr SS7
240-012-005 rlgghncbb002 yes --- 1-112-2 10-13-10-0-ge SS7
240-012-006 rlgghncbb003 yes --- 1-112-3 10-13-10-1-fr SS7
240-012-007 ----- yes --- 1-117-3 10-13-11-1-fr SS7
240-012-008 ----- yes --- 1-113-5 10-13-10-2-ge SS7

```

```

DPCI      CLLI      BEI  ELEI  ALIASA      ALIASN/N24  DMN
0-015-0   ----- no --- ----- SS7
0-017-0   ----- no --- ----- SS7
1-011-1   ----- no --- ----- SS7
1-011-2   ----- no --- ----- SS7
1-207-0   ----- no --- ----- SS7
2-131-1   rlgghncbb023 no --- 222-210-000 11-11-8-1-ge SS7
2-131-2   ----- no --- 222-211-001 11-11-8-2-fr SS7
2-131-3   ----- no --- 222-211-002 11-11-8-3-ge SS7
3-003-3   ----- no --- ----- SS7
4-163-5   ----- no --- 250-200-007 ----- SS7

```

```

DPCN      CLLI      BEI  ELEI  ALIASA      ALIASI      DMN
7-9-10-1-fr ----- no --- 210-090-100 1-75-6      SS7
7-9-10-1-ge ----- no --- 210-100-100 2-175-6     SS7
10-12-0-0-fr ----- no --- ----- SS7
10-15-2-3-fr rlgghncbb013 no --- 222-200-200 2-121-1     SS7
10-15-2-3-ge rlgghncbb013 no --- 222-100-200 2-100-1     SS7
10-15-3-0-fr rlgghncbb013 no --- 222-200-201 2-121-2     SS7
10-15-3-0-ge rlgghncbb013 no --- 222-100-201 2-100-2     SS7

```

```

DESTINATION ENTRIES ALLOCATED: 2000
  FULL DPC(s):                  38
  EXCEPTION DPC(s):             3
  NETWORK DPC(s):               1
  CLUSTER DPC(s):              3
  TOTAL DPC(s):                 45
  CAPACITY (% FULL):            2%
ALIASES ALLOCATED:              8000
  ALIASES USED:                 29
  CAPACITY (% FULL):            1%
X-LIST ENTRIES ALLOCATED:      500
RTRV-DSTN: MASP A - COMPLTD

```

If a quantity of proxy point codes is enabled, the number of proxy point codes that are provisioned in the database are shown at the end of the `rtrv-dstn` output as shown in this example.

```

DESTINATION ENTRIES ALLOCATED: 2000
  FULL DPC(s):                  38
  EXCEPTION DPC(s):             3

```

```

NETWORK DPC(s):          1
CLUSTER DPC(s):         3
Proxy DPC (s):          2
TOTAL DPC(s):           47
CAPACITY (% FULL):      2%
ALIASES ALLOCATED:      8000
ALIASES USED:           29
CAPACITY (% FULL):      1%
X-LIST ENTRIES ALLOCATED: 500
RTRV-DSTN: MASP A - COMPLTD
    
```

2. Verify whether or not the **DPC** to be removed from the database is a DPC of a route, by entering the `rtrv-rte` command with the DPC that is to be removed from the database. For this example, enter these commands.

```
rtrv-rte:dpca=240-012-007
```

This is an example of the possible output.

```

rlghncxa03w 07-05-17 16:02:05 GMT EAGLE5 37.0.0

      DPCA          ALIASI          ALIASN/N24  LSN          RC          APCA
      240-012-007    1-117-3      10-13-11-1-fr  ls04         10          240-012-007
                                          ls02         20          004-004-004
                                          ls03         30          003-003-003
                                          RTX:No      CLLI=ls04c1li
    
```

```
rtrv-rte:dpca=002-002-002
```

```

rlghncxa03w 07-05-17 16:02:05 GMT EAGLE5 37.0.0

      DPCA          ALIASI          ALIASN/N24  LSN          RC          APCA
      002-002-002    -----
                                          ls20         10          002-002-002
                                          RTX:No      CLLI=-----
    
```

If the DPC being removed from the database is a DPC of a route, perform the [Removing a Route](#) procedure to remove the route from the database.

3. Verify whether or not the DPC to be removed from the database is an **APC** of a linkset, by entering the `rtrv-ls` command. This is an example of the possible output.

```

rlghncxa03w 07-05-10 11:43:04 GMT EAGLE5 37.0.0

                                L3T SLT                                GWS GWS GWS
LSN          APCA  (SS7)  SCRN SET SET BEI LST LNKS ACT MES DIS SLSCI NIS
ele2         001-207-000  none 1 1 no B 6 off off off no off
ls1305       000-005-000  none 1 1 no A 1 off off off no off
ls1307       000-007-000  none 1 1 no A 1 off off off no off
elm1s1       001-001-001  none 1 1 no A 7 off off off no off
elm1s2       001-001-002  none 1 1 no A 7 off off off no off
ls01         002-004-100  none 1 1 no A 1 off off off no off
ls20         002-002-002  none 1 1 no PRX 1 off off off no off

                                L3T SLT                                GWS GWS GWS
LSN          APCI  (SS7)  SCRN SET SET BEI LST LNKS ACT MES DIS SLSCI NIS
ele2i        1-207-0      none 1 1 no B 4 off off off --- on
ls1315       0-015-0      none 1 1 no A 1 off off off --- off
ls1317       0-017-0      none 1 1 no A 1 off off off --- on
elm2s1       1-011-1      none 1 1 no A 7 off off off --- off
    
```



```
elm2s2      1-011-2      none 1  1  no  A  7  off off off ---  off
```

Link set table is (11 of 1024) 1% full.

Perform the [Removing a Linkset Containing SS7 Signaling Links](#) procedure to remove the linkset from the database.

4. Verify that the **GTT** feature is on, by entering the `rtrv-feat` command. If the GTT feature is on, the GTT field should be set to on.

Note: The `rtrv-feat` command output contains other fields that are not used by this procedure. If you wish to see all the fields displayed by the `rtrv-feat` command, see the `rtrv-feat` command description in *Commands User's Guide*.

If the GTT feature is off, continue the procedure with [8](#).

If the GTT feature is on, continue the procedure with [5](#).

5. Display the mated applications in the database, using the `rtrv-map` command and the DPC being removed from the database. For this example, enter these commands.

```
rtrv-map:pca=244-012-007
```

This is an example of the possible output.

```
rlghncxa03w 10-07-25 09:42:31 GMT EAGLE5 42.0.0
```

```
PCA          Mate PCA      SSN RC MULT SRM MRC GRP NAME SSO
244-012-007          252 10  SOL *N  *N  GRP01  OFF
```

```
MAP TABLE IS (5 of 1024) 1 % FULL
```

```
rtrv-map:pca=002-002-002
```

This is an example of the possible output.

```
rlghncxa03w 10-07-25 09:42:31 GMT EAGLE5 42.0.0
```

```
PCA          Mate PCA      SSN RC MULT SRM MRC GRP NAME SSO
002-002-002          254 10  SOL *N  *N  GRP01  OFF
```

```
MAP TABLE IS (5 of 1024) 1 % FULL
```

If the DPC is shown in the `rtrv-map` command output (in the PCA, PCI, PCN, PCN24, MPCA, MPC1, MCPN, or MPCN24 fields), go to the "Removing a Mated Application" procedure in *Database Administration - GTT User's Guide*, and remove the remove the point code from the mated application that references the DPC.

If no entries are shown in the `rtrv-map` output, or the "Removing a Mated Application" procedure was performed in this step, continue the procedure with [6](#).

6. Verify that the **IGTTLS** feature is enabled, by entering the `rtrv-ctrl-feat` command with the IGTTLS part number. Enter this command.

```
rtrv-ctrl-feat:partnum=893006901
```

The following is an example of the possible output.

```
rlghncxa03w 07-05-28 21:15:37 GMT EAGLE5 37.0.0
The following features have been permanently enabled:
```

Feature Name	Partnum	Status	Quantity
Intermed GTT Load Sharing	893006901	on	----

```
The following features have been temporarily enabled:
Feature Name          Partnum    Status    Quantity    Trial Period Left
```

```
Zero entries found.
The following features have expired temporary keys:
```

Feature Name	Partnum
Zero entries found.	

- If the `rtrv-ctrl-feat` output in 6 shows that the IGTTLS feature is not enabled, continue the procedure with 8.
 - If the `rtrv-ctrl-feat` output in 6 shows that the IGTTLS feature is enabled, continue the procedure with 7.
7. Verify whether or not the DPC is in the mated relay node table using the `rtrv-mrn` command, specifying the destination point code being removed from the database. For this example, enter these commands.

```
rtrv-mrn:pca=244-012-007
```

This is an example of the possible output.

```
rlghncxa03w 09-05-07 00:34:31 GMT EAGLE5 41.0.0
```

PC	RC
007-007-007	10
008-001-001	20
240-012-007	30
008-001-003	40
008-001-004	50
008-001-005	60
008-001-006	70
008-001-007	80
008-001-008	90

```
MRN table is (39 of 3000) 1% full.
```

```
rtrv-mrn:pca=002-002-002
```

This is an example of the possible output.

```
rlghncxa03w 10-07-07 00:34:31 GMT EAGLE5 42.0.0
```

PC	RC
002-002-002	10
009-001-001	20
009-001-003	40
009-001-004	50
009-001-005	60

```

009-001-006    70
009-001-007    80
009-001-008    90

```

MRN table is (39 of 3000) 1% full.

If the destination point code is shown in the `rtrv-mrn` command output, remove the point code from the MRN table, by executing the "Removing an MRN Group or MRN Group Entry" procedure in *Database Administration - GTT User's Guide*.

8. Verify whether or not the DPC is defined as an end office internal point code using the `rtrv-rmt-appl` command. This is an example of the possible output.

```

rlghncxa03w 09-05-28 09:12:36 GMT EAGLE5 41.0.0
IPCA          SI SSN
003-003-003   3 100, 110-119, 200
               5

IPCI          SI SSN
3-003-3       3 5, 50-100, 250
               5

IPCN          SI SSN
10-12-0-0-fr  3 250
               5

IPCN24        SI SSN

```

If the destination point code is shown in the `rtrv-rmt-appl` command output, go to the "Removing an End Node Internal Point Code" procedure in *Database Administration - IP7 User's Guide* to remove the internal point code.

9. If the point code being removed in this procedure is a proxy point code, the proxy point code cannot be removed if the proxy point code is assigned to a destination point code or assigned to a linkset. Proxy point codes are shown in the `rtrv-dstn` output with the entry `PRX=yes`.
 - a. If the number of proxy point codes is not shown in `rtrv-dstn` output in 1, there are no proxy codes in the database. Continue the procedure with 15. Continue the procedure by performing one of these steps.

Continue the procedure with 15 if the destination point code is not an ANSI point code.

Continue the procedure with 12 if the destination point code is an ANSI point code.

- b. If the number of proxy point codes are shown in `rtrv-dstn` output in 1, verify whether or not the DPC being removed is a proxy point code. Display the DPC being removed in this procedure using the `rtrv-dstn` command specifying the point code being removed. For this example, enter this command.

```
rtrv-dstn:dpca=002-002-002
```

This is an example of the possible output.

```
rlghncxa03w 10-12-28 21:16:37 GMT EAGLE5 43.0.0
```

```

DPCA          CLLI          BEI ELEI  ALIASI          ALIASN/N24  DMN
002-002-002  ----- no  --- -----  -----  SS7

PPCA          NCAI PRX      RCAUSE NPRST SPLITIAM HMSMSC HMSCP SCCPMSGCNV
-----  ---- yes      15    on   17        no    no    none

DESTINATION ENTRIES ALLOCATED:  2000
FULL DPC(s):                    38
EXCEPTION DPC(s):                3
NETWORK DPC(s):                  1
CLUSTER DPC(s):                  3
Proxy DPC (s):                   2
TOTAL DPC(s):                    47
CAPACITY (% FULL):               2%
ALIASES ALLOCATED:                8000
ALIASES USED:                     29
CAPACITY (% FULL):                1%
X-LIST ENTRIES ALLOCATED:        500
RTRV-DSTN: MASP A - COMPLTD

```

- If the DPC is a proxy point code, shown by the value YES in the PRX column, continue the procedure with 10.
- If the DPC is not a proxy point code, continue the procedure with 15. continue the procedure by performing one of these steps.
 - Continue the procedure with 15 if the destination point code is not an ANSI point code.
 - Continue the procedure with 12 if the destination point code is an ANSI point code.

10. Display the linksets in the database that have the proxy point code assigned to them by entering the `rtrv-ls` command with the `ppc` parameter. The `ppc` parameter value is the proxy point code being removed in this procedure. For this example, enter this command.

```
rtrv-ls:ppc=002-002-002
```

This is an example of the possible output.

```

rlghncxa03w 07-05-28 21:16:37 EDT EAGLE5 37.0.0

PPCA = 002-002-002

LSN          APCA   (SS7)  SCRN SET SET BEI LST LNKS ACT MES DIS SLSCI
NIS
ls1305       000-005-000  none 1  1  no  A  1  off off off no  off
elmls2       001-001-002  none 1  1  no  A  7  off off off no  off

```

Link set table is (10 of 1024) 1% full.

The linksets displayed in this step have the proxy point code assigned to them. Perform the [Removing a Linkset Containing SS7 Signaling Links](#) procedure to remove these linksets. After the linksets have been removed, continue the procedure with 11.

If no linksets are displayed in this step, then no linksets have the proxy point code assigned to them. Continue the procedure with 11.

11. Display the point codes in the database that have the proxy point code assigned to them by entering the `rtrv-dstn` command with the `ppc` parameter. The `ppc` parameter value is the proxy point code being removed in this procedure. For this example, enter this command.

```
rtrv-dstn:ppc=002-002-002
```

This is an example of the possible output.

```
rlghncxa03w 09-05-28 21:16:37 EDT EAGLE5 41.0.0
```

```
PPCA = 002-002-002
```

DPCA	CLLI	BEI	ELEI	ALIASI	ALIASN/N24	DMN
000-005-000	-----	no	---	-----	-----	SS7
001-001-002	-----	no	---	-----	-----	SS7

```
Destination table is (42 of 2000) 2% full
```

```
Alias table is (29 of 8000) 1% full
```

```
PPC table is (2 of 10) 10% full
```

If no point codes are displayed in this step, then no point codes have the proxy point code assigned to them. Continue the procedure with 15. Continue the procedure by performing one of these steps.

- Continue the procedure with 15 if the destination point code is not an ANSI point code.
- Continue the procedure with 12 if the destination point code is an ANSI point code.

If point codes are displayed in this step, these point codes have the proxy point code assigned to them. Remove these point codes by entering the `dlt-dstn` with the point code value shown in the `rtrv-dstn` output.

For this example, enter these commands.

```
dlt-dstn:dpca=000-005-000
```

```
dlt-dstn:dpca=001-001-002
```

When the `dlt-dstn` command has successfully completed, and the Cluster Routing and Management Diversity feature is turned off (`CRMD = off` in the `rtrv-feat` command output), this message should appear.

```
rlghncxa03w 09-05-17 15:35:05 GMT EAGLE5 41.0.0
```

```
Destination table is (40 of 2000) 2% full
```

```
PPC table is (2 of 10) 20% full
```

```
DLT-DSTN: MASP A - COMPLTD
```

If the Cluster Routing and Management Diversity feature is turned on (`CRMD = on` in the `rtrv-feat` command output), this is an example of the message that should appear when the `dlt-dstn` command has successfully completed.

```
rlghncxa03w 09-05-17 15:35:05 GMT EAGLE5 41.0.0
```

```
DESTINATION ENTRIES ALLOCATED: 2000
```

```
FULL DPC(s): 36
```

```
EXCEPTION DPC(s): 3
```

```
NETWORK DPC(s): 1
```

```

CLUSTER DPC(s):          3
Proxy DPC (s)           2
TOTAL DPC(s):          45
CAPACITY (% FULL):      2%
ALIASES ALLOCATED:      8000
ALIASES USED:           29
CAPACITY (% FULL):      1%
X-LIST ENTRIES ALLOCATED: 500
RTRV-DSTN: MASP A - COMPLTD
    
```

After the point codes have been removed, continue the procedure with 15. continue the procedure by performing one of these steps.

- Continue the procedure with 15 if the destination point code is not an ANSI point code.
- Continue the procedure with 12 if the destination point code is an ANSI point code.

12. Verify whether or not the destination point code is a member of a cluster point code by entering the `rtrv-dstn` command with these parameters and values.

- The `dpca` parameter containing the network and cluster values of the destination point code.
- Three asterisks (***) for the network-cluster member value of the point code.

For this example, enter these commands.

```
rtrv-dstn:dpca=240-012-***
```

This is an example of the possible output.

```

rlghncxa03w 10-12-17 16:00:32 GMT EAGLE5 43.0.0
DPCA          CLLI          BEI ELEI  ALIASI          ALIASN/N24  DMN
240-012-*     rlghncbb000 yes yes  -----          -----  SS7
240-012-004   rlghncbb001 yes ---   1-111-1          10-13-9-3-fr SS7
240-012-005   rlghncbb002 yes ---   1-112-2          10-13-10-0-ge SS7
240-012-006   rlghncbb003 yes ---   1-112-3          10-13-10-1-fr SS7
240-012-007   ----- yes ---   1-117-3          10-13-11-1-fr SS7
240-012-008   ----- yes ---   1-113-5          10-13-10-2-ge SS7
    
```

```

Destination table is (45 of 2000) 2% full
Alias table is (29 of 8000) 1% full
    
```

```
rtrv-dstn:dpca=002-002-***
```

This is an example of the possible output.

```

rlghncxa03w 10-12-17 16:00:32 GMT EAGLE5 43.0.0
DPCA          CLLI          BEI ELEI  ALIASI          ALIASN/N24  DMN
002-002-002   ----- yes ---  -----          -----  SS7
    
```

```

Destination table is (45 of 2000) 2% full
Alias table is (29 of 8000) 1% full
    
```

Continue the procedure by performing one of these steps.

- Continue the procedure with 15 if the destination point code is not a member of the cluster point code.

- Continue the procedure with [13](#) if the destination point code is a member of a cluster point code.
- 13.** Display the attributes of the cluster point code shown in [12](#) by entering the `rtrv-dstn` command with the cluster point code shown in [12](#).

For this example, enter this command.

```
rtrv-dstn:dpca=240-012-*
```

This is an example of the possible output.

```
rlghncxa03w 10-12-17 16:00:32 GMT EAGLE5 43.0.0
  DPCA          CLLI          BEI  ELEI  ALIASI          ALIASN/N24  DMN
  240-012-*    rlghncbb000 yes yes -----
                                     ----- SS7

  SPCA          NCAI          RCAUSE NPRST SPLITIAM HMSMSC  HMSCP  SCCPMSGCNV
  ----- no          none   off   none      no     no     none

  Destination table is (45 of 2000) 2% full
  Alias table is (29 of 8000) 1% full
```

Continue the procedure by performing one of these steps.

- Continue the procedure with [15](#) if the NCAI value of the cluster point code is yes.
 - Continue the procedure with [14](#) if the NCAI value of the cluster point code is no.
- 14.** Display the route exception table entries referencing the destination point code by entering the `rtrv-rtx` command with the destination point code that is being removed in this procedure. For this example, enter these commands.

```
rtrv-rtx:dpca=240-012-007
```

This is an example of the possible output.

```
rlghncxa03w 10-12-07 00:34:31 GMT EAGLE5 43.0.0

  DPCA          RTX-CRITERIA          LSN          RC          APC
  240-012-007  OPCA
                    007-007-007          1s01          1          002-004-100

  DESTINATION ENTRIES ALLOCATED:  2000
  FULL DPC(s):                    38
  EXCEPTION DPC(s):                3
  NETWORK DPC(s):                  1
  CLUSTER DPC(s):                  3
  TOTAL DPC(s):                    45
  CAPACITY (% FULL):               1%
  ALIASES ALLOCATED:               8000
  ALIASES USED:                    29
  CAPACITY (% FULL):               1%
  X-LIST ENTRIES ALLOCATED:        500
```

```
rtrv-rtx:dpca=002-002-002
```

This is an example of the possible output.

```
rlghncxa03w 10-12-07 00:34:31 GMT EAGLE5 43.0.0
```

```

DPCA          RTX-CRITERIA          LSN          RC          APC

002-002-002   OPCA
              007-007-007          ls01         1          002-004-100

DESTINATION ENTRIES ALLOCATED:  2000
  FULL DPC(s):                   38
  EXCEPTION DPC(s):               3
  NETWORK DPC(s):                 1
  CLUSTER DPC(s):                 3
  TOTAL DPC(s):                   45
  CAPACITY (% FULL):              1%
ALIASES ALLOCATED:                8000
  ALIASES USED:                   29
  CAPACITY (% FULL):              1%
X-LIST ENTRIES ALLOCATED:        500

```

If the destination point code that is being removed in this procedure is not shown in the `rtrv-rtx` output, continue the procedure with [15](#).

If the destination point code that is being removed in this procedure is shown in the `rtrv-rtx` output, perform the [Removing a Route Exception Entry](#) procedure to remove all the route exception table entries shown in this step. After the exception routes have been removed, continue the procedure with [15](#).

- Remove the destination point code from the database, using the `dlt-dstn` command. For this example, enter these commands.

```
dlt-dstn:dpca=240-012-007
dlt-dstn:dpca=002-002-002
```

When the `dlt-dstn` command has successfully completed, and the Cluster Routing and Management Diversity feature is turned off (`CRMD = off` in the `rtrv-feat` command output), this message should appear.

```
rlghncxa03w 09-05-17 15:35:05 GMT EAGLE5 41.0.0
Destination table is (41 of 2000) 2% full
DLT-DSTN: MASP A - COMPLTD
```

If the Cluster Routing and Management Diversity feature is turned on (`CRMD = on` in the `rtrv-feat` command output), this is an example of the message that should appear when the `dlt-dstn` command has successfully completed.

```
rlghncxa03w 09-05-17 15:35:05 GMT EAGLE5 41.0.0
DESTINATION ENTRIES ALLOCATED:  2000
  FULL DPC(s):                   36
  EXCEPTION DPC(s):               1
  NETWORK DPC(s):                 1
  CLUSTER DPC(s):                 3
  TOTAL DPC(s):                   41
  CAPACITY (% FULL):              2%
ALIASES ALLOCATED:                8000
  ALIASES USED:                   27
  CAPACITY (% FULL):              1%
X-LIST ENTRIES ALLOCATED:        500
DLT-DSTN: MASP A - COMPLTD
```


If a proxy point code quantity is enabled and the Cluster Routing and Management Diversity feature is turned off (shown with the `CRMD = off` entry in the `rtrv-feat` command output), this message should appear.

```
rlghncxa03w 09-05-17 15:35:05 GMT EAGLE5 41.0.0
Destination table is (41 of 2000) 2% full
Alias table is (27 of 12000) 1% full
PPC table is (1 of 10) 10% full
DLT-DSTN: MASP A - COMPLTD
```

If the Cluster Routing and Management Diversity feature is turned on (`CRMD = on` in the `rtrv-feat` command output), and a proxy point code quantity is enabled, this message should appear.

```
rlghncxa03w 09-05-17 15:35:05 GMT EAGLE5 41.0.0
DESTINATION ENTRIES ALLOCATED: 2000
  FULL DPC(s): 33
  EXCEPTION DPC(s): 0
  NETWORK DPC(s): 1
  CLUSTER DPC(s): 2
  Proxy DPC (s) 1
  TOTAL DPC(s): 37
  CAPACITY (% FULL): 2%
ALIASES ALLOCATED: 8000
  ALIASES USED: 27
  CAPACITY (% FULL): 1%
X-LIST ENTRIES ALLOCATED: 500
DLT-DSTN: MASP A - COMPLTD
```

16. Verify the changes using the `rtrv-dstn` command with the `DPC` specified in 15. For this example, enter these commands.

```
rtrv-dstn:dpca=240-012-007
rtrv-dstn:dpca=002-002-002
```

This is an example of the possible output for both of these commands.

```
rlghncxa03w 09-05-17 16:02:05 GMT EAGLE5 41.0.0

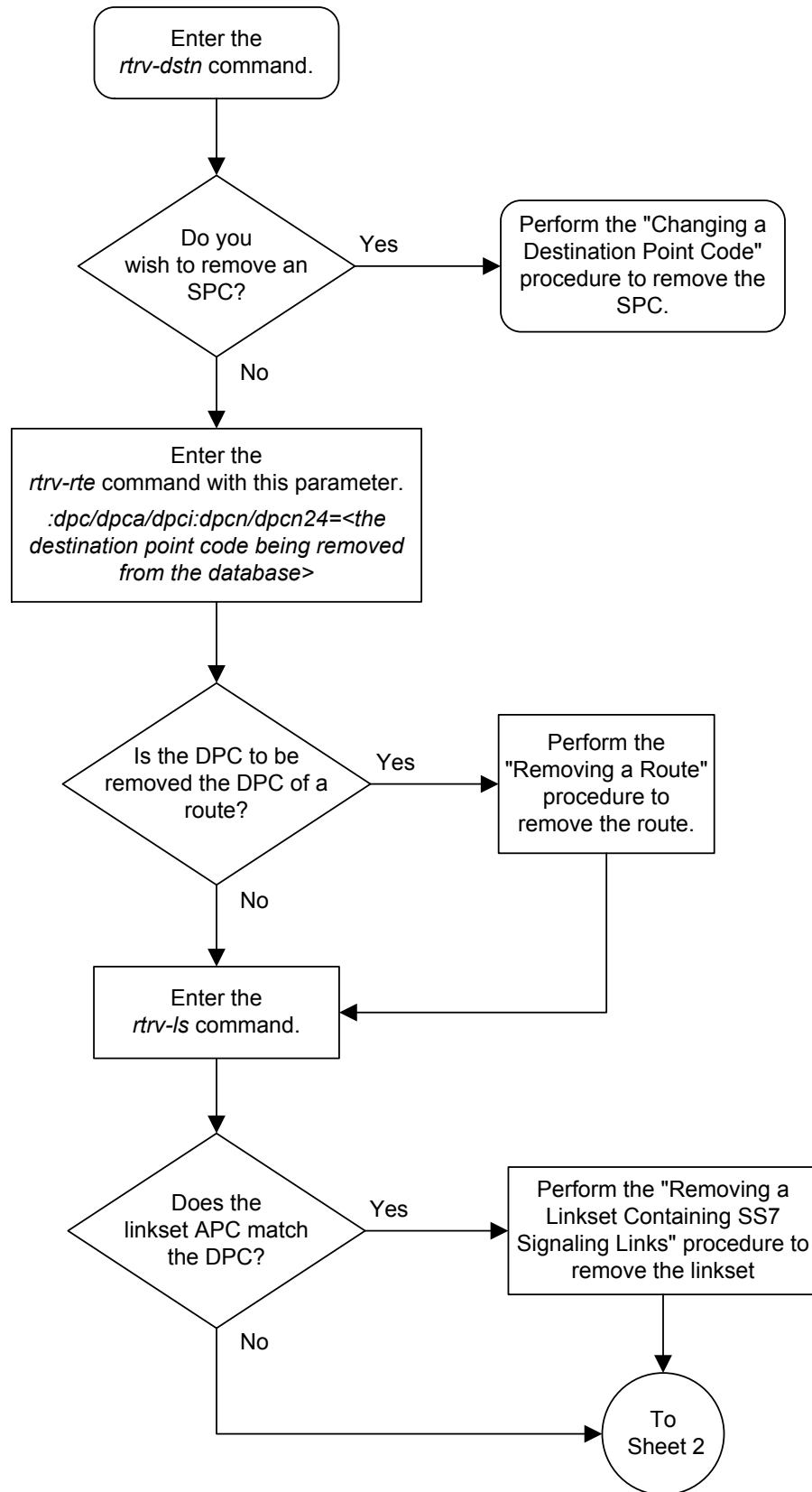
No destinations meeting the requested criteria were found

Destination table is (36 of 2000) 2% full
Alias table is (27 of 8000) 1% full
```

17. Back up the new changes, using the `chg-db:action=backup:dest=fixed` command. These messages should appear; the active **Maintenance and Administration Subsystem Processor (MASP)** appears first.

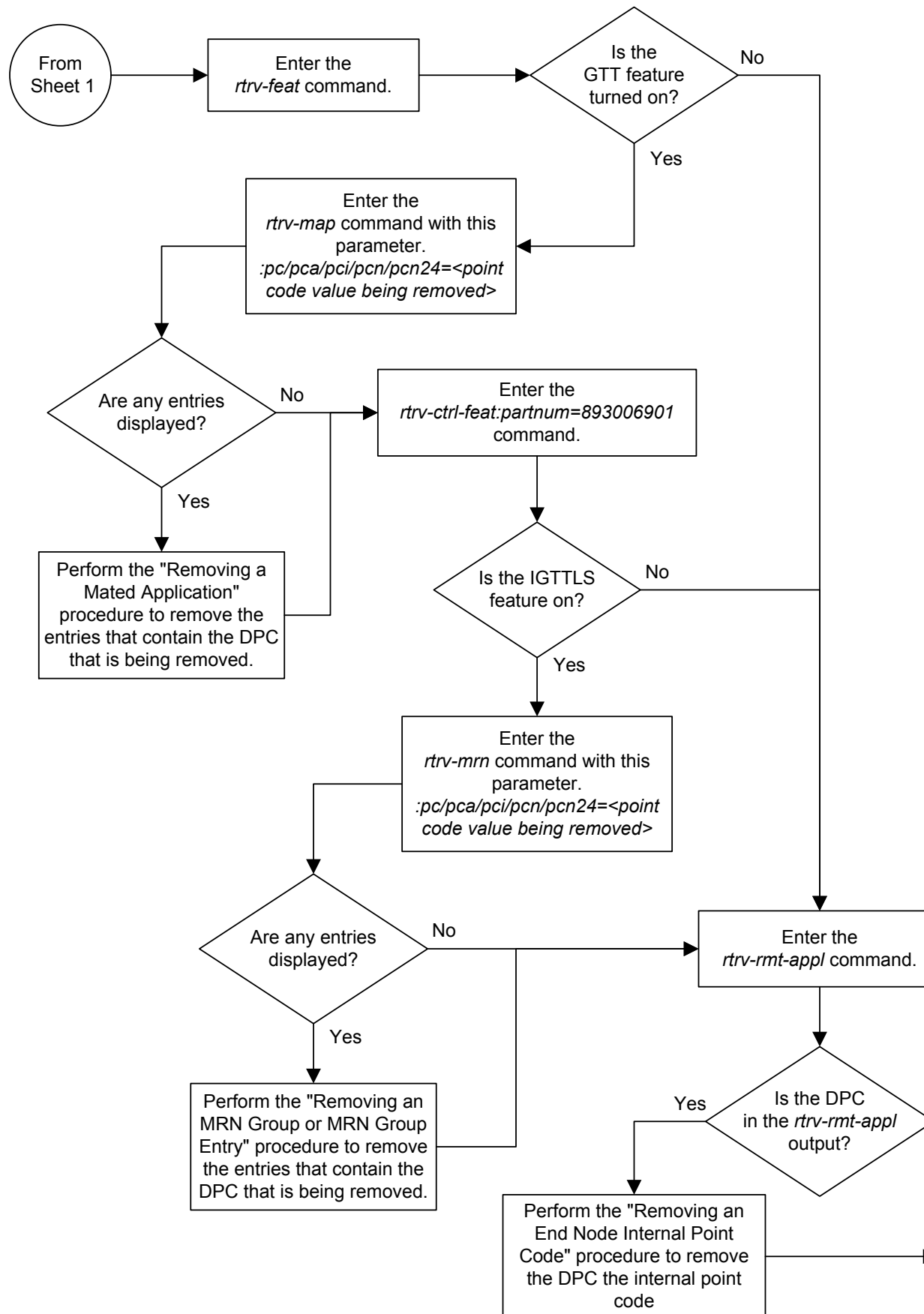
```
BACKUP (FIXED) : MASP A - Backup starts on active MASP.
BACKUP (FIXED) : MASP A - Backup on active MASP to fixed disk complete.
BACKUP (FIXED) : MASP A - Backup starts on standby MASP.
BACKUP (FIXED) : MASP A - Backup on standby MASP to fixed disk complete.
```

Figure 2-31 Removing a Destination Point Code



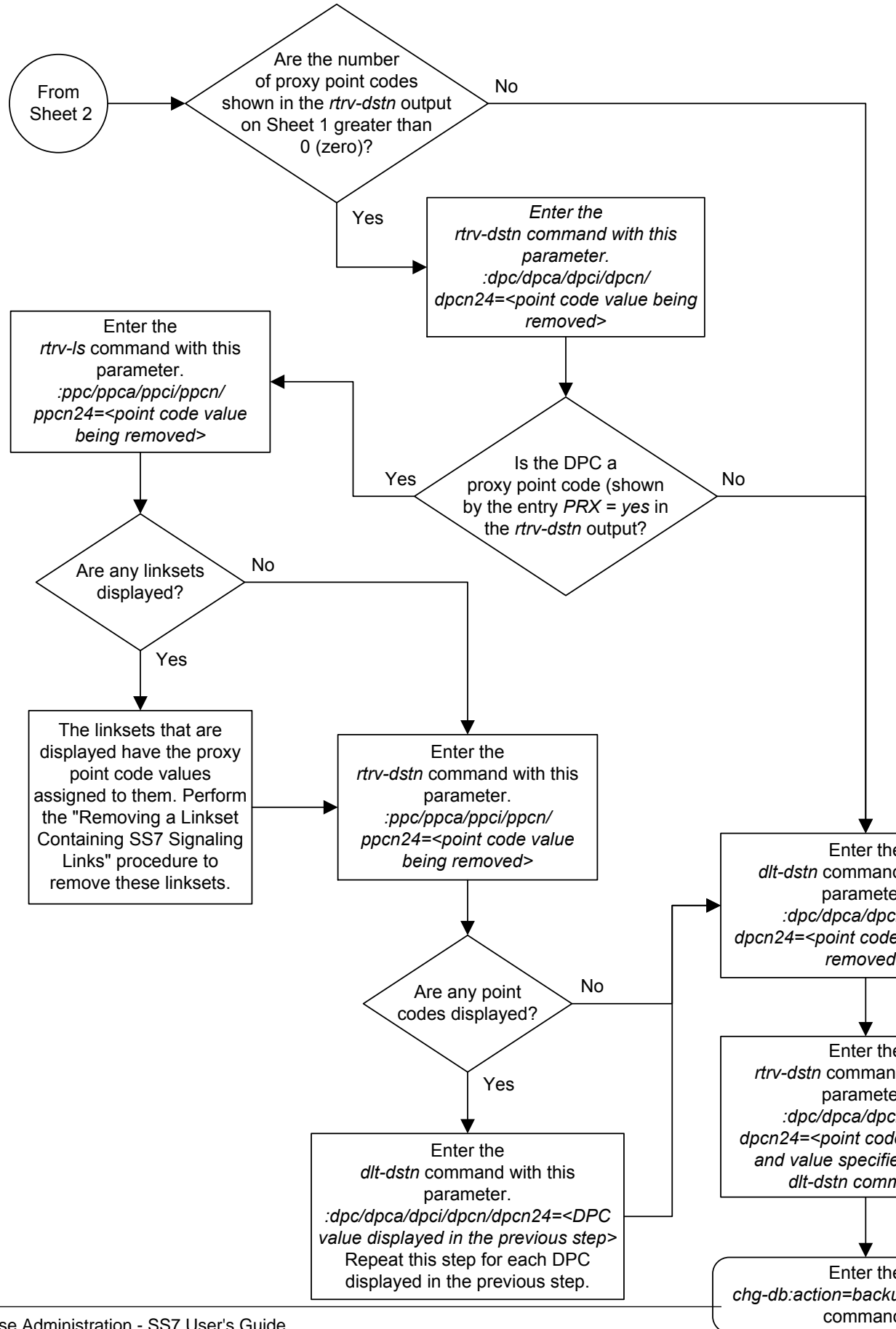
Sheet 1 of 3

Sheet 1 of 4

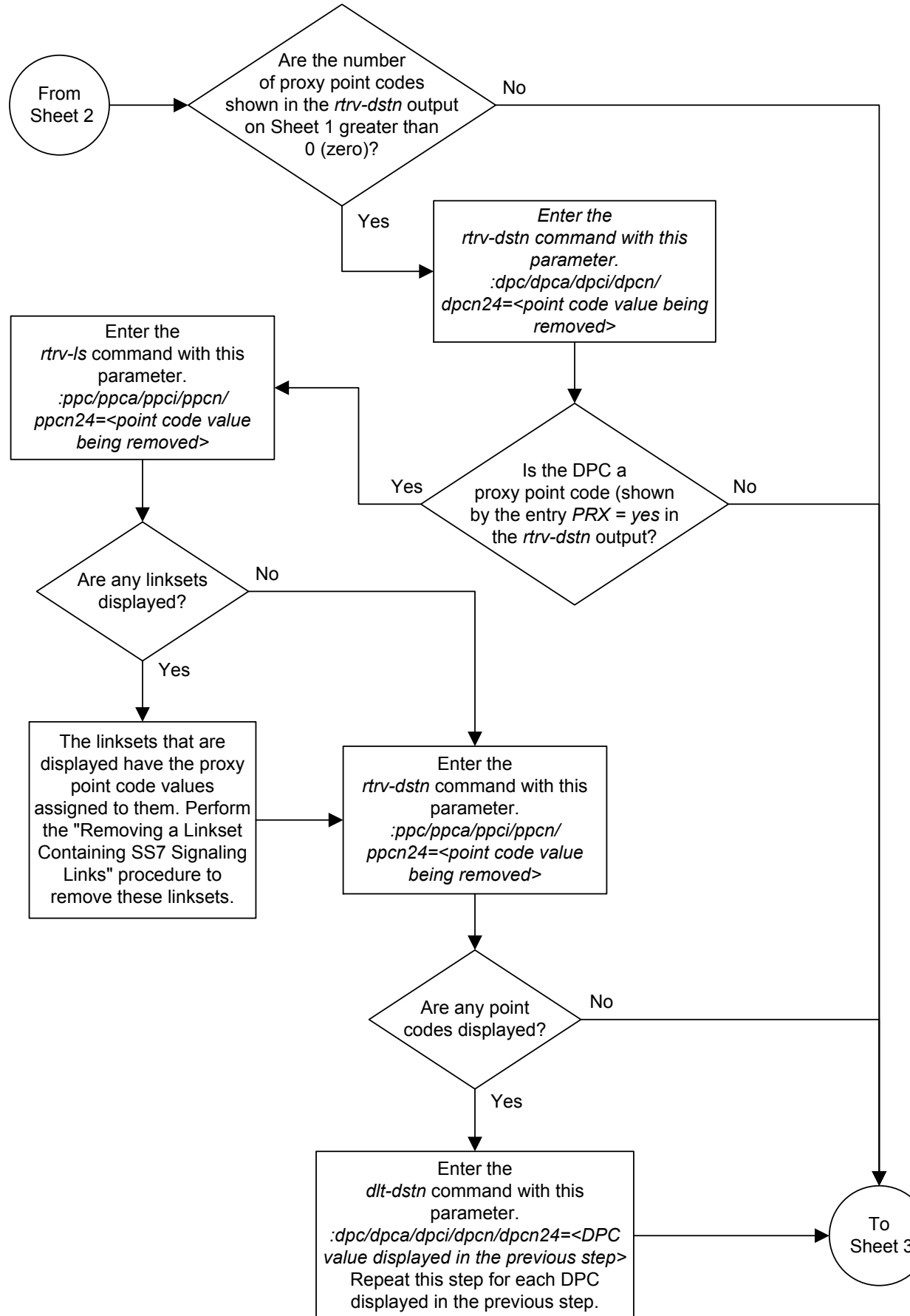


Sheet 2 of 3

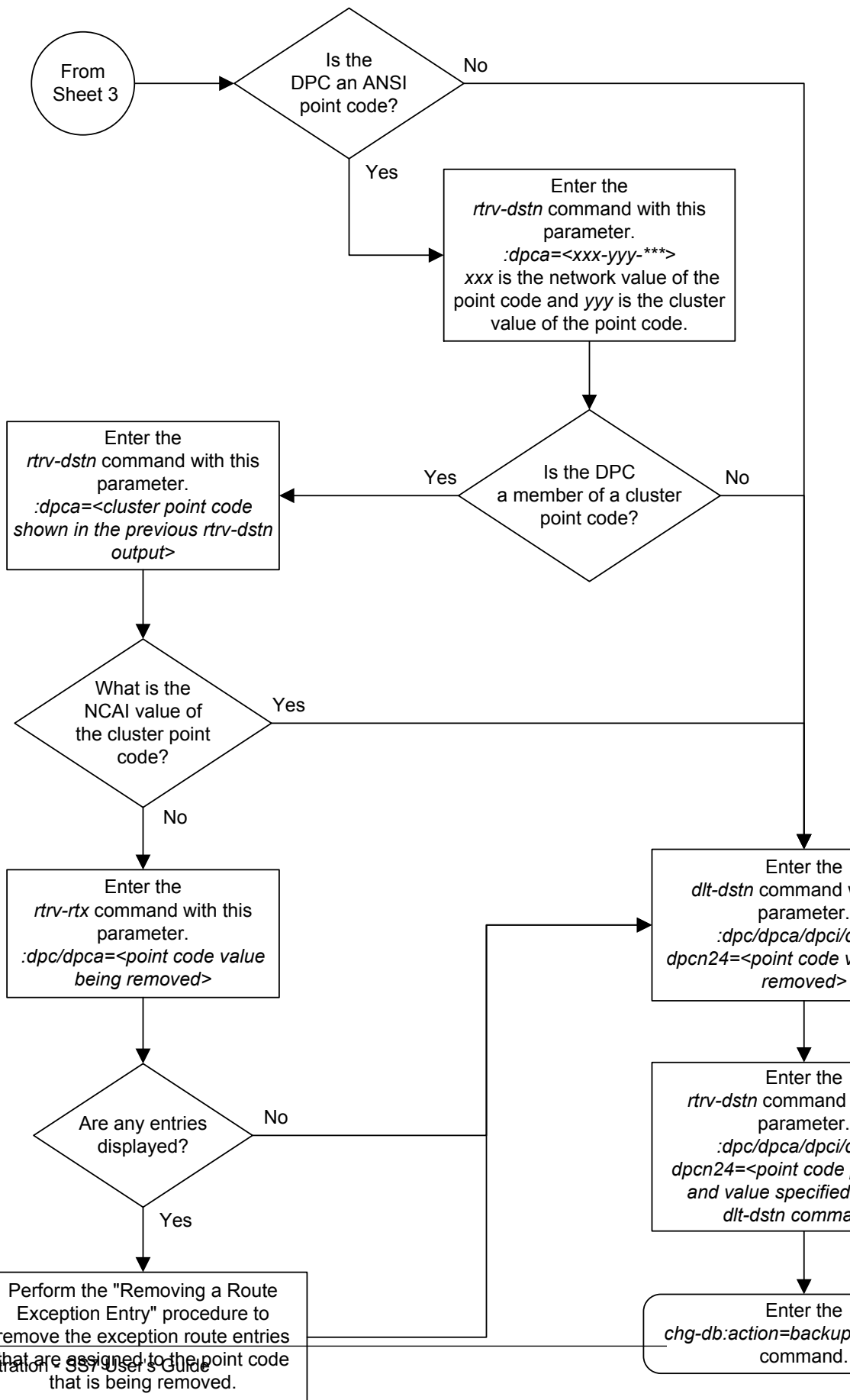
Sheet 2 of 4



Sheet 3 of 3



Sheet 3 of 4



Changing a Destination Point Code

This procedure is used to change the attributes of a full destination point code in the database, using the `chg-dstn` command.

To change the attributes of a cluster point code, go to the [Changing the Attributes of a Cluster Point Code](#) procedure.

This procedure cannot be used to change a true point code (`dpc/dpca/dpci/dpcn/dpcn24`), or a proxy point code value assigned to a DPC. To change a true point code or a proxy point code value assigned to a DPC, the destination point code must be removed, then re-entered. Perform the [Removing a Destination Point Code](#) procedure to remove the point code from the database. To add the new point code, perform one of these procedures:

- Cluster point code – [Adding a Cluster Point Code](#)
- Network routing point code – [Adding a Network Routing Point Code](#)
- All other point codes – [Adding a Destination Point Code](#)

Note: To add a proxy point code, the point code cannot be a cluster point code or a network routing point code.

The destination point code to be changed must be in the database.

The `chg-dstn` command uses these parameters:

`:dpc/dpca/dpci/dpcn/dpcn24` – The destination point code in the database being changed.

`:aliasa/aliasi/aliasn/aliasn24` – The alternate destination point code. Two optional alias addresses can be defined.

Note: See [Point Code Formats](#) for a definition of the point code types that are used on the EAGLE and for a definition of the different formats that can be used for ITU national point codes. A private point code cannot be used as an alias point code.

`:clli` – The **Common Language Location Identifier** assigned to this point code

`:bei` – Broadcast exception indicator that indicates whether transfer-prohibited (TFP) messages will be broadcast from this node. The `bei=yes` parameter means TFPs will not be broadcast. The `bei=no` parameter means TFPs will be broadcast.

`:spc/spca/spci/spcn/spcn24` – The secondary point code as defined by the `ent-spc` command. The secondary point code allows the EAGLE to use another point code in addition to the one defined by the `dpc`, `dpca`, `dpci`, `dpcn`, or `dpcn24` parameters of the `chg-dstn` command for SS7 routing purposes. See the [Multiple Point Code Support](#) section for more information on secondary point codes. A private point code cannot be used as a secondary point code.

`:prx` – This parameter specified whether or not the destination point code is proxy point code. This parameter has two values, `yes` or `no`. If the `prx` parameter value is `yes`, the destination point code is a proxy point code. If the `prx` parameter value is `no`,

the destination point code is not a proxy point code. To specify the `prx=yes` parameter, the destination point code value must be a full point code, in the SS7 domain, and cannot be a private point code. The destination point code value cannot have the `ipgwapc=yes` parameter value assigned.

To specify the `prx=no` parameter, the proxy point code cannot be assigned to a destination point code or assigned to a linkset. Proxy point codes are shown in the `rtrv-dstn:dpc=<DPC being changed>` output with the entry `PRX=yes`. To verify if the proxy point code is assigned to a destination point code, enter the `rtrv-dstn` command with the `ppc` parameter equal to the proxy point code value. This will display all the destination point codes that reference the proxy point code. These destination point codes must be removed before the `prx=no` parameter can be specified..

To verify if the proxy point code is assigned to a linkset, enter the `rtrv-ls` command with the `ppc` parameter equal to the proxy point code value. This will display all the linksets that reference the proxy point code. These linksets must be removed before the proxy point code can be removed.

`:nprst` - NM bits reset. This parameter specifies whether the NM bits in an ITU IAM message should be set to 00. This parameter has two values.

- `off` - Do not set NM bits to 00 in an ITU IAM message if the `nptype` option value in the `rtrv-tifopts` output is `nm`.
- `on` - Set the NM bits to 00 in an ITU IAM message if the `nptype` option value in the `rtrv-tifopts` output is `nm`.

The default value for this parameter is `off`.

`:rcause` - Release cause. This parameter specifies the condition that triggers the sending of a Release message. This parameter has these values.

- 0 - 127
- `none` - use the values specified for the `rcausenp` and `rcausepfx` parameters in the `rtrv-tifopts` output.

The default value for this parameter is `none`.

If the `rlcopc` parameter value in the `rtrv-tifopts` output is `on` and a value of 0-127 is specified for the `rcause` parameter, then the `rcause` parameter value overrides the values specified for the `rcausenp` and `rcausepfx` parameters in the `rtrv-tifopts` output.

`:splitiam` - This parameter specifies how and when to split an ITU IAM message into one IAM message and one SAM message. This parameter has these values.

- 15-31 - The maximum number of CdPN digits allowed in the IAM message before the splitting occurs. The remaining digits, up to a total of 32, are encoded in the SAM message.
- `none` - the value specified for the `splitiam` parameter in the `rtrv-tifopts` output is used to determine when to split the IAM message.

The default value for this parameter is `none`.

To specify the `nprst` or `rcause` parameters, the TIF Number Portability feature, part number 893018901, must be enabled. To specify the `splitiam` parameter, at least one of these features must be enabled.

- TIF Number Portability - part number 893018901
- TIF SCS Forwarding - part number 893022201
- TIF Simple Number Substitution - part number 893024001
- TIF Additional Subscriber Data - part number 893024501
- TIF Generic Routing Number - part number 893025501

The status of these features is shown in the `rtrv-ctrl-feat` output. Perform the procedures in *TIF - User's Guide* to enable these features.

`:homescp` - This parameter specifies whether the destination point code should be considered a home **SCP** when performing SCCP processing for messages that have no global title address digits (the global title indicator (GTI) is set to zero). This parameter cannot be specified for a cluster point code or a network routing point code. These are the values for this parameter.

- yes- the specified DPC is considered a home SCP.
- no - the specified DPC is not considered a home SCP.

`:homesmsc` - This parameter specifies whether the destination point code (DPC) should be considered a home **SMSC** when performing SCCP processing for messages that have no global title address digits (the global title indicator (GTI) is set to zero). This parameter cannot be specified for a cluster point code or a network routing point code. These are the values for this parameter.

- yes- the specified DPC is considered a home SMSC.
- no - the specified DPC is not considered a home SMSC.

`:sccpmsgcnv` - The `sccpmsgcnv` parameter controls SCCP UDT(S)/XUDT(S) message conversion for the specified destination. This parameter can be specified only if the XUDT UDT Conversion feature is enabled and turned on. The `rtrv-ctrl-feat` output shows the status of the XUDT UDT Conversion feature. If the XUDT UDT Conversion feature is not enabled or turned on, perform the "Activating the XUDT UDT Conversion Feature" procedure in *Database Administration - GTT User's Guide* to enable and turn on the XUDT UDT Conversion feature. This parameter contains these values.

- none - SCCP UDT(S)/XUDT(S) message conversion is not required on messages for the destination.
- udt2xudt - All UDT(S) messages for the destination are converted to XUDT(S) messages.
- xudt2udt - All non-segmented XUDT(S) messages for the destination are converted to UDT(S) messages. Segmented XUDT(S) messages for the destination are not converted to UDT(S) messages.
- sxudt2udt - All segmented and non-segmented XUDT(S) messages for the destination are converted to UDT(S) messages.

The `elei` and `ncai` parameters cannot be specified in this procedure. To use these parameters to provision a destination point code, perform the [Changing the Attributes of a Cluster Point Code](#) procedure.

Secondary point codes must be a full point code. A secondary point code can only be assigned to a full point code in the SS7 domain. Secondary point codes cannot be

assigned to DPCs that have proxy point codes assigned to them. The same secondary point code value cannot be assigned to DPCs and to linksets. The network type of the secondary point code must match the network type of the destination point code. The secondary point code used in this procedure must be configured in the database with the `ent-spc` command. The secondary point codes are shown in the `SPCA`, `SPC-I`, `SPC-N`, and `SPC-N24` fields of the `rtrv-spc` command output. If the desired secondary point code is not shown in the output of the `rtrv-spc` command, perform the [Adding a Secondary Point Code](#) procedure to configure the desired point code as a secondary point code.

If a secondary point code is assigned to the destination point code, the group code of the 14-bit ITU-N destination point code must match the group code of the secondary point code. Otherwise, the group code of the destination point code must match the group code assigned to the EAGLE's true 14-bit ITU-N point code, shown in the `PCN` field of the `rtrv-sid` output.

The value `none` for the `spca`, `spci`, `spcn`, or `spcn24` parameters removes the assignment of the current secondary point code and leaves the destination point code without a secondary point code.

The value of the `clli` parameter cannot be in the destination point code table and cannot match the **CLLI** of the EAGLE. Verify this by entering the `rtrv-dstn` and the `rtrv-sid` commands. If the value of the `clli` parameter matches any CLLI values in either of these outputs, choose another value for the `clli` parameter that does not match any CLLIs shown in either of these command outputs.

To enter point codes of any network type (**ANSI**, ITU-I, or ITU-N - 14-bit or 24-bit) into the database with the `chg-dstn` command, the self ID of the EAGLE must be defined for these networks. Verify this with the `rtrv-sid` command.

If a point code value is shown in the `PCA` field of the `rtrv-sid` command, then ANSI point codes can be specified with the `chg-dstn` command.

If a point code value is shown in the `PCI` field of the output of the `rtrv-sid` command, then ITU-I point codes can be specified with the `chg-dstn` command. The `PCI` column of the `rtrv-sid` output can contain spare and non-spare point code values. To provision ITU-I non-spare point codes in this procedure, the `rtrv-sid` output must contain an ITU-I non-spare point code in the `PCI` column. To provision ITU-I spare point codes in this procedure, the `rtrv-sid` output must contain an ITU-I spare point code in the `PCI` column.

If a point code value is shown in the `PCN` field of the output of the `rtrv-sid` command, then 14-bit ITU-N point codes can be specified with the `chg-dstn` command. The `PCN` column of the `rtrv-sid` output can contain spare and non-spare point code values. To provision 14-bit ITU-N non-spare point codes in this procedure, the `rtrv-sid` output must contain a 14-bit ITU-N non-spare point code in the `PCN` column. To provision 14-bit ITU-N spare point codes in this procedure, the `rtrv-sid` output must contain a 14-bit ITU-N spare point code in the `PCN` column.

If a point code value is shown in the `PCN24` field of the output of the `rtrv-sid` command, then 24-bit ITU-N point codes can be specified with the `chg-dstn` command.

If no values are shown in the `PCA`, `PCI`, `PCN`, or `PCN24` fields in the `rtrv-sid` command output, the self-identification of the EAGLE must be updated with an ANSI point code, ITU international point code or a 14-bit ITU national point code. Perform the [Changing the Self-Identification of the EAGLE](#) procedure to change the self-identification of the EAGLE.

Note: The EAGLE can contain 14-bit ITU national point codes or 24-bit ITU national point codes, but both at the same time.

Private point codes cannot be specified in the self-identification of the EAGLE, therefore, private point codes can be added as long as the self identification of the EAGLE contains a point code with the same network type as the private point code being added in this procedure. The ITU National and International **Spare Point Code** Support feature does not have to be enabled to add a private point code.

The type of alias point code that can be provisioned with the `chg-dstn` command is dependent on the type of DPC that is being provisioned. [Table 2-17](#) shows the DPC and alias point type combinations that can be used with the `chg-dstn` command.

Table 2-17 Destination Point Code Type and Alias Point Code Type Combinations

DPC Type	Alias Point Code Type (See Notes 1 - 7)	Alias Point Code Type (See Notes 1 - 7)	DPC TYPE	Alias Point Code Type (See Notes 1 - 7)	Alias Point Code Type (See Notes 1 - 7)
ANSI	no alias specified	no alias specified	ITU-I	no alias specified	no alias specified
	ITU-I	no alias specified		ANSI	no alias specified
	ITU-I	ITU-N		ANSI	ITU-N
	ITU-I	ITU-N Spare		ANSI	ITU-N Spare
	ITU-I	ITU-N24		ANSI	ITU-N24
	ITU-I Spare	no alias specified		ITU-I Spare	no alias specified
	ITU-I Spare	ITU-N		ITU-I Spare	ITU-N
	ITU-I Spare	ITU-N Spare		ITU-I Spare	ITU-N Spare
	ITU-I Spare	ITU-N24		ITU-I Spare	ITU-N24
	ITU-N	no alias specified		ITU-N	no alias specified
	ITU-N Spare	no alias specified		ITU-N (Note 9)	ITU-N Spare (Note 9)
	ITU-N24	no alias specified		ITU-N Spare	no alias specified
	ITU-I Spare	no alias specified		no alias specified	ITU-N
ANSI		no alias specified	no alias specified	no alias specified	
ANSI		ITU-N	ANSI	no alias specified	
ANSI		ITU-N Spare	ANSI	ITU-I	

Table 2-17 (Cont.) Destination Point Code Type and Alias Point Code Type Combinations

DPC Type	Alias Point Code Type (See Notes 1 - 7)	Alias Point Code Type (See Notes 1 - 7)	DPC TYPE	Alias Point Code Type (See Notes 1 - 7)	Alias Point Code Type (See Notes 1 - 7)
	ANSI	ITU-N24		ANSI	ITU-I Spare
	ITU-I	no alias specified		ITU-I	no alias specified
	ITU-I	ITU-N		ITU-I (Note 8)	ITU-I Spare (Note 8)
	ITU-I	ITU-N Spare		ITU-I Spare	no alias specified
	ITU-I	ITU-N24		ITU-N Spare	no alias specified
	ITU-N	no alias specified		ITU-N Spare	ITU-I
	ITU-N (Note 9)	ITU-N Spare (Note 9)		ITU-N Spare	ITU-I Spare
	ITU-N Spare	no alias specified	ITU-N24	no alias specified	no alias specified
	ITU-N24	no alias specified		ANSI	no alias specified
ITU-N Spare	no alias specified	no alias specified		ANSI	ITU-I
	ANSI	no alias specified		ANSI	ITU-I Spare
	ANSI	ITU-I		ITU-I	no alias specified
	ANSI	ITU-I Spare		ITU-I Spare	no alias specified
	ITU-I	no alias specified			
	ITU-I (Note 8)	ITU-I Spare (Note 8)			
	ITU-I Spare	no alias specified			
	ITU-N	no alias specified			
	ITU-N	ITU-I			
	ITU-N	ITU-I Spare			

Table 2-17 (Cont.) Destination Point Code Type and Alias Point Code Type Combinations

DPC Type	Alias Point Code Type (See Notes 1 - 7)	Alias Point Code Type (See Notes 1 - 7)	DPC TYPE	Alias Point Code Type (See Notes 1 - 7)	Alias Point Code Type (See Notes 1 - 7)
Notes:					
1. ANSI alias point codes are specified with the <code>aliasa</code> parameter.					
2. ITU-I and ITU-I Spare alias point codes are specified with the <code>aliasi</code> parameter.					
3. ITU-N and ITU-N Spare alias point codes are specified with the <code>aliasn</code> parameter.					
4. ITU-N24 alias point codes are specified with the <code>aliasn24</code> parameter.					
5. If the alias point code parameter is not specified, the parameter's value is not changed.					
6. If the value <code>none</code> is specified for an alias point code parameter, the current value for that parameter is removed from the DPC.					
7. The new alias point code value replaces the current alias point code value that is assigned to the DPC.					
8. To specify the ITU-I and ITU-I Spare alias point codes for the DPC, both point code values are specified with the <code>aliasi</code> parameter and the values are separated by a comma. For example, to specify the alias point codes 2-005-7 and s-3-002-1, the <code>aliasi</code> parameter is specified like this; <code>aliasi=2-005-7,s-3-002-1</code> . The <code>aliasa</code> and <code>aliasn</code> parameters cannot be specified for the DPC.					
9. To specify the ITU-N and ITU-N Spare alias point codes for the DPC, both point code values are specified with the <code>aliasn</code> parameter and the values are separated by a comma. For example, to specify the alias point codes 00010 and s-00020, the <code>aliasn</code> parameter is specified like this; <code>aliasn=00010,s-00020</code> . The <code>aliasa</code> and <code>aliasi</code> parameters cannot be specified for the DPC.					

Alias point codes can only be specified for full point code entries and must be full point codes.

Destination point codes and alias point codes must be unique in the database. A point code cannot be defined as a true destination point code and an alias point code.

The EAGLE can contain the quantities of alias point codes shown in [Table 2-18](#) depending the features that are enabled or turned on.

Table 2-18 Maximum Alias Point Code Quantities

Feature Status	Maximum Alias Point Code Quantity
The 5000 Routes feature is off and 6000, 7000, 8000, or 10,000 routesets are not enabled	12000
The 5000 Routes feature is on and 6000, 7000, 8000, or 10,000 routesets are not enabled	12000

Table 2-18 (Cont.) Maximum Alias Point Code Quantities

Feature Status	Maximum Alias Point Code Quantity
6000 routesets are enabled	12000
7000 routesets are enabled	8000
8000 routesets are enabled	8000
10,000 routesets are enabled	10000

If either the `dpcn` or `aliasn` parameters are specified with the `chg-dstn` command, the format of the 14-bit ITU-N point code values must match the format shown in the `NPCFMTI` field of the `rtrv-stpopts` command output. For more information, refer to the [14-Bit ITU National Point Code Formats](#) section.

Canceling the RTRV-DSTN Command

Because the `rtrv-dstn` command used in this procedure can output information for a long period of time, the `rtrv-dstn` command can be canceled and the output to the terminal stopped. There are three ways that the `rtrv-dstn` command can be canceled:

- Press the F9 function key on the keyboard at the terminal where the `rtrv-dstn` command was entered
- Enter the `canc-cmd` without the `trm` parameter at the terminal where the `rtrv-dstn` command was entered
- Enter the `canc-cmd:trm=<xx>`, where `<xx>` is the terminal where the `rtrv-dstn` command was entered, from another terminal other than the terminal where the `rtrv-dstn` command was entered. To enter the `canc-cmd:trm=<xx>` command, the terminal must allow Security Administration commands to be entered from it and the user must be allowed to enter Security Administration commands. The terminal's permissions can be verified with the `rtrv-secu-trm` command. The user's permissions can be verified with the `rtrv-user` or `rtrv-secu-user` commands.

For more information about the `canc-cmd` command, refer to *Commands User's Guide*.

1. Display the current destination point codes using the `rtrv-dstn` command.

This is an example of the possible output.

```
rlghncxa03w 10-12-10 11:43:04 GMT EAGLE5 43.0.0
Extended Processing Time may be Required

DPCA          CLI          BEI  ELEI  ALIASI          ALIASN/N24  DMN
007-*-*      -----  yes  ---  -----  -----  SS7
030-045-*    rlghncbb010  yes  yes  -----  -----  SS7
111-011-*    rlghncbb000  yes  yes  -----  -----  SS7
240-012-004  rlghncbb001  yes  ---  1-111-1      10-13-9-3-fr  SS7
240-012-005  rlghncbb002  yes  ---  1-112-2      10-13-10-0-ge  SS7
240-012-006  rlghncbb003  yes  ---  1-112-3      10-13-10-1-fr  SS7
240-012-007  -----  yes  ---  1-117-3      10-13-11-1-fr  SS7
240-012-008  -----  yes  ---  1-113-5      10-13-10-2-ge  SS7

DPCI          CLI          BEI  ELEI  ALIASA          ALIASN/N24  DMN
```

```

2-131-1      rlghncbb023 no --- 222-210-000 11-11-8-1-ge SS7
2-131-2      ----- no --- 222-211-001 11-11-8-2-fr SS7
2-131-3      ----- no --- 222-211-002 11-11-8-3-ge SS7
4-163-5      ----- no --- 250-200-007 ----- SS7

DPCN        CLLI        BEI  ELEI  ALIASA        ALIASI        DMN
7-9-10-1-fr ----- no --- 210-090-100 1-75-6        SS7
7-9-10-1-ge ----- no --- 210-100-100 2-175-6       SS7
10-15-2-3-fr rlghncbb013 no --- 222-200-200 2-121-1       SS7
10-15-2-3-ge rlghncbb013 no --- 222-100-200 2-100-1       SS7
10-15-3-0-fr rlghncbb013 no --- 222-200-201 2-121-2       SS7
10-15-3-0-ge rlghncbb013 no --- 222-100-201 2-100-2       SS7

DESTINATION ENTRIES ALLOCATED: 2000
FULL DPC(s):                    21
EXCEPTION DPC(s):                0
NETWORK DPC(s):                  1
CLUSTER DPC(s):                  2
TOTAL DPC(s):                    24
CAPACITY (% FULL):               1%
ALIASES ALLOCATED:                8000
ALIASES USED:                     29
CAPACITY (% FULL):               1%
X-LIST ENTRIES ALLOCATED:        500
RTRV-DSTN: MASP A - COMPLTD

```

If a quantity of proxy point codes is enabled, the number of proxy point codes that are provisioned in the database are shown at the end of the `rtrv-dstn` output as shown in this example.

```

DESTINATION ENTRIES ALLOCATED: 2000
FULL DPC(s):                    31
EXCEPTION DPC(s):                0
NETWORK DPC(s):                  1
CLUSTER DPC(s):                  2
Proxy DPC (s)                    2
TOTAL DPC(s):                    36
CAPACITY (% FULL):               1%
ALIASES ALLOCATED:                8000
ALIASES USED:                     22
CAPACITY (% FULL):               1%
X-LIST ENTRIES ALLOCATED:        500
RTRV-DSTN: MASP A - COMPLTD

```

This procedure cannot be used to change the DPC value (`dpc/dpca/dpci/dpcn/dpcn24`). To change the DPC value, the destination point code must be removed, then re-entered. Perform the [Removing a Destination Point Code](#) procedure to remove the point code from the database. To add the new point code, perform one of these procedures.

- Cluster point code – [Adding a Cluster Point Code](#)
- Network routing point code – [Adding a Network Routing Point Code](#)
- All other point codes – [Adding a Destination Point Code](#)

If the DPC value is not being changed, continue the procedure with 2.

2. Display all the attributes of the point code being changed, using the `rtrv-dstn` command with either the `dpca`, `dpci`, `dpcn`, or `dpcn24` parameters.

For this example, enter this command.

```
rtrv-dstn:dpca=240-012-007
```

This is an example of the possible output.

```
rlghncxa03w 10-12-28 21:16:37 GMT EAGLE5 43.0.0

      DPCA          CLLI          BEI ELEI  ALIASI          ALIASN/N24  DMN
      240-012-007  ----- yes ---   1-117-3          10-13-11-1-fr SS7

      SPCA          NCAI PRX      RCAUSE NPRST SPLITIAM HMSMSC HMSSCP SCCPMSGCNV
      ----- ---- no          none  off   none    no    no    none

DESTINATION ENTRIES ALLOCATED:    2000
      FULL DPC(s):                21
      EXCEPTION DPC(s):            0
      NETWORK DPC(s):              1
      CLUSTER DPC(s):              2
      TOTAL DPC(s):                24
      CAPACITY (% FULL):           1%
ALIASES ALLOCATED:                8000
      ALIASES USED:                29
      CAPACITY (% FULL):           1%
X-LIST ENTRIES ALLOCATED:         500
RTRV-DSTN: MASP A - COMPLTD
```

If a proxy point code is assigned to the DPC, and you wish to change the proxy point code assigned to the DPC, the DPC must be removed, then re-entered with the new proxy point code value. Perform the [Removing a Destination Point Code](#) procedure to remove the point code from the database. To add the new point code, perform one of these procedures.

- Cluster point code – [Adding a Cluster Point Code](#)
- Network routing point code – [Adding a Network Routing Point Code](#)
- All other point codes – [Adding a Destination Point Code](#)

If a proxy point code is not assigned to the DPC, continue the procedure with 3.

3. To change the attributes of a DPC, these entities must be checked depending on how the attributes of the DPC will be changed. Perform these commands and procedures as required depending on how the attributes of the DPC will be changed.

The type of point code being added, ANSI, ITU-I, ITU-N, ITU-N24 must be shown in the `rtrv-dstn` output or the `rtrv-sid` output. If the point code type is not shown in the `rtrv-dstn` output, perform the `rtrv-sid` command in 4. If the point code type is not shown in the `rtrv-dstn` and `rtrv-sid` outputs, perform the [Adding a Point Code to the Self-Identification of the EAGLE](#) procedure to add a point code of the desired point code type.

If the new point code will be a 14-bit ITU-N point code, and a group code will be assigned to the point code, the group code must be defined in `rtrv-sid` output in 4, `rtrv-dstn` output in 1, or `rtrv-spc` output in 5. If the group code is not shown in either of these outputs, perform the [Adding a Point Code to the Self-Identification of the EAGLE](#) procedure to add an entry with the desired group code. If the group code will be different from the ones shown in the `rtrv-sid` or

`rtrv-dstn` outputs, perform the [Adding a Secondary Point Code](#) procedure to add a secondary point code with the desired group code.

If a secondary point code value will be changed, the new secondary point code must be shown in the `rtrv-spc` output in 5. If the new secondary point code is shown in the `rtrv-spc` output, and the Multiple Linksets to Single Adjacent PC feature is enabled and turned on, the new secondary point code cannot be the secondary point code of a linkset. Enter the `rtrv-ctrl-feat` command in 8 to verify if the Multiple Linksets to Single Adjacent PC feature is enabled and turned on. If the Multiple Linksets to Single Adjacent PC feature is enabled and turned on, enter the `rtrv-ls` command in 6 with the `spc/spca/spci/spcn/spcn24` parameter with the new secondary point code value from the `rtrv-spc` output. If the secondary point code is not shown in the `rtrv-spc` output, perform the [Adding a Secondary Point Code](#) procedure to add the desired secondary point code. The `spc/spca/spci/spcn/spcn24` parameter cannot be specified for a DPC that contains a proxy point code, shown the `PPCA/PPCI/PPCN/PPCN24` field when the individual DPC is displayed.

If the `clli` parameter value will be changed, the new `clli` parameter value cannot be shown in the `rtrv-sid` or `rtrv-dstn` outputs. Enter the `rtrv-sid` command in 4 to verify the CLI value in the self-identification of the EAGLE.

The format of a 14-bit ITU-N point code must match the format defined by the `NPCFMTI` value in the `rtrv-stpopts` output. Enter the `rtrv-stpopts` in 7 to verify the `NPCFMTI` value. If you wish to change the format, perform [14-Bit ITU National Point Code Formats](#).

To specify an alias point code with the DPC, specifying the new alias point code cannot exceed the maximum alias point code quantity shown in the `ALIASES ALLOCATED:` or the `Alias` table row in the `rtrv-dstn` output. If the maximum alias point code quantity will be exceeded, remove enough alias point codes to allow the new alias point code to be added. Enter the `chg-dstn` command with the DPC that contains the alias point code that is being removed and with the `aliasa/aliasi/aliasn/aliasn24=none` parameter. Enter this command as needed to remove the required number of alias point codes.

If the `nprst` or `rcause` parameters will be specified with the DPC, the TIF Number Portability feature must be enabled. If the current `rcause` value is `none` and the current `nprst` value is `off`, enter the `rtrv-ctrl-feat` command in 8 to verify that the feature is enabled. If the feature is not enabled, perform the procedures in *TIF - User's Guide* to enable the TIF Number Portability feature.

If the `splitiam` parameter will be specified with the DPC, at least one of these features must be enabled.

- TIF Number Portability
- TIF SCS Forwarding
- TIF Simple Number Substitution
- TIF Additional Subscriber Data
- TIF Generic Routing Number

If the current `splitiam` value is `none`, enter the `rtrv-ctrl-feat` command in 8 to verify if any of these features are enabled. If none of these features are enabled, perform the procedures in *TIF - User's Guide* to enable one of more of these features.

If the `prx=yes` parameter will be specified with the DPC, the Proxy Point Code feature must be enabled. The addition of the proxy point code with the `prx=yes` parameter cannot exceed the enabled proxy point code quantity, shown in the `PPC table` or `PROXY DPC(s)` row of the `rtrv-dstn` output. Enter the `rtrv-ctrl-feat` command in 8 to verify if a proxy point code quantity is enabled. If a proxy point code quantity is enabled, the Proxy Point Code feature is enabled. To enable the Proxy Point Code feature or increase the proxy point code quantity, perform the [Changing the Proxy Point Code Quantity](#) procedure. The `prx=yes` parameter cannot be specified for the DPC if any of these conditions are present.

- If the enabled quantity is 100 and 100 proxy point codes are in the database.
- If the DPC is a private point code, a cluster point code, a network routing point code, or the adjacent point code of an IPGWx linkset. The private point codes, cluster point codes, and network routing point codes are shown in the `rtrv-dstn` output. Display the linkset with the `rtrv-ls` command in 10, then re-enter the `rtrv-ls` command in 11 with the name of the linkset that has the DPC as its adjacent point code to verify if the linkset is an IPGWx linkset.

If the current `PRX` value is `yes`, the `PRX` value cannot be changed if the DPC is referenced by other point codes as a proxy point code. Enter the `rtrv-dstn` command in 9 with the `ppc/ppca/ppci/ppcn/ppcn24` parameter and the DPC that is being changed to verify if the proxy point code is referenced by other point codes. Perform the [Removing a Destination Point Code](#) procedure to remove the point code that reference the proxy point code.

The `scpmsgcnv` parameter specifies the kind of conversion performed on messages for the specified destination. This parameter can be specified only if the XUDT UDT Conversion feature is enabled and turned on. Enter the `rtrv-ctrl-feat` command in 8 to verify that the XUDT UDT Conversion feature is enabled and turned on. If the XUDT UDT Conversion feature is not enabled or turned on, perform the "Activating the XUDT UDT Conversion Feature" procedure in *Database Administration - GTT User's Guide* to enable and turn on the XUDT UDT Conversion feature.

After the required entities have been verified and provisioned, continue the procedure with 12.

4. Display the EAGLE self-identification, using the `rtrv-sid` command.

This is an example of the possible output.

```
rlghncxa03w 07-05-10 11:43:04 GMT EAGLE5 37.0.0
PCA          PCI          PCN          CLLI          PCTYPE
100-100-100  3-75-7        7-9-8-1-fr   rlghncxa03w  OTHER

CPCA
002-002-002  002-002-003  002-002-004  002-002-005
002-002-006  002-002-007  002-002-008  002-002-009
004-002-001  004-003-003  050-060-070

CPCA (LNP)
005-005-002  005-005-004  005-005-005

CPCI
1-002-1      1-002-2      1-002-3      1-002-4
2-001-1      7-222-7

CPCN
```

```

2-0-10-3-fr      2-0-11-0-fr      2-0-11-2-fr      2-0-12-1-fr
2-2-3-3-fr      2-2-4-0-fr      10-14-10-1-fr

```

5. Display the secondary point codes in the database with the `rtrv-spc` command.

This is an example of the possible output.

```

rlghncxa03w 07-05-17 16:02:05 GMT EAGLE5 37.0.0
SPC (Secondary Point Codes)
SPCA
    001-010-010
    002-010-010
    003-010-010
    010-100-010
SPC-I
    1-253-5
    2-254-6
    3-255-7
    4-100-1
SPC-N
    10-1-11-1-ge
    13-2-12-0-ge
    14-15-12-1-ge
SPC-N24
none
Secondary Point Code table is (11 of 40) 28% full

```

6. A secondary point code cannot be added to a DPC if that secondary point code is assigned to any linksets.

Display the linksets that have the secondary point code assigned to them by entering the `rtrv-ls` command with either the `spc/spca`, `spci`, `spcn`, or `spcn24` parameters.

For this example, enter this command.

```
rtrv-ls:spca=010-100-010
```

This is an example of the possible output.

```

rlghncxa03w 07-05-19 17:06:08 EST 37.5.0

SPCA = 010-100-010

LSN          APCA  (SS7)  SCRN  SET  SET  BEI  LST  LNKS  ACT  MES  DIS  SLSCI
NIS
lsn1         000-007-000  none  1    1    no  PRX  0    off  off  off  no
off
lsn2         001-001-001  none  1    1    no  PRX  0    off  off  off  no
off

Link set table is (11 of 1024) 1% full.

```

7. Display the existing values for the `npcfmt i` parameter by entering the `rtrv-stpopts` command.

The value for the `npcfmt i` parameter is shown in the `NPCFMTI` field. This is an example of the possible output.

```
rlghncxa03w 07-05-17 16:02:05 GMT EAGLE5 37.0.0
```

```
STP OPTIONS
-----
NPCFMTI      4-4-4-2
```

Note: Thertrv-stpopts command output contains other fields that are not used by this procedure. If you wish to see all the fields displayed by thertrv-stpopts command, see thertrv-stpopts command description in *Commands User's Guide*.

8. Display the features that are enabled by entering the rtrv-ctrl-featcommand.

The following is an example of the possible output.

```
rlghncxa03w 07-05-28 21:15:37 GMT EAGLE5 37.0.0
The following features have been permanently enabled:
```

Feature Name	Partnum	Status	Quantity
Command Class Management	893005801	on	----
LNP Short Message Service	893006601	on	----
Intermed GTT Load Sharing	893006901	on	----
XGTT Table Expansion	893006101	on	4000000
XMAP Table Expansion	893007710	on	3000
Large System # Links	893005901	on	1500
Routesets	893006401	on	6000
HC-MIM SLK Capacity	893012707	on	64

The following features have been temporarily enabled:

Feature Name	Partnum	Status	Quantity	Trial Period Left
Zero entries found.				

The following features have expired temporary keys:

Feature Name	Partnum
Zero entries found.	

9. Display the point codes in the database that have the proxy point code assigned to them by entering the rtrv-dstn command with the ppc/ppca/ppci/ppcn/ppcn24 parameter. The ppc/ppca/ppci/ppcn/ppcn24 parameter value is the proxy point code being removed in this procedure. For this example, enter this command.

```
rtrv-dstn:ppca=002-002-002
```

This is an example of the possible output.

```
rlghncxa03w 09-05-28 21:16:37 EDT EAGLE5 41.0.0

DPCA      CLI      BEI  ELEI  ALIASI      ALIASN/N24  DMN
000-005-000  ----- no  --- -----  -----  SS7
PRX = no    PPC =    002-002-002

001-001-002  ----- no  --- -----  -----  SS7
PRX = no    PPC =    002-002-002

Destination table is (11 of 2000) 1% full
Alias table is (0 of 12000) 0% full
PPC table is (2 of 10) 20% full
```


10. Display the linksets in the database by entering the `rtrv-ls` command. This is an example of the possible output.

```
rlghncxa03w 07-05-10 11:43:04 GMT EAGLE5 37.0.0
```

LSN	APCA (SS7)	SCRN	L3T SLT			LST	LNKS	GWS GWS GWS			SLSCI	NIS
			SET	SET	BEI			ACT	MES	DIS		
ele2	001-207-000	none	1	1	no	B	6	off	off	off	no	off
ls1305	000-005-000	none	1	1	no	A	1	off	off	off	no	off
ls1307	000-007-000	none	1	1	no	A	1	off	off	off	no	off
elm1s1	001-001-001	none	1	1	no	A	7	off	off	off	no	off
elm1s2	001-001-002	none	1	1	no	A	7	off	off	off	no	off
lsn10	240-012-007	none	1	1	no	A	1	off	off	off	no	off
ls20	002-002-002	none	1	1	no	PRX	1	off	off	off	no	off

LSN	APCI (SS7)	SCRN	L3T SLT			LST	LNKS	GWS GWS GWS			SLSCI	NIS
			SET	SET	BEI			ACT	MES	DIS		
ele2i	1-207-0	none	1	1	no	B	4	off	off	off	---	on
ls1315	0-015-0	none	1	1	no	A	1	off	off	off	---	off
ls1317	0-017-0	none	1	1	no	A	1	off	off	off	---	on
elm2s1	1-011-1	none	1	1	no	A	7	off	off	off	---	off
elm2s2	1-011-2	none	1	1	no	A	7	off	off	off	---	off

Link set table is (10 of 1024) 1% full.

11. Display the attributes of the linkset shown in 10 whose APC is the DPC being changed by entering the `rtrv-ls` command with the `lsn` parameter.

For this example, enter this command.

```
rtrv-ls:lsn=lsn10
```

This is an example of the possible output.

```
rlghncxa03w 07-05-28 21:16:37 EDT EAGLE5 37.0.0
```

LSN	APCA (SS7)	SCRN	L3T SLT			LST	LNKS	GWS GWS GWS			SLSCI	NIS
			SET	SET	BEI			ACT	MES	DIS		
lsn10	240-012-007	none	1	1	no	A	1	off	off	off	no	off

```
CLLI          TFATCABMLQ MTPRSE ASL8
----- 1          --- no
```

```
IPGWAPC MATELSN      IPTPS LSUSEALM SLKUSEALM GTTMODE
yes      ----- 200    100    % 80      % CdPA
```

```
LOC  PORT  SLC  TYPE
1211 A    0  SS7IPGW
```

Link set table is (10 of 1024) 1% full.

12. Change the destination point code using the `chg-dstn` command.

If alias point code values will be changed, [Table 2-17](#) shows the DPC and alias point type combinations that can be used with the `chg-dstn` command.

For this example, enter these commands.

```
chg-
dstn:dpca=240-012-007:clli=ls09clli:bei=no:aliasi=2-66-1 :ali
```

```
asn=0-10-13-3-
fr:spca=003-010-010:homescp=yes:homesmsc=yes:sccpmsgcnv=udt2x
udt
chg-dstn:dpci=2-131-2:aliasn=8-10-2-0-fr,s-9-11-1-3-fr
chg-dstn:dpcn=10-15-3-0-fr:aliasi=3-150-7,s-3-125-2
```

If the point code is being changed to a proxy point code, the `prx=yes` parameter must be specified. The point code cannot be a private point code, cannot have the `ipgwapc=yes` parameter assigned, and cannot be a cluster or network routing point code.

If the point code is being changed from a proxy point code to a non-proxy point code, the `prx=no` parameter must be specified. The proxy point code cannot be assigned to a linkset or to other destination point codes.

An SPC cannot be assigned to a destination point code if the SPC is assigned to a linkset.

If the `aliasn` parameter is specified with the `chg-dstn` command, make sure that the format of the ITU national alias point code matches the format shown in the `NPCFMTI` field of the `rtrv-stpopts` command output shown in 7 or with the format that was defined when the procedure in the [14-Bit ITU National Point Code Formats](#) section was performed in 3.

When this command has successfully completed, and the Cluster Routing and Management Diversity feature is turned off (`CRMD = off` in the `rtrv-feat` command output), and no proxy point code quantity is enabled, this message should appear.

```
rlghncxa03w 07-05-17 15:35:05 GMT EAGLE5 37.0.0
Destination table is (24 of 2000) 1% full
Alias table is (29 of 8000) 1% full
CHG-DSTN: MASP A - COMPLTD
```

If the Cluster Routing and Management Diversity feature is turned on (`CRMD = on` in the `rtrv-feat` command output), and no proxy point code quantity is enabled, this message should appear when each command has successfully completed.

```
rlghncxa03w 07-05-17 15:35:05 GMT EAGLE5 37.0.0
DESTINATION ENTRIES ALLOCATED:    2000
  FULL DPC(s):                    21
  EXCEPTION DPC(s):               0
  NETWORK DPC(s):                 1
  CLUSTER DPC(s):                 2
  TOTAL DPC(s):                   24
  CAPACITY (% FULL):              1%
ALIASES ALLOCATED:                8000
  ALIASES USED:                   29
  CAPACITY (% FULL):              1%
X-LIST ENTRIES ALLOCATED:        500
CHG-DSTN: MASP A - COMPLTD
```

If a proxy point code quantity is enabled and the Cluster Routing and Management Diversity feature is turned off (shown with the `CRMD = off` entry in the `rtrv-feat` command output), this message should appear.

```
rlghncxa03w 06-10-17 15:35:05 GMT EAGLE5 36.0.0
```

```

Destination table is (24 of 2000) 1% full
Alias table is (29 of 12000) 1% full
PPC table is (2 of 10) 20% full
ENT-DSTN: MASP A - COMPLTD

```

If the Cluster Routing and Management Diversity feature is turned on (CRMD = on in the `rtrv-feat` command output), and a proxy point code quantity is enabled, this message should appear.

```

rlghncxa03w 06-10-17 15:35:05 GMT EAGLE5 36.0.0
DESTINATION ENTRIES ALLOCATED: 2000
  FULL DPC(s): 24
  EXCEPTION DPC(s): 0
  NETWORK DPC(s): 0
  CLUSTER DPC(s): 2
  Proxy DPC(s): 2
  TOTAL DPC(s): 28
  CAPACITY (% FULL): 1%
ALIASES ALLOCATED: 8000
  ALIASES USED: 27
  CAPACITY (% FULL): 1%
X-LIST ENTRIES ALLOCATED: 500
ENT-DSTN: MASP A - COMPLTD

```

- 13.** Verify the changes using the `rtrv-dstn` command, and specifying the destination point code that was entered in [12](#).
- If an ANSI destination point code was changed in [12](#), use the `dpca` parameter to display the attributes of the destination point code.
 - If an ITU international destination point code was changed in [12](#), use the `dpcli` parameter to display the attributes of the destination point code.
 - If a 14-bit ITU national destination point code was changed in [12](#), use the `dpcli` parameter to display the attributes of the destination point code.
 - If a 24-bit ITU national destination point code was changed in [12](#), use the `dpcli24` parameter to display the attributes of the destination point code.

For this example, enter these commands.

```
rtrv-dstn:dpca=240-012-007
```

This is an example of the possible output.

```

rlghncxa03w 10-12-28 21:16:37 GMT EAGLE5 43.0.0

      DPCA          CLLI          BEI  ELEI  ALIASI          ALIASN/N24  DMN
      240-012-007  ls09clli          no  ---   2-66-1          0-10-13-3-fr  SS7

      SPCA          NCAI  PRX          RCAUSE  NPRST  SPLITIAM  HMSMSC  HMSCP  SCCPMSGCNV
      003-010-010  ----  no          none   off   none       yes    yes   udt2xudt

DESTINATION ENTRIES ALLOCATED: 2000
  FULL DPC(s): 21
  EXCEPTION DPC(s): 0
  NETWORK DPC(s): 1
  CLUSTER DPC(s): 2
  TOTAL DPC(s): 24
  CAPACITY (% FULL): 1%

```

```
ALIASES ALLOCATED:          8000
  ALIASES USED:              29
  CAPACITY (% FULL):        1%
X-LIST ENTRIES ALLOCATED:  500
RTRV-DSTN: MASP A - COMPLTD
```

```
rtrv-dstn:dpci=2-131-2
```

This is an example of the possible output.

```
rlghncxa03w 10-12-28 21:16:37 GMT EAGLE5 43.0.0
```

DPCI	CLLI	BEI	ELEI	ALIASN	ALIASN	DMN
2-131-2	-----	no	---	8-10-2-0-fr	s-9-11-1-3-fr	SS7
SPCI	NCAI PRX	RCAUSE	NPRST	SPLITIAM	HMSMSC	HMSCP
-----	---- no	none	off	none	no	no
					SCCPMSGCNV	none

```
DESTINATION ENTRIES ALLOCATED:  2000
  FULL DPC(s):                   21
  EXCEPTION DPC(s):               0
  NETWORK DPC(s):                 1
  CLUSTER DPC(s):                 2
  TOTAL DPC(s):                   24
  CAPACITY (% FULL):              1%
ALIASES ALLOCATED:                8000
  ALIASES USED:                    29
  CAPACITY (% FULL):              1%
X-LIST ENTRIES ALLOCATED:        500
RTRV-DSTN: MASP A - COMPLTD
```

```
rtrv-dstn:dpcn=10-15-3-0-fr
```

This is an example of the possible output.

```
rlghncxa03w 10-12-28 21:16:37 GMT EAGLE5 43.0.0
```

DPCN	CLLI	BEI	ELEI	ALIASI	ALIASI	DMN
10-15-3-0-fr	rlgnncbb013	no	---	3-150-7	s-3-125-2	SS7
SPCN	NCAI PRX	RCAUSE	NPRST	SPLITIAM	HMSMSC	HMSCP
-----	---- no	none	off	none	no	no
					SCCPMSGCNV	none

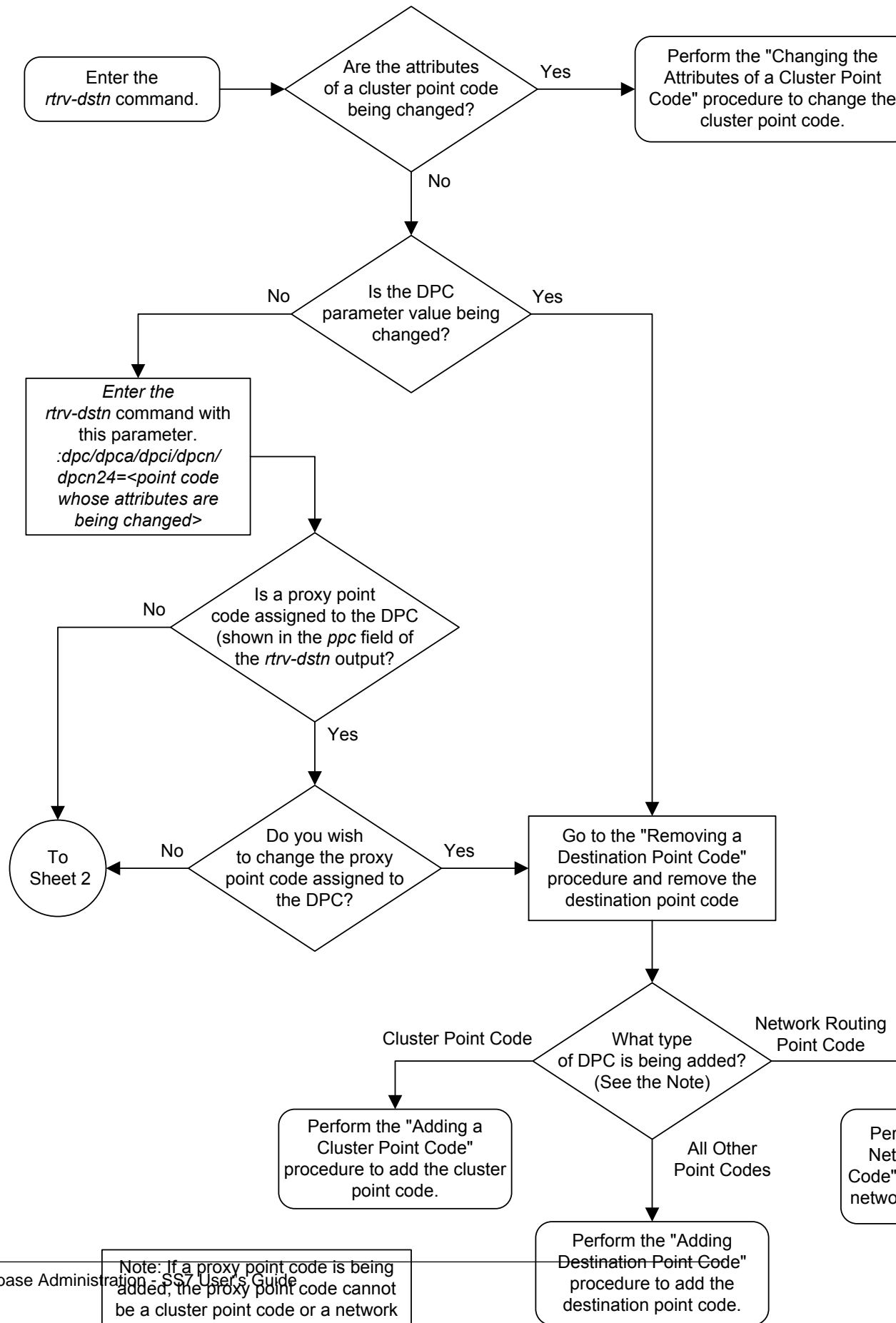
```
DESTINATION ENTRIES ALLOCATED:  2000
  FULL DPC(s):                   21
  EXCEPTION DPC(s):               0
  NETWORK DPC(s):                 1
  CLUSTER DPC(s):                 2
  TOTAL DPC(s):                   24
  CAPACITY (% FULL):              1%
ALIASES ALLOCATED:                8000
  ALIASES USED:                    29
  CAPACITY (% FULL):              1%
X-LIST ENTRIES ALLOCATED:        500
RTRV-DSTN: MASP A - COMPLTD
```

14. Back up the new changes, using the `chg-db:action=backup:dest=fixed` command.

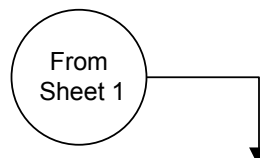
These messages should appear; the active **Maintenance and Administration Subsystem Processor (MASP)** appears first.

```
BACKUP (FIXED) : MASP A - Backup starts on active MASP.  
BACKUP (FIXED) : MASP A - Backup on active MASP to fixed disk complete.  
BACKUP (FIXED) : MASP A - Backup starts on standby MASP.  
BACKUP (FIXED) : MASP A - Backup on standby MASP to fixed disk complete.
```

Figure 2-32 Changing a Destination Point Code



Sheet 1 of 4



To change the attributes of a DPC, these entities must be checked depending on how the attributes of the DPC are changed. Perform the commands and procedures as required depending on how the attributes of the DPC are changed.

The type of point code being added, ANSI, ITU-I, ITU-N, ITU-N24 must be shown in the *rtrv-dstn* output of the *rtrv-sid* command. If the point code type is not shown in the *rtrv-dstn* output, perform the *rtrv-sid* command. If the point code type is not shown in the *rtrv-dstn* and *rtrv-sid* outputs, perform the Adding a Point Code to the Self-Identification of the EAGLE 5 ISS to add a point code of the desired point code type.

If the new point code will be a 14-bit ITU-N point code, and a group code will be assigned to the point code, the group code must be defined in *rtrv-sid*, *rtrv-dstn*, or *rtrv-spc* outputs. If the group code is not shown in either of the outputs, perform the Adding a Point Code to the Self-Identification of the EAGLE 5 ISS procedure to add an entry with the desired group code. If the group code will be different from the ones shown in the *rtrv-sid* or *rtrv-dstn* outputs, perform the Adding a Secondary Point Code procedure to add a secondary point code with the desired group code.

If a secondary point code value will be changed, the new secondary point code must be shown in the *rtrv-spc* output, and the new secondary point code is shown in the *rtrv-spc* output.

If the Multiple Linksets to Single Adjacent PC feature is enabled and turned on, the new secondary point code cannot be the secondary point code of a linkset. Enter the *rtrv-ctrl-feat* command to verify if the Multiple Linksets to Single Adjacent PC feature is enabled and turned on. If the Multiple Linksets to Single Adjacent PC feature is enabled and turned on, enter the *rtrv-ls* command with the *spc/spca/spci/spcn/spcn24* parameter with the secondary point code value from the *rtrv-spc* output. If the secondary point code is not shown in the *rtrv-spc* output, perform the Adding a Secondary Point Code to add the desired secondary point code. The *spc/spca/spci/spcn/spcn24* parameter cannot be specified for a DPC that contains a proxy point code, shown the *PPCA/PPCI/PPCN* outputs when the individual DPC is displayed.

If the *clli* parameter value will be changed, the new *clli* parameter value cannot be shown in the *rtrv-sid* or *rtrv-dstn* outputs. Enter the *rtrv-sid* command to verify the *CLLI* value in the self-identification of the EAGLE 5 ISS.

The format of a 14-bit ITU-N point code must match the format defined by the *NPCFMTI* value in the *rtrv-spc* output. Enter the *rtrv-stpopts* to verify the *NPCFMTI* value. If you wish to change the format, perform the 14-Bit ITU-N Point Code Formats procedure.

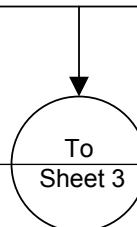
To specify an alias point code with the DPC, specifying the new alias point code cannot exceed the maximum number of alias point codes shown in the *ALIASES ALLOCATED:* or the *Alias table* row in the *rtrv-dstn* output. If the maximum number of alias point codes will be exceeded, remove enough alias point codes to allow the new alias point code to be added. Enter the *chg-dstn* command with the DPC that contains the alias point code that is being removed and with the *aliasi/aliasn/aliasn24=none* parameter. Enter this command as needed to remove the required number of alias point codes.

If the *nprst* or *rcause* parameters will be specified with the DPC, the TIF Number Portability feature must be enabled. If the current *rcause* value is *none* and the current *nprst* value is *off*, enter the *rtrv-ctrl-feat* command to verify if the TIF Number Portability feature is enabled. If the feature is not enabled, perform the procedures in *Feature Manual - TIF* to enable the TIF Number Portability feature.

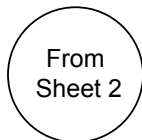
If the *splitiam* parameter will be specified with the DPC, at least one of these features must be enabled.

- TIF Number Portability
- TIF SCS Forwarding
- TIF Simple Number Substitution
- TIF Additional Subscriber Data
- TIF Generic Routing Number

If the current *splitiam* value is *none*, enter the *rtrv-ctrl-feat* command to verify if any of these features are enabled. If none of these features are enabled, perform the procedures in *Feature Manual - TIF* to enable one of the features.



Sheet 2 of 4



If the *prx=yes* parameter will be specified with the DPC, the Proxy Point Code feature must be enabled. To enable the proxy point code with the *prx=yes* parameter cannot exceed the enabled proxy point code quantity, shown in the *PPC table* or *PROXY DPC(s)*: row of the *rtrv-dstn* output. Enter the *rtrv-ctrl-feat* command to verify if a proxy point code quantity is enabled. If a proxy point code quantity is enabled, the Proxy Point Code feature is enabled. To disable the Proxy Point Code feature or increase the proxy point code quantity, perform the Changing the Proxy Point Code Quantity procedure. The *prx=yes* parameter cannot be specified for the DPC if any of these conditions are met:

If the enabled quantity is 100 and 100 proxy point codes are in the database.

If the DPC is a private point code, a cluster point code, a network routing point code, or the adjacent point code of an IPGWx linkset. The private point codes, cluster point codes, and network routing point codes are shown in the *rtrv-dstn* output. Display the linkset with the *rtrv-ls* command, then re-enter the *rtrv-ls* command with the name of the linkset that has the DPC as its adjacent point code to verify if the linkset is an IPGWx linkset.

If the current *PRX* value is *yes*, the *PRX* value cannot be changed if the DPC is referenced by other point codes. Enter the *rtrv-dstn* command with the *ppc/ppca/ppci/ppcn/ppcn24* parameter and the DPC value to be changed to verify if the proxy point code is referenced by other point codes. Perform the Removing a Point Code procedure to remove the point code that reference the proxy point code.

If the *sccpmsgcnv* parameter will be specified with the DPC, the XUDT UDT Conversion feature must be enabled and turned on. Enter the *rtrv-ctrl-feat* command to verify that the feature is enabled and turned on. If the feature is not enabled and turned on, perform the "Activating the XUDT UDT Conversion Feature" procedure to enable the XUDT UDT Conversion feature.

Enter the *chg-dstn* command with this mandatory parameter
:dpc/:dpca/:dpci/:dpcn/:dpcn24=<point code value>
 and these optional parameters.
:cli=<CLI value>
:bei=<yes, no>
:aliasa/:aliasi/:aliasn/:aliasn24=<alias point code value> or *none*
:spc/:spca/:spci/:spcn/:spcn24=<secondary point code value> or *none*
:prx=<yes, no>
:nprst=<on, off>
:rcause=<0 – 127, or the value none>
:splitiam=< 15 – 31, or the value none>
:homespc=<yes, no>
:homesmsc=<yes, no>
:sccpmsgcnv = <none, udt2xudt, xudt2udt, sxudt2udt>
 (See the Notes on Sheet 4)

Enter the *rtrv-dstn* command with this parameter.
:dpc/:dpca/:dpci/:dpcn/:dpcn24=<DPC value that was specified in the chg-dstn command>

Enter the *chg-db:action=ba* command

Sheet 3 of 4

Notes:

1. One or more optional parameters must be specified
2. The values for parameters not specified with the *chg-dstn* command will not be changed.
3. The *:dpc/:dpcal/:dpcil/:dpcnl/:dpcn24*, *:aliasal/:aliasil/:aliasnl/:aliasn24*, and *:spcl/:spcal/:spcil/:spcnl/:spcn24* parameters provision either ANSI, ITU-I, 14-bit ITU-N, or 24-bit ITU-N point codes.
 - :dpc/:dpcal*, *:spcl/:spcal*, *:aliasa* = ANSI DPC, private ANSI DPC, SPC, alias point code
 - :dpci*, *:spci*, *:aliasi* = ITU-I DPC (non-spare point code, spare point code, private point code, private spare point code), SPC (non-spare or spare point code), alias point code (non-spare or spare point code)
 - :dpcn*, *:spcn*, *:aliasn* = 14-bit ITU-N DPC (non-spare point code, spare point code, private point code, private spare point code), SPC (non-spare or spare point code), alias point code (non-spare or spare point code)
 - :dpcn24*, *:spcn24*, *:aliasn24* = 24-bit ITU-N DPC, private 24-bit ITU-N DPC, SPC, alias point code
4. The network type of alias point codes cannot be the same as the network type of the DPC.
 - If the DPC is ANSI, then either ITU-I or ITU-N (14-bit or 24-bit) alias point codes can be assigned.
 - If the DPC is ITU-I, then either ANSI or ITU-N (14-bit or 24-bit) alias point codes can be assigned.
 - If the DPC is either a 14-bit or a 24-bit ITU-N, then either ITU-I or ANSI alias point codes can be assigned.
5. The EAGLE 5 ISS can contain 14-bit ITU-N point codes or 24-bit ITU-N point codes, but not both at the same time.
6. The value *none* for the *:aliasal/:aliasil/:aliasn*, and *:spcl/:spcal/:spcil/:spcn* parameters removes the alias point code or DPC.
7. The network type of an SPC must be the same as the network type of the DPC.
8. The alias point code and SPC value must be full point codes.
9. The alias point code value cannot be shown in the *rtrv-dstn* output.
10. The NI and NC values of an ANSI point code cannot be the same as the NI and NC values of any cluster point code shown in the *rtrv-dstn* output.
11. The *rtrv-sid* output must show values in the PCA, PCI, PCN, or PCN24 fields before a DPC of the network type code can be added.
12. The CLLI value being added cannot be shown in the *rtrv-sid* output.
13. The SPC value must be shown in the *rtrv-spc* output.
14. If a 14-bit ITU-N DPC is being added and the ITU Duplicate Point Code feature is on, and no SPC is being assigned to the DPC, the group code assigned to the DPC must be the same as the group code value shown in the PCN field of the *rtrv-sid* output.
15. If a 14-bit ITU-N DPC is being added and the ITU Duplicate Point Code feature is on, and an SPC is being assigned to the DPC, the group code assigned to the DPC must be the same as the group code assigned to the SPC.
16. The format of 14-bit ITU-N point codes must match the format defined by the NPCFMTI value of the *rtrv-stpopts* output.
17. The EAGLE 5 ISS can contain these quantities of alias point codes depending the features that are enabled or turned on:
 - 5000 routes is not turned on, 6000, 7000, 8000, or 10,000 routesets is not enabled – 12,000 alias point codes
 - 5000 routes is turned on, 6000, 7000, 8000, or 10,000 routesets is not enabled – 12,000 alias point codes
 - 6000 routesets are enabled – 12,000 alias point codes
 - 7000 routesets are enabled – 8000 alias point codes
 - 8000 routeset are enabled – 8000 alias point codes
 - 10,000 routesets are enabled – 10,000 alias point codes

The number of alias point codes is shown in the *chg-dstn* and *rtrv-dstn* outputs.
18. To change a DPC to a proxy point code with the *prx=yes* parameter, the DPC cannot be a private point code and cannot be a cluster point code or a network routing point code. The DPC cannot be an APC of a linkset whose *ipgwapc* parameter is set to *yes*.
19. To change a proxy point code to a non-proxy point code with the *prx=no* parameter, the proxy point code cannot be assigned to any linksets or DPCs.
20. An SPC cannot be assigned to a DPC that has a proxy point code assigned to it.
21. The type of alias point code that can be provisioned is dependent on the type of DPC that is being provisioned. Refer to the Destination Point Code and Alias Point Code Type Combinations table in the “Changing a Destination Point Code” procedure in the *Database Administration Manual – SS7* for the alias point code parameter combinations.

Changing the Group Code Assigned to a 14-Bit ITU National Point Code

This procedure is used to change the group code that is assigned to a 14-bit ITU national point code. The 14-bit ITU national point code to be changed must be in the database.

To change a group code assigned to a ITU national point code, a duplicate point code with the new group code must be configured in the database with a route, linkset, and signaling link to the new destination. Then the 14-bit ITU national point code with the old group code with its route can be removed from the database.

The `chg-dstn` command cannot be used to change the group code assigned to 14-bit ITU national point codes.

The examples in this procedure are used to remove the group code assigned to ITU national destination point code 7-9-10-1-aa to 7-9-10-1-de. The format of the 14-bit ITU national point codes used in these examples is 4-4-4-2.

Canceling the `RTRV-DSTN` and `RTRV-RTE` Commands

Because the `rtrv-dstn` and `rtrv-rte` commands used in this procedure can output information for a long period of time, the `rtrv-dstn` and `rtrv-rte` commands can be canceled and the output to the terminal stopped. There are three ways that the `rtrv-dstn` and `rtrv-rte` commands can be canceled:

- Press the F9 function key on the keyboard at the terminal where the `rtrv-dstn` or `rtrv-rte` command was entered
- Enter the `canc-cmd` without the `trm` parameter at the terminal where the `rtrv-dstn` or `rtrv-rte` command was entered
- Enter the `canc-cmd:trm=<xx>`, where `<xx>` is the terminal where the `rtrv-dstn` or `rtrv-rte` command was entered, from another terminal other than the terminal where the `rtrv-dstn` or `rtrv-rte` command was entered. To enter the `canc-cmd:trm=<xx>` command, the terminal must allow Security Administration commands to be entered from it and the user must be allowed to enter Security Administration commands. The terminal's permissions can be verified with the `rtrv-secu-trm` command. The user's permissions can be verified with the `rtrv-user` or `rtrv-secu-user` commands.

For more information about the `canc-cmd` command, refer to *Commands User's Guide*.

1. Display all the attributes of the 14-bit ITU national point code whose group code is being changed, using the `rtrv-dstn` command with the `dpcn` parameter.

For this example, enter this command.

```
rtrv-dstn:dpcn=7-9-10-1-aa
```

This is an example of the possible output.

```
rlghncxa03w 10-12-28 21:16:37 GMT EAGLE5 43.0.0
```

DPCN	CLLI	BEI	ELEI	ALIASA	ALIASI	DMN	
7-9-10-1-aa	-----	no	---	210-090-100	1-75-6	SS7	
SPCA	NCAI	RCAUSE	NPRST	SPLITIAM	HMSMSC	HMSCP	SCCPMSGCNV
13-2-12-0-aa	no	none	off	none	no	no	none

```
Destination table is (17 of 2000) 1% full
Alias table is (8 of 8000) 1% full
RTRV-DSTN: MASP A - COMPLTD
```

2. Display the route configuration of the 14-bit ITU national point code specified in 1, by entering the `rtrv-rte` command with the `dpcn` parameter.

For this example, enter this command.

```
rtrv-rte:dpcn=7-9-10-1-aa
```

This is an example of the possible output.

```
rlghncxa03w 07-05-17 16:02:05 GMT EAGLE5 37.0.0
DPCN          ALIASA          ALIASI  LSN          RC      APC
7-9-10-1-aa   210-090-100  1-75-6  ls04         10     10-4-15-1-aa
              1s02         20     12-11-2-0-aa
              1s03         30     8-1-15-2-aa
RTX:No  CLLI=1s04clli
```

3. Go to the [Removing a Destination Point Code](#) procedure and add the duplicate ITU national point code with the new group code.

For this example, the new point code is 7-9-10-1-de.

4. Go to the [Removing a Destination Point Code](#) procedure and remove the 14-bit ITU national point code with the old group code, specified is 1 and 2.

This procedure will also remove the route to the point code with the old group code, the linkset used by this route, and the signaling links in that linkset. Record the configuration of the signaling links in the linkset. This information will be used to restore these signaling links in 6.

Note: If the DPC specified in 2 is not the adjacent point code of a linkset, shown in the APCN field of the `rtrv-rte` output, continue the procedure with 7.b of 7.

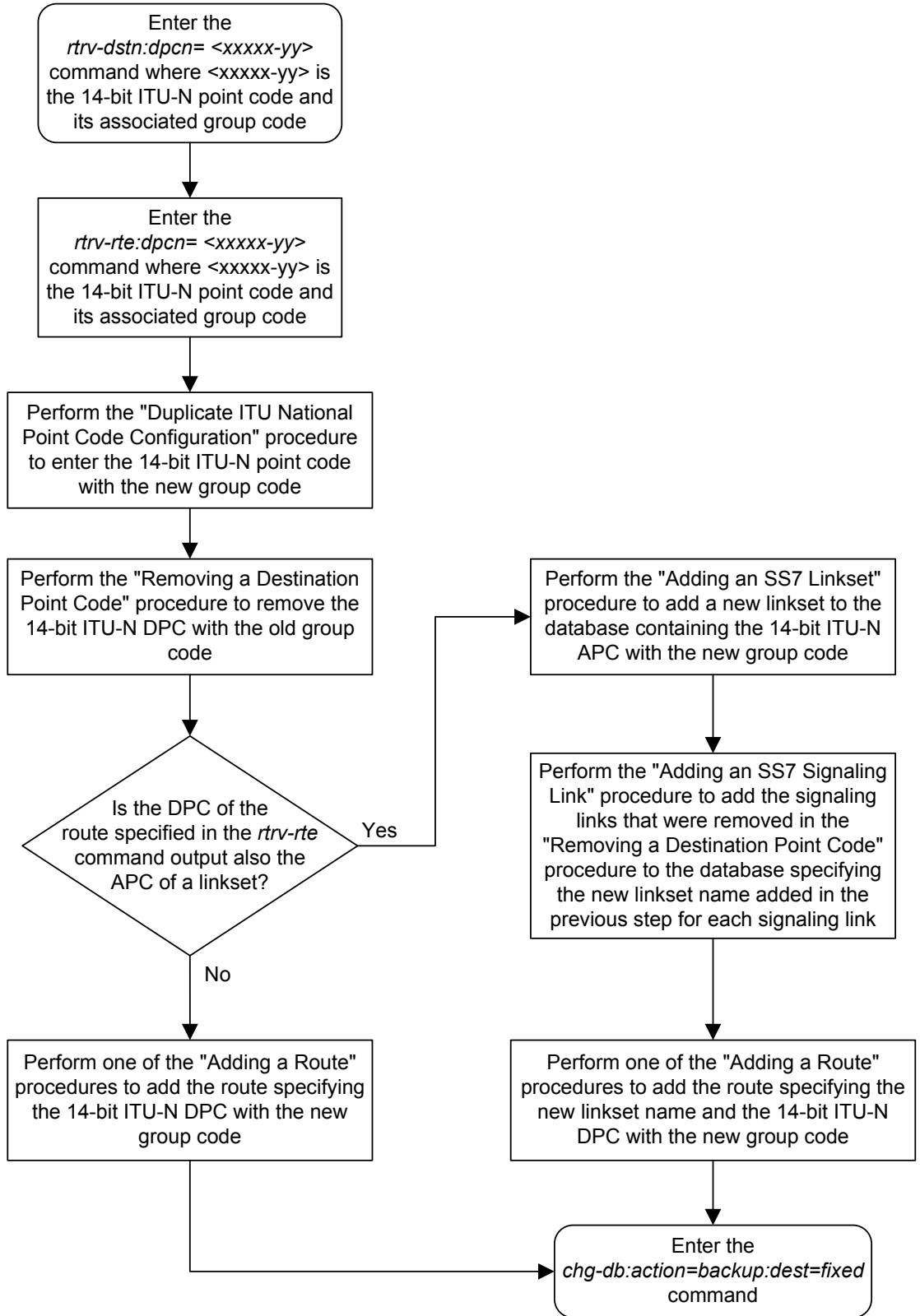
5. Perform the [Adding an SS7 Linkset](#) procedure to add a new linkset to the database containing the 14-bit ITU national point code with the new group code specified in 3 as the APC of the linkset.
6. Perform the [Adding an SS7 Signaling Link](#) procedure to add the signaling links that were removed by the [Removing a Destination Point Code](#) procedure in step 4 and specifying the linkset name of the linkset that was added in 5.
7. If the DPC specified in 2 is the adjacent point code of a linkset and a new linkset was created in 5, then perform 7.a. If the DPC specified in 2 is not the adjacent point code of a linkset, then perform 7.b. Do not perform 7.a and 7.b.
 - a. Perform one of the “Adding a **Route**” procedures in Chapter 3 to add the route to the 14-bit ITU national point code with the new group code specifying the name of the linkset created in step 5 and the 14-bit ITU national point code with the new group code from 3.
 - b. Perform one of the “Adding a Route” procedures in Chapter 3 to add the route to the 14-bit ITU national point code with the new group code specifying the 14-bit ITU national point code with the new group code from 3.

8. Back up the new changes, using the `chg-db:action=backup:dest=fixed` command.

These messages should appear; the active **Maintenance and Administration Subsystem Processor (MASP)** appears first.

```
BACKUP (FIXED) : MASP A - Backup starts on active MASP.  
BACKUP (FIXED) : MASP A - Backup on active MASP to fixed disk complete.  
BACKUP (FIXED) : MASP A - Backup starts on standby MASP.  
BACKUP (FIXED) : MASP A - Backup on standby MASP to fixed disk complete.
```

Figure 2-33 Changing the Group Code Assigned to a 14-Bit ITU National Point Code



SS7 Configuration

Chapter 3, SS7 Configuration, describes the procedures necessary to configure the EAGLE 5 ISS to support the SS7 network.

Introduction

This chapter contains the procedures necessary to configure the EAGLE to support the SS7 network. These items are configured to support the SS7 network.

- Linksets, including linksets for these features:
 - MTP restart
 - 5-Bit to 8-Bit SLS conversion
 - ITUSLS enhancement
 - Configuring the option for determining how the EAGLE routes messages over restricted linksets and routes - the restricted linkset option.
 - Configuring the options for determining how the EAGLE handles TFC messages from ITU-I and ITU-N networks.
- Signaling links
- Routes
- Level 2 timers
- Level 3 timers
- Signaling link test messages
- The rate that TFA and TFP messages are sent
- Circular route detection
- The frequency that signaling-route-set-test (RST) messages are sent for lower priority routes
- Remote loopback points for the link fault sectionalization feature
- Options for the TDM Global Timing Interface
- Changing the high-capacity card temperature alarm thresholds.

Enabling the Large System # Links Controlled Feature

This procedure is used to enable the Large System # Links controlled feature using the feature's part number and a feature access key.

The feature access key for the Large System # Links controlled feature is based on the feature's part number and the serial number of the **EAGLE**, making the feature access key site-specific.

This feature allows the **EAGLE** to contain a maximum of either 1500, 2000, or 2800 signaling links.

The `enable-ctrl-feat` command enables the controlled feature by inputting the controlled feature's access key and the controlled feature's part number with these parameters:

`: fak` – The feature access key provided by Oracle. The feature access key contains 13 alphanumeric characters and is not case sensitive.

`: partnum` – The Oracle-issued part number associated with the signaling link quantity being enabled:

- 893005901 for the 1500 signaling link quantity
- 893005910 for the 2000 signaling link quantity.
- 893005911 for the 2800 signaling link quantity.

The `enable-ctrl-feat` command requires that the database contain a valid serial number for the **EAGLE**, and that this serial number is locked. This can be verified with the `rtrv-serial-num` command. The **EAGLE** is shipped with a serial number in the database, but the serial number is not locked. The serial number can be changed, if necessary, and locked once the **EAGLE** is on-site, by using the `ent-serial-num` command. The `ent-serial-num` command uses these parameters.

`: serial` – The serial number assigned to the **EAGLE**. The serial number is not case sensitive.

`: lock` – Specifies whether or not the serial number is locked. This parameter has only one value, `yes`, which locks the serial number. Once the serial number is locked, it cannot be changed.

Note: To enter and lock the **EAGLE**'s serial number, the `ent-serial-num` command must be entered twice, once to add the correct serial number to the database with the `serial` parameter, then again with the `serial` and the `lock=yes` parameters to lock the serial number. You should verify that the serial number in the database is correct before locking the serial number. The serial number can be found on a label affixed to the control shelf (shelf 1100).

This feature cannot be temporarily enabled (with the temporary feature access key).

Once this feature is enabled with the `enable-ctrl-feat` command, the feature is also activated. The `chg-ctrl-feat` command is not necessary to activate the feature.

This feature cannot be turned off with the `chg-ctrl-feat` command and the `status=off` parameter.

Hardware Supported for Signaling Link Quantities Greater than 2000

This hardware is the only hardware that is supported for an EAGLE containing 2001 to 2800 signaling links.

- **HC-MIM**
- **E5-E1/T1**
- **E5-ATM**
- **E5-SM4G**
- **E5-ENET**
- E5-based control cards
- **E5-SLAN** card for the STPLAN feature
- **E5-STC** card for the EAGLE 5 Integrated Monitoring Support feature

To increase the signaling link quantity to more than 2000 signaling links, HIPR2 cards must be installed into card locations 9 and 10 in each shelf in the **EAGLE**. Enter the `rept-stat-gpl:gpl=hipr2` command to verify whether or not **HIPR2** cards are installed in the EAGLE shelves.

1. Display the status of the Large System # Links controlled feature by entering the `rtrv-ctrl-feat` command.

The following is an example of the possible output.

```
rlghncxa03w 06-10-28 21:15:37 GMT EAGLE5 36.0.0
The following features have been permanently enabled:
```

Feature Name	Partnum	Status	Quantity
Command Class Management	893005801	on	----
LNP Short Message Service	893006601	on	----
Intermed GTT Load Sharing	893006901	on	----
XGTT Table Expansion	893006101	on	400000
XMAP Table Expansion	893007710	off	----
Routesets	893006401	on	6000
HC-MIM SLK Capacity	893012707	on	64

The following features have been temporarily enabled:

Feature Name	Partnum	Status	Quantity	Trial Period Left
Zero entries found.				

The following features have expired temporary keys:

Feature Name	Partnum
Zero entries found.	

If the `rtrv-ctrl-feat` output shows that the controlled feature is enabled for the desired quantity or for a quantity that is greater than the desired quantity, no further action is necessary. This procedure does not need to be performed.

If the `rtrv-ctrl-feat` output in [1](#) shows any controlled features, or if the Large System # Links controlled feature is enabled for a quantity that is less than the desired quantity, continue the procedure by performing one of these steps.

- If the enabled quantity will be 1500, continue the procedure with [8](#).

- If the enabled quantity will be 2000 or 2800, continue the procedure with 5.

Note: If the `rtrv-ctrl-feat` output shows only the HC-MIM SLK Capacity feature with a quantity of 64, 2 through 5 must be performed.

2. Display the serial number in the database with the `rtrv-serial-num` command.

This is an example of the possible output.

```
rlghncxa03w 06-10-28 21:15:37 GMT EAGLE5 36.0.0
System serial number = nt00001231
```

System serial number is not locked.

```
rlghncxa03w 06-10-28 21:15:37 GMT EAGLE5 36.0.0
Command Completed
```

If the serial number is correct and locked, continue the procedure by performing one of these steps.

- If the enabled quantity will be 1500, continue the procedure with 8.
- If the enabled quantity will be 2000 or 2800, continue the procedure with 6.

If the serial number is correct but not locked, continue the procedure with 5.

If the serial number is not correct, but is locked, this feature cannot be enabled and the remainder of this procedure cannot be performed. Contact the Customer Care Center to get an incorrect and locked serial number changed. Refer to [My Oracle Support \(MOS\)](#) for the contact information. The serial number can be found on a label affixed to the control shelf (shelf 1100).

3. Enter the correct serial number into the database using the `ent-serial-num` command with the `serial` parameter.

For this example, enter this command.

```
ent-serial-num:serial=<EAGLE's correct serial number>
```

When this command has successfully completed, the following message should appear.

```
rlghncxa03w 06-10-28 21:15:37 GMT EAGLE5 36.0.0
ENT-SERIAL-NUM: MASP A - COMPLTD
```

4. Verify that the serial number entered into 3 was entered correctly using the `rtrv-serial-num` command.

This is an example of the possible output.

```
rlghncxa03w 06-10-28 21:15:37 GMT EAGLE5 36.0.0
System serial number = nt00001231
```

System serial number is not locked.

```
rlghncxa03w 06-10-28 21:15:37 GMT EAGLE5 36.0.0
Command Completed
```

If the serial number was not entered correctly, repeat [3](#) and [4](#) and re-enter the correct serial number.

5. Lock the serial number in the database by entering the `ent-serial-num` command with the serial number shown in [2](#), if the serial number shown in [2](#) is correct, or with the serial number shown in [4](#), if the serial number was changed in [3](#), and with the `lock=yes` parameter.

For this example, enter this command.

```
ent-serial-num:serial=<EAGLE's serial number>:lock=yes
```

When this command has successfully completed, the following message should appear.

```
rlghncxa03w 06-10-28 21:15:37 GMT EAGLE5 36.0.0
ENT-SERIAL-NUM: MASP A - COMPLTD
```

Continue the procedure by performing one of these steps.

- If the enabled quantity will be 1500, continue the procedure with [8](#).
 - If the enabled quantity will be 2000 or 2800, continue the procedure with [6](#).
6. Verify that HIPR2 cards are installed in card locations 9 and 10 in each shelf of the EAGLE. Enter this command.

```
rept-stat-gpl:gpl=hipr2
```

This is an example of the possible output.

```
rlghncxa03w 09-07-01 11:40:26 GMT EAGLE5 41.1.0
GPL          CARD          RUNNING          APPROVED          TRIAL
HIPR2        1109          126-002-000    126-002-000    126-003-000
HIPR2        1110          126-002-000    126-002-000    126-003-000
HIPR2        1209          126-002-000    126-002-000    126-003-000
HIPR2        1210          126-002-000    126-002-000    126-003-000
HIPR2        1309          126-002-000    126-002-000    126-003-000
HIPR2        1310          126-002-000    126-002-000    126-003-000
HIPR2        2109          126-002-000    126-002-000    126-003-000
HIPR2        2110          126-002-000    126-002-000    126-003-000
Command Completed
```

If HIPR2 cards are installed at the card locations 9 and 10 on the shelf where the **E5-SLAN** card is to be installed, continue the procedure with [7](#).

If HIPR2 cards are not installed at the card locations 9 and 10 on the shelf where the **E5-SLAN** card is to be installed, refer to *Installation Guide* to install the HIPR or HIPR2 cards. Once the HIPR2 cards have been installed, continue the procedure with [7](#).

7. Before the 2000 or 2800 signaling link quantity can be enabled, make sure the EAGLE is configured with the hardware shown in the [“Hardware Supported for Signaling Link Quantities Greater than 2000”](#) section.

If hardware other than the hardware shown in the [“Hardware Supported for Signaling Link Quantities Greater than 2000”](#) section is installed and provisioned, contact the Customer Care Center before enabling the 2000 or 2800 signaling link quantity. Refer to [My Oracle Support \(MOS\)](#) for the contact information.

8. Enable the Large System # Links controlled feature for the desired quantity with the `enable-ctrl-feat` command specifying the part number corresponding to the new quantity of signaling links and the feature access key.

To increase the number of signaling links the EAGLE can contain to 1500, enter this command.

```
enable-ctrl-feat:partnum=893005901:fak=<feature access key>
```

To increase the number of signaling links the EAGLE can contain to 2000, enter this command.

```
enable-ctrl-feat:partnum=893005910:fak=<feature access key>
```

To increase the number of signaling links the EAGLE can contain to 2800, enter this command.

```
enable-ctrl-feat:partnum=893005911:fak=<feature access key>
```

Note: A temporary feature access key cannot be specified to enable this feature.

Note: The values for the feature access key (the `fak` parameter) are provided by Oracle. If you do not have the feature access key for the feature you wish to enable, contact your Sales Representative or Account Representative.

When the `enable-ctrl-feat` command has successfully completed, this message should appear.

```
rlghncxa03w 06-10-28 21:15:37 GMT EAGLE5 36.0.0
ENABLE-CTRL-FEAT: MASP B - COMPLTD
```

9. Verify the changes by entering the `rtrv-ctrl-feat` command with the part number specified in 8.

If the 1500 signaling link quantity was enabled in 8, enter this command.

```
rtrv-ctrl-feat:partnum=893005901
```

The following is an example of the possible output.

```
rlghncxa03w 06-10-28 21:15:37 GMT EAGLE5 36.0.0
The following features have been permanently enabled:
```

Feature Name	Partnum	Status	Quantity
Large System # Links	893005901	on	1500

The following features have been temporarily enabled:

Feature Name	Partnum	Status	Quantity	Trial Period Left
Zero entries found.				

The following features have expired temporary keys:

Feature Name	Partnum
Zero entries found.	

If the 2000 signaling link quantity was enabled in 8, enter this command.

```
rtrv-ctrl-feat:partnum=893005910
```

The following is an example of the possible output.

```
rlghncxa03w 06-10-28 21:15:37 GMT EAGLE5 36.0.0
```

The following features have been permanently enabled:

Feature Name	Partnum	Status	Quantity
Large System # Links	893005910	on	2000

The following features have been temporarily enabled:

Feature Name	Partnum	Status	Quantity	Trial Period Left
Zero entries found.				

The following features have expired temporary keys:

Feature Name	Partnum
Zero entries found.	

If the 2800 signaling link quantity was enabled in 8, enter this command.

```
rtrv-ctrl-feat:partnum=893005911
```

The following is an example of the possible output.

```
rlghncxa03w 09-07-28 21:15:37 GMT EAGLE5 41.1.0
```

The following features have been permanently enabled:

Feature Name	Partnum	Status	Quantity
Large System # Links	893005911	on	2800

The following features have been temporarily enabled:

Feature Name	Partnum	Status	Quantity	Trial Period Left
Zero entries found.				

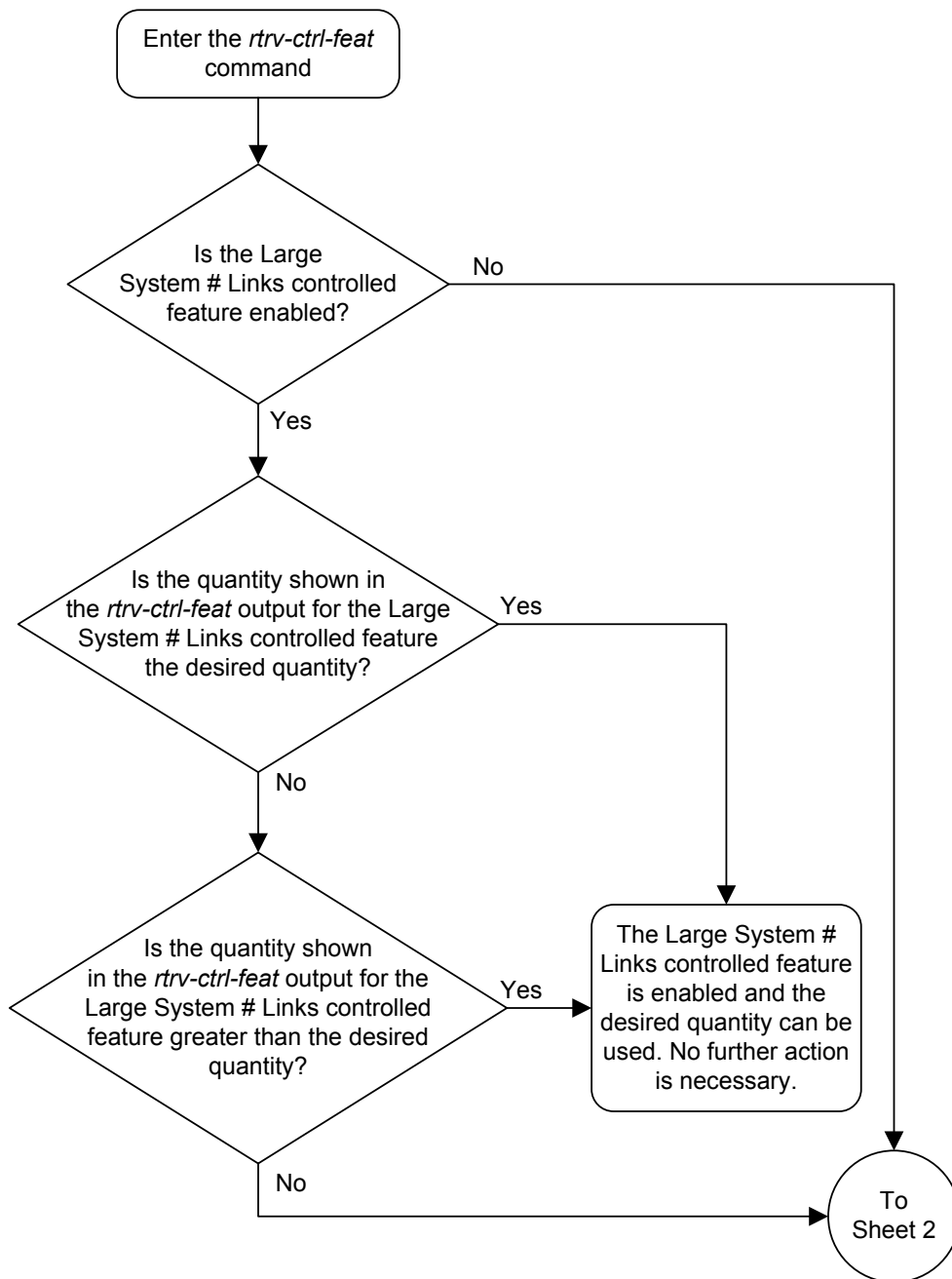
The following features have expired temporary keys:

Feature Name	Partnum
Zero entries found.	

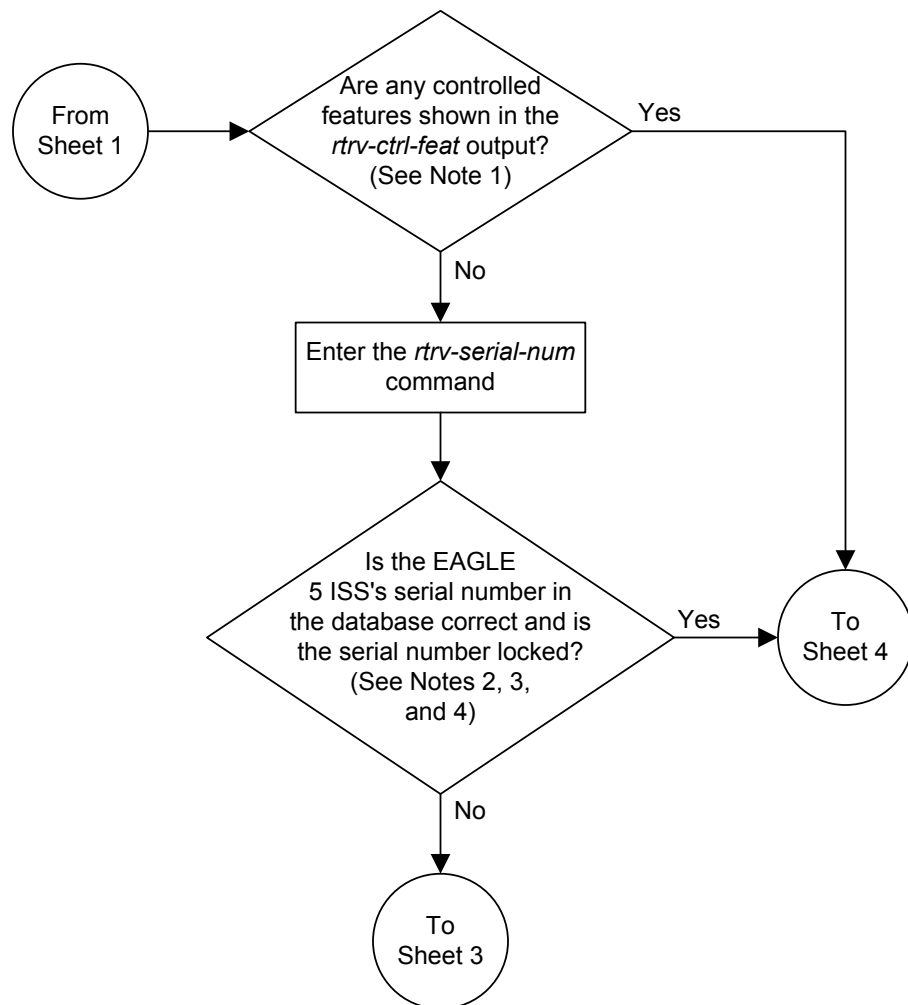
10. Back up the new changes using the `chg-db:action=backup:dest=fixed` command.

These messages should appear, the active **Maintenance and Administration Subsystem Processor (MASP)** appears first.

```
BACKUP (FIXED) : MASP A - Backup starts on active MASP.
BACKUP (FIXED) : MASP A - Backup on active MASP to fixed disk complete.
BACKUP (FIXED) : MASP A - Backup starts on standby MASP.
BACKUP (FIXED) : MASP A - Backup on standby MASP to fixed disk complete.
```



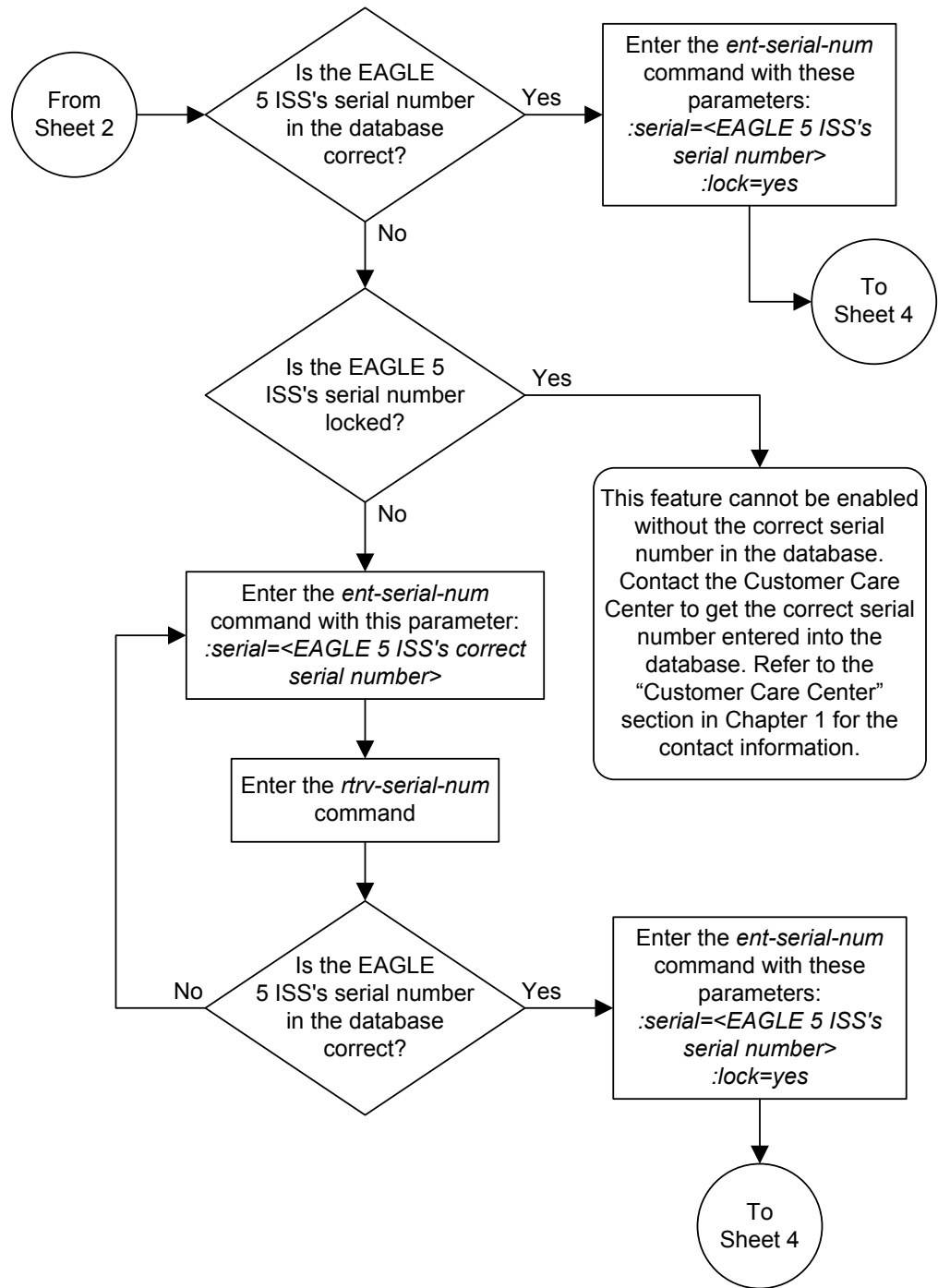
Sheet 1 of 6



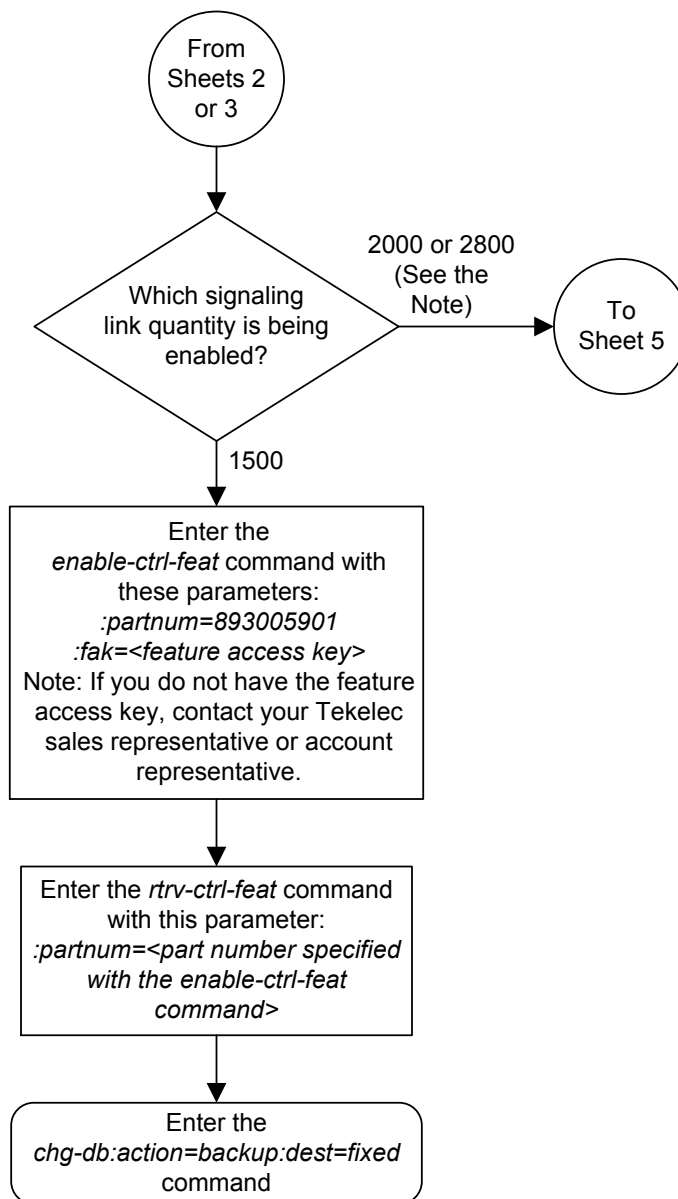
Notes:

1. If the *rtrv-ctrl-feat* output shows only the HC-MIM SLK Capacity feature with a quantity of 64, the answer to this question is no and the Eagle 5 ISS's serial number must be verified. This is the default entry for the *rtrv-ctrl-feat* output. This entry is shown whether or not the Eagle 5 ISS's serial number is in the database.
2. If the serial number is locked, it cannot be changed.
3. If the serial number is not locked, the controlled feature cannot be enabled.
4. The serial number can be found on a label affixed to the control shelf (shelf 1100).

Sheet 2 of 6



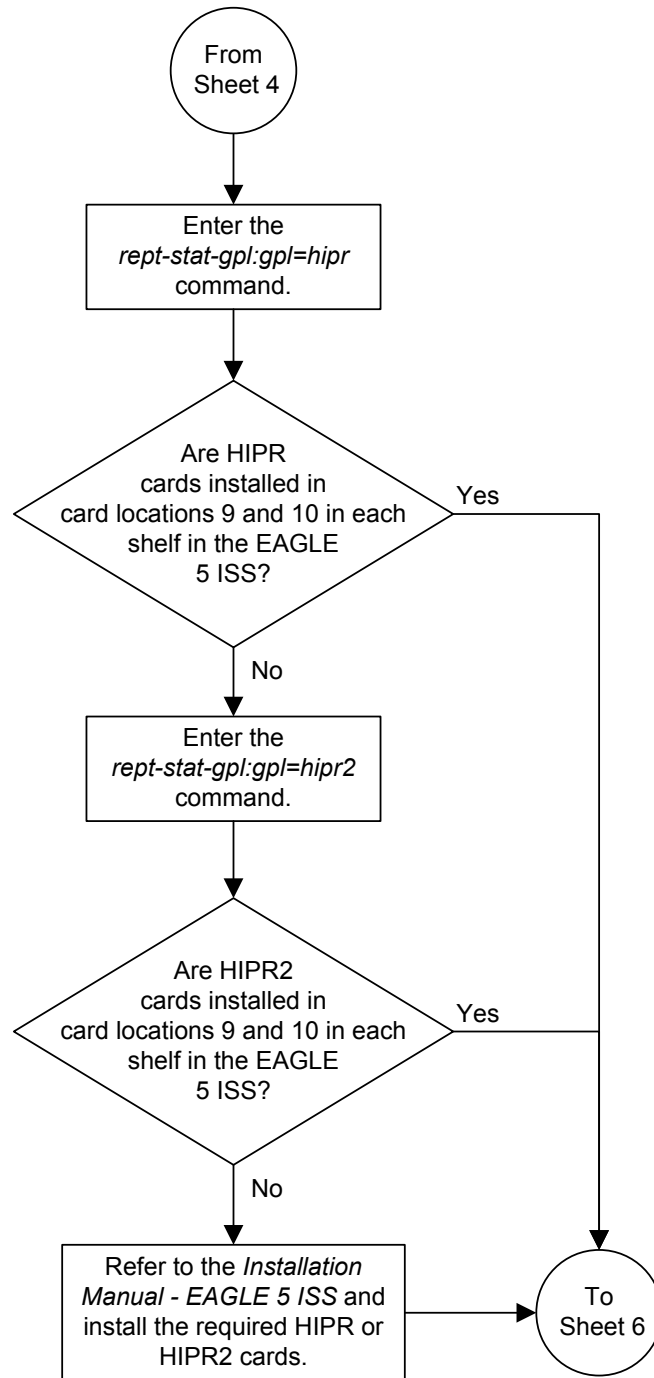
Sheet 3 of 6



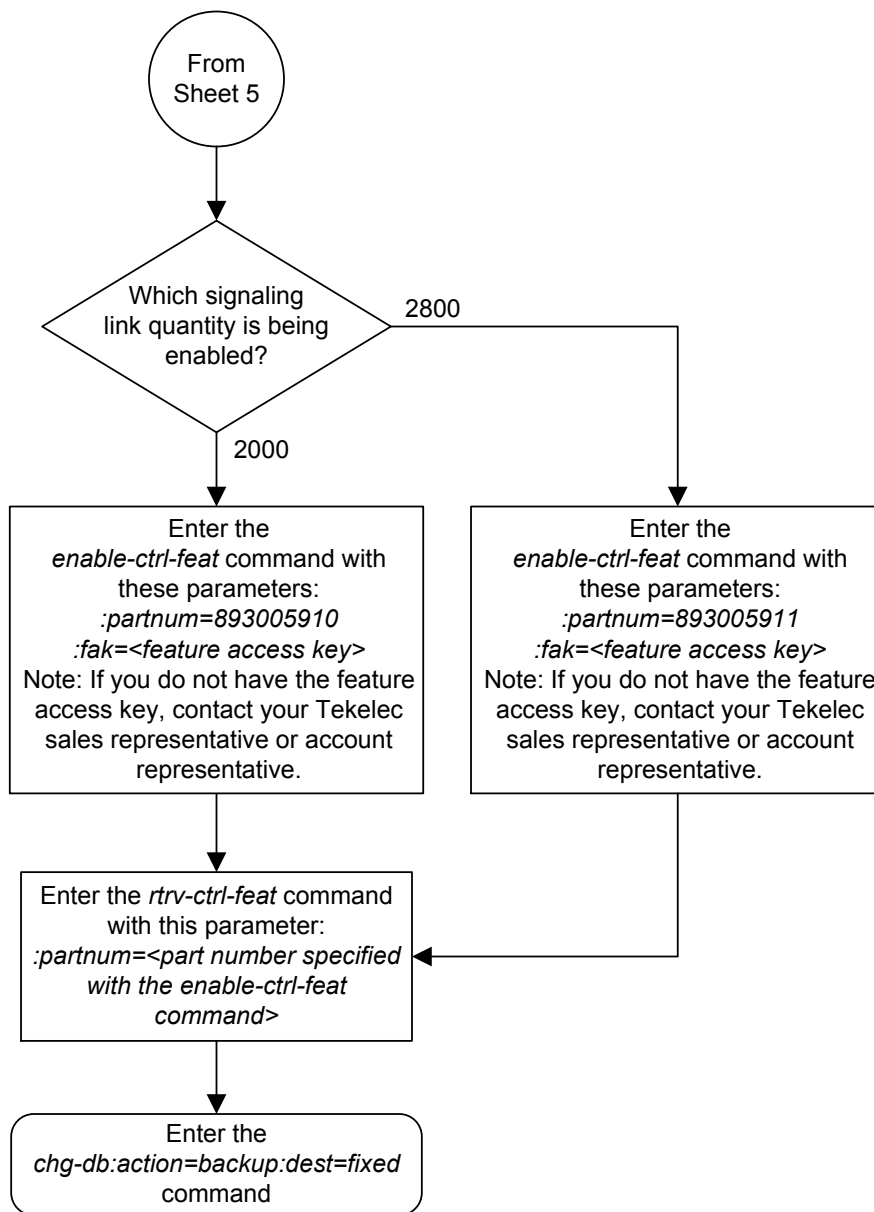
Note: Before the 2800 signaling link quantity is enabled, make sure the EAGLE 5 ISS is configured with the required hardware shown in the “Hardware Supported for Signaling Link Quantities Greater than 2000” section in this procedure.

If hardware other than the hardware shown in the “Hardware Supported for Signaling Link Quantities Greater than 2000” section is installed and provisioned, contact the Customer Care Center before enabling the 2800 signaling link quantity. Refer to the “Customer Care Center” section in Chapter 1 for the contact information.

Sheet 4 of 6



Sheet 5 of 6



Adding an SS7 Linkset

This procedure is used to add **SS7** linksets to the EAGLE using the `ent-1s` command and the following parameters shown in [Table 3-1](#).

Table 3-1 Linkset Parameters

lsn	apc/apca/apci/ apcn/apcn24	ppc/ppca/ ppci/ ppcn/ppcn24	spc/spca/spci/ spcn/spcn24	apcntype
lst	clli	sltset	l3tset	scrn
gwsa	gwsn	gwsd	bei	nis
itutfr	mtprse	slsci	asl8	slrsrb
slsobit	multgc	gttmode	randsls	cgttmode
islrsrb				

The `ent-1s` command contains other optional parameters that are not used this procedure. These parameters are discussed in more detail in *Commands User's Guide* or in these sections.

- The "Configuring a Linkset for the GSM MAP Screening Feature" procedure in *Database Administration - Features User's Guide*.
- These procedures in *Database Administration - IP7 User's Guide*.
 - Configuring an IPGWx Linkset
 - Adding a Mate IPGWx Linkset to another IPGWx Linkset
 - Adding an IPSG M3UA Linkset
 - Adding an IPSG M2PA Linkset

`:1sn` – The name of the linkset. The linkset name can contain up to 10 characters, with the first character being a letter. However, the **SEAS** interface supports only eight characters. If this linkset is displayed on the **SEAS** interface and the linkset name contains more than eight characters, only the first eight characters in the linkset name are shown. If this linkset name contains more than eight characters, and is specified with the linkset commands on the **SEAS** interface, only the first eight characters can be specified.

`:apc/apca/apci/apcn/apcn24` – Adjacent point code – the point code identifying the node that is next to the **EAGLE**. The adjacent point code can be one of the following types of point codes:

- `:apc/apca` – ANSI point code
- `:apci` – ITU-I point code, ITU-I spare point code

- :apcn – 14-bit ITU-N point code, 14-bit ITU-N spare point code
- :apcn24 – 24-bit ITU-N point code

:ppc/ppca/ppci/ppcn/ppcn24 – Proxy point code used for proxy linksets. Proxy point codes can be used only if a quantity of proxy point codes (shown in the `rtrv-ctrl-feat` output) is enabled. The proxy point code can be one of the following types of point codes:

- :ppc/ppca – ANSI point code
- :ppci – ITU-I point code, ITU-I spare point code
- :ppcn – 14-bit ITU-N point code, 14-bit ITU-N spare point code
- :ppcn24 – 24-bit ITU-N point code

:spc/spca/spci/spcn/spcn24 – Secondary point code used for multiple linksets that have the same APC. Secondary point codes can be used only if the Multiple Linksets to Single Adjacent PC feature is enabled and turned on (shown in the `rtrv-ctrl-feat` output). The secondary point code can be one of the following types of point codes:

- :spc/spca – ANSI point code
- :spci – ITU-I point code, ITU-I spare point code
- :spcn – 14-bit ITU-N point code, 14-bit ITU-N spare point code
- :spcn24 – 24-bit ITU-N point code

Note: Refer to [Point Code Formats](#) for a definition of the point code types that are used on the **EAGLE** and for a definition of the different formats that can be used for ITU national point codes. Private point codes can be assigned only to **IPGWx** linksets. The procedures for configuring **IPGWx** linksets are in *Database Administration - IP7 User's Guide*.

:apctype – Specifies whether or not the linkset containing either a 14-bit ITU-N adjacent point code or a 24-bit ITU-N adjacent point code is being used in China (`apctype=itunchina`) or in countries other than China (`apctype=itun`). Signaling links in linksets with the `apctype=itunchina` parameter are handled according to the specifications in *YD/N 068-1997, Technical Specification of National No.7 Signaling System - Message Transfer Part (MTP)*. Signaling links in linksets with the `apctype=itun` parameter are handled according to the specifications in *ITU-T Q.2210 (07/96), Switching and Signaling, Broadband ISDN- Signaling Network Protocols*. The default value for the `apctype` parameter is `itun`.

Linksets shown in section of the `rtrv-ls` output with the LSN (CHINA) column (and with either the APCN or APCN24 column) have the `apctype=itunchina` parameter assigned to them.

Linksets shown in section of the `rtrv-ls` output with the LSN column (and with either the APCN or APCN24 column) have the `apctype=itun` parameter assigned to them.

:lst – The linkset type of the specified linkset

:c1li – The **Common Language Location Identifier** assigned to this point code. The value of the `c1li` parameter is only displayed in the `rtrv-ls` command output when

a specific linkset is being displayed with the `rtrv-ls:lsn=<linkset name>` command.

`:sltset` – The signaling link test message record to be associated with the linkset.

`:l3tset` – The level 3 timer set table. This parameter identifies which level three timer set is to be assigned to this linkset.

`:scrn` – The name of the screenset to be assigned to this linkset if gateway screening is to be used.

`:gwsa` – Gateway screening action determines whether gateway screening (**GWS**) is on or off for the specified link set.

`:gwsn` – Gateway screening messaging is used to turn on or off the display of messages generated for each screened message. When an **MSU** is rejected by gateway screening, a message is output to alert personnel of the event.

`:gwsd` – Gateway screening **MSU** discard is used to turn on or off the discarding of **MSUs** that bypass the gateway screening function due to load shedding. Also use this parameter with the `redirect` function; **MSUs** that cannot be screened are discarded if you specify `gwsd=on`.

`:bei` – The broadcast exception indicator. This parameter indicates whether **TFP** (transfer prohibited) messages are allowed to be broadcast on the linkset. The `yes` parameter means **TFPs** are not broadcast. The `no` parameter means **TFPs** are broadcast.

`:nis` – specifies whether the National Spare for Network Indicator feature is on or off for the specific linkset. This feature allows the linkset to use the national spare value (3) for the network indicator code field in the service information octet (**SIO**) of the **MSU** for **ANSI** linksets and **ITU** national linksets (linksets containing either 14-bit **ITU-N** point codes or 24-bit **ITU-N** point codes). This parameter cannot be specified for **ITU** international linksets. The default value for the `nis` parameter is `off`.

For **MSUs** on incoming linksets, only those **MSUs** having the network indicator code values shown in [Table 3-2](#) are allowed into the **EAGLE**.

For **MSUs** on outgoing linksets, the network indicator code value in the **MSU** is changed to either the national network indicator code value (2) or the national spare network indicator code value (3). If the `nis` parameter is set to `off`, the network indicator code value is set to 2.

These actions are summarized in [Table 3-2](#).

The actions described for this parameter apply only if the **ITU National and International Spare Point Code Support** feature is not enabled.

If the **ITU National and International Spare Point Code Support** feature is enabled, the `nis` parameter value is ignored for **ITU-I** and 14-bit **ITU-N** linksets. All the network indicator values are permitted on **ITU-I** and **ITU-N** linksets, and the network indicator value for transmission is based on the International/National and Spare/Non-Spare status of the **DPC** of the message.

Having the **ITU National and International Spare Point Code Support** feature enabled has no effect on **ANSI** and 24-bit **ITU-N** linksets. The `nis` parameter value determines which incoming network indicator spare bit values to permit, and what network indicator spare bit value should be transmitted.

Table 3-2 Actions of the National Spare for Network Indicator Feature

Linkset Type	Feature Disabled	Feature Enabled
Incoming ANSI Linkset	MSUs containing the national network indicator code (2) are allowed into the EAGLE.	MSUs containing these network indicator code values are allowed into the EAGLE. <ul style="list-style-type: none"> National Network Indicator Code (2) National Spare Network Indicator Code (3)
Outgoing ANSI Linkset	The network indicator code value in the MSU is set to the national network indicator code (2).	The network indicator code value in the MSU is set to the national spare network indicator code (3).
Incoming ITU National Linkset	MSUs containing these network indicator code values are allowed into the EAGLE. <ul style="list-style-type: none"> International Network Indicator Code (0) National Network Indicator Code (2) 	MSUs containing these network indicator code values are allowed into the EAGLE. <ul style="list-style-type: none"> International Network Indicator Code (0) National Network Indicator Code (2) National Spare Network Indicator Code (3)
Outgoing ITU National Linkset	The network indicator code value in the MSU is set to the national network indicator code (2).	The network indicator code value in the MSU is set to the national spare network indicator code (3).

`:itutfr` – specifies whether or not **ITUTFR** (transfer restricted) procedures are being used on the linkset. This parameter applies only to linksets with **ITU** national adjacent point codes (linksets containing either 14-bit **ITU-N** point codes or 24-bit **ITU-N** point codes) and can be specified only for linksets with **ITU** national adjacent point codes. **TFR** procedures are used to redirect traffic away from a node that is having problems routing traffic to a destination. When a node determines that a destination is restricted, the node sends a **TFR** message informing the adjacent nodes about the destination's status. When a destination is restricted, the node should not be used to route messages to the destination even though it still has limited capability to do so. The values for this parameter are either `on` (**ITUTFR** procedures are enabled) or `off` (**ITUTFR** procedures are disabled). For more information about using the `itutfr` parameter, refer to [ITU TFR Procedures](#).

`:mtrpse` – shows if the node adjacent to the **EAGLE** is equipped with the **MTP** restart capability. The `mtrpse=yes` parameter can only be specified if the **MTP** restart feature is turned on for **ANSI** linksets (`MTPRS = on` in the `rtrv-feat` command output), or if the **ITUMTP** restart is on for **ITU** linksets (`ITUMTPRS=on` in the `rtrv-feat` command output). If the **MTP** restart feature is not turned on, the value of the `mtrpse` parameter defaults to `no`. The value of the `mtrpse` parameter value is not dependent on the value of the `mtrpsi` parameter (the **MTP** restart indicator) in the `chg-stpopts` command. The value of the `mtrpse` parameter is only displayed in the `rtrv-ls` command output when a specific linkset is being displayed with the `rtrv-`

`ls:lsn=<linkset name>` command. For more information on MTP Restart feature, refer to [Configuring the MTP Restart Feature](#).

`:slsci` – indicates whether the 5-bit to 8-bit **SLS** conversion feature is used to select signaling links for outgoing messages on the specified link set. If the `slsci=yes` parameter is specified, the **EAGLE** replaces any 5-bit **SLS** values contained in received messages with a random 8-bit value before they are used by the **EAGLE** to select the outgoing signaling link in that linkset. The 5-bit to 8-bit **SLS** conversion is also controlled by the `slscnv` parameter of the `chg-stpopts` command. The `slscnv` parameter of the `chg-stpopts` command has three values: `on`, `off`, and `perl`. The `slsci` parameter can only be specified for linksets with **ANSI SS7** adjacent point codes.

`:asl8` – shows if the node adjacent to the **EAGLE** is sending **MSUs** with 8-bit **SLSs**. If the `asl8=yes` parameter is specified with the `lst=a` parameter (a linkset containing access signaling links), this indicates that the originator of the **MSUs** is generating 8-bit **SLSs**. For other linkset types, the `asl8=yes` parameter indicates that the adjacent node is converting 5-bit **SLSs** to 8-bit **SLSs**. The **SLS** in **MSUs** received by the **EAGLE** on a linkset that has the `asl8=yes` parameter assigned to it will not be converted. These **MSUs** are assumed to contain 8-bit **SLSs**. If the `asl8=no` parameter is specified for the linkset, the **SLS** will be converted to an 8-bit **SLS**. The `asl8` parameter can only be specified for linksets with **ANSI SS7** adjacent point codes. The value of the `asl8` parameter is only displayed in the `rtrv-ls` command output when a specific linkset is being displayed with the `rtrv-ls:lsn=<linkset name>` command. For more information on the `slsci` and `asl8` parameters and 5-bit to 8-bit **SLS** conversion, refer to [Configuring the 5-Bit to 8-Bit SLS Conversion Feature](#).

`:slsrbs` – selects which bit (1 - 4) of the **SLS** field to use as the least significant bit for signaling link selection in the link set for all messages on outgoing ITU linksets.

`:islrsb` – selects which bit of the **SLS** field, 1 - 5 for an ANSI linkset or 1 - 4 for an ITU linkset, to use as the least significant bit for signaling link selection in the link set for all messages on ANSI and ITU linksets on incoming linksets. The `:islrsb` value for an ANSI linkset can be 1 - 8, but can be only 1 - 5 when adding an ANSI linkset. If you wish to use the values 6, 7, or 8 for the `islrsb` parameter, the `rsls8` value for the linkset must be `yes`. Perform these procedures after adding the linkset.

- [Configuring the RLS8 Value for ANSI Linksets](#) – to change the `rsls8` value for the linkset to `yes`.
- [Changing an SS7 Linkset](#) – to change the `islrsb` value.

`:slsocbit` – selects which bit (5 - 16) of the **SLS** field to use as the most significant bit for signaling link selection in the link set for all ITU messages.

Note: For more information on the `slsrbs`, `islrsb`, and `slsocbit` parameters and **ITUSLS** enhancement, refer to [ITU SLS Enhancement](#).

`:multgc` – specifies whether multiple group codes (for 14-bit ITU-N point codes) are supported for the linkset. When this parameter value is `yes`, secondary adjacent point codes whose group codes are different from the adjacent point code of the linkset can be assigned to the linkset. If the parameter value is `no`, the group code of the secondary adjacent point code must be the same as the group code of the linkset's adjacent point code. For more information on secondary adjacent point codes, refer to [Configuring an ITU Linkset with a Secondary Adjacent Point Code \(SAPC\)](#).

This parameter only applies to linksets whose adjacent point codes are either **ITU** international point codes or **ITU** national point codes. All the signaling links in this linkset must be assigned to cards running the **IPLIMI** application. For more information on assigning signaling links to cards running the **IPLIMI** application, go to the “Adding an **IPSignaling Link**” procedure in the *Database Administration - IP7 User's Guide*.

The **ITU** duplicate point code feature must be on before this parameter can be specified. Verify this with the `rtrv-feat` command. If the **ITU** duplicate point code feature is turned on, the `ITUDUPPC` field should be set to `on`. If the **ITU** duplicate point code feature is not turned on, enter the `chg-feat:ituduppc=on` command.

Note: Once the **ITU** duplicate point code feature is turned on with the `chg-feat` command, it cannot be turned off.

The **ITU** duplicate point code feature must be purchased before you turn the feature on with the `chg-feat` command. If you are not sure if you have purchased the **ITU** duplicate point code feature, contact your Oracle Sales Representative or Account Representative.

`:gttmode` – The **GTT** mode assigned to the linkset when performing global title translation on the specified linkset. The values for this parameter are:

- `sysdf1t` – the value of the `df1tgttmode` parameter shown in the `rtrv-sccpopts` command output.
- `cd` - **CdPA** GTT only
- `cg` - **CgPA** GTT only
- `acdc` - Advanced **CdPA** GTT, **CdPA** GTT
- `acdcg` - Advanced **CdPA** GTT, **CgPA** GTT, **CdPA** GTT
- `acdcg` - Advanced **CdPA** GTT, **CdPA** GTT, **CgPA** GTT
- `cgacdc` - **CgPAGTT**, Advanced **CdPA** GTT, **CdPA** GTT
- `cgcd` - **CgPAGTT**, **CdPA** GTT
- `cdcg` - **CdPA** GTT, **CgPA** GTT
- `fc` - Flexible Linkset Optional Based Routing (**FLOBR**) **CdPA** only
- `fcg` - **FLOBR** **CgPA** only
- `fcdfcg` - **FLOBR** **CdPA**, **FLOBR** **CgPA**
- `fcgfc` - **FLOBR** **CgPA**, **FLOBR** **CdPA**

The default value for this parameter is `sysdf1t`. For more information on using the `gttmode` parameter, refer to the Origin-Based SCCP Routing Feature section or the Flexible Linkset Optional Based Routing section in *Database Administration - GTT User's Guide*.

To use the values `cg`, `acdc`, `acdcg`, `acdcg`, `cgacdc`, or `cgcd` for the `gttmode` parameter, the Origin-Based SCCP Routing feature must be enabled and turned on.

To use the values `fc`, `fcg`, `fcdfcg`, or `fcgfc` for the `gtmode` parameter, the Flexible Linkset Optional Based Routing feature must be enabled and turned on.

`:randsls` – The random **SLS** value assigned to the linkset. This parameter is used to apply random **SLS** generation for the specified linkset. The `randsls` parameter has three values:

- `off` – Random **SLS** generation is not applied to the specified linkset.
- `class0` – Random **SLS** generation is applied to only Class 0 **SCCP** messages on either incoming ANSI or outgoing ITU linksets.
- `all` – Random **SLS** generation is applied to both Class 0 and Class 1 **SCCP** messages on outgoing ITU linksets, or to Class 0 **SCCP** messages and **ISUP** messages on ANSI linksets.

For more information about random **SLS** generation on a specific linkset, refer to [Per-Linkset Random SLS](#).

`:cggtmod` - The calling party GT modification indicator. This parameter specifies whether or not calling party global title modification is required. The values for this parameter are `yes` (calling party global title modification is required) or `no` (calling party global title modification is not required). The default value for the `cggtmod` parameter is `no`. This parameter can be specified only if the **AMGTT** or **AMGTT CgPA Upgrade** feature is enabled. Enter the `rtrv-ctrl-feat` command to verify that either the **AMGTT** or **AMGTT CgPA Upgrade** feature is enabled. If the **AMGTT** or **AMGTT CgPA Upgrade** feature is not enabled, perform the "Activating the Advanced GT Modification Feature" procedure in *Database Administration - GTT User's Guide* procedure to enable the required feature. For more information about the Advanced GT Modification feature, refer to the "Advanced GT Modification Feature" section in *Database Administration - GTT User's Guide*.

The linkset also contains the `tfatcabmlq` parameter, whose value is shown in the `rtrv-ls:lsn=<linkset name>` command. The `tfatcabmlq` parameter exists only in the `chg-ls` command and not the `ent-ls` command, because no links are assigned to the linkset when the linkset is first created with the `ent-ls` command. The default value for the `tfatcabmlq` parameter (`tfatcabmlq=0`) is entered for the linkset, and shown in the `rtrv-ls` output as 1, when a new linkset is added to the database.

The **EAGLE** can contain 1024 linksets, with a maximum of 255 of these linksets being gateway linksets. A gateway linkset is a linkset that contains routes to a different network.

The linkset to be added cannot be in the database. This can be verified in step 1 of this procedure.

The adjacent point code (**APC**) must be defined in the database, must be in the **SS7** domain and cannot match the point code or capability point code of the **EAGLE**. This can be verified in steps 2 and 3 of this procedure. The domain of the point code is shown in the `DMN` field in the output of the `rtrv-dstn` command (step 3). The point code of the **EAGLE** is shown in the `PCA`, `PCN`, `PCN24`, or `PCI` fields and the capability point code of the **EAGLE** are shown in the `CPCA`, `CPCN`, `CPCN24`, or `CPCI` fields in the output of the `rtrv-sid` command (step 2). The adjacent point code must be a full point code and cannot be a cluster point code or a network routing point code.

If the **APC** is not in the destination point code table, perform [Adding a Destination Point Code](#) and add the **APC** to the destination point code table.

The `ent-ls` command has a parameter, `gwsd`, that can allow the discarding of messages that should have gone through the gateway screening process, but did not. The `gwsd` parameter is only intended to be used with the **Database Transport Access (DTA)** feature. If you are not using the **DTA** feature, the `gwsd` parameter should not be specified or should be set to `no` (`gwsd=no`).

The `gwsa`, `gwsn`, and `gwsd` parameters can only be specified if the `scrn` parameter is specified. If the `scrn` parameter is specified, the gateway screening screen set name specified by this parameter must also be defined as a gateway screening screen set entity. This can be verified with the `rtrv-scrset` command.

Caution: When **Gateway Screening** is in the screen test mode, as defined by the linkset parameters `gwsa=off` and `gwsn=on`, the gateway screening action in the gateway screening stop action set specified by the `actname` parameter of the gateway screening screen set at the end of the gateway screening process will be performed.

To help manage congestion on signaling links, the **EAGLE** starts the level 3 T31 timer whenever a signaling link goes into congestion level 1 or congestion level 2. The congestion level that is associated with the level 3 T31 timer is set using the `chg-stpopts` command with the `mtpt31ctl` parameter and is displayed with the `MTPT31CTL` field in the `rtrv-stpopts` command output. When the level 3 timer T31 and the `chg-stpopts` command are first introduced to the **EAGLE**, the system default value for the `mtpt31ctl` parameter of the `chg-stpopts` command is 1, for congestion level 1, and the system default value for the level 3 T31 timer is 60 seconds. To change the value of the level 3 T31 timer, perform [Changing Level 3 Timers](#). To change value of the `mtpt31ctl` parameter, enter the either `chg-stpopts:mtpt31ctl=1` or the `chg-stpopts:mtpt31ctl=2` command, depending on the current value of the `mtpt31ctl` parameter.

To help prevent the signaling link in the linkset from oscillating in out of service, the **EAGLE** starts the level 3 T32 timer. When the **EAGLE** begins restoring an out of service signaling link, the **EAGLE** starts the level 3 T32 timer. If the signaling link fails again before the level 3 T32 expires, the **EAGLE** does not attempt to continue to bring the signaling link into service until the level 3 T32 timer expires. Once the level 3 T32 timer expires, the **EAGLE** attempts to restore the signaling link into service. When the level 3 timer T32 is first introduced to the **EAGLE**, the default value for the level 3 T32 timer is 60 seconds. To change the value of the level 3 T32 timer, perform [Changing Level 3 Timers](#).

The word **SEAS** cannot be used as a value for the `scrn` parameter of the `ent-ls` command. The word **SEAS** is used in the `rtrv-ls` command output, in the `SCRN` field, to show gateway linksets created on the **SEAS** interface. A gateway linkset combines the functions of a gateway screening screen set and an **SS7** linkset specifying the `gwsa=on` and `scrn` parameters. Like a **EAGLE** gateway screening screen set, a gateway linkset defines the screening references that are to be used to screen the messages on the linkset. It also defines the linkset whose messages are to be screened. A gateway linkset can only be configured from a **SEAS** terminal and not from a **EAGLE** terminal.

If the `clli` parameter is specified with the `ent-ls` command, the value of the `clli` parameter must match the **CLLI** value of the adjacent point code of the linkset. The **CLLI** value of the adjacent point code is shown in the `CLLI` field of the `rtrv-dstn` command.

If the `randsls` parameter of the `chg-stpopts` command is set to either `all` or `class0`, a maximum of 16 links continues to be supported in a single linkset to a destination. However, it is now possible to have up to 32 links in a combined linkset to a destination, with a maximum of 16 links per linkset. The 32 links is a change from the current **EAGLE** maximum of only 16 links per combined linkset, which is due to ITU protocol restrictions. If more than 16 links are used in a combined linkset, the operator needs to be aware that a maximum of 16 links can be used by non-Random **SLS** traffic over the linkset. The non-Random **SLS** traffic continues to operate under the rules of the ITU protocol. For more information on the Random **SLS** Generation feature, perform [Configuring the System for Random SLS Generation](#).

Canceling the **RTRV-LS** and **RTRV-DSTN** Commands

Because the `rtrv-ls` and `rtrv-dstn` commands used in this procedure can output information for a long period of time, the `rtrv-ls` and `rtrv-dstn` commands can be canceled and the output to the terminal stopped. There are three ways that the `rtrv-ls` and `rtrv-dstn` commands can be canceled.

- Press the F9 function key on the keyboard at the terminal where the `rtrv-ls` or `rtrv-dstn` commands were entered.
- Enter the `canc-cmd` without the `trm` parameter at the terminal where the `rtrv-ls` or `rtrv-dstn` commands were entered.
- Enter the `canc-cmd:trm=<xx>`, where `<xx>` is the terminal where the `rtrv-ls` or `rtrv-dstn` commands were entered, from another terminal other than the terminal where the `rtrv-ls` or `rtrv-dstn` commands were entered. To enter the `canc-cmd:trm=<xx>` command, the terminal must allow Security Administration commands to be entered from it and the user must be allowed to enter Security Administration commands. The terminal's permissions can be verified with the `rtrv-secu-trm` command. The user's permissions can be verified with the `rtrv-user` or `rtrv-secu-user` commands.

For more information about the `canc-cmd` command, go to *Commands User's Guide*.

1. Display the current linkset configuration using the `rtrv-ls` command.

This is an example of the possible output.

```
rlghncxa03w 08-12-10 11:43:04 GMT EAGLE5 40.0.0

      L3T SLT
LSN      APCA  (SS7)  SCRN SET SET BEI LST LNKS  GWS GWS GWS
ele2     001-207-000  none 1  1  no B  6  off off off no  off
ls1305   001-005-000  none 1  1  no A  1  off off off no  off
ls1307   001-007-000  none 1  1  no A  1  off off off no  off
elm1s1   001-001-003  none 1  1  no A  7  off off off no  off
elm1s2   001-001-002  none 1  1  no A  7  off off off no  off

      L3T SLT
LSN      APCI  (SS7)  SCRN SET SET BEI LST LNKS  GWS GWS GWS
ele2i    1-207-0    none 1  1  no B  4  off off off ---  on
ls1315   0-015-0    none 1  1  no A  1  off off off ---  off
ls1317   0-017-0    none 1  1  no A  1  off off off ---  on
elm2s1   1-011-1    none 1  1  no A  7  off off off ---  off
elm2s2   1-011-2    none 1  1  no A  7  off off off ---  off
```

Link set table is (10 of 1024) 1% full.

If the APC of the new linkset will be an APC that is currently assigned to an existing linkset, continue the procedure with 5.

If the APC of the new linkset will not be an APC that is currently assigned to an existing linkset, continue the procedure with 2.

2. Display the point code and capability point code of the **EAGLE** by using the `rtv-sid` command.

This is an example of the possible output.

```
rlghncxa03w 08-12-10 11:43:04 GMT EAGLE5 40.0.0
PCA          PCI          PCN          CLLI          PCTYPE
001-001-001  1-200-6      13482       rlghncxa03w  OTHER

CPCA
002-002-002      002-002-003      002-002-004      002-002-005
002-002-006      002-002-007      002-002-008      002-002-009
004-002-001      004-003-003      144-212-003

CPCA (LNP)
005-005-002      005-005-004      005-005-005

CPCI
1-001-1          1-001-2          1-001-3          1-001-4

CPCN
02091           02092           02094           02097
02191           02192           11177
```

3. Display the point codes in the destination point code table by using the `rtv-dstn` command.

This is an example of the possible output.

```
rlghncxa03w 10-12-10 11:43:04 GMT EAGLE5 43.0.0
Extended Processing Time may be Required

DPCA          CLLI          BEI ELEI  ALIASI          ALIASN/N24  DMN
001-002-003  ls04clli     yes --- -----  -----  SS7
002-002-100  ls01clli     no  --- -----  -----  SS7
002-007-008  ls06clli     yes --- -----  -----  SS7
002-009-003  -----     no  --- -----  -----  SS7
002-250-010  -----     no  --- -----  -----  SS7
003-003-003  ls03clli     yes --- -----  -----  SS7
003-020-100  -----     no  --- -----  -----  SS7
004-004-004  ls02clli     yes --- -----  -----  SS7
004-030-200  -----     no  --- -----  -----  SS7
009-002-003  -----     no  --- -----  -----  SS7
179-100-087  -----     yes --- -----  -----  SS7
200-050-176  -----     yes --- -----  -----  SS7
240-007-000  -----     yes --- -----  -----  SS7
240-012-004  rlghncbb001 yes --- 1-111-1      11111      SS7
240-012-005  rlghncbb002 yes --- 1-112-2      11112      SS7
240-012-006  rlghncbb003 yes --- 1-112-3      11113      SS7
240-012-008  -----     yes --- 1-113-5      11114      SS7

DPCI          CLLI          BEI ELEI  ALIASA          ALIASN/N24  DMN
2-131-1      rlghncbb023 no  --- 222-210-000    12001      SS7
2-131-2      -----     no  --- 222-211-001    12002      SS7
```

```

2-131-3      -----   no ---   222-211-002   12003   SS7
3-150-4      lsi7c1li   yes --- ----- ----- SS7

DPCN        CLLI        BEI  ELEI   ALIASA        ALIASI        DMN
10685      lsn5c1li   yes --- ----- ----- SS7
11211      rlghncbb013 no ---   222-200-200   2-121-1   SS7
11212      rlghncbb013 no ---   222-200-201   2-121-2   SS7

```

Destination table is (24 of 2000) 1% full

Alias table is (18 of 8000) 1% full

If the adjacent point code is not shown in the `rtrv-dstn` command output, go to the [Adding a Destination Point Code](#) procedure and add the adjacent point code to the destination point code table. After the adjacent point code has been added, continue the procedure with 5.

If the adjacent point code is shown in the `rtrv-dstn` command output, continue the procedure with 4.

4. The **APC** of the linkset cannot be the **DPC** of any exception route.

Verify that the adjacent point code of the linkset is not the **DPC** of any exception route by entering the `rtrv-rtx` command with the `dpc/dpca/dpci/dpcn/dpcn24` parameter. The `dpc/dpca/dpci/dpcn/dpcn24` parameter value is the adjacent point code value that will be specified for the linkset.

For this example, enter this command.

```
rtrv-rtx:dpca=002-009-009
```

This is an example of the possible output.

```

rlghncxa03w 08-12-10 11:43:04 GMT EAGLE5 40.0.0
  DPCA          RTX-CRITERIA          LSN          RC          APC
  002-009-009   OPCA
                   007-008-009          ls1305       20          001-005-000
                   008-008-100          ls1307       40          001-007-000

DESTINATION ENTRIES ALLOCATED:    2000
  FULL DPC(s):                    13
  EXCEPTION DPC(s):                5
  NETWORK DPC(s):                  0
  CLUSTER DPC(s):                  1
  TOTAL DPC(s):                    19
  CAPACITY (% FULL):                1%
ALIASES ALLOCATED:                12000
  ALIASES USED:                    0
  CAPACITY (% FULL):                0%
X-LIST ENTRIES ALLOCATED:          500

```

For this example, the `rtrv-rtx` command is entered with the following `dpc/dpca/dpci/dpcn/dpcn24` parameter values:

- `dpca=002-007-008`
- `dpca=009-002-002`
- `dpca=179-100-087`
- `dpca=200-050-176`
- `dpci=3-150-4`

- dpcn=10685
- dpcn=12543

In this example, these point codes are not the **DPC** of a route exception table entry. If the adjacent point code of the linkset is not the **DPC** of a route exception table entry, no entries are displayed in the `rtrv-rtx` output, but a summary of the point code quantities is displayed, as shown in the following output example.

```
r1ghncxa03w 08-12-10 11:43:04 GMT EAGLE5 40.0.0
  DESTINATION ENTRIES ALLOCATED:    2000
    FULL DPC(s):                    15
    EXCEPTION DPC(s):                5
    NETWORK DPC(s):                  0
    CLUSTER DPC(s):                  1
    TOTAL DPC(s):                    21
    CAPACITY (% FULL):                1%
  ALIASES ALLOCATED:                12000
    ALIASES USED:                    0
    CAPACITY (% FULL):                0%
  X-LIST ENTRIES ALLOCATED:         500
```

If the point code specified in this step is shown in the **DPCA** column in this step, the point code value cannot be used as an adjacent point code unless one of two actions are taken:

- Choose another adjacent point code value and repeat this procedure from [2](#).
 - Remove all the entries displayed in this step by performing the [Removing a Route Exception Entry](#) procedure.
5. To specify the following optional parameters for the linkset, the feature that corresponds to the parameters must be shown as turned on in the `rtrv-feat` output, or enabled, and turned on if required, in the `rtrv-ctrl-feat` output, or other database entities that correspond to the parameters must be configured in the database.

Perform the procedure, shown in the following list, that corresponds to the parameters that you wish to specify for the linkset.

- `scrn, gwsa, gwsn, gwsd` – [Verifying the Gateway Screening Configuration for a Linkset](#)
- `mtprse` – [Configuring the MTP Restart Feature](#)
- `slsci, asl8` – [Configuring the 5-Bit to 8-Bit SLS Conversion Feature](#). These parameters only apply to ANSI linksets.
- `:islrsrb` – [Activating the SLS Bit Rotation by Incoming Linkset Feature](#). If you wish to use the values 6, 7, or 8 for the `islrsrb` parameter of an ANSI linkset, the `rsls8` value for the linkset must be `yes`. Perform these procedures after adding the linkset.
 - [Configuring the RLS8 Value for ANSI Linksets](#) – to change the `rsls8` value for the linkset to `yes`.
 - [Changing an SS7 Linkset](#) – to change the `islrsrb` value.

- `gttmode` – If the value for this parameter will be `cg`, `acdc`, `acdcgc`, `acdcgcg`, `cgacdc`, `cgcd`, or `cdcg`, perform the "Activating the Origin-Based SCCP Routing Feature" in *Database Administration – GTT User's Guide*. The Origin-Based SCCP Routing feature must be enabled and turned on. If the value for this parameter will be `fc`, `fcg`, `fcgfc`, or `fcdfcg`, perform the "Activating the Flexible Linkset Optional Based Routing Feature" procedure in *Database Administration – GTT User's Guide*. The Flexible Linkset Optional Based Routing feature must be enabled and turned on.
- `randsls` – [Configuring the System for Random SLS Generation](#). The value of the `randsls` parameter of the `chg-stpopts` command must be `perls`.
- `cgttmode` - "Activating the Advanced GT Modification Feature" in *Database Administration – GTT User's Guide*. Either the AMGTT or AMGTT CgPA Upgrade feature must be enabled.
- `ppc/ppca/ppci/ppcn/ppcn24`, `spc/spca/spci/spcn/spcn24` – [Using Proxy Point Codes and Secondary Point Codes when Adding a Linkset](#).

If you do not wish to specify the parameters shown in this list for the new linkset, continue the procedure by performing one of these steps.

- If the `slsobit` parameter will be specified for the new linkset, continue the procedure with [6](#).
 - If the `multgc` parameter will be specified for the new linkset and the `slsobit` parameter will not be specified for the new linkset, continue the procedure with [8](#).
 - If the `slsobit` and `multgc` parameters will not be specified for the new linkset, continue the procedure with [10](#).
6. To use the `slsobit` parameter with either the `ent-ls` command, the Use of the Other **CIC** Bit feature must be on.

Enter the `rtrv-feat` command to verify that either of this feature is on. The entry `SLSOCB = on` in the `rtrv-feat` command output shows that this feature is on. In this example, the Use of the Other **CIC** Bit feature is off.

Note: The `rtrv-feat` command output contains other fields that are not used by this procedure. If you wish to see all the fields displayed by the `rtrv-feat` command, refer to the `rtrv-feat` command description in *Commands User's Guide*.

If the Use of the Other **CIC** Bit feature is on (`SLSOCB = on`), continue the procedure by performing one of these steps.

- If the `multgc` parameter will be specified for the new linkset, continue the procedure with [8](#).
 - If the `multgc` parameter will not be specified for the new linkset, continue the procedure with [10](#).
7. Turn the Use of the Other **CIC** Bit feature is on feature on by entering this command.

```
chg-feat:slsob=on
```

Note: Once the Use of the Other **CIC** Bit feature is turned on with the `chg-feat` command, it cannot be turned off.

The Use of the Other **CIC** Bit feature must be purchased before you turn the feature on with the `chg-feat` command. If you are not sure if you have purchased the Use of the Other **CIC** Bit feature, contact your Oracle Sales Representative or Account Representative.

When this command has successfully completed, this message should appear.

```
rlghncxa03w 08-12-10 11:43:04 GMT EAGLE5 40.0.0
CHG-FEAT: MASP A - COMPLTD
```

Continue the procedure by performing one of these steps.

- If the `multgc` parameter will be specified for the new linkset, continue the procedure by performing one of these steps.
 - If the `rtrv-feat` command was performed in 6, continue the procedure with [Oracle](#).
 - If the `rtrv-feat` command was not performed in 6, continue the procedure with 8.
 - If the `multgc` parameter will not be specified for the new linkset, continue the procedure with 10.
8. To specify the `multgc=yes` parameter with the `ent-ls` command, the **ITU Duplicate Point Code** feature must be on.

For the **ITU Duplicate Point Code** feature to be on, the **Multiple Point Code** feature must be on. Enter the `rtrv-feat` command to verify that either of these features are on. The entry `MPC = on` in the `rtrv-feat` command output shows that the **Multiple Point Code** feature is on. The entry `ITUDUPPC = on` in the `rtrv-feat` command output shows that the **ITU Duplicate Point Code** feature is on. In this example, both features are off.

Note: The `rtrv-feat` command output contains other fields that are not used by this procedure. If you wish to see all the fields displayed by the `rtrv-feat` command, refer to the `rtrv-feat` command description in *Commands User's Guide*.

If the **ITU Duplicate Point Code** feature is on (`ITUDUPPC = on`), continue the procedure with 10.

If the **ITU Duplicate Point Code** feature is not on (`ITUDUPPC = off`), continue the procedure with [Oracle](#).

9. Turn the **ITU Duplicate Point Code** feature on, and the **Multiple Point Code** feature if necessary, by entering one of these commands.

To turn the **ITU Duplicate Point Code** feature on only.

```
chg-feat:ituduppc=on
```

To turn both the **ITU Duplicate Point Code** and **Multiple Point Code** features on.


```
chg-feat:mpc=on:ituduppc=on.
```

Note: Once the ITU Duplicate **Point Code** and **Multiple Point Code** features are turned on with the `chg-feat` command, they cannot be turned off.

The ITU Duplicate **Point Code** and **Multiple Point Code** features must be purchased before you turn either of these features on with the `chg-feat` command. If you are not sure if you have purchased these features, contact your Oracle Sales Representative or Account Representative.

When this command has successfully completed, this message should appear.

```
rlghncxa03w 08-12-10 11:43:04 GMT EAGLE5 40.0.0
CHG-FEAT: MASP A - COMPLTD
```

10. Add the new linkset to the database using the `ent-ls` command. Use [Table 3-3](#) as a guide for the parameters that can be specified with the `ent-ls` command.

Table 3-3 Adding a Linkset Parameter Combinations

ANSI Adjacent Point Code	ITU-I Adjacent Point Code	ITU-N Adjacent Point Code	ITU-N24 Adjacent Point Code
Mandatory Parameters			
:lsn=<the name of the linkset>	:lsn=<the name of the linkset>	:lsn=<the name of the linkset>	:lsn=<the name of the linkset>
:apc/apca=<the ANSI adjacent point code of the linkset> See Notes 1 and 2.	:apci=<the ITU-I adjacent point code of the linkset> See Notes 1 and 2.	:apcn=<the ITU-N adjacent point code of the linkset> See Notes 1 and 2.	:apcn24=<the ITU-N24 adjacent point code of the linkset> See Notes 1 and 2.
:lst=<a, b, c, d, e, prx> See Note 12.	:lst=<a, b, c, d, e, prx> See Note 12.	:lst=<a, b, c, d, e, prx> See Note 12.	:lst=<a, b, c, d, e, prx> See Note 12.
Optional Parameters			
:cli=<the CLLI value>	:cli=<the CLLI value>	:cli=<the CLLI value>	:cli=<the CLLI value>
:bei=<yes, no>	:bei=<yes, no>	:bei=<yes, no>	:bei=<yes, no>
:scrn=<the name of the Gateway Screening screen set> See Note 3.	:scrn=<the name of the Gateway Screening screen set> See Note 3.	:scrn=<the name of the Gateway Screening screen set> See Note 3.	:scrn=<the name of the Gateway Screening screen set> See Note 3.
:gwsa=<on, off> See Notes 4 and 5.	:gwsa=<on, off> See Notes 4 and 5.	:gwsa=<on, off> See Notes 4 and 5.	:gwsa=<on, off> See Notes 4 and 5.
:gwsn=<on, off> See Notes 4 and 5.	:gwsn=<on, off> See Notes 4 and 5.	:gwsn=<on, off> See Notes 4 and 5.	:gwsn=<on, off> See Notes 4 and 5.
:gwsd=<on, off> See Notes 4 and 5.	:gwsd=<on, off> See Notes 4 and 5.	:gwsd=<on, off> See Notes 4 and 5.	:gwsd=<on, off> See Notes 4 and 5.

Table 3-3 (Cont.) Adding a Linkset Parameter Combinations

ANSI Adjacent Point Code	ITU-I Adjacent Point Code	ITU-N Adjacent Point Code	ITU-N24 Adjacent Point Code
:l3tset=1	:l3tset=1	:l3tset=1	:l3tset=1
:asl8=<yes, no> See Note 6.	:mtpmse=<yes, no> See Note 15.	:mtpmse=<yes, no> See Note 15.	:mtpmse=<yes, no> See Note 15.
:slsci=<yes, no> See Note 6.	:slsocbit=<5 - 16, none> See Notes 17 and 18.	:slsocbit=<5 - 16, none> See Notes 17 and 18.	:slsocbit=<5 - 16, none> See Notes 17 and 18.
:mtpmse=<yes, no> See Note 15.	:slrsrb=<1 - 4> See Note 18.	:slrsrb=<1 - 4> See Note 18.	:slrsrb=<1 - 4> See Note 18.
:sltset=<1 - 20>	:sltset=<1 - 20>	:sltset=<1 - 20>	:sltset=<1 - 20>
:nis=<on, off>	:nis=off	:nis=<on, off>	:nis=<on, off>
:gttmode=<sysdflt, cd, acdcd, cgacdcd, acdcdcg, acdcdcg, cgd, cdcg, cg, fcd, fcg, fcdfcg, fcgfcd> See Note 16.	:gttmode=<sysdflt, cd, acdcd, cgacdcd, acdcdcg, acdcdcg, cgd, cdcg, cg, fcd, fcg, fcdfcg, fcgfcd> See Note 16.	:gttmode=<sysdflt, cd, acdcd, cgacdcd, acdcdcg, acdcdcg, cgd, cdcg, cg, fcd, fcg, fcdfcg, fcgfcd> See Note 16.	:gttmode=<sysdflt, cd, acdcd, cgacdcd, acdcdcg, acdcdcg, cgd, cdcg, cg, fcd, fcg, fcdfcg, fcgfcd> See Note 16.
:spc/spca=<the ANSI secondary point code> See Notes 9 and 11.	:spci=<the ITU-I secondary point code> See Notes 9 and 11.	:spcn=<the ITU-N secondary point code> See Notes 9 and 11.	:spcn24=<the ITU-N24 secondary point code> See Notes 9 and 11.
:ppc/ppca=<the ANSI proxy point code> See Notes 10, 11, and 12.	:ppci=<the ITU-I proxy point code> See Notes 10, 11, and 12.	:ppcn=<the ITU-N proxy point code> See Notes 10, 11, and 12.	:ppcn24=<the ITU-N24 proxy point code> See Notes 10, 11, and 12.
:cggmod=<yes, no> See Note 13.	:cggmod=<yes, no> See Note 13.	:cggmod=<yes, no> See Note 13.	:cggmod=<yes, no> See Note 13.
:islsrsb=<1 - 5> See Note 14.	:islsrsb=<1 - 4> See Note 14.	:islsrsb=<1 - 4> See Note 14.	:islsrsb=<1 - 4> See Note 14.
:randsls=<all, class0, off> See Note 8.	:itutfr=<on, off>	:itutfr=<on, off>	:itutfr=<on, off>
	:multgc=<yes, no> See Note 7.	:multgc=<yes, no> See Note 7.	:multgc=<yes, no> See Note 7.
	:randsls=<all, class0, off> See Note 8.	:randsls=<all, class0, off> See Note 8.	:randsls=<all, class0, off> See Note 8.
		:apcntype=<itun, itunchina>	:apcntype=<itun, itunchina>

Table 3-3 (Cont.) Adding a Linkset Parameter Combinations

ANSI Adjacent Point Code	ITU-I Adjacent Point Code	ITU-N Adjacent Point Code	ITU-N24 Adjacent Point Code
Notes:			
<p>a. The adjacent point code must be a full point code, cannot be an alias point code, and must be shown in the <code>rtrv-dstn</code> output. Private point codes cannot be used as an adjacent point code in this procedure. Private point codes can be assigned only to IPGWx linksets. The procedures for configuring IPGWx linksets are in <i>Database Administration - IP7 User's Guide</i>.</p>			
<p>b. The adjacent point code cannot be shown in the <code>rtrv-sid</code> output as the system's point code or any capability point codes.</p>			
<p>c. If a gateway screening screen set is assigned to the linkset, the gateway screening screen set must be in the database – shown in Verifying the Gateway Screening Configuration for a Linkset.</p>			
<p>d. The <code>gwsa</code>, <code>gwsn</code>, and <code>gwsd</code> parameters can be specified only if the <code>scrn</code> parameter is specified.</p>			
<hr/> <p>Caution: When Gateway Screening is in the screen test mode, as defined by the linkset parameters <code>gwsa=off</code> and <code>gwsn=on</code>, the gateway screening action in the gateway screening stop action set specified by the <code>actname</code> parameter of the gateway screening screen set at the end of the gateway screening process will be performed.</p> <hr/>			
<p>e. The <code>gwsd=on</code> parameter can be specified only with the <code>gwsa=on</code> parameter.</p>			
<p>f. Refer to Table 3-9 for the combinations of the <code>asl8</code> and <code>slsci</code> parameters, and the <code>slscv</code> STP option, and the results that these combinations produce. The <code>asl8</code> and <code>slsci</code> values for two linksets that are in a combined linkset should be the same.</p>			
<p>g. The <code>multgc=yes</code> parameter can be specified only if the linkset being added will contain signaling links assigned to the IPLIMI application, and only for linksets with ITU-I or 14-bit ITU-N APCs. The <code>multgc=yes</code> parameter can be specified only if the ITU National Duplicate Point Code (ITUDUPPC) and Multiple Point Code Support (MPC) features are turned on.</p>			
<p>h. It is recommended that when configuring <code>randsls</code> values on two linksets that are in a combined linkset that the <code>randsls</code> values for these linksets are the same. If these values are not the same, undesired SLS distribution of the traffic on these linksets may result.</p>			
<p>i. The <code>spc/spca/spci/spcn/spcn24</code> parameter can be specified only if the Multiple Linksets to Single PC feature is enabled and turned on.</p>			
<p>j. The <code>ppc/ppca/ppci/ppcn/ppcn24</code> parameter can be specified only if a proxy point code quantity is enabled.</p>			
<p>k. A linkset may not contain both secondary point codes (<code>spc/spca/spci/spcn/spcn24</code>) and proxy point codes (<code>ppc/ppca/ppci/ppcn/ppcn24</code>).</p>			
<p>l. If the linkset type for the linkset is <code>prx</code>, the first time that the APC for this linkset is specified, a proxy point code must be assigned to the APC of the linkset and that proxy point code must be specified for the linkset.</p>			
<p>m. The <code>cggmod</code> parameter can be specified only if either the AMGTT or AMGTT CgPA Upgrade feature is enabled.</p>			

Table 3-3 (Cont.) Adding a Linkset Parameter Combinations

ANSI Adjacent Point Code	ITU-I Adjacent Point Code	ITU-N Adjacent Point Code	ITU-N24 Adjacent Point Code
n.	<p>The <code>islsrsb</code> parameter can be specified only if the SLS Bit Rotation by Incoming Linkset feature is enabled. If you wish to use the values 6, 7, or 8 for the <code>islsrsb</code> parameter of an ANSI linkset, the <code>rsls8</code> value for the linkset must be <code>yes</code>. Perform these procedures after adding the linkset.</p> <ul style="list-style-type: none"> • Configuring the RLS8 Value for ANSI Linksets – to change the <code>rsls8</code> value for the linkset to <code>yes</code>. • Changing an SS7 Linkset – to change the <code>islsrsb</code> value. 		
o.	<p>The <code>mtprse</code> parameter can be specified only if the ANSI or ITU MTP Restart feature is turned on.</p>		
p.	<p>The <code>gttmode</code> parameter can be specified only if the Origin-Based SCCP Routing feature is enabled and turned on, or the Flexible Linkset Optional Based Routing feature is enabled and turned on. If the value for this parameter will be <code>cg</code>, <code>acdc</code>, <code>acdcgc</code>, <code>acdcgcg</code>, <code>cgacd</code>, <code>cgcd</code>, or <code>cdcg</code>, the Origin-Based SCCP Routing feature must be enabled and turned on. If the value for this parameter will be <code>fc</code>, <code>fcg</code>, <code>fcgfc</code>, or <code>fcdfcg</code>, the Flexible Linkset Optional Based Routing feature must be enabled and turned on.</p>		
q.	<p>The <code>sloco</code> parameter can be specified only if the SLSOCB feature is turned on.</p>		
r.	<p>When two linksets are used as a combined linkset, both linksets should use the same <code>srsb</code> and <code>sloco</code> values.</p>		

For this example, enter these commands.

```

ent-
ls:lsn=ls05:apca=002-009-009:lsta=a:scrn=scr2:gwsa=on :gws=of
f:gwsd=on:bei=no:sltset=1:nis=off

ent-
ls:lsn=ls06:apca=002-007-008:lsta=a:scrn=scr4:gwsa=on :gws=of
f:gwsd=off:bei=yes:sltset=4:nis=on

ent-
ls:lsn=ls07:apca=009-002-002:lsta=a:scrn=scr2:gwsa=on :gws=of
f:gwsd=on:bei=no:sltset=1:nis=off:gttmode=cg

ent-
ls:lsn=atmans10:apca=179-100-087:lsta=a:scrn=scr2:gwsa=on :gws
m=off:gwsd=off:bei=yes:sltset=16:nis=off

ent-
ls:lsn=atmans11:apca=200-050-176:lsta=a:scrn=scr1:gwsa=on :gws
d=off:clli=rlghnccc001:bei=no:sltset=9:nis=off:islsrsb=3

ent-
ls:lsn=lsi7:apci=3-150-4:lsta=a:scrn=scr1:gwsa=on:gwsd=off:slt
set=2 :gttmode=acdcgc:randsls=all

ent-
ls:lsn=lsn5:apcn=10685:lsta=a:scrn=scr3:gwsa=on :gwsd=off:slts
et=2:itutfr=on

```

```
ent-
ls:lsn=lsn6:apcn=12543:lst=a:scrn=scr3:gwsa=on :gwsd=off:slts
et=3:itutfr=on:apcntype=itunchina:randsls=class0
```

To provision a proxy linkset for this example, enter this command.

```
ent-ls:lsn=lsnpxy1:apca=004-004-004:lst=prx:ppca=002-002-002
```

To provision a linkset with an existing APC that is not a proxy linkset, for this example enter this command.

```
ent-ls:lsn=lsnmls1:apca=001-001-002:lst=a:spca=021-021-021
```

To provision a linkset with an existing APC that is a proxy linkset, for this example enter this command.

```
ent-ls:lsn=lsnmls2:apca=001-001-002:lst=prx:ppca=002-002-002
```

When each of these commands have successfully completed, this message should appear.

```
rlghncxa03w 08-12-17 16:23:21 GMT EAGLE5 40.0.0
Link set table is ( 19 of 1024) 2% full
ENT-LS: MASP A - COMPLTD
```

11. Verify the changes using the `rtrv-ls` command specifying the linkset name specified in 10 with the `lsn` parameter.

For this example, enter these commands.

```
rtrv-ls:lsn=ls05
```

This is an example of the possible output.

```
rlghncxa03w 09-05-17 11:43:04 GMT EAGLE5 41.0.0

LSN                APCA  (SS7)  L3T  SLT          GWS  GWS  GWS
ls05                002-009-003  scr2  1    1    no  a    0    on  off  on  no  off

                SPCA          CLLI          TFATCABMLQ  MTPRSE  ASL8
                -----  -----  1          no      no

RANDSLS
off

ISLSRSB  RLSLS8
1        no

IPSG  IPGWAPC  GTTMODE          CGGTMOD
no    no      CdPA          no
```

```
Link set table is ( 20 of 1024) 2% full
```

```
rtrv-ls:lsn=ls06
```

This is an example of the possible output.

```
rlghncxa03w 09-05-17 11:43:04 GMT EAGLE5 41.0.0

                L3T  SLT          GWS  GWS  GWS
```

```

LSN          APCA  (SS7)  SCRN SET SET BEI LST LNKS ACT MES DIS SLSCI NIS
ls06         002-007-008  scr4 1  4  no  a  0  on  off off no  on

          SPCA          CLLI          TFATCABMLQ MTPRSE ASL8
----- ls06clli          1          no  no

RANDSLS
off

ISLSRSB RLS8
1      no

IPSG IPGWAPC GTTMODE          CGGTMOD
no   no      CdPA          no

```

Link set table is (20 of 1024) 2% full

rtrv-ls:lsn=ls07

This is an example of the possible output.

rlghncxa03w 09-05-17 11:43:04 GMT EAGLE5 41.0.0

```

          L3T SLT          GWS GWS GWS
LSN          APCA  (SS7)  SCRN SET SET BEI LST LNKS ACT MES DIS SLSCI NIS
ls07         009-002-003  scr2 1  1  no  a  0  on  off on  no  off

          SPCA          CLLI          TFATCABMLQ MTPRSE ASL8
----- ls06clli          1          no  no

RANDSLS
off

ISLSRSB RLS8
1      no

IPSG IPGWAPC GTTMODE          CGGTMOD
no   no      CdPA          no

```

Link set table is (20 of 1024) 2% full

rtrv-ls:lsn=atmansi0

This is an example of the possible output.

rlghncxa03w 09-05-17 11:43:04 GMT EAGLE5 41.0.0

```

          L3T SLT          GWS GWS GWS
LSN          APCA  (SS7)  SCRN SET SET BEI LST LNKS ACT MES DIS SLSCI NIS
atmansi0    179-100-087  scr2 1  16  yes a  0  on  off off no  off

          SPCA          CLLI          TFATCABMLQ MTPRSE ASL8
----- ls06clli          1          no  no

RANDSLS
off

ISLSRSB RLS8
1      no

```

```

      IPSTG IPGWAPC GTTMODE          CGGTMOD
      no   no      CdPA              no

```

Link set table is (20 of 1024) 2% full

```
rtrv-ls:lsn=atmansil
```

This is an example of the possible output.

```
rlghncxa03w 09-05-17 11:43:04 GMT EAGLE5 41.0.0
```

```

      L3T SLT          GWS GWS GWS
LSN      APCA  (SS7)  SCRN SET SET BEI LST LNKS ACT MES DIS SLSCI NIS
atmansil 200-050-176 scr1 1  9  no  a  0  on  off off no  off

```

```

      SPCA          CLLI          TFATCABMLQ MTPRSE ASL8
----- rlgncccc001 1          no  no

```

```

RANDSLS
off

```

```

ISLSRSB RLS8
3      no

```

```

      IPSTG IPGWAPC GTTMODE          CGGTMOD
      no   no      CdPA              no

```

Link set table is (20 of 1024) 2% full

```
rtrv-ls:lsn=lsi7
```

This is an example of the possible output.

```
rlghncxa03w 08-12-17 11:43:04 GMT EAGLE5 40.0.0
```

```

      L3T SLT          GWS GWS GWS
LSN      APCI  (SS7)  SCRN SET SET BEI LST LNKS ACT MES DIS SLSCI NIS
lsi7     3-150-4      scr1 1  2  no  a  0  on  off off no  off

```

```

      SPCI          CLLI          TFATCABMLQ MTPRSE ASL8
-----

```

```

SLSOEBIT SLSRSB RANDSLS ITUTFR
none     1      all     off

```

```

ISLSRSB
1

```

```

      IPSTG IPGWAPC GTTMODE          CGGTMOD
      no   no      AdvCdPA,CgPA,CdPA no

```

Link set table is (20 of 1024) 2% full

```
rtrv-ls:lsn=lsn5
```

This is an example of the possible output.

```
rlghncxa03w 08-12-17 11:43:04 GMT EAGLE5 40.0.0
```

```
L3T SLT
```

```
GWS GWS GWS
```

```

LSN          APCN  (SS7)  SCRN  SET SET BEI LST LNKS ACT MES DIS SLSCI NIS
lsn5         10685          scr3  1  2  no  a  0   on  off off no   off
    
```

```

          SPCN          CLLI          TFATCABMLQ MTPRSE ASL8
-----  -  -  -  -  -  -  -  -  -  -  -  -  -  -  -  -  -  -  -  -  -  -
          lsn5clli          1          no          ---
    
```

```

SLSOCBIT SLSRSB RANDSLS ITUTFR
none     1     off     on
    
```

```

ISLSRSB
1
    
```

```

IPSG  IPGWAPC  GTTMODE          CGGTMOD
no    no      CdPA          no
    
```

Link set table is (20 of 1024) 2% full

```
rtrv-ls:lsn=lsn6
```

This is an example of the possible output.

```
rlghncxa03w 08-12-17 11:43:04 GMT EAGLE5 40.0.0
```

```

          L3T SLT          GWS GWS GWS
LSN (CHINA) APCN  (SS7)  SCRN  SET SET BEI LST LNKS ACT MES DIS SLSCI NIS
lsn6         12543          scr3  1  3  no  A  0   on  off off ---  off
    
```

```

          SPCN          CLLI          TFATCABMLQ MTPRSE ASL8
-----  -  -  -  -  -  -  -  -  -  -  -  -  -  -  -  -  -  -  -  -  -  -
          1          1          ---          ---
    
```

```

SLSOCBIT SLSRSB RANDSLS ITUTFR
none     1     off     on
    
```

```

ISLSRSB
1
    
```

```

IPSG  IPGWAPC  GTTMODE          CGGTMOD
no    no      CdPA          no
    
```

Link set table is (20 of 1024) 2% full

If a proxy linkset was provisioned in 10, for this example, enter this command.

```
rtrv-ls:lsn=lsnpxy1
```

This is an example of the possible output.

```
rlghncxa03w 09-05-14 09:24:36 EST 41.0.0
```

```

          L3T SLT          GWS GWS GWS
LSN          APCA  (SS7)  SCRN  SET SET BEI LST LNKS ACT MES DIS SLSCI NIS
lsnpxy1      004-004-004  none 1  1  no  PRX 0   off off off no   off
    
```

```

          PPCA          CLLI          TFATCABMLQ MTPRSE ASL8
          002-002-002  -----  1          ---          no
    
```

```

RANDSLS
off
    
```



```

ISLSRSB RLS8
1      no

IPSG  IPGWAPC  GTTMODE          CGGTMOD
no    no      CdPA             no

```

Link set table is (9 of 1024) 1% full.

If linkset was provisioned in 10 with an existing APC that is not a proxy linkset, for this example, enter this command.

```
rtrv-ls:lsn=lsnmls1
```

This is an example of the possible output.

```

rlghncxa03w 09-05-14 09:24:36 EST 41.0.0

LSN          APCA  (SS7)  L3T SLT          GWS GWS GWS
lsnmls1     001-001-001  none 1  1  no A  0  off off off no  off

          SPCA          CLLI          TFATCABMLQ MTPRSE ASL8
          021-021-021  -----  1          ---  no

RANDSLS
off

ISLSRSB RLS8
1      no

IPSG  IPGWAPC  GTTMODE          CGGTMOD
no    no      CdPA             no

```

Link set table is (9 of 1024) 1% full.

If linkset was provisioned in 10 with an existing APC that is a proxy linkset, for this example, enter this command.

```
rtrv-ls:lsn=lsnmls2
```

This is an example of the possible output.

```

rlghncxa03w 09-05-14 09:24:36 EST 41.0.0

LSN          APCA  (SS7)  L3T SLT          GWS GWS GWS
lsnmls2     001-001-002  none 1  1  no PRX 0  off off off no  off

          PPCA          CLLI          TFATCABMLQ MTPRSE ASL8
          002-002-002  -----  1          ---  no

RANDSLS
off

ISLSRSB RLS8
1      no

IPSG  IPGWAPC  GTTMODE          CGGTMOD

```

no no CdPA no

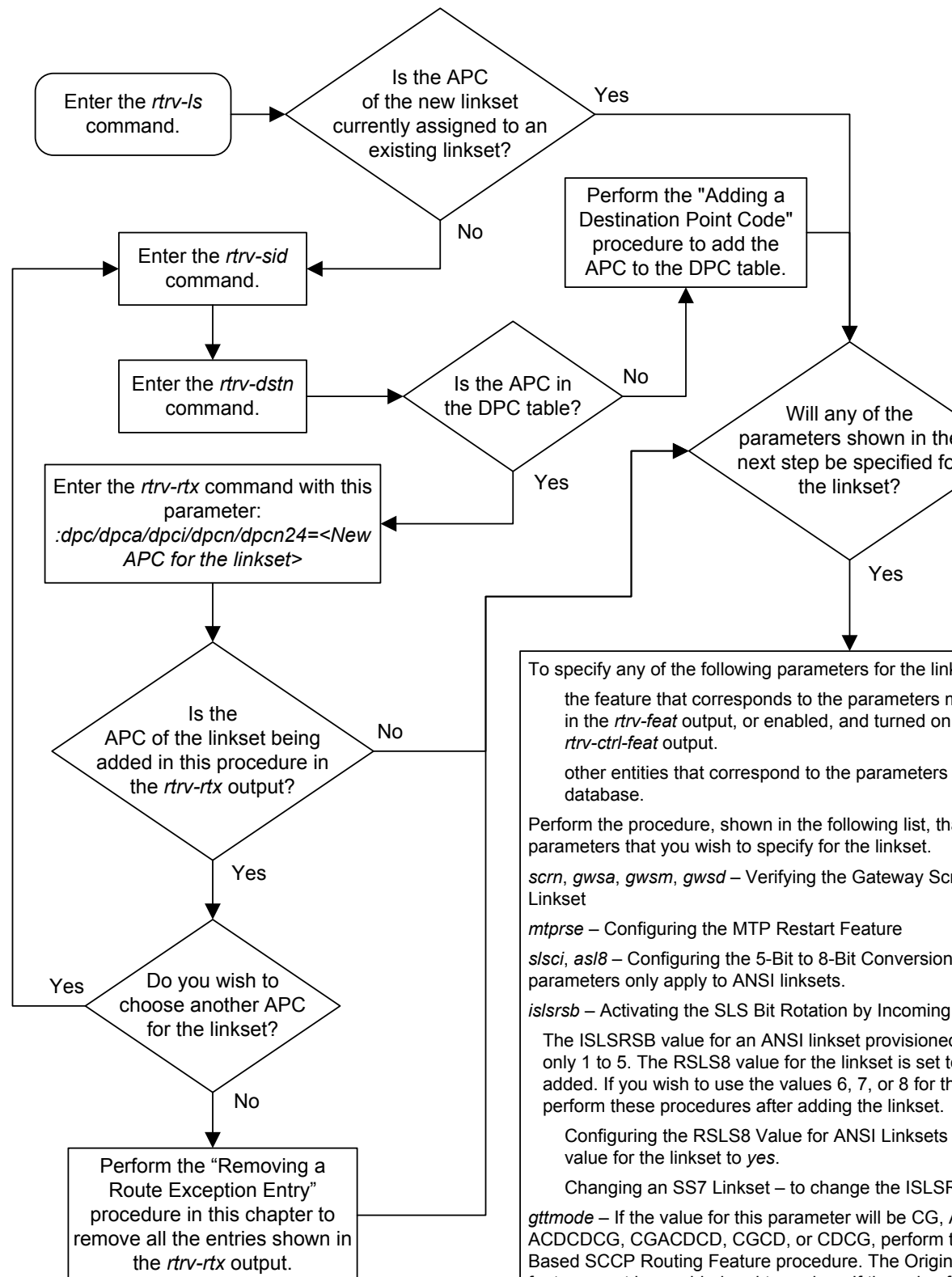
Link set table is (9 of 1024) 1% full.

12. Back up the new changes using the `chg-db:action=backup:dest=fixed` command.

These messages should appear, the active **Maintenance and Administration Subsystem Processor (MASP)** appears first.

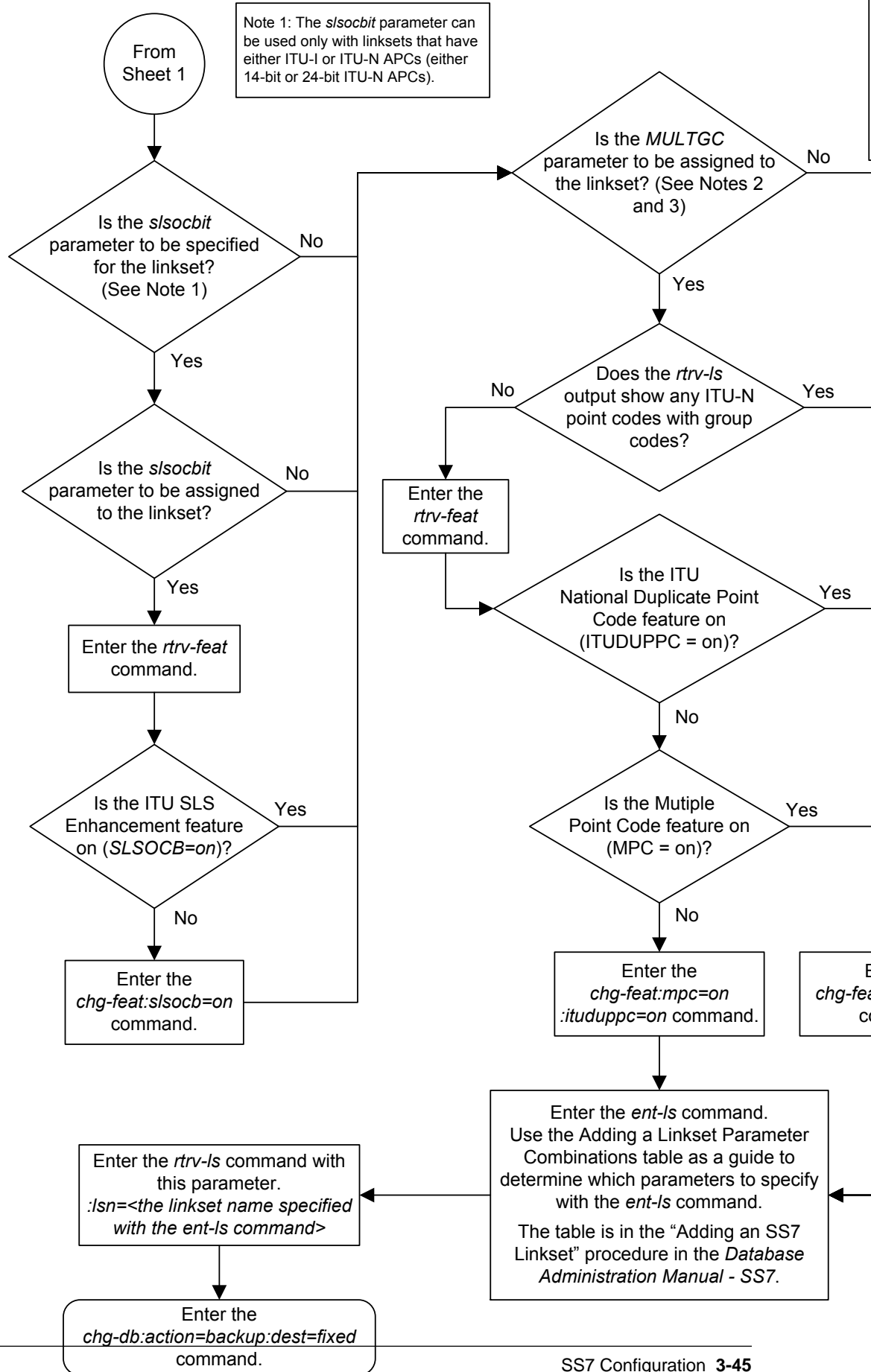
```
BACKUP (FIXED) : MASP A - Backup starts on active MASP.  
BACKUP (FIXED) : MASP A - Backup on active MASP to fixed disk complete.  
BACKUP (FIXED) : MASP A - Backup starts on standby MASP.  
BACKUP (FIXED) : MASP A - Backup on standby MASP to fixed disk complete.
```

Figure 3-1 Adding a SS7 Linkset



To specify any of the following parameters for the linkset, the feature that corresponds to the parameters must be enabled in the *rtrv-feat* output, or enabled, and turned on in the *rtrv-ctrl-feat* output.

- scrn*, *gwsa*, *gwsn*, *gwsd* – Verifying the Gateway Signaling Linkset
- mtrprse* – Configuring the MTP Restart Feature
- slsci*, *asl8* – Configuring the 5-Bit to 8-Bit Conversion parameters only apply to ANSI linksets.
- islsrsb* – Activating the SLS Bit Rotation by Incoming
 - The ISLSRSB value for an ANSI linkset provisioned only 1 to 5. The RLS8 value for the linkset is set to 6. If you wish to use the values 6, 7, or 8 for the RLS8 value, perform these procedures after adding the linkset.
 - Configuring the RLS8 Value for ANSI Linksets – Set the RLS8 value for the linkset to yes.
 - Changing an SS7 Linkset – to change the ISLSRSB value for the linkset to yes.
- gtrmode* – If the value for this parameter will be CG, ACDCDCG, CGACDCD, CGCD, or CDCG, perform the Origin Based SCCP Routing Feature procedure. The Origin Based Routing feature must be enabled and turned on. If the value for this parameter is FCD, FCG, FCGFCD, or FCDFCG, perform the Activation of Optional Based Routing Feature procedure. The Flex Based Routing feature must be enabled and turned on.
- randsls* – Configuring the System for Random SLS Grouping. The *randsls* parameter of the *chg-stpopts* command must be set to yes.
- cgtrmode* – Activating the Advanced GT Modification or AMGTT CgPA Upgrade feature must be enabled.
- ppclppcalppcilppcnlppcn24*, *spclspcalspcilspcnlspcn24* – Configuring Codes and Secondary Point Codes when Adding a Linkset



ITU SLS Enhancement

The ITU SLS Enhancement gives customers the ability to modify the method the EAGLE distributes traffic across SS7 links.

The EAGLE uses the least significant bit of the SLS to load share between linksets of a combined linkset. ITU ISUP messages use a SLS that is obtained from the lower 4 bits of the CIC field representing the circuit being used. Figure 3-2 shows the ITU ISUP routing label with the CIC field.

Figure 3-2 ITU ISUP Routing Label with CIC

16	15	14	13	12	11	10	9	8	7	6	5	4	3	2	1	Bit Location
DPC															Routing Label word 1	
SLS (CIC)					OPC										Routing Label word 2	
Spare					"Other" CIC bits (bits 5-16)										ISUP CIC (cont.)	

CIC selection can be determined based on an odd or even method where a SSP uses either all odd CICs, or all even CICs, to help prevent "glaring" (that is, 2 SSPs attempting to seize the same trunk at the same time). This causes the least significant bit of the SLS to be fixed. If the least significant bit is fixed, inadequate load sharing occurs for the SS7 network. This situation can also occur within a single linkset (international), since the EAGLE also uses the lower 4 bits of the SLS (containing a fixed least significant bit) to select a link within a linkset.

This enhancement provides the user three options for addressing the problem:

- **Bit Rotation** – The EAGLE rotates the 4 bits of the SLS, thus changing the least significant bit of the SLS. If selected, this option is applied to all ITU messages. This option is set with the `slsrsb` parameter of either the `ent-ls` or `chg-ls` commands. This action takes place on the outgoing linkset. More information on this option can be found in [Bit Rotation](#).
- **Use of Other CIC Bit** – The EAGLE derives the SLS from the bits 2 through 4 of the CIC to serve as the three lower bits of SLS, and one other bit of the CIC to serve as the most significant bit of the SLS. If selected, this option is only applied to ITU ISUP messages. This option is set with the `slsocbit` parameter of either the `ent-ls` or `chg-ls` commands. More information on this option can be found in [Use of the Other CIC Bit](#).

Before the Use of the Other CIC Bit option can be set, the Other CIC Bit Used feature must be turned on with the `chg-feat` command and the `slsocb=on` parameter. This can be verified with the `SLSOCB = on` entry of the `rtrv-feat` command output.

The `slsrsb` and `slsocbit` parameters can only be specified for linksets that contain either an ITU international or ITU national adjacent point code (either a 14-bit or 24-bit ITU-N adjacent point code).

The value of the `slsrsb` and `slsocbit` parameters are only displayed in the `rtrv-ls` command output when a specific linkset is being displayed with the `rtrv-ls:lsn=<linkset name>` command.

Note: When two linksets are used as a combined linkset, both linksets should use the same `slsrsb` and `slsobit` values.

Note: If the `randsls` parameter of the `chg-stpopts` command, a system-wide option, is set to either `all` or `class0`, the **EAGLE** uses the Random **SLS** Generation feature to perform load sharing between **ITU** linksets. The `slsrsb` parameter value is ignored. However, the `ent-ls` and `chg-ls` commands allow the `slsrsb` parameter value to be specified. For more information on the Random **SLS** Generation feature, refer to [Configuring the System for Random SLS Generation](#).

- Incoming Bit Rotation - The **EAGLE** changes the least significant bit of the **SLS** on ANSI and ITU messages on incoming linksets by rotating the 4 bits of the **SLS**. This option is set with the `islsrsb` parameter of either the `ent-ls` or `chg-ls` commands. More information on this option can be found in [Incoming Bit Rotation](#).

Only the link selection algorithm is modified by this feature, not the actual **SLS** field of the message (that is, the **SLS** value received by the **EAGLE** is the **SLS** value sent by the **EAGLE**).

Bit Rotation

To alleviate the situation of the **EAGLE** selecting the same linkset of a combined linkset, the customer can apply the bit rotation option. Bit rotation can be used, on a per linkset basis, to ensure the **EAGLE** does not use the static least significant bit (always 0 or always 1) in the received **SLS** for linkset selection.

When defining a link set using the `ent-ls` or `chg-ls` commands, the customer will be able to select which bit (1-4) of the **SLS** field to use as the least significant bit for link set selection. This rotation only affects the 4 bits of the **SLS** during linkset selection, as follows:

- If bit 4 is selected, bit locations 4 3 2 1 will be rotated to 3 2 1 4.
For example: **SLS** = 0110 becomes Rotated **SLS** = 1100. **SLS** = 1011 becomes Rotated **SLS** = 0111
- If bit 3 is selected, bit locations 4 3 2 1 will be rotated to 2 1 4 3.
For example: **SLS** = 0110 becomes Rotated **SLS** = 1001. **SLS** = 1011 becomes Rotated **SLS** = 1110
- If bit 2 selected, bit locations 4 3 2 1 will be rotated to 1 4 3 2.
For example: **SLS** = 0110 becomes Rotated **SLS** = 0011. **SLS** = 1011 becomes Rotated **SLS** = 1101
- If bit 1 is selected, no rotation is performed, since bit 1 is the existing least significant bit. Bit 1 is the default value.

[Figure 3-3](#) shows an example of bit rotation.

Figure 3-3 Example of Bit Rotation

- 1) Customer has selected bit 2 as the "Rotated LSB"
- 2) Received CIC contains the following bits with SLS = 1001



After the **SLS** is rotated, the existing algorithm for selecting a linkset and signaling link is performed, and the message is sent out the selected link. Note that the **SLS** is modified only for the link selection algorithm, and is not modified in the outgoing message.

Use of bit rotation alone does not guarantee an even distribution of **ITU-ISUP** messages across all links within a linkset. The **EAGLE** uses all 4 bits of the **SLS** to determine the actual link to route messages. Since the static bit is simply rotated within the **SLS**, all possible values of the **SLS** field will still not be realized. A second option, Use of the Other **CIC** Bit, must be applied to guarantee even distribution across all links within the linkset.

Use of the Other **CIC Bit**

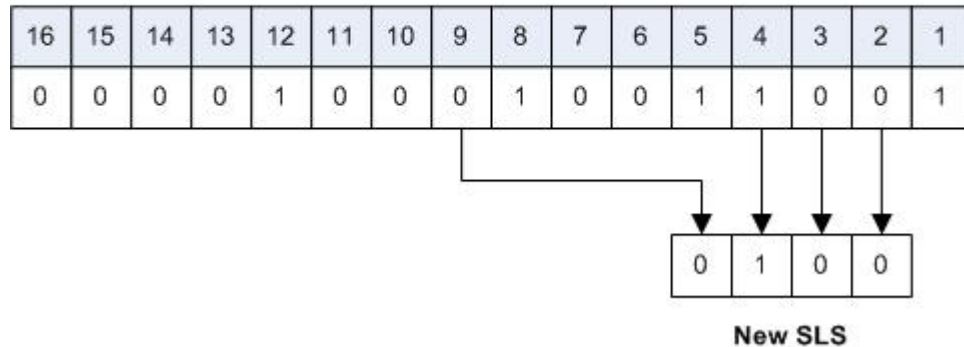
The Use of the Other **CIC** Bit option can be applied by the customer to alleviate the problem of the **EAGLE** not load sharing between all links within a linkset. When defining a linkset with the `chg-ls` or `ent-ls` command, the user can specify whether the Use of the Other **CIC** Bit option is to be used during link selection. If the option is to be used, the customer can also specify which bit (bits 5 through 16 of **CIC**) is to be used as the "other **CIC** bit".

During link selection, the specified bit acts as the most significant bit of the new **SLS**, and bits 2 through 4 of the received **CIC** become the least significant bits of the new **SLS**.

[Figure 3-4](#) shows how the new **SLS** field is generated using the "other **CIC** bit."

Figure 3-4 SLS creation Using “Other CIC Bit”

- 1) Customer has selected bit 9 as the “other CIC bit”
- 2) Received CIC contains the following bits



After the SLS is generated using the “other CIC bit”, the existing algorithm for selecting a linkset and signaling link is performed, and the message is sent out from the selected link. Note that the SLS is modified only for the link selection algorithm, and is not modified in the outgoing message.

Incoming Bit Rotation

Incoming Bit Rotation is set on the incoming linkset, where the existing SLS bit rotation option is set on the outgoing linkset. The algorithm used for rotating the SLS bits on outgoing linksets is also used on incoming linksets. This method provides additional capability to fairly distribute traffic across links and linksets, however it still does not guarantee an even distribution of messages for all set of input SLS values. Rotating SLS Bits on outgoing linksets is supported only for ITU linksets. Rotating SLS bits on incoming linksets is supported for ANSI and ITU linksets. For ITU linksets, the SLS value is only four bits and all four bits are considered for bit rotation. [Table 3-4](#) shows examples of bit rotation for ITU linksets.

Table 3-4 ITU SLS Bit Rotation

Incoming ITU SLS Value	Least Significant Bit Being Rotated	Rotated SLS Value
0110	2	0011
1110	3	1011
0010	1	0010
1101	4	1011

For ANSI linksets, which may have a five or eight bit SLS value, the full five or eight bits are considered for link and linkset selection. [Table 3-5](#) shows the rules that apply to rotating the SLS bit value in an ANSI linkset.

Table 3-5 ANSI Linkset Incoming Bit Rotation Rules

Rule	Incoming Linkset ASL8 Value	Incoming Linkset RLS8 Value	ISLSRSB Values	SLSCNV/ Outgoing Linkset SLSCI Value	Incoming SLS Bit Rotation (ISLSBR)
1	No	No	1 - 5	No	The least significant 5 bits of the SLS are considered for rotation.
2	No	No	1 - 5	Yes	The least significant 5 bits of the SLS are considered for rotation.
3	No	Yes	1 - 8	No	No incoming SLS bit rotation is performed. The 5-Bit to 8-Bit SLS Conversion feature must be turned on to perform incoming SLS bit rotation.
4	No	Yes	1 - 8	Yes	The 8 bit SLS value is obtained after the 5-bit to 8-bit SLS conversion is performed is considered for rotation.
5	Yes	No	1 - 5	N/A	The least significant 5 bits of the SLS are considered for rotation.
6	Yes	Yes	1 - 8	N/A	The 8-bit SLS value is considered for rotation.

Rotating the SLS bits on ANSI linksets is based on the combination of the ASL8, RLSL8, SLSCNV/SLSCI, and ISLSRSB parameter values.

The ASL8 parameter value for the incoming linkset specifies whether the adjacent node is sending messages with a 5-bit SLS or an 8-bit SLS.

If the ASL8 parameter value for the incoming linkset is No, and the global SLSCNV/SLSCI parameter value for the outgoing linkset is Yes, the 5-Bit to 8-Bit SLS Conversion feature is applied to the incoming 5-bit SLS value.

The RLSL8 parameter value for the incoming linkset specifies the number of SLS bits to be considered for rotation. If the RLSL8 value is Yes, 8 bits are considered for rotation. If the RLSL8 value is No, the least significant 5 bits of the SLS are considered for rotation. If the ASL8 value is No, the RLSL8 value is Yes, and the STPCNV/SLSCI value is No, then no rotation is performed. See [Table 3-6](#).

Table 3-6 ANSI SLS Bit Rotation

Incoming ANSI SLS	Incoming Linkset RLSL8 Value	Least Significant Bit Being Rotated	Outgoing ANSI SLS	Rotated SLS	Rule Applied
11000110	No	Bit 2	11000110	11000011	5
01011110	Yes	Bit 7	01011110	01111001	6
10010	No	Bit 4	10110010	10101010	2
10010	Yes	Bit 8	10110010	01100101	4
01101	No	Bit 4	01101	10101	1
01101	Yes	Bit 7	01101	No Rotation	3

The digits shown in bold show the digits that were added to the SLS value by the 5-Bit to 8-Bit SLS Conversion feature. The SLS bits are rotated in this manner.

1. All the bits to the right side of the bit chosen to the least significant bit are removed as a block.
2. The remaining bits are right justified.
3. The block of digits that was removed in step 1 is inserted to the left of the bits that were right justified in step 2.

The new SLS value created after the SLS bits have been rotated is used for linkset and signaling link selection.

Combining the Bit Rotation, Use of the Other CIC Bit, Incoming Bit Rotation, and Random SLS Options

The Bit Rotation, Use of the Other CIC Bit, Incoming Bit Rotation, or Random SLS option, can be applied to provide an even distribution of ITU and ANSI messages sent by the EAGLE. If these options have been activated for a given linkset, the SLS field is processed in the following order.

1. If the RANDSLS value (system-wide or on the incoming linkset) is on, then an 8-bit random SLS value is generated.

2. If the Random SLS option is applied and the system-wide SLSREPLACE value is on, the randomly generated SLS value is replaced. Go to step 5.
3. If the global SLSCNV/SLSCI value for the outgoing linkset is on, the 5-bit ANSI SLS value is converted to an 8-bit SLS value using the 5-Bit to 8-bit SLS Conversion feature.
4. If the Random SLS option is not applied, the converted SLS value is modified using the Incoming Bit Rotation option.
5. The modified SLS value is used by the existing linkset and signaling link selection algorithm to select a linkset and a signaling link.
6. If the linkset type of the outgoing linkset is C (1st=c), the SLS value is modified using the standard fifth bit rotation, replaced in the MSU, and sent to the selected signaling link.

ITU TFR Procedures

Receiving TFR Messages

If ITU TFR procedures have been enabled for the linkset and a TFR message is received on that linkset, the EAGLE marks the route to the destination as restricted and performs controlled rerouting of the messages that are destined for the destination specified in the TFR message.

If ITU TFR procedures have not been enabled for the linkset and a TFR message is received on that linkset, the TFR message is converted to a TFA (transfer allowed) message and traffic is routed to the destination specified in the TFR message. When this condition is present and a TFR is received on this linkset, UIM 1233 is displayed showing that a TFR was received on a linkset that does not support the TFR procedure.

When a TFR message is received for a route that is already prohibited, and no alternative route exists, the traffic to the concerned node is restarted toward the signaling point from which the TFR message was received.

Invalid TFR messages

The TFR message is ignored under any of these conditions:

- The TFR message is not from an adjacent point code.
- The point code specified in the TFR message is being sent from that same point code.
- The TFR message is from an unknown destination.
- The TFR message is from an adjacent point code, but the adjacent point code is not the route for concerned point code.
- If the route to the concerned point code is already restricted.
- The route to concerned point code not found or is unavailable.

Sending TFR Messages

The EAGLE must send a TFR message containing the affected point code (restricted destination) to all accessible adjacent nodes, whose linkset has the TFR procedure enabled, when the following conditions are in effect:

- When long term failure occurs on the ITU-N linkset (primary) used to route messages to the affected point code. Long term failure occurs when all links of a linkset remain unavailable for more than the amount of time specified by level 3 timer T11.
- While waiting for “long term failure” to be determined, if congestion (or “danger of congestion”) is detected on an alternate linkset used to route messages to the affected point code, then **TFRs** are sent immediately without waiting for level 3 timer T11 to expire. For example: level 3 timer T11 is set to 30 seconds, the links of the linkset to the adjacent node fail and **MSUs** are now sent out the alternate linkset. Within 10 seconds of the failure, congestion is detected on the alternate linkset, so **TFR** messages are sent to each adjacent point code (if linkset has **ITUTFR** procedures enabled) for each destination (affected point code) routed through that node.
- When an adjacent node becomes accessible by an alternate route, the **EAGLE** sends a **TFR** for each destination that is restricted to the node.
- During restarts, **TFRs** are broadcast to all accessible adjacent nodes for each restricted destination.

Unlike the **ANSI** network, the **ITU** national network does not use response method **TFR** messages. The **ITU** national network only uses broadcast method **TFR** messages that are sent to all adjacent nodes under the conditions described above.

Note: In **ANSI** networks, response method **TFRs** are sent to adjacent nodes in response to a **MSU**, when that node continues to send **MSUs** after a broadcast method **TFR** has already been sent.

The **EAGLE** maintains the status (allowed, restricted, or prohibited) for all destinations. XREF shows the type of message sent when a destination transitions from one status to another.

Table 3-7 Route Management Messages Sent on Status Transition

Status Transition	ITUTFR Procedures Enabled	ITUTFR Procedures Disabled
Prohibited to Restricted	TFR	TFA
Allowed to Restricted	TFR	None
Restricted to Prohibited	TFP	TFP
Restricted to Allowed	TFA	None

Per-Linkset Random SLS

To achieve load balancing of outgoing traffic on **ITU** linksets, linksets that have either an **ITU-I**, 14-bit **ITU-N**, or 24-bit **ITU-N** adjacent point code assigned, the **EAGLE 5 ISS** currently uses the Random **SLS** option to generate a new **SLS** (signaling link selector) value. The randomly generated **SLS** value is used to select an outgoing signaling link and linkset. Random **SLS** generation applies to either Class 0 **SCCP** messages or to both Class 0 and Class 1 **SCCP** messages. The Random **SLS** option is configured using the `randsls` parameter of the `chg-stpopts` command. Refer to

[Configuring the System for Random SLS Generation](#) for more information on configuring the Random SLS option.

This method of selecting outgoing signaling links and linksets is applied system-wide to all ITU linksets. This may cause problems for some end nodes that may have specific requirements for handling incoming SCCP messages, such as sequencing of Class 1 SCCP messages.

The **Per-Linkset Random SLS** feature provides the ability to apply Random SLS generation to Class 0 and Class 1 SCCP messages on specific outgoing ITU linksets and to Class 0 SCCP messages and ISUP messages on specific incoming ANSI linksets. The `randsls` parameter of either the `ent-ls` or `chg-ls` command applies this feature to the linkset. The `randsls` parameter has three values:

- `off` – Random SLS generation is not applied to the specified linkset.
- `class0` – Random SLS generation is applied to only Class 0 SCCP messages.
- `all` – Random SLS generation is applied to both Class 0 and Class 1 SCCP messages on a specific outgoing ITU linksets, and to both Class 0 SCCP and ISUP messages on specific ANSI linksets.

When per-linkset random SLS is applied to ANSI linksets, linksets that have ANSI adjacent point codes, the SLS of the message is replaced with a randomly generated SLS, only if the `slsreplace` parameter value is set to `yes`. The `slsreplace` parameter value is shown in the `rtrv-ss7opts` output. If the `slsreplace` parameter value is `no`, the EAGLE 5 ISS uses the randomly generated SLS to select the signaling link, but the message retains the original SLS. If the linkset's `asl8` or `slsci` parameter value is `off`, or the `chg-stpopts slscnv` parameter is `off`, a 5-bit SLS is placed in the message. The three most significant bits of the SLS are zeroes. If the linkset's `asl8` or `slsci` parameter value is `on`, or the `slscnv` parameter of the `chg-stpopts` command is `on`, an 8-bit SLS is placed in the message. The linkset's `asl8` parameter value is not used for internal linkset and signaling link selection. The linkset's `asl8` parameter applies only to incoming linksets. The linkset's `slsci` parameter applies only to outgoing linksets. The randomly generated SLS value is used for internal linkset and signaling link selection. When an ANSI to ITU conversion takes place, the randomly generated SLS value for the incoming ANSI linkset is used for internal linkset and signaling link selection and Random SLS generation on outgoing linkset is not performed.

The `randsls` parameter is optional. If the `randsls` parameter is not specified when adding a linkset with the `ent-ls` command, the value of the `randsls` parameter is `off`. If the `randsls` parameter is not specified when changing a linkset with the `chg-ls` command, the value of the `randsls` parameter is not changed.

The value of the `randsls` parameter assigned to the linkset is displayed in the `RANDSLS` column of the `rtrv-ls` command output. The `RANDSLS` column is displayed only when a specific linkset is being displayed with the `rtrv-ls:lsn=<linkset name>` command. All linksets having a particular `randsls` value can be displayed by entering the `rtrv-ls` command with the `randsls` parameter with one of these values:

- `off` – Displays the linksets where random SLS generation is disabled.
- `class0` – Displays the linksets where random SLS generation for Class 0 SCCP traffic is enabled.

- `all` – Displays the linksets where random **SLS** generation for Class 0 and Class 1 **SCCP** traffic on a specific outgoing ITU linksets is enabled, and Class 0 **SCCP** and **ISUP** messages on specific incoming ANSI linksets is enabled..

For random SLS generation to be performed on a specific linkset, the `randsls` parameter value for that linkset must be set to either `class0` or `all`. The system-wide random SLS STP option `randsls` must be set to `perls` using the `chg-stpopts` command with the `randsls=perls` parameter. Refer to [Configuring the System for Random SLS Generation](#) for more information on configuring the system-wide Random **SLS** option, and, if Random SLS is applied to ANSI linksets, to configure the SS7 option for replacing the SLS in the message with the randomly generated SLS.

It is recommended that when configuring `randsls` values on two linksets that are in a combined linkset that the `randsls` values for these linksets are the same. If these values are not the same, undesired **SLS** distribution of the traffic on these linksets may result.

Verifying the Gateway Screening Configuration for a Linkset

This procedure is used to verify that the screen set that will be assigned to the linkset, and its associated screens, is in the database.

1. Display the current linkset configuration using the `rtrv-ls` command.

This is an example of the possible output.

```
rlghncxa03w 08-12-10 11:43:04 GMT EAGLE5 40.0.0
```

LSN	APCA	(SS7)	SCRN	L3T SLT			LST	LNKS	GWS			SLSCI	NIS
				SET	SET	BEI			ACT	MES	DIS		
ele2	001-207-000	none	1	1	no	B	6	off	off	off	no	off	
ls04	001-002-003	scr2	1	1	no	a	4	off	off	off	yes	off	
ls1305	001-005-000	none	1	1	no	A	1	off	off	off	no	off	
ls1307	001-007-000	none	1	1	no	A	1	off	off	off	no	off	
elm1s1	001-001-003	none	1	1	no	A	7	off	off	off	no	off	
elm1s2	001-001-002	none	1	1	no	A	7	off	off	off	no	off	

LSN	APCI	(SS7)	SCRN	L3T SLT			LST	LNKS	GWS			SLSCI	NIS
				SET	SET	BEI			ACT	MES	DIS		
ele2i	1-207-0	none	1	1	no	B	4	off	off	off	---	on	
ls1315	0-015-0	none	1	1	no	A	1	off	off	off	---	off	
ls1317	0-017-0	none	1	1	no	A	1	off	off	off	---	on	
elm2s1	1-011-1	none	1	1	no	A	7	off	off	off	---	off	
elm2s2	1-011-2	none	1	1	no	A	7	off	off	off	---	off	

Link set table is (10 of 1024) 1% full.

A screenset that is assigned to another linkset can be assigned to the new linkset or the linkset that is being changed. If you wish to use a screenset shown in the `rtrv-ls` output, continue the procedure by performing one of these actions.

- If you wish to examine the content of the screen set, continue the procedure with the [3](#).
- If you do not wish to examine the content of the screen set, and the screen set is being assigned to a new linkset, this procedure is finished. If the screen set is being assigned to an existing linkset, continue the procedure with [5](#).

If you do not wish to use a screenset shown in the `rtrv-ls` output, continue the procedure with the [2](#).

2. Verify that the gateway screening screen set that is to be assigned to the linkset is in the database by entering the `rtrv-scrset` command.

This is an example of the possible output.

```
rlghncxa03w 08-12-28 16:37:05 GMT EAGLE5 40.0.0
ENTIRE GWS DATABASE IS 1% FULL
CDPA + AFTPC TABLES ARE 1% FULL
SCREEN SET TABLE IS (12 OF 255) 5% FULL
THERE ARE 0 SEAS SCREEN SETS USED ( prefix 00nn )
THERE ARE 12 EAGLE SCREEN SETS USED
```

SCRN	NSFI	NSR/ACT	FULL	RULES	TABLES	DESTFLD
fld1	OPC	fld2	1%	5	4	NO
gws1	OPC	gws4	1%	9	7	NO
gws2	BLKOPC	gws5	1%	5	4	NO
ls01	SIO	ls02	1%	3	3	YES
scr1	OPC	opc1	1%	13	10	YES
scr2	OPC	opc2	2%	75	22	YES
scr3	OPC	opc3	2%	75	22	YES
scr4	OPC	opc1	51%	2075	22	NO
scr5	OPC	opc1	51%	2075	22	YES
scr6	OPC	opc1	51%	2075	22	NO
ss28	OPC	opc1	51%	2075	22	YES
wrld1	SIO	iec	1%	6	5	YES

If you wish to examine the contents of a particular screen set, continue the procedure with [3](#).

If you do not wish to examine the content of the screen set, and the screen set is being assigned to a new linkset, this procedure is finished. If the screen set is being assigned to an existing linkset, continue the procedure with [5](#).

If the screen set is being assigned to a new linkset, this procedure is finished. If the screen set is being assigned to an existing linkset, continue the procedure with [5](#).

3. Enter the `rtrv-scrset` command specifying a screen set name shown in the `SCRN` field of either the `rtrv-scrset` command executed in [2](#) or the `rtrv-ls` command executed in [1](#).

For this example, enter this command.

```
rtrv-scrset:scrn=scr1
```

This is an example of the possible output.

```
rlghncxa03w 08-12-14 16:39:04 GMT EAGLE5 40.0.0
SCRN NSFI NSR/ACT RULES DESTFLD
scr1 OPC opc1 1 Y
      BLKDPC bkd2 2
      CGPA cgp1 3
      TT tt1 1
      TT tt2 1
      TT tt3 1
      CDPA cdp1 1
      CDPA cdp2 1
```



```

CDPA    cdp3        1
AFTPC   end1       1

```

The output of this command shows the screens that make up the screen set. These screens can be examined by entering the gateway screening retrieve command corresponding to the value in the `NSFI` field and specifying the screening reference name shown in the `NSR/ACT` field.

If you wish to examine the content of these screens, continue the procedure with [4](#).

If you do not wish to examine the content of these screens, and the screen set is being assigned to a new linkset, this procedure is finished. If the screen set is being assigned to an existing linkset, continue the procedure with [5](#).

4. Enter the gateway screening retrieve command corresponding to the value in the `NSFI` field and specifying the screening reference name shown in the `NSR/ACT` field

For this example, enter these commands.

```
rtrv-scr-opc:sr=opc1
```

The following is an example of the possible output.

```

rlghncxa03w 08-12-25 15:30:30 GMT  EAGLE5 40.0.0
SCREEN = ALLOWED OPC
SR   NI      NC      NCM      NSFI      NSR/ACT
opc1 001      001      001      BLKOPC   bkd2

```

```
rtrv-scr-blkdpc:sr=bkd2
```

The following is an example of the possible output.

```

rlghncxa03w 08-12-25 15:30:30 GMT  EAGLE5 40.0.0
SCREEN = BLOCKED OPC
SR   NI      NC      NCM      NSFI      NSR/ACT
bkd2 002      002      002      FAIL      -----
bkd2 C        C        C        CGPA      cgp1

```

```
rtrv-scr-cgpa:sr=cgp1
```

The following is an example of the possible output.

```

rlghncxa03w 08-12-25 15:30:30 GMT  EAGLE5 40.0.0
SCREEN = ALLOWED CGPA
SR   NI      NC      NCM      SSN      RI      SCCPMT  NSFI      NSR/ACT
cgp1 007      007      007      250      SSN    017      TT        tt1
cgp1 007      007      008      50       SSN    017      TT        tt2
cgp1 007      007      009      75       SSN    017      TT        tt3

```

```
rtrv-scr-tt:sr=tt1
```

The following is an example of the possible output.

```

rlghncxa03w 08-12-25 15:30:30 GMT  EAGLE5 40.0.0
SCREEN = ALLOWED TT
SR   TYPE      NSFI      NSR/ACT
tt1  250          CDPA      cdp1

```

```
rtrv-scr-tt:sr=tt2
```

The following is an example of the possible output.

```
rlghncxa03w 08-12-25 15:30:30 GMT EAGLE5 40.0.0
SCREEN = ALLOWED TT
SR   TYPE   NSFI   NSR/ACT
tt2   50     CDPA   cdp2
```

```
rtrv-scr-tt:sr=tt3
```

The following is an example of the possible output.

```
rlghncxa03w 08-12-25 15:30:30 GMT EAGLE5 40.0.0
SCREEN = ALLOWED TT
SR   TYPE   NSFI   NSR/ACT
tt3  100     CDPA   cdp3
```

```
rtrv-scr-cdpa:sr=cdp1
```

The following is an example of the possible output.

```
rlghncxa03w 08-12-25 15:30:30 GMT EAGLE5 40.0.0
SCREEN = ALLOWED CDPA
SR   NI     NC     NCM     SSN     SCMGFID  NSFI   NSR/ACT
cdp1 007     007     007     001     100     AFTPC  end1
```

```
rtrv-scr-cdpa:sr=cdp2
```

The following is an example of the possible output.

```
rlghncxa03w 08-12-25 15:30:30 GMT EAGLE5 40.0.0
SCREEN = ALLOWED CDPA
SR   NI     NC     NCM     SSN     SCMGFID  NSFI   NSR/ACT
cdp2 007     007     008     001     120     AFTPC  end1
```

```
rtrv-scr-cdpa:sr=cdp3
```

The following is an example of the possible output.

```
rlghncxa03w 08-12-25 15:30:30 GMT EAGLE5 40.0.0
SCREEN = ALLOWED CDPA
SR   NI     NC     NCM     SSN     SCMGFID  NSFI   NSR/ACT
cdp3 007     007     009     001     150     AFTPC  end1
```

```
rtrv-scr-aftpc:sr=end1
```

The following is an example of the possible output.

```
rlghncxa03w 08-12-25 15:30:30 GMT EAGLE5 40.0.0
SCREEN = ALLOWED AFTPC
SR   NI     NC     NCM     SSN     NSFI   NSR/ACT
end1 008     008     008     250     STOP   -----
```

If you do not wish to assign this screen set to the linkset, perform the "Adding a Screen Set" procedure in the *Database Administration Manual - Gateway Screening* to add the desired screen set to the database.

If the screen set is being assigned to a new linkset, this procedure is finished. If the screen set is being assigned to an existing linkset, continue the procedure with 5.

- Remove the existing screen set assignment from the linkset by entering the `chg-ls` command with the name of the linkset and the `scrn=none` parameter.

For this example, enter this command.

```
chg-ls:lsn=ls04:scrn=none
```

When this command has successfully completed, this message should appear.

```
rlghncxa03w 08-12-17 16:23:21 GMT EAGLE5 40.0.0
Link set table is ( 19 of 1024) 2% full
CHG-LS: MASP A - COMPLTD
```

- Verify the changes using the `rtrv-ls` command specifying the linkset name specified in 5 with the `lsn` parameter.

For this example, enter this command.

```
rtrv-ls:lsn=ls04
```

This is an example of the possible output.

```
rlghncxa03w 09-10-17 11:43:04 GMT EAGLE5 41.1.0

LSN                APCA  (SS7)  SCRN SET SET BEI LST LNKS ACT MES DIS SLSCI NIS
ls04                001-002-003 none 1  1  no  a  4  off off off yes  off

                CLLI          TFATCABMLQ MTPRSE ASL8
                ls04clli        2          no    no

                IPGWAPC MATELSN   IPTPS LSUSEALM SLKUSEALM GTTMODE
                no          ----- ---    ---    ---          CdPA

                L2T
                LOC  LINK SLC TYPE  SET  BPS  ECM  PCR  PCR
                1205 b   0  LIMDS0  1   56000 BASIC ---  -----
                1213 b   1  LIMDS0  1   56000 BASIC ---  -----
                1211 a   2  LIMDS0  1   56000 BASIC ---  -----
                1207 b   3  LIMDS0  1   56000 BASIC ---  -----
```

```
Link set table is ( 19 of 1024) 2% full
```

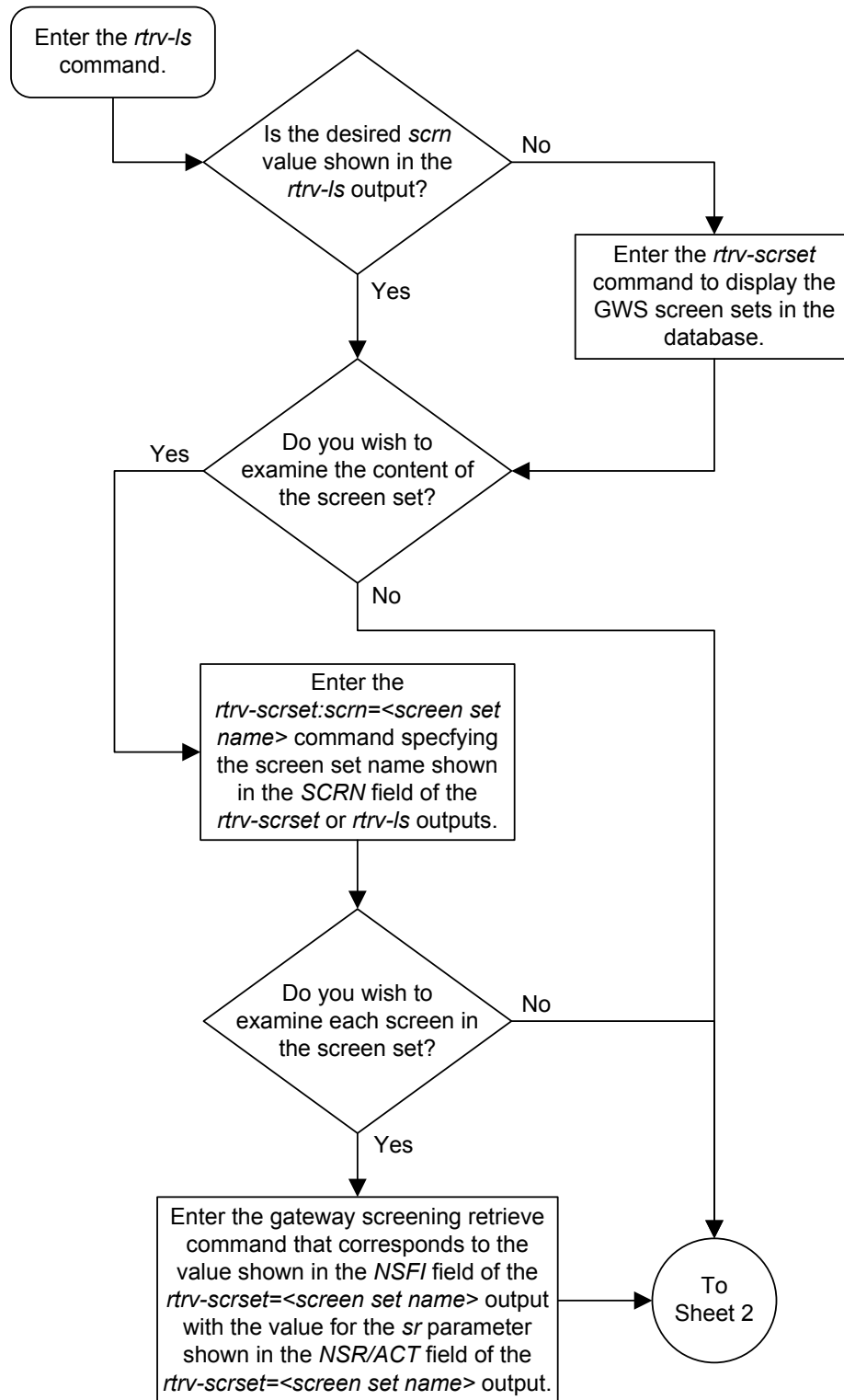
- Back up the new changes using the `chg-db:action=backup:dest=fixed` command.

These messages should appear, the active **Maintenance and Administration Subsystem Processor (MASP)** appears first.

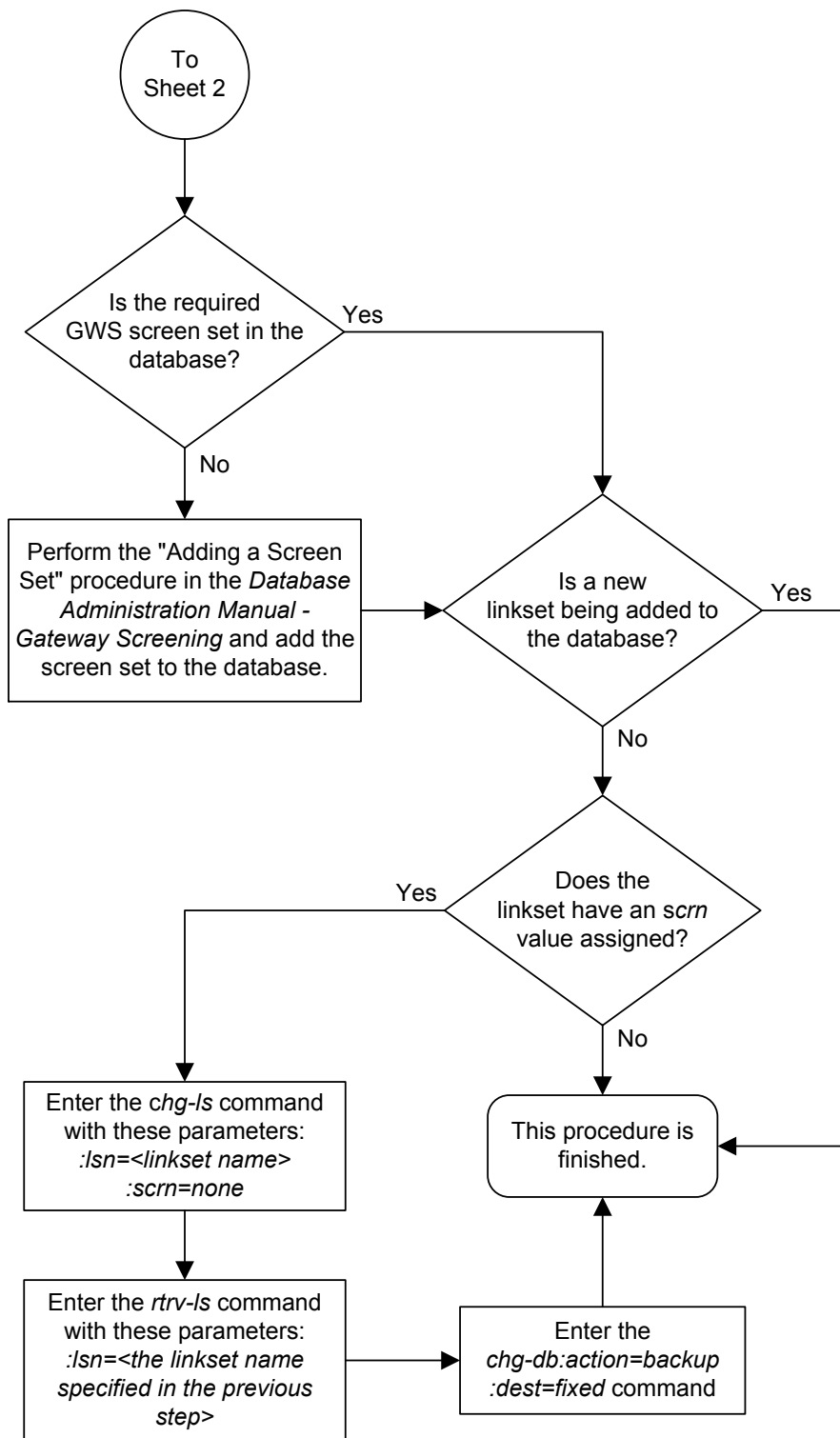
```
BACKUP (FIXED) : MASP A - Backup starts on active MASP.
BACKUP (FIXED) : MASP A - Backup on active MASP to fixed disk complete.
BACKUP (FIXED) : MASP A - Backup starts on standby MASP.
BACKUP (FIXED) : MASP A - Backup on standby MASP to fixed disk complete.
```

This procedure is finished.

Figure 3-5 Verifying the Gateway Screening Configuration for a Linkset



Sheet 1 of 2



Configuring the MTP Restart Feature

This procedure is used to configure the MTP Restart feature with the following commands and parameters.

- `chg-feat - mtprs=on` (to turn on MTP Restart for ANSI signaling links) and `itumtprs=on` (to turn on MTP Restart for ITU signaling links)
- `chg-stpopts`
 - `on=mtparsi` - to enable the MTP Restart process, or `off=mtparsi` , to disable the MTP Restart process. When the `on=mtparsi` parameter is specified for the `chg-stpopts` command, the value `yes` is shown in the `MTPRSI` field of the `rtrv-stpopts` output. When the `off=mtparsi` parameter is specified for the `chg-stpopts` command, the value `no` is shown in the `MTPRSI` field of the `rtrv-stpopts` output. The system default value for this option is `no`.
 - `mtprsit` - the MTP restart isolation timer - 2000 to 900000 milliseconds. The system default value is 5000 milliseconds.

The MTP restart feature is applied to the signaling links in a linkset by specifying the `mtpmse=yes` parameter of the `ent-ls` or `chg-ls` commands. Perform [Adding an SS7 Linkset](#) or [Changing an SS7 Linkset](#) to specify the `mtpmse` value for a linkset.

If the MTP restart feature is turned on, the alignment of all signaling links is delayed until all the LIMs containing signaling links are in service. This allows the EAGLE to be restored to network service in an orderly fashion and allows all the LIMs containing signaling links to participate in the MTP restart process. The amount of time that the alignment of the signaling links is delayed is dependent on the number of LIMs and DCMs in the EAGLE and is shown in [Table 3-8](#). [Table 3-8](#) shows an example of MTP signaling link alignment delay for LIMs.

Note: The MTP restart feature can be used on linksets containing non-IP signaling links, IP signaling links with the `ipliml2=m2pa` parameter, or IPSP signaling links with the `ipsg=yes` and `adapter=m2pa` parameters.

Table 3-8 MTP Restart Signaling Link Alignment Delay

Number of LIMs Containing Signaling Links	Signaling Link Alignment Delay
1 to 64	62 seconds
64 to 127	97 seconds
128 to 191	132 seconds
192 or more	167 seconds

If the ANSI MTP restart feature is on (`MTPRS = on` in the `rtrv-feat` command output), the `mtparsi` parameter is set to `yes`, and at least one ANSI linkset has the `mtpmse` parameter set to `yes`, the EAGLE starts these level 3 timers; T22, T23, T24, T25, T26, T28, T29, and T30 to control the behavior of the MTP restart feature. These timers control when the TRA and TRW network management messages are sent to the

nodes adjacent to the **EAGLE** when the **EAGLE** is going through the **MTP** restart process. When these timers are first introduced to the **EAGLE**, the system default values for these timers are:

- T22 - 10 seconds
- T23 - 10 seconds
- T24 - 10 seconds
- T25 - 30 seconds
- T26 - 12 seconds
- T28 - 3 seconds
- T29 - 60 seconds
- T30 - 30 seconds.

To change the values of these timers, perform [Changing Level 3 Timers](#).

If the **ITU** MTP restart feature is on (`ITUMTPRS = on` in the `rtrv-feat` command output), the `mtparsi` parameter is set to `yes`, and at least one **ITU** linkset has the `mtparse` parameter set to `yes`, the **EAGLE** starts these level 3 timers; **IT18**, **IT19**, **IT20**, and **IT21** to control the behavior of the **ITU** MTP restart feature. These timers control when the **TRA** and **TRW** network management messages are sent to the nodes adjacent to the **EAGLE** when the **EAGLE** is going through the **MTP** restart process. When these timers are first introduced to the **EAGLE**, the default values for these timers are:

- **IT18** - 50 seconds
- **IT19** - 67 seconds
- **IT20** - 59 seconds
- **IT21** - 63 seconds.

To change the values of these timers, perform [Changing Level 3 Timers](#).

If both the **ANSI** and **ITU** MTP restart features are on, the `mtparsi` parameter is set to `yes`, and at least one **ANSI** and **ITU** linkset has the `mtparse` parameter set to `yes`, the **EAGLE** starts the level 3 timers for both the **ANSI** and **ITU** MTP restart features to control the behavior of both the **ANSI** and **ITU** MTP restart features.

1. If you wish to use either the **ANSI** MTP restart feature or the **ITU** MTP restart feature, enter the `rtrv-feat` command to verify that either of these features are on.

The entry `MTPRS = on` in the `rtrv-feat` command output shows that the **ANSI** MTP restart feature is on. The entry `ITUMTPRS = on` in the `rtrv-feat` command output shows that the **ITU** MTP restart feature is on. In this example, both features are off.

Note: The `rtrv-feat` command output contains other fields that are not used by this procedure. If you wish to see all the fields displayed by the `rtrv-feat` command, see the `rtrv-feat` command description in *Commands User's Guide*.

If both the **ANSI** and **ITU MTP** restart feature are on, continue the procedure with [4](#).

If you are not going to turn the **ANSI MTP** restart feature on, or if the output of the `rtrv-feat` command in this step shows that the **ANSI MTP** restart feature is on (shown by the `MPTRS = on` entry), continue the procedure with [3](#).

- Turn the **ANSI MTP** restart feature on by entering this command.

```
chg-feat:mtprs=on
```

Note: Once the **ANSI MTP** restart feature is turned on with the `chg-feat` command, it cannot be turned off.

The **ANSI MTP** restart feature must be purchased before you turn the feature on with the `chg-feat` command. If you are not sure if you have purchased the **ANSI MTP** restart feature, contact your Sales Representative or Account Representative.

When this command has successfully completed, this message should appear.

```
rlghncxa03w 06-10-10 11:43:04 GMT EAGLE5 36.0.0
CHG-FEAT: MASP A - COMPLTD
```

Note: If you are not going to turn the **ITUMTP** restart feature on, or if the output of the `rtrv-feat` command in [1](#) shows that the **ITU MTP** restart feature is on (shown by the `ITUMPTRS = on` entry), continue the procedure with [4](#).

- Turn the **ITU MTP** restart feature on by entering this command.

```
chg-feat:itumtprs=on
```

Note: Once the **ITU MTP** restart feature is turned on with the `chg-feat` command, it cannot be turned off.

The **ITU MTP** restart feature must be purchased before you turn the feature on with the `chg-feat` command. If you are not sure if you have purchased the **ITU MTP** restart feature, contact your Sales Representative or Account Representative.

When this command has successfully completed, this message should appear.

```
rlghncxa03w 06-10-10 11:43:04 GMT EAGLE5 36.0.0
CHG-FEAT: MASP A - COMPLTD
```

- Enter the `rtrv-stpopts` command to display the value of the `MTPRSI` and `MTPRSIT` fields. This is an example of the possible output.

```
rlghncxa03w 06-10-17 16:02:05 GMT EAGLE5 36.0.0
STP OPTIONS
-----
```

```
MTPRSI          no
MTPRSIT        5000
```

Note: The `rtrv-stpopts` command output contains other fields that are not used by this procedure. If you wish to see all the fields displayed by the `rtrv-stpopts` command, see the `rtrv-stpopts` command description in *Commands User's Guide*.

To change the value of the MTPRSI or the MTPRSIT fields, continue the procedure with 5.

If you do not wish to change the value of the MTPRSI or the MTPRSIT fields, continue the procedure with 7.

- Change the MTPRSI or MTPRSIT values by entering the `chg-stpopts` command with one or more of these parameters.

- `:on=mtprsi` - to enable the MTP restart process.
- `:off=mtprsi` - to disable the MTP restart process.
- `:mtprsit` - to specify a new value for the MTP restart isolation timer.

For this example, enter this command.

```
chg-stpopts:on=mtprsi:mtprsit=7500
```

For this example, the MTP restart process is enabled and the value of the MTP restart isolation timer is changed.

When the `chg-stpopts` command has successfully completed, this message should appear.

```
rlghncxa03w 06-10-07 00:22:57 GMT  EAGLE5 36.0.0
CHG-STPOPTS: MASP A - COMPLTD
```

- Verify the changes using the `rtrv-stpopts` command.

This is an example of the possible output.

```
rlghncxa03w 06-10-17 16:02:05 GMT  EAGLE5 36.0.0
STP OPTIONS
-----
MTPRSI          yes
MTPRSIT        7500
```

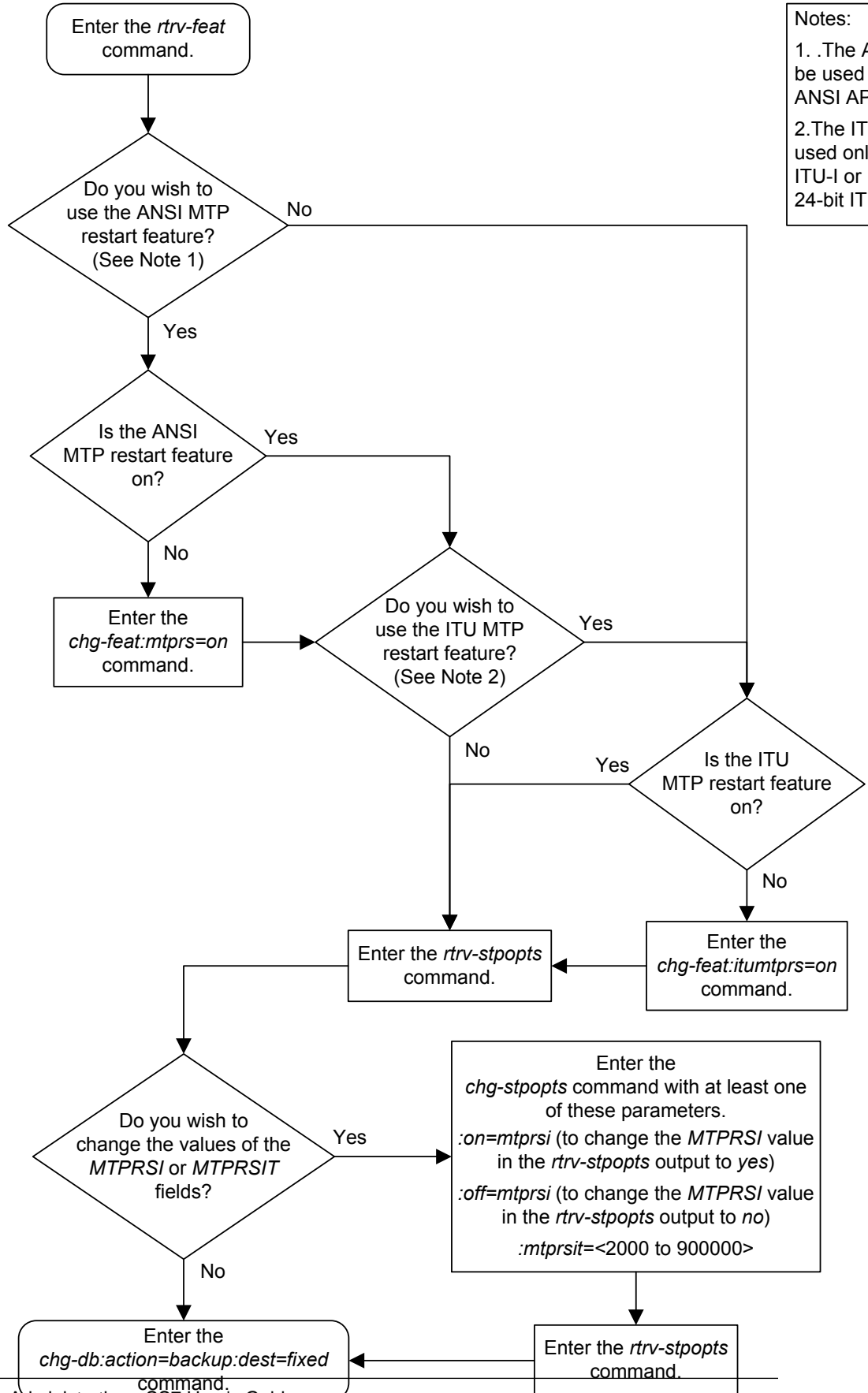
Note: The `rtrv-stpopts` command output contains other fields that are not used by this procedure. If you wish to see all the fields displayed by the `rtrv-stpopts` command, see the `rtrv-stpopts` command description in *Commands User's Guide*.

- Back up the new changes using the `chg-db:action=backup:dest=fixed` command.

These messages should appear, the active **Maintenance and Administration Subsystem Processor (MASP)** appears first.

BACKUP (FIXED) : MASP A - Backup starts on active MASP.
BACKUP (FIXED) : MASP A - Backup on active MASP to fixed disk complete.
BACKUP (FIXED) : MASP A - Backup starts on standby MASP.
BACKUP (FIXED) : MASP A - Backup on standby MASP to fixed disk complete.

Figure 3-6 Configuring the MTP Restart Feature



Notes:
 1. .The ANSI MTP restart feature can be used only with links that use 24-bit ANSI APCs.
 2.The ITU MTP restart feature can be used only with links that use 24-bit ITU-I or ITU-N APCs (24-bit ITU-N APCs).

Configuring the 5-Bit to 8-Bit SLS Conversion Feature

This procedure is used to configure the 5-Bit to 8-Bit SLS Conversion feature using the `chg-stpopts` command with the `slscnv` parameter.

The `slscnv` parameter of the `chg-stpopts` command has three values: `on`, `off`, and `perls`.

- `slscnv=on` – 5-bit to 8-bit conversion is performed on all linksets in the **EAGLE**, regardless of what the value of the `slsci` parameter of the `ent-ls` or `chg-ls` command is for the specific linkset. If the `asl8=yes` parameter of either the `ent-ls` or `chg-ls` commands is assigned to the linkset, no **SLS** conversion is performed.
- `slscnv=off` – 5-bit to 8-bit conversion is not performed on the linksets in the **EAGLE**, regardless of what the value of the `slsci` parameter of the `ent-ls` or `chg-ls` command is for the specific linkset.
- `slscnv=perls` – 5-bit to 8-bit **SLS** conversion is only performed on the **MSUs** arriving at the **EAGLE** on linksets that have the `asl8=no` parameter assigned to them, and leaving the **EAGLE** on linksets that have the `slsci=yes` parameter assigned to them. The `asl8` and `slsci` parameters are configured with either the `ent-ls` or `chg-ls` commands.

5-Bit to 8-Bit **SLS** conversion is performed based on the values assigned to the `slsci` and `asl8` parameters for the linkset and the `slscnv` parameter of the `chg-stpopts` command.

Note: The `slsci` and `asl8` parameters can be specified only for linksets containing **ANSI** adjacent point codes.

The `slsci` parameter indicates whether the 5-bit to 8-bit SLS conversion feature is used to select signaling links for outgoing messages on the specified link set. If the `slsci=yes` parameter is specified, the **EAGLE** replaces any 5-bit **SLS** values contained in received messages with a random 8-bit value before they are used by the **EAGLE** to select the outgoing signaling link in that linkset. The 5-bit to 8-bit SLS conversion is also controlled by the `slscnv` parameter of the `chg-stpopts` command.

The `asl8` parameter shows if the node adjacent to the **EAGLE** is sending **MSUs** with 8-bit **SLSs**. If the `asl8=yes` parameter is specified with the `lst=a` parameter (a linkset containing access signaling links), this indicates that the originator of the **MSUs** is generating 8-bit **SLSs**. For other linkset types, the `asl8=yes` parameter indicates that the adjacent node is converting 5-bit **SLSs** to 8-bit **SLSs**. The **SLS** in **MSUs** received by the **EAGLE** on a linkset that has the `asl8=yes` parameter assigned to it will not be converted. These **MSUs** are assumed to contain 8-bit **SLSs**. If the `asl8=no` parameter is specified for the linkset, the **SLS** will be converted to an 8-bit **SLS**. The value of the `asl8` parameter is only displayed in the `rtrv-ls` command output when a specific linkset is being displayed with the `rtrv-ls:lsn=<linkset name>` command.

The interaction between the `slsci` and `asl8` parameters of the `ent-ls` command and the `slscnv` parameter of the `chg-stpopts` command is shown in [Table 3-9](#).

Table 3-9 Signaling Link Selector (SLS) Conversion (ANSI Linksets Only)

CHG-STPOPTSSLSCNV Parameter Value	Outgoing Linkset SLSCI Parameter Value	Incoming Linkset ASL8 Parameter Value	Result
ON	Not Applicable	YES	The adjacent node is sending 8-bit SLSs . No SLS conversion is performed on MSUs received on this linkset.
ON	Not Applicable	NO	The adjacent node is not sending 8-bit SLSs . 5-bit to 8-bit SLS conversion on MSUs received on this linkset.
OFF	Not Applicable	YES	The adjacent node is sending 8-bit SLSs . No SLS conversion is performed on any linksets.
OFF	Not Applicable	NO	The adjacent node is not sending 8-bit SLSs . 5-bit to 8-bit SLS conversion is not performed on all linksets.
PERLS*	YES	YES	The adjacent node is sending 8-bit SLSs . No SLS conversion is performed.
PERLS*	YES	NO	The adjacent node is not sending 8-bit SLSs . 5-bit to 8-bit SLS conversion is performed.
PERLS*	NO	YES	The adjacent node is sending 8-bit SLSs . No SLS conversion is performed.
PERLS*	NO	NO	The adjacent node is not sending 8-bit SLSs . 5-bit to 8-bit SLS conversion is not performed.

Table 3-9 (Cont.) Signaling Link Selector (SLS) Conversion (ANSI Linksets Only)

CHG-STPOPTSSLSCNV Parameter Value	Outgoing Linkset SLSCI Parameter Value	Incoming Linkset ASL8 Parameter Value	Result
*When the <code>slscnv=perl</code> s parameter is specified with the <code>chg-stpopts</code> command, 5-bit to 8-bit SLS conversion is only performed on the MSUs arriving at the EAGLE on linksets that have the <code>asl8=no</code> parameter of the <code>ent-ls</code> command assigned to them, and leaving the EAGLE on linksets that have the <code>slsci=yes</code> parameter of the <code>ent-ls</code> command assigned to them.			

When a 5-bit ANSI SLS is converted to an 8-bit ANSI SLS, the three most significant bits of the SLS are set using a function of originating point code and incoming signaling link. This ensures that MSUs with the same originating point code, SLS, and incoming signaling link will always have the same SLS after the conversion, guaranteeing that the MSUs arrive at the destination in the same sequence that they were sent.

5-bit to 8-bit SLS conversion is performed under these conditions.

- The incoming linkset is an ANSI linkset, a linkset containing an ANSI adjacent point code.
- The `asl8=no` parameter of the `ent-ls` or `chg-ls` command is assigned to the incoming linkset.
- The outgoing linkset is an ANSI linkset.
- The `slscnv=on` parameter of the `chg-stpopts` command is specified
- The `slscnv=perl`s parameter of the `chg-stpopts` command is specified and `slsci=yes` parameter of the `ent-ls` or `chg-ls` command assigned to the outgoing linkset.
- The three most significant bits of the SLS in the MSU are zero.

All ANSI MSUs originating from the EAGLE have an 8-bit SLS.

The EAGLE also converts ANSI SLSs to ITU SLSs, and ITU SLSs to ANSI SLSs.

When an ITU SLS is converted to an ANSI SLS, the ITU SLS is always converted to an ANSI 5-bit SLS. If the MSU containing the converted SLS is rerouted because of a link outage, the SLS may be converted from a 5-bit SLS to an 8-bit SLS.

When an ANSI SLS is converted to an ITU SLS, the ANSI SLS is always converted to an ITU 4-bit SLS.

The EAGLE does not convert a 4-bit ITU SLS to an 8-bit ANSI SLS.

The 5-bit to 8-bit SLS conversion takes place during the routing process, after the linkset is selected, but before the signaling link is selected. The ITU to ANSI SLS conversion takes place during the ANSI to ITU MSU conversion and after the outgoing signaling link is chosen.

1. Display the existing value for the `slscnv` parameter by entering the `rtrv-stpopts` command.

The value for the `slscnv` parameter is shown in the `SLSCNV` field. This is an example of the possible output.

```
rlghncxa03w 08-12-17 16:02:05 GMT EAGLE5 40.0.0
STP OPTIONS
-----
SLSCNV          on
```

Note: The `rtrv-stpopts` command output contains other fields that are not used by this procedure. If you wish to see all the fields displayed by the `rtrv-stpopts` command, see the `rtrv-stpopts` command description in *Commands User's Guide*.

If the `slscnv` parameter is not being changed, no further action is necessary. The procedure is finished.

If you wish to change the `slscnv` parameter value, continue the procedure with 2.

2. Change the `slscnv` parameter value using the `chg-stpopts` command.

For this example, the value of the `slscnv` parameter is being changed from `on` to `perls`. Enter this command: `chg-stpopts:slscnv=perls`. When this command has successfully completed, this message should appear.

```
rlghncxa03w 08-12-07 00:22:57 GMT EAGLE5 40.0.0
CHG-STPOPTS: MASP A - COMPLTD
```

3. Verify the changes using the `rtrv-stpopts` command.

This is an example of the possible output.

```
rlghncxa03w 08-12-17 16:02:05 GMT EAGLE5 40.0.0
STP OPTIONS
-----
SLSCNV          perls
```

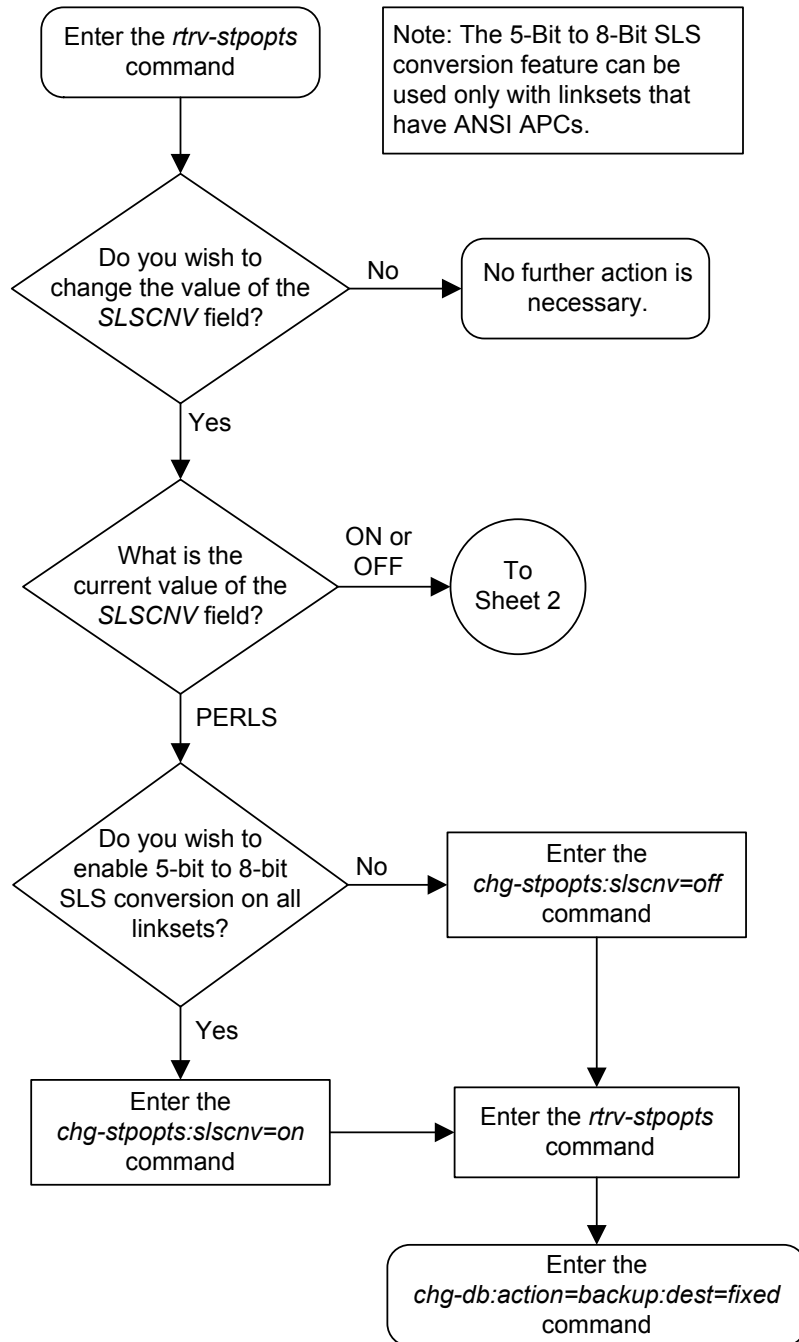
Note: The `rtrv-stpopts` command output contains other fields that are not used by this procedure. If you wish to see all the fields displayed by the `rtrv-stpopts` command, see the `rtrv-stpopts` command description in *Commands User's Guide*.

4. Back up the new changes using the `chg-db:action=backup:dest=fixed` command.

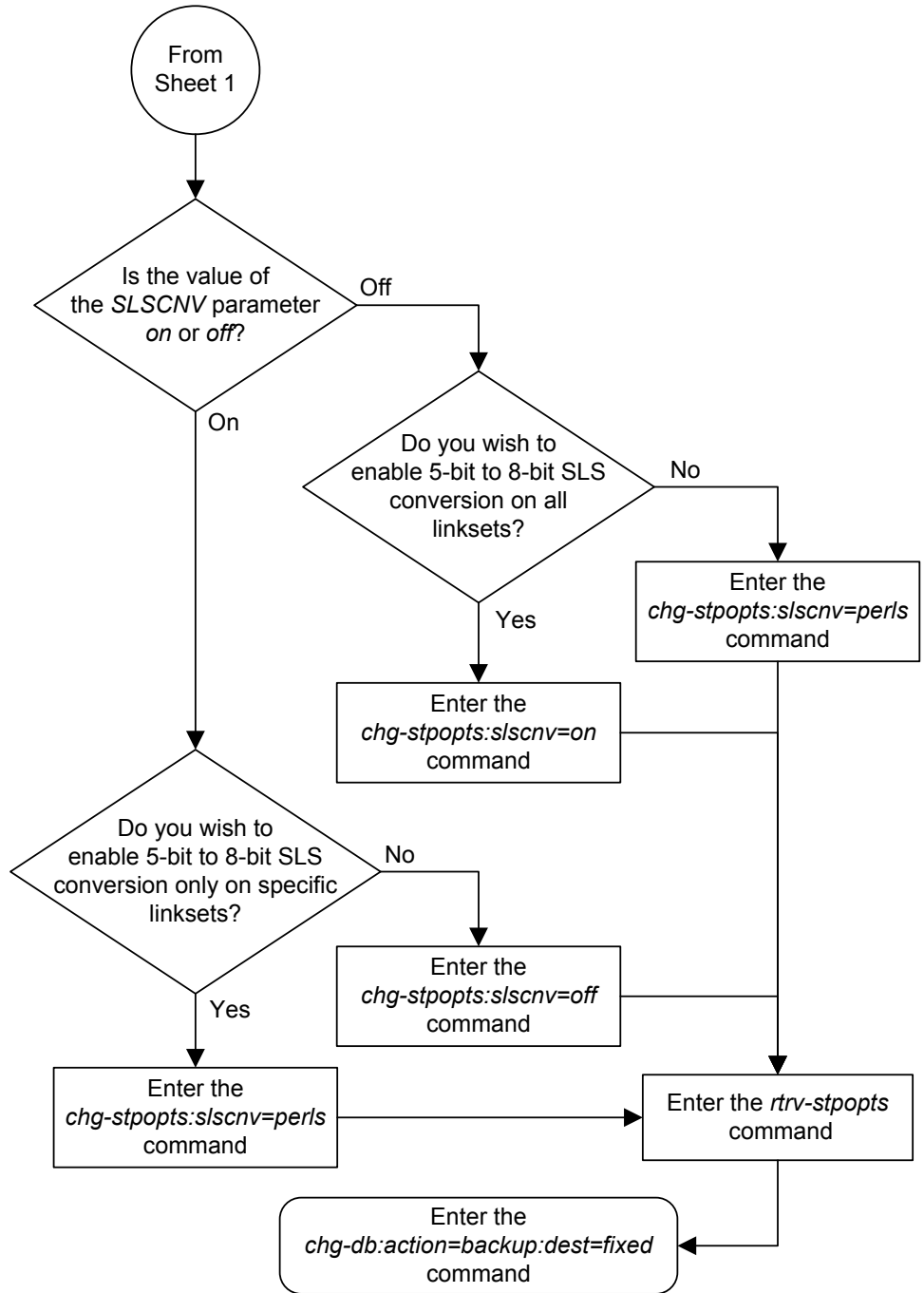
These messages should appear, the active **Maintenance and Administration Subsystem Processor (MASP)** appears first.

```
BACKUP (FIXED) : MASP A - Backup starts on active MASP.
BACKUP (FIXED) : MASP A - Backup on active MASP to fixed disk complete.
BACKUP (FIXED) : MASP A - Backup starts on standby MASP.
BACKUP (FIXED) : MASP A - Backup on standby MASP to fixed disk complete.
```


Figure 3-7 Configuring the 5-Bit to 8-Bit SLS Conversion Feature



Sheet 1 of 2



Using Proxy Point Codes and Secondary Point Codes when Adding a Linkset

This procedure is used to verify that the following items are configured in the database.

- Proxy point codes for adding proxy linksets
- Secondary point codes for adding multiple linksets with the same adjacent point code.

To add a proxy linkset, a proxy point code must be assigned to the APC of the linkset, a proxy point code must be assigned to the linkset with the `ppc/ppca/ppci/ppcn/ppcn24` parameter, and the linkset type must be `prx`. A quantity of proxy point codes must be enabled with the `enable-ctrl-feat` command before a proxy point code and a proxy linkset can be added. The first time a proxy linkset is added, the proxy point code that is assigned to the linkset must be the same proxy point code that is assigned to the APC of the proxy linkset. A maximum of 10 linksets can be added using the same proxy point code. For more information on proxy point codes, refer to [Proxy Point Codes](#).

To add more than one linkset with the same APC, the Multiple Linksets to Single Adjacent PC feature must be enabled and turned on. The database can contain a maximum of six linksets that have the same APC. If the linkset is not a proxy linkset (linkset types A, B, C, D, or E), a secondary point code (shown in the `rtrv-spc` output) must be specified with the linkset. The network type and format of the secondary point code must be the same as the APC of the linkset. Secondary point codes can also be assigned to the APC of the linkset when the point code is added in the database with the `ent-dstn` or `chg-dstn` commands. The secondary point code that is assigned to the linkset with the `spc/spca/spci/spcn/spcn24` parameter cannot be the same secondary point code that is assigned to the APC of the linkset.

If the linkset is a proxy linkset (linkset type PRX), a proxy point code (shown in the `rtrv-dstn` output) must be specified with the linkset. The proxy point code is assigned to the linkset with the `ppc/ppca/ppci/ppcn/ppcn24` parameter. The network type and format of the proxy point code must be the same as the APC of the linkset. If proxy linksets are added, the database must contain one proxy linkset with a proxy point code assigned to the APC of the linkset and the same proxy point code must be assigned to the linkset. The proxy point code that is assigned to the other proxy linksets using this APC cannot be the same as the proxy point code that is assigned to the APC of the linkset.

1. Display the current linkset configuration using the `rtrv-ls` command.

This is an example of the possible output.

```
rlghncxa03w 08-12-10 11:43:04 GMT EAGLE5 40.0.0
```

LSN	APCA (SS7)	SCRN	L3T SLT				LST	LNKS	GWS GWS GWS			SLSCI	NIS
			SET	SET	BEI				ACT	MES	DIS		
ele2	001-207-000	none	1	1	no	B	6	off	off	off	no	off	
ls1305	001-005-000	none	1	1	no	A	1	off	off	off	no	off	
ls1307	001-007-000	none	1	1	no	A	1	off	off	off	no	off	
e1mls1	001-001-003	none	1	1	no	A	7	off	off	off	no	off	
e1mls2	001-001-002	none	1	1	no	A	7	off	off	off	no	off	

LSN	APCI (SS7)	SCRN	L3T SLT			LST	LNKS	GWS GWS GWS			SLSCI	NIS
			SET	SET	BEI			ACT	MES	DIS		
ele2i	1-207-0	none	1	1	no	B	4	off	off	off	---	on
ls1315	0-015-0	none	1	1	no	A	1	off	off	off	---	off
ls1317	0-017-0	none	1	1	no	A	1	off	off	off	---	on
elm2s1	1-011-1	none	1	1	no	A	7	off	off	off	---	off
elm2s2	1-011-2	none	1	1	no	A	7	off	off	off	---	off

Link set table is (10 of 1024) 1% full.

If the APC of the linkset is not being assigned to more than one linkset and a proxy linkset is being added, continue the procedure with [8](#).

If the APC of the linkset is not being assigned to more than one linkset, and a proxy linkset is not being added, this procedure is finished.

If the APC of the linkset is being assigned to more than one linkset, and multiple linksets with the same APC are shown in the `rtrv-ls` output in [1](#), continue the procedure with [3](#).

If the APC of the linkset is being assigned to more than one linkset, and multiple linksets with the same APC are not shown in the `rtrv-ls` output in [1](#), continue the procedure with [2](#).

2. Verify whether or not the Multiple Linksets to Single Adjacent PC feature is enabled and turned on by entering this command.

```
rtrv-ctrl-feat:partnum=893017901
```

This is an example of the possible output.

```
rlghncxa03w 08-12-21 15:48:20 EST 40.0.0
The following features have been permanently enabled:
```

Feature Name	Partnum	Status	Quantity
Multiple Linkset to APC	893019701	on	----

The following features have been temporarily enabled:

Feature Name	Partnum	Status	Quantity	Trial Period Left
Zero entries found.				

The following features have expired temporary keys:

Feature Name	Partnum
Zero entries found.	

If the Multiple Linksets to Single Adjacent PC feature is not enabled or turned on, perform [Activating the Multiple Linksets to Single Adjacent PC \(MLS\) Feature](#) to enable and turn on this feature. After this feature has been enabled and turned on, continue the procedure with [3](#).

If the Multiple Linksets to Single Adjacent PC feature is enabled and turned on, continue the procedure with [3](#).

3. Display the linksets that contain the APC for the new linkset by entering the `rtrv-ls` command with the APC of the linkset. For this example, enter this command.

```
rtrv-ls:apca=001-001-002
```

This is an example of the possible output.

```
rlghncxa03w 08-12-22 08:09:26 EST 40.0.0
```

```
APCA = 001-001-002
```

LSN	SPCA	SCRN	L3T	SLT	SET	BEI	LST	LNKS	GWS	GWS	GWS	SLSCI	NIS
elmls2	020-020-021	none	1	1	no	A	7	off	off	off	no	off	

Link set table is (10 of 1024) 1% full.

The maximum number of linksets that can use the same APC is six. If six linksets are shown in this step, the specified APC cannot be used with the new linkset. Select another APC from the `rtrv-ls` output in 1 and repeat this step.

If one to five linksets are shown in this step and the linksets are proxy linksets (`lst=prx`), continue the procedure with 6.

If one to five linksets are shown in this step and the linksets are not proxy linksets, continue the procedure with 4.

- To use an APC for more than one linkset, a secondary point code must be assigned to the linkset. The secondary point code that will be assigned to the new linkset cannot be assigned to any of the linksets shown in 3.

The secondary point code that will be assigned to the linkset cannot be assigned to the APC of this linkset. Verify this by entering the `rtrv-dstn` command with the APC of the linkset shown in 3. For this example, enter this command.

```
rtrv-dstn:dpca=001-001-002
```

This is an example of the possible output.

```
rlghncxa03w 10-12-22 08:09:26 EST 43.0.0
```

DPCA	CLLI	BEI	ELEI	ALIASI	ALIASN/N24	DMN
001-001-002	-----	no	---	-----	-----	SS7

SPCA	NCAI	PRX	RCAUSE	NPRST	SPLITIAM	HMSMSC	HMSCP	SCCPMSGCNV
020-020-020	----	no	none	off	none	no	no	none

Destination table is (37 of 2000) 2% full

Alias table is (0 of 12000) 0% full

PPC table is (13 of 20) 65% full

If a secondary point code is shown in this step, this secondary point code cannot be assigned to the new linkset.

Continue the procedure with 5.

- Display the secondary point codes by entering the `rtrv-spc` command. This is an example of the possible output.

```
rlghncxa03w 08-12-22 09:39:30 EST 40.0.0
```

```
SPC (Secondary Point Codes)
```

```
SPCA
  020-020-020
  020-020-021
  021-021-021
```

```

022-022-022
026-026-026
026-026-027
026-026-028
026-026-029
200-010-000

```

SPC-I

none

SPC-N

00002

SPC-N24

none

Secondary Point Code table is (10 of 40) 25% full.

If the desired secondary point code is shown in this step, this procedure is finished.

If the desired secondary point code is not shown in this step, perform [Adding a Secondary Point Code](#) to add the desired secondary point code. The network type of the new secondary point code must be the same as the APC of the linkset. After the secondary point code has been added, this procedure is finished.

- To use an APC for more than one proxy linkset, a proxy point code must be assigned to the linkset. The proxy point code that will be assigned to the new linkset cannot be assigned to any of the linksets shown in 3.

The proxy point code that will be assigned to the linkset must be in the database. Verify the proxy point codes in the database by entering the `rtrv-dstn:prx=yes` command.

This is an example of the possible output.

```
rlghncxa03w 09-05-22 08:09:26 EST 41.0.0
```

PRX = yes

DPCA	CLLI	BEI	ELEI	ALIASI	ALIASN/N24	DMN
002-002-002	-----	no	---	-----	-----	SS7
006-006-006	-----	no	---	-----	-----	SS7
050-050-050	-----	no	---	-----	-----	SS7
100-100-100	-----	no	---	-----	-----	SS7
100-100-101	-----	no	---	-----	-----	SS7
100-100-102	-----	no	---	-----	-----	SS7
100-100-103	-----	no	---	-----	-----	SS7
100-100-104	-----	no	---	-----	-----	SS7
200-001-001	-----	no	---	-----	-----	SS7
200-001-002	-----	no	---	-----	-----	SS7

DPCI	CLLI	BEI	ELEI	ALIASA	ALIASN/N24	DMN
2-003-4	-----	no	---	-----	-----	SS7

DPCN	CLLI	BEI	ELEI	ALIASA	ALIASI	DMN
00003	-----	no	---	-----	-----	SS7
00004	-----	no	---	-----	-----	SS7

```
Destination table is (37 of 2000) 2% full
Alias table is (0 of 12000) 0% full
PPC table is (13 of 20) 65% full
```

If the desired proxy point code is not shown in this step, perform [Adding a Destination Point Code](#) to add the desired proxy point code. The network type of the new proxy point code must be the same as the APC of the linkset. After the proxy point code has been added, this procedure is finished.

If the desired proxy point code is shown in this step, continue the procedure with [7](#).

7. A proxy point code can be assigned to a maximum of 10 linksets. Verify how many linksets are using the proxy point code by entering the `rtrv-dstn` command with the proxy point code shown in [6](#). For this example, enter this command.

```
rtrv-dstn:dpca=002-002-002
```

This is an example of the possible output.

```
rlghncxa03w 10-12-22 10:08:11 EST 43.0.0
```

DPCA	CLLI	BEI	ELEI	ALIASI	ALIASN/N24	DMN		
002-002-002	-----	no	---	-----	-----	SS7		
SPCA	NCAI	PRX	RCAUSE	NPRST	SPLITIAM	HMSMSC	HMSCP	SCCPMSGCNV
026-026-029	----	yes, 1	none	off	none	no	no	none

```
Destination table is (37 of 2000) 2% full
Alias table is (0 of 12000) 0% full
PPC table is (13 of 20) 65% full
```

The number of linksets using the proxy point code is the number shown in the `PRX` column. If 10 linksets are using the proxy point code, this proxy point code cannot be assigned to any other linkset. Repeat [6](#) and [7](#).

If the number of linksets using the proxy point code is from 0 to 9, this procedure is finished.

8. To add a proxy linkset, a linkset whose linkset type is `PRX`, a quantity of proxy point codes must be enabled. Verify whether or not a quantity of proxy point codes is enabled by entering the `rtrv-ctrl-feat` command.

Note: If proxy linksets are shown in the `rtrv-ls` output in [1](#), then a quantity of proxy point codes has been enabled. If proxy linksets are shown in the `rtrv-ls` output in [1](#), this step does not have to be performed. Continue the procedure with [9](#).

This is an example of the possible output.

```
rlghncxa03w 08-12-22 10:58:06 EST 40.0.0
```

The following features have been permanently enabled:

Feature Name	Partnum	Status	Quantity
HC-MIM SLK Capacity	893012707	on	64
Origin-Based MTP Routing	893014201	on	----
Multiple Linkset to APC	893019701	on	----
Proxy Point Code	893018702	on	20

The following features have been temporarily enabled:

```
Feature Name          Partnum  Status Quantity  Trial Period Left
Zero entries found.
```

The following features have expired temporary keys:

```
Feature Name          Partnum
Zero entries found.
```

If a quantity of proxy point codes is enabled, continue the procedure with 9.

If a quantity of proxy point codes is not enabled, perform [Changing the Proxy Point Code Quantity](#) to enable a quantity of proxy point codes. After the quantity of proxy point codes is enabled, perform [Adding a Destination Point Code](#) to add the desired proxy point code to the database, then assign the proxy point code to the destination point code that will be the APC of the proxy linkset. After [Adding a Destination Point Code](#) has been performed, this procedure is finished.

- The APC of a proxy linkset must be a destination point code that contains a proxy point code. Verify the proxy point codes in the database by entering the `rtrv-dstn:prx=yes` command.

This is an example of the possible output.

```
rlghncxa03w 09-05-22 08:09:26 EST 41.0.0
```

```
PRX = yes
```

DPCA	CLLI	BEI	ELEI	ALIASI	ALIASN/N24	DMN
002-002-002	-----	no	---	-----	-----	SS7
006-006-006	-----	no	---	-----	-----	SS7
050-050-050	-----	no	---	-----	-----	SS7
100-100-100	-----	no	---	-----	-----	SS7
100-100-101	-----	no	---	-----	-----	SS7
100-100-102	-----	no	---	-----	-----	SS7
100-100-103	-----	no	---	-----	-----	SS7
100-100-104	-----	no	---	-----	-----	SS7
200-001-001	-----	no	---	-----	-----	SS7
200-001-002	-----	no	---	-----	-----	SS7

DPCI	CLLI	BEI	ELEI	ALIASA	ALIASN/N24	DMN
2-003-4	-----	no	---	-----	-----	SS7

DPCN	CLLI	BEI	ELEI	ALIASA	ALIASI	DMN
00003	-----	no	---	-----	-----	SS7
00004	-----	no	---	-----	-----	SS7

```
Destination table is (37 of 2000) 2% full
```

```
Alias table is (0 of 12000) 0% full
```

```
PPC table is (13 of 20) 65% full
```

- Display the attributes of the proxy point that will be added to the proxy linkset by entering the `rtrv-dstn` command with a proxy point code shown in 9. For this example, enter this command.

```
rtrv-dstn:ppca=002-002-002
```

This is an example of the possible output.

```
rlghncxa03w 09-05-22 13:57:23 EST 41.0.0

PPCA = 002-002-002

      DPCA          CLLI          BEI ELEI  ALIASI          ALIASN/N24  DMN
      004-004-004  ----- no  --- -----  -----  SS7

Destination table is (37 of 2000) 2% full
Alias table is (0 of 12000) 0% full
PPC table is (13 of 20) 65% full
```

If destination point codes are displayed in this step, continue the procedure with [11](#).

If destination are not shown in this step, then the proxy point code is not assigned to any destination point codes. Perform [Adding a Destination Point Code](#) to assign the proxy point code to a destination point code. The network type of the proxy point code must be the same as the APC of the linkset. After the proxy point code has been assigned to a destination point code, this procedure is finished.

11. A proxy point code can be assigned to a maximum of 10 linksets. Verify how many linksets are using the proxy point code by entering the `rtrv-dstn` command with the proxy point code shown in [10](#). For this example, enter this command.

```
rtrv-dstn:dpca=002-002-002
```

This is an example of the possible output.

```
rlghncxa03w 10-12-22 10:08:11 EST 43.0.0

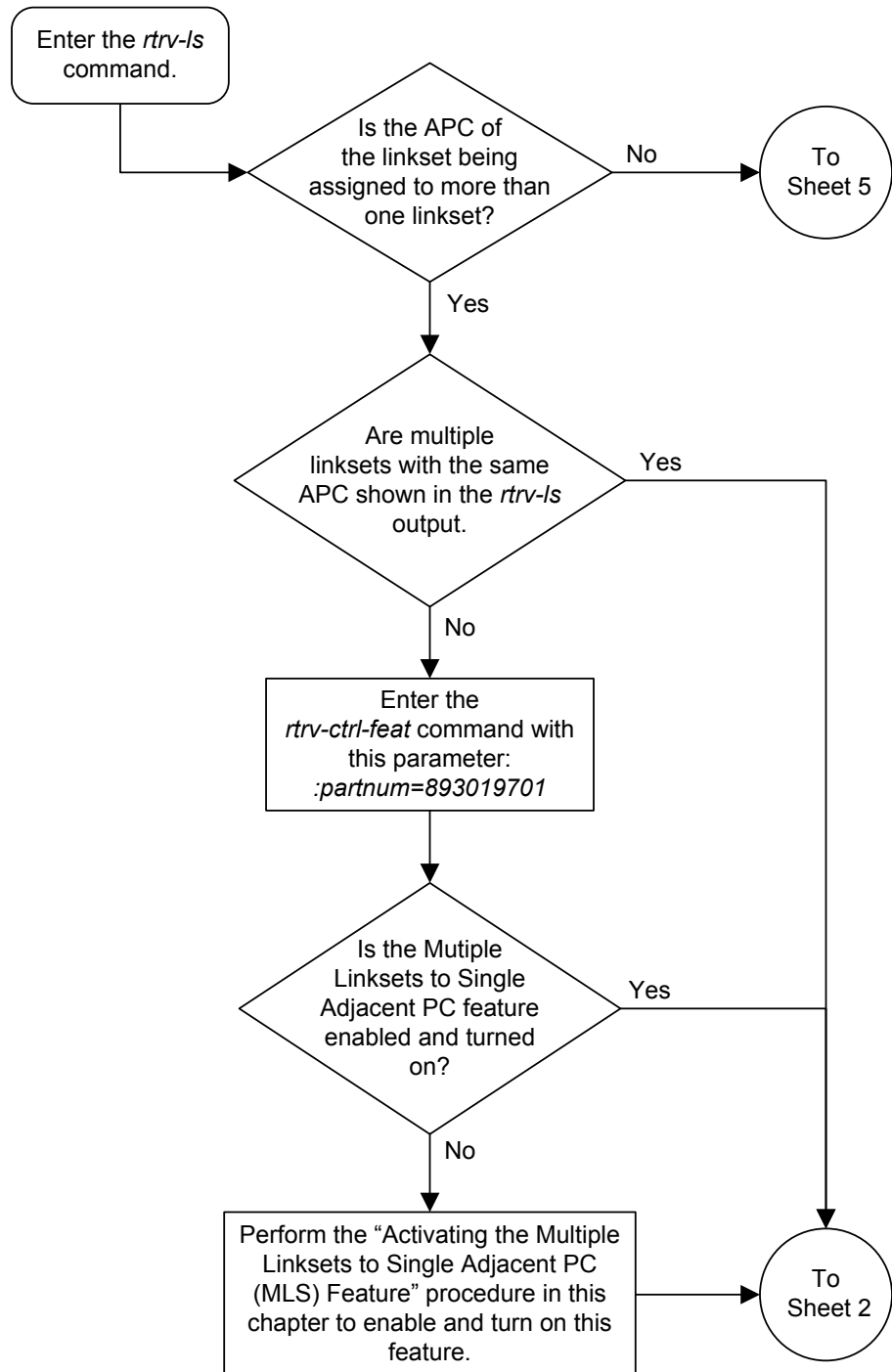
      DPCA          CLLI          BEI ELEI  ALIASI          ALIASN/N24  DMN
      002-002-002  ----- no  --- -----  -----  SS7

      SPCA          NCAI PRX      RCAUSE NPRST SPLITIAM HMSMSC HMSCP SCCPMSGCNV
      026-026-029  ---- yes, 1  none  off  none    no    no    none

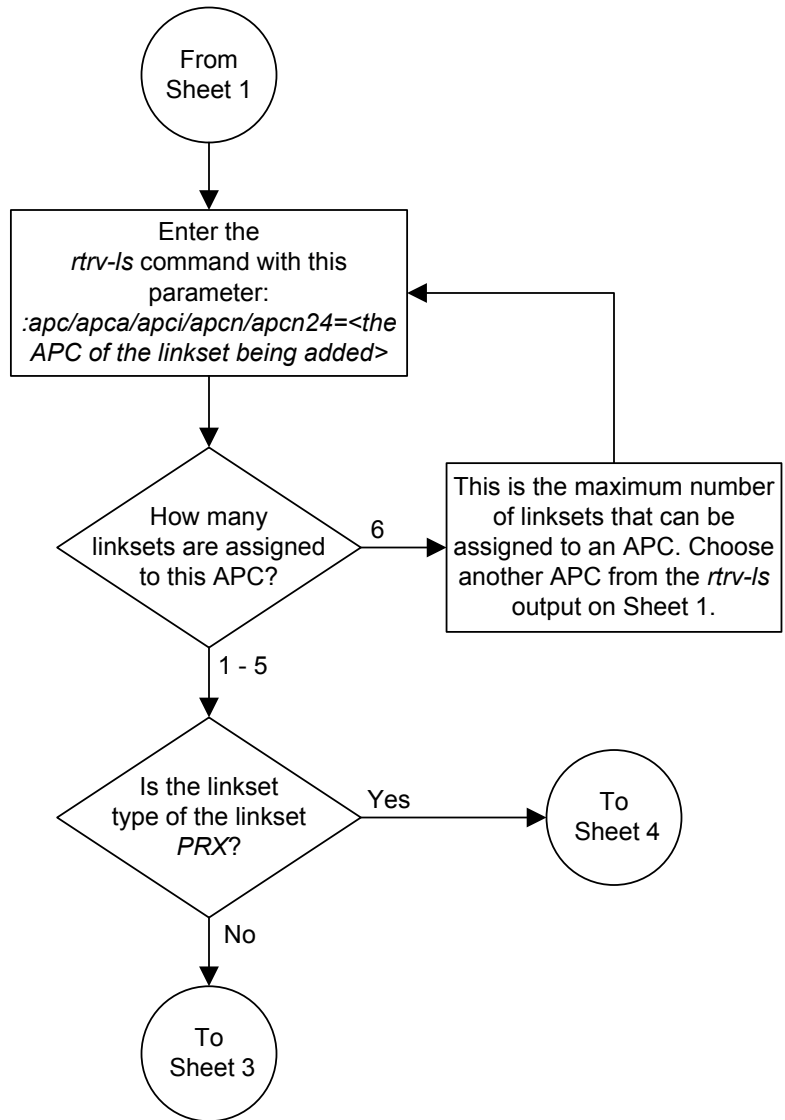
Destination table is (37 of 2000) 2% full
Alias table is (0 of 12000) 0% full
PPC table is (13 of 20) 65% full
```

The number of linksets using the proxy point code is the number shown in the `PRX` column. If 10 linksets are using the proxy point code, this proxy point code cannot be assigned to any other linkset. Repeat [10](#) and [11](#).

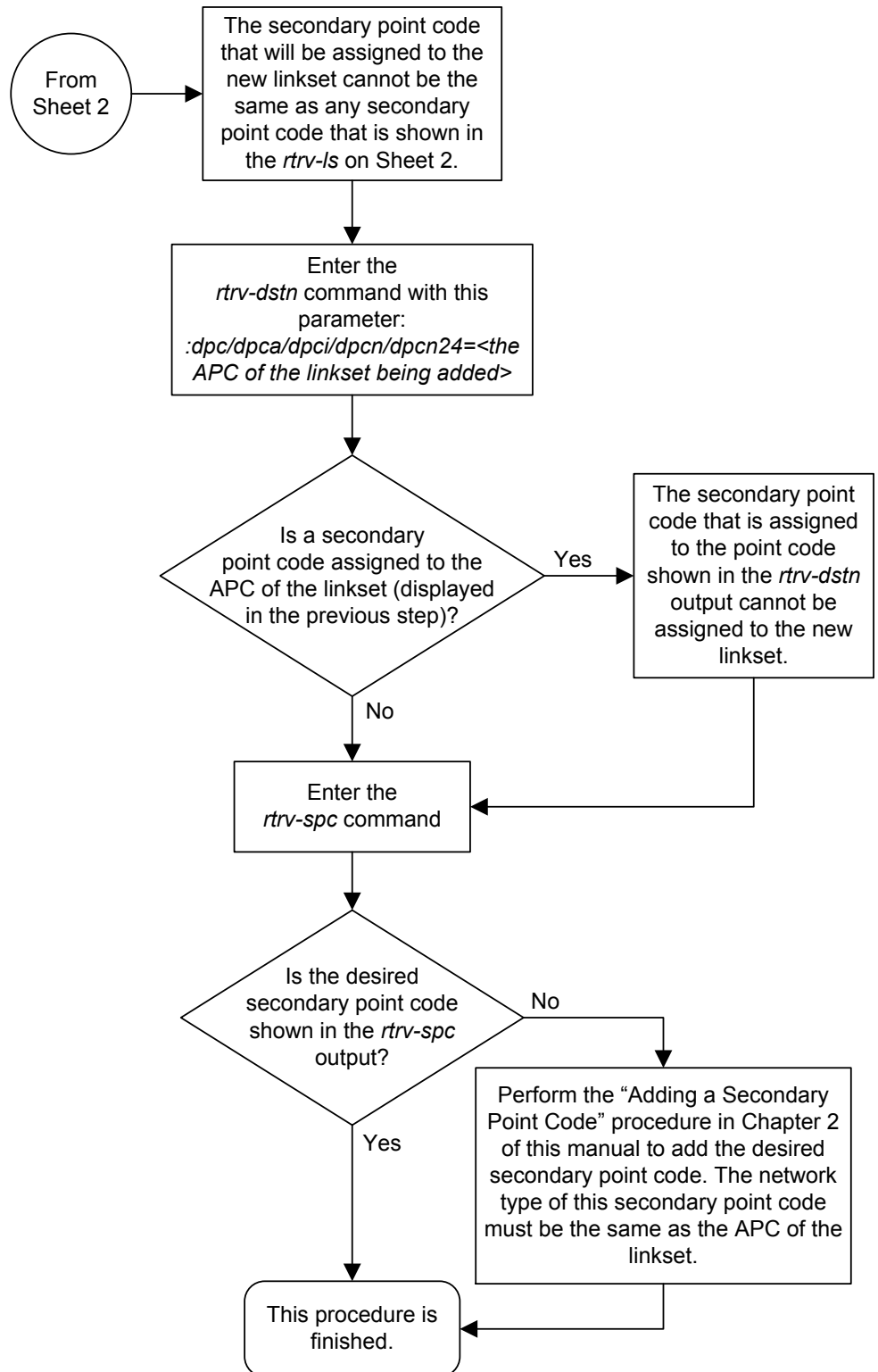
If the number of linksets using the proxy point code is from 0 to 9, this procedure is finished.

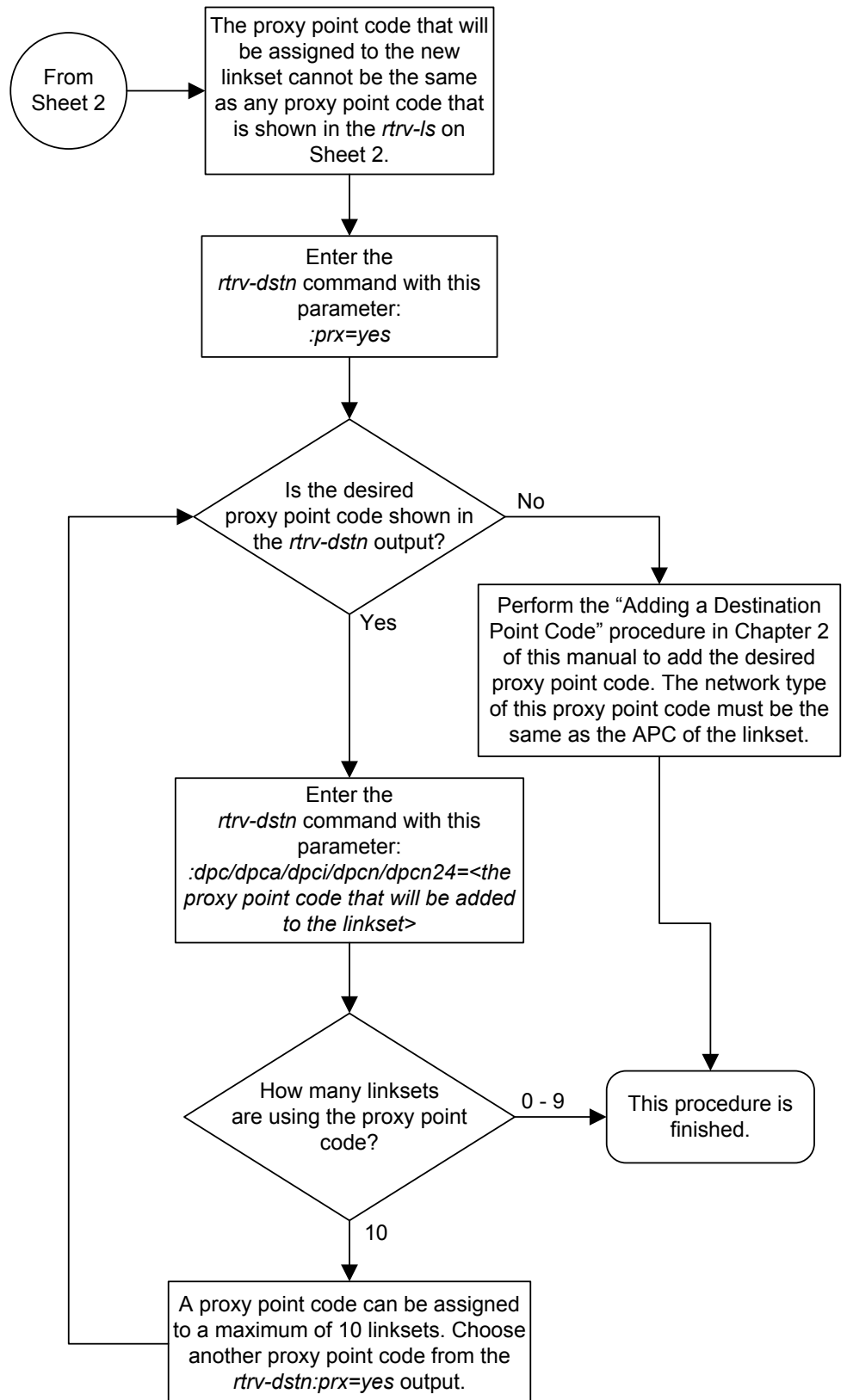
Figure 3-8 Using Proxy Point Codes and Secondary Point Codes when Adding a Linkset

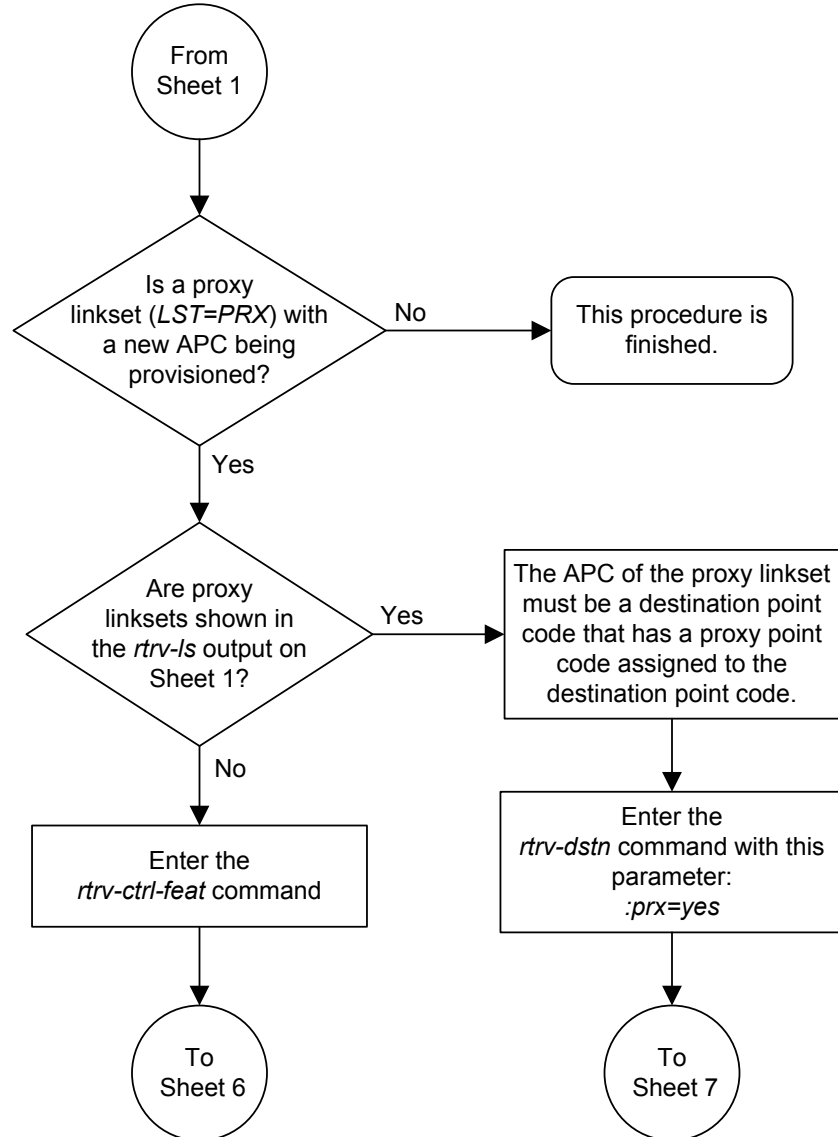
Sheet 1 of 7

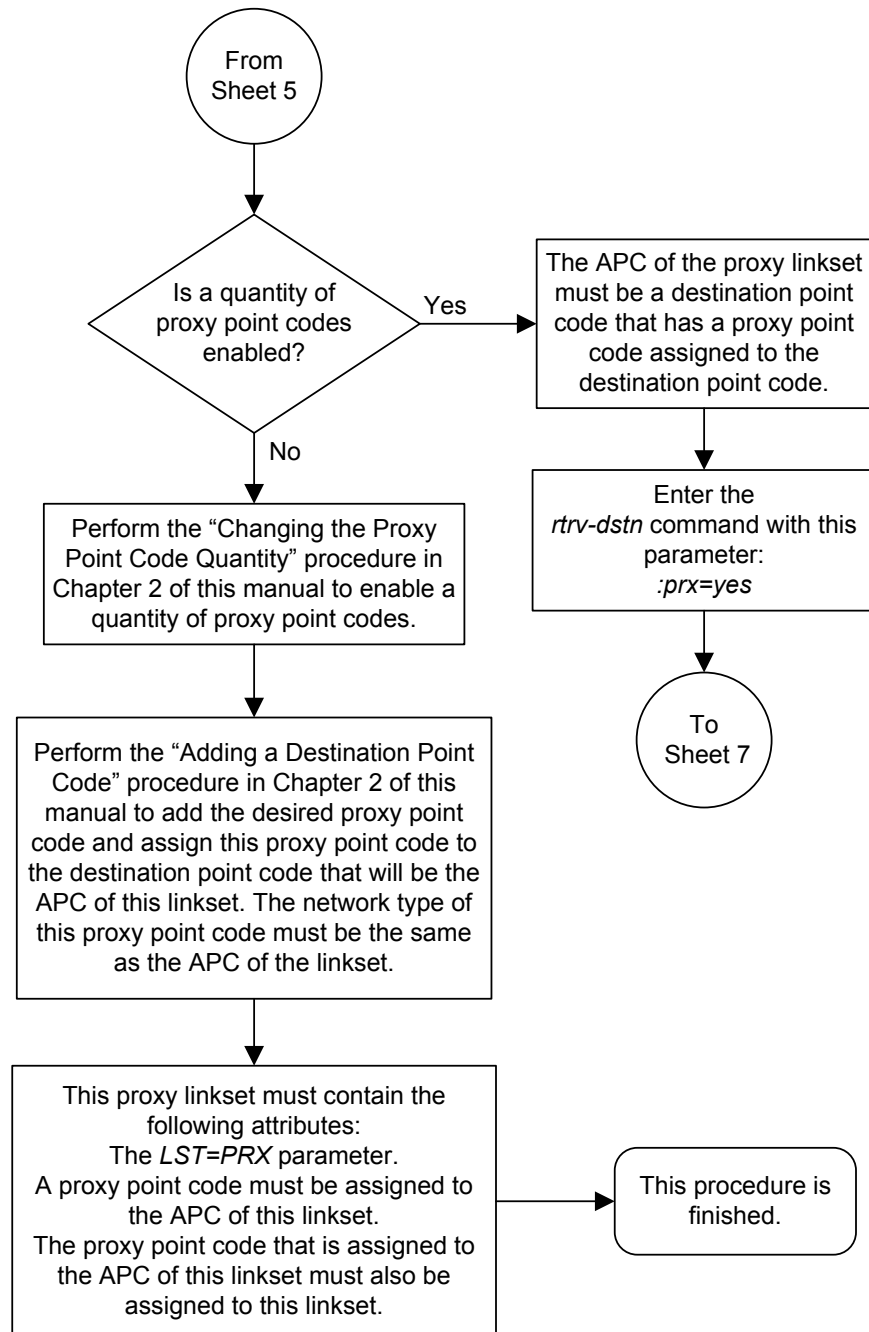


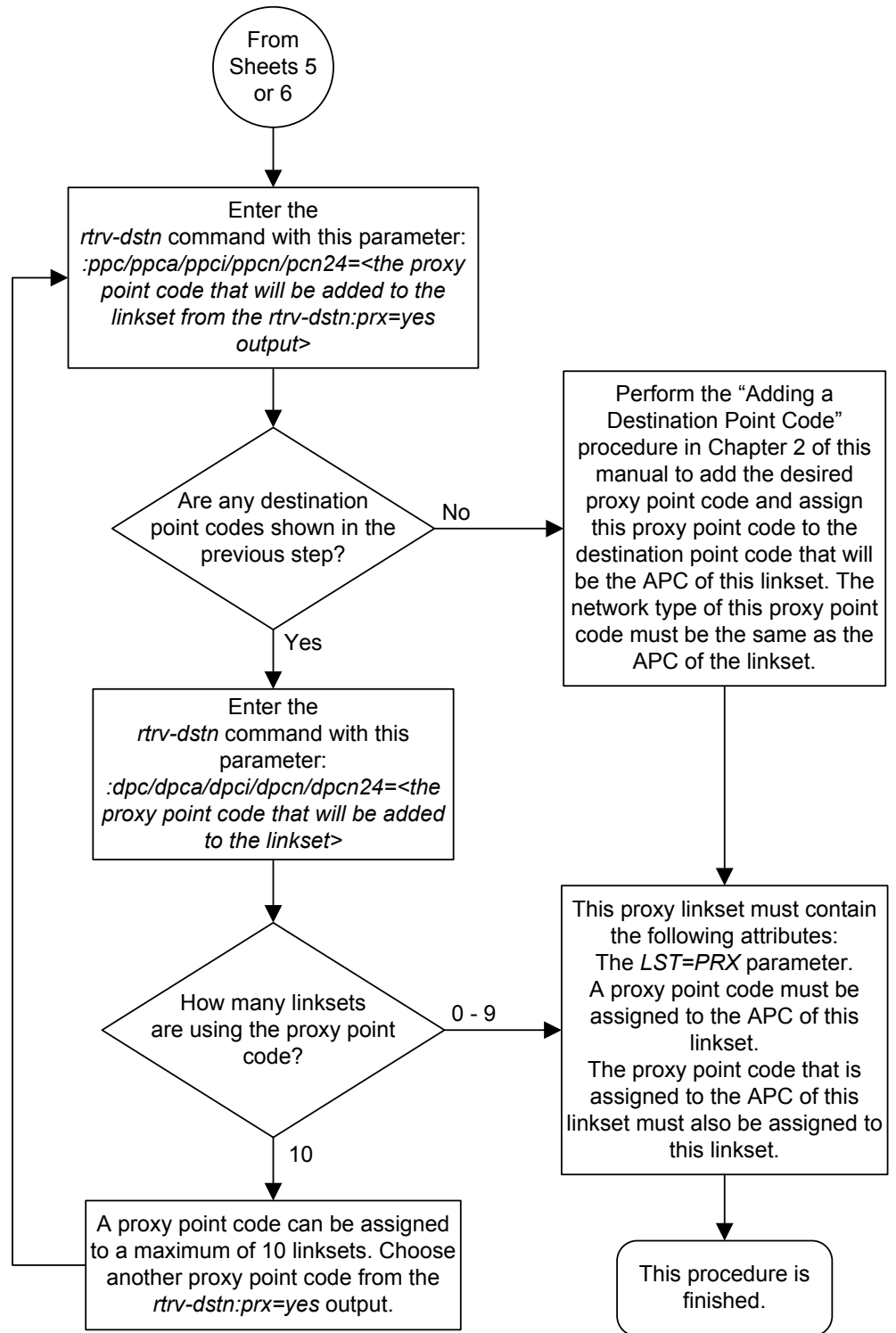
Sheet 2 of 7











Activating the SLS Bit Rotation by Incoming Linkset Feature

This procedure is used to enable and turn on the SLS Bit Rotation by Incoming Linkset feature using the feature's part number and a feature access key.

The feature access key for the SLS Bit Rotation by Incoming Linkset feature is based on the features part number and the serial number of the EAGLE, making the feature access key site-specific.

The `enable-ctrl-feat` command enables the feature by inputting the feature access key and the feature part number with these parameters:

`: fak` – The feature access key provided by Oracle.

`: partnum` – The Oracle-issued part number of the SLS Bit Rotation by Incoming Linkset feature, 893026501.

Once this feature is enabled, it is permanently enabled. This feature cannot be enabled with a temporary feature access key.

The `enable-ctrl-feat` command requires a valid serial number for the **EAGLE** to be configured in the database, and that this serial number is locked. This can be verified with the `rtrv-serial-num` command. The **EAGLE** is shipped with a serial number in the database, but the serial number is not locked. The serial number can be changed, if necessary, and locked once the **EAGLE** is on-site, by using the `ent-serial-num` command. The `ent-serial-num` command uses these parameters.

`: serial` – The serial number assigned to the EAGLE. The serial number is not case sensitive.

`: lock` – Specifies whether or not the serial number is locked. This parameter has only one value, `yes`, which locks the serial number. Once the serial number is locked, it cannot be changed.

Note: To enter and lock the **EAGLE**'s serial number, the `ent-serial-num` command must be entered twice, once to add the correct serial number to the database with the `serial` parameter, then again with the `serial` and the `lock=yes` parameters to lock the serial number. You should verify that the serial number in the database is correct before locking the serial number. The serial number can be found on a label affixed to the control shelf (shelf 1100).

The `chg-ctrl-feat` command uses these parameters:

`: partnum` – The Oracle-issued part number of the SLS Bit Rotation by Incoming Linkset feature, 893026501.

`: status=on` – used to turn the SLS Bit Rotation by Incoming Linkset feature on.

Once the SLS Bit Rotation by Incoming Linkset feature has been turned on, it cannot be turned off.

The status of the SLS Bit Rotation by Incoming Linkset feature is shown with the `rtrv-ctrl-feat` command.

1. Display the controlled features in the database by entering the `rtrv-ctrl-feat` command. This is an example of the possible output.


```
rlghncxa03w 08-12-28 11:43:04 GMT EAGLE5 40.0.0
```

The following features have been permanently enabled:

Feature Name	Partnum	Status	Quantity
SCCP Conversion	893012001	on	----
EIR	893012301	on	----
GSM Map Screening (GMS)	893013201	on	----
HC-MIM SLK Capacity	893012707	on	64

The following features have been temporarily enabled:

Feature Name	Partnum	Status	Quantity	Trial Period Left
Zero entries found.				

The following features have expired temporary keys:

Feature Name	Partnum
Zero entries found.	

If the SLS Bit Rotation by Incoming Linkset feature is enabled, the entry `ISLSBR` is shown in the permanently enabled section of the `rtrv-ctrl-feat` output. If the status of the SLS Bit Rotation by Incoming Linkset feature is on, no further action can be performed.

If the SLS Bit Rotation by Incoming Linkset feature is enabled but not turned on, continue the procedure with [7](#).

If the SLS Bit Rotation by Incoming Linkset feature is not enabled, continue the procedure by performing one of these steps.

- If the `rtrv-ctrl-feat` output in [1](#) shows any controlled features in addition to the HC-MIM SLK Capacity feature with a quantity of 64, continue the procedure with [6](#).
- If the `rtrv-ctrl-feat` output shows only the HC-MIM SLK Capacity feature with a quantity of 64, continue the procedure with [2](#).

2. Display the serial number in the database with the `rtrv-serial-num` command.

This is an example of the possible output.

```
rlghncxa03w 08-12-28 11:43:04 GMT EAGLE5 40.0.0
```

```
System serial number = nt00001231
```

```
System serial number is not locked.
```

```
rlghncxa03w 08-12-28 11:43:04 GMT EAGLE5 40.0.0
```

```
Command Completed
```

Continue the procedure by performing one of these actions.

- If the serial number is correct and locked, continue the procedure with [6](#).
- If the serial number is correct but not locked, continue the procedure with [5](#).
- If the serial number is not correct, but is locked, the SLS Bit Rotation by Incoming Linkset feature cannot be enabled and the remainder of this

procedure cannot be performed. Contact the Customer Care Center to get an incorrect and locked serial number changed. Refer to [My Oracle Support \(MOS\)](#) for the contact information. The serial number can be found on a label affixed to the control shelf (shelf 1100).

3. Enter the correct serial number into the database using the `ent-serial-num` command with the `serial` parameter.

For this example, enter this command.

```
ent-serial-num:serial=<EAGLE's correct serial number>
```

When this command has successfully completed, the following message should appear.

```
rlghncxa03w 08-12-28 11:43:04 GMT EAGLE5 40.0.0
ENT-SERIAL-NUM: MASP A - COMPLTD
```

4. Verify that the serial number entered into 3 was entered correctly using the `rtrv-serial-num` command.

This is an example of the possible output.

```
rlghncxa03w 08-12-28 11:43:04 GMT EAGLE5 40.0.0
System serial number = nt00001231
```

System serial number is not locked.

```
rlghncxa03w 08-12-28 11:43:04 GMT EAGLE5 40.0.0
Command Completed
```

If the serial number was not entered correctly, repeat 3 and 4 to re-enter the correct serial number.

5. Lock the serial number in the database by entering the `ent-serial-num` command with the serial number shown in 2, if the serial number shown in 2 is correct, or with the serial number shown in 4, if the serial number was changed in 3, and with the `lock=yes` parameter.

For this example, enter this command.

```
ent-serial-num:serial=<EAGLE's serial number>:lock=yes
```

When this command has successfully completed, the following message should appear.

```
rlghncxa03w 08-12-28 11:43:04 GMT EAGLE5 40.0.0
ENT-SERIAL-NUM: MASP A - COMPLTD
```

6. Enable the SLS Bit Rotation by Incoming Linkset feature by entering the `enable-ctrl-feat` command. For this example, enter this command.

```
enable-ctrl-feat:partnum=893026501:fak= <SLS Bit Rotation by Incoming Linkset feature access key>
```

Note: The values for the feature access key (the fak parameter) are provided by Oracle. If you do not have the feature access key for the SLS Bit Rotation by Incoming Linkset feature, contact your Oracle Sales Representative or Account Representative.

When the `enable-ctrl-feat` command has successfully completed, this message should appear.

```
rlghncxa03w 08-12-28 11:43:04 GMT EAGLE5 40.0.0
ENABLE-CTRL-FEAT: MASP B - COMPLTD
```

- Turn the SLS Bit Rotation by Incoming Linkset feature on by entering the `chg-ctrl-feat` command with the part number used in 6 and the `status=on` parameter.

For this example, enter this command.

```
chg-ctrl-feat:partnum=893026501:status=on
```

When this command has successfully completed, the following message should appear.

```
rlghncxa03w 08-12-28 11:43:04 GMT EAGLE5 40.0.0
CHG-CTRL-FEAT: MASP A - COMPLTD
```

- Verify the changes by entering this command.

```
rtrv-ctrl-feat:partnum=893026501
```

The following is an example of the possible output.

```
rlghncxa03w 08-12-28 11:43:04 GMT EAGLE5 40.0.0
The following features have been permanently enabled:
```

Feature Name	Partnum	Status	Quantity
ISLSBR	893026501	on	----

The following features have been temporarily enabled:

Feature Name	Partnum	Status	Quantity	Trial Period Left
Zero entries found.				

The following features have expired temporary keys:

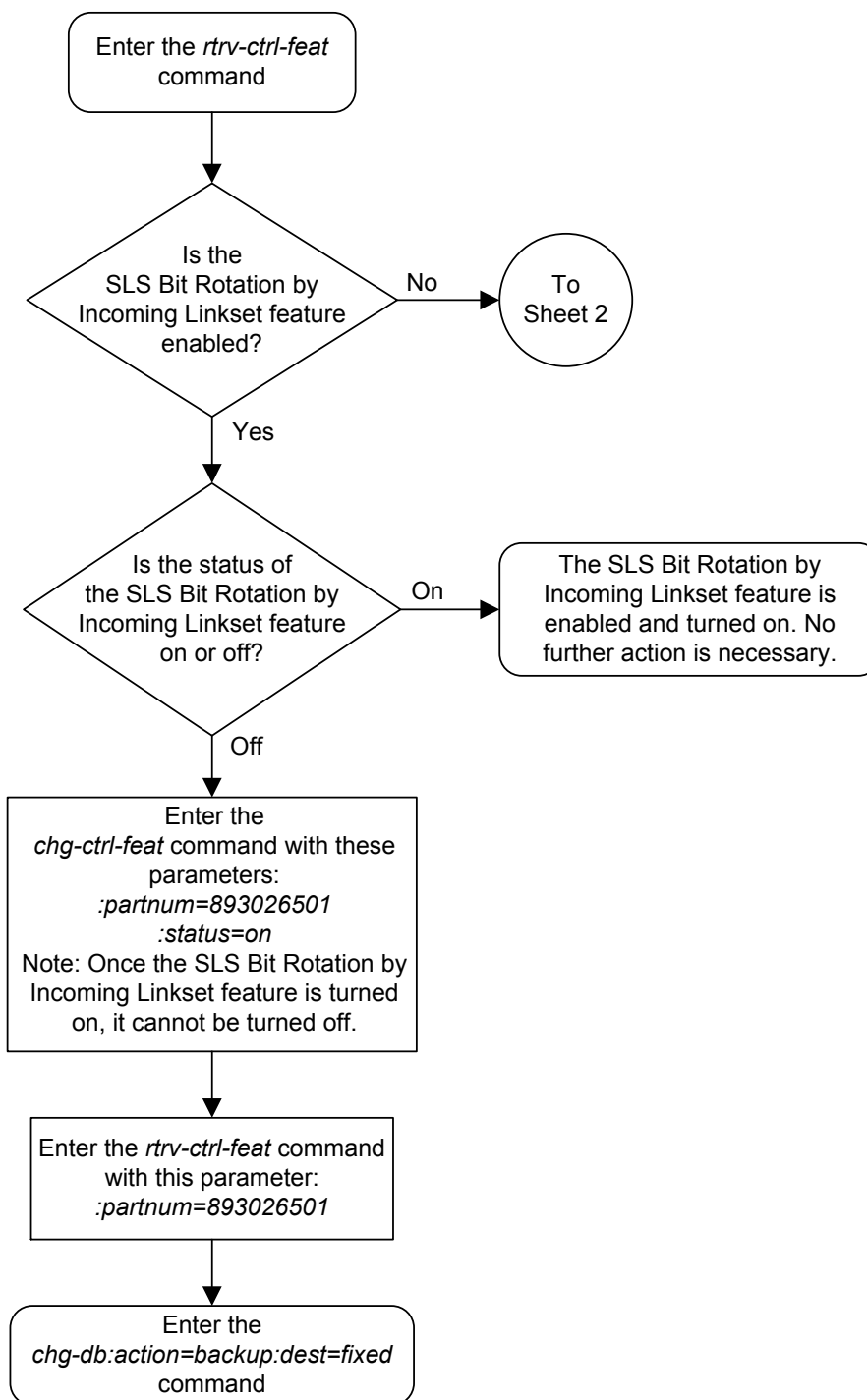
Feature Name	Partnum
Zero entries found.	

- Back up the new changes, using the `chg-db:action=backup:dest=fixed` command.

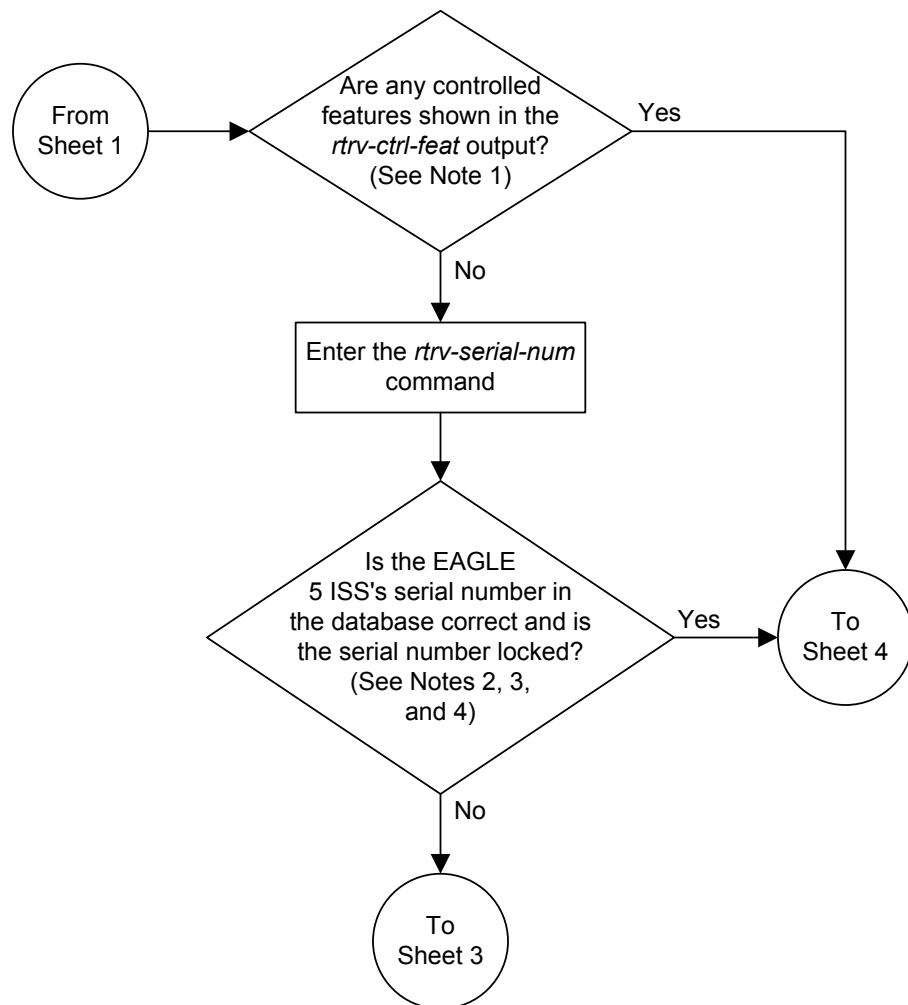
These messages should appear; the active **Maintenance and Administration Subsystem Processor (MASP)** appears first.

```
BACKUP (FIXED): MASP A - Backup starts on active MASP.
BACKUP (FIXED): MASP A - Backup on active MASP to fixed disk complete.
BACKUP (FIXED): MASP A - Backup starts on standby MASP.
BACKUP (FIXED): MASP A - Backup on standby MASP to fixed disk complete.
```

Figure 3-9 Activating the SLS Bit Rotation by Incoming Linkset Feature



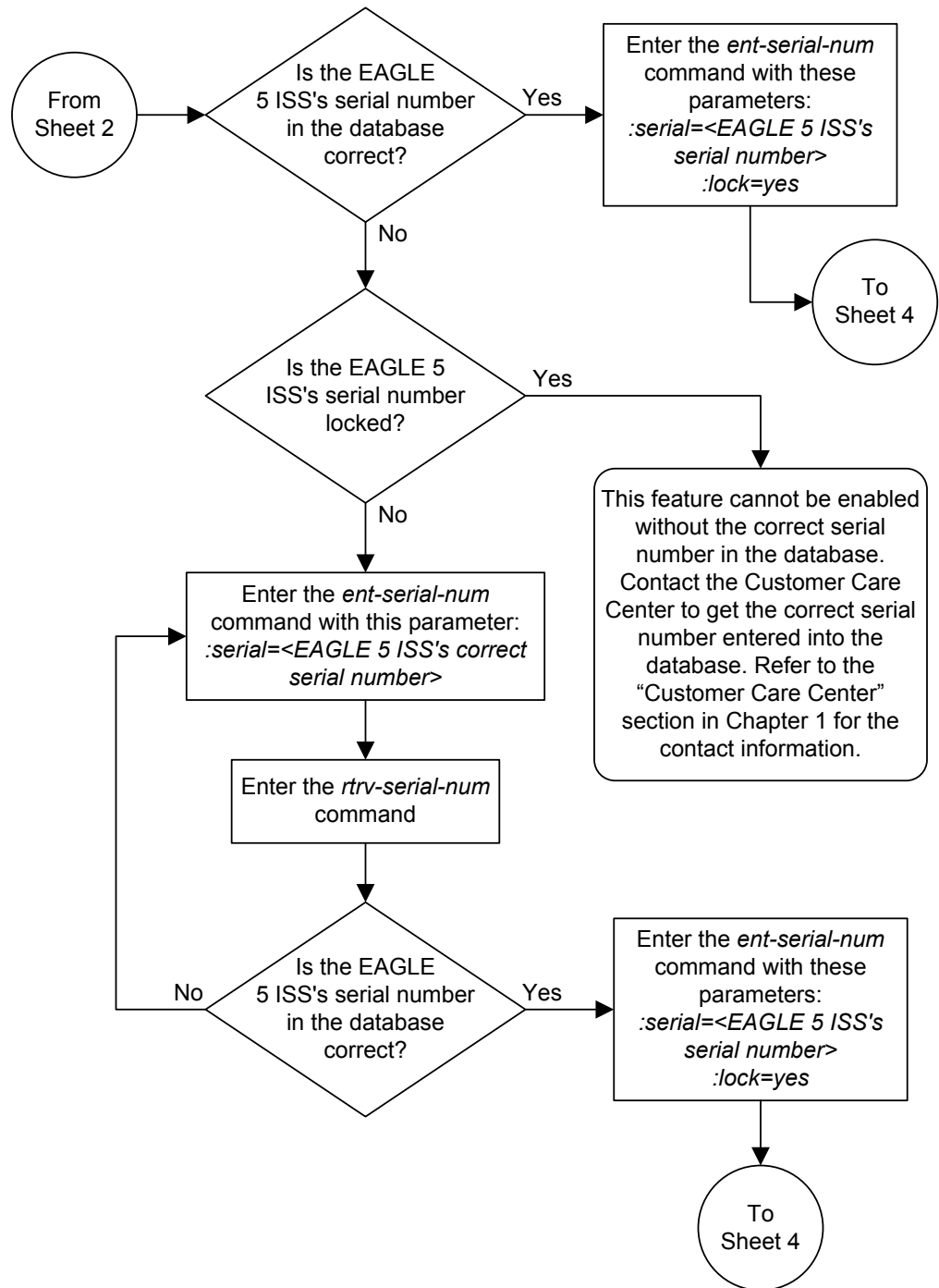
Sheet 1 of 4



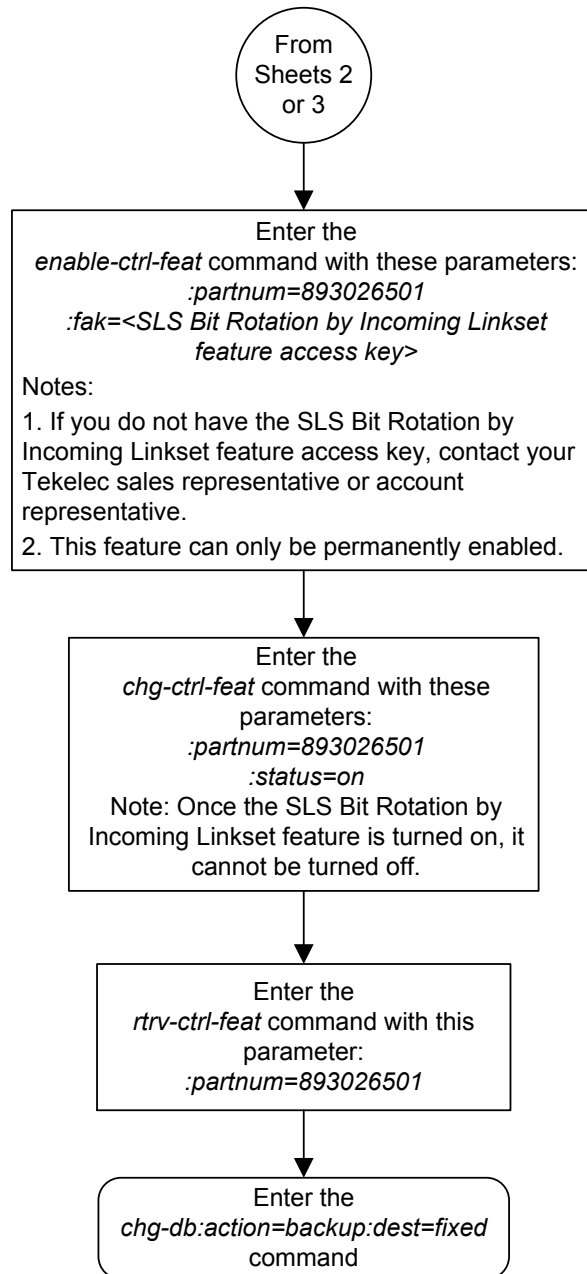
Notes:

1. If the *rtrv-ctrl-feat* output shows only the HC-MIM SLK Capacity feature with a quantity of 64, the answer to this question is no and the Eagle 5 ISS's serial number must be verified. This is the default entry for the *rtrv-ctrl-feat* output. This entry is shown whether or not the Eagle 5 ISS's serial number is in the database.
2. If the serial number is locked, it cannot be changed.
3. If the serial number is not locked, the controlled feature cannot be enabled.
4. The serial number can be found on a label affixed to the control shelf (shelf 1100).

Sheet 2 of 4



Sheet 3 of 4



Configuring the RLS8 Value for ANSI Linksets

This procedure is used to configure the RLS8 value for ANSI linksets feature using the `chg-lsopts` command with the `lsn` and `rls8` parameters.

The `rls8` parameter specifies how many bits of the SLS for messages on ANSI linksets are considered for bit rotation. The `rls8` parameter of the `chg-lsopts` command has two values.

- `yes` - 8 bits of the SLS are considered for bit rotation.
- `no` - 5 bits of the SLS are considered for bit rotation.

The `lsn` parameter specifies the name of the linkset that is being changed, specified in either [Adding an SS7 Linkset](#) or [Changing an SS7 Linkset](#).

The `rls8` parameter can be specified only if the SLS Bit Rotation by Incoming Linkset feature is enabled. Perform [Activating the SLS Bit Rotation by Incoming Linkset Feature](#) to enable the SLS Bit Rotation by Incoming Linkset feature.

The value of the `rls8` parameter is shown in the RLS8 column of the `rtrv-ls` output. The RLS8 column is shown when the `lsn` parameter is specified with the `rtrv-ls` command, and is displayed only for ANSI linksets.

Refer to [ITU SLS Enhancement](#) for information on how the `rls8` parameter value is used with SLS bit rotation.

1. Display the RLS8 value of the linkset that is being changed by entering the `rtrv-ls` with the name of the ANSI linkset that is being changed. For this example, enter this command

```
rtrv-ls:lsn=atmansil
```

This is an example of the possible output.

```
rlghncxa03w 09-05-17 11:43:04 GMT EAGLE5 41.0.0
```

LSN	APCA (SS7)	SCRN	SET	SET	BEI	LST	LNKS	ACT	MES	DIS	SLSCI	NIS
atmansil	200-050-176	scr1	1	9	no	a	0	on	off	off	no	off

SPCA	CLLI	TFATCABMLQ	MTPRSE	ASL8
-----	rlghnccc001	1	no	no

```
RANDSLS
off
```

```
ISLSRSB RLS8
1      no
```

IPSG	IPGWAPC	GTTMODE	CGGTMOD
no	no	CdPA	no

```
Link set table is ( 20 of 1024) 2% full
```

If the RLS8 column is not shown in the `rtrv-ls` output, the SLS Bit Rotation by Incoming Linkset feature is not enabled. Perform [Activating the SLS Bit Rotation by](#)

[Incoming Linkset Feature](#) to enabled the SLS Bit Rotation by Incoming Linkset feature. After the SLS Bit Rotation by Incoming Linkset feature is enabled, the RLS8 value for the linkset is set to no.

If you do not wish to change the RLS8 value for the linkset, this procedure does not need to be performed.

If you wish to change the RLS8 value, continue the procedure with 2.

2. Change the `rls8` parameter value using the `chg-lsopts` command.

If the current RLS8 value is `no`, for this example, enter this command

```
chg-lsopts:lsn=atmansil:rls8=yes
```

If the current RLS8 value is `yes`, for this example, enter this command

```
chg-lsopts:lsn=atmansil:rls8=no
```

When this command has successfully completed, this message should appear.

```
rlghncxa03w 09-05-07 00:22:57 GMT EAGLE5 41.0.0
CHG-LSOPTS: MASP A - COMPLTD
```

3. Verify the changes by entering the `rtrv-ls` command with the name of the linkset that was specified in 3.

```
rtrv-ls:lsn=atmansil
```

This is an example of the possible output.

```
rlghncxa03w 09-05-17 11:43:04 GMT EAGLE5 41.0.0

LSN          APCA  (SS7)  L3T SLT          GWS GWS GWS
atmansil     200-050-176  scr1 1  9  no  a  0  on  off  off  no  off
              SPCA          CLLI          TFATCABMLQ MTPRSE ASL8
-----
              rlgnc001  1          no      no

RANDSLS
off

ISLSRSB RLS8
1      yes

IPSG  IPGWAPC  GTTMODE          CGGTMOD
no    no      CdPA          no
```

Link set table is (20 of 1024) 2% full

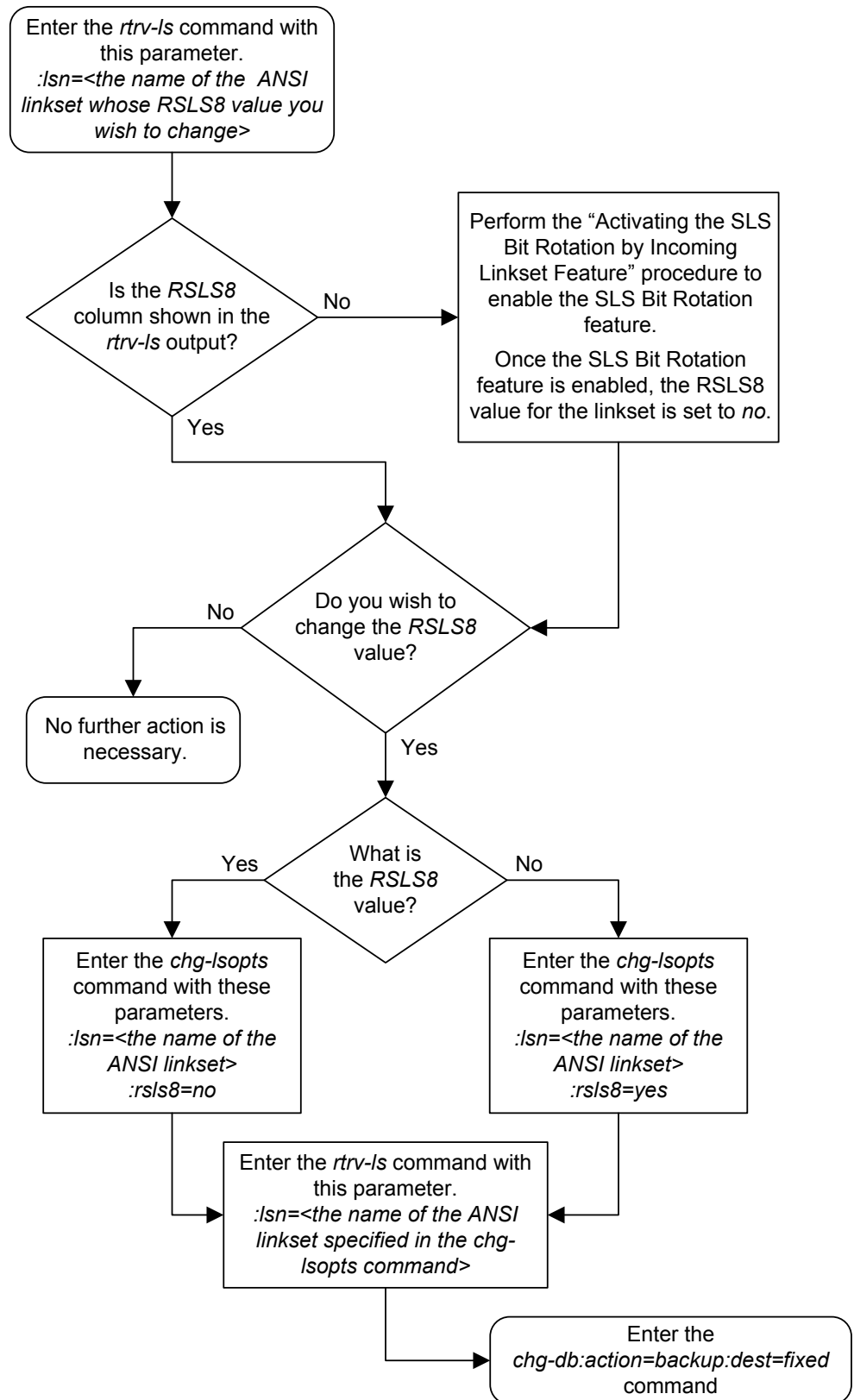
4. Back up the new changes using the `chg-db:action=backup:dest=fixed` command.

These messages should appear, the active **Maintenance and Administration Subsystem Processor (MASP)** appears first.

```
BACKUP (FIXED) : MASP A - Backup starts on active MASP.
BACKUP (FIXED) : MASP A - Backup on active MASP to fixed disk complete.
```

BACKUP (FIXED) : MASP A - Backup starts on standby MASP.
BACKUP (FIXED) : MASP A - Backup on standby MASP to fixed disk complete.

Figure 3-10 Configuring the RSLs8 Value for ANSI Linksets



Removing a Linkset Containing SS7 Signaling Links

This procedure is used to remove a linkset containing **SS7** signaling links from the database using the `dlr-ls` command.

The `dlr-ls` command has only one parameter, `lsn`, which is the name of the linkset to be removed from the database.

The linkset to be removed must exist in the database.

To remove a linkset, all links associated with the linkset must be removed.

The linkset to be removed cannot be referenced by a routeset.

If the Flexible Linkset Optional Based Routing feature is enabled and turned on, and the linkset is referenced by a GTT selector, the linkset cannot be removed.

To remove an **IPGWx** linkset, a linkset containing signaling links assigned to cards running either the **SS7IPGW** or **IPGWI** applications, the **IPGWx** linkset cannot be the mate of another **IPGWx** linkset.

A proxy linkset whose APC is assigned to more than one proxy linkset cannot be removed if the linkset contains the proxy point code (shown in the `PPCA/PPCI/PPCN/PPCN24` field in the `rtrv-ls:apc/apca/apci/apcn/apcn24=<APC of the linkset>` output) that is also assigned to the APC of the linkset. The proxy point code assigned to the APC of the linkset is shown in the `rtrv-dstn:dpc/dpca/dpci/dpcn/dpcn24=<APC of the linkset>` output. The linksets that do not contain the proxy point code that is assigned to the APC of the linkset must be removed before the linkset containing proxy point code that is assigned to the APC of the linkset can be removed.

Canceling the **RTRV-LS** Command

Because the `rtrv-ls` command used in this procedure can output information for a long period of time, the `rtrv-ls` command can be canceled and the output to the terminal stopped. There are three ways that the `rtrv-ls` command can be canceled.

- Press the F9 function key on the keyboard at the terminal where the `rtrv-ls` command was entered.
- Enter the `canc-cmd` without the `trm` parameter at the terminal where the `rtrv-ls` command was entered.
- Enter the `canc-cmd:trm=<xx>`, where `<xx>` is the terminal where the `rtrv-ls` command was entered, from another terminal other than the terminal where the `rtrv-ls` command was entered. To enter the `canc-cmd:trm=<xx>` command, the terminal must allow Security Administration commands to be entered from it and the user must be allowed to enter Security Administration commands. The terminal's permissions can be verified with the `rtrv-secu-trm` command. The user's permissions can be verified with the `rtrv-user` or `rtrv-secu-user` commands.

For more information about the `canc-cmd` command, go to *Commands User's Guide*.

1. Display the current linkset configuration using the `rtrv-ls` command. This is an example of the possible output.

```
rlghncxa03w 07-05-10 11:43:04 GMT EAGLE5 37.0.0
```

LSN	APCA (SS7)	SCRN	L3T SLT			LST	LNKS	GWS GWS GWS			SLSCI	NIS
			SET	SET	BEI			ACT	MES	DIS		
ele2	001-207-000	none	1	1	no	B	6	off	off	off	no	off
ls1	240-012-004	scr1	1	1	yes	a	4	off	off	off	yes	off
ls1305	000-005-000	none	1	1	no	A	1	off	off	off	no	off
ls1307	000-007-000	none	1	1	no	A	1	off	off	off	no	off
elm1s1	001-001-001	none	1	1	no	A	7	off	off	off	no	off
elm1s2	001-001-002	none	1	1	no	A	7	off	off	off	no	off
lsgw1103	003-002-004	none	1	1	no	A	1	off	off	off	no	off
lsn150	150-001-002	none	1	1	no	PRX	1	off	off	off	no	off
lsn151	150-001-002	none	1	1	no	PRX	1	off	off	off	no	off

LSN	APCI (SS7)	SCRN	L3T SLT			LST	LNKS	GWS GWS GWS			SLSCI	NIS
			SET	SET	BEI			ACT	MES	DIS		
ele2i	1-207-0	none	1	1	no	B	4	off	off	off	---	on
ls1315	0-015-0	none	1	1	no	A	1	off	off	off	---	off
ls1317	0-017-0	none	1	1	no	A	1	off	off	off	---	on
elm2s1	1-011-1	none	1	1	no	A	7	off	off	off	---	off
elm2s2	1-011-2	none	1	1	no	A	7	off	off	off	---	off

Link set table is (14 of 1024) 1% full.

If the linkset being removed is a proxy linkset (LST=PRX), and more than one linkset is shown in the `rtrv-ls` output that contains the APC of the linkset being removed, continue the procedure with 2.

If the linkset being removed is not a proxy linkset, or is a proxy linkset whose APC is not used by more than one linkset, continue the procedure with 4.

2. Display the linksets that contain the APC of the linkset being removed by entering the `rtrv-ls` command with the APC of the linkset. For this example, enter this command.

```
rtrv-ls:apca=150-001-002
```

This is an example of the possible output.

```
rlghncxa03w 07-08-23 11:09:57 EST 37.0.0
```

```
APCA = 150-001-002
```

LSN	PPCA	SCRN	L3T SLT			LST	LNKS	GWS GWS GWS			SLSCI	NIS
			SET	SET	BEI			ACT	MES	DIS		
lsn150	150-001-001	none	1	1	no	PRX	1	off	off	off	no	off
lsn151	150-001-004	none	1	1	no	PRX	1	off	off	off	no	off

Link set table is (14 of 1024) 1% full.

3. Display the attributes of the APC of the linkset being removed by entering the `rtrv-dstn` command with the APC of the linkset. For this example, enter this command.

```
rtrv-dstn:dpca=150-001-002
```

This is an example of the possible output.

```
Oraclestp 10-12-15 09:22:39 EST 43.0.0
```

DPCA	CLLI	BEI	ELEI	ALIASI	ALIASN/N24	DMN
150-001-002	-----	no	---	-----	-----	SS7


```

PPCA          NCAI PRX      RCAUSE NPRST SPLITIAM HMSMSC HMSCP SCCPMSGCNV
150-001-001  ---- no       none  off  none    no    no    none
    
```

```

Destination table is (14 of 2000) 1% full
Alias table is (0 of 12000) 0% full
PPC table is (2 of 10) 20% full
    
```

A proxy linkset whose APC is assigned to more than one proxy linkset cannot be removed if the linkset contains the proxy point code (shown in the PPCA/PPCI/PPCN/PPCN24 field in 2) that is also assigned to the APC of the linkset (shown in 3). The linksets that do not contain the proxy point code that is assigned to the APC of the linkset must be removed before the linkset containing proxy point code that is assigned to the APC of the linkset can be removed.

4. Display the signaling links in that linkset being removed using the `rtrv-ls` command, specifying the linkset name of the linkset you wish to remove from the database. For this example, enter these commands.

```
rtrv-ls:lsn=ls1
```

This is an example of the possible output.

```
tekelecstp 18-01-22 05:31:51 EST EAGLE 46.6.0.0-71.21.0
```

```

          L3T SLT          GWS GWS GWS
LSN      APCA  (SS7)  SCRN  SET SET BEI LST LNKS ACT MES DIS SLSCI
NIS
ls1      003-003-003  gws1  1  1  no  A  15  on  on  on  yes
off

          SPCA          CLLI          TFATCABMLQ MTPRSE ASL8
-----
          RANDSLS
          off

          IPSP  GTTMODE          CGGTMOD
          no   CdPA              no

          LP          ATM
LOC  LINK  SLC  TYPE  SET  BPS  TSEL  VCI  VPI  LL
1102 A    2   LIMATM  1   1.544M  EXTERNAL  5    0    0

          LOC  LINK  SLC  TYPE  IPLIML2
          1201 A    5   IPLIM  M2PA

          LOC  LINK  SLC  TYPE  L2T          PCR  PCR  E1  E1
          LOC  LINK  SLC  TYPE  SET  BPS  ECM  N1  N2  LOC  PORT
TS
          1205 A    6   LIME1  1   56000  BASIC  ---  -----  1205  1    1

          LOC  LINK  SLC  TYPE  L2T          PCR  PCR  T1  T1
          LOC  LINK  SLC  TYPE  SET  BPS  ECM  N1  N2  LOC  PORT
TS
          1206 A    10  LIMT1  1   56000  BASIC  ---  -----  1206  1    1
    
```

```
Link set table is (7 of 1024) 1% full.
```

```
rtrv-ls:lsn=lsgw1103
```

This is an example of the possible output.

```
rlghncxa03w 07-05-17 11:43:04 GMT EAGLE5 37.0.0

          L3T SLT          GWS GWS GWS
LSN      APCA  (SS7)  SCRN SET SET BEI LST LNKS ACT MES DIS SLSCI NIS
lsgw1103  003-002-004  none 1  1  no  A  1  off off off no  off

          SPCA          CLLI          TFATCABMLQ MTPRSE ASL8
          -----          -----          1          no          no

IPGWAPC MATELSN  IPTPS  LSUSEALM  SLKUSEALM  GTTMODE
yes      -----  10000 70      % 70      % CdPA

LOC LINK SLC TYPE
1103 A  0  SS7IPGW
```

Link set table is (14 of 1024) 1% full

```
rtrv-ls:lsn=lsn151
```

This is an example of the possible output.

```
rlghncxa03w 09-07-23 13:10:34 EST 41.1.0

          L3T SLT          GWS GWS GWS
LSN      APCA  (SS7)  SCRN SET SET BEI LST LNKS ACT MES DIS SLSCI NIS
lsn151   150-001-002  none 1  1  no  PRX 1  off off off no  off

          PPCA          CLLI          TFATCABMLQ MTPRSE ASL8
          150-001-004  -----          1          no          no

IPGWAPC MATELSN  IPTPS  LSUSEALM  SLKUSEALM  GTTMODE
no      -----  ----  ---  ---  ---  CdPA

          L2T          PCR PCR
LOC LINK SLC TYPE  SET BPS  ECM N1 N2
2105 A  0  LIMDS0  1  56000  BASIC ---  ---

Link set table is (14 of 1024) 1% full.
```

5. Display the routes in the database by using the `rtrv-rte` command, specifying the name of the linkset you wish to remove. For this example, enter these commands.

```
rtrv-rte:lsn=ls1
```

This is an example of the possible output.

```
rlghncxa03w 07-05-10 11:43:04 GMT EAGLE5 37.0.0
LSN      DPC
RC
ls1      240-012-004  10
```

```
rtrv-rte:lsn=lsgw1103
```

This is an example of the possible output.

```
rlghncxa03w 07-05-10 11:43:04 GMT EAGLE5 37.0.0
LSN          DPC
RC
lsgw1103     003-002-004  10
```

```
rtrv-rte:lsn=lsn151
```

This is an example of the possible output.

```
rlghncxa03w 07-05-10 11:43:04 GMT EAGLE5 37.0.0
LSN          DPC
RC
lsn151       150-001-002  10
```

If any routes reference the linkset to be removed, remove these routes by performing the [Removing a Route](#) procedure.

- Deactivate the signaling links in the linkset using the `dact-slk` command. For this example, enter these commands.

```
dact-slk:loc=1205:link=b
dact-slk:loc=1207:link=b
dact-slk:loc=1211:link=a
dact-slk:loc=1213:link=b
dact-slk:loc=1103:link=a
dact-slk:loc=2105:link=a
```

When each of these commands have successfully completed, this message should appear.

```
rlghncxa03w 07-05-07 08:41:12 GMT EAGLE5 37.0.0
Deactivate Link message sent to card
```

- Verify that the linkset is out-of-service maintenance disabled (**OOS-MT-DSBLD**) using the `rept-stat-ls` command, specifying the linkset name. For this example, enter these commands.

```
rept-stat-ls:lsn=ls1
```

This is an example of the possible output.

```
rlghncxa03w 07-05-23 13:35:08 GMT EAGLE5 37.0.0
LSN          APCA          PST          SST          AST
ls1          240-012-004  OOS-MT-DSBLD  Prohibit  -----
SPCA        = -----
ALARM STATUS      = No Alarms
SCRSET       = scr1
GWSA        = ----
GWSM        = ----
GWSD        = ----
SLC SLK      SST          SLC SLK      SST
0  1205,B  Unavail      8  ----,-  UEQ
1  1213,B  Unavail      9  ----,-  UEQ
2  1211,A  Unavail     10  ----,-  UEQ
3  1207,B  Unavail     11  ----,-  UEQ
```

```

4 ----,- UEQ      12 ----,- UEQ
5 ----,- UEQ      13 ----,- UEQ
6 ----,- UEQ      14 ----,- UEQ
7 ----,- UEQ      15 ----,- UEQ

```

Command Completed.

```
rept-stat-ls:lsn=lsgw1103
```

This is an example of the possible output.

```

rlghncxa03w 07-05-23 13:35:08 GMT EAGLE5 37.0.0
LSN          APCA          PST          SST          AST
lsgw1103     003-002-004    OOS-MT-DSBLD Prohibit     -----
  SPCA      = -----
ALARM STATUS      = No Alarms
SCRSET   = scr1
GWSA     = ----
GWSM     = ----
GWSD     = ----
SLC SLK   SST          SLC SLK   SST
0  1103,A Unavail     8  ----,- UEQ
1  ----,- UEQ         9  ----,- UEQ
2  ----,- UEQ        10  ----,- UEQ
3  ----,- UEQ        11  ----,- UEQ
4  ----,- UEQ        12  ----,- UEQ
5  ----,- UEQ        13  ----,- UEQ
6  ----,- UEQ        14  ----,- UEQ
7  ----,- UEQ        15  ----,- UEQ

```

Command Completed.

```
rept-stat-ls:lsn=lsn151
```

This is an example of the possible output.

```

rlghncxa03w 07-05-23 13:35:08 GMT EAGLE5 37.0.0
LSN          APCA          PST          SST          AST
lsn151       150-001-002    OOS-MT-DSBLD Prohibit     -----
  PPCA      = 150-001-004
ALARM STATUS      = No Alarms
SCRSET   = ----
GWSA     = ----
GWSM     = ----
GWSD     = ----
SLC SLK   SST          SLC SLK   SST
0  2105,A Unavail     8  ----,- UEQ
1  ----,- UEQ         9  ----,- UEQ
2  ----,- UEQ        10  ----,- UEQ
3  ----,- UEQ        11  ----,- UEQ
4  ----,- UEQ        12  ----,- UEQ
5  ----,- UEQ        13  ----,- UEQ
6  ----,- UEQ        14  ----,- UEQ
7  ----,- UEQ        15  ----,- UEQ

```

Command Completed.

8. If any signaling links in the linkset are the last signaling link on a card, the card must be placed out of service before that signaling link can be removed. Verify this by entering the `rtrv-slk` command and specifying each of the card locations shown in the output of 4. Do not specify the link parameter. For this example, enter these commands.

rtrv-slk:loc=1205

This is an example of the possible output.

```
rlghncxa03w 09-07-19 21:17:04 GMT EAGLE5 41.1.0
                                L2T                PCR PCR
LOC LINK LSN          SLC TYPE   SET  BPS   ECM  N1  N2
1205 B   ls1          0 LIMDS0   1   56000 BASIC ---  -----
```

rtrv-slk:loc=1207

This is an example of the possible output.

```
rlghncxa03w 09-07-19 21:17:04 GMT EAGLE5 41.1.0
                                L2T                PCR PCR
LOC LINK LSN          SLC TYPE   SET  BPS   ECM  N1  N2
1207 A   ls3          1 LIMDS0   1   56000 BASIC ---  -----
1207 B   ls1          3 LIMDS0   1   56000 BASIC ---  -----
```

rtrv-slk:loc=1211

This is an example of the possible output.

```
rlghncxa03w 09-07-17 11:43:04 GMT EAGLE5 41.1.0
                                L2T                PCR PCR
LOC LINK LSN          SLC TYPE   SET  BPS   ECM  N1  N2
1211 A   ls1          2 LIMDS0   1   56000 BASIC ---  -----
1211 B   ls2          0 LIMDS0   1   56000 BASIC ---  -----
```

rtrv-slk:loc=1213

This is an example of the possible output.

```
rlghncxa03w 09-07-19 21:17:04 GMT EAGLE5 41.1.0
                                L2T                PCR PCR
LOC LINK LSN          SLC TYPE   SET  BPS   ECM  N1  N2
1213 A   ls2          1 LIMDS0   1   56000 BASIC ---  -----
1213 B   ls1          1 LIMDS0   1   56000 BASIC ---  -----
```

rtrv-slk:loc=1103

This is an example of the possible output.

```
rlghncxa03w 07-05-19 21:17:04 GMT EAGLE5 37.0.0
LOC LINK LSN          SLC TYPE
1103 A   lsn1          0 SS7IPGW
```

rtrv-slk:loc=2105

This is an example of the possible output.

```
rlghncxa03w 09-07-19 21:17:04 GMT EAGLE5 41.1.0
                                L2T                PCR PCR
LOC LINK LSN          SLC TYPE   SET  BPS   ECM  N1  N2
2105 A   lsn151       0 LIMDS0   1   56000 BASIC ---  ---
```

9. If the output of 8 shows that any of the signaling links in the specified linkset are the last signaling links on the card, place that card out of service by using the `rmv-`

card command, specifying the card location to be taken out of service. For this example, enter these commands.

```
rmv-card:loc=1205
```

When this command has successfully completed, this message should appear.

```
rlghncxa03w 07-05-07 11:11:28 GMT EAGLE5 37.0.0
Card has been inhibited.
```

```
rmv-card:loc=1103
```

When this command has successfully completed, this message should appear.

```
rlghncxa03w 07-05-07 11:11:28 GMT EAGLE5 37.0.0
Card has been inhibited.
```

```
rmv-card:loc=2105
```

When this command has successfully completed, this message should appear.

```
rlghncxa03w 07-05-07 11:11:28 GMT EAGLE5 37.0.0
Card has been inhibited.
```

10. Remove all links in the linkset using the `dlt-slk` command. For this example, enter these commands.

```
dlt-slk:loc=1205:link=b
```

```
dlt-slk:loc=1207:link=b
```

```
dlt-slk:loc=1211:link=a
```

```
dlt-slk:loc=1213:link=b
```

```
dlt-slk:loc=1103:link=a
```

```
dlt-slk:loc=2105:link=a
```

When each of these commands have successfully completed, this message should appear.

```
rlghncxa03w 07-05-07 08:41:17 GMT EAGLE5 37.0.0
DLT-SLK: MASP A - COMPLTD
```

Note: If the signaling links removed in this step were not assigned to either the SS7IPGW or IPGWI applications, continue the procedure with [14](#).

11. Display the IPGWx linksets by entering the `rept-stat-iptps` command.

This is an example of the possible output.

```
rlghncxa03w 10-07-19 21:16:37 GMT EAGLE5 42.0.0
IP TPS USAGE REPORT

          THRESH  CONFIG/  CONFIG/          TPS   PEAK   PEAKTIMESTAMP
                   RSVD    MAX
-----
LSN
```

```

lsgw1101      80%   ----   10000  TX:   7200   7600  04-06-10 11:40:04
              RCV:   7200   7600  04-06-10 11:40:04
lsgw1103      80%   ----   10000  TX:   6700   7600  04-06-10 11:40:04
              RCV:   6500   7600  04-06-10 11:40:04
lsgw1105      80%   ----   10000  TX:   7300   7450  04-06-10 11:40:04
              RCV:   7300   7450  04-06-10 11:40:04
-----

```

Command Completed.

- Enter the `rtrv-ls` command with one of the linkset names shown in 11. This is to verify if the linkset being removed in this procedure is a mate to another IPGWx linkset.

Repeat this step until all the linksets in 11 have been displayed, or a linkset is found that has the linkset being removed as a mate. For this example, enter this command.

```
rtrv-ls:lsn=lsgw1105
```

This is an example of the possible output.

```
rlghncxa03w 07-05-17 11:43:04 GMT EAGLE5 37.0.0
```

```

              L3T SLT              GWS GWS GWS
LSN          APCA  (SS7)  SCRN SET SET BEI LST LNKS ACT MES DIS SLSCI NIS
lsgw1105     009-002-003  none 1  1  no  A  1  off off off no  off

          CLLI          TFATCABMLQ MTPRSE ASL8
          ----- 1          no  no

          IPGWAPC MATELSN  IPTPS LSUSEALM SLKUSEALM GTTMODE
          yes  lsgw1103  10000 70  % 70  % CdPA

          LOC LINK SLC TYPE
          1105 A  0  SS7IPGW

```

Link set table is (14 of 1024) 1% full

Note: If the `rtrv-ls` output in this step shows that the linkset being removed is not the mate of another IPGWx linkset, continue the procedure with 14.

- Remove the mate linkset assignment shown in 12 by performing the “Configuring a Mate IPGWx Linkset” procedure in *Database Administration - IP7 User’s Guide* using these parameters.

:lsn = the name of the linkset shown in the LSN field in 12.

:matelsn = the name of the linkset shown in the MATELSN field in 12.

:action=delete

- Display any entires in the route exception table whose linkset name is the name of the linkset being removed in this procedure. Enter the `rtrv-rtx` command with the `lsn` parameter. For this example, enter this command.

Remove all the entries displayed in this step by performing the [Removing a Route Exception Entry](#) procedure.

```
rtrv-rtx:lsn=ls1
```

This is an example of the possible output.

```
rlghncxa03w 07-05-10 11:43:04 GMT EAGLE5 37.0.0
```

DPCA	RTX-CRITERIA	LSN	RC	APC
240-012-006	OPCA 008-008-008	ls1	40	240-012-004

```

DESTINATION ENTRIES ALLOCATED: 2000
  FULL DPC(s): 15
  EXCEPTION DPC(s): 5
  NETWORK DPC(s): 0
  CLUSTER DPC(s): 1
  TOTAL DPC(s): 21
  CAPACITY (% FULL): 1%
ALIASES ALLOCATED: 12000
  ALIASES USED: 0
  CAPACITY (% FULL): 0%
X-LIST ENTRIES ALLOCATED: 500
    
```

```
rtrv-rtx:lsn=lsgw1103
```

This is an example of the possible output.

```
rlghncxa03w 07-05-10 11:43:04 GMT EAGLE5 37.0.0
```

```

DESTINATION ENTRIES ALLOCATED: 2000
  FULL DPC(s): 15
  EXCEPTION DPC(s): 5
  NETWORK DPC(s): 0
  CLUSTER DPC(s): 1
  TOTAL DPC(s): 21
  CAPACITY (% FULL): 1%
ALIASES ALLOCATED: 12000
  ALIASES USED: 0
  CAPACITY (% FULL): 0%
X-LIST ENTRIES ALLOCATED: 500
    
```

```
rtrv-rtx:lsn=lsn151
```

This is an example of the possible output.

```
rlghncxa03w 07-05-10 11:43:04 GMT EAGLE5 37.0.0
```

```

DESTINATION ENTRIES ALLOCATED: 2000
  FULL DPC(s): 15
  EXCEPTION DPC(s): 5
  NETWORK DPC(s): 0
  CLUSTER DPC(s): 1
  TOTAL DPC(s): 21
  CAPACITY (% FULL): 1%
ALIASES ALLOCATED: 12000
  ALIASES USED: 0
    
```



```

CAPACITY (% FULL):          0%
X-LIST ENTRIES ALLOCATED:   500

```

If the linkset being removed in this procedure is not assigned to a route exception table entry, no entries are displayed in the `rtrv-rtx` output, but a summary of the point code quantities is displayed.

If the name of the linkset being removed in this procedure shown in the `LSN` column in this step, perform one of these procedures:

- a. Change the name of the linkset in the entries displayed in this step by performing the [Changing a Route Exception Entry](#) procedure.
- b. Remove all the entries displayed in this step by performing the [Removing a Route Exception Entry](#) procedure.

15. If the Flexible Linkset Optional Based Routing feature is enabled and turned on, and the linkset is referenced by any GTT selectors, the linkset cannot be removed.

If the linkset contains the entries `fc`, `fcg`, `fcdfcg`, or `fcgfc` in the `GTTMODE` column of the `rtrv-ls` output in 4, the Flexible Linkset Optional Based Routing feature is enabled and turned on. Continue the procedure with 17.

If the linkset does not contain the entries `fc`, `fcg`, `fcdfcg`, or `fcgfc` in the `GTTMODE` column of the `rtrv-ls` output in 4, continue the procedure with 16.

16. Verify whether or not the Flexible Linkset Optional Based Routing feature is enabled and turned on by entering this command.

```
rtrv-ctrl-feat:partnum=893027701
```

This is an example of the possible output.

```
rlghncxa03w 09-05-10 11:43:04 GMT EAGLE5 41.0.0
The following features have been permanently enabled:
```

Feature Name	Partnum	Status	Quantity
Flex Lset Optnl Based Rtg	893027701	on	----

The following features have been temporarily enabled:

Feature Name	Partnum	Status	Quantity	Trial Period Left
Zero entries found.				

The following features have expired temporary keys:

Feature Name	Partnum
Zero entries found.	

If the Flexible Linkset Optional Based Routing feature is enabled and turned on, continue the procedure with 17.

If the Flexible Linkset Optional Based Routing feature is not enabled or not turned on, continue the procedure with 18.

17. Display the GTT selectors that contain the linkset that is being removed by entering the `rtrv-gttsel` command with the name of the linkset. For this example, enter these commands.

rtrv-gttset:lsn=ls1

This is an example of the possible output.

rlghncxa03w 09-05-10 11:43:04 GMT EAGLE5 41.0.0

GTI				CG			CDPA		CGPA
ANSI	TT	NP	NAI	SSN	SELID	LSN	GTTSET		GTTSET
2	180	--	---	any	none	ls1	-----	(---) cdgta4 (cdgta)

GTI				CG			CDPA		CGPA
INTL	TT	NP	NAI	SSN	SELID	LSN	GTTSET		GTTSET

GTI				CG			CDPA		CGPA
NATL	TT	NP	NAI	SSN	SELID	LSN	GTTSET		GTTSET

GTI				CG			CDPA		CGPA
N24	TT	NP	NAI	SSN	SELID	LSN	GTTSET		GTTSET

rtrv-gttset:lsn=lsgw1103

This is an example of the possible output.

rlghncxa03w 09-05-10 11:43:04 GMT EAGLE5 41.0.0

GTI				CG			CDPA		CGPA
ANSI	TT	NP	NAI	SSN	SELID	LSN	GTTSET		GTTSET
2	170	--	---	any	none	lsgw1103	-----	(---) cdgta4 (cdgta)

GTI				CG			CDPA		CGPA
INTL	TT	NP	NAI	SSN	SELID	LSN	GTTSET		GTTSET

GTI				CG			CDPA		CGPA
NATL	TT	NP	NAI	SSN	SELID	LSN	GTTSET		GTTSET

GTI				CG			CDPA		CGPA
N24	TT	NP	NAI	SSN	SELID	LSN	GTTSET		GTTSET

rtrv-gttset:lsn=lsn151

This is an example of the possible output.

rlghncxa03w 09-05-10 11:43:04 GMT EAGLE5 41.0.0

GTI				CG			CDPA		CGPA
ANSI	TT	NP	NAI	SSN	SELID	LSN	GTTSET		GTTSET
2	160	--	---	any	none	lsn151	-----	(---) cdgta4 (cdgta)

GTI				CG			CDPA		CGPA
INTL	TT	NP	NAI	SSN	SELID	LSN	GTTSET		GTTSET

```
GTI          CG          CDPA          CGPA
NATL TT NP   NAI  SSN SELID LSN  GTTSET      GTTSET
```

```
GTI          CG          CDPA          CGPA
N24 TT NP   NAI  SSN SELID LSN  GTTSET      GTTSET
```

If GTT selectors are shown in the `rtrv-gttset` output, perform the "Removing a GTT Selector" procedure in *Database Administration - GTT User's Guide* to remove all entries shown in this step. After the GTT selectors have been removed, continue the procedure with [18](#).

If GTT selectors are not shown in the `rtrv-gttset` output, continue the procedure with [18](#).

- 18.** Remove the linkset using the `dlt-ls` command. For this example, enter these commands.

```
dlt-ls:lsn=lsn1
dlt-ls:lsn=lsgw1103
dlt-ls:lsn=lsn151
```

When each of these commands have successfully completed, this message should appear.

```
rlghncxa03w 07-05-17 16:03:12 GMT  EAGLE5 37.0.0
Link set table is ( 23 of 1024) 2% full
DLT-LS: MASP A - COMPLTD
```

- 19.** Verify the changes using the `rtrv-ls` command with the linkset name used in [18](#).

For this example, enter these commands.

```
rtrv-ls:lsn=lsn1
rtrv-ls:lsn=lsgw1103
rtrv-ls:lsn=lsn151
```

If the removal of the linkset was successful, the following message is displayed.

```
rlghncxa03w 09-07-10 11:43:04 GMT  EAGLE5 41.1.0
No matching entry found.
Link set table is (11 of 1024) 1% full.
```

Continue the procedure with [20](#) if the linkset that was removed in has any of these attributes.

- The linkset was not a proxy linkset.
- The linkset was a proxy linkset whose APC was assigned to only the proxy linkset that was removed in [18](#).
- The linkset was a proxy linkset and:
 - The APC of this linkset is assigned to more than one linkset.

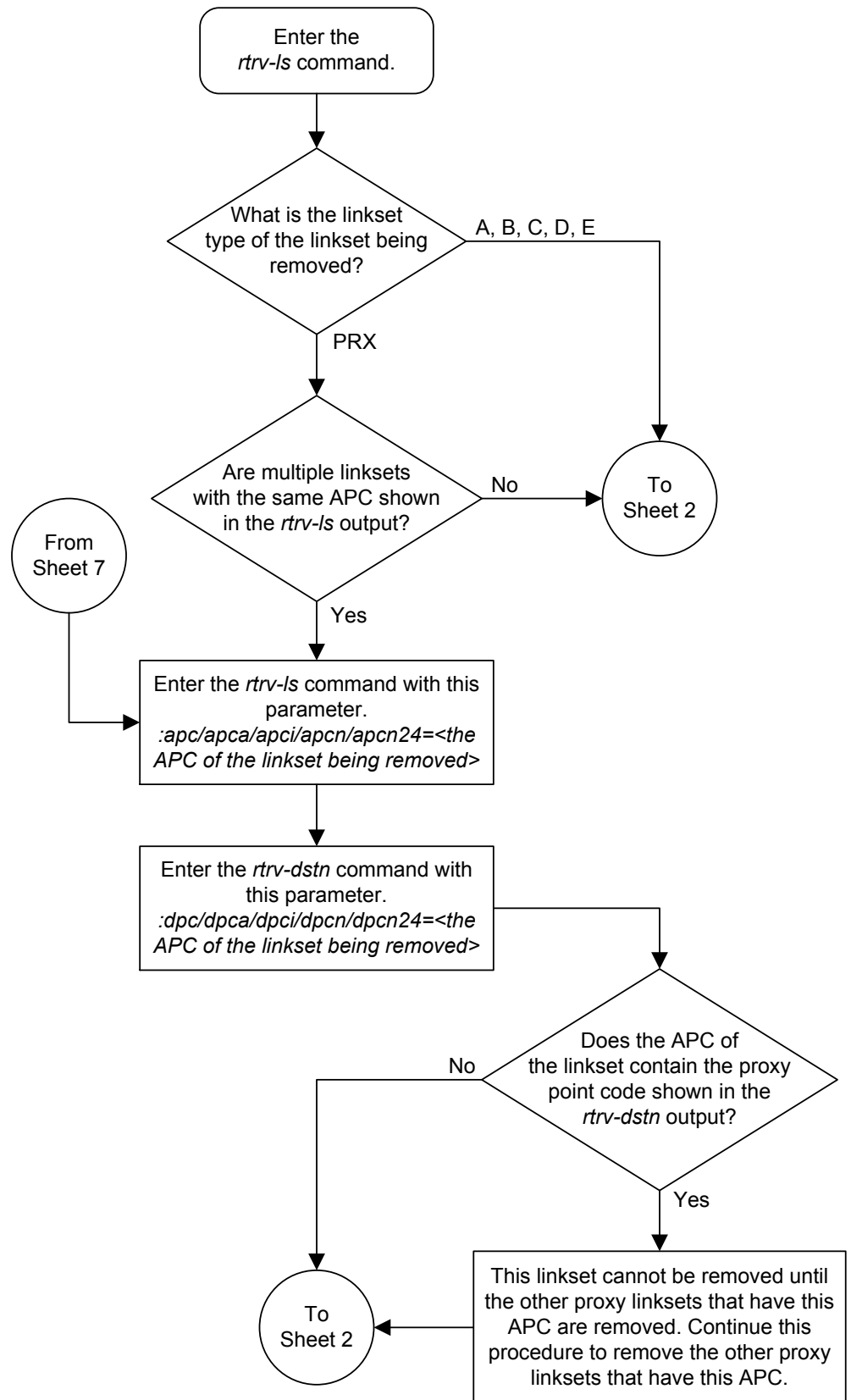
- The linkset did not contain the proxy point code that was assigned to the APC of the linkset.
- The linkset that contains the proxy point code that is assigned to the APC of the linkset will not be removed from the database.

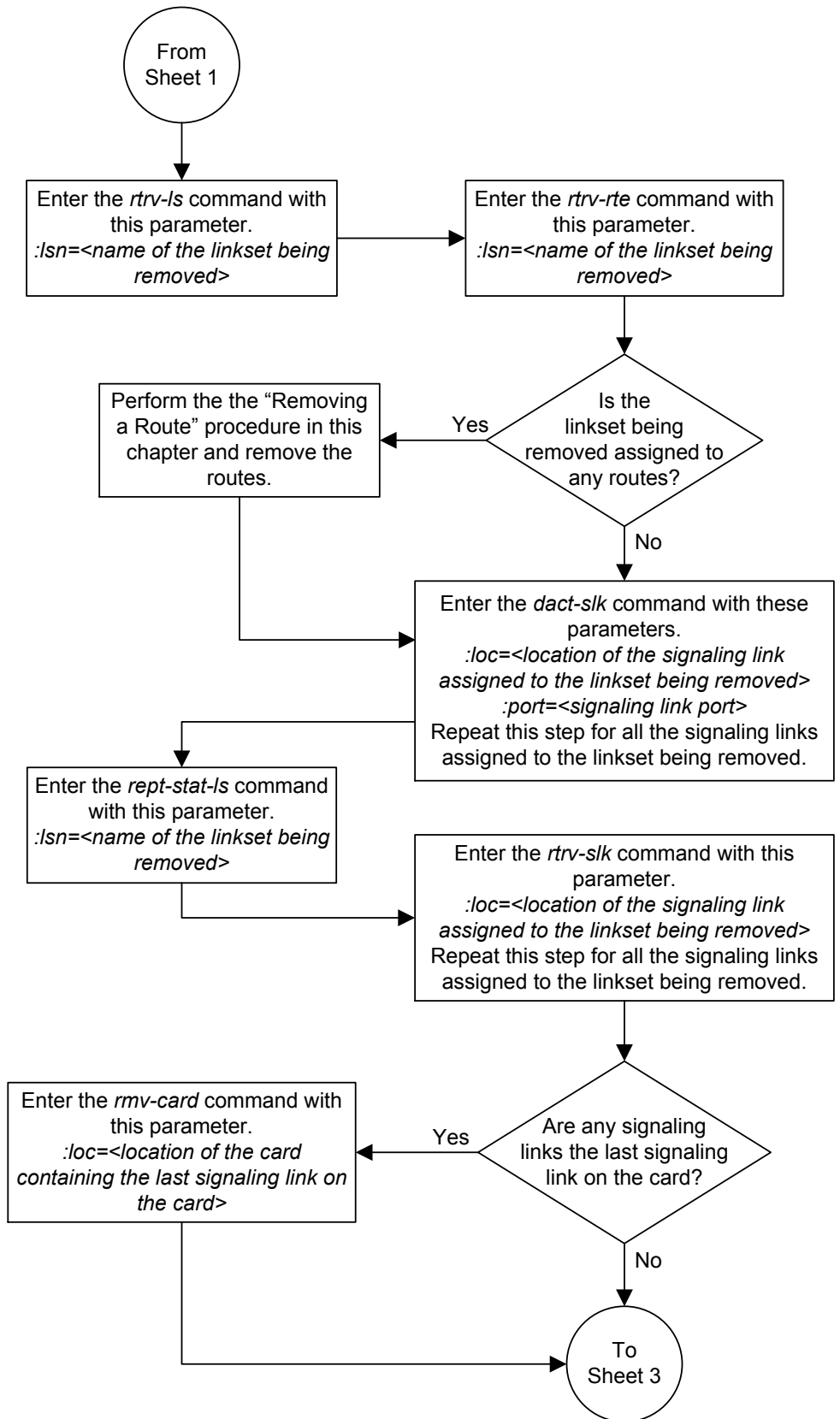
If you wish to remove the proxy linkset that contains the proxy point code that is also assigned to the APC of the linkset, and the database contains other linksets that are assigned to this APC, these other linksets must be removed before the proxy linkset that contains the proxy point code that is also assigned to the APC of the linkset can be removed. Repeat this procedure from [2](#) to remove these linksets. After these linksets have been removed, perform this procedure again from [2](#) to remove the proxy linkset that contains the proxy point code that is also assigned to the APC of the linkset.

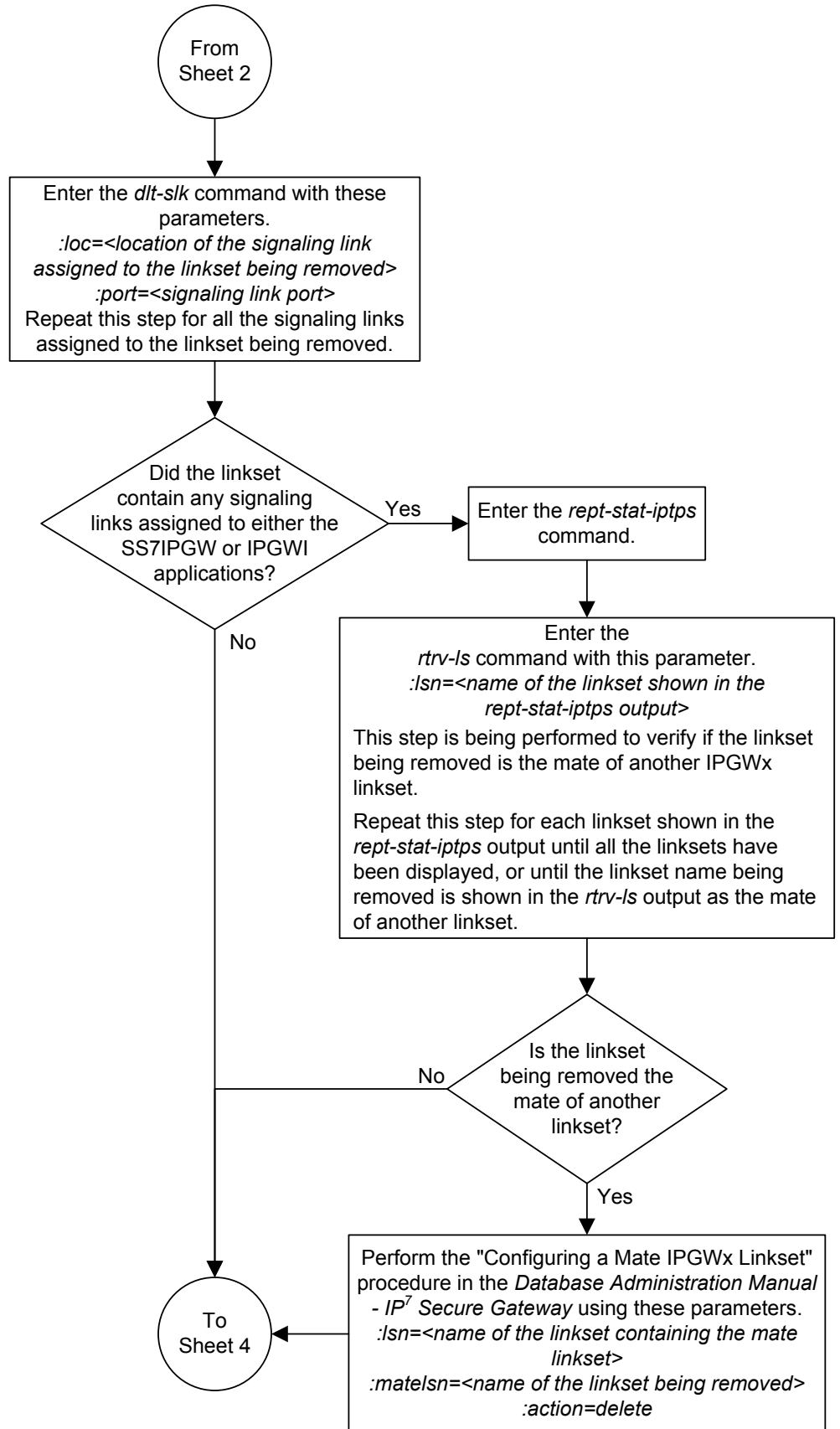
- 20.** Back up the new changes using the `chg-db:action=backup:dest=fixed` command. These messages should appear, the active **Maintenance and Administration Subsystem Processor (MASP)** appears first.

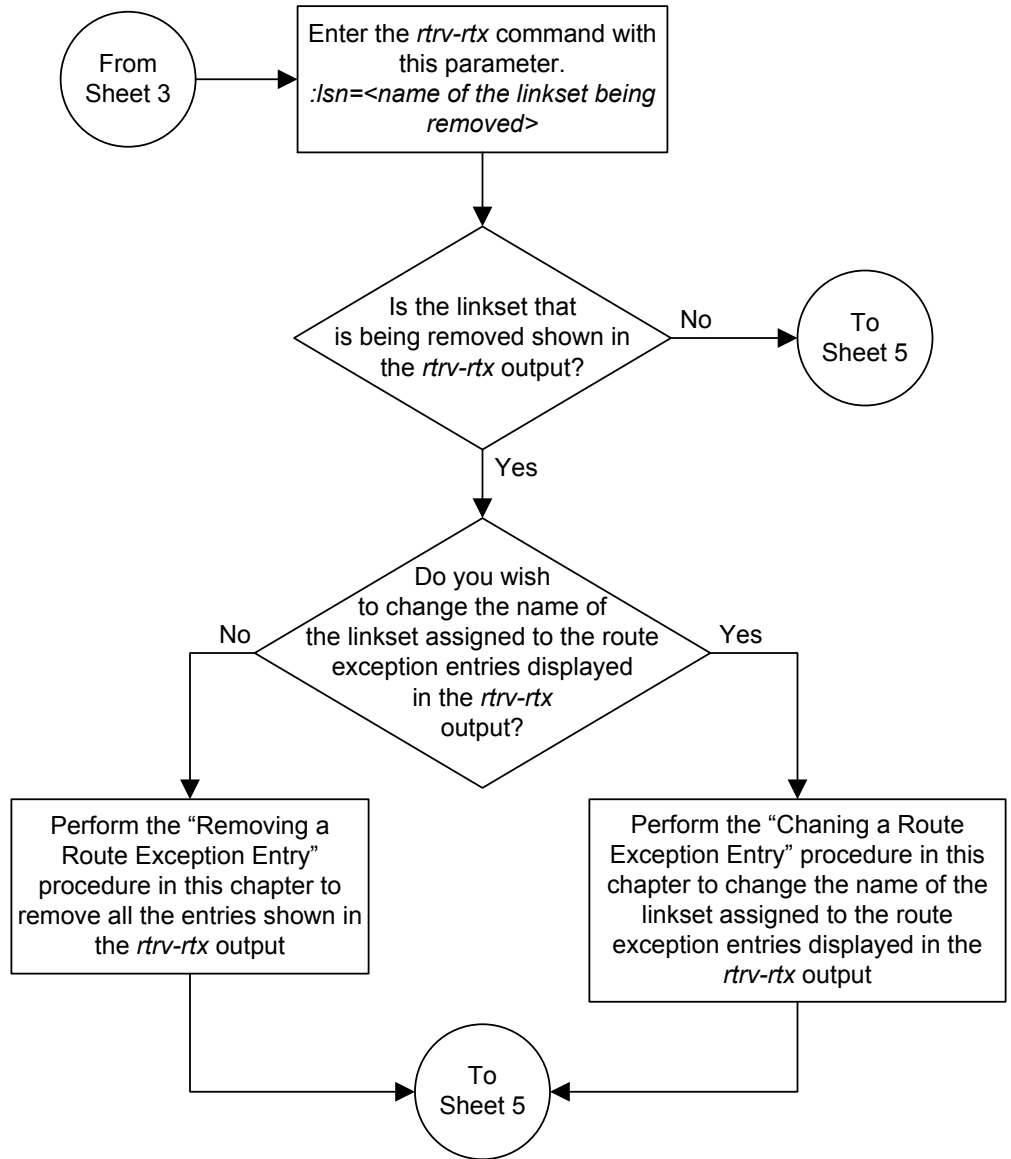
```
BACKUP (FIXED) : MASP A - Backup starts on active MASP.  
BACKUP (FIXED) : MASP A - Backup on active MASP to fixed disk complete.  
BACKUP (FIXED) : MASP A - Backup starts on standby MASP.  
BACKUP (FIXED) : MASP A - Backup on standby MASP to fixed disk complete.
```

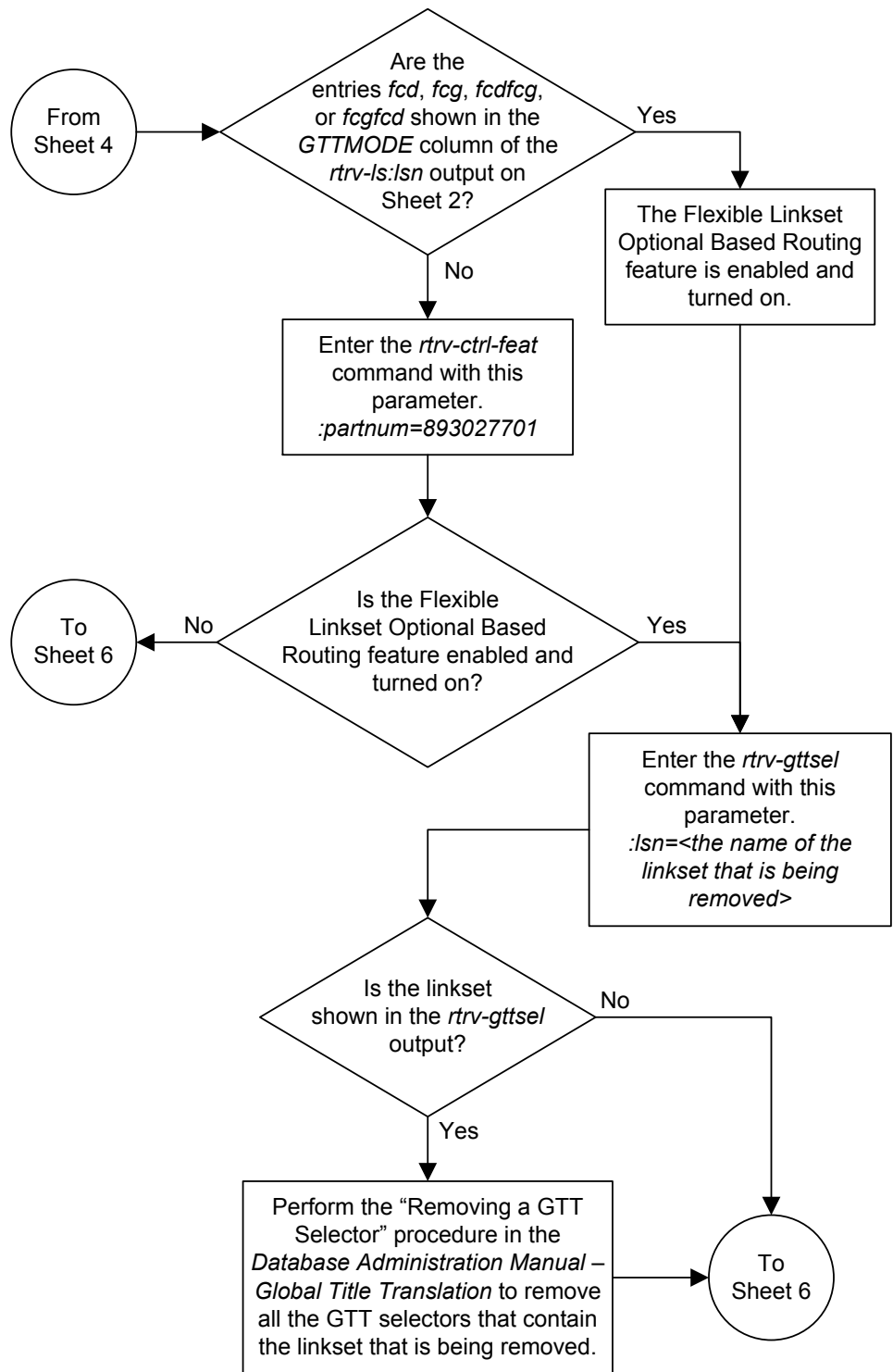
Figure 3-11 Removing a Linkset Containing SS7 Signaling Links

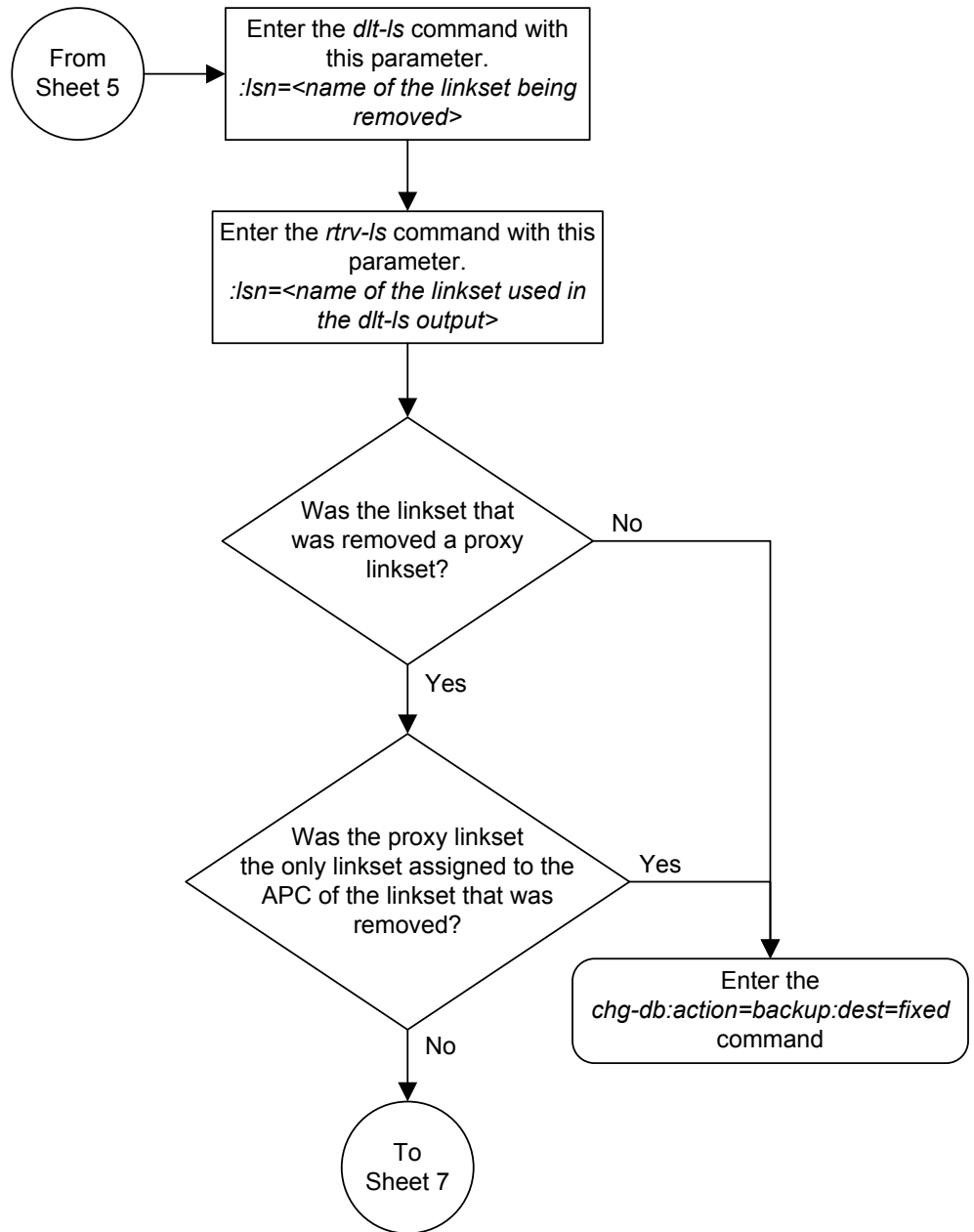


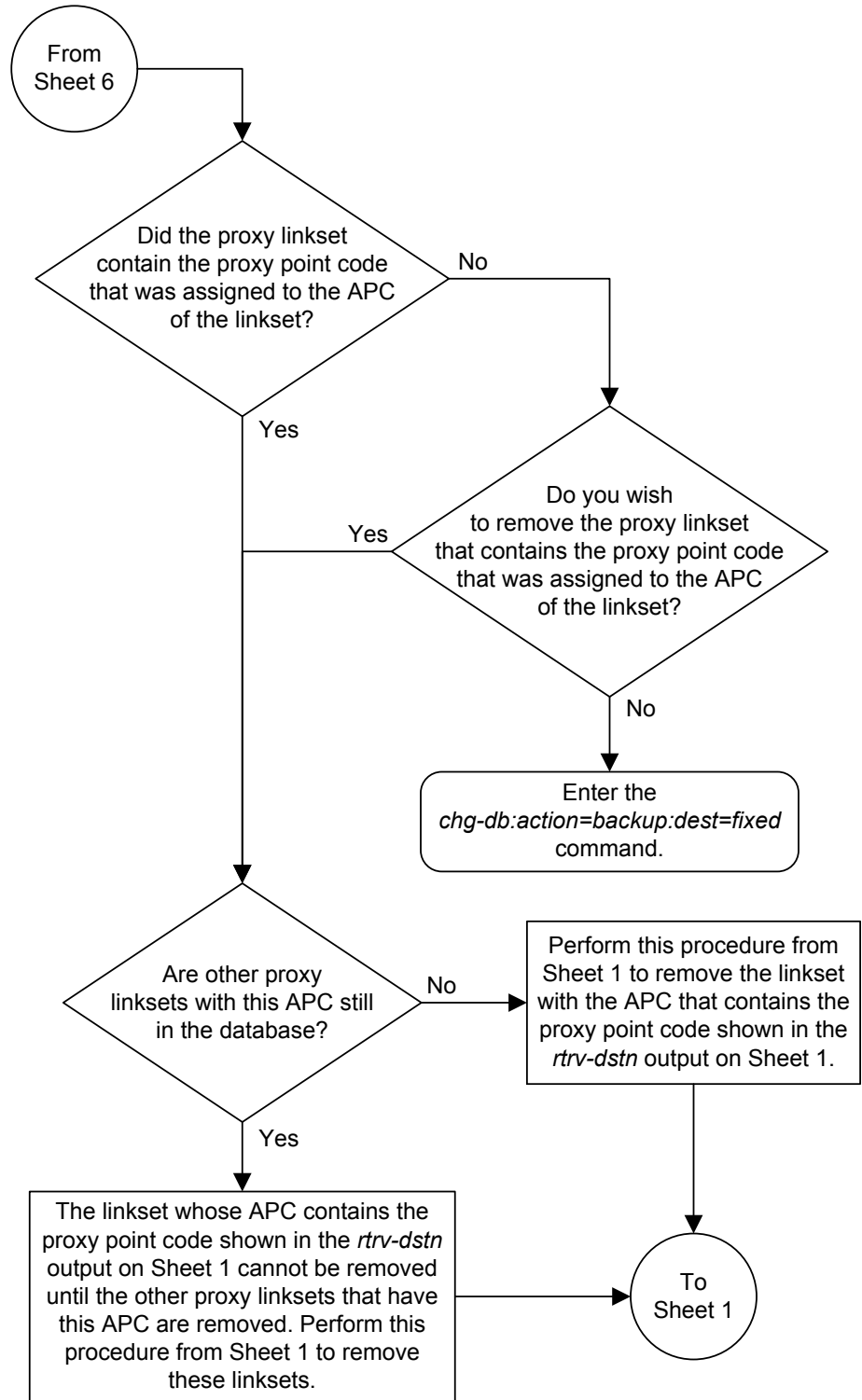












Changing an SS7 Linkset

This procedure is used to change the attributes of a **SS7** linksets to the EAGLE using the `chg-ls` command and the following parameters shown in [Table 3-10](#).

Table 3-10 Linkset Parameters

lsn	nlsn	apc/apca/ apci/ apcn/apcn24	spc/spca/ spci/ spcn/spcn24	apcntype	lst
cli	sltset	l3tset	scrn	gwsa	gwsn
gwsd	bei	tfatcabmlq	nis	itutfr	mtprse
slsci	asl8	slsrsb	slsocbit	multgc	gttmode
randsls	cggmod	islsrsb			

:lsn – The name of the linkset

:nlsn – The new name of the linkset

The linkset name can contain up to 10 characters, with the first character being a letter. However, the **SEAS** interface supports only eight characters. If this linkset is displayed on the **SEAS** interface and the linkset name contains more than eight characters, only the first eight characters in the linkset name are shown. If this linkset name contains more than eight characters, and is specified with the linkset commands on the **SEAS** interface, only the first eight characters can be specified.

:apc/apca/apci/apcn/apcn24 – Adjacent point code – the point code identifying the node that is next to the EAGLE. The adjacent point code can be one of the following types of point codes:

- :apc/apca – ANSI point code
- :apci – ITU-I point code, ITU-I spare point code
- :apcn – 14-bit ITU-N point code, 14-bit ITU-N spare point code
- :apcn24 – 24-bit ITU-N point code

:spc/spca/spci/spcn/spcn24 – Secondary point code used for multiple linksets that have the same APC, or the value none. If the value none is specified, the existing secondary point code that is assigned to the linkset is removed. Secondary point codes can be used only if the Multiple Linksets to Single Adjacent PC feature is enabled and turned on (shown in the `rtrv-ctrl-feat` output. The secondary point code can be one of the following types of point codes:

- :spc/spca – ANSI point code
- :spci – ITU-I point code, ITU-I spare point code
- :spcn – 14-bit ITU-N point code, 14-bit ITU-N spare point code
- :spcn24 – 24-bit ITU-N point code

Note: Refer to [Point Code Formats](#) for a definition of the point code types that are used on the **EAGLE** and for a definition of the different formats that can be used for **ITU** national point codes. Private point codes can be assigned only to **IPGWx** linksets. The procedures for configuring **IPGWx** linksets are in *Database Administration - IP7 User's Guide*.

:apctype – Specifies whether or not the linkset containing either a 14-bit **ITU-N** adjacent point code or a 24-bit **ITU-N** adjacent point code is being used in China (apctype=itunchina) or in countries other than China (apctype=itun). Signaling links in linksets with the apctype=itunchina parameter are handled according to the specifications in *YD/N 068-1997, Technical Specification of National No.7 Signaling System - Message Transfer Part (MTP)*. Signaling links in linksets with the apctype=itun parameter are handled according to the specifications in *ITU-T Q.2210 (07/96), Switching and Signaling, Broadband ISDN- Signaling Network Protocols*. The default value for the apctype parameter is itun.

Linksets shown in section of the rtrv-ls output with the LSN (CHINA) column (and with either the APCN or APCN24 column) have the apctype=itunchina parameter assigned to them.

Linksets shown in section of the rtrv-ls output with the LSN column (and with either the APCN or APCN24 column) have the apctype=itun parameter assigned to them.

:lst – The linkset type of the specified linkset

:c11i – The **Common Language Location Identifier** assigned to this point code. The value of the c11i parameter is only displayed in the rtrv-ls command output when a specific linkset is being displayed with the rtrv-ls:lsn=<linkset name> command.

:sltset – The signaling link test message record to be associated with the linkset.

:l3tset – The level 3 timer set table. This parameter identifies which level three timer set is to be assigned to this linkset. Currently, only one is supported.

:scrn – The name of the screenset to be assigned to this linkset if gateway screening is to be used.

:gwsa – Gateway screening action determines whether gateway screening (**GWS**) is on or off for the specified link set.

:gwsn – Gateway screening messaging is used to turn on or off the display of messages generated for each screened message. When an **MSU** is rejected by gateway screening, a message is output to alert personnel of the event.

:gwsd – Gateway screening **MSU** discard is used to turn on or off the discarding of **MSUs** that bypass the gateway screening function due to load shedding. Also use this parameter with the redirect function; **MSUs** that cannot be screened are discarded if you specify gwsd=on.

:bei – The broadcast exception indicator. This parameter indicates whether **TFP** (transfer prohibited) messages are allowed to be broadcast on the linkset. The yes parameter means **TFPs** are not broadcast. The no parameter means **TFPs** are broadcast.

:tfatcabmlq – the **TFA/TCA** broadcast minimum link quantity shows the minimum number of signaling links in the given link set (or in the combined link set in which it resides) that must be available for traffic. When the number of signaling links in the specified linkset is equal to or greater than the value of the tfatcabmlq parameter,

the status of the routes that use the specified linkset is set to allowed and can carry traffic. Otherwise, these routes are restricted. The value of the `tfatcabmlq` parameter cannot exceed the total number of signaling links contained in the linkset. The system default value for the `tfatcabmlq` parameter is 0.

The value of the `tfatcabmlq` parameter is only displayed in the `rtrv-ls` command output when a specific linkset is being displayed with the `rtrv-ls:lsn=<linkset name>` command.

The `tfatcabmlq` parameter exists only in the `chg-ls` command and not the `ent-ls` command, because no links are assigned to the linkset when the linkset is first created with the `ent-ls` command. The default value for the `tfatcabmlq` parameter (`tfatcabmlq=0`) is entered for the linkset, and shown in the `rtrv-ls` output as 1, when a new linkset is added to the database.

When the `tfatcabmlq` parameter value is 0, the **EAGLE 5 ISS** broadcasts **TFAs/TCAs** only when 1/2 of the links in the linkset (or in the combined link set in which it resides) become available. The `tfatcabmlq` parameter value displayed in the `rtrv-ls` output is 1/2 of the number of signaling links contained in the linkset. If the number of signaling links in the linkset is an odd number, the `tfatcabmlq` parameter value is rounded up to the next whole number. As signaling links are added or removed from the linkset, the `tfatcabmlq` parameter value will be changed automatically.

When the `lst=c` parameter is specified, or when the current (unchanged) `LST` value is `C`, the `tfatcabmlq` parameter cannot be specified unless the `LSRESTRICT SS7` option is on. The state of the `LSRESTRICT SS7` option is shown in the `rtrv-ss7opts` output.

`:nis` – specifies whether the National Spare for Network Indicator feature is on or off for the specific linkset. This feature allows the linkset to use the national spare value (3) for the network indicator code field in the service information octet (**SIO**) of the **MSU** for **ANSI** linksets and **ITU** national linksets (linksets containing either 14-bit **ITU-N** point codes or 24-bit **ITU-N** point codes). This parameter cannot be specified for **ITU** international linksets. The default value for the `nis` parameter is `off`.

For **MSUs** on incoming linksets, only those **MSUs** having the network indicator code values shown in [Table 3-11](#) are allowed into the **EAGLE 5 ISS**.

For **MSUs** on outgoing linksets, the network indicator code value in the **MSU** is changed to either the national network indicator code value (2) or the national spare network indicator code value (3). If the `nis` parameter is set to `off`, the network indicator code value is set to 2.

These actions are summarized in [Table 3-11](#).

The actions described for this parameter apply only if the **ITU National and International Spare Point Code Support** feature is not enabled.

If the **ITU National and International Spare Point Code Support** feature is enabled, the `nis` parameter value is ignored for **ITU-I** and 14-bit **ITU-N** linksets. All the network indicator values are permitted on **ITU-I** and **ITU-N** linksets, and the network indicator value for transmission is based on the International/National and Spare/Non-Spare status of the **DPC** of the message.

Having the **ITU National and International Spare Point Code Support** feature enabled has no effect on **ANSI** and 24-bit **ITU-N** linksets. The `nis` parameter value determines which incoming network indicator spare bit values to permit, and what network indicator spare bit value should be transmitted.

Table 3-11 Actions of the National Spare for Network Indicator Feature

Linkset Type	Feature Disabled	Feature Enabled
Incoming ANSI Linkset	MSUs containing the national network indicator code (2) are allowed into the EAGLE.	MSUs containing these network indicator code values are allowed into the EAGLE. <ul style="list-style-type: none"> • National Network Indicator Code (2) • National Spare Network Indicator Code (3)
Outgoing ANSI Linkset	The network indicator code value in the MSU is set to the national network indicator code (2).	The network indicator code value in the MSU is set to the national spare network indicator code (3).
Incoming ITU National Linkset	MSUs containing these network indicator code values are allowed into the EAGLE. <ul style="list-style-type: none"> • International Network Indicator Code (0) • National Network Indicator Code (2) 	MSUs containing these network indicator code values are allowed into the EAGLE. <ul style="list-style-type: none"> • International Network Indicator Code (0) • National Network Indicator Code (2) • National Spare Network Indicator Code (3)
Outgoing ITU National Linkset	The network indicator code value in the MSU is set to the national network indicator code (2).	The network indicator code value in the MSU is set to the national spare network indicator code (3).

`:itutfr` – specifies whether or not **ITU TFR** (transfer restricted) procedures are being used on the linkset. This parameter applies only to linksets with **ITU** national adjacent point codes (linksets containing either 14-bit **ITU-N** point codes or 24-bit **ITU-N** point codes) and can be specified only for linksets with **ITU** national adjacent point codes. **TFR** procedures are used to redirect traffic away from a node that is having problems routing traffic to a destination. When a node determines that a destination is restricted, the node sends a **TFR** message informing the adjacent nodes about the destination's status. When a destination is restricted, the node should not be used to route messages to the destination even though it still has limited capability to do so. The values for this parameter are either on (**ITU TFR** procedures are enabled) or off (**ITU TFR** procedures are disabled). For more information on the `itutfr` parameter and **ITUTFR** procedures, refer to [ITU TFR Procedures](#).

`:mtrprse` – shows if the node adjacent to the **EAGLE** is equipped with the **MTP** restart capability. The `mtrprse=yes` parameter can only be specified if the **MTP** restart feature is turned on for **ANSI** linksets (`MTPRS = on` in the `rtrv-feat` command output), or if the **ITU MTP** restart is on for **ITU** linksets (`ITUMTPRS=on` in the `rtrv-feat` command output). If the **MTP** restart feature is not turned on, the value of the `mtrprse` parameter defaults to `no`. The value of the `mtrprse` parameter value is not dependent on the value of the `mtrprsi` parameter (the **MTP** restart indicator) in the

chg-stpopts command. The value of the mtrprse parameter is only displayed in the rtrv-ls command output when a specific linkset is being displayed with the rtrv-ls:lsn=<linkset name> command. For more information on the mtrprse parameter and MTP restart, refer to [Configuring the MTP Restart Feature](#).

:slsci – indicates whether the 5-bit to 8-bit **SLS** conversion feature is used to select signaling links for outgoing messages on the specified link set. If the slsci=yes parameter is specified, the **EAGLE** replaces any 5-bit **SLS** values contained in received messages with a random 8-bit value before they are used by the **EAGLE** to select the outgoing signaling link in that linkset. The 5-bit to 8-bit **SLS** conversion is also controlled by the slscnv parameter of the chg-stpopts command. The slscnv parameter of the chg-stpopts command has three values: on, off, and perls. The slsci parameter can only be specified for linksets with **ANSI SS7** adjacent point codes.

:asl8 – shows if the node adjacent to the **EAGLE 5 ISS** is sending **MSUs** with 8-bit **SLSs**. If the asl8=yes parameter is specified with the lst=a parameter (a linkset containing access signaling links), this indicates that the originator of the **MSUs** is generating 8-bit **SLSs**. For other linkset types, the asl8=yes parameter indicates that the adjacent node is converting 5-bit **SLSs** to 8-bit **SLSs**. The **SLS** in **MSUs** received by the **EAGLE** on a linkset that has the asl8=yes parameter assigned to it will not be converted. These **MSUs** are assumed to contain 8-bit **SLSs**. If the asl8=no parameter is specified for the linkset, the **SLS** will be converted to an 8-bit **SLS**. The asl8 parameter can only be specified for linksets with **ANSI SS7** adjacent point codes. The value of the asl8 parameter is only displayed in the rtrv-ls command output when a specific linkset is being displayed with the rtrv-ls:lsn=<linkset name> command.

For more information on the slsci and asl8 parameters and 5-bit to 8-bit conversion, refer to [Configuring the 5-Bit to 8-Bit SLS Conversion Feature](#).

:slsrbs – selects which bit (1 - 4) of the **SLS** field to use as the least significant bit for signaling link selection in the link set for all **ITU** messages on outgoing **ITU** linksets.

:islrsb – selects which bit of the **SLS** field, 1 - 8 for an **ANSI** linkset or 1 - 4 for an **ITU** linkset, to use as the least significant bit for signaling link selection in the link set for all messages on **ANSI** and **ITU** linksets on incoming linksets. If you wish to use the values 6, 7, or 8 for the islrsb parameter of a **ANSI** linkset, the rsls8 value for the linkset must be yes. Perform [Configuring the RSL8 Value for ANSI Linksets](#) to change the rsls8 value for the linkset to yes.

:slsocbit – selects which bit (5 - 16) of the **SLS** field to use as the most significant bit for signaling link selection in the link set for all **ITU** messages.

For more information on the slsrbs, islrsb, and slsocbit parameters and **ITU SLS** enhancement, refer to [ITU SLS Enhancement](#).

:multgc – specifies whether multiple group codes are supported for the linkset. When this parameter value is yes, secondary adjacent point codes whose group codes are different from the adjacent point code of the linkset can be assigned to the linkset. If the parameter value is no, the group code of the secondary adjacent point code must be the same as the group code of the linkset's adjacent point code. For more information on secondary adjacent point codes, go to the [Configuring an ITU Linkset with a Secondary Adjacent Point Code \(SAPC\)](#) procedure.

This parameter only applies to linksets whose adjacent point codes are either **ITU** international point codes or 14-bit **ITU** national point codes. All the signaling links in this linkset must be assigned to cards running the **IPLIMI** application. For more information on assigning signaling links to cards running the **IPLIMI** application,

perform the Adding an IPLIMx Signaling Link procedure in *Database Administration - IP7 User's Guide*.

The **ITU** duplicate point code feature must be on before this parameter can be specified. Verify this with the `rtrv-feat` command. If the **ITU** duplicate point code feature is turned on, the `ITUDUPPC` field should be set to `on`. If the **ITU** duplicate point code feature is not turned on, enter the `chg-feat:ituduppc=on` command.

Note: Once the **ITU** duplicate point code feature is turned on with the `chg-feat` command, it cannot be turned off.

The **ITU** duplicate point code feature must be purchased before you turn the feature on with the `chg-feat` command. If you are not sure if you have purchased the **ITU** duplicate point code feature, contact your Oracle Sales Representative or Account Representative.

`:gttmode` – The **GTT** mode assigned to the linkset when performing global title translation on the specified linkset. The values for this parameter are:

- `sysdflt` – the value of the `dfלטgttmode` parameter shown in the `rtrv-sccpopts` command output.
- `cd` - **CdPAGTT** only
- `cg` - **CgPA GTT** only
- `acdc` - Advanced CdPA GTT, CdPA GTT
- `acdcg` - Advanced CdPA GTT, CgPA GTT, CdPA GTT
- `acdcg` - Advanced CdPA GTT, CdPA GTT, CgPA GTT
- `cgacdc` - CgPA GTT, Advanced CdPA GTT, CdPA GTT
- `cgcd` - CgPA GTT, CdPA GTT
- `cdcg` - CdPA GTT, CgPA GTT
- `fc` - Flexible Linkset Optional Based Routing (**FLOBR**) CdPA only
- `fcg` - FLOBR CgPA only
- `fcdfcg` - FLOBR CdPA, FLOBR CgPA
- `fcgfc` - FLOBR CgPA, FLOBR CdPA

For more information on using the `gttmode` parameter, refer to the Origin-Based SCCP Routing Feature section or the Flexible Linkset Optional Based Routing section in *Database Administration - GTT User's Guide*.

To use the values `cg`, `acdc`, `acdcg`, `acdcg`, `cgacdc`, or `cgcd` for the `gttmode` parameter, the Origin-Based SCCP Routing feature must be enabled and turned on.

To use the values `fc`, `fcg`, `fcdfcg`, or `fcgfc` for the `gttmode` parameter, the Flexible Linkset Optional Based Routing feature must be enabled and turned on.

`:randsls` – The random **SLS** value assigned to the linkset. This parameter is used to apply random **SLS** generation for the specified linkset.

The `randsls` parameter has three values:

- `off` – Random **SLS** generation is not applied to the specified linkset.
- `class0` – Random **SLS** generation is applied to only Class 0 **SCCP** messages on either incoming ANSI or outgoing ITU linksets.
- `all` – Random **SLS** generation is applied to both Class 0 and Class 1 **SCCP** messages on outgoing ITU linksets, or to Class 0 **SCCP** messages and **ISUP** messages on ANSI linksets.

For more information about random **SLS** generation on a specific linkset, refer to [Per-Linkset Random SLS](#).

`:cggmod` - The calling party GT modification indicator. This parameter specifies whether or not calling party global title modification is required. The values for this parameter are `yes` (calling party global title modification is required) or `no` (calling party global title modification is not required). This parameter can be specified only if the **AMGTT** or **AMGTT CgPA Upgrade** feature is enabled. Enter the `rtrv-ctrl-feat` command to verify that either the **AMGTT** or **AMGTT CgPA Upgrade** feature is enabled. If the **AMGTT** or **AMGTT CgPA Upgrade** feature is not enabled, perform the "Activating the Advanced GT Modification Feature" procedure in *Database Administration - GTT User's Guide* procedure to enable the required feature. For more information about the Advanced GT Modification feature, refer to the "Advanced GT Modification Feature" section in *Database Administration - GTT User's Guide*.

The **EAGLE** can contain 1024 linksets, with a maximum of 255 of these linksets being gateway linksets. A gateway linkset is a linkset that contains routes to a different network.

The linkset to be changed must exist in the database.

If the adjacent point code (**APC**) is changed, the new **APC** must be in the destination point code table and must be defined as a true point code in the destination point code table and cannot be an alias point code. The domain and point code type of the new **APC** must be the same as the **APC** being changed. For example, if the current adjacent point code is an **ITU-I** point code, the new adjacent point code must be an **ITU-I** point code. The new **APC** of the linkset cannot match the self **ID** of the **EAGLE**. The new **APC** must be a full point code and cannot be a cluster point code or a network routing point code.

Linksets containing **E1 ATM** signaling links cannot contain 24-bit **ITU-N APCs** or **SAPCs**. **E1 ATM** signaling links are identified by the value `LIME1ATM` in the `TYPE` column of the `rtrv-ls:lsn=<linkset name>` output.

The signaling link configuration of the linkset can be verified by entering the `rtrv-ls:lsn=<linkset name>` command.

Use the `rtrv-dstn` command to verify that the new **APC** is in the destination point code table and to verify the domain of the new **APC**. If the new **APC** is not shown in the `rtrv-dstn` command output, go to the [Adding a Destination Point Code](#) procedure and add the **APC** to the destination point code table.

To change the **APC** of a linkset, all signaling links in the linkset must be in the **OOS-MT-DSBLD** state.

The `gwsa`, `gwsn`, and `gwsd` parameters can only be specified if the `scrn` parameter is defined. Enter the `rtrv-ls` command to verify that the `scrn` parameter is defined for the specified linkset. If the `scrn` parameter is defined, a gateway screening screen set name is shown in the `SCRN` field of the output. This gateway screening screen set name

must also be defined as a gateway screening screen set entity. This can be verified with the `rtrv-scrset` command.

Caution: When **Gateway Screening** is in the screen test mode, as defined by the linkset parameters `gwsa=off` and `gwsn=on`, the gateway screening action in the gateway screening stop action set specified by the `actname` parameter of the gateway screening screen set at the end of the gateway screening process will be performed.

The `chg-ls` command has a parameter, `gwsd`, that can allow the discarding of messages that should have gone through the gateway screening process, but could not. The `gwsd` parameter is only intended to be used with the database transport access (DTA) feature. If you are not using the DTA feature, the `gwsd` parameter should not be specified or should be set to `no` (`gwsd=no`).

If the `gwsa=off` parameter is specified, then the `gwsd=off` parameter must be specified.

To help manage congestion on signaling links, the **EAGLE** starts the level 3 T31 timer whenever a signaling link goes into congestion level 1 or congestion level 2. The congestion level that is associated with the level 3 T31 timer is set using the `chg-stpopts` command with the `mtpt31ctl` parameter and is displayed with the `MTPT31CTL` field in the `rtrv-stpopts` command output. When the level 3 timer T31 and the `chg-stpopts` command are first introduced to the **EAGLE**, the system default value for the `mtpt31ctl` parameter of the `chg-stpopts` command is 1, for congestion level 1, and the system default value for the level 3 T31 timer is 60 seconds. To change the value of the level 3 T31 timer, perform [Changing Level 3 Timers](#). To change value of the `mtpt31ctl` parameter, enter the either `chg-stpopts:mtpt31ctl=1` or the `chg-stpopts:mtpt31ctl=2` command, depending on the current value of the `mtpt31ctl` parameter.

To help prevent the signaling link in the linkset from oscillating in out of service, the **EAGLE** starts the level 3 T32 timer. When the **EAGLE** begins restoring an out of service signaling link, the **EAGLE** starts the level 3 T32 timer. If the signaling link fails again before the level 3 T32 expires, the **EAGLE** does not attempt to continue to bring the signaling link into service until the level 3 T32 timer expires. Once the level 3 T32 timer expires, the **EAGLE** attempts to restore the signaling link into service. When the level 3 timer T32 is first introduced to the **EAGLE**, the system default value for the level 3 T32 timer is 60 seconds. To change the value of the level 3 T32 timer, perform [Changing Level 3 Timers](#).

The word **SEAS** cannot be used as a value for the `scrn` parameter of the `chg-ls` command. The word **SEAS** is used in the `rtrv-ls` command output, in the `SCRN` field, to show gateway linksets created on the **SEAS** interface. A gateway linkset combines the functions of a gateway screening screen set and an **SS7** linkset specifying the `gwsa=on` and `scrn` parameters. Like an **EAGLE** gateway screening screen set, a gateway linkset defines the screening references that are to be used to screen the messages on the linkset. It also defines the linkset whose messages are to be screened. A gateway linkset can only be configured from a **SEAS** terminal and not from an **EAGLE** terminal.

If the `clli` parameter is specified with the `chg-ls` command, the value of the `clli` parameter must match the **CLLI** value of the adjacent point code of the linkset. The **CLLI** value of the adjacent point code is shown in the `CLLI` field of the `rtrv-dstn` command.

The `clli` parameter can only be specified with the `apc` or `apca` parameters.

If the `randsls` parameter of the `chg-stpopts` command is set to either `all` or `class0`, a maximum of 16 links continues to be supported in a single linkset to a destination. However, it is now possible to have up to 32 links in a combined linkset to a destination, with a maximum of 16 links per linkset. The 32 links is a change from the current **EAGLE** maximum of only 16 links per combined linkset, which is due to ITU protocol restrictions. If more than 16 links are used in a combined linkset, the operator needs to be aware that a maximum of 16 links can be used by non-Random **SLS** traffic over the linkset. The non-Random **SLS** traffic continues to operate under the rules of the ITU protocol. For more information on the Random **SLS** Generation feature, refer to [Configuring the System for Random SLS Generation](#).

To provision more than one linkset with the same APC, the Multiple Linksets to Single Adjacent PC feature must be enabled and turned on. The database can contain a maximum of six linksets that have the same APC. If the linkset is not a proxy linkset (linkset types A, B, C, D, or E), a secondary point code (shown in the `rtrv-spc` output) must be specified with the linkset. The network type and format of the secondary point code must be the same as the APC of the linkset. Secondary point codes can also be assigned to the APC of the linkset when the point code is provisioned in the database with the `ent-dstn` or `chg-dstn` commands. The secondary point codes that are assigned to the linksets that have the same APC must be unique for each linkset and cannot be the same as the secondary point code that is assigned to the APC of the linksets.

The secondary point code that is assigned to a linkset can be removed from the linkset by specifying the value `none` for the `spc/spca/spci/spcn/spcn24` parameter. A secondary point code can be removed from only one of the linksets in a group of linksets that have the same APC.

If the linkset is a proxy linkset (linkset type PRX), the APC and linkset type of the linkset cannot be changed. A secondary point code and a secondary adjacent point code cannot be specified for a proxy linkset.

Other Optional Parameters

The `chg-ls` command contains other optional parameters that are not used this procedure. These parameters are discussed in more detail in *Commands User's Guide* or in these sections.

- [Configuring an ITU Linkset with a Secondary Adjacent Point Code \(SAPC\)](#)
- The "Configuring a Linkset for the GSM MAP Screening Feature" procedure in *Database Administration - Features User's Guide*.
- These procedures in *Database Administration - IP7 User's Guide*
 - Configuring an IPGWx Linkset
 - Adding a Mate IPGWx Linkset to another IPGWx Linkset
 - Removing a Mate IPGWx Linkset from another IPGWx Linkset
 - Changing an IPSP M3UA Linkset
 - Changing an IPSP M2PA Linkset

If you wish to change the attributes of IPSP linksets, perform one of these procedures in *Database Administration - IP7 User's Guide*

- Changing an IPSP M3UA Linkset

- Changing an IPSP M2PA Linkset

The `gsmscrn` parameter is used for the **GSM MAP** Screening feature. To configure an **SS7** linkset for the **GSM MAP** Screening feature, perform the “Configuring a Linkset for the **GSM MAP** Screening Feature,” in Chapter 5, “**GSM MAP** Screening Configuration,” in *Database Administration - Features User's Guide*.

The network indicator (NI) value of messages on ITU-I or ITU-N linksets can be changed to other values by entering the `icnimap` and `ognimap` parameters of the `chg-lsopts` command. Perform [Configuring the ITU Linkset NI Mapping Options](#) to change these values for the ITU-I or ITU-N linksets.

Canceling the `RTRV-LS` Command

Because the `rtrv-ls` command used in this procedure can output information for a long period of time, the `rtrv-ls` command can be canceled and the output to the terminal stopped. There are three ways that the `rtrv-ls` command can be canceled.

- Press the F9 function key on the keyboard at the terminal where the `rtrv-ls` command was entered.
- Enter the `canc-cmd` without the `trm` parameter at the terminal where the `rtrv-ls` command was entered.
- Enter the `canc-cmd:trm=<xx>`, where `<xx>` is the terminal where the `rtrv-ls` command was entered, from another terminal other than the terminal where the `rtrv-ls` command was entered. To enter the `canc-cmd:trm=<xx>` command, the terminal must allow Security Administration commands to be entered from it and the user must be allowed to enter Security Administration commands. The terminal's permissions can be verified with the `rtrv-secu-trm` command. The user's permissions can be verified with the `rtrv-user` or `rtrv-secu-user` commands.

For more information about the `canc-cmd` command, go to *Commands User's Guide*.

1. Display the current linkset configuration using the `rtrv-ls` command.

This is an example of the possible output.

```
rlghncxa03w 08-12-10 11:43:04 GMT EAGLE5 40.0.0
```

LSN	APCA (SS7)	SCRN	L3T SLT			LST	LNKS	GWS GWS GWS			SLSCI	NIS
			SET	SET	BEI			ACT	MES	DIS		
ele2	001-207-000	none	1	1	no	B	6	off	off	off	no	off
elmls1	001-001-001	none	1	1	no	A	7	off	off	off	no	off
elmls2	001-001-002	none	1	1	no	A	7	off	off	off	no	off
ls04	001-002-003	scr2	1	1	no	a	4	off	off	off	yes	off
ls1305	000-005-000	none	1	1	no	A	1	off	off	off	no	off
ls1307	000-007-000	none	1	1	no	A	1	off	off	off	no	off

LSN	APCI (SS7)	SCRN	L3T SLT			LST	LNKS	GWS GWS GWS			SLSCI	NIS
			SET	SET	BEI			ACT	MES	DIS		
ele2i	1-207-0	none	1	1	no	B	4	off	off	off	---	on
ls1315	0-015-0	none	1	1	no	A	1	off	off	off	---	off
ls1317	0-017-0	none	1	1	no	A	1	off	off	off	---	on
elm2s1	1-011-1	none	1	1	no	A	7	off	off	off	---	off
elm2s2	1-011-2	none	1	1	no	A	7	off	off	off	---	off

LSN	APCN (SS7)	SCRN	L3T SLT			LST	LNKS	GWS GWS GWS			SLSCI	NIS
			SET	SET	BEI			ACT	MES	DIS		
lsn5	11520	scr3	1	1	no	a	3	on	off	off	---	on

```
lsn6          11211          scr3 1 1 no a 3 on off off --- on
```

Link set table is (10 of 1024) 1% full.

2. Display the attributes of the linkset that is being changed by entering the `rtrv-ls` command with the name of the linkset shown in 1. For this example, enter these commands.

```
rtrv-ls:lsn=ls04
```

This is an example of the possible output.

```
rlghncxa03w 09-07-17 11:43:04 GMT EAGLE5 41.1.0
```

```

                                L3T SLT                      GWS GWS GWS
LSN          APCA  (SS7)  SCR N SET SET BEI LST LNKS ACT MES DIS SLSCI NIS
ls04         001-002-003  scr2 1 1 no a 4 off off off yes off

                                SPCA          CLLI          TFATCABMLQ MTPRSE ASL8
-----
                                2          ---          no

RANDSLS
off

IPSG  IPGWAPC  GTTMODE          CGGTMOD
no    no       CdPA          no

                                L2T                      PCR  PCR
LOC   LINK  SLC  TYPE    SET  BPS   ECM  N1  N2
1205  b    0   LIMDS0  1    56000  BASIC ---  -----
1213  b    1   LIMDS0  1    56000  BASIC ---  -----
1211  a    2   LIMDS0  1    56000  BASIC ---  -----
1207  b    3   LIMDS0  1    56000  BASIC ---  -----

```

Link set table is (24 of 1024) 2% full

```
rtrv-ls:lsn=lsn5
```

This is an example of the possible output.

```
rlghncxa03w 09-07-17 11:43:04 GMT EAGLE5 41.1.0
```

```

                                L3T SLT                      GWS GWS GWS
LSN          APCN  (SS7)  SCR N SET SET BEI LST LNKS ACT MES DIS SLSCI NIS
lsn5         11211          scr3 1 1 no a 3 on off off --- on

                                CLLI          TFATCABMLQ MTPRSE ASL8
lsn5clli    1          no          ---

SLSOCCBIT SLRSRB RANDSLS ITUTFR ICNIMAP          OGNIMAP
none      1          off  off  itun2ituns  ituns2itun

IPSG  IPGWAPC  GTTMODE          CGGTMOD
no    no       CdPA          no

                                L2T                      PCR  PCR
LOC   LINK  SLC  TYPE    SET  BPS   ECM  N1  N2
2106  b    0   LIMDS0  1    56000  BASIC ---  -----
2114  b    1   LIMDS0  1    56000  BASIC ---  -----
2112  a    2   LIMDS0  1    56000  BASIC ---  -----

```

Link set table is (24 of 1024) 2% full

Continue the procedure by performing one of these actions.

- If the adjacent point code (APC) or secondary point code (SPC) assigned to the linkset is being changed, perform [Verifying the New Adjacent Point Code or New Secondary Point Code for a Linkset](#). After [Verifying the New Adjacent Point Code or New Secondary Point Code for a Linkset](#) has been performed, continue the procedure with 3.
 - If the adjacent point code (APC) or secondary point code (SPC) assigned to the linkset is not being changed, continue the procedure with 3.
3. To specify the following optional parameters for the linkset, the feature that corresponds to the parameters must be shown as turned on in the `rtrv-feat` output, or enabled, and turned on if required, in the `rtrv-ctrl-feat` output, or other database entities that correspond to the parameters must be configured in the database.

Perform the procedure, shown in the following list, that corresponds to the parameters that you wish to specify for the linkset.

- `scrn, gwsa, gwsn, gwsd` – [Verifying the Gateway Screening Configuration for a Linkset](#)
- `mtprse` – [Configuring the MTP Restart Feature](#)
- `slsci, asl8` – [Configuring the 5-Bit to 8-Bit SLS Conversion Feature](#). These parameters only apply to ANSI linksets.
- `:islrsrb` – [Activating the SLS Bit Rotation by Incoming Linkset Feature](#). If you wish to use the values 6, 7, or 8 for the `islrsrb` parameter of an ANSI linkset, the `rsls8` value for the linkset must be `yes`. Perform [Configuring the RLS8 Value for ANSI Linksets](#) to change the `rsls8` value for the linkset to `yes`.
- `gttmde` – If the value for this parameter will be `cg, acdcd, acdcgd, acdcdg, cgacdcd, cgcd, or cdcg`, perform the "Activating the Origin-Based SCCP Routing Feature" in *Database Administration – GTT User's Guide*. The Origin-Based SCCP Routing feature must be enabled and turned on. If the value for this parameter will be `fgd, fcg, fcgfd, or fcdfcg`, perform the "Activating the Flexible Linkset Optional Based Routing Feature" procedure in *Database Administration – GTT User's Guide*. The Flexible Linkset Optional Based Routing feature must be enabled and turned on.
- `randsls` – [Configuring the System for Random SLS Generation](#). The value of the `randsls` parameter of the `chg-stpopts` command must be `perls`.
- `cgttmode` - "Activating the Advanced GT Modification Feature" in *Database Administration – GTT User's Guide*. Either the AMGTT or AMGTT CgPA Upgrade feature must be enabled.
- `multgc` - [Using the MULTGC Parameter when Changing the Attributes of a Linkset](#). This parameter applies only to linksets with ITU-I and 14-bit ITU-N adjacent point codes.

After the necessary procedures shown in this step have been performed, or if you do not wish to specify the parameters shown in this list for the linkset, continue the procedure by performing one of these steps.

- If the `slsobit` parameter will be specified for the linkset, continue the procedure with [4](#).
 - If the `tfatcabmlq` parameter will be specified for the linkset and the `slsobit` parameter will not be specified for the linkset, continue the procedure with [6](#).
 - If the linkset type of an ANSI linkset is being changed, and the `slsobit` and `tfatcabmlq` parameters will not be specified for the linkset, continue the procedure with [9](#).
 - If the `slsobit` and `tfatcabmlq` parameters will not be specified for the new linkset, and the linkset type of an ANSI linkset will not be changed, continue the procedure with [10](#).
4. To use the `slsobit` parameter with either the `chg-ls` command, the Use of the Other **CIC** Bit feature must be on.

Enter the `rtrv-feat` command to verify that either of this feature is on. The entry `SLSOCB = on` in the `rtrv-feat` command output shows that this feature is on. In this example, the Use of the Other **CIC**Bit feature is off

Note: The `rtrv-feat` command output contains other fields that are not used by this procedure. If you wish to see all the fields displayed by the `rtrv-feat` command, refer to `rtrv-feat` command description in *Commands User's Guide*.

If the Use of the Other **CIC** Bit feature is off (`SLSOCB = off`), continue the procedure with [5](#).

If the Use of the Other **CIC** Bit feature is on (`SLSOCB = on`), continue the procedure by performing one of these steps.

- If the `tfatcabmlq` parameter will be specified for the linkset and the `slsobit` parameter will not be specified for the linkset, continue the procedure with [6](#).
 - If the linkset type of an ANSI linkset is being changed, and the `tfatcabmlq` parameter will not be specified for the linkset, continue the procedure with [9](#).
 - If the `tfatcabmlq` parameter will not be specified for the new linkset, and the linkset type of an ANSI linkset will not be changed, continue the procedure with [10](#).
5. Turn the Use of the Other **CIC** Bit feature is on feature on by entering this command.

```
chg-feat:slsob=on
```

Note: Once the Use of the Other **CIC** Bit feature is turned on with the `chg-feat` command, it cannot be turned off.

The Use of the Other **CIC** Bit feature must be purchased before you turn the feature on with the `chg-feat` command. If you are not sure if you have purchased the Use of the Other **CIC** Bit feature, contact your Oracle Sales Representative or Account Representative.

When this command has successfully completed, this message should appear.

```
rlghncxa03w 08-12-10 11:43:04 GMT EAGLE5 40.0.0
CHG-FEAT: MASP A - COMPLTD
```

Continue the procedure by performing one of these steps.

- If the `tfatcabmlq` parameter will be specified for the linkset and the `slsobit` parameter will not be specified for the linkset, continue the procedure with [6](#).
 - If the linkset type of an ANSI linkset is being changed, and the `tfatcabmlq` parameter will not be specified for the linkset, continue the procedure with [9](#).
 - If the `tfatcabmlq` parameter will not be specified for the new linkset, and the linkset type of an ANSI linkset will not be changed, continue the procedure with [10](#).
- 6.** If the linkset type of the linkset (shown in the `LST` column in the `rtrv-ls` output) is `C`, or will be changed to `C` in this procedure, the linkset's `tfatcabmlq` parameter value can be changed only if the `LSRESTRICTSS7` option is `ON`.

If the linkset's `tfatcabmlq` parameter value is being changed, or if the linkset type will be changed to `C`, continue the procedure with [7](#).

If the linkset's `tfatcabmlq` parameter value is not being changed, or if the linkset type will be changed to or will remain (if unchanged) `A`, `B`, `D`, or `E`, continue the procedure by performing one of these steps.

- If the linkset type of an ANSI linkset is being changed, continue the procedure with [9](#).
- If the linkset type of an ANSI linkset is not being be changed, continue the procedure with [10](#).

Note: The linkset type of a proxy linkset (`LST=PRX`) cannot be changed. If the linkset is a proxy linkset, continue the procedure with [10](#).

- 7.** Display the existing value for the `lsrestrict` parameter by entering the `rtrv-ss7opts` command.

This is an example of the possible output.

```
rlghncxa03w 08-12-17 16:02:05 GMT EAGLE5 40.0.0
SS7 OPTIONS
-----
LSRESTRICT          off
```

Note: The `rtrv-ss7opts` command output contains other fields that are not used by this procedure. If you wish to see all the fields displayed by the `rtrv-ss7opts` command, refer to the `rtrv-ss7opts` command description in *Commands User's Guide*.

If the `lsrestrict` parameter value shown in this step is `off`, continue the procedure with [8](#).

If the `lsrestrict` parameter value shown in this step is `on`, continue the procedure by performing one of these steps.

- If the linkset type of an ANSI linkset is being changed, continue the procedure with [9](#).
 - If the linkset type of an ANSI linkset is not being be changed, continue the procedure with [10](#).
8. Change the value of the `lsrestrict` parameter to `on` by entering this command.

```
chg-ss7opts:lsrestrict=on
```

When this command has successfully completed, this message should appear.

```
rlghncxa03w 08-12-07 00:22:57 GMT EAGLE5 40.0.0  
CHG-SS7OPTS: MASP A - COMPLTD
```

Caution: Turning the `lsrestrict` option on changes the way the **EAGLE** routes messages by using the state of the route along with the cost of the route to determine the preferred route to use. With this option on, the preferred route is not the absolute lowest cost available route in the routeset. A route is considered available if its status is either **Allowed** or **Restricted**. If the state of the absolute lowest cost route in the routeset is **Restricted**, the preferred route is the lowest cost route in the routeset whose status is **Allowed**. Make sure that you wish to have the **EAGLE** route messages in this manner before turning the `lsrestrict` option on.

Continue the procedure by performing one of these steps.

- If the linkset type of an ANSI linkset is being changed, continue the procedure with [9](#).
 - If the linkset type of an ANSI linkset is not being be changed, continue the procedure with [10](#).
9. If the linkset type of the ANSI linkset is being changed, and the linkset is assigned to a route whose DPC is a cluster point code or a network routing point code, the new linkset type must be either B, C, or D. Display the routes that the linkset is assigned to by entering the `rtrv-rte` command with the `lsn` parameter and the name of the linkset that is being changed.

For this example, enter this command.

```
rtrv-rte:lsn=ls04
```

This is an example of the possible output.


```

rlghncxa03w 08-12-01 19:58:14 EST 40.0.0
LSN          DPC          RC
ls04         003-003-*    1
              003-003-004  1
              003-003-006  1
              003-003-007  1

```

10. Deactivate the signaling links in the linkset using the `dact-slk` command.

For this example, enter these commands.

```

dact-slk:loc=1205:link=b
dact-slk:loc=1207:link=b
dact-slk:loc=1211:link=a
dact-slk:loc=1213:link=b
dact-slk:loc=2105:link=b
dact-slk:loc=2111:link=a
dact-slk:loc=2113:link=b

```

When each of these commands have successfully completed, this message should appear.

```

rlghncxa03w 08-12-07 08:41:12 GMT EAGLE5 40.0.0
Deactivate Link message sent to card

```

11. Change the linkset database using the `chg-ls` command. Use [Table 3-12](#) as a guide for the parameters that can be specified with the `chg-ls` command.

Table 3-12 Changing a Linkset Parameter Combinations

ANSI Adjacent Point Code	ITU-I Adjacent Point Code	ITU-N Adjacent Point Code	ITU-N24 Adjacent Point Code
Mandatory Parameter			
:lsn=<the name of the linkset>	:lsn=<the name of the linkset>	:lsn=<the name of the linkset>	:lsn=<the name of the linkset>
Optional Parameters			
:apc/apca=<the ANSI adjacent point code of the linkset> See Notes 1, 2, and 18.	:apci=<the ITU-I adjacent point code of the linkset> See Notes 1, 2, and 18.	:apcn=<the ITU-N adjacent point code of the linkset> See Notes 1, 2, and 18.	:apcn24=<the ITU-N24 adjacent point code of the linkset> See Notes 1, 2, and 18.
:lst=<a, b, c, d, e> See Notes 15 and 19.	:lst=<a, b, c, d, e> See Note 15.	:lst=<a, b, c, d, e> See Note 15.	:lst=<a, b, c, d, e> See Note 15.
:cli=<the CLLI value>	:cli=<the CLLI value>	:cli=<the CLLI value>	:cli=<the CLLI value>
:bei=<yes, no>	:bei=<yes, no>	:bei=<yes, no>	:bei=<yes, no>

Table 3-12 (Cont.) Changing a Linkset Parameter Combinations

ANSI Adjacent Point Code	ITU-I Adjacent Point Code	ITU-N Adjacent Point Code	ITU-N24 Adjacent Point Code
:scrn=<the name of the Gateway Screening screen set> See Note 3.	:scrn=<the name of the Gateway Screening screen set> See Note 3.	:scrn=<the name of the Gateway Screening screen set> See Note 3.	:scrn=<the name of the Gateway Screening screen set> See Note 3.
:gwsa=<on, off> See Notes 4 and 5.	:gwsa=<on, off> See Notes 4 and 5.	:gwsa=<on, off> See Notes 4 and 5.	:gwsa=<on, off> See Notes 4 and 5.
:gwsn=<on, off> See Notes 4 and 5.	:gwsn=<on, off> See Notes 4 and 5.	:gwsn=<on, off> See Notes 4 and 5.	:gwsn=<on, off> See Notes 4 and 5.
:gwsd=<on, off> See Notes 4 and 5.	:gwsd=<on, off> See Notes 4 and 5.	:gwsd=<on, off> See Notes 4 and 5.	:gwsd=<on, off> See Notes 4 and 5.
:l3tset=1	:l3tset=1	:l3tset=1	:l3tset=1
:asl8=<yes, no> See Note 6.	:mtrprse=<yes, no> See Note 12.	:mtrprse=<yes, no> See Note 12.	:mtrprse=<yes, no> See Note 12.
:slsci=<yes, no> See Note 6.	:slsocbit=<5 - 16, none> See Notes 14 and 20.	:slsocbit=<5 - 16, none> See Notes 14 and 20.	:slsocbit=<5 - 16, none> See Notes 14 and 20.
:mtrprse=<yes, no> See Note 12.	:slrsrb=<1 - 4> See Note 20.	:slrsrb=<1 - 4> See Note 20.	:slrsrb=<1 - 4> See Note 20.
:sltset=<1 - 20>	:sltset=<1 - 20>	:sltset=<1 - 20>	:sltset=<1 - 20>
:nis=<on, off>	:nis=off	:nis=<on, off>	:nis=<on, off>
:gttmode=<sysdflt, cd, acdcd, cgacdcd, acdcgcd, acdcdcg, cgcd, cdcg, cg, fcd, fcg, fcdfcg, fcgfcg> See Note 13.	:gttmode=<sysdflt, cd, acdcd, cgacdcd, acdcgcd, acdcdcg, cgcd, cdcg, cg, fcd, fcg, fcdfcg, fcgfcg> See Note 13.	:gttmode=<sysdflt, cd, acdcd, cgacdcd, acdcgcd, acdcdcg, cgcd, cdcg, cg, fcd, fcg, fcdfcg, fcgfcg> See Note 13.	:gttmode=<sysdflt, cd, acdcd, cgacdcd, acdcgcd, acdcdcg, cgcd, cdcg, cg, fcd, fcg, fcdfcg, fcgfcg> See Note 13.
:spc/spca=<the ANSI secondary point code> See Notes 8 and 9.	:spci=<the ITU-I secondary point code> See Notes 8 and 9.	:spcn=<the ITU-N secondary point code> See Notes 8 and 9.	:spcn24=<the ITU-N24 secondary point code> See Notes 8 and 9.
:tfatcabmlq=<0 - 16> See Notes 15 and 16.	:tfatcabmlq=<0 - 16> See Notes 15 and 16.	:tfatcabmlq=<0 - 16> See Notes 15 and 16.	:tfatcabmlq=<0 - 16> See Notes 15 and 16.
:nlisn=< new linkset name>	:nlisn=< new linkset name>	:nlisn=< new linkset name>	:nlisn=< new linkset name>
:cggmod=<yes, no> See Note 10.	:cggmod=<yes, no> See Note 10.	:cggmod=<yes, no> See Note 10.	:cggmod=<yes, no> See Note 10.
:islrsrb=<1 - 8> See Note 11.	:islrsrb=<1 - 4> See Note 11.	:islrsrb=<1 - 4> See Note 11.	:islrsrb=<1 - 4> See Note 11.

Table 3-12 (Cont.) Changing a Linkset Parameter Combinations

ANSI Adjacent Point Code	ITU-I Adjacent Point Code	ITU-N Adjacent Point Code	ITU-N24 Adjacent Point Code
:randsls=<all, class0, off> See Note 7.	:itutfr=<on, off>	:itutfr=<on, off>	:itutfr=<on, off>
	:multgc=<yes, no> See Note 17.	:multgc=<yes, no> See Note 17.	:multgc=<yes, no> See Note 17.
	:randsls=<all, class0, off> See Note 7.	:randsls=<all, class0, off> See Note 7.	:randsls=<all, class0, off> See Note 7.
		:apcntype=<itun, itunchina>	:apcntype=<itun, itunchina>

Table 3-12 (Cont.) Changing a Linkset Parameter Combinations

ANSI Adjacent Point Code	ITU-I Adjacent Point Code	ITU-N Adjacent Point Code	ITU-N24 Adjacent Point Code
Notes:			
<p>a. The adjacent point code must be a full point code, cannot be an alias point code, and must be shown in the <code>rtv-dstn</code> output. This is shown in Verifying the New Adjacent Point Code or New Secondary Point Code for a Linkset. Private point codes cannot be used as an adjacent point code in this procedure. Private point codes can be assigned only to IPGWx linksets. The procedures for configuring IPGWx linksets are in <i>Database Administration - IP7 User's Guide</i>.</p> <p>b. The adjacent point code cannot be shown in the <code>rtv-sid</code> output as the system's point code or any capability point codes - shown in Verifying the New Adjacent Point Code or New Secondary Point Code for a Linkset.</p> <p>c. If a gateway screening screen set is assigned to the linkset, the gateway screening screen set must be in the database – shown in Verifying the Gateway Screening Configuration for a Linkset.</p> <p>d. The <code>gwsa</code>, <code>gwsn</code>, and <code>gwsd</code> parameters can be specified only if the <code>scrn</code> parameter is specified.</p> <hr/> <p>Caution: When Gateway Screening is in the screen test mode, as defined by the linkset parameters <code>gwsa=off</code> and <code>gwsn=on</code>, the gateway screening action in the gateway screening stop action set specified by the <code>actname</code> parameter of the gateway screening screen set at the end of the gateway screening process will be performed.</p> <hr/> <p>e. The <code>gwsd=on</code> parameter can be specified only with the <code>gwsa=on</code> parameter.</p> <p>f. Refer to Table 3-9 for the combinations of the <code>asl8</code> and <code>slsci</code> parameters, and the <code>slscv</code> STP option, and the results that these combinations produce. The <code>asl8</code> and <code>slsci</code> values for two linksets that are in a combined linkset should be the same.</p> <p>g. It is recommended that when configuring <code>randsls</code> values on two linksets that are in a combined linkset that the <code>randsls</code> values for these linksets are the same. If these values are not the same, undesired SLS distribution of the traffic on these linksets may result.</p> <p>h. The <code>spc/spca/spci/spcn/spcn24</code> parameter can be specified only if the Multiple Linksets to Single PC feature is enabled and turned on.</p> <p>i. A linkset may not contain both secondary point codes (<code>spc/spca/spci/spcn/spcn24</code>) and proxy point codes (<code>ppc/ppca/ppci/ppcn/ppcn24</code>).</p> <p>j. The <code>cggtmod</code> parameter can be specified only if either the AMGTT or AMGTT CgPA Upgrade feature is enabled.</p> <p>k. The <code>islsrsb</code> parameter can be specified only if the SLS Bit Rotation by Incoming Linkset feature is enabled. If you wish to use the values 6, 7, or 8 for the <code>islsrsb</code> parameter of an ANSI linkset, the <code>rsls8</code> value for the linkset must be <code>yes</code>. Perform Configuring the RLS8 Value for ANSI Linksets to change the <code>rsls8</code> value for the linkset to <code>yes</code>.</p> <p>l. The <code>mtprse</code> parameter can be specified only if the ANSI or ITU MTP Restart feature is turned on.</p> <p>m. The <code>gtmode</code> parameter can be specified only if the Origin-Based SCCP Routing feature is enabled and turned on, or the Flexible Linkset Optional Based Routing</p>			

Table 3-12 (Cont.) Changing a Linkset Parameter Combinations

ANSI Adjacent Point Code	ITU-I Adjacent Point Code	ITU-N Adjacent Point Code	ITU-N24 Adjacent Point Code
<p>feature is enabled and turned on. If the value for this parameter will be <i>cg</i>, <i>acdc</i>, <i>acdcg</i>, <i>acdcg</i>, <i>cgacd</i>, <i>cgcd</i>, or <i>cdcg</i>, the Origin-Based SCCP Routing feature must be enabled and turned on. If the value for this parameter will be <i>fc</i>, <i>fcg</i>, <i>fcgfc</i>, or <i>fcdfcg</i>, the Flexible Linkset Optional Based Routing feature must be enabled and turned on.</p>			
<p>n. The <i>slsocbit</i> parameter can be specified only if the SLSOCB feature is turned on.</p>			
<p>o. If the <i>lst=c</i> parameter is specified, or if the current (unchanged) <i>lst</i> value for the linkset is <i>c</i>, the <i>tfatcabmlq</i> parameter cannot be specified unless the LSRESTRICT value shown in the <i>rtrv-ss7opts</i> output is on.</p>			
<p>p. The value of the <i>tfatcabmlq</i> parameter cannot exceed the number of signaling links assigned to the linkset.</p>			
<p>q. The <i>multgc=yes</i> parameter can be specified in this procedure only if the signaling links in the linkset are assigned to the IPLIMI application, and only for linksets with ITU-I or 14-bit ITU-N APCs.</p>			
<p>r. If the adjacent point code is being changed, the point code type of the new adjacent point code must be the same as the current adjacent point code. For example, if the current adjacent point code is an ITU-I point code, the new adjacent point code must be an ITU-I point code.</p>			
<p>s. If the linkset type of the ANSI linkset is being changed, and the linkset is assigned to a route whose DPC is a cluster point code or a network routing point code, the new linkset type must be either B, C, or D.</p>			
<p>t. When two linksets are used as a combined linkset, both linksets should use the same <i>slsrsb</i> and <i>slsocbit</i> values.</p>			

For this example, enter these commands.

```
chg-ls:lsn=ls04:apca=240-070-000:scrn=scr7:gwsa=on:nis=on
chg-ls:lsn=lsn5:apcn=10685:itutfr=on:randsls=class0
```

When each of these commands has successfully completed, this message should appear.

```
rlghncxa03w 08-12-07 08:38:45 GMT EAGLE5 40.0.0
Link set table is ( 24 of 1024) 2% full
CHG-LS: MASP A - COMPLTD
```

- 12.** Verify the changes using the *rtrv-ls* command, specifying the linkset name that was changed in [11](#).

For this example, enter these commands.

```
rtrv-ls:lsn=ls04
```

This is an example of the possible output.

```
rlghncxa03w 09-07-17 11:43:04 GMT EAGLE5 41.1.0
```

```

                                L3T SLT                GWS GWS GWS
LSN          APCA  (SS7)  SCRN SET SET BEI LST LNKS ACT MES DIS SLSCI NIS
ls04         240-070-000  scr7 1  1  no  a  4  on  off off yes  on

          CLLI          TFATCABMLQ MTPRSE ASL8
ls04clli    2          no      no

RANDSLS
off

ISLSRSB RLSL8
1          no

IPGWAPC MATELSN      IPTPS LSUSEALM SLKUSEALM GTTMODE
no      ----- ---  ---  ---  CdPA

                                L2T                PCR  PCR
LOC  LINK SLC TYPE      SET  BPS  ECM  N1  N2
1205 b  0  LIMDS0  1  56000  BASIC ---  -----
1213 b  1  LIMDS0  1  56000  BASIC ---  -----
1211 a  2  LIMDS0  1  56000  BASIC ---  -----
1207 b  3  LIMDS0  1  56000  BASIC ---  -----

```

Link set table is (24 of 1024) 2% full

rtrv-ls:lsn=lsn5

This is an example of the possible output.

rlghncxa03w 09-07-17 11:43:04 GMT EAGLE5 41.1.0

```

                                L3T SLT                GWS GWS GWS
LSN          APCN  (SS7)  SCRN SET SET BEI LST LNKS ACT MES DIS SLSCI NIS
lsn5         10685      scr3 1  1  no  a  3  on  off off ---  on

          CLLI          TFATCABMLQ MTPRSE ASL8
lsn5clli    1          no      ---

SLSOCSBIT SLSRSB RANDSLS ITUTFR ICNIMAP      OGNIMAP
none      1      class0 on      itun2ituns  ituns2itun

ISLSRSB
1

IPSG  IPGWAPC GTTMODE      CGGTMOD
no    no      CdPA          no

                                L2T                PCR  PCR
LOC  LINK SLC TYPE      SET  BPS  ECM  N1  N2
1206 b  0  LIMDS0  1  56000  BASIC ---  -----
1214 b  1  LIMDS0  1  56000  BASIC ---  -----
1212 a  2  LIMDS0  1  56000  BASIC ---  -----

```

Link set table is (24 of 1024) 2% full

13. Activate the signaling links that were deactivated in 10 using the `act-slk` command.

For this example, enter these commands.

```
act-slk:loc=1205:link=b
```

```
act-slk:loc=1207:link=b
act-slk:loc=1211:link=a
act-slk:loc=1213:link=b
act-slk:loc=2105:link=b
act-slk:loc=2111:link=a
act-slk:loc=2113:link=b
```

When each of these commands have successfully completed, this message should appear.

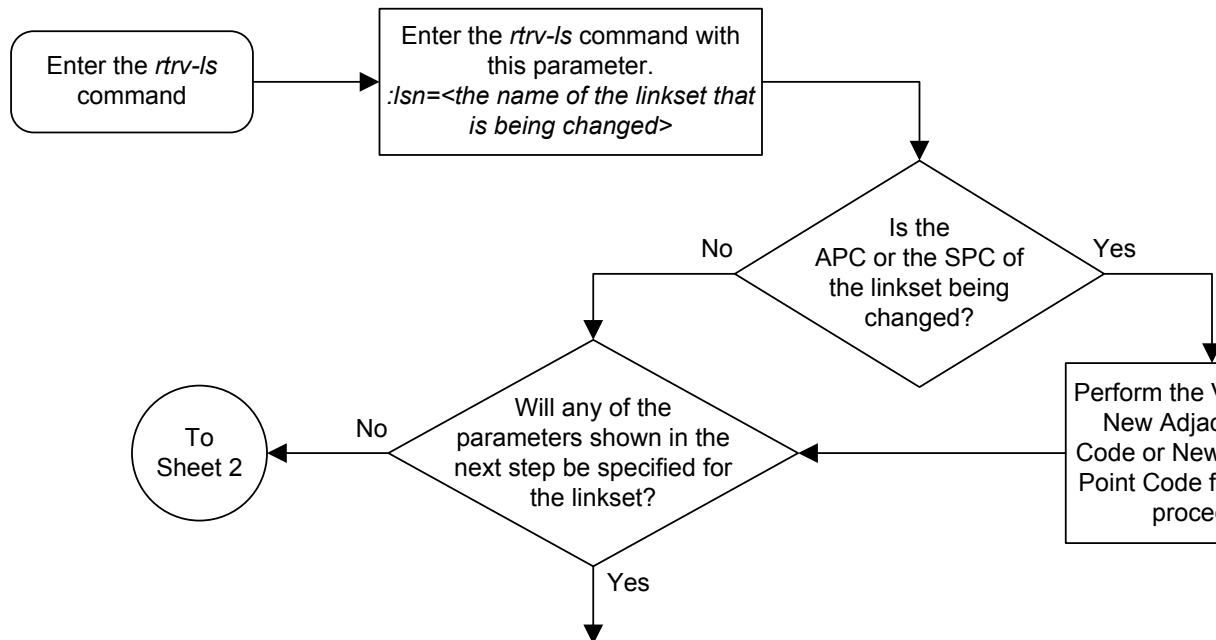
```
rlghncxa03w 08-12-07 08:41:12 GMT EAGLE5 40.0.0
Activate Link message sent to card
```

14. Back up the new changes using the `chg-db:action=backup:dest=fixed` command.

These messages should appear, the active **Maintenance and Administration Subsystem Processor (MASP)** appears first.

```
BACKUP (FIXED) : MASP A - Backup starts on active MASP.
BACKUP (FIXED) : MASP A - Backup on active MASP to fixed disk complete.
BACKUP (FIXED) : MASP A - Backup starts on standby MASP.
BACKUP (FIXED) : MASP A - Backup on standby MASP to fixed disk complete.
```

Figure 3-12 Changing an SS7 Linkset



To specify any of the following parameters for the linkset:

- the feature that corresponds to the parameters must be shown as turned on in the *rtrv-feat* output, or enabled, and turned on if required, in the *rtrv-ctrl-feat* output.
- other entities that correspond to the parameters must be configured in the database.

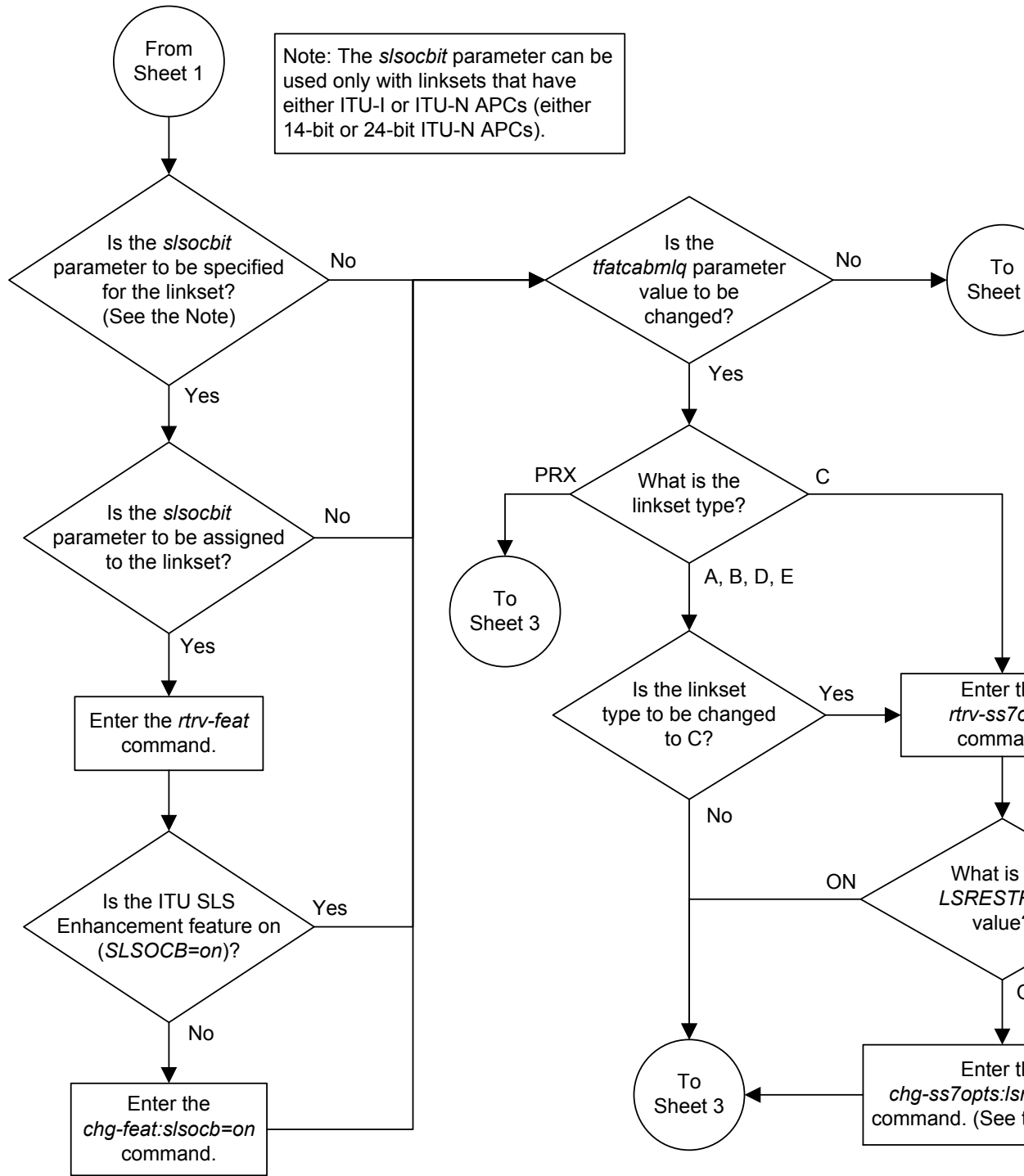
Perform the procedure, shown in the following list, that corresponds to the parameters that you wish to specify for the linkset.

- scrn, gwsa, gwsm, gwsd* – Verifying the Gateway Screening Configuration for a Linkset
- mtpmse* – Configuring the MTP Restart Feature
- slsci, asl8* – Configuring the 5-Bit to 8-Bit Conversion Feature. These parameters only apply to ANSI linksets.
- multgc* – Using the MULTGC Parameter when Changing the Attributes of a Linkset. This parameter applies to linksets with ITU-I and 14-bit ITU-N adjacent point codes.
- islsrsb* – Activating the SLS Bit Rotation by Incoming Linkset Feature

If you wish to use the values 6, 7, or 8 for the ISLSRSB parameter of an ANSI linkset, and the current RLS8 value for the linkset is *no*, or the RLS8 column is not shown in the *rtrv-ls:lsn* output on Sheet 1, perform the Configuring the RLS8 Value for ANSI Linksets procedure to change the RLS8 value for the linkset to *yes*.

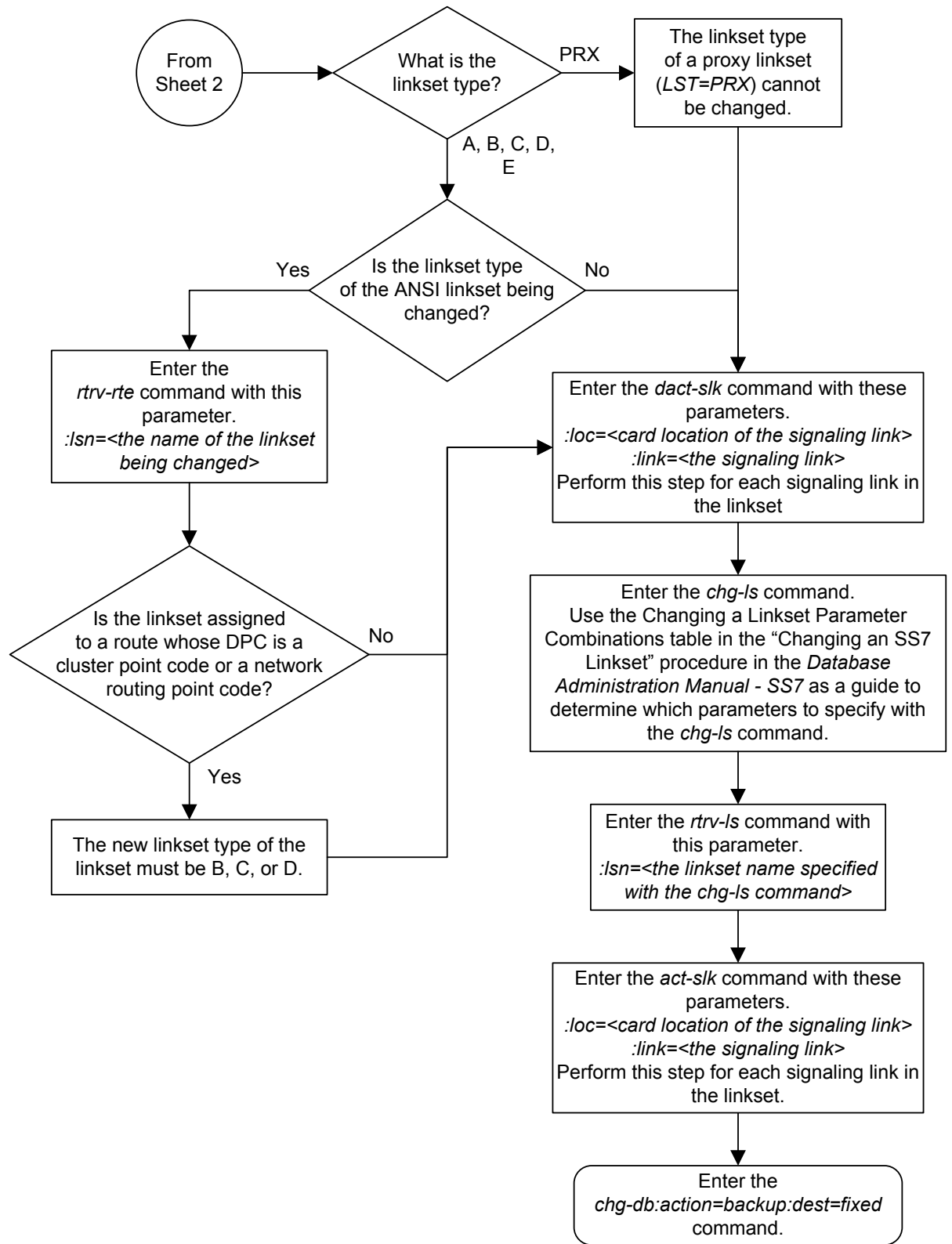
- gttmode* – If the value for this parameter will be CG, ACDCD, ACDCGCD, ACDCDCG, CGACDCD, CGCD, or CDCG, perform the Activating the Origin-Based SCCP Routing Feature procedure. The Origin-Based SCCP Routing feature must be enabled and turned on. If the value for this parameter will be FCD, FCG, FCGFCD, or FCDFCG, perform the Activating the Flexible Linkset Optional Based Routing Feature procedure. The Flexible Linkset Optional Based Routing feature must be enabled and turned on.
- randsls* – Configuring the System for Random SLS Generation. The value of the *randsls* parameter of the *chg-stpopts* command must be *perls*.
- cgttmode* - Activating the Advanced GT Modification Feature. Either the AMGTT or AMGTT CgPA Upgrade feature must be enabled.

Sheet 1 of 3



Caution: Turning the *lsrestrict* option on changes the way the EAGLE 5 ISS routes messages by using the state of the route along with the cost of the route to determine the preferred route to use. With this option on, the preferred route is not the absolute lowest cost available route in the routeset. A route is considered available if its status is either Allowed or Restricted. If the state of the absolute lowest cost route in the routeset is Restricted, the preferred route is the lowest cost route in the routeset whose status is Allowed. Make sure that you wish to have the EAGLE 5 ISS route messages in this manner before turning the *lsrestrict* option on.

Sheet 2 of 3



Verifying the New Adjacent Point Code or New Secondary Point Code for a Linkset

This procedure is used to verify that the new adjacent point code or new secondary point code for a linkset whose attributes are being changed is in the database.

If the linkset is a proxy linkset (linkset type PRX), the APC and linkset type of the linkset cannot be changed. A secondary point code and a secondary adjacent point code cannot be specified for a proxy linkset.

If the adjacent point code (APC) is changed, the new APC must be in the destination point code table and must be defined as a true point code in the destination point code table and cannot be an alias point code. The domain and point code type of the new APC must be the same as the APC being changed. For example, if the current adjacent point code is an ITU-I point code, the new adjacent point code must be an ITU-I point code. The new APC of the linkset cannot match the self ID of the EAGLE. The new APC must be a full point code and cannot be a cluster point code or a network routing point code.

Linksets containing E1 ATM signaling links cannot contain 24-bit ITU-N APCs or SAPCs. E1 ATM signaling links are identified by the value LIME1ATM in the TYPE column of the `rtrv-ls:lsn=<linkset name>` output.

Use the `rtrv-dstn` command to verify that the new APC is in the destination point code table and to verify the domain of the new APC. If the new APC is not shown in the `rtrv-dstn` command output, perform [Adding a Destination Point Code](#) to add the APC to the destination point code table.

To provision more than one linkset with the same APC, the Multiple Linksets to Single Adjacent PC feature must be enabled and turned on. The database can contain a maximum of six linksets that have the same APC. If the linkset is not a proxy linkset (linkset types A, B, C, D, or E), a secondary point code (shown in the `rtrv-spc` output) must be specified with the linkset. The network type and format of the secondary point code must be the same as the APC of the linkset. Secondary point codes can also be assigned to the APC of the linkset when the point code is provisioned in the database with the `ent-dstn` or `chg-dstn` commands. The secondary point codes that are assigned to the linksets that have the same APC must be unique for each linkset and cannot be the same as the secondary point code that is assigned to the APC of the linksets.

The secondary point code that is assigned to a linkset can be removed from the linkset by specifying the value `none` for the `spc/spca/spci/spcn/spcn24` parameter. A secondary point code can be removed from only one of the linksets in a group of linksets that have the same APC.

Canceling the RTRV-LS and RTRV-DSTN Commands

Because the `rtrv-ls` and `rtrv-dstn` commands used in this procedure can output information for a long period of time, the `rtrv-ls` and `rtrv-dstn` commands can be canceled and the output to the terminal stopped. There are three ways that the `rtrv-ls` and `rtrv-dstn` commands can be canceled.

- Press the F9 function key on the keyboard at the terminal where the `rtrv-ls` or `rtrv-dstn` commands were entered.

- Enter the `canc-cmd` without the `trm` parameter at the terminal where the `rtrv-ls` or `rtrv-dstn` commands were entered.
- Enter the `canc-cmd:trm=<xx>`, where `<xx>` is the terminal where the `rtrv-ls` or `rtrv-dstn` commands were entered, from another terminal other than the terminal where the `rtrv-ls` or `rtrv-dstn` commands were entered. To enter the `canc-cmd:trm=<xx>` command, the terminal must allow Security Administration commands to be entered from it and the user must be allowed to enter Security Administration commands. The terminal's permissions can be verified with the `rtrv-secu-trm` command. The user's permissions can be verified with the `rtrv-user` or `rtrv-secu-user` commands.

For more information about the `canc-cmd` command, go to the *Commands Manual*.

1. Perform one of the following steps.

The APC and linkset type for a proxy linkset (LST=PRX) cannot be changed. A secondary point code and a secondary adjacent point code cannot be specified for a proxy linkset. If the attributes of a proxy linkset (LST=PRX) are being changed, this procedure is finished.

If you wish to change the APC of a linkset to an APC that is assigned to another linkset and multiple linksets with the same APC are shown in the `rtrv-ls` output, continue the procedure with 3. If multiple linksets with the same APC are not shown in the `rtrv-ls` output, continue the procedure with 2.

If you wish to change the secondary point code that is assigned to a linkset and multiple linksets with the same APC are shown in the `rtrv-ls` output, continue the procedure with 3. If multiple linksets with the same APC are not shown in the `rtrv-ls` output, continue the procedure with 2.

If you wish to change the APC of a linkset to an APC that is not assigned to another linkset or do not wish to change the secondary point code that is assigned to a linkset, output, continue the procedure with 12.

2. Verify whether or not the Multiple Linksets to Single Adjacent PC feature is enabled and turned on by entering this command.

```
rtrv-ctrl-feat:partnum=893017901
```

This is an example of the possible output.

```
rlghncxa03w 08-12-17 11:43:04 GMT EAGLE5 40.0.0
The following features have been permanently enabled:
```

Feature Name	Partnum	Status	Quantity
Multiple Linkset to APC	893019701	on	----

The following features have been temporarily enabled:

Feature Name	Partnum	Status	Quantity	Trial Period Left
Zero entries found.				

The following features have expired temporary keys:

Feature Name	Partnum
Zero entries found.	

If the Multiple Linksets to Single Adjacent PC feature is not enabled or turned on, perform [Activating the Multiple Linksets to Single Adjacent PC \(MLS\) Feature](#) to enable and turn on this feature. After this feature has been enabled and turned on, and the APC of the linkset is being changed, continue the procedure with [3](#). If only the secondary point code that is assigned to the linkset is being changed, continue the procedure with [4](#).

If the Multiple Linksets to Single Adjacent PC feature is enabled and turned on, and the APC of the linkset is being changed, continue the procedure with [3](#). If only the secondary point code that is assigned to the linkset is being changed, continue the procedure with [4](#).

3. A maximum of six linksets can be assigned to an APC. Verify the number of linksets that are assigned to the new APC of the linkset that is being changed by entering the `rtrv-ls` command with the new APC of the linkset. For this example, enter this command.

```
rtrv-ls:apca=002-002-002
```

This is an example of the possible output.

```
rlghncxa03w 08-12-17 11:43:04 GMT EAGLE5 40.0.0
```

```
APCA = 002-002-002
```

LSN	SPCA	SCRN	L3T SLT			LST	LNKS	GWS GWS GWS			SLSCI	NIS
			SET	SET	BEI			ACT	MES	DIS		
lsn2	001-001-002	none	1	1	no	A	2	off	off	off	no	off
lsn40	020-020-021	none	1	1	no	A	2	off	off	off	no	off
lsn41	021-021-021	none	1	1	no	A	2	off	off	off	no	off
lsn42	022-022-022	none	1	1	no	A	3	off	off	off	no	off

Link set table is (29 of 1024) 3% full.

If six linksets are shown in this step, choose another APC for the linkset from the `rtrv-ls` output [1](#) (in [Changing an SS7 Linkset](#)) and repeat this step.

If one to five linksets are shown in this step, continue this procedure with [4](#).

4. Display the linkset that is being changed by entering the `rtrv-ls` command with the name of the linkset. For this example, enter this command.

```
rtrv-ls:lsn=ls04
```

This is an example of the possible output.

```
rlghncxa03w 09-07-17 11:43:04 GMT EAGLE5 41.1.0
```

LSN	APCA (SS7)	SCRN	L3T SLT			LST	LNKS	GWS GWS GWS			SLSCI	NIS
			SET	SET	BEI			ACT	MES	DIS		
ls04	001-002-003	scr2	1	1	no	a	4	off	off	off	yes	off
	SPCA	CLLI										
	-----	-----					2	---			no	
	IPGWAPC	MATELSN	IPTPS	LSUSEALM	SLKUSEALM	GTMODE						
	no	-----	---	---	---						CdPA	

LOC	LINK	SLC	TYPE	L2T		ECM	PCR	
				SET	BPS		N1	N2
1205	b	0	LIMDS0	1	56000	BASIC	---	-----
1213	b	1	LIMDS0	1	56000	BASIC	---	-----
1211	a	2	LIMDS0	1	56000	BASIC	---	-----
1207	b	3	LIMDS0	1	56000	BASIC	---	-----

Link set table is (24 of 1024) 2% full

To use the APC displayed in 3, the secondary point code assigned to the linkset shown in this step cannot be shown in 3, unless the secondary point code that is assigned to the linkset shown in this step is changed. If you wish to change the secondary point code assigned to linkset shown in this step, continue the procedure with 6.

If you do not wish to change the secondary point code assigned to linkset shown in this step, choose another APC for the linkset from the `rtrv-ls` output in 1 (in [Changing an SS7 Linkset](#)) and repeat this procedure from 2.

If the secondary point code assigned to the linkset shown in this step is not shown in 3, continue the procedure with 5.

5. Display the new APC of the linkset by entering the `rtrv-dstn` command with the new APC of the linkset specified in 3. For this example, enter this command.

```
rtrv-dstn:dpca=002-002-002
```

This is an example of the possible output.

```
rlghncxa03w 10-12-17 11:43:04 GMT EAGLE5 43.0.0
```

DPCA	CLLI	BEI	ELEI	ALIASI	ALIASN/N24	DMN
002-002-002	-----	no	---	-----	-----	SS7

SPCA	NCAI	PRX	RCAUSE	NPRST	SPLITIAM	HMSMSC	HMSCP	SCCPMSGCNV
020-020-020	----	no	none	off	none	no	no	none

Destination table is (37 of 2000) 2% full

Alias table is (0 of 12000) 0% full

PPC table is (13 of 20) 65% full

To use the APC displayed in this step, the secondary point code assigned to the linkset shown in 4 cannot be shown in this step, unless the secondary point code that is assigned to the linkset shown in this step is changed. If you wish to change the secondary point code assigned to the linkset shown in this step, continue the procedure with 6.

If you do not wish to change the secondary point code assigned to the linkset shown in this step, choose another APC for the linkset from the `rtrv-ls` output in 1 (in [Changing an SS7 Linkset](#)) and repeat this procedure from 2.

If the secondary point code assigned to the linkset shown in 4 is not shown in this step, the new APC for the linkset can be used. However, the secondary point code that is assigned to the linkset can also be changed. If you wish to change the secondary point code and the APC, continue the procedure with 6. If you only wish to change the APC of the linkset, continue the procedure with 13.

6. To change the secondary point code that is assigned to the linkset, verify the secondary point code by displaying the linkset that is being changed by entering

the `rtrv-ls` command with the name of the linkset. For this example, enter this command.

Note: If 4 was performed, this step does need to be performed.

```
rtrv-ls:lsn=ls04
```

This is an example of the possible output.

```
rlghncxa03w 09-07-17 11:43:04 GMT EAGLE5 41.1.0
```

```

LSN          APCA  (SS7)  SCRN SET SET BEI LST LNKS ACT MES DIS SLSCI NIS
ls04         001-002-003  scr2 1  1  no  a  4  off off off yes  off

          SPCA          CLLI          TFATCABMLQ MTPRSE ASL8
          -----          -----          2          ---  no

IPGWAPC MATELSN  IPTPS LSUSEALM SLKUSEALM GTTMODE
no          -----  ---  ---  ---          CdPA

          L2T          PCR PCR
          SET BPS  ECM  N1  N2
1205  b  0  LIMDS0  1  56000  BASIC  ---  -----
1213  b  1  LIMDS0  1  56000  BASIC  ---  -----
1211  a  2  LIMDS0  1  56000  BASIC  ---  -----
1207  b  3  LIMDS0  1  56000  BASIC  ---  -----

```

```
Link set table is ( 24 of 1024) 2% full
```

If a secondary point code is not assigned to the linkset, continue the procedure with 8.

If a secondary point code is assigned to the linkset, the secondary point code can be changed to another secondary point code value or can be removed from the linkset. If you wish to change the secondary point code to another secondary point code value, continue the procedure with 8. If you wish to remove the secondary point code value from the linkset, continue the procedure with 7.

7. Only one linkset can be assigned to an APC that does not have a secondary point code. Verify the secondary point codes of the linksets that are assigned to the APC specified in 6 by entering the `rtrv-ls` command with the APC of the linkset specified in 6. For this example, enter this command.

```
rtrv-ls:apca=001-002-003
```

This is an example of the possible output.

```
rlghncxa03w 08-12-17 11:43:04 GMT EAGLE5 40.0.0
```

```
APCA  =  001-002-003
```

```

LSN          SPCA          SCRN SET SET BEI LST LNKS ACT MES DIS SLSCI NIS
ls04         -----          scr2 1  1  no  a  4  off off off yes  off

```

```
Link set table is (29 of 1024) 3% full.
```

If one linkset is shown in this step that does not have a secondary point code, then no secondary point codes can be removed from any of the linksets shown in this step. The secondary point code value can be changed to another secondary point code value. If you wish to change the secondary point code value to another secondary point code value, continue the procedure with [8](#).

If all the linksets shown in this step have a secondary point code, then the secondary point code from one of these linksets can be removed. If the APC of the linkset is also being changed ([3](#), [4](#), [5](#) were performed), continue the procedure with [13](#). If the APC of the linkset is not being changed, this procedure is finished..

8. Display the secondary point codes by entering the `rtrv-spc` command. This is an example of the possible output.

```
rlghncxa03w 08-12-17 11:43:04 GMT EAGLE5 40.0.0
SPC (Secondary Point Codes)
```

```
SPCA
    020-020-020
    020-020-021
    021-021-021
    022-022-022
    026-026-026
    026-026-027
    026-026-028
    026-026-029
    200-010-000
```

```
SPC-I
```

```
none
```

```
SPC-N
    00002
```

```
SPC-N24
```

```
none
```

```
Secondary Point Code table is (10 of 40) 25% full.
```

If the desired secondary point code is shown in this step, continue the procedure with [9](#).

If the desired secondary point code is not shown in this step, perform [Adding a Secondary Point Code](#) to add the desired secondary point code. The network type of the new secondary point code must be the same as the APC of the linkset. If the APC of the linkset is being changed, after the secondary point code has been added, continue the procedure with [13](#). If the APC of the linkset is not being changed, after the secondary point code has been added, this procedure is finished..

9. Verify the secondary point codes of the linksets that are assigned to the APC specified in [6](#) by entering the `rtrv-ls` command with the APC of the linkset specified in [6](#). For this example, enter this command.

```
rtrv-ls:apca=001-002-003
```

This is an example of the possible output.

```
rlghncxa03w 08-12-17 11:43:04 GMT EAGLE5 40.0.0
```

```
APCA = 001-002-003
```

```

                L3T SLT                GWS GWS GWS
LSN          SPCA          SCRN SET SET BEI LST LNKS ACT MES DIS SLSCI NIS
ls04          ----- scr2 1 1 no a 4 off off off yes off

```

Link set table is (29 of 1024) 3% full.

10. Display the APC of the linkset by entering the `rtrv-dstn` command with the APC of the linkset specified in 9. For this example, enter this command.

```
rtrv-dstn:dpca=001-002-003
```

This is an example of the possible output.

```
rlghncxa03w 10-12-17 11:43:04 GMT EAGLE5 43.0.0
```

```

DPCA          CLLI          BEI ELEI ALIASI          ALIASN/N24  DMN
001-002-003  ----- no --- -----          -----  SS7

SPCA          NCAI PRX          RCAUSE NPRST SPLITIAM HMSMSC HMSCP SCCPMSGCNV
----- ---- no          none off none no no none

```

Destination table is (37 of 2000) 2% full

Alias table is (0 of 12000) 0% full

PPC table is (13 of 20) 65% full

The new secondary point code that will be assigned to the linkset cannot be shown in the `rtrv-ls` output in 9 or in the `rtrv-dstn` output in this step. If the new secondary point code is not shown in 8 and 9, and the APC of the linkset is being changed, continue the procedure with 13. If the APC of the linkset is not being changed, and the new secondary point code is not shown in 8 and 9, this procedure is finished.

If the new secondary point code is shown in the `rtrv-ls` output in 9 or in the `rtrv-dstn` output in this step, this secondary point code value cannot be used. Repeat this procedure from 8 and choose another secondary point code value.

11. Display the point code and capability point code of the EAGLE by using the `rtrv-sid` command.

This is an example of the possible output.

```
rlghncxa03w 08-12-17 11:43:04 GMT EAGLE5 40.0.0
```

```

PCA          PCI          PCN          CLLI          PCTYPE
001-001-001  1-200-6          13482          rlghncxa03w  OTHER

CPCA
002-002-002  002-002-003      002-002-004      002-002-005
002-002-006  002-002-007      002-002-008      002-002-009
004-002-001  004-003-003      144-212-003

CPCA (LNP)
005-005-002  005-005-004      005-005-005

```

```

CPCI
1-001-1          1-001-2          1-001-3          1-001-4

CPCN
02091           02092           02094           02097
02191           02192           11177
    
```

12. Display the point codes in the destination point code table by using the `rtrv-dstn` command.

This is an example of the possible output.

```

rlghncxa03w 10-12-10 11:43:04 GMT EAGLE5 43.0.0
Extended Processing Time may be Required
    
```

```

DPCA          CLLI          BEI ELEI  ALIASI          ALIASN/N24  DMN
001-002-003  ls04ccli     yes --- -----
002-002-100  ls01ccli     no  --- -----
002-007-008  ls06ccli     yes --- -----
002-009-003  -----     no  --- -----
002-250-010  -----     no  --- -----
003-003-003  ls03ccli     yes --- -----
003-020-100  -----     no  --- -----
004-004-004  ls02ccli     yes --- -----
004-030-200  -----     no  --- -----
009-002-003  -----     no  --- -----
179-100-087  -----     yes --- -----
200-050-176  -----     yes --- -----
240-007-000  -----     yes --- -----
240-012-004  rlghncbb001 yes --- 1-111-1      11111
240-012-005  rlghncbb002 yes --- 1-112-2      11112
240-012-006  rlghncbb003 yes --- 1-112-3      11113
240-012-008  -----     yes --- 1-113-5      11114
SS7

DPCI          CLLI          BEI ELEI  ALIASA          ALIASN/N24  DMN
2-131-1      rlghncbb023 no  --- 222-210-000    12001
2-131-2      -----     no  --- 222-211-001    12002
2-131-3      -----     no  --- 222-211-002    12003
3-150-4      lsi7ccli     yes --- -----
SS7

DPCN          CLLI          BEI ELEI  ALIASA          ALIASI          DMN
11520        lsn5ccli     yes --- -----
11211        rlghncbb013 no  --- 222-200-200    2-121-1
11212        rlghncbb013 no  --- 222-200-201    2-121-2
SS7
    
```

```

Destination table is (22 of 2000) 1% full
Alias table is (18 of 8000) 1% full
    
```

If the adjacent point code is not shown in the `rtrv-dstn` command output, perform the [Adding a Destination Point Code](#) procedure to add the adjacent point code to the destination point code table. After the adjacent point code has been added, this procedure is finished.

If the adjacent point code is shown in the `rtrv-dstn` output, continue the procedure with [13](#).

13. The new APC of the linkset cannot be the DPC of any exception route.

Verify that the new adjacent point code of the linkset is not the DPC of any exception route by entering the `rtrv-rtx` command with the `dpc/dpca/dpci/`

dpcn/ dpcn24 parameter. The dpc/dpca/dpci/dpcn/dpcn24 parameter value is the adjacent point code value that will be specified for the linkset. For this example, enter these commands.

```
rtrv-rtx:dpca=240-070-000
```

This is an example of the possible output.

```
rlghncxa03w 08-12-17 11:43:04 GMT EAGLE5 40.0.0
DPCA          RTX-CRITERIA          LSN          RC          APC
240-070-000   OPCA
                007-008-009                e1e2         20         001-207-000

DESTINATION ENTRIES ALLOCATED:  2000
FULL DPC(s):                    13
EXCEPTION DPC(s):               5
NETWORK DPC(s):                 0
CLUSTER DPC(s):                 1
TOTAL DPC(s):                   19
CAPACITY (% FULL):              1%
ALIASES ALLOCATED:              12000
ALIASES USED:                   0
CAPACITY (% FULL):              0%
X-LIST ENTRIES ALLOCATED:       500
```

```
rtrv-rtx:dpcn=10685
```

This is an example of the possible output.

```
rlghncxa03w 08-12-17 11:43:04 GMT EAGLE5 40.0.0
DPCN          RTX-CRITERIA          LSN          RC          APC
10685         OPCN
                6543                lsn6         20         11211

DESTINATION ENTRIES ALLOCATED:  2000
FULL DPC(s):                    13
EXCEPTION DPC(s):               5
NETWORK DPC(s):                 0
CLUSTER DPC(s):                 1
TOTAL DPC(s):                   19
CAPACITY (% FULL):              1%
ALIASES ALLOCATED:              12000
ALIASES USED:                   0
CAPACITY (% FULL):              0%
X-LIST ENTRIES ALLOCATED:       500
```

If the adjacent point code of the linkset is not the DPC of a route exception table entry, no entries are displayed in the `rtrv-rtx` output, but a summary of the point code quantities is displayed, as shown in the following output example.

```
rlghncxa03w 08-12-17 11:43:04 GMT EAGLE5 40.0.0

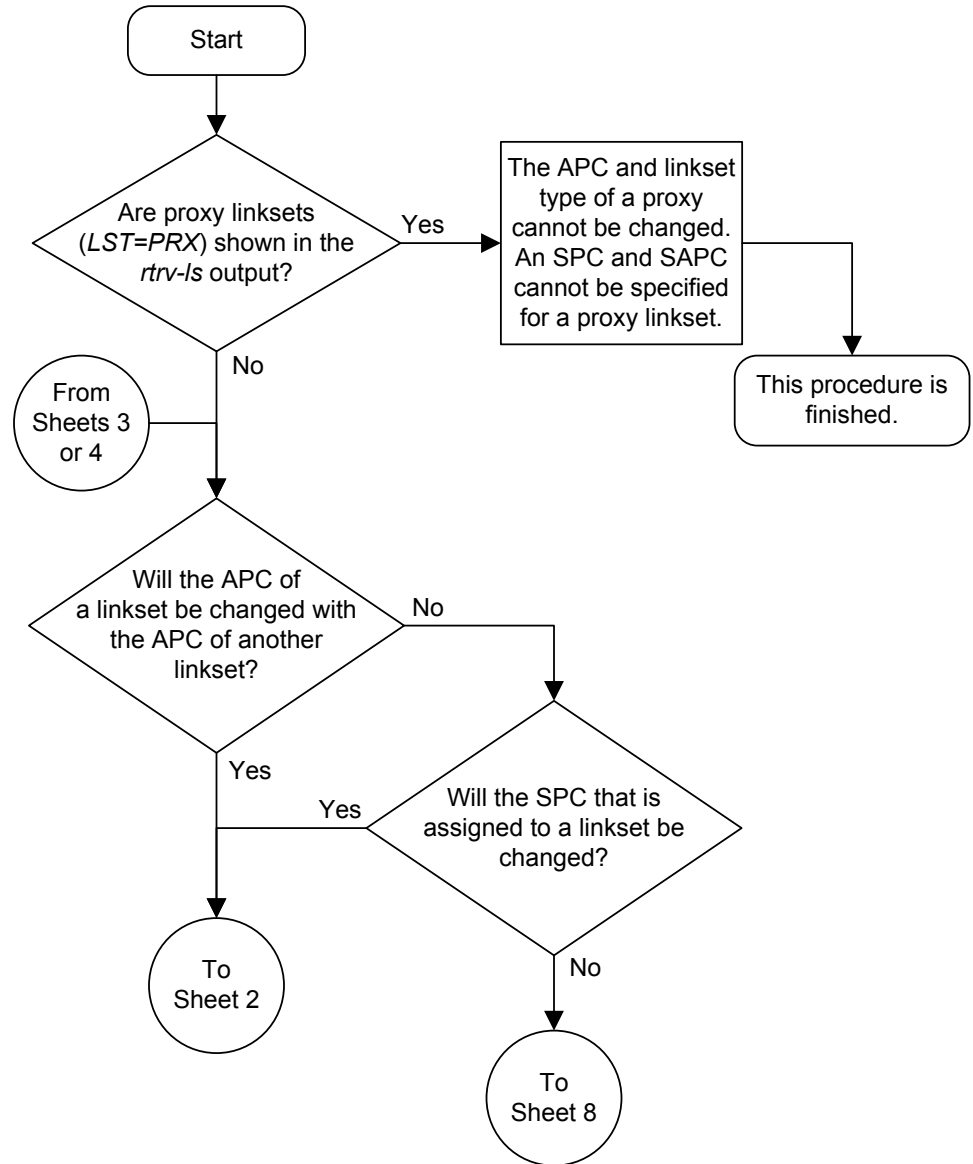
DESTINATION ENTRIES ALLOCATED:  2000
FULL DPC(s):                    15
EXCEPTION DPC(s):               5
NETWORK DPC(s):                 0
CLUSTER DPC(s):                 1
TOTAL DPC(s):                   21
CAPACITY (% FULL):              1%
```

ALIASES ALLOCATED:	12000
ALIASES USED:	0
CAPACITY (% FULL):	0%
X-LIST ENTRIES ALLOCATED:	500

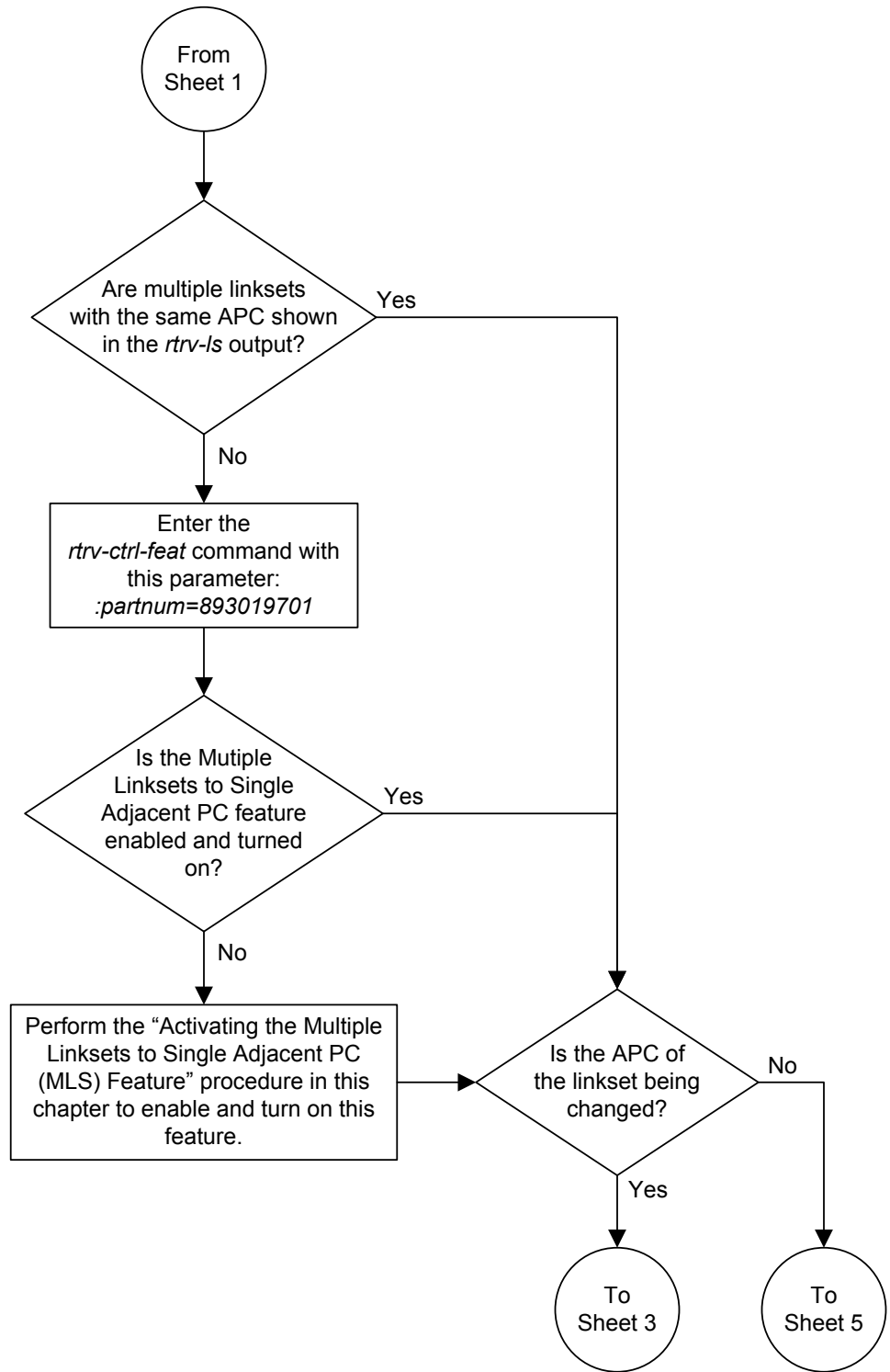
If the point code specified in this step is shown in the DPCA column in this step, the point code value cannot be used as an adjacent point code unless one of two actions are taken:

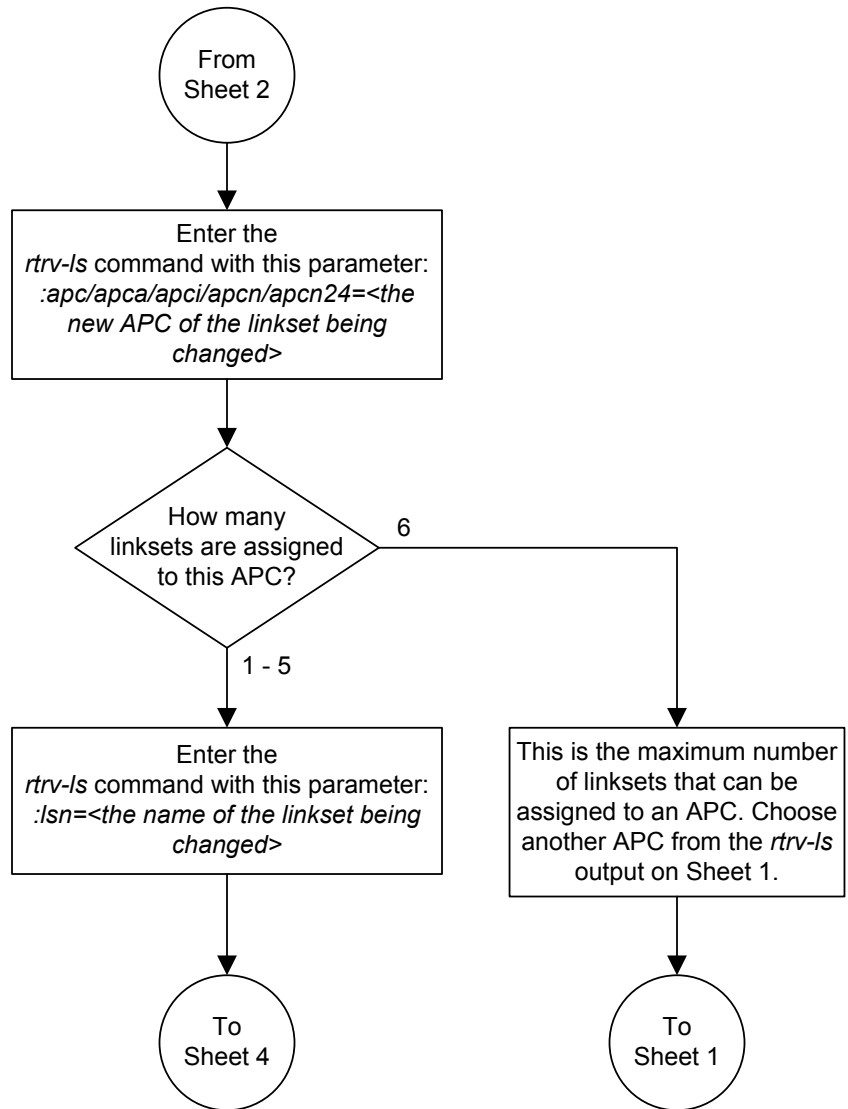
- a. Choose another adjacent point code value and repeat [11](#), [12](#), and [13](#).
- b. Remove all the entries displayed in this step by performing [Removing a Route Exception Entry](#). After the route exception entries have been removed, this procedure is finished.

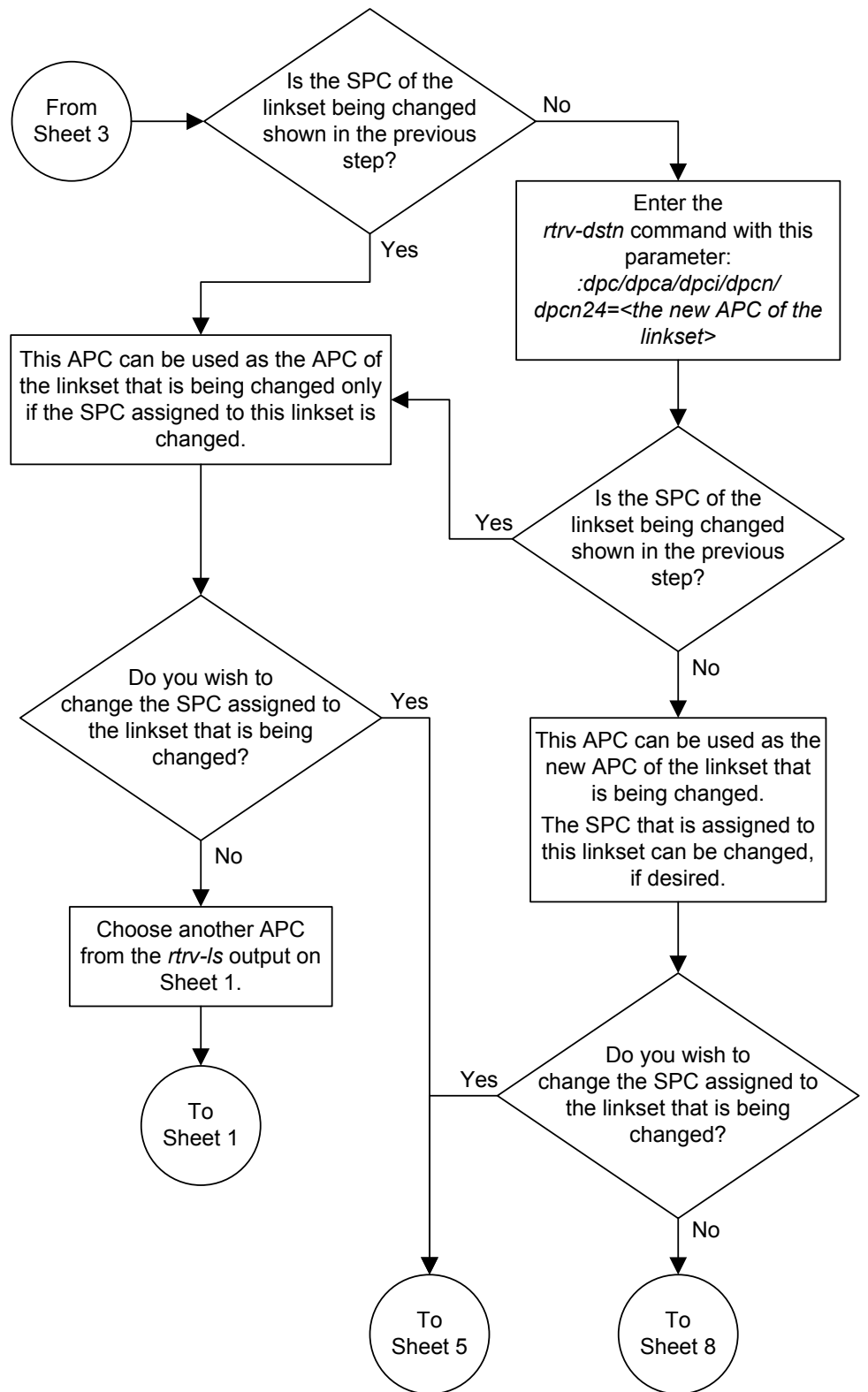
Figure 3-13 Verifying the New Adjacent Point Code or New Secondary Point Code for a Linkset

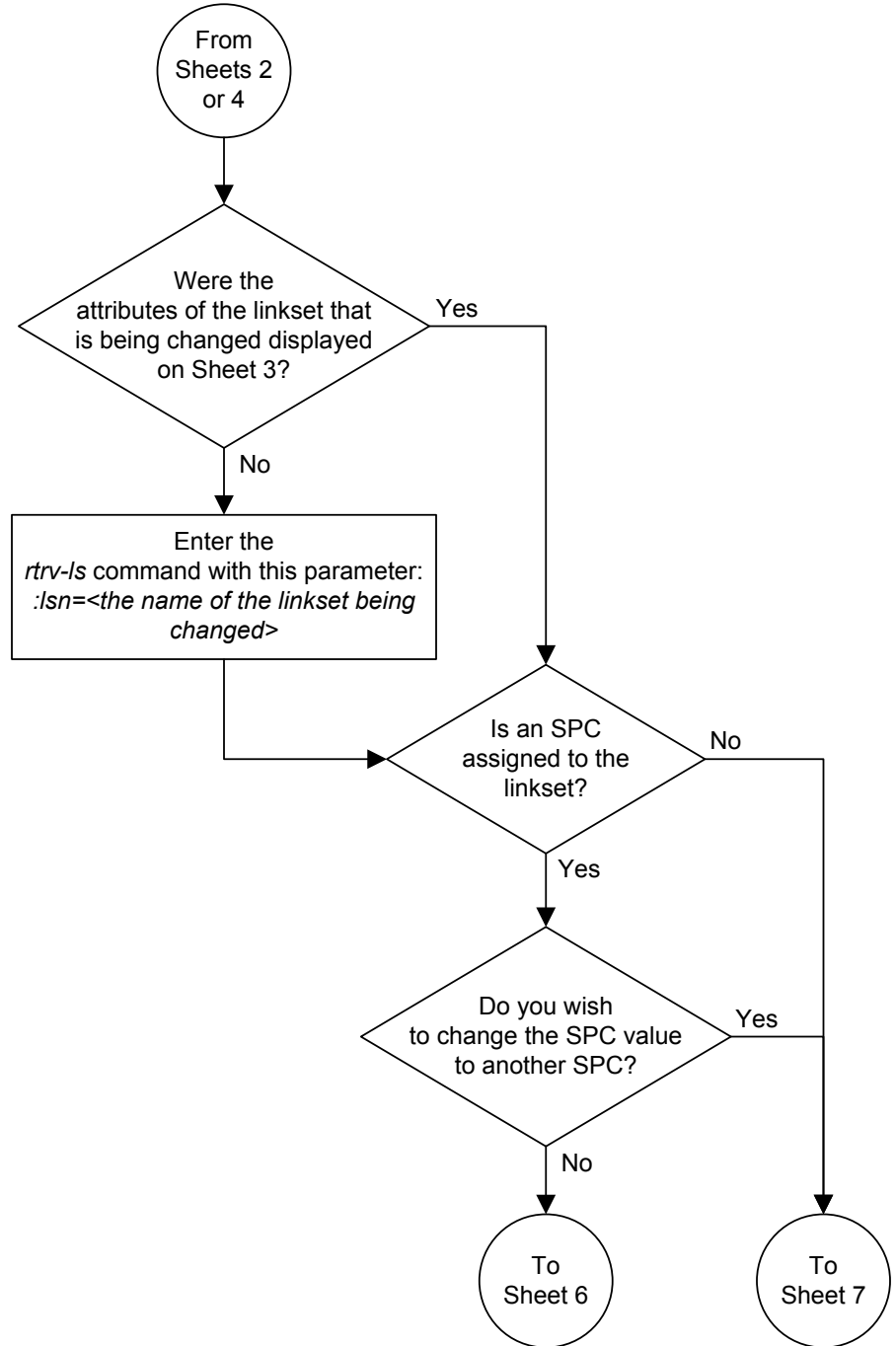


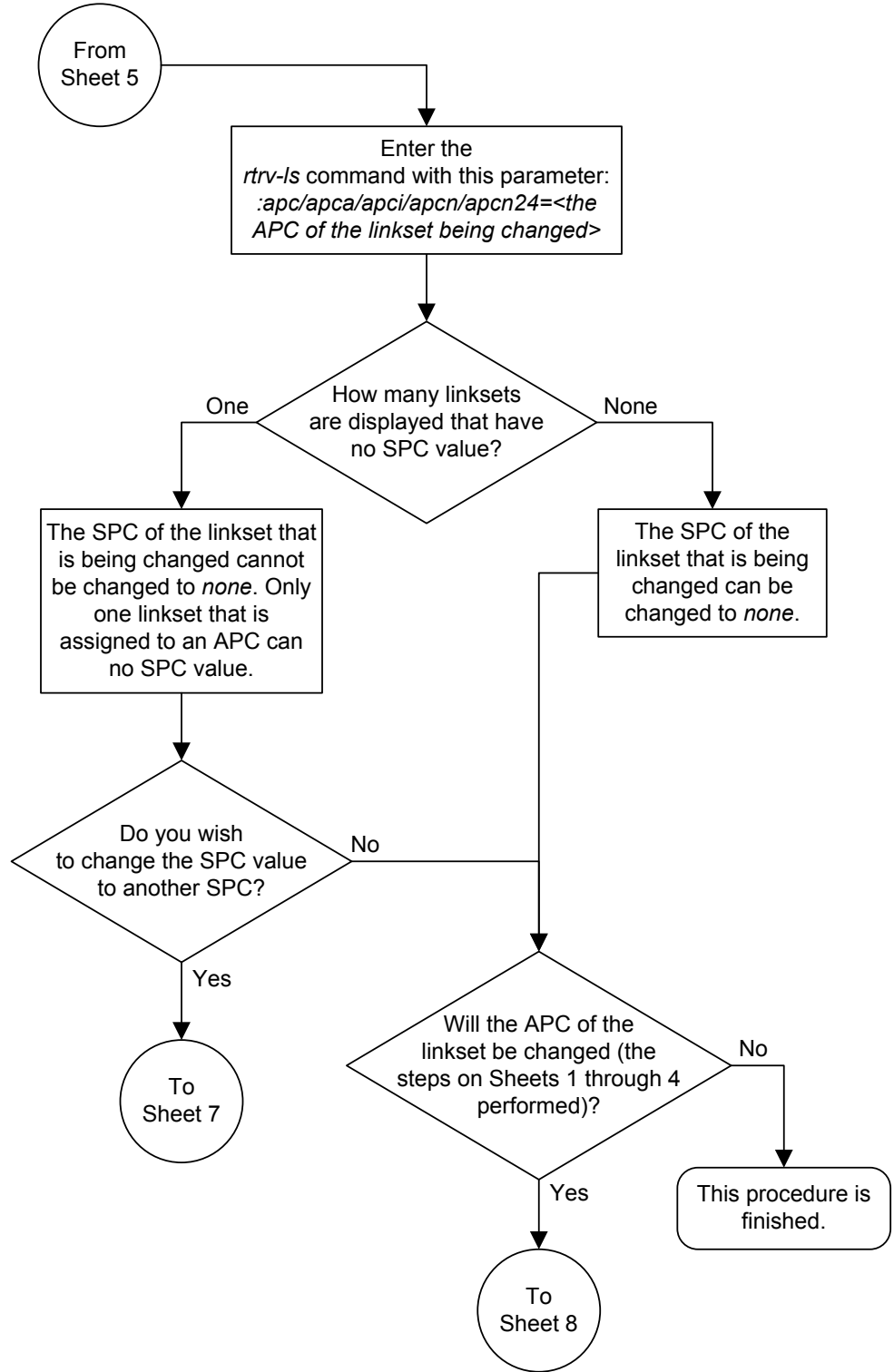
Sheet 1 of 8

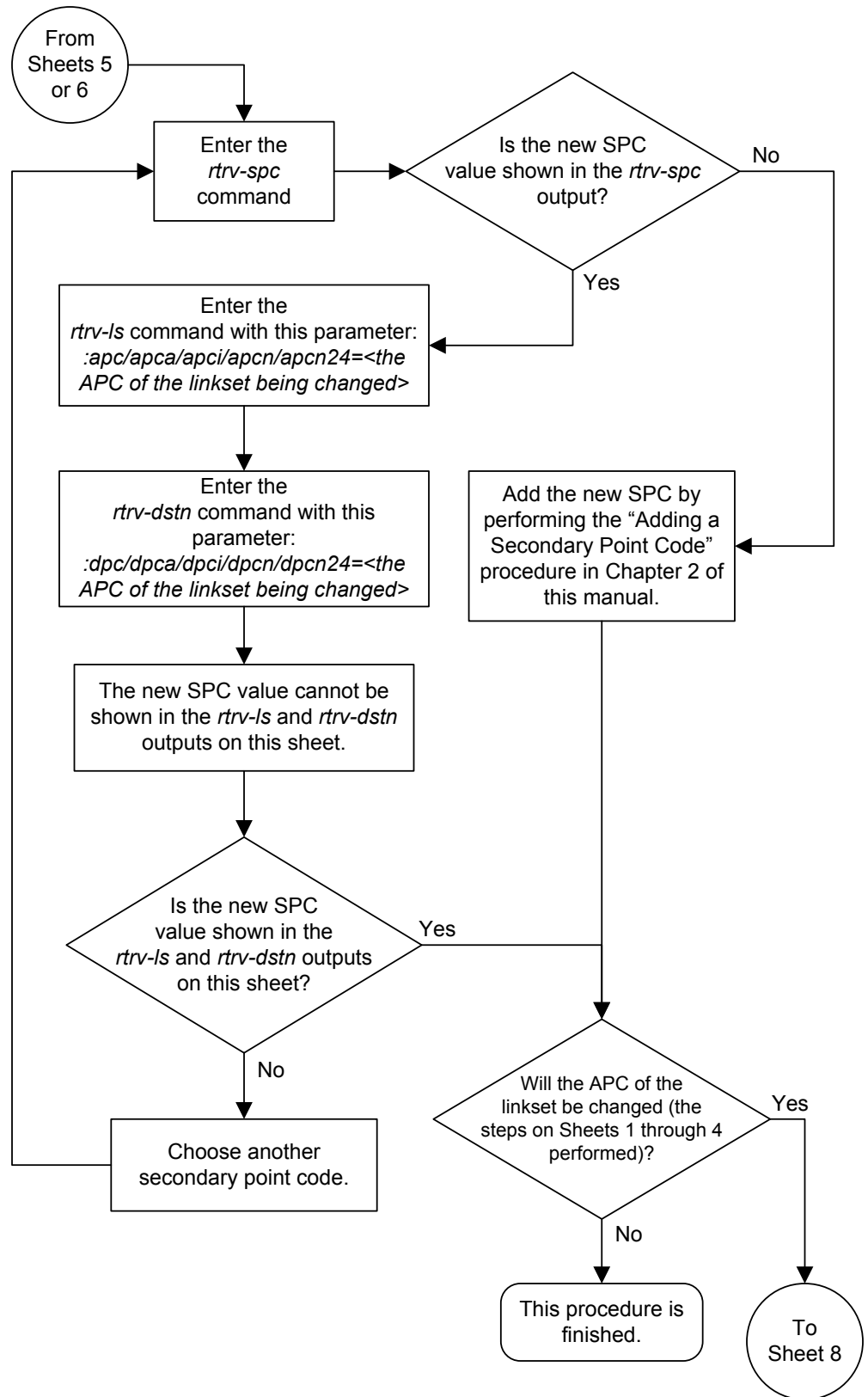


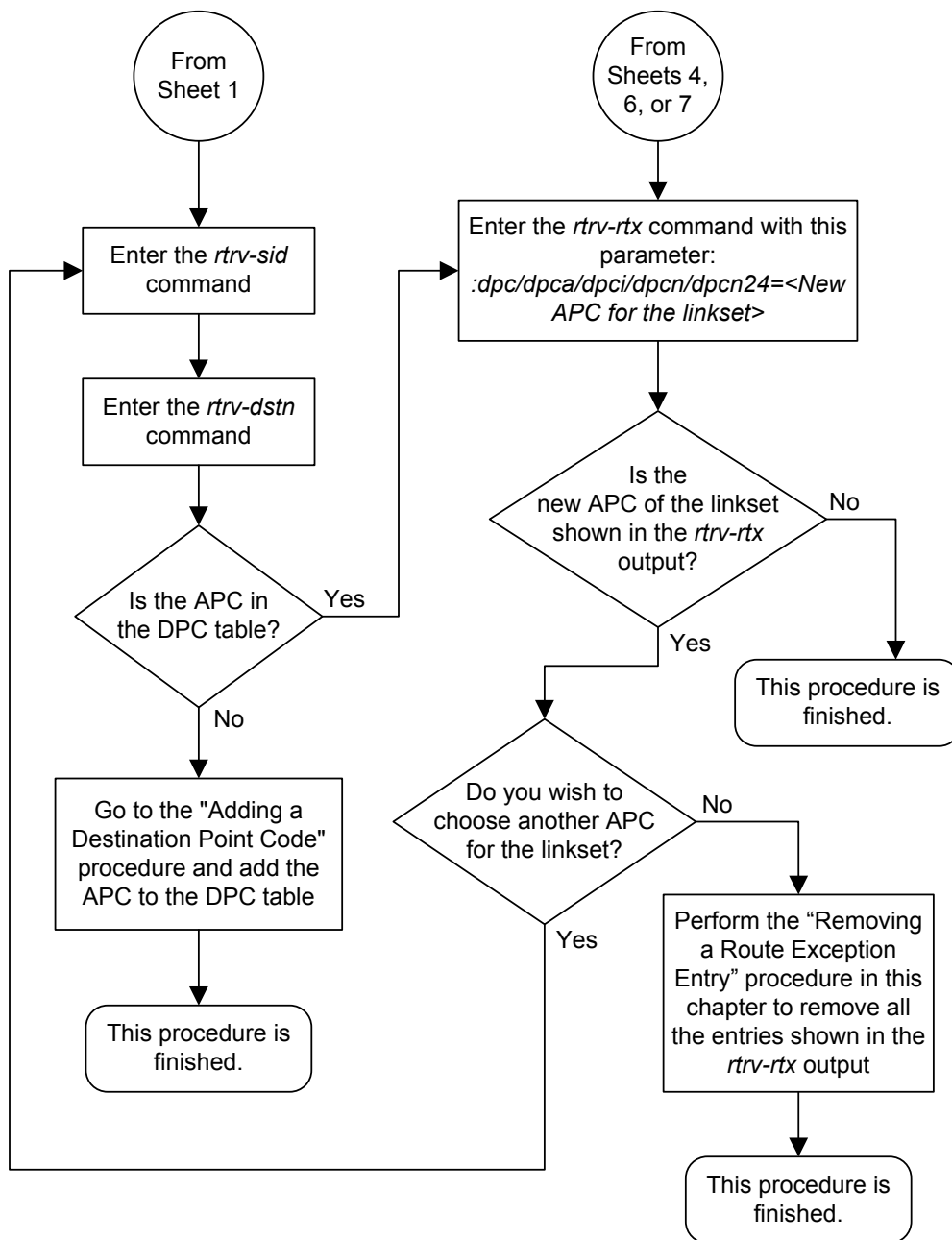












Note: If the adjacent point code is being changed, the point code type of the new adjacent point code must be the same as the current adjacent point code.

For example, if the current adjacent point code is an ITU-I point code, the new adjacent point code must be an ITU-I point code.

Private point codes cannot be used as an adjacent point code in this procedure. Private point codes can be assigned only to IPGWx linksets. The procedures for configuring IPGWx linksets are in the *Database Administration Manual - IP⁷ Secure Gateway*.

Using the MULTGC Parameter when Changing the Attributes of a Linkset

This procedure is used to verify that the following items are configured in the database.

- The ITU Duplicate Point Code feature is turned on.
- If the `multgc` parameter value is being changed to `no`, and the linkset contains more than one 14-bit ITU-N secondary adjacent point code, all but one of these secondary adjacent point codes must be removed from the linkset.

The `multgc` parameter only applies to linksets whose adjacent point codes are either ITU international point codes or 14-bit ITU national point codes. All the signaling links in this linkset must be assigned to cards running the **IPLIMI** or **IPGWI** applications, or the linkset must be an IPSP M2PA linkset. The linkset cannot be a proxy linkset.

Canceling the RTRV-LS Command

Because the `rtrv-ls` command used in this procedure can output information for a long period of time, the `rtrv-ls` command can be canceled and the output to the terminal stopped. There are three ways that the `rtrv-ls` command can be canceled.

- Press the F9 function key on the keyboard at the terminal where the `rtrv-ls` command was entered.
- Enter the `canc-cmd` without the `trm` parameter at the terminal where the `rtrv-ls` command was entered.
- Enter the `canc-cmd:trm=<xx>`, where `<xx>` is the terminal where the `rtrv-ls` command was entered, from another terminal other than the terminal where the `rtrv-ls` command was entered. To enter the `canc-cmd:trm=<xx>` command, the terminal must allow Security Administration commands to be entered from it and the user must be allowed to enter Security Administration commands. The terminal's permissions can be verified with the `rtrv-secu-trm` command. The user's permissions can be verified with the `rtrv-user` or `rtrv-secu-user` commands.

For more information about the `canc-cmd` command, go to the *Commands User's Guide*.

1. Display the current linkset configuration using the `rtrv-ls` command.

This is an example of the possible output.

```
rlghncxa03w 06-10-10 11:43:04 GMT EAGLE5 36.0.0

                L3T SLT                GWS GWS GWS
LSN            APCA  (SS7)  SCRN SET SET BEI LST LNKS ACT MES DIS SLSCI NIS
ele2           001-207-000  none 1  1  no  B   6   off off off no  off
elmls1        001-001-001  none 1  1  no  A   7   off off off no  off
elmls2        001-001-002  none 1  1  no  A   7   off off off no  off
ls04          001-002-003  scr2 1  1  no  a   4   off off off yes off
ls1305        000-005-000  none 1  1  no  A   1   off off off no  off
ls1307        000-007-000  none 1  1  no  A   1   off off off no  off

                L3T SLT                GWS GWS GWS
```

```

LSN          APCI  (SS7)  SCRN SET SET BEI LST LNKS ACT MES DIS SLSCI NIS
ele2i        1-207-0      none 1  1  no  B  4   off off off ---  on
ls1315       0-015-0      none 1  1  no  A  1   off off off ---  off
ls1317       0-017-0      none 1  1  no  A  1   off off off ---  on
elm2s1       1-011-1      none 1  1  no  A  7   off off off ---  off
elm2s2       1-011-2      none 1  1  no  A  7   off off off ---  off

```

```

                L3T SLT                GWS GWS GWS
LSN          APCN  (SS7)  SCRN SET SET BEI LST LNKS ACT MES DIS SLSCI NIS
lsn4         11520-aa    scr3 1  1  no  a  3   on  off off ---  on
lsn5         11211-aa    scr3 1  1  no  a  1   on  off off ---  on

```

Link set table is (10 of 1024) 1% full.

2. Display the current linkset configuration of the linkset to be changed using the `rtrv-ls` command with the linkset name.

For this example, enter these commands.

```
rtrv-ls:lsn=lsn5
```

This is an example of the possible output.

```
rlghncxa03w 06-10-17 11:43:04 GMT EAGLE5 36.0.0
```

```

                L3T SLT                GWS GWS GWS
LSN          APCN  (SS7)  SCRN SET SET BEI LST LNKS ACT MES DIS SLSCI NIS
lsn5         11211-aa    scr3 1  1  no  a  1   on  off off ---  on

```

```

          SPCN          CLLI          TFATCABMLQ MTPRSE ASL8
          -----          -
          1              no          ---

```

```

SLRSRB RANDSLS MULTGC ITUTFR
1      off      no      off

```

```

IPSG  IPGWAPC  GTTMODE          CGGTMOD
no    no        CdPA          no

```

```

LOC  LINK  SLC  TYPE          IPLIML2
1105 A    0    IPLIMI    M2PA

```

```

SAPCI
5-005-5

```

```

SAPCN
11213-de
12114-fr
12115-uk

```

Link set table is (24 of 1024) 2% full

The `multgc` parameter can be specified only for linksets with either ITU-I or 14-bit ITU-N APCs. The linkset can contain only signaling links assigned to the **IPLIMI** or **IPGWI** applications, or must be an **IPSG M2PA** linkset. The linkset cannot be a proxy linkset; a linkset whose linkset type is **PRX** (`lst=prx`). If the shown in this step does not meet this criteria, the `multgc` parameter value for this linkset cannot be changed. This procedure is finished.

If the linkset does meet the criteria described in the previous paragraph, continue the procedure by performing one of these steps.

- To change the `multgc` parameter value, the ITU Duplicate Point Code feature must be turned on. If the MULTGC column is shown in the `rtrv-ls` output in this step, the ITU Duplicate Point Code feature is turned on. If the MULTGC column is not shown in the `rtrv-ls` output in this step, continue the procedure with 3.
 - If the MULTGC column is shown in the `rtrv-ls` output in this step, and the `multgc` parameter value will be changed to `no`, continue the procedure with 5.
 - If the MULTGC column is shown in the `rtrv-ls` output in this step, and the `multgc` parameter value will be changed to `yes`, this procedure is finished.
3. To specify the `multgc=yes` parameter with the `chg-ls` command, the ITU Duplicate **Point Code** feature must be on.

For the ITU Duplicate **Point Code** feature to be on, the **Multiple Point Code** feature must be on. Enter the `rtrv-feat` command to verify that either of these features are on. The entry `MPC = on` in the `rtrv-feat` command output shows that the **Multiple Point Code** feature is on.

Note: The `rtrv-feat` command output contains other fields that are not used by this procedure. If you wish to see all the fields displayed by the `rtrv-feat` command, see the `rtrv-feat` command description in *Commands User's Guide*.

4. Turn the ITU Duplicate **Point Code** feature on, and the **Multiple Point Code** feature if necessary, by entering one of these commands.
- To turn the ITU Duplicate **Point Code** feature on only.
`chg-feat:ituduppc=on`
 - To turn both the ITU Duplicate **Point Code** and **Multiple Point Code** features on.
`chg-feat:mpc=on:ituduppc=on`

Note: Once the ITU Duplicate **Point Code** and **Multiple Point Code** features are turned on with the `chg-feat` command, they cannot be turned off.

The ITU Duplicate **Point Code** and **Multiple Point Code** features must be purchased before you turn either of these features on with the `chg-feat` command. If you are not sure if you have purchased these features, contact your Oracle Sales Representative or Account Representative.

When this command has successfully completed, this message should appear.

```
rlghncxa03w 06-10-10 11:43:04 GMT EAGLE5 36.0.0
CHG-FEAT: MASP A - COMPLTD
```

This procedure is finished.

5. If the `multgc` parameter value is changed to `no`, the linkset can contain only one secondary adjacent point code.

An ITU international linkset can contain only one 14-bit ITU national secondary adjacent point code. If the ITU international linkset contains more than one 14-bit ITU national secondary adjacent point code, all but one of these 14-bit ITU national secondary adjacent point codes must be removed from the linkset. An ITU national linkset can contain only one ITU international secondary adjacent point code. All 14-bit ITU-N secondary adjacent point codes must be removed from the linkset. All routes to these secondary adjacent point codes must be removed from the database before the secondary adjacent point codes can be removed.

Display the routes using the secondary adjacent point code being removed from the linkset with the `rtrv-rte` command, specifying the secondary adjacent point code being removed as the value of the `dpc` parameter.

For this example, enter these commands.

```
rtrv-rte:dpcn=11213-de
```

This is an example of the possible output.

```
rlghncxa03w 06-10-07 11:43:04 GMT EAGLE5 36.0.0
DPCN          ALIASA          ALIASI  LSN          RC          APC
11213-de      -----
RTX:No  CLLI=-----
```

```
rtrv-rte:dpcn=12114-fr
```

This is an example of the possible output.

```
rlghncxa03w 06-10-07 11:43:04 GMT EAGLE5 36.0.0
DPCN          ALIASA          ALIASI  LSN          RC          APC
12114-fr      -----
RTX:No  CLLI=-----
```

```
rtrv-rte:dpcn=12115-uk
```

This is an example of the possible output.

```
rlghncxa03w 06-10-07 11:43:04 GMT EAGLE5 36.0.0
DPCN          ALIASA          ALIASI  LSN          RC          APC
12115-uk      -----
RTX:No  CLLI=-----
```

If the secondary adjacent point code is assigned to a route, that route must be removed from the database. Perform [Removing a Route](#) to remove the route from the database.

- Remove the secondary adjacent point codes specified in 5 from the linkset with the `chg-ls` command with the `sapcn` and the `action=delete` parameters.

For this example, enter these commands.

```
chg-ls:lsn=lsn5:sapcn=11213-de:action=delete
```

```
chg-ls:lsn=lsn5:sapcn=12114-fr:action=delete
```

```
chg-ls:lsn=lsn5:sapcn=12115-uk:action=delete
```

When the `chg-ls` command has successfully completed, this message should appear.

```
rlghncxa03w 06-10-17 16:23:21 GMT EAGLE5 36.0.0
Link set table is ( 13 of 255) 5% full
CHG-LS: MASP A - COMPLTD
```

7. Verify that the SAPCs have been removed from the linkset by entering the `rtrv-ls` command with the name of the linkset specified in 6.

For this example, enter these commands.

```
rtrv-ls:lsn=lsn5
```

This is an example of the possible output.

```
rlghncxa03w 06-10-17 11:43:04 GMT EAGLE5 36.0.0

LSN          APCN   (SS7)  L3T SLT          GWS GWS GWS
lsn5         11211-aa  scr3 1 1  no a 1  on off off --- on

          SPCN          CLLI          TFATCABMLQ MTPRSE ASL8
          -----  -----  1          no      ---

SLRSRB RANDSLS MULTGC ITUTFR
1      off    no    off

IPSG  IPGWAPC  GTTMODE          CGGTMOD
no    no      CdPA          no

LOC  LINK  SLC  TYPE          IPLIML2
1105 A  0  IPLIMI  M2PA

SAPCI
5-005-5
```

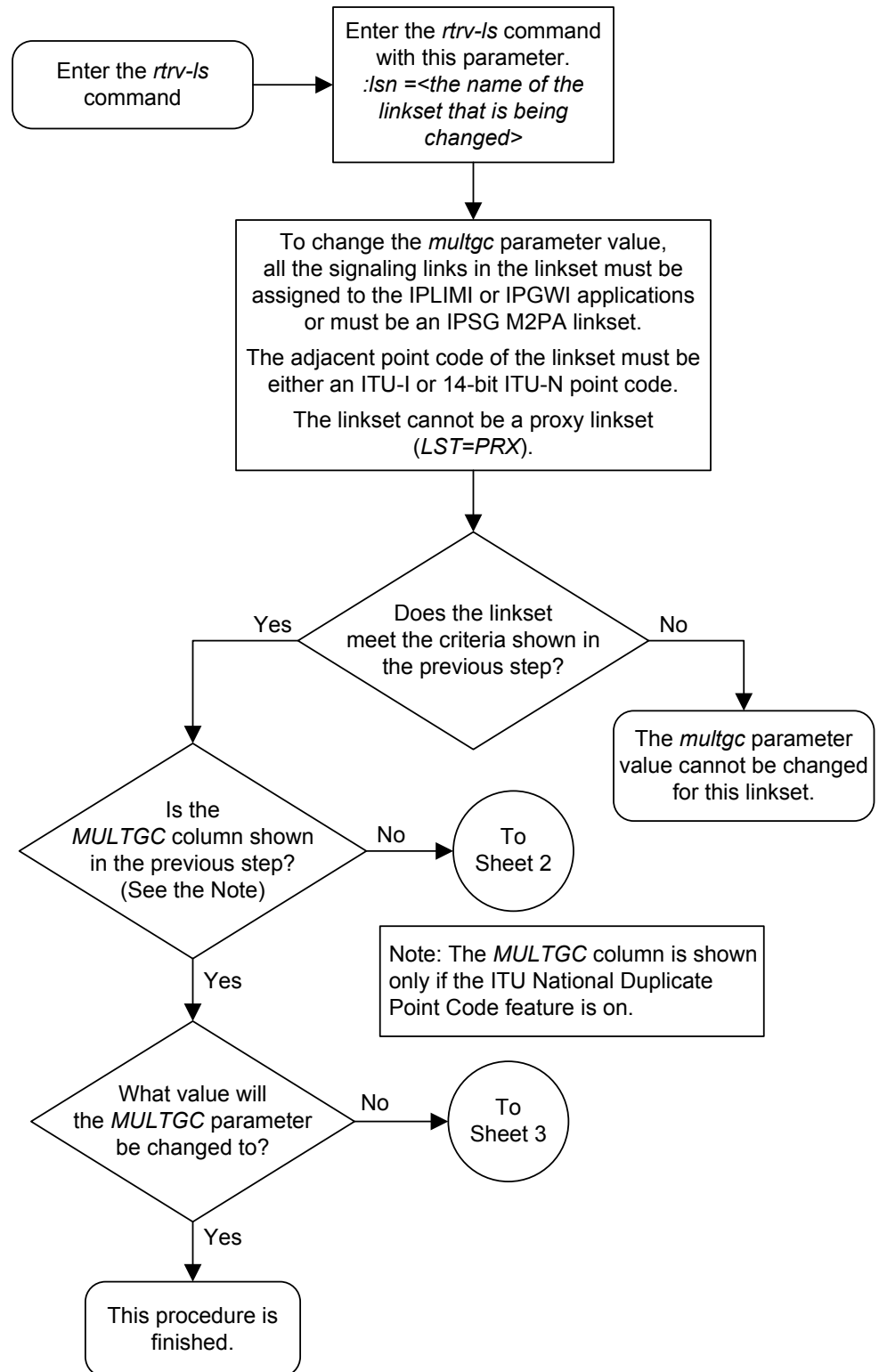
```
Link set table is ( 24 of 1024) 2% full
```

8. Back up the new changes using the `chg-db:action=backup:dest=fixed` command.

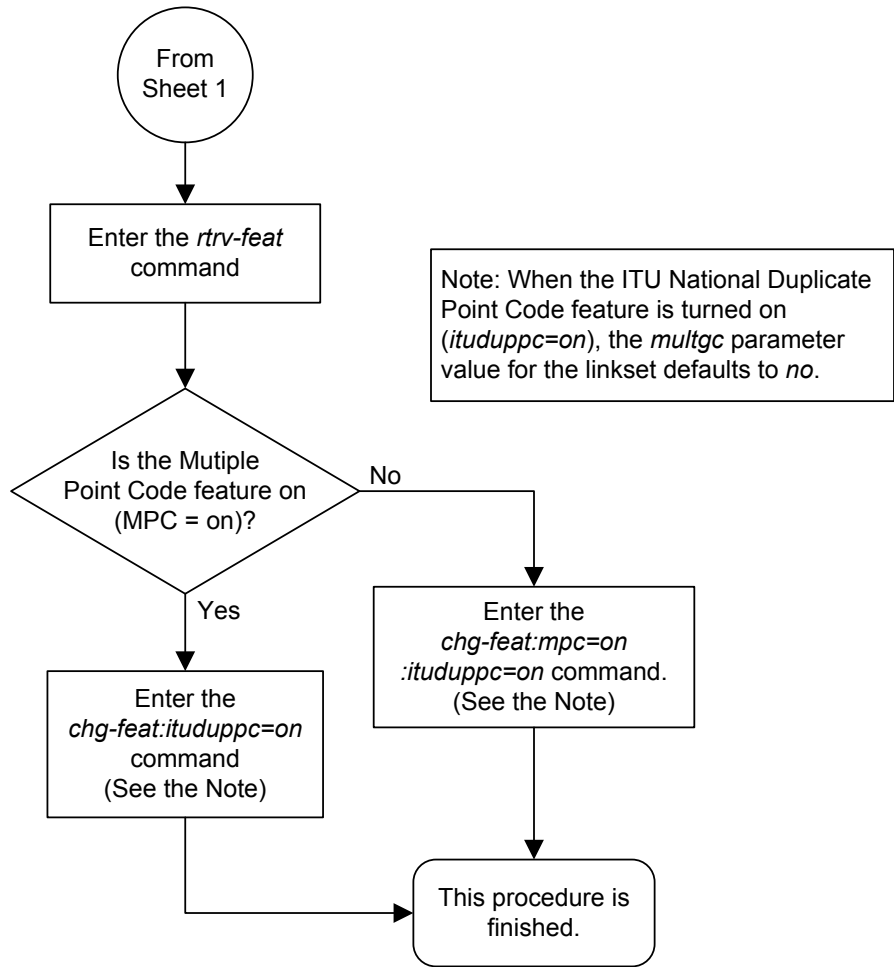
These messages should appear, the active **Maintenance and Administration Subsystem Processor (MASP)** appears first.

```
BACKUP (FIXED) : MASP A - Backup starts on active MASP.
BACKUP (FIXED) : MASP A - Backup on active MASP to fixed disk complete.
BACKUP (FIXED) : MASP A - Backup starts on standby MASP.
BACKUP (FIXED) : MASP A - Backup on standby MASP to fixed disk complete.
```

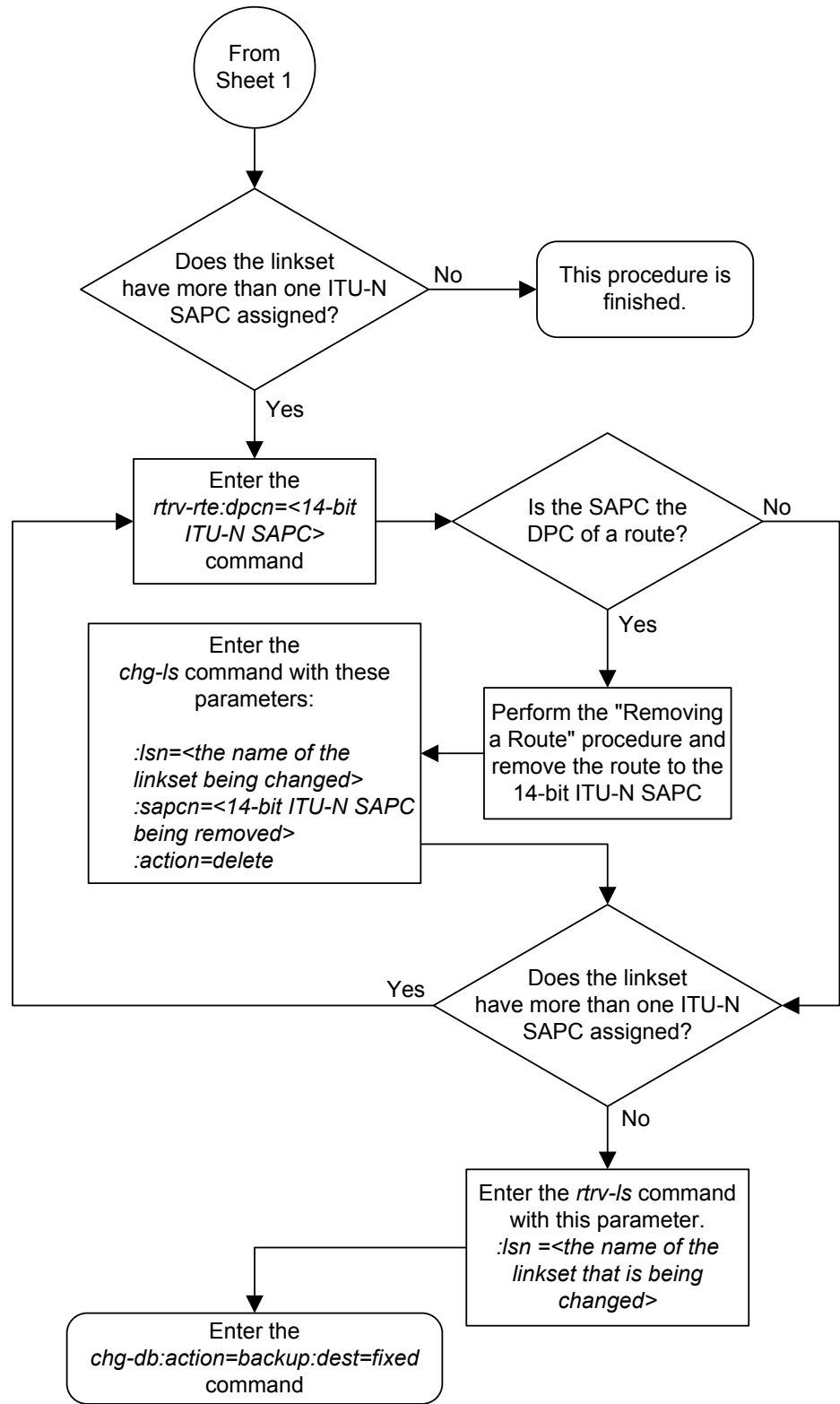
Figure 3-14 Using the MULTGC Parameter when Changing the Attributes of a Linkset



Sheet 1 of 3



Sheet 2 of 3



Configuring an ITU Linkset with a Secondary Adjacent Point Code (SAPC)

This procedure is used to configure a secondary adjacent point code for **SS7 ITU** linksets using the `lsn`, `sapci`, `sapcn`, `sapcn24`, and `action` parameters of the `chg-ls` command. Only these parameters can be specified in this procedure. The `chg-ls` command contains other parameters.

These parameters are discussed in more detail in *Commands User's Guide* or in these sections.

- [Changing an SS7 Linkset](#)
- The "Configuring a Linkset for the GSM MAP Screening Feature" procedure in *Database Administration - Features User's Guide*.
- These procedures in *Database Administration - IP7 User's Guide*.
 - Configuring an IPGWx Linkset
 - Adding a Mate IPGWx Linkset to another IPGWx Linkset
 - Removing a Mate IPGWx Linkset from another IPGWx Linkset
 - Adding an IPSP M3UA Linkset
 - Addingn IPSP M2PA Linkset

Note: A secondary adjacent point code cannot be assigned to a proxy linkset. A proxy linkset is a linkset whose linkset type is `PRX`. A secondary adjacent point code cannot be assigned to a linkset that contains an IPSP-M3UA linkset. An IPSP-M3UA linkset is a linkset that contains the `ipsp=yes` and `adapter=m3ua` parameter values.

The secondary adjacent point code is used to enhance the network management in the **ITU** international and **ITU** national nodes when messages from different countries to be routed over the same linkset.

The `lsn` parameter specifies the name of the linkset being changed.

The `sapci` parameter specifies the **ITU** international secondary adjacent point code.

The `sapcn` parameter specifies a 14-bit **ITU** national secondary adjacent point code.

The `sapcn24` parameter specifies a 24-bit **ITU** national secondary adjacent point code.

The `action` parameter specifies whether the secondary adjacent point code (`sapci`, `sapcn`, or `sapcn24`) is being added (`action=add`) to the linkset or removed (`action=delete`) from the linkset.

While the `multgc` parameter is not specified with the `chg-ls` command in this procedure, in addition to specifying whether or not multiple group codes are supported for the linkset, its value does help determine how secondary adjacent point codes are configured in the linkset.

When this parameter value is `yes`, and the **APC** of the linkset is a 14-bit **ITU** national point code, the linkset can contain one 14-bit **ITU** national secondary adjacent point code for each group code in the **EAGLE**, and one **ITU** international secondary adjacent

point code. If the **APC** of the linkset is **ITU** international, the linkset can contain either one 14-bit **ITU** national secondary adjacent point code for each group code in the **EAGLE**, or only one 24-bit **ITU** national secondary adjacent point code, but no **ITU** international secondary adjacent point codes.

If the **APC** of the linkset is a 24-bit **ITU** national point code, the linkset contains only one **ITU** international secondary adjacent point code.

If the `multgc` parameter value is `no`, the linkset can contain only one secondary adjacent point code. An **ITU** international linkset can contain either a 14-bit **ITU-N** point code or a 24-bit **ITU-N** point code. An **ITU** national linkset, a linkset containing either a 14-bit **APC** or a 24-bit **APC**, can contain only an **ITU** international secondary adjacent point code.

The secondary adjacent point codes must be defined in the destination point code table and can be assigned only to linksets with **ITU** international or **ITU** national adjacent point codes, except linksets containing **E1 ATM** signaling links cannot contain 24-bit **ITU** national secondary adjacent point codes. Secondary adjacent point codes can be non-spare, spare, private, or private spare point codes. Private and private spare point codes can be specified only for **IPGWI** linksets (linksets containing **IPGWI** signaling links).

The secondary adjacent point code parameters (`sapci`, `sapcn`, or `sapcn24`) and the `action` parameter must be specified together.

You cannot delete an **SAPC** with the `action` parameter when routes exist for its **SS7** domain.

The values of the `multgc`, `sapci`, `sapcn`, and `sapcn24` parameters are only displayed in the `rtrv-ls` command output when a specific linkset is being displayed with the `rtrv-ls:lsn=<linkset name>` command.

This examples used in this procedure are based on the information shown in [Table 3-13](#).

Table 3-13 Secondary Adjacent Point Code Configuration Table

Linkset Names	SAPCI	SAPCN	ACTION
lsi3	N/A	11212-ge	add
lsn5	4-75-7	N/A	add
lsn3	3-150-5	N/A	delete

Canceling the **RTRV-LS** and **RTRV-DSTN** Commands

Because the `rtrv-ls` and `rtrv-dstn` commands used in this procedure can output information for a long period of time, the `rtrv-ls` and `rtrv-dstn` commands can be canceled and the output to the terminal stopped. There are three ways that the `rtrv-ls` and `rtrv-dstn` commands can be canceled.

- Press the **F9** function key on the keyboard at the terminal where the `rtrv-ls` or `rtrv-dstn` commands were entered.
- Enter the `canc-cmd` without the `trm` parameter at the terminal where the `rtrv-ls` or `rtrv-dstn` commands were entered.
- Enter the `canc-cmd:trm=<xx>`, where `<xx>` is the terminal where the `rtrv-ls` or `rtrv-dstn` commands were entered, from another terminal other than the

terminal where the `rtrv-ls` or `rtrv-dstn` commands were entered. To enter the `canc-cmd:trm=<xx>` command, the terminal must allow Security Administration commands to be entered from it and the user must be allowed to enter Security Administration commands. The terminal's permissions can be verified with the `rtrv-secu-trm` command. The user's permissions can be verified with the `rtrv-user` or `rtrv-secu-user` commands.

For more information about the `canc-cmd` command, go to *Commands User's Guide*.

1. Display the current linkset configuration using the `rtrv-ls` command.

This is an example of the possible output.

```
rlghncxa03w 06-10-10 11:43:04 GMT EAGLE5 36.0.0
```

LSN	APCA (SS7)	SCRN	L3T SLT		BEI	LST	LNKS	GWS GWS GWS			SLSCI	NIS
			SET	SET				ACT	MES	DIS		
ele2	001-207-000	none	1	1	no	B	6	off	off	off	no	off
ls1305	000-005-000	none	1	1	no	A	1	off	off	off	no	off
ls1307	000-007-000	none	1	1	no	A	1	off	off	off	no	off
elm1s1	001-001-001	none	1	1	no	A	7	off	off	off	no	off
elm1s2	001-001-002	none	1	1	no	A	7	off	off	off	no	off

LSN	APCI (SS7)	SCRN	L3T SLT		BEI	LST	LNKS	GWS GWS GWS			SLSCI	NIS
			SET	SET				ACT	MES	DIS		
ele2i	1-207-0	none	1	1	no	B	4	off	off	off	---	on
ls1315	0-015-0	none	1	1	no	A	1	off	off	off	---	off
ls1317	0-017-0	none	1	1	no	A	1	off	off	off	---	on
elm2s1	1-011-1	none	1	1	no	A	7	off	off	off	---	off
elm2s2	1-011-2	none	1	1	no	A	7	off	off	off	---	off
lsi3	1-111-3	scr3	1	3	yes	c	1	off	off	off	---	---

LSN	APCN (SS7)	SCRN	L3T SLT		BEI	LST	LNKS	GWS GWS GWS			SLSCI	NIS
			SET	SET				ACT	MES	DIS		
lsn3	11113-ge	scr3	1	3	yes	c	1	on	off	off	---	off
lsn5	10685-fr	scr1	1	3	yes	a	1	off	off	off	---	off

Link set table is (10 of 1024) 1% full.

Note: A secondary adjacent point code cannot be assigned to a proxy linkset. A proxy linkset is a linkset whose linkset type is PRX. Choose a linkset whose linkset type is not PRX and continue the procedure with 2.

2. Display the current linkset configuration of the linkset to be changed using the `rtrv-ls` command with the linkset name.

For this example, enter this command.

```
rtrv-ls:lsn=lsi3
```

This is an example of the possible output.

```
rlghncxa03w 06-10-17 11:43:04 GMT EAGLE5 36.0.0
```

LSN	APCI (SS7)	SCRN	L3T SLT		BEI	LST	LNKS	GWS GWS GWS			SLSCI	NIS
			SET	SET				ACT	MES	DIS		
lsi3	1-111-3	scr3	1	3	yes	c	1	off	off	off	---	---

```

CLLI          TFATCABMLQ MTPRSE ASL8 SLSOCBIT SLSRSB MULTGC
----- 1          no    --- none    7      yes

ITUTFR RANDSLS
off    all

IPGWAPC MATELSN    IPTPS LSUSEALM SLKUSEALM GTTMODE
yes     ----- 100   100    % 80    % CdPA

LOC  LINK SLC TYPE
1317 A  0  IPGWI

SAPCN
11211-uk
Link set table is ( 13 of 255) 5% full

```

rtrv-ls:lsn=lsn3

This is an example of the possible output.

rlghncxa03w 06-10-17 11:43:04 GMT EAGLE5 36.0.0

LSN	APCN	(SS7)	SCRN	SET	SET	BEI	LST	LNKS	ACT	MES	DIS	SLSCI	NIS
lsn3	11113-ge		scr3	1	3	yes	c	1	on	off	off	---	off

```

CLLI          TFATCABMLQ MTPRSE ASL8 SLSOCBIT SLSRSB MULTGC
----- 1          no    --- none    7      yes

```

```

ITUTFR RANDSLS
off    off

```

```

IPGWAPC MATELSN    IPTPS LSUSEALM SLKUSEALM GTTMODE
no     -----  ---  ---    ---    CdPA

```

```

LOC  LINK SLC TYPE    IPLIML2
1301 A  0  IPLIMI  M2PA

```

```

SAPCI
3-150-5
SAPCN
11213-de
Link set table is ( 13 of 255) 5% full

```

rtrv-ls:lsn=lsn5

This is an example of the possible output.

rlghncxa03w 06-10-17 11:43:04 GMT EAGLE5 36.0.0

LSN	APCN	(SS7)	SCRN	SET	SET	BEI	LST	LNKS	ACT	MES	DIS	SLSCI	NIS
lsn5	10685-fr		scr1	1	3	yes	a	1	off	off	off	---	off

```

CLLI          TFATCABMLQ MTPRSE ASL8 SLSOCBIT SLSRSB MULTGC
----- 1          no    --- none    7      no

```

```

ITUTFR RANDSLS
off    off

```

```

IPGWAPC MATELSN      IPTPS LSUSEALM SLKUSEALM GTTMODE
no          ----- ---   ---   ---          CdPA

LOC  LINK SLC TYPE      IPLIML2
1201 A    0  IPLIMI    M2PA
    
```

Link set table is (13 of 255) 5% full

If 24-bit ITU-N secondary adjacent point codes are being added to the linkset, and the linkset specified in this step contains E1 ATM signaling links, choose another linkset from 1 and repeat this step. Linksets containing E1 ATM signaling links cannot have 24-bit ITU-N secondary adjacent point codes.

If the desired linkset is an IPSP-M3UA linkset, choose another linkset from 1 and repeat this step. Secondary adjacent point codes cannot be assigned to IPSP-M3UA linksets.

Note: If you are not adding any secondary adjacent point codes to the linkset, continue the procedure with 5.

3. Display the point code and capability point code of the EAGLE by using the `rtrv-sid` command.

This is an example of the possible output.

```

rlghncxa03w 06-10-10 11:43:04 GMT EAGLE5 36.0.0
PCA          PCI          PCN          CLLI          PCTYPE
001-001-001  3-150-4          12345-uk     rlghncxa03w   OTHER

CPCA
002-002-002      002-002-003      002-002-004      002-002-005
002-002-006      002-002-007      002-002-008      002-002-009
004-002-001      004-003-003      144-212-003

CPCI
1-001-1          1-001-2          1-001-3          1-001-4

CPCN
02091-uk        02092-uk        02094-uk        02097-uk
02191-uk        02192-uk        11177-uk
    
```

4. Display the point codes in the destination point code table by using the `rtrv-dstn` command.

This is an example of the possible output.

```

rlghncxa03w 10-12-10 11:43:04 GMT EAGLE5 43.0.0
Extended Processing Time may be Required

DPCA          CLLI          BEI ELEI  ALIASI          ALIASN/N24  DMN
001-002-003  1s04ccli     yes --- -----          -----          SS7
001-002-003  1s04ccli     yes --- -----          -----          SS7
002-002-100  1s01ccli     no  --- -----          -----          SS7
002-007-008  1s06ccli     yes --- -----          -----          SS7
002-009-003  -----      no  --- -----          -----          SS7
002-250-010  -----      no  --- -----          -----          SS7
003-003-003  1s03ccli     yes --- -----          -----          SS7
003-020-100  -----      no  --- -----          -----          SS7
    
```

004-004-004	ls02clli	yes	---	-----	-----	SS7
004-030-200	-----	no	---	-----	-----	SS7
009-002-003	-----	no	---	-----	-----	SS7
179-100-087	-----	yes	---	-----	-----	SS7
200-050-176	-----	yes	---	-----	-----	SS7
240-007-000	-----	yes	---	-----	-----	SS7
240-012--004	rlghncbb001	yes	---	1-111-1	11111	SS7
240-012-005	rlghncbb002	yes	---	1-112-2	11112	SS7
240-012-008	-----	yes	---	1-113-5	11114	SS7
DPCI	CLLI	BEI	ELEI	ALIASA	ALIASN/N24	DMN
2-131-1	rlghncbb023	no	---	222-210-000	12001	SS7
2-131-2	-----	no	---	222-211-001	12002	SS7
2-131-3	-----	no	---	222-211-002	12003	SS7
3-150-4	lsi7clli	yes	---	-----	-----	SS7
DPCN	CLLI	BEI	ELEI	ALIASA	ALIASI	DMN
10685	lsn5clli	yes	---	-----	-----	SS7
11211	rlghncbb013	no	---	222-200-200	2-121-1	SS7
11212	rlghncbb013	no	---	222-200-201	2-121-2	SS7

Destination table is (23 of 2000) 1% full

Alias table is (18 of 8000) 1% full

If a secondary adjacent point code is being added to the linkset, and the secondary adjacent point code is not shown in the `rtrv-dstn` command output, go to the [Adding a Destination Point Code](#) procedure procedures and add the secondary adjacent point code to the destination point code table.

Note: If a secondary adjacent point code is being added, and a new point code was added in 4, continue the procedure with 6.

5. Display the routes using the secondary adjacent point code being added to the linkset or being removed from the linkset with the `rtrv-rte` command, specifying the secondary adjacent point code as the value of the `dpci` parameter.

For this example, enter this command.

```
rtrv-rte:dpci=3-150-5
```

This is an example of the possible output.

```
rlghncxa03w 06-10-07 11:43:04 GMT EAGLE5 36.0.0
DPCI      ALIASN/N24      ALIASA      LSN      RC      APC
3-150-5  -----          -----          lsn3      10      3-150-5
                                           RTX:No  CLLI=-----
```

If the secondary adjacent point code is not the **DPC** of a route, the point code entry is displayed in the `rtrv-rte` output, but the **LSN**, **RC**, and **APC** columns contain dashes, as shown in the following output example.

```
rlghncxa03w 06-10-10 11:43:04 GMT EAGLE5 36.0.0
DPCI      ALIASN/N24      ALIASA      LSN      RC      APC
3-150-5  -----          -----          -----  --  -----
                                           RTX:No  CLLI=-----
```

If the point code specified in this step is shown in the DPCA/DPCI/DPCN/ DPCN24 columns in this step, and the secondary adjacent point code is being added to the linkset, the point code value cannot be used as a secondary adjacent point code unless one of two actions are taken:

- Choose another secondary adjacent point code value and repeat 3, 4, and 5.
- Remove all the entries displayed in this step by performing the [Removing a Route](#) procedure.

If the point code specified in this step is shown in the DPCA/DPCI/DPCN/ DPCN24 columns in this step, and the secondary adjacent point code is removed from the linkset, the routes shown in this step must be removed from the database. Perform the [Removing a Route](#) procedure to remove the routes from the database.

Note: If you are adding only ITU-I or 24-bit ITU-N secondary adjacent point codes, continue the procedure with 7.

6. Display the secondary point codes in the destination point code table to verify any group codes that are assigned to 14-bit ITU-N secondary point codes in the database by using the `rt rv-spc` command.

This is an example of the possible output.

```
rlghncxa03w 06-10-17 16:02:05 GMT EAGLE5 36.0.0
SPC (Secondary Point Codes)

SPCA
  001-010-010
  002-010-010
  003-010-010
  010-100-010

SPC-I
  1-253-5
  2-254-6
  3-255-7
  4-100-1

SPC-N
  5175-de
  6744-uk
  7673-ge
  7673-fr

SPC-N24
Secondary Point Code table is (12 of 40) 30% full
```

7. Perform one of these steps to configure the linkset with a secondary adjacent point code.
 - a. To add the secondary adjacent point code to the linkset, enter the `chg-ls` command with these parameters.

```
:lsn=<linkset name being changed>
```

```
:action=add
```

```
:sapci=<ITU-I secondary adjacent point code being added>
```

or

```
:sapcn=<14-bit ITU-N secondary adjacent point code being added>
```

or

```
:sapcn24=<24-bit ITU-N secondary adjacent point code being added>
```

If the value of the `multgpc` parameter is `yes`, and the **APC** of the linkset is a 14-bit **ITU** national point code, the linkset can contain one 14-bit **ITU** national secondary adjacent point code for each group code in the **EAGLE**, and one **ITU** international secondary adjacent point code. If the **APC** of the linkset is an **ITU** international point code, the linkset can contain either one 14-bit **ITU** national secondary adjacent point code for each group code in the **EAGLE**, or one 24-bit **ITU** national secondary adjacent point code, but no **ITU** international secondary adjacent point codes. If the **APC** of the linkset is a 24-bit **ITU** national point code, the linkset contains only one **ITU** international secondary adjacent point code. The output of the `rtrv-dstn` command in 4 and the `rtrv-spc` command in 5 shows the group codes in the database.

If the value of the `multgpc` parameter is `no`, the linkset can contain only one secondary adjacent point code. An **ITU** international linkset can contain either a 14-bit **ITU-N** point code or a 24-bit **ITU-N** point code. An **ITU** national linkset, a linkset containing either a 14-bit **APC** or a 24-bit **APC**, can contain only an **ITU** international secondary adjacent point code.

Secondary adjacent point codes can be non-spare, spare, private, or private spare point codes. Private and private spare point codes can be specified only for **IPGWI** linksets (linksets containing **IPGWI** signaling links).

- b. To remove the secondary adjacent point code from the linkset, enter the `chg-ls` command with these parameters.

```
:lsn=<linkset name being changed>
```

```
:action=delete
```

```
:sapci=<ITU-I secondary adjacent point code being removed>
```

or

```
:sapcn=<14-bit ITU-N secondary adjacent point code being added>
```

or

```
:sapcn24=<24-bit ITU-N secondary adjacent point code being added>
```

- c. If only one secondary adjacent point code can be assigned to the linkset, and that secondary adjacent point code is being replaced, perform step **b** to remove the existing secondary adjacent point code, then perform step **a** to add the new secondary adjacent point code.

For this example, enter these commands.

```
chg-ls:lsn=lsi3:sapcn=11212-ge:action=add
```

```
chg-ls:lsn=lsn3:sapci=4-75-7:action=add
```

```
chg-ls:lsn=lsn5:sapci=3-150-5:action=delete
```

When the `chg-ls` command has successfully completed, this message should appear.

```
rlghncxa03w 06-10-17 16:23:21 GMT EAGLE5 36.0.0
Link set table is ( 13 of 255) 5% full
CHG-LS: MASP A - COMPLTD
```

- Verify the changes using the `rtrv-ls` command specifying the linkset name specified in 7 with the `lsn` parameter.

For this example, enter these commands.

```
rtrv-ls:lsn=lsi3
```

This is an example of the possible output.

```
rlghncxa03w 06-10-17 11:43:04 GMT EAGLE5 36.0.0

LSN          APCI  (SS7)  L3T SLT          GWS GWS GWS
1-111-3      scr3  1    3    yes c    1    off off off --- ---

CLLI          TFATCABMLQ MTPRSE ASL8 SLSOCBIT SLSRSB MULTGC
----- 1          no    --- none    7    yes

ITUTFR RANDSLS
off    all

IPGWAPC MATELSN    IPTPS LSUSEALM SLKUSEALM GTTMODE
yes    ----- 100    100    % 80    % CdPA

LOC  LINK SLC TYPE
1317 A    0    IPGWI

SAPCN
11211-uk
11212-ge
Link set table is ( 13 of 255) 5% full
```

```
rtrv-ls:lsn=lsn3
```

This is an example of the possible output.

```
rlghncxa03w 06-10-17 11:43:04 GMT EAGLE5 36.0.0

LSN          APCN  (SS7)  L3T SLT          GWS GWS GWS
11113-ge     scr3  1    3    yes c    1    on off off --- off

CLLI          TFATCABMLQ MTPRSE ASL8 SLSOCBIT SLSRSB MULTGC
----- 1          no    --- none    7    yes

ITUTFR RANDSLS
off    off

IPGWAPC MATELSN    IPTPS LSUSEALM SLKUSEALM GTTMODE
no    ----- ---    ---    ---    CdPA

LOC  LINK SLC TYPE          IPLIML2
```



```

1301 A 0 IPLIMI M2PA

SAPCN
11213-de
Link set table is ( 13 of 255) 5% full

rtrv-ls:lsn=lsn5

```

This is an example of the possible output.

```

rlghncxa03w 06-10-17 11:43:04 GMT EAGLE5 36.0.0

LSN          APCN  (SS7)  L3T SLT          GWS GWS GWS
lsn5         10685-fr  scr1 1 3  yes a 1  off off off  --- off

CLLI          TFATCABMLQ MTPRSE ASL8 SLSOCBIT SLSRSB MULTGC
----- 1          no  --- none 7 no

ITUTFR RANDSLS
off off

IPGWAPC MATELSN IPTPS LSUSEALM SLKUSEALM GTTMODE
no ----- --- --- --- CdPA

LOC LINK SLC TYPE IPLIML2
1201 A 0 IPLIMI M2PA

SAPCI
4-75-7
Link set table is ( 13 of 255) 5% full

```

9. Back up the new changes using the `chg-db:action=backup:dest=fixed` command.

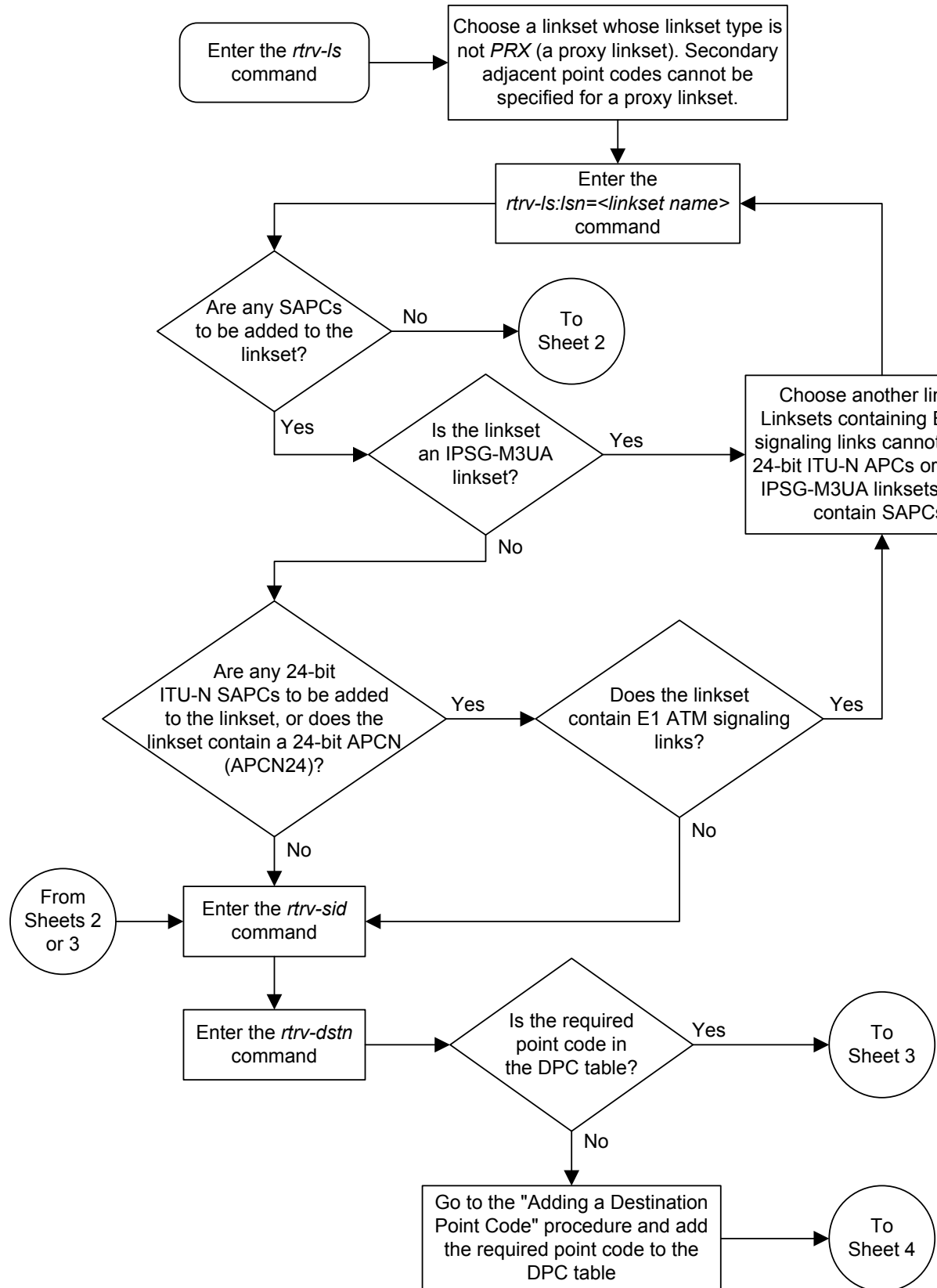
These messages should appear, the active **Maintenance and Administration Subsystem Processor (MASP)** appears first.

```

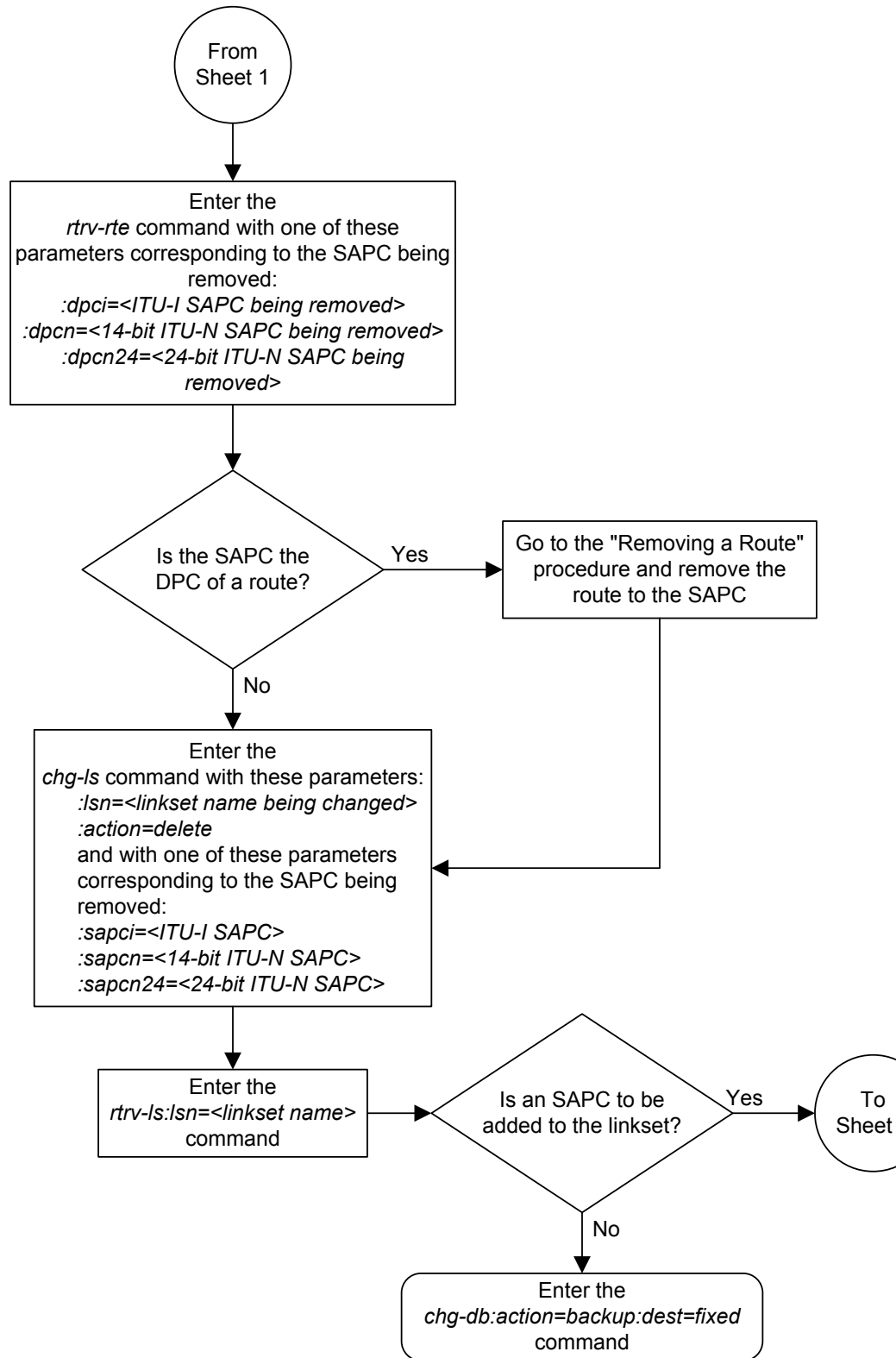
BACKUP (FIXED) : MASP A - Backup starts on active MASP.
BACKUP (FIXED) : MASP A - Backup on active MASP to fixed disk complete.
BACKUP (FIXED) : MASP A - Backup starts on standby MASP.
BACKUP (FIXED) : MASP A - Backup on standby MASP to fixed disk complete.

```

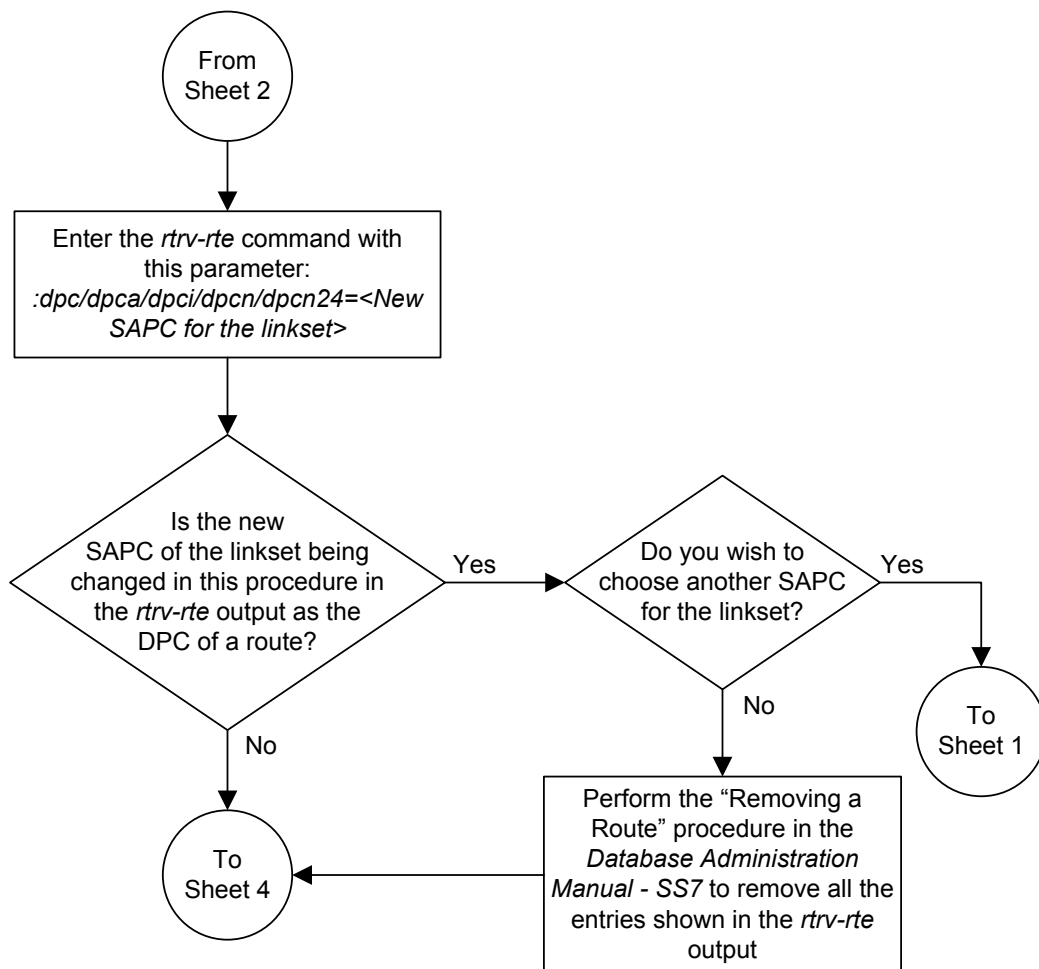
Figure 3-15 Configuring an ITU Linkset with a Secondary Adjacent Point Code (SAPC)



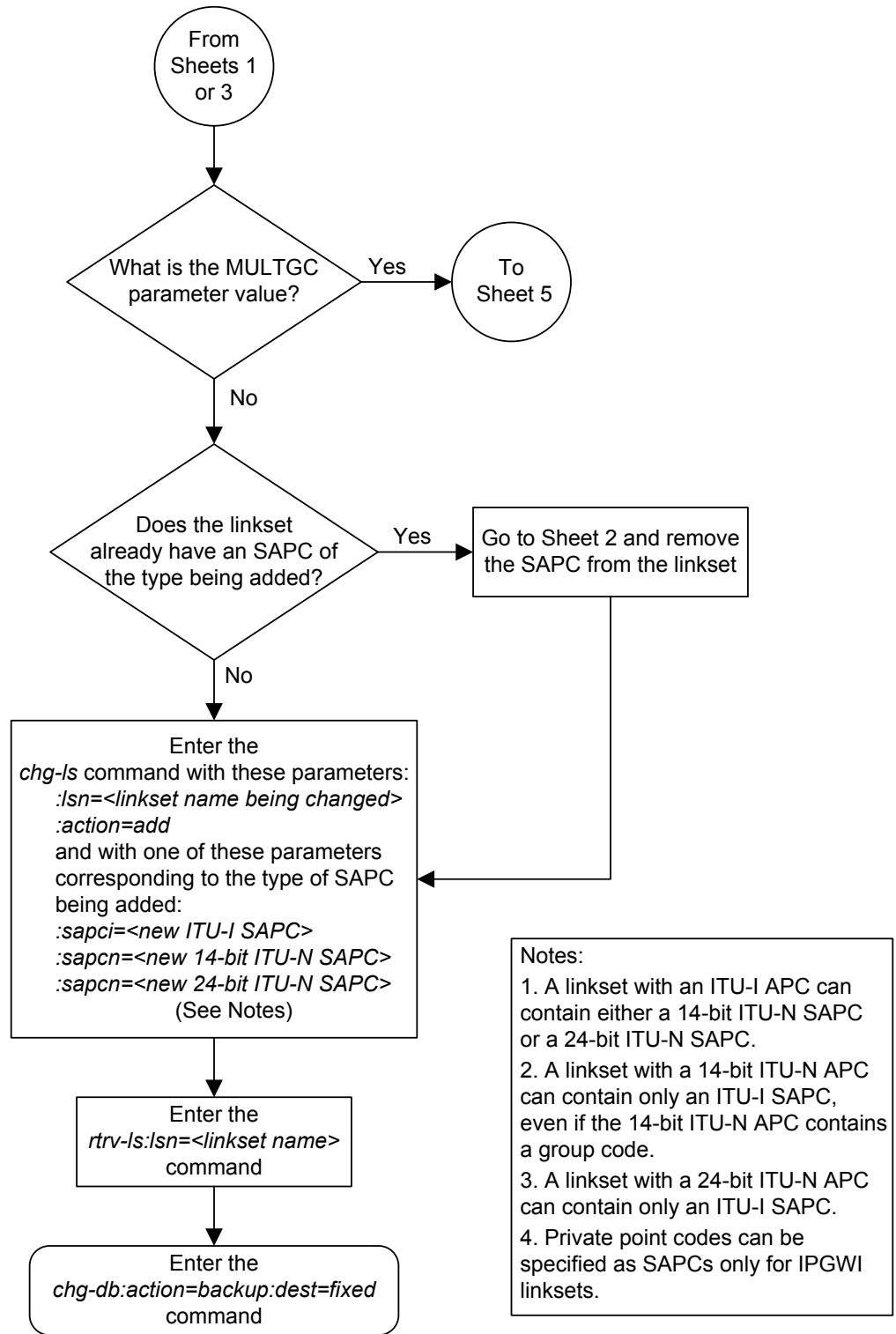
Sheet 1 of 6



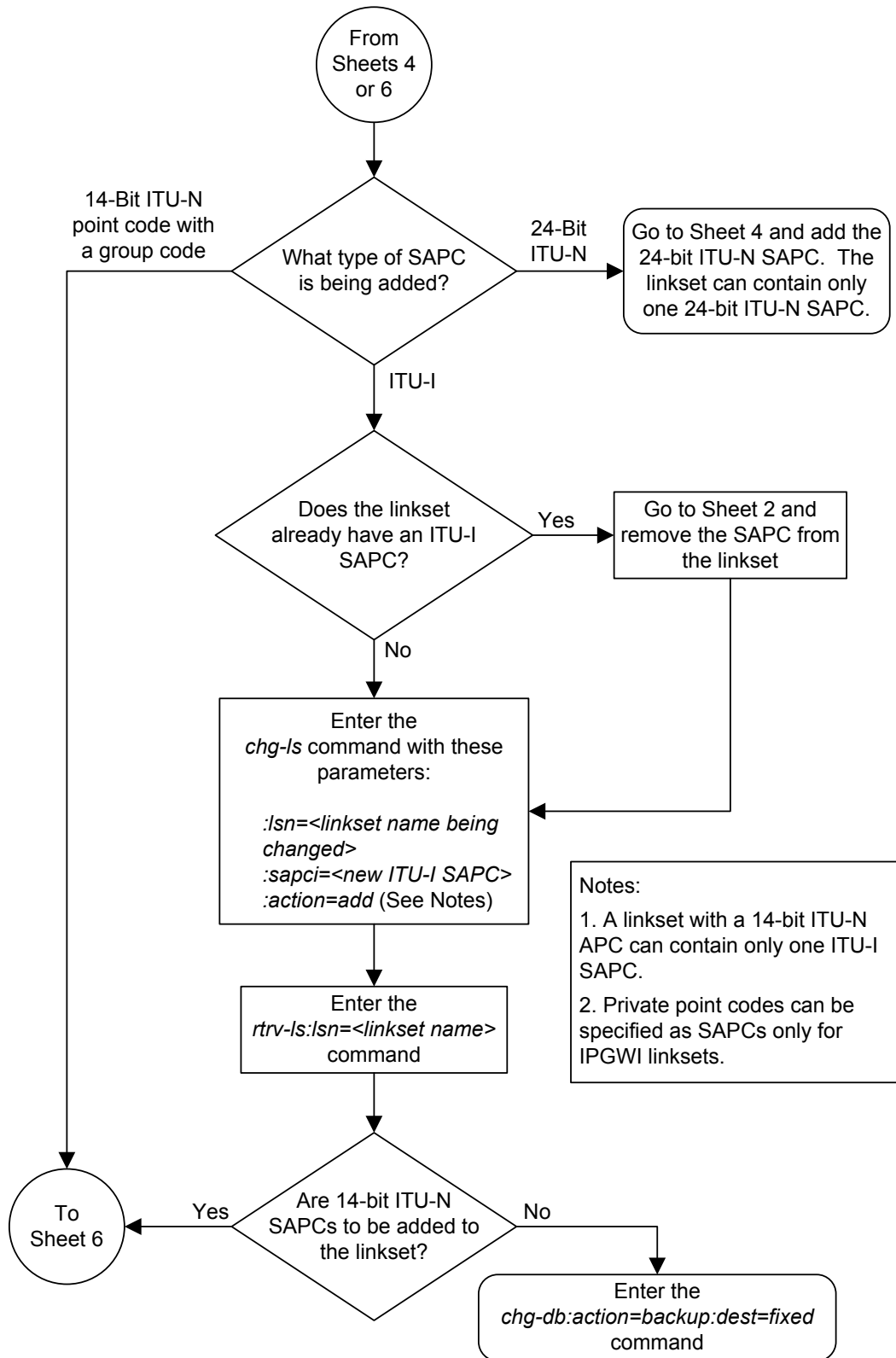
Sheet 2 of 6



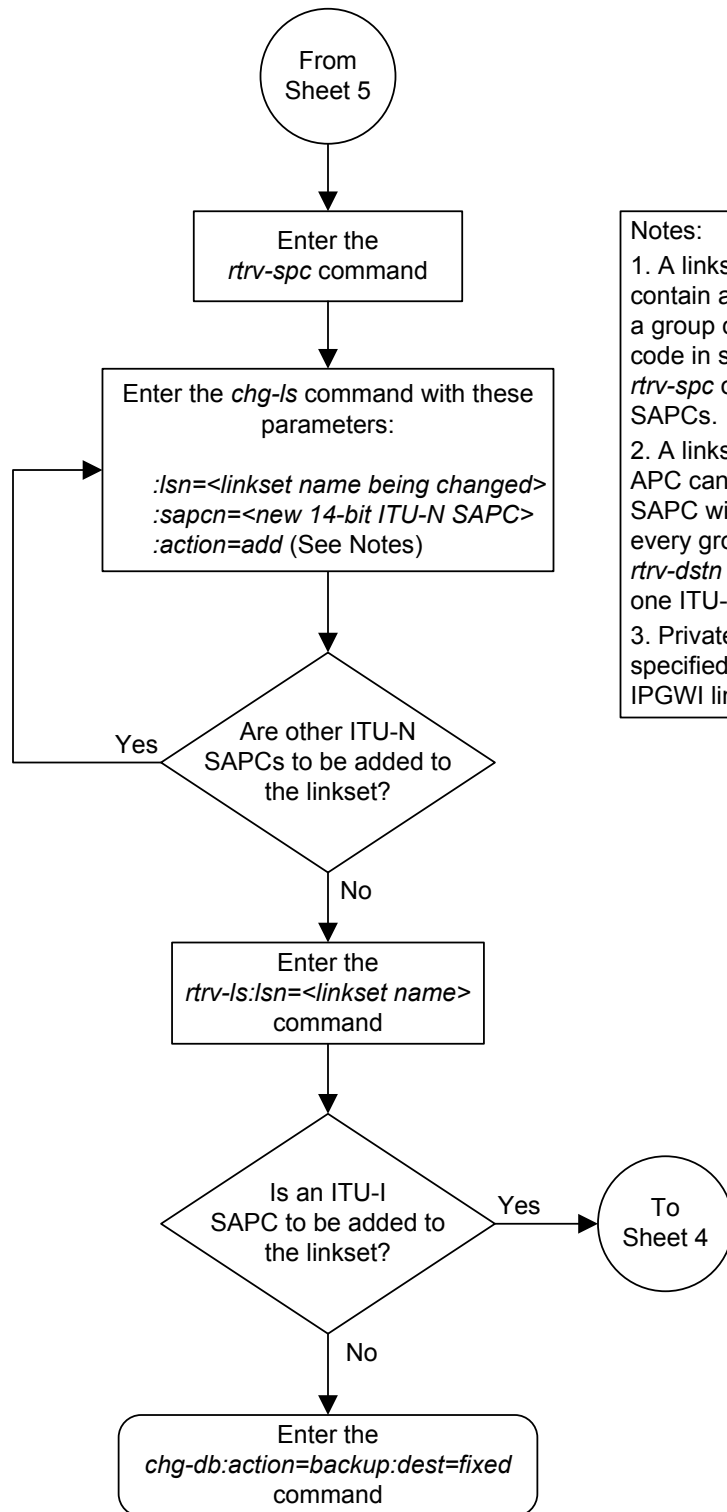
Sheet 3 of 6



Sheet 4 of 6



Sheet 5 of 6



Notes:

1. A linkset with an ITU-I APC contain a 14-bit ITU-N SAPC with a group code, for every group code in shown in the *rtv-dstn* and *rtv-spc* outputs, and no ITU-I SAPCs.
2. A linkset with a 14-bit ITU-N APC can contain a 14-bit ITU-N SAPC with a group code, for every group code in shown in *rtv-dstn* and *rtv-spc* outputs, one ITU-I SAPC.
3. Private point codes can be specified as SAPCs only for IPGWI linksets.

Adding an SS7 Signaling Link

This procedure is used to add an ANSI **SS7** low-speed signaling link to an MPL card using the `ent-slk` command with these parameters shown in [Table 3-14](#).

Table 3-14 Signaling Link Parameters

loc	link	lsn
slc	l2tset	bps
ecm	pcrn1	pcrn2

The `ent-slk` command contains other optional parameters that are not used this procedure. These parameters are discussed in more detail in the *Commands Manual* or in these sections. These sections are also used to configure ITU signaling links.

- These procedures in this manual.
 - The [Adding an E1 Signaling Link](#) procedure
 - The [Adding a T1 Signaling Link](#) procedure
 - The [Adding an ATM High-Speed Signaling Link](#) procedure.
- These procedures in *Database Administration - IP7 User's Guide*
 - Adding an IPGWx Signaling Link
 - Adding an IPLIMx Signaling Link
 - Adding an IPSG M3UA Signaling Link
 - Adding an IPSG M2PA Signaling Link

:loc – The card location of the **LIM** that the **SS7** signaling link will be assigned to.

:link – The signaling link on the card specified in the loc parameter.

:lsn – The name of the linkset that will contain the signaling link.

:slc – The signaling link code. The **SLC** must be unique within the linkset. It must be the same at both the **EAGLE** location and the distant node.

:l2tset – The level 2 timer set table. A signaling link may be assigned to any of the thirty tables. The type of linkset the signaling link is assigned to and the **LIM**'s application determines the value of the l2tset parameter. The level 2 timer set tables are defined in [Changing Level 2 Timers](#) .

:bps – The transmission rate for the link in bits per second.

:ecm – Error correction method

:pcrn1 – The threshold of the number of **MSUs** available for retransmission. If the error correction method being used is **PCR** (:ecm=pcr), and this threshold is reached, no new **MSUs** or **FISUs** are sent. The retransmission cycle is continued up to the last **MSU** entered into the retransmission buffer in the order in which they were originally transmitted.

:pcrn2 – The threshold of the number of **MSU** octets available for retransmission. If the error correction method being used is **PCR** (:ecm=pcr), and this threshold is reached, no new **MSUs** or **FISUs** are sent. The retransmission cycle is continued up to the last **MSU** entered into the retransmission buffer in the order in which they were originally transmitted.

These items must be configured in the database before an **SS7** signaling link can be added:

- Shelf – see "Adding a Shelf in *Database Administration - System Management User's Guide*
- Card – see "Adding an SS7 LIM" in *Database Administration - System Management User's Guide*
- Destination **Point Code** – see [Adding a Destination Point Code](#)
- Linkset – [Adding an SS7 Linkset](#) .

Verify that the link has been physically installed (all cable connections have been made).

To configure the **EAGLE** to perform circular routing detection test on the signaling links, perform the [Configuring Circular Route Detection](#) procedure.

Note: Circular route detection is not supported in **ITU** networks.

To provision a **EAGLE** with more than 1200 signaling links, the **EAGLE** must have certain levels of hardware installed. See the [Requirements for EAGLEs Containing more than 1200 Signaling Links](#) section for more information on these hardware requirements.

The **EAGLE** can contain a mixture of low-speed, **E1**, **T1**, **ATM** high-speed, and **IP** signaling links. The [Determining the Number of High-Speed and Low-Speed Signaling Links](#) section describes how to determine the quantities of the different types of signaling links the **EAGLE** can have.

SS7 Signaling Link Parameter Combinations

[Table 3-15](#) shows the parameters and values that can be used to provision an ANSI **SS7** signaling link.

Table 3-15 SS7 Signaling Link Parameter Combinations

MPL Signaling Link (See Note 1)
Mandatory Parameters
:loc = location of the MPL with the SS7ANSI application and the LIMDS0 card type.
:link = A, A1, A2, A3, B, B1, B2, or B3 (See Note 4)
:lsn = linkset name (See Note 3)
:slc = 0 - 15
Optional Parameters

Table 3-15 (Cont.) SS7 Signaling Link Parameter Combinations

MPL Signaling Link (See Note 1)
:bps = 56000 default value = 56000
:l2tset = Table 3-16
:ecm = basic or pcr default value = basic
:pcrn1 = 1 - 127 (See Note 2) default value = 76
:pcrn2 = 300 - 35500 (See Note 2) default value = 3800

Notes:

1. This procedure is not used to configure **ATM**, **IP**, **E1**, or **T1** signaling links. To configure these types of links, perform one of these procedures:
 - **E1** signaling links – [Adding an E1 Signaling Link](#).
 - **T1** signaling links – [Adding a T1 Signaling Link](#).
 - **ATM** signaling links – [Adding an ATM High-Speed Signaling Link](#).
 - **IP** signaling links – "Adding an IPLIMx Signaling Link," "Adding an IPGWX Signaling Link," "Adding an IPSP M3UA Signaling Link," or "Adding an IPSP M2PA Signaling Link" procedures in *Database Administration - IP7 User's Guide*.
2. These parameters can be specified only with the `ecm=pcr` parameter.
3. The linkset adjacent point code type must be **ANSI**. The domain of the linkset adjacent point code must be **SS7**.
4. The `port` parameter can be used in place of the `link` parameter to specify the signaling link on the card.

Canceling the REPT-STAT-SLK and RTRV-SLK Commands

Because the `rept-stat-slk` and `rtrv-slk` commands used in this procedure can output information for a long period of time, the `rept-stat-slk` and `rtrv-slk` commands can be canceled and the output to the terminal stopped. There are three ways that the `rept-stat-slk` and `rtrv-slk` commands can be canceled.

- Press the F9 function key on the keyboard at the terminal where the `rept-stat-slk` or `rtrv-slk` commands were entered.
- Enter the `canc-cmd` without the `trm` parameter at the terminal where the `rept-stat-slk` or `rtrv-slk` commands were entered.
- Enter the `canc-cmd:trm=<xx>`, where `<xx>` is the terminal where the `rept-stat-slk` or `rtrv-slk` commands were entered, from another terminal other than the terminal where the `rept-stat-slk` or `rtrv-slk` commands were entered. To enter the `canc-cmd:trm=<xx>` command, the terminal must allow Security Administration commands to be entered from it and the user must be

allowed to enter Security Administration commands. The terminal's permissions can be verified with the `rtrv-secu-trm` command. The user's permissions can be verified with the `rtrv-user` or `rtrv-secu-user` commands.

For more information about the `canc-cmd` command, go to *Commands User's Guide*.

1. Display the maximum number of signaling links the EAGLE can have and the number of signaling links that are currently provisioned by entering the `rtrv-tbl-capacity` command.

This is an example of the possible output.

```
rlghncxa03w 09-07-19 21:16:37 GMT EAGLE5 41.1.0
SLK      table is (      7 of      1200)  1% full
```

Note: The `rtrv-tbl-capacity` command output contains other fields that are not used by this procedure. If you wish to see all the fields displayed by the `rtrv-tbl-capacity` command, refer to the `rtrv-tbl-capacity` command description in *Commands User's Guide*.

If the addition of the new signaling link will exceed the maximum number of signaling links the EAGLE can have (in this example, the maximum number of signaling links is 1200), and the maximum number of signaling links is 2800, this procedure cannot be performed. The EAGLE cannot contain more than 2800 signaling links.

If the addition of the new signaling link will exceed the maximum number of signaling links the EAGLE can have, and the maximum number of signaling links is less than 2800, perform the [Enabling the Large System # Links Controlled Feature](#) procedure to enable the desired quantity of signaling links. After the new quantity of signaling links has been enabled, continue the procedure with [2](#).

If the addition of the new signaling link will not exceed the maximum number of signaling links the EAGLE can have, continue the procedure with [2](#).

2. Display the current signaling link configuration using the `rtrv-slk` command. This is an example of the possible output.

```
rlghncxa03w 09-07-19 21:16:37 GMT EAGLE5 41.1.0

LOC LINK LSN          SLC TYPE      L2T          PCR PCR
      SET BPS      ECM  N1  N2
1201 B   lsa1          0 LIMDS0      1   56000 BASIC ---  -----
1203 B   lsa2          0 LIMDS0      1   56000 BASIC ---  -----
1205 A   lsa3          0 LIMDS0      3   56000 BASIC ---  -----
1207 A   lsn1207a      0 LIMDS0      1   56000 BASIC ---  -----
1207 B   lsn1207b      0 LIMDS0      1   56000 BASIC ---  -----
1214 A   lsn1214a      0 LIMDS0      2   56000 BASIC ---  -----
1214 B   lsa3          1 LIMDS0      3   56000 BASIC ---  -----

SLK table is (7 of 1200) 1% full.
```

3. Display the cards in the database using the `rtrv-card` command. This is an example of the possible output.


```

rlghncxa03w 09-10-28 09:12:36 GMT EAGLE5 41.1.0
CARD   TYPE     APPL     LSET NAME     LINK SLC LSET NAME     LINK SLC
1101   DSM       VSCCP
1102   TSM       GLS
1113   GSPM     OAM
1114   TDM-A
1115   GSPM     OAM
1116   TDM-B
1117   MDAL
1201   LIMDS0   SS7ANSI   lsa1           B      0
1202   LIMDS0   SS7ANSI
1203   LIMDS0   SS7ANSI   lsa2           B      0
1205   LIMDS0   SS7ANSI   lsa3           A      0
1207   LIMDS0   SS7ANSI   lsn1207a      A      0   lsn1207b      B      0
1214   LIMDS0   SS7ANSI   lsn1214a      A      0   lsa3           B      1
1302   LIMATM   ATMANSI
1305   LIMATM   ATMANSI
1311   LIMDS0   SS7ANSI
1318   LIMATM   ATMANSI

```

If the required card is not in the database, go to the "Adding an SS7 LIM" procedure in *Database Administration - System Management User's Guide* and add the card to the database.

4. Display the current linkset configuration using the `rtrv-ls` command. This is an example of the possible output.

```

rlghncxa03w 09-10-10 11:43:04 GMT EAGLE5 41.1.0
                                     L3T SLT
LSN          APCA  (SS7)  SCRN SET SET BEI LST LNKS  GWS GWS GWS
lsn01        000-005-000 none 1 1 no A 0 off off off no off
lsn02        000-007-000 none 1 1 no A 0 off off off no off
lsa1         001-207-000 none 1 1 no B 1 off off off no off
lsa2         001-002-001 none 1 1 no A 1 off off off no off
lsa3         001-001-003 none 1 1 no A 2 off off off no off
lsn1207a     001-003-002 none 1 1 no A 1 off off off no off
lsn1207b     001-004-002 none 1 1 no A 1 off off off no off
lsn1214a     001-005-002 none 1 1 no A 1 off off off no off

```

Link set table is (8 of 1024) 1% full.

If the desired linkset is not in the database, perform [Adding an SS7 Linkset](#) to add the linkset to the database. After the linkset has been added to the database, continue the procedure with [6](#).

If the desired linkset is in the database, continue the procedure with [5](#).

5. Display the attributes of the linkset that will contain the new signaling link by entering the `rtrv-ls` command with the name of the linkset shown in [4](#). For this example, enter these commands.

```
rtrv-ls:lsn=ls1305
```

This is an example of the possible output.

```

rlghncxa03w 09-10-10 11:43:04 GMT EAGLE5 41.1.0
                                     L3T SLT
                                     GWS GWS GWS

```

```

LSN          APCA  (SS7)  SCRN SET SET BEI LST LNKS ACT MES DIS SLSCI NIS
ls01         000-005-000  none 1  1  no  A  0   off off off no  off

          SPCA          CLLI          TFATCABMLQ MTPRSE ASL8
          -----          -----          1          ---   no

RANDSLS
off

IPSG  IPGWAPC  GTTMODE          CGGTMOD
no    no      CdPA          no

```

Link set table is (8 of 1024) 1% full.

rtrv-ls:lsn=ls1307

This is an example of the possible output.

rlghncxa03w 09-10-10 11:43:04 GMT EAGLE5 41.1.0

```

          L3T SLT          GWS GWS GWS
LSN          APCA  (SS7)  SCRN SET SET BEI LST LNKS ACT MES DIS SLSCI NIS
ls02         000-007-000  none 1  1  no  A  0   off off off no  off

          SPCA          CLLI          TFATCABMLQ MTPRSE ASL8
          -----          -----          1          ---   no

RANDSLS
off

IPSG  IPGWAPC  GTTMODE          CGGTMOD
no    no      CdPA          no

```

Link set table is (8 of 1024) 1% full.

The signaling link cannot be assigned to a linkset whose IPSPG or IPGWAPC values are yes. If either the IPSPG or IPGWAPC value for the linkset is yes, repeat the procedure from 4 and choose another linkset.

If the IPSPG and IPGWAPC values for the linkset are no, continue the procedure with 6.

6. Add the signaling link to the database using the `ent-slk` command. Use [Table 3-15](#) as a guide for the parameters that can be specified with the `ent-slk` command. For this example, enter these commands.

```

ent-slk:loc=1201:link=a:lsn=ls01:slc=0:l2tset=1
ent-slk:loc=1202:link=b:lsn=ls02:slc=0:l2tset=2
ent-slk:loc=1311:link=a:lsn=ls01:slc=2:l2tset=1
ent-slk:loc=1311:link=a1:lsn=ls05:slc=2:l2tset=5
ent-slk:loc=1311:link=b:lsn=ls03:slc=2:l2tset=3
ent-slk:loc=1311:link=b1:lsn=ls07:slc=1:l2tset=7

```

When each of these commands have successfully completed, this message should appear.

```
rlghncxa03w 06-10-07 08:29:03 GMT EAGLE5 36.0.0
ENT-SLK: MASP A - COMPLTD
```

Note: If adding the new signaling link will result in more than 700 signaling links in the database and the OAMHCMEAS value in the `rtrv-measopts` output is `on`, the scheduled UI measurement reports will be disabled.

- Verify the changes using the `rtrv-slk` command and specifying the card location specified in 6. For this example, enter these commands.

```
rtrv-slk:loc=1201
```

This is an example of the possible output.

```
rlghncxa03w 09-07-10 11:43:04 GMT EAGLE5 41.1.0
```

LOC	LINK	LSN	SLC	TYPE	L2T SET	BPS	ECM	PCR N1	PCR N2
1201	A	ls01	0	LIMDS0	1	56000	BASIC	---	-----
1201	B	lsa1	0	LIMDS0	1	56000	BASIC	---	-----

```
rtrv-slk:loc=1202
```

This is an example of the possible output.

```
rlghncxa03w 09-07-10 11:43:04 GMT EAGLE5 41.1.0
```

LOC	LINK	LSN	SLC	TYPE	L2T SET	BPS	ECM	PCR N1	PCR N2
1202	B	ls02	0	LIMDS0	2	56000	BASIC	---	-----

```
rtrv-slk:loc=1311
```

This is an example of the possible output.

```
rlghncxa03w 09-07-10 11:43:04 GMT EAGLE5 41.1.0
```

LOC	LINK	LSN	SLC	TYPE	L2T SET	BPS	ECM	PCR N1	PCR N2
1311	A	ls01	2	LIMDS0	1	56000	BASIC	---	-----
1311	A1	ls05	2	LIMDS0	5	56000	BASIC	---	-----
1311	B	ls03	2	LIMDS0	3	56000	BASIC	---	-----
1311	B1	ls07	1	LIMDS0	7	56000	BASIC	---	-----

If any of the cards shown in this step contain the first signaling link on a card, continue the procedure with 8.

If signaling links were assigned to all the cards shown in this step when 6 was performed, continue the procedure with 9.

- Bring the cards into service with the `rst-card` command, specifying the location of the card specified in 7. For this example, enter these commands.

```
rst-card:loc=1202
```

```
rst-card:loc=1311
```

When each of these commands have successfully completed, this message should appear.

```
rlghncxa03w 06-10-23 13:05:05 GMT EAGLE5 36.0.0
Card has been allowed.
```

9. Activate all signaling links on the cards using the `act-slk` command, specifying the card location and signaling link specified in 6. For this example, enter these commands.

```
act-slk:loc=1201:link=a
act-slk:loc=1202:link=b
act-slk:loc=1311:link=a
act-slk:loc=1311:link=a1
act-slk:loc=1311:link=b
act-slk:loc=1311:link=b1
```

When each of these commands have successfully completed, this message should appear.

```
rlghncxa03w 06-10-07 08:31:24 GMT EAGLE5 36.0.0
Activate Link message sent to card
```

10. Check the status of the signaling links added in 6 using the `rept-stat-slk` command with the card location and signaling link. The state of each signaling link should be in service normal (**IS-NR**) after the link has completed alignment (shown in the **PST** field). For this example, enter these commands.

```
rept-stat-slk:loc=1201:link=a
```

This is an example of the possible output.

```
rlghncxa03w 08-12-23 13:06:25 GMT EAGLE5 40.0.0
SLK      LSN      CLLI      PST      SST      AST
1201,A   ls01      ls01c1li IS-NR     Avail    ----
  ALARM STATUS      = No Alarms
  UNAVAIL REASON    = --
```

```
rept-stat-slk:loc=1202:link=b
```

This is an example of the possible output.

```
rlghncxa03w 08-12-23 13:06:25 GMT EAGLE5 40.0.0
SLK      LSN      CLLI      PST      SST      AST
1202,B   ls02      ls02c1li IS-NR     Avail    ----
  ALARM STATUS      = No Alarms
  UNAVAIL REASON    = --
```

```
rept-stat-slk:loc=1311:link=a
```

This is an example of the possible output.

```
rlghncxa03w 08-12-23 13:06:25 GMT EAGLE5 40.0.0
SLK      LSN      CLLI      PST      SST      AST
1311,A   ls01      ls01c1li IS-NR     Avail    ----
```

```
ALARM STATUS      = No Alarms
UNAVAIL REASON    = --
```

```
rept-stat-slk:loc=1311:link=a1
```

This is an example of the possible output.

```
rlghncxa03w 08-12-23 13:06:25 GMT EAGLE5 40.0.0
SLK      LSN      CLLI      PST      SST      AST
1311,A1  ls05      ls05clli  IS-NR    Avail    ----
  ALARM STATUS      = No Alarms
  UNAVAIL REASON    = --
```

```
rept-stat-slk:loc=1311:link=b
```

This is an example of the possible output.

```
rlghncxa03w 08-12-23 13:06:25 GMT EAGLE5 40.0.0
SLK      LSN      CLLI      PST      SST      AST
1311,B  ls03      ls03clli  IS-NR    Avail    ----
  ALARM STATUS      = No Alarms
  UNAVAIL REASON    = --
```

```
rept-stat-slk:loc=1311:link=b1
```

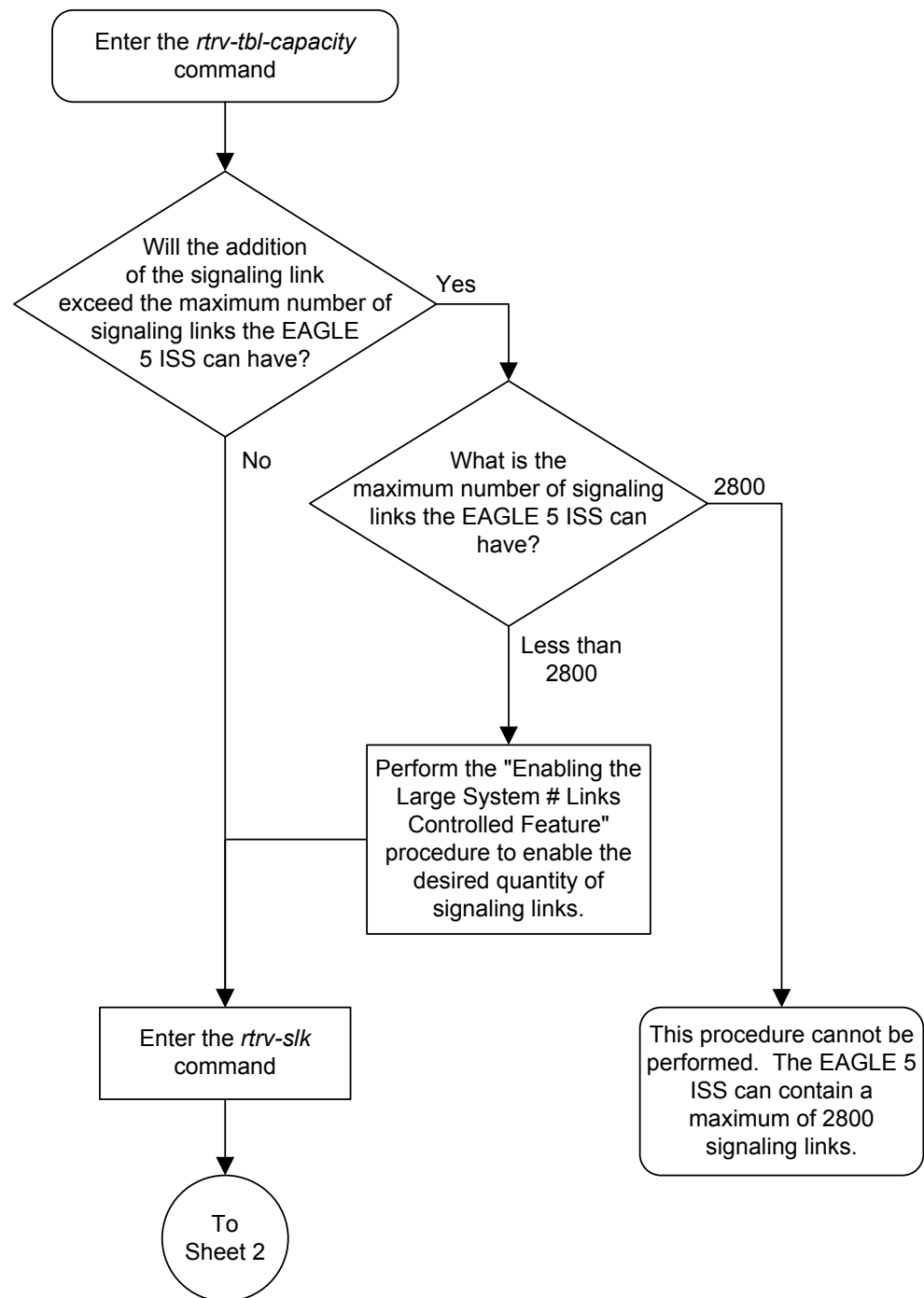
This is an example of the possible output.

```
rlghncxa03w 08-12-23 13:06:25 GMT EAGLE5 40.0.0
SLK      LSN      CLLI      PST      SST      AST
1311,B1  ls07      ls07clli  IS-NR    Avail    ----
  ALARM STATUS      = No Alarms
  UNAVAIL REASON    = --
```

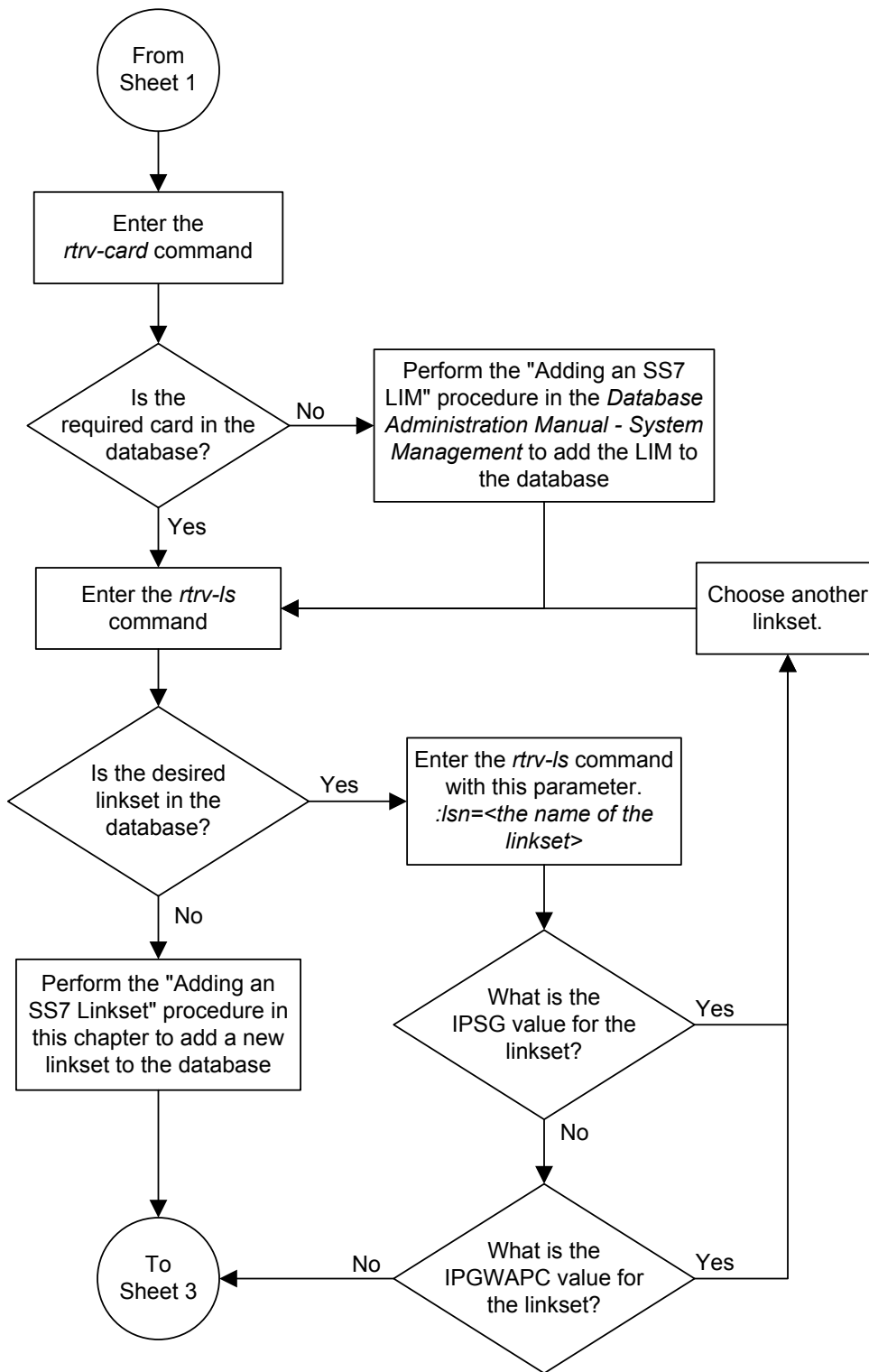
11. Back up the new changes using the `chg-db:action=backup:dest=fixed` command. These messages should appear, the active **Maintenance and Administration Subsystem Processor (MASP)** appears first.

```
BACKUP (FIXED) : MASP A - Backup starts on active MASP.
BACKUP (FIXED) : MASP A - Backup on active MASP to fixed disk complete.
BACKUP (FIXED) : MASP A - Backup starts on standby MASP.
BACKUP (FIXED) : MASP A - Backup on standby MASP to fixed disk complete.
```

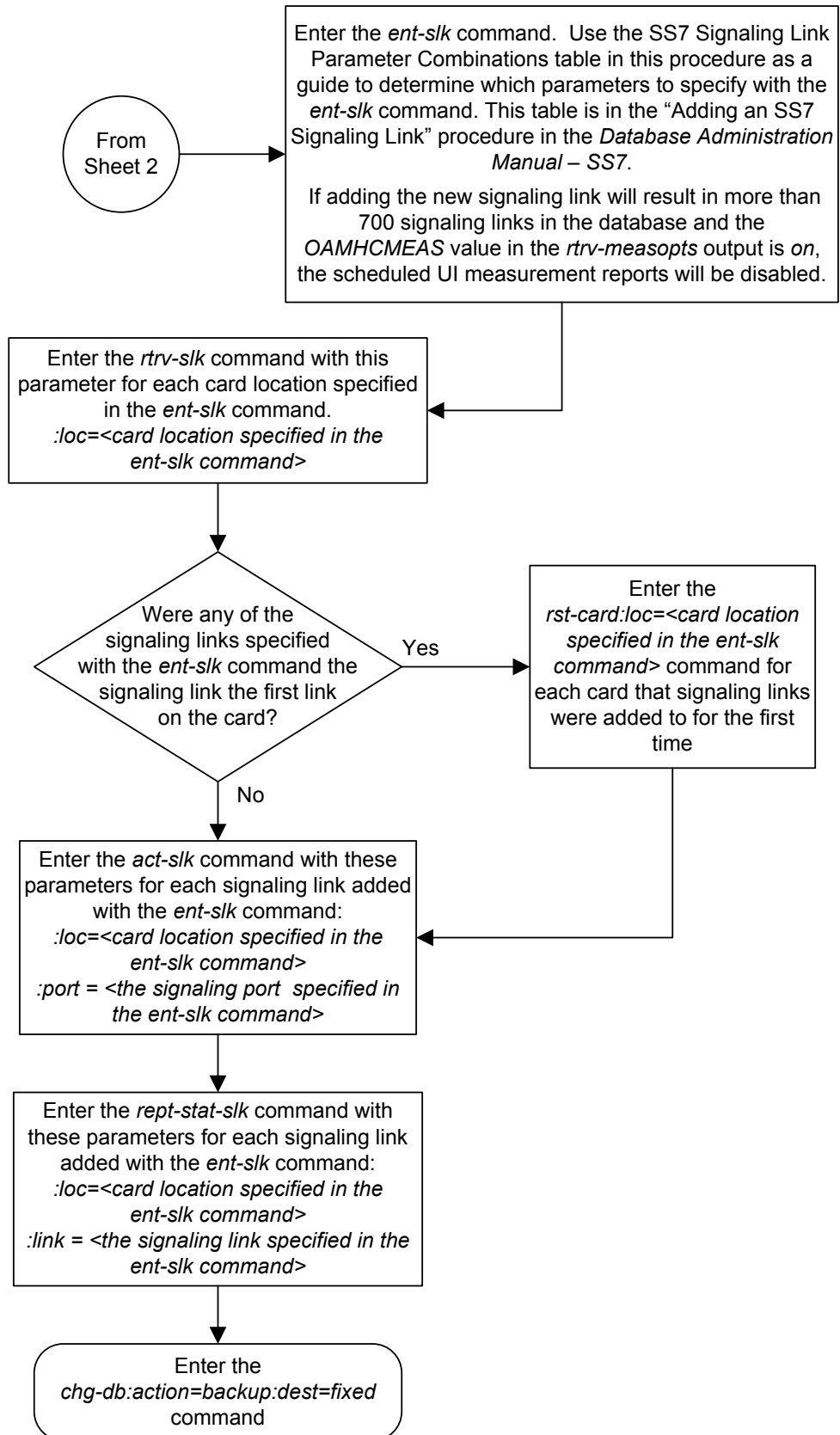
Figure 3-16 Adding an SS7 Signaling Link



Sheet 1 of 3



Sheet 2 of 3



Removing an SS7 Signaling Link

This procedure is used to remove an **SS7** low-speed, **ATM**, **E1**, **E1** high-speed, or **T1** signaling link from the database using the `dlt-slk` command. To remove other types of signaling links from the database, go to one of these procedures.

The link to be removed must exist in the database. This can be verified in [1](#).

The `dlt-slk` command uses these parameters.

`:loc` – The card location of the **LIM** that the **SS7** signaling link is assigned to.

`:link` – The signaling link on the card specified in the `loc` parameter.

`:force` – This parameter must be used to remove the last link in a linkset without having to remove all of the routes that referenced the linkset.

The `tfatcabmlq` parameter (**TFA/TCA Broadcast Minimum Link Quantity**), assigned to linksets, shows the minimum number of links in the given linkset (or in the combined link set in which it resides) that must be available for traffic. When the number of signaling links in the specified linkset is equal to or greater than the value of the `tfatcabmlq` parameter, the status of the routes that use the specified linkset is set to allowed and can carry traffic. Otherwise, these routes are restricted. The value of the `tfatcabmlq` parameter cannot exceed the total number of signaling links contained in the linkset.

If the linkset type of the linkset that contains the signaling link that is being removed is either A, B, D, E, or PRX, the signaling link can be removed regardless of the `tfatcabmlq` parameter value of the linkset and regardless of the `LSRESTRICT` option value. When a signaling link in one of these types of linksets is removed, the `tfatcabmlq` parameter value of the linkset is decreased automatically.

If the linkset type of the linkset that contains the signaling link that is being removed is C, the signaling link can be removed only:

- If the `LSRESTRICT` option is off. The `LSRESTRICT` option value is shown in the `rtrv-ss7opts` output.
- If the `LSRESTRICT` option is on and the number of signaling links assigned to the linkset will be equal to or greater than the value of the `tfatcabmlq` parameter value of the linkset after the signaling link is removed.

The `tfatcabmlq` parameter value of the linkset is shown in the `TFATCABMLQ` column of the `rtrv-ls:lsn=<linkset name>` output. The `tfatcabmlq` parameter value can be a fixed value (1 to 16) or 0. If the `tfatcabmlq` parameter value of the linkset is a fixed value, the number of signaling links that are in the linkset after the signaling link is removed must be equal to or greater than the `tfatcabmlq` parameter value of the linkset.

If the `tfatcabmlq` parameter value is 0, the signaling link can be removed. When the `tfatcabmlq` parameter value is 0, the value displayed in the `TFATCABMLQ` column of the `rtrv-ls` output is 1/2 of the number of signaling links contained in the linkset. If the number of signaling links in the linkset is an odd number, the `tfatcabmlq` parameter value is rounded up to the next whole number. As the signaling links are removed, the `tfatcabmlq` parameter value of the linkset is decreased automatically.

The signaling link cannot be removed from the database if link fault sectionalization (LFS) tests are being performed on it. This can be verified using the `rept-stat-lfs` command.

Canceling the RTRV-SLK Command

Because the `rtrv-slk` command used in this procedure can output information for a long period of time, the `rtrv-slk` command can be canceled and the output to the terminal stopped. There are three ways that the `rtrv-slk` command can be canceled.

- Press the F9 function key on the keyboard at the terminal where the `rtrv-slk` command was entered.
- Enter the `canc-cmd` without the `trm` parameter at the terminal where the `rtrv-slk` command was entered.
- Enter the `canc-cmd:trm=<xx>`, where `<xx>` is the terminal where the `rtrv-slk` command was entered, from another terminal other than the terminal where the `rtrv-slk` command was entered. To enter the `canc-cmd:trm=<xx>` command, the terminal must allow Security Administration commands to be entered from it and the user must be allowed to enter Security Administration commands. The terminal's permissions can be verified with the `rtrv-secu-trm` command. The user's permissions can be verified with the `rtrv-user` or `rtrv-secu-user` commands.

For more information about the `canc-cmd` command, go to the *Commands Manual*.

1. Display the current link configuration using the `rtrv-slk` command. This is an example of the possible output.

```
rlghncxa03w 09-07-19 21:16:37 GMT EAGLE5 41.1.0
```

LOC	LINK	LSN	SLC	TYPE	L2T		ECM	PCR	
					SET	BPS		N1	N2
1201	A	ls01	0	LIMDS0	1	56000	BASIC	---	-----
1201	B	lsa1	0	LIMDS0	1	56000	BASIC	---	-----
1202	B	ls02	0	LIMDS0	2	56000	BASIC	---	-----
1203	A	ls03	0	LIMDS0	3	56000	BASIC	---	-----
1203	B	lsa2	0	LIMDS0	1	56000	BASIC	---	-----
1204	B	ls01	1	LIMDS0	1	56000	BASIC	---	-----
1205	A	lsa3	0	LIMDS0	4	56000	BASIC	---	-----
1206	A	ls02	1	LIMDS0	2	56000	BASIC	---	-----
1207	A	lsn1207a	0	LIMDS0	1	56000	BASIC	---	-----
1207	B	lsn1207b	0	LIMDS0	1	56000	BASIC	---	-----
1208	B	ls03	1	LIMDS0	3	56000	BASIC	---	-----
1212	A	ls04	0	LIMDS0	4	56000	BASIC	---	-----
1213	B	ls05	0	LIMDS0	5	56000	BASIC	---	-----
1214	A	lsn1214a	0	LIMDS0	2	56000	BASIC	---	-----
1214	B	lsa3	1	LIMDS0	4	56000	BASIC	---	-----
1215	A	ls05	1	LIMDS0	5	56000	BASIC	---	-----
1301	B	ls06	0	LIMDS0	6	56000	BASIC	---	-----
1304	B	ls06	1	LIMDS0	6	56000	BASIC	---	-----
1308	A	ls06	2	LIMDS0	6	56000	BASIC	---	-----
1311	A	ls01	2	LIMDS0	1	56000	BASIC	---	-----
1311	A1	ls05	2	LIMDS0	5	56000	BASIC	---	-----
1311	B	ls03	2	LIMDS0	3	56000	BASIC	---	-----
1311	B1	ls07	1	LIMDS0	7	56000	BASIC	---	-----
1313	A	ls07	0	LIMDS0	7	56000	BASIC	---	-----
1315	A	lsn5	0	LIMDS0	11	56000	BASIC	---	-----
1317	A	lsi7	0	LIMDS0	11	56000	BASIC	---	-----

LOC	LINK	LSN	SLC	TYPE	LP SET	BPS	ATM TSEL	VCI	VPI	LL
1302	A	atmansio	0	LIMATM	3	1544000	EXTERNAL	35	15	0
1305	A	atmansil	0	LIMATM	4	1544000	INTERNAL	100	20	2
1318	A	atmansio	1	LIMATM	9	1544000	LINE	150	25	4

LOC	LINK	LSN	SLC	TYPE	LP SET	BPS	ATM TSEL	VCI	VPI	E1ATM		
2101	A	atmitul	0	LIME1ATM	5	2.048M	LINE	150	2	ON	1	20
2105	A	atmitul	1	LIME1ATM	5	2.048M	LINE	35	15	ON	2	15

SLK table is (31 of 1200) 3% full

2. Display the linkset that contains the signaling link that is being removed by entering the `rtrv-ls` command with the name of the linkset shown in the LSN column of the `rtrv-slk` output.

For this example, enter this command.

```
rtrv-ls:lsn=ls04
```

This is an example of the possible output.

```
rlghncxa03w 10-07-17 11:43:04 GMT EAGLE5 42.0.0
```

LSN	APCA	(SS7)	SCRN	SET	SET	BEI	LST	LNKS	ACT	MES	DIS	SLSCI	NIS
ls04	002-009-003		scr2	1	1	no	a	1	on	off	on	no	off

SPCA	CLLI	TFATCABMLQ	MTPRSE	ASL8
-----	-----	1	no	no

RANDSLS
off

ISLSRSB	RSL8
1	no

IPSG	IPGWAPC	GTTMODE	CGGTMOD
no	no	CdPA	no

LOC	LINK	SLC	TYPE	L2T SET	BPS	ECM	PCR N1	PCR N2
1212	A	0	LIMDS0	1	56000	BASIC	----	-----

Link set table is (20 of 1024) 2% full

If the linkset type of the linkset is A, B, D, E, or PRX, continue the procedure with [5](#).

If the linkset type of the linkset is C, continue the procedure with [3](#).

3. Display the LSRESTRICT option value by entering the `rtrv-ss7opts` command.

This is an example of the possible output.

```
rlghncxa03w 10-07-30 15:09:00 GMT 42.0.0
```

```
SS7 OPTIONS
-----
LSRESTRICT    on
```

Note: The `rtrv-feat` command output contains other fields that are not used by this procedure. If you wish to see all the fields displayed by the `rtrv-feat` command, refer to the `rtrv-feat` command description in the *Commands Manual*.

The signaling link cannot be removed, if the `LSRESTRICT` option is on and the number of signaling links assigned to the linkset will be less than the value of the `tfatcabmlq` parameter value of the linkset if the signaling link is removed.

If the `LSRESTRICT` option is on and the number of signaling links assigned to the linkset will be equal to or greater than the value of the `tfatcabmlq` parameter value of the linkset if the signaling link is removed, continue the procedure with 5.

If the `LSRESTRICT` option is on and the number of signaling links assigned to the linkset will be less than the value of the `tfatcabmlq` parameter value of the linkset if the signaling link is removed, the signaling link cannot be removed unless the `tfatcabmlq` parameter value of the linkset is changed to 0. Continue the procedure with 4..

If the `LSRESTRICT` value is `off`, continue the procedure with 5.

4. Change the `tfatcabmlq` parameter value of the linkset to 0 by entering the `chg-ls` command with the name of the linkset that contains the signaling link that is being removed and the `tfatcabmlq` parameters. For this example, enter this command.

```
chg-ls:lsn=ls17:tfatcabmlq=0
```

When this command has successfully completed, this message should appear.

```
rlghncxa03w 10-07-07 08:41:12 GMT EAGLE5 42.0.0
```

```
Link set table is (20 of 1024) 2% full.
```

```
CHG-LS: MASP A - COMPLTD
```

5. Enter the `rept-stat-lfs` command to verify whether or not a link fault sectionalization test is being performed on the signaling link to be removed from the database. This is an example of the possible output.

```
rlghncxa03w 06-10-0708:41:12 GMT EAGLE5 36.0.0
SLK      LBP  PATTERN      MAX-ERRORS  BIT_ERRORS  MAX-TIME  TEST-TIME
1201,A   5   B0247         56           30  01:00:00  00:00:50
1202,A   3   B511          56           27  01:00:00  00:01:05
1203,A   1   OCTET         56           12  01:00:00  00:02:07
1204,A   6   ALTERNATE     56           28  01:00:00  00:04:08
1205,A   2   B0247         56           36  01:00:00  00:03:05
1206,A   1   B0247         56           15  01:00:00  00:06:06
1207,A   3   B0247         56           19  01:00:00  00:02:04
1208,A   5   B0247         56           23  01:00:00  00:04:01
1208,B1  4   B0247         56           23  01:00:00  00:08:01
```

Note: If the `rept-stat-lfs` command output in 5 shows that no **LFS** tests are being performed on the signaling link to be removed from the database, continue the procedure with 7.

6. Deactivate the **LFS** test being performed on the signaling link using the `dact-lbp` command, specifying the location signaling link being removed.

For this example, enter this command.

```
dact-lbp:loc=1212:link=a
```

When this command has successfully completed, this message should appear.

```
rlghncxa03w 06-10-07 08:41:12 GMT EAGLE5 36.0.0
LOC = 1212 LINK = A
```

```
CLEAR STATUS = PASS, loop-back was cleared.
```

7. Deactivate the link to be removed using the `dact-slk` command, using the output from [1](#) to obtain the card location and signaling link information of the signaling link to be removed.

For this example, enter this command.

```
dact-slk:loc=1212:link=a
```

When this command has successfully completed, this message should appear.

```
rlghncxa03w 06-10-07 08:41:12 GMT EAGLE5 36.0.0
Deactivate Link message sent to card
```

8. Verify that the link is out of service - maintenance disabled (**OOS-MT-DSBLD**) using the `rept-stat-slk` command with the card location and signaling link.

For this example, enter this command.

```
rept-stat-slk:loc=1212:link=a
```

This is an example of the possible output.

```
rlghncxa03w 06-10-23 13:06:25 GMT EAGLE5 36.0.0
SLK      LSN      CLLI      PST      SST      AST
1212,A   ls04      ls04clli  OOS-MT   Unavail   ----
ALARM STATUS      = *   0235 REPT-LNK-MGTINH: local inhibited
UNAVAIL REASON    = LI
```

9. If the signaling link to be removed is the last signaling link on a card, the card must be inhibited before the signaling link is removed. Before entering the `dlt-slk` command, enter the `rmv-card` command and specify the location of the card to be inhibited. The card location is shown in the output of `rept-stat-slk` command executed in [8](#). If the signaling link to be removed is not the last signaling link on the card, continue the procedure with [10](#).

In the example used for this procedure, the signaling link is the last signaling link on the card and must be inhibited. Enter this command.

```
rmv-card:loc=1212
```

When this command has successfully completed, this message should appear.

```
rlghncxa03w 06-10-07 08:41:12 GMT EAGLE5 36.0.0
Card has been inhibited.
```

10. Remove the signaling link from the **EAGLE 5 ISS** using the `dlt-slk` command. If there is only one signaling link in the linkset, the `force=yes` parameter must be specified to remove the signaling link.

In the example used in this procedure, the signaling link is the last signaling link in the linkset. Enter this command.

```
dlt-slk:loc=1212:link=a:force=yes
```

When this command has successfully completed, this message should appear.

```
rlghncxa03w 06-10-07 08:41:17 GMT EAGLE5 36.0.0
DLT-SLK: MASP A - COMPLTD
```

Note: If removing the signaling link will result in 700 or less signaling links in the database and the `OAMHCMEAS` value in the `rtrv-measopts` output is on, the scheduled UI measurement reports will be enabled.

11. Verify the changes using the `rtrv-slk` command. This is an example of the possible output.

```
rlghncxa03w 09-05-19 21:16:37 GMT EAGLE5 41.0.0
```

LOC	LINK	LSN	SLC	TYPE	L2T SET	BPS	L1 MODE	TSET	ECM	PCR N1	PCR N2
1201	A	ls01	0	LIMDS0	1	56000	---	---	BASIC	---	-----
1201	B	lsa1	0	LIMDS0	1	56000	---	---	BASIC	---	-----
1202	B	ls02	0	LIMDS0	2	56000	---	---	BASIC	---	-----
1203	A	ls03	0	LIMDS0	3	56000	---	---	BASIC	---	-----
1203	B	lsa2	0	LIMDS0	1	56000	---	---	BASIC	---	-----
1204	B	ls01	1	LIMDS0	1	56000	---	---	BASIC	---	-----
1205	A	lsa3	0	LIMDS0	4	56000	---	---	BASIC	---	-----
1206	A	ls02	1	LIMDS0	2	56000	---	---	BASIC	---	-----
1207	A	lsn1207a	0	LIMDS0	1	56000	---	---	BASIC	---	-----
1207	B	lsn1207b	0	LIMDS0	1	56000	---	---	BASIC	---	-----
1208	B	ls03	1	LIMDS0	3	56000	---	---	BASIC	---	-----
1213	B	ls05	0	LIMDS0	5	56000	---	---	BASIC	---	-----
1214	A	lsn1214a	0	LIMDS0	2	56000	---	---	BASIC	---	-----
1214	B	lsa3	1	LIMDS0	4	56000	---	---	BASIC	---	-----
1215	A	ls05	1	LIMDS0	5	56000	---	---	BASIC	---	-----
1301	B	ls06	0	LIMDS0	6	56000	---	---	BASIC	---	-----
1304	B	ls06	1	LIMDS0	6	56000	---	---	BASIC	---	-----
1308	A	ls06	2	LIMDS0	6	56000	---	---	BASIC	---	-----
1311	A	ls01	2	LIMDS0	1	56000	---	---	BASIC	---	-----
1311	A1	ls05	2	LIMDS0	5	56000	---	---	BASIC	---	-----
1311	B	ls03	2	LIMDS0	3	56000	---	---	BASIC	---	-----
1311	B1	ls07	1	LIMDS0	7	56000	---	---	BASIC	---	-----
1313	A	ls07	0	LIMDS0	7	56000	---	---	BASIC	---	-----
1315	A	lsn5	0	LIMDS0	11	56000	---	---	BASIC	---	-----
1317	A	lsi7	0	LIMDS0	11	56000	---	---	BASIC	---	-----

LOC	LINK	LSN	SLC	TYPE	LP SET	BPS	ATM TSEL	VCI	VPI	LL
1302	A	atmansio	0	LIMATM	3	1544000	EXTERNAL	35	15	0
1305	A	atmansil	0	LIMATM	4	1544000	INTERNAL	100	20	2
1318	A	atmansio	1	LIMATM	9	1544000	LINE	150	25	4

LP	ATM	E1ATM

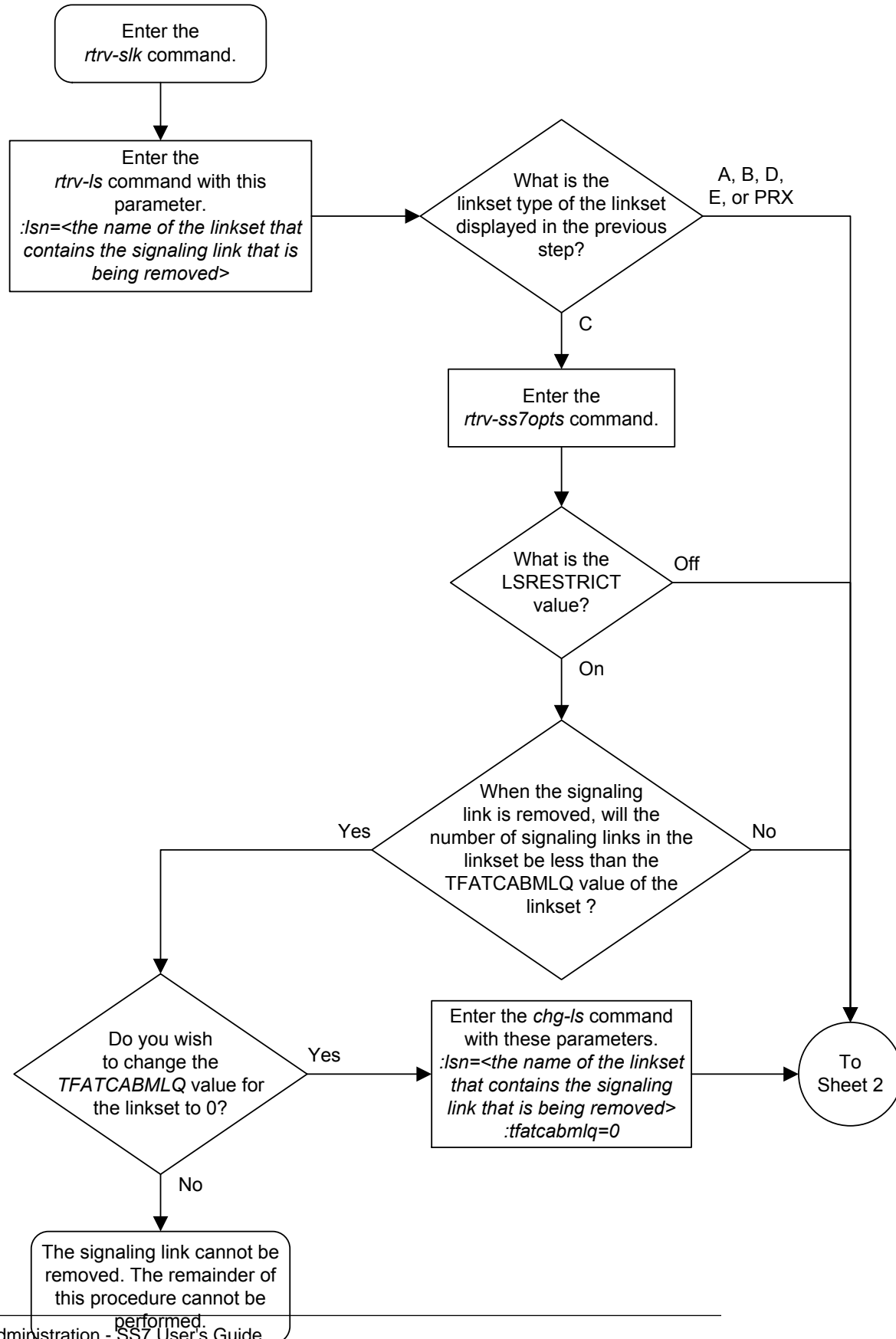
LOC	LINK	LSN	SLC	TYPE	SET	BPS	TSEL	VCI	VPI	CRC4	SI	SN
2101	A	atmitul	0	LIME1ATM	5	2.048M	LINE	150	2	ON	1	20
2105	A	atmitul	1	LIME1ATM	5	2.048M	LINE	35	15	ON	2	15

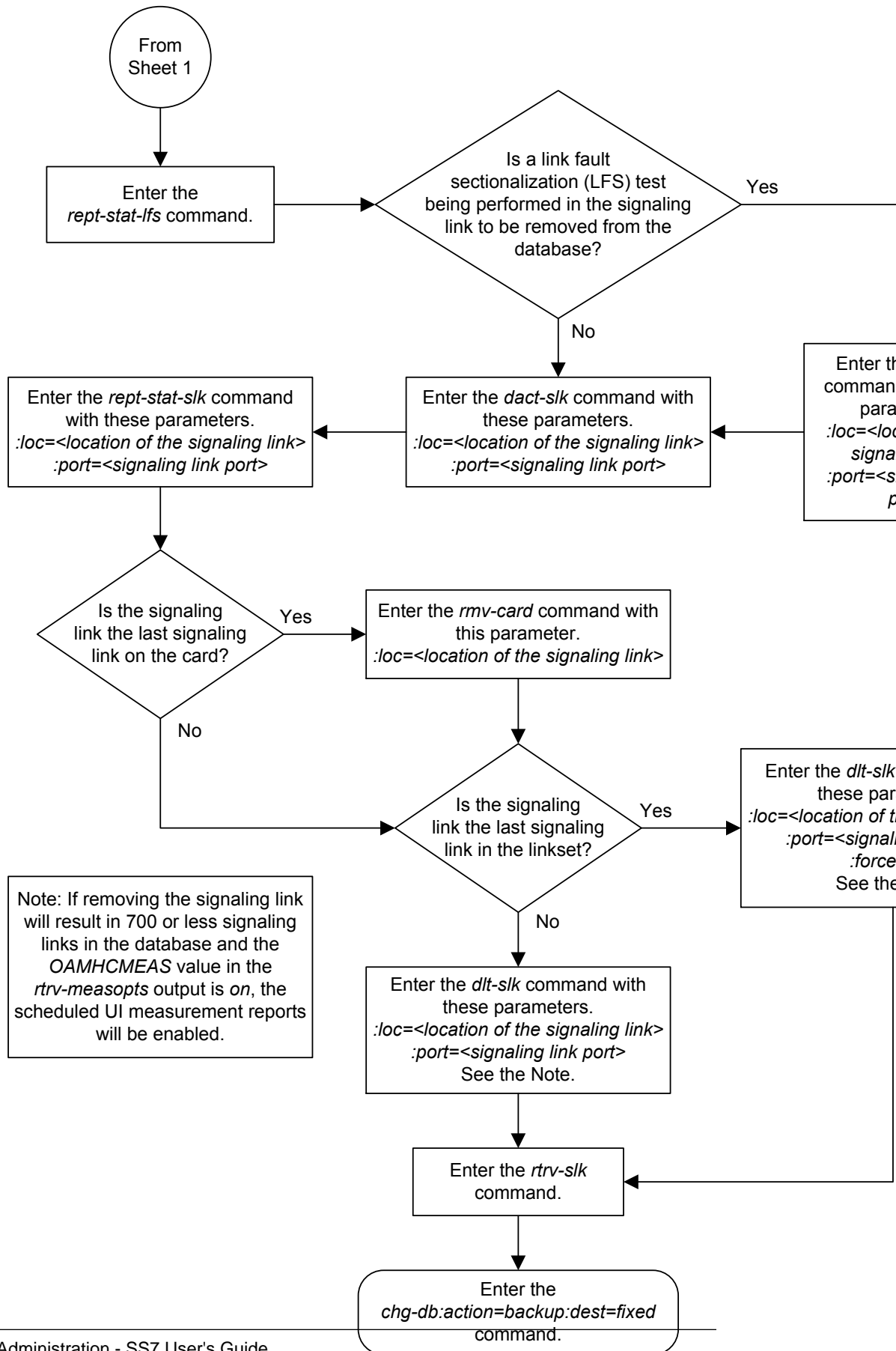
SLK table is (31 of 1200) 3% full

12. Back up the new changes using the `chg-db:action=backup:dest=fixed` command. These messages should appear, the active **Maintenance and Administration Subsystem Processor (MASP)** appears first.

```
BACKUP (FIXED) : MASP A - Backup starts on active MASP.  
BACKUP (FIXED) : MASP A - Backup on active MASP to fixed disk complete.  
BACKUP (FIXED) : MASP A - Backup starts on standby MASP.  
BACKUP (FIXED) : MASP A - Backup on standby MASP to fixed disk complete.
```

Figure 3-17 Removing an SS7 Signaling Link





Adding a Route Containing an SS7 DPC

This procedure is used to add a route containing an **SS7 DPC** to the database using the `ent-rte` command. The routes configured in this procedure do not contain cluster point codes as DPCs, or **IPGWx** linksets. These routes are configured in these procedures:

- [Adding a Route Containing a Cluster Point Code](#)
- [Adding a Route Containing an IPGWx Linkset](#)

The `ent-rte` command uses these parameters.

`:dpc/dpca/dpci/dpcn/dpcn24` – The destination point code of the node that the traffic is being sent to.

Note: See [Point Code Formats](#) for a definition of the point code types that are used on the EAGLE and for a definition of the different formats that can be used for ITU national point codes.

`:lsn` – The name of the linkset that will carry the traffic to the node specified by the destination point code.

`:rc` – The relative cost (priority) for this route.

`:force` – This parameter allows a route to be added to the database even if the linkset to be assigned to the route does not have any signaling links in it.

These items must be configured in the database before a route can be added in this procedure:

- Destination point code (DPC) – see one of these procedures depending on the type of point code required:
 - For a Network Routing DPC – see [Adding a Network Routing Point Code](#).
 - For all other DPCs – see [Adding a Destination Point Code](#)
- Linkset – see [Adding an SS7 Linkset](#)
- Link – see [Adding an SS7 Signaling Link](#).

The linkset assigned to this route must have an adjacent point code (**APC**) in the SS7 domain. The domain of the DPC is shown in the `DMN` field in the output of the `rtrv-dstn` command.

The DPC of the route must be of the same format as the APC of the linkset being added to the route. That is, routes containing ANSI DPCs must have linksets with ANSI APCs; routes containing ITU-I DPCs must have linksets with ITU-I APCs; routes containing 14-bit ITU-N DPCs must have linksets with 14-bit ITU-N APCs; routes containing 24-bit ITU-N DPCs must have linksets with 24-bit ITU-N APCs. The DPC of the route must be defined as a true point code in the `rtrv-dstn` output. Alias point codes and secondary point codes cannot be used. True point codes are shown in the output of the `rtrv-dstn` command in the `DPCA`, `DPCI`, `DPCN`, or `DPCN24` fields. Private point codes cannot be used as the DPC of a route in this procedure. Routes that have private point codes as the DPC of a route can contain only IPGWx linksets.

Perform the [Adding a Route Containing an IPGWx Linkset](#) procedure to add routes containing IPGWx linksets.

The DPC of the route is the destination point code to be reached by the route and is shown in the output of the `rtrv-rte` command in the `DPCA`, `DPCI`, `DPCN`, or `DPCN24` fields.

The `APCA`, `APCI`, `APCN`, and `APCN24` fields in the output of the `rtrv-rte` command show the point code of the node that is directly adjacent to the node in the route.

A linkset can only be entered once as a route for each DPC.

A maximum of six routes can be defined for each DPC.

If the 6-Way Loadsharing on Routesets feature is enabled and turned on, a maximum of six routes in the routeset can be assigned the same relative cost value. It is recommended that the routeset be provisioned with a group of four routes that have the same relative cost value and another group of two routes that have the same relative cost value. Three or five routes in the routeset that have the same relative cost value can be provisioned, but the odd number makes it more difficult to distribute the route traffic evenly. Six routes in the routeset that have the same relative cost value can be provisioned, but this does not allow for any backup routes and also offers the worst chance for congestion and queuing issues during network failures. If the 6-Way Loadsharing on Routesets feature is not enabled or not turned on, a maximum of two linksets can be assigned the same relative cost value. The relative cost value of the route is defined by the `rc` parameter of the `ent-rte` command and is shown in the `RC` field in the output of the `rtrv-rte` command.

The `force=yes` parameter must be specified if the specified linkset has no signaling links assigned to it. Otherwise, each linkset must have at least one signaling link assigned to it.

The ANSI DPC (DPC/DPCA) of the route can use either a full point code or a network routing point code. ITU DPCs (DPCI, DPCN, and DPCN24) must use full point codes. For more information on network routing point codes, go to the [Network Routing](#) section.

If the DPC of the route is a network routing point code, only linksets, specified with either the `lsn` or `nlsn` parameters, whose linkset type is either B, C, or D can be assigned to the route. The linkset type is shown in the `LST` field of the `rtrv-ls` command output. If the linkset type of the desired linkset is either A, E, or PRX, one of three actions must be taken.

- Choose another linkset with the linkset type B, C, or D.
- Change the linkset type of an existing linkset - perform the [Changing an SS7 Linkset](#) procedure.
- Add a new linkset to the database with the necessary signaling links and the linkset type B, C, or D.
 1. Perform the [Adding an SS7 Linkset](#) procedure to add the linkset.
 2. If the necessary signaling links are not in the database, go to the [Adding an SS7 Signaling Link](#) procedure and add the signaling links to the database.

If the DPC of the route is a member of a cluster point code, and the nested cluster allowed indicator (`ncai` parameter of either the `ent-dstn` or `chg-dstn` command) is set to no, then the route to the DPC must be the same as the route to the cluster point code. If the nested cluster allowed indicator is set to yes, the route to the member

of the cluster does not have to be the same as the route to the cluster point code. For more information, see the [Nested Cluster Routing](#) section.

For routes containing 14-bit ITU National DPCs with group codes, if the linkset assigned to the route has the `MULTGC` value set to `yes`, then 14-bit ITU National DPCs with group codes that are different from the linkset APC group code can be assigned to the route. If the `MULTGC` value is set to `no`, then only 14-bit ITU National DPCs with group codes that are the same as the linkset APC group code can be assigned to the route.

When a new route is being added and the DPC of that route contains a proxy point code, the first route assigned to this DPC must be a linkset whose linkset type is `PRX` and must have a proxy point code assigned to the linkset. The proxy point code that is assigned to the linkset must be the proxy point code that is assigned to the DPC of the route. After this route has been added, other routes can be added to this DPC. The linksets for these routes can contain proxy point codes, but do not have to contain proxy point codes.

Canceling the `RTRV-LS`, `RTRV-DSTN`, and `RTRV-RTE` Commands

Because the `rtrv-ls`, `rtrv-dstn`, and `rtrv-rte` commands used in this procedure can output information for a long period of time, the `rtrv-ls`, `rtrv-dstn`, and `rtrv-rte` commands can be canceled and the output to the terminal stopped. There are three ways that the `rtrv-ls`, `rtrv-dstn`, and `rtrv-rte` commands can be canceled.

- Press the F9 function key on the keyboard at the terminal where the `rtrv-ls`, `rtrv-dstn`, or `rtrv-rte` commands were entered.
- Enter the `canc-cmd` without the `trm` parameter at the terminal where the `rtrv-ls`, `rtrv-dstn`, or `rtrv-rte` commands were entered.
- Enter the `canc-cmd:trm=<xx>`, where `<xx>` is the terminal where the `rtrv-ls`, `rtrv-dstn`, or `rtrv-rte` commands were entered, from another terminal other than the terminal where the `rtrv-ls`, `rtrv-dstn`, or `rtrv-rte` commands were entered. To enter the `canc-cmd:trm=<xx>` command, the terminal must allow Security Administration commands to be entered from it and the user must be allowed to enter Security Administration commands. The terminal's permissions can be verified with the `rtrv-secu-trm` command. The user's permissions can be verified with the `rtrv-user` or `rtrv-secu-user` commands.

For more information about the `canc-cmd` command, go to *Commands User's Guide*.

1. Display the current route configuration using the `rtrv-rte` command. This is an example of the possible output.

```
rlghncxa03w 10-12-10 11:43:04 GMT EAGLE5 43.0.0
Extended Processing Time may be Required

      DPCA          ALIASI      ALIASN/N24    LSN          RC      APCA
140-012-004      1-111-1      10-13-12-1    1s000001     10     240-012-002
                                     1s000002     10     240-012-002
                                     1s000003     20     240-012-002
                                     1s000004     30     240-012-002
                                     1s000005     40     240-012-002
                                     1s000006     50     240-012-002
                                     RTX:No  CLI:dp1
140-012-005 1-111-2 10-13-12-2    1s000001     10     240-012-002
                                     1s000002     10     240-012-002
```

DPCI	ALIASN/N24	ALIASA	LSN	RTX:No	CLLI=dp2	RC	APC
				1s000003	20		240-012-002
				1s000004	30		240-012-002
				1s000005	40		240-012-002
				1s000006	50		240-012-002
				RTX:No			CLLI=dp2
2-234-5	11-13-3-3	240-111-111	1s100001	10			1-234-5
			1s100002	10			1-234-6
			1s100003	20			1-234-7
			1s100004	30			1-234-1
			1s100005	40			1-234-2
			1s100006	50			1-234-3
				RTX:No			CLLI=idp1
DPCN	ALIASA	ALIASI	LSN			RC	APC
12-12-13-3	011-222-111	0-001-1	1s200001	10			10-13-9-3
			1s200002	10			10-13-10-0
			1s200003	20			10-13-10-1
			1s200004	30			10-13-10-2
			1s200005	40			10-13-10-3
			1s200006	50			10-13-11-0
				RTX:No			CLLI=ndp1
DPCN24	ALIASA	ALIASI	LSN			RC	APC

If the destination point code of the route being added in this procedure is not shown in the `rtrv-rte` output, perform one of these procedures in Chapter 2 to add the destination point code of the route to the destination point code table.

- For a Network Routing **DPC** – [Adding a Network Routing Point Code](#).
- For all other **DPCs** – [Adding a Destination Point Code](#).

After the new DPC has been added, continue the procedure by performing one of these steps.

- If a proxy point code was assigned to the new DPC that was added, continue this procedure with [2](#).
- If a proxy point code was not assigned to the new DPC that was added, continue the procedure by performing one of these steps.
 - If no more than two routes in the routeset will have the same relative cost value, and the new DPC is a member of a cluster, continue the procedure with [6](#).
 - If no more than two routes in the routeset will have the same relative cost value, and the new DPC is not a member of a cluster, continue the procedure with [7](#).
 - If more than two routes in the routeset will have the same relative cost value, and routesets that contain more than two routes with the same relative cost value are shown in the `rtrv-rte` output, continue the procedure by performing one of these steps.
 - If the new DPC is a member of a cluster, continue the procedure with [6](#).
 - If the new DPC is not a member of a cluster, continue the procedure with [7](#).

- If more than two routes in the routeset will have the same relative cost value, and routesets that contain more than two routes with the same relative cost value are not shown in the `rtrv-rte` output, continue the procedure with 5.

If the destination point code of the route being added in this procedure is shown in the `rtrv-rte` output, continue the procedure by performing one of these steps.

- If the DPC that you wish to add the route to contains six routes, no more routes can be added to this DPC. A DPC of a route can contain a maximum of six routes. Choose another DPC to add the routes to and repeat this step.
 - If the DPC that you wish to add the route to is a network routing point code, or already has at least one route assigned to it, continue the procedure by performing one of these steps.
 - If no more than two routes in the routeset will have the same relative cost value, and the DPC is a member of a cluster, continue the procedure with 6.
 - If no more than two routes in the routeset will have the same relative cost value, and the DPC is not a member of a cluster, continue the procedure with 7.
 - If more than two routes in the routeset will have the same relative cost value, and routesets that contain more than two routes with the same relative cost value are shown in the `rtrv-rte` output, continue the procedure by performing one of these steps.
 - If the DPC is a member of a cluster, continue the procedure with 6.
 - If the DPC is not a member of a cluster, continue the procedure with 7.
 - If more than two routes in the routeset will have the same relative cost value, and routesets that contain more than two routes with the same relative cost value are not shown in the `rtrv-rte` output, continue the procedure with 5.
 - If the DPC that you wish to add the route to is not a network routing point code, and has no routes assigned to it, continue this procedure with 2.
2. The first route to a DPC that contains a proxy point code must be a linkset whose linkset type is PRX. This linkset must contain the proxy point code that is assigned to the DPC of the route..

Verify if the DPC of the route contains a proxy point code by entering the `rtrv-dstn` command with the DPC of the route. For this example, enter this command.

```
rtrv-dstn:dpca=003-003-003
```

This is an example of the possible output.

```
rlghncxa03w 10-12-15 09:22:39 EST 43.0.0
```

DPCA	CLLI	BEI	ELEI	ALIASI	ALIASN/N24	DMN		
003-003-003	-----	no	---	-----	-----	SS7		
PPCA	NCAI	PRX	RCAUSE	NPRST	SPLITIAM	HMSMSC	HMSCP	SCCPMSGCNV
010-010-010	----	no	none	off	none	no	no	none

```
Destination table is (14 of 2000) 1% full
Alias table is (0 of 12000) 0% full
PPC table is (2 of 10) 20% full
```

If a proxy point code is not shown in this step, continue the procedure by performing one of these steps.

- If no more than two routes in the routeset will have the same relative cost value, and the DPC is a member of a cluster, continue the procedure with [6](#).
- If no more than two routes in the routeset will have the same relative cost value, and the DPC is not a member of a cluster, continue the procedure with [7](#).
- If more than two routes in the routeset will have the same relative cost value, and routesets that contain more than two routes with the same relative cost value are shown in the `rtrv-rte` output, continue the procedure by performing one of these steps.
 - If the DPC is a member of a cluster, continue the procedure with [6](#).
 - If the DPC is not a member of a cluster, continue the procedure with [7](#).
- If more than two routes in the routeset will have the same relative cost value, and routesets that contain more than two routes with the same relative cost value are not shown in the `rtrv-rte` output, continue the procedure with [5](#).

If a proxy point code is shown in this step, continue this procedure with [3](#).

3. Display the linksets that contain the proxy point code that is assigned to the DPC of the route by entering the `rtrv-ls` command with the proxy point code. For this example, enter this command.

```
rtrv-ls:ppca=010-010-010
```

This is an example of the possible output.

```
r1ghncxa03w 07-08-15 09:50:20 EST 37.0.0
```

```
PPCA = 010-010-010
```

LSN	APCA (SS7)	SCRN	SET	SET	BEI	LST	LNKS	ACT	MES	DIS	SLSCI	NIS
lsn3	003-003-003	none	1	1	no	PRX	2	off	off	off	no	off
lsn5	012-012-012	none	1	1	no	PRX	2	off	off	off	no	off
lsn15	015-015-015	none	1	1	no	PRX	2	off	off	off	no	off

```
Link set table is (11 of 1024) 1% full.
```

The linkset that is being assigned to the DPC of the route must be shown in this step. The APC of this linkset must be the same as the DPC of the route. If this linkset is not shown in this step, perform the [Adding an SS7 Linkset](#) procedure to add a linkset that contains these attributes.

- The APC of the linkset must be the same as the DPC of the route.
- The linkset type must be PRX.
- The proxy point code that is assigned to the DPC of the route must be assigned to the linkset.

After the linkset has been added, continue the procedure with 4.

If a linkset is shown in this step whose APC is the same as the DPC of the route, continue the procedure with 4.

4. Add the route containing the proxy linkset (the linkset type is PRX) using the `ent-rte` command. For this example, enter this command.

```
ent-rte:dpca=003-003-003:lsn=lsn3:rc=10
```

When this command has successfully completed, this message should appear.

```
rlghncxa03w 06-10-07 08:28:30 GMT EAGLE5 36.0.0
ENT-RTE: MASP A - COMPLTD
```

Other routes can be added to this DPC. If you wish to add more routes, continue the procedure by performing one of these steps.

- If no more than two routes in the routeset will have the same relative cost value, and the DPC is a member of a cluster, continue the procedure with 6.
- If no more than two routes in the routeset will have the same relative cost value, and the DPC is not a member of a cluster, continue the procedure with 7.
- If more than two routes in the routeset will have the same relative cost value, and routesets that contain more than two routes with the same relative cost value are shown in the `rtrv-rte` output, continue the procedure by performing one of these steps.
 - If the DPC is a member of a cluster, continue the procedure with 6.
 - If the DPC is not a member of a cluster, continue the procedure with 7.
- If more than two routes in the routeset will have the same relative cost value, and routesets that contain more than two routes with the same relative cost value are not shown in the `rtrv-rte` output, continue the procedure with 5.

If you do not wish to add more routes to this DPC, continue the procedure with 10.

5. For a routeset to have more than two routes with the same relative cost value, the 6-Way Loadsharing on Routesets feature must be enabled and turned on.

To verify the status of the 6-Way Loadsharing on Routesets feature, enter this command.

```
rtrv-ctrl-feat:partnum=893019801
```

The following is an example of the possible output.

```
rlghncxa03w 09-05-28 21:15:37 GMT EAGLE5 41.0.0
The following features have been permanently enabled:
```

Feature Name	Partnum	Status	Quantity
6-Way LS on Routesets	893019801	on	----

The following features have been temporarily enabled:

Feature Name	Partnum	Status	Quantity	Trial Period Left
Zero entries found.				

The following features have expired temporary keys:

```
Feature Name          Partnum
Zero entries found.
```

If the 6-Way Loadsharing on Routesets feature is not enabled or not turned on, perform the [Activating the 6-Way Loadsharing on Routesets Feature](#) procedure to enable and turn on the 6-Way Loadsharing on Routesets feature.

After the 6-Way Loadsharing on Routesets feature has been enabled and turned on, or if the `rtrv-ctrl-feat` output shows that the 6-Way Loadsharing on Routesets feature is enabled and turned on, continue this procedure by performing one of these steps.

- If the DPC is a member of a cluster, continue the procedure with 6.
 - If the DPC is not a member of a cluster, continue the procedure with 7.
6. Display the `ncai` parameter value assigned to the cluster point code using the `rtrv-dstn` command and specifying the cluster point code. If the `ncai` parameter value is `no`, then the route to the DPC must be the same as the route to the cluster point code. If the `ncai` parameter value is `yes`, the route to the member of the cluster does not have to be the same as the route to the cluster point code. The `ncai` value is shown in the `NCAI` field of the `rtrv-dstn` output. For this example, enter this command.

```
rtrv-dstn:dpca=111-011-*
```

This is an example of the possible output.

```
rlghncxa03w 10-12-28 21:16:37 GMT EAGLE5 43.0.0
```

DPCA	CLLI	BEI	ELEI	ALIASI	ALIASN/N24	DMN	
111-011-*	rlghncbb000	yes	yes	-----	-----	SS7	
SPCA	NCAI	RCAUSE	NPRST	SPLITIAM	HMSMSC	HMSCP	SCCPMSGCNV
-----	yes	none	off	none	no	no	none

```
Destination table is (12 of 2000) 1% full
Alias table is (18 of 8000) 1% full
```

If the `ncai` parameter value of the cluster point code is `no`, and you wish to change the `ncai` parameter value to `yes`, perform the [Changing the Attributes of a Cluster Point Code](#) procedure. If the `ncai` parameter value of the cluster point code is `no`, and you do not wish to change the `ncai` parameter value to `yes`, add a new DPC for the route by performing either the [Adding a Destination Point Code](#) procedure or the [Adding a Network Routing Point Code](#) procedure.

7. Verify that the required linkset for the route is in the database by displaying the linksets in the database with the `rtrv-ls` command.

This is an example of the possible output.

```
rlghncxa03w 06-10-10 11:43:04 GMT EAGLE5 36.0.0
```

LSN	APCA	(SS7)	SCRN	SET	SET	BEI	LST	LNKS	ACT	MES	DIS	SLSCI	NIS
ele2	001-207-000		none	1	1	no	B	6	off	off	off	no	off
ls1305	000-005-000		none	1	1	no	A	1	off	off	off	no	off

```

ls1307      000-007-000  none 1  1  no  A  1  off off off no  off
lsn7        002-002-002  none 1  1  no  C  8  off off off no  off
elm1s1      001-001-001  none 1  1  no  A  7  off off off no  off
elm1s2      001-001-002  none 1  1  no  A  7  off off off no  off

```

```

                                     L3T SLT                               GWS GWS GWS
LSN      APCI  (SS7)  SCRNR SET SET BEI LST LNKS ACT MES DIS SLSCI NIS
ele2i    1-207-0      none 1  1  no  B  4  off off off ---  on
ls1315   0-015-0      none 1  1  no  A  1  off off off ---  off
ls1317   0-017-0      none 1  1  no  A  1  off off off ---  on
ls7890   7-089-0      none 1  2  no  B  1  off off off ---  off
elm2s1   1-011-1      none 1  1  no  A  7  off off off ---  off
elm2s2   1-011-2      none 1  1  no  A  7  off off off ---  off

```

Link set table is (12 of 1024) 1% full.

If the required linkset is not in the database, perform the [Adding an SS7 Linkset](#) procedure to add the linkset to the database with the `ipgwapc=no` parameter value. The APC of the linkset cannot be a private point code. Continue the procedure with 8.

8. Display each linkset being assigned to the route to verify the `multgc` and `ipgwapc` parameter values with the `rtrv-ls` command, specifying the name of the linkset that will be assigned to the route.

If the `multgc` linkset parameter value is `yes`, then 14-bit ITU National DPCs with group codes that are different from the linkset APC group code can be assigned to the route. If the `multgc` value is set to `no`, then only 14-bit ITU National DPCs with group codes that are the same as the linkset APC group code can be assigned to the route. The `multgc` value is shown in the `MULTGC` field of the `rtrv-ls` output. Linksets that have the `ipgwapc=yes` parameter value are assigned to routes using the [Adding a Route Containing an IPGWx Linkset](#) procedure. If the linkset displayed in this step contains the `ipgwapc=yes` parameter, repeat this step with another linkset shown in 7. If all the linksets have been displayed, and the `ipgwapc` value for all the linksets is `yes`, add the desired linkset by performing [Adding an SS7 Linkset](#) with the `ipgwapc=no` parameter value. The APC of the linkset cannot be a private point code.

For this example, enter the following commands.

```
rtrv-ls:lsn=lsn7
```

This is an example of the possible output.

```
rlghncxa03w 09-07-17 11:43:04 GMT EAGLE5 41.1.0
```

```

                                     L3T SLT                               GWS GWS GWS
LSN      APCA  (SS7)  SCRNR SET SET BEI LST LNKS ACT MES DIS SLSCI NIS
lsn7     002-002-002  none 1  1  no  C  8  off off off no  off

```

```

CLLI      TFATCABMLQ MTPRSE ASL8
----- 4          ---  no

```

```

IPGWAPC MATELSN      IPTPS LSUSEALM SLKUSEALM GTTMODE
no      ----- ---  ---  ---  CdPA

```

```

                                     L2T                               PCR PCR
LOC  PORT SLC TYPE      SET BPS      ECM  N1  N2
1211 A   0  LIMDS0  1  56000  BASIC ---  -----
1211 B   1  LIMDS0  1  56000  BASIC ---  -----

```

```

1211 A1    2 LIMDS0  1   56000 BASIC --- -----
1211 A2    3 LIMDS0  1   56000 BASIC --- -----
1211 B2    4 LIMDS0  1   56000 BASIC --- -----
1211 B1    5 LIMDS0  1   56000 BASIC --- -----
1211 B3    6 LIMDS0  1   56000 BASIC --- -----
1211 A3    7 LIMDS0  1   56000 BASIC --- -----

```

Link set table is (12 of 1024) 1% full.

```
rtrv-ls:lsn=ls7890
```

```
rlghncxa03w 09-07-17 11:43:04 GMT EAGLE5 41.1.0
```

```

                L3T SLT                GWS GWS GWS
LSN             APCI  (SS7)  SCRN SET SET BEI LST LNKS ACT MES DIS SLSCI NIS
ls7890          7-089-0      none 1  2  no  B  1  off off off ---  off

CLLI           TFATCABMLQ MTPRSE ASL8 SLSOCSBIT SLRSRB MULTGC
dtaclli        1             no    --- none      1      no

ITUTFR
off

IPGWAPC MATELSN      IPTPS LSUSEALM SLKUSEALM GTTMODE
no      ----- ---  ---      ---      CdPA

                L2T                PCR PCR
LOC  PORT SLC TYPE  SET  BPS   ECM  N1  N2
1103 A    0 LIMDS0  11  56000 BASIC --- -----

```

Link set table is (12 of 1024) 1% full.

9. Add the route using the `ent-rte` command. For this example, enter these commands.

```

ent-rte:dpca=002-002-200:lsn=lsn7:rc=10
ent-rte:dpci=7-089-0:lsn=ls7890:rc=20
ent-rte:dpca=003-003-003:lsn=lsn7:rc=20

```

These are the rules that apply to adding a route.

- The `force=yes` parameter must be specified if the linkset being assigned to the route has no signaling links assigned to it. Otherwise, each linkset must have at least one signaling link assigned to it.
- A route can contain a maximum of six linksets.
- A maximum of two linksets can be assigned the same `rc` parameter value, if the 6-Way Loadsharing on Routesets feature is not enabled or turned on. If the 6-Way Loadsharing on Routesets feature is enabled and turned on, a maximum of six linksets in the route can have the same `rc` parameter value.
- If the DPC of the route is a member of a cluster point code, and the nested cluster allowed indicator (`ncai` parameter of either the `ent-dstn` or `chg-dstn` command) is set to `no`, then the route to the DPC must be the same as the route to the cluster point code. If the nested cluster allowed indicator is set to `yes`, the route to the member of the cluster does not have to be the same as the route to the cluster point code.

- For routes containing 14-bit ITU National DPCs with group codes, if the linkset assigned to the route has the `MULTGC` value set to `yes`, then 14-bit ITU National DPCs with group codes that are different from the linkset APC group code can be assigned to the route. If the `MULTGC` value is set to `no`, then only 14-bit ITU National DPCs with group codes that are the same as the linkset APC group code can be assigned to the route.
- The DPC of the route must be of the same format as the APC of the linkset being added to the route. That is, routes containing ANSI DPCs must have linksets with ANSI APCs; routes containing ITU-I DPCs must have linksets with ITU-I APCs; routes containing 14-bit ITU-N DPCs must have linksets with 14-bit ITU-N APCs; routes containing 24-bit ITU-N DPCs must have linksets with 24-bit ITU-N APCs. The DPC of the route must be defined as a true point code in the `rtrv-dstn` output. Alias point codes and secondary point codes cannot be used. True point codes are shown in the output of the `rtrv-dstn` command in the `DPCA`, `DPCI`, `DPCN`, or `DPCN24` fields.
- Private point codes can be specified as the DPC of a route only if the linkset assigned to the route is an IPGWx linkset (a linkset that has the `ipgwapc=yes` parameter assigned to it).
- If the DPC of the route is a network routing point code, the link set type of the linkset assigned to the route must be either B, C, or D.

When each of these commands have successfully completed, this message should appear.

```
r1ghncxa03w 06-10-07 08:28:30 GMT EAGLE5 36.0.0
ENT-RTE: MASP A - COMPLTD
```

10. Verify the changes using the `rtrv-rte` command, specifying the destination point code of the route.

For this example, enter these commands.

```
rtrv-rte:dpca=002-002-200
```

This is an example of the possible output.

```
r1ghncxa03w 06-10-07 11:43:04 GMT EAGLE5 36.0.0

DPCA          ALIASI          ALIASN/N24      LSN           RC           APCA
002-002-002  -----          -----          lsn7          10           002-002-002
RTX:No       CLLI=-----
```

```
rtrv-rte:dpci=7-089-0:lsn=ls7890:rc=20
```

This is an example of the possible output.

```
r1ghncxa03w 06-10-07 11:43:04 GMT EAGLE5 36.0.0

DPCI          ALIASN/N24      ALIASA          LSN           RC           APC
7-089-0      -----          -----          ls7890        10           7-089-0
RTX:No       CLLI=dtaccli
```

```
rtrv-rte:dpca=003-003-003
```

This is an example of the possible output.

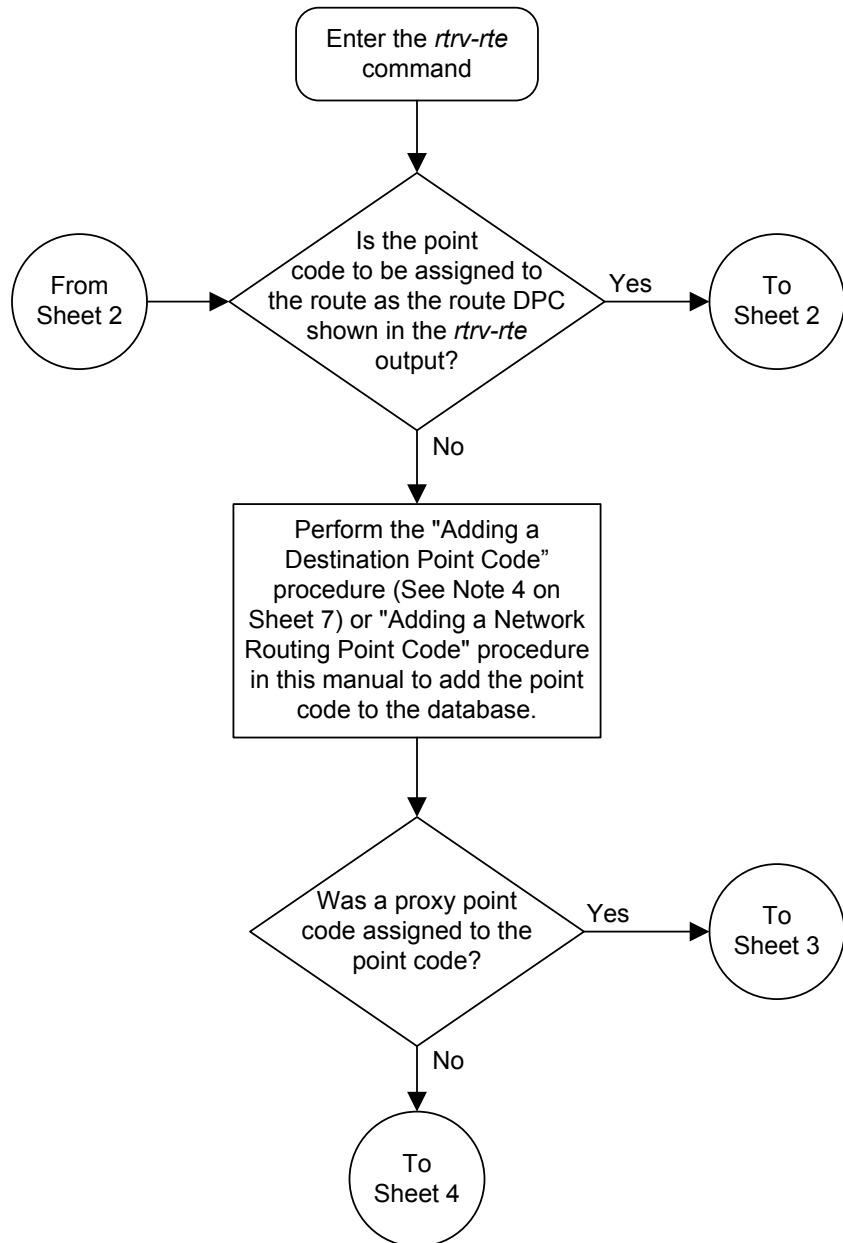
```
rlghncxa03w 06-10-07 11:43:04 GMT EAGLE5 36.0.0
```

```
      DPCA          ALIASI      ALIASN/N24    LSN          RC      APCA
003-003-003 -----
                                lsn3          10      003-003-003
                                lsn7          20      002-002-002
                                RTX:No  CLLI=-----
```

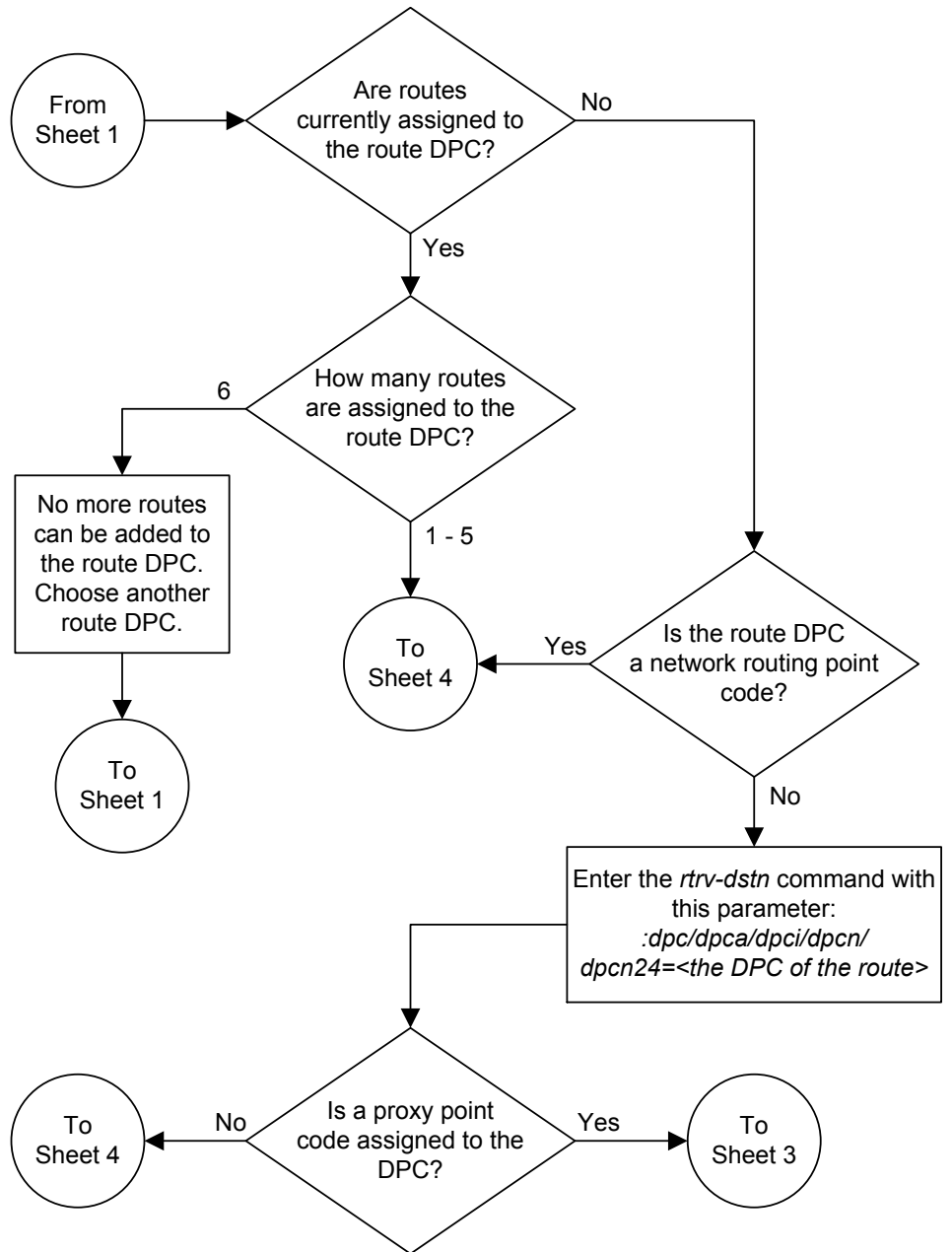
11. Back up the new changes using the `chg-db:action=backup:dest=fixed` command.

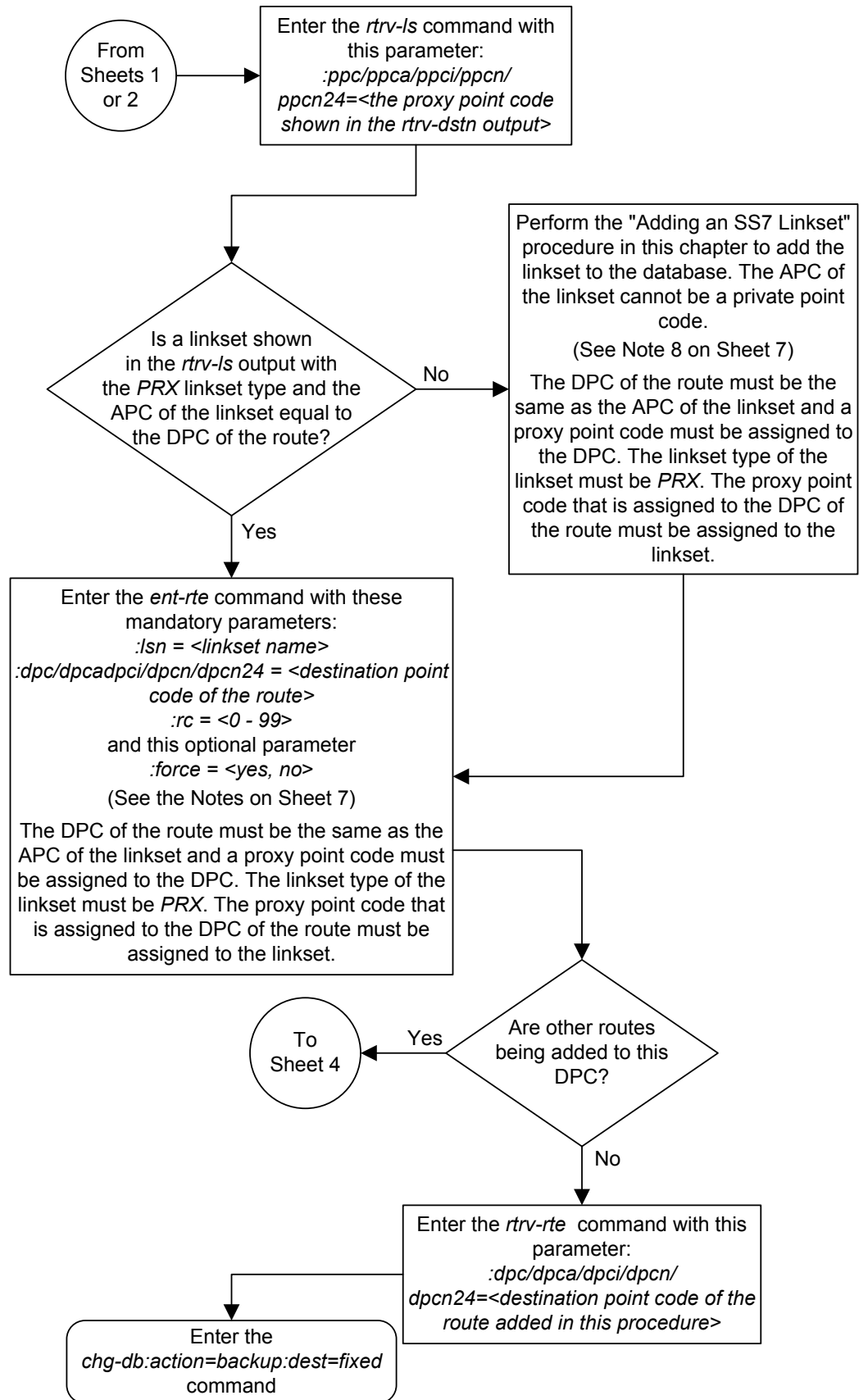
These messages should appear, the active **Maintenance and Administration Subsystem Processor (MASP)** appears first.

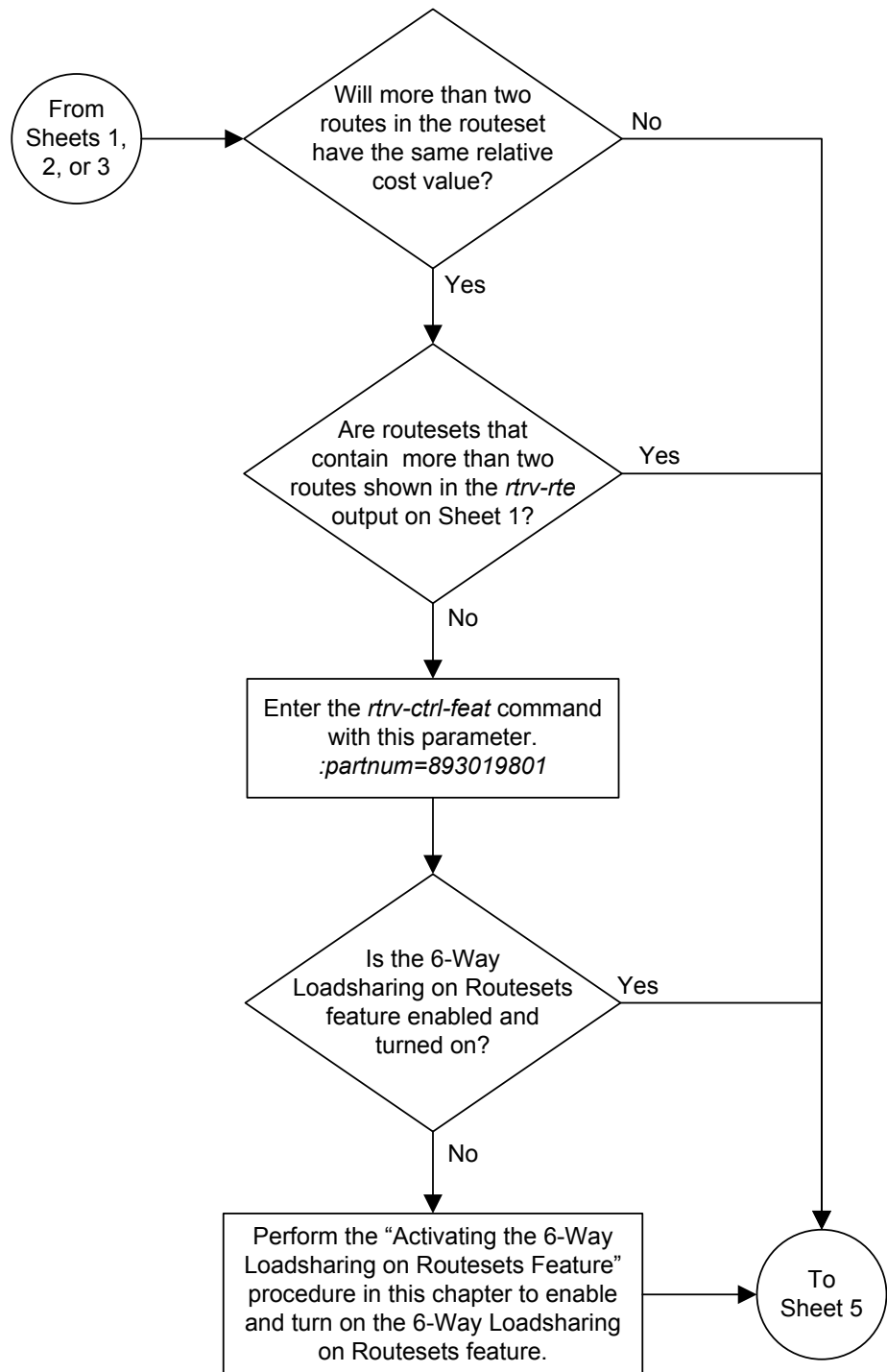
```
BACKUP (FIXED) : MASP A - Backup starts on active MASP.
BACKUP (FIXED) : MASP A - Backup on active MASP to fixed disk complete.
BACKUP (FIXED) : MASP A - Backup starts on standby MASP.
BACKUP (FIXED) : MASP A - Backup on standby MASP to fixed disk complete.
```

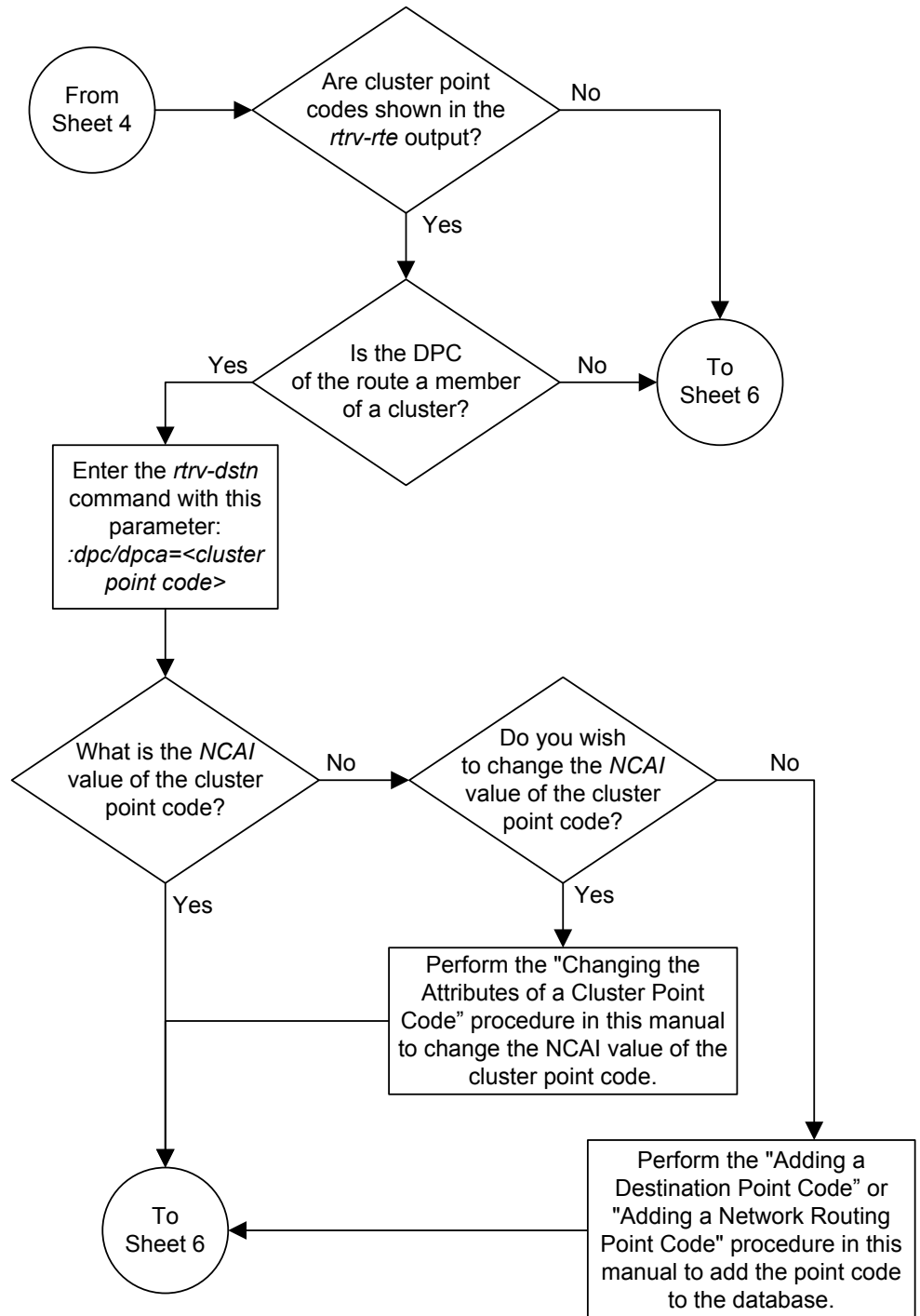

Figure 3-18 Adding a Route Containing an SS7 DPC

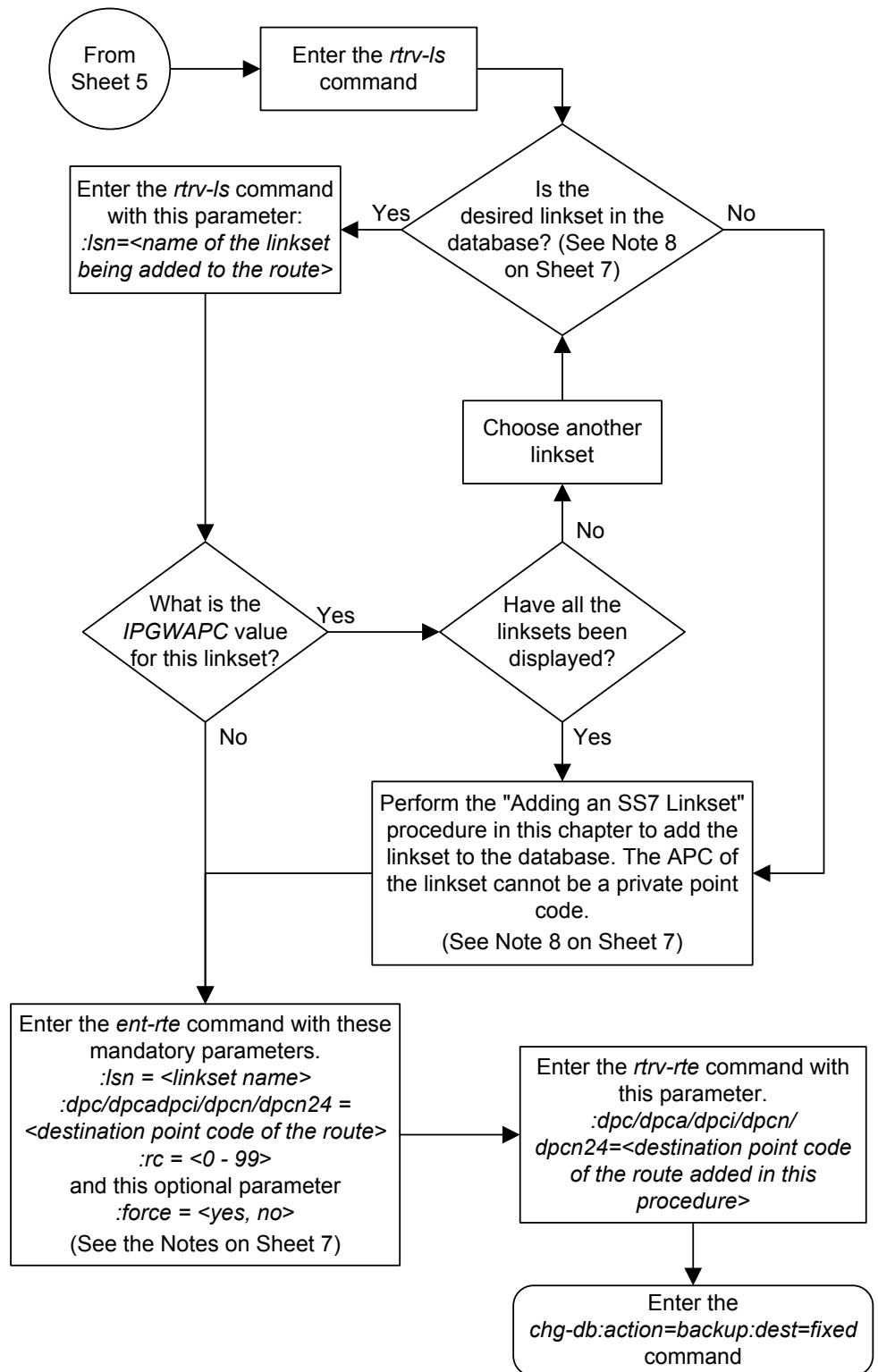
Sheet 1 of 7











Notes:

1. The *force=yes* parameter must be specified if the linkset being assigned to the route has no signaling links assigned to it. Otherwise, each linkset must have at least one signaling link assigned to it.
2. A route can contain a maximum of six linksets.
3. A maximum of two linksets can be assigned the same *rc* parameter value, if the 6-Way Loadsharing on Routesets feature is not enabled or turned on. If the 6-Way Loadsharing on Routesets feature is enabled and turned on, a maximum of six linksets in the route can have the same *rc* parameter value.
4. If the DPC of the route is a member of a cluster point code, and the nested cluster allowed indicator (*ncai* parameter of either the *ent-dstn* or *chg-dstn* command) is set to no, then the route to the DPC must be the same as the route to the cluster point code. If the nested cluster allowed indicator is set to yes, the route to the member of the cluster does not have to be the same as the route to the cluster point code.
5. For routes containing 14-bit ITU National DPCs with group codes, if the linkset assigned to the route has the MULTGC value set to yes, then 14-bit ITU National DPCs with group codes that are different from the linkset APC group code can be assigned to the route. If the MULTGC value is set to no, then only 14-bit ITU National DPCs with group codes that are the same as the linkset APC group code can be assigned to the route.
6. The DPC of the route must be of the same format as the APC of the linkset being added to the route. That is, routes containing ANSI DPCs must have linksets with ANSI APCs; routes containing ITU-I DPCs must have linksets with ITU-I APCs; routes containing 14-bit ITU-N DPCs must have linksets with 14-bit ITU-N APCs; routes containing 24-bit ITU-N DPCs must have linksets with 24-bit ITU-N APCs. The DPC of the route must be defined as a true point code in the *rtv-dstn* output. Alias point codes and secondary point codes cannot be used. True point codes are shown in the output of the *rtv-dstn* command in the *DPCA*, *DPCI*, *DPCN*, or *DPCN24* fields.
7. Private point codes can be specified as the DPC of a route only if the linkset assigned to the route is an IPGWx linkset (a linkset that has the *ipgwapc=yes* parameter assigned to it).
8. If the DPC of the route is a network routing point code, the link set type of the linkset assigned to the route must be either B, C, or D.

Adding a Route Containing a Cluster Point Code

This procedure is used to add a route to the database containing a cluster point code as the DPC of the route using the `ent-rte` command. Routes that do not contain a cluster point code as the DPC of the route are configured in these procedures:

- [Adding a Route Containing an SS7 DPC](#)
- [Adding a Route Containing an IPGWx Linkset](#)

The `ent-rte` command uses these parameters.

`:dpc/dpca` – The destination point code (cluster point code) of the node that the traffic is being sent to.

Note: See [Point Code Formats](#) for a definition of the point code types that are used on the EAGLE 5 ISS.

`:lsn` – The name of the linkset that will carry the traffic to the node specified by the destination point code.

`:rc` – The relative cost (priority) for this route.

`:force` – This parameter allows a route to be added to the database even if the linkset to be assigned to the route does not have any signaling links in it.

These items must be configured in the database before a route can be added:

- Destination point code (DPC) – see [Adding a Cluster Point Code](#)
- Linkset – see [Adding an SS7 Linkset](#)
- Link – see [Adding an SS7 Signaling Link](#)

The linkset assigned to this route must have an adjacent point code (APC) in the SS7 domain. The domain of the DPC is shown in the `DMN` field in the output of the `rtrv-dstn` command.

The DPC of the route must be of the same format as the APC of the linkset being added to the route. That is, routes containing ANSI DPCs must have linksets with ANSI APCs; routes containing ITU-I DPCs must have linksets with ITU-I APCs; routes containing 14-bit ITU-N DPCs must have linksets with 14-bit ITU-N APCs; routes containing 24-bit ITU-N DPCs must have linksets with 24-bit ITU-N APCs. The DPC of the route must be defined as a true point code in the `rtrv-dstn` output. Alias point codes and secondary point codes cannot be used. True point codes are shown in the output of the `rtrv-dstn` command in the `DPCA`, `DPCI`, `DPCN`, or `DPCN24` fields. Private point codes cannot be used as the DPC of a route in this procedure. Routes that have private point codes as the DPC of a route can contain only IPGWx linksets. Perform the [Adding a Route Containing an IPGWx Linkset](#) procedure to add routes containing IPGWx linksets.

The DPC of the route is the destination point code to be reached by the route and is shown in the output of the `rtrv-rte` command in the `DPCA`, `DPCI`, `DPCN`, or `DPCN24` fields.

The `APCA`, `APCI`, `APCN`, and `APCN24` fields in the output of the `rtrv-rte` command show the point code of the node that is directly adjacent to the node in the route.

A linkset can only be entered once as a route for each DPC.

A maximum of six routes can be defined for each DPC.

If the 6-Way Loadsharing on Routesets feature is enabled and turned on, a maximum of six routes in the routeset can be assigned the same relative cost value. It is recommended that the routeset be provisioned with a group of four routes that have the same relative cost value and another group of two routes that have the same relative cost value. Three or five routes in the routeset that have the same relative cost value can be provisioned, but the odd number makes it more difficult to distribute the route traffic evenly. Six routes in the routeset that have the same relative cost value can be provisioned, but this does not allow for any backup routes and also offers the worst chance for congestion and queuing issues during network failures. If the 6-Way Loadsharing on Routesets feature is not enabled or not turned on, a maximum of two linksets can be assigned the same relative cost value. The relative cost value of the route is defined by the `rc` parameter of the `ent-rte` command and is shown in the `RC` field in the output of the `rtrv-rte` command.

The `force=yes` parameter must be specified if the specified linkset has no signaling links assigned to it. Otherwise, each linkset must have at least one signaling link assigned to it.

If the DPC of the route is a cluster point code, only linksets whose linkset type is either B, C, or D can be assigned to the route. The linkset type is shown in the `LST` field of the `rtrv-ls` command output. If the linkset type of the desired linkset is either A, E, or PRX, one of three actions must be taken.

- Choose another linkset with the linkset type B, C, or D.
- Change the linkset type of an existing linkset – perform the [Changing an SS7 Linkset](#) procedure.
- Add a new linkset to the database with the necessary signaling links and the linkset type B, C, or D.
 1. Perform the [Adding an SS7 Linkset](#) procedure to add the linkset.
 2. If the necessary signaling links are not in the database, perform the [Adding an SS7 Signaling Link](#) procedure to add the signaling links to the database.

Canceling the `RTRV-LS`, `RTRV-DSTN`, and `RTRV-RTE` Commands

Because the `rtrv-ls`, `rtrv-dstn`, and `rtrv-rte` commands used in this procedure can output information for a long period of time, the `rtrv-ls`, `rtrv-dstn`, and `rtrv-rte` commands can be canceled and the output to the terminal stopped. There are three ways that the `rtrv-ls`, `rtrv-dstn`, and `rtrv-rte` commands can be canceled.

- Press the F9 function key on the keyboard at the terminal where the `rtrv-ls`, `rtrv-dstn`, or `rtrv-rte` commands were entered.
- Enter the `canc-cmd` without the `trm` parameter at the terminal where the `rtrv-ls`, `rtrv-dstn`, or `rtrv-rte` commands were entered.
- Enter the `canc-cmd:trm=<xx>`, where `<xx>` is the terminal where the `rtrv-ls`, `rtrv-dstn`, or `rtrv-rte` commands were entered, from another terminal other than the terminal where the `rtrv-ls`, `rtrv-dstn`, or `rtrv-rte` commands were entered. To enter the `canc-cmd:trm=<xx>` command, the terminal must allow Security Administration commands to be entered from it and the user must be allowed to enter Security Administration commands. The terminal's permissions

can be verified with the `rtrv-secu-trm` command. The user's permissions can be verified with the `rtrv-user` or `rtrv-secu-user` commands.

For more information about the `canc-cmd` command, go to the *Commands Manual*.

1. Display the current route configuration using the `rtrv-rte` command.

This is an example of the possible output.

```
rlghncxa03w 10-12-10 11:43:04 GMT EAGLE5 43.0.0
Extended Processing Time may be Required

      DPCA          ALIASI      ALIASN/N24    LSN          RC      APCA
      140-012-004   1-111-1      10-13-12-1   ls000001     10     240-012-002
                                           ls000002     10     240-012-002
                                           ls000003     20     240-012-002
                                           ls000004     30     240-012-002
                                           ls000005     40     240-012-002
                                           ls000006     50     240-012-002
                                           RTX:No  CLLI=dp1
      140-012-005  1-111-2    10-13-12-2   ls000001     10     240-012-002
                                           ls000002     10     240-012-002
                                           ls000003     20     240-012-002
                                           ls000004     30     240-012-002
                                           ls000005     40     240-012-002
                                           ls000006     50     240-012-002
                                           RTX:No  CLLI=dp2
      DPCI          ALIASN/N24      ALIASA      LSN          RC      APC
      2-234-5       11-13-3-3      240-111-111  ls100001     10     1-234-5
                                           ls100002     10     1-234-6
                                           ls100003     20     1-234-7
                                           ls100004     30     1-234-1
                                           ls100005     40     1-234-2
                                           ls100006     50     1-234-3
                                           RTX:No  CLLI=idp1
      DPCN          ALIASA          ALIASI      LSN          RC      APC
      12-12-13-3   011-222-111    0-001-1    ls200001     10     10-13-9-3
                                           ls200002     10     10-13-10-0
                                           ls200003     20     10-13-10-1
                                           ls200004     30     10-13-10-2
                                           ls200005     40     10-13-10-3
                                           ls200006     50     10-13-11-0
                                           RTX:No  CLLI=ndp1
      DPCN24       ALIASA          ALIASI      LSN          RC      APC
```

If the cluster point code of the route being added in this procedure is not shown in the `rtrv-rte` output, perform the [Adding a Cluster Point Code](#) procedure and add the cluster point code. Continue the procedure with 3.

If the cluster point code of the route being added in this procedure is shown in the `rtrv-rte` output, continue the procedure with 2.

2. Display the `ncai` parameter value assigned to the cluster point code using the `rtrv-dstn` command and specifying the cluster point code. If the `ncai` parameter value is `no`, then the route to the DPC must be the same as the route to the cluster point code. If the `ncai` parameter value is `yes`, the route to the member of the cluster does not have to be the same as the route to the cluster point code. The `ncai` value is shown in the `NCAI` field of the `rtrv-dstn` output. For this example, enter this command.


```
rtrv-dstn:dPCA=111-011-*
```

This is an example of the possible output.

```
rlghncxa03w 10-12-28 21:16:37 GMT EAGLE5 43.0.0
```

DPCA	CLLI	BEI	ELEI	ALIASI	ALIASN/N24	DMN
111-011-*	rlghncbb000	yes	yes	-----	-----	SS7

SPCA	NCAI	RCAUSE	NPRST	SPLITIAM	HMSMSC	HMSCP	SCCPMSGCNV
-----	yes	none	off	none	no	no	none

```
Destination table is (12 of 2000) 1% full
```

```
Alias table is (18 of 8000) 1% full
```

3. Verify that the required linkset for the route is in the database by displaying the linksets in the database with the `rtrv-ls` command.

This is an example of the possible output.

```
rlghncxa03w 06-10-10 11:43:04 GMT EAGLE5 36.0.0
```

LSN	APCA (SS7)	SCRN	L3T SLT			LST	LNKS	GWS GWS GWS			SLSCI	NIS
			SET	SET	BEI			ACT	MES	DIS		
ele2	001-207-000	none	1	1	no	B	6	off	off	off	no	off
ls1305	000-005-000	none	1	1	no	A	1	off	off	off	no	off
ls1307	000-007-000	none	1	1	no	A	1	off	off	off	no	off
lsn7	002-002-002	none	1	1	no	C	8	off	off	off	no	off
elm1s1	001-001-001	none	1	1	no	A	7	off	off	off	no	off
elm1s2	001-001-002	none	1	1	no	A	7	off	off	off	no	off

LSN	APCI (SS7)	SCRN	L3T SLT			LST	LNKS	GWS GWS GWS			SLSCI	NIS
			SET	SET	BEI			ACT	MES	DIS		
ele2i	1-207-0	none	1	1	no	B	4	off	off	off	---	on
ls1315	0-015-0	none	1	1	no	A	1	off	off	off	---	off
ls1317	0-017-0	none	1	1	no	A	1	off	off	off	---	on
ls7890	7-089-0	none	1	2	no	B	1	off	off	off	---	off
elm2s1	1-011-1	none	1	1	no	A	7	off	off	off	---	off
elm2s2	1-011-2	none	1	1	no	A	7	off	off	off	---	off

```
Link set table is (12 of 1024) 1% full.
```

The route containing a cluster point code can have only linksets with the linkset types B, C, or D assigned to it. If the required linkset is not in the database, perform the [Adding an SS7 Linkset](#) procedure to add the linkset to the database with the `ipgwapc=no` parameter value and with the linkset types B, C, or D. The APC of the linkset cannot be a private point code. Continue the procedure with [5](#).

If the linkset that will be added to the route is shown in the `rtrv-ls` output and is a B-, C-, or D-type linkset, continue the procedure with [4](#).

4. Display each linkset being assigned to the route to verify the `ipgwapc` parameter values with the `rtrv-ls` command, specifying the name of the linkset that will be assigned to the route.

The `ipgwapc` linkset parameter value is `yes`, the DPC of the route cannot be a cluster point code. The `ipgwapc` value is shown in the `IPGWAPC` field of the `rtrv-ls` output.

If the linkset displayed in this step contains the `ipgwapc=yes` parameter, repeat this step with another linkset shown in 3. If all the linksets have been displayed, and the `ipgwapc` value for all the linksets is `yes`, add the desired linkset by performing the [Adding an SS7 Linkset](#) procedure with the `ipgwapc=no` parameter value and with the linkset types B, C, or D. The APC of the linkset cannot be a private point code.

For this example, enter the following command.

```
rtrv-ls:lsn=lsn7
```

This is an example of the possible output.

```
rlghncxa03w 09-07-17 11:43:04 GMT EAGLE5 41.1.0

LSN              APCA  (SS7)  SCRN SET SET BEI LST LNKS ACT MES DIS SLSCI NIS
lsn7            002-002-002  none 1  1  no  C   8   off off off no  off

CLLI            TFATCABMLQ MTPRSE ASL8
----- 4          ---   no

IPGWAPC MATELSN      IPTPS LSUSEALM SLKUSEALM GTTMODE
no      -----  ---   ---      ---      CdPA

LOC  PORT  SLC  TYPE      L2T          PCR  PCR
SET  BPS   ECM   N1   N2
1211 A    0  LIMDS0  1    56000  BASIC ---  ----
1211 B    1  LIMDS0  1    56000  BASIC ---  ----
1211 A1   2  LIMDS0  1    56000  BASIC ---  ----
1211 A2   3  LIMDS0  1    56000  BASIC ---  ----
1211 B2   4  LIMDS0  1    56000  BASIC ---  ----
1211 B1   5  LIMDS0  1    56000  BASIC ---  ----
1211 B3   6  LIMDS0  1    56000  BASIC ---  ----
1211 A3   7  LIMDS0  1    56000  BASIC ---  ----
```

Link set table is (12 of 1024) 1% full.

- For a routeset to have more than two routes with the same relative cost value, the 6-Way Loadsharing on Routesets feature must be enabled and turned on.

To verify the status of the 6-Way Loadsharing on Routesets feature, enter this command.

```
rtrv-ctrl-feat:partnum=893019801
```

The following is an example of the possible output.

```
rlghncxa03w 09-05-28 21:15:37 GMT EAGLE5 41.0.0
The following features have been permanently enabled:
```

Feature Name	Partnum	Status	Quantity
6-Way LS on Routesets	893019801	on	----

The following features have been temporarily enabled:

Feature Name	Partnum	Status	Quantity	Trial Period Left
Zero entries found.				

The following features have expired temporary keys:

```
Feature Name          Partnum
Zero entries found.
```

If the 6-Way Loadsharing on Routesets feature is not enabled or not turned on, perform [Activating the 6-Way Loadsharing on Routesets Feature](#) to enable and turn on the 6-Way Loadsharing on Routesets feature.

After the 6-Way Loadsharing on Routesets feature has been enabled and turned on, or if the `rtrv-ctrl-feat` output shows that the 6-Way Loadsharing on Routesets feature is enabled and turned on, continue this procedure with 6.

6. Add the route using the `ent-rte` command specifying the cluster point code as the DPC of the route.

For this example, enter this command.

```
ent-rte:dPCA=111-011-*:lsn=lsn7:rc=10
```

When this command has successfully completed, this message should appear.

```
rlghncxa03w 06-10-07 08:28:30 GMT  EAGLE5 36.0.0
ENT-RTE: MASP A - COMPLTD
```

7. Verify the changes using the `rtrv-rte` command, specifying the destination point code of the route.

For this example, enter these commands.

```
rtrv-rte:dPCA=111-011-*
```

This is an example of the possible output.

```
rlghncxa03w 09-05-07 11:43:04 GMT  EAGLE5 41.0.0

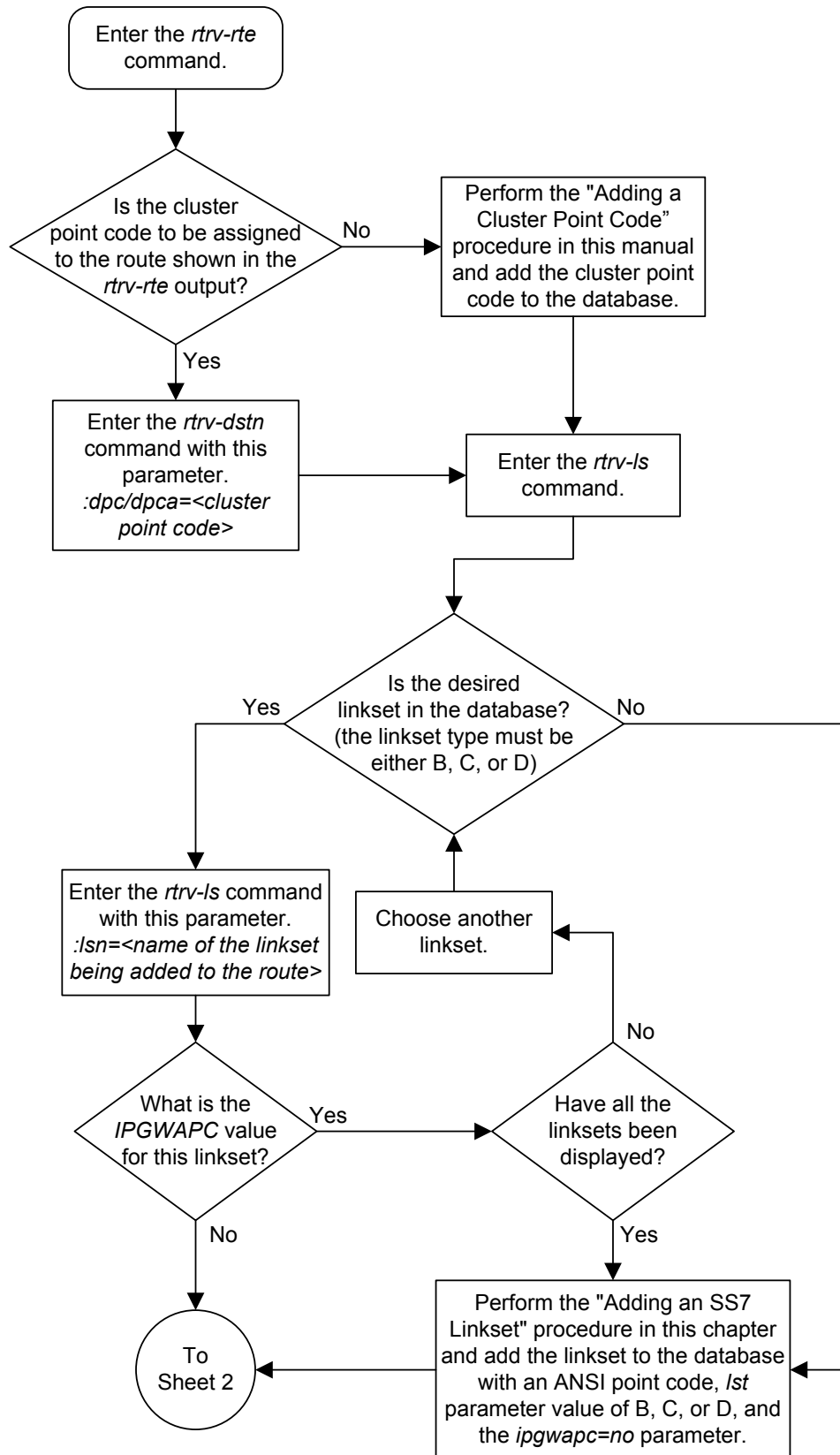
      DPCA          ALIASI          ALIASN/N24      RTX   CLLI
              -----          -----          RC     APCA
111-011-*      -----          -----          No    -----
                                   lsn7          10    002-002-002
```

8. Back up the new changes using the `chg-db:action=backup:dest=fixed` command.

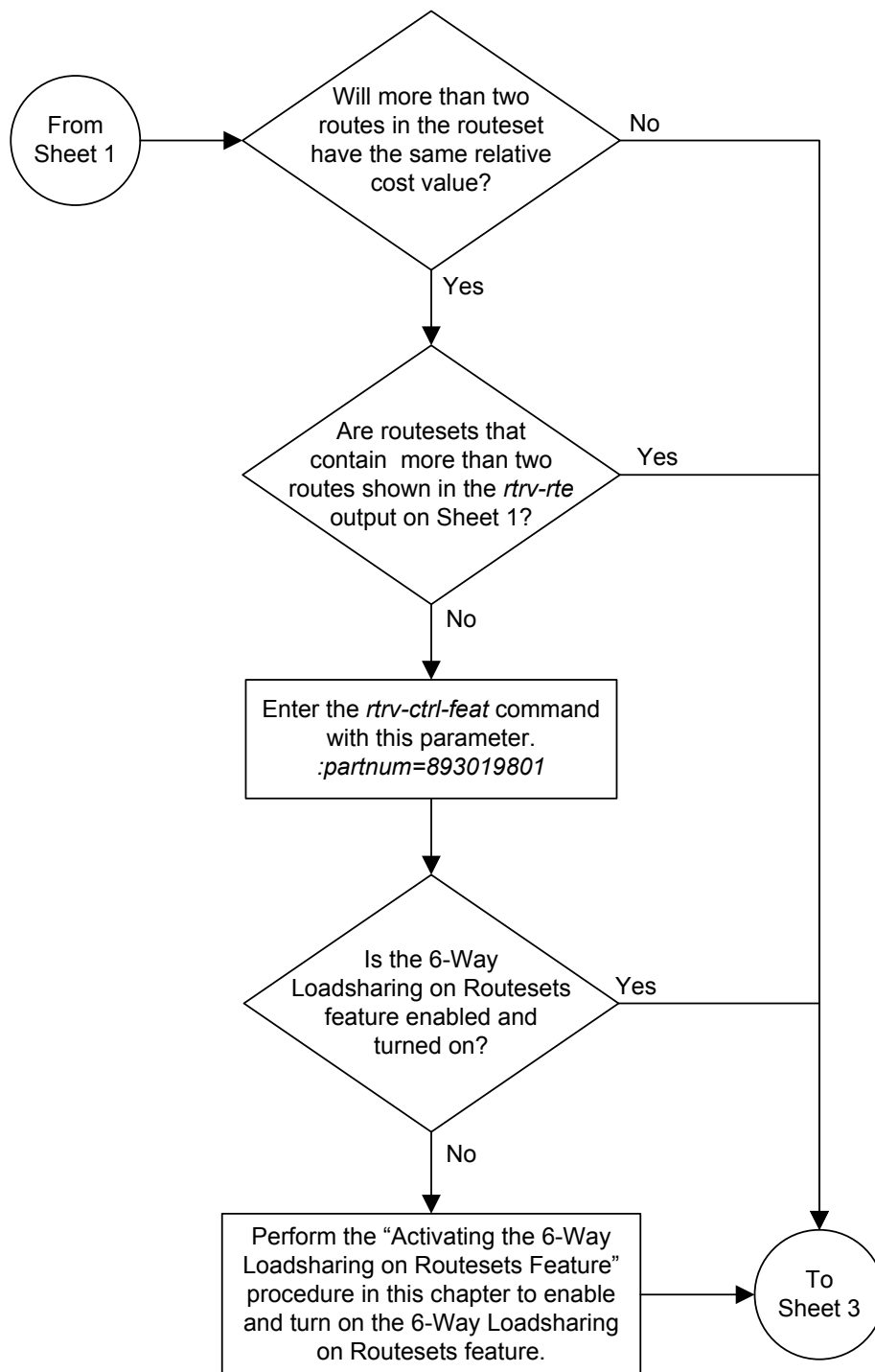
These messages should appear, the active **Maintenance and Administration Subsystem Processor (MASP)** appears first.

```
BACKUP (FIXED) : MASP A - Backup starts on active MASP.
BACKUP (FIXED) : MASP A - Backup on active MASP to fixed disk complete.
BACKUP (FIXED) : MASP A - Backup starts on standby MASP.
BACKUP (FIXED) : MASP A - Backup on standby MASP to fixed disk complete.
```

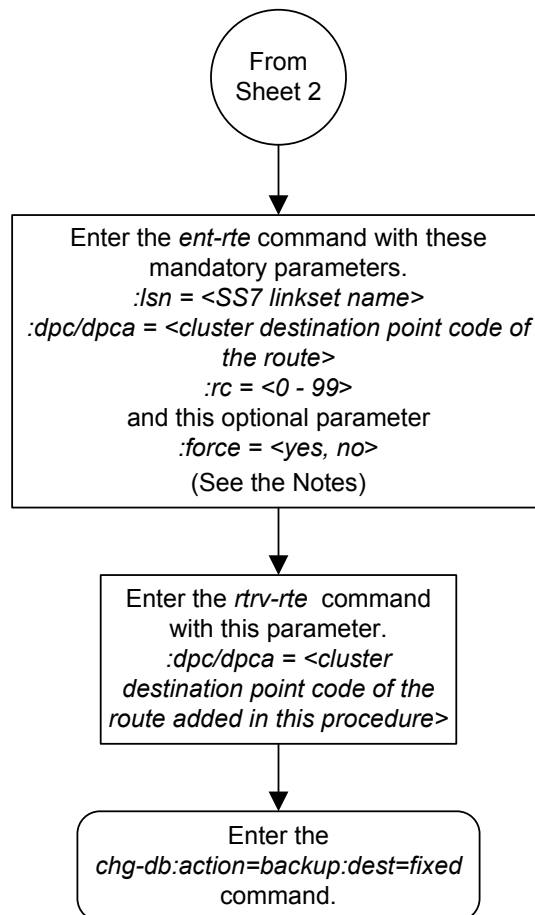
Figure 3-19 Adding a Route Containing a Cluster Point Code



Sheet 1 of 3



Sheet 2 of 3



Notes:

1. The *force=yes* parameter must be specified if the linkset being assigned to the route has no signaling links assigned to it. Otherwise, each linkset must have at least one signaling link assigned to it.
2. A route can contain a maximum of six linksets.
3. A maximum of two linksets can be assigned the same *rc* parameter value, if the 6-Way Loadsharing on Routesets feature is not enabled or turned on. If the 6-Way Loadsharing on Routesets feature is enabled and turned on, a maximum of six linksets in the route can have the same *rc* parameter value.
4. If the DPC of the route is a member of a cluster point code, and the nested cluster allowed indicator (*ncai* parameter of either the *ent-dstn* or *chg-dstn* command) is set to no, then the route to the DPC must be the same as the route to the cluster point code. If the nested cluster allowed indicator is set to yes, the route to the member of the cluster does not have to be the same as the route to the cluster point code.
5. Private point codes can be specified as the DPC of a route only if the linkset assigned to the route is an IPGWx linkset (a linkset that has the *ipgwapc=yes* parameter assigned to it).

Adding a Route Containing an IPGWx Linkset

This procedure is used to add a route to the database containing an **IPGWx** linkset using the `ent-rte` command. Routes that do not contain IPGWx linksets are configured in these procedures.

- [Adding a Route Containing an SS7 DPC](#)
- [Adding a Route Containing a Cluster Point Code](#)

The `ent-rte` command uses these parameters.

`:dpc/dpca/dpci/dpcn/dpcn24` – The destination point code of the node that the traffic is being sent to.

Note: See [Point Code Formats](#) for a definition of the point code types that are used on the EAGLE and for a definition of the different formats that can be used for ITU national point codes.

`:lsn` – The name of the linkset that will carry the traffic to the node specified by the destination point code.

`:rc` – The relative cost (priority) for this route.

`:force` – This parameter allows a route to be added to the database even if the linkset to be assigned to the route does not have any signaling links in it.

These items must be configured in the database before a route can be added:

- Destination point code (DPC) – see [Adding a Destination Point Code](#). The DPC of the route can be a private point code, but does not have to be.
- Linkset – see the “Configuring an IPGWx Linkset” procedure in *Database Administration - IP7 User’s Guide*.
- Link – see the “Adding an IPGWx Signaling Link” procedure in *Database Administration - IP7 User’s Guide*.

The linkset assigned to this route must have an adjacent point code (APC) in the SS7 domain and must contain the `ipgwapc=yes` parameter value. The domain of the DPC is shown in the `DMN` field in the output of the `rtrv-dstn` command. The `ipgwapc` parameter value is shown in the output of the `rtrv-ls:lsn=<linkset name>` command.

The DPC of the route must be the APC of the linkset, or the **SAPC** assigned to the linkset. The DPC of the route must be of the same format as the APC of the linkset being added to the route. That is, a routes containing ANSI DPC must have a linkset with an ANSI APC; a route containing an ITU-I DPC must have a linkset with an ITU-I APC; a route containing a 14-bit ITU-N DPC must have a linkset with a 14-bit ITU-N APC; a route containing a 24-bit ITU-N DPC must have a linkset with a 24-bit ITU-N APC. The DPC of the route must be defined as a true point code in the `rtrv-dstn` output. Cluster point codes, network routing point codes, alias point codes, and secondary point codes cannot be used. True point codes are shown in the output of the `rtrv-dstn` command in the `DPCA`, `DPCI`, `DPCN`, or `DPCN24` fields. The DPC of the route cannot be a proxy point code. A proxy point code or secondary point code

cannot be assigned to the DPC of the route. A secondary point code cannot be assigned to the linkset.

For a linkset with an ITU APC, if that linkset has an SAPC assigned to it, the SAPC of that linkset can be specified as the DPC of the route. The format of the SAPC can be different from the APC of the linkset. For example, an IPGWx linkset has an ITU-I APC and an ITU-N SAPC is assigned to the linkset. The DPC of the route can be either the ITU-I APC of the linkset or the ITU-N SAPC assigned to the linkset.

The DPC of the route is the destination point code to be reached by the route and is shown in the output of the `rtrv-rte` command in the `DPCA`, `DPCI`, `DPCN`, or `DPCN24` fields.

The `APCA`, `APCI`, `APCN`, and `APCN24` fields in the output of the `rtrv-rte` command show the point code of the node that is directly adjacent to the node in the route.

The route containing an IPGWx linkset can contain only one linkset.

The `force=yes` parameter must be specified if the specified linkset has no signaling links assigned to it. Otherwise, each linkset must have at least one signaling link assigned to it.

If the DPC of the route is a member of a cluster point code, and the nested cluster allowed indicator (`ncai` parameter of either the `ent-dstn` or `chg-dstn` command) is set to `no`, then the route to the DPC must be the same as the route to the cluster point code. If the nested cluster allowed indicator is set to `yes`, the route to the member of the cluster does not have to be the same as the route to the cluster point code. For more information, see the [Nested Cluster Routing](#) section.

For routes containing 14-bit ITU National DPCs with group codes, if the linkset assigned to the route has the `MULTGC` value set to `yes`, then 14-bit ITU National DPCs with group codes that are different from the linkset APC group code can be assigned to the route. If the `MULTGC` value is set to `no`, then only 14-bit ITU National DPCs with group codes that are the same as the linkset APC group code can be assigned to the route.

Canceling the `RTRV-LS`, `RTRV-DSTN`, and `RTRV-RTE` Commands

Because the `rtrv-ls`, `rtrv-dstn`, and `rtrv-rte` commands used in this procedure can output information for a long period of time, the `rtrv-ls`, `rtrv-dstn`, and `rtrv-rte` commands can be canceled and the output to the terminal stopped. There are three ways that the `rtrv-ls`, `rtrv-dstn`, and `rtrv-rte` commands can be canceled.

- Press the F9 function key on the keyboard at the terminal where the `rtrv-ls`, `rtrv-dstn`, or `rtrv-rte` commands were entered.
- Enter the `canc-cmd` without the `trm` parameter at the terminal where the `rtrv-ls`, `rtrv-dstn`, or `rtrv-rte` commands were entered.
- Enter the `canc-cmd:trm=<xx>`, where `<xx>` is the terminal where the `rtrv-ls`, `rtrv-dstn`, or `rtrv-rte` commands were entered, from another terminal other than the terminal where the `rtrv-ls`, `rtrv-dstn`, or `rtrv-rte` commands were entered. To enter the `canc-cmd:trm=<xx>` command, the terminal must allow Security Administration commands to be entered from it and the user must be allowed to enter Security Administration commands. The terminal's permissions can be verified with the `rtrv-secu-trm` command. The user's permissions can be verified with the `rtrv-user` or `rtrv-secu-user` commands.

For more information about the `canc-cmd` command, go to *Commands User's Guide*.

1. Display the current route configuration using the `rtrv-rte` command.

This is an example of the possible output.

```
rlghncxa03w 10-12-10 11:43:04 GMT EAGLE5 43.0.0
Extended Processing Time may be Required

      DPCA          ALIASI      ALIASN/N24  LSN      RC      APCA
      140-012-004    1-111-1    10-13-12-1  ls000001  10     240-012-002
                                           ls000002  10     240-012-002
                                           ls000003  20     240-012-002
                                           ls000004  30     240-012-002
                                           ls000005  40     240-012-002
                                           ls000006  50     240-012-002
                                           RTX:No  CLLI=dp1
      140-012-005  1-111-2  10-13-12-2  ls000001  10     240-012-002
                                           ls000002  10     240-012-002
                                           ls000003  20     240-012-002
                                           ls000004  30     240-012-002
                                           ls000005  40     240-012-002
                                           ls000006  50     240-012-002
                                           RTX:No  CLLI=dp2
p-004-004-004 -----  11-12-10-3  -----  --  -----
                                           RTX:No  CLLI=-----
      DPCI          ALIASN/N24      ALIASA      LSN      RC      APC
      2-234-5        11-13-3-3      240-111-111  ls100001  10     1-234-5
                                           ls100002  10     1-234-6
                                           ls100003  20     1-234-7
                                           ls100004  30     1-234-1
                                           ls100005  40     1-234-2
                                           ls100006  50     1-234-3
                                           RTX:No  CLLI=idp1
      DPCN          ALIASA          ALIASI      LSN      RC      APC
      12-12-13-3    011-222-111    0-001-1  ls200001  10     10-13-9-3
                                           ls200002  10     10-13-10-0
                                           ls200003  20     10-13-10-1
                                           ls200004  30     10-13-10-2
                                           ls200005  40     10-13-10-3
                                           ls200006  50     10-13-11-0
                                           RTX:No  CLLI=ndp1
      DPCN24        ALIASA          ALIASI      LSN      RC      APC
```

If the destination point code of the route being added in this procedure is not shown in the `rtrv-rte` output, perform the [Adding a Destination Point Code](#) procedure and add the destination point code of the route to the destination point code table. This point code can be a private point code, but does not have to be a private point code. The DPC of the route cannot be a proxy point code. A proxy point code or secondary point code cannot be assigned to the DPC of the route. After the point code is added, continue the procedure with 3.

If the point code that will be assigned to the route is shown in the `rtrv-rte` output, but has a route assigned to it, that point code cannot be used as the DPC of the route being added in this procedure. Choose another point code and repeat this step.

If the RC, LSN, and APC columns in the `rtrv-rte` output contain dashes for the given point code, a route is not assigned to the point code.

If the point code that will be assigned to the route is shown in the `rtrv-rte` output, but does not have a route assigned to it, continue the procedure with 2.

Note: If cluster point codes are not shown in 1, or if the DPC of the route being added is not a member of the cluster point code, continue the procedure with 4.

2. Enter the `rtrv-dstn` command with the DPC of the route. For this example, enter this command.

```
rtrv-dstn:dpca=004-004-004
```

This is an example of the possible output.

```
rlghncxa03w 10-12-28 21:16:37 GMT EAGLE5 43.0.0
```

DPCA	CLLI	BEI	ELEI	ALIASI	ALIASN/N24	DMN	
004-004-004	-----	no	---	-----	-----	SS7	
PPCA	NCAI PRX	RCAUSE	NPRST	SPLITIAM	HMSMSC	HMSCP	SCCPMSGCNV
010-010-010	---- no	none	off	none	no	no	none

```
Destination table is (14 of 2000) 1% full
Alias table is (0 of 12000) 0% full
PPC table is (2 of 10) 20% full
```

The DPC of the route cannot be a proxy point code. A proxy point code or secondary point code cannot be assigned to the DPC of the route. If any of these conditions are shown in the `rtrv-dstn` output, either choose another point code shown in 1 and repeat this procedure, or perform the [Adding a Destination Point Code](#) procedure and add the destination point code of the route to the destination point code table. This point code can be a private point code, but does not have to be a private point code. The DPC of the route cannot be a proxy point code. A proxy point code or secondary point code cannot be assigned to the DPC of the route.

Note: If cluster point codes are not shown in 1, or if the DPC of the route being added is not a member of the cluster point code, continue the procedure with 4.

3. Display the `ncai` parameter value assigned to the cluster point code using the `rtrv-dstn` command and specifying the cluster point code.

If the `ncai` parameter value is `no`, then the route to the DPC must be the same as the route to the cluster point code. If the `ncai` parameter value is `yes`, the route to the member of the cluster does not have to be the same as the route to the cluster point code. The `ncai` value is shown in the `NCAI` field of the `rtrv-dstn` output. For this example, enter this command.

```
rtrv-dstn:dpca=111-011-*
```

This is an example of the possible output.

```
rlghncxa03w 10-12-28 21:16:37 GMT EAGLE5 43.0.0
```

DPCA	CLLI	BEI	ELEI	ALIASI	ALIASN/N24	DMN	
111-011-*	rlghncbb000	yes	yes	-----	-----	SS7	
SPCA	NCAI	RCAUSE	NPRST	SPLITIAM	HMSMSC	HMSCP	SCCPMSGCNV

```
----- yes          none  off  none   no    no    none
```

```
Destination table is (12 of 2000) 1% full
Alias table is (18 of 8000) 1% full
```

If the `ncai` parameter value of the cluster point code is `no`, and you wish to change the `ncai` parameter value to `yes`, perform the [Changing the Attributes of a Cluster Point Code](#) procedure. If the `ncai` parameter value of the cluster point code is `no`, and you do not wish to change the `ncai` parameter value to `yes`, add a new DPC for the route by performing the [Adding a Destination Point Code](#) procedure. The DPC of the route cannot be a proxy point code. A proxy point code or secondary point code cannot be assigned to the DPC of the route.

4. Verify that the required linkset for the route is in the database by displaying the linksets in the database with the `rtrv-ls` command. This is an example of the possible output.

```
rlghncxa03w 06-10-10 11:43:04 GMT EAGLE5 36.0.0
```

LSN	APCA (SS7)	SCRN	L3T SLT				LST	LNKS	GWS GWS GWS				
			SET	SET	BEI				ACT	MES	DIS	SLSCI	NIS
ele2	001-207-000	none	1	1	no	B	6	off	off	off	no	off	
ls1305	000-005-000	none	1	1	no	A	1	off	off	off	no	off	
ls1307	000-007-000	none	1	1	no	A	1	off	off	off	no	off	
lsn4	p-004-004-004	none	1	1	no	A	6	off	off	off	no	off	
elm1s1	001-001-001	none	1	1	no	A	7	off	off	off	no	off	
elm1s2	001-001-002	none	1	1	no	A	7	off	off	off	no	off	

LSN	APCI (SS7)	SCRN	L3T SLT				LST	LNKS	GWS GWS GWS				
			SET	SET	BEI				ACT	MES	DIS	SLSCI	NIS
ele2i	1-207-0	none	1	1	no	B	4	off	off	off	---	on	
ls1315	0-015-0	none	1	1	no	A	1	off	off	off	---	off	
ls1317	0-017-0	none	1	1	no	A	1	off	off	off	---	on	
elm2s1	1-011-1	none	1	1	no	A	7	off	off	off	---	off	
elm2s2	1-011-2	none	1	1	no	A	7	off	off	off	---	off	

```
Link set table is (11 of 1024) 1% full.
```

If the point code chosen in [1](#) is not shown as the APC of a linkset, perform the “Configuring an IPGWx Linkset” procedure in *Database Administration - IP7 User’s Guide* and add the IPGWx linkset to the database. After the IPGWx linkset has been added, continue the procedure with [7](#).

If the point code chosen in [1](#) is shown as the APC of a linkset, continue the procedure with [5](#).

5. Display each linkset being assigned to the route to verify the `multgc` and `ipgwapc` parameter values with the `rtrv-ls` command, specifying the name of the linkset that will be assigned to the route.

If the `multgc` linkset parameter value is `yes`, then 14-bit ITU National DPCs with group codes that are different from the linkset APC group code can be assigned to the route. If the `multgc` value is set to `no`, then only 14-bit ITU National DPCs with group codes that are the same as the linkset APC group code can be assigned to the route. The `multgc` value is shown in the `MULTGC` field of the `rtrv-ls` output.

If the `ipgwapc` parameter value for the linkset is `yes`, continue the procedure with [6](#).

If the `ipgwapc` parameter value for the linkset is `no`, the linkset and point code cannot be assigned to the route. Either select another point code and repeat this procedure from 1, or add the desired linkset by perform the “Configuring an IPGWx Linkset” procedure in the *Database Administration Manual - IP7 Secure Gateway* and add the IPGWx linkset to the database. After the IPGWx linkset has been added, continue the procedure with 7.

For this example, enter the following commands.

```
rtrv-ls:lsn=lsn4
```

This is an example of the possible output.

```
rlghncxa03w 06-10-11 11:06:27 GMT EAGLE5 36.0.0

LSN              APCA  (SS7)  L3T SLT          GWS GWS GWS
lsn4             p-004-004-004  none 1   1   no  A   6   off off off no  off

CLLI              TFATCABMLQ MTPRSE ASL8
-----          3           no    no

IPGWAPC MATELSN      IPTPS LSUSEALM SLKUSEALM GTTMODE
yes      -----  100   100    % 80    % CdPA

LOC  PORT  SLC  TYPE
1107 A    0  SS7IPGW
1205 A    1  SS7IPGW
1305 A    2  SS7IPGW
1303 A    3  SS7IPGW
1307 A    4  SS7IPGW
1311 A    5  SS7IPGW
```

Link set table is (16 of 1024) 1% full.

6. Only one linkset can be assigned to a route containing an IPGWx linkset.

Verify that the linkset that will be assigned to the route is not assigned to any existing routes. Enter the `rtrv-rte` command with the name of the linkset that you wish to assign to the route. For this example, enter this command.

```
rtrv-rte:lsn=lsn4
```

If the linkset is not assigned to a route, no entries are displayed in the `rtrv-rte` output as shown in the following output example.

```
rlghncxa03w 06-10-11 11:06:27 GMT EAGLE5 36.0.0
LSN              DPC              RC
```

If the linkset is assigned to a route, add the desired linkset by perform the “Configuring an IPGWx Linkset” procedure in *Database Administration - IP7 User’s Guide* and add the IPGWx linkset to the database. After the IPGWx linkset has been added, continue the procedure with 7.

If the linkset is not assigned to a route, continue the procedure with 7.

7. Add the route using the `ent-rte` command with the IPGWx linkset.

These are the rules that apply to adding a route.

- The `force=yes` parameter must be specified if the linkset being assigned to the route has no signaling links assigned to it. Otherwise, each linkset must have at least one signaling link assigned to it.
- A route can contain only one linkset.
- If the DPC of the route is a member of a cluster point code, and the nested cluster allowed indicator (`ncai` parameter of either the `ent-dstn` or `chg-dstn` command) is set to `no`, then the route to the DPC must be the same as the route to the cluster point code. If the nested cluster allowed indicator is set to `yes`, the route to the member of the cluster does not have to be the same as the route to the cluster point code.
- For routes containing 14-bit ITU National DPCs with group codes, if the linkset assigned to the route has the `MULTGC` value set to `yes`, then 14-bit ITU National DPCs with group codes that are different from the linkset APC group code can be assigned to the route. If the `MULTGC` value is set to `no`, then only 14-bit ITU National DPCs with group codes that are the same as the linkset APC group code can be assigned to the route.
- The DPC of the route must be the APC of the linkset, or the SAPC assigned to the linkset. The DPC of the route must be of the same format as the APC of the linkset being added to the route. That is, a route containing an ANSI DPC must have a linkset with an ANSI APC; a route containing an ITU-I DPC must have a linkset with an ITU-I APC; a route containing a 14-bit ITU-N DPC must have a linkset with a 14-bit ITU-N APC; a route containing a 24-bit ITU-N DPC must have a linkset with a 24-bit ITU-N APC. The DPC of the route must be defined as a true point code in the `rtrv-dstn` output. Cluster point codes, network routing point codes, alias point codes, secondary point codes, and proxy point codes cannot be used. True point codes are shown in the output of the `rtrv-dstn` command in the `DPCA`, `DPCI`, `DPCN`, or `DPCN24` fields. For a linkset with an ITU APC, if that linkset has an SAPC assigned to it, the DPC of the route can be either the APC of the linkset or the SAPC assigned to the linkset. The format of the SAPC can be different from the APC of the linkset. For a linkset with an ITU APC, if that linkset does not have an SAPC assigned to it, the DPC of the route must be the APC of the linkset.
- Private point codes can be specified as the DPC of a route only if the linkset assigned to the route is an IPGWx linkset (a linkset that has the `ipgwapc=yes` parameter assigned to it).

```
ent-rte:dpca=p-004-004-004:lsn=lsn4:rc=10
```

When this command has successfully completed, this message should appear.

```
rlghncxa03w 06-10-07 08:28:30 GMT EAGLE5 36.0.0
ENT-RTE: MASP A - COMPLTD
```

8. Verify the changes using the `rtrv-rte` command, specifying the destination point code of the route.

For this example, enter this command.

```
rtrv-rte:dpca=p-004-004-004
```

This is an example of the possible output.

```
rlghncxa03w 06-10-07 11:43:04 GMT EAGLE5 36.0.0
```

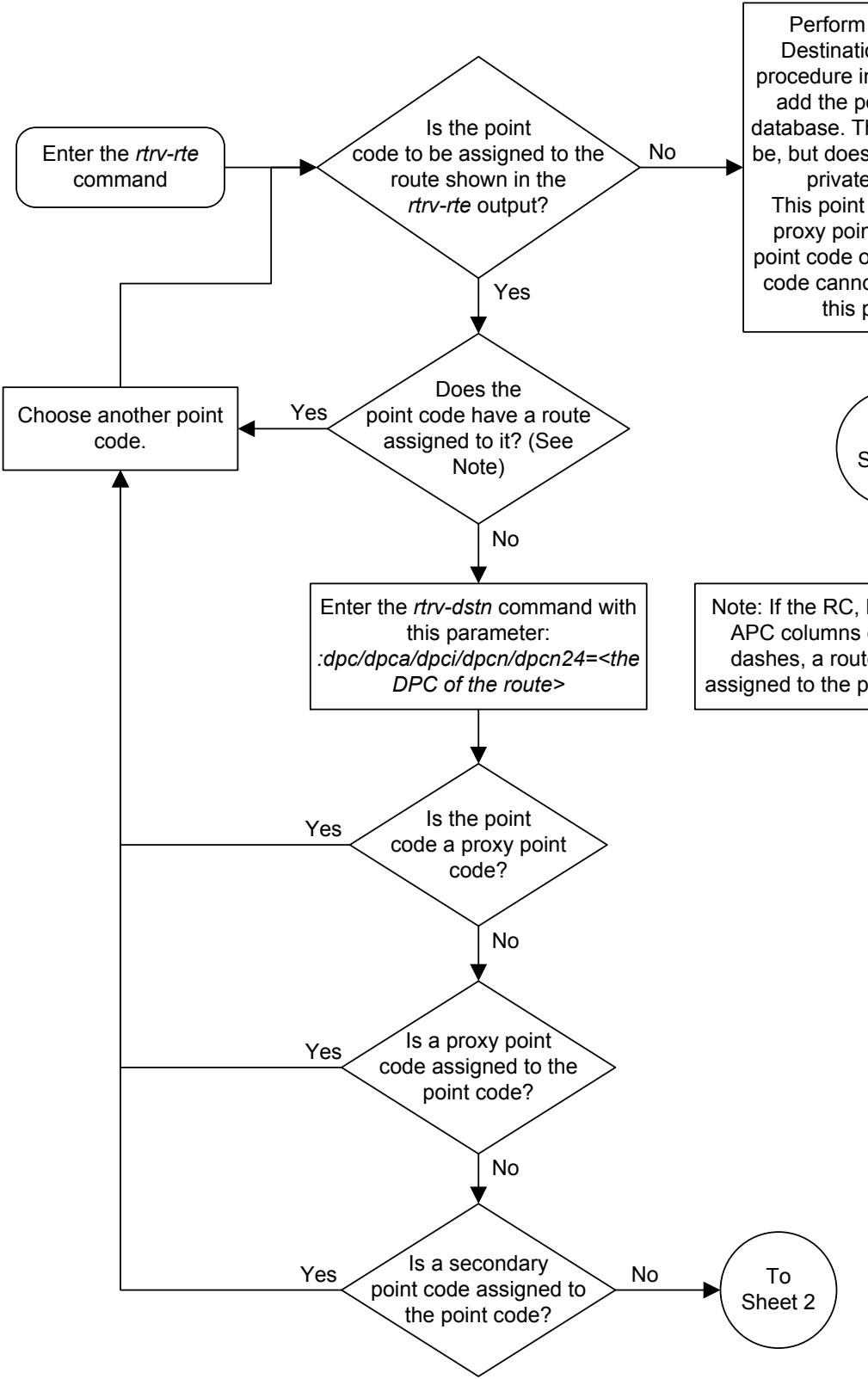
```
      DPCA          ALIASI      ALIASN/N24  LSN      RC      APCA
p-004-004-004 -----  11-12-10-3  lsn4      10  p-004-004-004
                                RTX:No  CLI=-----
```

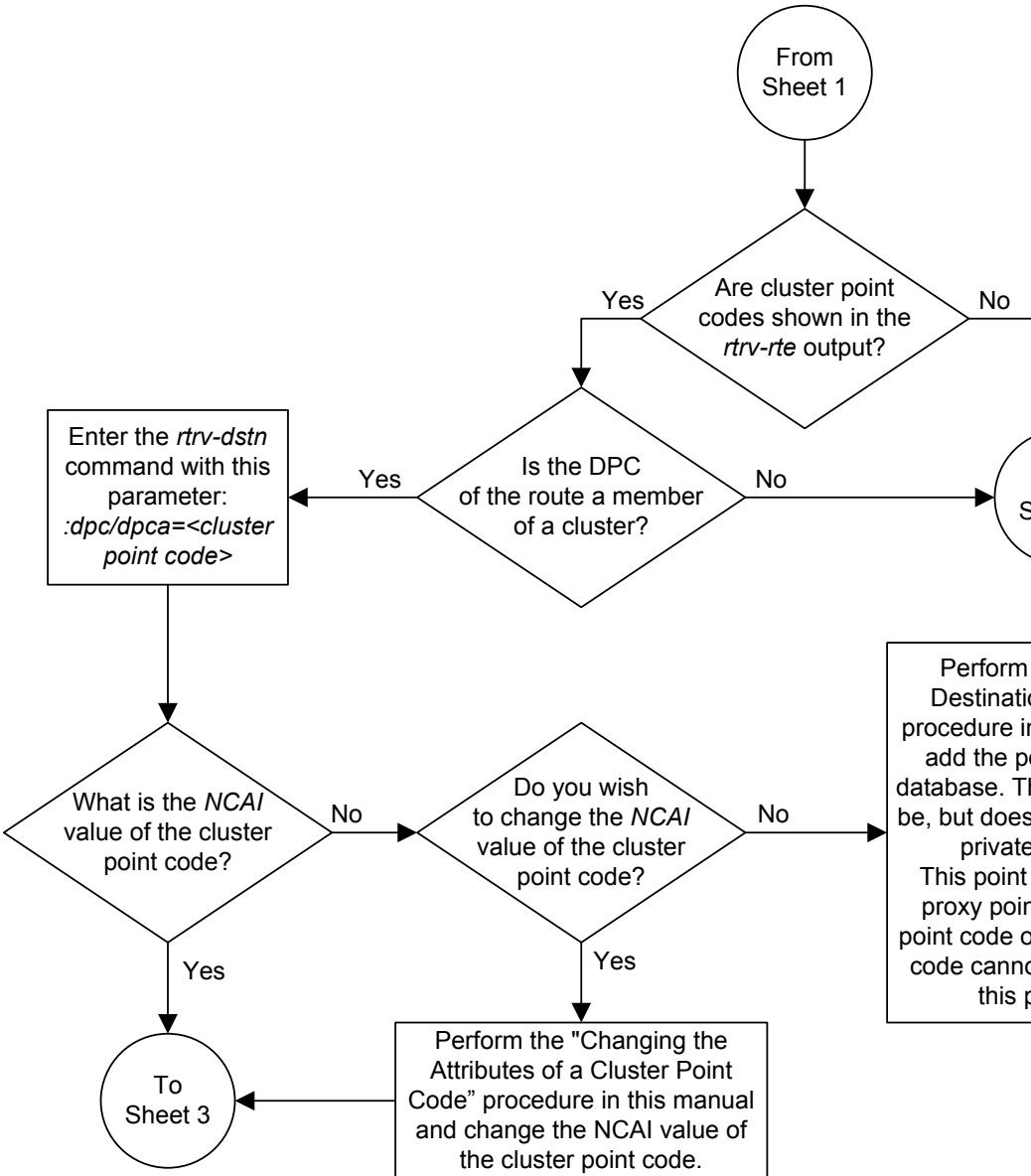
9. Back up the new changes using the `chg-db:action=backup:dest=fixed` command.

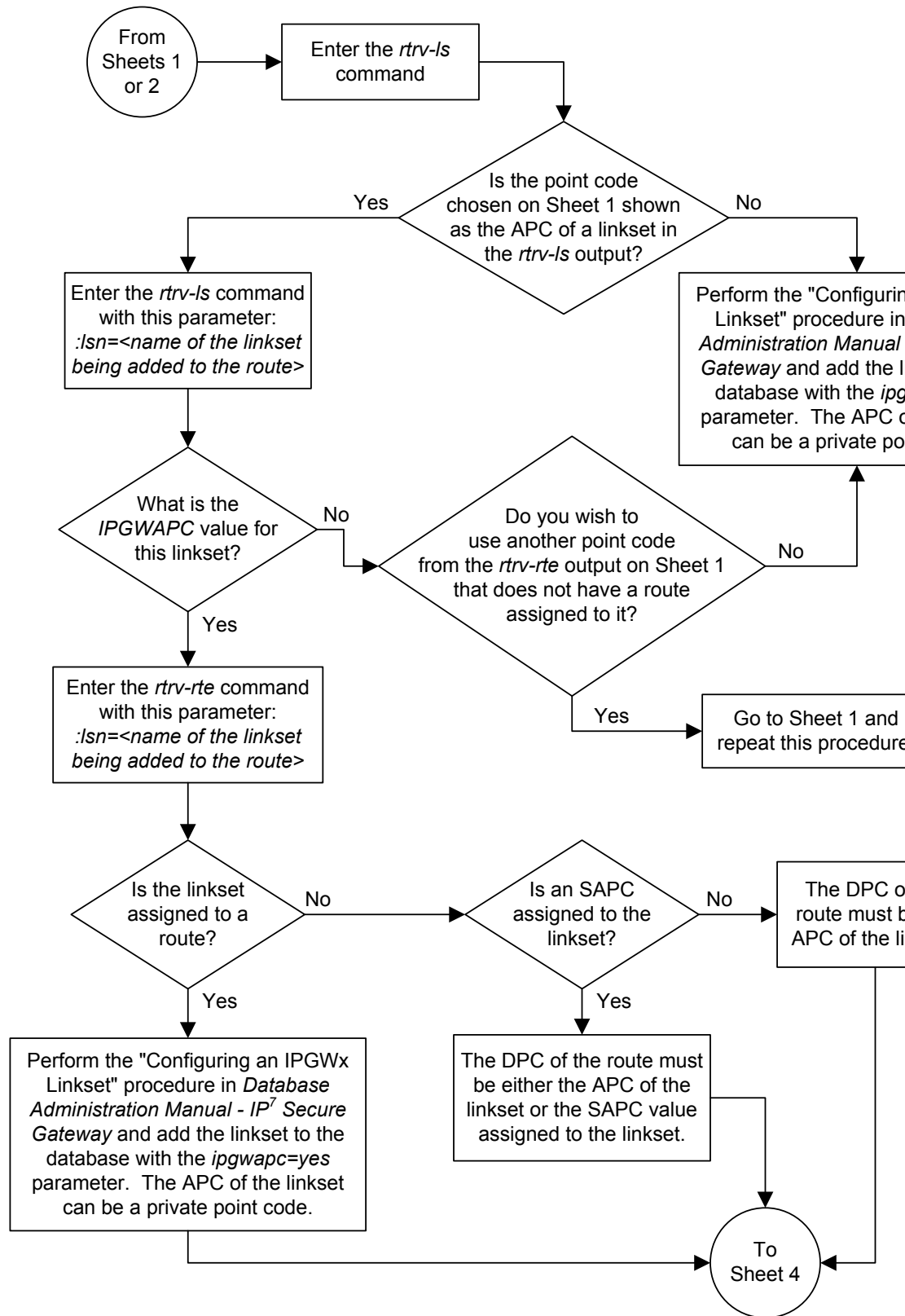
These messages should appear, the active **Maintenance and Administration Subsystem Processor (MASP)** appears first.

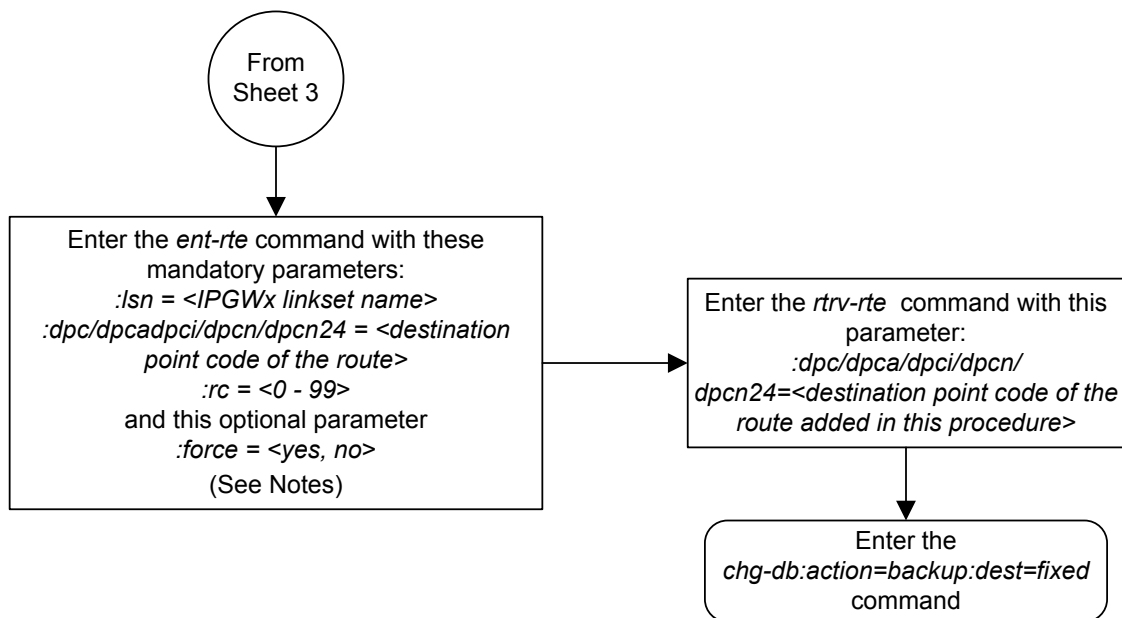
```
BACKUP (FIXED) : MASP A - Backup starts on active MASP.
BACKUP (FIXED) : MASP A - Backup on active MASP to fixed disk complete.
BACKUP (FIXED) : MASP A - Backup starts on standby MASP.
BACKUP (FIXED) : MASP A - Backup on standby MASP to fixed disk complete.
```


Figure 3-20 Adding a Route Containing an IPGWx Linkset









Notes:

1. The *force=yes* parameter must be specified if the linkset being assigned to the route has no signaling links assigned to it. Otherwise, each linkset must have at least one signaling link assigned to it.
2. A route can contain only one linkset.
3. If the DPC of the route is a member of a cluster point code, and the nested cluster allowed indicator (*ncal* parameter of either the *ent-dstn* or *chg-dstn* command) is set to no, then the route to the DPC must be the same as the route to the cluster point code. If the nested cluster allowed indicator is set to yes, the route to the member of the cluster does not have to be the same as the route to the cluster point code.
4. For routes containing 14-bit ITU National DPCs with group codes, if the linkset assigned to the route has the MULTGC value set to yes, then 14-bit ITU National DPCs with group codes that are different from the linkset APC group code can be assigned to the route. If the MULTGC value is set to no, then only 14-bit ITU National DPCs with group codes that are the same as the linkset APC group code can be assigned to the route.
5. The DPC of the route must be the APC of the linkset, or the SAPC assigned to the linkset. The DPC of the route must be of the same format as the APC of the linkset being added to the route. That is, a route containing an ANSI DPC must have a linkset with an ANSI APC; a route containing an ITU-I DPC must have a linkset with an ITU-I APC; a route containing a 14-bit ITU-N DPC must have a linkset with a 14-bit ITU-N APC; a route containing a 24-bit ITU-N DPC must have a linkset with a 24-bit ITU-N APC.

The DPC of the route must be defined as a true point code in the *rtv-dstn* output. Cluster point codes, network routing point codes, alias point codes, secondary point codes, and proxy point codes cannot be used. True point codes are shown in the output of the *rtv-dstn* command in the *DPCA*, *DPCI*, *DPCN*, or *DPCN24* fields.

For a linkset with an ITU APC, if that linkset has an SAPC assigned to it, the DPC of the route can be either the APC of the linkset or the SAPC assigned to the linkset. The format of the SAPC can be different from the APC of the linkset.

For a linkset with an ITU APC, if that linkset does not have an SAPC assigned to it, the DPC of the route must be the APC of the linkset.
6. Private point codes can be specified as the DPC of a route only if the linkset assigned to the route is an IPGWx linkset (a linkset that has the *ipgwapc=yes* parameter assigned to it).

Removing a Route

This procedure is used to remove a route from the database using the `dlt-rte` command.

The `dlt-rte` command uses these parameters.

`:dpc/dpca/dpci/dpcn/dpcn24` – The destination point code of the node shown in the `rtrv-rte` output.

Note: See [Point Code Formats](#) for a definition of the point code types that are used on the EAGLE and for a definition of the different formats that can be used for ITU national point codes.

`:lsn` – The name of the linkset that carries the traffic bound for the node specified by the destination point code.

`:all` – Are all routes associated with the **DPC** to be removed

The route to be removed must exist in the database. This can be verified in [1](#).

The last route to a DPC cannot be removed if it is reference by a mated application or concerned signaling point code group. If this condition exists, the command to remove the route from the database is rejected. Before removing the last route to a DPC from the database, enter the `rtrv-cspc` and `rtrv-map` commands to verify if the DPC to the route being removed from the database is referenced by either mated applications or concerned signaling point code groups. If `rtrv-cspc` command output shows a reference to the DPC of the route being removed by this procedure (in the `PCA`, `PCI`, `PCN`, or `PCN24` fields), perform the "Removing Concerned Signaling Point Codes" procedure in *Database Administration – GTT User's Guide*. If the `rtrv-map` command output shows a reference to the DPC of the route being removed by this procedure (shown in the `PCA`, `PCI`, `PCN`, or `PCN24` fields), perform the "Removing a Mated Application" procedure in *Database Administration – GTT User's Guide*.

The last route to a DPC cannot be removed if it is referenced by a route exception table entry. Use the `rtrv-rtx` command with the DPC value to display the route exception entries that reference the DPC of the route being removed. If route exception table entries reference the DPC of the route being removed, perform the [Removing a Route Exception Entry](#) procedure to remove the route exception table entries that reference the DPC of the route being removed.

The last route to a DPCdestination (**Route DPC**) cannot be removed if that route is referenced by the gateway screening redirect function's DPC parameter. Use the `rtrv-gws-redirect` command to verify the DPC used for the gateway screening redirect function. If the gateway screening redirect function is referencing the destination of the route to be removed from the database, change the gateway screening redirect function's DPC with the "Changing the Gateway Screening Redirect Parameters" procedures in *Database Administration – Features User's Guide*. The gateway screening redirect function can also be disabled by using the "Disabling the Gateway Screening Redirect Function" procedure in *Database Administration – Features User's Guide*.

The last route to a DPC cannot be removed if is referenced in the `rtrv-pct` output as either a `REALPC` or `FILTPC` value. Perform the [Removing a Point Code and CIC](#)

[Translation Entry](#) procedure to remove the point code and CIC entries that reference the DPC of the route.

Either the `lsn` or `all=yes` parameters must be specified with the `dlt-rte` command. If the `all=no` parameter is specified, the `lsn` parameter must be specified. If the `lsn` parameter is specified, the linkset must be defined in the database as a route to the specified route DPC. The linkset name is shown in the `LSN` field of the `rtrv-rte` command output.

The route assigned to a full point code DPC cannot be removed from the database if that DPC is a member of a cluster point code in the database if the network cluster allowed indicator (`ncai` parameter of either the `ent-dstn` or `chg-dstn` command) is set to `no`. If the nested cluster allowed indicator is set to `yes`, the route to the full point code DPC that is a member of a cluster point code can be removed from the database, but the route to the cluster point code will not be removed from the database, even if the cluster point code and the full point code are assigned to the same route. When the route to the member of the cluster point code is removed from the database, the member of the cluster point code assumes all the attributes of the cluster point code and will use the same routes that are assigned to the cluster point code.

If a route assigned to a cluster point code is removed from the database, all routes to any members of that cluster are also removed from the database if the network cluster allowed indicator is set to `no`. If the nested cluster allowed indicator is set to `yes`, the route to the cluster point code can be removed from the database, but any routes to any point codes that are members of the cluster point code remain in the database, even if the cluster point code and its members are assigned to the same route. For more information, refer to the [Nested Cluster Routing](#) section.

The destination point code of the route being removed from the database cannot be in the mated relay node (MRN) table. Verify this by entering the `rtrv-mrn` command, specifying the destination point code of the route being removed from the database. If the destination point code of the route is shown in the `rtrv-mrn` command output, remove the point code from the MRN table, by performing the "Removing an MRN Group or MRN Group Entry" procedure in *Database Administration – GTT User's Guide*.

The destination point code of the route being removed from the database cannot be referenced by a global title translation entry shown in the `rtrv-gtt` or `rtrv-gta` outputs. Verify this by entering the `rtrv-gtt` or `rtrv-gta` command, specifying the destination point code of the route being removed from the database. If the destination point code of the route is shown in the `rtrv-gtt` output, remove the global title translation entry by performing the "Removing a Global Title Translation" procedure in *Database Administration – GTT User's Guide*. If the destination point code of the route is shown in the `rtrv-gta` output, remove the global title translation entry by performing the "Removing Global Title Address Information" procedure in *Database Administration – GTT User's Guide*.

The destination point code of the route being removed from the database cannot be shown in the `rtrv-ppsopts` output. Verify this by entering the `rtrv-ppsopts` command. Any references to the destination point code the `rtrv-ppsopts` output are removed in 12.

If the APC of the linkset assigned to the route being removed is the same as the DPC of the route, this route cannot be removed if a proxy point code is assigned to the DPC of the route, and the linkset assigned to this route contains these attributes:

- The `LST=PRX` parameter value

- The proxy point code that is assigned to the DPC of the route is also assigned to the linkset.

If the DPC of the route contains a proxy point code and the linkset contains the value PRX for the linkset type (LST) and the proxy point code value assigned to the route DPC, and there are other routes assigned to this DPC, the other routes to this DPC must be removed before this route can be removed with the `dlt-rte` command.

The examples in this procedure are used to remove all routes to DPC 003-003-003 from the database.

Canceling the RTRV-RTE Command

Because the `rtrv-rte` command used in this procedure can output information for a long period of time, the `rtrv-rte` command can be canceled and the output to the terminal stopped. There are three ways that the `rtrv-rte` command can be canceled.

- Press the F9 function key on the keyboard at the terminal where the `rtrv-rte` command was entered.
- Enter the `canc-cmd` without the `trm` parameter at the terminal where the `rtrv-rte` command was entered.
- Enter the `canc-cmd:trm=<xx>`, where `<xx>` is the terminal where the `rtrv-rte` command was entered, from another terminal other than the terminal where the `rtrv-rte` command was entered. To enter the `canc-cmd:trm=<xx>` command, the terminal must allow Security Administration commands to be entered from it and the user must be allowed to enter Security Administration commands. The terminal's permissions can be verified with the `rtrv-secu-trm` command. The user's permissions can be verified with the `rtrv-user` or `rtrv-secu-user` commands.

For more information about the `canc-cmd` command, go to *Commands User's Guide*.

1. Display the current route configuration using the `rtrv-rte` command. This is an example of the possible output.

```
rlghncxa03w 10-12-10 11:43:04 GMT EAGLE5 43.0.0
Extended Processing Time may be Required

      DPCA          ALIASI      ALIASN/N24      LSN      RC      APCA
001-002-003 -----
                                ls04      10      001-002-003
                                RTX:No   CLLI=ls04clli
002-002-100 -----
                                ls01      10      002-002-100
                                ls02      20      004-004-004
                                ls03      30      003-003-003
                                RTX:No   CLLI=ls01clli
002-007-008 -----
                                ls06      10      002-007-008
                                RTX:No   CLLI=ls06clli
002-009-003 -----
                                ls05      10      002-009-003
                                RTX:No   CLLI=-----
003-003-003 -----
                                ls03      10      003-003-003
                                ls01      20      002-002-100
                                ls02      30      004-004-004
                                RTX:No   CLLI=ls03clli
004-004-004 -----
                                ls02      10      004-004-004
                                ls01      20      002-002-100
                                ls03      30      003-003-003
                                RTX:No   CLLI=ls02clli
009-002-003 -----
                                ls07      10      009-002-003
```

```

RTX:No  CLLI=-----
140-012-004  1-111-1  11121  ls000001  10  240-012-002
ls000002  10  240-012-003
ls000003  20  240-012-004
ls000004  30  240-012-005
ls000005  40  240-012-006
ls000006  50  240-012-007
RTX:No  CLLI=dp1
140-012-005  1-111-2  11122  ls000001  10  240-012-002
ls000002  10  240-012-003
ls000003  20  240-012-004
ls000004  30  240-012-005
ls000005  40  240-012-006
ls000006  50  240-012-007
RTX:No  CLLI=dp2
179-100-087  -----  -----  atmansi0  10  179-100-087
RTX:No  CLLI=-----
200-050-176  -----  -----  atmansi1  10  200-050-176
RTX:No  CLLI=-----

DPCI      ALIASN/N24      ALIASA      LSN      RC      APC
2-234-5    11-13-3-3        240-111-111  ls100001  10  1-234-5
ls100002  10  1-234-6
ls100003  20  1-234-7
ls100004  30  1-234-1
ls100005  40  1-234-2
ls100006  50  1-234-3
RTX:No  CLLI=idp1
3-150-4    -----  -----  lsi7      10  3-150-4
RTX:No  CLLI=lsi7c11i

DPCN      ALIASA      ALIASI      LSN      RC      APC
10685     -----  -----  lsn5      10  10685
RTX:No  CLLI=lsi5c11i
13111     011-222-111  0-001-1    ls200001  10  11111
ls200002  10  11112
ls200003  20  11113
ls200004  30  11114
ls200005  40  11115
ls200006  50  11116
RTX:No  CLLI=ndp1

DPCN24      ALIASA      ALIASI      LSN      RC      APC

```

2. Verify that the **GTT** feature is on, by entering the `rtrv-feat` command. If the GTT feature is on, the GTT field should be set to on.

Note: The `rtrv-feat` command output contains other fields that are not used by this procedure. If you wish to see all the fields displayed by the `rtrv-feat` command, see the `rtrv-feat` command description in *Commands User's Guide*.

If the GTT feature is off, continue the procedure with [13 #GUID-B7525B57-48D1-4B99-8E3C-4DF18124466D/V709422](#).

If the GTT feature is on, continue the procedure with [3](#).

3. Display the mated applications in the database, using the `rtrv-map` command and the DPC of the route being removed from the database. For this example, enter this command.

```
rtrv-map:pca=003-003-003
```

This is an example of the possible output.

```
rlghncxa03w 09-07-25 09:42:31 GMT EAGLE5 41.1.0

PCA          Mate PCA      SSN RC MULT SRM MRC GRP NAME SSO
003-003-003          252 10  SOL *N  *N  GRP01  OFF

MAP TABLE IS (5 of 1024) 1 % FULL
```

If the DPC of the route is shown in the `rtrv-map` command output (in the PCA, PCI, PCN, PCN24, MPCA, MPCI, MCPN, or MPCN24 fields), perform the "Removing a Mated Application" procedure in *Database Administration – GTT User's Guide*, to remove the remove the point code from the mated application that references the DPC of the route.

4. Display the group names in the database using the `rtrv-cspc` command.

This is an example of the possible output.

```
rlghncxa03w 06-10-07 00:27:31 GMT EAGLE5 36.0.0
CSPC GRP  NETWORK          PERCENT FULL
GRP01     ANSI             3%
GRP02     ITU-I             81%
GRP03     ITU-N             54%
GRP04     ANSI             42%
GRP05     ANSI             15%
GRP10     ANSI             15%
GRP15     ANSI             15%
```

5. Display the point codes in the **CSPC** group shown in 4, in the GRP NAME field, using the `rtrv-cspc` command with the CSPC group name whose point codes are the same network type as the DPC of the route being removed.

Repeat this step until all CSPC groups with the same network type as the DPC of the route have been displayed. For this example, enter this command.

```
rtrv-cspc:grp=grp01
```

This is an example of the possible output.

```
rlghncxa03w 06-10-07 00:28:31 GMT EAGLE5 36.0.0
CSPC GRP  PC          TYPE
GRP01     003-003-003  A
          009-009-009  A
```

If the DPC of the route is in the CSPC group, perform the "Removing Concerned Signaling Point Codes" procedure in *Database Administration – GTT User's Guide* to remove the point code from the CSPC group that references the DPC of the route.

6. Display the status of the Intermediate GTT Load Sharing (IGTTLS) controlled feature by entering this command.

```
rtrv-ctrl-feat:partnum=893006901
```

The following is an example of the possible output.

```
rlghncxa03w 06-10-28 21:15:37 GMT EAGLE5 36.0.0
The following features have been permanently enabled:
```

Feature Name	Partnum	Status	Quantity
INTERMED GTT LOAD SHARING	893006901	off	----

The following features have been temporarily enabled:

Feature Name	Partnum	Status	Quantity	Trial Period Left
Zero entries found.				

The following features have expired temporary keys:

Feature Name	Partnum
Zero entries found.	

If the IGTTLS feature is not enabled, continue the procedure with [8 #GUID-B7525B57-48D1-4B99-8E3C-4DF18124466D/V709422](#).

If the IGTTLS feature is enabled, continue the procedure with [7](#).

7. Display the mated relay node (MRN) groups in the database, using the `rtrv-mrn` command, specifying the destination point code of the route that is being removed from the database. For this example, enter this command.

```
rtrv-mrn:pca=003-003-003
```

This is an example of the possible output.

```
rlghncxa03w 10-07-07 00:34:31 GMT EAGLE5 42.0.0
```

PC	RC
003-003-003	10
008-001-001	20
240-012-007	30
008-001-003	40
008-001-004	50
008-001-005	60
008-001-006	70
008-001-007	80
008-001-008	90

```
MRN table is (39 of 3000) 1% full.
```

If the DPC of the route is not shown in the `rtrv-mrn` output in this step, continue the procedure with [8](#).

If the DPC of the route is shown in the `rtrv-mrn` output in this step, perform the "Removing an MRN Group or MRN Group Entry" procedure in *Database Administration – GTT User's Guide*, and remove the remove the point code from the MRN group that references the DPC of the route. After the point code has been removed from the MRN group, continue the procedure with [8](#).

8. Display the translation types in the database using the `rtrv-tt` command.

This is an example of the possible output.

```

rlghncxa03w 10-07-25 09:42:31 GMT EAGLE5 42.0.0
TYPEA      TTN      NDGT
1          lidb     5
2          c800    10
3          d700    6
5          scp1    6
10         scp2    6
15         scp3    3

ALIAS      TYPEA
30         5
40         10
50         3
65         3

TYPEI      TTN      NDGT
105       itudb    8

ALIAS      TYPEI
7         105

TYPEN      TTN      NDGT
120       dbitu    7

ALIAS      TYPEN
8         120

```

9. Display the global title translations in the database using the `rtrv-gtt` command specifying a translation type from the `rtrv-tt` command output shown in 8, and the DPC of the route from the database.

For this example, enter this command.

```
rtrv-gtt:typea=10:pca=003-003-003
```

This is an example of the possible output.

```

rlghncxa03w 10-07-25 09:43:31 GMT EAGLE5 42.0.0
TYPEA  TTN      NDGT
10     scp2    6

GTT TABLE IS  10 % FULL    (27000 of 269999)

START GTA          END GTA          XLAT  RI      PC
615370            615380            DPCSSN SSN    003-003-003
      MAPSET=6      SSN=254 NGT=---

```

Command Retrieved 1 Entries

Repeat this step for each translation type shown in 8.

If the `rtrv-gtt` output shows any entries, perform the "Removing a Global Title Translation" procedure in *Database Administration – GTT User's Guide* to remove the entries shown in this step.

If the `rtrv-gtt` output shows no entries or the "Removing a Global Title Translation" procedure was performed, continue the procedure with 10.

10. Display the GTT sets in the database using the `rtrv-gttset` command.

This is an example of the possible output.

```
rlghncxa03w 10-07-07 00:27:31 GMT EAGLE5 42.0.0
GTTSN      NETDOM  NDGT
lidx       ansi    10
t800       ansi    10
si000      itu     15
imsi       itu     15
abcd1234   itu     12
```

GTT-SET table is (5 of 2000) 1% full.

11. Display the global title address (GTA) information for a GTT set from 10.

Use the `rtrv-gta` command with the `gttsn` parameter value shown in 10, and with the DPC of the route that is being removed from the database. For this example, enter this command.

```
rtrv-gta:gttsn=t800:pca=003-003-003
```

This is an example of the possible output.

```
rlghncxa03w 10-07-07 00:27:31 GMT EAGLE5 42.0.0
GTTSN      NETDOM  NDGT
t800       ansi    10
GTA TABLE IS 1 % FULL (17 of 269999)

START GTA  END GTA   XLAT  RI    PC
3365840000 3365849999 dpc   ssn   003-003-003
          MAPSET=6   SSN=0   CCGT=no NTT=---
```

Command Retrieved 1 Entries

Repeat this step for each GTT set name type shown in 10.

If the `rtrv-gta` output shows any entries, perform the "Removing Global Title Address Information" procedure in *Database Administration – GTT User's Guide* to remove the entries shown in this step.

If the `rtrv-gta` output shows no entries or the "Removing Global Title Address Information" procedure was performed, continue the procedure with 12.

12. Enter the `rtrv-ppsopts` command to verify that the DPC of the route is not shown in the `rtrv-ppsopts` output. This is an example of the possible output.

```
rlghncxa03w 10-07-20 09:07:58 GMT EAGLE5 42.0.0
Prepaid SMS Options
-----
BPARTYCHK      = OFF
PPT            PCA/PCI/PCN                SSN      RI      Set ID
---            -
1             PCI:    1-001-1                    25      SSN     DFLT
2             -----                    NONE     GT      DFLT
3             -----                    NONE     GT      DFLT
4             PCI:    003-003-003                30      GT      1
5             -----                    NONE     GT      DFLT
6             -----                    NONE     GT      DFLT
7             -----                    NONE     GT      DFLT
8             PCI:    1-001-1                    75      SSN     1
9             -----                    NONE     GT      DFLT
```

Note: If the Flexible GTT Load Sharing feature is not enabled, the Set ID column is not displayed in the `rtrv-ppsopts` output.

If the `rtrv-ppsopts` output shows any entries that reference the DPC of the route, remove the reference using the `chg-ppsopts` command with the prepaid portability type (the `PPT` value) that contains the reference and either the `pci=none` or `pcn=none` parameters (depending on the type of point code the prepaid portability type contains).

```
chg-ppsopts:ppt=4:pci=none
```

This is an example of the possible output.

```
rlghncxa03w 07-05-20 09:07:58 GMT EAGLE5 37.0.0
CHG-PPSOPTS: MASP A - COMPLTD
```

Repeat this step for other entries shown in the `rtrv-ppsopts` output that reference the DPC of the route.

13. Verify whether or not the DPC of the route is referenced by the gateway screening redirect function by entering the `rtrv-gws-redirect` command.

The following is an example of the possible output.

```
rlghncxa03w 09-05-07 00:17:31 GMT EAGLE5 41.0.0
ENABLED   DPCA      RI   SSN  TT   GTA
on        003-003-003  GT   15   225  9105551212
```

If the DPC of the route is shown in the `DPCA` field, perform the "Changing the Gateway Screening Redirect Parameters" procedure in *Database Administration – Features User's Guide* to change the gateway screening redirect function's DPC.

14. If the APC of the linkset assigned to the route being removed is the same as the DPC of the route, this route cannot be removed if a proxy point code is assigned to the DPC of the route, and the linkset assigned to this route contains these attributes.

- The `LST=PRX` parameter value
- The proxy point code that is assigned to the DPC of the route is also assigned to the linkset.

A quantity of proxy point codes must be enabled for a proxy point code to be assigned to the DPC of the route and to the linkset, and for the linkset type to be `PRX` (`LST=PRX`). Enter this command to verify whether or not a proxy point code quantity is enabled.

```
rtrv-ctrl-feat:partnum=893018701
```

The following is an example of the possible output.

```
rlghncxa03w 06-10-28 21:15:37 GMT EAGLE5 36.0.0
The following features have been permanently enabled:
```

Feature Name	Partnum	Status	Quantity
Proxy Point Code	893018701	on	20

The following features have been temporarily enabled:

Feature Name	Partnum	Status	Quantity	Trial Period Left
Zero entries found.				

The following features have expired temporary keys:

Feature Name	Partnum
Zero entries found.	

If a proxy point code quantity is not enabled, continue the procedure by performing one of these steps.

- If the route that is being removed is not the last route to the DPC, continue the procedure by performing one of these steps.
 - If the DPC of the route is not an ANSI point code, continue the procedure with one of these steps.
 - Perform [19](#) if the RTX value of the route, shown in [1](#) is yes.
 - Perform [21](#) if the RTX value of the route is no.
 - If the DPC of the route is an ANSI point code, continue the procedure with [18](#).
- If the route that is being removed is the last route to the DPC, continue the procedure with [17](#).

If a proxy point code quantity is enabled, continue the procedure with [15](#).

- 15.** Verify if a proxy point code is assigned to the DPC of the route. Enter the `rtrv-dstn` command with the DPC of the route. For this example, enter this command.

```
rtrv-dstn:dpca=003-003-003
```

The following is an example of the possible output.

```
rlghncxa03w 10-12-14 09:13:33 GMT EAGLE5 43.0.0

DPCA          CLLI          BEI ELEI    ALIASI          ALIASN/N24    DMN
003-003-003   rlghncbb334  no  ---    1-112-3        10-13-10-1    SS7

PPCA          NCAI PRX      RCAUSE NPRST  SPLITIAM  HMSMSC  HMSCP  SCCPMSGCNV
010-010-010  ---- no       none  off   none    no     no     none
```

```
Destination table is (13 of 2000) 1% full
Alias table is (0 of 12000) 0% full
PPC table is (2 of 10) 20% full
```

If a proxy point code is not assigned to the DPC of the route, continue the procedure by performing one of these steps.

- If the route that is being removed is not the last route to the DPC, continue the procedure by performing one of these steps.
 - If the DPC of the route is not an ANSI point code, continue the procedure with one of these steps.
 - Perform [19](#) if the RTX value of the route, shown in [1](#) is yes.

- Perform [21](#) if the RTX value of the route is no.
- If the DPC of the route is an ANSI point code, continue the procedure with [18](#).
- If the route that is being removed is the last route to the DPC, continue the procedure with [17](#).

If a proxy point code is assigned to the DPC of the route, continue the procedure with [16](#).

- 16.** Verify the attributes of the linkset assigned to the route being removed by entering the `rtrv-ls` command with the name of the linkset. For this example, enter this command.

```
rtrv-ls:lsn=ls03
```

The following is an example of the possible output.

```
rlghncxa03w 07-08-14 09:24:36 EST 37.0.0
```

LSN	APCA (SS7)	SCRN	SET	SET	BEI	LST	LNKS	ACT	MES	DIS	SLSCI	NIS
ls03	003-003-003	none	1	1	no	PRX	0	off	off	off	no	off
	PPCA	CLLI				TFATCABMLQ		MTPRSE	ASL8			
	010-010-010	-----				1		---	no			
	IPGWAPC	MATELSN	IPTPS	LSUSEALM	SLKUSEALM	GTTMODE						
	no	-----	---	---	---	CdPA						

Link set table is (9 of 1024) 1% full.

If the linkset contains the value PRX for the linkset type (LST) and the proxy point code value shown in [15](#), the other routes to this DPC must be removed before this route can be removed in [21](#).

Whether or not the linkset contains the PRX linkset type and the proxy point code value shown in [15](#), continue the procedure by performing one of these steps.

- If the route that is being removed is not the last route to the DPC, continue the procedure by performing one of these steps.
 - If the DPC of the route is not an ANSI point code, continue the procedure with one of these steps.
 - Perform [19](#) if the RTX value of the route, shown in [1](#) is yes.
 - Perform [21](#) if the RTX value of the route is no.
 - If the DPC of the route is an ANSI point code, continue the procedure with [18](#).
- If the route that is being removed is the last route to the DPC, continue the procedure with [17](#).

- 17.** Display the PCT (point code and CIC translation) entries by entering the `rtrv-pct` command.

This is an example of the possible output.

```

rlghncxa03w 10-12-17 16:02:05 GMT EAGLE5 43.0.0

      EPCA          FILTPCA          REALPCA          SI  SSN  RELCAUSE
      001-001-001    *                002-002-002    5  ---  10

      ECICS = 10          ECICE = 20
      RCICS = 30          RCICE = 40

      001-001-001    *                003-003-003    5  ---  20

      ECICS = 70          ECICE = 80
      RCICS = 90          RCICE = 90

      006-006-006    003-003-003    020-020-020    3  200  ---

      ECICS = -----  ECICE = -----
      RCICS = -----  RCICE = -----

      007-007-007    009-009-009    008-008-008    3  135  ---

      ECICS = -----  ECICE = -----
      RCICS = -----  RCICE = -----

      007-007-007    010-010-010    008-008-008    5  ---  50

      ECICS = 200          ECICE = 224
      RCICS = 300          RCICE = 324

      EPCI          FILTPCI          REALPCI          SI  SSN  RELCAUSE
      1-001-2        2-002-2        2-002-2        3  10  ---

      ECICS = -----  ECICE = -----
      RCICS = -----  RCICE = -----

      EPCN          FILTPCN          REALPCN          SI  SSN  RELCAUSE
      00300          *                00200          *  ---  ---

      ECICS = -----  ECICE = -----
      RCICS = -----  RCICE = -----

```

```

Unique EPC      is 4 of 250
Unique RealPC  is 5 of 250

PCT table is (6 of 1000) 1% full.

```

If the DPC of the route is shown in the `rtrv-pct` output, perform the [Removing a Point Code and CIC Translation Entry](#) procedure to remove the PCT entries whose REALPC or FILTPC values are the DPC of the route.

If the DPC of the route is not shown in the `rtrv-pct` output, or the [Removing a Point Code and CIC Translation Entry](#) procedure was performed, continue the procedure by performing one of these steps.

- If the DPC of the route is not an ANSI point code, continue the procedure with one of these steps.
 - Perform [19](#) if the RTX value of the route, shown in [1](#) is yes.
 - Perform [21](#) if the RTX value of the route is no.

- If the DPC of the route is an ANSI point code, continue the procedure with [18](#).
- 18.** Verify whether or not the DPC of the route is a member of a cluster point code by entering the `rtrv-rte` command with these parameters and values.
- The `dpca` parameter containing the network and cluster values of the DPC of the route.
 - Three asterisks (***) for the network-cluster member value of the point code.
 - The `mode=full` parameter.

For this example, enter this command.

```
rtrv-rte:dpca=003-003-***:mode=full
```

This is an example of the possible output.

```
rlghncxa03w 10-12-17 16:00:32 GMT EAGLE5 43.0.0
```

DPCA	ALIASI	ALIASN/N24 LSN	RTX RC	CLLI APCA
003-003-*	-----	-----	No	-----
		ls1	1	002-002-002
		ls2	2	003-003-003
003-003-003	1-112-3	10-13-10-1	Yes	-----
		ls1	1	002-002-002
		ls2	2	003-003-003
	OPCA			
	011-011-011	ls3	1	004-004-004
003-003-200	1-117-3	10-13-11-1	Yes	-----
		ls1	1	002-002-002
		ls2	2	003-003-003
	OPCA			
	010-010-010	ls3	1	004-004-004
003-003-225	-----	-----	Yes	-----
		ls1	1	002-002-002
		ls2	2	003-003-003

If the DPC of the route is not a member of a cluster point code, continue the procedure by performing one of these steps.

- Perform [19](#) if the RTX value of the route, shown in RTX field of the `rtrv-rte` output in [1](#), is `yes` and the last route to the DPC of the route is being removed.
- Perform [21](#) if these either of these conditions are present.
 - The RTX value of the route is `no`.
 - The RTX value of the route is `yes` and the last route to the DPC is not being removed.

If the DPC of the route is a member of a cluster point code, continue the procedure with [20](#).

19. Display the route exception table entries referencing the DPC of the route by entering the `rtrv-rtx` command with the DPC of the route being removed in this procedure. For this example, enter this command.

```
rtrv-rtx:dpca=003-003-003
```

```
rlghncxa03w 10-12-07 00:34:31 GMT EAGLE5 43.0.0
```

DPCA	RTX-CRITERIA	LSN	RC	APC
003-003-003	OPCA 007-007-007	ls01	1	002-002-100

```

DESTINATION ENTRIES ALLOCATED: 2000
  FULL DPC(s): 40
  EXCEPTION DPC(s): 1
  TOTAL DPC(s): 41
  CAPACITY (% FULL): 1%
ALIASES ALLOCATED: 12000
  ALIASES USED: 0
  CAPACITY (% FULL): 0%
    
```

If the DPC of the route being removed in this procedure is shown in the `rtrv-rtx` output, perform the [Removing a Route Exception Entry](#) procedure to remove all the route exception table entries shown in this step. After the exception routes have been removed, continue the procedure with [21](#).

20. Display the attributes of the cluster point code by entering the `rtrv-dstn` command with the cluster point code value shown in [18](#). For this example, enter this command.

```
rtrv-dstn:dpca=003-003-*
```

This is an example of the possible output.

```
rlghncxa03w 10-12-28 21:16:37 GMT EAGLE5 43.0.0
```

DPCA	CLLI	BEI	ELEI	ALIASI	ALIASN/N24	DMN
003-003-*	rlghncbb333	yes	no	-----	-----	SS7

SPCA	NCAI	RCAUSE	NPRST	SPLITIAM	HMSMSC	HMSCP	SCCPMSGCNV
-----	no	none	off	none	no	no	none

```
Destination table is (11 of 2000) 1% full
```

```
Alias table is (6 of 8000) 1% full
```

To remove all the routes to the cluster point code and all the routes to the members of the cluster point code (shown in [18](#)) with the `all=yes` parameter of the `dlt-rte` command, the NCAI value of the cluster point code must be no. Perform the [Changing the Attributes of a Cluster Point Code](#) procedure to change the NCAI value of the cluster point code to no if required. The RTX=yes value in the `rtrv-rte` output shows that exception routes reference the DPC of the route. To remove the routes to the members of the cluster point code, the exception routes that reference the DPC of the routes must be removed. Perform the [Removing a Route Exception Entry](#) procedure to remove the exception routes shown in the `rtrv-rte` output in [18](#). After the NCAI value has been verified and changed in necessary, and any exception routes have been removed if necessary, continue the procedure with

21 specifying the cluster point code that was specified in this step and with the `all=yes` parameter.

To remove all the routes to the cluster point code and without removing all the routes to the members of the cluster point code (shown in 18) with the `all=yes` parameter of the `dlt-rte` command, the NCAI value of the cluster point code must be `yes`. Perform the [Changing the Attributes of a Cluster Point Code](#) procedure to change the NCAI value of the cluster point code to `yes` if required. After the NCAI value has been verified and changed in necessary, continue the procedure with 21 specifying the cluster point code that was specified in this step and with the `all=yes` parameter.

To remove a single route to the cluster point code or a route to a member of the cluster point code (shown in 18) with the `lsn` parameter of the `dlt-rte` command, the NCAI value of the cluster point code must be `yes`. Perform the [Changing the Attributes of a Cluster Point Code](#) procedure to change the NCAI value of the cluster point code to `yes` if required. The `RTX=yes` value in the `rtrv-rte` output shows that exception routes reference the DPC of the route. To remove the last route to the member of the cluster point code, the exception routes that reference the DPC of the route must be removed. Perform the [Removing a Route Exception Entry](#) procedure to remove the exception routes shown in the `rtrv-rte` output in 18. After the NCAI value has been verified and changed in necessary, and any exception routes have been removed if necessary, continue the procedure with 21 specifying the DPC of the route and with the `lsn` parameter.

21. Remove the routes from the database using the `dlt-rte` command. For this example, enter this command.

```
dlt-rte:dpca=003-003-003:all=yes
```

A specific route to a DPC can be removed from the database. To do this, specify the `lsn` parameter instead of the `all` parameter and the linkset name of the route you wish to remove. For this example, enter this command.

```
dlt-rte:dpca=003-003-003:lsn=ls03
```

If the linkset contains the value `PRX` for the linkset type (`LST`) (shown in 16) and the proxy point code value shown in 15, the other routes to this DPC must be removed before this route can be removed in this step. For this example, enter the `dlt-rte` command with the `lsn` parameter to remove the linksets `ls01` and `ls02` from route DPC `003-003-003`, before removing linkset `ls03`. For this example, enter these commands.

```
dlt-rte:dpca=003-003-003:lsn=ls01
```

```
dlt-rte:dpca=003-003-003:lsn=ls02
```

```
dlt-rte:dpca=003-003-003:lsn=ls03
```

If the NCAI field value in 20 is `no`, and was not changed, enter the `dlt-rte` command specifying the cluster point code as the value of the `dpca` parameter. For this example, enter this command.

```
dlt-rte:dpca=003-003-*:all=yes
```

When either of these commands have successfully completed, this message should appear.

```
rlghncxa03w 06-10-07 08:45:54 GMT EAGLE5 36.0.0
DLT-RTE: MASP A - COMPLTD
```

22. Verify the changes using the `rtrv-rte` command, specifying the destination point code of the route. For this example, enter this command.

```
rtrv-rte:dpc=003-003-003
```

If all routes to the DPC were removed in 21, this is an example of the possible output.

```
rlghncxa03w 06-10-10 11:43:04 GMT EAGLE5 36.0.0
  DPCA          ALIASI      ALIASN/N24   LSN          RC      APCA
  003-003-003  -----
                                     RTX:No  CLLI=ls03c1li
```

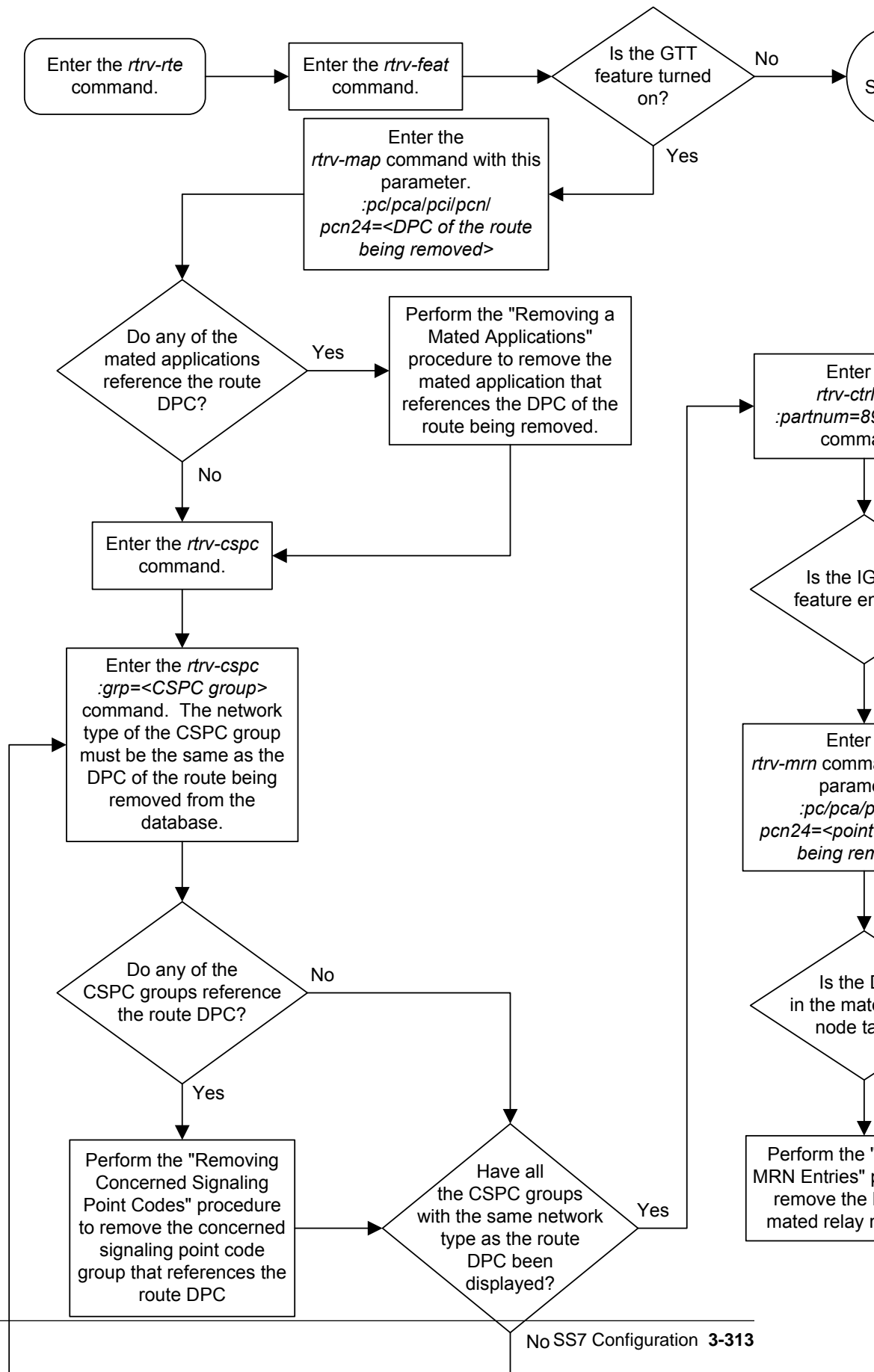
If a specific route to the DPC was removed in 21, this is an example of the possible output.

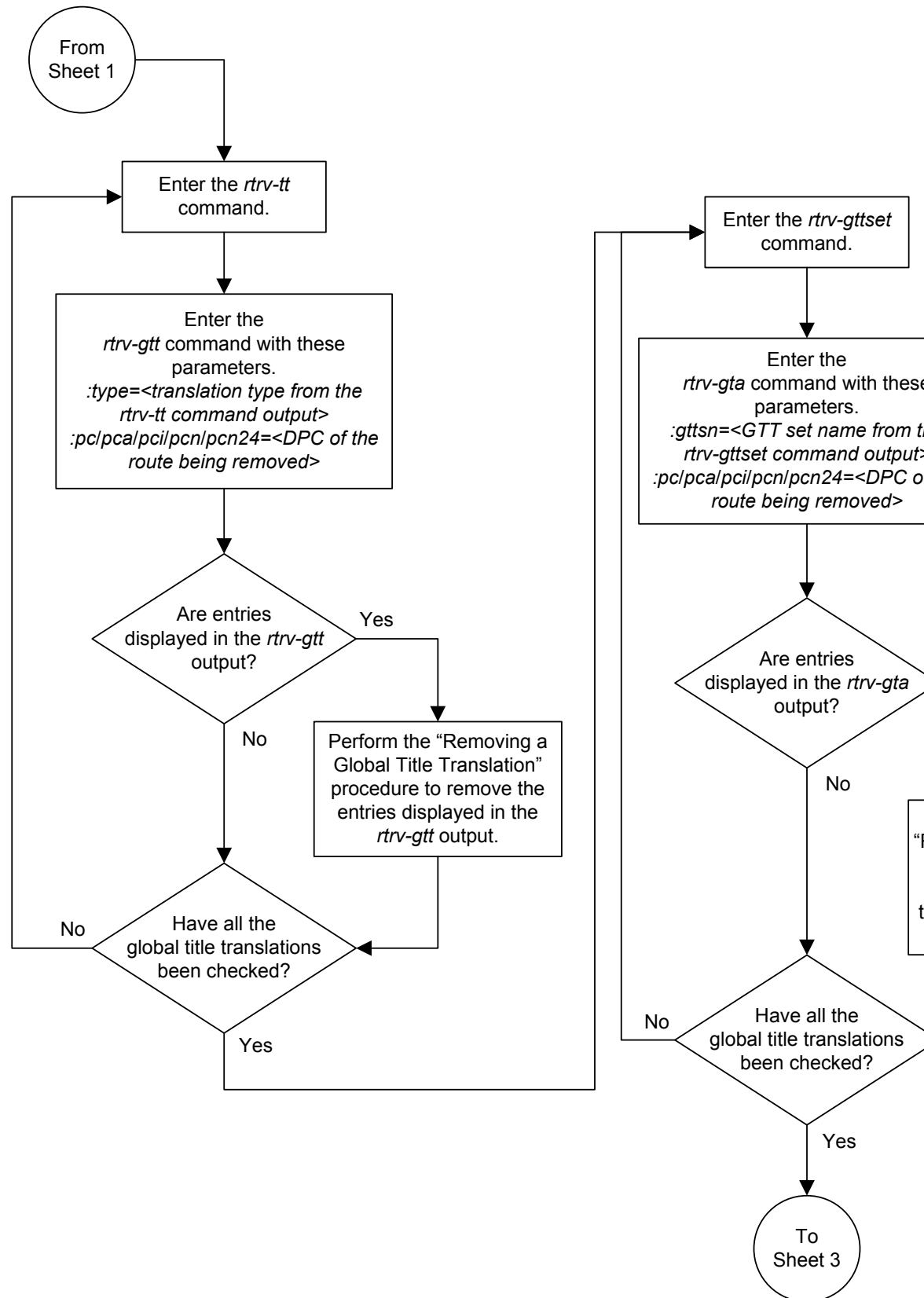
```
rlghncxa03w 06-10-10 11:43:04 GMT EAGLE5 36.0.0
  DPCA          ALIASI      ALIASN/N24   LSN          RC      APCA
  003-003-003  -----
                                     ls01        20      002-002-002
                                     ls02        30      004-004-004
                                     RTX:No  CLLI=ls03c1li
```

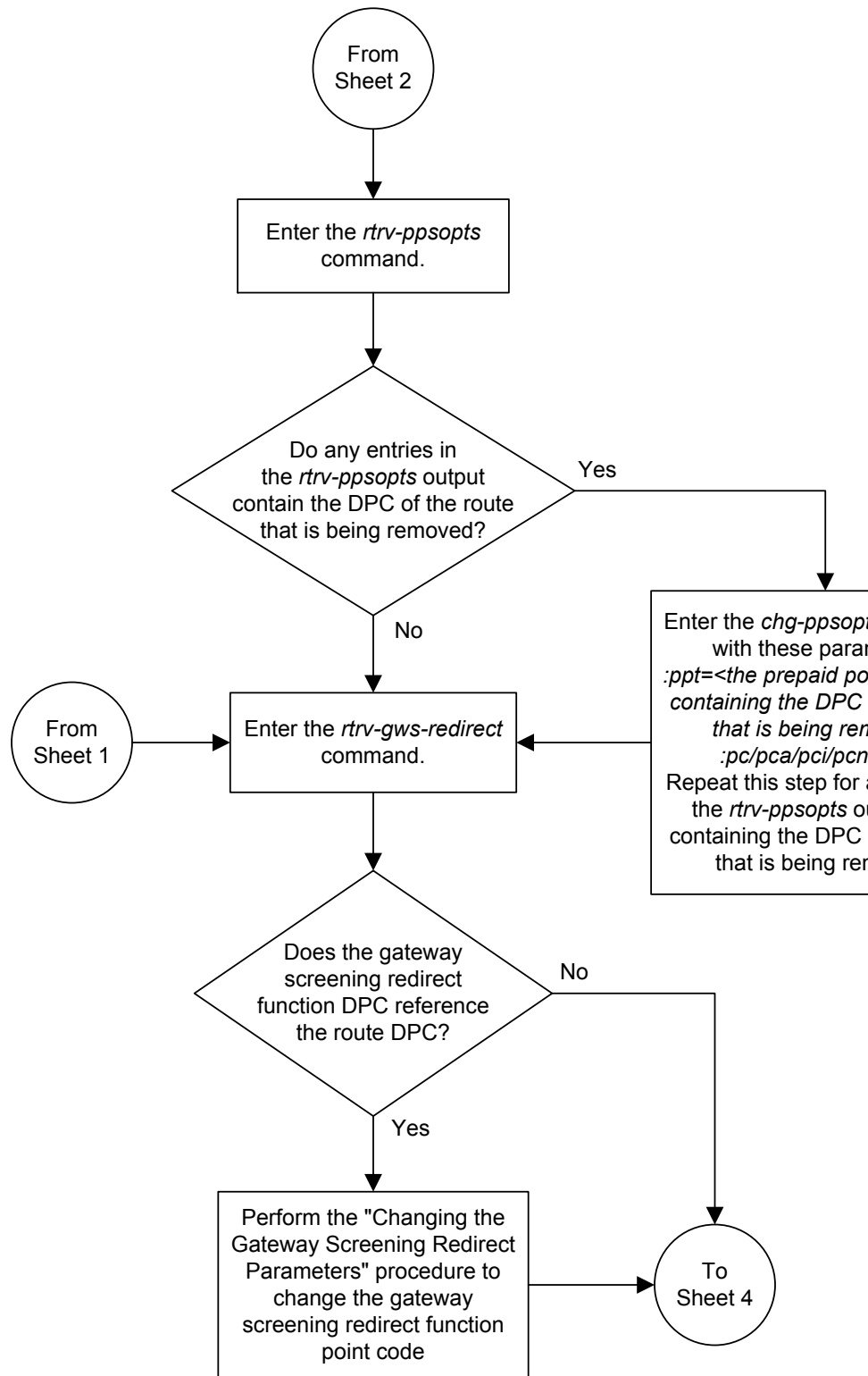
23. Back up the new changes using the `chg-db:action=backup:dest=fixed` command. These messages should appear, the active **Maintenance and Administration Subsystem Processor (MASP)** appears first.

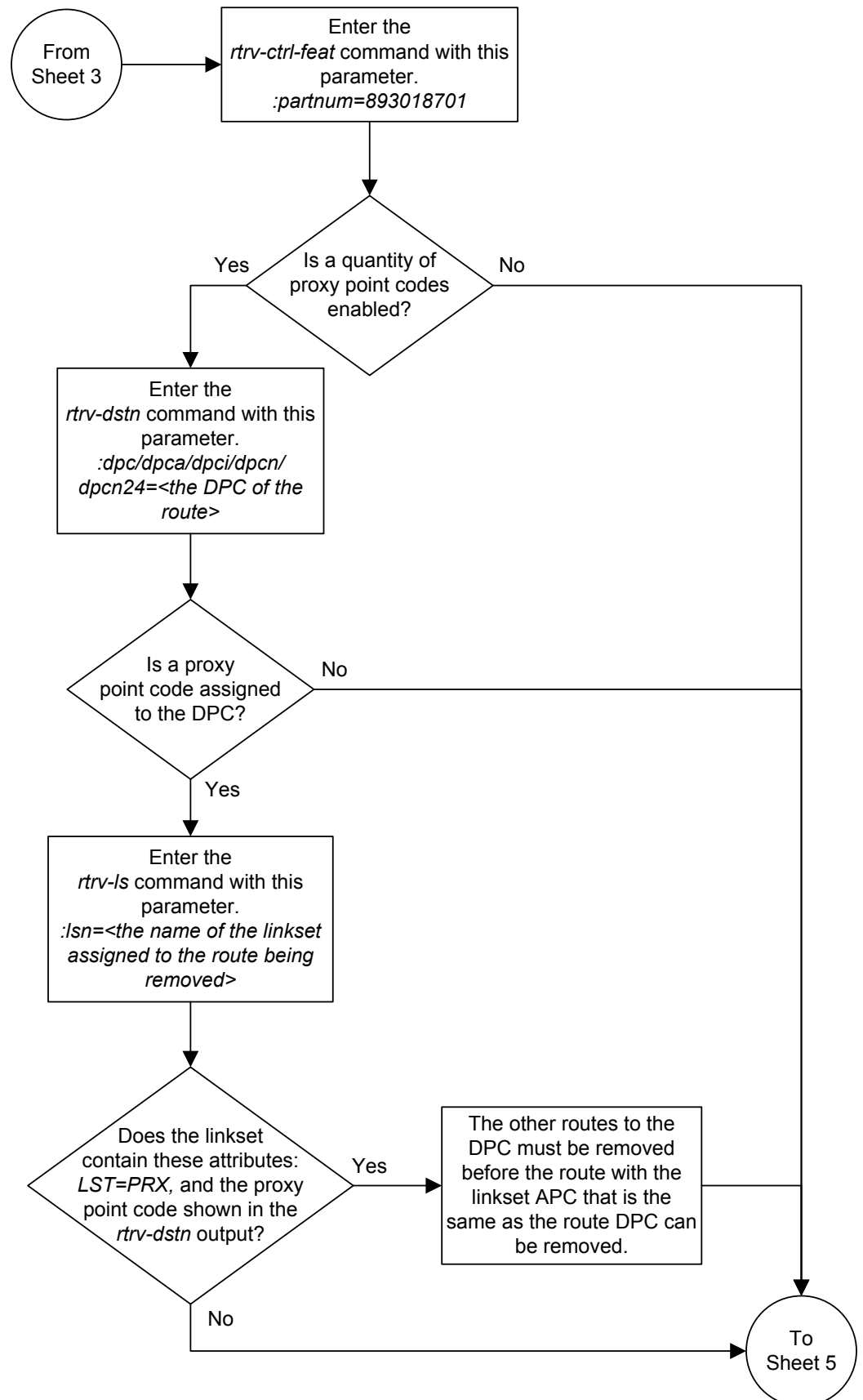
```
BACKUP (FIXED) : MASP A - Backup starts on active MASP.
BACKUP (FIXED) : MASP A - Backup on active MASP to fixed disk complete.
BACKUP (FIXED) : MASP A - Backup starts on standby MASP.
BACKUP (FIXED) : MASP A - Backup on standby MASP to fixed disk complete.
```

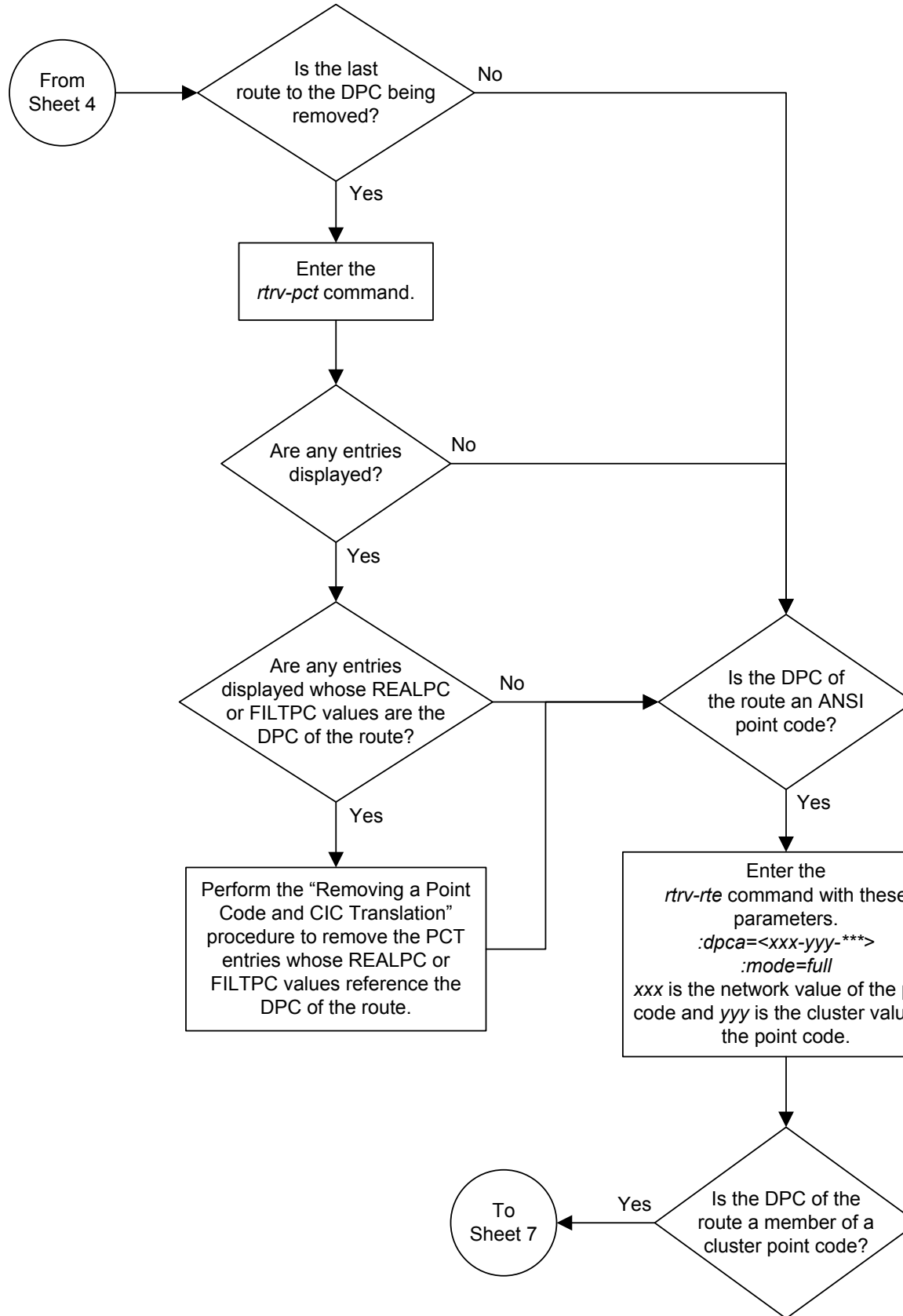

Figure 3-21 Removing a Route

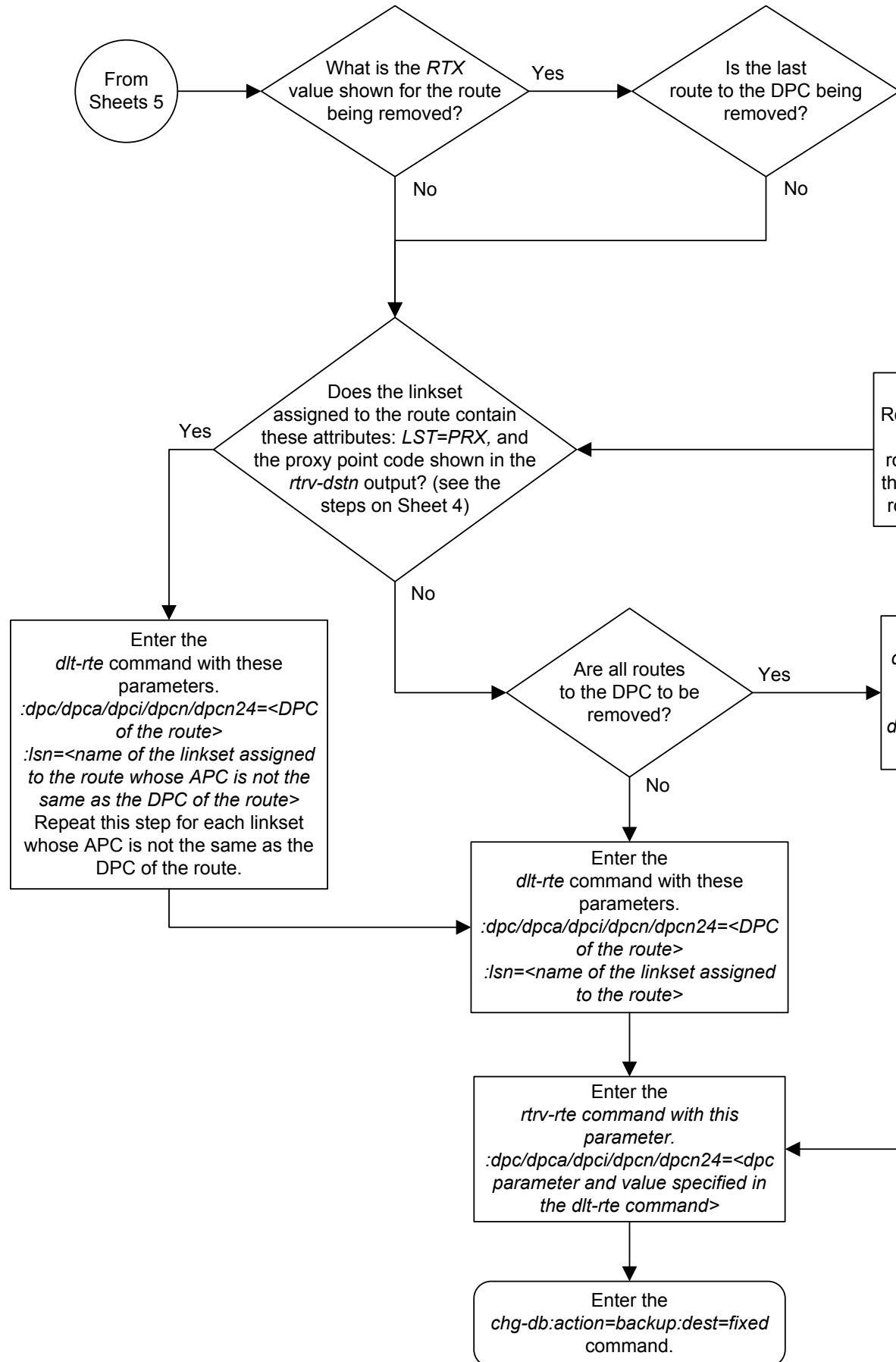


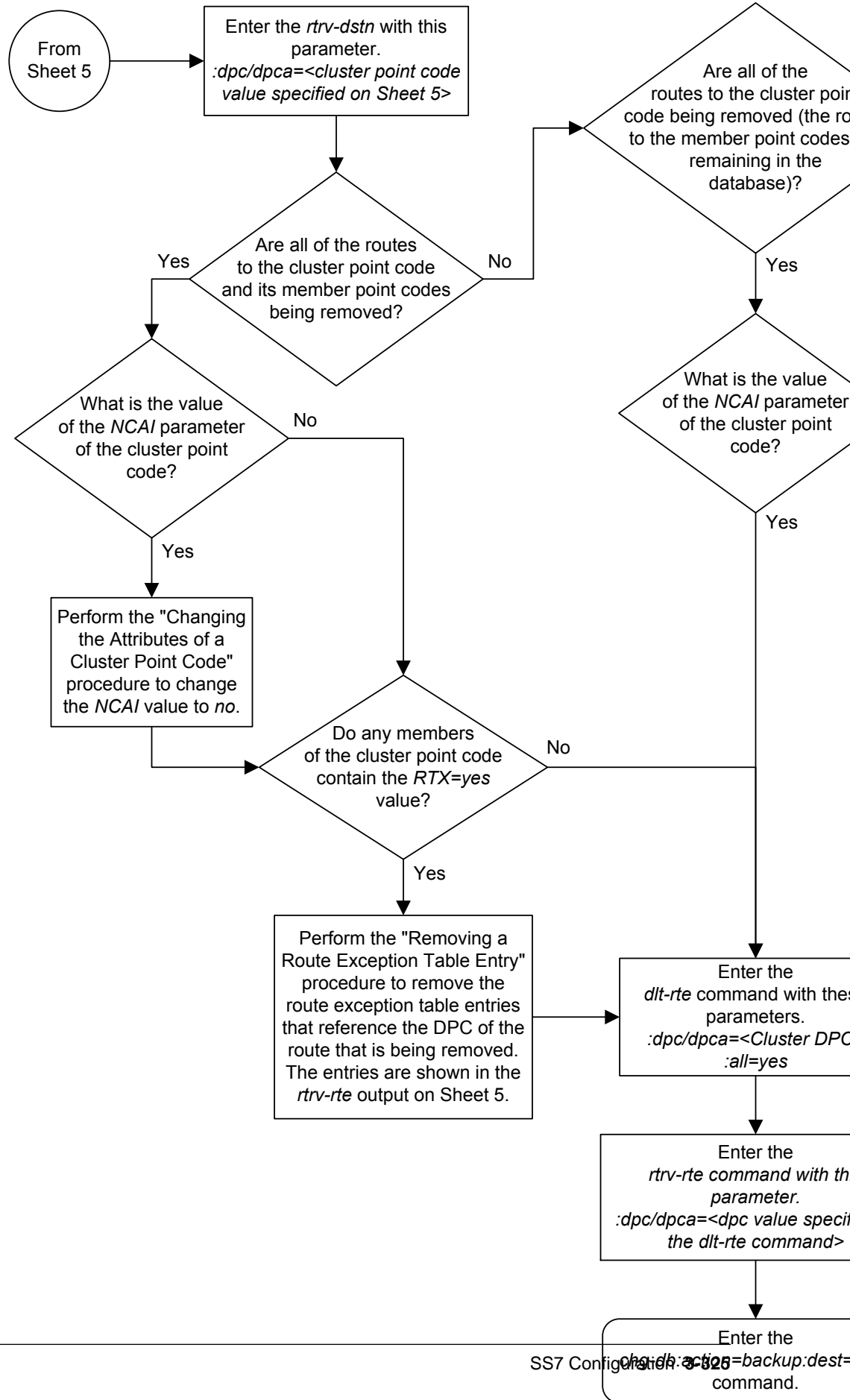


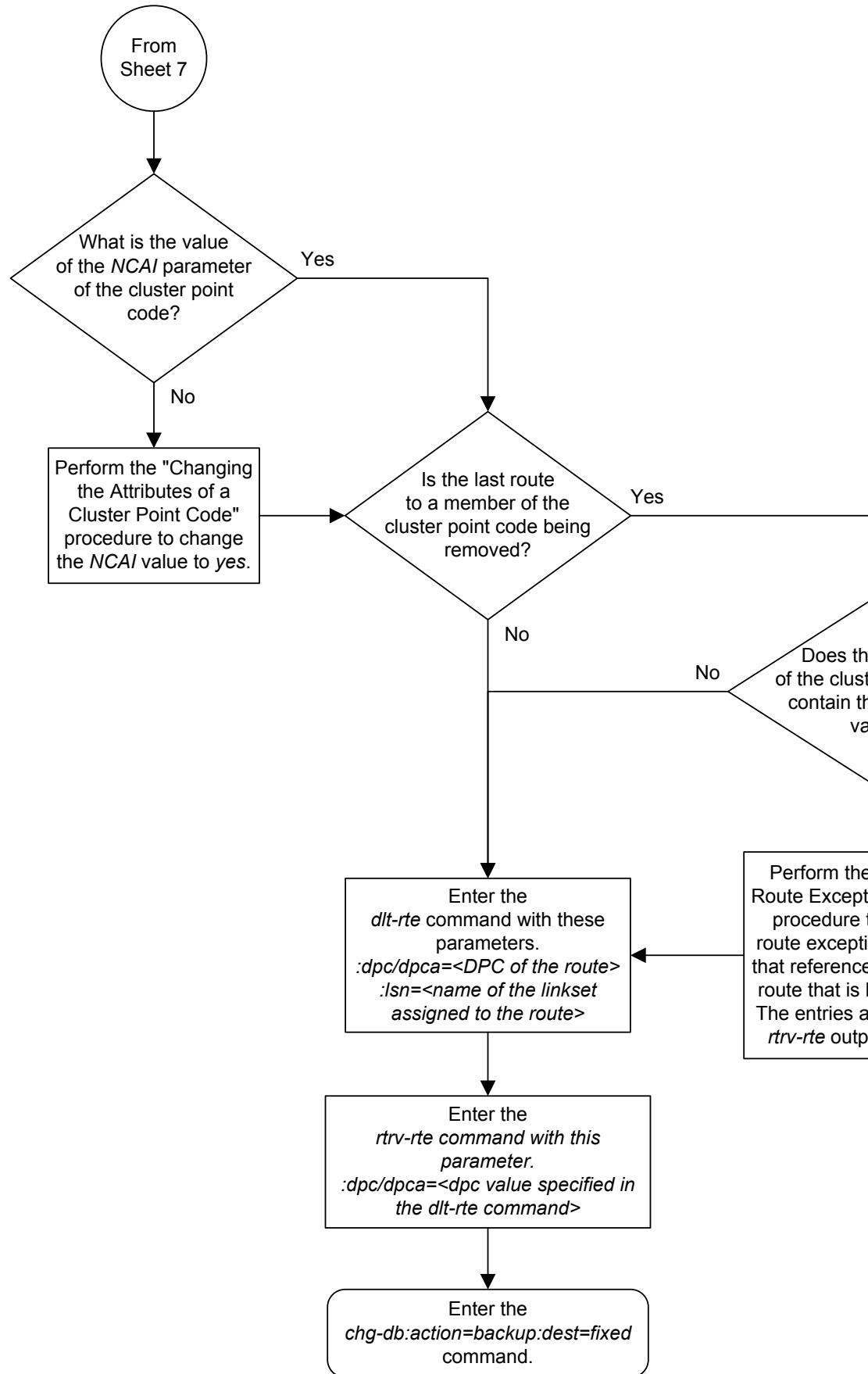












Changing a Route

This procedure is used to change the relative cost of a route or the linkset assigned to a route in the database using the `chg-rte` command.

The `chg-rte` command uses these parameters.

:dpc/dpca/dpci/dpcn/dpcn24 – The destination point code of the node that the traffic is bound for.

Note: See [Point Code Formats](#) for a definition of the point code types that are used on the EAGLE and for a definition of the different formats that can be used for ITU national point codes.

:lsn – The name of the linkset that is currently assigned to the route.

:rc – The relative cost (priority) for this route.

:nlsn – The name of the new linkset that will carry the traffic bound for the node specified by the destination point code.

The route to be changed must exist in the database. This can be verified in [1](#).

If the **DPC** of the route being changed is a private point code, or if the `ipgwapc` parameter of the linkset assigned to the route is `yes`, the route is an **IPGWx** route (a route that contains an IPGWx linkset). The IPGWx route can contain only one linkset. The DPC of an IPGWx route must either be the **APC** of the IPGWx linkset or the **SAPC** assigned to the IPGWx linkset. The DPC of the route cannot be changed. The SAPC can be assigned to only one linkset. As a result, the linkset assigned to the IPGWx route cannot be changed. Only the `rc` parameter value assigned to the route can be changed.

The examples in this procedure are used to change the relative cost assigned to the linkset `ls01` for the route to DPC `003-003-003` in the database to change the name of linkset `ls01` to `lsa2`.

Changing Routes Other than IPGWx Routes

If the 6-Way Loadsharing on Routesets feature is enabled and turned on, a maximum of six routes in the routeset can be assigned the same relative cost value. It is recommended that the routeset be provisioned with a group of four routes that have the same relative cost value and another group of two routes that have the same relative cost value. Three or five routes in the routeset that have the same relative cost value can be provisioned, but the odd number makes it more difficult to distribute the route traffic evenly. Six routes in the routeset that have the same relative cost value can be provisioned, but this does not allow for any backup routes and also offers the worst chance for congestion and queuing issues during network failures. If the 6-Way Loadsharing on Routesets feature is not enabled or not turned on, a maximum of two linksets can be assigned the same relative cost value. The relative cost value of the route is defined by the `rc` parameter of the `chg-rte` command and is shown in the `RC` field in the output of the `rtrv-rte` command.

The **ANSI DPC (DPC/DPCA)** of the route can use either a full point code, a cluster point code, or a network routing point code. ITU DPCs (**DPCI** and **DPCN** - 14-bit or 24-bit DPCNs) must use full point codes. For more information on full and cluster point codes, go to the [Cluster Routing and Management Diversity \(CRMD\)](#) section.

For more information on network routing point codes, go to the [Network Routing](#) section.

The DPC of the route must be of the same format as the APC of the linkset being added to the route. That is, routes containing ANSI DPCs must have linksets with ANSI APCs; routes containing ITU-I DPCs must have linksets with ITU-I APCs; routes containing 14-bit ITU-N DPCs must have linksets with 14-bit ITU-N APCs; routes containing 24-bit ITU-N DPCs must have linksets with 24-bit ITU-N APCs. The DPC of the route must be defined as a true point code in the `rtrv-dstn` output. Alias point codes and secondary point codes cannot be used. True point codes are shown in the output of the `rtrv-dstn` command in the `DPCA`, `DPCI`, `DPCN`, or `DPCN24` fields.

Either the `nlsn` or `rc` parameters, or both, must be specified with the `chg-rte` command. If neither of these parameters are specified, the command is rejected.

The linkset specified by the `nlsn` parameter must be in the database and must contain at least one signaling link. This can be verified with the `rtrv-ls` command and specifying the name of the linkset with the `lsn` parameter.

If the DPC of the route is a cluster point code or a network routing point code, only linksets, specified with either the `lsn` or `nlsn` parameters, whose linkset type is either B, C, or D can be assigned to the route. The linkset type is shown in the `LST` field of the `rtrv-ls` command output. If the linkset type of the desired linkset is either A, E, or PRX, one of three actions must be taken.

- Choose another linkset with the linkset type B, C, or D.
- Change the linkset type of an existing linkset – perform the [Changing an SS7 Linkset](#) procedure.
- Add a new linkset to the database with the necessary signaling links and the linkset type B, C, or D.
 1. Perform the [Adding an SS7 Linkset](#) procedure to add the linkset.
 2. If the necessary signaling links are not in the database, go to the [Adding an SS7 Signaling Link](#) procedure and add the signaling links to the database.

If the DPC of the route is a member of a cluster point code, and the nested cluster allowed indicator (`ncai` parameter of either the `ent-dstn` or `chg-dstn` command) is set to `no`, then all destinations in the cluster have the same route as the cluster point code, with the same attributes as the route to the cluster point code. If the nested cluster allowed indicator is set to `yes`, then the routes to the members of the cluster point code, and the attributes of these routes, can be different from the route to the cluster point code. For more information, see the [Nested Cluster Routing](#) section.

If the APC of the linkset assigned to the route and the DPC of the route are the same, the name of the linkset cannot be changed in this procedure if the linkset and the DPC of the route contain these attributes.

- The DPC of the route contains a proxy point code.
- The linkset type of the linkset is PRX (a proxy linkset) and the proxy point code that is assigned to the DPC of the route is also assigned to the linkset.

These attributes can be verified by entering the `rtrv-dstn` command with the DPC of the route and the `rtrv-ls` command with the linkset name assigned to the route. If these attributes are present and you wish to change the name of the linkset, perform the [Removing a Route](#) procedure to remove the linkset from the DPC of the route. To remove a proxy linkset from the DPC of the route, all the linksets assigned to the DPC

must be removed. After the linksets have been removed from the DPC, Add the new linkset to the DPC of the route by performing the [Adding a Route Containing an SS7 DPC](#) procedure.

Canceling the RTRV-LS and RTRV-RTE Commands

Because the `rtrv-ls` and `rtrv-rte` commands used in this procedure can output information for a long period of time, the `rtrv-ls` and `rtrv-rte` commands can be canceled and the output to the terminal stopped. There are three ways that the `rtrv-ls` and `rtrv-rte` commands can be canceled.

- Press the F9 function key on the keyboard at the terminal where the `rtrv-ls` or `rtrv-rte` commands were entered.
- Enter the `canc-cmd` without the `trm` parameter at the terminal where the `rtrv-ls` or `rtrv-rte` commands were entered.
- Enter the `canc-cmd:trm=<xx>`, where `<xx>` is the terminal where the `rtrv-ls` or `rtrv-rte` commands were entered, from another terminal other than the terminal where the `rtrv-ls` or `rtrv-rte` commands were entered. To enter the `canc-cmd:trm=<xx>` command, the terminal must allow Security Administration commands to be entered from it and the user must be allowed to enter Security Administration commands. The terminal's permissions can be verified with the `rtrv-secu-trm` command. The user's permissions can be verified with the `rtrv-user` or `rtrv-secu-user` commands.

For more information about the `canc-cmd` command, go to *Commands User's Guide*.

1. Display the current route configuration using the `rtrv-rte` command.

This is an example of the possible output.

```
rlghncxa03w 10-12-10 11:43:04 GMT EAGLE5 43.0.0
Extended Processing Time may be Required

DPCA          ALIASI      ALIASN/N24   LSN          RC          APCA
001-002-003  -----  -----      ls04         10          001-002-003
                                RTX:No     CLLI=ls04clli
002-002-100  -----  -----      ls01         10          002-002-100
                                ls02         20          004-004-004
                                ls03         30          003-003-003
                                RTX:No     CLLI=ls01clli
002-007-008  -----  -----      ls06         10          002-007-008
                                RTX:No     CLLI=ls06clli
002-009-003  -----  -----      ls05         10          002-009-003
                                RTX:No     CLLI=-----
003-003-003  -----  -----      ls03         10          003-003-003
                                ls01         20          002-002-100
                                ls02         30          004-004-004
                                RTX:No     CLLI=ls03clli
004-004-004  -----  -----      ls02         10          004-004-004
                                ls01         20          002-002-100
                                ls03         30          003-003-003
                                RTX:No     CLLI=ls02clli
009-002-003  -----  -----      ls07         10          009-002-003
                                RTX:No     CLLI=-----
140-012-004  1-111-1    11121        ls000001    10          240-012-002
                                ls000002    10          240-012-002
                                ls000003    20          240-012-002
                                ls000004    30          240-012-002
```

```

ls000005 40 240-012-002
ls000006 50 240-012-002
RTX:No CLLI=dp1
140-012-005 1-111-2 11122 ls000001 10 240-012-002
ls000002 10 240-012-002
ls000003 20 240-012-002
ls000004 30 240-012-002
ls000005 40 240-012-002
ls000006 50 240-012-002
RTX:No CLLI=dp2
179-100-087 ----- atmansi0 10 179-100-087
RTX:No CLLI=-----
200-050-176 ----- atmansi1 10 200-050-176
RTX:No CLLI=-----
DPCI ALIASN/N24 ALIASA LSN RC APC
2-234-5 11-13-3-3 240-111-111 ls100001 10 1-234-5
ls100002 10 1-234-6
ls100003 20 1-234-7
ls100004 30 1-234-1
ls100005 40 1-234-2
ls100006 50 1-234-3
RTX:No CLLI=idp1
3-150-4 ----- lsi7 10 3-150-4
RTX:No CLLI=lsi7c1li
DPCN ALIASA ALIASI LSN RC APC
10685 ----- lsn5 10 10685
RTX:No CLLI=lsi5c1li
13111 011-222-111 0-001-1 ls200001 10 11111
ls200002 10 11112
ls200003 20 11113
ls200004 30 11114
ls200005 40 11115
ls200006 50 11116
RTX:No CLLI=ndp1
DPCN24 ALIASA ALIASI LSN RC APC

```

If the DPC of the route being changed is a private point code, the route is an IPGWx route (a route that contains an IPGWx linkset). The DPC of an IPGWx route must either be the APC of the IPGWx linkset or the SAPC assigned to the IPGWx linkset. The DPC of the route cannot be changed. The SAPC can be assigned to only one linkset. As a result, the linkset assigned to the IPGWx route cannot be changed. Only the rc parameter value assigned to the route can be changed. If you wish to change the rc parameter value, continue the procedure with 9.

If you do not wish to change the rc parameter value, this procedure cannot be performed.

If the DPC of the route being changed is not a private point code, the route contains two or more linksets, and the rc parameter values of the routes are being changed, continue the procedure performing one of these steps.

- If no more than two routes in the routeset will have the same relative cost value, continue the procedure by performing one of these steps.
 - If the linkset name will not be changed, continue the procedure with 9.
 - If the linkset name will be changed, continue the procedure by performing one of these steps.

- if the APC of the linkset and the DPC of the route are the same. continue the procedure with 4.
- If the APC of the linkset and the DPC of the route are not the same, continue the procedure with 6.
- If more than two routes in the routeset will have the same relative cost value, continue the procedure by performing one of these steps.
 - If routesets that contain more than two routes with the same relative cost value are shown in the `rtrv-rte` output, continue the procedure by performing one of these steps.
 - If the linkset name will not be changed, continue the procedure with 9.
 - If the linkset name will be changed, continue the procedure by performing one of these steps.
 - if the APC of the linkset and the DPC of the route are the same. continue the procedure with 4.
 - If the APC of the linkset and the DPC of the route are not the same, continue the procedure with 6.
 - If routesets that contain more than two routes with the same relative cost value are not shown in the `rtrv-rte` output, continue the procedure with 3.

If the DPC of the route being changed is not a private point code, and the route contains only one linkset, continue the procedure with 2 to verify the `ipgwapc` value assigned to the linkset.

2. Display the linkset assigned to the route by entering the `rtrv-ls` command with the name of the linkset.

For this example, enter this command.

```
rtrv-ls:lsn=ls04
```

This is an example of the possible output.

```
rlghncxa03w 06-10-17 11:43:04 GMT EAGLE5 36.0.0

LSN          APCA  (SS7)  SCRN SET SET BEI LST LNKS ACT MES DIS SLSCI NIS
ls04         001-002-003 none 1  1  no  A  1  off off off ---  on

          CLLI          TFATCABMLQ MTPRSE ASL8
ls04clli    1          no      ---

IPGWAPC MATELSN IPTPS LSUSEALM SLKUSEALM GTTMODE
yes      ----- 100  100  % 80  % CdPA

LOC LINK SLC TYPE
1303 A  0  SS7IPGW
```

Link set table is (10 of 1024) 1% full.

If the `ipgwapc` parameter value of the linkset is `yes`, the route is an IPGWx route (a route that contains an IPGWx linkset). The DPC of an IPGWx route must either

be the APC of the IPGWx linkset or the **SAPC** assigned to the IPGWx linkset. The DPC of the route cannot be changed. The SAPC can be assigned to only one linkset. As a result, the linkset assigned to the IPGWx route cannot be changed. Only the `rc` parameter value assigned to the route can be changed. If you wish to change the `rc` parameter value, continue the procedure with 9.

If you do not wish to change the `rc` parameter value, this procedure cannot be performed.

If the `ipgwapc` parameter value of the linkset is `no`, continue the procedure by performing one of these step.

- If no more than two routes in the routeset will have the same relative cost value, continue the procedure by performing one of these steps.
 - If the linkset name will not be changed, continue the procedure with 9.
 - If the linkset name will be changed, continue the procedure by performing one of these steps.
 - if the APC of the linkset and the DPC of the route are the same. continue the procedure with 4.
 - If the APC of the linkset and the DPC of the route are not the same, continue the procedure with 6.
 - If more than two routes in the routeset will have the same relative cost value, continue the procedure by performing one of these steps.
 - If routesets that contain more than two routes with the same relative cost value are shown in the `rtrv-rte` output, continue the procedure by performing one of these steps.
 - If the linkset name will not be changed, continue the procedure with 9.
 - If the linkset name will be changed, continue the procedure by performing one of these steps.
 - if the APC of the linkset and the DPC of the route are the same. continue the procedure with 4.
 - If the APC of the linkset and the DPC of the route are not the same, continue the procedure with 6.
 - If routesets that contain more than two routes with the same relative cost value are not shown in the `rtrv-rte` output, continue the procedure with 3.
- 3.** For a routeset to have more than two routes with the same relative cost value, the 6-Way Loadsharing on Routesets feature must be enabled and turned on.

To verify the status of the 6-Way Loadsharing on Routesets feature, enter this command.

```
rtrv-ctrl-feat:partnum=893019801
```

The following is an example of the possible output.

```
rlghncxa03w 09-05-28 21:15:37 GMT EAGLE5 41.0.0
The following features have been permanently enabled:
```

```

Feature Name          Partnum   Status  Quantity
6-Way LS on Routesets 893019801 on      ----
  
```

The following features have been temporarily enabled:

```

Feature Name          Partnum   Status  Quantity  Trial Period Left
Zero entries found.
  
```

The following features have expired temporary keys:

```

Feature Name          Partnum
Zero entries found.
  
```

If the 6-Way Loadsharing on Routesets feature is not enabled or not turned on, perform [Activating the 6-Way Loadsharing on Routesets Feature](#) to enable and turn on the 6-Way Loadsharing on Routesets feature.

After the 6-Way Loadsharing on Routesets feature has been enabled and turned on, or if the `rtrv-ctrl-feat` output shows that the 6-Way Loadsharing on Routesets feature is enabled and turned on, continue this procedure by performing one of these steps.

- If the linkset name will not be changed, continue the procedure with [9](#).
 - If the linkset name will be changed, continue the procedure by performing one of these steps.
 - if the APC of the linkset and the DPC of the route are the same. continue the procedure with [4](#).
 - If the APC of the linkset and the DPC of the route are not the same, continue the procedure with [6](#).
4. Display the attributes of the linkset whose DPC is the same as the DPC of the route by entering the `rtrv-ls` command with the name of the linkset. For this example, enter this command.

```
rtrv-ls:lsn=ls02
```

This is an example of the possible output.

```

rlghncxa03w 07-08-14 09:24:36 GMT  EAGLE5 37.0.0

                                L3T SLT                                GWS GWS GWS
LSN          APCA  (SS7)  SCRN SET SET BEI LST LNKS ACT MES DIS SLSCI NIS
ls02         004-004-004  none 1  1  no  PRX 1  off off off no  off

                                PPCA          CLLI          TFATCABMLQ MTPRSE ASL8
                                010-010-010  -----  1          ---  no

                                IPGWAPC MATELSN  IPTPS  LSUSEALM SLKUSEALM GTTMODE
                                no          -----  ----  ---  ---  CdPA
  
```

Link set table is (9 of 1024) 1% full.

If the linkset type is PRX, continue the procedure with [5](#).

If the linkset type is not PRX, continue the procedure with [6](#).

5. Display the DPC of the route by entering the `rtrv-dstn` command with the DPC of the route. For this example, enter this command.

```
rtrv-dstn:dpca=004-004-004
```

This is an example of the possible output.

```
rlghncxa03w 10-12-15 09:22:39 GMT EAGLE5 43.0.0
```

DPCA	CLLI	BEI	ELEI	ALIASI	ALIASN/N24	DMN
004-004-004	-----	no	---	-----	-----	SS7

PPCA	NCAI	PRX	RCAUSE	NPRST	SPLITIAM	HMSMSC	HMSCP	SCCPMSGCNV
010-010-010	----	no	none	off	none	no	no	none

Destination table is (14 of 2000) 1% full

Alias table is (0 of 12000) 0% full

PPC table is (2 of 10) 20% full

If the linkset shown in 4 does not contain the proxy point code shown in this step, continue the procedure with 6.

If the linkset shown in 4 contains the proxy point code shown in this step, the linkset name cannot be changed in this procedure. If you wish to change the linkset name, perform the [Removing a Route](#) procedure to remove the linkset from the DPC of the route. To remove a proxy linkset from the DPC of the route, all the linksets assigned to the DPC must be removed. After the linksets have been removed from the DPC, Add the new linkset to the DPC of the route by performing the [Adding a Route Containing an SS7 DPC](#) procedure. However, the RC value for this linkset can be changed. If you wish to change the RC value for this linkset, repeat this procedure from 3.

6. Display the linksets in the database with the `rtrv-ls` command.

This is an example of the possible output.

```
rlghncxa03w 06-10-10 11:43:04 GMT EAGLE5 36.0.0
```

LSN	APCA (SS7)	SCRN	L3T SLT		BEI	LST	LNKS	GWS GWS GWS			SLSCI	NIS
			SET	SET				ACT	MES	DIS		
ele2	001-207-000	none	1	1	no	B	6	off	off	off	no	off
ls1305	000-005-000	none	1	1	no	A	1	off	off	off	no	off
ls1307	000-007-000	none	1	1	no	A	1	off	off	off	no	off
elm1s1	001-001-001	none	1	1	no	A	7	off	off	off	no	off
elm1s2	001-001-002	none	1	1	no	A	7	off	off	off	no	off

LSN	APCI (SS7)	SCRN	L3T SLT		BEI	LST	LNKS	GWS GWS GWS			SLSCI	NIS
			SET	SET				ACT	MES	DIS		
ele2i	1-207-0	none	1	1	no	B	4	off	off	off	---	on
ls1315	0-015-0	none	1	1	no	A	1	off	off	off	---	off
ls1317	0-017-0	none	1	1	no	A	1	off	off	off	---	on
elm2s1	1-011-1	none	1	1	no	A	7	off	off	off	---	off
elm2s2	1-011-2	none	1	1	no	A	7	off	off	off	---	off

Link set table is (10 of 1024) 1% full.

If the new linkset to be added to the route is not shown in the `rtrv-ls` output, and the DPC of the route is not an ANSI point code, add the new linkset by performing the [Adding an SS7 Linkset](#) procedure.

After the new linkset has been added, or if the new linkset is shown in the `rtrv-ls` output, continue the procedure by performing one of these steps.

- If the DPC of the route is not a cluster point code, continue the procedure with [8](#).
 - If the DPC of the route is a cluster point code, continue the procedure with [7](#).
7. Display the `ncai` parameter value assigned to the cluster point code using the `rtrv-dstn` command and specifying the cluster point code.

If the `ncai` parameter value is `no`, then the route to the **DPC** must be the same as the route to the cluster point code. If the `ncai` parameter value is `yes`, the route to the member of the cluster does not have to be the same as the route to the cluster point code. The `ncai` value is shown in the `NCAI` field of the `rtrv-dstn` output. For this example, enter this command.

```
rtrv-dstn:dPCA=111-011-*
```

This is an example of the possible output.

```
rlghncxa03w 10-12-28 21:16:37 GMT EAGLE5 43.0.0

DPCA          CLLI          BEI ELEI  ALIASI          ALIASN/N24  DMN
111-011-*     rlghncbb000  yes yes  -----        -----        SS7

SPCA          NCAI          RCAUSE NPRST SPLITIAM HMSMSC HMSCP SCCPMSGCNV
-----      ----          none  off  none      no      no      none

Destination table is (12 of 2000) 1% full
Alias table is (6 of 8000) 1% full
```

Note: If the DPC of the route is not a cluster point code or a 14-bit ITU-N point code with group codes, continue the procedure with [9](#).

8. Display each linkset being assigned to the route to verify the `multgc` parameter value with the `rtrv-ls` command, specifying the name of the linkset that will be assigned to the route.

If the `multgc` linkset parameter value is `yes`, then 14-bit ITU National DPCs with group codes that are different from the linkset APC group code can be assigned to the route. If the `multgc` value is set to `no`, then only 14-bit ITU National DPCs with group codes that are the same as the linkset APC group code can be assigned to the route. The `multgc` value is shown in the `MULTGC` field of the `rtrv-ls` output.

For this example, enter the following command.

```
rtrv-ls:lsn=e1e2i
```

This is an example of the possible output.

```
rlghncxa03w 06-10-10 11:43:04 GMT EAGLE5 36.0.0

LSN          APCI  (SS7)  SCRN SET SET  BEI LST LNKS ACT MES DIS SLSCI NIS
e1e2i        1-202-0  none 1 1  no B 10  off off off ---  on

          CLLI          TFATCABMLQ MTPRSE ASL8 SLSOCBIT SLSRSB MULTGC
          -----      5          no  --- none 1 no
```



```

ITUTFR
off

IPGWAPC MATELSN   IPTPS LSUSEALM SLKUSEALM GTTMODE
no      -----   ---   ---   ---   CdPA

LOC LINK SLC TYPE      IPLIML2
1311 A    0  IPLIMI  M2PA
1313 A    1  IPLIMI  M2PA
1311 B    2  IPLIMI  M2PA
1313 B    3  IPLIMI  M2PA

SAPCN
03664

```

Link set table is (10 of 1024) 1% full.

9. Change the route configuration in the database using the `chg-rte` command.

For this example, enter this command.

```
chg-rte:dpca=003-003-003:lsn=ls01:rc=50:nlsn=lsa2
```

These are the rules that apply to adding a route.

- An IPGWx route can contain only one linkset, and only the `rc` parameter value for an IPGWx route can be changed. For an SS7 route other than an IPGWx route, a maximum of two linksets can be assigned the same `rc` parameter value, if the 6-Way Loadsharing on Routesets feature is not enabled or turned on. If the 6-Way Loadsharing on Routesets feature is enabled and turned on, a maximum of six linksets in the route can have the same `rc` parameter value.
- If the DPC of the route is a cluster point code or a network routing point code, the link set type of the linkset assigned to the route must be either B, C, or D.
- If the DPC of the route is a member of a cluster point code, and the nested cluster allowed indicator (`ncai` parameter of either the `ent-dstn` or `chg-dstn` command) is set to `no`, then the route to the DPC must be the same as the route to the cluster point code. If the nested cluster allowed indicator is set to `yes`, the route to the member of the cluster does not have to be the same as the route to the cluster point code.
- For routes containing 14-bit ITU National DPCs with group codes, if the linkset assigned to the route has the `MULTGC` value set to `yes`, then the group code of the linkset's APC can be different from the group code of the route's DPC. If the `MULTGC` value is set to `no`, then the group code of the linkset's APC must be the same as the group code of the route's DPC.
- If the DPC of the route is a cluster point code, the linksets that will be assigned to the route, with the `nlsn` parameter, cannot specify the `ipgwapc=yes` parameter.
- The DPC of the route must be of the same format as the APC of the linkset being added to the route. That is, routes containing ANSI DPCs must have linksets with ANSI APCs; routes containing ITU-I DPCs must have linksets with ITU-I APCs; routes containing 14-bit ITU-N DPCs must have linksets with 14-bit ITU-N APCs; routes containing 24-bit ITU-N DPCs must have linksets with 24-bit ITU-N APCs.

When this command has successfully completed, this message should appear.

```
rlghncxa03w 06-10-07 08:45:54 GMT EAGLE5 36.0.0
CHG-RTE: MASP A - COMPLTD
```

10. Verify the changes using the `rtrv-rte` command, specifying the destination point code of the route or the name of the routeset assigned to the route.

For this example, enter this command.

```
rtrv-rte:dpca=003-003-003
```

This is an example of the possible output.

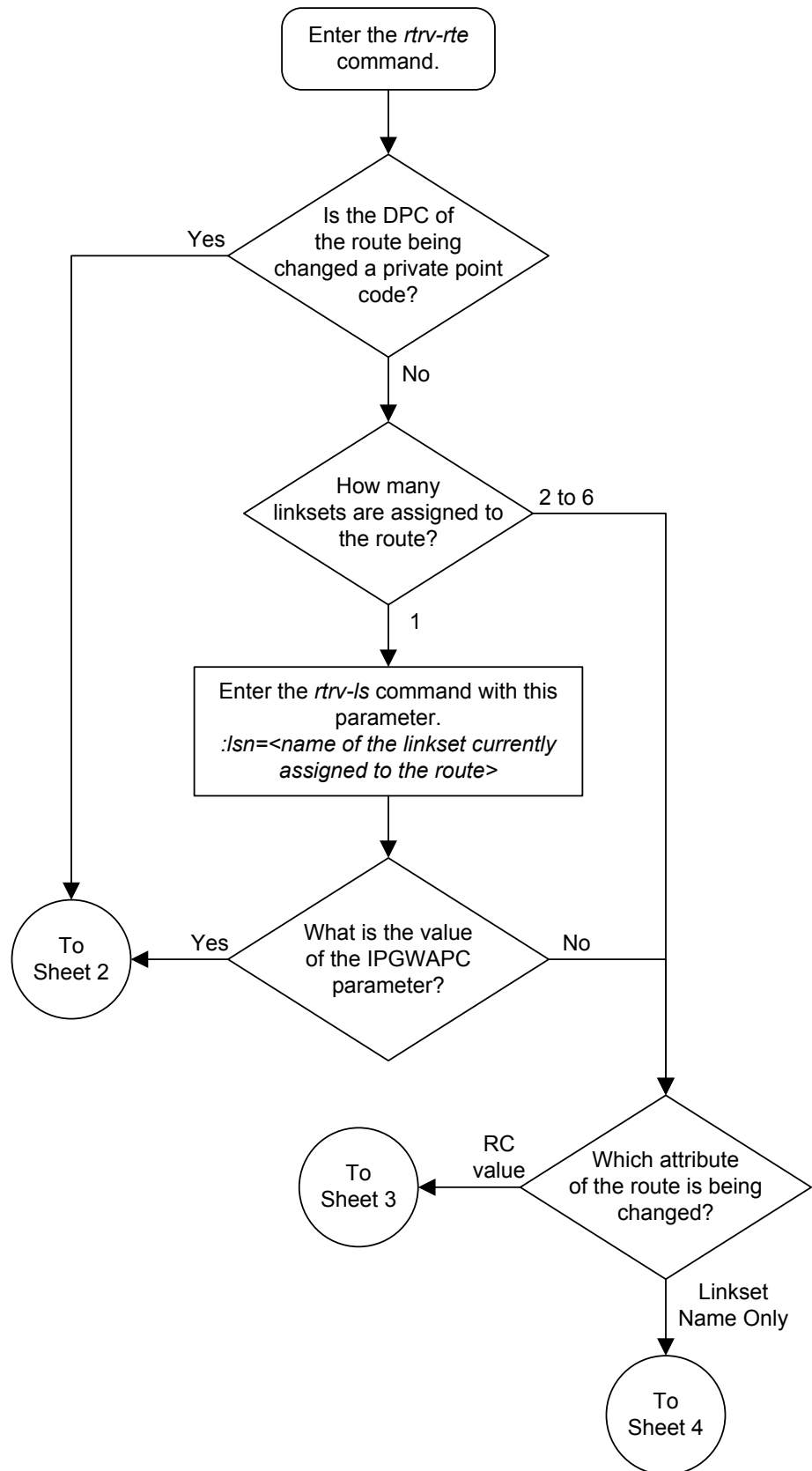
```
rlghncxa03w 06-10-07 11:43:04 GMT EAGLE5 36.0.0
  DPCA          ALIASI      ALIASN/N24    LSN          RC          APCA
  003-003-003  -----  -----  ls03         10         003-003-003
                                     ls01         20         002-002-100
                                     ls02         30         004-004-004
                                     RTX:No  CLLI=ls03c1li
```

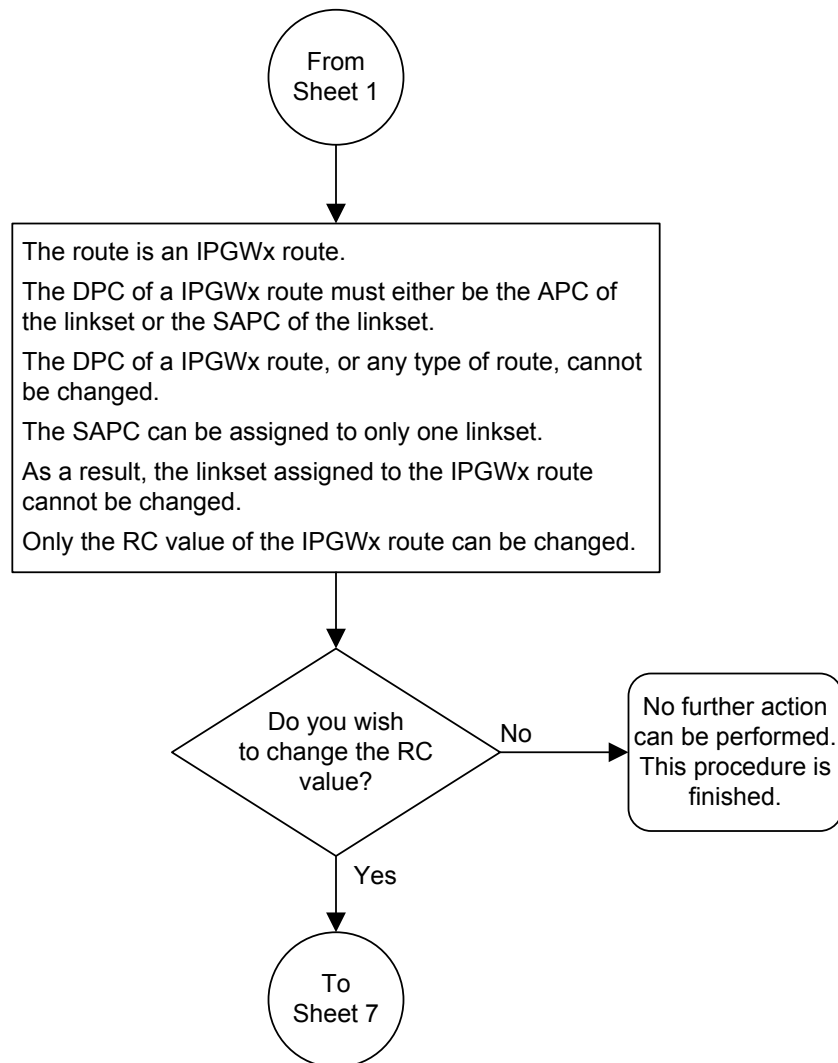
11. Back up the new changes using the `chg-db:action=backup:dest=fixed` command.

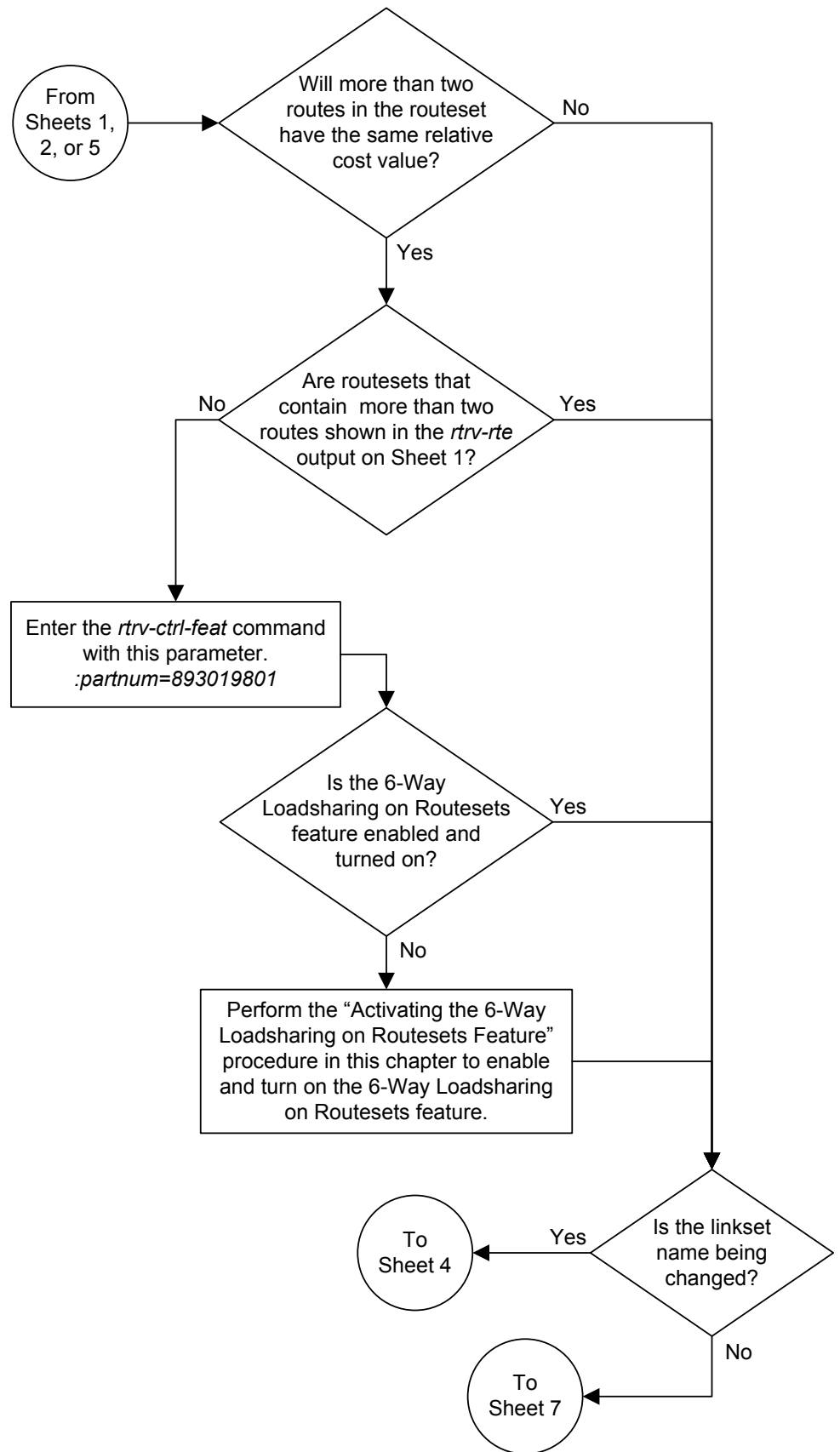
These messages should appear, the active **Maintenance and Administration Subsystem Processor (MASP)** appears first.

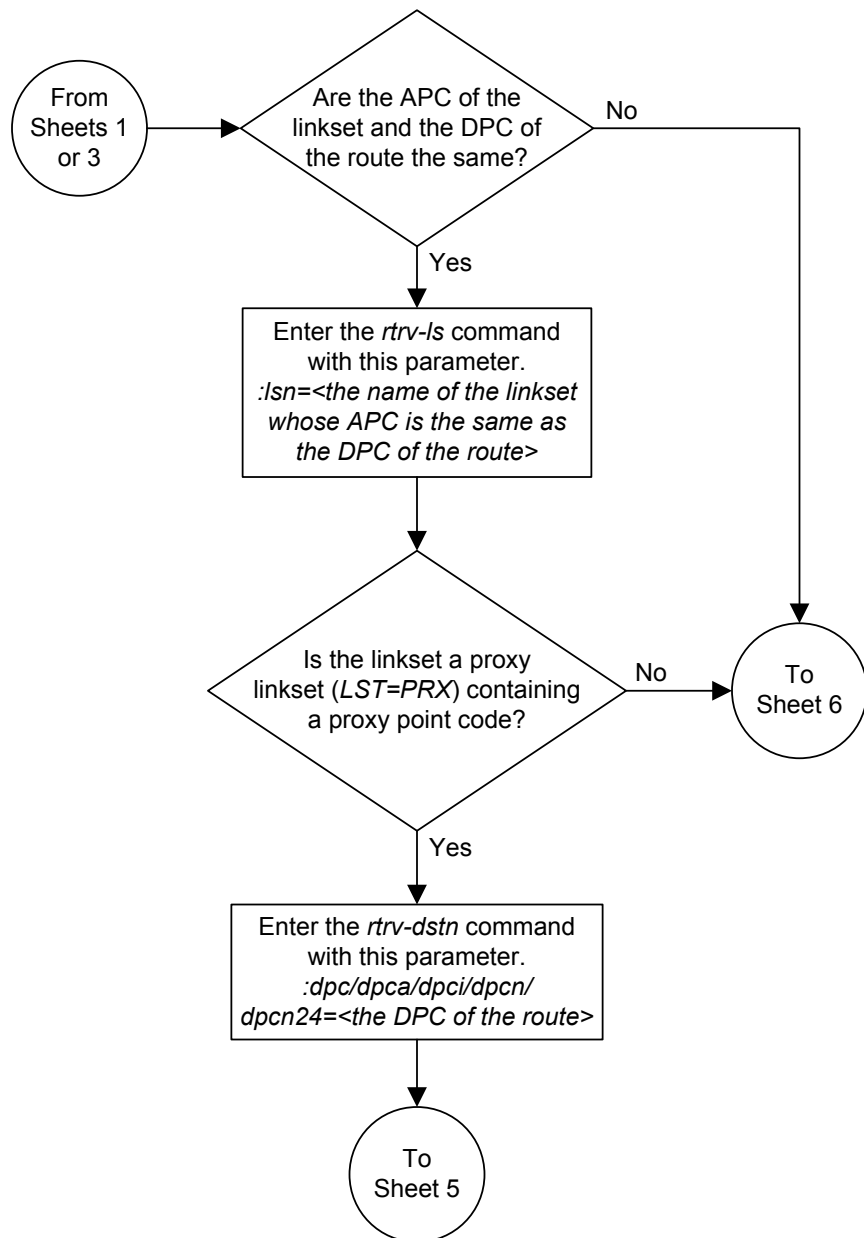
```
BACKUP (FIXED) : MASP A - Backup starts on active MASP.
BACKUP (FIXED) : MASP A - Backup on active MASP to fixed disk complete.
BACKUP (FIXED) : MASP A - Backup starts on standby MASP.
BACKUP (FIXED) : MASP A - Backup on standby MASP to fixed disk complete.
```

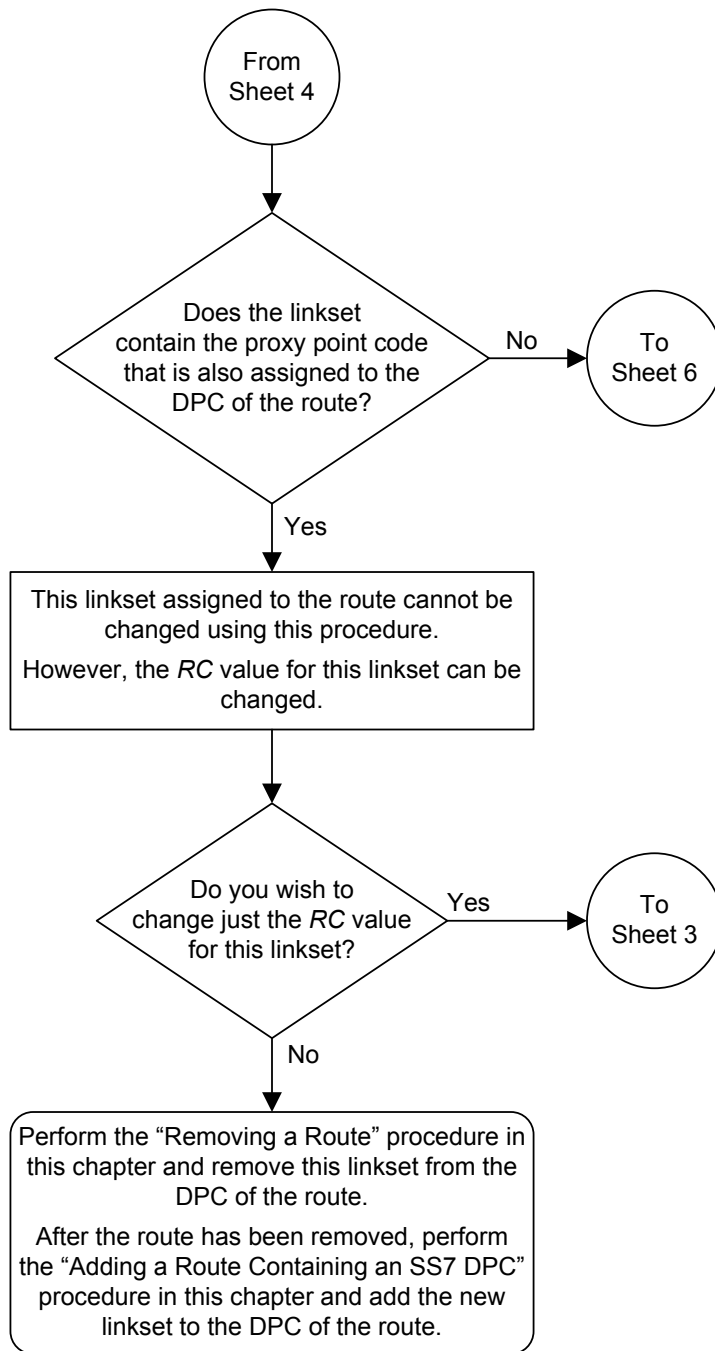
Figure 3-22 Changing a Route

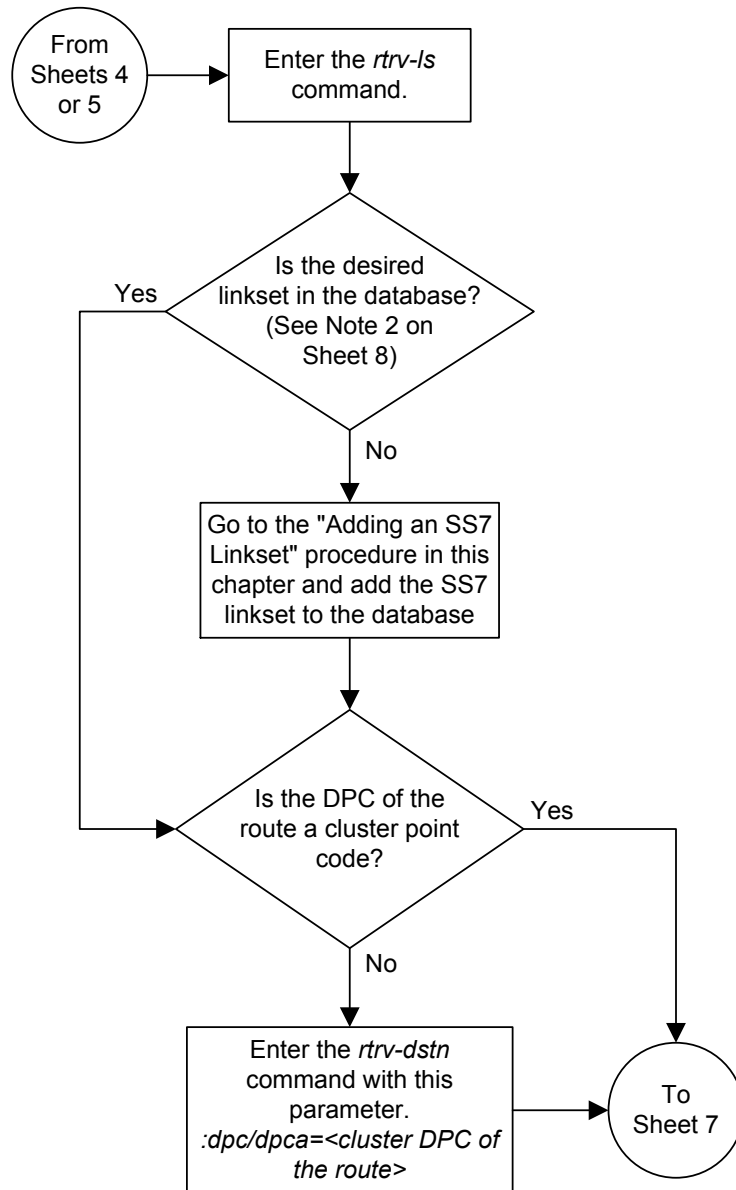


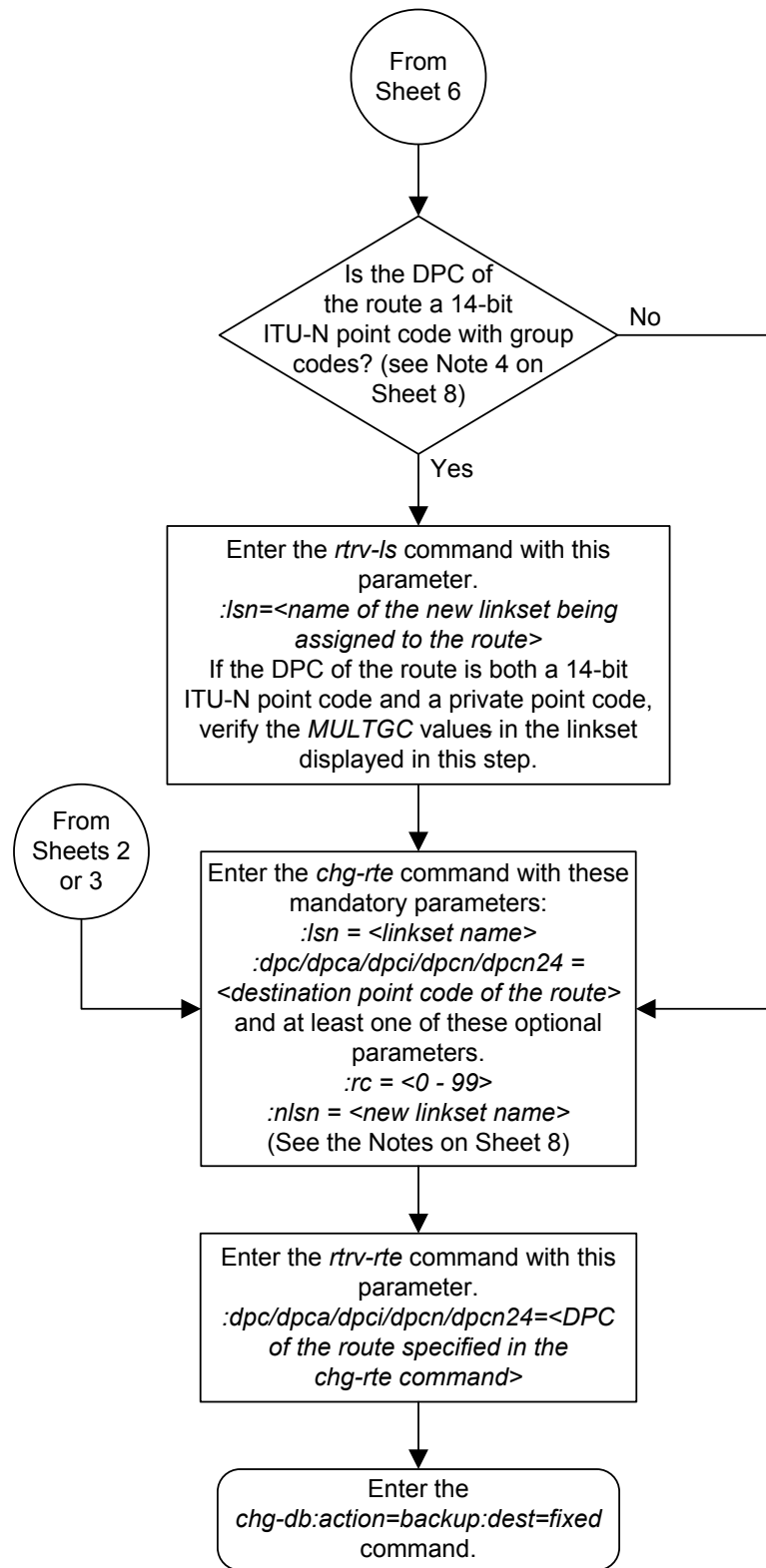












Notes:

1. An IPGWx route can contain only one linkset, and only the *rc* parameter value for an IPGWx route can be changed. For an SS7 route other than an IPGWx route, a maximum of two linksets can be assigned the same *rc* parameter value, if the 6-Way Loadsharing on Routesets feature is not enabled or turned on. If the 6-Way Loadsharing on Routesets feature is enabled and turned on, a maximum of six linksets in the route can have the same *rc* parameter value.
2. If the DPC of the route is a cluster point code or a network routing point code, the link set type of the linkset assigned to the route must be either B, C, or D.
3. If the DPC of the route is a member of a cluster point code, and the nested cluster allowed indicator (*ncai* parameter of either the *ent-dstn* or *chg-dstn* command) is set to no, then the route to the DPC must be the same as the route to the cluster point code. If the nested cluster allowed indicator is set to yes, the route to the member of the cluster does not have to be the same as the route to the cluster point code.
4. For routes containing 14-bit ITU National DPCs with group codes, if the linkset assigned to the route has the MULTGC value set to yes, then the group code of the linkset's APC can be different from the group code of the route's DPC. If the MULTGC value is set to no, then the group code of the linkset's APC must be the same as the group code of the route's DPC.
5. If the DPC of the route is a cluster point code, the linksets that will be assigned to the route, with the *nlsn* parameter, cannot specify the *ipgwapc=yes* parameter.
6. The DPC of the route must be of the same format as the APC of the linkset being added to the route. That is, routes containing ANSI DPCs must have linksets with ANSI APCs; routes containing ITU-I DPCs must have linksets with ITU-I APCs; routes containing 14-bit ITU-N DPCs must have linksets with 14-bit ITU-N APCs; routes containing 24-bit ITU-N DPCs must have linksets with 24-bit ITU-N APCs.

Changing Level 2 Timers

This procedure is used to change the values of a level 2 timer set using the `chg-12t` command.

The `12tset` parameter specifies the level 2 timer set that is being changed. The **EAGLE** contains 35 level 2 timer sets that signaling links can be assigned to. Level 2 timer sets are assigned to different types of signaling links as shown in [Table 3-16](#).

Table 3-16 Level 2 Timer Sets

Level 2 Timer Set (12tset Parameter Value)	Default Level 2 Timer Set Value for Signaling Links	Type of Signaling Link
1 - 10	1	Low-speed ANSI signaling links
11 - 20	11	Low-speed ITU signaling links
21 - 25	21	ITU-N high-speed signaling links for China
26 - 30	26	ITU-N high-speed signaling links for areas other than China
31 - 35	31	Unchannelized T1 high-speed signaling links

Each level 2 timer set contains seven timers. These tables define the timers and their values.

- [Table 3-17](#)
- [Table 3-18](#)
- [Table 3-19](#)
- [Table 3-20](#)
- [Table 3-21](#)

Table 3-17 Level 2 Timer Values - Low-Speed ANSI Signaling Links

Level 2 Timers	Level 2 Timer Sets 1 - 10 (in milliseconds)
Timer 1 – Aligned ready ($\tau 1$ parameter)	5000 - 20000 System Default - 13000
Timer 2 – Not aligned ($\tau 2$ parameter)	5000 - 30000 System Default - 11500

Table 3-17 (Cont.) Level 2 Timer Values - Low-Speed ANSI Signaling Links

Level 2 Timers	Level 2 Timer Sets 1 - 10 (in milliseconds)
Timer 3 – Aligned (τ_3 parameter)	5000 - 20000 System Default - 11500
Timer 4 – Normal proving period (τ_{4npp} parameter)	500 - 5000 System Default - 2300
Timer 4 – Emergency proving period (τ_{4epp} parameter)	200 - 1000 System Default - 600
Timer 5 – Sending SIB (τ_5 parameter)	40 - 500 System Default - 100
Timer 6 – Remote congestion (τ_6 parameter)	1000 - 10000 System Default - 4000
Timer 7 – Excessive delay of acknowledgment (τ_7 parameter)	200 - 3000 System Default - 1500
NODATA - See the Notes.	100 - 500 System Default - 100

Notes:

1. The NODATA timer specifies the amount of time that must pass with no transmissions on a signaling link before the EAGLE interprets the condition as a signaling link failure or a terminal equipment failure and initiates changeover procedures.

Note: The NODATA timer is configurable only for low speed SS7 links running BASIC Error Correction Method (ECM).

The NODATA timer is not configurable for low speed SS7 links running PCR ECM. The NODATA timer value is calculated as T2 (L2 timer 2 value)/3 for low speed SS7 links running PCR ECM.

Table 3-18 Level 2 Timer Values - Low-Speed ITU Signaling Links

Level 2 Timers	Level 2 Timer Sets 11 - 20 (in milliseconds)
Timer 1 – Aligned ready (τ_1 parameter)	40000 - 50000 System Default - 40000
Timer 2 – Not aligned (τ_2 parameter)	5000 - 150000 System Default - 30000
Timer 3 – Aligned (τ_3 parameter)	1000 - 2000 System Default - 2000

Table 3-18 (Cont.) Level 2 Timer Values - Low-Speed ITU Signaling Links

Level 2 Timers	Level 2 Timer Sets 11 - 20 (in milliseconds)
Timer 4 – Normal proving period (t_{4npp} parameter)	7500 - 9500 System Default - 8200
Timer 4 – Emergency proving period (t_{4epp} parameter)	400 - 600 System Default - 500
Timer 5 – Sending SIB (t_5 parameter)	80 - 120 System Default - 100
Timer 6 – Remote congestion (t_6 parameter)	3000 - 6000 System Default - 4000
Timer 7 – Excessive delay of acknowledgment (t_7 parameter)	500 - 2000 System Default - 1500
NODATA - See the Notes.	100 - 500 System Default - 100

Notes:

1. The NODATA timer specifies the amount of time that must pass with no transmissions on a signaling link before the EAGLE interprets the condition as a signaling link failure or a terminal equipment failure and initiates changeover procedures.

Note: The NODATA timer is configurable only for low speed SS7 links running BASIC Error Correction Method (ECM).
The NODATA timer is not configurable for low speed SS7 links running PCR ECM. The NODATA timer value is calculated as T_2 (L2 timer 2 value)/3 for low speed SS7 links running PCR ECM.

Table 3-19 Level 2 Timer Values - ITU-N High-Speed Signaling Links for China

Level 2 Timers	Level 2 Timer Sets 21 - 25 (in milliseconds)
Timer 1 – Aligned ready (t_1 parameter)	25000 - 350000 System Default - 150000
Timer 2 – Not aligned (t_2 parameter)	5000 - 150000 System Default - 130000
Timer 3 – Aligned (t_3 parameter)	1000 - 2000 System Default - 1000
Timer 4 – Normal proving period (t_{4npp} parameter)	3000 - 70000 System Default - 30000

Table 3-19 (Cont.) Level 2 Timer Values - ITU-N High-Speed Signaling Links for China

Level 2 Timers	Level 2 Timer Sets 21 - 25 (in milliseconds)
Timer 4 – Emergency proving period (t_{4epp} parameter)	400 - 600 System Default - 500
Timer 5 – Sending SIB (t_5 parameter)	80 - 120 System Default - 100
Timer 6 – Remote congestion (t_6 parameter)	3000 - 6000 System Default - 5000
Timer 7 – Excessive delay of acknowledgment (t_7 parameter)	500 - 2000 System Default - 800

Table 3-20 Level 2 Timer Values - ITU-N High-Speed Signaling Links for Areas other than China

Level 2 Timers	Level 2 Timer Sets 26 - 30 (in milliseconds)
Timer 1 – Aligned ready (t_1 parameter)	25000 - 350000 System Default - 300000
Timer 2 – Not aligned (t_2 parameter)	5000 - 150000 System Default - 130000
Timer 3 – Aligned (t_3 parameter)	1000 - 2000 System Default - 1000
Timer 4 – Normal proving period (t_{4npp} parameter)	3000 - 70000 System Default - 30000
Timer 4 – Emergency proving period (t_{4epp} parameter)	400 - 600 System Default - 500
Timer 5 – Sending SIB (t_5 parameter)	80 - 120 System Default - 100
Timer 6 – Remote congestion (t_6 parameter)	3000 - 6000 System Default - 5000
Timer 7 – Excessive delay of acknowledgment (t_7 parameter)	500 - 2000 System Default - 800

Table 3-21 Level 2 Timer Values - Unchannelized T1 High-Speed Signaling Links

Level 2 Timers	Level 2 Timer Sets 31- 35 (in milliseconds)
Timer 1 – Aligned ready (t_1 parameter)	16000 - 151000 System Default - 151000

Table 3-21 (Cont.) Level 2 Timer Values - Unchannelized T1 High-Speed Signaling Links

Level 2 Timers	Level 2 Timer Sets 31- 35 (in milliseconds)
Timer 2 – Not aligned (τ_2 parameter)	5000 - 14000 System Default - 14000
Timer 3 – Aligned (τ_3 parameter)	5000 - 14000 System Default - 14000
Timer 4 – Normal proving period (τ_{4npp} parameter)	3000 - 30000 System Default - 30000
Timer 4 – Emergency proving period (τ_{4epp} parameter)	3000 - 10000 System Default - 3000
Timer 5 – Sending SIB (τ_5 parameter)	80 - 120 System Default - 80
Timer 6 – Remote congestion (τ_6 parameter)	3000 - 6000 System Default - 3000
Timer 7 – Excessive delay of acknowledgment (τ_7 parameter)	500 - 2000 System Default - 500

The examples in this procedure are used to change the values of the level 2 timer set number 2.

1. Display the values of the level 2 timer set you wish to change.

Use the `rtrv-l2t` command, specifying the level 2 timer set to be changed. For this example, enter this command.

```
rtrv-l2t:l2tset=2
```

Note: Timer sets are individual sets of timer configurations; each link is assigned one of these timer sets. This allows different links to have different level 2 timer settings. This is an example of the possible output.

```
rlghncxa03w 06-10-07 08:39:46 GMT EAGLE5 39.0.0
L2T TIMERS (IN SECONDS)
L2TSET T1 T2 T3 T4NPP T4EPP T5 T6 T7 NODATA
2 10.0 20.0 20.0 5.0 1.00 0.50 10.0 3.0 0.10
```

2. Change the values of the level 2 timer in this set using the `chg-l2t` command.

Refer to these tables for the values that can be used with the `chg-l2t` command. For this example, the values of the level 2 timer set number 2 that are being changed are T2 and T6. To change these two values, enter this command.

- [Table 3-17](#)

- [Table 3-18](#)
- [Table 3-19](#)
- [Table 3-20](#)
- [Table 3-21](#)

```
chg-l2t:l2tset=2:t2=15000:t6=5000:nodata=200
```

When this command has successfully completed, this message should appear.

```
rlghncxa03w 06-10-07 08:39:36 GMT EAGLE5 36.0.0
CHG-L2T: MASP A - COMPLTD
```

Caution: If the `nodata` parameter value is greater than 200 milliseconds, this message appears.

WARNING: If `NODATA` timer value is greater than 200 ms, links could go into congestion before link failure is declared.

3. Verify the changes using the `rtrv-l2t` command, specifying the level 2 timer set that has been changed.

For this example, enter this command.

```
rtrv-l2t:l2tset=2
```

This is an example of the possible output.

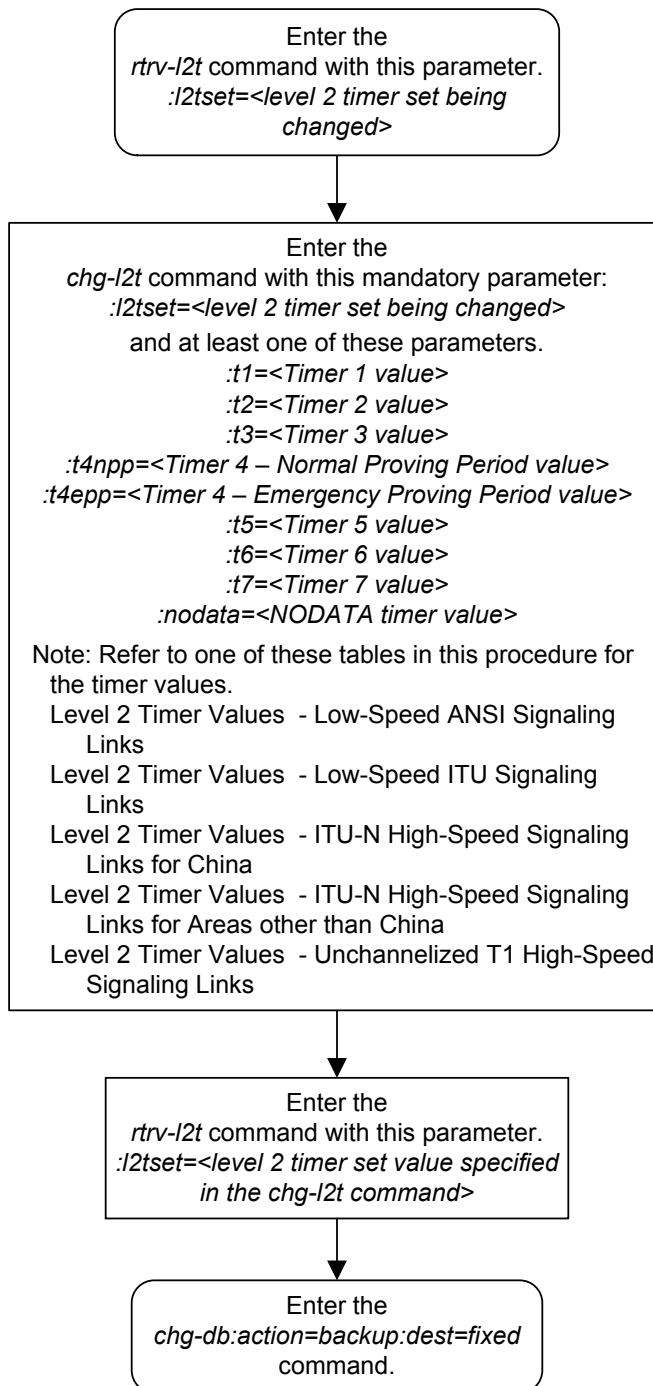
```
rlghncxa03w 06-10-07 08:39:46 GMT EAGLE5 39.0.0
L2T TIMERS (IN SECONDS)
L2TSET T1    T2    T3    T4NPP  T4EPP  T5    T6    T7    NODATA
2      10.0  15.0  20.0  5.0    1.00  0.50  5.0  3.0  0.20
```

4. Back up the new changes using the `chg-db:action=backup:dest=fixed` command.

These messages should appear, the active **Maintenance and Administration Subsystem Processor (MASP)** appears first.

```
BACKUP (FIXED) : MASP A - Backup starts on active MASP.
BACKUP (FIXED) : MASP A - Backup on active MASP to fixed disk complete.
BACKUP (FIXED) : MASP A - Backup starts on standby MASP.
BACKUP (FIXED) : MASP A - Backup on standby MASP to fixed disk complete.
```

Figure 3-23 Changing Level 2 Timers



Changing Level 3 Timers

This procedure is used to change the values of the level 3 timers using the `chg-13t` command. The level 3 timers apply to both **ANSI** and **ITU** linksets, except as noted for the specific timer.

Note: Only one level 3 timer set exists.

The level 3 timers are defined as follows:

:t1 – Timer 1 – Delay to avoid message mis-sequencing on changeover. Values - 100-2000 milliseconds; system default value - 800 milliseconds.

:t2 – Timer 2 – Waiting for changeover acknowledgment. Values - 100-3000 milliseconds; system default value - 1400 milliseconds.

:t3 – Timer 3 – Time controlled diversion – delay to avoid mis-sequencing on changeback. Values - 100 - 2000 milliseconds; system default value - 800 milliseconds.

:t4 – Timer 4 – Waiting for changeback acknowledgment (1st attempt). Values - 100-2000 milliseconds; system default value - 800 milliseconds.

:t5 – Timer 5 – Waiting for changeback acknowledgment (2nd attempt). Values - 100-2000 milliseconds; system default value - 800 milliseconds.

:t6 – Timer 6 – Delay to avoid message mis-sequencing on controlled rerouting. Values - 100-2000 milliseconds; system default values - 800 milliseconds. If the 6-Way Loadsharing on Routesets feature is enabled and turned on, it is recommended that the value for this timer is set to 100 milliseconds. Enter the `rtrv-ctrl-feat:partnum=893019801` command to verify the status of the 6-Way Loadsharing on Routesets feature.

:t7 – Timer 7 – Waiting for signaling data link connection acknowledgment. Values - 100-3000 milliseconds; system default value - 1000 milliseconds.

:t8 – Timer 8 – Transfer-prohibited (**TFP**) inhibited timer (transient solution). Values - 500-2000 milliseconds; system default value - 800 milliseconds.

:t10 – Timer 10 – Waiting to repeat signaling-route-set-test (**SRST**) message. Values - 20000-90000 milliseconds; system default value - 30000 milliseconds.

:t11 – Timer 11 – Transfer-restricted timer. Values - 1000-90000 milliseconds; system default - 30000 milliseconds.

:t12 – Timer 12 – Waiting for uninhibit acknowledgment. Values - 100-2000 milliseconds; system default value - 800 milliseconds.

:t13 – Timer 13 – Waiting for force uninhibit. Values - 100-2000 milliseconds; system default value - 800 milliseconds.

:t14 – Timer 14 – Waiting for inhibition acknowledgment. Values - 200-4000 milliseconds; system default value - 2000 milliseconds.

:t15 – Timer 15 – Waiting to repeat signaling route set congestion test (**RSCT**). Values - 200-4000 milliseconds; system default value - 3000 milliseconds.

:t16 – Timer 16 – Waiting for route set congestion (**RSC**) status update. Values - 200-3000 milliseconds; system default value - 1400 milliseconds.

- :t17 – Timer 17 – Delay to avoid oscillation of initial alignment failure and link restart. Values - 500-2000 milliseconds; system default value - 800 milliseconds.
- :t18 – Timer 18 – **ANSI** linksets – Repeat **TFR** once by response method. Values - 2000-20000 milliseconds; system default value - 10000 milliseconds.
- :it18 – Timer 18 – **ITU** linksets – Timer within a signaling point whose **MTP** restarts to supervise the receipt of routing information and activation of the link and linkset. Values - 19000-50000 milliseconds; system default value - 50000 milliseconds.
- :t19 – Timer 19 – **ANSI** linksets – Failed link craft referral timer. Values - 30000-600000 milliseconds; system default value - 480000 milliseconds.
- :it19 – Timer 19 – **ITU** linksets – Supervision timer during **MTP** restart to avoid ping of **TFR**, **TFR1**, and **TRA** messages. Values - 67000-69000 milliseconds; system default value - 67000 milliseconds.
- :t20 – Timer 20 – **ANSI** linksets – Waiting to repeat local inhibit test. The value of the t20 parameter overwrites the value of the it22 parameter. Values - 90000-120000 milliseconds; system default value - 90000 milliseconds.
- :it20 – Timer 20 – **ITU** linksets – Overall **MTP** restart timer at the signaling point whose **MTP** restarts. Values - 59000-61000 milliseconds; system default value - 59000 milliseconds.
- :it20 – Timer 20 – **ITU** linksets – Waiting to repeat local inhibit test (it22 parameter). Values - 59000-61000 milliseconds; system default value - 59000 milliseconds.
- :t21 – Timer 21 – **ANSI** linksets – Waiting to repeat remote inhibit test. The value of the t21 parameter overwrites the value of the it23 parameter. Values - 90000-120000 milliseconds; system default value - 90000 milliseconds.
- :it21 – Timer 21 – **ITU** linksets – Overall **MTP** restart timer at a signaling point adjacent to one whose **MTP** restarts. Values - 63000-65000 milliseconds; system default value - 63000 milliseconds.
- :t22 – Timer 22 – **ANSI** linksets – the amount of time the restarting node waits for the signaling links to become available. This parameter is used when the **MTP** restart feature is turned on. Values - 10000-60000 milliseconds; system default value - 10000 milliseconds.
- :it22 – Timer 22 – **ITU** linksets – Waiting to repeat local inhibit test. The value of the it22 parameter overwrites the value of the t20 parameter. Values - 180000-360000 milliseconds; system default value - 90000 milliseconds.
- :t23 – Timer 23 – **ANSI** linksets – the amount of time the restarting node waits to receive the **TRA** message. This parameter is used when the **MTP** restart feature is turned on. Values - 9000-100000 milliseconds; system default value - 10000 milliseconds.
- :it23 – Timer 23 – **ITU** linksets – Waiting to repeat remote inhibit test. The value of the it23 parameter overwrites the value of the t21 parameter. Values - 180000-360000 milliseconds; system default value - 90000 milliseconds.
- :t24 – Timer 24 – **ANSI** linksets – the amount of time the restarting node waits to broadcast all **TRA** messages. This parameter is used when the **MTP** restart feature is turned on. Values - 9000-60000 milliseconds; system default value - 10000 milliseconds.
- :t25 – Timer 25 – **ANSI** linksets – the amount of time the adjacent node waits for the **TRA** message. This parameter is used when the **MTP** restart feature is turned on. Values - 30000-35000 milliseconds; system default value - 30000 milliseconds.

:t26 – Timer 26 – **ANSI** linksets – the amount of time the restarting node waits to repeat the **TRW** message. This parameter is used when the **MTP** restart feature is turned on. Values - 12000-15000 milliseconds; system default value - 12000 milliseconds.

:t28 – Timer 28 – **ANSI** linksets – the amount of time the adjacent node waits for the **TRW** message. This parameter is used when the **MTP** restart feature is turned on. Values - 3000-35000 milliseconds; system default value - 3000 milliseconds.

:t29 – Timer 29 – **ANSI** linksets – this timer is started when a **TRA** message is sent in response to an unexpected **TRA/TRW** message or when the **MTP** restart process has completed. Any **TRA/TRW** messages received while the T29 timer is running are ignored. This parameter is used when the **MTP** restart feature is turned on. Values - 60000-65000 milliseconds; system default value - 60000 milliseconds.

:t30 – Timer 30 – **ANSI** linksets – the amount of time between sending **TFPs/TFRs** in response to an unexpected **TRA/TRW** message. This parameter is used when the **MTP** restart feature is turned on. Values - 30000-35000 milliseconds; system default values - 30000 milliseconds.

:t31 – Timer 31 – **ANSI** linksets – False link congestion detection timer. Values - 10000-120000 milliseconds; system default value - 60000 milliseconds.

:t32 – Timer 32 – **Link** oscillation timer - Procedure A. Values - 60000-120000 milliseconds; system default values - 60000 milliseconds.

It is possible that a problem on a signaling link can cause one signaling link in a linkset to go into congestion, even though the traffic on the linkset is not high enough to cause congestion. For example, if a link has a large number of retransmissions, the throughput of the signaling link could drop enough to cause congestion on that signaling link. To help prevent this from happening, the **EAGLE** starts the level 3 T31 timer whenever a signaling link goes into congestion. If the signaling link remains in the same congestion state until the level 3 T31 timer expires, the signaling link is removed from service. The signaling link becomes unaligned, then the alignment procedure is started.

The congestion level that starts the level 3 T31 timer can be set to either congestion level 1 or congestion level 2 using the `chg-stpopts` command with the `mtpt31ctl` parameter. This congestion level can be verified with the `rtrv-stpopts` command and is shown in the `MTPT31CTL` field. The level 3 T31 timer is started when the signaling link reaches this congestion level or a higher level. An increase in congestion level or abatement to a lower congestion level restarts the timer. When the congestion level goes below the congestion level configured in the `chg-stpopts` command, the level 3 T31 timer is stopped. If the level 3 T31 timer expires and the signaling link's congestion level has not changed, the signaling link is restarted.

For example, if the level 3 T31 timer is set at 60 seconds and a signaling link goes into congestion level 1, the level 3 T31 timer is started. If, after 45 seconds, the signaling link's congestion increases to level 2, the timer is restarted to 60 seconds. If the signaling link remains at congestion level 2 for 60 seconds, the signaling link is taken out of service and it becomes unaligned. Then the alignment procedure is started, and the **EAGLE** attempts to realign the signaling link. The level 3 T31 timer can only be assigned to **ANSI SS7** linksets and signaling links.

The level 3 T32 timer helps to prevent a signaling link from oscillating in and out of service. When the **EAGLE** begins restoring an out of service signaling link, the **EAGLE** starts the level 3 T32 timer. If the signaling link fails again before the level 3 T32 expires, the **EAGLE** does not attempt to continue to bring the signaling link into

service until the level 3 T32 timer expires. Once the level 3 T32 timer expires, the **EAGLE** attempts to restore the signaling link into service.

The level 3 T32 timer is only started after a signaling link fails, not when a signaling link is manually deactivated. When a signaling link is manually taken out of service using the `deact-slk` command, the level 3 T32 timer is stopped, if it is running. When the signaling link is brought back into service using the `act-slk` command, the level 3 T32 timer is not started. The level 3 T32 timer is not started when a new signaling link is first aligned.

The `l3tset` parameter specifies the level 3 timer set. For any level 3 timer parameters not specified with the `chg-l3t` command, the values for those parameters are not changed.

1. Display the values for the level 3 timer set using the `rtrv-l3t` command.

This is an example of the possible output.

```
rlghncxa03w 06-10-17 16:03:12 GMT EAGLE5 36.0.0
LEVEL 3 TIMERS (IN SECONDS)
```

L3TSET	T1	T2	T3	T4	T5	T6	T7
1	2.0	3.0	2.0	2.0	2.0	2.0	3.0
	T8	T9	T10	T11	T12	T13	T14
	2.0	--	90.0	90.0	2.0	2.0	4.0
	T15	T16	T17	T18	IT18	T19	IT19
	4.0	3.0	2.0	20.0	19.0	600.0	67.0
	T20/IT22	IT20	T21/IT23	IT21	T22	T23	T24
	120.0	59.0	120.0	63.0	10.0	10.0	10.0
	T25	T26	T27	T28	T29	T30	T31
	30.0	12.0	--	3.0	60.0	30.0	60.0
	T32						
	60.0						

2. Change the values of the level 3 timer set using the `chg-l3t` command.

For this example, the level 3 timer values that are being changed are T10, T11, T19, T20, and T21. To change these timer values, enter this command.

```
chg-
l3t:l3tset=1:t10=40000:t11=50000t19=480000:t20=100000:t21=100
000
```

When this command has successfully completed, this message should appear.

```
rlghncxa03w 06-10-07 08:41:51 GMT EAGLE5 36.0.0
CHG-L3T: MASP A - COMPLTD
```

3. Verify the changes using the `rtrv-l3t` command.

This is an example of the possible output.

```
rlghncxa03w 06-10-17 16:03:12 GMT EAGLE5 36.0.0
LEVEL 3 TIMERS (IN SECONDS)
```

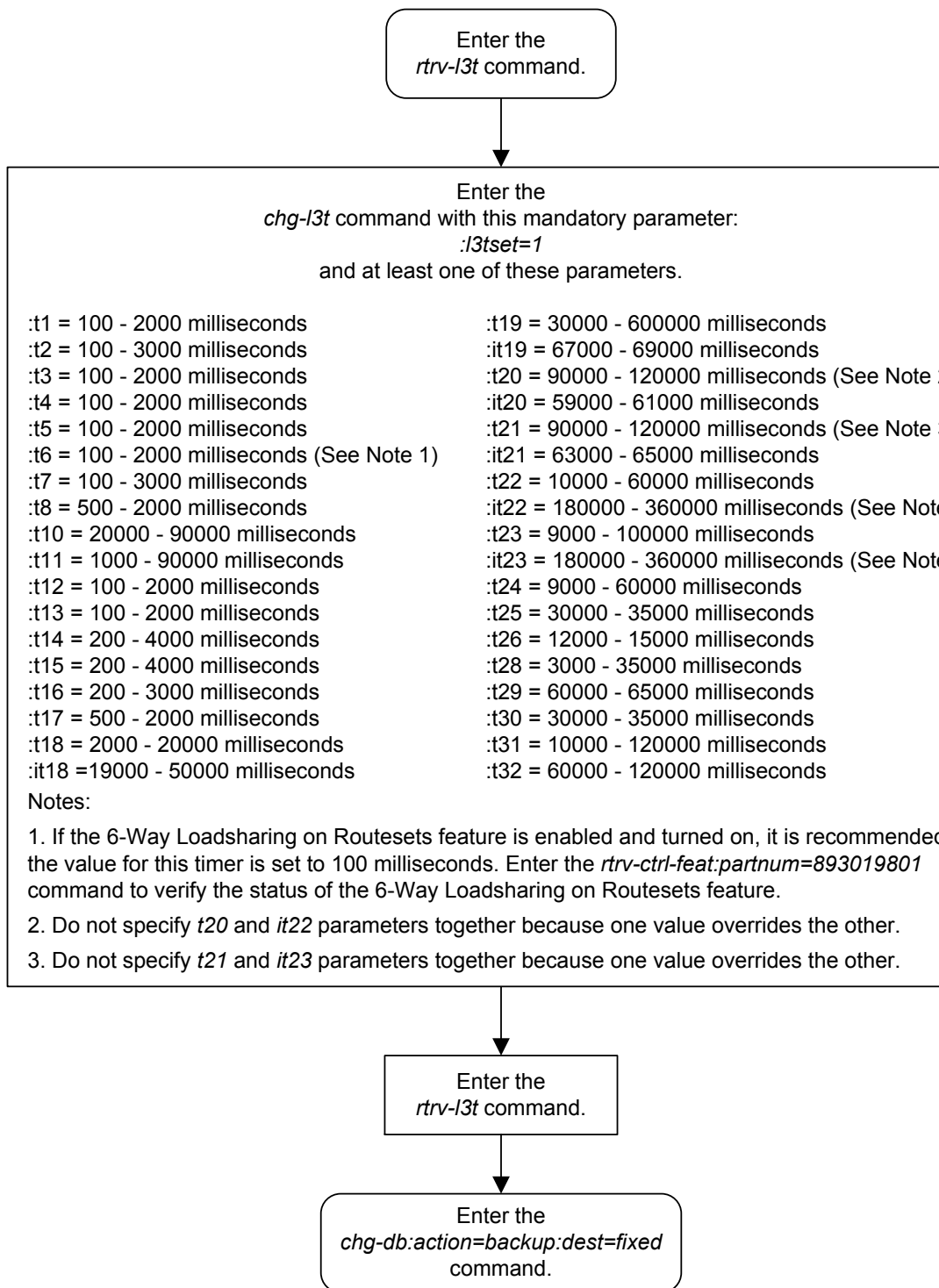
L3TSET	T1	T2	T3	T4	T5	T6	T7
1	2.0	3.0	2.0	2.0	2.0	2.0	3.0
	T8	T9	T10	T11	T12	T13	T14
	2.0	--	40.0	50.0	2.0	2.0	4.0
	T15	T16	T17	T18	IT18	T19	IT19
	4.0	3.0	2.0	20.0	19.0	480.0	67.0
	T20/IT22	IT20	T21/IT23	IT21	T22	T23	T24
	100.0	59.0	100.0	63.0	10.0	10.0	10.0
	T25	T26	T27	T28	T29	T30	T31
	30.0	12.0	--	3.0	60.0	30.0	60.0
	T32						
	60.0						

4. Back up the new changes using the `chg-db:action=backup:dest=fixed` command.

These messages should appear, the active **Maintenance and Administration Subsystem Processor (MASP)** appears first.

```
BACKUP (FIXED) : MASP A - Backup starts on active MASP.
BACKUP (FIXED) : MASP A - Backup on active MASP to fixed disk complete.
BACKUP (FIXED) : MASP A - Backup starts on standby MASP.
BACKUP (FIXED) : MASP A - Backup on standby MASP to fixed disk complete.
```

Figure 3-24 Changing Level 3 Timers



Changing a Signaling Link Test Message

This procedure is used to change an **SLTM** (signaling link test message) using the `chg-slt` command.

The `chg-slt` command uses these parameters.

`:sltset` – The signaling link test message record number in the **SLTM** table.

`:t1` – The **T1** timer for repeating the **SLTM** after a failure

`:t2` – The **T2** timer for the **SLTM** period

`:enabled` – Enables the signaling link test message.

`:mode` – The **SLTM** mode to be used when sending test messages.

`:pattern` – The test pattern to be sent with a signaling link test message.

1. Display the **SLTM** record to be changed using the `rtrv-slt` command.

This is an example of the possible output.

```
rlghncxa03w 06-10-07 00:21:24 GMT EAGLE5 36.0.0
SLTM PARAMETERS
SLTSET  T1   T2   MODE   ENABLED PATTERN
1       9.0  60.0 SPECIAL ON      AA2233445566778899AABBCCDDEEFF
2       12.0 30.0 SPECIAL OFF     F01234BCDE
3       4.0   50.0 REGULAR ON      CC2233445566778899AABBCCDDEEFF
4       6.0   90.0 SPECIAL OFF     BB23446789BCABEFG
5       6.0   90.0 SPECIAL OFF     BB23446789BCABEFG
6       6.0   90.0 SPECIAL OFF     BB23446789BCABEFG
7       6.0   90.0 SPECIAL OFF     BB23446789BCABEFG
8       6.0   90.0 SPECIAL OFF     BB23446789BCABEFG
9       6.0   90.0 REGULAR OFF     BB23446789BCABEFG
10      6.0   90.0 REGULAR OFF     BB23446789BCABEFG
11      6.0   90.0 REGULAR OFF     BB23446789BCABEFG
12      4.0   50.0 SPECIAL ON      FFEEDDCCBAA998877665544332211
13      4.0   50.0 SPECIAL ON      EE22334455
14      6.0   90.0 SPECIAL ON      AABBCDD
15      6.0   90.0 REGULAR ON      AABBCDD
16      6.0   90.0 REGULAR ON      AABBCDD
17      6.0   90.0 REGULAR ON      AABBCDD
18      6.0   90.0 SPECIAL ON      AABBCDD
19      6.0   90.0 SPECIAL ON      AABBCDD
20      6.0   90.0 SPECIAL ON      AABBCDD
```

2. Change the **SLTM** record using the `chg-slt` command.

For this example, signaling link test message 2 is being changed to these values:

T1 = 10.0

T2 = 50.0

MODE = REGULAR

ENABLED = ON

PATTERN = AB987654321

To make these changes, enter this command.

```
chg-
slt:sltset=2:t1=10.0:t2=50.0:mode=regular:enabled=on :pattern
=ab987654321
```

When this command has successfully completed, this message should appear.

```
rlghncxa03w 06-10-07 00:22:57 GMT EAGLE5 36.0.0
CHG-SLT: MASP A - COMPLTD
```

3. Verify the changes using the `rtrv-slt` command, specifying the **SLTM** record.

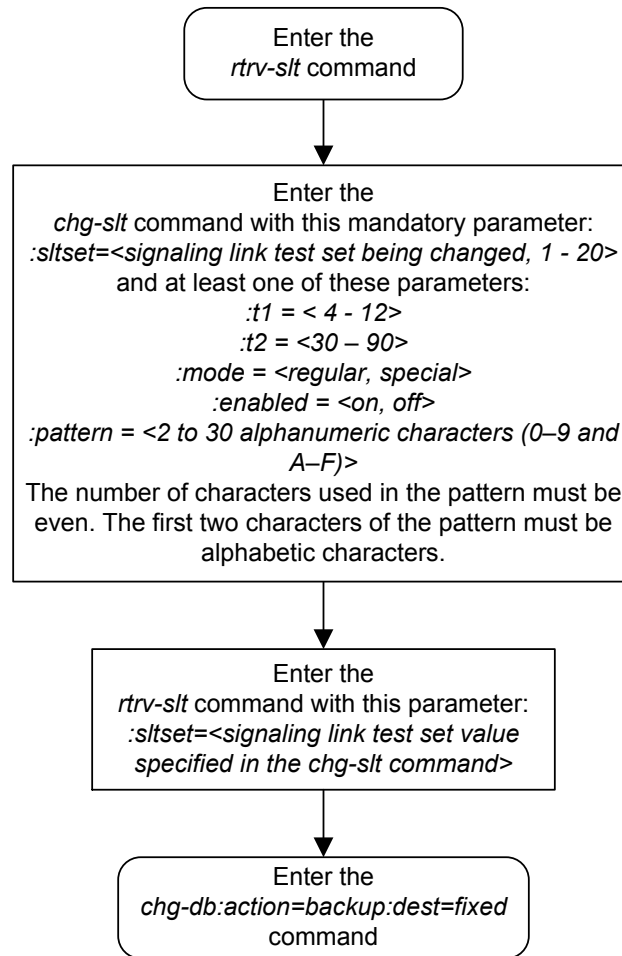
This is an example of the possible output.

```
rlghncxa03w 06-10-07 00:23:35 GMT EAGLE5 36.0.0
SLTM PARAMETERS
SLTSET  T1  T2  MODE  ENABLED  PATTERN
2      10.0 50.0 REGULAR ON      AB987654321
```

4. Back up the new changes using the `chg-db:action=backup:dest=fixed` command.

These messages should appear, the active **Maintenance and Administration Subsystem Processor (MASP)** appears first.

```
BACKUP (FIXED) : MASP A - Backup starts on active MASP.
BACKUP (FIXED) : MASP A - Backup on active MASP to fixed disk complete.
BACKUP (FIXED) : MASP A - Backup starts on standby MASP.
BACKUP (FIXED) : MASP A - Backup on standby MASP to fixed disk complete.
```


Figure 3-25 Changing a Signaling Link Test Message

Configuring Circular Route Detection

Note: Circular route detection is not supported in ITU networks.

This procedure is used to configure the EAGLE to detect circular routing with the `chg-stpopts` command. The `chg-stpopts` command uses these parameters to detect circular routing in the EAGLE.

`:on=mtplti` - to turn on the circular routing detection feature.

`:off=mtplti` - to turn off the circular routing detection feature.

`:mtplctdpcq` - the number of **DPCs** that the circular route test message is sent to.

`:mtpltst` - the duration of the circular route test detection procedures, in milliseconds (the **MTPLTST** timer).

These parameters are optional. For any parameters not specified with the `chg-stpopts` command, the values for these parameters are not changed.

When the `on=mtplti` parameter is specified for the `chg-stpopts` command, the value `yes` is shown in the **MTPLTI** field of the `rtrv-stpopts` output. When the `off=mtplti` parameter is specified for the `chg-stpopts` command, the value `no` is shown in the **MTPLTI** field of the `rtrv-stpopts` output.

The system default values, shown in the `rtrv-stpopts` output, for these parameters are:

- **MTPLTI** - yes
- **MTPLCTDPCQ** - 3
- **MTPLTST** - 10000.

For this example, the circular route detection procedures remain enabled, the number of most frequently occurring DPCs is changed from 3 to 6, and the duration of the circular route detection procedures is changed from 10000 milliseconds to 18000 milliseconds.

The EAGLE automatically tests for circular routing when congestion occurs on an **ANSI** signaling link. The circular route detection test cannot be performed for **ITU** signaling links. If the routing data is configured incorrectly, or is corrupted, MSUs could be routed in an endless circular route. The incorrect routing data could be on the EAGLE or at a remote node. With the addition of cluster routing and E links, the danger of circular routing is greater.

The EAGLE starts the test when a signaling link reaches onset congestion threshold 1. The EAGLE only runs the test for one signaling link per linkset. If a second signaling link in the same linkset goes into congestion, the EAGLE does not start a new test. Each time the signaling link's congestion level increases, the test is restarted. The **LIM** that contains the congested signaling link determines which DPCs have the most MSUs transmitted on the signaling link. The LIM then transmits a circular routing test message to the DPCs that have sent the most MSUs. The number of DPCs that the circular route test message is sent to is from 3 to 10. A circular routing test message is a routeset congestion test message with priority of 3.

If any LIM receives one of the test messages before the **MTPLTST** timer expires, the EAGLE performs these actions.

- Marks the destination as prohibited due to circular routing.
- Broadcasts **TFPs** for the destination.
- Reports that circular routing was detected for the destination.
- Raises a critical alarm.

The destination remains prohibited until it is manually allowed using the `rst-dstn` (reset destination) command.

If the destination is a cluster point code entry in the routing table, then an exception list (x-list) entry is created for the destination. If the cluster has the exception list exclusion indicator set to `yes` (meaning do not create x-lists for that cluster), then an x-list is not created, an **UAM** is generated, and a critical alarm is raised for the cluster. The critical alarm can be cleared by entering the `rst-dstn` command for the cluster.

If an x-list entry needs to be created, but the provisioned number of x-lists are already used, extra buffer space, equal to 100 entries in the routing table, is used to create the x-list. If this extra buffer space is also full, no x-list is created, a **UAM** is generated, and a critical alarm is raised for the cluster.

When a point code is prohibited due to circular routing, the EAGLE ignores **TFx/TCx** management messages for that point code. The EAGLE does not send routeset test messages for the point code. The EAGLE discards any MSUs received for the point code and sends response method **TFPs** or **TCPs**.

When EAGLE detects circular routing for a destination, it sets the circular routing flag for the destination in the routing table. The `rst-dstn` command clears this flag. Once the circular routing flag is cleared, the status of the destination depends on what type of entry is used.

- If the destination is a member of a cluster for which EAGLE performs full point code routing only, all routes to the destination are marked as allowed and the destination's status is allowed. The EAGLE broadcasts **TFAs** for the destination.
- If the destination has a full point code entry in the routing table, and there is also an entry for the point code's cluster, then each route used by the point code that is also used by the cluster entry assumes the status of the route for the cluster entry. Each route used by the point code that is not used by the cluster assumes the status of the cluster's route set. The EAGLE then determines the point codes route set status and broadcasts **TFA/TFR** if the point code becomes allowed or restricted.

If the `rst-dstn` command is entered for an x-list entry with the circular routing flag set, the x-list entry is deleted. The point code's status becomes the same as the cluster entry's status.

If Circular Route Auto-Recovery is enabled and turned on, and circular routing because of far-end loopback is detected, the status of the destination marked as prohibited is automatically cleared. Refer to the [Activating the Circular Route Auto-Recovery Feature](#) procedure for more information.

1. Display the existing values for the circular route test parameters by entering the `rtrv-stpopts` command.

The value for the circular route test parameters is shown in the `MTPLTI`, `MTPLTCTDPCQ`, `MTPLTST` fields. This is an example of the possible output.

```
rlghncxa03w 06-10-17 16:02:05 GMT EAGLE5 36.0.0
```

```

STP OPTIONS
-----
MTPLTI             no
MTPLTCTDPCQ       3
MTPLTST           10000
    
```

Note: The `rtrv-stpopts` command output contains other fields that are not used by this procedure. If you wish to see all the fields displayed by the `rtrv-stpopts` command, see the `rtrv-stpopts` command description in *Commands User's Guide*.

2. Change the circular routing detection parameters by entering the `chg-stpopts` command with at least one of these parameters..

- `on=mtplti` - if the current MTPLTI value is no.
- `off=mtplti` - if the current MTPLTI value is yes.
- `mtpltctdpcq`
- `mtpltst`

For this example, enter this command.

```
chg-stpopts:mtpltctdpcq=6:mtpltst=18000:on=mtplti
```

When this command has successfully completed, this message should appear.

```

rlghncxa03w 06-10-07 00:22:57 GMT  EAGLE5 36.0.0
CHG-STPOPTS: MASP A - COMPLTD
    
```

3. Verify the changes using the `rtrv-stpopts` command.

This is an example of the possible output.

```

rlghncxa03w 06-10-17 16:02:05 GMT  EAGLE5 36.0.0
STP OPTIONS
-----
MTPLTI             yes
MTPLTCTDPCQ       6
MTPLTST           18000
    
```

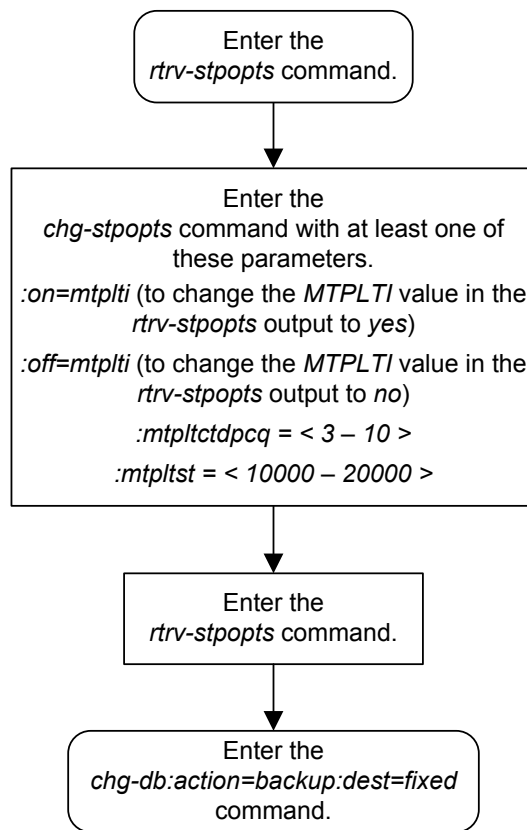
Note: The `rtrv-stpopts` command output contains other fields that are not used by this procedure. If you wish to see all the fields displayed by the `rtrv-stpopts` command, see the `rtrv-stpopts` command description in *Commands User's Guide*.

4. Back up the new changes using the `chg-db:action=backup:dest=fixed` command.

These messages should appear, the active **Maintenance and Administration Subsystem Processor (MASP)** appears first.

```

BACKUP (FIXED) : MASP A - Backup starts on active MASP.
BACKUP (FIXED) : MASP A - Backup on active MASP to fixed disk complete.
BACKUP (FIXED) : MASP A - Backup starts on standby MASP.
BACKUP (FIXED) : MASP A - Backup on standby MASP to fixed disk complete.
    
```

Figure 3-26 *Configuring Circular Route Detection*

Configuring the TFA/TFR Pacing Rate

Note: The pacing rate feature is not supported in ITU networks.

This procedure is used to configure the rate that the **EAGLE** sends the **TFR** and **TFA** messages, or the pacing rate. The pacing rate is configured with the `tfatfrpr` parameter of the `chg-stpopts` command. The value of the `tfatfrpr` parameter is from 0 to 1 second and can be set in 0.1 second intervals. When the `chg-stpopts` command is first introduced to the **EAGLE**, the default value for the `tfatfrpr` parameter is 1 second. A value of 0 for the `tfatfrpr` parameter indicates that the pacing should stop. The pacing of **TFR/TCR** is stopped and all remaining **TFR/TCR** are broadcast at once if the current alternate route used to route traffic to the affected point code is in danger of congestion. The value of the `tfatfrpr` parameter in the `chg-stpopts` command is entered and displayed in the `rtrv-stpopts` command output in milliseconds.

For this example, the **TFA/TFR** pacing rate is changed from 1 second to 0.5 seconds (1000 milliseconds to 500 milliseconds).

When the status of the route is changed to allowed (when the route was restricted) or restricted (when the route was prohibited), a burst of rerouted traffic can occur on that route, thus congesting the route. To help keep this from happening, the **EAGLE** can control the rate that it broadcasts **TFR** and **TFA** messages to adjacent signaling points. This can regulate the amount of traffic the adjacent signaling points can send to the **EAGLE** when the route becomes allowed or restricted.

The **TFA/TCA** and **TFR/TCR** messages for each affected point code are sent in groups of 20%. For each time period defined by the pacing rate, a group of 20% of the messages that are to be sent to the adjacent signaling points are broadcast to those signaling points.

This feature applies only to **ANSI** signaling links. The pacing is not done toward **ITU** networks.

If the destination becomes inaccessible or accessible before all of the **TFR/TCR** messages are broadcasted, then the remaining **TFR/TCR** messages are not sent.

TFA/TFC messages for multiple affected destinations are sent in parallel.

1. Display the existing values for the **TFA/TFR** pacing rate parameter by entering the `rtrv-stpopts` command. The value for the **TFA/TFR** pacing rate parameter is shown in the `TFATFRPR` field, and is shown in milliseconds. This is an example of the possible output.

```
rlghncxa03w 06-10-17 16:02:05 GMT  EAGLE5 36.0.0
STP OPTIONS
-----
TFATFRPR           1000
```

Note: The `rtrv-stpopts` command output contains other fields that are not used by this procedure. If you wish to see all the fields displayed by the `rtrv-stpopts` command, see the `rtrv-stpopts` command description in *Commands User's Guide*.

2. Change the TFA/TFR pacing rate parameter. For this example, enter this command.

```
chg-stpopts:tfatfrpr=500
```

When this command has successfully completed, this message should appear.

```
rlghncxa03w 06-10-07 00:22:57 GMT EAGLE5 36.0.0
CHG-STPOPTS: MASP A - COMPLTD
```

3. Verify the changes using the rtrv-stpopts command. This is an example of the possible output.

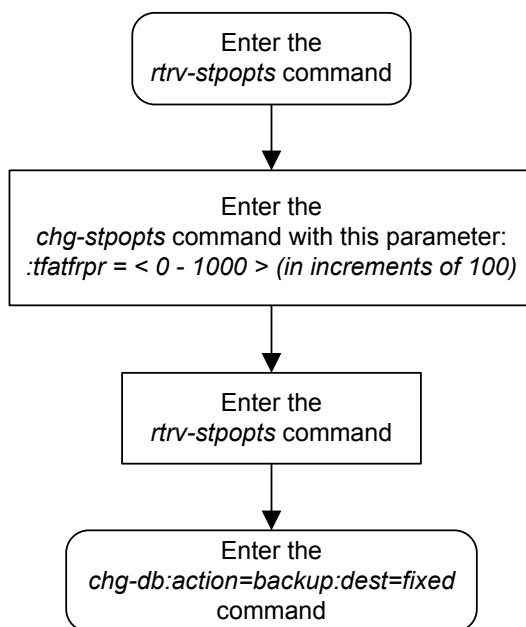
```
rlghncxa03w 06-10-17 16:02:05 GMT EAGLE5 36.0.0
STP OPTIONS
-----
TFATFRPR          500
```

Note: The rtrv-stpopts command output contains other fields that are not used by this procedure. If you wish to see all the fields displayed by the rtrv-stpopts command, see the rtrv-stpopts command description in *Commands User's Guide*.

4. Back up the new changes using the chg-db:action=backup:dest=fixed command. These messages should appear, the active **Maintenance and Administration Subsystem Processor (MASP)** appears first.

```
BACKUP (FIXED) : MASP A - Backup starts on active MASP.
BACKUP (FIXED) : MASP A - Backup on active MASP to fixed disk complete.
BACKUP (FIXED) : MASP A - Backup starts on standby MASP.
BACKUP (FIXED) : MASP A - Backup on standby MASP to fixed disk complete.
```

Figure 3-27 *Configuring the TFA/TFR Pacing Rate*



Configuring the Frequency of RST Messages on Low Priority Routes

This procedure is used to configure the frequency that signaling-route-set-test messages are sent for routes of lower priority than the current route. The frequency is configured with these parameters of the `chg-stpopts` command.

`:on=mtplprst` - to turn on the routeset test message for lower priority routes capability. The EAGLE sends routeset test messages at intervals specified by the value of the `mtpt10alt` parameter.

`:off=mtplprst` - to turn off the routeset test message for lower priority routes capability. The EAGLE does not send routeset test messages for the lower priority routes.

`:mtpt10alt` - the timer to control the frequency that the routeset test messages are sent. The values for this parameter are from 20000 to 10,000,000 milliseconds (20 - 10,000 seconds).

The value of the `mtpt10alt` parameter must be equal to or greater than the value of the level 3 T10 timer.

When the `on=mtplprst` parameter is specified for the `chg-stpopts` command, the value `yes` is shown in the `MTPLPRST` field of the `rtrv-stpopts` output. When the `off=mtplprst` parameter is specified for the `chg-stpopts` command, the value `no` is shown in the `MTPLPRST` field of the `rtrv-stpopts` output.

The system default values, shown in the `rtrv-stpopts` output, for these parameters are:

- `MTPLPRST` - `yes`
- `MTPT10ALT` - equal to the value of the level 3 T10 timer. The value of the level 3 T10 timer is shown in the `T10` field of the `rtrv-l3t` command output

If the Origin-Based MTP Routing feature is enabled and turned on, the `off=mtplprst` parameter cannot be specified with the `chg-stpopts` command. The status of the Origin-Based MTP Routing feature is shown in the `rtrv-ctrl-feat` command output.

These parameters of the `chg-stpopts` command are optional. For any parameters not specified with the `chg-stpopts` command, the values for these parameters are not changed.

For this example, the sending the signaling-route-set-test messages for the low priority routes is turned on, and the frequency of sending these messages is changed from 30,000 milliseconds to 120,000 milliseconds (30 seconds to 120 seconds).

1. Display the current `MTPLPRST` and `MTPT10ALT` values by entering the `rtrv-stpopts` command.

The `MTPT10ALT` value is shown in milliseconds. This is an example of the possible output.

```
rlghncxa03w 06-10-17 16:02:05 GMT EAGLE5 36.0.0
STP OPTIONS
-----
MTPLPRST          no
MTPT10ALT        30000
```

Note: The `rtrv-stpopts` command output contains other fields that are not used by this procedure. If you wish to see all the fields displayed by the `rtrv-stpopts` command, see the `rtrv-stpopts` command description in *Commands User's Guide*.

If the `MTPLPRST` value is not being changed, or if the `MTPLPRST` value is being changed from `no` to `yes`, continue the procedure with [3](#).

If the `MTPLPRST` value is being changed from `yes` to `no`, continue the procedure with [2](#).

2. Display the status of the Origin-Based MTP Routing feature by entering this command.

```
rtrv-ctrl-feat:partnum=893014201
```

This is an example of the possible output.

```
rlghncxa03w 06-10-28 21:15:37 GMT EAGLE5 36.0.0
The following features have been permanently enabled:
```

Feature Name	Partnum	Status	Quantity
MTP Origin-Based Routing	893014201	off	----

The following features have been temporarily enabled:

Feature Name	Partnum	Status	Quantity	Trial Period Left
Zero entries found.				

The following features have expired temporary keys:

Feature Name	Partnum
Zero entries found.	

If the Origin-Based MTP Routing feature is enabled and turned on, shown with entry `on` in the `Status` column, the `MTPLPRST` value cannot be changed to `no`.

3. Display the values for the level 3 timer set using the `rtrv-l3t` command.

The values of the level 3 timers are shown in seconds. This is an example of the possible output.

```
rlghncxa03w 06-10-17 16:03:12 GMT EAGLE5 36.0.0
LEVEL 3 TIMERS (IN SECONDS)
```

L3TSET	T1	T2	T3	T4	T5	T6	T7
1	2.0	3.0	2.0	2.0	2.0	2.0	3.0
	T8	T9	T10	T11	T12	T13	T14
	2.0	--	90.0	90.0	2.0	2.0	4.0
	T15	T16	T17	T18	IT18	T19	IT19
	4.0	3.0	2.0	20.0	19.0	600.0	67.0
	T20/IT22	IT20	T21/IT23	IT21	T22	T23	T24
	120.0	59.0	120.0	63.0	10.0	10.0	10.0
	T25	T26	T27	T28	T29	T30	T31

```

30.0  12.0  --   3.0  60.0  30.0  60.0

T32
60.0

```

4. Change the MTPLPRST or MTPT10ALT values by entering the `chg-stpopts` command with at least one of these parameters.

- `on=mtplprst` - if the current MTPLPRST value is no.
- `off=mtplprst` - if the current MTPLPRST value is yes.
- `mtpt10alt`

For this example, enter this command.

```
chg-stpopts:on=mtplprst:mtpt10alt=120000
```

When this command has successfully completed, this message should appear.

```
rlghncxa03w 06-10-07 00:22:57 GMT EAGLE5 36.0.0
CHG-STPOPTS: MASP A - COMPLTD
```

5. Verify the changes using the `rtrv-stpopts` command.

This is an example of the possible output.

```
rlghncxa03w 06-10-17 16:02:05 GMT EAGLE5 36.0.0
STP OPTIONS
-----
MTPLPRST          yes
MTPT10ALT         120000
```

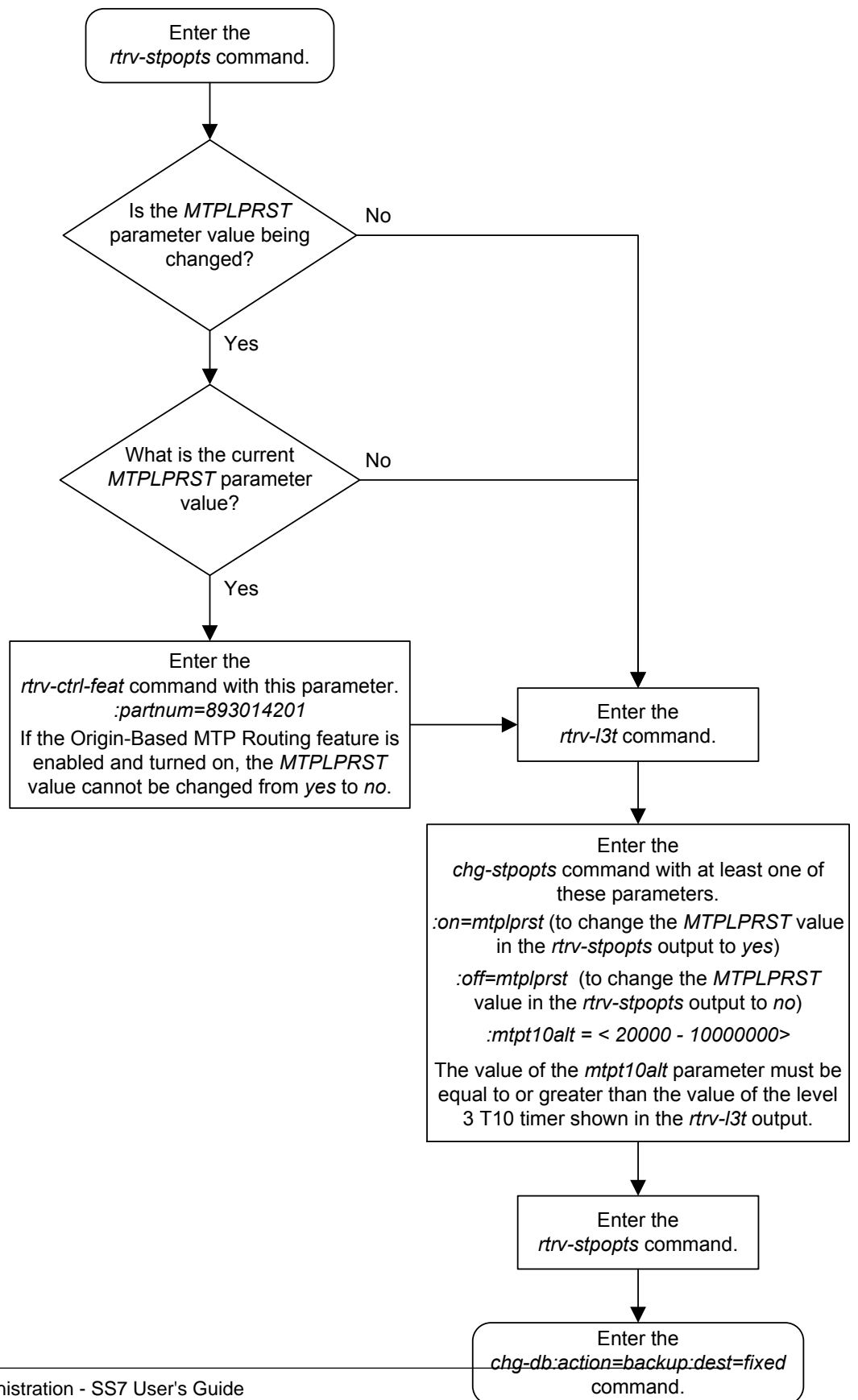
Note: The `rtrv-stpopts` command output contains other fields that are not used by this procedure. If you wish to see all the fields displayed by the `rtrv-stpopts` command, see the `rtrv-stpopts` command description in *Commands User's Guide*.

6. Back up the new changes using the `chg-db:action=backup:dest=fixed` command.

These messages should appear, the active **Maintenance and Administration Subsystem Processor (MASP)** appears first.

```
BACKUP (FIXED) : MASP A - Backup starts on active MASP.
BACKUP (FIXED) : MASP A - Backup on active MASP to fixed disk complete.
BACKUP (FIXED) : MASP A - Backup starts on standby MASP.
BACKUP (FIXED) : MASP A - Backup on standby MASP to fixed disk complete.
```

Figure 3-28 Configuring the Frequency of RST Messages on Low Priority Routes



Adding Remote Loopback Points

This procedure is used to add remote loopback points to be used by the link fault sectionalization feature to the database, using the `ent-lbp` command. The `ent-lbp` command uses these parameters.

`:loc` – The card location of the signaling link to be tested.

`:link` – The signaling link on the card specified in the `loc` parameter to be tested.

`:lbp` – Identifies the far-end loopback point that lies along a **SS7** signaling link path between the **EAGLE** up to and including the target device.

`:cli` – The **CLLI** code or other mnemonic identifier used to describe the specified loopback point.

`:rle` – The remote link element to be looped back for testing.

`:rep` – The number of link elements of the same type, not including the target device, that lies between the **EAGLE** and the link element to be tested.

`:lfst` – The type of link fault sectionalization loopback test to be performed.

To add remote loopback points to the database, the link fault sectionalization feature must be turned on.

The **DS0** and network element interface (**NEI**) link elements do not support non-latching loopbacks

If the remote link element to be tested is a network element interface (**NEI**), the value of the `rep` parameter must be zero.

The `rep` parameter can only be specified for a link fault sectionalization latching loopback test

The signaling link being tested can be assigned to one of these card types as defined by the `type` parameter of the `ent-card` command:

- `limds0` (multi-port **LIM** - P/N 870-2061-XX)
- `limt1` (**E1/T1 MIM** - P/N 870-2198-XX, **HC MIM** - P/N 870-2671-XX, or **E5-E1T1** - P/N 870-1873-XX)
- `limch` (**E1/T1 MIM** - configured as a **T1** channel card - P/N 870-2198-XX)

Any signaling link can be selected for testing, as long as the signaling link being tested is equipped. The **LIMs** must be assigned to either the `ss7ansi` or `ccs7itu` application. Use the `rtrv-card` command to verify the card type and the application.

The specified loopback point cannot already be in the database.

The loopback point **ID** value cannot exceed a previously defined network element interface loopback point value.

Only one network element interface loopback point can be defined for each **SS7** signaling link.

A network element interface (**NEI**) loopback point must be defined as the terminating **SS7** signaling link component.

The value specified for the `rep` parameter must be greater than the value of the `rep` parameter assigned to the previous loopback point and less than any `rep` parameter values for any subsequent loopback points, if any are defined. For example, the

signaling link on card 1215, link B, has 5 loopback points defined (see the `rtrv-lbp` command output in step 2). The value of the `rep` parameter used for loopback point 5 must be greater than the `rep` parameter value used for loopback point 3, and less than the `rep` parameter value used for loopback point 7.

The link fault sectionalization feature must be turned on. Verify this by entering the `rtrv-feat` command. If the link fault sectionalization feature is off, shown by the entry `LFS = off` in the output of the `rtrv-feat` command, it can be turned on by entering the `chg-feat:lfs=on` command.

Note: Once the link fault sectionalization feature is turned on with the `chg-feat` command, it cannot be turned off.

The link fault sectionalization feature must be purchased before you turn the feature on with the `chg-feat` command. If you are not sure if you have purchased the link fault sectionalization feature, contact your Oracle Sales Representative or Account Representative.

Refer to Appendix A of *Commands User's Guide* for a summary of loopback testing commands and functions.

The examples used in this procedure are based on the example network shown in [Table 3-22](#).

Table 3-22 Loopback Point Configuration Table

SLK LOC	SLK LINK	LBP	RLE	REP	LFST
		3	DS0	0	LLT
1204	B	6	DS0	4	LLT
		9	NEI	0	LLT

Canceling the RTRV-SLK Command

Because the `rtrv-slk` command used in this procedure can output information for a long period of time, the `rtrv-slk` command can be canceled and the output to the terminal stopped. There are three ways that the `rtrv-slk` command can be canceled.

- Press the F9 function key on the keyboard at the terminal where the `rtrv-slk` command was entered.
- Enter the `canc-cmd` without the `trm` parameter at the terminal where the `rtrv-slk` command was entered.
- Enter the `canc-cmd:trm=<xx>`, where `<xx>` is the terminal where the `rtrv-slk` command was entered, from another terminal other than the terminal where the `rtrv-slk` command was entered. To enter the `canc-cmd:trm=<xx>` command, the terminal must allow Security Administration commands to be entered from it and the user must be allowed to enter Security Administration commands. The terminal's permissions can be verified with the `rtrv-secu-trm` command. The user's permissions can be verified with the `rtrv-user` or `rtrv-secu-user` commands.

For more information about the `canc-cmd` command, go to *Commands User's Guide*.

1. Display the signaling links in the database by entering the `rtrv-slk` command.

This is an example of the possible output.

```
rlghncxa03w 09-07-19 21:16:37 GMT EAGLE5 41.1.0
```

LOC	LINK	LSN	SLC	TYPE	L2T SET	BPS	ECM	PCR N1	PCR N2
1201	A	ls01	0	LIMDS0	1	56000	BASIC	---	-----
1201	B	lsa1	0	LIMDS0	1	56000	BASIC	---	-----
1202	B	ls02	0	LIMDS0	2	56000	BASIC	---	-----
1203	A	ls03	0	LIMDS0	3	56000	BASIC	---	-----
1203	B	lsa2	0	LIMDS0	1	56000	BASIC	---	-----
1204	B	ls01	1	LIMDS0	1	56000	BASIC	---	-----
1205	A	lsa3	0	LIMDS0	4	56000	BASIC	---	-----
1206	A	ls02	1	LIMDS0	2	56000	BASIC	---	-----
1207	A	lsn1207a	0	LIMDS0	1	56000	BASIC	---	-----
1207	B	lsn1207b	0	LIMDS0	1	56000	BASIC	---	-----
1208	B	ls03	1	LIMDS0	3	56000	BASIC	---	-----
1212	A	ls04	0	LIMDS0	4	56000	BASIC	---	-----
1213	B	ls05	0	LIMDS0	5	56000	BASIC	---	-----
1214	A	lsn1214a	0	LIMDS0	2	56000	BASIC	---	-----
1214	B	lsa3	1	LIMDS0	4	56000	BASIC	---	-----
1215	A	ls05	1	LIMDS0	5	56000	BASIC	---	-----
1301	B	ls06	0	LIMDS0	6	56000	BASIC	---	-----
1304	B	ls06	1	LIMDS0	6	56000	BASIC	---	-----
1308	A	ls06	2	LIMDS0	6	56000	BASIC	---	-----
1311	A	ls01	2	LIMDS0	1	56000	BASIC	---	-----
1311	A1	ls05	2	LIMDS0	5	56000	BASIC	---	-----
1311	B	ls03	2	LIMDS0	3	56000	BASIC	---	-----
1311	B1	ls07	1	LIMDS0	7	56000	BASIC	---	-----
1313	A	ls07	0	LIMDS0	7	56000	BASIC	---	-----
1315	A	lsn5	0	LIMDS0	11	56000	BASIC	---	-----
1317	A	lsi7	0	LIMDS0	11	56000	BASIC	---	-----

LOC	LINK	LSN	SLC	TYPE	LP SET	BPS	ATM TSEL	VCI	VPI	LL
1302	A	atmansio	0	LIMATM	3	1544000	EXTERNAL	35	15	0
1305	A	atmansil	0	LIMATM	4	1544000	INTERNAL	100	20	2
1318	A	atmansio	1	LIMATM	9	1544000	LINE	150	25	4

LOC	LINK	LSN	SLC	TYPE	LP SET	BPS	ATM TSEL	VCI	VPI	CRC4	SI	SN
2101	A	atmitul	0	LIME1ATM	5	2.048M	LINE	150	2	ON	1	20
2105	A	atmitul	1	LIME1ATM	5	2.048M	LINE	35	15	ON	2	15

SLK table is (31 of 1200) 3% full

2. Display the existing loopback point values by entering the `rtrv-lbp` command.

This is an example of the possible output.

```
rlghncxa03w 06-10-17 16:02:05 GMT EAGLE5 36.0.0
```

LOC	LINK	LBP	RLE	REP	CLLI
LFST					
1201	A	1	DS0	0	----- LLT
		7	OCU	0	----- NLT
		9	NEI	0	----- LLT
1203	B	2	DS0	0	----- LLT

```

          3   DS0   4  ----- LLT
          4   NEI   0  ----- LLT
1207  B     1   DS0   0  ----- LLT
          6   NEI   0  ----- LLT
1215  A     1   DS0   0  ----- LLT
          3   DS0   4  ----- LLT
          5   DS0   5  ----- LLT
          7   DS0   8  ----- LLT
          9   NEI   0  ----- LLT
    
```

3. Add the loopback point to the database, using the `ent-lbp` command.

For this example, enter these commands.

```

ent-lbp:loc=1204:link=b:lbp=3:rle=ds0:rep=0:lfst=llt
ent-lbp:loc=1204:link=b:lbp=6:rle=ds0:rep=4:lfst=llt
ent-lbp:loc=1204:link=b:lbp=9:rle=nei:rep=0:lfst=llt
    
```

When each of these commands have completed, this message should appear.

```

rlghncxa03w 06-10-07 00:22:57 GMT  EAGLE5 36.0.0
ENT-LBP: MASP A - COMPLTD
    
```

4. Verify the changes using the `rttrv-lbp` command.

This is an example of the possible output.

```

rlghncxa03w 06-10-17 16:02:05 GMT  EAGLE5 36.0.0
LOC  LINK  LBP  RLE  REP  CLLI  LFST
1201  A     1   DS0   0  ----- LLT
          7   OCU   0  ----- NLT
          9   NEI   0  ----- LLT

1203  B     2   DS0   0  ----- LLT
          3   DS0   4  ----- LLT
          4   NEI   0  ----- LLT
1204  B     3   DS0   0  ----- LLT
          6   DS0   4  ----- LLT
          9   NEI   0  ----- LLT
1207  B     1   DS0   0  ----- LLT
          6   NEI   0  ----- LLT
1215  A     1   DS0   0  ----- LLT
          3   DS0   4  ----- LLT
          5   DS0   5  ----- LLT
          7   DS0   8  ----- LLT
          9   NEI   0  ----- LLT
    
```

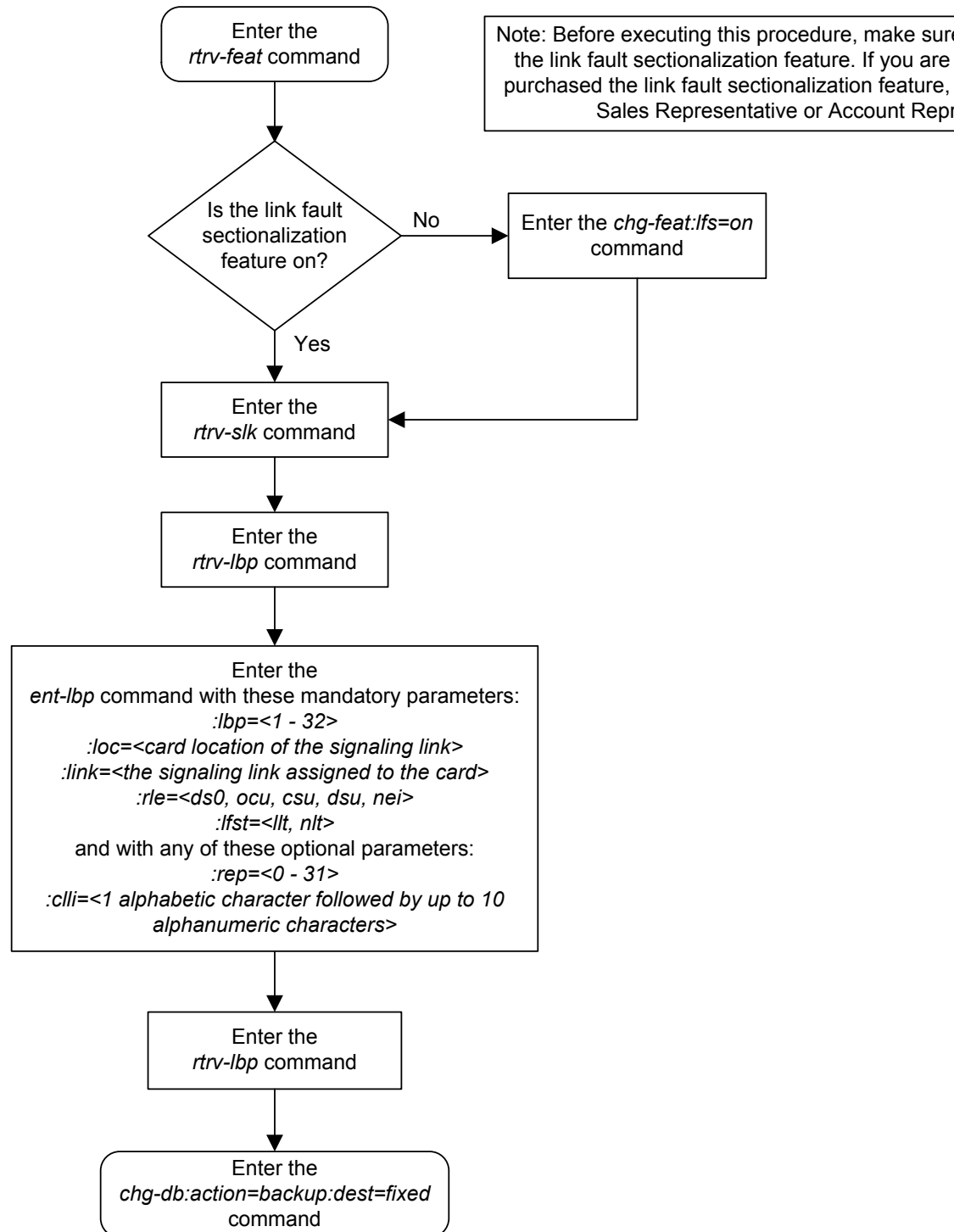
5. Back up the new changes using the `chg-db:action=backup:dest=fixed` command.

These messages should appear, the active **Maintenance and Administration Subsystem Processor (MASP)** appears first.

```

BACKUP (FIXED) : MASP A - Backup starts on active MASP.
BACKUP (FIXED) : MASP A - Backup on active MASP to fixed disk complete.
BACKUP (FIXED) : MASP A - Backup starts on standby MASP.
BACKUP (FIXED) : MASP A - Backup on standby MASP to fixed disk complete.
    
```


Figure 3-29 Adding Remote Loopback Points



Removing Remote Loopback Points

This procedure is used to remove remote loopback points used by the link fault sectionalization feature from the database, using the `dlt-lbp` command. The `dlt-lbp` command uses these parameters.

`:loc` – The card location of the signaling link to be tested.

`:link` – The signaling link on the card specified in the `loc` parameter.

`:lbp` – Identifies the far-end loopback point that lies along a **SS7** signaling link path between the **EAGLE 5 ISS** up to and including the target device.

`:all` – Are all loopback points for the specified signaling link to be removed

The specified loopback point must be in the database.

Either the `lbp` or `all` parameters must be specified, but not both.

This examples used in this procedure are used to remove the remote loopback point 5 on the signaling link assigned to card 1215, link B.

1. Display the existing loopback point values by entering the `rtrv-lbp` command. This is an example of the possible output.

```
rlghncxa03w 06-10-17 16:02:05 GMT EAGLE5 36.0.0
LOC  LINK  LBP  RLE  REP  CLLI  LFST
1201  A      1    DS0  0  -----  LLT
      7    OCU  0  -----  NLT
      9    NEI  0  -----  LLT

1203  B      2    DS0  0  -----  LLT
      3    DS0  4  -----  LLT
      4    NEI  0  -----  LLT

1204  B      3    DS0  0  -----  LLT
      6    DS0  4  -----  LLT
      9    NEI  0  -----  LLT

1207  B      1    DS0  0  -----  LLT
      6    NEI  0  -----  LLT

1215  A      1    DS0  0  -----  LLT
      3    DS0  4  -----  LLT
      5    DS0  5  -----  LLT
      7    DS0  8  -----  LLT
      9    NEI  0  -----  LLT
```

2. Remove the loopback point from the database, using the `dlt-lbp` command. For this example, enter this command.

```
dlt-lbp:loc=1215:link=b:lbp=5
```

If all the loopback points on the signaling link are to be removed from the database, enter this command.

```
dlt-lbp:loc=1215:link=b:all=yes
```

When the command has completed, this message should appear.

```
rlghncxa03w 06-10-07 00:22:57 GMT EAGLE5 36.0.0
DLT-LBP: MASP A - COMPLTD
```

3. Verify the changes using the `rtrv-lbp` command. This is an example of the possible output.

```
rlghncxa03w 06-10-17 16:02:05 GMT EAGLE5 36.0.0
LOC  LINK  LBP  RLE  REP  CLLI  LFST
1201  A      1    DS0  0  -----  LLT
      7    OCU  0  -----  NLT
      9    NEI  0  -----  LLT

1203  B      2    DS0  0  -----  LLT
      3    DS0  4  -----  LLT
      4    NEI  0  -----  LLT

1204  B      3    DS0  0  -----  LLT
      6    DS0  4  -----  LLT
      9    NEI  0  -----  LLT

1207  B      1    DS0  0  -----  LLT
      6    NEI  0  -----  LLT

1215  A      1    DS0  0  -----  LLT
      3    DS0  4  -----  LLT
      7    DS0  8  -----  LLT
      9    NEI  0  -----  LLT
```

If the `all=yes` parameter was specified in step 2, this is an example of the possible output.

```
rlghncxa03w 06-10-17 16:02:05 GMT EAGLE5 36.0.0
LOC  LINK  LBP  RLE  REP  CLLI  LFST
1201  A      1    DS0  0  -----  LLT
      7    OCU  0  -----  NLT
      9    NEI  0  -----  LLT

1203  B      2    DS0  0  -----  LLT
      3    DS0  4  -----  LLT
      4    NEI  0  -----  LLT

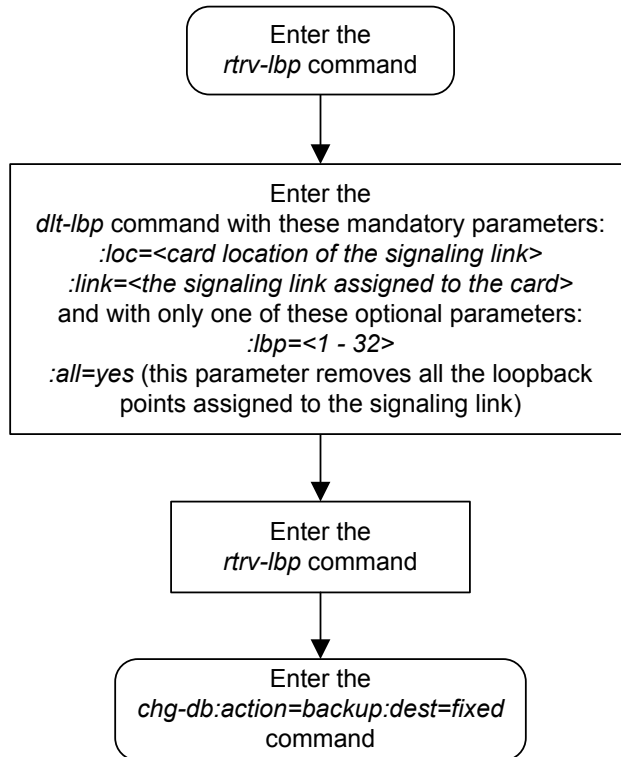
1204  B      3    DS0  0  -----  LLT
      6    DS0  4  -----  LLT
      9    NEI  0  -----  LLT

1207  B      1    DS0  0  -----  LLT
      6    NEI  0  -----  LLT
```

4. Back up the new changes using the `chg-db:action=backup:dest=fixed` command. These messages should appear, the active **Maintenance and Administration Subsystem Processor (MASP)** appears first.

```
BACKUP (FIXED) : MASP A - Backup starts on active MASP.
BACKUP (FIXED) : MASP A - Backup on active MASP to fixed disk complete.
BACKUP (FIXED) : MASP A - Backup starts on standby MASP.
BACKUP (FIXED) : MASP A - Backup on standby MASP to fixed disk complete.
```

Figure 3-30 Removing Remote Loopback Points



Changing Remote Loopback Points

This procedure is used to change the values of the remote loopback points to be used by the link fault sectionalization feature in the database, using the `chg-lbp` command. The `chg-lbp` command uses these parameters.

`:loc` – The card location of the signaling link to be tested.

`:link` – The signaling link on the card specified in the `loc` parameter.

`:lbp` – Identifies the far-end loopback point that lies along a **SS7** signaling link path between the **EAGLE** up to and including the target device.

`:clli` – The **CLLI** code or other mnemonic identifier used to describe the specified loopback point.

`:rle` – The remote link element to be looped back for testing.

`:rep` – The number of link elements of the same type, not including the target device, that lies between the **EAGLE** and the link element to be tested.

`:lfst` – The type of link fault sectionalization loopback test to be performed.

The **DS0** and network element interface (**NEI**) link elements do not support non-latching loopbacks.

If the remote link element to be tested is a network element interface (**NEI**), the value of the `rep` parameter must be zero.

The `rep` parameter can only be specified for a link fault sectionalization latching loopback test.

The specified loopback point must be in the database.

The loopback point **ID** value cannot exceed a previously defined network element interface loopback point value.

Only one network element interface loopback point can be defined for each **SS7** signaling link.

A network element interface (**NEI**) loopback point must be defined as the terminating **SS7** signaling link component.

The value specified for the `rep` parameter must be greater than the value of the `rep` parameter assigned to the previous loopback point and less than any `rep` parameter values for any subsequent loopback points, if any are defined. For example, the signaling link on card 1215, link B, has 5 loopback points defined (see the `rtrv-lbp` command output in step 1). The value of the `rep` parameter used for loopback point 5 must be greater than the `rep` parameter value used for loopback point 3, and less than the `rep` parameter value used for loopback point 7.

Refer to Appendix A of *Commands User's Guide* for a summary of loopback testing commands and functions.

1. Display the existing loopback point values by entering the `rtrv-lbp` command.

This is an example of the possible output.

```
rlghncxa03w 06-10-17 16:02:05 GMT EAGLE5 36.0.0
LOC  LINK  LBP  RLE  REP  CLLI  LFST
1201  A      1   DS0   0   -----  LLT
      7   OCU   0   -----  NLT
```

```

          9   NEI   0  ----- LLT
1203  B    2   DS0   0  ----- LLT
        3   DS0   4  ----- LLT
        4   NEI   0  ----- LLT
1204  B    3   DS0   0  ----- LLT
        6   DS0   4  ----- LLT
        9   NEI   0  ----- LLT
1207  B    1   DS0   0  ----- LLT
        6   NEI   0  ----- LLT
1215  A    1   DS0   0  ----- LLT
        3   DS0   4  ----- LLT
        5   DS0   5  ----- LLT
        7   DS0   8  ----- LLT
        9   NEI   0  ----- LLT

```

2. Change the loopback point values in the database, using the `chg-lbp` command.

For this example, enter this command.

```
chg-lbp:loc=1204:link=b:lbp=6:rle=csu:rep=10
```

When the command has completed, this message should appear.

```
rlghncxa03w 06-10-07 00:22:57 GMT  EAGLE5 36.0.0
CHG-LBP: MASP A - COMPLTD
```

3. Verify the changes using the `rtrv-lbp` command.

This is an example of the possible output.

```

rlghncxa03w 06-10-17 16:02:05 GMT  EAGLE5 36.0.0
LOC  LINK  LBP  RLE  REP  CLLI  LFST
1201  A    1   DS0   0  ----- LLT
        7   OCU   0  ----- NLT
        9   NEI   0  ----- LLT

1203  B    2   DS0   0  ----- LLT
        3   DS0   4  ----- LLT
        4   NEI   0  ----- LLT
1204  B    3   DS0   0  ----- LLT
        6   CSU  10  ----- LLT
        9   NEI   0  ----- LLT
1207  B    1   DS0   0  ----- LLT
        6   NEI   0  ----- LLT
1215  A    1   DS0   0  ----- LLT
        3   DS0   4  ----- LLT
        5   DS0   5  ----- LLT
        7   DS0   8  ----- LLT
        9   NEI   0  ----- LLT

```

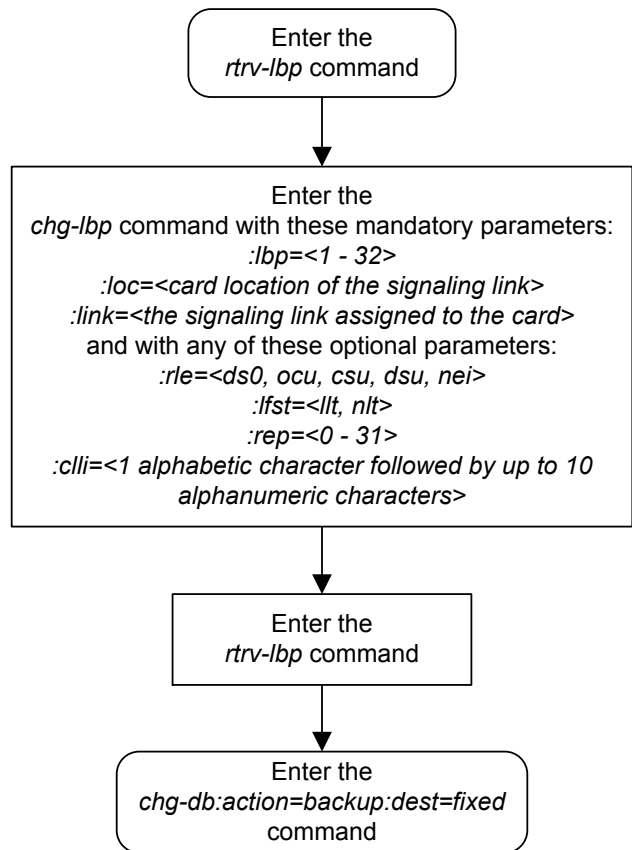
4. Back up the new changes using the `chg-db:action=backup:dest=fixed` command.

These messages should appear, the active **Maintenance and Administration Subsystem Processor (MASP)** appears first.

```
BACKUP (FIXED) : MASP A - Backup starts on active MASP.
BACKUP (FIXED) : MASP A - Backup on active MASP to fixed disk complete.
```

BACKUP (FIXED) : MASP A - Backup starts on standby MASP.
BACKUP (FIXED) : MASP A - Backup on standby MASP to fixed disk complete.

Figure 3-31 Changing Remote Loopback Points



Configuring the System for Random SLS Generation

The Random **SLS** Generation feature can alleviate problems of the **EAGLE** not load-sharing between all links within a linkset. This feature is available for both ITU and ANSI traffic.

The ITU protocol uses a 4 bit **Signaling Link Selection (SLS)** field with no modification of **SLS** values by intermediate nodes and a one-to-one mapping of **SLS** values to signaling links. These rules can be overly restrictive in situations where they are not necessary.

For both ITU and ANSI, the feature allows the user to have the **EAGLE** ignore the incoming **SLS** value and randomly generate a new 8-bit **SLS** value to select an outgoing linkset and a link. For ITU only, the original 4-bit **SLS** value is not changed and is still contained in the outgoing message. The newly generated **SLS** is used for link selection only. For ANSI, the original **SLS** value in the outgoing MSU can be replaced with the **SLS** value generated by the feature. This is done by appropriately setting `SS7OPTS:SLSREPLACE` parameter.

Messages destined for a particular destination are randomly distributed across all the links to that destination using an internally generated random 8-bit **SLS**. This means that this feature does not follow the ITU protocol requiring that all messages with the same **SLS** value must use the same signaling link. Also, correct sequencing of Class 1 messages is not guaranteed. Random **SLS** generation applies to all Class 0 and Class 1 **SCCP** messages.

This feature is implemented with one of these values for the `randsls` parameter of the `chg-stpopts` command.

- `class0` – Applies the Random **SLS** feature to Class 0 ITU **SCCP** messages and associated service. For example, Random **SLS** Generation would apply to Class 0 **UDT**, **XUDT**, and **UDTS**, **XUDTS** messages. Class 1 messages would still use the standard ITU method for link selection.
- `all` – Applies the Random **SLS** feature to all ITU **SCCP** messages
- `off` – Turns off the Random **SLS** feature.
- `perls` – Applies the Random **SLS** feature on a specific linkset instead of applying the Random **SLS** feature system-wide. To use the `randsls` with ANSI, the value for `randsls` must be specified as `perls`. For more information about random **SLS** generation on a specific linkset, refer to [Per-Linkset Random SLS](#).

Caution: If the `randsls` parameter value of the `chg-stpopts` command is `all`, thus activating the Random **SLS** feature for Class 1 ITU **SCCP** messages, and the value of the `class1seq` parameter of the `chg-sccpopts` command is `on`, there is no guarantee that **UDT/XUDT** ITU Class 1 messages are delivered to the remote node in the order in which they were received. To ensure that Class 1 **UDT/XUDT** ITU messages are delivered to the remote node in the order in which they were received, the `randsls` parameter value should be set to either `off` or `class0` if the value of the `class1seq` parameter of the `chg-sccpopts` command is `on`.

For ITU linksets, this feature is available as a system-wide option as well as on a per-linkset basis. For ANSI linksets, this feature is available only on a per-linkset basis. The

Random SLS feature is applied to incoming messages on ITU linksets as shown in [Table 3-23](#).

Table 3-23 ITU Random SLS Rules

System-Wide RANDSLS Value (in the RTRV-STPOPTS Output)	RANDSLS Value for the Outgoing Linkset	Random SLS Action
OFF	N/A	The Random SLS feature is not applied on any ITU message.
ALL	N/A	The Random SLS feature is applied on all ITU SCCP messages.
CLASS0	N/A	The Random SLS feature is applied on all ITU SCCP CLASS0 messages.
PERLS	OFF	The Random SLS feature is not applied on any ITU message on the specified linkset.
PERLS	ALL	The Random SLS feature is applied on all ITU SCCP messages on the specified linkset.
PERLS	CLASS0	The Random SLS feature is applied on all ITU SCCP CLASS0 messages on the specified linkset.

The Random SLS feature is applied to incoming messages on ANSI linksets as shown in [Table 3-24](#).

Table 3-24 ANSI Random SLS Rules

System-Wide RANDSLS Value (in the RTRV-STPOPTS Output)	RANDSLS Value for the Incoming Linkset	Random SLS Action
OFF	N/A	The Random SLS feature is not applied on any ANSI message.
ALL	N/A	The Random SLS feature is not applied on any ANSI message.
CLASS0	N/A	The Random SLS feature is not applied on any ANSI message.

Table 3-24 (Cont.) ANSI Random SLS Rules

System-Wide RANDSLs Value (in the RTRV-STPOPTS Output)	RANDSLs Value for the Incoming Linkset	Random SLS Action
PERLS	OFF	The Random SLS feature is not applied on any ANSI message on the specified linkset.
PERLS	ALL	The Random SLS feature is applied on ANSI SCCP and ISUP messages on the specified linkset.
PERLS	CLASS0	The Random SLS feature is applied on all ANSI SCCP CLASS0 messages on the specified linkset.

The settings for this feature are independent of the **ITU SLS Enhancement** feature settings for individual linksets. These settings are defined by the `slsobit` (Use of the Other **CIC BIT** capability) and `slsrbs` (**SLS Bit Rotation** capability) parameters of the `ent-ls` and `chg-ls` commands. The `randsls` parameter, however, overrides the `slsrbs` parameter for **SCCP** messages. If the `randsls` parameter value is `perls`, the `randsls` parameter also overrides the `islrsbs` (**SLS Bit Rotation on Incoming Linksets**) parameter of the `ent-ls` and `chg-ls` commands for Class 0 SCCP messages and ISUP messages on ANSI linksets. These parameters are described in greater detail in *Commands User's Guide* and in [ITU SLS Enhancement](#). Note that the `ent-ls` or `chg-ls` commands do not prevent the user from provisioning the `slsrbs` or `islrsbs` parameters.

With the implementation of this feature, a maximum of 16 links continues to be supported in a single linkset to a destination. However, it is now possible to have up to 32 links in a combined linkset to a destination, with a maximum of 16 links per linkset. The 32 links is a change from the current **EAGLE** maximum of only 16 links per combined linkset, which is due to **ITU** protocol restrictions. If more than 16 links are used in a combined linkset, the operator needs to be aware that a maximum of 16 links can be used by non-Random **SLS** traffic over the linkset. The non-Random **SLS** traffic continues to operate under the rules of the **ITU** protocol.

[Figure 3-32](#) shows an example of a combined linkset from node A to nodes B and C, with 8 links per linkset. Since 8 bits allows for values 0-255 (decimal), the figure shows how these values are internally mapped to the links of the combined linkset. For ease of reading, not all values are shown.

Figure 3-32 Random SLS Mapping to a Combined Linkset

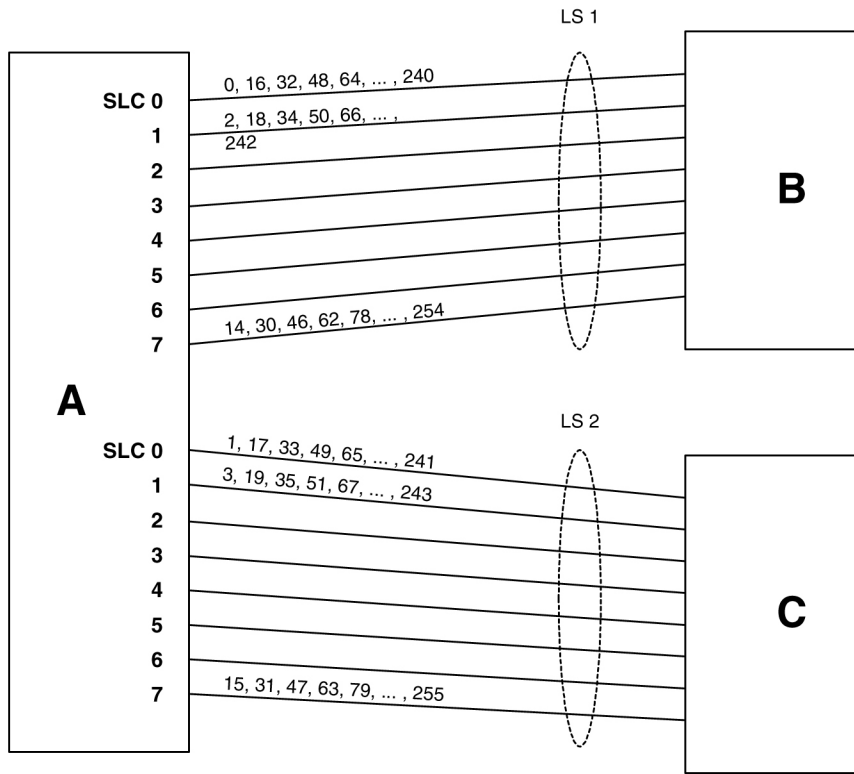
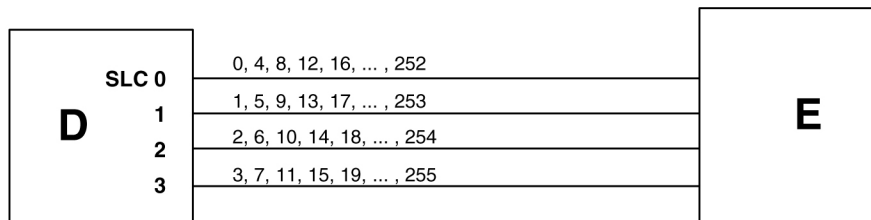


Figure 3-33 shows the mapping for a 4-link single linkset between nodes D and E. When an MSU is to be transmitted, a random 8 bit SLS is generated internally and a link is selected according to this predetermined mapping.

Figure 3-33 Random SLS Mapping to a Single Linkset



The 4 bit SLS in the outgoing message is equal to the SLS that the EAGLE received. There is no change to the SLS value in the SS7 message.

In a non-failure condition, the process for mapping the internally generated SLS values to SLC (Signaling Link Code) values for specific links is as follows:

1. A "random" 8-bit SLS value is generated. In reality, a single table of 256 unique SLS values, initially generated in random order, exists in the EAGLE. A counter is maintained for each linkset in the EAGLE that causes the linkset to cycle through the random values in the table as messages are routed out on that linkset. For a combined linkset, the counter for the first linkset in the EAGLE's linkset table is used.
2. For a combined linkset, the first bit is used to select the linkset and then is ignored when selecting the SLC. For a single linkset, the first bit is used when selecting the

SLC. In all cases, the fifth bit is ignored when selecting the **SLC**. This is due to internal **ANSI**-based processing in the **EAGLE**.

3. The changed **SLS** value (with fifth and possibly also first bits ignored) is then divided by the number of links in the linkset (not a combined linkset) and the remainder gives the **SLC** value. For example, in [Figure 3-32](#), the **SLS** value 78 is mapped to **SLC 7** in linkset **LS1** as follows:
 - a. The binary equivalent for decimal number 78 is 01001110.
 - b. The fifth bit is ignored leaving the binary number 0101110.
 - c. The least significant bit is used to select linkset **LS1** and is then ignored, leaving the binary number 010111.
 - d. The decimal equivalent of the binary number 010111 is 23. When the number 23 is divided by the number of links in the linkset, in this example, eight, a remainder of seven remains, thus **SLC 7** on linkset **LS1** is chosen for the outgoing message.

In the example shown in [Figure 3-33](#), the **SLS** value 78 is mapped to **SLC 2** in **LS1** (the only linkset) as follows:

- a. The binary equivalent for decimal number 78 is 01001110.
- b. The fifth bit is ignored leaving the binary number 0101110.
- c. The decimal equivalent of the binary number 0101110 is 46. When the number 46 is divided by the number of links in the linkset, in this example, four, a remainder of two remains, thus **SLC 2** on linkset **LS1** is chosen for the outgoing message.

[Table 3-25](#) shows the mapping for a combined linkset with 16 links in each linkset. This table is discussed in more detail in the next section.

Link failure scenarios

In any situation where a link is failed, **SLS** values that were mapped to that link are remapped to other links of the linkset or combined linkset. This is done in the reverse order that the **SLS** values were originally mapped to links, of course skipping the failed link. Subsequent link failures will have their **SLS** values, along with **SLS** values from the prior failures, remapped in the same way. The odd/even mapping rule for combined linksets does not apply to the remapped **SLS** values under failure conditions. This is to continue to achieve the best possible load balance across all links. No **MSUs** should be discarded in any case.

For example, [Table 3-25](#) shows how the internal 8-bit **SLS** values are distributed for a combined linkset with 16 links per linkset. It also shows what happens when one or two of the links fail. As this example shows, the **SLS** values that are identical after the fifth bit is dropped (for example, 0 and 16, 192 and 208, etc.) are remapped to the same link. This is why in this example the 8 different **SLS** values from the first failed link are remapped to only 4 links and not 8.

Table 3-25 Failure Scenarios for a 32-Link Combined Linkset

Linkset/SLC	Normal SLS Mapping	SLS Mapping for Single Link Failure	SLS Mapping for Dual Link Failure
LS1/0	0 16 64 80 128 144 192 208	Failed	Failed
LS1/1	2 18 66 82 130 146 194 210	Same as Normal SLS Mapping	Same as Normal SLS Mapping
LS1/7	14 30 78 94 142 158 206 222	Same as Normal SLS Mapping	Same as Normal SLS Mapping
LS1/8	32 48 96 112 160 176 224 240	Same as Normal SLS Mapping	Same as Normal SLS Mapping
LS1/9	34 50 98 114 162 178 226 242	Same as Normal SLS Mapping	Same as Normal SLS Mapping
LS1/12	40 56 104 120 168 184 232 248	Same as Normal SLS Mapping	40 56 ... 248 225 241
LS1/13	42 58 106 122 170 186 234 250	Same as Normal SLS Mapping	42 58 ... 250 161 177
LS1/14	44 60 108 124 172 188 236 252	44 60 ... 252 192 208	44 60 ... 252 97 113
LS1/15	46 62 110 126 174 190 238 254	46 62 ... 254 64 80	46 62 ... 254 33 49
LS2/0	1 17 65 81 129 145 193 208	Same as Normal SLS Mapping	Same as Normal SLS Mapping
LS2/7	15 31 79 95 143 159 207 223	Same as Normal SLS Mapping	Same as Normal SLS Mapping
LS2/8	33 49 97 113 161 177 225 241	Same as Normal SLS Mapping	Failed
LS2/12	41 57 105 121 169 185 233 249	Same as Normal SLS Mapping	41 57 ... 249 192 208
LS2/13	43 59 107 123 171 187 235 251	Same as Normal SLS Mapping	43 59 ... 251 128 144
LS2/14	45 61 109 125 173 189 237 253	45 61 ... 253 128 144	45 61 ... 253 64 80
LS2/15	47 63 111 127 175 191 239 255	47 63 ... 255 0 16	47 63 ... 255 0 16

Because of the large number of internal SLS values being remapped across the relatively small number of links, traffic is essentially evenly distributed across the

remaining links. This is true in all cases, regardless of the original number of links or the number of failed links.

1. Display the existing values for the `randsls` parameter by entering the `rtrv-stpopts` command. The value for the `randsls` parameter is shown in the `RANDSLS` field. This is an example of the possible output.

```
rlghncxa03w 06-10-17 16:02:05 GMT EAGLE5 36.0.0
STP OPTIONS
-----
RANDSLS          class0
```

Note: The `rtrv-stpopts` command output contains other fields that are not used by this procedure. If you wish to see all the fields displayed by the `rtrv-stpopts` command, see the `rtrv-stpopts` command description in *Commands User's Guide*.

If the `randsls=all` parameter will not be specified with the `chg-stpopts` command, continue the procedure with 5.

If the `randsls=all` parameter will be specified with the `chg-stpopts` command, continue the procedure with 2.

2. Verify the value of the `class1seq` parameter of the `chg-sccpopts` command by entering the `rtrv-sccpopts` command. This is an example of the possible output.

```
rlghncxa03w 06-10-17 16:02:05 GMT EAGLE5 36.0.0
SCCP OPTIONS
-----
CLASS1SEQ          on
```

If the value of the `class1seq` parameter is `on`, the `randsls=all` parameter of the `chg-stpopts` command should not be used. The `class1seq=on` parameter allows **UDT/XUDT Class 1 ITU** messages to be delivered to the remote node in the order that they were received. Using the `randsls=all` parameter with the `class1seq=on` parameter does not guarantee that **UDT/XUDT Class 1 ITU** messages are delivered to the remote node in the order that they were received.

If you wish to continue delivering **UDT/XUDT Class 1 ITU** messages to the remote node in the order that they were received, or if the value of the `class1seq` parameter of the `chg-sccpopts` command is `off`, continue the procedure with 5.

If you do not wish to continue delivering **UDT/XUDT Class 1 ITU** messages to the remote node in the order that they were received, continue the procedure with 3.

3. Change the value of the `class1seq` parameter of the `chg-sccpopts` command by entering this command.

```
chg-sccpopts:class1seq=off
```

When this command has successfully completed, this message should appear.

```
rlghncxa03w 06-10-07 00:22:57 GMT EAGLE5 36.0.0
CHG-SCCPOPTS: MASP A - COMPLTD
```

4. Verify the changes by entering the `rtrv-sccpopts` command. This is an example of the possible output.

```
rlghncxa03w 08-12-17 16:02:05 GMT EAGLE5 40.0.0

SCCP OPTIONS
-----
CLASS1SEQ          off
```

5. Change the `randsls` parameter value. For this example, enter this command.

```
chg-stpopts:randsls=all
```

When this command has successfully completed, this message should appear.

```
rlghncxa03w 06-10-07 00:22:57 GMT EAGLE5 36.0.0
CHG-STPOPTS: MASP A - COMPLTD
```

6. Verify the changes using the `rtrv-stpopts` command. This is an example of the possible output.

```
rlghncxa03w 06-10-17 16:02:05 GMT EAGLE5 36.0.0
STP OPTIONS
-----
RANDSLS           all
```

Note: The `rtrv-stpopts` command output contains other fields that are not used by this procedure. If you wish to see all the fields displayed by the `rtrv-stpopts` command, see the `rtrv-stpopts` command description in *Commands User's Guide*.

If the `randsls` parameter value is `off`, `all`, or `class0`, continue the procedure with [10](#).

If the `randsls` parameter value is `perls`, continue the procedure by performing one of these steps.

- If Random SLS will not be applied to ANSI linksets, continue the procedure with [10](#).
- If Random SLS will be applied to ANSI linksets, continue the procedure with [7](#).

7. Verify the value of the `slsreplace` parameter by entering the `rtrv-ss7opts` command. This is an example of the possible output.

```
rlghncxa03w 08-12-17 16:02:05 GMT EAGLE5 40.0.0

SS7 OPTIONS
-----
SLSREPLACE       no
```

Note: The `rtrv-ss7opts` command output contains other fields that are not used by this procedure. If you wish to see all the fields displayed by the `rtrv-ss7opts` command, see the `rtrv-ss7opts` command description in *Commands User's Guide*.

If the `slsreplace` parameter value is `yes`, continue the procedure with 10.

If the `slsreplace` parameter value is `no`, continue the procedure with 8.

8. Change the `slsreplace` parameter value. For this example, enter this command.

```
chg-ss7opts:slsreplace=yes
```

When this command has successfully completed, this message should appear.

```
rlghncxa03w 08-12-07 00:22:57 GMT EAGLE5 40.0.0
CHG-SS7OPTS: MASP A - COMPLTD
```

9. Verify the changes using the `rtrv-ss7opts` command. This is an example of the possible output.

```
rlghncxa03w 08-12-17 16:02:05 GMT EAGLE5 40.0.0

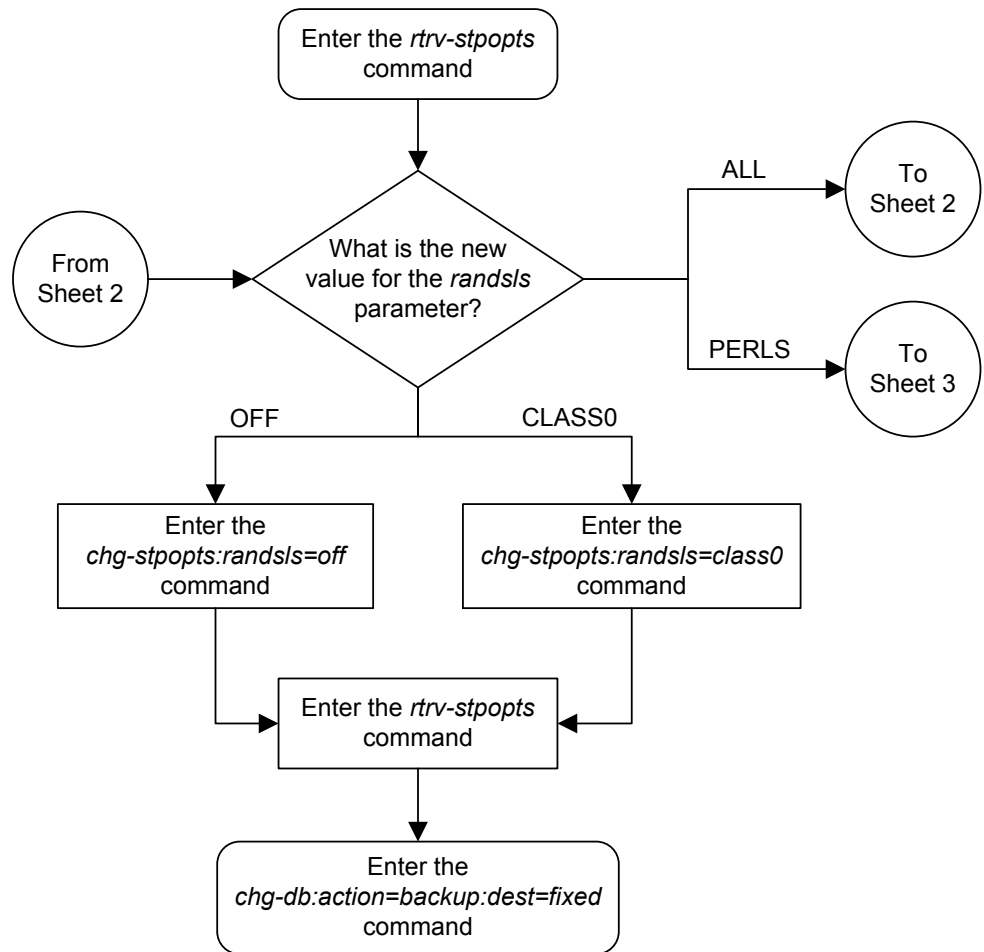
SS7 OPTIONS
-----
SLSREPLACE   yes
```

Note: The `rtrv-ss7opts` command output contains other fields that are not used by this procedure. If you wish to see all the fields displayed by the `rtrv-ss7opts` command, see the `rtrv-ss7opts` command description in *Commands User's Guide*.

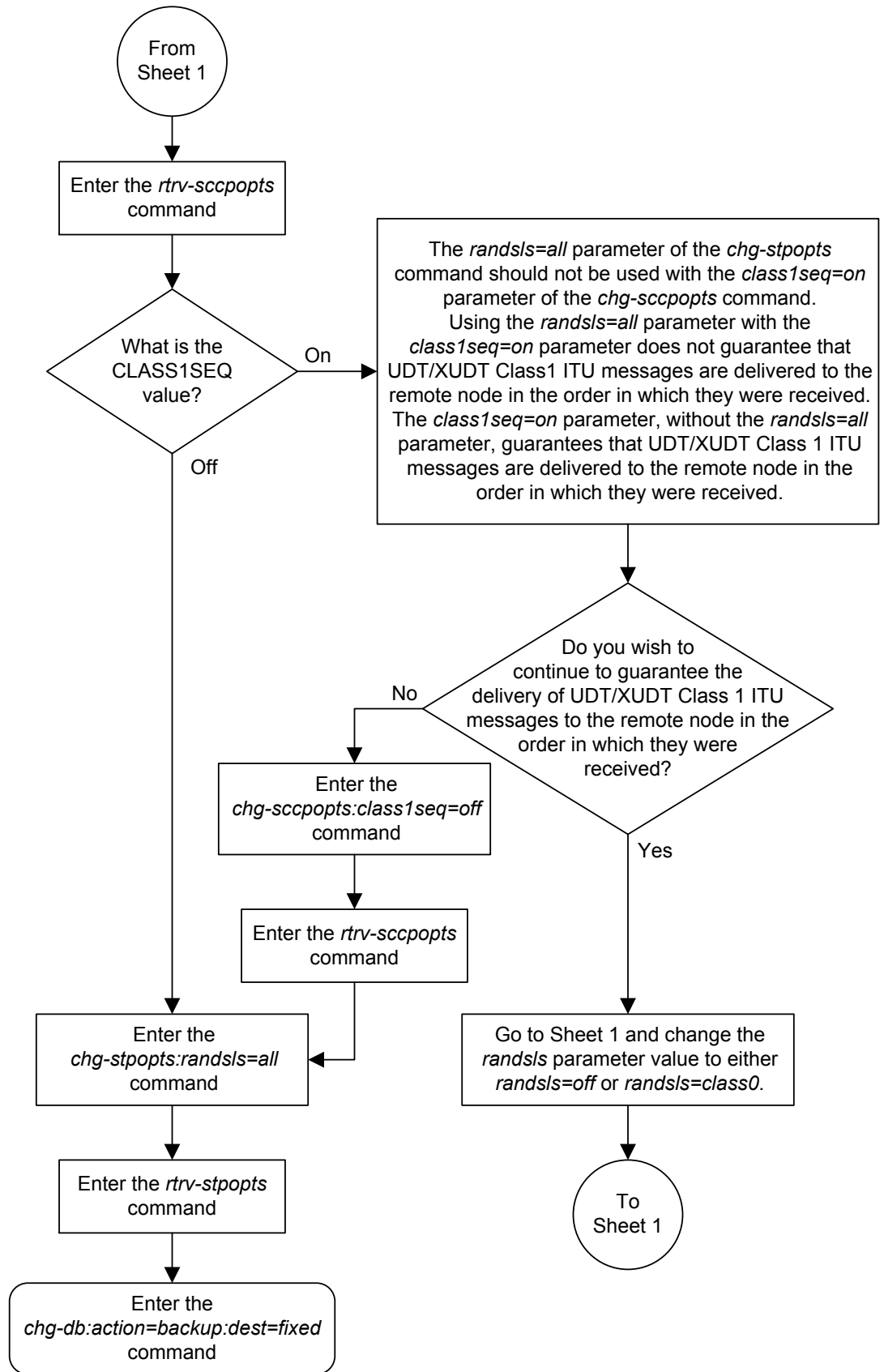
10. Back up the new changes using the `chg-db:action=backup:dest=fixed` command. These messages should appear, the active **Maintenance and Administration Subsystem Processor (MASP)** appears first.

```
BACKUP (FIXED) : MASP A - Backup starts on active MASP.
BACKUP (FIXED) : MASP A - Backup on active MASP to fixed disk complete.
BACKUP (FIXED) : MASP A - Backup starts on standby MASP.
BACKUP (FIXED) : MASP A - Backup on standby MASP to fixed disk complete.
```

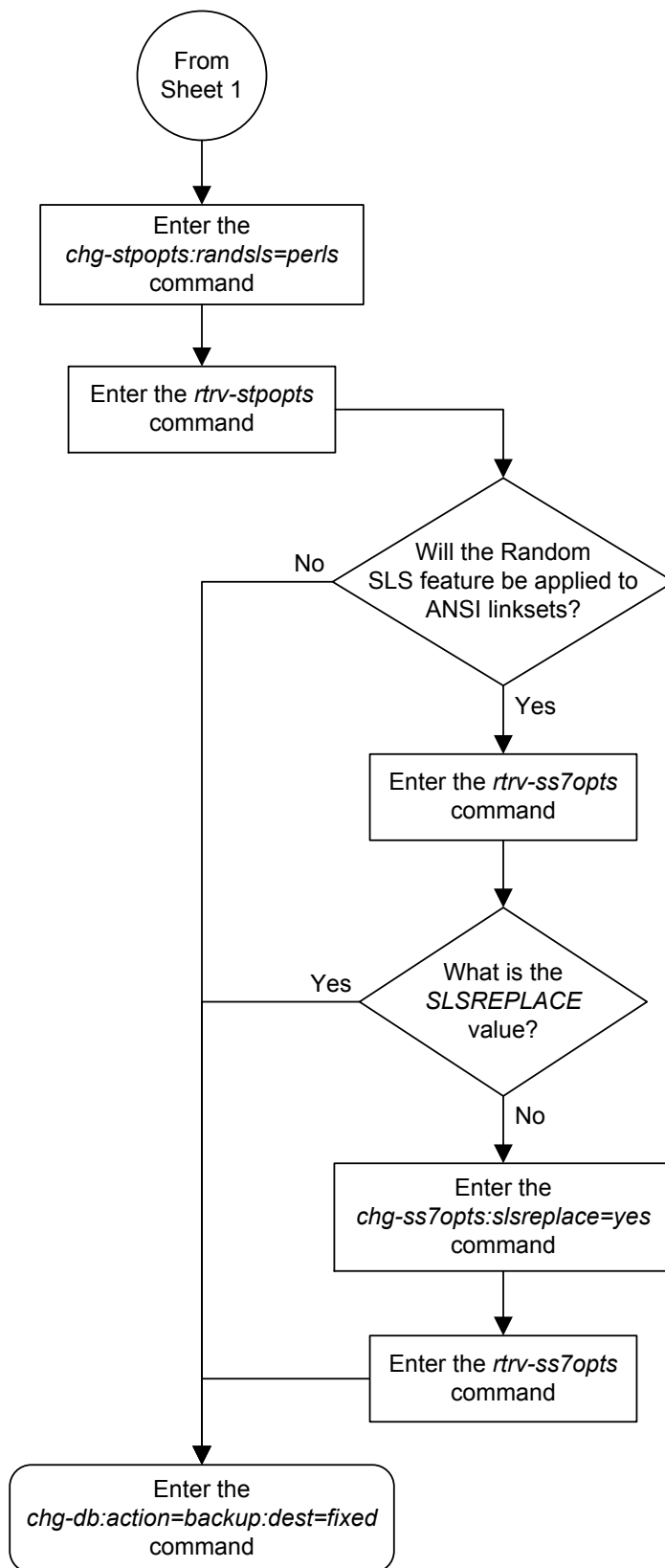
Figure 3-34 Configuring the System for Random SLS Generation



Sheet 1 of 3



Sheet 2 of 3



Configuring the Options for the TDM Global Timing Interface

This procedure is used to configure the options for the **TDM** Global Timing Interface using the `chg-clkopts` command with the following parameters.

`:clock` - the clock that is being updated. This parameter has three values.

- `primary` - the primary clock
- `secondary` - the secondary clock
- `all` - both the primary and secondary clocks

`:hsclksrc` - the source of the high-speed master clock.

- `rs422` - **T1** (1544 **KHz**) or **E1** (2048 **KHz**) **RS-422** clock interface
- `t1framed` - **T1** framed clocking as defined in *ANSI T1.101, Synchronization Interface Standard, 1999*.
- `t1unframed` - **T1** unframed clocking as defined in *ANSI T1.102, Digital Hierarchy Electrical Signals, 1987*.
- `e1framed` - **E1** framed clocking as defined in section 9 of *ITU-T Recommendation G.703, Physical/Electrical Characteristics of Hierarchical Digital Interfaces, October 1998*.
- `e1unframed` - **E1** unframed clocking as defined in section 13 of *ITU-T Recommendation G.703, Physical/Electrical Characteristics of Hierarchical Digital Interfaces, October 1998*.

`:hscclk11` - sets the gain of the **LIU** (line interface unit) of the **TDM** when the `hscclksrc` parameter value is either `t1framed`, `t1unframed`, `e1framed`, or `e1unframed`.

- `longhaul` - high gain for the **LIU**
- `shorthaul` - low gain for the **LIU**

Caution: Changing these options changes the external master clock source for all **E1**, **T1**, **ANSIATM**, or **E1ATM** high-speed signaling links using external timing.

`:force` - allows the `hscclksrc` parameter to be changed if the status of the high-speed clocks is valid. The `force` parameter must be specified when the **EAGLE** contains valid high-speed clocks. The `force` parameter can be specified only if the `hscclksrc` parameter is specified. The `force` parameter has only one value - `yes`. The status of the high-speed clocks is shown by the `rept-stat-clk` command.

When the **EAGLE** is delivered to the user, the values of the `hscclksrc` and `hscclk11` parameters are set to these values:

- `hscclksrc` - `rs422`
- `hscclk11` - `longhaul`

Either of these values can be changed only if the part number of both **TDMs** in card locations 1114 and 1116 is 870-0774-15 or later. If the part numbers of the **TDMs** are not correct, the **TDMs** with the incorrect part numbers must be replaced with **TDM** part number 870-0774-15 or later. If the **TDM** is being replaced with the E5-**TDMs**, the **GPSPM-II** cards in card locations 1113 and 1115 and the **TDMs** in card locations 1114 and 1116 must be replaced with E5-**MASP** cards.

Caution: Contact the Customer Care Center, Refer to [My Oracle Support \(MOS\)](#) for the contact information, before replacing the **TDMs**.

If the **EAGLE** does not contain **LIMDS0** cards, but contains **TDM** part numbers 870-0774-15 or later, the clock source for the **TSC** (Time Slot Counter) synchronization feature used by the **EAGLE 5 Integrated Monitoring Support** feature can be generated from the high-speed master clock source. An external **BITS** clock is not required.

If an external **BITS** clock is connected to a **EAGLE** without **LIMDS0** cards, but with **TDM** part numbers 870-0774-15 or later, the external **BITS** clock is used as the clock source for the **TSC** (Time Slot Counter) synchronization feature. If the external **BITS** clock fails, the clock source for the **TSC** synchronization feature is generated from the high-speed master clock source.

If **LIMDS0** cards are present in the **EAGLE**, the external **BITS** clock is required for timing of the **DS0** signaling links and for **TSC** (Time Slot Counter) synchronization used by the **Integrated Sentinel**. If the **EAGLE** also contains **TDM** part numbers 870-0774-15 or later along with the **LIMDS0** cards, this procedure can be used to select the source of the high-speed master clock for the high-speed links using external timing. The high-speed master clock source cannot be used to generate the clock source for any low-speed links and for the **TSC** (Time Slot Counter) synchronization feature.

1. Display the existing values for the `hsclksrc` and `hsclkll` parameters by entering the `rtrv-clkopts` command.

The value for the `hsclksrc` and `hsclkll` parameters is shown in the `HSCLKSRC` and `HSCLKLL` fields. This is an example of the possible output.

```
rlghncxa03w 09-02-17 16:02:05 GMT  EAGLE5 40.1.0
CLK OPTIONS
-----

PRIMARY
-----
HSCLKSRC          rs422
HSCLKLL           longhaul

SECONDARY
-----
HSCLKSRC          rs422
HSCLKLL           longhaul
```

If either the `HSCLKSRC` or `HSCLKLL` values in this step are not the system default values for these parameters (`HSCLKSRC` - `RS422`, `HSCLKLL` - `LONGHAUL`), continue this procedure with [3](#).

If the `HSCLKSRC` and `HSCLKLL` values in this step are the system default values for these parameters, continue this procedure with [2](#).

2. Visually verify the part numbers of the **TDMs** in card location 1114 and 1116.

To change these options, the part number of both **TDMs** must be 870-0774-15 or later. If the part number of one or both **TDMs** is not 870-0774-15 or later, the **TDM** with the incorrect part number must be replaced with **TDMs** with the correct part number.

Caution: Refer to [My Oracle Support \(MOS\)](#) before replacing the **TDMs**.

3. Verify the status of the high-speed clocks by entering the `rept-stat-clk` command.

This is an example of the possible output.

```
rlghncxa03w 08-06-01 11:34:04 GMT EAGLE5 39.0.0
COMPOSITE                                PST          SST          AST
  SYSTEM CLOCK                            IS-NR        Active       -----
ALARM STATUS = No Alarms.
  Primary Comp Clk 1114 (CLK A)           IS-NR        Active       -----
  Primary Comp Clk 1116 (CLK B)           IS-NR        Active       -----
  Secondary Comp Clk 1114 (CLK A)         IS-NR        Idle         -----
  Secondary Comp Clk 1116 (CLK B)         IS-NR        Idle         -----

Clock      Using      Bad
CLK A      9           0
CLK B      0           0
CLK I      0           --

HIGH SPEED                                PST          SST          AST
  SYSTEM CLOCK                            IS-NR        Idle         -----
ALARM STATUS = No Alarms.
  Primary HS Clk 1114 (HS CLK A)          IS-NR        Active       -----
  Primary HS Clk 1116 (HS CLK B)          IS-NR        Active       -----
  Secondary HS Clk 1114 (HS CLK A)        IS-NR        Idle         -----
  Secondary HS Clk 1116 (HS CLK B)        IS-NR        Idle         -----

HS CLK TYPE 1114      = RS422
HS CLK LINELEN 1114  = LONGHAUL
HS CLK TYPE 1116      = RS422
HS CLK LINELEN 1116  = LONGHAUL

Clock      Using      Bad
HS CLK A   2           0
HS CLK B   0           0
HS CLK I   0           --

Command Completed
```

If the `rept-stat-clk` output does not show any high-speed clocks (`HIGH SPEED SYSTEM CLOCK`, `Primary HS Clk`, `Secondary HS Clk`, `HS CLK TYPE`, and `HS CLK LINELEN` fields), the **EAGLE** does not contain any cards that are capable of using high-speed master timing.

4. Change either the `hscclksrc` or `hscclk11` parameter values, or both parameter values.

To change the primary and secondary clocks, for this example, enter this command.

```
chg-
clkopts:clock=all:hsclksrc=tlunframed:hsclkll=shorthaul:force
=yes
```

To change only the primary clock, for this example, enter this command.

```
chg-
clkopts:clock=primary:hsclksrc=tlunframed:hsclkll=shorthaul:force=yes
```

To change only the secondary clock, for this example, enter this command.

```
chg-
clkopts:clock=secondary:hsclksrc=tlunframed:hsclkll=shorthaul:force=yes
```

The `clock=primary` and `clock=secondary` parameters can be specified only if the EAGLE contains E5-MASP cards.

Note: If the `rept-stat-clk` output in 3 shows valid high-speed clocks, and the `hsclksrc` parameter is specified with the `chg-clkopts` command, the `force=yes` parameter must be specified with the `chg-clkopts` command.

Caution: Changing these options changes the external master clock source for all **E1**, **T1**, **ANSIATM**, or **E1ATM** high-speed signaling links using external timing. A clock outage can occur and traffic on these signaling links can be lost if the new source clock type does not match the source clock that these signaling links are actually using.

When this command has successfully completed, this message should appear.

```
rlghncxa03w 09-02-07 00:22:57 GMT EAGLE5 40.1.0
CHG-CLKOPTS: MASP A - COMPLTD
```

5. Verify the changes using the `rtrv-clkopts` command.

This is an example of the possible output.

```
rlghncxa03w 09-02-17 16:02:05 GMT EAGLE5 40.1.0
CLK OPTIONS
-----
PRIMARY
-----
HSCCLKSRC      tlunframed
HSCCLKLL      shorthaul

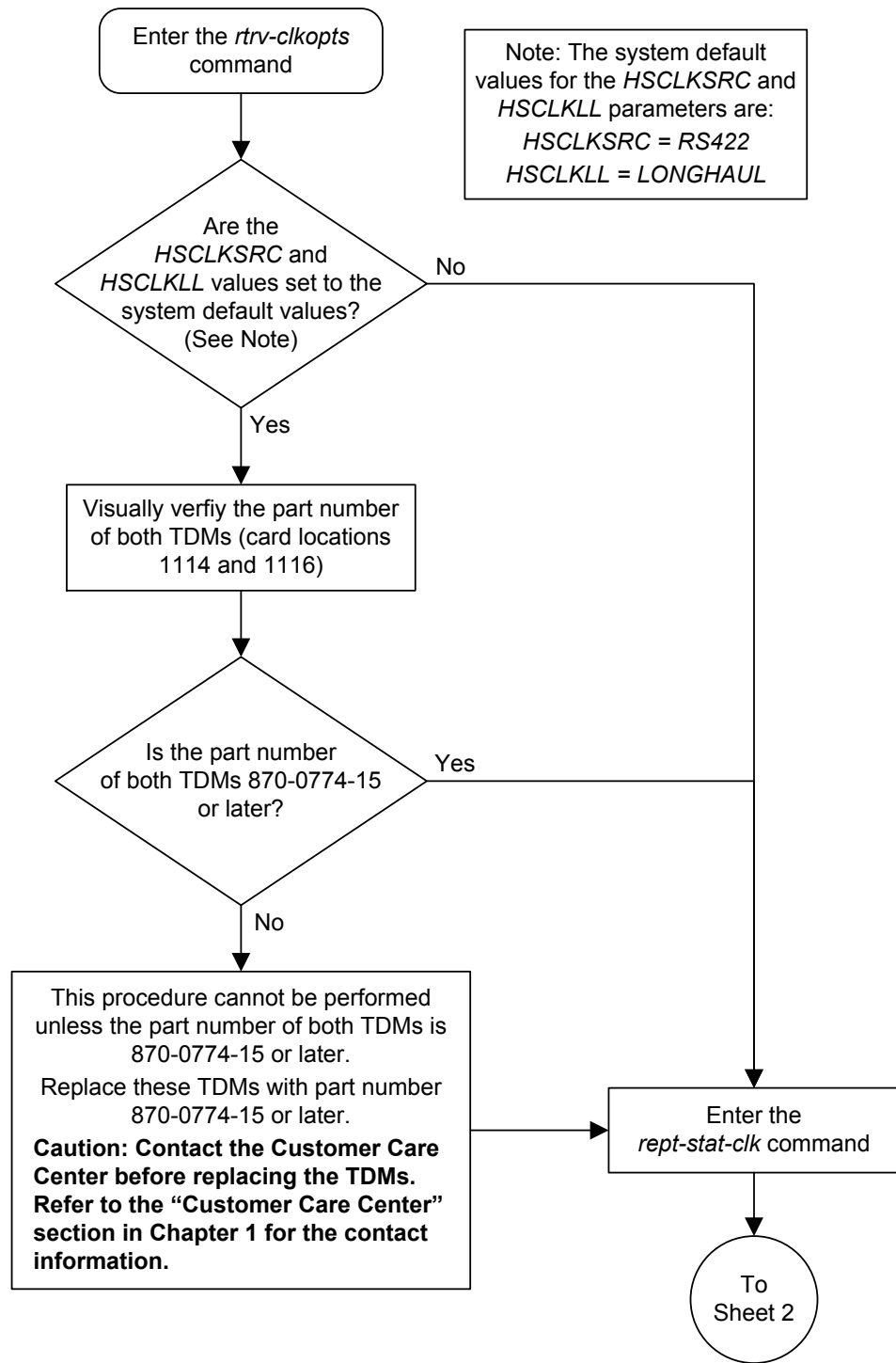
SECONDARY
-----
HSCCLKSRC      tlunframed
HSCCLKLL      shorthaul
```

6. Back up the new changes using the `chg-db:action=backup:dest=fixed` command.

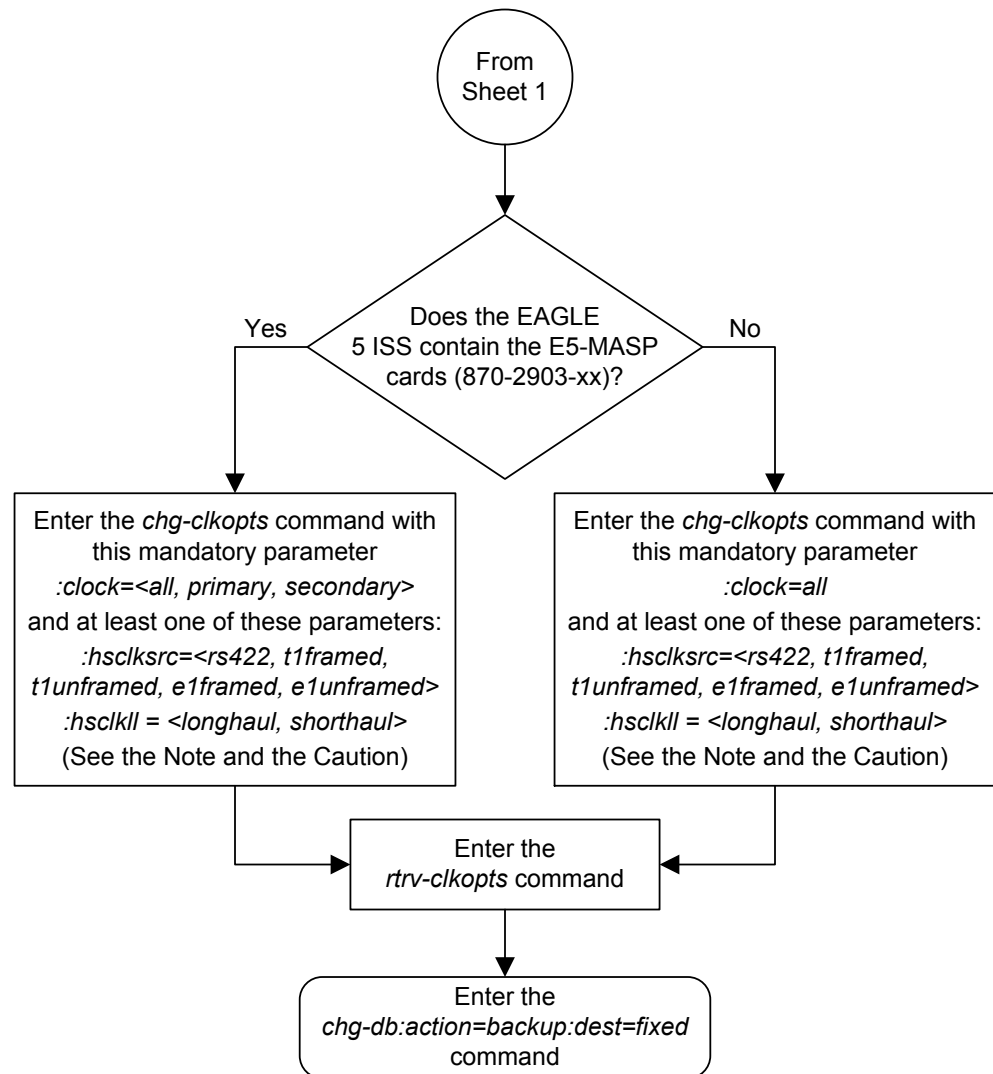
These messages should appear, the active **Maintenance and Administration Subsystem Processor (MASP)** appears first.

BACKUP (FIXED) : MASP A - Backup starts on active MASP.
BACKUP (FIXED) : MASP A - Backup on active MASP to fixed disk complete.
BACKUP (FIXED) : MASP A - Backup starts on standby MASP.
BACKUP (FIXED) : MASP A - Backup on standby MASP to fixed disk complete.

Figure 3-35 Configuring the Options for the TDM Global Timing Interface



Sheet 1 of 2



Note: If the *rept-stat-clk* output on Sheet 1 shows valid high-speed clocks, and the *hclksrc* parameter is specified with the *chg-clkopts* command, the *force=yes* parameter must be specified with the *chg-clkopts* command.

Caution: Changing these options changes the external master clock source for all E1, T1, ANSI ATM, or E1 ATM high-speed signaling links using external timing. A clock outage can occur and traffic on these signaling links can be lost if the new source clock type does not match the source clock that these signaling links are actually using.

Configuring the Restricted Linkset Option

This procedure is used to configure the restricted linkset option using the `chg-ss7opts` command with the `lsrestrict` parameter. The `lsrestrict` parameter has two values:

- `on` – enables the `lsrestrict` option
- `off` – disables the `lsrestrict` option.

When a large linkset (a linkset containing more than three links) first becomes available, there may not be enough available links to carry the normal amount of traffic on the linkset. The **EAGLE** sends response method **TFA/TFRs** when the number of links within a linkset, specified by the `tfatcabmlq` parameter for that linkset, are active and available to carry traffic. This was designed to prevent congestion on the newly available linksets. Internally in the **EAGLE**, if a single link within a lower cost route is active, the **EAGLE** attempts to route traffic over the lower cost route. If no traffic or small amounts of traffic are arriving due to the issuance of a **TFR**, then no congestion should occur.

However, this behavior applies only to traffic destined for remote nodes and not to traffic destined for the **EAGLE** itself. Typically, messages that are global title routed are destined for the **EAGLE**'s true, secondary or capability point code. The existing congestion prevention mechanism does not prevent traffic destined for **EAGLE** to be controlled by the linkset's `tfatcabmlq` parameter. This is because **TFx** messages have an affected point code field that is the far end destination point code and not the **EAGLE**'s point code, so traffic destined for **EAGLE** continues to arrive for the restricted destination. It is not feasible to place **EAGLE**'s point code in the affected destination field as this would affect all traffic destined for **EAGLE** and not just traffic over a specific route.

With the `lsrestrict=off` option, the **EAGLE** continues to route traffic in this manner.

The `lsrestrict=on` option enhances the **EAGLE**'s existing behavior of the linkset's `tfatcabmlq` parameter and allow the state of the route combined with the cost value of the route to determine the preferred route to use.

Turning the `lsrestrict` option on changes the way the **EAGLE** routes messages by using the state of the route along with the cost of the route to determine the preferred route to use. With this option on, the preferred route is not the absolute lowest cost available route in the routeset. A route is considered available if its status is either **Allowed** or **Restricted**. If the state of the absolute lowest cost route in the routeset is **Restricted**, the preferred route is the lowest cost route in the routeset whose status is **Allowed**. Make sure that you wish to have the **EAGLE** route messages in this manner before turning the `lsrestrict` option on.

In previous releases, a C linkset's `tfatcabmlq` parameter is not configurable and set to 1 (the linkset is allowed when the first link is available). This is because the C linkset is designed for message trafficking between the mate **STP**'s and would allow these messages to be transferred as soon as the first link in the C linkset was available. The `lsrestrict=on` option allows the `tfatcabmlq` parameter value for a C linkset to be from 0 to 16, just as any other linkset.

With the `lsrestrict=off` option, the `tfatcabmlq` parameter value for a C linkset is set to 1 and cannot be changed.

When a linkset that was previously prohibited becomes restricted (that is, the number of links that became available is less than the required number of links as specified by the linkset's `tfatcabmlq` parameter) the following events occur when the `lsrestrict` option is on:

1. The **EAGLE 5 ISS** does not broadcast **TFAs**.
2. Point codes that were previously prohibited and use the linkset as a lower cost route are marked restricted. The **EAGLE** continues to broadcast **TFRs**.
3. Point codes that were previously restricted and use the linkset as a least cost route remain restricted. The **EAGLE** does not broadcast any **TFx** message. For these point codes, **RSRT** will respond to **RSP** messages with a **TFR**, and will not respond to **RSR** messages.
4. The **EAGLE** marks the linkset as restricted.
5. If a higher cost route is available, the **EAGLE** routes the traffic over the higher cost route.

Once the required number of links are available for the linkset, the following events occur when the `lsrestrict` option is on:

1. The **EAGLE** marks the previously prohibited/restricted point codes as allowed that use the linkset as a lower cost route (unless the point code's nonadjacent status is prohibited).
2. The **EAGLE** does not broadcast **TFAs** for the newly allowed point codes, but responds to **RSR/RSP** messages with a **TFA**.
3. The **EAGLE** marks the linkset as allowed. The appropriate changeback procedures are performed and traffic is processed normally.

Canceling the **RTRV-LS** Command

Because the `rtrv-ls` command used in this procedure can output information for a long period of time, the `rtrv-ls` command can be canceled and the output to the terminal stopped. There are three ways that the `rtrv-ls` command can be canceled.

- Press the **F9** function key on the keyboard at the terminal where the `rtrv-ls` command was entered.
- Enter the `canc-cmd` without the `trm` parameter at the terminal where the `rtrv-ls` command was entered.
- Enter the `canc-cmd:trm=<xx>`, where `<xx>` is the terminal where the `rtrv-ls` command was entered, from another terminal other than the terminal where the `rtrv-ls` command was entered. To enter the `canc-cmd:trm=<xx>` command, the terminal must allow Security Administration commands to be entered from it and the user must be allowed to enter Security Administration commands. The terminal's permissions can be verified with the `rtrv-secu-trm` command. The user's permissions can be verified with the `rtrv-user` or `rtrv-secu-user` commands.

For more information about the `canc-cmd` command, go to *Commands User's Guide*.

1. Display the existing value for the `lsrestrict` parameter by entering the `rtrv-ss7opts` command. This is an example of the possible output.

```
rlghncxa03w 06-10-17 16:02:05 GMT EAGLE5 36.0.0
```


SS7 OPTIONS

```
-----
LSRESTRICT          off
```

Note: The `rtrv-ss7opts` command output contains other fields that are not used by this procedure. If you wish to see all the fields displayed by the `rtrv-ss7opts` command, see the `rtrv-ss7opts` command description in *Commands User's Guide*.

Note: If the `lsrestrict` parameter value in step 1 is `off`, skip steps 2 and 3, and go to step 4.

2. Display the linksets in the database by entering the `rtrv-ls` command. This is an example of the possible output.

```
rlghncxa03w 06-10-10 11:43:04 GMT EAGLE5 36.0.0
                                     L3T SLT                               GWS GWS GWS
LSN      APCA  (SS7)  SCRN  SET SET BEI  LST LNKS  ACT MES DIS SLSCI NIS
ele2     001-207-000  none  1  1  no  B   6   off off off no  off
ls05     002-009-003  scr2  1  1  no  C   4   on  off on  no  off
ls1305   000-005-000  none  1  1  no  A   1   off off off no  off
ls1307   000-007-000  none  1  1  no  A   1   off off off no  off
elm1s1   001-001-001  none  1  1  no  A   7   off off off no  off
elm1s2   001-001-002  none  1  1  no  A   7   off off off no  off
```

```
                                     L3T SLT                               GWS GWS GWS
LSN      APCI  (SS7)  SCRN  SET SET BEI  LST LNKS  ACT MES DIS SLSCI NIS
ele2i    1-207-0      none  1  1  no  B   4   off off off ---  on
ls1315   0-015-0      none  1  1  no  A   1   off off off ---  off
ls1317   0-017-0      none  1  1  no  A   1   off off off ---  on
elm2s1   1-011-1      none  1  1  no  A   7   off off off ---  off
elm2s2   1-011-2      none  1  1  no  A   7   off off off ---  off
```

Link set table is (11 of 1024) 1% full.

Note: If there are no C linksets (linksets with the value C in the LST column) shown in the `rtrv-ls` output in step 2, skip step 3 and go to step 4.

3. Change the `tfatcabmlq` parameter value for one of the C linksets shown in step 2 to 0 using the `chg-ls` command. For this example, enter this command.

```
chg-ls:lsn=ls05:tfatcabmlq=0
```

When this command has successfully completed, this message should appear.

```
rlghncxa03w 06-10-07 08:38:45 GMT EAGLE5 36.0.0
Link set table is ( 11 of 1024) 1% full
CHG-LS: MASP A - COMPLTD
```

After the `chg-ls` command has been performed, repeat step 3 with the name of another C linkset shown in step 2.

When all the C linksets have been changed, go to step 4.

Note: When the `tfatcabmlq` parameter is set to 0, its value in the `rtrv-ls:lsn=<linkset name>` output is shown as 1/2 of the number of signaling links contained in the linkset.

4. Change the value of the `lsrestrict` parameter.

If the current value of the `lsrestrict` parameter is off, enter this command.

```
chg-ss7opts:lsrestrict=on
```

If the current value of the `lsrestrict` parameter is on, enter this command.

```
chg-ss7opts:lsrestrict=off
```

When this command has successfully completed, this message should appear.

```
rlghncxa03w 06-10-07 00:22:57 GMT EAGLE5 36.0.0
CHG-SS7OPTS: MASP A - COMPLTD
```

Caution: Turning the `lsrestrict` option on changes the way the **EAGLE** routes messages by using the state of the route along with the cost of the route to determine the preferred route to use. With this option on, the preferred route is not the absolute lowest cost available route in the routeset. A route is considered available if its status is either Allowed or **Restricted**. If the state of the absolute lowest cost route in the routeset is **Restricted**, the preferred route is the lowest cost route in the routeset whose status is Allowed. Make sure that you wish to have the **EAGLE** route messages in this manner before turning the `lsrestrict` option on.

5. Verify the changes using the `rtrv-ss7opts` command. This is an example of the possible output.

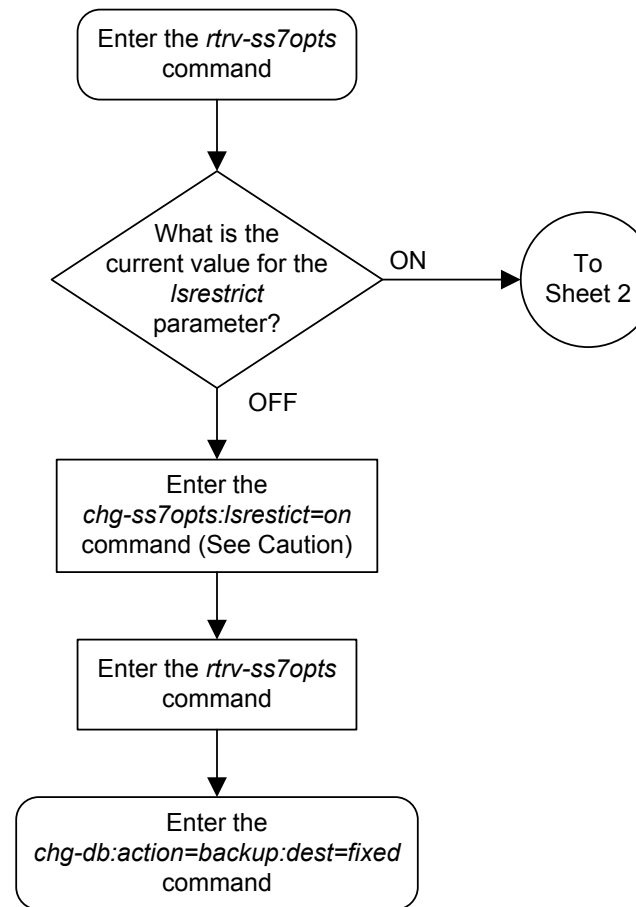
```
rlghncxa03w 06-10-17 16:02:05 GMT EAGLE5 36.0.0

SS7 OPTIONS
-----
LSRESTRICT          on
```

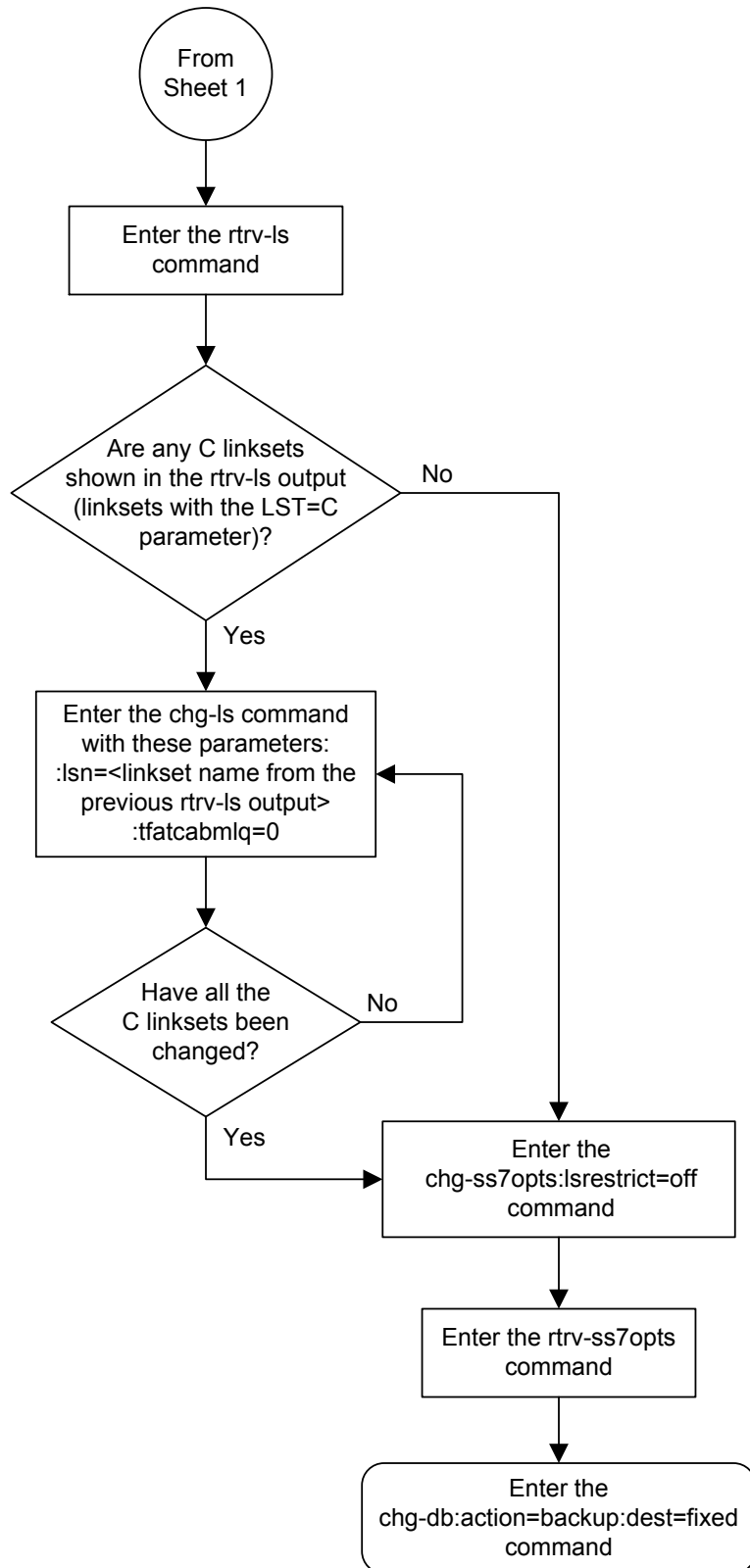
Note: The `rtrv-ss7opts` command output contains other fields that are not used by this procedure. If you wish to see all the fields displayed by the `rtrv-ss7opts` command, see the `rtrv-ss7opts` command description in *Commands User's Guide*.

6. Back up the new changes using the `chg-db:action=backup:dest=fixed` command. These messages should appear, the active **Maintenance and Administration Subsystem Processor (MASP)** appears first.

```
BACKUP (FIXED) : MASP A - Backup starts on active MASP.
BACKUP (FIXED) : MASP A - Backup on active MASP to fixed disk complete.
BACKUP (FIXED) : MASP A - Backup starts on standby MASP.
BACKUP (FIXED) : MASP A - Backup on standby MASP to fixed disk complete.
```

Figure 3-36 Configuring the Restricted Linkset Option

Caution: Turning the *Isrestrict* option on changes the way the EAGLE 5 ISS route messages by using the state of the route along with the cost of the route to determine the preferred route to use. With this option on, the preferred route is not the absolute lowest cost available route in the routeset. A route is considered available if its status is either Allowed or Restricted. If the state of the absolute lowest cost route in the routeset is Restricted, the preferred route is the lowest cost route in the routeset whose status is Allowed. Make sure that you wish to have the EAGLE 5 ISS route messages in this manner before turning the *Isrestrict* option on.



Configuring the Options for Handling TFCs on ITU-I and ITU-N Networks

This procedure is used to configure the options for handling TFCs on ITU-I and ITU-N networks using the `chg-ss7opts` command with these two parameters:

`:discardtfc` – This parameter specifies that the EAGLE 5 ISS discards TFC traffic received from an ITU-I network (`discardtfc=on`), or does not discard TFC traffic received from an ITU-I network (`discardtfc=off`). The system default value for this parameter is `off`.

`:discardtfcn` – This parameter specifies that the EAGLE 5 ISS discards TFC traffic received from an ITU-N network (`discardtfcn=on`), or does not discard TFC traffic received from an ITU-N network (`discardtfcn=off`). The system default value for this parameter is `off`.

1. Display the existing values for the `discardtfc` and `discardtfcn` parameters by entering the `rtrv-ss7opts` command.

This is an example of the possible output.

```
rlghncxa03w 06-10-17 16:02:05 GMT EAGLE5 36.0.0
SS7 OPTIONS
-----
DISCARDTFCI      off
DISCARDTFCN      off
```

Note: The `rtrv-ss7opts` command output contains other fields that are not used by this procedure. If you wish to see all the fields displayed by the `rtrv-ss7opts` command, see the `rtrv-ss7opts` command description in the *Commands Manual*.

2. Change the value of the `discardtfc` and `discardtfcn` parameters.

The values of these parameters is either `on` or `off`. The value specified in this step cannot be the same as the value shown in step 1.

If you wish to change the value of the `discardtfc` parameter, specify the `discardtfc` parameter with the `chg-ss7opts` command. For this example, enter this command.

```
chg-ss7opts:discardtfc=on
```

If you wish to change the value of the `discardtfcn` parameter, specify the `discardtfcn` parameter with the `chg-ss7opts` command. For this example, enter this command.

```
chg-ss7opts:discardtfcn=on
```

If you wish to change the value of both the `discardtfc` and `discardtfcn` parameters, specify the `discardtfc` and `discardtfcn` parameters with the `chg-ss7opts` command. For this example, enter this command.

```
chg-ss7opts:discardtfc=on:discardtfcn=on
```

When this command has successfully completed, this message should appear.

```
rlghncxa03w 06-10-07 00:22:57 GMT EAGLE5 36.0.0
CHG-SS7OPTS: MASP A - COMPLTD
```

3. Verify the changes using the `rtrv-ss7opts` command.

This is an example of the possible output.

```
rlghncxa03w 06-10-17 16:02:05 GMT EAGLE5 36.0.0
SS7 OPTIONS
-----
DISCARDTFCI          on
DISCARDTFCN          on
```

Note: The `rtrv-ss7opts` command output contains other fields that are not used by this procedure. If you wish to see all the fields displayed by the `rtrv-ss7opts` command, see the `rtrv-ss7opts` command description in the *Commands Manual*.

4. Back up the new changes using the `chg-db:action=backup:dest=fixed` command.

These messages should appear, the active **Maintenance and Administration Subsystem Processor (MASP)** appears first.

```
BACKUP (FIXED) : MASP A - Backup starts on active MASP.
BACKUP (FIXED) : MASP A - Backup on active MASP to fixed disk complete.
BACKUP (FIXED) : MASP A - Backup starts on standby MASP.
BACKUP (FIXED) : MASP A - Backup on standby MASP to fixed disk complete.
```

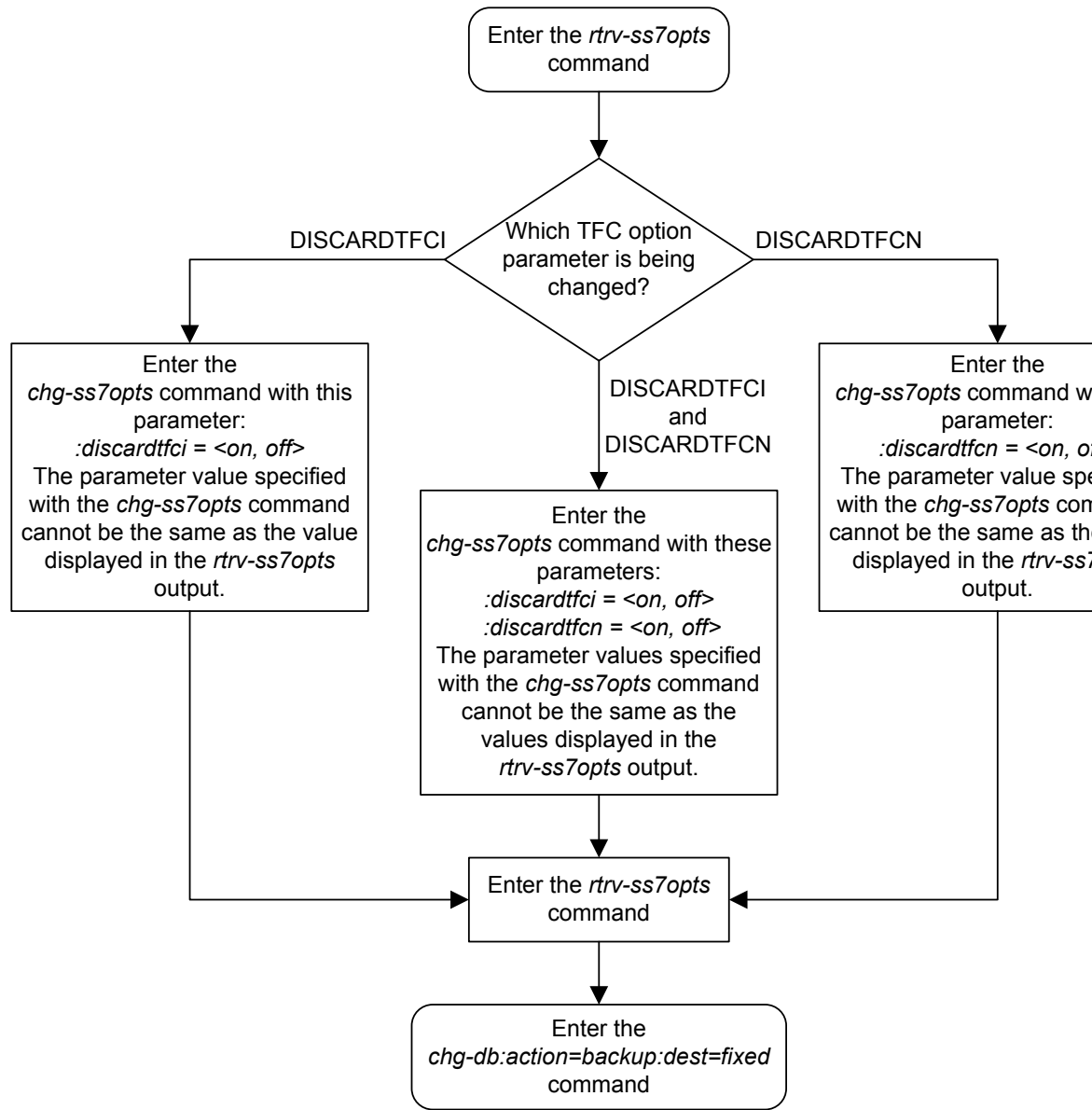
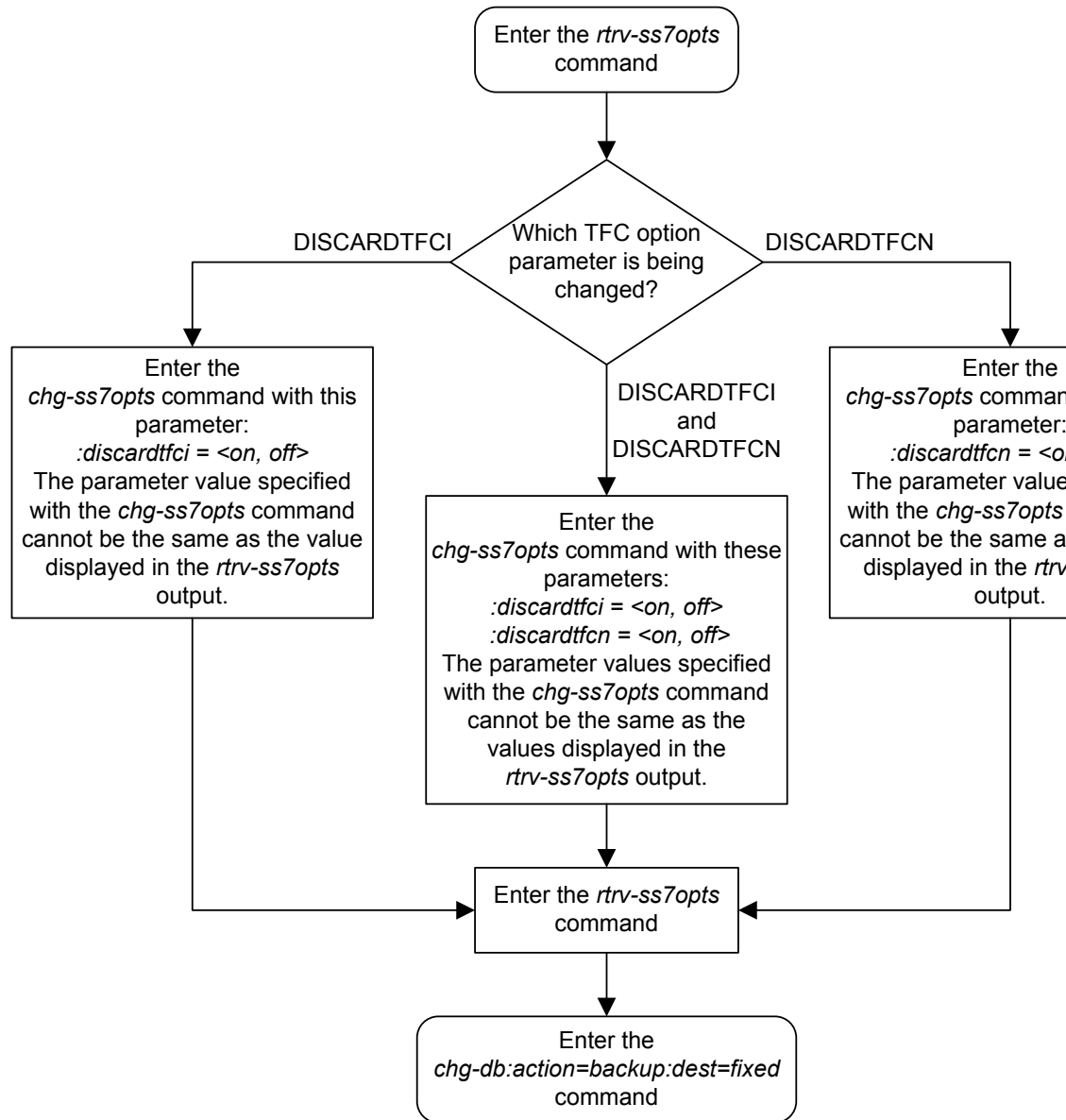


Figure 3-37 Configuring the Options for Handling TFCs on ITU-I and ITU-N Networks



Changing the High-Capacity Card Temperature Alarm Thresholds

This procedure is used to change the temperature alarm thresholds for high-capacity cards (shown in [Table 3-26](#)) using the `chg-th-alm` command and these parameters.

`:thermallv1` – The temperature threshold, specified as a percentage of the card's thermal shutdown temperature, at which major alarm **UAM 0078** is generated. **UAM 0078** is generated to alert the user that corrective action needs to be performed to prevent the high-capacity cards from overheating. If the high-capacity card is E5-SLAN, E5-STC, E5-SM4G, E5-TSM, or E5-MCPM-B, the state of the card is not changed. If the high-capacity card is an HC MIM, E5-E1T1, E5-ENET card, or E5-ATM card, or SLIC, the state of the card is changed to IS-ANR (in service-abnormal).

For the following cards, these actions occur when `thermallv1` temperature threshold is reached:

E5-ENET-B running ERTHC GPL

Alarm raised; no additional actions.

E5-ENET-B running SLANHC GPL

Alarm raised; no additional actions.

E5-ATM-B running ATMHC GPL

Alarm raised. PST/SST of card transitions to IS-ANR/Restrict.

E5-ENET-B running IPSHC GPL

Alarm raised; no additional actions. .

E5-ENET-B running IPSG GPL

Alarm raised; no additional actions.

E5-ENET-B running IPLIMx/IPGWx GPL

Alarm raised; no additional actions.

E5-MCPM-B running MCPHC GPL

Alarm raised; no additional actions.

The values for this parameter are 73 to 92. The system default value for this parameter is 92.

`:thermallv2` – The temperature threshold, specified as a percentage of the card's maximum operating temperature, at which critical alarm **UAM 0077** is generated. When this threshold is reached, the high-capacity cards shed their traffic load, accept no more traffic, and the state of the cards is changed to IS-ANR (in service-abnormal). The values for this parameter are 74 to 100. The system default value for this parameter is 100.

For EPM-B cards, when the `thermallv1` temperature threshold is reached, critical alarm 0077 is raised and the following additional actions occur:

E5-ENET-B or SLIC running ERTHC GPL

Outstanding grant requests will be completed but no new grant requests will be accepted. The card's state transitions "in-service abnormal."

E5-ENET-B or SLIC running SLANHC GPL

Outstanding grant requests will be completed but no new grant requests will be accepted. The card's state transitions "in-service abnormal."

E5-ATM-B running ATMHC GPL

PST/SST of card remains IS-ANR/Restrict.

E5-ENET-B or SLIC running IPSHC GPL

Auto inhibits all telnet terminals allowed by user on that card and sets their status to OOS-MT-DSBLD/MEA. Sets card state to out-of-service, maintenance fault.

E5-ENET-B or SLIC running IPSG GPL

Outstanding grant requests will be completed but no new grant requests will be accepted.

E5-ENET-B running IPLIMx/IPGWx GPL

Outstanding grant requests will be completed but no new grant requests will be accepted.

E5-MCPM-B or SLIC running MCPHC GPL

PST/SST of card transitions to IS-ANR/Restrict . If card is primary MCP, role change arbitration is initiated.

For more information on UAM 0078 and UAM 077, go to *Unsolicited Alarm and Information Messages Reference*.

Table 3-26 shows the maximum thermal operating limit of temperatures of these cards at selected threshold levels.

Table 3-26 High Capacity Thermal Limits

High Capacity Card	High Capacity Card's Temperature at the Maximum Thermal Operating Limit (thermally 2 = 100%)	High Capacity Card Temperatures at Selected Threshold Levels				
		95%	90%	85%	80%	75%
HC-MIM	82° C 179.6° F	77.9° C 172.2° F	73.8° C 164.8° F	69.7° C 157.5° F	65.6° C 150.1° F	61.5° C 147.2° F
E5-ENET	95° C	90.25° C	85.5° C	80.75° C	76° C	71.25° C
E5-E1T1	203° F	194.5° F	185.9° F	177.4° F	168.8° F	160.3° F
E5-STC						
E5-SLAN						
E5-TSM						
E5-ATM						

Table 3-26 (Cont.) High Capacity Thermal Limits

E5-SM4G	90° C	85.5° C	81° C	76.5° C	72° C	67.5° C
E5-MASP	194° F	185.9° F	177.8° F	169.7° F	161.6° F	153.5° F
E5-ENET-B						
E5-ATM-B						
E5-SM8G-B						
E5-MCPM-B						

The `chg-th-alm` command contains other optional parameters. These parameters are not shown here because they are not necessary to provision the high-capacity card temperature alarm thresholds. These parameters are explained in more detail in *Commands User's Guide*.

1. Display the current high-capacity card temperature alarm thresholds in the database by entering the `rtrv-th-alm` command.

This is an example of the possible output.

```
rlghncxa03w 06-10-28 09:12:36 GMT EAGLE5 36.0.0
Thermal Alarm Level 1:          92%
Thermal Alarm Level 2:          100%
RTRV-TH-ALM: MASP A - COMPLTD.
```

Note: The `rtrv-th-alm` command output contains other fields that are not used in this procedure. If you wish to see all the fields displayed by the `rtrv-th-alm` command, see the `rtrv-th-alm` command description in *Commands User's Guide*.

2. Change the temperature alarm thresholds by entering the `chg-th-alm` command with at least one of the temperature alarm threshold parameters.

The `thermallv2` parameter value shown in the `rtrv-th-alm` output after the `chg-th-alm` command has been executed must be greater than the `thermallv1` parameter value shown in the `rtrv-th-alm` output.

If a temperature alarm threshold parameter is not specified with the `chg-th-alm` command, that parameter value will not be changed. The system default values for the temperature alarm threshold parameters are:

- `:thermallv1 = 92`
- `:thermallv2 = 100`

For this example, enter this command.

```
chg-th-alm:thermallv1=74:thermallv2=80
```

When this command has successfully completed, this message should appear.

```
rlghncxa03w 06-10-28 09:12:36 GMT EAGLE5 36.0.0
CHG-TH-ALM: MASP A - COMPLTD
```

3. Verify the changes using the `rtrv-th-alm` command.

This is an example of the possible output.

```
rlghncxa03w 06-10-28 09:12:36 GMT EAGLE5 36.0.0
Thermal Alarm Level 1:                70%
Thermal Alarm Level 2:                80%
RTRV-TH-ALM: MASP A - COMPLTD.
```

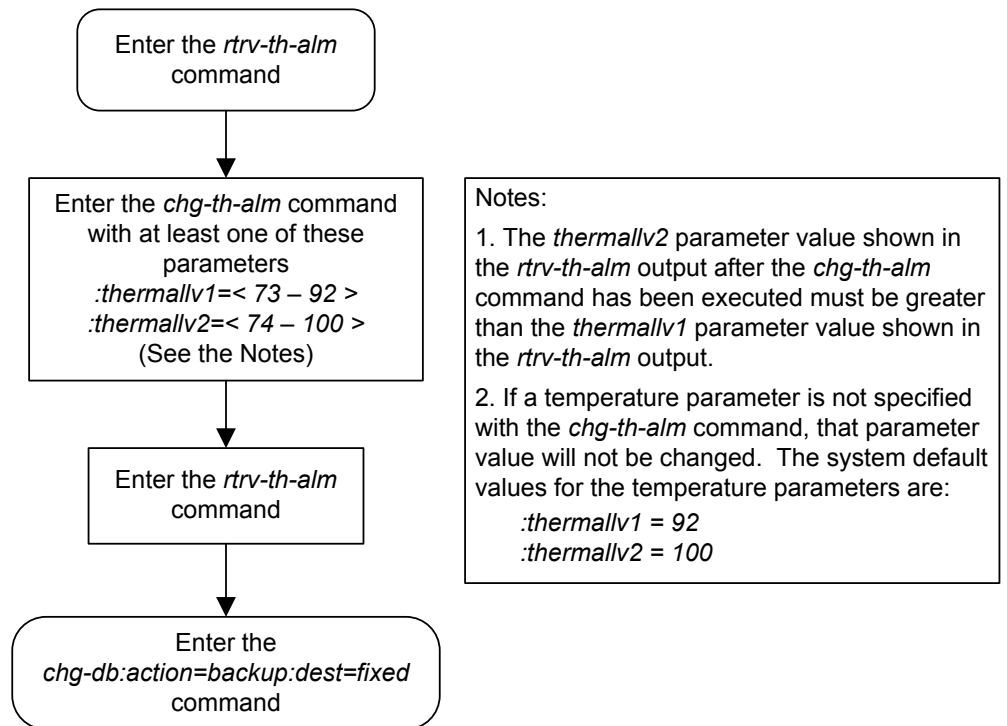
Note: The `rtrv-th-alm` command output contains other fields that are not used in this procedure. If you wish to see all the fields displayed by the `rtrv-th-alm` command, see the `rtrv-th-alm` command description in *Commands User's Guide*.

4. Backup the new changes using the `chg-db:action=backup:dest=fixed` command.

These messages should appear, the active **Maintenance and Administration Subsystem Processor (MASP)** appears first.

```
BACKUP (FIXED) : MASP A - Backup starts on active MASP.
BACKUP (FIXED) : MASP A - Backup on active MASP to fixed disk complete.
BACKUP (FIXED) : MASP A - Backup starts on standby MASP.
BACKUP (FIXED) : MASP A - Backup on standby MASP to fixed disk complete.
```

Figure 3-38 *Changing the High-Capacity Card Temperature Alarm Thresholds*



Activating the Origin-Based MTP Routing Feature

This procedure is used to enable and turn on the Origin-Based **MTP** Routing feature using the feature's part number and a feature access key.

The feature access key for the Origin-Based **MTP** Routing feature is based on the feature's part number and the serial number of the **EAGLE**, making the feature access key site-specific.

The `enable-ctrl-feat` command enables the feature by inputting the feature's access key and the feature's part number with these parameters:

Note: As of Release 46.3, the `fak` parameter is no longer required. This parameter is only used for backward compatibility.

`: fak` – The feature access key provided by Oracle.

`: partnum` – The Oracle-issued part number of the Origin-Based **MTP** Routing feature, 893014201.

Once this feature is enabled, it is permanently enabled. This feature cannot be enabled with a temporary feature access key.

The `enable-ctrl-feat` command requires that the database contain a valid serial number for the **EAGLE**, and that this serial number is locked. This can be verified with the `rtrv-serial-num` command. The **EAGLE** is shipped with a serial number in the database, but the serial number is not locked. The serial number can be changed, if necessary, and locked once the **EAGLE** is on-site, with the `ent-serial-num` command. The `ent-serial-num` command uses these parameters.

`: serial` – The serial number assigned to the **EAGLE**. The serial number is not case sensitive.

`: lock` – Specifies whether or not the serial number is locked. This parameter has only one value, `yes`, which locks the serial number. Once the serial number is locked, it cannot be changed.

Note: To enter and lock the **EAGLE**'s serial number, the `ent-serial-num` command must be entered twice, once to add the correct serial number to the database with the `serial` parameter, then again with the `serial` and the `lock=yes` parameters to lock the serial number. You should verify that the serial number in the database is correct before locking the serial number. The serial number can be found on a label affixed to the control shelf (shelf 1100).

The `chg-ctrl-feat` command uses these parameters:

`: partnum` – The Oracle-issued part number of the Origin-Based **MTP** Routing feature, 893014201.

`: status=on` – used to turn the Origin-Based **MTP** Routing feature on.

The status of the controlled features in the **EAGLE** is shown with the `rtrv-ctrl-feat` command.

To turn the Origin-Based **MTP** Routing feature on with the `chg-ctrl-feat` command, the **STP** option `MTPLPRST` must be set to `yes`. This can be verified by performing the `rtrv-stpopts` command. Perform the [Configuring the Frequency of](#)

[RST Messages on Low Priority Routes](#) procedure to change the `MTPLPRST` option value, if necessary.

Once the Origin-Based **MTP** Routing feature is enabled and turned on, provisioning for the Origin-Based **MTP** Routing feature can be performed. Perform these procedures to provision the Origin-Based **MTP** Routing feature.

- [Configuring the Origin-Based MTP Routing SCCP OPC Option](#)
- [Adding an Exception Route Entry](#)

Origin-Based MTP Routing Feature

Origin-Based **MTP** Routing provides greater flexibility and control over the **EAGLE** routing mechanisms by enabling the user to selectively route traffic to the same destination through different networks depending on various classes of exception routes. The classes of exception routes are shown in the following list.

- **DPC** and **OPC** - an exception route using the **DPC** (destination point code) and **OPC** (originating point code) in the message to determine how the message will be routed.
- **DPC** and the originating linkset - an exception route using the **DPC** and the name of the linkset carrying incoming traffic to the **EAGLE** to determine how the message will be routed.
- **DPC** and **CIC** - an exception route using the **DPC** and **CIC** (circuit identification code) in the message to determine how the message will be routed.
- **DPC** and **SI** - an exception route using the **DPC** and **SI** (service indicator) value in the message to determine how the message will be routed.
- **DPC** - an exception route using only the **DPC** in the message to determine how the message will be routed.

The **DPC** of a route coupled with an exception route class and exception route criteria creates a new destination for the route and also creates an additional entry in the **EAGLE**'s routing table. The number of entries in the **EAGLE**'s routing table is the number of **DPCs** provisioned with the `ent-dstn` command plus the number of exception route entries provisioned with the `ent-rtx` command.

The number of entries in the **EAGLE**'s routing table cannot exceed the number of **DPCs** allocated in the routing table, shown in the `DESTINATION ENTRIES ALLOCATED`: row of the `rtrv-rtx` and `rtrv-dstn` output. The **EAGLE** can contain a maximum of 10,000 entries in the routing table. The total number of entries provisioned in the routing table is shown in the `TOTAL DPC(s)`: row of the `rtrv-dstn` or `rtrv-rtx` output.

All other properties of a routeset apply to exception routesets with respect to provisioning (routes and route costs) and alarming with the exception of network management, which is discussed in the "Network Management and Exception Routes" section.

Exception Route Processing Order and Route Costs

The processing order of exception routes is pre-defined. The exception class list in the "Network Management and Exception Routes" section also shows the order that the classes of exception routes are processed.

If a particular route has two exception routes, a **DPC** and **OPC** and a **DPC** and **CIC** exception route, the **DPC** and **OPC** exception route is used first since it is processed before the **DPC** and **CIC** exception route.

To determine the priority of exception routes, a relative cost value is assigned to each exception route. The relative cost values are used only within an exception route class. The **DPC** of the exception route contains multiple entries exception route class value, for example multiple entries with the same **DPC** and **OPC** value. The relative cost value determines the order in which the exception routes with the same **DPC** and **OPC** values are used to route the messages.

For example, **DPC A** contains the following exception routes:

- **OPC = B: RC=20: LSN=LSB**
- **OPC = B: RC=20: LSN=LSC**
- **OPC = B: RC=30: LSN=LSD**
- **SI = 3: RC=10: LSN=LS3**

When an **SCCP** message is received from Node B, the exception route mechanism splits traffic matching exception routes **OPC = B** between the linksets **LSB** and **LSC**, treating it as a combined linkset, since both entries have the same relative cost value. When both linksets **LSB** and **LSC** are not available, traffic is switched to linkset **LSD**. Even through the **SI=3** exception route has a lower relative cost value than the other exception routes for **DPC A**, the **SI=3** exception route is used to route the messages only when the linksets **LSB**, **LSC**, and **LSD** are not available.

CIC Handling

Exception routes can be provisioned based on a single **CIC** value or a range of **CIC** values in an **ISUP** message. The only value used by this feature for all **CIC** triggers will be the **CIC** value placed after the routing label and not any **CIC** value placed within the mandatory fixed, variable or optional parts of the message. [Figure 3-39](#) shows the location of this value within the message.

Figure 3-39 ISDN User Part Message Parts

Routing Label
Circuit Identification Code
Message Type Code
Mandatory Fixed Part
Mandatory Variable Part
Optional Part

Since this feature will not consider any **CIC** value placed within the mandatory fixed, variable or optional part, messages within **ISUP** that are applied over a range of circuits (**GRS**, **CGB**, **CGU**, etc.) may be mishandled. Because of this, the user must consider how maintenance is handled before **CIC** ranging is used in order to ensure that circuit maintenance is performed properly.

For example, if a **GRS** is sent where the **CIC** field is 5 and the range field is 10, this implies that circuits 5 to 15 should be reset. If an exception route is provisioned for **CIC 5**, it would take the path (if available) provisioned since the **CIC** value in the message matches the one that is provisioned. However, if the exception route

provisioned is 6, the **CGU** will not take the path provisioned even though 6 is within the range specified by the **GRS** message.

Network Management and Exception Routes

The Origin-Based **MTP** Routing operates on an end-to-end scheme, and not a point-to-point scheme. As a result, adjacent point codes cannot have exception routes. Correct network handing is critical for the **EAGLE** and other routing mechanisms to operate properly. Imposing exception routes over adjacent point codes introduces a large element of risk since elements of the network may receive point code and link events late, impacting routing to those and other destinations.

When considering the impact that exception routing could have on the network, the following restrictions are in place to ensure network sanity:

- Adjacent point codes cannot not have exception routes.
- Exception routes do not factor into the status of a destination. A destination's status is defined only by the standard routes entered.
- If all the **DPC**-based routes to a destination are unavailable, then the status of the destination is listed as prohibited even if there are exception routes available.
- Preventative and broadcast **TfX** or **TCx** are not sent based on the status of exception routes. If an exception route is unavailable, the next exception route is chosen ending with the standard provisioned routes.

Congestion Handling and Origin-Based Routing

Since the only identifying characteristic of a **TFC** message is the capability point code (**CPC**), the **EAGLE** is unable to determine if the node or the route used to reach that destination is congested. Normally, the **EAGLE** would list the destination as congested since there was only one routeset to that destination.

With the Origin-Based **MTP** Routing feature, there is no longer only one routeset to a destination, but many. However, due to the inexact nature of the **TFC**, the **EAGLE** is still unable to determine if an exception route, a normal route, or the node itself that is congested. Thus, once a **TFC** is received regarding a node within exception routes provisioned against it, the **EAGLE** lists all routesets to that destination as congested.

To ensure that the **EAGLE** has the correct congestion status of the destination, the **EAGLE** sends an **RCT** regarding that destination over each impacted route and not just the normal route. This ensures that the destination does not "bounce" in and out of congestion. The **EAGLE** starts level 3 timer T15 at the beginning of the broadcast and level 3 timer T16 at the completion.

If the **EAGLE** receives a **TFC** regarding that destination in response to the poll, the **EAGLE** maintains the congestion level against it, even if it was received over a linkset which is part of an exception routeset and not the normal routeset. This is because the **EAGLE** can not rely on the incoming linkset of the **TFC** to identify the route that is congested since the adjacent nodes routing provisioning may be different the **EAGLE**.

Circular Route Detection and Origin-Based Routing

Normally, if the **EAGLE** detects that traffic originated from a route is to be sent back over the same route, it changes the status of the **DPC** to prohibited so that the linkset does not enter into congestion and potentially impact other valid routes. However, with Origin-Based **MTP** Routing, this can occur since there are some situations where this is the desired action. In order to reduce the impact to the true route of the **DPC**, the **EAGLE** prohibits only the impacted route to a destination, and not the destination itself.

This ensures that only the exception route provisioned in this manner is impacted if circular routing is detected and allow all other remaining traffic to reach the **DPC**.

However, since this is an abnormal routing condition, the **EAGLE** requires the use of the `force=yes` parameter when entering an exception route where the **ILSN** and the **LSN** parameters values are the same

If circular routing is detected on an exception route, enter the `rst-dstn` command to clear this condition.

Gateway Nodes and Exception Routes

Exception routes can be provisioned across networks, where the **OPC** and **DPC** do not exist within the same network type (**ANSI**, **ITU-I** or **ITU-N**). However, exception routes can be provisioned only through using full point code values, not alias or cluster point code values. This allows the user to understand which exception routes apply without trying to remember what aliases are provisioned for specific point codes.

Because of **MTP** conversion restrictions it is necessary that each **OPC** that is used within a gateway exception routeset must have an alias point code entry in the destination table for the network that the **DPC** of the exception route resides in. If the alias point code is not present, then the **EAGLE** is not able to route messages across networks.

SCCP Handling

With **SCCP** messaging, there are three possible **OPC** values that may be used; the **OPC** originally in the routing header, the **EAGLE** true point code, and the **CGPA OPC** (determined by whether the **CGPA** portion of the message is `route-on-dpcssn` or `route-on-gt`). To provide the option on which criteria to use, Origin-Based **MTP** Routing provides an **SCCP** option (**MOBRSCCPOPC**) which has three values:

- `mtp` – The original **OPC** in the message is used as the **OPC** value to use for routing the **SCCP** message.
- `sccp` – If the **CGPA** portion of the message is `route-on-dpcssn`, the point code in the **CGPA** portion of the message, if the **CGPA** portion of the message is `route-on-dpcssn`, is used as the **OPC** value to use for routing the **SCCP** message. If the **CGPA** portion of the message is `route-on-gt`, the **MTP** option, the original **OPC** in the message, is used as the **OPC** value to use for routing the **SCCP** message.
- `tpc` – The **EAGLE**'s true point code is used as the **OPC** value to use for routing the **SCCP** message.

The **MOBRSCCPOPC** option is provisioned with the `chg-sccpopts` command.

If traffic truly originates from the **EAGLE** (for example, a **UDTS**), then the **ilsn** parameter of an exception route is not used in evaluating which exception route to use, if any. This is because the traffic was generated by the **EAGLE** and did not enter through any linkset.

UDTS/XUDTS messages generated by the **EAGLE** and messages undergoing global title translation are routed over **OPC** exception routes. However, other messages originated by the **EAGLE**, for example, response messages generated by the **EAGLE** **SCCP** services/subsystems, do not use **OPC** exception routes. These messages are routed using other exception criteria, for example, **SI** based exception routes, if these exception routes are defined. If these exception routes are not defined, normal routing is applied to these messages.

1. Display the controlled features in the database by entering the `rtrv-ctrl-feat` command.

This is an example of the possible output.

```
rlghncxa03w 06-10-28 11:43:04 GMT EAGLE5 36.0.0
The following features have been permanently enabled:
```

Feature Name	Partnum	Status	Quantity
SCCP Conversion	893012001	on	----
EIR	893012301	on	----
GSM Map Screening (GMS)	893013201	on	----
HC-MIM SLK Capacity	893012707	on	64

The following features have been temporarily enabled:

Feature Name	Partnum	Status	Quantity	Trial Period Left
Zero entries found.				

The following features have expired temporary keys:

Feature Name	Partnum
Zero entries found.	

If the Origin-Based **MTP** Routing feature is enabled, the entry `MTP Origin-Based Routing` is shown in the permanently enabled section of the `rtrv-ctrl-feat` output. If the status of the Origin-Based **MTP** Routing feature is on, no further action can be performed.

If the Origin-Based **MTP** Routing feature is not enabled, continue the procedure with [2](#).

If the `rtrv-ctrl-feat` output in [1](#) shows any controlled features, continue the procedure with [Oracle](#). If the `rtrv-ctrl-feat` output shows only the HC-MIM SLK Capacity feature with a quantity of 64, [2](#) through [5](#) must be performed.

If the Origin-Based **MTP** Routing feature is enabled but not turned on, continue the procedure with [7](#).

2. Display the serial number in the database with the `rtrv-serial-num` command.

This is an example of the possible output.

```
rlghncxa03w 06-10-28 21:15:37 GMT EAGLE5 36.0.0
System serial number = nt00001231
```

System serial number is not locked, yet.

Note: If the serial number is correct and locked, continue the procedure with [Oracle](#). If the serial number is correct but not locked, continue the procedure with [5](#). If the serial number is not correct, but is locked, this feature cannot be enabled and the remainder of this procedure cannot be performed. Contact the Customer Care Center to get an incorrect and locked serial number changed. Refer to [My Oracle Support \(MOS\)](#) for the contact information. The serial number can be found on a label affixed to the control shelf (shelf 1100).

3. Enter the correct serial number into the database using the `ent-serial-num` command with the `serial` parameter.

For this example, enter this command.

```
ent-serial-num:serial=<EAGLE's correct serial number>
```

When this command has successfully completed, the following message should appear.

```
rlghncxa03w 06-10-28 21:15:37 GMT EAGLE5 36.0.0
ENT-SERIAL-NUM: MASP A - COMPLTD
```

4. Verify that the serial number entered into 3 was entered correctly using the `rtrv-serial-num` command.

This is an example of the possible output.

```
rlghncxa03w 06-10-28 21:15:37 GMT EAGLE5 36.0.0
System serial number = nt00001231
```

System serial number is not locked, yet.

If the serial number was not entered correctly, repeat 2 and 3 and re-enter the correct serial number.

5. Lock the serial number in the database by entering the `ent-serial-num` command with the serial number shown in 2, if the serial number shown in 2 is correct, or with the serial number shown in 4, if the serial number was changed in 3, and with the `lock=yes` parameter.

For this example, enter this command.

```
ent-serial-num:serial=<EAGLE's serial number>:lock=yes
```

When this command has successfully completed, the following message should appear.

```
rlghncxa03w 06-10-28 21:15:37 GMT EAGLE5 36.0.0
ENT-SERIAL-NUM: MASP A - COMPLTD
```

6. Enable the Origin-Based MTP Routing feature by entering the `enable-ctrl-feat` command.

For this example, enter this command.

```
enable-ctrl-feat:partnum=893014201:fak=<Origin-Based MTP
Routing feature access key>
```

Note: The values for the feature access key (the `fak` parameter) are provided by Oracle. If you do not have the feature access key for the Origin-Based MTP Routing feature, contact your Oracle Sales Representative or Account Representative.

When the `enable-ctrl-feat` command has successfully completed, this message should appear.

```
rlghncxa03w 06-10-28 21:15:37 GMT EAGLE5 36.0.0
ENABLE-CTRL-FEAT: MASP A - COMPLTD
```

7. Display the existing value for the `mtplprst` parameter by entering the `rtrv-stpopts` command. The value for the `mtplprst` parameter is shown in the `MTPLPRST` field.

This is an example of the possible output.

```
rlghncxa03w 06-10-17 16:02:05 GMT EAGLE5 36.0.0
STP OPTIONS
-----
MTPLPRST          no
```

Note: The `rtrv-stpopts` command output contains other fields that are not used by this procedure. If you wish to see all the fields displayed by the `rtrv-stpopts` command, see the `rtrv-stpopts` command description in *Commands User's Guide*.

8. Turn the Origin-Based MTP Routing feature on by entering the `chg-ctrl-feat` command with the part number used in [Oracle](#) and the `status=on` parameter.

Caution: Once the Origin-Based MTP Routing feature is turned on, it cannot be turned off.

For this example, enter this command.

```
chg-ctrl-feat:partnum=893014201:status=on
```

When this command has successfully completed, the following message should appear.

```
rlghncxa03w 06-10-28 21:15:37 GMT EAGLE5 36.0.0
CHG-CTRL-FEAT: MASP A - COMPLTD
```

9. Verify the changes by entering this command.

```
rtrv-ctrl-feat:partnum=893014201
```

This is an example of the possible output.

```
rlghncxa03w 06-10-28 21:15:37 GMT EAGLE5 36.0.0
The following features have been permanently enabled:
```

Feature Name	Partnum	Status	Quantity
MTP Origin-Based Routing	893014201	on	----

The following features have been temporarily enabled:

Feature Name	Partnum	Status	Quantity	Trial Period Left
Zero entries found.				

The following features have expired temporary keys:

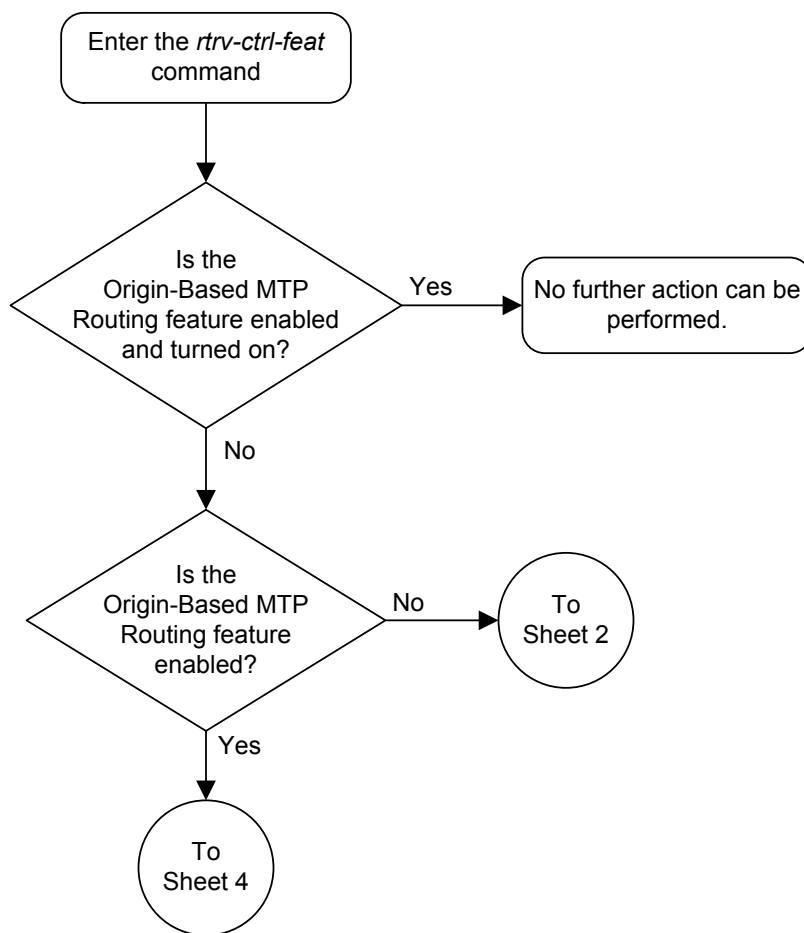
Feature Name Partnum
Zero entries found.

10. Back up the new changes, using the `chg-db:action=backup:dest=fixed` command.

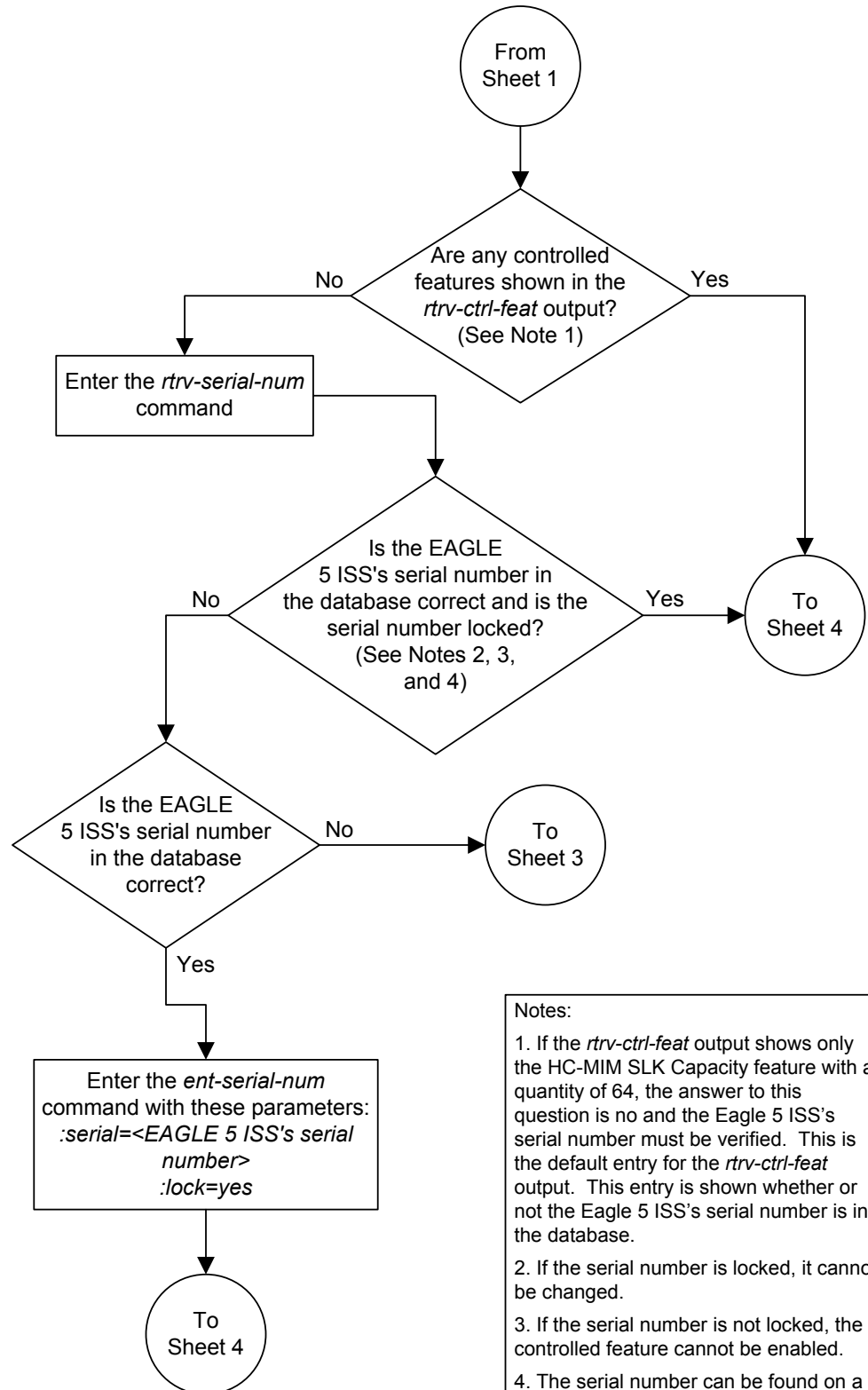
These messages should appear; the active **Maintenance and Administration Subsystem Processor (MASP)** appears first.

```
BACKUP (FIXED): MASP A - Backup starts on active MASP.  
BACKUP (FIXED): MASP A - Backup on active MASP to fixed disk complete.  
BACKUP (FIXED): MASP A - Backup starts on standby MASP.  
BACKUP (FIXED): MASP A - Backup on standby MASP to fixed disk complete.
```

Figure 3-40 *Activating the Origin-Based MTP Routing Feature*



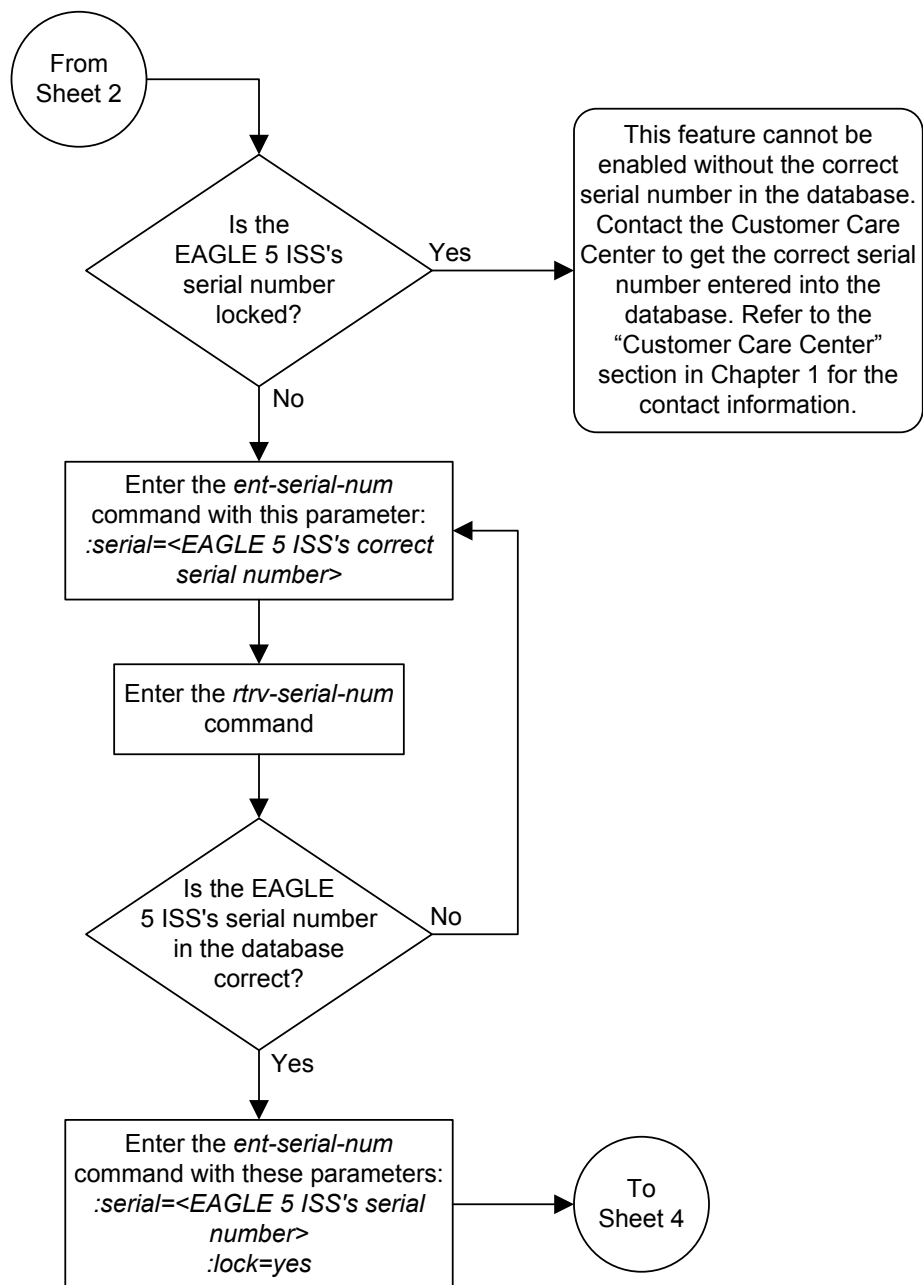
Sheet 1 of 4



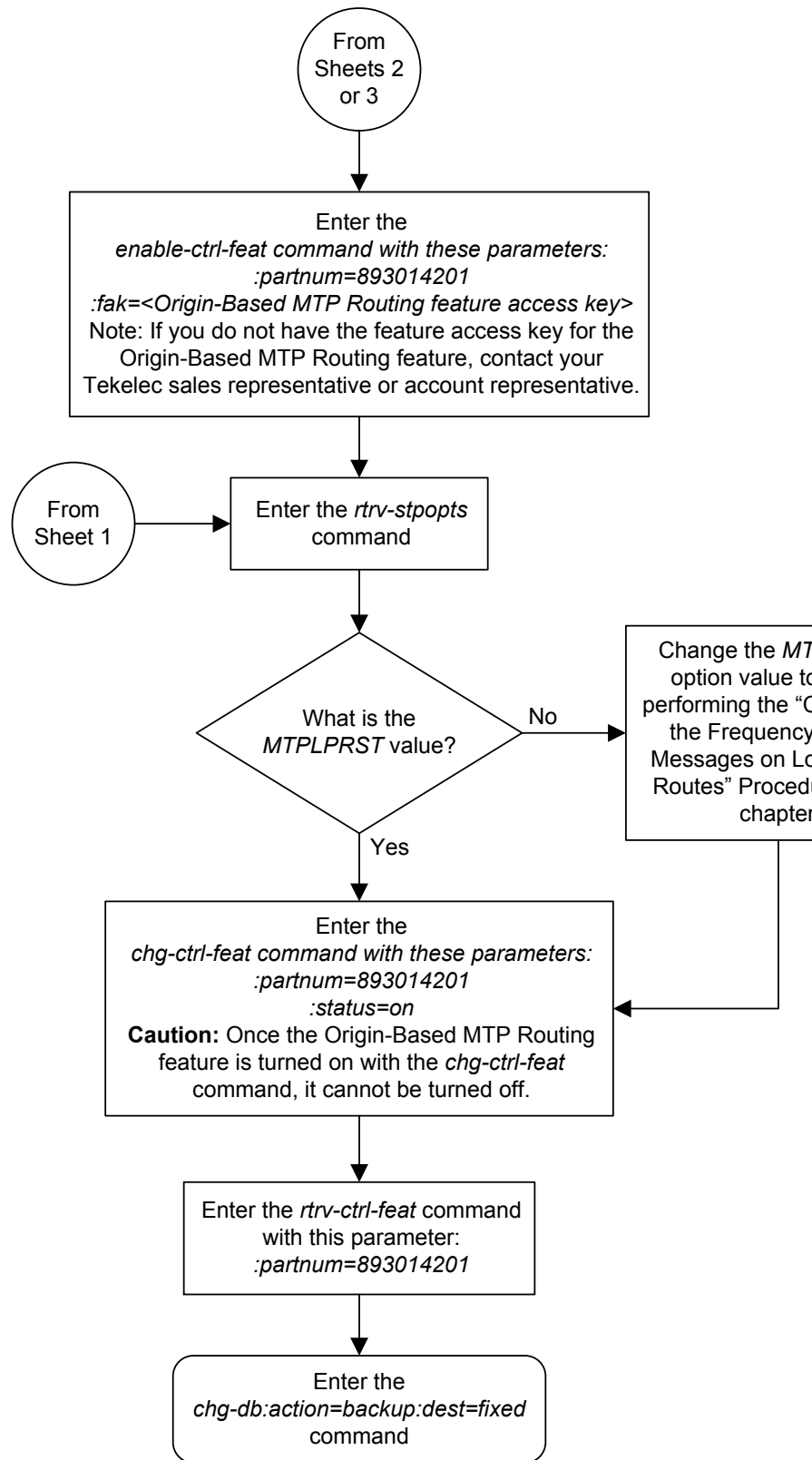
Notes:

1. If the *rtrv-ctrl-feat* output shows only the HC-MIM SLK Capacity feature with a quantity of 64, the answer to this question is no and the Eagle 5 ISS's serial number must be verified. This is the default entry for the *rtrv-ctrl-feat* output. This entry is shown whether or not the Eagle 5 ISS's serial number is in the database.
2. If the serial number is locked, it cannot be changed.
3. If the serial number is not locked, the controlled feature cannot be enabled.
4. The serial number can be found on a label affixed to the control shelf (shelf 1100).

Sheet 2 of 4



Sheet 3 of 4



Configuring the Origin-Based MTP Routing SCCP OPC Option

This procedure is used to configure the option that determines which of the three **OPC** values can be used to route **SCCP** messages for the Origin-Based **MTP** Routing feature. The option is configured with the `mobrscppopc` parameter of the `chg-sccpopts` command. The `mobrscppopc` parameter has three values:

`mtp` – The original **OPC** in the message is used as the **OPC** value to use for routing the **SCCP** message.

`sccp` – If the **CGPA** portion of the message is `route-on-dpcssn`, the point code in the **CGPA** portion of the message, if the **CGPA** portion of the message is `route-on-dpcssn`, is used as the **OPC** value to use for routing the **SCCP** message. If the **CGPA** portion of the message is `route-on-gt`, the **MTP** option, the original **OPC** in the message, is used as the **OPC** value to use for routing the **SCCP** message.

`tpc` – The **EAGLE 5 ISS**'s true point code is used as the **OPC** value to use for routing the **SCCP** message.

If traffic originated from the Eagle, (for example, a **UDTS** message) then the incoming linkset name (`ilsn` parameter) of the exception route is not used in evaluating which exception route to use, if any. This is because since the traffic was generated by the Eagle it did not enter through any linkset.

The current value of the `mobrscppopc` parameter is shown in the `MOBRSCCPOPC` field in the `rtrv-sccpopts` command output.

The `mobrscppopc` parameter can be specified with the `chg-sccpopts` command, and the `MOBRSCCPOPC` field in the `rtrv-sccpopts` command output is displayed only if the Origin-Based **MTP** Routing feature is enabled and turned on. If the `MOBRSCCPOPC` field is not shown in the `rtrv-sccpopts` command output, perform the [Activating the Origin-Based MTP Routing Feature](#) procedure to enable and turn on the Origin-Based **MTP** Routing feature.

1. Display the existing value for the `mobrscppopc` parameter by entering the `rtrv-sccpopts` command.

If the Origin-Based **MTP** Routing feature is not enabled and turned on, this is an example of the possible output.

```
rlghncxa03w 06-10-17 16:02:05 GMT EAGLE5 36.0.0
```

```
SCCP OPTIONS
-----
CLASS1SEQ                off
DFLTGTTMODE              CdPA
```

If the Origin-Based **MTP** Routing feature is enabled and turned on, this is an example of the possible output.

```
rlghncxa03w 06-10-17 16:02:05 GMT EAGLE5 36.0.0
```

```
SCCP OPTIONS
-----
CLASS1SEQ                off
DFLTGTTMODE              CdPA
MOBRSCCPOPC              MTP
```

Note: The `rtrv-sccopts` command output contains other fields that are not used by this procedure. If you wish to see all the fields displayed by the `rtrv-sccopts` command, see the `rtrv-sccopts` command description in the *Commands Manual*.

If the `MOBRSCCPOPC` field is not shown in the `rtrv-sccopts` command output, perform the [Activating the Origin-Based MTP Routing Feature](#) procedure to enable and turn on the Origin-Based MTP Routing feature.

2. Change the `mobrscpopc` parameter value.

The value of the `mobrscpopc` parameter must be different from the value shown in the `rtrv-sccopts` output in step 1.

If you wish to use original **OPC** in the message is used as the **OPC** value to use for routing the **SCCP** message, enter this command.

```
chg-sccopts:mobrscpopc=mtp
```

If you wish to use the point code in the **CGPA** portion of the message is used as the **OPC** value to use for routing the **SCCP** message (when the **CGPA** portion of the message is route-on-dpcsn), enter this command.

```
chg-sccopts:mobrscpopc=sccp
```

If you wish to use the **EAGLE 5 ISS's** true point code is used as the **OPC** value to use for routing the **SCCP** message, enter this command.

```
chg-sccopts:mobrscpopc=tpc
```

```
rlghncxa03w 06-10-07 00:22:57 GMT EAGLE5 36.0.0
CHG-SCCPOPTS: MASP A - COMPLTD
```

3. Verify the changes using the `rtrv-sccopts` command.

This is an example of the possible output.

```
rlghncxa03w 06-10-17 16:02:05 GMT EAGLE5 36.0.0
SCCP OPTIONS
-----
CLASS1SEQ                off
DFLTGTTMODE              CdPA
MOBRSCCPOPC              MTP
```

Note: The `rtrv-sccopts` command output contains other fields that are not used by this procedure. If you wish to see all the fields displayed by the `rtrv-sccopts` command, see the `rtrv-sccopts` command description in the *Commands Manual*.

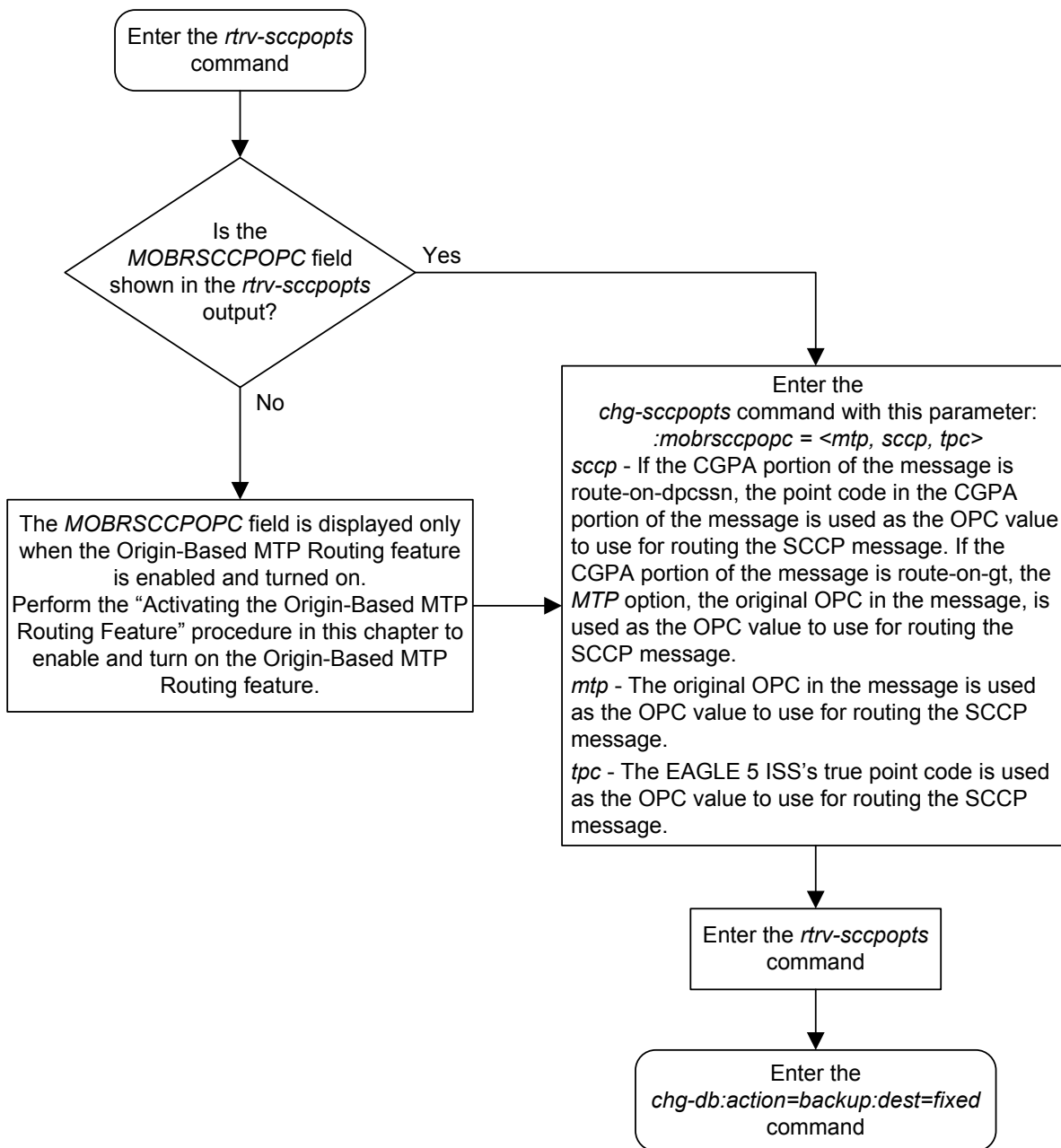
4. Back up the new changes using the `chg-db:action=backup:dest=fixed` command.

These messages should appear, the active **Maintenance and Administration Subsystem Processor (MASP)** appears first.

```
BACKUP (FIXED) : MASP A - Backup starts on active MASP.
BACKUP (FIXED) : MASP A - Backup on active MASP to fixed disk complete.
```


BACKUP (FIXED) : MASP A - Backup starts on standby MASP.
BACKUP (FIXED) : MASP A - Backup on standby MASP to fixed disk complete.

Figure 3-41 Configuring the Origin-Based MTP Routing SCCP OPC Option



Adding an Exception Route Entry

This procedure is used to add an exception route to the database using the `ent-rtx` command. The `ent-rtx` command uses these parameters.

`:dpc/dpca/dpci/dpcn/dpcn24` – The destination point code of the node that the traffic is being sent to.

`:opc/opca/opci/opcn/opcn24` – The originating point code of the node sending traffic to the EAGLE.

Note: See [Point Code Formats](#) for a definition of the point code types that are used on the EAGLE and for a definition of the different formats that can be used for ITU national point codes.

`:ilsn` – The name of the linkset carrying incoming traffic to the EAGLE.

`:lsn` – The name of the linkset that will carry the traffic to the node specified by the destination point code.

`:si` – The service indicator value that will be assigned to the exception route. The value of the `si` parameter is 3 to 15.

`:cic` – The circuit identification code (CIC) value that will be assigned to an exception route containing a single CIC entry or the CIC value that begins a range of CICs that will be assigned to the exception route. The value of the `cic` parameter is 0 to 16383.

`:ecic` – The circuit identification code value that ends the range of CICs that will be assigned to the exception route. The value of the `ecic` parameter is 0 to 16383.

`:rc` – The relative cost value (priority) that will be assigned to the exception route. The value of the `rc` parameter is 0 to 99.

`:force` – This parameter allows an exception route to be added to the database even if the `ilsn` parameter value is the same as the `lsn` parameter value. This parameter has only one value, `yes`.

The combinations of these parameters that can be used with the `ent-rtx` command are shown in [Table 3-27](#).

To add an exception route to the database, the Origin-Based MTP Routing feature must be enabled and turned on. If error message E4584 is displayed after the `rtrv-rtx` command is executed, the Origin-Based MTP Routing feature is not enabled or turned on.

E4584 Cmd Rej: MTP Origin Based Routing Feature must be ON

If the Origin-Based MTP Routing feature is not enabled or turned on, perform the [Activating the Origin-Based MTP Routing Feature](#) procedure to enable, if required, and turn on the Origin-Based MTP Routing feature.

The DPC value assigned to the exception route must be assigned to a route. If the required route is not shown in the `rtrv-rte` output, perform one of these procedures to add the required route.

- [Adding a Route Containing an SS7 DPC](#)
- [Adding a Route Containing a Cluster Point Code](#)

- [Adding a Route Containing an IPGWx Linkset](#)

The names of the linksets required specified for the `lsn` and `ilsn` parameters must be provisioned in the database. This can be verified by entering the `rtv-ls` command. If the required linkset is not in the database, perform one of these procedures to add the linkset.

- [Adding an SS7 Linkset](#)
- "Configuring an IPGWx Linkset," "Adding an IPSG M2PA Linkset," or "Adding an IPSG M3UA Linkset" procedures in *Database Administration - IP7 User's Guide*.

The linkset must be added according to the rules shown in the "[Adding Linksets for Exception Routes](#)" section.

Adding Linksets for Exception Routes

The linkset must be added according to the following rules:

- If the `dpc` value of the exception route entry is an ANSI point code, the adjacent point code of the `lsn` value must be an ANSI point code.
- If the exception route is an OPC-based exception route, the `opc` parameter value cannot be the adjacent point code of the linkset that is specified by the `lsn` parameter value.
- If the `dpc` value of the exception route entry is an ITU-I point code, the adjacent point code of the `lsn` value must be an ITU-I point code. If the linkset contains an SAPC (secondary adjacent point code), the adjacent point code of the `lsn` value can be either an ITU-N or ITU-N24 point code if the `sapc` value is an ITU-I point code. If the adjacent point code of the `lsn` value is an ITU-N point code with a group code, when the exception route is added, the group code of the adjacent point code of the linkset does not have to be the same as the group code of the `opc` value. If an ITU-N linkset is specified for the `ilsn` parameter, the group code of the adjacent point code of the `ilsn` value does not have to match the group code of the adjacent point code of the `lsn` value.
- If the `dpc` value of the exception route entry is an ITU-N point code, the adjacent point code of the `lsn` value must be an ITU-N point code.
 - If the `dpc` value of the exception route entry is an ITU-N point code with no group code assigned to the ITU-N point code, the adjacent point code of the `lsn` value or the adjacent point code of all the linksets in the routeset can be an ITU-I point code if the `sapc` (secondary adjacent point code) value is an ITU-N point code.
 - If the `dpc` value of the exception route entry is an ITU-N point code with a group code, the adjacent point code of the `lsn` value can be an ITU-I point code if the `sapc` value is an ITU-N point code. When the exception route is added, the group code of the `dpcn` value and the `opc` value must be the same. The group code of the adjacent point code of the `lsn` value and the `ilsn` value must be the same. The group code of the `dpcn` value must be the same as the group code of either the adjacent point code of the `lsn` value or the `sapc` (secondary adjacent point code) assigned to the `lsn` value.
- If the `dpc` value of the exception route entry is an ITU-N24 point code, the adjacent point code of the `lsn` value must be an ITU-N24 point code. If the linkset contains an SAPC (secondary adjacent point code), the adjacent point code of the `lsn` value can be an ITU-I point code if the `sapc` value is an ITU-N24 point code.

The SAPC values assigned to the linksets can be verified by entering the `rtrv-ls:lsn=<linkset name>` command.

1. Display the exception routes in the database by entering the `rtrv-rtx` command.

This is an example of the possible output.

```
rlghncxa03w 08-02-11 11:43:04 GMT EAGLE5 38.0.0

      DPCA          RTX-CRITERIA          LSN          RC          APC

003-003-003  OPCA
              009-009-009          lsn1          3          002-002-002
              010-010-010          lsn1          2          002-002-002
              ILSN
              lsn3          lsn2          2          002-002-003
              lsn4          lsn2          1          002-002-003
              CIC - ECIC
              15    15          lsn2          1          002-002-003
              17    17          lsn2          7          002-002-003
              18    30          lsn1          8          002-002-002
              SI
              3          lsn2          5          002-002-003
              5          lsn2          5          002-002-003

      DPCI          RTX-CRITERIA          LSN          RC          APC

0-123-7      OPCI
              1-222-3          lsn3          10         1-234-5
              1-222-4          lsn3          11         1-234-5
              1-222-5          lsn4          11         2-145-6

DESTINATION ENTRIES ALLOCATED:    2000
FULL DPC(s):                      20
EXCEPTION DPC(s):                 12
TOTAL DPC(s):                     32
CAPACITY (% FULL):                2%
ALIASES ALLOCATED:                12000
ALIASES USED:                      0
CAPACITY (% FULL):                0%
```

If the `rtrv-rtx` output contains any entries, the Origin-Based MTP Routing feature is enabled. Continue the procedure with [3](#).

If error message E4584 is displayed after the `rtrv-rtx` command is executed, the Origin-Based MTP Routing feature is not turned on.

```
E4584 Cmd Rej: MTP Origin Based Routing Feature must be ON
```

If error message E4584 is displayed, perform the [Activating the Origin-Based MTP Routing Feature](#) procedure to enable, if required, and turn on the Origin-Based MTP Routing feature. After the Origin-Based MTP Routing feature is turned on, continue the procedure with [2](#).

2. Display the number of DPCs currently in the database and the number of DPCs that EAGLE can contain by entering the `rtrv-dstn` command with the `msar=only` parameter.

This is an example of the possible output.

```

rlghncxa03w 08-02-11 11:43:04 GMT EAGLE5 38.0.0
DESTINATION ENTRIES ALLOCATED:    2000
  FULL DPC(s):                    20
  EXCEPTION DPC(s):               12
  TOTAL DPC(s):                   32
  CAPACITY (% FULL):              2%
ALIASES ALLOCATED:                12000
  ALIASES USED:                   0
  CAPACITY (% FULL):              0%

```

- The number of entries in the EAGLE routing table consists of the number of DPCs provisioned by the `ent-dstn` command and the number of exception routes provisioned by `ent-rtx` command.

The number of entries in the EAGLE's routing table cannot exceed the number of DPCs allocated in the routing table, shown in the `DESTINATION ENTRIES ALLOCATED:` row of the `rtrv-rtx` and `rtrv-dstn` output. The EAGLE can contain a maximum of 10,000 entries in the routing table. The total number of entries provisioned in the routing table is shown in the `TOTAL DPC(s):` row of the `rtrv-dstn` or `rtrv-rtx` output. If adding the new exception route entry would exceed the number of DPCs allocated in the routing table, perform one of these actions:

- Increase the number of DPCs allocated in the routing table by performing the [Changing the DPC Quantity](#) procedure.
- Remove enough entries from the routing table to allow the addition of the new exception routes by performing either the [Removing a Destination Point Code](#) procedure or the [Removing a Route Exception Entry](#) procedure.

After either these actions are performed, continue the procedure with 4.

Note: If adding the new exception route entry would exceed the number of DPCs allocated in the routing table and neither of these actions are performed, this procedure cannot be performed. If the number of DPCs provisioned in the routing table is 10,000, the only action that can be performed that would allow the addition of new exception routes is to remove existing entries from the routing table.

If adding the new exception route entry would not exceed the number of DPCs allocated in the routing table, continue the procedure with 4.

- Display the routes in the database by entering the `rtrv-rte` command.

If the new exception route entry will be added to an existing DPC shown in the `rtrv-rtx` output, continue the procedure with 5.

This is an example of the possible output.

```

rlghncxa03w 10-12-10 11:43:04 GMT EAGLE5 43.0.0
Extended Processing Time may be Required

DPCA          ALIASI      ALIASN/N24   LSN          RC          APCA
002-002-002  -----  -----  -----  --  -----
                                     RTX:No  CLI=-----
002-002-003  -----  -----  -----  --  -----

```

```

RTX:No  CLLI=-----
003-003-003 ----- lsn1      1      002-002-002
                    lsn2      2      002-002-003
                    RTX:Yes CLLI=-----
004-004-004 ----- --
                    RTX:No  CLLI=-----
005-005-005 ----- --
                    RTX:No  CLLI=-----
006-006-006 ----- lsn11     1      004-004-004
                    lsn12     2      005-005-006
                    RTX:No  CLLI=-----
DPCI      ALIASN/N24      ALIASA  LSN      RC      APC
0-123-7 ----- lsn3      1      1-234-5
                    lsn4      2      2-145-6
                    RTX:Yes CLLI=-----
1-234-5 ----- --
                    RTX:No  CLLI=-----
2-145-6 ----- --
                    RTX:No  CLLI=-----
3-025-6 ----- lsn13     1      1-100-5
                    lsn14     2      4-139-4
                    RTX:No  CLLI=-----
1-100-5 ----- --
                    RTX:No  CLLI=-----
4-139-4 ----- --
                    RTX:No  CLLI=-----
DPCN      ALIASA      ALIASI  LSN      RC      APC
00002 ----- --
                    RTX:No  CLLI=-----
00003 ----- --
                    RTX:Yes CLLI=-----
00004 ----- lsn5      1      00002
                    lsn6      2      00003
                    RTX:No  CLLI=-----
11302 ----- --
                    RTX:No  CLLI=-----
12567 ----- --
                    RTX:No  CLLI=-----
09852 ----- lsn15     1      11302
                    lsn16     2      12567
                    RTX:No  CLLI=-----
DPCN24    ALIASA      ALIASI  LSN      RC      APC

```

The DPC value assigned to the exception route must be assigned to a route. If the required route is not shown in the `rtrv-rte` output, perform one of these procedures to add the required route.

- [Adding a Route Containing an SS7 DPC](#)
- [Adding a Route Containing a Cluster Point Code](#)
- [Adding a Route Containing an IPGWx Linkset](#)

After the required routes have been configured, continue the procedure with [5](#).

5. Display the linksets in the database by entering the `rtrv-ls` command.

This is an example of the possible output.

```
rlghncxa03w 06-10-10 11:43:04 GMT EAGLE5 38.0.0
```

LSN	APCA (SS7)	SCRN	SET	SET	BEI	LST	LNKS	ACT	MES	DIS	SLSCI	NIS
		L3T	SLT				GWS	GWS	GWS			
lsn1	002-002-002	none	1	1	no	B	2	off	off	off	no	off
lsn2	002-002-003	none	1	1	no	B	3	off	off	off	no	off
lsn11	004-004-004	none	1	1	no	B	1	off	off	off	no	off
lsn12	005-005-005	none	1	1	no	B	4	off	off	off	no	off

LSN	APCI (SS7)	SCRN	SET	SET	BEI	LST	LNKS	ACT	MES	DIS	SLSCI	NIS
		L3T	SLT				GWS	GWS	GWS			
lsn3	1-234-5	none	1	2	no	B	2	off	off	off	---	off
lsn4	2-145-6	none	1	2	no	B	2	off	off	off	---	off
lsn13	1-100-5	none	1	2	no	B	1	off	off	off	---	off
lsn14	4-139-4	none	1	2	no	B	1	off	off	off	---	off

LSN	APCN (SS7)	SCRN	SET	SET	BEI	LST	LNKS	ACT	MES	DIS	SLSCI	NIS
		L3T	SLT				GWS	GWS	GWS			
lsn5	00002	none	1	2	no	B	2	off	off	off	---	off
lsn6	00003	none	1	2	no	B	2	off	off	off	---	off
lsn15	11302	none	1	2	no	B	2	off	off	off	---	off
lsn16	12567	none	1	2	no	B	2	off	off	off	---	off

Link set table is (12 of 1024) 1% full.

If the required linkset is not in the database, perform one of these procedures to add the linkset.

- [Adding an SS7 Linkset](#)
- "Configuring an IPGWx Linkset," "Adding an IPSG M2PA Linkset," or "Adding an IPSG M3UA Linkset" procedures in *Database Administration - IP7 User's Guide*.

The linkset must be added according to the rules shown in the ["Adding Linksets for Exception Routes"](#) section.

Note: If the DPC exception route entry is an ANSI DPC, the adjacent point code of the lsn value must be an ANSI point code. If the DPC exception route entry is an ANSI DPC, continue the procedure with 7.

6. Display the linkset that will be assigned to the exception route entry by entering the `rtrv-ls` command with the name of the linkset.

For this example, enter these commands.

```
rtrv-ls:lsn=lsn13
```

This is an example of the possible output.

```
rlghncxa03w 08-02-11 11:43:04 GMT EAGLE5 38.0.0

LSN          APCI (SS7)  SCRN SET SET BEI LST LNKS ACT MES DIS SLSCI NIS
lsn13       1-100-5     none 1  2  no  B  1  off off off ---  off

          CLLI          TFATCABMLQ MTPRSE ASL8 SLSOCBIT SLSRSB MULTGC
          ----- 1          no    --- none    7      no

ITUTFR RANDSLS
off    all
```



```

IPGWAPC MATELSN      IPTPS LSUSEALM SLKUSEALM GTTMODE
no          -----  ---   ---          ---          CdPA

LOC  LINK SLC TYPE      IPLIML2
1301 A    0   IPLIMI   M2PA

SAPCN
11211
Link set table is (12 of 1024) 1% full.

```

```
rtrv-ls:lsn=lsn16
```

This is an example of the possible output.

```
rlghncxa03w 08-02-11 11:43:04 GMT EAGLE5 38.0.0
```

```

                                L3T SLT                GWS GWS GWS
LSN          APCI  (SS7)  SCRN SET SET BEI LST LNKS ACT MES DIS SLSCI NIS
lsn16        12567          none 1  2  no  B  2   off off off ---  off

CLLI          TFATCABMLQ MTPRSE ASL8 SLSOCBIT SLSRSB MULTGC
----- 1          no    --- none    7      no

ITUTFR RANDSLS
off    all

IPGWAPC MATELSN      IPTPS LSUSEALM SLKUSEALM GTTMODE
no          -----  ---   ---          ---          CdPA

LOC  LINK SLC TYPE      IPLIML2
1301 A    0   IPLIMI   M2PA

SAPCI
5-067-1
Link set table is (12 of 1024) 1% full.

```

If the linkset does not meet the criteria shown in the ["Adding Linksets for Exception Routes"](#) section, either choose another linkset from the `rtrv-ls` output in 5 and repeat this step, or add a new linkset by performing one of these procedures:

- [Adding an SS7 Linkset](#)
- "Configuring an IPGWx Linkset," "Adding an IPSG M2PA Linkset," or "Adding an IPSG M3UA Linkset" procedures in *Database Administration - IP7 User's Guide*.

The linkset must be added according to the rules shown in the ["Adding Linksets for Exception Routes"](#) section. After this step is performed, continue the procedure by performing one of these steps.

- If no more than two entries in the exception route will contain the same exception route criteria, except for the linkset name, continue the procedure with 14.
- If more than two entries in the exception route will contain the same exception route criteria, except for the linkset name, continue the procedure by performing one of these steps.

- If more than two entries in an exception route that contain the same exception route criteria, except for the linkset name, are shown in the `rtrv-rtx` command in 1, continue the procedure with 14.
- If more than two entries in an exception route that contain the same exception route criteria, except for the linkset name, are not shown in the `rtrv-rtx` command in 1, continue the procedure with 13.

7. Display the DPCs in the database by entering the `rtrv-dstn` command.

Note: If cluster point codes are displayed in the `rtrv-rtx` or `rtrv-rte` outputs, skip this step and continue the procedure with 8.

This is an example of the possible output.

```

rlghncxa03w 10-12-10 11:43:04 GMT EAGLE5 43.0.0
Extended Processing Time may be Required

DPCA          CLLI          BEI  ELEI   ALIASI          ALIASN/N24    DMN
002-002-002   ----- no   --- -----
002-002-003   ----- no   --- -----
003-003-003   ----- no   --- -----
004-004-004   ----- no   --- -----
005-005-005   ----- no   --- -----
006-006-006   ----- no   --- -----

DPCI          CLLI          BEI  ELEI   ALIASA          ALIASN/N24    DMN
1-234-5       ----- no   --- -----
2-145-6       ----- no   --- -----
0-123-7       ----- no   --- -----
3-025-6       ----- no   --- -----
1-100-5       ----- no   --- -----
4-139-4       ----- no   --- -----
5-067-1       ----- no   --- -----

DPCN          CLLI          BEI  ELEI   ALIASA          ALIASI         DMN
00002        ----- no   --- -----
00003        ----- no   --- -----
00004        ----- no   --- -----
09852        ----- no   --- -----
11211        ----- no   --- -----
11302        ----- no   --- -----
12567        ----- no   --- -----

DESTINATION ENTRIES ALLOCATED:  2000
  FULL DPC(s):                  20
  EXCEPTION DPC(s):             12
  TOTAL DPC(s):                 32
  CAPACITY (% FULL):            2%
ALIASES ALLOCATED:             12000
  ALIASES USED:                  0
  CAPACITY (% FULL):            0%

```

If a cluster point code is not shown in the `rtrv-dstn` output, continue the procedure with 12.

If a cluster point code is shown in the `rtrv-dstn` output, and the DPC of the exception route is not a member of a cluster point code, continue the procedure with [12](#).

If a cluster point code is shown in the `rtrv-dstn` output, and the DPC of the exception route is a member of a cluster point code, continue the procedure with [8](#).

8. Display the cluster point code by entering the `rtrv-dstn` command with the cluster point code.

For this example, enter this command.

```
rtrv-dstn:dpca=010-010-*
```

This is an example of the possible output.

```
rlghncxa03w 10-12-10 11:43:04 GMT EAGLE5 43.0.0
```

DPCA	CLLI	BEI	ELEI	ALIASI	ALIASN/N24	DMN	
010-010-*	-----	no	no	-----	-----	SS7	
SPCA	NCAI	RCAUSE	NPRST	SPLITIAM	HMSMSC	HMSCP	SCCPMSGCNV
-----	yes	none	off	none	no	no	none

```
Destination table is (33 of 2000) 1% full
```

```
Alias table is (0 of 12000) 0% full
```

The DPC of an exception route cannot be a member of a cluster point code unless the NCAI value of the cluster point code is `yes`. If the NCAI value of the cluster point code is `yes`, continue the procedure with [12](#).

If the NCAI value of the cluster point code is `no`, continue the procedure with [9](#).

9. Verify that the **NCR** (Nested Cluster Routing) feature is on by entering the `rtrv-feat` command.

The entry `NCR = on` in the `rtrv-feat` command output shows that the NCR feature is on.

Note: The `rtrv-feat` command output contains other fields that are not used by this procedure. If you wish to see all the fields displayed by the `rtrv-feat` command, see the `rtrv-feat` command description in *Commands User's Guide*.

If the NCR feature is on, continue the procedure with [11](#).

If the NCR feature is off, continue the procedure with [10](#).

10. Turn the NCR feature on by entering this command.

```
chg-feat:ncr=on
```

Note: Once the NCR feature is turned on with the `chg-feat` command, it cannot be turned off.

The NCR feature must be purchased before you turn the feature on with the `chg-feat` command. If you are not sure if you have purchased the NCR feature, contact your Sales Representative or Account Representative.

When this command has successfully completed, this message should appear.

```
rlghncxa03w 06-10-10 11:43:04 GMT EAGLE5 38.0.0
CHG-FEAT: MASP A - COMPLTD
```

11. Change the NCAI value for the cluster point code from no to yes by entering the `chg-dstn` command with the cluster point code and the `ncai=yes` parameter. For this example, enter this command.

```
chg-dstn:dpca=010-010-*:ncai=yes.
```

When this command has successfully completed, this message should appear.

```
rlghncxa03w 08-02-11 15:35:05 GMT EAGLE5 38.0.0
DESTINATION ENTRIES ALLOCATED:    2000
  FULL DPC(s):                    20
  EXCEPTION DPC(s):                12
  NETWORK DPC(s):                  0
  CLUSTER DPC(s):                  1
  TOTAL DPC(s):                    33
  CAPACITY (% FULL):               1%
ALIASES ALLOCATED:                12000
  ALIASES USED:                    0
  CAPACITY (% FULL):               0%
X-LIST ENTRIES ALLOCATED:         500
CHG-DSTN: MASP A - COMPLTD
```

Note: If the `opc/opca` parameter will not be specified with the `ent-rtx` command, continue the procedure with [12](#).

12. The `opc/opca` value of the exception route can be specified with the network cluster and network cluster member values of the point code as asterisks (*).

If the network cluster and network cluster member values of the `opc/opca` value will not be specified as asterisks, continue the procedure by performing one of the steps shown at the end of this step.

If the network cluster and network cluster member values of the `opc/opca` value will be specified as asterisks, and the network indicator value of the `opc/opca` value is 6 or greater, continue the procedure by performing one of the steps shown at the end of this step.

If the network cluster and network cluster member values of the `opc/opca` value will be specified as asterisks, and the network indicator value of the `opc/opca` value will be 1 through 5, the `PCTYPE` value shown in the `rtrv-sid` output must be OTHER. Enter the `rtrv-sid` command to verify the `PCTYPE` value.

This is an example of the possible output.

```
rlghncxa03w 06-10-10 11:43:04 GMT EAGLE5 38.0.0
```

PCA	PCI	PCN	CLLI	PCTYPE
001-001-001	1-001-1	00001	rlghncxa03w	OTHER
CPCA				
002-002-004	002-002-005	002-002-006	002-002-007	
002-002-008	002-002-009	004-002-001	004-003-003	
050-060-070				
CPCI				
1-001-2	1-001-3	1-001-4	1-002-1	
1-002-2	1-002-3	1-002-4	2-001-1	
7-222-7				
CPCN				
00050	00060	00070	00100	
00080	00090			

If the PCTYPE value shown in the `rtrv-sid` output is OTHER, continue the procedure by performing one of the steps shown at the end of this step.

If the PCTYPE value shown in the `rtrv-sid` output is ANSI, Change the PCTYPE value of the self-identification of the EAGLE to OTHER by performing the [Changing the Self-Identification of the EAGLE](#) procedure. After the PCTYPE value is changed, continue the procedure by performing one of the steps shown at the end of this step.

Continue the procedure by performing one of these steps.

- If no more than two entries in the exception route will contain the same exception route criteria, except for the linkset name, continue the procedure with [14](#).
- If more than two entries in the exception route will contain the same exception route criteria, except for the linkset name, continue the procedure by performing one of these steps.
 - If more than two entries in an exception route that contain the same exception route criteria, except for the linkset name, are shown in the `rtrv-rtx` command in [1](#), continue the procedure with [14](#).
 - If more than two entries in an exception route that contain the same exception route criteria, except for the linkset name, are not shown in the `rtrv-rtx` command in [1](#), continue the procedure with [13](#).

- 13.** For an exception route to have more than two entries with the same exception route criteria, except for the linkset name (the `lsn` parameter value), the 6-Way Loadsharing on Routesets feature must be enabled and turned on.

To verify the status of the 6-Way Loadsharing on Routesets feature, enter this command.

```
rtrv-ctrl-feat:partnum=893019801
```

The following is an example of the possible output.

```
rlghncxa03w 09-05-28 21:15:37 GMT EAGLE5 41.0.0
```

```
The following features have been permanently enabled:
```

```

Feature Name          Partnum   Status  Quantity
6-Way LS on Routesets  893019801  on      ----
    
```

The following features have been temporarily enabled:

```

Feature Name          Partnum   Status  Quantity  Trial Period Left
Zero entries found.
    
```

The following features have expired temporary keys:

```

Feature Name          Partnum
Zero entries found.
    
```

If the 6-Way Loadsharing on Routesets feature is not enabled or not turned on, perform the [Activating the 6-Way Loadsharing on Routesets Feature](#) procedure to enable and turn on the 6-Way Loadsharing on Routesets feature.

After the 6-Way Loadsharing on Routesets feature has been enabled and turned on, or if the `rtrv-ctrl-feat` output shows that the 6-Way Loadsharing on Routesets feature is enabled and turned on, continue this procedure with 14.

14. Add the exception route entry by entering the `ent-rtx` command and specifying the parameter combinations shown in [Table 3-27](#) for the exception route criteria being assigned to the exception route.

Table 3-27 Add Exception Route Parameter Combinations

OPC- Based Exception Lists	ILSN- Based Exception Lists	SI- Based Exception Lists	Single CIC- Based Exception Lists	Range of CICs- Based Exception Lists
:dpc/dpca/ dpci/dpcn/ dpcn24 = DPC of the exception route shown in the <code>rtrv-rtx</code> or <code>rtrv-rte</code> outputs (See Notes 1, 2, 3, and 5)	:dpc/dpca/ dpci/dpcn/ dpcn24 = DPC of the exception route shown in the <code>rtrv-rtx</code> or <code>rtrv-rte</code> outputs (See Notes 1, 2, and 3)	:dpc/dpca/ dpci/dpcn/ dpcn24 = DPC of the exception route shown in the <code>rtrv-rtx</code> or <code>rtrv-rte</code> outputs (See Notes 1, 2, and 3)	:dpc/dpca/ dpci/dpcn/ dpcn24 = DPC of the exception route shown in the <code>rtrv-rtx</code> or <code>rtrv-rte</code> outputs (See Notes 1, 2, and 3)	:dpc/dpca/ dpci/dpcn/ dpcn24 = DPC of the exception route shown in the <code>rtrv-rtx</code> or <code>rtrv-rte</code> outputs (See Notes 1, 2, and 3)
:opc/opca/ opci/opcn/ opcn24 = OPC value of the exception route (See Notes 5, 6, and 9)	:ilsn = incoming linkset name shown in the <code>rtrv-ls</code> output (See Notes 4 and 6)	:si = service indicator, 3 - 15	:cic = circuit identification code, 0 - 16383 (See Note 8)	:cic = the circuit identification code value beginning a range of CICs , 0 - 16383 (See Note 8)
:lsn = linkset name shown in the <code>rtrv-ls</code> output (See Notes 4 and 6)	:lsn = linkset name shown in the <code>rtrv-ls</code> output (See Notes 5, 6, and 9)	:lsn = linkset name shown in the <code>rtrv-ls</code> output (See Note 4)	:lsn = linkset name shown in the <code>rtrv-ls</code> output (See Note 4)	:ecic = the circuit identification code value ending a range of CICs , 0 - 16383 (See Notes 7 and 8)

Table 3-27 (Cont.) Add Exception Route Parameter Combinations

OPC- Based Exception Lists	ILSN- Based Exception Lists	SI- Based Exception Lists	Single CIC- Based Exception Lists	Range of CICs- Based Exception Lists
:rc = 0 - 99	:rc = 0 - 99	:rc = 0 - 99	:rc = 0 - 99	:lsn = linkset name shown in the <code>rtrv-ls</code> output (See Note 4)
:force=yes (See Note 6)	:force=yes (See Note 6)			:rc = 0 - 99

Notes:

1. The DPC of an exception route entry can contain only a maximum of two entries with the same RC value and with either the same OPC value, the same ILSN value, the same SI value, the same CIC value, or range of CIC values if the 6-Way Loadsharing on Routesets feature is not enabled or turned on. If the 6-Way Loadsharing on Routesets feature is enabled and turned on, the DPC of an exception route entry can contain more than two entries with the same RC value and with either the same OPC value, the same ILSN value, the same SI value, the same CIC value, or range of CIC values, the LSN value for each entry must be different.
2. Each DPC can contain a maximum of six entries with either the same OPC value, the same ILSN value, the same SI value, or the same range of CIC values. The LSN value for each entry must be different. If the 6-Way Loadsharing on Routesets feature is not enabled or turned on, the DPC of a route exception entry can contain only one entry with a single CIC value. If the 6-Way Loadsharing on Routesets feature is enabled and turned on, the DPC of a route exception entry can contain more than one entry with a single CIC value.
4. The linksets specified in this step must meet the criteria shown in the ["Adding Linksets for Exception Routes"](#) section.
5. The DPC value cannot be the same as the OPC value.
6. The `force=yes` parameter must be used if the LSN and ILSN values are the same, or if the OPC value is the same as the APC of the linkset specified by the `lsn` parameter.
7. The `ecic` parameter value must be greater than the `cic` parameter value.
8. The range of CIC values cannot overlap an existing range of CIC values. A single CIC value cannot be within a range of CIC values provisioned for another exception route entry. The `cic` or `ecic` values cannot be the same as any single CIC values provisioned for another exception route entry.
9. Asterisks can be used as the values for the network cluster and network cluster member portions of an ANSI point code value for the `opc/opca` parameter. For example, the `opc/opca` value could be `004-004-*` or `007-*-*`. An `opc/opca` value containing all asterisks (`*-*`) is not allowed.

For this example, enter these commands.

```
ent-rtx:dpca=006-006-006:opca=125-150-175:lsn=lsn11:rc=10
ent-rtx:dpca=006-006-006:opci=2-103-1:lsn=lsn11:rc=20
ent-rtx:dpca=006-006-006:ilsn=lsn12:lsn=lsn11:rc=11
ent-rtx:dpca=006-006-006:ilsn=lsn13:lsn=lsn11:rc=12
ent-rtx:dpca=006-006-006:si=5:lsn=lsn12:rc=10
ent-rtx:dpca=006-006-006:cic=250:lsn=lsn12:rc=15
ent-rtx:dpca=006-006-006:cic=300:ecic=500:lsn=lsn12:rc=25
```

```

ent-rtx:dpci=3-025-6:opca=135-102-089:lsn=lsn13:rc=10
ent-rtx:dpci=3-025-6:opci=4-054-0:lsn=lsn13:rc=15
ent-rtx:dpci=3-025-6:opcn=00503:lsn=lsn13:rc=45
ent-rtx:dpci=3-025-6:ilsn=lsn2:lsn=lsn14:rc=20
ent-rtx:dpci=3-025-6:ilsn=lsn4:lsn=lsn13:rc=25
ent-rtx:dpci=3-025-6:ilsn=lsn16:lsn=lsn16:rc=50:force=yes
ent-rtx:dpci=3-025-6:si=3:lsn=lsn13:rc=30
ent-rtx:dpci=3-025-6:cic=100:lsn=lsn14:rc=35
ent-rtx:dpci=3-025-6:cic=50:ecic=75:lsn=lsn13:rc=40
ent-rtx:dpcn=09852:opca=127-063-048:lsn=lsn15:rc=10
ent-rtx:dpcn=09852:opci=3-037-1:lsn=lsn16:rc=15
ent-rtx:dpcn=09852:opcn=00409:lsn=lsn13:rc=20
ent-rtx:dpcn=09852:ilsn=lsn13:lsn=lsn15:rc=25
ent-rtx:dpcn=09852:ilsn=lsn4:lsn=lsn16:rc=30
ent-rtx:dpcn=09852:si=4:lsn=lsn15:rc=35
ent-rtx:dpcn=09852:cic=1000:lsn=lsn16:rc=40
ent-rtx:dpcn=09852:cic=2000:ecic=3000:lsn=lsn15:rc=45

```

When each of these commands have successfully completed, this message should appear.

```

rlghncxa03w 08-02-11 08:28:30 GMT EAGLE5 38.0.0
ENT-RTX: MASP A - COMPLTD

```

15. Verify the changes using the `rtrv-rtx` command, specifying these parameters depending on the exception route criteria specified in 14.

- If the `opc/opca/opci/opcn/opcn24` parameter was specified in 14 - enter these parameters and values specified in 14 with the `rtrv-rtx` command - `dpc/dpca/dpci/dpcn/dpcn24`, `opc/opca/opci/opcn/opcn24`, and `lsn`.
- If the `ilsn` parameter was specified in 14 - enter these parameters and values specified in 14 with the `rtrv-rtx` command - `dpc/dpca/dpci/dpcn/dpcn24`, `ilsn`, and `lsn`.
- If the `si` parameter was specified in 14 - enter these parameters and values specified in 14 with the `rtrv-rtx` command - `dpc/dpca/dpci/dpcn/dpcn24`, `si`, and `lsn`.
- If only the `cic` parameter was specified in 14 - enter these parameters and values specified in 14 with the `rtrv-rtx` command - `dpc/dpca/dpci/dpcn/dpcn24`, `cic`, and `lsn`.
- If the `cic` and `ecic` parameters were specified in 14 - enter these parameters and values specified in 14 with the `rtrv-rtx` command - `dpc/dpca/dpci/dpcn/dpcn24`, `cic`, `ecic`, and `lsn`.

For this example, enter these commands.

```
rtrv-rtx:dpca=006-006-006:opca=125-150-175:lsn=lsn11
```


rlghncxa03w 08-02-11 08:28:30 GMT EAGLE5 38.0.0

DPCA	RTX-CRITERIA	LSN	RC	APC
006-006-006	OPCA 125-150-175	lsn11	10	004-004-004

DESTINATION ENTRIES ALLOCATED: 2000
 FULL DPC(s): 20
 EXCEPTION DPC(s): 36
 TOTAL DPC(s): 56
 CAPACITY (% FULL): 3%
 ALIASES ALLOCATED: 12000
 ALIASES USED: 0
 CAPACITY (% FULL): 0%

rtrv-rtx:dpca=006-006-006:opci=2-103-1:lsn=lsn11

rlghncxa03w 08-02-11 08:28:30 GMT EAGLE5 38.0.0

DPCA	RTX-CRITERIA	LSN	RC	APC
006-006-006	OPCI 2-103-1	lsn11	20	004-004-004

DESTINATION ENTRIES ALLOCATED: 2000
 FULL DPC(s): 20
 EXCEPTION DPC(s): 36
 TOTAL DPC(s): 56
 CAPACITY (% FULL): 3%
 ALIASES ALLOCATED: 12000
 ALIASES USED: 0
 CAPACITY (% FULL): 0%

rtrv-rtx:dpca=006-006-006:ilsn=lsn12:lsn=lsn11

rlghncxa03w 08-02-11 08:28:30 GMT EAGLE5 38.0.0

DPCA	RTX-CRITERIA	LSN	RC	APC
006-006-006	ILSN lsn12	lsn11	11	004-004-004

DESTINATION ENTRIES ALLOCATED: 2000
 FULL DPC(s): 20
 EXCEPTION DPC(s): 36
 TOTAL DPC(s): 56
 CAPACITY (% FULL): 3%
 ALIASES ALLOCATED: 12000
 ALIASES USED: 0
 CAPACITY (% FULL): 0%

rtrv-rtx:dpca=006-006-006:ilsn=lsn13:lsn=lsn11

rlghncxa03w 08-02-11 08:28:30 GMT EAGLE5 38.0.0

DPCA	RTX-CRITERIA	LSN	RC	APC
------	--------------	-----	----	-----

```
006-006-006 ILSN
                lsn13                lsn11    12    004-004-004
```

```
DESTINATION ENTRIES ALLOCATED: 2000
FULL DPC(s):                    20
EXCEPTION DPC(s):               36
TOTAL DPC(s):                   56
CAPACITY (% FULL):              3%
ALIASES ALLOCATED:              12000
ALIASES USED:                   0
CAPACITY (% FULL):              0%
```

```
rtrv-rtx:dpca=006-006-006:si=5:lsn=lsn12
```

```
rlghncxa03w 08-02-11 08:28:30 GMT EAGLE5 38.0.0
```

```
DPCA          RTX-CRITERIA          LSN      RC      APC
006-006-006  SI
                5                    lsn12    10     005-005-005
```

```
DESTINATION ENTRIES ALLOCATED: 2000
FULL DPC(s):                    20
EXCEPTION DPC(s):               36
TOTAL DPC(s):                   56
CAPACITY (% FULL):              3%
ALIASES ALLOCATED:              12000
ALIASES USED:                   0
CAPACITY (% FULL):              0%
```

```
rtrv-rtx:dpca=006-006-006:cic=250:lsn=lsn12
```

```
rlghncxa03w 08-02-11 08:28:30 GMT EAGLE5 38.0.0
```

```
DPCA          RTX-CRITERIA          LSN      RC      APC
006-006-006  CIC - ECIC
                250  250            lsn12    15     005-005-005
```

```
DESTINATION ENTRIES ALLOCATED: 2000
FULL DPC(s):                    20
EXCEPTION DPC(s):               36
TOTAL DPC(s):                   56
CAPACITY (% FULL):              3%
ALIASES ALLOCATED:              12000
ALIASES USED:                   0
CAPACITY (% FULL):              0%
```

```
rtrv-rtx:dpca=006-006-006:cic=300:ecic=500:lsn=lsn12
```

```
rlghncxa03w 08-02-11 08:28:30 GMT EAGLE5 38.0.0
```

```
DPCA          RTX-CRITERIA          LSN      RC      APC
006-006-006  CIC - ECIC
                250  250            lsn12    15     005-005-005
```

```
DESTINATION ENTRIES ALLOCATED: 2000
FULL DPC(s):                    20
```

```

EXCEPTION DPC(s):          36
TOTAL DPC(s):             56
CAPACITY (% FULL):        3%
ALIASES ALLOCATED:        12000
ALIASES USED:              0
CAPACITY (% FULL):        0%
    
```

rtrv-rtx:dpci=3-025-6:opca=135-102-089:lsn=lsn13

rlghncxa03w 08-02-11 08:28:30 GMT EAGLE5 38.0.0

DPCI	RTX-CRITERIA	LSN	RC	APC
3-025-6	OPCA 135-102-089	lsn13	10	1-100-5

```

DESTINATION ENTRIES ALLOCATED:  2000
FULL DPC(s):                    20
EXCEPTION DPC(s):                36
TOTAL DPC(s):                    56
CAPACITY (% FULL):                3%
ALIASES ALLOCATED:                12000
ALIASES USED:                      0
CAPACITY (% FULL):                0%
    
```

rtrv-rtx:dpci=3-025-6:opci=4-054-0:lsn=lsn13

rlghncxa03w 08-02-11 08:28:30 GMT EAGLE5 38.0.0

DPCI	RTX-CRITERIA	LSN	RC	APC
3-025-6	OPCI 4-054-0	lsn13	15	1-100-5

```

DESTINATION ENTRIES ALLOCATED:  2000
FULL DPC(s):                    20
EXCEPTION DPC(s):                36
TOTAL DPC(s):                    56
CAPACITY (% FULL):                3%
ALIASES ALLOCATED:                12000
ALIASES USED:                      0
CAPACITY (% FULL):                0%
    
```

rtrv-rtx:dpci=3-025-6:opcn=00503:lsn=lsn13

rlghncxa03w 08-02-11 08:28:30 GMT EAGLE5 38.0.0

DPCI	RTX-CRITERIA	LSN	RC	APC
3-025-6	OPCN 00503	lsn11	15	1-100-5

```

DESTINATION ENTRIES ALLOCATED:  2000
FULL DPC(s):                    20
EXCEPTION DPC(s):                36
TOTAL DPC(s):                    56
CAPACITY (% FULL):                3%
ALIASES ALLOCATED:                12000
    
```

ALIASES USED: 0
 CAPACITY (% FULL): 0%

rtrv-rtx:dpci=3-025-6:ilsn=lsn2:lsn=lsn14

rlghncxa03w 08-02-11 08:28:30 GMT EAGLE5 38.0.0

DPCI	RTX-CRITERIA	LSN	RC	APC
3-025-6	ILSN lsn2	lsn14	45	4-139-4

DESTINATION ENTRIES ALLOCATED: 2000
 FULL DPC(s): 20
 EXCEPTION DPC(s): 36
 TOTAL DPC(s): 56
 CAPACITY (% FULL): 3%
 ALIASES ALLOCATED: 12000
 ALIASES USED: 0
 CAPACITY (% FULL): 0%

rtrv-rtx:dpci=3-025-6:ilsn=lsn4:lsn=lsn13

rlghncxa03w 08-02-11 08:28:30 GMT EAGLE5 38.0.0

DPCI	RTX-CRITERIA	LSN	RC	APC
3-025-6	ILSN lsn4	lsn13	25	1-100-5

DESTINATION ENTRIES ALLOCATED: 2000
 FULL DPC(s): 20
 EXCEPTION DPC(s): 36
 TOTAL DPC(s): 56
 CAPACITY (% FULL): 3%
 ALIASES ALLOCATED: 12000
 ALIASES USED: 0
 CAPACITY (% FULL): 0%

rtrv-rtx:dpci=3-025-6:ilsn=lsn16:lsn=lsn16

rlghncxa03w 08-02-11 08:28:30 GMT EAGLE5 38.0.0

DPCI	RTX-CRITERIA	LSN	RC	APC
3-025-6	ILSN lsn16	lsn16	50	12567

DESTINATION ENTRIES ALLOCATED: 2000
 FULL DPC(s): 20
 EXCEPTION DPC(s): 36
 TOTAL DPC(s): 56
 CAPACITY (% FULL): 3%
 ALIASES ALLOCATED: 12000
 ALIASES USED: 0
 CAPACITY (% FULL): 0%

rtrv-rtx:dpci=3-025-6:si=3:lsn=lsn13

rlghncxa03w 08-02-11 08:28:30 GMT EAGLE5 38.0.0

DPCI	RTX-CRITERIA	LSN	RC	APC
3-025-6	SI 3	lsn13	30	1-100-5

DESTINATION ENTRIES ALLOCATED: 2000
 FULL DPC(s): 20
 EXCEPTION DPC(s): 36
 TOTAL DPC(s): 56
 CAPACITY (% FULL): 3%
 ALIASES ALLOCATED: 12000
 ALIASES USED: 0
 CAPACITY (% FULL): 0%

rtrv-rtx:dpci=3-025-6:cic=100:lsn=lsn14

rlghncxa03w 08-02-11 08:28:30 GMT EAGLE5 38.0.0

DPCI	RTX-CRITERIA	LSN	RC	APC
3-025-6	CIC - ECIC 100 100	lsn14	35	4-139-4

DESTINATION ENTRIES ALLOCATED: 2000
 FULL DPC(s): 20
 EXCEPTION DPC(s): 36
 TOTAL DPC(s): 56
 CAPACITY (% FULL): 3%
 ALIASES ALLOCATED: 12000
 ALIASES USED: 0
 CAPACITY (% FULL): 0%

rtrv-rtx:dpci=3-025-6:cic=50:ecic=75:lsn=lsn13

rlghncxa03w 08-02-11 08:28:30 GMT EAGLE5 38.0.0

DPCI	RTX-CRITERIA	LSN	RC	APC
3-025-6	CIC - ECIC 50 75	lsn13	40	1-100-5

DESTINATION ENTRIES ALLOCATED: 2000
 FULL DPC(s): 20
 EXCEPTION DPC(s): 36
 TOTAL DPC(s): 56
 CAPACITY (% FULL): 3%
 ALIASES ALLOCATED: 12000
 ALIASES USED: 0
 CAPACITY (% FULL): 0%

rtrv-rtx:dpcn=09852:opca=127-063-048:lsn=lsn15

rlghncxa03w 08-02-11 08:28:30 GMT EAGLE5 38.0.0

DPCN	RTX-CRITERIA	LSN	RC	APC
------	--------------	-----	----	-----

```

09852          OPCA
                127-063-048                lsn15    10    11302

DESTINATION ENTRIES ALLOCATED:  2000
FULL DPC(s):                    20
EXCEPTION DPC(s):               36
TOTAL DPC(s):                   56
CAPACITY (% FULL):              3%
ALIASES ALLOCATED:              12000
ALIASES USED:                   0
CAPACITY (% FULL):              0%
    
```

rtrv-rtx:dpcn=09852:opci=3-037-1:lsn=lsn16

rlghncxa03w 08-02-11 08:28:30 GMT EAGLE5 38.0.0

```

DPCN          RTX-CRITERIA                LSN      RC    APC

09852          OPCI
                3-037-1                lsn16    15    12567

DESTINATION ENTRIES ALLOCATED:  2000
FULL DPC(s):                    20
EXCEPTION DPC(s):               36
TOTAL DPC(s):                   56
CAPACITY (% FULL):              3%
ALIASES ALLOCATED:              12000
ALIASES USED:                   0
CAPACITY (% FULL):              0%
    
```

rtrv-rtx:dpcn=09852:opcn=00409:lsn=lsn13

rlghncxa03w 08-02-11 08:28:30 GMT EAGLE5 38.0.0

```

DPCN          RTX-CRITERIA                LSN      RC    APC

09852          OPCN
                00409                lsn13    20    1-100-5

DESTINATION ENTRIES ALLOCATED:  2000
FULL DPC(s):                    20
EXCEPTION DPC(s):               36
TOTAL DPC(s):                   56
CAPACITY (% FULL):              3%
ALIASES ALLOCATED:              12000
ALIASES USED:                   0
CAPACITY (% FULL):              0%
    
```

rtrv-rtx:dpcn=09852:ilsn=lsn13:lsn=lsn15

rlghncxa03w 08-02-11 08:28:30 GMT EAGLE5 38.0.0

```

DPCN          RTX-CRITERIA                LSN      RC    APC

09852          ILSN
                lsn13                lsn15    25    11302

DESTINATION ENTRIES ALLOCATED:  2000
FULL DPC(s):                    20
    
```

```

EXCEPTION DPC(s):          36
TOTAL DPC(s):             56
CAPACITY (% FULL):        3%
ALIASES ALLOCATED:        12000
ALIASES USED:              0
CAPACITY (% FULL):        0%
    
```

rtrv-rtx:dpcn=09852:ilsn=lsn4:lsn=lsn16

rlghncxa03w 08-02-11 08:28:30 GMT EAGLE5 38.0.0

DPCN	RTX-CRITERIA	LSN	RC	APC
09852	ILSN lsn4	lsn16	30	12567

```

DESTINATION ENTRIES ALLOCATED: 2000
FULL DPC(s):                    20
EXCEPTION DPC(s):                36
TOTAL DPC(s):                    56
CAPACITY (% FULL):                3%
ALIASES ALLOCATED:                12000
ALIASES USED:                      0
CAPACITY (% FULL):                0%
    
```

rtrv-rtx:dpcn=09852:si=4:lsn=lsn15

rlghncxa03w 08-02-11 08:28:30 GMT EAGLE5 38.0.0

DPCN	RTX-CRITERIA	LSN	RC	APC
09852	SI 4	lsn15	35	11302

```

DESTINATION ENTRIES ALLOCATED: 2000
FULL DPC(s):                    20
EXCEPTION DPC(s):                36
TOTAL DPC(s):                    56
CAPACITY (% FULL):                3%
ALIASES ALLOCATED:                12000
ALIASES USED:                      0
CAPACITY (% FULL):                0%
    
```

rtrv-rtx:dpcn=09852:cic=1000:lsn=lsn16

rlghncxa03w 08-02-11 08:28:30 GMT EAGLE5 38.0.0

DPCN	RTX-CRITERIA	LSN	RC	APC
09852	CIC - ECIC 1000	lsn16	40	12567

```

DESTINATION ENTRIES ALLOCATED: 2000
FULL DPC(s):                    20
EXCEPTION DPC(s):                36
TOTAL DPC(s):                    56
CAPACITY (% FULL):                3%
ALIASES ALLOCATED:                12000
    
```

```
ALIASES USED:          0
CAPACITY (% FULL):    0%
```

```
rtrv-rtx:dpcn=09852:cic=2000:ecic=3000:lsn=lsn15
```

```
rlghncxa03w 08-02-11 08:28:30 GMT EAGLE5 38.0.0
```

DPCN	RTX-CRITERIA	LSN	RC	APC
09852	CIC - ECIC 2000 3000	lsn15	45	11302

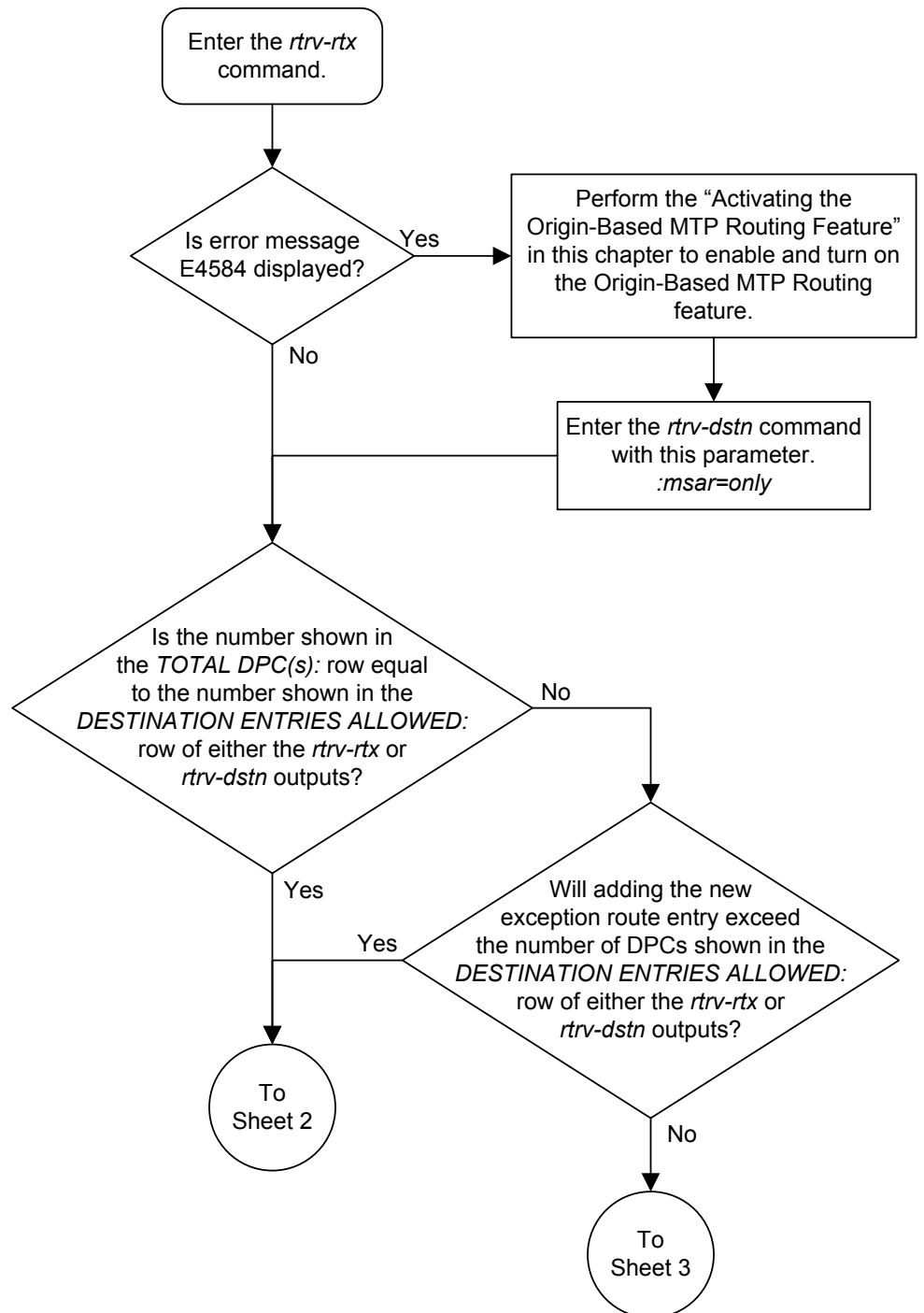
```
DESTINATION ENTRIES ALLOCATED: 2000
FULL DPC(s):                    20
EXCEPTION DPC(s):               36
TOTAL DPC(s):                   56
CAPACITY (% FULL):              3%
ALIASES ALLOCATED:              12000
ALIASES USED:                   0
CAPACITY (% FULL):              0%
```

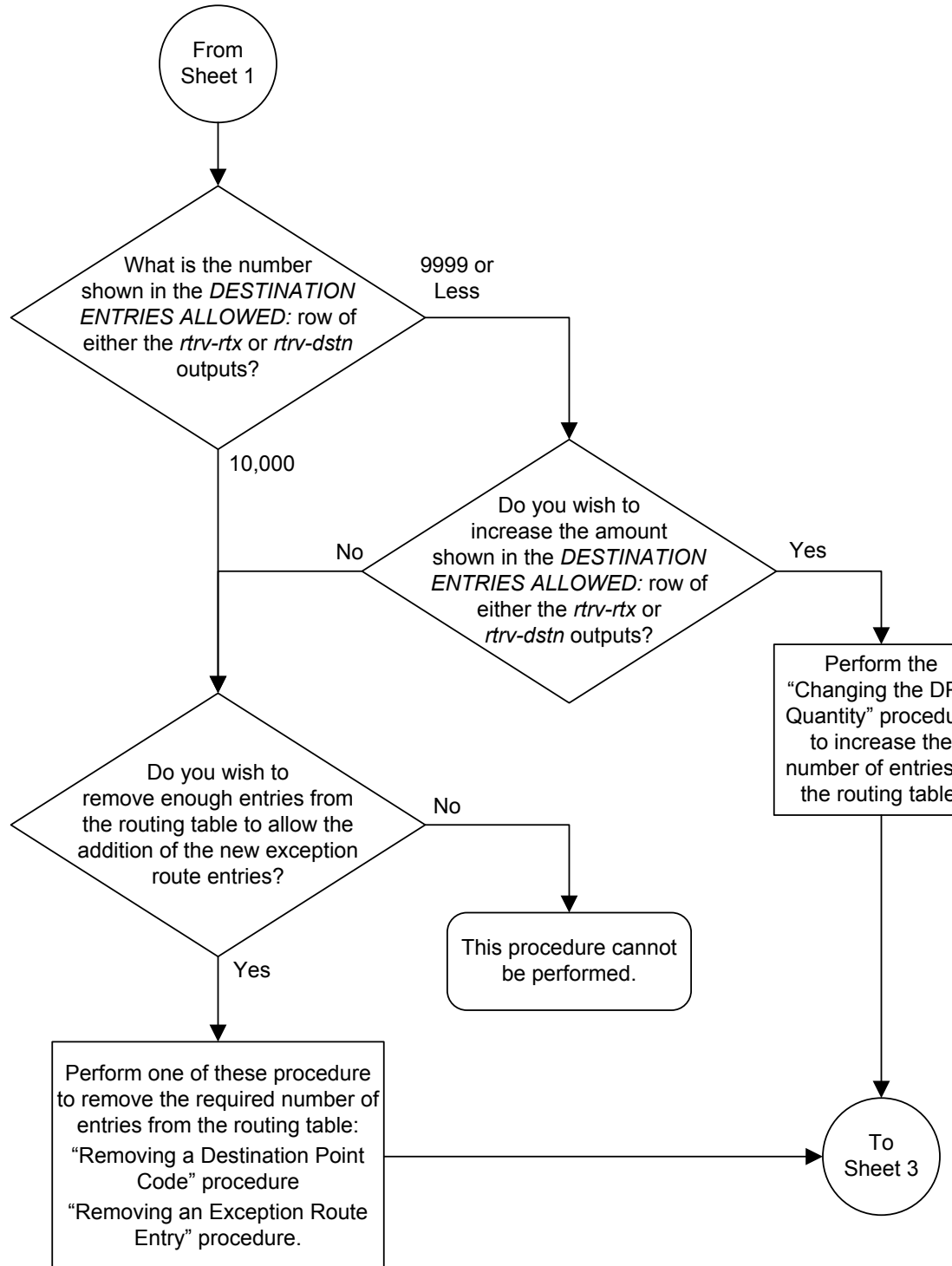
- Back up the new changes using the `chg-db:action=backup:dest=fixed` command.

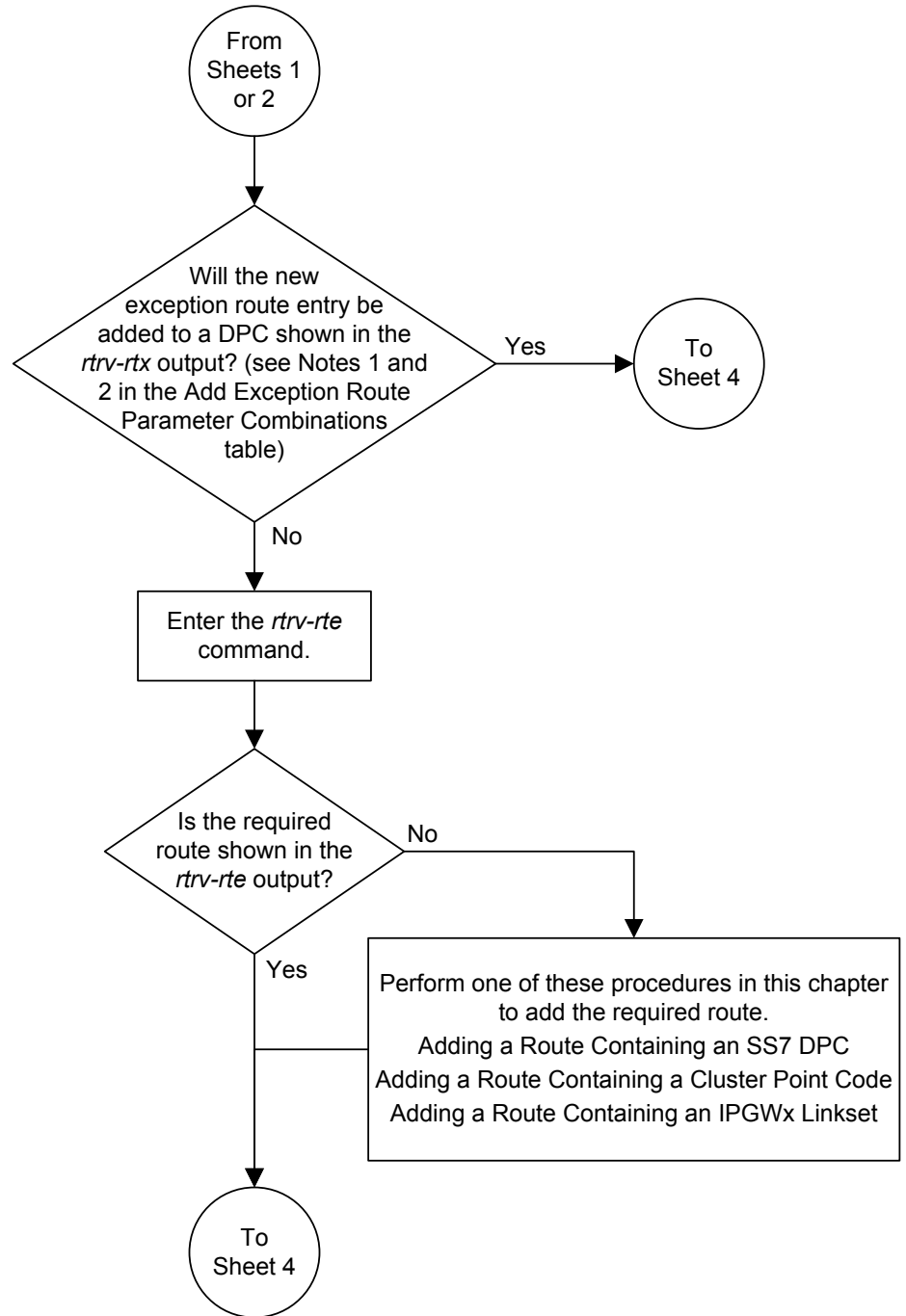
These messages should appear, the active **Maintenance and Administration Subsystem Processor (MASP)** appears first.

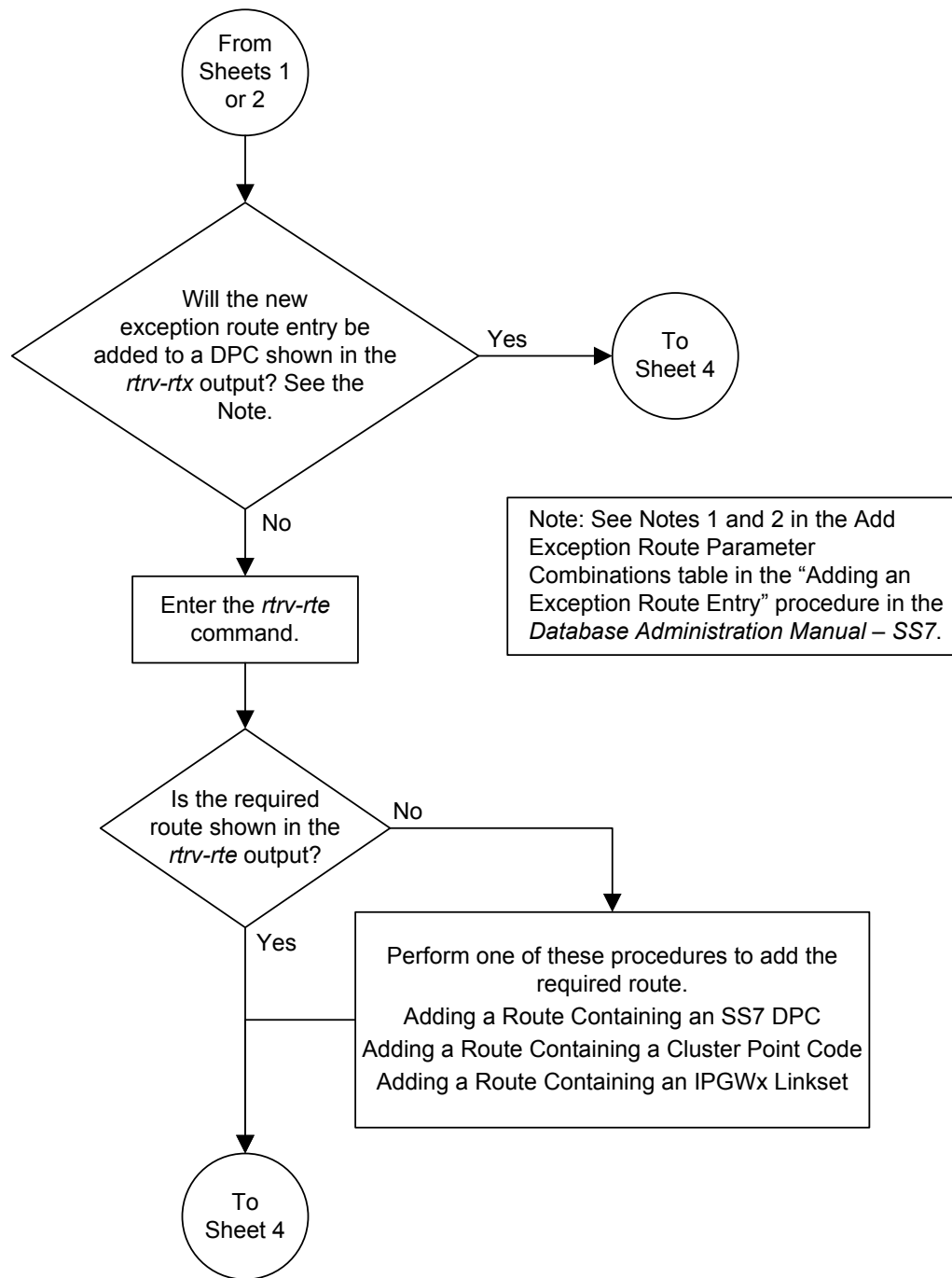
```
BACKUP (FIXED) : MASP A - Backup starts on active MASP.
BACKUP (FIXED) : MASP A - Backup on active MASP to fixed disk complete.
BACKUP (FIXED) : MASP A - Backup starts on standby MASP.
BACKUP (FIXED) : MASP A - Backup on standby MASP to fixed disk complete.
```


Figure 3-42 Adding an Exception Route Entry

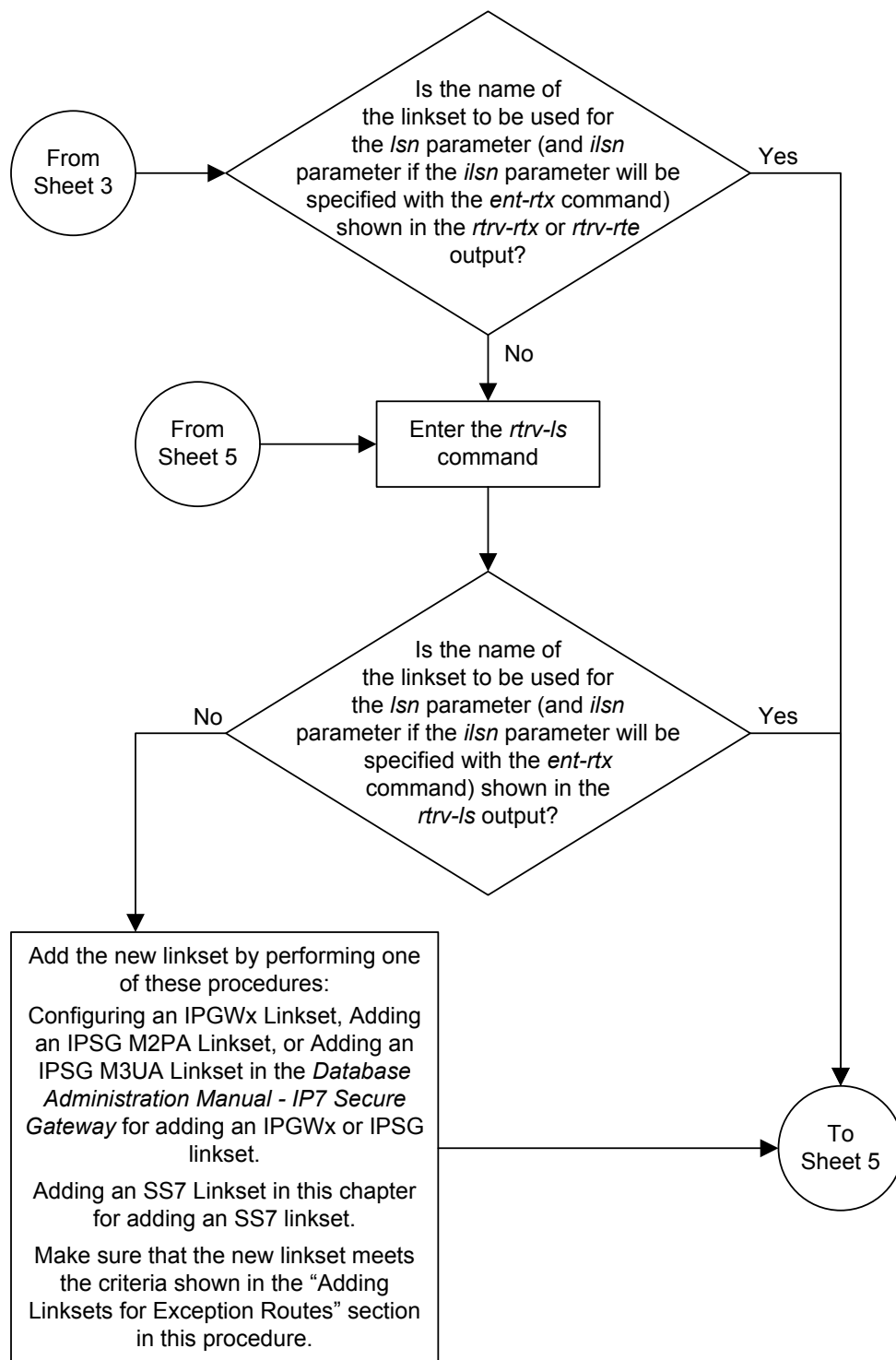


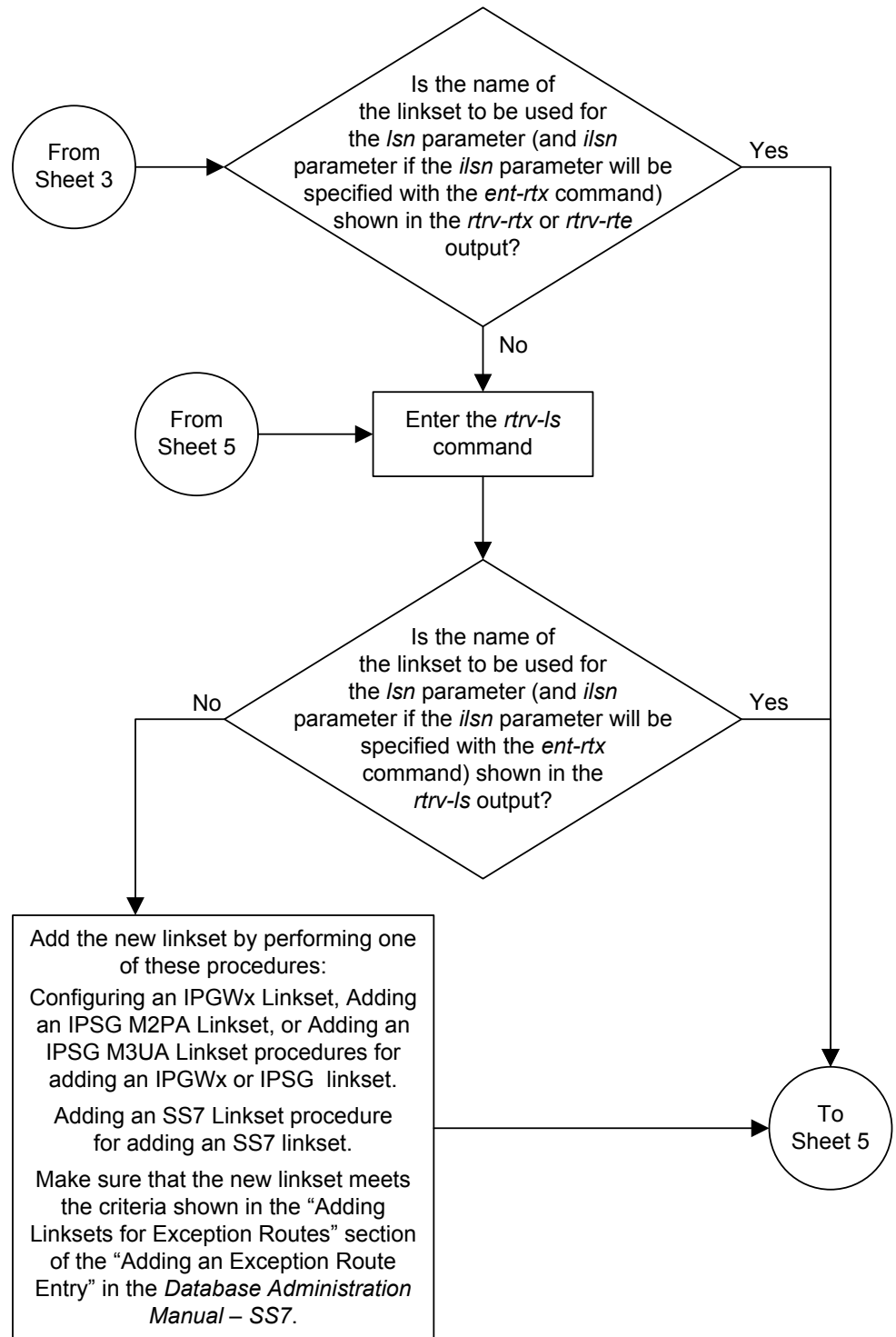


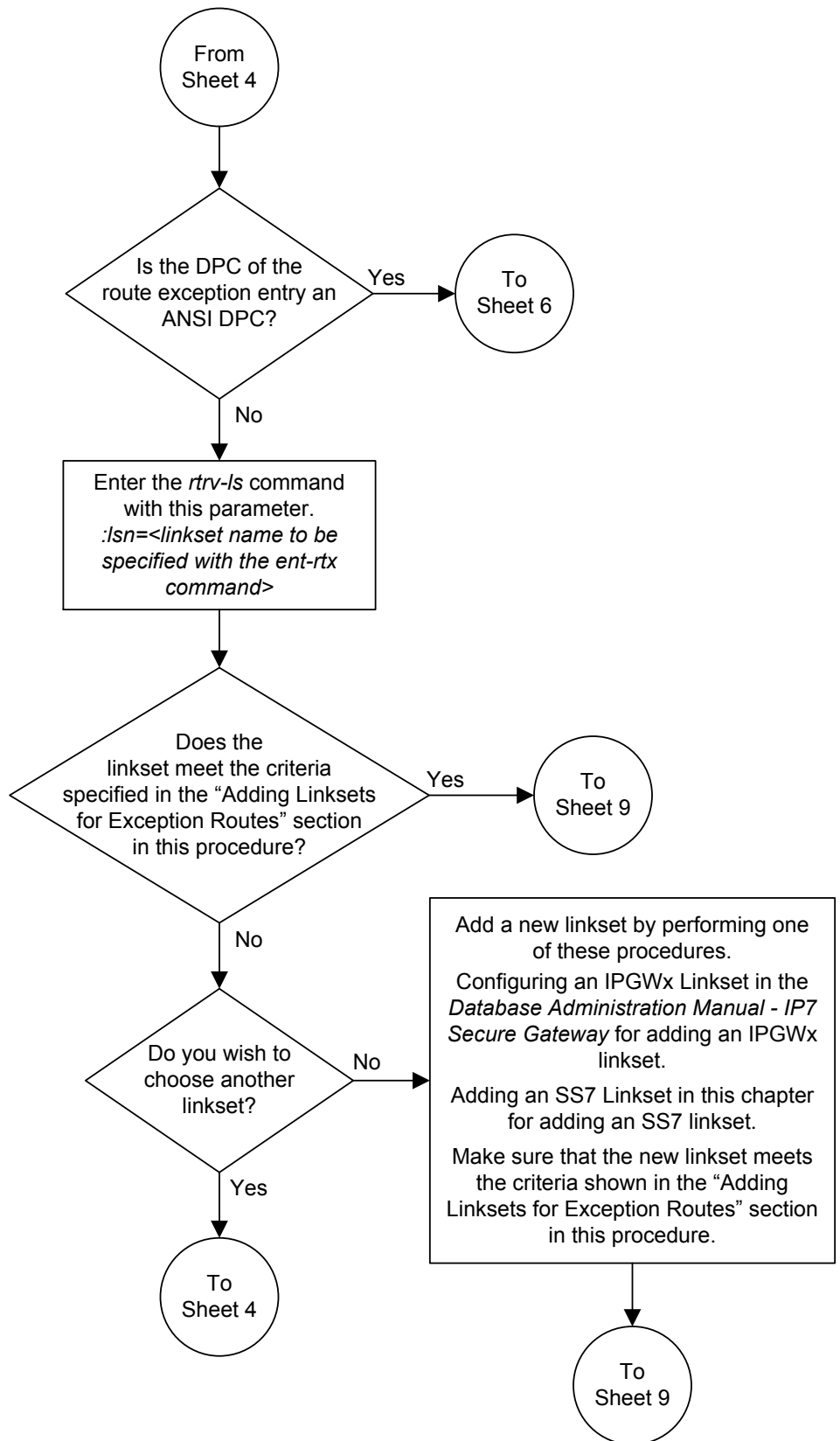


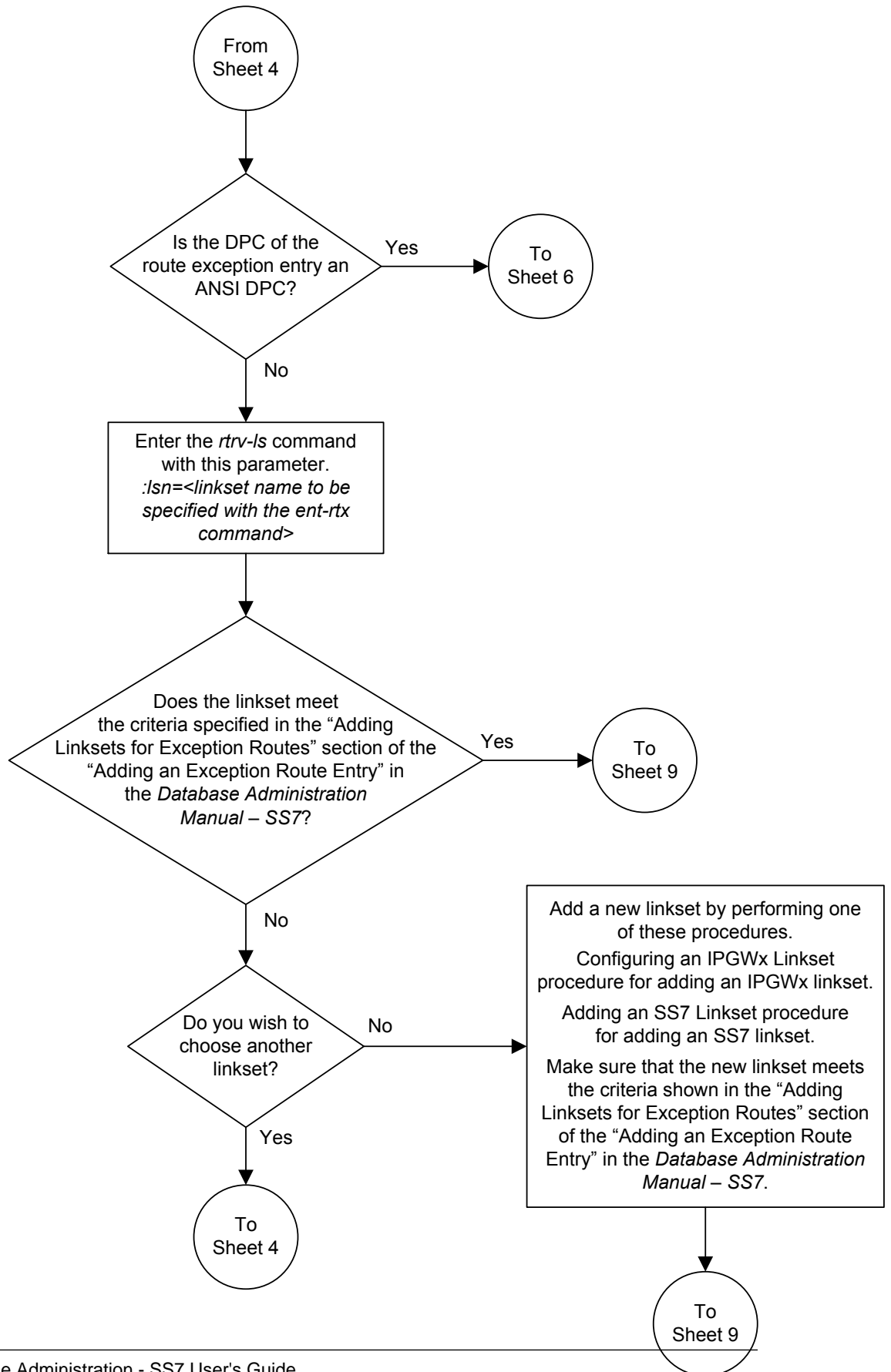


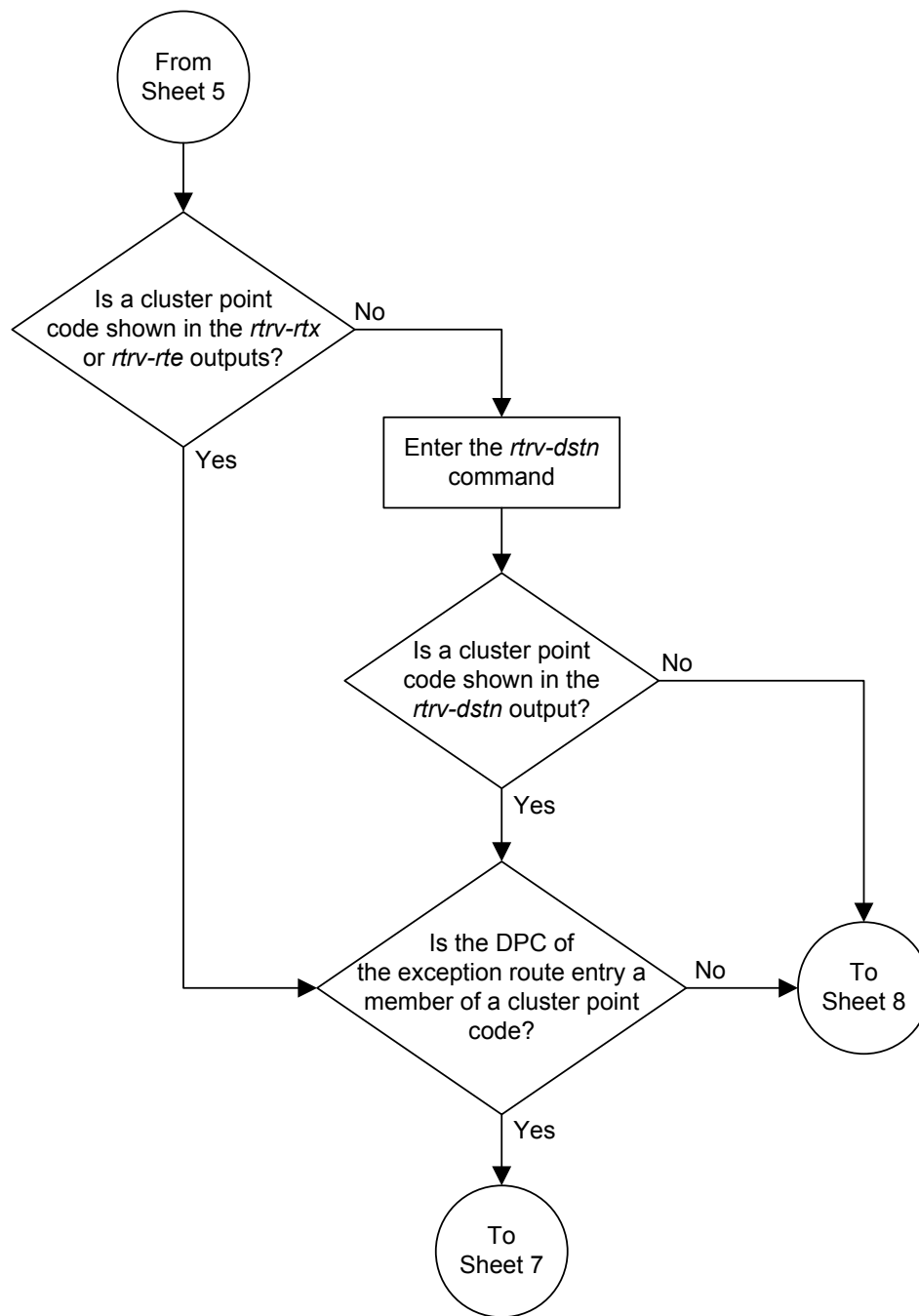
Sheet 3 of 10



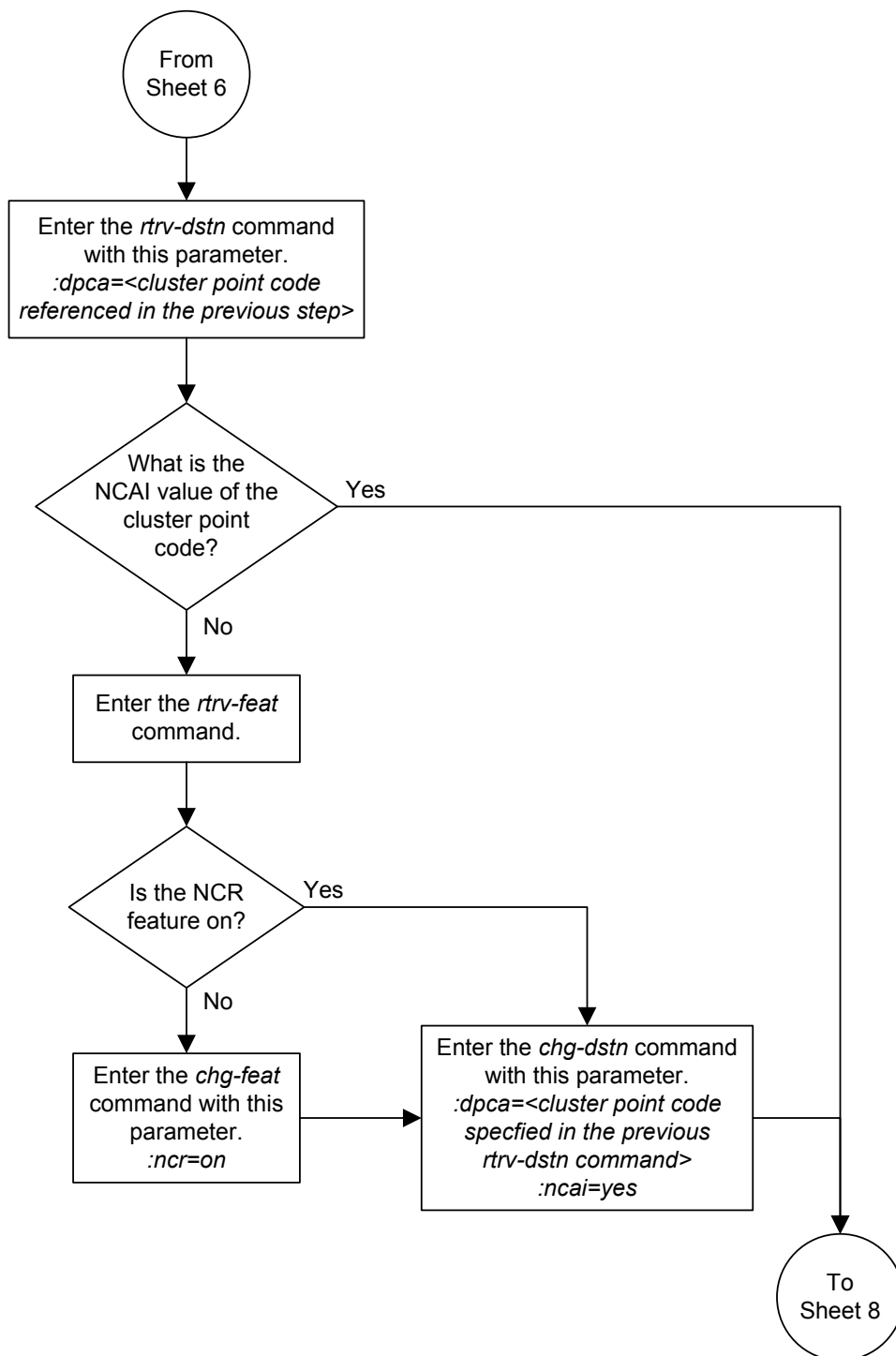


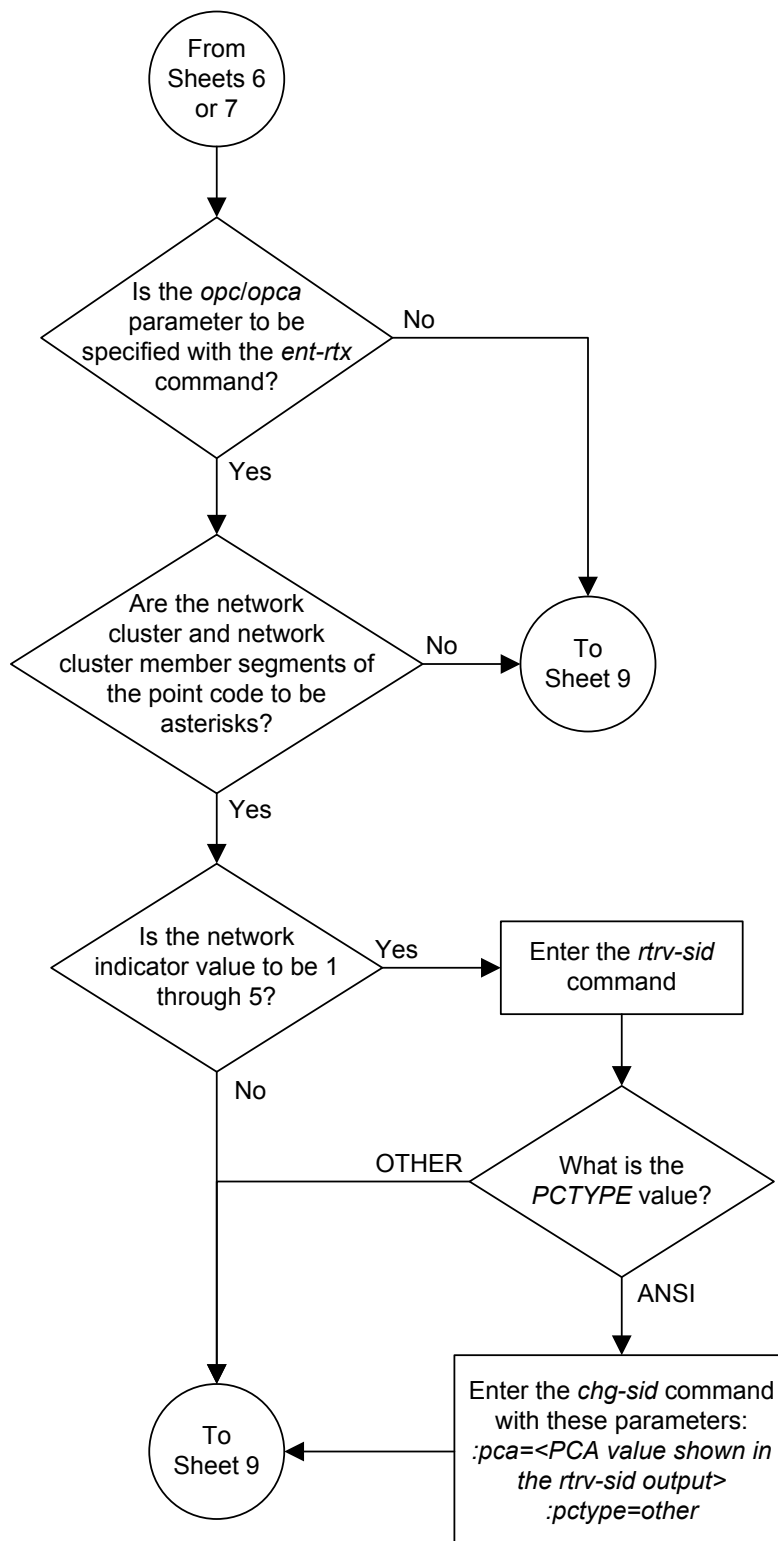


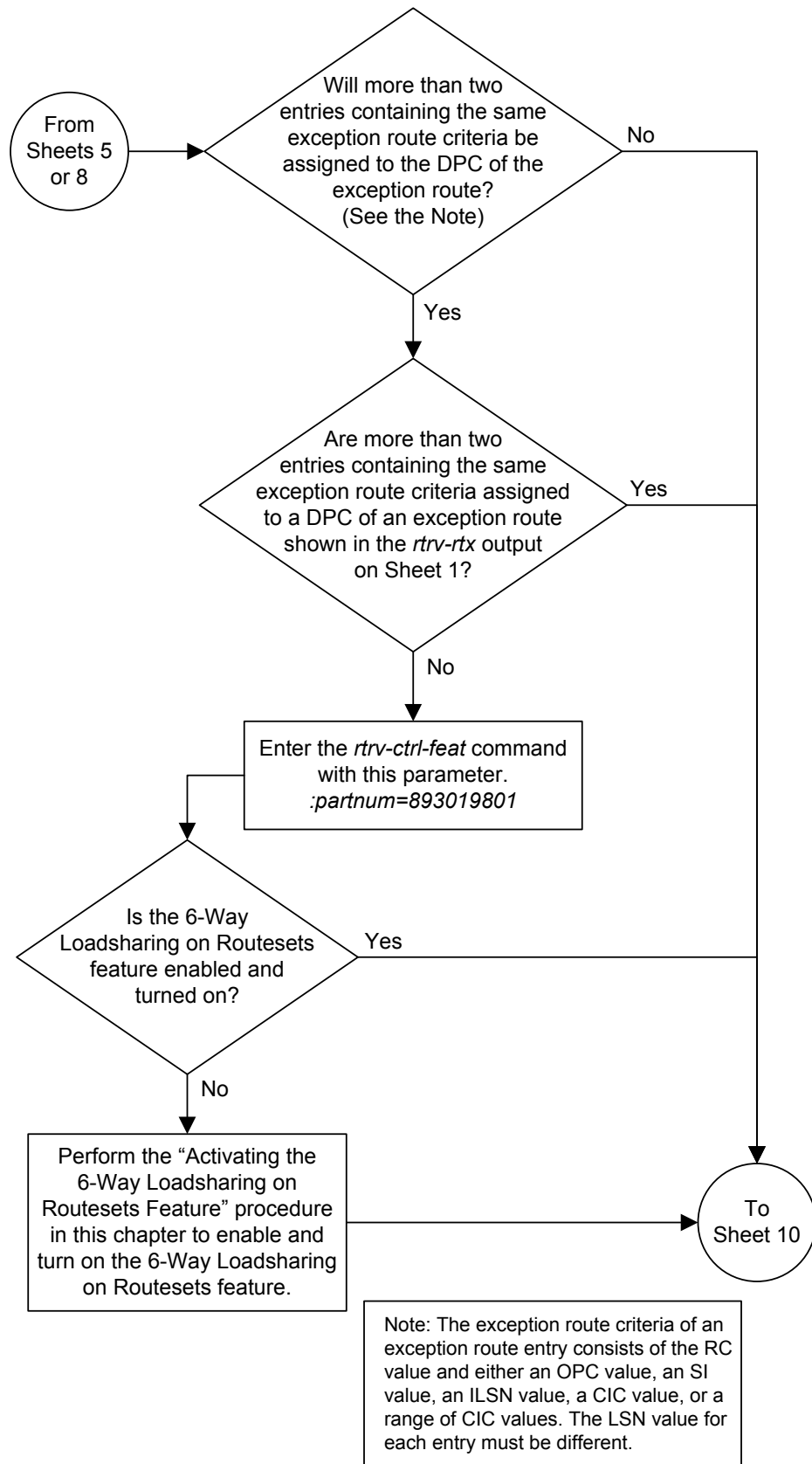


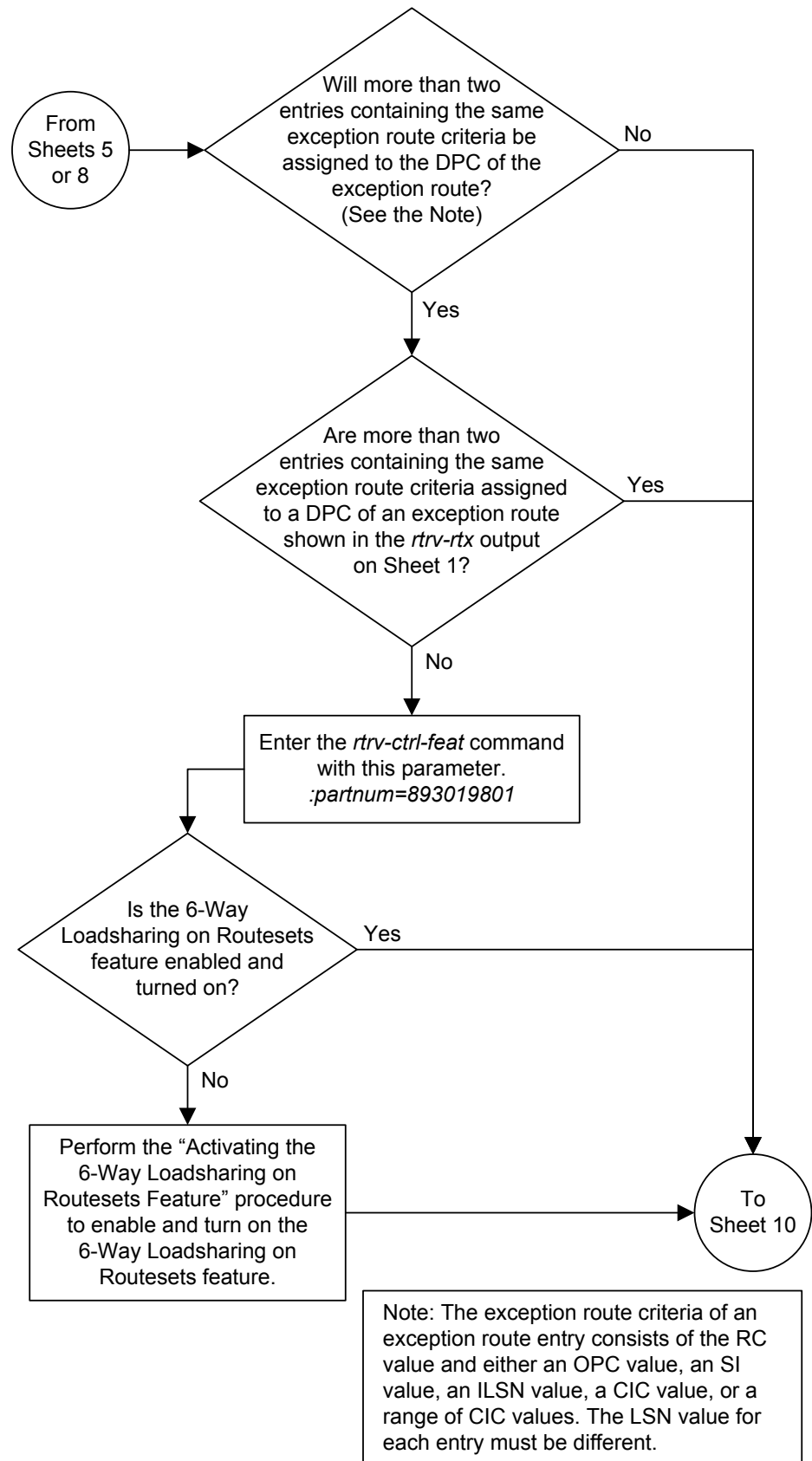


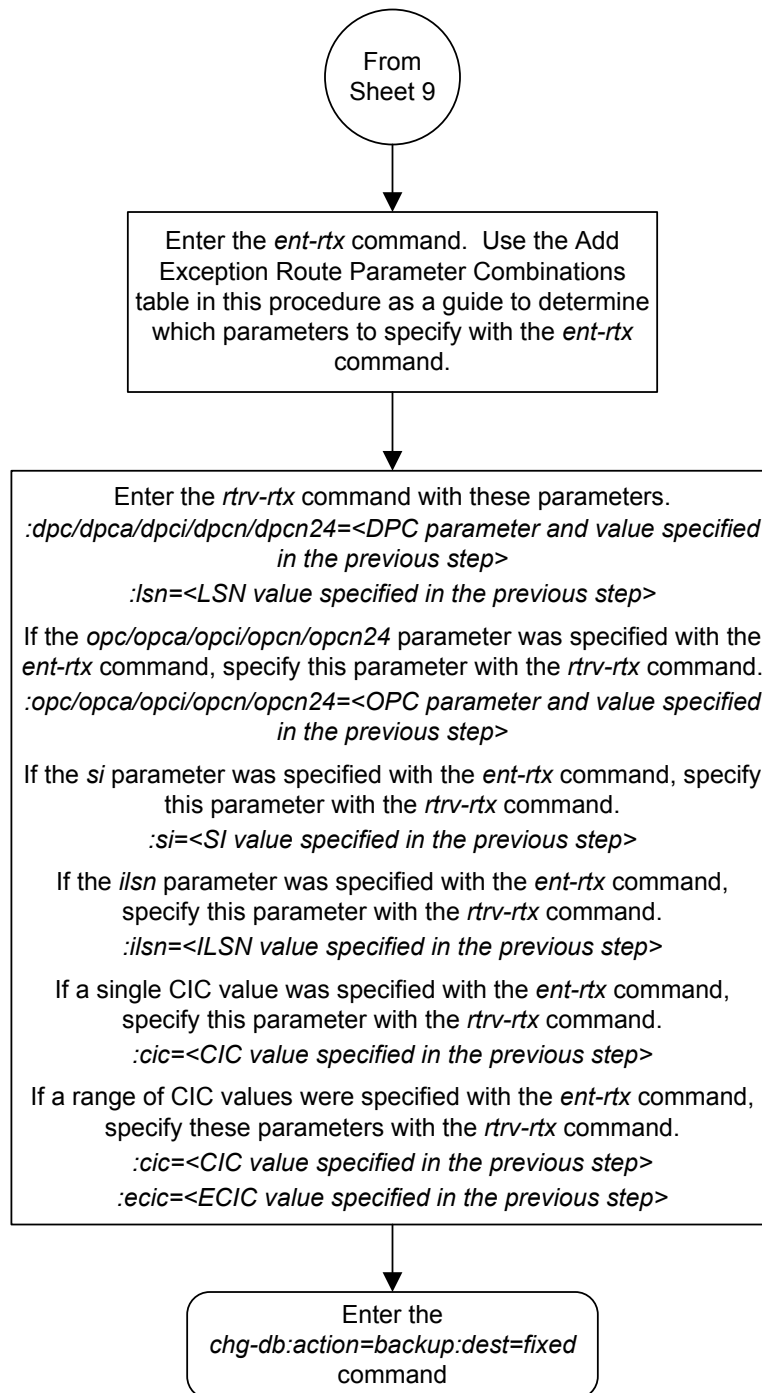
Sheet 6 of 10

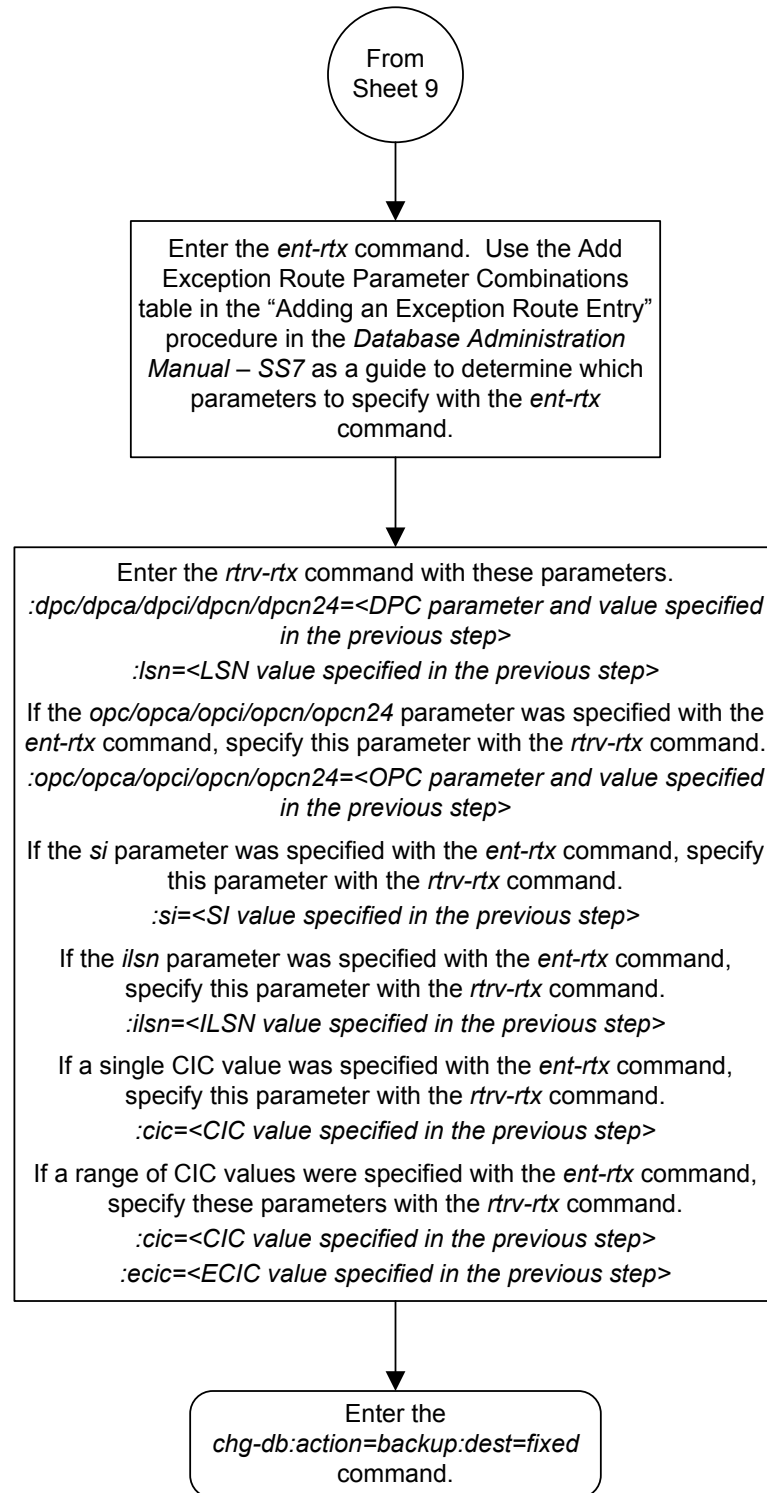












Removing a Route Exception Entry

This procedure is used to remove an exception route from the database using the `dlt-rtx` command. The `dlt-rtx` command uses these parameters.

:dpc/dpca/dpci/dpcn/dpcn24 – The destination point code of the node that the traffic is being sent to.

:opc/opca/opci/opcn/opcn24 – The originating point code of the node sending traffic to the **EAGLE**.

:ilsn – The name of the linkset carrying incoming traffic to the **EAGLE**.

:lsn – The name of the linkset carrying the traffic to the node specified by the destination point code.

:si – The service indicator value assigned to the exception route.

:cic – The circuit identification code value assigned to an exception route containing a single **CIC** entry or the **CIC** value that begins a range of **CICs** assigned to the exception route.

:ecic – The circuit identification code value that ends the range of **CICs** assigned to the exception route.

:all – This parameter, along with the `force=yes` parameter, allows all the exception routes containing the exception route criteria, **OPC**, **ILSN**, **SI**, **CIC**, **CIC** and **ECIC**, to be removed from the database. This parameter has only one value, `yes`.

:force – This parameter, along with the `all=yes` parameter, allows all the exception routes containing the exception route criteria, **OPC**, **ILSN**, **SI**, **CIC**, **CIC** and **ECIC**, to be removed from the database. This parameter has only one value, `yes`.

The values of all the parameters specified for the `dlt-rtx` command, except the `all=yes` and `force=yes` parameters, must be shown in the `rtrv-rtx` output and must be assigned to the specified `dpc/dpca/dpci/dpcn/dpcn24` value.

The combinations of these parameters that can be used with the `dlt-rtx` command are shown in [Table 3-28](#).

1. Display the exception routes in the database by entering the `rtrv-rtx` command. This is an example of the possible output.

```
rlghncxa03w 06-10-07 11:43:04 GMT EAGLE5 36.0.0

      DPCA          RTX-CRITERIA          LSN          RC          APC
      003-003-003  OPCA
                        009-009-009          lsn1          3          002-002-002
                        010-010-010          lsn1          2          002-002-002
                        010-010-010          lsn2          10         002-002-003
                        ILSN
                        lsn3          lsn2          2          002-002-003
                        lsn4          lsn2          1          002-002-003
                        lsn4          lsn1          10         002-002-002
                        CIC - ECIC
                        15    15          lsn2          1          002-002-003
                        17    17          lsn2          7          002-002-003
```

Removing a Route Exception Entry

	17	17	lsn1	10	002-002-002
	18	30	lsn1	8	002-002-002
	18	30	lsn2	10	002-002-003
	SI				
	3		lsn2	5	002-002-003
	3		lsn1	10	002-002-002
	5		lsn2	5	002-002-003
006-006-006	OPCA				
	125-150-175		lsn11	10	004-004-004
	OPCI				
	2-103-1		lsn11	20	004-004-004
	ILSN				
	lsn12		lsn11	11	004-004-004
	lsn13		lsn11	12	004-004-004
	CIC - ECIC				
	250 250		lsn12	15	005-005-005
	300 500		lsn12	25	005-005-005
	SI				
	5		lsn12	10	005-005-005
DPCI	RTX-CRITERIA		LSN	RC	APC
0-123-7	OPCI				
	1-222-3		lsn3	10	1-234-5
	1-222-4		lsn3	11	1-234-5
	1-222-5		lsn4	11	2-145-6
3-025-6	OPCA				
	135-102-089		lsn13	10	1-100-5
	OPCI				
	4-054-0		lsn13	15	1-100-5
	OPCN				
	00503		lsn11	15	1-100-5
	ILSN				
	lsn2		lsn14	45	4-139-4
	lsn4		lsn13	25	1-100-5
	lsn16		lsn16	50	12567
	CIC - ECIC				
	100 100		lsn14	35	4-139-4
	50 75		lsn13	40	1-100-5
	SI				
	3		lsn13	30	1-100-5
DPCN	RTX-CRITERIA		LSN	RC	APC
09852	OPCA				
	127-063-048		lsn15	10	11302
	OPCI				
	3-037-1		lsn16	15	12567

```

OPCN
00409                               lsn13      20      1-100-5

ILSN
lsn13                               lsn15      25      11302
lsn4                                lsn16      30      12567

CIC - ECIC
1000 1000                           lsn16      40      12567
2000 3000                           lsn15      45      11302

SI
4                                    lsn15      35      11302

DESTINATION ENTRIES ALLOCATED:      2000
FULL DPC(s):                        20
EXCEPTION DPC(s):                   41
TOTAL DPC(s):                       61
CAPACITY (% FULL):                  3%
ALIASES ALLOCATED:                  12000
ALIASES USED:                       0
CAPACITY (% FULL):                  0%

```

2. Remove the exception route entry by entering the `dlt-rtx` command and specifying the parameter combinations shown in [Table 3-28](#) for the exception route criteria being assigned to the exception route.

Table 3-28 Remove Exception Route Parameter Combinations

Exception Route Criteria				
:dpc/dpca/ dpci/dpcn/ dpcn24 = DPC of the exception route shown in the <code>rtrv-rtx</code> output	:dpc/dpca/ dpci/dpcn/ dpcn24 = DPC of the exception route shown in the <code>rtrv-rtx</code> output	:dpc/dpca/ dpci/dpcn/ dpcn24 = DPC of the exception route shown in the <code>rtrv-rtx</code> output	:dpc/dpca/ dpci/dpcn/ dpcn24 = DPC of the exception route shown in the <code>rtrv-rtx</code> output	:dpc/dpca/ dpci/dpcn/ dpcn24 = DPC of the exception route shown in the <code>rtrv-rtx</code> output
:opc/opca/ opci/opcn/ opc24 = OPC value of the exception route assigned to the DPC value	:ilsn = incoming linkset name of the exception route assigned to the DPC value	:si = service indicator value of the exception route assigned to the DPC value	:cic = circuit identification code value of the exception route assigned to the DPC value	:cic = the circuit identification code value beginning a range of CICs of the exception route assigned to the DPC value
:lsn = linkset name of the exception route assigned to the DPC value (See Notes)	:lsn = linkset name of the exception route assigned to the DPC value (See Notes)	:lsn = linkset name of the exception route assigned to the DPC value (See Notes)	:lsn = linkset name shown of the exception route assigned to the DPC value (See Notes)	:ecic = the circuit identification code value ending a range of CICs of the exception route assigned to the DPC value

Table 3-28 (Cont.) Remove Exception Route Parameter Combinations

Exception Route Criteria				
:force=yes (See Notes)	:force=yes (See Notes)	:force=yes (See Notes)	:force=yes (See Notes)	:lsn = linkset name shown of the exception route assigned to the DPC value (See Notes)
:all=yes (See Notes)	:all=yes (See Notes)	:all=yes (See Notes)	:all=yes (See Notes)	:force=yes (See Notes) :all=yes (See Notes)

Note:

- a. The `all=yes` and `force=yes` parameter cannot be specified with the `lsn` parameter. If the `all=yes` parameter is specified, the `force=yes` parameter must be specified.
- b. If the exception route entry being removed contains only one entry for the specified exception route criteria, the `all=yes` and `force=yes` parameters can be specified, but do not have to be specified. If the `all=yes` and `force=yes` parameters are not specified, the `lsn` parameter must be specified.

For this example, enter these commands to remove a single entry for a specific exception route criteria.

```
dlt-rtx:dpca=003-003-003:opca=010-010-010:lsn=lsn1
dlt-rtx:dpca=003-003-003:ilsn=lsn4:lsn=lsn2
dlt-rtx:dpca=003-003-003:cic=17:lsn=lsn2
dlt-rtx:dpca=003-003-003:cic=18:ecic=30:lsn=lsn2
dlt-rtx:dpca=003-003-003:si=3:lsn=lsn1
```

To remove all the entries for a specific exception route criteria, for this example enter these commands.

```
dlt-rtx:dpca=003-003-003:opca=010-010-010:all=yes:force=yes
dlt-rtx:dpca=003-003-003:ilsn=lsn4:all=yes:force=yes
dlt-rtx:dpca=003-003-003:cic=17:all=yes:force=yes
dlt-rtx:dpca=003-003-003:cic=18:ecic=30:all=yes:force=yes
dlt-rtx:dpca=003-003-003:si=3:all=yes:force=yes
```

When each of these commands have successfully completed, this message should appear.

```
rlghncxa03w 06-10-07 08:28:30 GMT EAGLE5 36.0.0
DLT-RTX: MASP A - COMPLTD
```

3. Verify the changes using the `rtrv-rtx` command, specifying these parameters depending on the parameters specified in 2.
 - a. If the `ilsn` and `lsn` parameters were specified in 2 - enter these parameters and values specified in 2 with the `rtrv-rtx` command `-dpc/dpca/dpci/dpcn/dpcn24, ils, and lsn.`
 - b. If the `si` and `lsn` parameters were specified in 2 - enter these parameters and values specified in 2 with the `rtrv-rtx` command `-dpc/dpca/dpci/dpcn/dpcn24, si, and lsn.`
 - c. If only the `cic` and `lsn` parameters were specified in 2 - enter these parameters and values specified in 2 with the `rtrv-rtx` command `-dpc/dpca/dpci/dpcn/dpcn24, cic, and lsn.`
 - d. If the `cic` and `ecic` and `lsn` parameters were specified in 2 - enter these parameters and values specified in 2 with the `rtrv-rtx` command `-dpc/dpca/dpci/dpcn/dpcn24, cic, ecic, and lsn.`
 - e. If the `opc/opca/opci/opcn/opcn24, all=yes, and force=yes` parameters were specified in 2 - enter these parameters and values specified in 2 with the `rtrv-rtx` command `-dpc/dpca/dpci/dpcn/dpcn24 and opc/opca/opci/opcn/opcn24.`
 - f. If the `ilsn, all=yes, and force=yes` parameters were specified in 2 - enter these parameters and values specified in 2 with the `rtrv-rtx` command `-dpc/dpca/dpci/dpcn/dpcn24 and ils.`
 - g. If the `si, all=yes, and force=yes` parameters were specified in 2 - enter these parameters and values specified in 2 with the `rtrv-rtx` command `-dpc/dpca/dpci/dpcn/dpcn24 and si.`
 - h. If only the `cic, all=yes, and force=yes` parameters were specified in 2 - enter these parameters and values specified in 2 with the `rtrv-rtx` command `-dpc/dpca/dpci/dpcn/dpcn24 and cic.`
 - i. If the `cic, ecic, all=yes, and force=yes` parameters were specified in 2 - enter these parameters and values specified in 2 with the `rtrv-rtx` command `-dpc/dpca/dpci/dpcn/dpcn24, cic, and ecic.`

For this example, if a single entry for the specified exception route criteria was removed in step 2, enter these commands.

```
rtrv-rtx:dpca=003-003-003:opca=010-010-010:lsn=lsn1
```

```
rlghncxa03w 06-10-07 08:28:30 GMT EAGLE5 36.0.0
```

```
DESTINATION ENTRIES ALLOCATED: 2000
  FULL DPC(s): 20
  EXCEPTION DPC(s): 31
  TOTAL DPC(s): 51
  CAPACITY (% FULL): 3%
ALIASES ALLOCATED: 12000
  ALIASES USED: 0
  CAPACITY (% FULL): 0%
```

```
rtrv-rtx:dpca=003-003-003:ilsn=lsn4:lsn=lsn2
```

rlghncxa03w 06-10-07 08:28:30 GMT EAGLE5 36.0.0

```

DESTINATION ENTRIES ALLOCATED: 2000
  FULL DPC(s):                20
  EXCEPTION DPC(s):           31
  TOTAL DPC(s):               51
  CAPACITY (% FULL):          3%
ALIASES ALLOCATED:            12000
  ALIASES USED:                0
  CAPACITY (% FULL):           0%
    
```

rtrv-rtx:dpca=003-003-003:cic=17:lsn=lsn2

rlghncxa03w 06-10-07 08:28:30 GMT EAGLE5 36.0.0

```

DESTINATION ENTRIES ALLOCATED: 2000
  FULL DPC(s):                20
  EXCEPTION DPC(s):           31
  TOTAL DPC(s):               51
  CAPACITY (% FULL):          3%
ALIASES ALLOCATED:            12000
  ALIASES USED:                0
  CAPACITY (% FULL):           0%
    
```

rtrv-rtx:dpca=003-003-003:cic=18:ecic=30:lsn=lsn2

rlghncxa03w 06-10-07 08:28:30 GMT EAGLE5 36.0.0

```

DESTINATION ENTRIES ALLOCATED: 2000
  FULL DPC(s):                20
  EXCEPTION DPC(s):           31
  TOTAL DPC(s):               51
  CAPACITY (% FULL):          3%
ALIASES ALLOCATED:            12000
  ALIASES USED:                0
  CAPACITY (% FULL):           0%
    
```

rtrv-rtx:dpca=003-003-003:si=3:lsn=lsn1

rlghncxa03w 06-10-07 08:28:30 GMT EAGLE5 36.0.0

```

DESTINATION ENTRIES ALLOCATED: 2000
  FULL DPC(s):                20
  EXCEPTION DPC(s):           31
  TOTAL DPC(s):               51
  CAPACITY (% FULL):          3%
ALIASES ALLOCATED:            12000
  ALIASES USED:                0
  CAPACITY (% FULL):           0%
    
```

For this example, if multiple entries for a specific exception route criteria were removed in step 2, enter these commands.

rtrv-rtx:dpca=003-003-003:opca=010-010-010

rlghncxa03w 06-10-07 08:28:30 GMT EAGLE5 36.0.0

```

DESTINATION ENTRIES ALLOCATED: 2000
  FULL DPC(s):                20
    
```

```
EXCEPTION DPC(s):          26
TOTAL DPC(s):              46
CAPACITY (% FULL):        2%
ALIASES ALLOCATED:        12000
ALIASES USED:              0
CAPACITY (% FULL):        0%
```

```
rtrv-rtx:dpca=003-003-003:ilsn=lsn4
```

```
rlghncxa03w 06-10-07 08:28:30 GMT EAGLE5 36.0.0
```

```
DESTINATION ENTRIES ALLOCATED:  2000
FULL DPC(s):                     20
EXCEPTION DPC(s):                26
TOTAL DPC(s):                    46
CAPACITY (% FULL):               2%
ALIASES ALLOCATED:               12000
ALIASES USED:                    0
CAPACITY (% FULL):               0%
```

```
rtrv-rtx:dpca=003-003-003:cic=17
```

```
rlghncxa03w 06-10-07 08:28:30 GMT EAGLE5 36.0.0
```

```
DESTINATION ENTRIES ALLOCATED:  2000
FULL DPC(s):                     20
EXCEPTION DPC(s):                26
TOTAL DPC(s):                    46
CAPACITY (% FULL):               2%
ALIASES ALLOCATED:               12000
ALIASES USED:                    0
CAPACITY (% FULL):               0%
```

```
rtrv-rtx:dpca=003-003-003:cic=18:ecic=30
```

```
rlghncxa03w 06-10-07 08:28:30 GMT EAGLE5 36.0.0
```

```
DESTINATION ENTRIES ALLOCATED:  2000
FULL DPC(s):                     20
EXCEPTION DPC(s):                26
TOTAL DPC(s):                    46
CAPACITY (% FULL):               2%
ALIASES ALLOCATED:               12000
ALIASES USED:                    0
CAPACITY (% FULL):               0%
```

```
rtrv-rtx:dpca=003-003-003:si=3
```

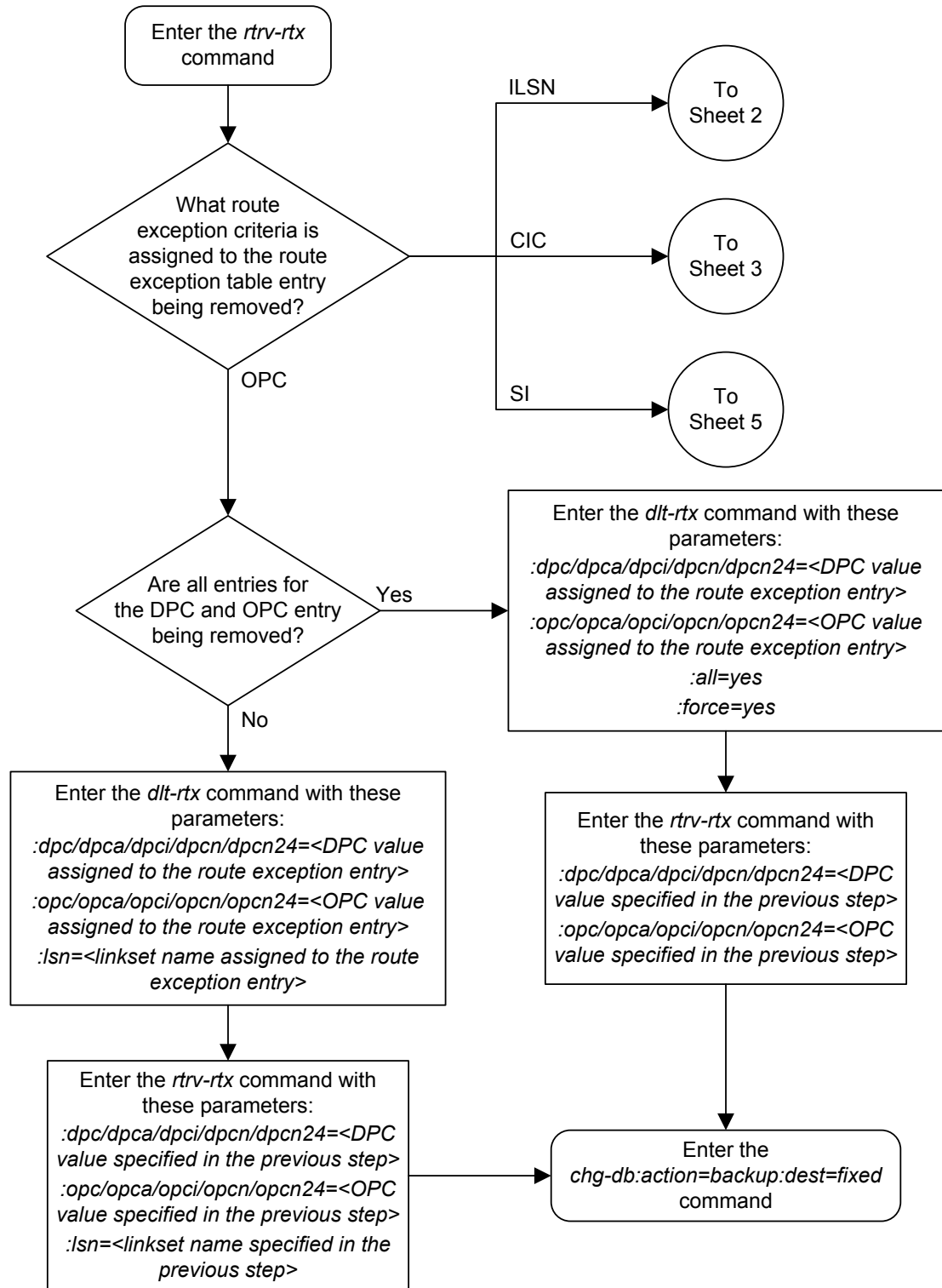
```
rlghncxa03w 06-10-07 08:28:30 GMT EAGLE5 36.0.0
```

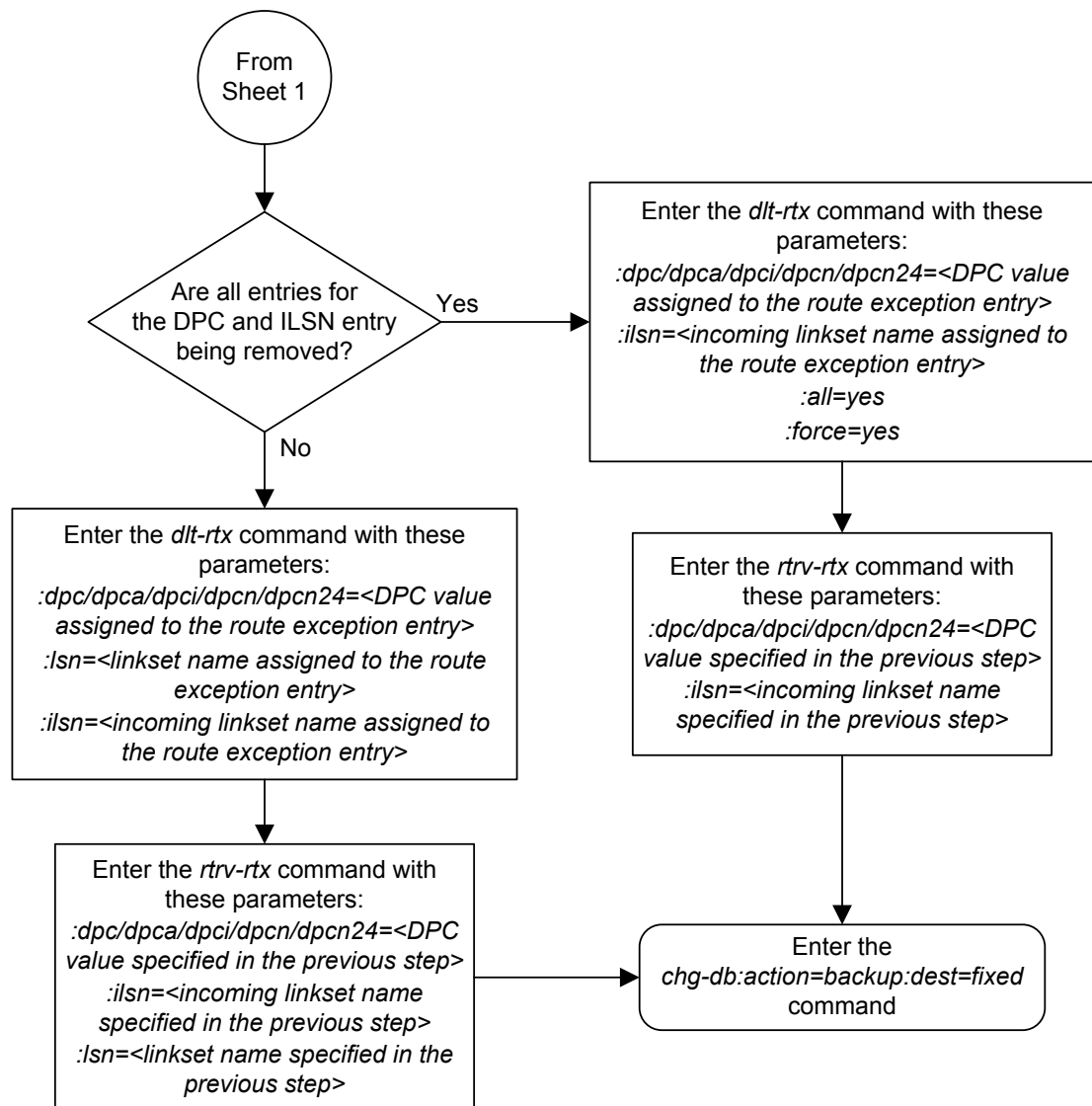
```
DESTINATION ENTRIES ALLOCATED:  2000
FULL DPC(s):                     20
EXCEPTION DPC(s):                26
TOTAL DPC(s):                    46
CAPACITY (% FULL):               2%
ALIASES ALLOCATED:               12000
ALIASES USED:                    0
CAPACITY (% FULL):               0%
```

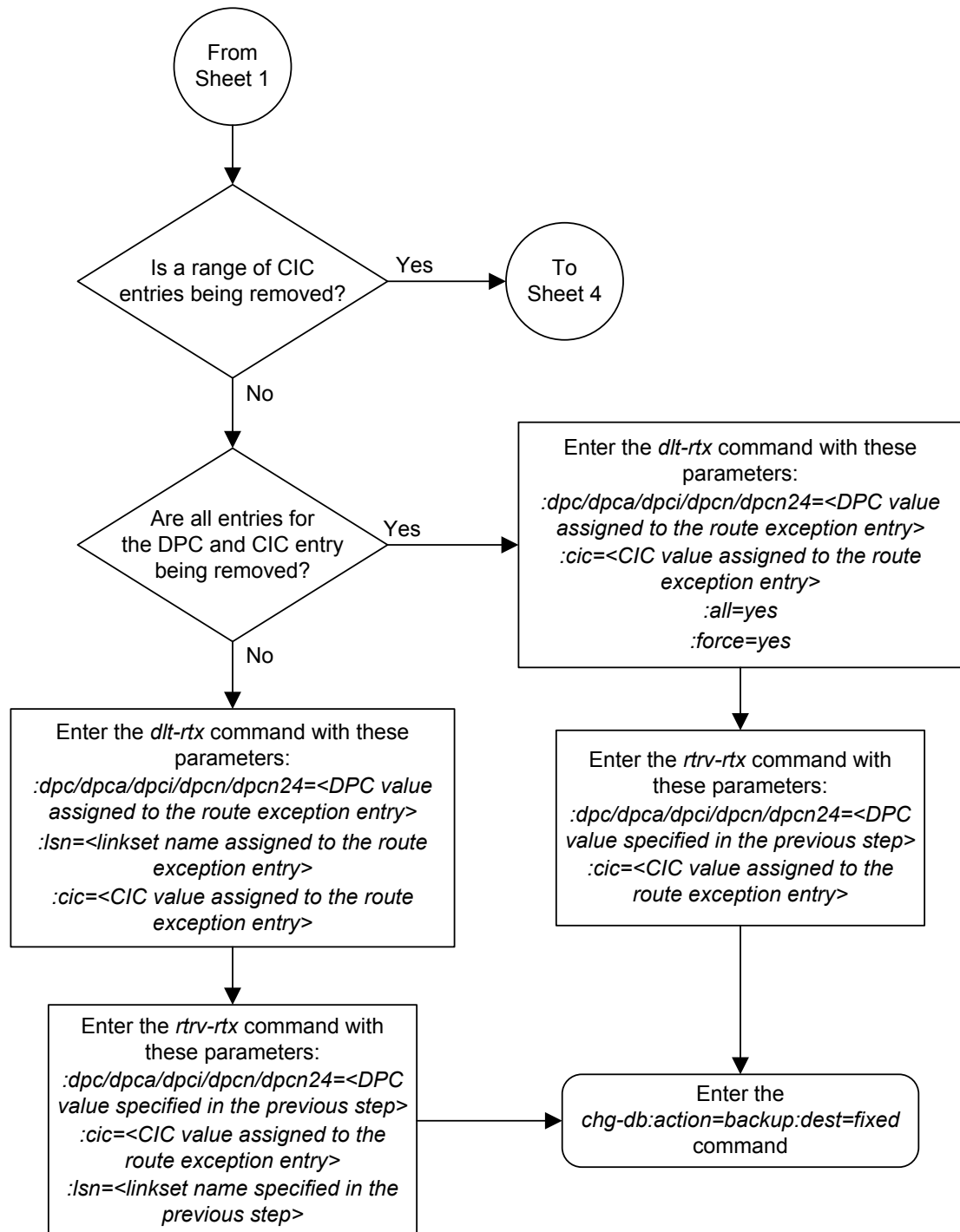
4. Back up the new changes using the `chg-db:action=backup:dest=fixed` command. These messages should appear, the active **Maintenance and Administration Subsystem Processor (MASP)** appears first.

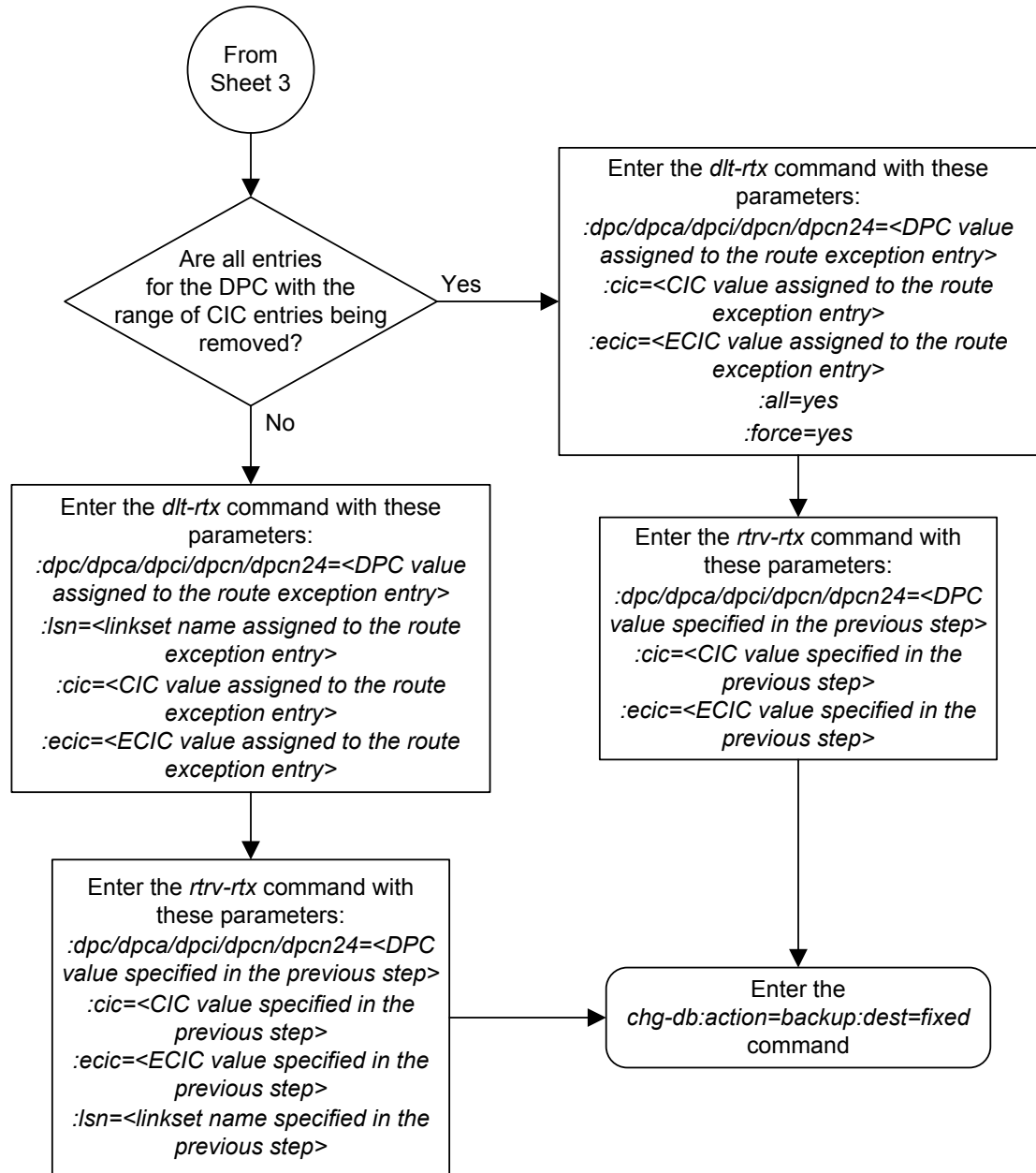
```
BACKUP (FIXED) : MASP A - Backup starts on active MASP.  
BACKUP (FIXED) : MASP A - Backup on active MASP to fixed disk complete.  
BACKUP (FIXED) : MASP A - Backup starts on standby MASP.  
BACKUP (FIXED) : MASP A - Backup on standby MASP to fixed disk complete.
```

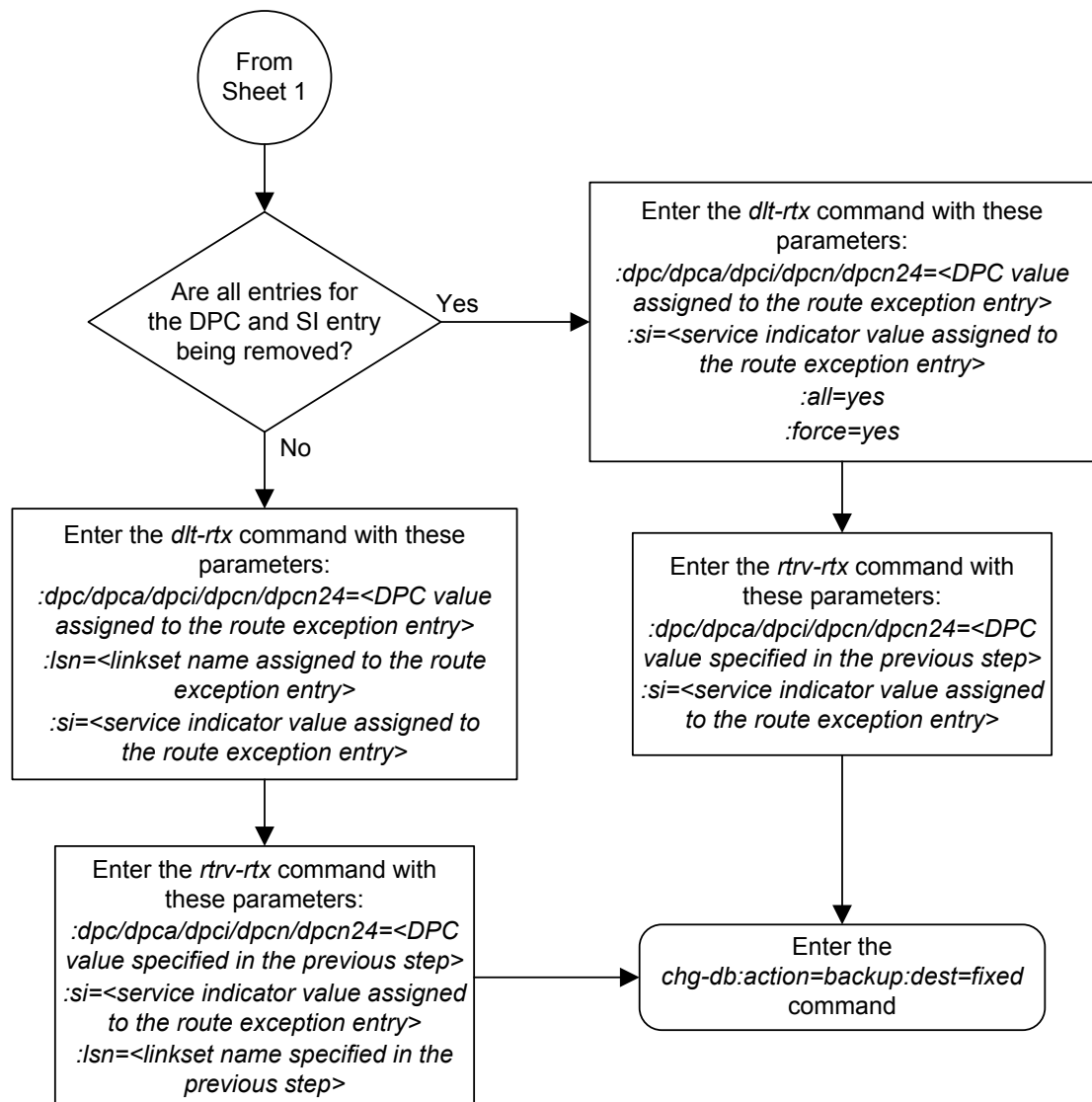

Figure 3-43 Removing a Route Exception Entry











Changing a Route Exception Entry

This procedure is used to change the attributes of an exception route in the database using the `chg-rtx` command. The attributes of the exception route that can be changed are the linkset (`lsn` parameter) and the relative cost (`rc` parameter) of the exception route.

The `chg-rtx` command uses these parameters.

`:dpc/dpca/dpci/dpcn/dpcn24` – The destination point code of the node that the traffic is being sent to.

`:opc/opca/opci/opcn/opcn24` – The originating point code of the node sending traffic to the **EAGLE 5 ISS**.

`:ilsn` – The name of the linkset carrying incoming traffic to the **EAGLE**.

`:lsn` – The name of the linkset that carries the traffic to the node specified by the destination point code.

`:si` – The service indicator value assigned to the exception route.

`:cic` – The circuit identification code value assigned to an exception route containing a single **CIC** entry or the **CIC** value that begins a range of **CICs** assigned to the exception route.

`:ecic` – The circuit identification code value that ends the range of **CICs** assigned to the exception route.

`:rc` – The new relative cost value (priority) that will be assigned to the exception route. The value of the `rc` parameter is 0 to 99.

`:nlsn` – The name of the new linkset that will carry the traffic to the node specified by the destination point code.

`:force` – This parameter allows the exception route to be changed even if the `ilsn` parameter value is the same as the `nlsn` parameter value. This parameter has only one value, `yes`.

The values of all the parameters specified for the `chg-rtx` command, except the `rc`, `nlsn`, and `force=yes` parameters, must be shown in the `rtrv-rtx` output and must be assigned to the specified `dpc/dpca/dpci/dpcn/dpcn24` value.

The combinations of these parameters that can be used with the `chg-rtx` command are shown in [Table 3-29](#).

The names of the linksets required specified for the `nlsn` parameter must be provisioned in the database. This can be verified by entering the `rtrv-ls` command. If the required linkset is not in the database, perform one of these procedures to add the linkset.

- [Adding an SS7 Linkset](#)
- "Adding an X.25 Linkset" procedure in *Database Administration - Features User's Guide*
- "Configuring an IPGWx Linkset," "Adding an IPSG M2PA Linkset," or "Adding an IPSG M3UA Linkset" procedures in *Database Administration - IP7 User's Guide*.

The linkset must be added according to the rules shown in the "[Adding Linksets for Exception Routes](#)" section.

Adding Linksets for Exception Routes

The linkset must be added according to the following rules:

- If the `dpc` value of the exception route entry is an **ANSI** point code, the adjacent point code of the new linkset must be an **ANSI** point code.
- If the exception route is an OPC-based exception route, the `opc` parameter value cannot be the adjacent point code of the linkset that is specified by the `lslsn` parameter value.
- If the `dpc` value of the exception route entry is an **ITU-I** point code, the adjacent point code of the new linkset must be an **ITU-I** point code. If the linkset contains an **SAPC** (secondary adjacent point code), the adjacent point code of the new linkset can be either an **ITU-N** or **ITU-N24** point code if the `sapc` value is an **ITU-I** point code. If the adjacent point code of the `nlsn` value is an **ITU-N** point code with a group code, when the exception route is changed, the group code of the adjacent point code of the new linkset does not have to be the same as the group code of the `opcn` value. If an **ITU-N** linkset is specified for the `ilsn` parameter, the group code of the adjacent point code of the `ilsn` value does not have to match the group code of the adjacent point code of the `nlsn` value.
- If the adjacent point code of the `nlsn` value is an **ITU-N** point code with a group code, when the exception route is changed, the group code of the adjacent point code of the new linkset does not have to be the same as the group code of the `opcn` value. If an **ITU-N** linkset is specified for the `ilsn` parameter, the group code of the adjacent point code of the `ilsn` value does not have to match the group code of the adjacent point code of the `nlsn` value.
- If the `dpc` value of the exception route entry is an **ITU-N** point code, the adjacent point code of the `nlsn` value must be an **ITU-N** point code.
 - If the `dpc` value of the exception route entry is an **ITU-N** point code with no group code assigned to the **ITU-N** point code, the adjacent point code of the `nlsn` value or the adjacent point code of all the linksets in the routeset can be an **ITU-I** point code if the `sapc` (secondary adjacent point code) value is an **ITU-N** point code.
 - If the `dpc` value of the exception route entry is an **ITU-N** point code with a group code, the adjacent point code of the `nlsn` value can be an **ITU-I** point code if the `sapc` value is an **ITU-N** point code. When the exception route is changed, the group code of the adjacent point code of the `nlsn` value and the `ilsn` value must be the same. The group code of the `dpcn` value must be the same as the group code of either the adjacent point code of the `nlsn` value or the `sapc` (secondary adjacent point code) assigned to the `nlsn` value.
- If the `dpc` value of the exception route entry is an **ITU-N24** point code, the adjacent point code of the `lslsn` value must be an **ITU-N24** point code. If the linkset contains an **SAPC** (secondary adjacent point code), the adjacent point code of the `lslsn` value can be an **ITU-I** point code if the `sapc` value is an **ITU-N24** point code.

The **SAPC** values assigned to the linksets can be verified by entering the `rtrv-ls:lslsn=<linkset name>` command.

1. Display the exception routes in the database by entering the `rtrv-rtx` command.

This is an example of the possible output.

```

rlghncxa03w 07-05-07 11:43:04 GMT EAGLE5 37.0.0
  DPCA          RTX-CRITERIA          LSN          RC          APC

003-003-003  OPCA
                009-009-009          lsn1          3          002-002-002
                010-010-010          lsn1          2          002-002-002
                010-010-010          lsn2          10         002-002-003

                ILSN
                lsn3          lsn2          2          002-002-003
                lsn4          lsn2          1          002-002-003
                lsn4          lsn1          10         002-002-002

                CIC - ECIC
                15    15          lsn2          1          002-002-003
                17    17          lsn2          7          002-002-003
                17    17          lsn1          10         002-002-002
                18    30          lsn1          8          002-002-002
                18    30          lsn2          10         002-002-003

                SI
                3          lsn2          5          002-002-003
                3          lsn1          10         002-002-002
                5          lsn2          5          002-002-003

006-006-006  OPCA
                125-150-175          lsn11         10         004-004-004

                OPCI
                2-103-1          lsn11         20         004-004-004

                ILSN
                lsn12          lsn11         11         004-004-004

                lsn13          lsn11         12         004-004-004

                CIC - ECIC
                250  250          lsn12         15         005-005-005
                300  500          lsn12         25         005-005-005

                SI
                5          lsn12         10         005-005-005

DPCI          RTX-CRITERIA          LSN          RC          APC
0-123-7      OPCI
                1-222-3          lsn3          10         1-234-5
                1-222-4          lsn3          11         1-234-5
                1-222-5          lsn4          11         2-145-6

3-025-6      OPCA
                135-102-089          lsn13         10         1-100-5

                OPCI
                4-054-0          lsn13         15         1-100-5

                OPCN
                00503          lsn11         15         1-100-5

                ILSN
                lsn2          lsn14         45         4-139-4
                lsn4          lsn13         25         1-100-5

```

	lsn16		lsn16	50	12567
	CIC - ECIC				
	100 100		lsn14	35	4-139-4
	50 75		lsn13	40	1-100-5
	SI				
	3		lsn13	30	1-100-5
DPCN	RTX-CRITERIA		LSN	RC	APC
09852	OPCA				
	127-063-048		lsn15	10	11302
	OPCI				
	3-037-1		lsn16	15	12567
	OPCN				
	00409		lsn13	20	1-100-5
	ILSN				
	lsn13		lsn15	25	11302
	lsn4		lsn16	30	12567
	CIC - ECIC				
	1000 1000		lsn16	40	12567
	2000 3000		lsn15	45	11302
	SI				
	4		lsn15	35	11302

```

DESTINATION ENTRIES ALLOCATED: 2000
FULL DPC(s): 20
EXCEPTION DPC(s): 41
TOTAL DPC(s): 61
CAPACITY (% FULL): 3%
ALIASES ALLOCATED: 12000
ALIASES USED: 0
CAPACITY (% FULL): 0%

```

The DPC of an exception route entry can contain only a maximum of two entries with the same RC value and with either the same OPC value, the same ILSN value, the same single CIC value, the same range of CIC values, or the same SI value. The LSN value for each entry must be different. The DPC of an exception route entry can contain only one entry with a single CIC value. Continue the procedure by performing one of these steps.

- If no more than two entries in the exception route will contain the same exception route criteria, except for the linkset name, continue the procedure with [3](#).
- If more than two entries in the exception route will contain the same exception route criteria, except for the linkset name, continue the procedure by performing one of these steps.
 - If more than two entries in an exception route that contain the same exception route criteria, except for the linkset name, are shown in this step, continue the procedure with [3](#).

- If more than two entries in an exception route that contain the same exception route criteria, except for the linkset name, are not shown in this step, continue the procedure with 2.
2. For an exception route to have more than two entries with the same exception route criteria, except for the linkset name (the `lsn` parameter value), the 6-Way Loadsharing on Routesets feature must be enabled and turned on.

To verify the status of the 6-Way Loadsharing on Routesets feature, enter this command.

```
rtrv-ctrl-feat:partnum=893019801
```

The following is an example of the possible output.

```
rlghncxa03w 09-05-28 21:15:37 GMT EAGLE5 41.0.0
The following features have been permanently enabled:
```

Feature Name	Partnum	Status	Quantity
6-Way LS on Routesets	893019801	on	----

The following features have been temporarily enabled:

Feature Name	Partnum	Status	Quantity	Trial Period Left
Zero entries found.				

The following features have expired temporary keys:

Feature Name	Partnum
Zero entries found.	

If the 6-Way Loadsharing on Routesets feature is not enabled or not turned on, perform [Activating the 6-Way Loadsharing on Routesets Feature](#) to enable and turn on the 6-Way Loadsharing on Routesets feature.

After the 6-Way Loadsharing on Routesets feature has been enabled and turned on, or if the `rtrv-ctrl-feat` output shows that the 6-Way Loadsharing on Routesets feature is enabled and turned on, continue this procedure by performing one of these steps.

- If only the relative cost of the exception route (`rc` parameter) is being changed, continue the procedure with 5.
 - If the name of the linkset that will be specified for the `lsn` parameter is shown in the `rtrv-rtx` output, continue the procedure with 4. If the name of the linkset is not shown in the `rtrv-rtx` output, continue the procedure with 3
3. Display the linksets in the database by entering the `rtrv-ls` command.

This is an example of the possible output.

```
rlghncxa03w 06-10-10 11:43:04 GMT EAGLE5 36.0.0
```

LSN	APCA (SS7)	SCRN	L3T SLT				LNKS	GWS GWS GWS				
			SET	SET	BEI	LST		ACT	MES	DIS	SLSCI	NIS
lsn1	002-002-002	none	1	1	no	B	2	off	off	off	no	off
lsn2	002-002-003	none	1	1	no	B	3	off	off	off	no	off
lsn11	004-004-004	none	1	1	no	B	1	off	off	off	no	off
lsn12	005-005-005	none	1	1	no	B	4	off	off	off	no	off

LSN	APCI (SS7)	SCRN	L3T SLT				LNKS	GWS GWS GWS				
			SET	SET	BEI	LST		ACT	MES	DIS	SLSCI	NIS
lsn3	1-234-5	none	1	2	no	B	2	off	off	off	---	off
lsn4	2-145-6	none	1	2	no	B	2	off	off	off	---	off
lsn13	1-100-5	none	1	2	no	B	1	off	off	off	---	off
lsn14	4-139-4	none	1	2	no	B	1	off	off	off	---	off

LSN	APCN (SS7)	SCRN	L3T SLT				LNKS	GWS GWS GWS				
			SET	SET	BEI	LST		ACT	MES	DIS	SLSCI	NIS
lsn5	00002	none	1	2	no	B	2	off	off	off	---	off
lsn6	00003	none	1	2	no	B	2	off	off	off	---	off
lsn15	11302	none	1	2	no	B	2	off	off	off	---	off
lsn16	12567	none	1	2	no	B	2	off	off	off	---	off

Link set table is (12 of 1024) 1% full.

If the required linkset is shown in the `rtrv-ls` output, continue the procedure with 4.

If the required linkset is not in the database, (see the ["Adding Linksets for Exception Routes"](#) section), perform one of these procedures to add the linkset.

- a. [Adding an SS7 Linkset](#)
- b. "Adding an X.25 Linkset" procedure in *Database Administration - Features User's Guide*
- c. "Configuring an IPGWx Linkset," "Adding an IPSG M2PA Linkset," or "Adding an IPSG M3UA Linkset" procedures in *Database Administration - IP7 User's Guide*.

The linkset must be added according to the rules shown in the ["Adding Linksets for Exception Routes"](#) section. After the new linkset has been added, continue the procedure with 5.

Note: If the **DPC** exception route entry is an **ANSIDPC**, the adjacent point code of the `lsn` value must be an **ANSI** point code. If the **DPC** exception route entry is an **ANSIDPC**, continue the procedure with 5.

4. Display the linkset that will be assigned to the exception route entry by entering the `rtrv-ls` command with the name of the linkset.

For this example, enter these commands.

```
rtrv-ls:lsn=lsn13
```

This is an example of the possible output.

```
rlghncxa03w 06-10-17 11:43:04 GMT EAGLE5 36.0.0
```

LSN	APCI (SS7)	SCRN	L3T SLT				LNKS	GWS GWS GWS				
			SET	SET	BEI	LST		ACT	MES	DIS	SLSCI	NIS
lsn13	1-100-5	none	1	2	no	B	1	off	off	off	---	off
	CLLI		TFATCABMLQ	MTPRSE	ASL8	SLSOCSBIT	SLSRSB	MULTGC				
	-----		1	no	---	none	7	no				

```

ITUTFR RANDSLS
off    all

IPGWAPC MATELSN    IPTPS LSUSEALM SLKUSEALM GTTMODE
no      -----   ---   ---       ---       CdPA

LOC  LINK SLC TYPE    IPLIML2
1301 A    0  IPLIMI  M2PA

SAPCN
11211
Link set table is (12 of 1024) 1% full.

```

`rtrv-ls:lsn=lsn16`

This is an example of the possible output.

```

rlghncxa03w 06-10-17 11:43:04 GMT  EAGLE5 36.0.0

LSN          APCI  (SS7)  SCRN SET SET BEI LST LNKS ACT MES DIS SLSCI NIS
lsn16       12567      none 1  2  no  B  2  off off off ---  off

          CLLI          TFATCABMLQ MTPRSE ASL8  SLSOCSBIT SLSRSB MULTGC
          ----- 1          no    --- none    7      no

ITUTFR RANDSLS
off    all

IPGWAPC MATELSN    IPTPS LSUSEALM SLKUSEALM GTTMODE
no      -----   ---   ---       ---       CdPA

LOC  LINK SLC TYPE    IPLIML2
1301 A    0  IPLIMI  M2PA

SAPCI
5-067-1
Link set table is (12 of 1024) 1% full.

```

If the linkset does not meet the criteria shown in the "Adding Linksets for Exception Routes" section, either choose another linkset with an ITU-I, ITU-N, or ITU-N24 adjacent point code from the `rtrv-ls` output in 3 and repeat 4, or add a new linkset by performing one of these procedures:

- a. [Adding an SS7 Linkset](#)
- b. "Configuring an IPGWx Linkset," "Adding an IPSP M2PA Linkset," or "Adding an IPSP M3UA Linkset" procedures in *Database Administration - IP7 User's Guide*.

The linkset must be added according to the rules shown in the "Adding Linksets for Exception Routes" section.

5. Change the exception route entry by entering the `chg-rtx` command and specifying the parameter combinations shown in [Table 3-29](#) for the exception route criteria being assigned to the exception route.

Table 3-29 Change Exception Route Parameter Combinations

Exception Route Criteria				
:dpc/dpca/ dpci/dpcn/ dpcn24 = DPC of the exception route being changed (See Note 1)	:dpc/dpca/ dpci/dpcn/ dpcn24 = DPC of the exception route being changed (See Note 1)	:dpc/dpca/ dpci/dpcn/ dpcn24 = DPC of the exception route being changed (See Note 1)	:dpc/dpca/ dpci/dpcn/ dpcn24 = DPC of the exception route being changed (See Note 1)	:dpc/dpca/ dpci/dpcn/ dpcn24 = DPC of the exception route being changed (See Note 1)
:opc/opca/ opci/opcn/ opcn24 = OPC value of the exception route being changed. (See Note 3)	:lsn = incoming linkset name of the exception route being changed (See Note 3)	:si = service indicator value of the exception route being changed	:cic = circuit identification code value of the exception route being changed	:cic = the circuit identification code value beginning a range of CICs of the exception route being changed
:lsn = linkset name of the exception route being changed	:lsn = linkset name of the exception route being changed	:lsn = linkset name of the exception route being changed	:lsn = linkset name shown of the exception route being changed	:ecic = the circuit identification code value ending a range of CICs of the exception route being changed
:nlsn = new linkset name shown in the <code>rtrv-ls</code> output (See Notes 2, 3, 4, and 6)	:nlsn = new linkset name shown in the <code>rtrv-ls</code> output (See Notes 2, 3, 4, and 6)	:nlsn = new linkset name shown in the <code>rtrv-ls</code> output (See Notes 2, 4, and 6)	:nlsn = new linkset name shown in the <code>rtrv-ls</code> output (See Notes 2, 4, and 6)	:lsn = linkset name shown of the exception route being changed
:rc = new relative cost value, 0 - 99 (See Notes 4 and 5)	:rc = new relative cost value, 0 - 99 (See Notes 4 and 5)	:rc = new relative cost value, 0 - 99 (See Notes 4 and 5)	:rc = new relative cost value, 0 - 99 (See Notes 4 and 5)	:nlsn = new linkset name shown in the <code>rtrv-ls</code> output (See Notes 2, 4, and 6)
:force=yes (See Note 3)	:force=yes (See Note 3)			:rc = new relative cost value, 0 - 99 (See Notes 4 and 5)

Table 3-29 (Cont.) Change Exception Route Parameter Combinations**Exception Route Criteria**

Notes:

1. The **DPC** of an exception route entry can contain only a maximum of two entries with the same **RC** value and with either the same **OPC** value, the same **ILSN** value, the same **SI** value, the same **CIC** value, or range of **CIC** values if the 6-Way Loadsharing on Routesets feature is not enabled or turned on. If the 6-Way Loadsharing on Routesets feature is enabled and turned on, the **DPC** of an exception route entry can contain more than two entries with the same **RC** value and with either the same **OPC** value, the same **ILSN** value, the same **SI** value, the same **CIC** value, or range of **CIC** values, the **LSN** value for each entry must be different.
2. The new linkset specified in this step must meet the criteria shown in the "[Adding Linksets for Exception Routes](#)" section.
3. The `force=yes` parameter must be used if the **LSN** and **ILSN** values are the same, or if the **OPC** value is the same as the **APC** of the linkset specified by the `lsn` parameter.
4. The `nlsn` or `rc` parameters, or both parameters, must be specified with the `chg-rtx` command.
5. The new `rc` parameter value must be different from the current `rc` parameter value.
6. The `nlsn` parameter value cannot be currently assigned to the **DPC** of the exception route that is being changed.

For this example, enter these commands.

```
chg-
rtx:dPCA=003-003-003:opca=009-009-009:lsn=lsn1:nlsn=lsn2 :rc=
20

chg-rtx:dpci=0-123-7:ilsn=lsn4:lsn=13:nlsn=lsn16

chg-rtx:dpci=0-123-7:cic=50:ecic=75:lsn=lsn13:rc=20

chg-rtx:dpcn=09852:cic=1000:lsn=lsn16:rc=45

chg-rtx:dpcn=09852:si=4:lsn=lsn15:nlsn=lsn16:rc=50

chg-rtx:dpcn=09852:ilsn=lsn13:nlsn=lsn13:force=yes
```

When each of these commands have successfully completed, this message should appear.

```
rlghncxa03w 06-10-07 08:28:30 GMT EAGLE5 36.0.0
CHG-RTX: MASP A - COMPLTD
```

Note: If the linkset name was changed in 5, the `lsn` value for the `rtrv-rtx` command must be the `nlsn` value specified in 5.

6. Verify the changes using the `rtrv-rtx` command, specifying these parameters depending on the exception route criteria specified in 5.
 - a. If the `opc/opca/opci/opcn/opcn24` parameter was specified in 5 - enter these parameters and values specified in 5 with the `rtrv-rtx` command - `dpc/dPCA/dpci/dpcn/dpcn24`, `opc/opca/opci/opcn/opcn24`, and `lsn`.
 - b. If the `ilsn` parameter was specified in 5 - enter these parameters and values specified in 5 with the `rtrv-rtx` command - `dpc/dPCA/dpci/dpcn/dpcn24`, `ilsn`, and `lsn`.

- c. If the `si` parameter was specified in 5 - enter these parameters and values specified in 5 with the `rtrv-rtx` command - `dpc/dpca/dpci/dpcn/dpcn24`, `si`, and `lsn`.
- d. If only the `cic` parameter was specified in 5 - enter these parameters and values specified in 5 with the `rtrv-rtx` command - `dpc/dpca/dpci/dpcn/dpcn24`, `cic`, and `lsn`.
- e. If the `cic` and `ecic` parameters were specified in 5 - enter these parameters and values specified in 5 with the `rtrv-rtx` command - `dpc/dpca/dpci/dpcn/dpcn24`, `cic`, `ecic`, and `lsn`.

For this example, enter these commands.

```
rtrv-rtx:dpca=003-003-003:opca=009-009-009:lsn=lsn2
```

```
rlghncxa03w 06-10-07 08:28:30 GMT EAGLE5 36.0.0
```

DPCA	RTX-CRITERIA	LSN	RC	APC
003-003-003	OPCA 009-009-009	lsn2	20	002-002-003

```
DESTINATION ENTRIES ALLOCATED: 2000
FULL DPC(s): 20
EXCEPTION DPC(s): 36
TOTAL DPC(s): 56
CAPACITY (% FULL): 3%
ALIASES ALLOCATED: 12000
ALIASES USED: 0
CAPACITY (% FULL): 0%
```

```
rtrv-rtx:dpci=3-025-6:ilsn=lsn4:lsn=lsn16
```

```
rlghncxa03w 06-10-07 08:28:30 GMT EAGLE5 36.0.0
```

DPCI	RTX-CRITERIA	LSN	RC	APC
3-025-6	ILSN lsn4	lsn16	25	12567

```
DESTINATION ENTRIES ALLOCATED: 2000
FULL DPC(s): 20
EXCEPTION DPC(s): 36
TOTAL DPC(s): 56
CAPACITY (% FULL): 3%
ALIASES ALLOCATED: 12000
ALIASES USED: 0
CAPACITY (% FULL): 0%
```

```
rtrv-rtx:dpci=3-025-6:cic=50:ecic=75:lsn=lsn13
```

```
rlghncxa03w 06-10-07 08:28:30 GMT EAGLE5 36.0.0
```

DPCI	RTX-CRITERIA	LSN	RC	APC
3-025-6	CIC - ECIC 50 75	lsn13	20	1-100-5

```

DESTINATION ENTRIES ALLOCATED: 2000
  FULL DPC(s): 20
  EXCEPTION DPC(s): 36
  TOTAL DPC(s): 56
  CAPACITY (% FULL): 3%
ALIASES ALLOCATED: 12000
  ALIASES USED: 0
  CAPACITY (% FULL): 0%
    
```

rtrv-rtx:dpcn=09852:ilsn=lsn13:lsn=13

rlghncxa03w 06-10-07 08:28:30 GMT EAGLE5 36.0.0

DPCN	RTX-CRITERIA	LSN	RC	APC
09852	ILSN lsn13	lsn13	25	1-100-5

```

DESTINATION ENTRIES ALLOCATED: 2000
  FULL DPC(s): 20
  EXCEPTION DPC(s): 36
  TOTAL DPC(s): 56
  CAPACITY (% FULL): 3%
ALIASES ALLOCATED: 12000
  ALIASES USED: 0
  CAPACITY (% FULL): 0%
    
```

rtrv-rtx:dpcn=09852:si=4:lsn=lsn16

rlghncxa03w 06-10-07 08:28:30 GMT EAGLE5 36.0.0

DPCN	RTX-CRITERIA	LSN	RC	APC
09852	SI 4	lsn16	50	12567

```

DESTINATION ENTRIES ALLOCATED: 2000
  FULL DPC(s): 20
  EXCEPTION DPC(s): 36
  TOTAL DPC(s): 56
  CAPACITY (% FULL): 3%
ALIASES ALLOCATED: 12000
  ALIASES USED: 0
  CAPACITY (% FULL): 0%
    
```

rtrv-rtx:dpcn=09852:cic=1000:lsn=lsn16

rlghncxa03w 06-10-07 08:28:30 GMT EAGLE5 36.0.0

DPCN	RTX-CRITERIA	LSN	RC	APC
09852	CIC - ECIC 1000	lsn16	45	12567

```

DESTINATION ENTRIES ALLOCATED: 2000
  FULL DPC(s): 20
  EXCEPTION DPC(s): 36
  TOTAL DPC(s): 56
  CAPACITY (% FULL): 3%
ALIASES ALLOCATED: 12000
    
```

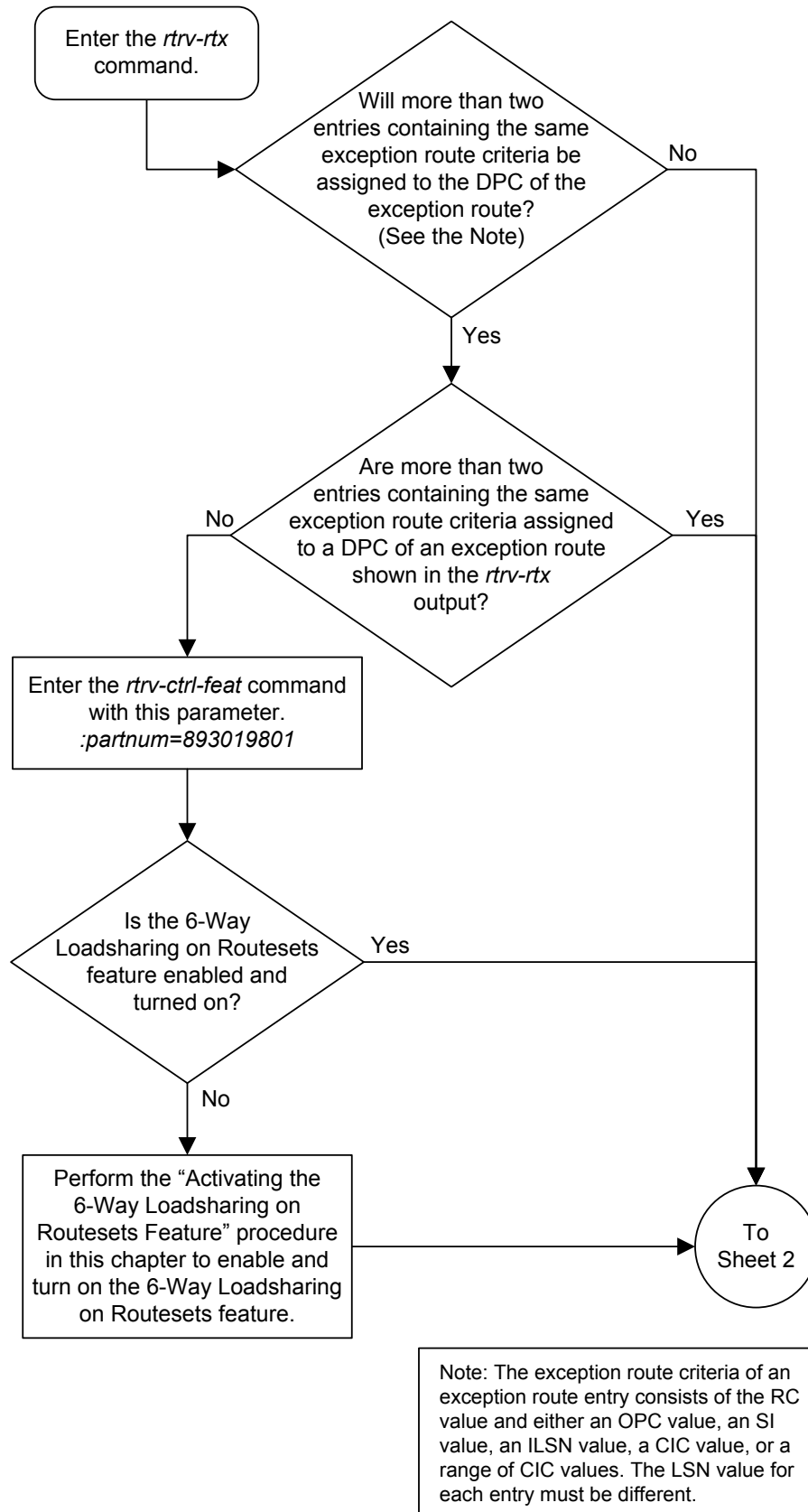
ALIASES USED: 0
CAPACITY (% FULL): 0%

7. Back up the new changes using the `chg-db:action=backup:dest=fixed` command.

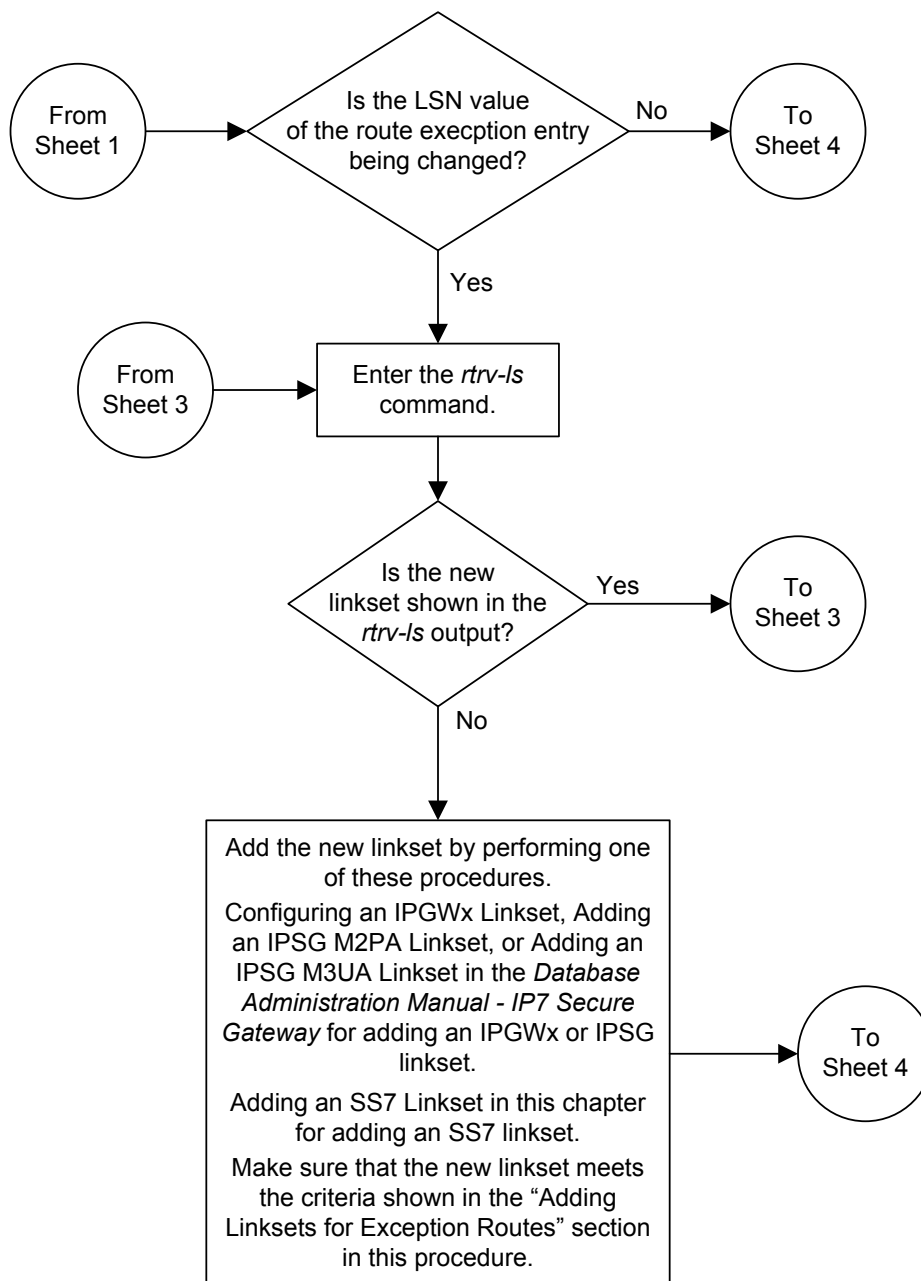
These messages should appear, the active **Maintenance and Administration Subsystem Processor (MASP)** appears first.

```
BACKUP (FIXED) : MASP A - Backup starts on active MASP.  
BACKUP (FIXED) : MASP A - Backup on active MASP to fixed disk complete.  
BACKUP (FIXED) : MASP A - Backup starts on standby MASP.  
BACKUP (FIXED) : MASP A - Backup on standby MASP to fixed disk complete.
```

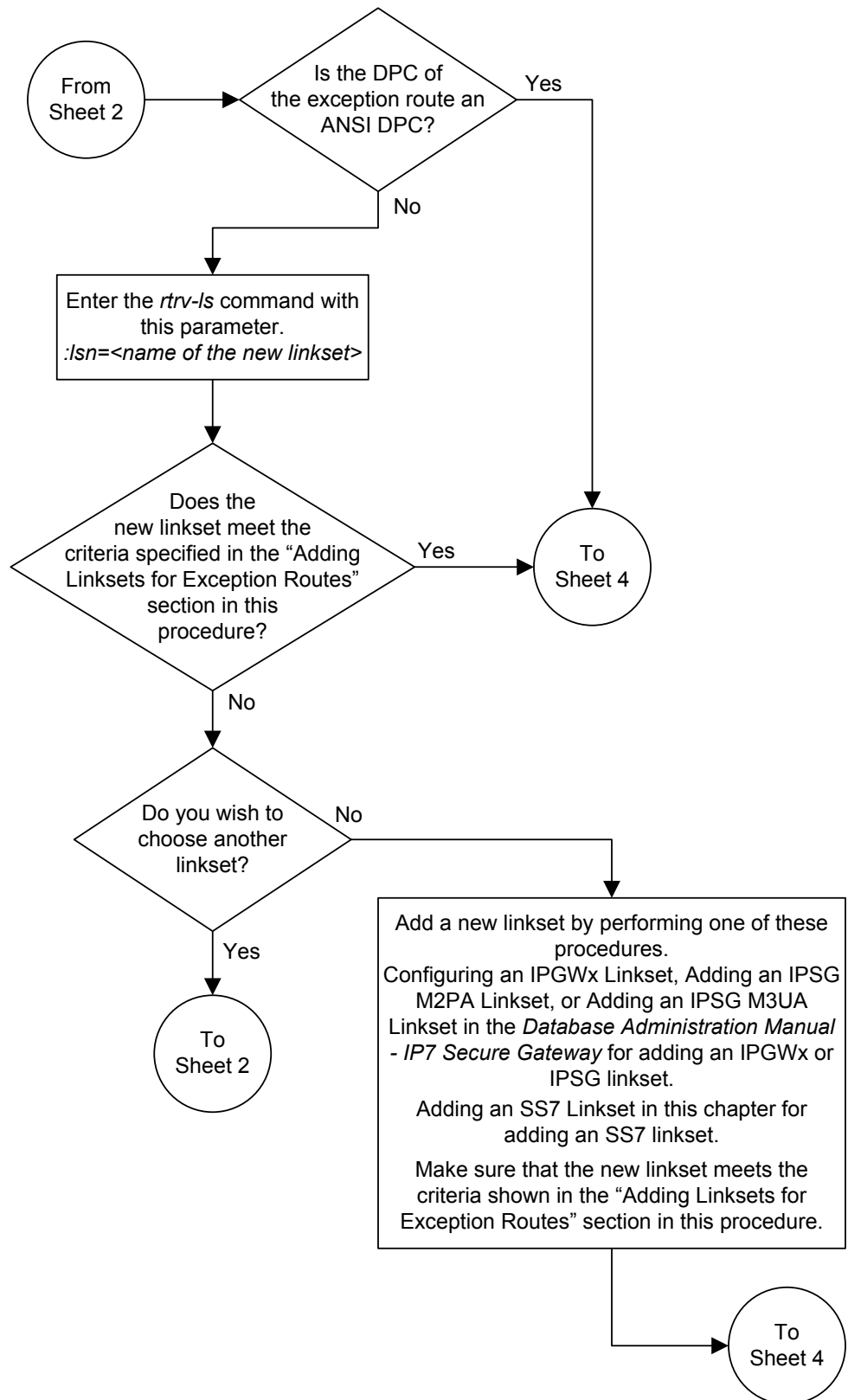
Figure 3-44 Changing a Route Exception Entry

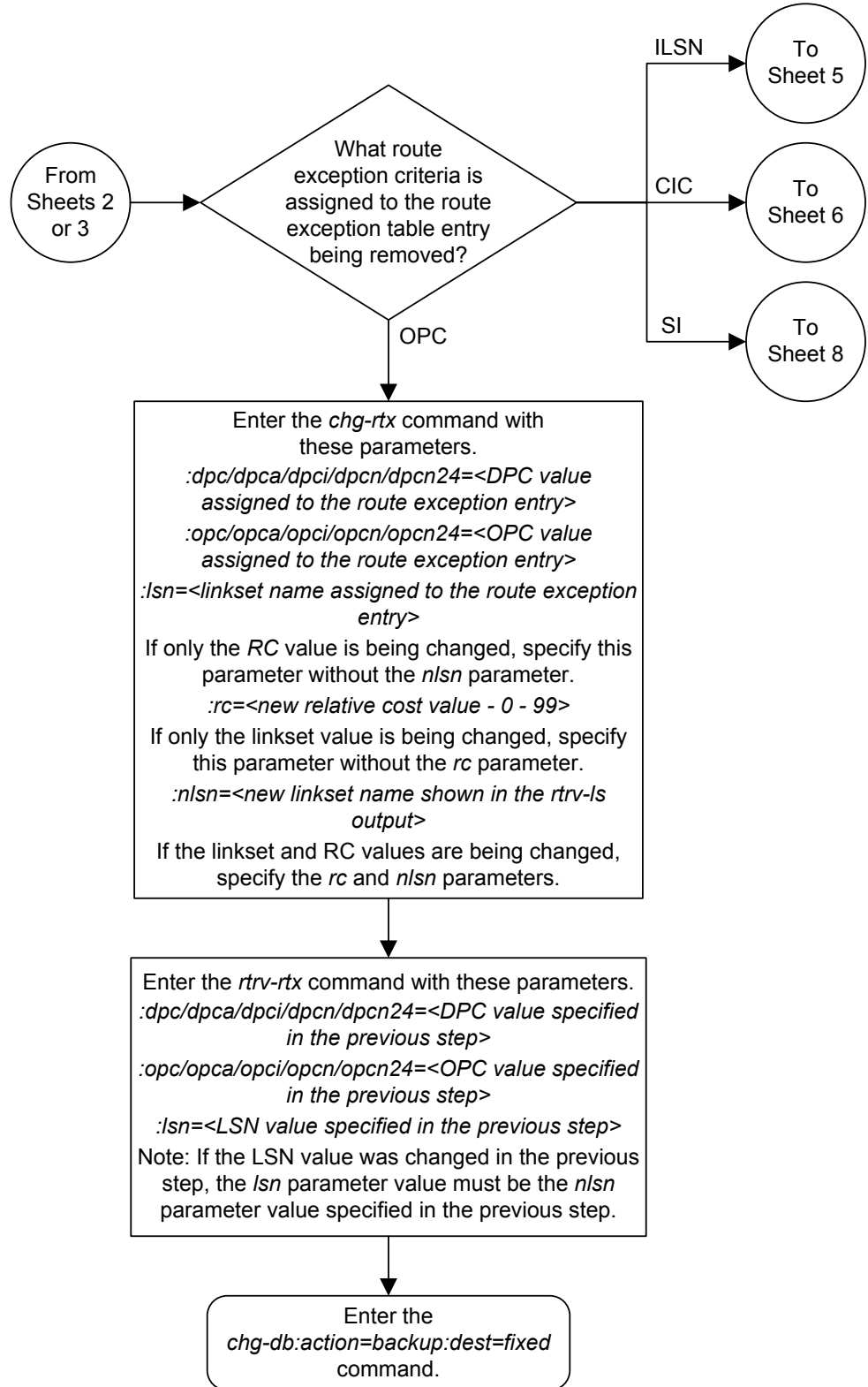


Sheet 1 of 8

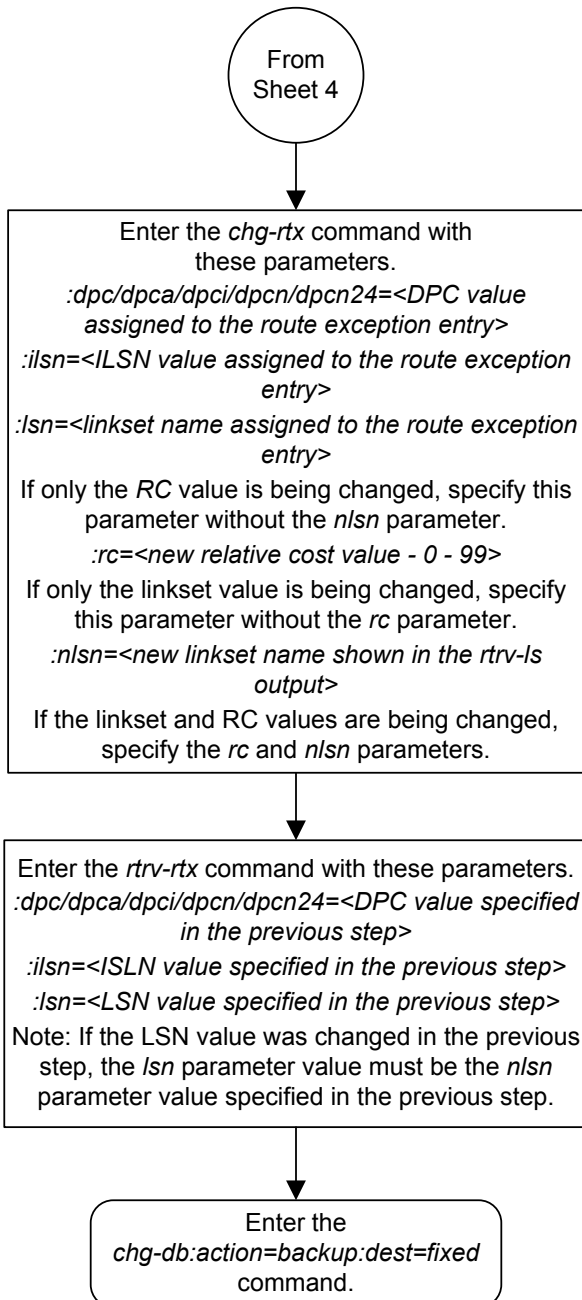


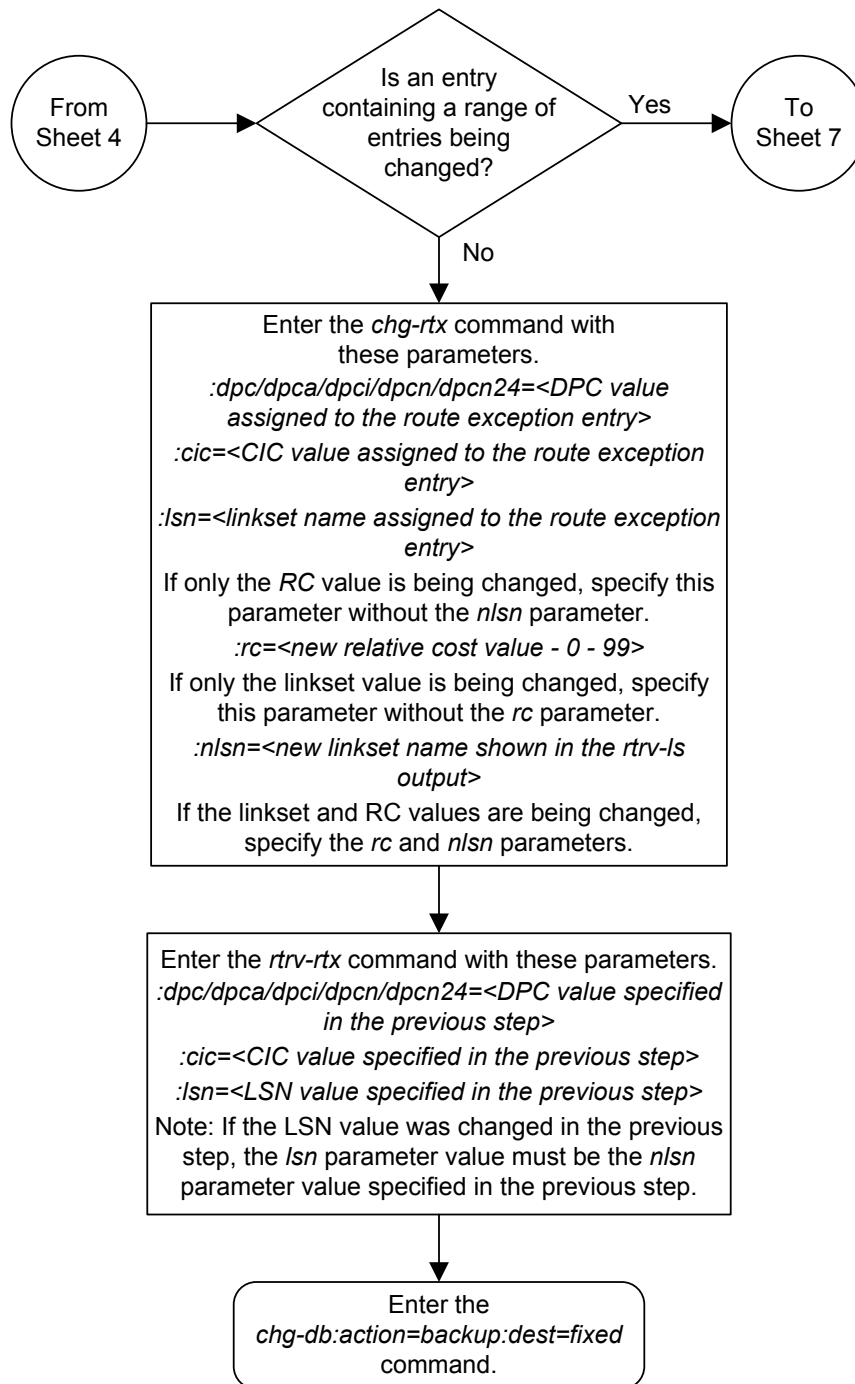
Sheet 2 of 8

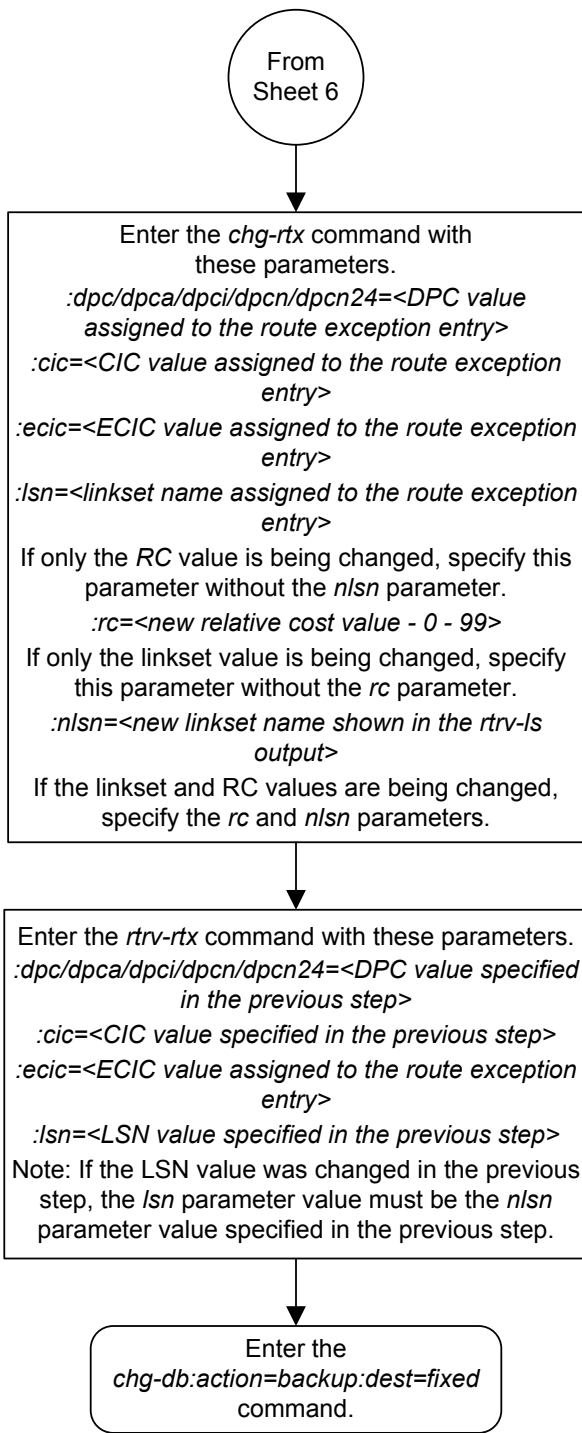


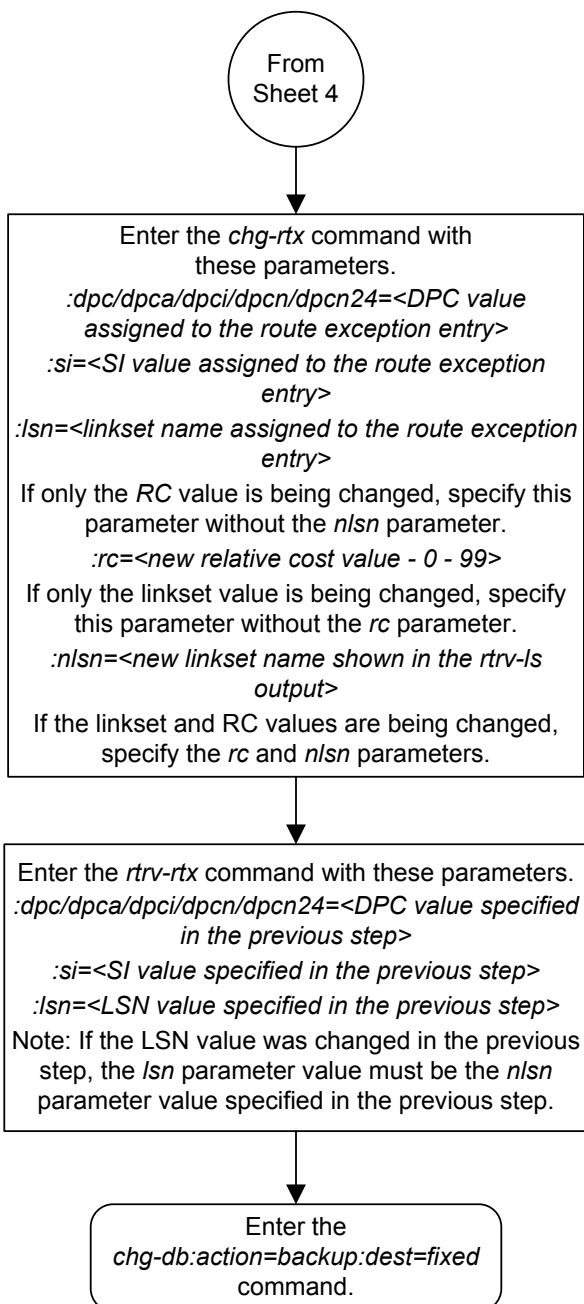


Sheet 4 of 8









Activating the Circular Route Auto-Recovery Feature

This procedure is used to enable and turn on the Circular Route Auto-Recovery feature using the feature's part number and a feature access key.

The feature access key for the Circular Route Auto-Recovery feature is based on the features part number and the serial number of the EAGLE, making the feature access key site-specific.

The `enable-ctrl-feat` command enables the feature by inputting the features access key and the features part number with these parameters:

`: fak` – The feature access key provided by Oracle.

`: partnum` – The Oracle-issued part number of the Circular Route Auto-Recovery feature, 893017601.

Once this feature is enabled, it is permanently enabled. This feature cannot be enabled with a temporary feature access key.

The `enable-ctrl-feat` command requires a valid serial number for the **EAGLE** to be configured in the database, and that this serial number is locked. This can be verified with the `rtrv-serial-num` command. The **EAGLE** is shipped with a serial number in the database, but the serial number is not locked. The serial number can be changed, if necessary, and locked once the **EAGLE** is on-site, by using the `ent-serial-num` command. The `ent-serial-num` command uses these parameters.

`: serial` – The serial number assigned to the EAGLE. The serial number is not case sensitive.

`: lock` – Specifies whether or not the serial number is locked. This parameter has only one value, `yes`, which locks the serial number. Once the serial number is locked, it cannot be changed.

Note: To enter and lock the **EAGLE**'s serial number, the `ent-serial-num` command must be entered twice, once to add the correct serial number to the database with the `serial` parameter, then again with the `serial` and the `lock=yes` parameters to lock the serial number. You should verify that the serial number in the database is correct before locking the serial number. The serial number can be found on a label affixed to the control shelf (shelf 1100).

The `chg-ctrl-feat` command uses these parameters:

`: partnum` – The Oracle-issued part number of the Circular Route Auto-Recovery feature, 893017601.

`: status=on` – used to turn the Circular Route Auto-Recovery feature on.

The status of the Circular Route Auto-Recovery feature is shown with the `rtrv-ctrl-feat` command.

Once the Circular Route Auto-Recovery feature has been turned on, it can be turned off. For more information on turning off the Circular Route Auto-Recovery feature, go to the [Turning Off the Circular Route Auto-Recovery Feature](#) procedure.

Once the Circular Route Auto-Recovery feature has been turned on, it automatically clears CRD when Far End Loopback is detected.

1. Display the controlled features in the database by entering the `rtrv-ctrl-feat` command. This is an example of the possible output.

```
rlghncxa03w 07-03-28 11:43:04 GMT EAGLE5 35.6.0
The following features have been permanently enabled:
```

Feature Name	Partnum	Status	Quantity
SCCP Conversion	893012001	on	----
EIR	893012301	on	----
GSM Map Screening (GMS)	893013201	on	----
HC-MIM SLK Capacity	893012707	on	64

The following features have been temporarily enabled:

Feature Name	Partnum	Status	Quantity	Trial Period Left
Zero entries found.				

The following features have expired temporary keys:

Feature Name	Partnum
Zero entries found.	

If the Circular Route Auto-Recovery feature is enabled, the entry `Circ Route Auto-Recovery` is shown in the permanently enabled section of the `rtrv-ctrl-feat` output. If the status of the Circular Route Auto-Recovery feature is on, no further action can be performed.

If the Circular Route Auto-Recovery feature is enabled but not turned on, skips steps 2 through 6 and go to step 7.

If the Circular Route Auto-Recovery feature is not enabled, go to step 2.

Note: If the `rtrv-ctrl-feat` output in step 1 shows any controlled features, skip steps 2 through 5, and go to step 6. If the `rtrv-ctrl-feat` output shows only HC-MIM SLK Capacity feature with a quantity of 64, steps 2 through 5 must be performed.

2. Display the serial number in the database with the `rtrv-serial-num` command.

This is an example of the possible output.

```
rlghncxa03w 07-05-28 21:15:37 GMT EAGLE5 37.0.0
System serial number = nt00001231
```

System serial number is not locked.

```
rlghncxa03w 07-10-28 21:15:37 GMT EAGLE5 37.0.0
Command Completed
```

Note: If the serial number is correct and locked, skip steps 4, 5, and 6, and go to step 7. If the serial number is correct but not locked, skip steps 4 and 5, and go to step 6. If the serial number is not correct, but is locked, the Circular Route Auto-Recovery feature cannot be enabled and the remainder of this procedure cannot be performed. Contact the Customer Care Center to get an incorrect and locked serial number changed. Refer to [My Oracle Support \(MOS\)](#) for the contact information. The serial number can be found on a label affixed to the control shelf (shelf 1100).

3. Enter the correct serial number into the database using the `ent-serial-num` command with the `serial` parameter.

For this example, enter this command.

```
ent-serial-num:serial=<EAGLE's correct serial number>
```

When this command has successfully completed, the following message should appear.

```
rlghncxa03w 07-05-28 21:15:37 GMT EAGLE5 37.0.0
ENT-SERIAL-NUM: MASP A - COMPLTD
```

4. Verify that the serial number entered into step 3 was entered correctly using the `rtrv-serial-num` command.

This is an example of the possible output.

```
rlghncxa03w 07-05-28 21:15:37 GMT EAGLE5 37.0.0
System serial number = nt00001231
```

```
System serial number is not locked.
```

```
rlghncxa03w 07-05-28 21:15:37 GMT EAGLE5 37.0.0
Command Completed
```

If the serial number was not entered correctly, repeat steps 3 and 4 and re-enter the correct serial number.

5. Lock the serial number in the database by entering the `ent-serial-num` command with the serial number shown in step 2, if the serial number shown in step 2 is correct, or with the serial number shown in step 4, if the serial number was changed in step 3, and with the `lock=yes` parameter.

For this example, enter this command.

```
ent-serial-num:serial=<EAGLE's serial number>:lock=yes
```

When this command has successfully completed, the following message should appear.

```
rlghncxa03w 07-05-28 21:15:37 GMT EAGLE5 37.0.0
ENT-SERIAL-NUM: MASP A - COMPLTD
```

6. Enable the Circular Route Auto-Recovery feature by entering the `enable-ctrl-feat` command. For this example, enter this command.

```
enable-ctrl-feat:partnum=893017603:fak= <Circular Route Auto-
Recovery feature access key>
```

Note: The values for the feature access key (the fak parameter) are provided by Oracle. If you do not have the feature access key for the Circular Route Auto-Recovery feature, contact your Oracle Sales Representative or Account Representative.

When the `enable-ctrl-feat` command has successfully completed, this message should appear.

```
rlghncxa03w 07-05-28 21:15:37 GMT EAGLE5 37.0.0
ENABLE-CTRL-FEAT: MASP B - COMPLTD
```

7. Turn the Circular Route Auto-Recovery feature on by entering the `chg-ctrl-feat` command with the part number used in step 6 and the `status=on` parameter.

For this example, enter this command.

```
chg-ctrl-feat:partnum=893017601:status=on
```

When this command has successfully completed, the following message should appear.

```
rlghncxa03w 07-03-28 21:15:37 GMT EAGLE5 35.6.0
CHG-CTRL-FEAT: MASP A - COMPLTD
```

8. Verify the changes by entering this command.

```
rtrv-ctrl-feat:partnum=893017601
```

The following is an example of the possible output.

```
rlghncxa03w 07-05-28 21:15:37 GMT EAGLE5 37.0.0
The following features have been permanently enabled:
```

Feature Name	Partnum	Status	Quantity
Circ Route Auto-Recovery	893017601	on	----

The following features have been temporarily enabled:

Feature Name	Partnum	Status	Quantity	Trial Period Left
Zero entries found.				

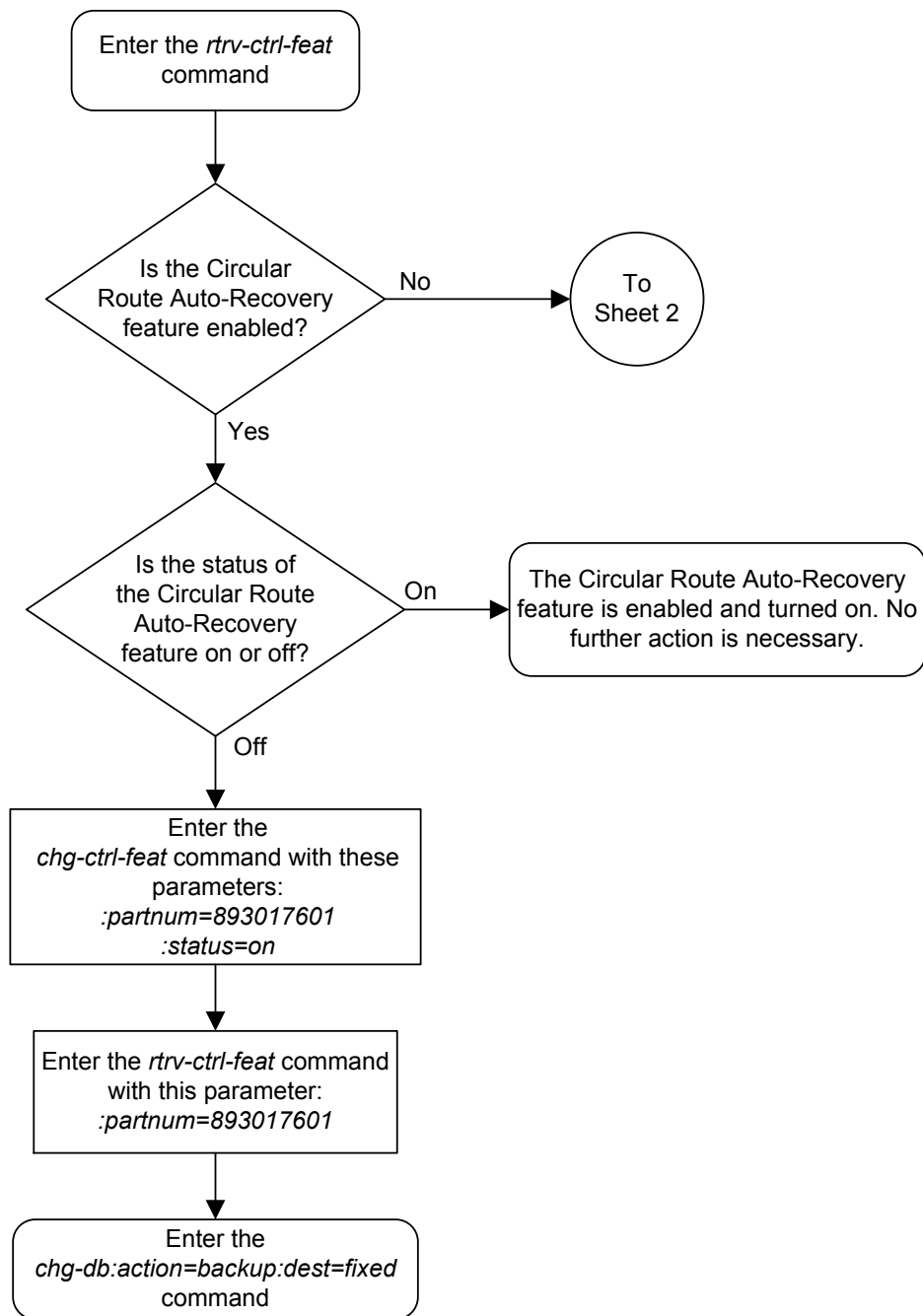
The following features have expired temporary keys:

Feature Name	Partnum
Zero entries found.	

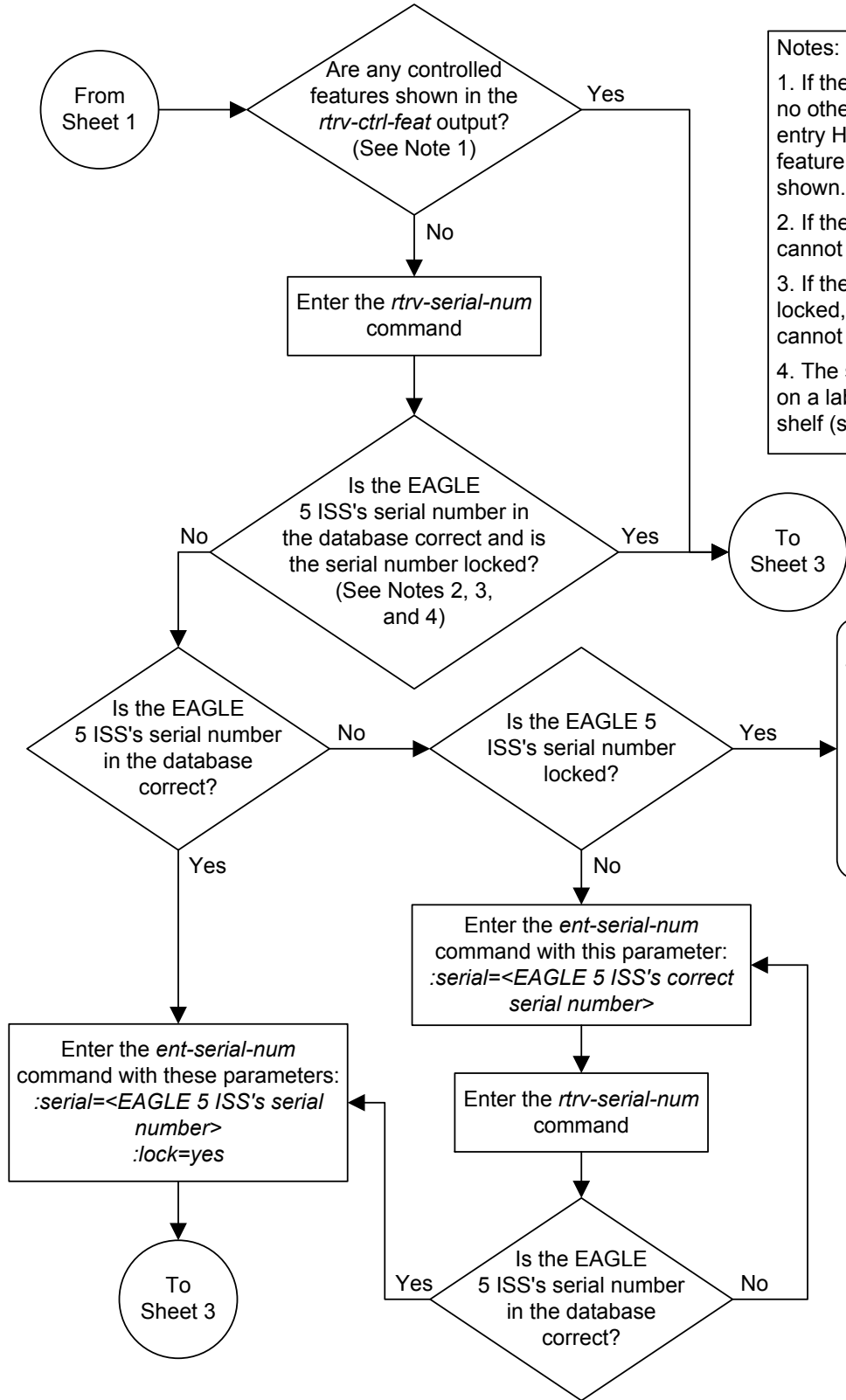
9. Back up the new changes, using the `chg-db:action=backup:dest=fixed` command.

These messages should appear; the active **Maintenance and Administration Subsystem Processor (MASP)** appears first.

```
BACKUP (FIXED): MASP A - Backup starts on active MASP.
BACKUP (FIXED): MASP A - Backup on active MASP to fixed disk complete.
BACKUP (FIXED): MASP A - Backup starts on standby MASP.
BACKUP (FIXED): MASP A - Backup on standby MASP to fixed disk complete.
```


Figure 3-45 Activating the Circular Route Auto-Recovery Feature

Sheet 1 of 3

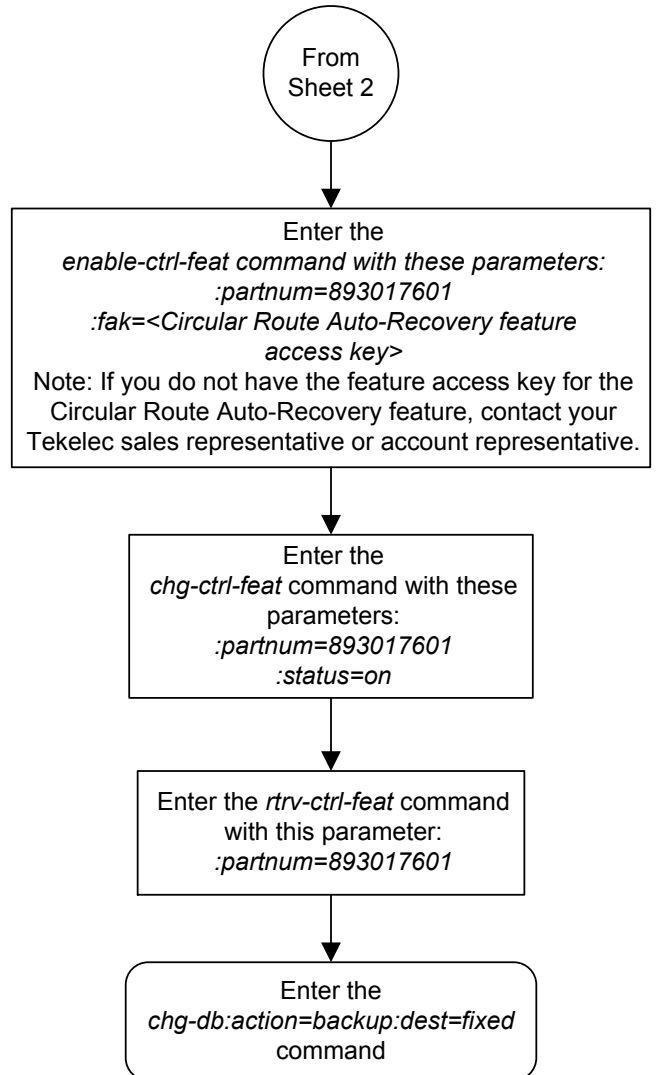


Notes:

1. If the *rtrv-ctrl-feat* output shows no other features, only the entry HC-MIM SLK Capabilities feature with a quantity of 1 is shown.
2. If the serial number is locked, the controlled feature cannot be enabled.
3. If the serial number is not in the database, the controlled feature cannot be enabled.
4. The serial number can be found on a label affixed to the chassis shelf (shelf 1100).

This feature cannot be enabled without the correct serial number in the database. For more information, see Customer Care Center, correct serial number into the database. See "Customer Care Center" in Chapter 1 for more information.

Sheet 2 of 3



Turning Off the Circular Route Auto-Recovery Feature

This procedure is used to turn off the Circular Route Auto-Recovery feature using the `chg-ctrl-feat` command.

The `chg-ctrl-feat` command uses these parameters:

`:partnum` – The Oracle-issued part number of the Circular Route Auto-Recovery feature, 893017601.

`:status=off` – used to turn off the Circular Route Auto-Recovery feature.

The status of the Circular Route Auto-Recovery feature must be `on` and is shown with the `rtrv-ctrl-feat` command.

Caution: Circular Route Auto-Recovery will not be performed if the Circular Route Auto-Recovery feature is turned off.

1. Display the status of the Circular Route Auto-Recovery feature by entering the `rtrv-ctrl-feat:partnum=893017601` command. The following is an example of the possible output.

```
rlghncxa03w 07-03-28 11:43:04 GMT EAGLE5 35.6.0
The following features have been permanently enabled:
```

Feature Name	Partnum	Status	Quantity
Circ Route Auto-Recovery	893017601	on	----

The following features have been temporarily enabled:

Feature Name	Partnum	Status	Quantity	Trial Period Left
Zero entries found.				

The following features have expired temporary keys:

Feature Name	Partnum
Zero entries found.	

If the status of the Circular Route Auto-Recovery feature is `off`, or if the Circular Route Auto-Recovery feature is not enabled, this procedure cannot be performed.

2. Turn off the Circular Route Auto-Recovery feature by entering the `chg-ctrl-feat` command with the `status=off` parameter.

For this example, enter this command.

```
chg-ctrl-feat:partnum=893017601:status=off
```

When this command has successfully completed, the following message should appear.

```
rlghncxa03w 07-03-28 21:15:37 GMT EAGLE5 35.6.0
CHG-CTRL-FEAT: MASP A - COMPLTD
```

3. Verify that the Circular Route Auto-Recovery feature has been turned off by using the `rtrv-ctrl-feat:partnum=893017601` command. The following is an example of the possible output.

rlghncxa03w 07-05-28 21:15:37 GMT EAGLE5 37.0.0

The following features have been permanently enabled:

Feature Name	Partnum	Status	Quantity
Circ Route Auto-Recovery	893017601	off	----

The following features have been temporarily enabled:

Feature Name	Partnum	Status	Quantity	Trial Period Left
Zero entries found.				

The following features have expired temporary keys:

Feature Name	Partnum
Zero entries found.	

4. Back up the new changes, using the `chg-db:action=backup:dest=fixed` command.

These messages should appear; the active **Maintenance and Administration Subsystem Processor (MASP)** appears first.

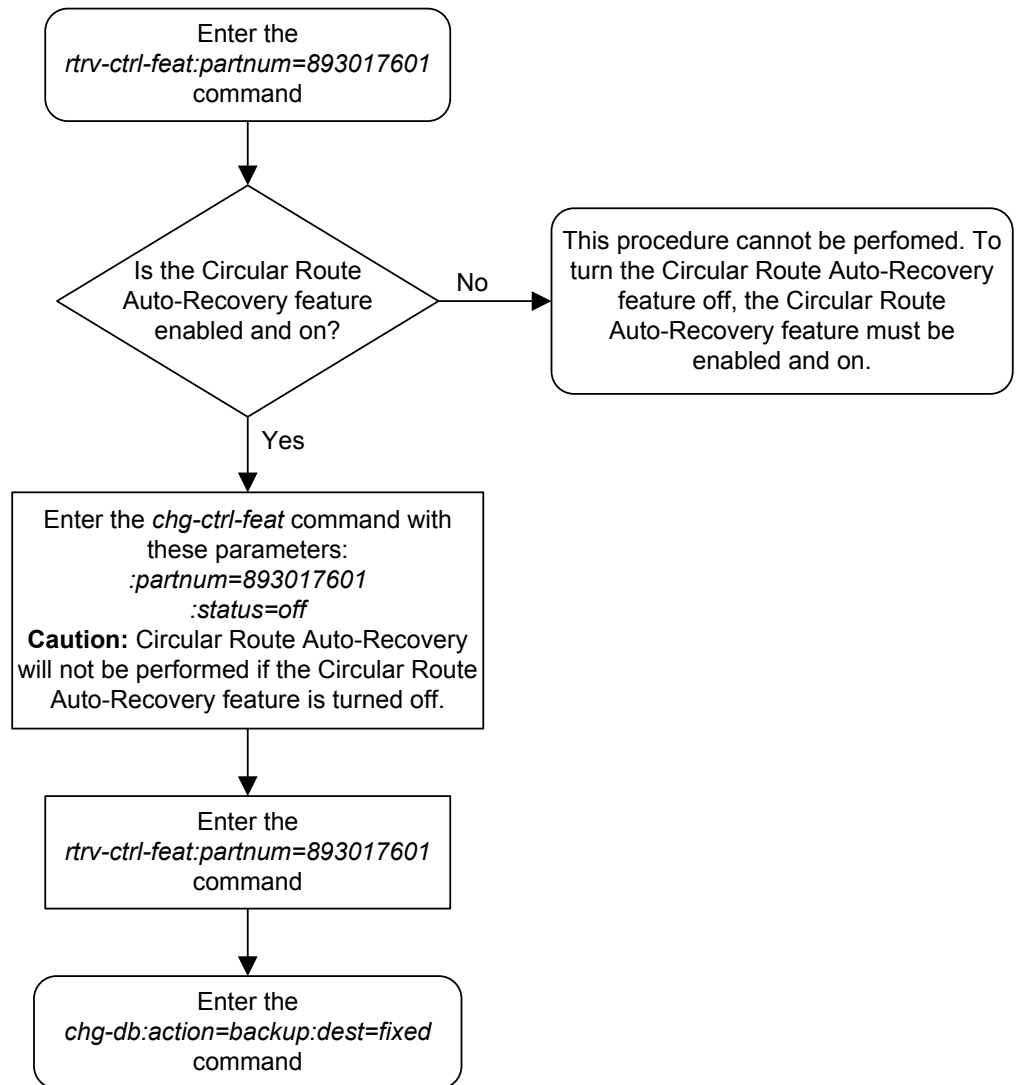
BACKUP (FIXED): MASP A - Backup starts on active MASP.

BACKUP (FIXED): MASP A - Backup on active MASP to fixed disk complete.

BACKUP (FIXED): MASP A - Backup starts on standby MASP.

BACKUP (FIXED): MASP A - Backup on standby MASP to fixed disk complete.

Figure 3-46 Turning Off the Circular Route Auto-Recovery Feature



Activating the Enhanced Far-End Loopback Detection Feature

This procedure is used to enable and turn on the Enhanced Far-End Loopback Detection feature using the feature's part number and a feature access key.

The feature access key for the Enhanced Far-End Loopback Detection feature is based on the features part number and the serial number of the EAGLE, making the feature access key site-specific.

The `enable-ctrl-feat` command enables the feature by inputting the features access key and the features part number with these parameters:

`: fak` – The feature access key provided by Oracle.

`: partnum` – The Oracle-issued part number of the Enhanced Far-End Loopback Detection feature, 893017601.

Once this feature is enabled, it is permanently enabled. This feature cannot be enabled with a temporary feature access key.

The `enable-ctrl-feat` command requires a valid serial number for the **EAGLE** to be configured in the database, and that this serial number is locked. This can be verified with the `rtrv-serial-num` command. The **EAGLE** is shipped with a serial number in the database, but the serial number is not locked. The serial number can be changed, if necessary, and locked once the **EAGLE** is on-site, by using the `ent-serial-num` command. The `ent-serial-num` command uses these parameters.

`: serial` – The serial number assigned to the EAGLE. The serial number is not case sensitive.

`: lock` – Specifies whether or not the serial number is locked. This parameter has only one value, `yes`, which locks the serial number. Once the serial number is locked, it cannot be changed.

Note: To enter and lock the **EAGLE**'s serial number, the `ent-serial-num` command must be entered twice, once to add the correct serial number to the database with the `serial` parameter, then again with the `serial` and the `lock=yes` parameters to lock the serial number. You should verify that the serial number in the database is correct before locking the serial number. The serial number can be found on a label affixed to the control shelf (shelf 1100).

The `chg-ctrl-feat` command uses these parameters:

`: partnum` – The Oracle-issued part number of the Circular Route Auto-Recovery feature, 893018101.

`: status=on` – used to turn the Enhanced Far-End Loopback Detection feature on.

The status of the Enhanced Far-End Loopback Detection feature is shown with the `rtrv-ctrl-feat` command.

Once the Enhanced Far-End Loopback Detection feature has been turned on, it can be turned off. For more information on turning off the Enhanced Far-End Loopback Detection feature, go to the [Turning Off the Enhanced Far-End Loopback Detection Feature](#) procedure.

Once the Enhanced Far-End Loopback Detection feature has been turned on, it significantly decreases the time required to take a link out of service. Whenever a trigger event occurs that indicates that Far-End Loopback may have occurred, the

EAGLE will send an SLTM within 250 milliseconds after the trigger event has occurred. Normal processing of this SLTM will take the link out of service if the same SLTM is received at the OPC. The Enhanced Far-End Loopback feature will fail the link as quickly as possible. This rapid failure will prevent the EAGLE from marking DPCs as CRD-prohibited.

1. Display the controlled features in the database by entering the `rtrv-ctrl-feat` command. This is an example of the possible output.

```
rlghncxa03w 07-03-28 11:43:04 GMT EAGLE5 35.6.0
The following features have been permanently enabled:
```

Feature Name	Partnum	Status	Quantity
SCCP Conversion	893012001	on	----
EIR	893012301	on	----
GSM Map Screening (GMS)	893013201	on	----
HC-MIM SLK Capacity	893012707	on	64

The following features have been temporarily enabled:

Feature Name	Partnum	Status	Quantity	Trial Period Left
Zero entries found.				

The following features have expired temporary keys:

Feature Name	Partnum
Zero entries found.	

If the Enhanced Far-End Loopback Detection feature is enabled, the entry Enhanced Far-End Loopback is shown in the permanently enabled section of the `rtrv-ctrl-feat` output. If the status of the Enhanced Far-End Loopback Detection feature is on, no further action can be performed.

If the Enhanced Far-End Loopback Detection feature is enabled but not turned on, skips steps 2 through 6 and go to step 7.

If the Enhanced Far-End Loopback Detection feature is not enabled, go to step 2.

Note: If the `rtrv-ctrl-feat` output in step 1 shows any controlled features, skip steps 2 through 5, and go to step 6. If the `rtrv-ctrl-feat` output shows only the HC-MIM SLK Capacity feature with a quantity of 64, steps 2 through 5 must be performed.

2. Display the serial number in the database with the `rtrv-serial-num` command.

This is an example of the possible output.

```
rlghncxa03w 07-05-28 21:15:37 GMT EAGLE5 37.0.0
System serial number = nt00001231
```

System serial number is not locked.

```
rlghncxa03w 07-10-28 21:15:37 GMT EAGLE5 37.0.0
Command Completed
```

Note: If the serial number is correct and locked, skip steps 4, 5, and 6, and go to step 7. If the serial number is correct but not locked, skip steps 4 and 5, and go to step 6. If the serial number is not correct, but is locked, the Circular Route Auto-Recovery feature cannot be enabled and the remainder of this procedure cannot be performed. Contact the Customer Care Center to get an incorrect and locked serial number changed. Refer to [My Oracle Support \(MOS\)](#) for the contact information. The serial number can be found on a label affixed to the control shelf (shelf 1100).

3. Enter the correct serial number into the database using the `ent-serial-num` command with the `serial` parameter.

For this example, enter this command.

```
ent-serial-num:serial=<EAGLE's correct serial number>
```

When this command has successfully completed, the following message should appear.

```
rlghncxa03w 07-05-28 21:15:37 GMT EAGLE5 37.0.0
ENT-SERIAL-NUM: MASP A - COMPLTD
```

4. Verify that the serial number entered into step 3 was entered correctly using the `rtrv-serial-num` command.

This is an example of the possible output.

```
rlghncxa03w 07-05-28 21:15:37 GMT EAGLE5 37.0.0
System serial number = nt00001231
```

```
System serial number is not locked.
```

```
rlghncxa03w 07-05-28 21:15:37 GMT EAGLE5 37.0.0
Command Completed
```

If the serial number was not entered correctly, repeat steps 3 and 4 and re-enter the correct serial number.

5. Lock the serial number in the database by entering the `ent-serial-num` command with the serial number shown in step 2, if the serial number shown in step 2 is correct, or with the serial number shown in step 4, if the serial number was changed in step 3, and with the `lock=yes` parameter.

For this example, enter this command.

```
ent-serial-num:serial=<EAGLE's serial number>:lock=yes
```

When this command has successfully completed, the following message should appear.

```
rlghncxa03w 07-05-28 21:15:37 GMT EAGLE5 37.0.0
ENT-SERIAL-NUM: MASP A - COMPLTD
```

6. Enable the Enhanced Far-End Loopback Detection feature by entering the `enable-ctrl-feat` command. For this example, enter this command.

```
enable-ctrl-feat:partnum=893018103:fak= <Enhanced Far-End
Loopback Detection feature access key>
```

Note: The values for the feature access key (the fak parameter) are provided by Oracle. If you do not have the feature access key for the Enhanced Far-End Loopback Detection feature, contact your Oracle Sales Representative or Account Representative.

When the `enable-ctrl-feat` command has successfully completed, this message should appear.

```
rlghncxa03w 07-05-28 21:15:37 GMT EAGLE5 37.0.0
ENABLE-CTRL-FEAT: MASP B - COMPLTD
```

- Turn the Enhanced Far-End Loopback Detection feature on by entering the `chg-ctrl-feat` command with the part number used in step 6 and the `status=on` parameter.

For this example, enter this command.

```
chg-ctrl-feat:partnum=893018101:status=on
```

When this command has successfully completed, the following message should appear.

```
rlghncxa03w 07-03-28 21:15:37 GMT EAGLE5 35.6.0
CHG-CTRL-FEAT: MASP A - COMPLTD
```

- Verify the changes by entering this command.

```
rtrv-ctrl-feat:partnum=893018101
```

The following is an example of the possible output.

```
rlghncxa03w 07-05-28 21:15:37 GMT EAGLE5 37.0.0
The following features have been permanently enabled:
```

Feature Name	Partnum	Status	Quantity
Enhanced Far-End Loopback	893018101	on	----

The following features have been temporarily enabled:

Feature Name	Partnum	Status	Quantity	Trial Period Left
Zero entries found.				

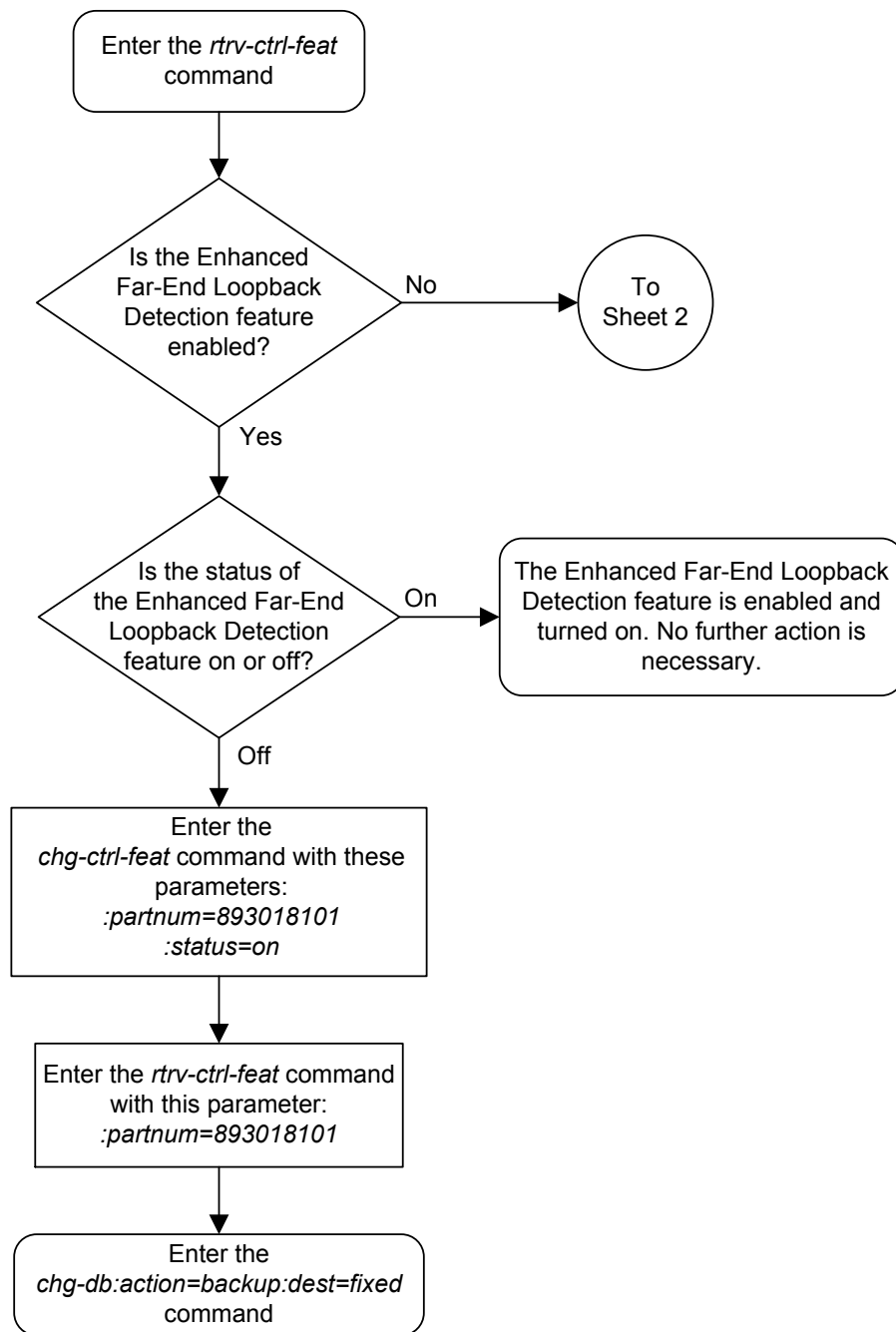
The following features have expired temporary keys:

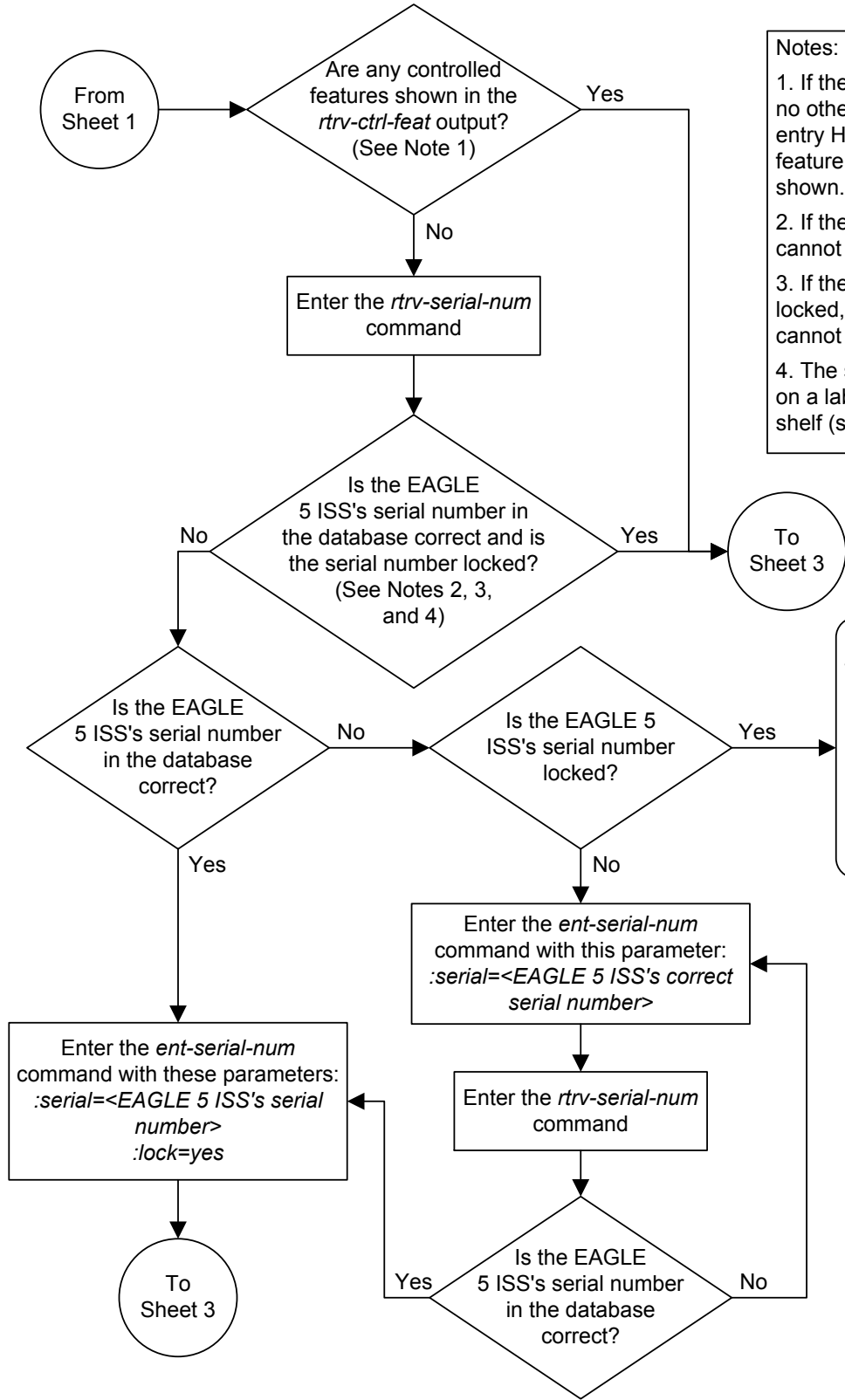
Feature Name	Partnum
Zero entries found.	

- Back up the new changes, using the `chg-db:action=backup:dest=fixed` command.

These messages should appear; the active **Maintenance and Administration Subsystem Processor (MASP)** appears first.

```
BACKUP (FIXED): MASP A - Backup starts on active MASP.
BACKUP (FIXED): MASP A - Backup on active MASP to fixed disk complete.
BACKUP (FIXED): MASP A - Backup starts on standby MASP.
BACKUP (FIXED): MASP A - Backup on standby MASP to fixed disk complete.
```

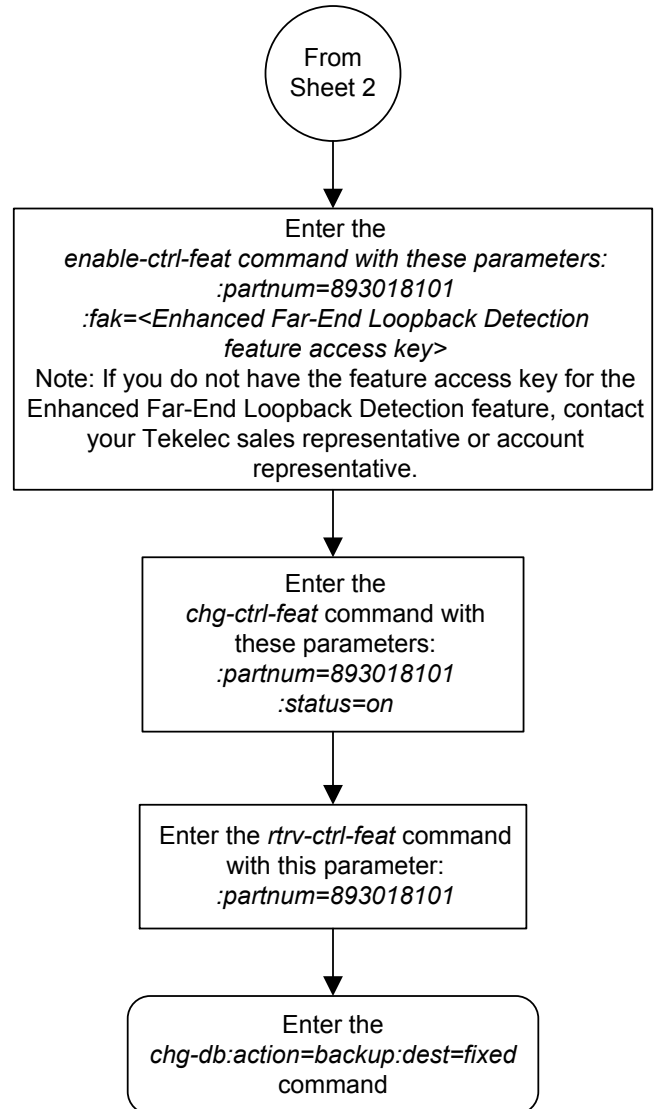
Figure 3-47 Activating the Enhanced Far-End Loopback Detection Feature



Notes:

1. If the *rtrv-ctrl-feat* output shows no other features, only the entry HC-MIM SLK Capabilities feature with a quantity of 1 is shown.
2. If the serial number is locked, the controlled feature cannot be enabled.
3. If the serial number is not in the database, the controlled feature cannot be enabled.
4. The serial number can be found on a label affixed to the chassis (shelf 1100).

This feature cannot be enabled without the correct serial number in the database. For more information, see Customer Care Center, correct serial number into the database. See "Customer Care Center" in Chapter 1 for more information.



Turning Off the Enhanced Far-End Loopback Detection Feature

This procedure is used to turn off the Enhanced Far-End Loopback Detection feature using the `chg-ctrl-feat` command.

The `chg-ctrl-feat` command uses these parameters:

`:partnum` – The Oracle-issued part number of the Enhanced Far-End Loopback Detection feature, 893018101.

`:status=off` – used to turn off the Enhanced Far-End Loopback Detection feature.

The status of the Enhanced Far-End Loopback Detection feature must be on and is shown with the `rtrv-ctrl-feat` command.

Caution: Enhanced Far-End Loopback Detection will not be performed if the Enhanced Far-End Loopback Detection feature is turned off.

1. Display the status of the Enhanced Far-End Loopback Detection feature by entering the `rtrv-ctrl-feat:partnum=893018101` command. The following is an example of the possible output.

```
rlghncxa03w 07-03-28 11:43:04 GMT EAGLE5 35.6.0
The following features have been permanently enabled:
```

Feature Name	Partnum	Status	Quantity
Enhanced Far-End Loopback	893018101	on	----

```
The following features have been temporarily enabled:
```

Feature Name	Partnum	Status	Quantity	Trial Period Left
Zero entries found.				

```
The following features have expired temporary keys:
```

Feature Name	Partnum
Zero entries found.	

If the status of the Enhanced Far-End Loopback Detection feature is off, or if the Enhanced Far-End Loopback Detection feature is not enabled, this procedure cannot be performed.

2. Turn off the Enhanced Far-End Loopback Detection feature by entering the `chg-ctrl-feat` command with the `status=off` parameter.

For this example, enter this command.

```
chg-ctrl-feat:partnum=893018101:status=off
```

When this command has successfully completed, the following message should appear.

```
rlghncxa03w 07-03-28 21:15:37 GMT EAGLE5 35.6.0
CHG-CTRL-FEAT: MASP A - COMPLTD
```

3. Verify that the Enhanced Far-End Loopback Detection feature has been turned off by using the `rtrv-ctrl-feat:partnum=893018101` command. The following is an example of the possible output.

rlghncxa03w 07-05-28 21:15:37 GMT EAGLE5 37.0.0

The following features have been permanently enabled:

Feature Name	Partnum	Status	Quantity
Enhanced Far-End Loopback	893018101	on	----

The following features have been temporarily enabled:

Feature Name	Partnum	Status	Quantity	Trial Period Left
Zero entries found.				

The following features have expired temporary keys:

Feature Name	Partnum
Zero entries found.	

4. Back up the new changes, using the `chg-db:action=backup:dest=fixed` command.

These messages should appear; the active **Maintenance and Administration Subsystem Processor (MASP)** appears first.

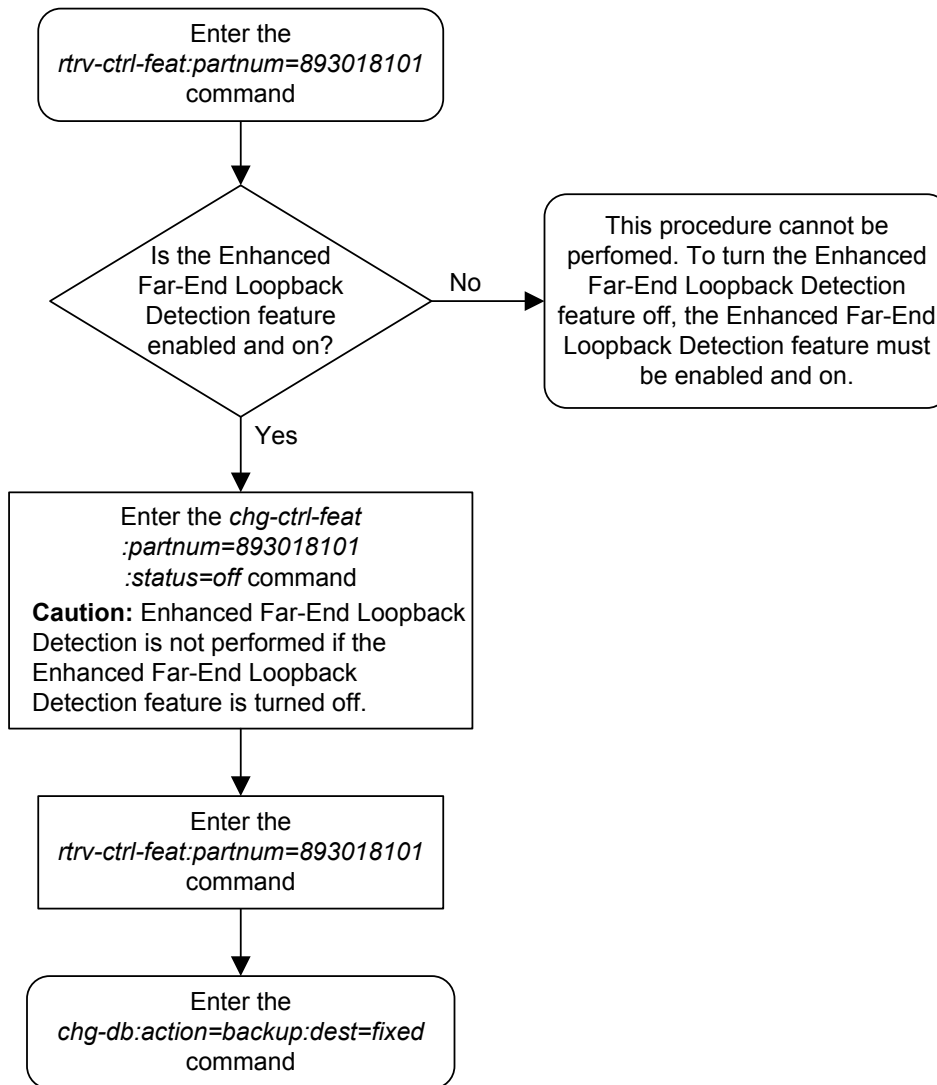
BACKUP (FIXED): MASP A - Backup starts on active MASP.

BACKUP (FIXED): MASP A - Backup on active MASP to fixed disk complete.

BACKUP (FIXED): MASP A - Backup starts on standby MASP.

BACKUP (FIXED): MASP A - Backup on standby MASP to fixed disk complete.

Figure 3-48 Turning Off the Enhanced Far-End Loopback Detection Feature



Activating the Multiple Linksets to Single Adjacent PC (MLS) Feature

This procedure is used to enable and turn on the Multiple Linksets to Single Adjacent PC (MLS) feature with the `enable-ctrl-feat` and `chg-ctrl-feat` commands.

The `enable-ctrl-feat` command enables the Multiple Linksets to Single Adjacent PC (MLS) feature by specifying the part number and feature access key for this feature with these parameters:

`:fak` – The feature access key supplied by Oracle. The feature access key contains 13 alphanumeric characters and is not case sensitive. If you do not have the feature access key for the proxy point code quantity you wish to enable, contact your Oracle Sales Representative or Account Representative.

`:partnum` – The Oracle-issued part number for the Multiple Linksets to Single Adjacent PC (MLS), 893019701.

The `enable-ctrl-feat` command requires a valid serial number for the **EAGLE** to be configured in the database, and that this serial number is locked. This can be verified with the `rtrv-serial-num` command. The **EAGLE** is shipped with a serial number in the database, but the serial number is not locked. The serial number can be changed, if necessary, and locked once the **EAGLE** is on-site, by using the `ent-serial-num` command. The `ent-serial-num` command uses these parameters.

`:serial` – The serial number assigned to the **EAGLE**. The serial number is not case sensitive.

`:lock` – Specifies whether or not the serial number is locked. This parameter has only one value, `yes`, which locks the serial number. Once the serial number is locked, it cannot be changed.

Note: To enter and lock the **EAGLE**'s serial number, the `ent-serial-num` command must be entered twice, once to add the correct serial number to the database with the `serial` parameter, then again with the `serial` and the `lock=yes` parameters to lock the serial number. You should verify that the serial number in the database is correct before locking the serial number. The serial number can be found on a label affixed to the control shelf (shelf 1100).

To enable the Multiple Linksets to Single Adjacent PC (MLS) feature, the Multiple Point Code feature must be turned on using the `chg-feat` command. The `rtrv-feat` command shows whether or not the Multiple Point Code feature is turned on.

Note: Once the Multiple Point Code feature is turned on with the `chg-feat` command, it cannot be turned off.

The Multiple Point Code feature must be purchased before you turn this feature on with the `chg-feat` command. If you are not sure if you have purchased the Multiple Point Code feature, contact your Oracle Sales Representative or Account Representative.

The `chg-ctrl-feat` command uses these parameters:

`:partnum` – The Oracle-issued part number of the Multiple Linksets to Single Adjacent PC (MLS) feature, 893019701.

:status=on – used to turn the Multiple Linksets to Single Adjacent PC (MLS) feature on.

The status of this feature in the **EAGLE** is shown with the `rtrv-ctrl-feat` command.

After this feature is enabled and turned on, an adjacent point code can be assigned to a maximum of six linksets.

1. Display the features that are enabled by entering the `rtrv-ctrl-feat` command.

The following is an example of the possible output.

```
rlghncxa03w 07-05-28 21:15:37 GMT EAGLE5 37.0.0
The following features have been permanently enabled:
```

Feature Name	Partnum	Status	Quantity
Command Class Management	893005801	on	----
LNP Short Message Service	893006601	on	----
Intermed GTT Load Sharing	893006901	on	----
XGTT Table Expansion	893006101	on	4000000
XMAP Table Expansion	893007710	on	3000
Large System # Links	893005901	on	1500
Routesets	893006401	on	6000
HC-MIM SLK Capacity	893012707	on	64

The following features have been temporarily enabled:

Feature Name	Partnum	Status	Quantity	Trial Period Left
Zero entries found.				

The following features have expired temporary keys:

Feature Name	Partnum
Zero entries found.	

If the Multiple Linksets to Single Adjacent PC (MLS) feature is enabled and turned on, the entry `MLS` is shown in the permanently enabled section of the `rtrv-ctrl-feat` output. If the status of the Origin-Based MTP Routing feature is on, no further action can be performed.

If the Multiple Linksets to Single Adjacent PC (MLS) feature is enabled but not turned on, continue the procedure with [9](#).

If the Multiple Linksets to Single Adjacent PC (MLS) feature is not enabled, continue the procedure with [2](#).

2. Enter the `rtrv-feat` command and verify that the Multiple Point Code feature is turned on.

If the Multiple Point Code feature is on, the `MPC = on` entry appears in the output.

Note: The `rtrv-feat` command output contains other fields that are not used by this procedure. If you wish to see all the fields displayed by the `rtrv-feat` command, see the `rtrv-feat` command description in *Commands User's Guide*.

If the Multiple Point Code feature is not on, continue the procedure with [3](#).

If the Multiple Point Code feature is on, continue the procedure with [4](#).

If the `rtrv-ctrl-feat` output in [1](#) shows any controlled features, continue the procedure with [Oracle](#). If the `rtrv-ctrl-feat` output shows only the HC-MIM SLK Capacity feature with a quantity of 64, [4](#) through [7](#) must be performed.

3. Turn the Multiple Point Code feature on by entering this command.

```
chg-feat:mpc=on
```

Note: Once the Multiple Point Code feature is turned on with the `chg-feat` command, it cannot be turned off.

The Multiple Point Code feature must be purchased before you turn this feature on with the `chg-feat` command. If you are not sure if you have purchased the Multiple Point Code feature, contact your Oracle Sales Representative or Account Representative.

When the `chg-feat` has successfully completed, this message appears.

```
rlghncxa03w 07-05-28 11:43:04 GMT EAGLE5 37.0.0
CHG-FEAT: MASP A - COMPLTD
```

Continue the procedure with [4](#).

If the `rtrv-ctrl-feat` output in [1](#) shows any controlled features, continue the procedure with [Oracle](#). If the `rtrv-ctrl-feat` output shows only the HC-MIM SLK Capacity feature with a quantity of 64, [4](#) through [7](#) must be performed.

4. Display the serial number in the database with the `rtrv-serial-num` command.

This is an example of the possible output.

```
rlghncxa03w 07-05-28 21:15:37 GMT EAGLE5 37.0.0
System serial number = nt00001231
```

```
System serial number is not locked, yet.
```

Note: If the serial number is correct and locked, continue the procedure with [Oracle](#). If the serial number is correct but not locked, continue the procedure with [7](#). If the serial number is not correct, but is locked, the Multiple Linksets to Single Adjacent PC (MLS) feature cannot be enabled and the remainder of this procedure cannot be performed. Contact the Customer Care Center to get an incorrect and locked serial number changed. Refer to [My Oracle Support \(MOS\)](#) for the contact information. The serial number can be found on a label affixed to the control shelf (shelf 1100).

5. Enter the correct serial number into the database using the `ent-serial-num` command with the `serial` parameter.

For this example, enter this command.

```
ent-serial-num:serial=<EAGLE's correct serial number>
```

When this command has successfully completed, the following message should appear.

```
rlghncxa03w 07-05-28 21:15:37 GMT EAGLE5 37.0.0
ENT-SERIAL-NUM: MASP A - COMPLTD
```

6. Verify that the serial number entered into 5 was entered correctly using the `rtrv-serial-num` command.

This is an example of the possible output.

```
rlghncxa03w 07-05-28 21:15:37 GMT EAGLE5 37.0.0
System serial number = nt00001231
```

System serial number is not locked, yet.

If the serial number was not entered correctly, repeat 5 and 6 and re-enter the correct serial number.

7. Lock the serial number in the database by entering the `ent-serial-num` command with the serial number shown in 4, if the serial number shown in 4 is correct, or with the serial number shown in 6, if the serial number was changed in 5, and with the `lock=yes` parameter.

For this example, enter this command.

```
ent-serial-num:serial=<EAGLE's serial number>:lock=yes
```

When this command has successfully completed, the following message should appear.

```
rlghncxa03w 07-05-28 21:15:37 GMT EAGLE5 37.0.0
ENT-SERIAL-NUM: MASP A - COMPLTD
```

8. Enable the Multiple Linksets to Single Adjacent PC (MLS) feature with the `enable-ctrl-feat` command specifying the part number for the Multiple Linksets to Single Adjacent PC (MLS) feature and the feature access key.

For this example, enter this command.

```
enable-ctrl-feat:partnum=893019701:fak=<Multiple Linksets to
Single Adjacent PC (MLS) feature access key>
```

Note: A temporary feature access key cannot be specified to enable the Multiple Linksets to Single Adjacent PC (MLS) feature.

Note: The values for the feature access key (the `fak` parameter) are provided by Oracle. If you do not have the feature access key for the Multiple Linksets to Single Adjacent PC (MLS) feature you wish to enable, contact your Oracle Sales Representative or Account Representative.

When the `enable-ctrl-feat` command has successfully completed, this message should appear.

```
rlghncxa03w 07-05-28 21:15:37 GMT EAGLE5 37.0.0
ENABLE-CTRL-FEAT: MASP B - COMPLTD
```


9. Turn the Multiple Linksets to Single Adjacent PC (MLS) feature on by entering the `chg-ctrl-feat` command with the part number used in [Oracle](#) and the `status=on` parameter.

Caution: Once the Multiple Linksets to Single Adjacent PC (MLS) feature is turned on, it cannot be turned off.

For this example, enter this command.

```
chg-ctrl-feat:partnum=893019701:status=on
```

When this command has successfully completed, the following message should appear.

```
rlghncxa03w 06-10-28 21:15:37 GMT EAGLE5 36.0.0
CHG-CTRL-FEAT: MASP A - COMPLTD
```

10. Verify the changes by entering the `rtrv-ctrl-feat` command with the routeset quantity part number specified in 9.

For this example, enter this command.

```
rtrv-ctrl-feat:partnum=893019701
```

The following is an example of the possible output.

```
rlghncxa03w 07-05-28 21:15:37 GMT EAGLE5 37.0.0
The following features have been permanently enabled:
```

Feature Name	Partnum	Status	Quantity
Multiple Linkset to APC	893019701	on	----

The following features have been temporarily enabled:

Feature Name	Partnum	Status	Quantity	Trial Period Left
Zero entries found.				

The following features have expired temporary keys:

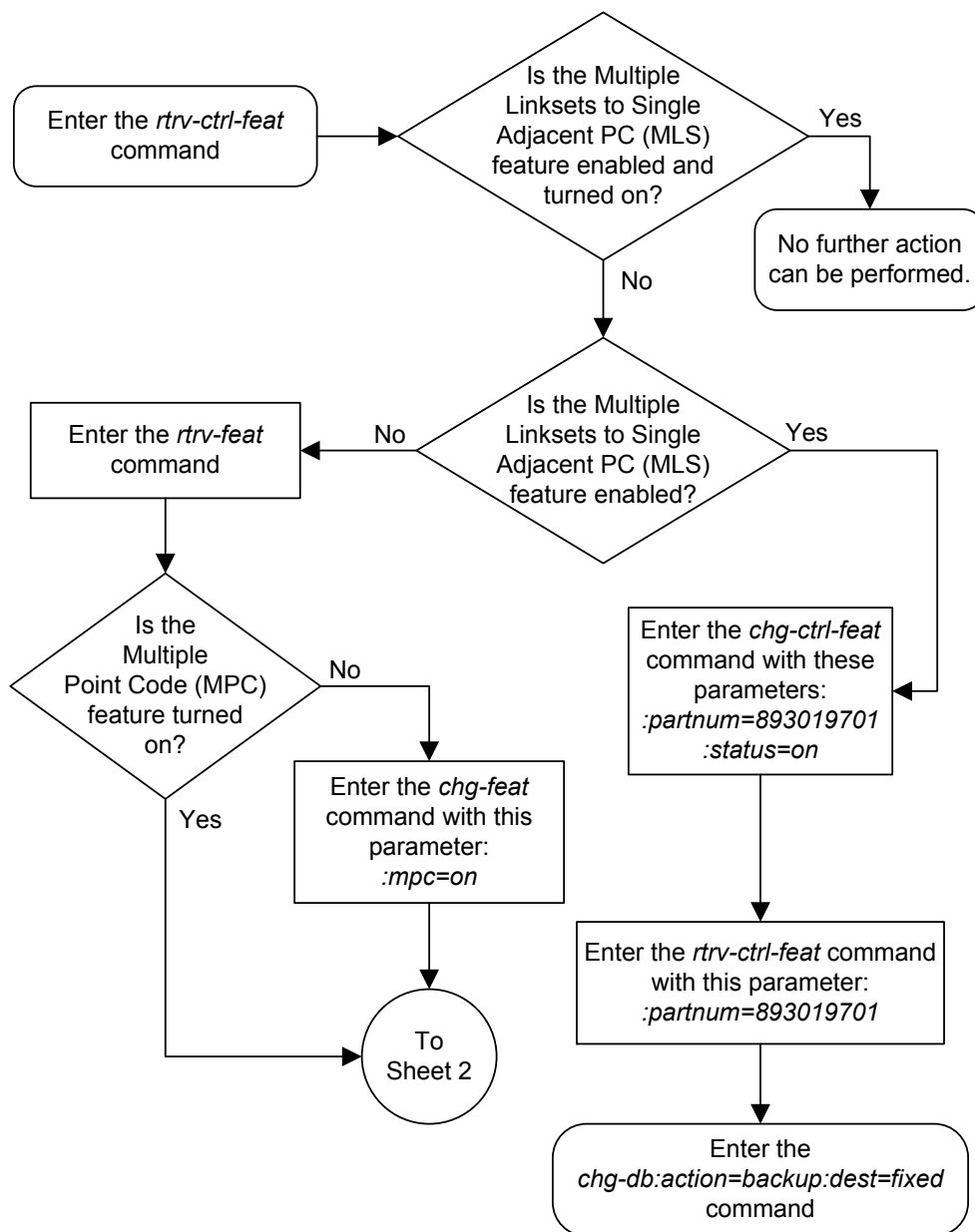
Feature Name	Partnum
Zero entries found.	

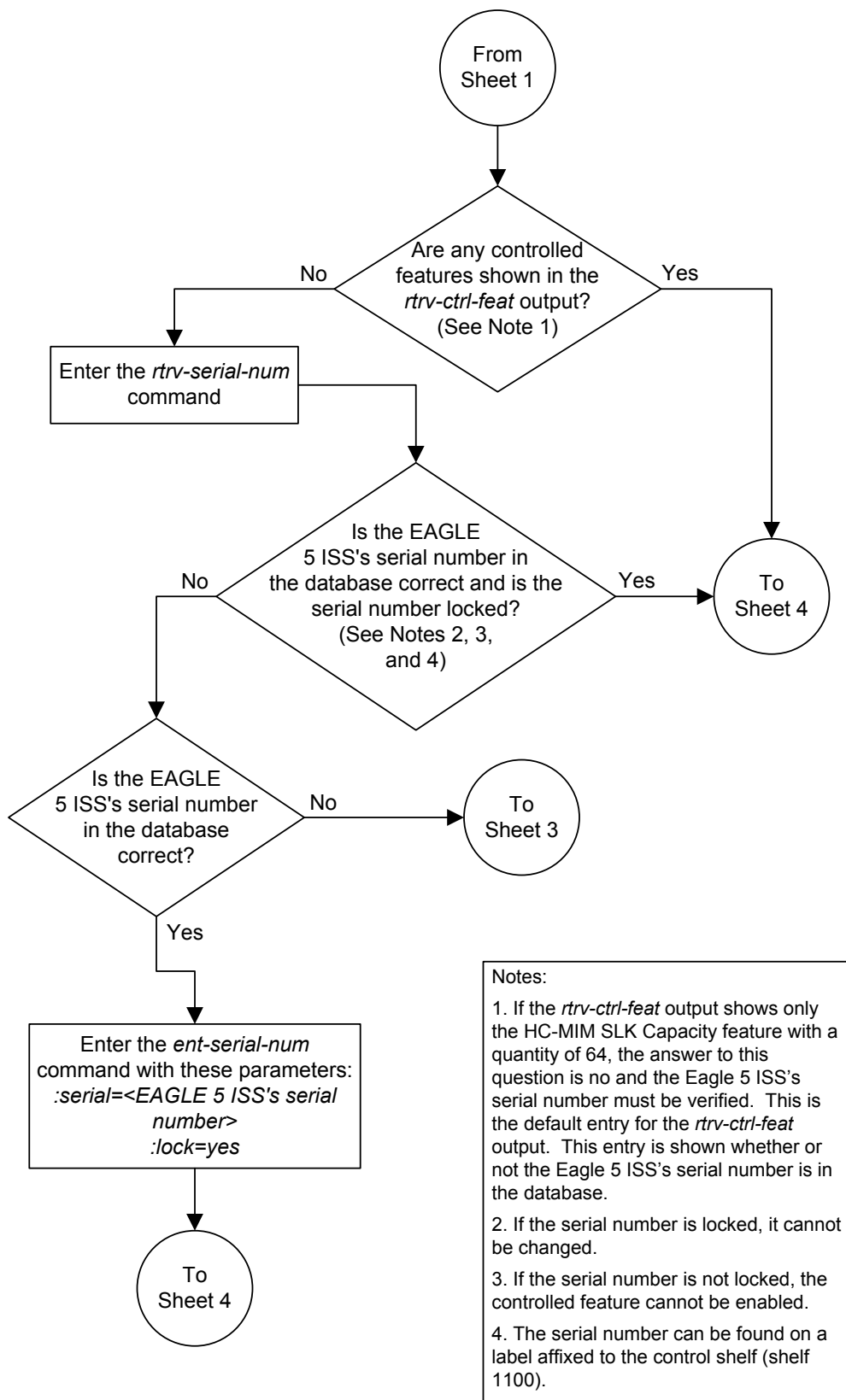
11. Back up the new changes, using the `chg-db:action=backup:dest=fixed` command.

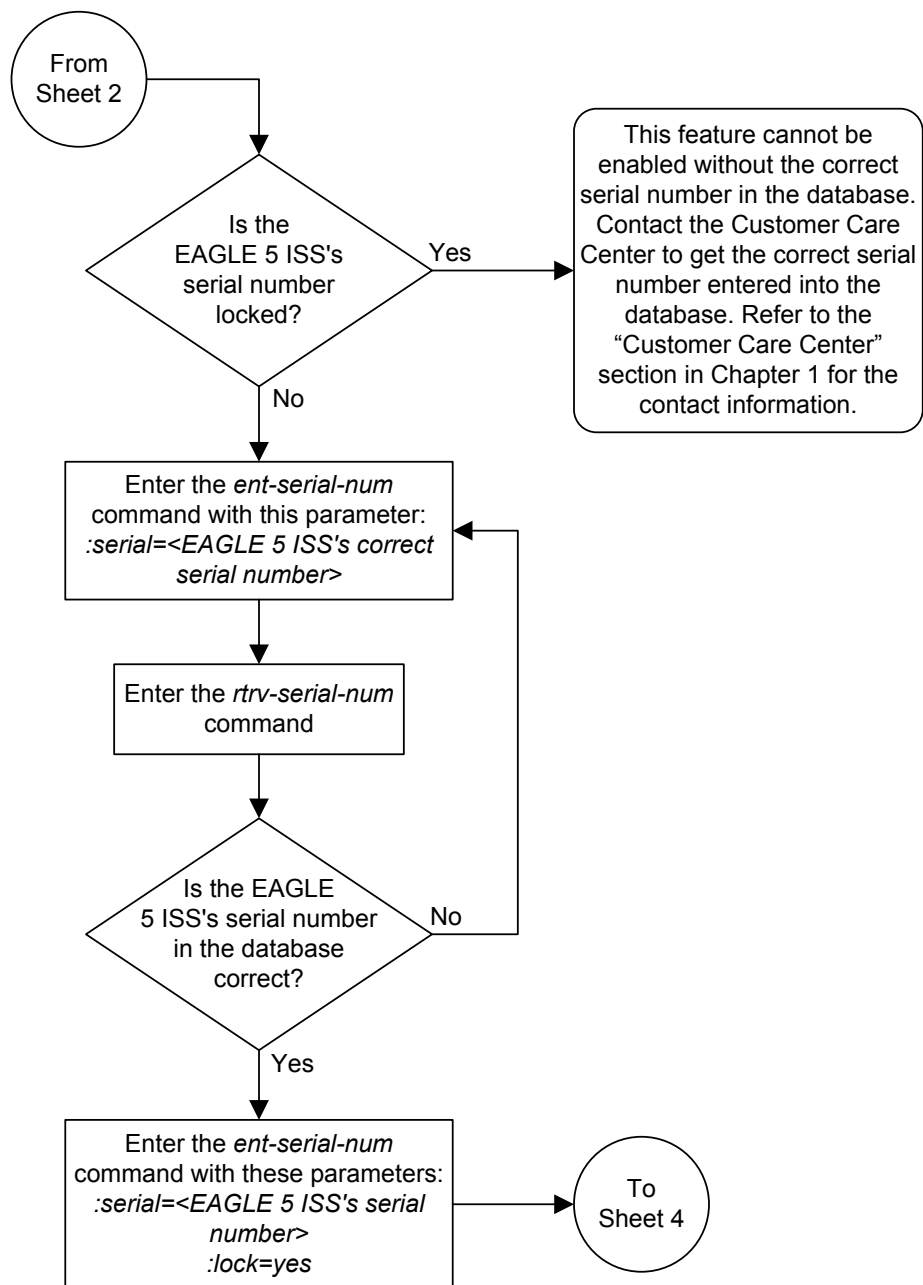
These messages should appear; the active **Maintenance and Administration Subsystem Processor (MASP)** appears first.

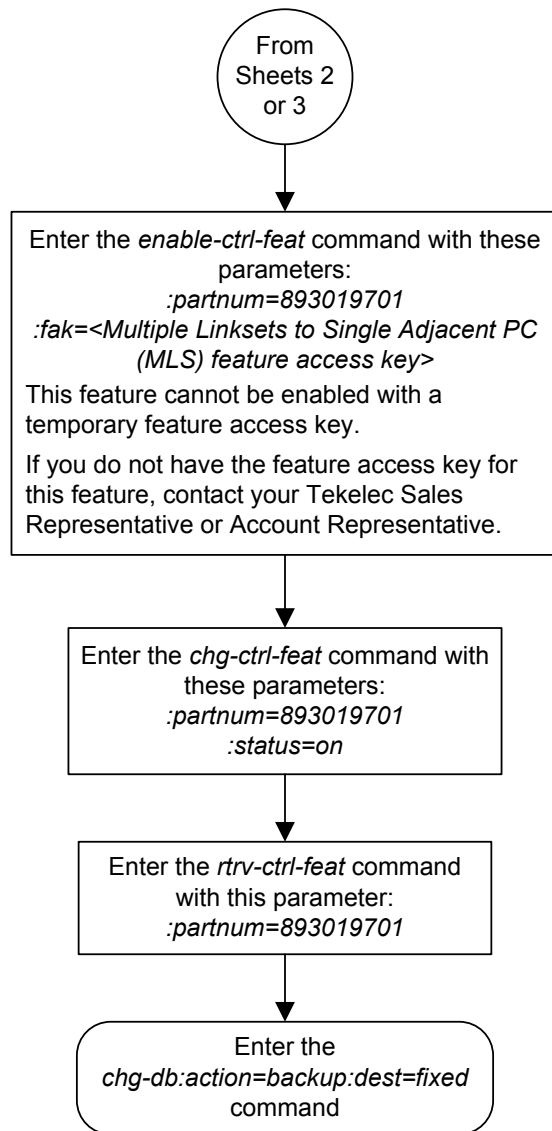
```
BACKUP (FIXED): MASP A - Backup starts on active MASP.
BACKUP (FIXED): MASP A - Backup on active MASP to fixed disk complete.
BACKUP (FIXED): MASP A - Backup starts on standby MASP.
BACKUP (FIXED): MASP A - Backup on standby MASP to fixed disk complete.
```

Figure 3-49 Activating the Multiple Linksets to Single Adjacent PC (MLS) Feature









Configuring the ITU Linkset NI Mapping Options

This procedure is used to configure the network indicator (NI) mapping options for an ITU-I or ITU-N linkset. These options are configured with the `chg-lsopts` command and these parameters.

`:lsn` - The name of the ITU-I or ITU-N linkset.

`:icnimap` - This parameter specifies the type of network indicator (NI) mapping for incoming MSUs on the linkset. The NI value in the incoming MSU is changed to the value specified by the `icnimap` parameter before processing the message. The values for this parameter are: `itui2ituis`, `ituis2itui`, `itun2ituns`, `ituns2itun`, or `none`.

- `itui2ituis` - Map the ITU international network indicator value to the ITU international spare network indicator value
- `ituis2itui` - Map the ITU international spare network indicator value to the ITU international network indicator value
- `itun2ituns` - Map the ITU national network indicator value to the ITU national spare network indicator value
- `ituns2itun` - Map the ITU national spare network indicator value to the ITU national network indicator value
- `none` - network indicator mapping is not performed on the specified linkset.

The value of the `icnimap` parameter for the linkset is not changed if the `icnimap` parameter is not specified with the `chg-lsopts` command. The system default value for the `icnimap` parameter is `none`.

`:ognimap` - This parameter specifies the type of network indicator (NI) mapping for outgoing MSUs on the linkset. The NI value in the processed MSU is changed to the value specified by the `ognimap` parameter for that linkset before routing the message to its intended destination. The values for this parameter are: `itui2ituis`, `ituis2itui`, `itun2ituns`, `ituns2itun`, or `none`.

- `itui2ituis` - Map the ITU international network indicator value to the ITU international spare network indicator value
- `ituis2itui` - Map the ITU international spare network indicator value to the ITU international network indicator value
- `itun2ituns` - Map the ITU national network indicator value to the ITU national spare network indicator value
- `ituns2itun` - Map the ITU national spare network indicator value to the ITU national network indicator value
- `none` - network indicator mapping is not performed on the specified linkset.

The value of the `ognimap` parameter for the linkset is not changed if the `ognimap` parameter is not specified with the `chg-lsopts` command. The system default value for the `ognimap` parameter is `none`.

To specify the `icnimap` and `ognimap` parameters, the ITU National and International Spare Point Code Support feature must be enabled. Refer to the [Activating the ITU](#)

[National and International Spare Point Code Support Feature](#) procedure for information about enabling the ITU National and International Spare Point Code Support feature. Values for the `icnimap` and `ognimap` parameters other than `none` can be specified only for linksets that have ITU-I or 14-bit ITU-N adjacent point codes. If either the `icnimap` or `ognimap` parameters are specified for the `chg-lsopts` command, both parameters must be specified for the `chg-lsopts` command. The network indicator mapping value for incoming messages on the linkset must be compatible with the network indicator mapping value for the outgoing messages on the linkset. For example, if the `icnimap=itui2ituis` parameter is specified for the linkset, the `ognimap=ituis2itui` parameter must be specified for the linkset. [Table 3-30](#) shows the relationship between the `icnimap` and `ognimap` parameter values.

Table 3-30 Network Indicator Mapping Rules

ICNIMAP Parameter Value	OGNIMAP Parameter Value
ITUI2ITUIS	ITUIS2ITUI
ITUIS2ITUI	ITUI2ITUIS
ITUN2ITUNS	ITUNS2ITUN
ITUNS2ITUN	ITUN2ITUNS
NONE	NONE

The values of the `icnimap` and `ognimap` parameters are shown in the `ICNIMAP` and `OGNIMAP` columns of the `rtrv-ls` output. The `ICNIMAP` and `OGNIMAP` columns are shown only if the linkset name (`lsn` parameter) is specified with the `rtrv-ls` command, the ITU National and International Spare Point Code Support feature is enabled, and if the adjacent point code of the linkset is either an ITU-I or ITU-N point code.

1. Display the linksets that are provisioned in the database by entering the `rtrv-ls` command.

The following is an example of the possible output.

```
rlghncxa03w 08-08-10 11:43:04 GMT EAGLE5 39.0.0

LSN          APCA  (SS7)  L3T SLT  BEI LST LNKS  ACT MES DIS SLSCI NIS
ele2         001-207-000 none 1 1 no B 6 off off off no off
elm1s1       001-001-001 none 1 1 no A 7 off off off no off
elm1s2       001-001-002 none 1 1 no A 7 off off off no off
ls04         001-002-003 scr2 1 1 no a 4 off off off yes off
ls1305       000-005-000 none 1 1 no A 1 off off off no off
ls1307       000-007-000 none 1 1 no A 1 off off off no off

LSN          APCI  (SS7)  L3T SLT  BEI LST LNKS  ACT MES DIS SLSCI NIS
ele2i        1-207-0 none 1 1 no B 4 off off off --- on
ls1315       0-015-0 none 1 1 no A 1 off off off --- off
ls1317       0-017-0 none 1 1 no A 1 off off off --- on
elm2s1       1-011-1 none 1 1 no A 7 off off off --- off
elm2s2       1-011-2 none 1 1 no A 7 off off off --- off

L3T SLT          GWS GWS GWS
```

```

LSN          APCN  (SS7) SCRN SET SET BEI LST LNKS ACT MES DIS SLSCI NIS
lsn5         11520          scr3 1 1 no a 3 on off off --- on
lsn6         11211          scr3 1 1 no a 3 on off off --- on

```

Link set table is (10 of 1024) 1% full.

This procedure can be performed only on ITU-I or ITU-N linksets. An ITU-I linkset is a linkset whose adjacent point code is shown in the APCN column of the `rtrv-ls` output. An ITU-N linkset is a linkset whose adjacent point code is shown in the LST column of the `rtrv-ls` output. If no ITU-I or ITU-N linksets are shown in this step, this procedure cannot be performed.

If ITU-I or ITU-N linksets are shown in this step, continue the procedure with 2.

2. Display one of the ITU-I or ITU-N linksets shown in 1 by entering the `rtrv-ls` command with the name of one of the ITU-I or ITU-N linksets shown in 1. For this example, enter this command.

```
rtrv-ls:lsn=lsn5
```

The following is an example of the possible output.

```

rlghncxa03w 09-07-17 11:43:04 GMT EAGLE5 41.1.0

LSN          APCN  (SS7) SCRN SET SET BEI LST LNKS ACT MES DIS SLSCI NIS
lsn5         11211          scr3 1 1 no a 3 on off off --- on

          CLLI          TFATCABMLQ MTPRSE ASL8 SLSOCSBIT SLSRSB ITUTFR
lsn5c11i    1          no          --- none          1          off

          RANDSLS  ICNIMAP          OGNIMAP
          off          none          none

          IPGWAPC MATELSN          IPTPS LSUSEALM SLKUSEALM GTTMODE
          no          ----- ---          ---          ---          CdPA

          LOC  LINK SLC TYPE          L2T          PCR PCR
          SET BPS ECM N1 N2
2105 b 0 LIMDS0 1 56000 BASIC --- -----
2113 b 1 LIMDS0 1 56000 BASIC --- -----
2111 a 2 LIMDS0 1 56000 BASIC --- -----

```

Link set table is (24 of 1024) 2% full

The ITU NI mapping options are shown in the ICNIMAP and OGNIMAP columns in the `rtrv-ls` output. The ITU National and International Spare Point Support feature must be enabled for these columns to appear in the `rtrv-ls` output.

- If the ICNIMAP and OGNIMAP columns are shown in the `rtrv-ls` output, continue the procedure with 3.
- If the ICNIMAP and OGNIMAP columns are not shown in the `rtrv-ls` output, the ITU National and International Spare Point Code Support feature must be enabled. Perform the [Activating the ITU National and International Spare Point Code Support Feature](#) procedure to enable the ITU National and International Spare Point Code Support feature. After the ITU National and International Spare Point Code Support feature has been enabled, continue the procedure with 3.

- Configure the ITU network indicator mapping options for the linkset displayed in 2 by entering the `chg-lsopts` command.

For this example, enter this command.

```
chg-lsopts:lsn=lsn5:icnimap=itun2ituns:ognimap=ituns2itun
```

Note: The network indicator mapping value for incoming messages on the linkset must be compatible with the network indicator mapping value for the outgoing messages on the linkset. For example, if the `icnimap=itui2ituis` parameter is specified for the linkset, the `ognimap=ituis2itui` parameter must be specified for the linkset. [Table 3-30](#) shows the relationship between the `icnimap` and `ognimap` parameter values. The `icnimap` and `ognimap` parameter values entered in this step must be entered according to the relationships shown in [Table 3-30](#).

When this command has successfully completed, the following message should appear.

```
rlghncxa03w 08-08-28 21:18:37 GMT EAGLE5 39.0.0
Link set table is (13 of 1024) 1% full.
CHG-LSOPTS: MASP A - COMPLTD
```

- Verify the changes by entering the `rtrv-ls` command with the name of the linkset specified in 3. For this example, enter this command.

```
rtrv-ls:lsn=lsn5
```

The following is an example of the possible output.

```
rlghncxa03w 09-07-17 11:43:04 GMT EAGLE5 41.1.0

LSN          APCN   (SS7)  L3T SLT          GWS GWS GWS
lsn5         11211          scr3 1 1 no a 3 on off off --- on

          CLLI          TFATCABMLQ MTPRSE ASL8 SLSOCSBIT SLSRSB ITUTFR
lsn5clli    1          no    --- none 1 off

RANDSLS  ICNIMAP  OGNIMAP
off      itun2ituns ituns2itun

IPGWAPC MATELSN  IPTPS LSUSEALM SLKUSEALM GTTMODE
no      ----- --- --- --- CdPA

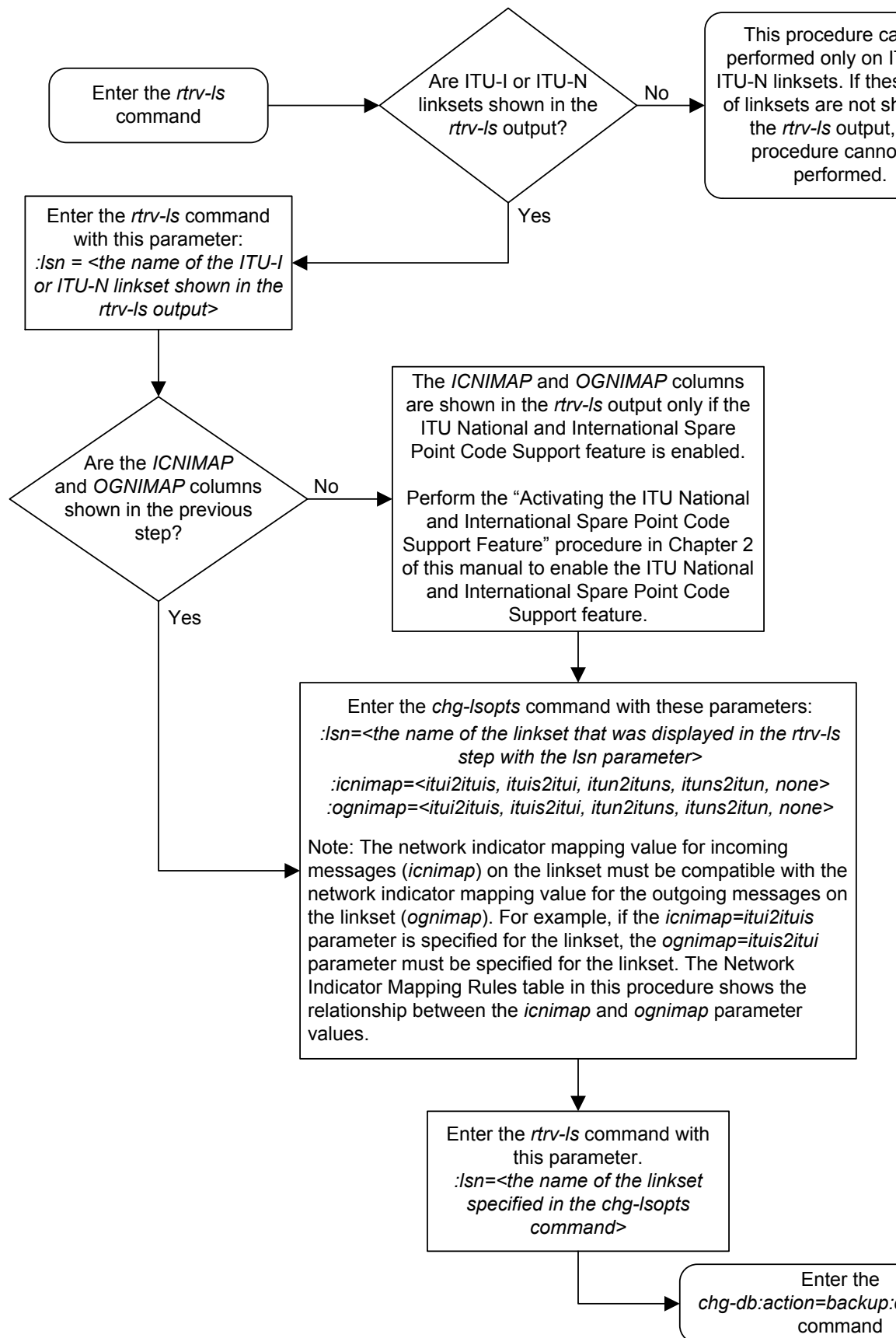
          L2T          PCR PCR
LOC  LINK SLC TYPE  SET BPS  ECM N1 N2
2105 b 0 LIMDS0 1 56000 BASIC --- -----
2113 b 1 LIMDS0 1 56000 BASIC --- -----
2111 a 2 LIMDS0 1 56000 BASIC --- -----

Link set table is ( 24 of 1024) 2% full
```

- Back up the new changes using the `chg-db:action=backup:dest=fixed` command. These messages should appear, the active **Maintenance and Administration Subsystem Processor (MASP)** appears first.

BACKUP (FIXED) : MASP A - Backup starts on active MASP.
BACKUP (FIXED) : MASP A - Backup on active MASP to fixed disk complete.
BACKUP (FIXED) : MASP A - Backup starts on standby MASP.
BACKUP (FIXED) : MASP A - Backup on standby MASP to fixed disk complete.

Figure 3-50 Configuring the ITU Linkset NI Mapping Options



Configuring the Option for Handling Message Priorities for Messages Crossing into ITU-I and ITU-N Networks

This procedure is used to configure the option for handling the priority value of messages that cross into ITU-I and ITU-N networks using the `chg-ss7opts` command with these two parameters.

`:msgpri2itui` – This parameter specifies the priority value for messages that cross into an ITU-I network. The values for this parameter are:

- `df1t` - The priority value for an MTP-routed message is set to 0. A message routed by Global Title Translation retains the priority value set by the incoming message.
- `0 - 3` - The priority value for any message crossing into an ITU-I network is changed to this parameter value.

The system default value for the `msgpri2itui` parameter is `df1t`.

`:msgpri2itun` – This parameter specifies the priority value for messages that cross into an ITU-N or ITU-N24 network. The values for this parameter are:

- `df1t` - The priority value for an MTP-routed message is set to 0. A message routed by Global Title Translation retains the priority value set by the incoming message.
- `0 - 3` - The priority value for any message crossing into an ITU-N or ITU-N24 network is changed to this parameter value. Messages crossing into an ANSI network are not affected.

The system default value for the `msgpri2itun` parameter is `df1t`.

These parameters are optional, but at least one of these parameters must be specified in this procedure. If a parameter is not specified, its value is not changed.

1. Display the existing values for the `msgpri2itui` and `msgpri2itun` parameters by entering the `rtrv-ss7opts` command.

This is an example of the possible output.

```
rlghncxa03w 09-03-17 16:02:05 GMT EAGLE5 40.1.0
```

```
SS7 OPTIONS
-----
MSGPRI2ITUI df1t
MSGPRI2ITUN df1t
```

Note: The `rtrv-ss7opts` command output contains other fields that are not used by this procedure. If you wish to see all the fields displayed by the `rtrv-ss7opts` command, see the `rtrv-ss7opts` command description in the *Commands Manual*.

2. Change the value of the `msgpri2itui` and `msgpri2itun` parameters.

The value specified in this step cannot be the same as the value shown in 1.

If you wish to change the value of the `msgpri2itui` parameter, specify the `msgpri2itui` parameter with the `chg-ss7opts` command. For this example, enter this command.

```
chg-ss7opts:msgpri2itui=1
```

If you wish to change the value of the `msgpri2itun` parameter, specify the `msgpri2itun` parameter with the `chg-ss7opts` command. For this example, enter this command.

```
chg-ss7opts:msgpri2itun=2
```

If you wish to change the value of both the `msgpri2itui` and `msgpri2itun` parameters, specify the `msgpri2itui` and `msgpri2itun` parameters with the `chg-ss7opts` command. For this example, enter this command.

```
chg-ss7opts:msgpri2itui=1:msgpri2itun=2
```

When this command has successfully completed, this message should appear.

```
rlghncxa03w 09-03-07 00:22:57 GMT EAGLE5 40.1.0
CHG-SS7OPTS: MASP A - COMPLTD
```

3. Verify the changes using the `rtrv-ss7opts` command.

This is an example of the possible output.

```
rlghncxa03w 09-03-17 16:02:05 GMT EAGLE5 40.1.0

SS7 OPTIONS
-----
MSGPRI2ITUI      1
MSGPRI2ITUN      2
```

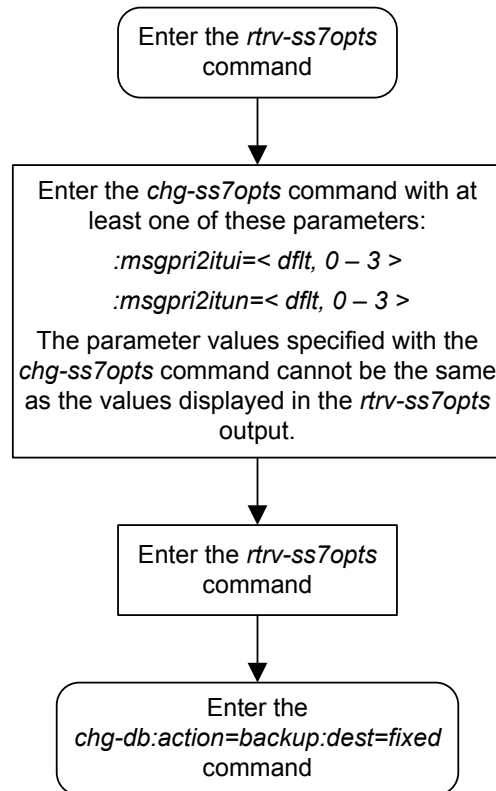
Note: The `rtrv-ss7opts` command output contains other fields that are not used by this procedure. If you wish to see all the fields displayed by the `rtrv-ss7opts` command, see the `rtrv-ss7opts` command description in the *Commands Manual*.

4. Back up the new changes using the `chg-db:action=backup:dest=fixed` command.

These messages should appear, the active **Maintenance and Administration Subsystem Processor (MASP)** appears first.

```
BACKUP (FIXED) : MASP A - Backup starts on active MASP.
BACKUP (FIXED) : MASP A - Backup on active MASP to fixed disk complete.
BACKUP (FIXED) : MASP A - Backup starts on standby MASP.
BACKUP (FIXED) : MASP A - Backup on standby MASP to fixed disk complete.
```


Figure 3-51 Configuring the Option for Handling Message Priorities for Messages Crossing into ITU-I and ITU-N Networks



Activating the 6-Way Loadsharing on Routesets Feature

This procedure is used to enable and turn on the 6-Way Loadsharing on Routesets feature with the `enable-ctrl-feat` and `chg-ctrl-feat` commands.

The `enable-ctrl-feat` command enables the 6-Way Loadsharing on Routesets feature by specifying the part number and feature access key for this feature with these parameters:

`: fak` – The feature access key supplied by Oracle. The feature access key contains 13 alphanumeric characters and is not case sensitive. If you do not have the feature access key for the proxy point code quantity you wish to enable, contact your Oracle Sales Representative or Account Representative.

`: partnum` – The Oracle-issued part number for the 6-Way Loadsharing on Routesets feature, 893019801.

The `enable-ctrl-feat` command requires a valid serial number for the **EAGLE** to be configured in the database, and that this serial number is locked. This can be verified with the `rtrv-serial-num` command. The **EAGLE** is shipped with a serial number in the database, but the serial number is not locked. The serial number can be changed, if necessary, and locked once the **EAGLE** is on-site, by using the `ent-serial-num` command. The `ent-serial-num` command uses these parameters.

`: serial` – The serial number assigned to the **EAGLE**. The serial number is not case sensitive.

`: lock` – Specifies whether or not the serial number is locked. This parameter has only one value, `yes`, which locks the serial number. Once the serial number is locked, it cannot be changed.

Note: To enter and lock the **EAGLE**'s serial number, the `ent-serial-num` command must be entered twice, once to add the correct serial number to the database with the `serial` parameter, then again with the `serial` and the `lock=yes` parameters to lock the serial number. You should verify that the serial number in the database is correct before locking the serial number. The serial number can be found on a label affixed to the control shelf (shelf 1100).

The `chg-ctrl-feat` command uses these parameters:

`: partnum` – The Oracle-issued part number of the 6-Way Loadsharing on Routesets feature, 893019801.

`: status=on` – used to turn the 6-Way Loadsharing on Routesets feature on.

Caution: Once the 6-Way Loadsharing on Routesets feature is turned on, it cannot be turned off.

The status of this feature in the **EAGLE** is shown with the `rtrv-ctrl-feat` command.

After this feature is enabled and turned on, a maximum of six routes in a routeset can be assigned the same relative cost value.

1. Display the features that are enabled by entering the `rtrv-ctrl-feat` command.

The following is an example of the possible output.

```
rlghncxa03w 09-05-28 21:15:37 GMT EAGLE5 41.0.0
The following features have been permanently enabled:
```

Feature Name	Partnum	Status	Quantity
Command Class Management	893005801	on	----
LNP Short Message Service	893006601	on	----
Intermed GTT Load Sharing	893006901	on	----
XGTT Table Expansion	893006101	on	4000000
XMAP Table Expansion	893007710	on	3000
Large System # Links	893005901	on	1500
Routesets	893006401	on	6000
HC-MIM SLK Capacity	893012707	on	64

The following features have been temporarily enabled:

Feature Name	Partnum	Status	Quantity	Trial Period Left
Zero entries found.				

The following features have expired temporary keys:

Feature Name	Partnum
Zero entries found.	

If the 6-Way Loadsharing on Routesets feature is enabled and turned on, the entry 6-Way LS on Routesets is shown in the permanently enabled section of the `rtrv-ctrl-feat` output. If the status of the 6-Way Loadsharing on Routesets feature is on, no further action can be performed.

If the 6-Way Loadsharing on Routesets feature is enabled but not turned on, continue the procedure with [7](#).

If the 6-Way Loadsharing on Routesets feature is not enabled, continue the procedure with [2](#).

Note: If the `rtrv-ctrl-feat` output in this step shows any controlled features, continue the procedure with [Oracle](#). If the `rtrv-ctrl-feat` output shows only the HC-MIM SLK Capacity feature with a quantity of 64, [2](#) through [5](#) must be performed.

2. Display the serial number in the database with the `rtrv-serial-num` command.

This is an example of the possible output.

```
rlghncxa03w 09-05-28 21:15:37 GMT EAGLE5 41.0.0
System serial number = nt00001231
```

System serial number is not locked, yet.

Note: If the serial number is correct and locked, continue the procedure with [Oracle](#). If the serial number is correct but not locked, continue the procedure with [5](#). If the serial number is not correct, but is locked, the 6-Way Loadsharing on Routesets feature cannot be enabled and the remainder of this procedure cannot be performed. Contact the Customer Care Center to get an incorrect and locked serial number changed. Refer to [My Oracle Support \(MOS\)](#) for the contact information. The serial number can be found on a label affixed to the control shelf (shelf 1100).

3. Enter the correct serial number into the database using the `ent-serial-num` command with the `serial` parameter.

For this example, enter this command.

```
ent-serial-num:serial=<EAGLE's correct serial number>
```

When this command has successfully completed, the following message should appear.

```
rlghncxa03w 09-05-28 21:15:37 GMT EAGLE5 41.0.0
ENT-SERIAL-NUM: MASP A - COMPLTD
```

4. Verify that the serial number entered into [3](#) was entered correctly using the `rtrv-serial-num` command.

This is an example of the possible output.

```
rlghncxa03w 09-05-28 21:15:37 GMT EAGLE5 41.0.0
System serial number = nt00001231
```

System serial number is not locked, yet.

If the serial number was not entered correctly, repeat [3](#) and [4](#) and re-enter the correct serial number.

5. Lock the serial number in the database by entering the `ent-serial-num` command with the serial number shown in [2](#), if the serial number shown in [2](#) is correct, or with the serial number shown in [4](#), if the serial number was changed in [3](#), and with the `lock=yes` parameter.

For this example, enter this command.

```
ent-serial-num:serial=<EAGLE's serial number>:lock=yes
```

When this command has successfully completed, the following message should appear.

```
rlghncxa03w 09-05-28 21:15:37 GMT EAGLE5 41.0.0
ENT-SERIAL-NUM: MASP A - COMPLTD
```

6. Enable the 6-Way Loadsharing on Routesets feature with the `enable-ctrl-feat` command specifying the part number for the 6-Way Loadsharing on Routesets feature and the feature access key.

For this example, enter this command.

```
enable-ctrl-feat:partnum=893019801:fak=<6-Way Loadsharing on
Routesets feature access key>
```

Note: A temporary feature access key cannot be specified to enable the 6-Way Loadsharing on Routesets feature.

Note: The values for the feature access key (the `fk` parameter) are provided by Oracle. If you do not have the feature access key for the 6-Way Loadsharing on Routesets feature, contact your Oracle Sales Representative or Account Representative.

When the `enable-ctrl-feat` command has successfully completed, this message should appear.

```
rlghncxa03w 09-05-28 21:15:37 GMT EAGLE5 41.0.0
ENABLE-CTRL-FEAT: MASP B - COMPLTD
```

- Turn the 6-Way Loadsharing on Routesets feature on by entering the `chg-ctrl-feat` command with the part number used in [Oracle](#) and the `status=on` parameter.

Caution: Once the 6-Way Loadsharing on Routesets feature is turned on, it cannot be turned off.

For this example, enter this command.

```
chg-ctrl-feat:partnum=893019801:status=on
```

When this command has successfully completed, the following message should appear.

```
rlghncxa03w 09-05-28 21:15:37 GMT EAGLE5 41.0.0
CHG-CTRL-FEAT: MASP A - COMPLTD
```

- Verify the changes by entering the `rtrv-ctrl-feat` command with the routeset quantity part number specified in [7](#).

For this example, enter this command.

```
rtrv-ctrl-feat:partnum=893019801
```

The following is an example of the possible output.

```
rlghncxa03w 09-05-28 21:15:37 GMT EAGLE5 41.0.0
The following features have been permanently enabled:
```

Feature Name	Partnum	Status	Quantity
6-Way LS on Routesets	893019801	on	----

The following features have been temporarily enabled:

Feature Name	Partnum	Status	Quantity	Trial Period Left
Zero entries found.				

The following features have expired temporary keys:

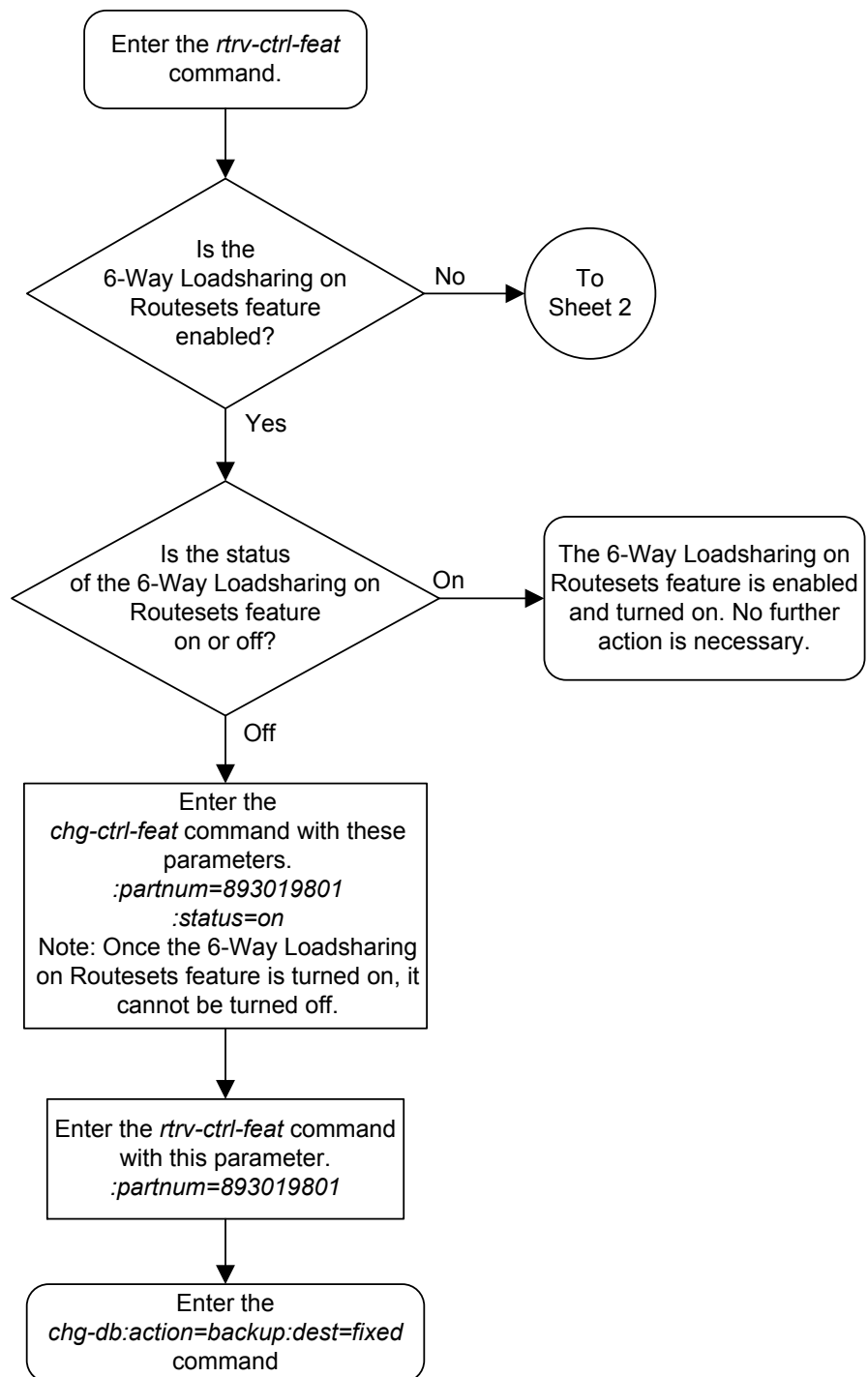
Feature Name	Partnum
Zero entries found.	

9. Back up the new changes, using the `chg-db:action=backup:dest=fixed` command.

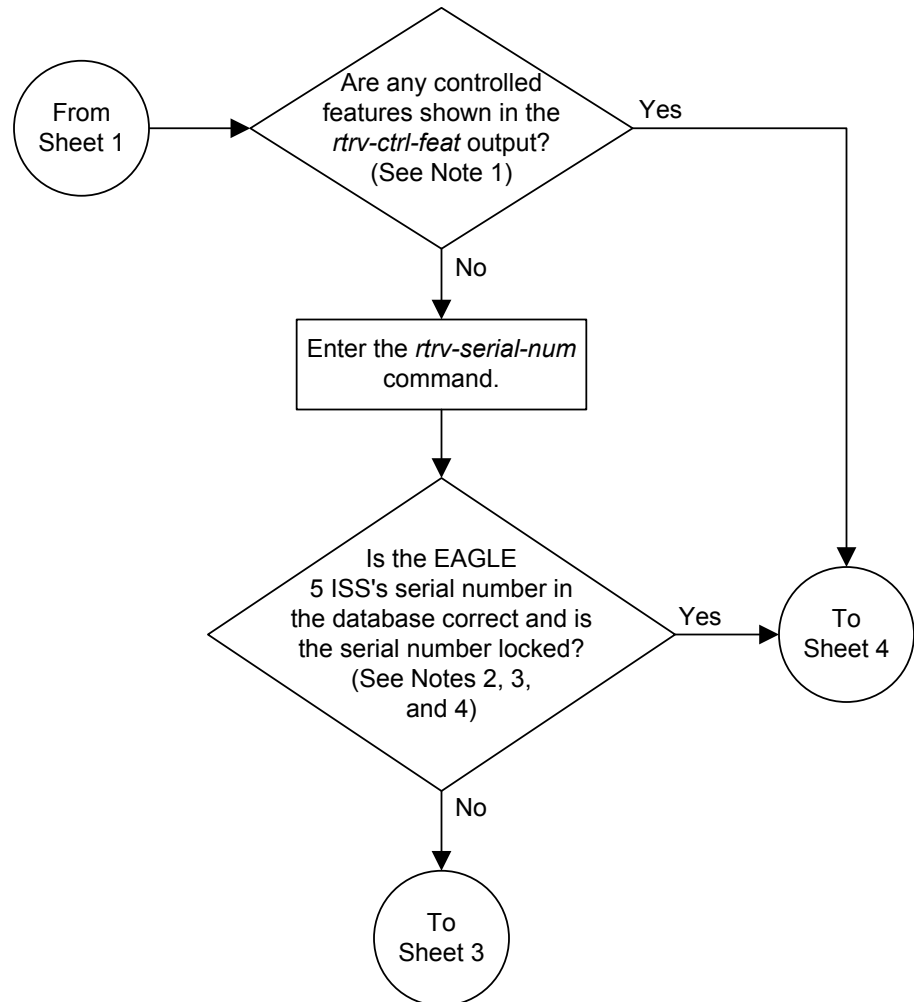
These messages should appear; the active **Maintenance and Administration Subsystem Processor (MASP)** appears first.

```
BACKUP (FIXED): MASP A - Backup starts on active MASP.  
BACKUP (FIXED): MASP A - Backup on active MASP to fixed disk complete.  
BACKUP (FIXED): MASP A - Backup starts on standby MASP.  
BACKUP (FIXED): MASP A - Backup on standby MASP to fixed disk complete.
```

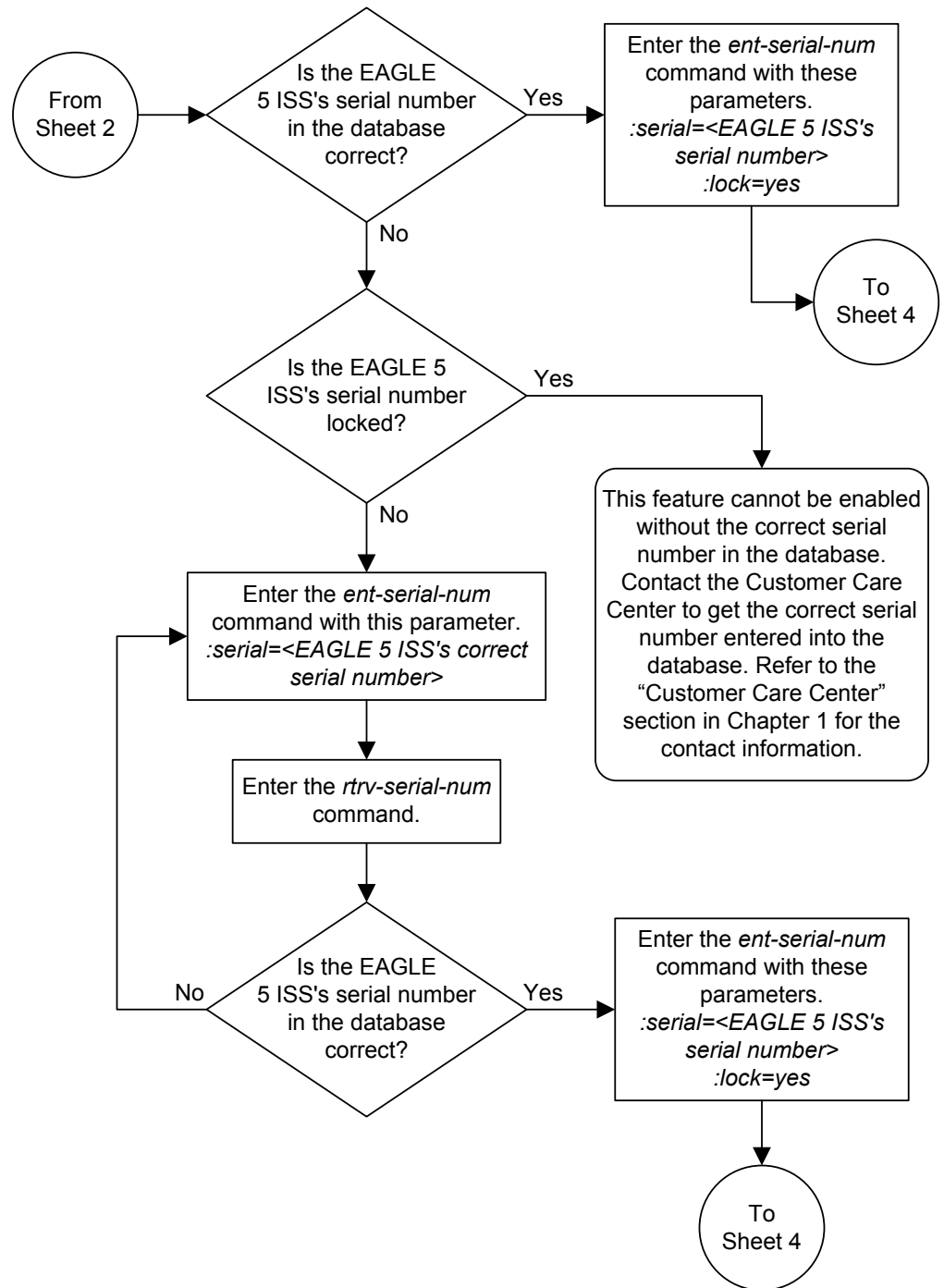
Figure 3-52 *Activating the 6-Way Loadsharing on Routesets Feature*

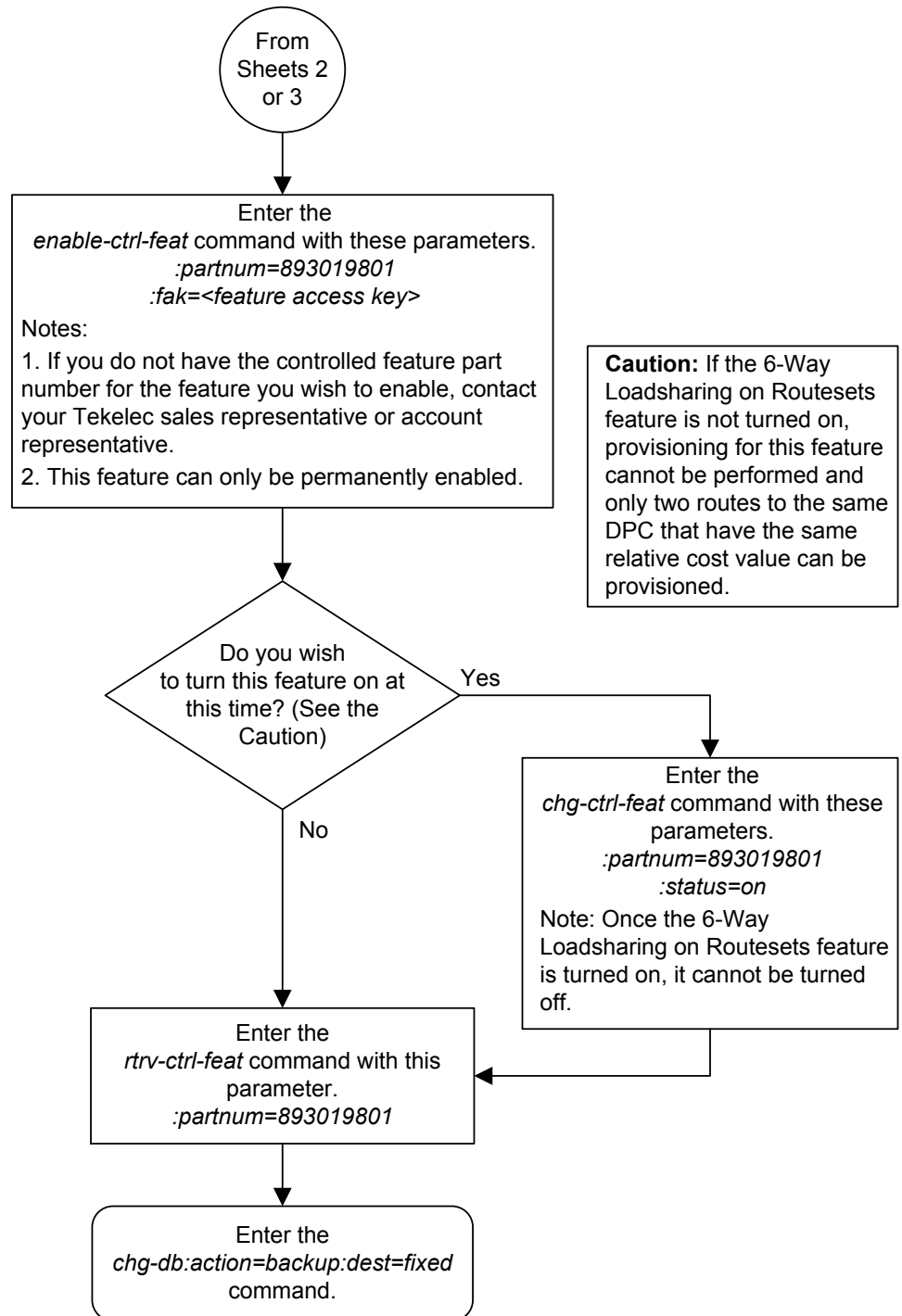


Sheet 1 of 4

**Notes:**

1. If the *rtrv-ctrl-feat* output shows only the HC-MIM SLK Capacity feature with a quantity of 64, the answer to this question is no and the Eagle 5 ISS's serial number must be verified. This is the default entry for the *rtrv-ctrl-feat* output. This entry is shown whether or not the Eagle 5 ISS's serial number is in the database.
2. If the serial number is locked, it cannot be changed.
3. If the serial number is not locked, the controlled feature cannot be enabled.
4. The serial number can be found on a label affixed to the control shelf (shelf 1100).





Point Code and CIC Translation Configuration

This chapter describes the procedures necessary to configure the Point Code and CIC Translation feature.

Introduction

The Point Code and CIC Translation (**PCT**) feature allows the EAGLE to change the destination point code (DPC) and originating point code (OPC) of an MTP-routed MSU to previously configured values. This functionality allows external networks to continue using the old point codes by emulating and mapping them to the new real point codes within the networks. The feature can also be used to change the circuit identifier code (**CIC**) for the MSU.

24-bit ITU-N point codes, spare point codes, and private point codes are not supported by PCT entries.

Network nodes can send and receive traffic to and from the emulated point code (**EPC**) without knowing the real point code that is being emulated by the emulated point code. This ability allows the real point code to be changed transparently from the rest of the network, which can continue using the emulated point code to route traffic.

For each incoming MTP-routed MSU, a DPC lookup is performed if the PCT feature is applied either by using the global setting defined by the `chg-stpopts` command or using the setting for the incoming linkset defined by the `chg-lsopts` command. If a translation is found during the DPC lookup, then the DPC of the MSU is replaced by the real point code as the MSU is received by the EAGLE. If the matching translation also contains provisioning for CIC translations, then the CIC of the MSU is changed to the value from the real CIC range.

For each incoming MTP-routed MSU, a DPC lookup and an OPC lookup are performed. If a translation is found during the DPC lookup, then the DPC of the MSU is replaced by the real point code as the MSU is received by the EAGLE. If a real CIC was provisioned in the translation, then the CIC of the MSU is changed to the value from the real CIC range.

If no matching translation is found during the DPC lookup, the OPC lookup is performed. If a translation is found during the OPC lookup, then the OPC of the MSU is replaced by the emulated point code as the MSU leaves the EAGLE. If the matching translation also contains provisioning for CIC translations, then the CIC of the MSU is changed to the value from the emulated CIC range. The OPC lookup is also performed on MTP-routed MSUs which are processed by the service module after feature processing has completed but before the service module sends the MSUs to an outbound LIM for routing. The OPC lookup is performed only on MSUs whose OPC is not the EAGLE's point code, a capability point code, or a secondary point code.

If no matching translation is found during the DPC lookup, the OPC lookup is performed. If a translation is found during the OPC lookup, then the OPC of the MSU is replaced by the emulated point code as the MSU leaves the EAGLE. If an emulated CIC was provisioned in the translation, then the CIC of the MSU is changed to the value from the emulated CIC range. The OPC lookup is also performed on SCCP MSUs after the GTT feature processing has completed but before the service module sends the MSUs to an outbound LIM for routing. The OPC lookup is performed only on MSUs whose OPC is not the EAGLE's point code, a capability point code, or a secondary point code.

To provision the PCT feature, these procedures must be performed.

- [Changing the Point Code and CIC Translation Quantity](#) - Used to enable the number of PCT entries that the EAGLE can contain. The EAGLE can contain a maximum of 1000 PCT entries.
- [Adding a Point Code and CIC Translation Entry](#) - Used to add a PCT entry to the database.
- [Configuring the Point Code and CIC Translation STP Option](#) - Used to configure a system-wide option for controlling the behavior of the PCT feature. This option has three values.
 - `on` – The PCT feature is applied to all MSUs.
 - `off` – The PCT feature is not applied to any MSUs. This is the default value for this option.
 - `lset` – The PCT feature is applied to incoming MSUs or outgoing MSUs on a linkset whose PCT option value is `on`.
- [Configuring the Point Code and CIC Translation Linkset Option](#) - Used to configure the PCT value for a specific linkset when the system-wide option is set to `lset`. This option has two values.
 - `on` – The PCT feature is applied to incoming MSUs or outgoing MSUs on a linkset.
 - `off` – The PCT feature is not applied to incoming MSUs or outgoing MSUs on a linkset. This is the default value for this option.
- [Removing a Point Code and CIC Translation Entry](#) - used to remove a PCT entry from the database.

Changing the Point Code and CIC Translation Quantity

This procedure is used to increase the number of PCT (point code and CIC translations) entries that are allowed in the EAGLE. The EAGLE can contain a maximum of 1000 PCT entries.

The `enable-ctrl-feat` command enables the PCT quantity by specifying the part number for the PCT quantity and the PCT quantity's feature access key with these parameters.

`: fak` – The feature access key supplied by Oracle. The feature access key contains 13 alphanumeric characters and is not case sensitive. If you do not have the feature access key for the PCT quantity you wish to enable, contact your Oracle Sales Representative or Account Representative.

:partnum – The Oracle-issued part number for the PCT quantity shown in [Table 4-1](#).

Table 4-1 PCT Quantities and Part Numbers

Part Number	PCT Quantity
893037201	25
893037202	50
893037203	75
893037204	100
893037205	150
893037206	200
893037207	250
893037208	1000

The `enable-ctrl-feat` command requires a valid serial number for the EAGLE to be configured in the database, and that this serial number is locked. This can be verified with the `rtrv-serial-num` command. The EAGLE is shipped with a serial number in the database, but the serial number is not locked. The serial number can be changed, if necessary, and locked once the EAGLE is on-site, by using the `ent-serial-num` command. The `ent-serial-num` command uses these parameters.

:serial – The serial number assigned to the EAGLE. The serial number is not case sensitive.

:lock – Specifies whether or not the serial number is locked. This parameter has only one value, `yes`, which locks the serial number. Once the serial number is locked, it cannot be changed.

Note: To enter and lock the EAGLE’s serial number, the `ent-serial-num` command must be entered twice, once to add the correct serial number to the database with the `serial` parameter, then again with the `serial` and the `lock=yes` parameters to lock the serial number. You should verify that the serial number in the database is correct before locking the serial number. The serial number can be found on a label affixed to the control shelf (shelf 1100).

Once the PCT quantity is enabled with the `enable-ctrl-feat` command, the PCT quantity is also turned on. The `chg-ctrl-feat` command is not necessary to turn on the PCT quantity.

1. Display the features that are enabled by entering the `rtrv-ctrl-feat` command.

The following is an example of the possible output.

```
rlghncxa03w 10-12-28 21:15:37 GMT EAGLE5 43.0.0
The following features have been permanently enabled:

Feature Name           Partnum   Status   Quantity
Command Class Management 893005801 on       ----
LNP Short Message Service 893006601 on       ----
Intermed GTT Load Sharing 893006901 on       ----
XGTT Table Expansion     893006101 on       4000000
```

XMAP Table Expansion	893007710	on	3000
Large System # Links	893005901	on	1500
Routesets	893006401	on	6000
HC-MIM SLK Capacity	893012707	on	64

The following features have been temporarily enabled:

Feature Name	Partnum	Status	Quantity	Trial Period Left
Zero entries found.				

The following features have expired temporary keys:

Feature Name	Partnum
Zero entries found.	

If a PCT quantity is shown in the `rtrv-ctrl-feat` output, and the enabled quantity is 1000, this procedure cannot be performed. The EAGLE can contain a maximum of 1000 PCT entries.

If a PCT quantity is shown in the `rtrv-ctrl-feat` output, and the enabled quantity is less than 1000, continue the procedure with [Oracle](#).

If a PCT quantity is not shown in the `rtrv-ctrl-feat` output, continue the procedure by performing one of these steps.

- If the `rtrv-ctrl-feat` output in [1](#) shows any controlled features, continue the procedure with [Oracle](#).
- If the `rtrv-ctrl-feat` output shows only the HC-MIM SLK Capacity feature with a quantity of 64, [2](#) through [5](#) must be performed. Continue the procedure with [2](#).

2. Display the serial number in the database with the `rtrv-serial-num` command.

This is an example of the possible output.

```
rlghncxa03w 10-12-28 21:15:37 GMT EAGLE5 43.0.0
System serial number = nt00001231
System serial number is not locked.
rlghncxa03w 10-12-28 21:15:37 GMT EAGLE5 43.0.0
Command Completed
```

Note: If the serial number is correct and locked, continue the procedure with [Oracle](#). If the serial number is correct but not locked, continue the procedure with [5](#). If the serial number is not correct, but is locked, a PCT quantity cannot be enabled and the remainder of this procedure cannot be performed. Contact the Customer Care Center to get an incorrect and locked serial number changed. Refer to the [My Oracle Support \(MOS\)](#) section for the contact information. The serial number can be found on a label affixed to the control shelf (shelf 1100).

3. Enter the correct serial number into the database using the `ent-serial-num` command with the `serial` parameter.

For this example, enter this command.

```
ent-serial-num:serial=<EAGLE's correct serial number>
```

When this command has successfully completed, the following message should appear.

```
rlghncxa03w 10-12-28 21:15:37 GMT EAGLE5 43.0.0
ENT-SERIAL-NUM: MASP A - COMPLTD
```

4. Verify that the serial number entered into 3 was entered correctly using the `rtrv-serial-num` command.

This is an example of the possible output.

```
rlghncxa03w 10-12-28 21:15:37 GMT EAGLE5 43.0.0
System serial number = nt00001231
System serial number is not locked.
rlghncxa03w 10-12-28 21:15:37 GMT EAGLE5 43.0.0
Command Completed
```

If the serial number was not entered correctly, repeat 3 and 4 and re-enter the correct serial number.

5. Lock the serial number in the database by entering the `ent-serial-num` command with the serial number shown in 2, if the serial number shown in 2 is correct, or with the serial number shown in 4, if the serial number was changed in 3, and with the `lock=yes` parameter.

For this example, enter this command.

```
ent-serial-num:serial=<EAGLE's serial number>:lock=yes
```

When this command has successfully completed, the following message should appear.

```
rlghncxa03w 10-12-28 21:15:37 GMT EAGLE5 43.0.0
ENT-SERIAL-NUM: MASP A - COMPLTD
```

6. Enable a PCT quantity with the `enable-ctrl-feat` command specifying the part number for the point code, shown in Table 4-1, and CIC translation quantity and the feature access key.

For this example, enter this command.

```
enable-ctrl-feat:partnum=893037203:fak=<feature access key
for 75 PCT entries>
```

Note: A temporary feature access key cannot be specified to enable the routeset quantity.

Note: The values for the feature access key (the `fak` parameter) are provided by Oracle. If you do not have the feature access key for the PCT quantity you wish to enable, contact your Oracle Sales Representative or Account Representative.

When the `enable-ctrl-feat` command has successfully completed, this message should appear.

```
rlghncxa03w 10-12-28 21:15:37 GMT EAGLE5 43.0.0
ENABLE-CTRL-FEAT: MASP B - COMPLTD
```

7. Verify the changes by entering the `rtrv-ctrl-feat` command with the PCT quantity part number specified in [Oracle](#).

For this example, enter this command.

```
rtrv-ctrl-feat:partnum=893037203
```

The following is an example of the possible output.

```
rlghncxa03w 10-12-28 21:15:37 GMT EAGLE5 43.0.0
The following features have been permanently enabled:
```

Feature Name	Partnum	Status	Quantity
PC & CIC Translation	893037203	on	75

The following features have been temporarily enabled:

Feature Name	Partnum	Status	Quantity	Trial Period Left
Zero entries found.				

The following features have expired temporary keys:

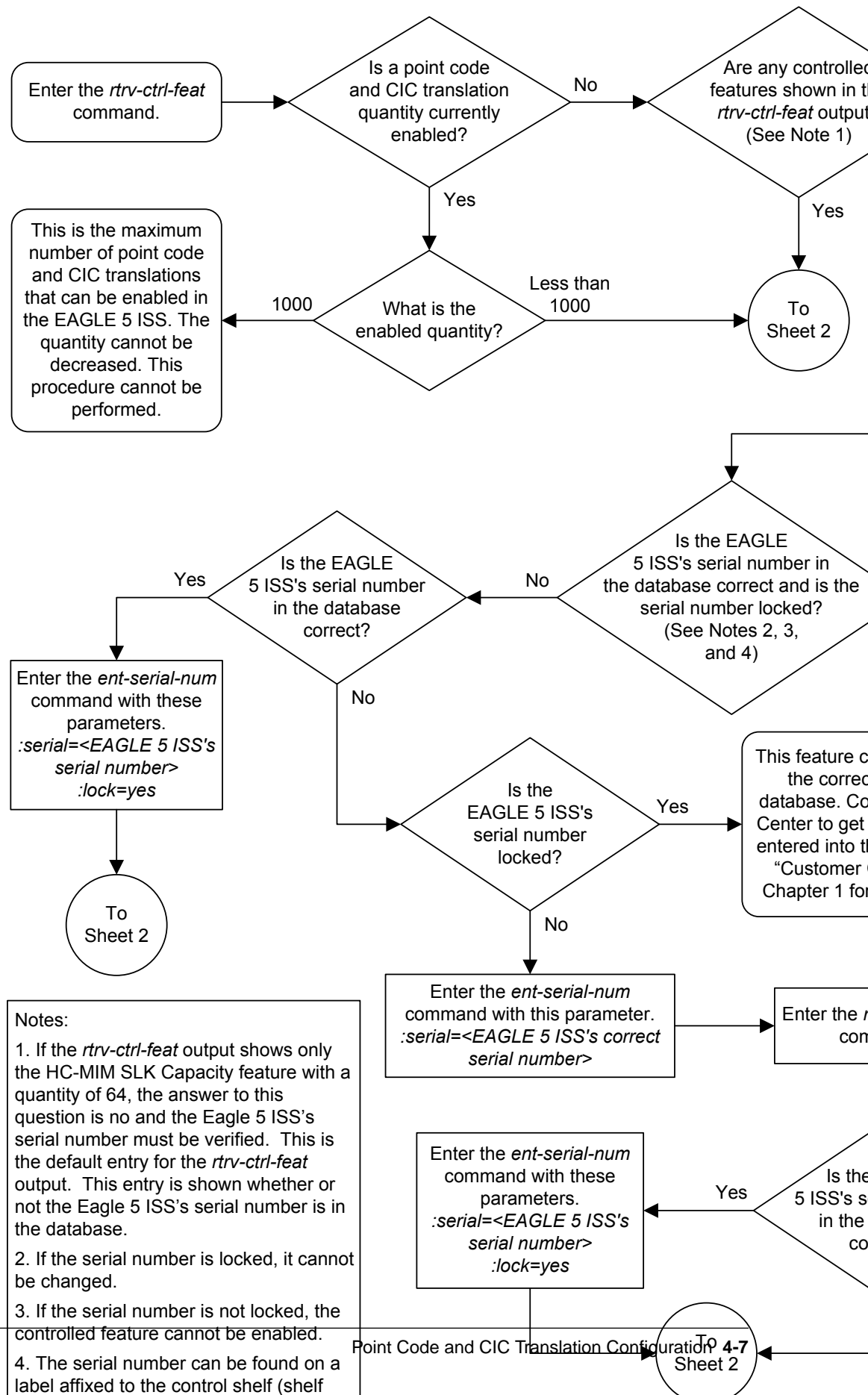
Feature Name	Partnum
Zero entries found.	

8. Back up the new changes, using the `chg-db:action=backup:dest=fixed` command.

These messages should appear; the active **Maintenance and Administration Subsystem Processor (MASP)** appears first.

```
BACKUP (FIXED): MASP A - Backup starts on active MASP.
BACKUP (FIXED): MASP A - Backup on active MASP to fixed disk complete.
BACKUP (FIXED): MASP A - Backup starts on standby MASP.
BACKUP (FIXED): MASP A - Backup on standby MASP to fixed disk complete.
```

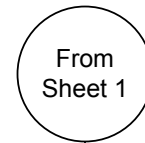
Figure 4-1 Changing the Point Code and CIC Translation Quantity



Notes:

1. If the *rtv-ctrl-feat* output shows only the HC-MIM SLK Capacity feature with a quantity of 64, the answer to this question is no and the Eagle 5 ISS's serial number must be verified. This is the default entry for the *rtv-ctrl-feat* output. This entry is shown whether or not the Eagle 5 ISS's serial number is in the database.
2. If the serial number is locked, it cannot be changed.
3. If the serial number is not locked, the controlled feature cannot be enabled.
4. The serial number can be found on a label affixed to the control shelf (shelf 1100).

Sheet 1 of 2



Enter the *enable-ctrl-feat* command with these parameters.
:partnum=<point code and CIC translation quantity part number>
 (See Notes 1 and 2)
:fak=<point code and CIC translation quantity feature access key>
 (See Notes 3 and 4)

Notes:

1. This list contains the part numbers for the point code and CIC translation quantities that can be enabled.

Part Number	Point Code and CIC Translation Quantity
893037201	25
893037202	50
893037203	75
893037204	100
893037205	150
893037206	200
893037207	250
893037208	1000

2. A point code and CIC translation quantity cannot be decreased.
3. A point code and CIC translation quantity cannot be enabled with a temporary feature access key.
4. If you do not have the feature access key for the point code and CIC translation quantity that you wish to enable, contact your Tekelec Sales Representative or Account Representative.

Enter the *rtv-ctrl-feat* command with this parameter.
:partnum=<part number specified in the enable-ctrl-feat command>

Enter the *chg-db:action=backup:dest=fixed* command.

Adding a Point Code and CIC Translation Entry

This procedure is used to add a PCT (point code and CIC translation) entry to the database, using the `ent-pct` command.

The `ent-pct` command uses the parameters shown in [Table 4-2](#).

Table 4-2 ENT-PCT Parameters

Parameter	Range of Values	Type of Parameter	Default Values	Description
EPC/EPCA/ EPCI/EPCN	ANSI, ITU-I, or 14-bit ITU-N Point Code	Mandatory	N/A	Emulated point code. See Notes 1 through 8.
REALPC/ REALPCA/ REALPCI/ REALPCN	ANSI, ITU-I, or 14-bit ITU-N Point Code	Mandatory	N/A	Real point code. See Notes 1 through 9.
FILTPC/ FILTPCA/ FILTPCI/ FILTPCN	ANSI, ITU-I, 14- bit ITU-N Point Code, or wildcard (*)	Optional	wildcard (*)	Filter point code. See Notes 2 through 5, 8 through 11, and 25.
SI	0 (Network Management) 3 (SCCP) 4 (TUP) 5 (ISUP) 13 (ANSI Q.BICC) wildcard (*)	Optional	wildcard (*)	Service indicator value. See Notes 24 and 25.
ECICS	See Note 12	Optional	wildcard (*)	Start value of a range of emulated CIC values. See Notes 13, 19, 20, and 25.
ECICE	See Note 12	Optional	wildcard (*)	End value of a range of emulated CIC values. See Notes 13, 14, 17, 18, 19, 20, and 25.

Table 4-2 (Cont.) ENT-PCT Parameters

Parameter	Range of Values	Type of Parameter	Default Values	Description
RCICS	See Note 12	Optional	wildcard (*)	Start value of a range of real CIC values. See Notes 13, 15, 19, 20, and 25.
RCICE	See Note 12	Optional	wildcard (*)	End value of a range of real CIC values. See Notes 13, 14, 16, 18, 19, 20, and 25.
RELCAUSE	0 - 127	Optional	0	Release cause value. See Notes 21 and 22.
SSN	0 - 255 or wildcard (*)	Optional	wildcard (*)	Subsystem number. See Notes 23 and 25.

Table 4-2 (Cont.) ENT-PCT Parameters

Parameter	Range of Values	Type of Parameter	Default Values	Description
Notes:				
1.				The ANSI point code value must be a full point code and not a cluster point code or a network routing point code.
2.				The point code value cannot be shown in the <code>rtrv-sid</code> output.
3.				ITU-I and 14-bit ITU-N point code values cannot be a spare point code. None of the point code values can be a private point code.
4.				The network type of the emulated point code, real point code, and filter point code (if specified) values must be the same.
5.				The group code of the 14-bit ITU-N emulated point code, real point code, and filter point code (if specified) values must be the same.
6.				There can be a maximum of 100 PCT entries that use the same emulated point code value. There can be a maximum of 100 PCT entries that use the same real point code value.
7.				A maximum of 250 different emulated point code values can be used in all the PCT entries that are provisioned. A maximum of 250 different real point code values can be used in all the PCT entries that are provisioned.
8.				Duplicate entries with these key combinations are not allowed. <ul style="list-style-type: none"> emulated point code + filter point code + service indicator + subsystem number / (range of emulated CIC values) real point code + filter point code + service indicator + subsystem number / (range of real CIC values)
9.				The real point code and filter point code value must be shown in the DPC column of the <code>rtrv-rte</code> output. There must be at least one route assigned the DPC value.
10.				The ANSI filter point code values can be a full point code, a cluster point code, or a network routing point code.
11.				Only one filter point code value can be specified with the PCT entry, either an ANSI filter point code (<code>filtpc/filtpca</code>), an ITU-I filter point code (<code>filtpci</code>), or a 14-bit ITU-N filter point code (<code>filtpcn</code>).
12.				These are the values for the ECICS, ECICE, RCICS, and RCICE parameter values. <ul style="list-style-type: none"> Service indicator value 4 - 0 to 4095 or wildcard (*). Service indicator value 5 (with an ITU point code) - 0 to 4095 or wildcard (*). Service indicator value 5 (with an ANSI point code) - 0 to 16383 or wildcard (*). Service indicator value 13 - 0 to 4294967295 or wildcard (*).
13.				The service indicator parameter with a value of 4, 5, or 13 must be specified.
14.				If the ECICE parameter is specified, the ECICS parameter must be specified. If the RCICE parameter is specified, the RCICS parameter must be specified.
15.				If the RCICS parameter is specified, the ECICS parameter must be specified.

Table 4-2 (Cont.) ENT-PCT Parameters

Parameter	Range of Values	Type of Parameter	Default Values	Description
16.				If the ECICS, ECICE, and RCICS parameters are specified, the RCICE parameter must be specified.
17.				If the ECICS, RCICS, and RCICE parameters are specified, the ECICE parameter must be specified.
18.				The value of the ECICE parameter must be greater or equal to the ECICS parameter value. The value of the RCICE parameter must be greater or equal to the RCICS parameter value.
19.				If a range of emulated CIC and real CIC values are specified, the difference between the ECICS and ECICE values must be the same as the difference between the RCICS and RCICE values. Where CIC translations are not applied uniformly across a trunk group, it is recommended that the CIC should be provisioned in ranges such that a trunk is not split across PCT translations.
20.				If the <code>epc/epca/epci/epcn</code> parameter value is equal to the <code>realpc/realpca/realpci/realpcn</code> parameter value, the range of emulated CIC values cannot be the same as the range of real CIC values.
21.				The service indicator parameter value must be either 5 or 13.
22.				The ECICS parameter must be specified.
23.				The service indicator parameter value must be 3.
24.				If the service indicator value is 0 or wildcard (*), only the emulated point code, real point code, and filter point code parameters can be specified.
25.				The wildcard (*) value indicates that the parameter is not part of the key to find the matching translation.

To add a PCT entry, a PCT quantity must be enabled. Adding the new PCT entry cannot exceed the enabled PCT quantity. The enabled PCT quantity is shown in the `rtrv-pct` output. The EAGLE can contain a maximum of 1000 PCT entries. Perform the [Changing the Point Code and CIC Translation Quantity](#) procedure to enable the required PCT quantity if adding the new PCT entry will exceed the enabled PCT quantity and the current PCT quantity is less than 1000.

Canceling the `RTRV-RTE` Command

Because the `rtrv-rte` command used in this procedure can output information for a long period of time, the `rtrv-rte` command can be canceled and the output to the terminal stopped. There are three ways that the `rtrv-rte` command can be canceled.

- Press the F9 function key on the keyboard at the terminal where the `rtrv-rte` command was entered
- Enter the `canc-cmd` without the `trm` parameter at the terminal where the `rtrv-rte` command was entered

- Enter the `canc-cmd:trm=<xx>`, where `<xx>` is the terminal where the `rtrv-rte` command was entered, from another terminal other than the terminal where the `rtrv-rte` command was entered. To enter the `canc-cmd:trm=<xx>` command, the terminal must allow Security Administration commands to be entered from it and the user must be allowed to enter Security Administration commands. The terminal's permissions can be verified with the `rtrv-secu-trm` command. The user's permissions can be verified with the `rtrv-user` or `rtrv-secu-user` commands.

For more information about the `canc-cmd` command, refer to *Commands User's Guide*.

1. Display the current PCT entries by entering the `rtrv-pct` command.

This is an example of the possible output.

```
rlghncxa03w 10-12-17 16:02:05 GMT EAGLE5 43.0.0

      EPCA          FILTPCA          REALPCA          SI  SSN  RELCAUSE
      001-001-001    *                002-002-002     5  ---  10

      ECICS = 10          ECICE = 20
      RCICS = 30          RCICE = 40

      EPCI          FILTPCI          REALPCI          SI  SSN  RELCAUSE
      1-001-2        2-002-2          2-002-2         3  10  ---

      ECICS = -----  ECICE = -----
      RCICS = -----  RCICE = -----

      EPCN          FILTPCN          REALPCN          SI  SSN  RELCAUSE
      04-11-0-fr     *                0-6-4-0-fr     *  ---  ---

      ECICS = -----  ECICE = -----
      RCICS = -----  RCICE = -----

Unique EPC      is 3 of 250
Unique RealPC  is 3 of 250

PCT table is (3 of 1000) 1% full.
```

If adding the PCT entry will exceed the enabled PCT quantity and the enabled PCT quantity is 1000, this procedure cannot be performed.

If adding the PCT entry will exceed the enabled PCT quantity and the enabled PCT quantity is less than 1000, perform the [Changing the Point Code and CIC Translation Quantity](#) procedure to enable the new PCT quantity. The new quantity must be greater than the current enabled quantity.

If adding the PCT entry will not exceed the enabled PCT quantity, or the [Changing the Point Code and CIC Translation Quantity](#) procedure has been performed, continue the procedure by performing one of these steps.

- If no entries are displayed in the `rtrv-pct` output, continue the procedure with [3](#).
- If entries are displayed in the `rtrv-pct` output, continue the procedure with [2](#).

2. There can be a maximum of 100 PCT entries that use the same emulated point code value. There can be a maximum of 100 PCT entries that use the same real point code value.

The EAGLE contain a maximum of 250 unique emulated point code values and 250 unique real point code values.

If adding the new PCT entry will not exceed these maximum quantities, continue the procedure with 3.

If adding the new PCT entry will exceed these maximum quantities, the new PCT entry must contain one or more of these point code values, depending on the quantity that will be exceeded.

- If the EAGLE contains 100 PCT entries that use the same emulated point code value, a different emulated point code value must be used for the new PCT entry.
 - If the EAGLE contains 100 PCT entries that use the same real point code value, a different real point code value must be used for the new PCT entry.
 - If the EAGLE contains a maximum of 250 unique emulated point code values, the new entry must contain one of these emulated point code values.
 - If the EAGLE contains a maximum of 250 unique real point code values, the new entry must contain one of these real point code values.
 - Continue the procedure with 3
3. Display the self-identification of the EAGLE using the `rtrv-sid` command.

This is an example of the possible output.

```
rlghncxa03w 10-12-10 11:43:04 GMT EAGLE5 43.0.0
  PCA          PCI          PCN          CLLI          PCTYPE
  100-100-100  3-75-7          7-9-8-1-fr   rlghncxa03w   OTHER

  CPCA
  102-002-002  102-002-003    102-002-004  102-002-005
  102-002-006  102-002-007    102-002-008  102-002-009
  004-002-001  004-003-003    050-060-070

  CPCA (LNP)
  005-005-002  005-005-004    005-005-005

  CPCI
  1-002-1      1-002-2        1-002-3      1-002-4
  2-001-1      7-222-7

  CPCN
  0-1-9-0-fr   0-1-11-2-fr   0-1-14-0-fr  0-2-0-2-fr
  0-3-2-0=fr   0-3-7-0-fr    0-3-12-0-fr
```

The emulated point code, real point code, or filter point code values cannot be shown in the `rtrv-sid` output.

4. Display the current secondary point codes, using the `rtrv-spc` command.

This is an example of the possible output.

```
rlghncxa03w 10-12-17 16:02:05 GMT EAGLE5 43.0.0
SPC (Secondary Point Codes)
```

SPCA

```
001-010-010
002-010-010
003-010-010
```

SPC-I

```
1-253-5
2-254-6
3-255-7
```

SPC-N

```
10-01-11-1-fr
13-02-12-0-fr
```

SPC-N24

none

Secondary Point Code table is (8 of 40) 20% full

The emulated point code, real point code, and filter point code values cannot be shown in the `rtrv-spc` output.

5. Display the current route configuration using the `rtrv-rte` command. This is an example of the possible output.

```
rlghncxa03w 10-12-07 11:43:04 GMT EAGLE5 43.0.0
Extended Processing Time may be Required
```

DPCA	ALIASI	ALIASN/N24	LSN	RC	APCA
140-012-004	1-111-1	10-13-12-1-fr	ls000001	10	240-012-002
			ls000002	10	240-012-002
			ls000003	20	240-012-002
			ls000004	30	240-012-002
			ls000005	40	240-012-002
			ls000006	50	240-012-002
			RTX:No	CLLI=dp1	
140-012-005	1-111-2	10-13-12-2-fr	ls000001	10	240-012-002
			ls000002	10	240-012-002
			ls000003	20	240-012-002
			ls000004	30	240-012-002
			ls000005	40	240-012-002
			ls000006	50	240-012-002
			RTX:No	CLLI=dp2	
DPCI	ALIASN/N24	ALIASA	LSN	RC	APC
2-234-5	11-13-3-3-fr	240-111-111	ls100001	10	1-234-5
			ls100002	10	1-234-6
			ls100003	20	1-234-7
			ls100004	30	1-234-1
			ls100005	40	1-234-2
			ls100006	50	1-234-3
			RTX:No	CLLI=idp1	
DPCN	ALIASA	ALIASI	LSN	RC	APC
12-12-13-3-fr	011-222-111	0-001-1	ls200001	10	10-13-9-3

```

ls200002  10  10-13-10-0
ls200003  20  10-13-10-1
ls200004  30  10-13-10-2
ls200005  40  10-13-10-3
ls200006  50  10-13-11-0
RTX:No  CLLI=ndp1

```

```

DPCN24      ALIASA      ALIASI  LSN      RC      APC

```

The real point code value, and the filter point code value if a point code value is specified for the filter point code parameter, must be the DPC of a routeset that contains at least one route.

The real point code value must be a full point code and cannot be a spare point code, a private point code, or a 24-bit ITU-N point code.

The filter point code value can be a full point code, a cluster point code, or a network routing point code. The filter point code value cannot be a spare point code, a private point code, or a 24-bit ITU-N point code.

The emulated point code, real point code, and filter point code values must be the same network type, either ANSI, ITU-I, or a 14-bit ITU-N point codes.

If the 14-bit ITU-N point codes contain group codes, the group codes of the emulated point code, real point code, and filter point code values must be the same.

If the required point codes for the PCT entry are not shown in the `rtrv-rte` output, perform one of these procedures to add the routes with the required point code values.

- [Adding a Route Containing an SS7 DPC](#)
- [Adding a Route Containing a Cluster Point Code](#)
- [Adding a Route Containing an IPGWx Linkset](#)

If the required point codes for the PCT entry are shown in the `rtrv-rte` output, or one of the Adding a Route procedures was performed, continue the procedure with 6.

6. Add the PCT entry by entering the `ent-pct` command.

The `epc/epca/epci/epcn` and `realpc/realpca/realpci/realpcn` must be specified with the `ent-pct` command. All other parameters are optional.

The values for the `ent-pct` parameters and the rules for specifying these parameters are shown in [Table 4-2](#).

For this example, enter these commands.

```

ent-
pct:epca=007-007-007:realpca=008-008-008:filtpca=009-009-009:
si=3:ssn=135

```

```

ent-
pct:epca=007-007-007:realpca=008-008-008:filtpca=010-010-010:
si=5 :ecics=200:ecice=224:rcics=300:rcice=324:relcause=50

```

When each of these commands have successfully completed, this message should appear.

```
rlghncxa03w 10-12-17 15:35:05 GMT EAGLE5 43.0.0
ENT-PCT: MASP A - COMPLTD
```

7. Verify the changes using the `rtrv-pct` command with the parameters and values that were entered in 6.

For this example, enter these commands.

```
rtrv-
pct:epca=007-007-007:realpca=008-008-008:filtpca=009-009-009:
si=3:ssn=135
```

This is an example of the possible output.

```
rlghncxa03w 10-12-17 16:02:05 GMT EAGLE5 43.0.0

      EPCA          FILTPCA          REALPCA          SI  SSN  RELCAUSE
      007-007-007    009-009-009    008-008-008    3  135  ---

      ECICS = -----  ECICE = -----
      RCICS = -----  RCICE = -----

Unique EPC      is 4 of 250
Unique RealPC  is 4 of 250

PCT table is (5 of 1000) 1% full.
```

```
rtrv-
pct:epca=007-007-007:realpca=008-008-008:filtpca=010-010-010:
si=5 :ecics=200:ecice=224:rcics=200:rcice=224:relcause=50
```

This is an example of the possible output.

```
rlghncxa03w 10-12-17 16:02:05 GMT EAGLE5 43.0.0

      EPCA          FILTPCA          REALPCA          SI  SSN  RELCAUSE
      007-007-007    010-010-010    008-008-008    5  ---  50

      ECICS = 200      ECICE = 224
      RCICS = 300      RCICE = 324

Unique EPC      is 4 of 250
Unique RealPC  is 4 of 250

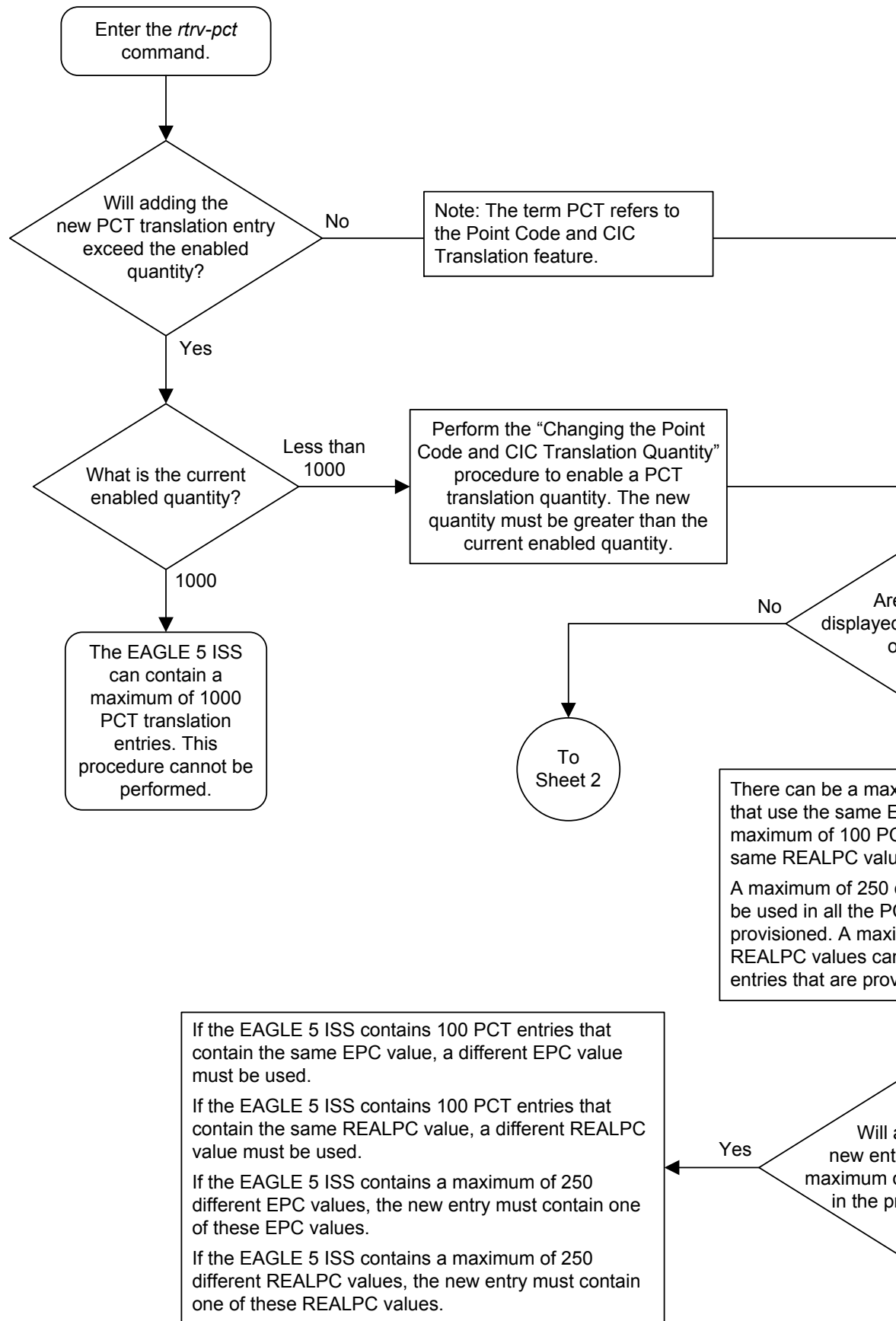
PCT table is (5 of 1000) 1% full.
```

8. Back up the new changes using the `chg-db:action=backup:dest=fixed` command.

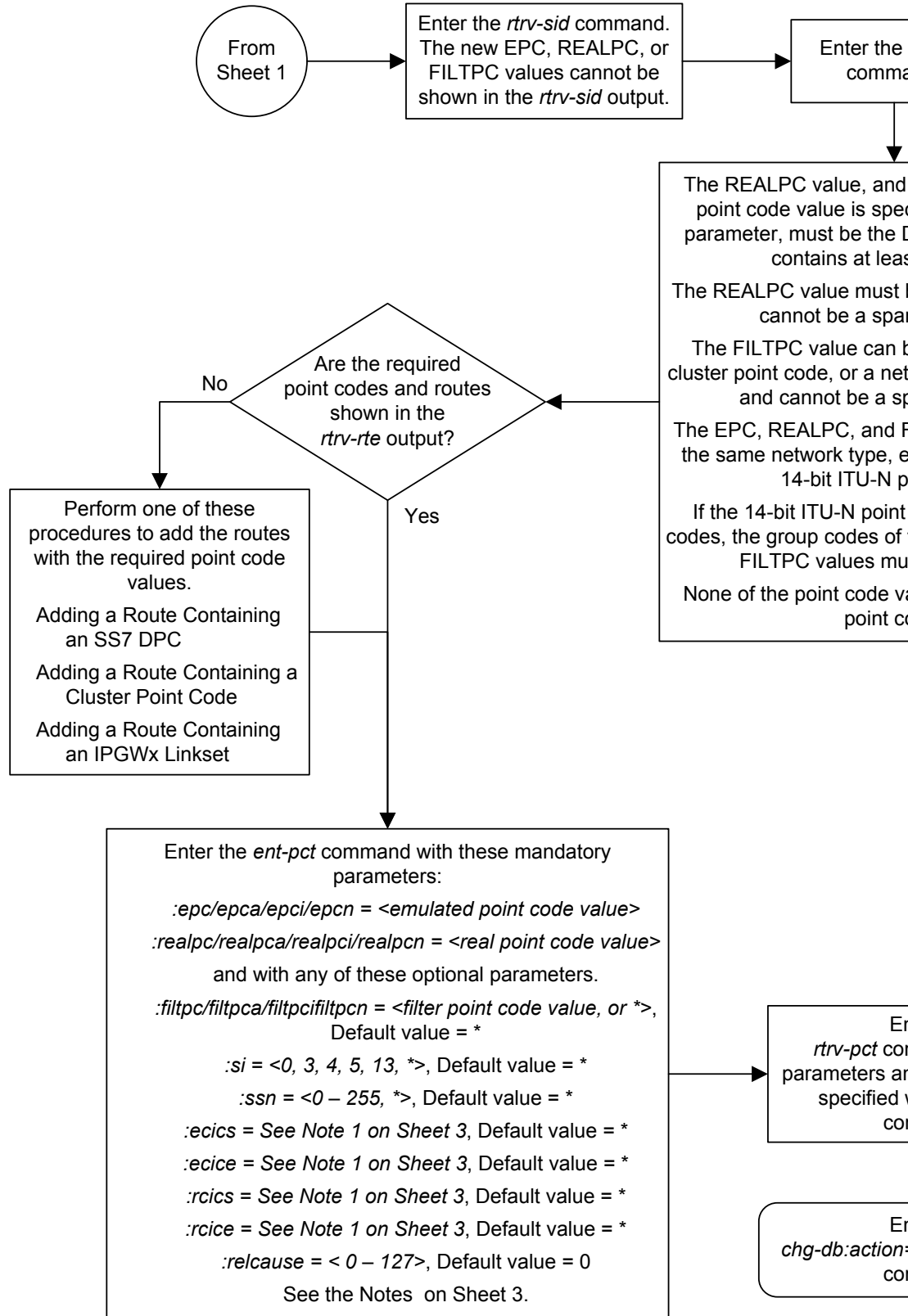
These messages should appear; the active **Maintenance and Administration Subsystem Processor (MASP)** appears first.

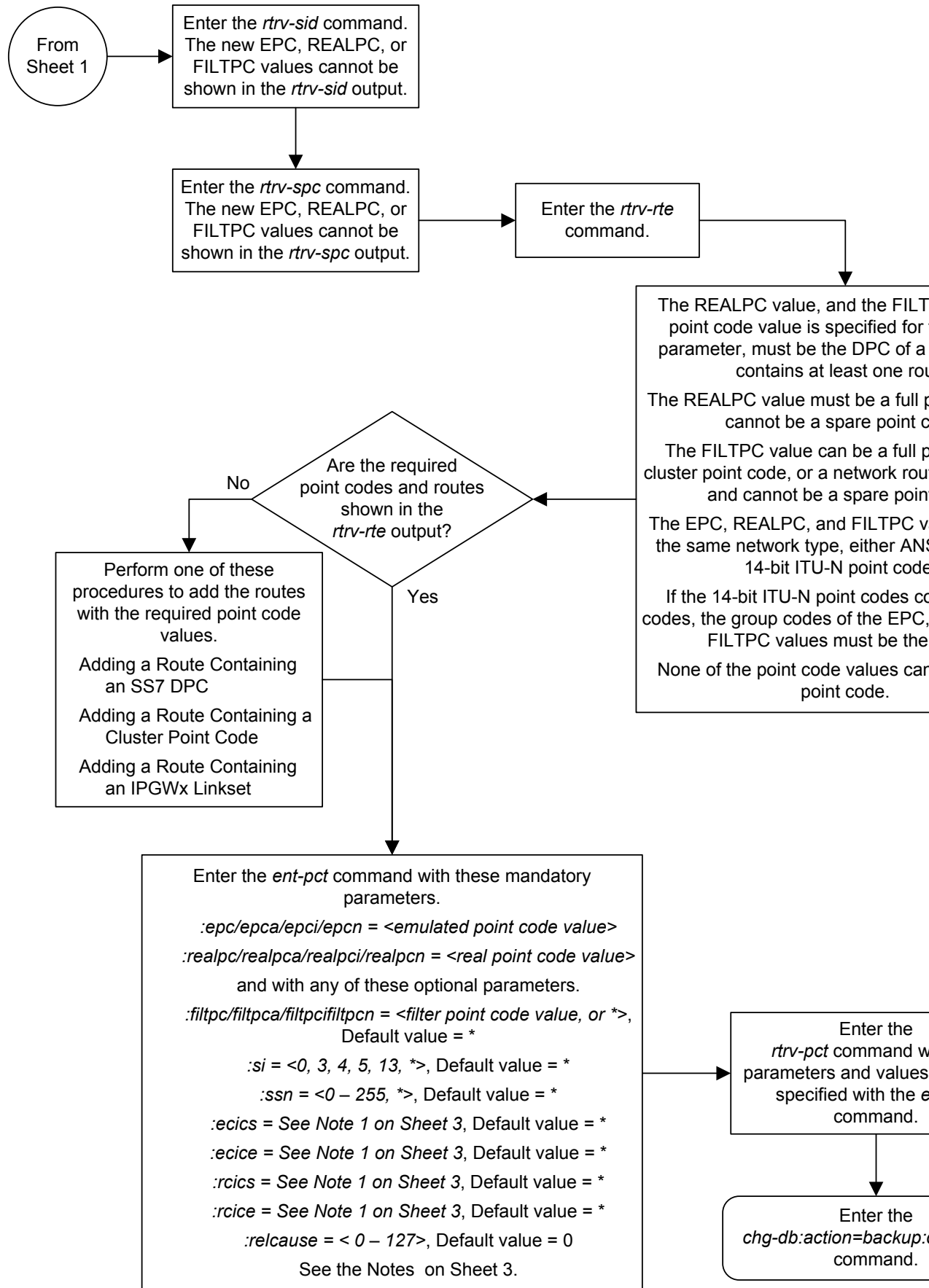
```
BACKUP (FIXED) : MASP A - Backup starts on active MASP.
BACKUP (FIXED) : MASP A - Backup on active MASP to fixed disk complete.
BACKUP (FIXED) : MASP A - Backup starts on standby MASP.
BACKUP (FIXED) : MASP A - Backup on standby MASP to fixed disk complete.
```


Figure 4-2 Adding a Point Code and CIC Translation Entry



Sheet 1 of 3





Notes:

1. The value of the *ecics/ecice* and *rcics/rcice* parameters is dependent on the value of the *si* parameter.
 - If the *si* value is 4, the value of the *ecics/ecice* and *rcics/rcice* parameters is 0 – 4095 or *.
 - If the *si* value is 5 and the entry contains ITU point codes, the value of the *ecics/ecice* and *rcics/rcice* parameters is 0 – 4095 or *.
 - If the *si* value is 5 and the entry contains ANSI point codes, the value of the *ecics/ecice* and *rcics/rcice* parameters is 0 – 16383 or *.
 - If the *si* value is 13, the value of the *ecics/ecice* and *rcics/rcice* parameters is 0 – 4294967295 or *.
2. If the *ssn* parameter is specified, the *si* value must be specified with the value 3.
3. If the *ecics/ecice* and *rcics/rcice* parameters are specified, the *si* parameter must be specified with the value 3 or 13.
4. The *epc/epca/epci/epcn* parameter value must be a full point code and cannot be a spare point code.
5. If the *relcause* parameter is specified, the *si* parameter value must be 5 or 13, and the *ecics* parameter must be specified.
6. If a range of emulated CIC values is specified, the *ecics* and *ecice* parameters must be specified. The *ecice* parameter value must be equal to or greater than the *ecics* parameter value.
7. If a range of real CIC values is specified, the *rcics* and *rcice* parameters must be specified. The *rcice* parameter value must be equal to or greater than the *rcics* parameter value.
8. If the *ecice* parameter is specified, the *ecics* parameter must be specified.
9. If the *rcice* parameter is specified, the *rcics* parameter must be specified.
10. If the *rcics* parameter is specified, the *ecics* parameter must be specified.
11. If the *ecics*, *ecice*, and *rcics* parameters are specified, the *rcice* parameter must be specified.
12. If the *ecics*, *rcics*, and *rcice* parameters are specified, the *ecice* parameter must be specified.
13. If a range of emulated CIC and real CIC values are specified, the difference between the ECICS and ECICE values must be the same as the difference between the RCICS and RCICE values. Where CIC translations are provisioned uniformly across a trunk group, it is recommended that the CIC should be provisioned in ranges such that they are not split across PCT translations.
14. If the *epc/epca/epci/epcn* parameter value is equal to the *realpc/realpca/realpci/realpcn* parameter value, the range of emulated CIC values cannot be the same as the range of real CIC values.
15. Duplicate values for these key combinations are not allowed.
 - epc/epca/epci/epcn + filtpc/filtpca/filtpci/filtpcn + si + ssn(ecics/ecice)*
 - realpc/realpca/realpci/realpcn + filtpc/filtpca/filtpci/filtpcn + si + ssn(rcics/rcice)*
16. Only one filter point code value can be specified with the PCT entry, either an ANSI filter point code (*filtpci*), an ITU-I filter point code (*filtpci*), or a 14-bit ITU-N filter point code (*filtpcn*).
17. If the *si* parameter value is 0 or wildcard (*), only the *epc/epca/epci/epcn*, *realpc/realpca/realpci/realpcn*, *filtpca/filtpci/filtpcn* parameters can be specified.
18. The value * is a wildcard value. The wildcard value indicates that the parameter is not part of the key matching translation.

Sheet 3 of 3

Removing a Point Code and CIC Translation Entry

This procedure is used to remove a PCT (point code and CIC translation) entry from the database, using the `dlt-pct` command.

The `dlt-pct` command uses these parameters.

`:epc/epca/epci/epcn` – The emulated point code of the PCT entry shown in the EPCA, EPCI or EPCN columns.

`:realpc/realpca/realpci/realpcn` – The real point code of the PCT entry shown in the REALPCA, REALPCI or REALPCN columns.

`:filtpc/filtpca/filtpci/filtpcn` – The filter point code of the PCT entry shown in the FILTPCA, FILTPCI or FILTPCN columns.

`:si` – The service indicator value of the PCT entry shown in the SI column.

`:ssn` – The subsystem number value of the PCT entry shown in the SSN column.

`:ecics` – The emulated CIC start value of the PCT entry shown in the ECICS field.

`:ecice` – The emulated CIC end value of the PCT entry shown in the ECICE field.

`:rcics` – The real CIC start value of the PCT entry shown in the RCICS field.

`:rcice` – The real CIC end value of the PCT entry shown in the RCICE field.

The PCT entry that is being removed must exist in the database. The values for the parameters of the PCT entry must be entered as shown in the `rtrv-pct` output. If dashes are shown in a field or column, the field or column has no value and the parameter that corresponds to that field or column cannot be specified with the `dlt-pct` command.

1. Display the PCT entries by entering the `rtrv-pct` command.

This is an example of the possible output.

```
rlghncxa03w 10-12-17 16:02:05 GMT EAGLE5 43.0.0

      EPCA          FILTPCA          REALPCA      SI  SSN  RELCAUSE
      001-001-001      *              002-002-002    5  ---   10

      ECICS = 10          ECICE = 20
      RCICS = 30          RCICE = 40

      EPCI          FILTPCI          REALPCI      SI  SSN  RELCAUSE
      1-001-2        2-002-2          2-002-2      3  10   ---

      ECICS = -----   ECICE = -----
      RCICS = -----   RCICE = -----

      EPCN          FILTPCN          REALPCN      SI  SSN  RELCAUSE
      00300          *              00200        *  ---   ---

      ECICS = -----   ECICE = -----
      RCICS = -----   RCICE = -----

Unique EPC      is 3 of 250
Unique RealPC   is 3 of 250
```

PCT table is (3 of 1000) 1% full.

If no entries are shown in the `rtrv-pct` output, this procedure cannot be performed.

If entries are shown in the `rtrv-pct` output, continue the procedure with 2.

2. Remove the PCT entry from the database using the `dlt-pct` command with the values shown in the columns and fields of the PCT entry, shown in 1, that is being removed. For this example, enter this command.

```
dlt-  
pct:epca=001-001-001:realpca=002-002-002:filtpca=:si=5:ecics  
=10 :ecice=20:rcics=30:rcice=40
```

When the `dlt-pct` command has successfully completed, this message should appear.

```
rlghncxa03w 10-12-17 15:35:05 GMT EAGLE5 43.0.0  
DLT-PCT: MASP A - COMPLTD
```

3. Verify the changes using the `rtrv-pct` command with the parameters and values specified in 2. For this example, enter this command.

```
rtrv-  
pct:epca=001-001-001:realpca=002-002-002:filtpca=:si=5:ecics  
=10 :ecice=20:rcics=30:rcice=40
```

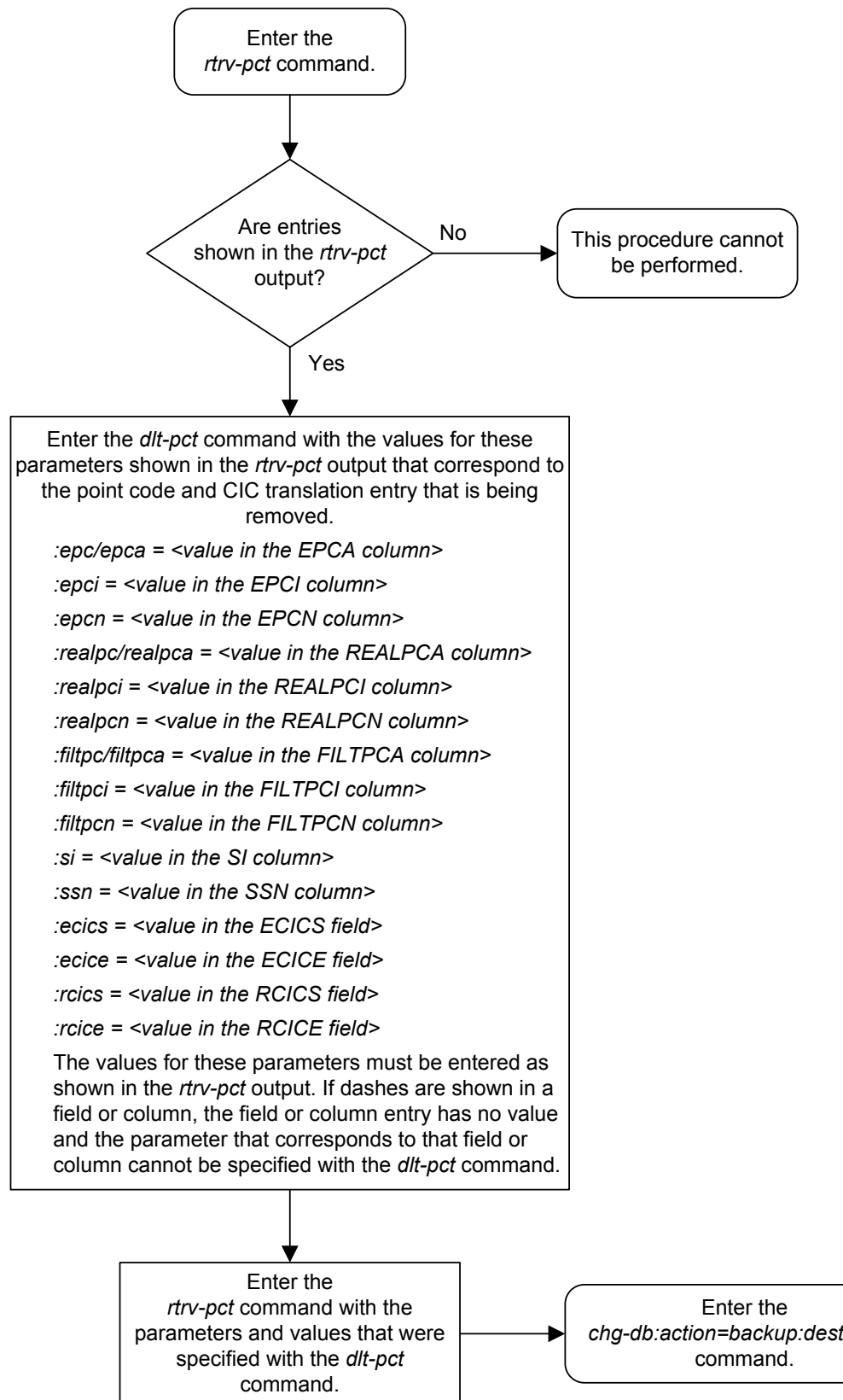
This message should appear.

```
E5401 Cmd Rej: Single translation entry not found
```

4. Back up the new changes, using the `chg-db:action=backup:dest=fixed` command. These messages should appear; the active **Maintenance and Administration Subsystem Processor (MASP)** appears first.

```
BACKUP (FIXED) : MASP A - Backup starts on active MASP.  
BACKUP (FIXED) : MASP A - Backup on active MASP to fixed disk complete.  
BACKUP (FIXED) : MASP A - Backup starts on standby MASP.  
BACKUP (FIXED) : MASP A - Backup on standby MASP to fixed disk complete.
```


Figure 4-3 Removing a Point Code and CIC Translation Entry



Configuring the Point Code and CIC Translation STP Option

This procedure is used to configure the STP option for the PCT (Point Code and CIC Translation) feature using the `chg-stpopts` command with the `pct` parameter. The `pct` parameter has three values.

- `on` – The PCT feature is applied to all MSUs.
- `off` – The PCT feature is not applied to any MSUs.
- `lset` – The PCT feature is applied to incoming MSUs or outgoing MSUs on a linkset whose PCT option value is `on`.

The default value for the `pct` parameter is `off`.

The value of the `pct` parameter is shown in the `PCT` field of the `rtrv-stpopts` output. The `PCT` field of the `rtrv-stpopts` is shown only if a PCT quantity is enabled.

1. Display the features that are enabled by entering the `rtrv-ctrl-feat` command.

The following is an example of the possible output.

```
rlghncxa03w 10-12-28 21:15:37 GMT EAGLE5 43.0.0
The following features have been permanently enabled:
```

Feature Name	Partnum	Status	Quantity
Command Class Management	893005801	on	----
LNP Short Message Service	893006601	on	----
Intermed GTT Load Sharing	893006901	on	----
XGTT Table Expansion	893006101	on	4000000
XMAP Table Expansion	893007710	on	3000
Large System # Links	893005901	on	1500
Routesets	893006401	on	6000
HC-MIM SLK Capacity	893012707	on	64

The following features have been temporarily enabled:

Feature Name	Partnum	Status	Quantity	Trial Period Left
Zero entries found.				

The following features have expired temporary keys:

Feature Name	Partnum
Zero entries found.	

If a PCT quantity is not enabled, perform the [Changing the Point Code and CIC Translation Quantity](#) procedure to enable a PCT quantity. The value of the `PCT` field in the `rtrv-stpopts` output is set to the default value of `off`. After the [Changing the Point Code and CIC Translation Quantity](#) procedure has been performed, continue the procedure with [3](#).

If a PCT quantity is enabled, continue the procedure with [2](#).

2. Display the existing value for the `pct` parameter by entering the `rtrv-stpopts` command. This is an example of the possible output.

```
rlghncxa03w 10-12-17 16:02:05 GMT EAGLE5 43.0.0
```

```
STP OPTIONS
-----
PCT                off
```

Note: The `rtrv-stpopts` command output contains other fields that are not used by this procedure. If you wish to see all the fields displayed by the `rtrv-stpopts` command, see the `rtrv-stpopts` command description in the *Commands Manual*.

3. Change the value of the `pct` parameter. Enter one of these commands.

- a. To change the `pct` parameter value to `off`, enter this command.

```
chg-stpopts:pct=off
```

- b. To change the `pct` parameter value to `on`, enter this command.

```
chg-stpopts:pct=on
```

- c. To change the `pct` parameter value to `lset`, enter this command.

```
chg-stpopts:pct=lset
```

When this command has successfully completed, this message should appear.

```
rlghncxa03w 10-12-17 16:02:05 GMT EAGLE5 43.0.0
CHG-STPOPTS: MASP A - COMPLTD
```

4. Verify the changes using the `rtrv-stpopts` command. This is an example of the possible output.

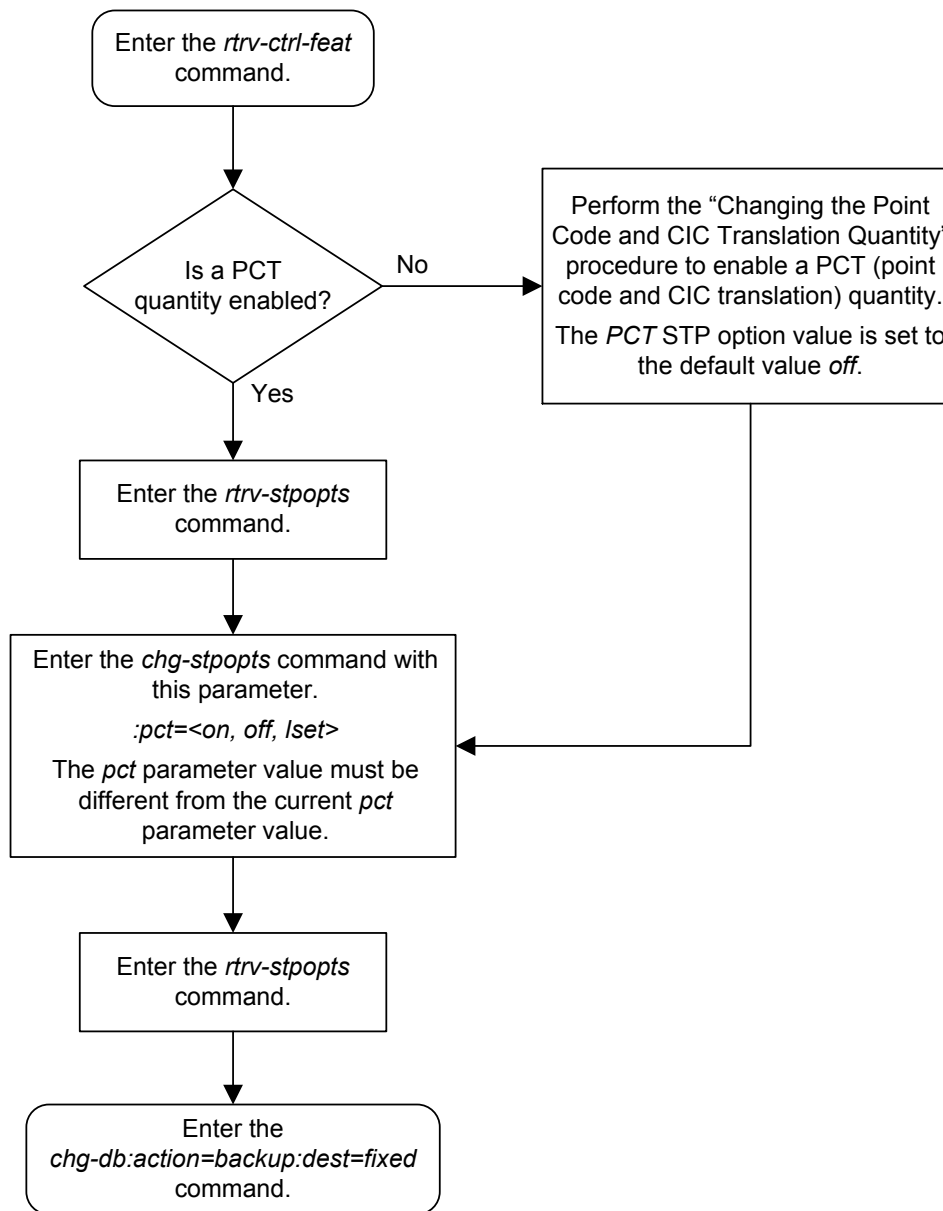
```
rlghncxa03w 10-12-17 16:02:05 GMT EAGLE5 43.0.0
STP OPTIONS
-----
PCT                lset
```

Note: The `rtrv-stpopts` command output contains other fields that are not used by this procedure. If you wish to see all the fields displayed by the `rtrv-stpopts` command, see the `rtrv-stpopts` command description in the *Commands Manual*.

5. Back up the new changes using the `chg-db:action=backup:dest=fixed` command. These messages should appear, the active **Maintenance and Administration Subsystem Processor (MASP)** appears first.

```
BACKUP (FIXED) : MASP A - Backup starts on active MASP.
BACKUP (FIXED) : MASP A - Backup on active MASP to fixed disk complete.
BACKUP (FIXED) : MASP A - Backup starts on standby MASP.
BACKUP (FIXED) : MASP A - Backup on standby MASP to fixed disk complete.
```

Figure 4-4 Configuring the Point Code and CIC Translation STP Option



Configuring the Point Code and CIC Translation Linkset Option

This procedure is used to configure the PCT (point code and CIC translation) option for a linkset using the `chg-lsopts` command with the `pct` and `lsn` parameters.

The `pct` parameter has two values.

- `on` – The PCT feature is applied to incoming MSUs or outgoing MSUs on a linkset.
- `off` – The PCT feature is not applied to incoming MSUs or outgoing MSUs on a linkset.

The default value for the `pct` parameter is `off`.

The `lsn` parameter value is the name of the linkset that is being changed. The `lsn` value is shown in the `LSN` column of the `rtrv-ls` output.

The value of the `pct` parameter of the linkset can be changed only if a PCT quantity is enabled. The `pct` parameter value the linkset will effect the linkset's traffic only if the PCT value in the `rtrv-stpopts` output is `lset`. The PCT field of the `rtrv-stpopts` is shown only if a PCT quantity is enabled.

The value of the `pct` parameter of the linkset is shown when an individual linkset is displayed by entering the `rtrv-ls:lsn=<linkset name>` command. The `pct` parameter value is shown in the `PCT` column.

Canceling the RTRV-LS Command

Because the `rtrv-ls` command used in this procedure can output information for a long period of time, the `rtrv-ls` command can be canceled and the output to the terminal stopped. There are three ways that the `rtrv-ls` command can be canceled.

- Press the F9 function key on the keyboard at the terminal where the `rtrv-ls` command was entered.
- Enter the `canc-cmd` without the `trm` parameter at the terminal where the `rtrv-ls` command was entered.
- Enter the `canc-cmd:trm=<xx>`, where `<xx>` is the terminal where the `rtrv-ls` command was entered, from another terminal other than the terminal where the `rtrv-ls` command was entered. To enter the `canc-cmd:trm=<xx>` command, the terminal must allow Security Administration commands to be entered from it and the user must be allowed to enter Security Administration commands. The terminal's permissions can be verified with the `rtrv-secu-trm` command. The user's permissions can be verified with the `rtrv-user` or `rtrv-secu-user` commands.

For more information about the `canc-cmd` command, go to the *Commands Manual*.

1. Display the features that are enabled by entering the `rtrv-ctrl-feat` command.

The following is an example of the possible output.

```
rlghncxa03w 10-12-28 21:15:37 GMT EAGLE5 43.0.0
The following features have been permanently enabled:

Feature Name           Partnum   Status   Quantity
Command Class Management 893005801 on       ----
LNP Short Message Service 893006601 on       ----
Intermed GTT Load Sharing 893006901 on       ----
```

```

XGTT Table Expansion      893006101  on    4000000
XMAP Table Expansion      893007710  on     3000
Large System # Links      893005901  on    1500
Routesets                  893006401  on    6000
HC-MIM SLK Capacity       893012707  on     64
    
```

The following features have been temporarily enabled:

```

Feature Name          Partnum  Status  Quantity  Trial Period Left
Zero entries found.
    
```

The following features have expired temporary keys:

```

Feature Name          Partnum
Zero entries found.
    
```

If a PCT quantity is not enabled, perform the [Changing the Point Code and CIC Translation Quantity](#) procedure to enable a PCT quantity. The PCT value for all linksets is set to the default value `off` and the value of the PCT field in the `rtrv-stpopts` output is set to the default value `off`. After the [Changing the Point Code and CIC Translation Quantity](#) procedure has been performed, continue the procedure with 2.

If a PCT quantity is enabled, continue the procedure with 2.

2. Display the linksets in the database by entering the `rtrv-ls` command. This is an example of the possible output.

```

rlghncxa03w 10-12-10 11:43:04 GMT EAGLE5 43.0.0

                                L3T SLT                                GWS GWS GWS
LSN      APCA  (SS7)  SCRNR  SET SET BEI  LST LNKS  ACT MES DIS SLSCI NIS
ele2     001-207-000  none  1  1  no  B   6   off off off no  off
ls05     002-009-003  scr2  1  1  no  C   4   on  off on  no  off
ls1305   000-005-000  none  1  1  no  A   1   off off off no  off
ls1307   000-007-000  none  1  1  no  A   1   off off off no  off
elm1s1   001-001-001  none  1  1  no  A   7   off off off no  off
elm1s2   001-001-002  none  1  1  no  A   7   off off off no  off

                                L3T SLT                                GWS GWS GWS
LSN      APCI  (SS7)  SCRNR  SET SET BEI  LST LNKS  ACT MES DIS SLSCI NIS
ele2i    1-207-0      none  1  1  no  B   4   off off off --- on
ls1315   0-015-0      none  1  1  no  A   1   off off off --- off
ls1317   0-017-0      none  1  1  no  A   1   off off off --- on
elm2s1   1-011-1      none  1  1  no  A   7   off off off --- off
elm2s2   1-011-2      none  1  1  no  A   7   off off off --- off
    
```

Link set table is (11 of 1024) 1% full.

3. Display the attributes of the linkset that is being changed by entering the `rtrv-ls` command with the name of the linkset shown in 2. For this example, enter these commands.

```
rtrv-ls:lsn=ls05
```

This is an example of the possible output.

```

rlghncxa03w 10-12-17 11:43:04 GMT EAGLE5 43.0.0

                                L3T SLT                                GWS GWS GWS
    
```

```

LSN          APCA  (SS7)  SCRN SET SET BEI LST LNKS ACT MES DIS SLSCI NIS
ls05        002-009-003  scr2 1  1  no  C  4   on  off on  no   off

          SPCA          CLLI          TFATCABMLQ MTPRSE ASL8
          -----          -----          2          ---   no

RANDSLS
off

IPSG  IPGWAPC  GTTMODE          CGGTMOD  PCT
no    no      CdPA          no          off

          L2T          PCR PCR
          SET BPS     ECM N1  N2
LOC  LINK SLC TYPE          SET BPS     ECM N1  N2
1205 b  0  LIMDS0  1  56000 BASIC ---  -----
1213 b  1  LIMDS0  1  56000 BASIC ---  -----
1211 a  2  LIMDS0  1  56000 BASIC ---  -----
1207 b  3  LIMDS0  1  56000 BASIC ---  -----

```

Link set table is (24 of 1024) 2% full

4. Change the PCT value of the linkset by entering one of these commands. The new PCT value of the linkset must be different from the current value.
 - a. To change the pct parameter value to off, enter this command.

```
chg-lsopts:lsn=ls05:pct=off
```

- b. To change the pct parameter value to on, enter this command.

```
chg-lsopts:lsn=ls05:pct=on
```

When this command has successfully completed, this message should appear.

```

rlghncxa03w 10-12-07 00:22:57 GMT  EAGLE5 43.0.0
Link set table is (24 of 1024) 2% full.
CHG-LSOPTS: MASP A - COMPLTD

```

5. Verify the changes by entering the rtrv-ls command with the name of the linkset that was specified in 4. For this example, enter this command.

This is an example of the possible output.

```

rlghncxa03w 10-12-17 11:43:04 GMT EAGLE5 43.0.0

          L3T SLT          GWS GWS GWS
LSN          APCA  (SS7)  SCRN SET SET BEI LST LNKS ACT MES DIS SLSCI NIS
ls05        002-009-003  scr2 1  1  no  C  4   on  off on  no   off

          SPCA          CLLI          TFATCABMLQ MTPRSE ASL8
          -----          -----          2          ---   no

RANDSLS
off

IPSG  IPGWAPC  GTTMODE          CGGTMOD  PCT
no    no      CdPA          no          on

          L2T          PCR PCR
          SET BPS     ECM N1  N2
LOC  LINK SLC TYPE          SET BPS     ECM N1  N2

```

```

1205 b 0 LIMDS0 1 56000 BASIC --- -----
1213 b 1 LIMDS0 1 56000 BASIC --- -----
1211 a 2 LIMDS0 1 56000 BASIC --- -----
1207 b 3 LIMDS0 1 56000 BASIC --- -----

```

Link set table is (24 of 1024) 2% full

The PCT value of the linkset will have no effect on the linkset's traffic unless the PCT value shown in the `rtrv-stpopts` output (6) is `lset`.

6. Display the existing value for the `pct` parameter by entering the `rtrv-stpopts` command. This is an example of the possible output.

```

rlghncxa03w 10-12-17 16:02:05 GMT EAGLE5 43.0.0
STP OPTIONS
-----
PCT                lset

```

Note: The `rtrv-stpopts` command output contains other fields that are not used by this procedure. If you wish to see all the fields displayed by the `rtrv-stpopts` command, see the `rtrv-stpopts` command description in the *Commands Manual*.

If the PCT value is `lset`, continue the procedure with 7.

If the PCT value is either `on` or `off`, perform one of these actions.

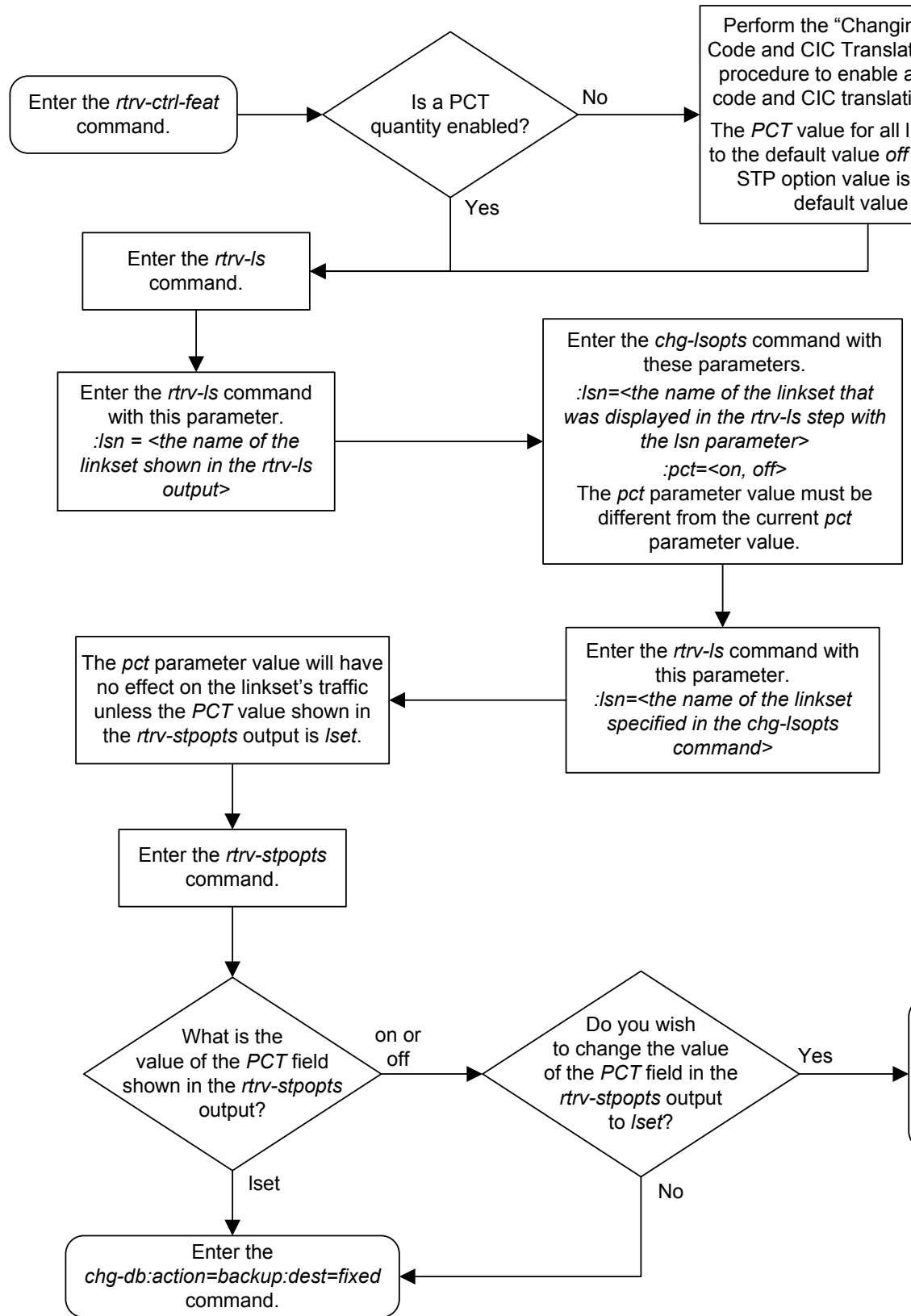
- If you wish to change the PCT value to `lset`, perform the [Configuring the Point Code and CIC Translation STP Option](#) procedure. This procedure is finished.
 - If you do not wish to change the PCT value to `lset`, continue the procedure with 7
7. Back up the new changes using the `chg-db:action=backup:dest=fixed` command. These messages should appear, the active **Maintenance and Administration Subsystem Processor (MASP)** appears first.

```

BACKUP (FIXED) : MASP A - Backup starts on active MASP.
BACKUP (FIXED) : MASP A - Backup on active MASP to fixed disk complete.
BACKUP (FIXED) : MASP A - Backup starts on standby MASP.
BACKUP (FIXED) : MASP A - Backup on standby MASP to fixed disk complete.

```


Figure 4-5 Configuring the Point Code and CIC Translation Linkset Option



E1 Interface

Appendix A, E1 Interface, contains general information about the E1 interface and how to provision it.

Introduction

The **E1** interface terminates or distributes **E1** facility signals for the purpose of processing the **SS7** signaling links carried by the **E1** carrier. The **E1** interface can be either a an **E1/T1 MIM** card, an **E5-E1T1-B** card, or SLIC card as shown in [Figure A-1](#), and [Figure A-2](#). The **E1/T1 MIM** or **E5-E1T1-B** card can also be used as a **T1** interface. This appendix describes how an **E1** interface is configured using either the the **E1/T1 MIM** card or **E5-E1T1-B** card. The **T1** interface configuration is described in [T1 Interface](#).

Note: The procedures in this appendix are used only to configure **E1** signaling links on the **E1/T1MIM** card or **E5-E1T1-B** card. To configure an **E1** high-speed signaling link (on the **LIME1ATM** card), go to the [Adding an ATM High-Speed Signaling Link](#) procedure.

The **E1/T1 MIM** card contains up to eight signaling links and allows the **EAGLE** to contain more than 500 signaling links.

Figure A-1 E1/T1 MIM Block Diagram

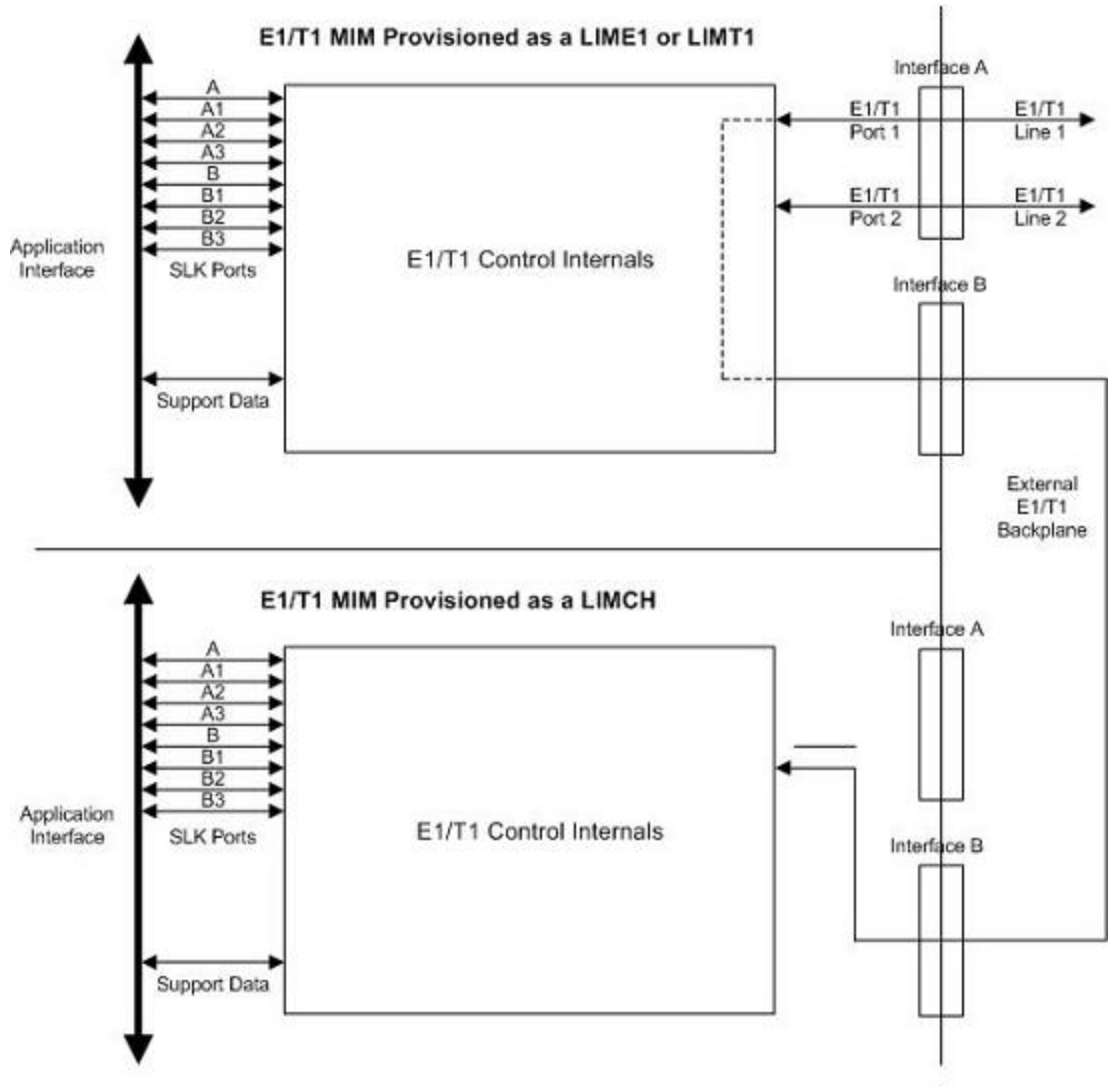


Figure A-2 E5-E1T1-B Block Diagram

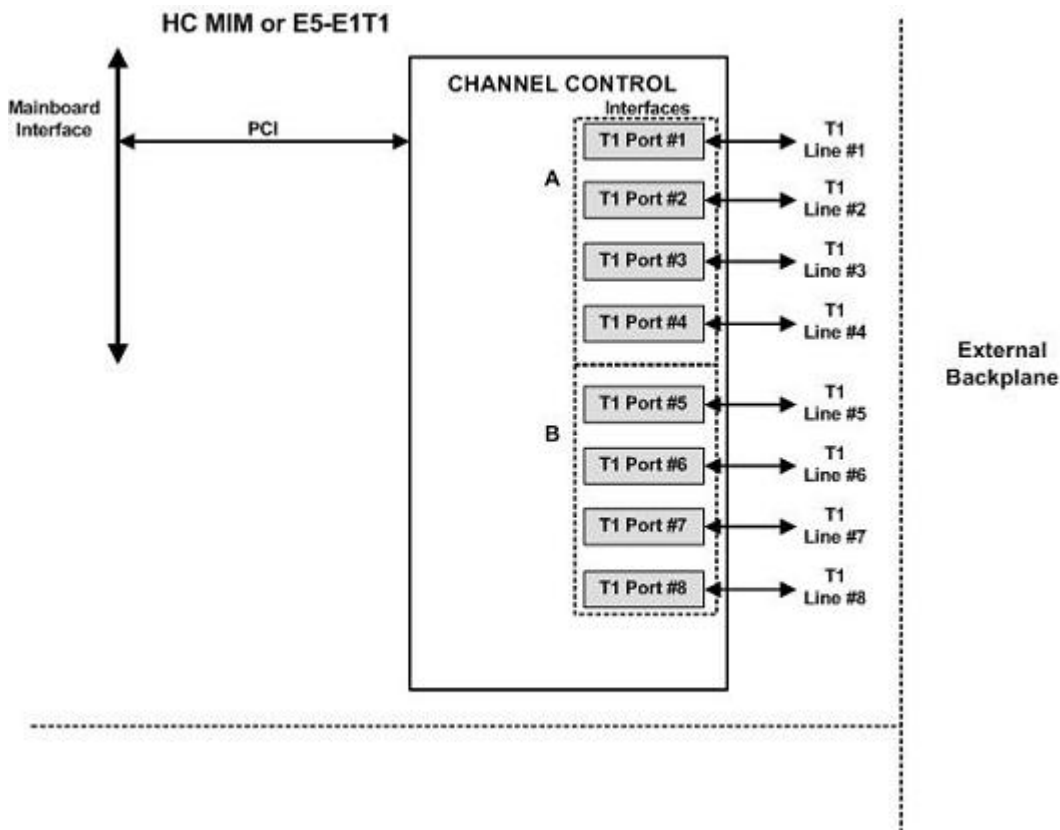


Table A-1 provides an overview of the functions of the E1 card and the channel card.

Table A-1 Functional Overview of the E1 and Channel Card

Card	Function
E1	<ul style="list-style-type: none"> Connectivity of both E1 interfaces to a 120 Ohm or 75 Ohm E1 interface. An external adapter is required for the 75 Ohm interface. Processing up to a total of eight (only two if an E1T1 MIM is being used) time slots from the E1 interfaces Interface E1 port 1 through an external backplane to channel cards for processing of additional time slots
Channel	<ul style="list-style-type: none"> Processing up to eight (only two if an E1T1 MIM configured as a channel card is being used) time slots from the E1 interface Interface through an external backplane to an E1 card to process up to eight (only two if an E1T1 MIM configured as a channel card is being used) time slots

Configured as an E1 Card

Configured as an **E1** card, two separate and independent **E1** inputs can be terminated on an **E1** card. If an **E1/T1 MIM** is being used, one to eight bi-directional channels are extracted from the **E1** inputs and processed as **SS7** signaling links. Implemented as **E1 Link Interface Modules**, up to thirty two separate and independent **E1** inputs can be terminated in an **Extension Shelf**. The **E1** card can support signaling links transmitting at either 56 kbps or 64 kbps.

Configured as a Channel Card

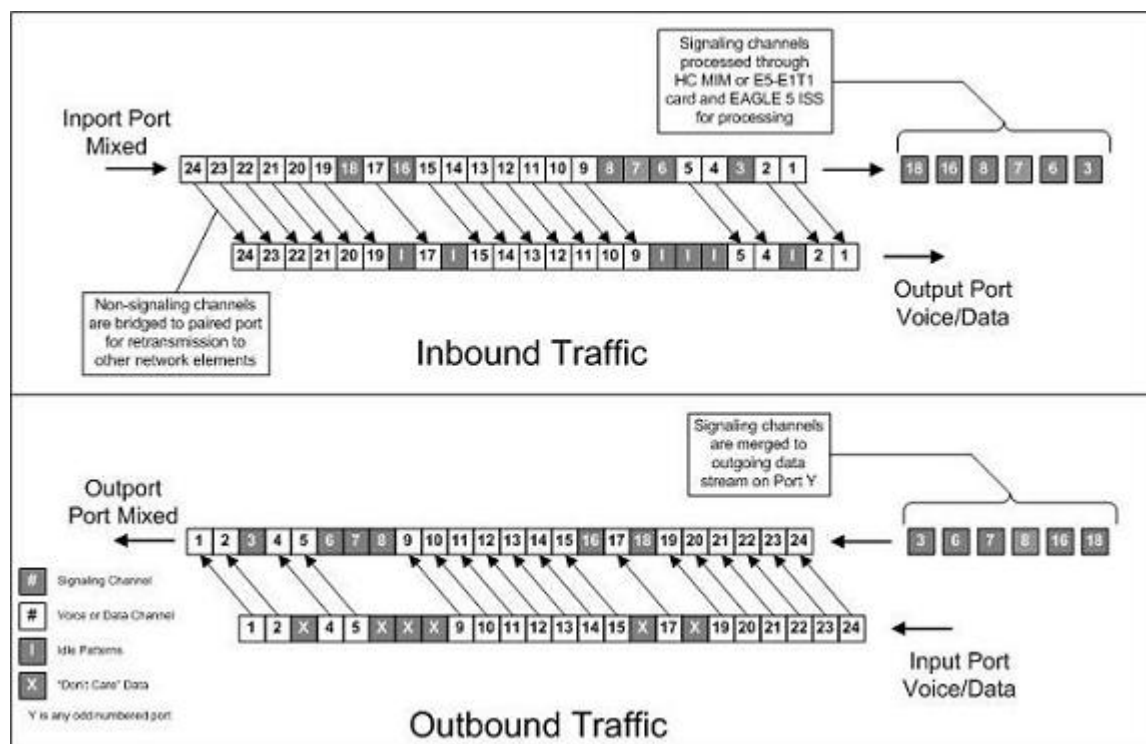
In an Extension shelf equipped with an **E1** cabling backplane, an **E1** card terminates one or two **E1** inputs and connects the **E1** port 1 input to one of eight available busses on the **E1** cabling backplane. **Channel** cards also connected to the **E1** cabling backplane are able to extract any eight signaling channels from the same **E1** port 1 input. In this manner, up to 31 **E1** channels can be used for signaling - the 32nd channel is reserved for **E1** synchronization. The **E1** card can support signaling links transmitting at either 56 kbps or 64 kbps.

Note: An E5-E1T1-B card cannot be used as a channel card.

High Capacity Multi-Channel Interface Module (HC-MIM) and Eagle 5 - E1 T1 Interface (E5-E1T1)

The **EAGLE 5 - E1 T1-B Interface (E5-E1T1-B)** provides access to eight **E1** ports residing on backplane connectors A and B. Each data stream consists of 31 **E1 DS0** signaling links assigned in a time-division multiplex manner. Each channel occupies a unique timeslot in the data stream and can be selected as a local signaling link on the interface card. A maximum of 64 **E1** signaling links can be assigned to an appropriate card. A maximum of 32 **E1** signaling links can be assigned to an **E5-E1T1-B** card.

To support the processing of signaling channels that are intermixed on trunks with voice or data channels, the **E5-E1T1-B** card allows **E1** ports to be channel bridged. This allows better utilization of **E1** bandwidth without dedicating entire trunks to signaling.

Figure A-3 Channel Bridging

Channel bridging is implemented by pairing odd and even E1 ports. The E1 port selected for channel bridging is the odd numbered port (1, 3, 5, 7). When the E1 port is selected for channel bridging, it is paired with its adjacent even numbered port (2, 4, 6, 8) as shown in [Table A-2](#).

Table A-2 Channel Bridging E1 Port Pairing

Odd Numbered E1 Port (Bridging Master)	Even Numbered E1 Port Bridged to the Odd Numbered E1 Port (Bridging Slave)
1	2
3	4
5	6
7	8

By pairing E1 ports, the adjacent even numbered E1 port could be used to allow data received on the bridging master (odd) E1 port to reach downstream network elements. This interface is a bi-directional interface so data is also able to enter the bridging slave (even) E1 port and leave the EAGLE through the bridging master (odd) E1 port. There is a 1 to 1 correspondence between the timeslots on the bridging master and slave E1 ports.

In order to use channel bridging without facility errors, both E1 ports (bridging master and slave) must be synchronous (timed off the same clock source). This may be accomplished in one of the following ways:

- The bridging master E1 port and the bridging slave E1 port use timing recovered from each other (using the `eltse1=recovered` parameter with either the `ent-e1` or `chg-e1` command). When provisioning channel bridged E1 port, only the

bridging master **E1** port is provisioned with the `ent-e1` or `chg-e1` command. The bridging slave **E1** port is automatically provisioned with the same attributes as the bridging master **E1** port.

- Both the bridging master and slave **E1** ports are using an external clock source (using the `eltsel=external` parameter when provisioning the channel bridged **E1** port with either the `ent-e1` or `chg-e1` command).

Any other methods used for timing could cause problems on the **E1** trunk and are not supported.

Idle patterns on the shadow channels, that is, the timeslots located on the bridging slave **E1** port that have been not been dropped from the bridging master **E1** port, are provided by the **EAGLE**. All other idle timeslots that are not dropped by the **EAGLE** must contain an idle pattern provided by the remote network elements connected to both **E1** ports (bridging master and slave). Without these patterns on the idle timeslots, instability of the **E1** signaling link may occur.

Provisioning of signaling links on the bridging slave **E1** port is not allowed while the bridging master **E1** port is channel bridged.

Determining the Configuration

External Interface Descriptions

The **E1** Interface Backplane provides a method for extending individual **E1** channels from the **E1**-configured cards to any channel-configured cards in use. Note the following issues regarding the **E1** backplane:

- Only one **E1**-configured card may be plugged into each bus on the backplane.
- When installing non-**E1** cards on the shelf equipped with the **E1** interface backplane, ensure that none of the slots to be used are cabled to the **E1** interface backplane. If a non-**E1** card is installed in a slot that is connected to the **E1** backplane, all **E1** cards on that bus may fail.
- Only one **E1** card may be connected (via the B port) to each bus of the **E1** cabling backplane, and all **SS7** links derived from any particular **E1** must be processed on the same shelf on which the incoming **E1** is terminated.
- Due to cable congestion, Oracle does not recommend use of the **E1** cabling backplane on the control shelf.
- If the control shelf is used, a maximum of 20 **E1** interfaces can be utilized in the control shelf.

The **E1** backplane is impedance-controlled for 120 Ohms and is designed for use with **RS-485** transmission characteristics.

Descriptions of the **T1** hardware and the procedures for installing the **T1** hardware are contained in *Hardware Reference* and *Installation Guide*.

Possible Configurations

The **E1** backplane was designed to allow the maximum number of possible customer setups. It allows the customer to choose between several levels of diversity and convenience. Configurations depend on the number of cards configured as **E1** cards versus the number of cards configured as channel cards. The level of diversity required by the customer also affects the configuration requirements. Note that all signals labelled "**E1** input" may be one or two **E1** ports depending on the cable used.

Support of Two E1 Ports

The **E1** card will support two **E1** ports, which are independently configurable. On an **E1** card, **E1** port 1 will support channel cards. The second port of that **E1** card will only support up to a maximum of eight time slots and will not support channel cards.

Clocking Options

Each **E1** interface must independently operate in one of two clocking modes. When configured as a channel card, an **E1** card is required for the channel card's clocking source.

- **Slave Timing** - The default receive clock on the **E1** card will be used as the source of the transmit clock.
- **Master Timing** - The transmit clock of the **E1** card will originate on this board. The oscillator on the board provides the clock source. *Note the oscillator is less accurate than the network clock.*

The Master Timing feature allows an **E1** signaling link to take its high-speed clock reference directly from an external high-speed master clock source.

Support of E1 Framing Options

The **E1** interfaces will independently support the following **E1** framing options. Selection of these options will be made by the `cr4` and `cas` parameters of either the `ent-e1` or `chg-e1` commands.

- **Clear Channel Signaling (CCS)**
- **Channel Associated Signaling (CAS)**
- **Cyclic Redundancy Check (CRC4)**

The following provide for zero bit suppression: **HDB3** (High Density Bipolar encoding of order 3).

On any given **E1** card, **CCS** and **CAS** are mutually exclusive and cannot be used together. However, **CRC4** may be added to either **CCS** or **CAS**.

LIM-E1 Card to Channel Card Interface

Whether the **E1**/channel card is operating as an **E1** card or a channel card, the card will map any eight channels from the **E1** interfaces to an **HDLC** controller (ports **A**, **B**, **A1**, **B1**, **A2**, **B2**, **A3**, **B3** for the **E1/T1 MIM** card). These channels could be dropped either both from **E1** port 1 or one from **E1** port 1 and the other from **E1** port 2. When the **E1**/channel card is configured as an **E1** card, it will support the external **E1** cabling backplane interface from **E1** port 1 (*E1 port 2 will not have this capability*) to additional **E1**/channel cards, within the same shelf, configured as channel cards. Idle time slots not assigned to an **E1** card or a channel card will be filled with a one's pattern.

Channel Support

The **E1**/channel card will independently support either 56 kbps or 64 kbps on any channel.

Configuring the Signaling Links

The main consideration for the provisioning of **E1**s is to determine the number of **E1**s existing in the network and the equipment needed for grooming into the **EAGLE**. To utilize the flexibility of the **E1** interface feature, you may want to determine the minimum number of **E1** cards needed to process the total number of **SS7** links and then consider diversity for reliability reasons.

Use the following points as guidelines when considering diversity for **E1**:

- If possible, no two E1s containing links from a common link set should be on the same **E1**/dual port channel card.
- If possible, no two E1s containing links from a common link set should be on adjacent **E1**/dual port channel cards where they are powered from the same fuse position.
- If possible, no two E1s containing links from a common link set should be terminated on the same shelf because of the shelf clock cabling, and is only an issue if using master clocking sync to the network
- If possible, no two links in a link set should arrive at the **EAGLE** on the same **E1**.
- If possible, for link sets containing more than two links, you should minimize the number of links in that link set on any given **E1**.

As an example, consider a network to be groomed into the **EAGLE** consisting of 30 E1s with a total number of 100 links where the largest link set size is 8. The most efficient way to provision the **EAGLE** would be to have four extension shelves equipped with the **E1** cabling backplane, one **E1** card, and 12 channel cards per shelf. Utilizing one B bus on each shelf, 25 signaling links would be terminated on each shelf for a total of 100. *This is also the minimum number of E1 cards required for this example.*

With the same example but using the third and fifth bullets above as a consideration, the **EAGLE** would be provisioned with eight extension shelves equipped with the **E1** cabling backplane. Four of the shelves would be equipped with one **E1** card and six channel cards, and the other four shelves would be equipped with one **E1** card and five channel cards. *Since the largest link set size is eight, a total of eight E1 cards is required.* Utilizing one B bus on each shelf, 13 signaling links would be terminated on each shelf with six channel cards, and 12 signaling links would be terminated on each shelf with five channel cards.

Note: When retrieving link information from the database, the links for an **E1** or channel card is not displayed until after the card is allowed.

E1 Configuration Form

Use the form provided below to record your **E1** configuration. An example of the required input is shown in italics under each column heading.

Table A-3 E1 Signaling Link Configuration Form

Card Location and Port (1201 A)	Timeslot (1)	E1 Number (1)	E1 Card Location (1201)	Adjacent Point Code (4001)	Linkset (ST1ME)	SLC (1)
------------------------------------------	-----------------	------------------	-------------------------------	----------------------------------	--------------------	---------

Table A-3 (Cont.) E1 Signaling Link Configuration Form

Card Location and Port (1201 A)	Timeslot (1)	E1 Number (1)	E1 Card Location (1201)	Adjacent Point Code (4001)	Linkset (ST1ME)	SLC (1)
----------------------------------------------------	-------------------------	--------------------------	----------------------------------------	-------------------------------------------	----------------------------	----------------

E1 Interface Configuration Procedures

This appendix contains these procedures because they contain information specific to the E1 Interface:

- [Adding a LIM-E1 Card](#)
- [Removing a LIM-E1 Card](#)
- [Adding Channelized and non-Channel Bridged E1 Ports](#)
- [Adding Channel Bridged E1 Ports](#)
- [Adding Unchannelized E1 Ports](#)
- [Removing the E1 Interface Parameters](#)

- [Changing the Attributes of a Channelized E1 Port](#)
- [Changing the Attributes of an Unchannelized E1 Port](#)
- [Making a Channel Bridged E1 Port from a Channelized E1 Port](#)
- [Making a Non-Channel Bridged E1 Port from a Channel Bridged E1 Port](#)
- [Adding an E1 Signaling Link](#)

Procedures for configuring the linksets and routes, for removing **SS7** signaling links (which includes **E1** signaling links), and for configuring the **HC MIM** temperature alarms are contained in [SS7 Configuration](#) interface, therefore, are not included in this appendix.

The procedures contained in this appendix use a variety of commands. If more information on these commands is needed, go to *Commands User's Guide* to find the required information.

Adding a LIM-E1 Card

The LIM-E1 card is provisioned as either an **E1** card or a channel card in the database using the `ent-card` command. The card being provisioned in the database can be one of these cards shown in [Table A-4](#).

Table A-4 E1 Card Part Numbers

Card Type	Part Number
E1/T1MIM	870-2198-XX
E5-E1T1	870-1873-XX

The `ent-card` command uses these parameters.

:loc – The location of the card being added to the database.

Note: The **HC-MIM** can be inserted only in a odd-numbered card location. The **HC-MIM** will not power up if it is inserted in an even-numbered card location. All the **E1** backplane cabling should be removed from the B connector for the slot that the **HC-MIM** will occupy.

The **HC-MIM** occupies two card locations, so the even numbered card location adjacent to the odd numbered slot where the **HC-MIM** has been inserted must be empty, as shown in [Table A-5](#). The **HC-MIM** is connected to the network through the odd numbered card slot connector.

Table A-5 HC-MIM Card Locations

Location of the HC-MIM	Empty Card Location	Location of the HC-MIM	Empty Card Location
Slot 01	Slot 02	Slot 11	Slot 12
Slot 03	Slot 04	Slot 13	Slot 14

Table A-5 (Cont.) HC-MIM Card Locations

Location of the HC-MIM	Empty Card Location	Location of the HC-MIM	Empty Card Location
Slot 05	Slot 06	Slot 15	Slot 16
Slot 07	Slot 08	Slot 17	Slot 18

The **E1**, **E1/T1 MIM** and **E5-E1T1** cards occupy one card location. These cards can be placed in any card location except for even numbered card locations whose adjacent odd numbered card location is occupied by a card that occupies two card locations.

:type – The type of card being added to the database. For this procedure, the value of this parameter is `lime1` (**E1** card) or `limch` (channel card).

Note: The **HC-MIM** and **E5-E1T1** card cannot be provisioned as a channel card.

:appl – The application software that is assigned to the card. For this procedure, the value of this parameter is either `ccs7itu` or `ss7ansi`.

The shelf to which the card is to be added must already be in the database. This can be verified with the `rtrv-shlf` command. If the shelf is not in the database, see the Adding a Shelf procedure in *Database Administration - System Management User's Guide*.

The examples in this procedure are used to add the **LIM-E1** cards in card locations 1201, 1202, 1203, 1204, 1211, and 1212 to the database.

1. Display the cards in the **EAGLE** using the `rtrv-card` command.

```
rlghncxa03w 09-05-28 09:12:36 GMT EAGLE5 41.0.0
CARD  TYPE      APPL    LSET NAME  LINK SLC LSET NAME  LINK SLC
1102  TSM          GLS
1113  GSPM         OAM
1114  TDM-A
1115  GSPM         OAM
1116  TDM-B
1117  MDAL
1316  DCM          STPLAN
```

The cards should be distributed throughout the **EAGLE** for proper power distribution. Refer to *Installation Guide* for the shelf power distribution.

2. Verify that the correct hardware has been installed on the **EAGLE** to support the **E1** card as shown in *Installation Guide*.
3. Physically verify that the **E1** card has been installed into the card location that will be specified in [step 6](#).

If the **E1** card is an **HC-MIM**, make sure the **HC-MIM** is installed according to the card location requirements shown in [Table A-5](#). If a card is installed and provisioned in the even numbered card location adjacent to the desired odd numbered card, either choose another card location to install and provision the **HC-MIM**, or remove the card in the even-numbered card location by performing the appropriate procedure shown in [Table A-6](#).

Note: Channel cards must be installed in the same shelf as the E1 card that is servicing the timeslots on those channel cards.

Table A-6 Card Removal Procedures

Card Application	Procedure
SS7ANSI, ATMANSI, CCS7ITU, ATMITU	"Removing an SS7 LIM " in Chapter 4, "System Configuration Procedures" in <i>Database Administration - System Management User's Guide</i> "Removing a LIM-E1Card" "Removing a LIM-T1Card"
VSCCP	Removing a Service Module in Chapter 2 in <i>Database Administration - GTT User's Guide</i>
GLS	Removing a GLS Card in Chapter 2, Gateway Screening (GWS) Overview, in <i>Database Administration - GWS User's Guide</i>
STPLAN	"Removing an STP LAN Card" in <i>Database Administration - Features User's Guide</i>
IPLIM, IPLIMI, SS7IPGW, IPGWI	"Removing an IPLIMx Card" or Removing an IPGWx Card" in <i>Database Administration - IP7 User's Guide</i>
IPSG	"Removing an IPSG Card" in <i>Database Administration - IP7 User's Guide</i>
EROUTE	"Removing an STC Card" in <i>Database Administration - Features User's Guide</i>
MCP	"Removing an MCPM " in Chapter 4, "System Configuration Procedures" in <i>Database Administration - System Management User's Guide</i>
IPS	"Removing an IPSM " in Chapter 4, "System Configuration Procedures" in <i>Database Administration - System Management User's Guide</i>

Note: If the E1 card being added in this procedure is not an **HC-MIM** or **E5-E1T1** card, continue the procedure with [7](#).

- If the card is an EPM-B based card (E5-E1T1-B), enter the `rtvr-stpopts` command to verify whether or not the MFC option is on. If the card is not an EPM-B based card, continue the procedure with [5](#)

This is an example of the possible output.

```
rlghncxa03w 11-10-17 16:02:05 GMT EAGLE5 44.0.0
STP OPTIONS
-----
```

MFC off

The `rtrv-stpopts` command output contains other fields that are not used by this procedure. To see all fields displayed by the `rtrv-stpopts` command, see the `rtrv-stpopts` command description in *Commands User's Guide*.

If the **MFC** option is off, perform the Configuring the MFC Option procedure in *Database Administration - System Management User's Guide* to turn on the MFC option.

If the MFC option is on or the MFC Option procedure in *Database Administration - System Management User's Guide* was performed in this step, continue the procedure with 5.

5. The Fan feature must be turned on. Enter the `rtrv-feat` command to verify that the Fan feature is on.

If the Fan feature is on, shown in the `rtrv-feat` output in this step, the `FAN` field should be set to on.

The `rtrv-feat` command output contains other fields that are not used by this procedure. To see all fields displayed by the `rtrv-feat` command, see the `rtrv-feat` command description in *Commands User's Guide*.

If the Fan feature is on, continue the procedure with 7.

If the Fan feature is off, continue the procedure with 6.

6. Turn the Fan feature on by entering this command.

```
chg-feat : fan=on
```

Note: Once the Fan feature is turned on with the `chg-feat` command, it cannot be turned off.

When the `chg-feat` has successfully completed, this message appears.

```
rlghncxa03w 11-10-28 11:43:04 GMT EAGLE5 44.0.0
CHG-FEAT: MASP A - COMPLTD
```

7. Add the card using the `ent-card` command. If the **LIM-E1** card is an **HC-MIM**, the **HC-MIM** can be only in a odd-numbered card location, and cannot be provisioned as a channel card. The **E5-E1T1** card cannot be provisioned as a channel card. The **E1/T1MIM** and **E5-E1T1** cards occupy only one card location. These cards can be placed in any card location except for even numbered card locations whose adjacent odd numbered card location is occupied by a card that occupies two card locations.

For this example, enter these commands.

```
ent-card:loc=1201:type=limel:appl=ccs7itu
ent-card:loc=1202:type=limch:appl=ccs7itu
ent-card:loc=1203:type=limel:appl=ccs7itu
ent-card:loc=1204:type=limch:appl=ccs7itu
ent-card:loc=1211:type=limel:appl=ccs7itu
```

```
ent-card:loc=1212:type=limch:appl=ccs7itu
```

When each of these commands have successfully completed, this message should appear.

```
rlghncxa03w 06-10-12 09:12:36 GMT EAGLE5 36.0.0
ENT-CARD: MASP A - COMPLTD
```

- Verify the changes using the `rtrv-card` command with the card location specified in 7.

For this example, enter these commands.

```
rtrv-card:loc=1201
```

```
rlghncxa03w 06-10-28 09:12:36 GMT EAGLE5 36.0.0
CARD  TYPE      APPL      LSET NAME  LINK SLC LSET NAME  LINK SLC
1201  LIME1       CCS7ITU
```

```
rtrv-card:loc=1202
```

```
rlghncxa03w 06-10-28 09:12:36 GMT EAGLE5 36.0.0
CARD  TYPE      APPL      LSET NAME  LINK SLC LSET NAME  LINK SLC
1202  LIMCH       CCS7ITU
```

```
rtrv-card:loc=1203
```

```
rlghncxa03w 06-10-28 09:12:36 GMT EAGLE5 36.0.0
CARD  TYPE      APPL      LSET NAME  LINK SLC LSET NAME  LINK SLC
1203  LIME1       CCS7ITU
```

```
rtrv-card:loc=1204
```

```
rlghncxa03w 06-10-28 09:12:36 GMT EAGLE5 36.0.0
CARD  TYPE      APPL      LSET NAME  LINK SLC LSET NAME  LINK SLC
1204  LIMCH       CCS7ITU
```

```
rtrv-card:loc=1211
```

```
rlghncxa03w 06-10-28 09:12:36 GMT EAGLE5 36.0.0
CARD  TYPE      APPL      LSET NAME  LINK SLC LSET NAME  LINK SLC
1211  LIME1       CCS7ITU
```

```
rtrv-card:loc=1212
```

```
rlghncxa03w 06-10-28 09:12:36 GMT EAGLE5 36.0.0
CARD  TYPE      APPL      LSET NAME  LINK SLC LSET NAME  LINK SLC
1212  LIMCH       CCS7ITU
```

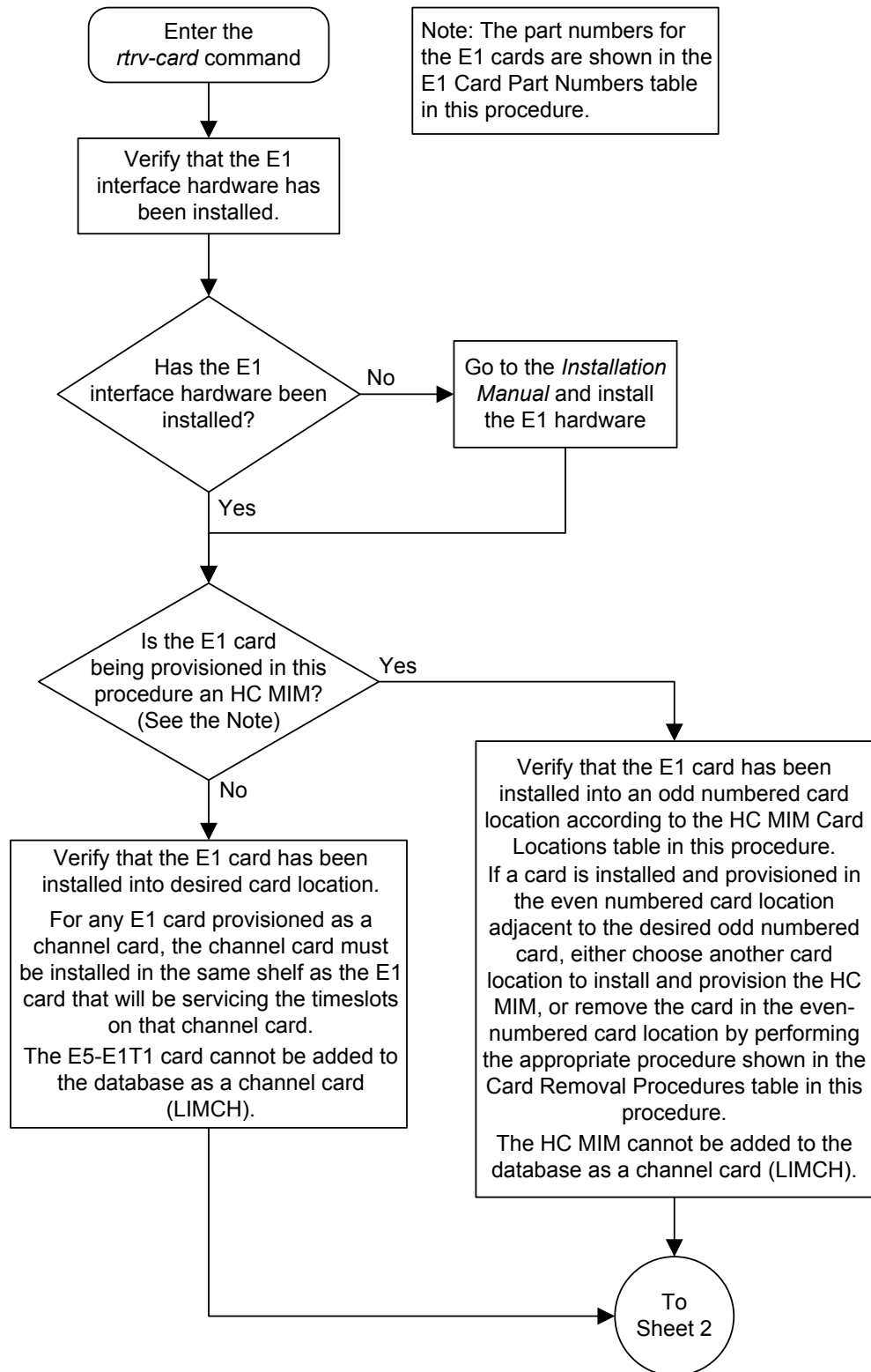
- Back up the new changes using the `chg-db:action=backup:dest=fixed` command.

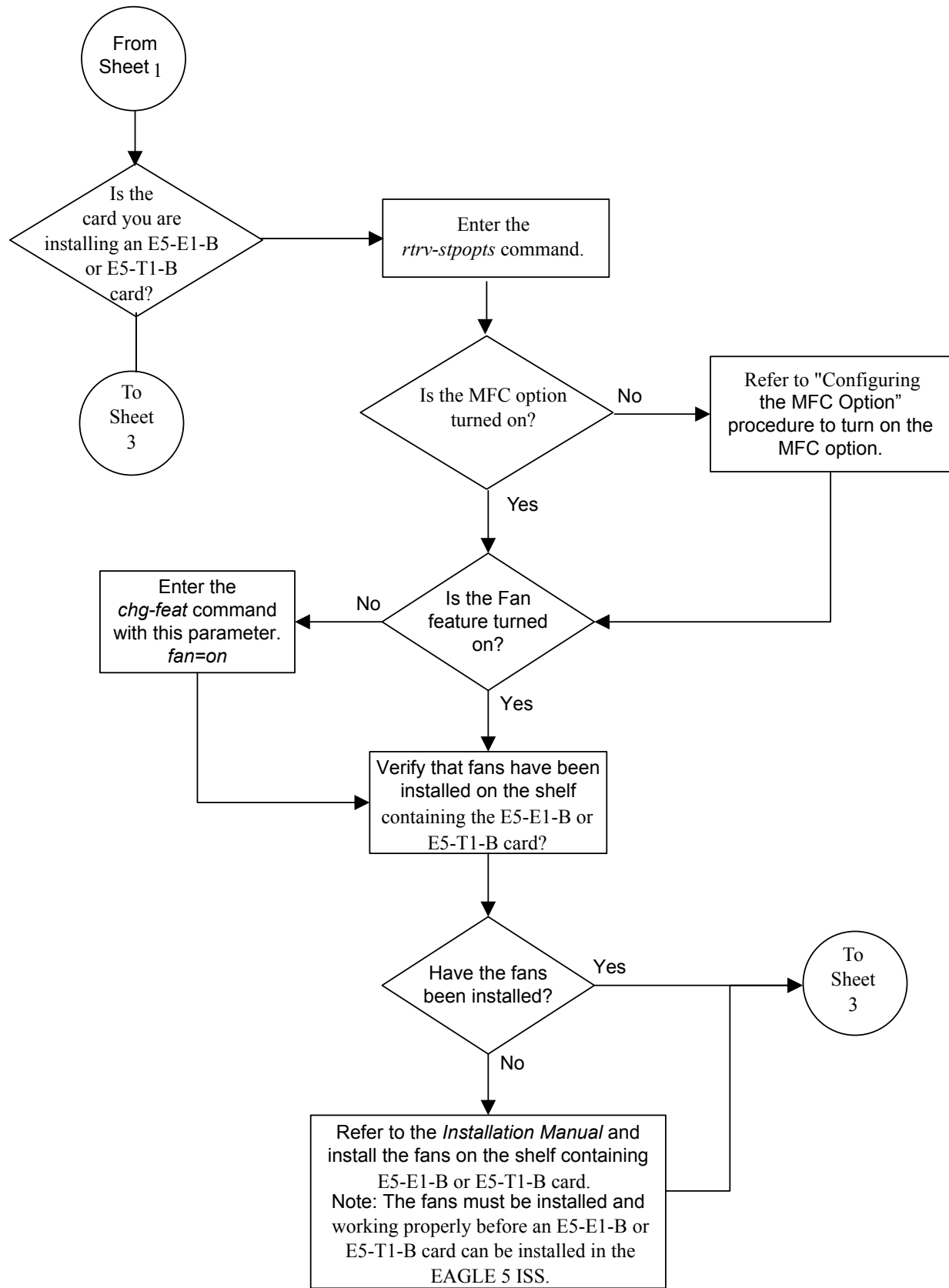
These messages should appear, the active **Maintenance and Administration Subsystem Processor (MASP)** appears first.

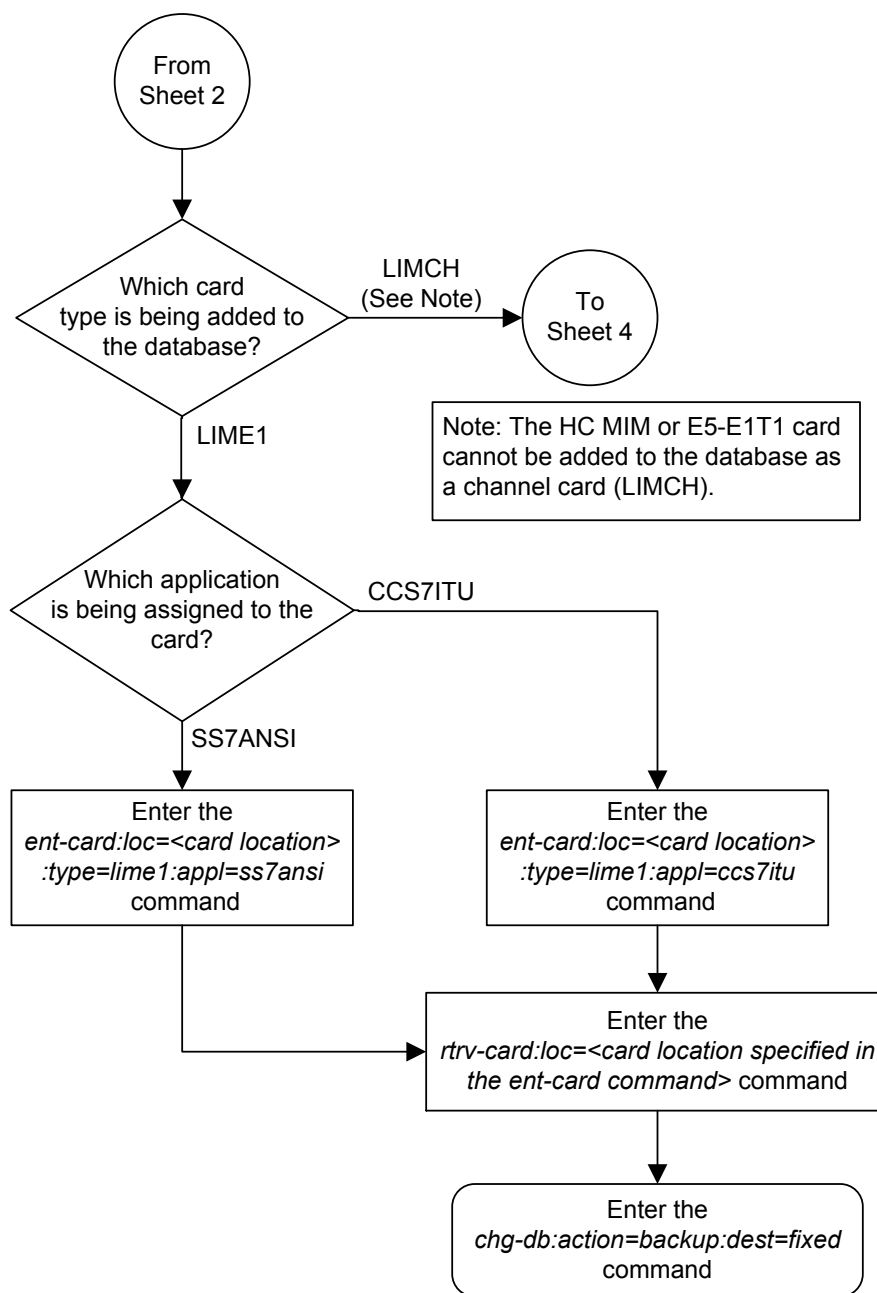
```
BACKUP (FIXED) : MASP A - Backup starts on active MASP.
```

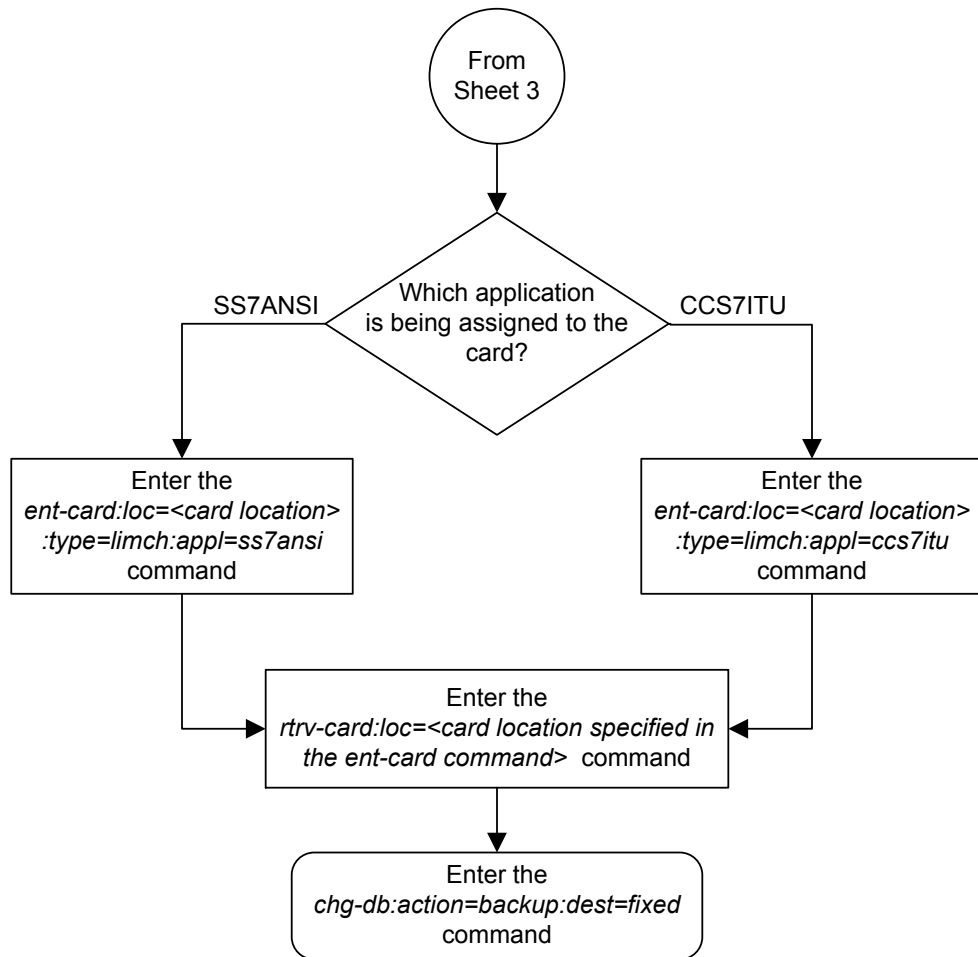

BACKUP (FIXED) : MASP A - Backup on active MASP to fixed disk complete.
BACKUP (FIXED) : MASP A - Backup starts on standby MASP.
BACKUP (FIXED) : MASP A - Backup on standby MASP to fixed disk complete.

Figure A-4 Adding a LIM-E1 Card









Sheet 4 of 4

Removing a LIM-E1 Card

This procedure is used to remove either an **E1** card or a channel card from the database using the `dlt-card` command. The card being removed must exist in the database.

If an **E1** card is being removed, then no **E1** interfaces can be assigned to the card. This can be verified with the `rtrv-e1` command. Go to the [Removing the E1 Interface Parameters](#) procedure to remove the **E1** interfaces assigned to the **E1** card being removed from the database.

If only a channel card is being removed from the database, then no **SS7** signaling links can be assigned to the card. This can be verified with the `rtrv-slk` command. Go to the [Removing an SS7 Signaling Link](#) procedure to remove the signaling links assigned to the channel card being removed from the database.

Caution: If the **E1** card or channel card is the last **SS7LIM** in service, removing this card from the database will cause **SS7** traffic to be lost and isolate the **EAGLE** from the network.

The examples in this procedure are used to remove the **E1** cards in card locations 1202 and 1203.

1. Display the cards in the database using the `rtrv-card` command.

```
rlghncxa03w 09-05-28 09:12:36 GMT EAGLE5 41.0.0
CARD  TYPE      APPL      LSET NAME  LINK SLC LSET NAME  LINK SLC
1102  TSM          GLS
1113  GSPM         OAM
1114  TDM-A
1115  GSPM         OAM
1116  TDM-B
1117  MDAL
1201  LIME1       CCS7ITU  lsne12    A      0
1202  LIMCH       CCS7ITU  lsne12    A      1
1203  LIME1       CCS7ITU  lsne13
1204  LIMCH       CCS7ITU  lsne13
1211  LIME1       CCS7ITU  lsne145   A      0
1212  LIMCH       CCS7ITU  lsne145   A      1  lsne145   A2    2
1316  DCM         STPLAN
```

Note: If an **E1** card is being removed from the database, skip step 2 and go to step 3.

2. Display the signaling links on the channel card you wish to remove by entering the `rtrv-slk` command, specifying the card location shown in the `rtrv-card` command output. For this example, enter this command.

```
rtrv-slk:loc=1202
```

```
rlghncxa03w 06-10-19 21:17:04 GMT EAGLE5 36.0.0

                                L2T                                PCR  PCR  E1  E1
```

LOC	LINK	LSN	SLC	TYPE	SET	BPS	ECM	N1	N2	LOC	PORT	TS
1202	A	lsne12	1	LIMCH	1	64000	BASIC	---	-----	1201	2	1

Go to the [Removing an SS7 Signaling Link](#) procedure to remove the signaling links assigned to the channel card.

Note: If only a channel card is being removed from the database, skip step 3 and go to step 4.

3. Display the **E1** interfaces assigned to the **E1** card being removed from the database using the `rtrv-e1` command with no parameters.

```
rlghncxa03w 06-10-19 21:17:04 GMT EAGLE5 36.0.0
```

E1										LINK	MINSU
LOC	PORT	CRC4	CAS	ENCODE	E1TSEL	SI	SN	CHANBRDG	CLASS	RATE	
1201	2	ON	OFF	HDB3	LINE	0	0	-----	CHAN	----	
1203	1	OFF	ON	HDB3	EXTERNAL	3	6	-----	CHAN	----	

Go to the [Removing the E1 Interface Parameters](#) procedure to remove the **E1** interfaces assigned to the **E1** card.

4. Remove the card using the `dlt-card` command. The `dlt-card` command has only one parameter, `loc`, which is the location of the card. For this example, enter these commands.

```
dlt-card:loc=1201
```

```
dlt-card:loc=1203
```

5. Verify the changes using the `rtrv-card` command specifying the card that was removed in step 4. For this example, enter these commands.

```
rtrv-card:loc=1201
```

```
rtrv-card:loc=1202
```

When these commands have successfully completed, this message should appear.

```
E2144 Cmd Rej: Location invalid for hardware configuration
```

6. Back up the new changes using the `chg-db:action=backup:dest=fixed` command. These messages should appear, the active **Maintenance and Administration Subsystem Processor (MASP)** appears first.

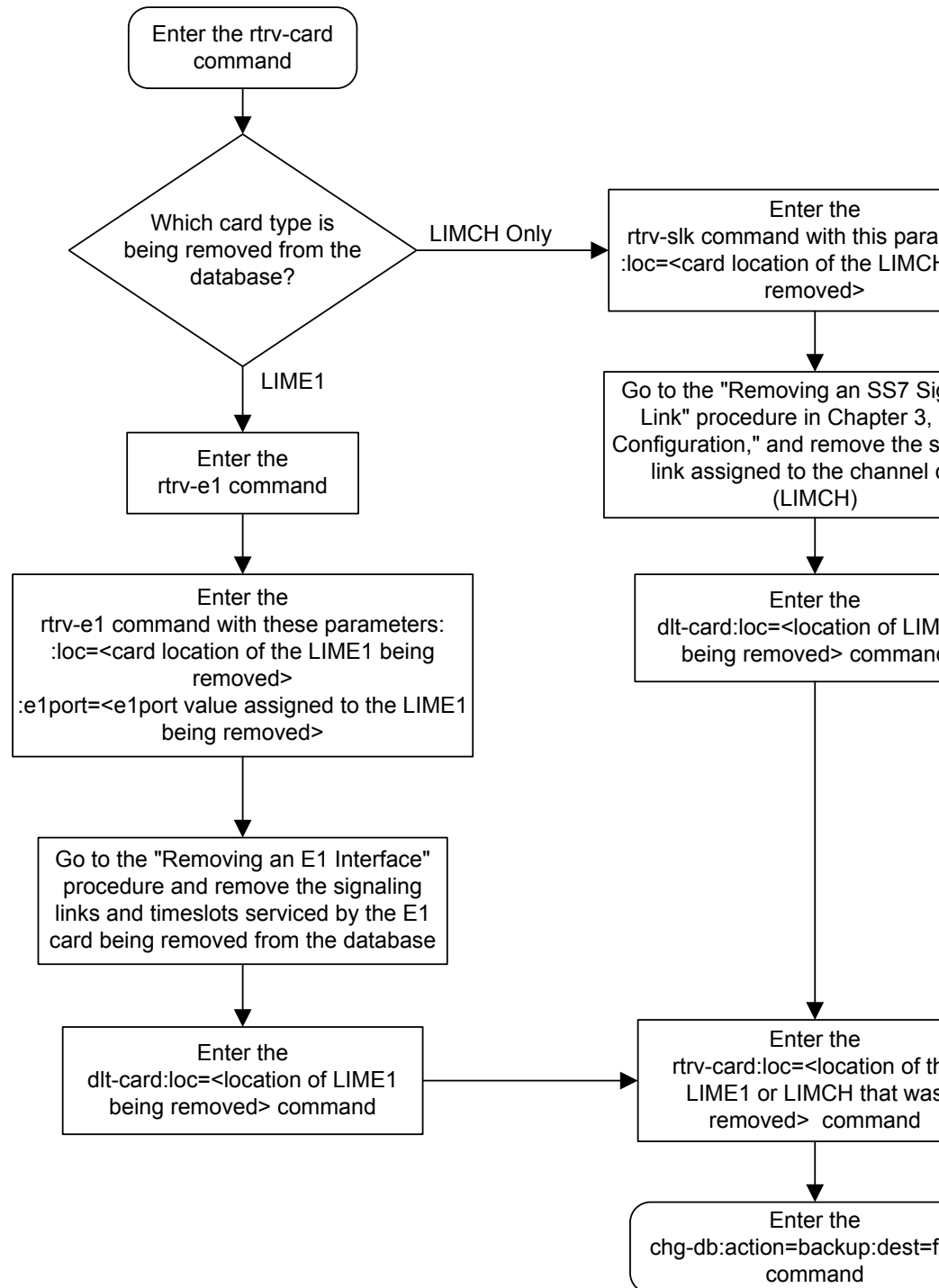
```
BACKUP (FIXED) : MASP A - Backup starts on active MASP.
```

```
BACKUP (FIXED) : MASP A - Backup on active MASP to fixed disk complete.
```

```
BACKUP (FIXED) : MASP A - Backup starts on standby MASP.
```

```
BACKUP (FIXED) : MASP A - Backup on standby MASP to fixed disk complete.
```

Figure A-5 Removing a LIM-E1 Card



Adding Channelized and non-Channel Bridged E1 Ports

The channelized and non-channel bridged E1 ports are provisioned in the database using the `ent-e1` command using these parameters.

`:loc` – The location of the E1 card (card type `1ime1`) that is servicing the E1 signaling link. The location of a channel card (card type `1imch`) cannot be specified for this parameter.

`:e1port` – The E1 port on the E1 card used to service the E1 signaling link. The `e1port` value cannot already be assigned to the E1 card specified by the `loc` parameter.

`:crc4` – Specifies whether or not CRC4 is enabled on the E1 signaling link. The default value is `on` (`crc4=on`).

`:cas` – Specifies whether CAS or CCS is used on the E1 signaling link. CAS is enabled with the `cas=on` parameter. CCS is enabled with the `cas=off` parameter. The default value is CCS enabled (`cas=off`). The `cas=on` parameter cannot be specified for an HC-MIM or an E5-E1T1 card.

`:encode` – Specifies the type of encoding or decoding that is used on the E1 signaling link, either HDB3 or AMI. The default value is HDB3 encoding (`encode=hdb3`). AMI encoding can be specified only for an HC-MIM, or an E5-E1T1 card.

`:eltset` – The timing source for the E1 signaling link, master (`external`), slave (`line`), or recovered. The default value is slave timing (`eltset=line`).

The recovered timing source can be used only with the `chanbrdg=on` parameter and cannot be used in this procedure.

Note: To use an external high-speed master clock source other than RS-422, TDMs 870-0774-15 or later must be installed in card locations 1114 and 1116, and the TDM Global Timing Interface options must be configured. For more information, see [Configuring the Options for the TDM Global Timing Interface](#).

`:si` – Specifies the value of the two spare international bits of NFAS data, from 0 to 3. The default value is 0 (`si=0`).

`:sn` – Specifies the value of the five spare national bits of NFAS data, from 0 to 31. The default value is 0 (`sn=0`).

The `ent-e1` command contains other parameters that are not used in this procedure. These parameters and their usage are described in these sections:

- `eltset=recovered`, `chanbrdg`, and `force=yes` – [Adding Channel Bridged E1 Ports](#).
- `linkclass` and `minsurate` – [Adding Unchannelized E1 Ports](#).

The E1 card specified in this procedure must be in the database. This can be verified with the `rtrv-card` command.

If the `cas=on` parameter is specified with the `ent-e1` command, timeslot 16 cannot be used when the E1 signaling link is provisioned with the `ent-slk` command in [Adding an E1 Signaling Link](#).

The E1 card cannot contain channelized and unchannelized E1 ports.

1. Display the existing E1 interfaces in the database using the `rtrv-e1` command with no parameters. This is an example of the possible output.

```
rlghncxa03w 06-10-19 21:17:04 GMT EAGLE5 36.0.0
```

E1										
LOC	PORT	CRC4	CAS	ENCODE	E1TSEL	SI	SN	CHANBRDG	LINK CLASS	MINSU RATE
1201	1	ON	OFF	HDB3	EXTERNAL	2	6	-----	CHAN	----
1201	2	ON	OFF	HDB3	EXTERNAL	3	5	-----	CHAN	----
1202	1	ON	OFF	HDB3	EXTERNAL	1	10	-----	CHAN	----
1203	1	ON	OFF	HDB3	EXTERNAL	1	11	-----	CHAN	----
1203	2	ON	OFF	HDB3	EXTERNAL	3	7	-----	CHAN	----
1204	1	ON	OFF	HDB3	EXTERNAL	3	8	-----	CHAN	----
1211	2	ON	OFF	HDB3	EXTERNAL	0	0	-----	CHAN	----
1212	1	ON	OFF	HDB3	EXTERNAL	1	1	-----	CHAN	----
1213	1	ON	OFF	HDB3	EXTERNAL	2	2	-----	CHAN	----
1213	5	ON	OFF	HDB3	EXTERNAL	3	3	-----	CHAN	----

Continue the procedure by performing one of these substeps.

- a. If the E1 card that the E1 port is being assigned to in this procedure is not shown in the `rtrv-e1` output, or if the E1 card has unchannelized E1 ports assigned to it, continue the procedure with [2](#) to verify if there are any E1 cards in the database that have no E1 ports assigned to them.
- b. If the `rtrv-e1` output shows that the E1 card has channel bridged E1 ports assigned to it, or that E1 ports 3, 4, 5, 6, 7, or 8 are assigned to the E1 card, the E1 card is an HC MIM or an E5-E1T1 card. Continue the procedure with [7](#) to add the E1 port with the parameters allowed for an HC MIM or an E5-E1T1 card.
- c. If the `rtrv-e1` output shows that the E1 card does not have channel bridged E1 ports assigned to it, or that E1 ports 3, 4, 5, 6, 7, or 8 are not assigned to the E1 card, verify the type of E1 card that the E1 port will be assigned to. The E1 card types and their part numbers are shown in [Table A-4](#). If the E1 card is an HC MIM or an E5-E1T1 card, continue the procedure by performing one of these steps.
 - If the E1 cards shown in this step are on the same shelf as the card that will contain the E1 port that is being added, and these cards have E1 ports 3 through 8 provisioned, contain channel bridged E1 ports, or unchannelized E1 ports, continue the procedure with [7](#).
 - If the E1 cards shown in this step are not on the same shelf as the card that will contain the E1 port that is being added, continue the procedure with [3](#).
 - If the E1 cards shown in this step are on the same shelf as the card that will contain the E1 port that is being added, and these cards do not have E1 ports 3 through 8 provisioned, do not contain channel bridged E1 ports, or do not have unchannelized E1 ports, continue the procedure with [3](#).
- d. If the E1 card you wish to use in this procedure has all the E1 ports that are allowed to be assigned to it, select another E1 card to add the E1 port to, or continue the procedure with [2](#) to verify if there are any E1 cards in the database that have no E1 ports assigned to them. [Table A-7](#) shows the number of E1 ports that are allowed for the different E1 card types.

Table A-7 Maximum Number of E1 Ports

E1 Card Types	Maximum Number of E1 Ports
HC MIM	8
E5-E1T1	8

2. Display the cards in the **EAGLE** using the `rtrv-card` command. This is an example of the possible output.

```
rlghncxa03w 09-05-28 09:12:36 GMT EAGLE5 41.0.0
CARD  TYPE      APPL      LSET NAME  LINK SLC LSET NAME  LINK SLC
1102  TSM           GLS
1113  GSPM         OAM
1114  TDM-A
1115  GSPM         OAM
1116  TDM-B
1117  MDAL
1201  LIME1       CCS7ITU  lsn1      A   13  lsn1      B   12
1202  LIMCH       CCS7ITU  lsn1      A   0   lsn1      B   8
1203  LIME1       CCS7ITU  lsn1      A1  4   lsn1      B1  9
1204  LIMCH       CCS7ITU  lsn1      A2  5   lsn1      A3  6
1211  LIME1       CCS7ITU  lsn1      A   14
1212  LIMCH       CCS7ITU  lsn1      A   10  lsn1      B   11
1213  LIME1       CCS7ITU  lsn1      A4  1   lsn1      A5  7
                               lsn1      B5  2   lsn1      A6  3
1316  DCM         STPLAN
```

Continue the procedure by performing one of these substeps.

- a. If the desired E1 card is not shown in the `rtrv-card` output, perform [Adding a LIM-E1 Card](#) to add the desired E1 card. If you wish to assign E1 ports 3, 4, 5, 6, 7, or 8 to the E1 card, the E1 card being added must be an HC MIM or an E5-E1T1 card.
 - b. If the E1 card that will be used in this procedure is an HC MIM or an E5-E1T1 card, continue the procedure by performing one of these steps.
 - If E1 cards are shown in [1](#) that are on the same shelf as the card that will contain the E1 port that is being added, and these cards have E1 ports 3 through 8 provisioned, contain channel bridged E1 ports, or unchannelized E1 ports, continue the procedure with [7](#) to add the E1 port with the parameters allowed for an HC MIM or an E5-E1T1 card.
 - If no E1 cards, shown in [1](#), are not on the same shelf as the card that will contain the E1 port that is being added, continue the procedure with [3](#).
 - If E1 cards are shown in [1](#) that are on the same shelf as the card that will contain the E1 port that is being added, and these cards do not have E1 ports 3 through 8 provisioned, do not contain channel bridged E1 ports, or do not have unchannelized E1 ports, continue the procedure with [3](#).
3. Verify that **HIPR2** cards are installed in card locations 9 and 10 in the shelf containing the HC MIM or E5-E1T1 card that will contain the E1 port being added in this procedure by entering this command.

```
rept-stat-gpl:gpl=hipr2
```

This is an example of the possible output.

```
rlghncxa03w 09-07-05 08:12:53 GMT 41.1.0
GPL          CARD          RUNNING          APPROVED          TRIAL
HIPR2        1109          126-002-000     126-002-000     126-003-000
HIPR2        1110          126-002-000     126-002-000     126-003-000
HIPR2        1209          126-002-000     126-002-000     126-003-000
HIPR2        1210          126-002-000     126-002-000     126-003-000
HIPR2        1309          126-002-000     126-002-000     126-003-000
HIPR2        1310          126-002-000     126-002-000     126-003-000
HIPR2        2109          126-002-000     126-002-000     126-003-000
HIPR2        2110          126-002-000     126-002-000     126-003-000
Command Completed
```

If **HIPR2** cards are installed in the shelf containing the HC MIM or E5-E1T1 card, continue the procedure by performing one of these steps.

- If the card is an E5-E1T1 card, continue the procedure with [7](#).
- If the card is an HC MIM, continue the procedure with [4](#).

If HIPR2 cards are not installed on the shelf containing the HC MIM or E5-E1T1 card, go to *Installation Guide* and install the HIPR2 cards. Once the HIPR2 cards have been installed, continue the procedure by performing one of these steps.

- If the card is an E5-E1T1 card, continue the procedure with [7](#).
- If the card is an HC MIM, continue the procedure with [4](#).

4. Verify whether or not that the Fan feature is on, by entering the `rtrv-feat` command. If the Fan feature is on, the entry `FAN = on` appears in the `rtrv-feat` command output.

Note: The `rtrv-feat` command output contains other fields that are not used by this procedure. If you wish to see all the fields displayed by the `rtrv-feat` command, see the `rtrv-feat` command description in *Commands User's Guide*.

If the Fan feature is on, continue the procedure with [7](#).

If the Fan feature is off, continue the procedure with [Oracle](#).

5. Turn the Fan feature on by entering this command.

```
chg-feat : fan=on
```

Note: Once the Fan feature is turned on with the `chg-feat` command, it cannot be turned off.

The Fan feature must be purchased before you turn this feature on with the `chg-feat` command. If you are not sure if you have purchased the Fan feature, contact your Sales Representative or Account Representative.

When the `chg-feat` has successfully completed, this message appears.

```
rlghncxa03w 09-05-28 11:43:04 GMT EAGLE5 41.0.0
CHG-FEAT: MASP A - COMPLTD
```

- The shelf containing the HC MIM being added in this procedure must have fans installed. Verify whether or not fans are installed on the shelf.

If the fans are installed, continue the procedure with 7.

If the fans are not installed on the shelf containing the HC MIM, go to *Installation Guide* and install the fans. After the fans have been installed and tested, continue the procedure with 7.

- Add the new **E1** interface information to the database using the `ent-e1` command and the parameter combinations shown in [Table A-8](#), based on the type of **E1** card being used.

Table A-8 E1 Interface Parameter Combinations

HC-MIM or an E5 E1T1 Card without Channel Bridging
Mandatory Parameters
:loc=location of the E1 card
:e1port=1, 2, 3, 4, 5, 6, 7, 8
Optional Parameters
:cas=off Default value = off
:crc4=on, off Default value = on
:encode=ami, hdb3 Default value = hdb3
:si=0 - 3 Default value = 0
:sn=0 - 31 Default value = 0
:e1tsel=line, external Default value = line
Notes:
1. Channel cards cannot be specified with the <code>ent-e1</code> command.
2. To configure the E1 port for master timing, use the <code>e1tsel=external</code> parameter.
3. The <code>linkclass=chan</code> parameter configures a channelized E1 port. Specifying the <code>linkclass=chan</code> parameter in this procedure is unnecessary as this is the default value for the <code>linkclass</code> parameter.

For this example, enter these commands.

```
ent-e1:loc=1203:e1port=2:encode=hdb3:e1tsel=line:si=1:sn=7
ent-e1:loc=1211:e1port=2:crc4=on:encode=hdb3:e1tsel=line
```


- Verify the changes using the `rtrv-e1` command specifying the card location and the `e1port` value specified in 7. For this example, enter these commands.

```
rtrv-e1:loc=1203:e1port=2
```

```
rlghncxa03w 06-10-28 09:12:36 GMT EAGLE5 36.0.0
```

E1								LINK	MINSU	
LOC	PORT	CRC4	CAS	ENCODE	E1TSEL	SI	SN	CHANBRDG	CLASS	RATE
1203	2	OFF	OFF	HDB3	LINE	1	7	-----	CHAN	----
TS0	(N/A)	TS8	-----	TS16	-----	TS24	-----			
TS1	-----	TS9	-----	TS17	-----	TS25	-----			
TS2	-----	TS10	-----	TS18	-----	TS26	-----			
TS3	-----	TS11	-----	TS19	-----	TS27	-----			
TS4	-----	TS12	-----	TS20	-----	TS28	-----			
TS5	-----	TS13	-----	TS21	-----	TS29	-----			
TS6	-----	TS14	-----	TS22	-----	TS30	-----			
TS7	-----	TS15	-----	TS23	-----	TS31	-----			

```
rtrv-e1:loc=1211:e1port=2
```

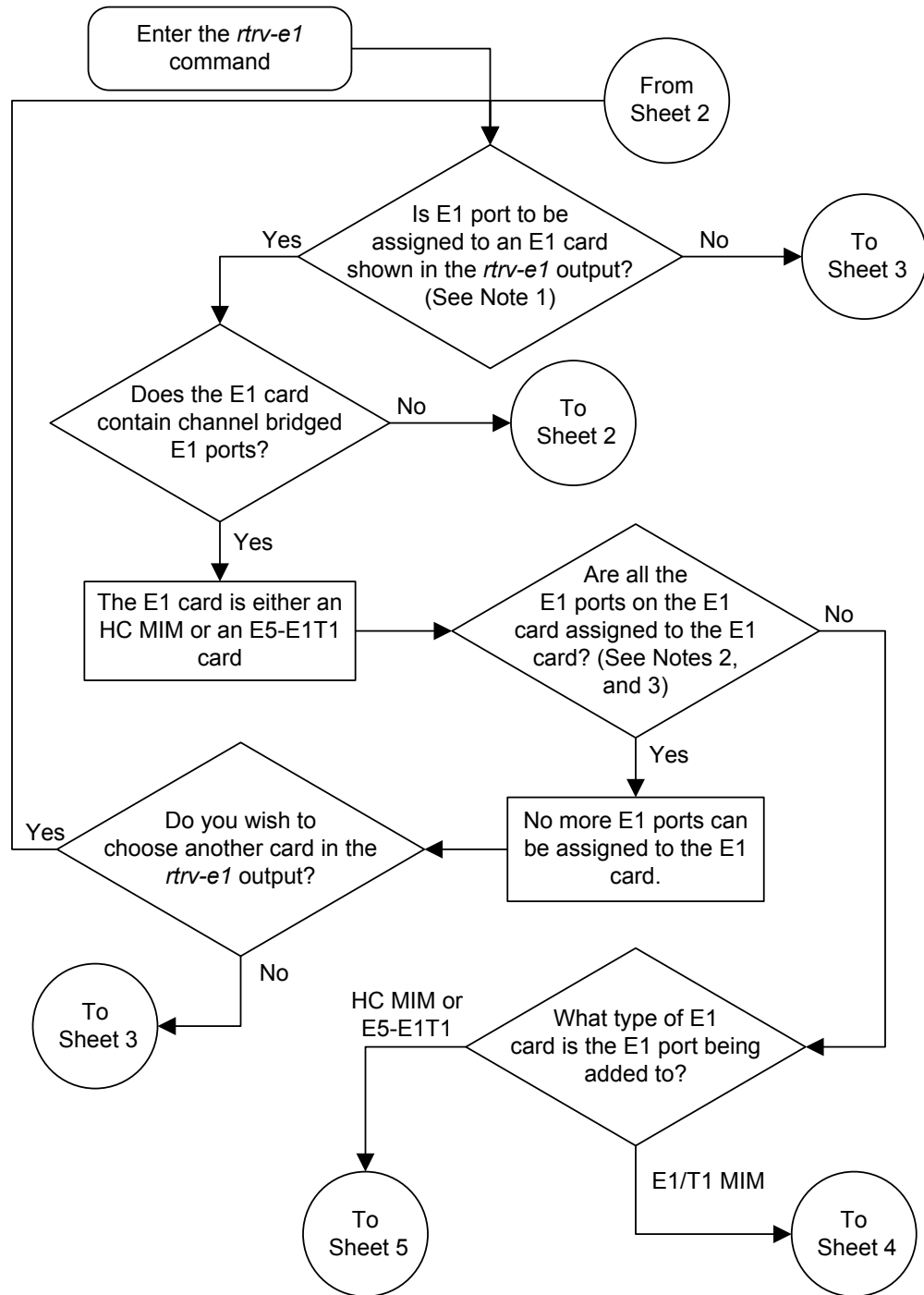
```
rlghncxa03w 06-10-28 09:12:36 GMT EAGLE5 36.0.0
```

E1								LINK	MINSU	
LOC	PORT	CRC4	CAS	ENCODE	E1TSEL	SI	SN	CHANBRDG	CLASS	RATE
1211	2	ON	OFF	HDB3	LINE	0	0	-----	CHAN	----
TS0	(N/A)	TS8	-----	TS16	-----	TS24	-----			
TS1	-----	TS9	-----	TS17	-----	TS25	-----			
TS2	-----	TS10	-----	TS18	-----	TS26	-----			
TS3	-----	TS11	-----	TS19	-----	TS27	-----			
TS4	-----	TS12	-----	TS20	-----	TS28	-----			
TS5	-----	TS13	-----	TS21	-----	TS29	-----			
TS6	-----	TS14	-----	TS22	-----	TS30	-----			
TS7	-----	TS15	-----	TS23	-----	TS31	-----			

- Back up the new changes using the `chg-db:action=backup:dest=fixed` command. These messages should appear, the active **Maintenance and Administration Subsystem Processor (MASP)** appears first.

```
BACKUP (FIXED) : MASP A - Backup starts on active MASP.
BACKUP (FIXED) : MASP A - Backup on active MASP to fixed disk complete.
BACKUP (FIXED) : MASP A - Backup starts on standby MASP.
BACKUP (FIXED) : MASP A - Backup on standby MASP to fixed disk complete.
```

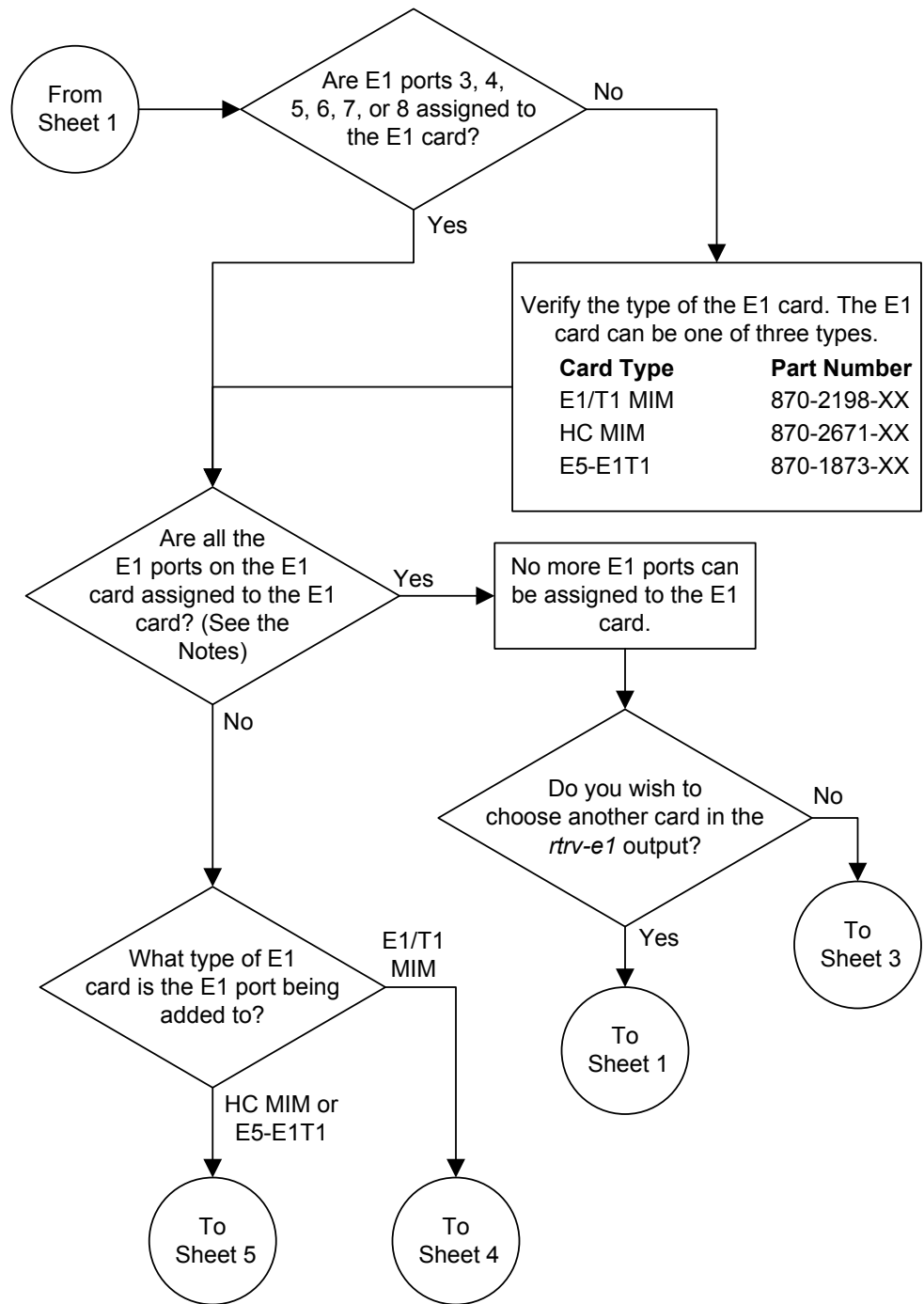
Figure A-6 Adding Channelized and non-Channel Bridged E1 Ports



Notes:

1. E1 ports assigned in this procedure cannot be assigned to an E1 card containing unchannelized E1 ports.
2. The E1/T1 MIM can have only E1 ports 1 and 2 assigned to it.
3. The HC MIM or E5-E1T1 card can have E1 ports 1 through 8 assigned to it.

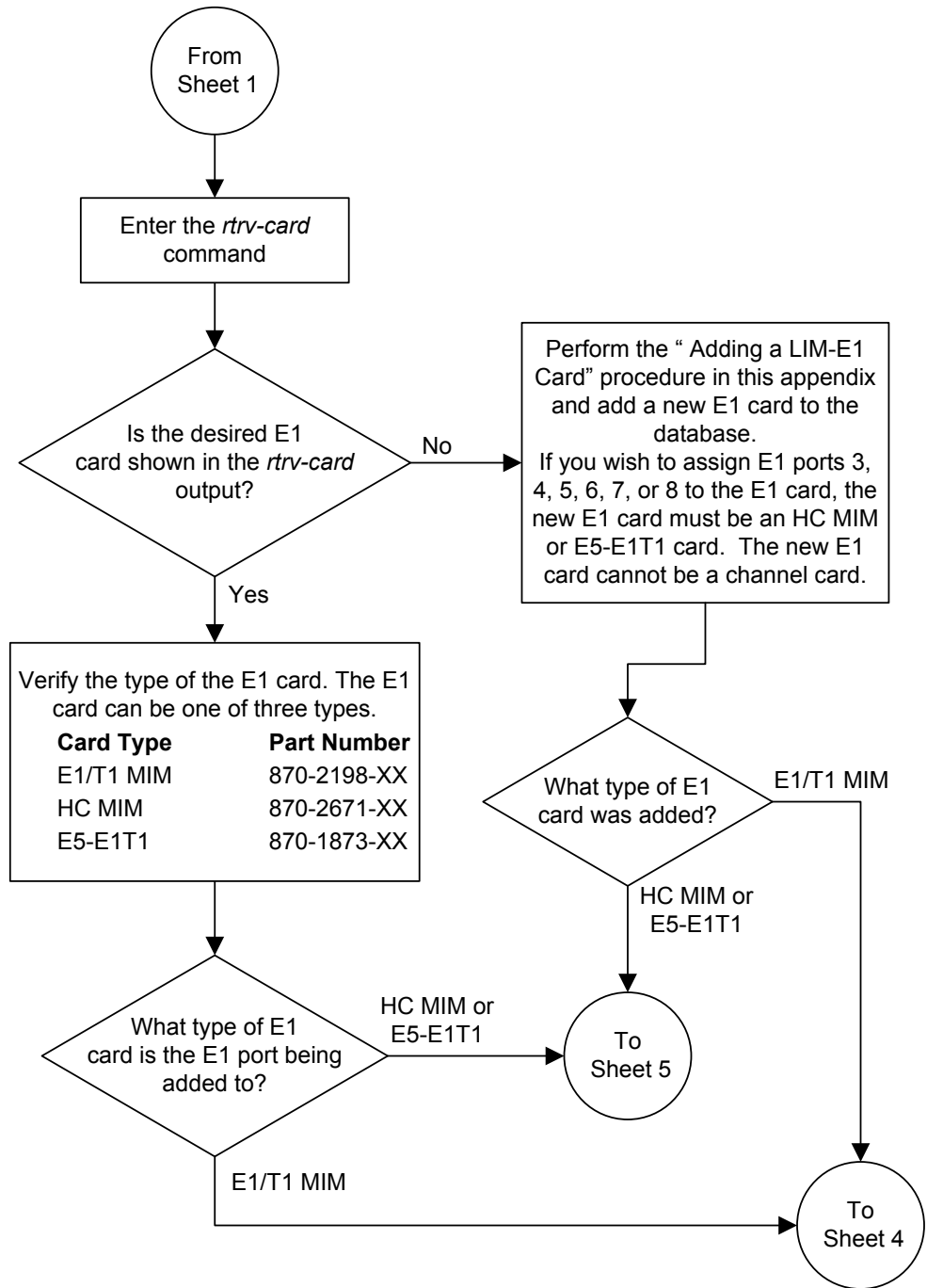
Sheet 1 of 7



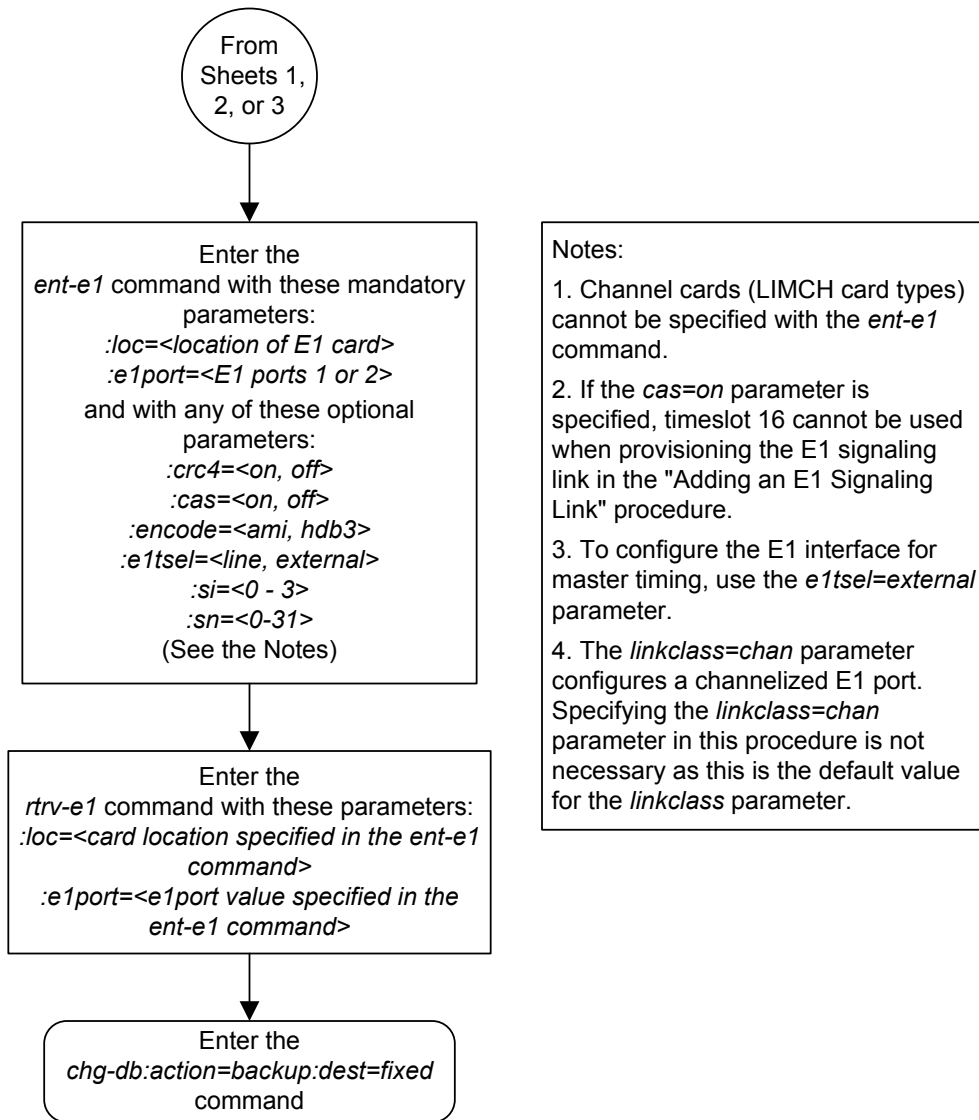
Notes:

1. The E1/T1 MIM can have only E1 ports 1 and 2 assigned to it.
2. The HC MIM or E5-E1T1 card can have E1 ports 1 through 8 assigned to it.

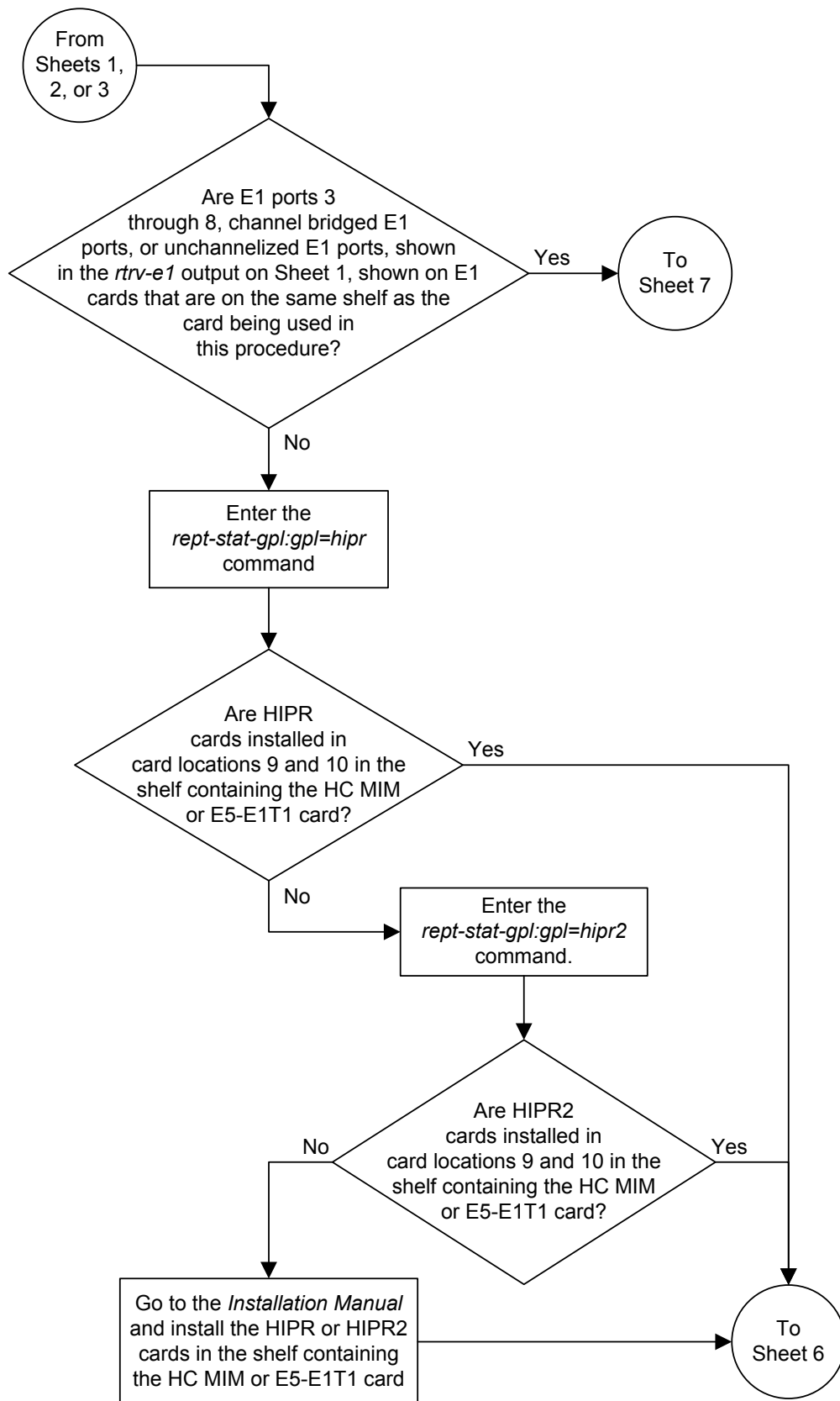
Sheet 2 of 7



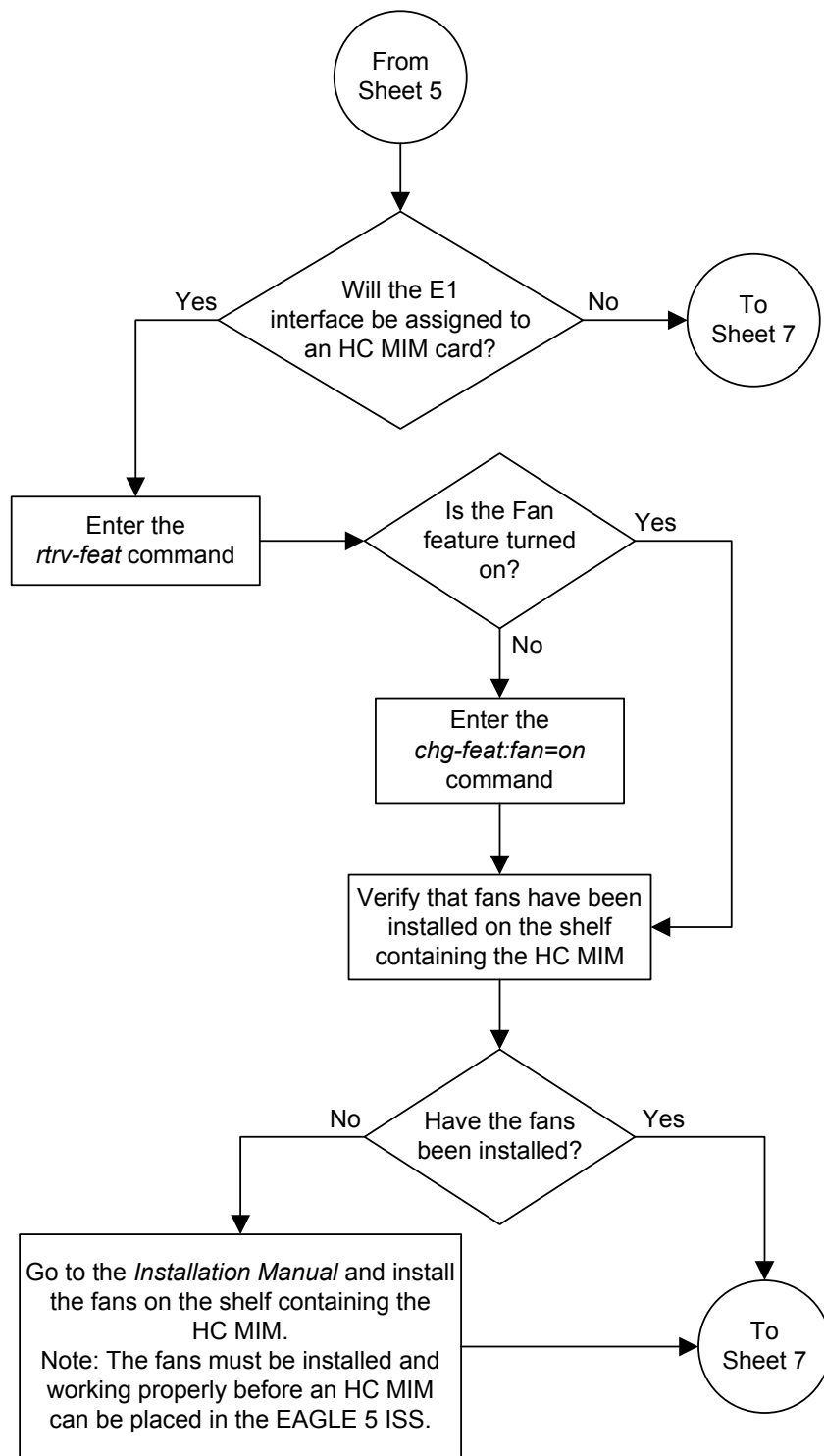
Sheet 3 of 7



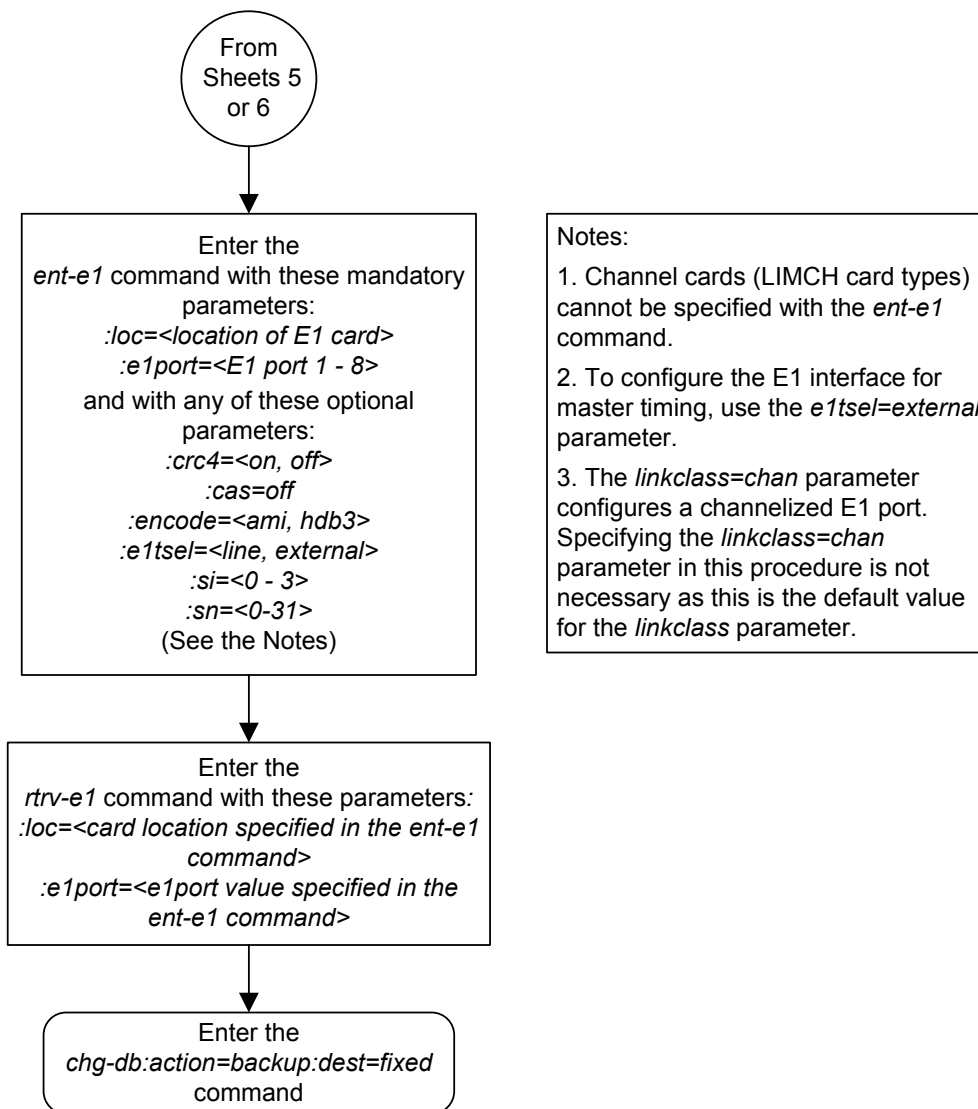
Sheet 4 of 7



Sheet 5 of 7



Sheet 6 of 7



Adding Channel Bridged E1 Ports

The channel bridged E1 ports are provisioned in the database using the `ent -e1` command using these parameters.

`:loc` – The location of the E1 card (card type `lime1`) that is servicing the E1 signaling link. The E1 card must be an HC-MIM or an E5-E1T1 card. The location of a channel card (card type `limch`) cannot be specified for this parameter.

`:e1port` – The E1 port on the E1 card used to service the E1 signaling link. The `e1port` value cannot already be assigned to the E1 card specified by the `loc` parameter.

`:crc4` – Specifies whether or not CRC4 is enabled on the E1 signaling link. The default value is `on` (`crc4=on`).

`:cas` – Specifies whether CAS or CCS is used on the E1 signaling link. CAS is enabled with the `cas=on` parameter. CCS is enabled with the `cas=off` parameter. The default value is CCS enabled (`cas=off`). The `cas=on` parameter cannot be specified for an HC-MIM or an E5-E1T1 card.

`:encode` – Specifies the type of encoding or decoding that is used on the E1 signaling link, either HDB3 or AMI. The default value is HDB3 encoding (`encode=hdb3`).

`:eltsel` – The timing source for the E1 signaling link, master (external) or recovered. The default value is slave timing (`eltsel=line`) which cannot be used for a channel bridged E1 port.

The recovered timing source can be used only with the `chanbrdg=on` parameter and uses the even numbered member of the bridged-pair as a clock source, ensuring that port in the pair can recover the timing from its partner.

Note: To use an external high-speed master clock source other than RS-422, TDMs 870-0774-15 or later must be installed in card locations 1114 and 1116, and the TDM Global Timing Interface options must be configured. For more information, see [Configuring the Options for the TDM Global Timing Interface](#).

`:si` – Specifies the value of the two spare international bits of NFAS data, from 0 to 3. The default value is 0 (`si=0`).

`:sn` – Specifies the value of the five spare national bits of NFAS data, from 0 to 31. The default value is 0 (`sn=0`).

`:force=yes` – Required when the even numbered E1 port being channel bridged is provisioned in the database before this procedure is performed.

`:chanbrdg` – Specifies whether or not the odd numbered E1 port specified in this procedure is channel bridged to its adjacent even numbered E1 port. Table A-9 shows the E1 ports that can be specified with the `chanbrdg=on` parameter and the even-numbered E1 ports that are bridged to the odd numbered E1 port.

Table A-9 Channel Bridging Ports

Odd Numbered E1 Port	Even Numbered Bridged E1 Port
1	2
3	4
5	6
7	8

The `ent-e1` command contains the `linkclass` and `minsurate` parameters that are not used in this procedure. These parameters and their usage are described in [Adding Unchannelized E1 Ports](#).

The **E1** card specified in this procedure must be in the database. This can be verified with the `rtrv-card` command.

The **E1** card cannot contain channelized and un-channelized **E1** ports.

1. Display the cards in the **EAGLE** using the `rtrv-card` command.

```
rlghncxa03w 09-05-28 09:12:36 GMT EAGLE5 41.0.0
CARD  TYPE      APPL      LSET NAME  LINK SLC LSET NAME  LINK SLC
1102  TSM           GLS
1113  GSPM          OAM
1114  TDM-A
1115  GSPM          OAM
1116  TDM-B
1117  MDAL
1201  LIME1         CCS7ITU   lsn1      A   13  lsn1      B   12
1202  LIMCH         CCS7ITU   lsn1      A   0   lsn1      B   8
1203  LIME1         CCS7ITU   lsn1      A1  4   lsn1      B1  9
1204  LIMCH         CCS7ITU   lsn1      A2  5   lsn1      A3  6
1211  LIME1         CCS7ITU   lsn1      A   14
1212  LIMCH         CCS7ITU   lsn1      A   10  lsn1      B   11
1213  LIME1         CCS7ITU   lsn1      A4  1   lsn1      A5  7
                               lsn1      B5  2   lsn1      A6  3
1316  DCM           STPLAN
```

If there no LIME1 cards shown in the `rtrv-card` output, perform [Adding a LIM-E1 Card](#) to add an HC-MIM or an E5-E1T1 card to the database. Continue the procedure with [2](#).

If LIME1 cards are shown in the `rtrv-card` output, continue the procedure with [2](#).

2. Display the existing **E1** interfaces in the database using the `rtrv-e1` command with no parameters. This is an example of the possible output.

```
rlghncxa03w 06-10-19 21:17:04 GMT EAGLE5 36.0.0

      E1
LOC  PORT  CRC4  CAS  ENCODE  E1TSEL  SI  SN  CHANBRDG  LINK  MINSU
1201  1      ON    OFF  HDB3    EXTERNAL  2  6  -----  CHAN  ----
1201  2      ON    OFF  HDB3    EXTERNAL  3  5  -----  CHAN  ----
1202  1      ON    OFF  HDB3    EXTERNAL  1  10 -----  CHAN  ----
```


1203	1	ON	OFF	HDB3	EXTERNAL	1	11	-----	CHAN	----
1203	2	ON	OFF	HDB3	EXTERNAL	3	7	-----	CHAN	----
1204	1	ON	OFF	HDB3	EXTERNAL	3	8	-----	CHAN	----
1211	2	ON	OFF	HDB3	EXTERNAL	0	0	-----	CHAN	----
1212	1	ON	OFF	HDB3	EXTERNAL	1	1	-----	CHAN	----
1213	1	ON	OFF	HDB3	EXTERNAL	2	2	-----	CHAN	----
1213	5	ON	OFF	HDB3	EXTERNAL	3	3	-----	CHAN	----

Continue the procedure by performing one of these substeps.

- a. If the `rtrv-e1` output shows that the E1 card has E1 ports 3, 4, 5, 6, 7, or 8 assigned to it, or that E1 ports on the E1 card are channel bridged, continue this procedure with [3](#).
- b. Channel bridged E1 ports cannot be added to an E1 card containing unchannelized E1 ports. If the E1 card contains unchannelized E1 ports, choose another E1 card from [1](#) and repeat this step, or add a new HC-MIM or an E5-E1T1 card by performing [Adding a LIM-E1 Card](#).
- c. If the `rtrv-e1` output shows that the E1 card does not have E1 ports 3, 4, 5, 6, 7, or 8 assigned to it, or that E1 ports on the E1 card are not channel bridged, verify that the E1 card that the channel bridged E1 port will be assigned to is an HC-MIM or an E5-E1T1 card. The part number of the HC-MIM is 870-2671-XX. The part number of the E5-E1T1 is 870-1873-XX. If the E1 card is not an HC-MIM or an E5-E1T1 card, add a new HC-MIM or an E5-E1T1 card by performing [Adding a LIM-E1 Card](#).
 - If an existing E1 card is being used in this procedure continue the procedure with [3](#).
 - If an HC-MIM or an E5-E1T1 card was added in this substep or substep b, continue the procedure by performing one of these steps.
 - If the E1 cards shown in this step are on the same shelf as the card that will contain the E1 port that is being added, and these cards have E1 ports 3 through 8 provisioned, contain channel bridged E1 ports, or unchannelized E1 ports, continue the procedure with [8](#).
 - If the E1 cards shown in this step are not on the same shelf as the card that will contain the E1 port that is being added, continue the procedure with [4](#).
 - If the E1 cards shown in this step are on the same shelf as the card that will contain the E1 port that is being added, and these cards do not have E1 ports 3 through 8 provisioned, do not contain channel bridged E1 ports, or do not have unchannelized E1 ports, continue the procedure with [4](#).

3. Display the E1 signaling links in the EAGLE by entering this command.

```
rtrv-slk:class=e1
```

This is an example of the possible output.

```
rlghncxa03w 06-10-19 21:17:04 GMT EAGLE5 36.0.0
```

LOC	LINK	LSN	SLC	TYPE	L2T SET	BPS	ECM	PCR N1	PCR N2	E1 LOC	E1 PORT	TS
1201	A	lsn1	13	LIME1	1	56000	BASIC	---	-----	1201	2	25

1201 B	lsn1	12	LIME1	1	56000	BASIC	---	-----	1201	1	20
1202 A	lsn1	0	LIMCH	1	56000	BASIC	---	-----	1201	1	5
1202 B	lsn1	8	LIMCH	1	56000	BASIC	---	-----	1201	1	1
1203 A1	lsn1	4	LIME1	1	56000	BASIC	---	-----	1203	2	20
1203 B1	lsn1	9	LIME1	1	56000	BASIC	---	-----	1203	1	2
1204 A2	lsn1	5	LIMCH	1	56000	BASIC	---	-----	1203	1	21
1204 A3	lsn1	6	LIMCH	1	56000	BASIC	---	-----	1203	1	22
1211 A	lsn1	14	LIME1	1	56000	BASIC	---	-----	1211	1	7
1212 A	lsn1	10	LIMCH	1	56000	BASIC	---	-----	1211	1	28
1212 B	lsn1	11	LIMCH	1	56000	BASIC	---	-----	1211	1	25
1213 A4	lsn1	1	LIME1	1	56000	BASIC	---	-----	1213	1	17
1213 A5	lsn1	7	LIME1	1	56000	BASIC	---	-----	1213	5	23
1213 B5	lsn1	2	LIME1	1	56000	BASIC	---	-----	1213	1	24
1213 A6	lsn1	3	LIME1	1	56000	BASIC	---	-----	1213	5	19

If an even numbered **E1** port is to be channel bridged, and that **E1** port is assigned to signaling links, these signaling links must be removed before the **E1** port can be channel bridged. Perform [Removing an SS7 Signaling Link](#) and remove these signaling links. After the signaling links have been removed, continue the procedure with [4](#).

If the even numbered **E1** port to be channel bridged is not assigned to signaling links, continue the procedure with [4](#).

4. Verify that **HIPR2** cards are installed in card locations 9 and 10 in the shelf containing the HC MIM or E5-E1T1 card that will contain the E1 port being added in this procedure by entering this command.

```
rept-stat-gpl:gpl=hipr2
```

This is an example of the possible output.

```
rlghncxa03w 09-07-05 08:12:53 GMT 41.1.0
GPL          CARD      RUNNING          APPROVED         TRIAL
HIPR2        1109      126-002-000     126-002-000     126-003-000
HIPR2        1110      126-002-000     126-002-000     126-003-000
HIPR2        1209      126-002-000     126-002-000     126-003-000
HIPR2        1210      126-002-000     126-002-000     126-003-000
HIPR2        1309      126-002-000     126-002-000     126-003-000
HIPR2        1310      126-002-000     126-002-000     126-003-000
HIPR2        2109      126-002-000     126-002-000     126-003-000
HIPR2        2110      126-002-000     126-002-000     126-003-000
Command Completed
```

If **HIPR2** cards are installed in the shelf containing the HC MIM or E5-E1T1 card, continue the procedure by performing one of these steps.

- If the card is an E5-E1T1 card, continue the procedure with [8](#).
- If the card is an HC MIM, continue the procedure with [5](#).

If **HIPR2** cards are not installed on the shelf containing the HC MIM or E5-E1T1 card, go to *Installation Guide* and install the **HIPR2** cards. Once the **HIPR2** cards have been installed, continue the procedure by performing one of these steps.

- If the card is an E5-E1T1 card, continue the procedure with [8](#).
- If the card is an HC MIM, continue the procedure with [5](#).

- Verify whether or not that the Fan feature is on, by entering the `rtrv-feat` command. If the Fan feature is on, the entry `FAN = on` appears in the `rtrv-feat` command output.

Note: The `rtrv-feat` command output contains other fields that are not used by this procedure. If you wish to see all the fields displayed by the `rtrv-feat` command, see the `rtrv-feat` command description in *Commands User's Guide*.

If the Fan feature is on, continue the procedure with [8](#).

If the Fan feature is off, continue the procedure with [Oracle](#).

- Turn the Fan feature on by entering this command.

```
chg-feat : fan=on
```

Note: Once the Fan feature is turned on with the `chg-feat` command, it cannot be turned off.

The Fan feature must be purchased before you turn this feature on with the `chg-feat` command. If you are not sure if you have purchased the Fan feature, contact your Oracle Sales Representative or Account Representative.

When the `chg-feat` has successfully completed, this message appears.

```
rlghncxa03w 09-05-28 11:43:04 GMT EAGLE5 41.0.0
CHG-FEAT: MASP A - COMPLTD
```

- The shelf containing the HC-MIM being added in this procedure must have fans installed. Verify whether or not fans are installed on the shelf.

If the fans are installed, continue the procedure with [8](#).

If the fans are not installed on the shelf containing the HC-MIM, go to *Installation Guide* and install the fans. After the fans have been installed and tested, continue the procedure with [8](#).

- Add the new **E1** interface information to the database using the `ent-e1` command and the parameter combinations shown in [Table A-10](#).

Table A-10 Channel Bridged E1 Port Combinations

Mandatory Parameters	
:loc=location of the E1 card	:e1tsel=external, recovered
:e1port=1, 3, 5, 7	:chanbrdg=on
Optional Parameters	
:cas=off Default value = off	:si=0 - 3 Default value = 0

Table A-10 (Cont.) Channel Bridged E1 Port Combinations

:crc4=on, off Default value = on	:sn=0 - 31 Default value = 0
:encode=ami, hdb3 Default value = hdb3	:force=yes

Notes:

1. **Channel** cards cannot be specified with the `ent-e1` command.
2. To configure the **E1** port for master timing, use the `eltset=external` parameter.
3. The `linkclass=chan` parameter configures a channelized **E1** port. Specifying the `linkclass=chan` parameter in this procedure is unnecessary as this is the default value for the `linkclass` parameter.
4. The **E1** card cannot contain channelized and un-channelized **E1** ports.
5. The `force=yes` parameter must be used when the even numbered port being channel bridged is shown in the `rtrv-e1` output in 2. If the even numbered port being channel bridged is not shown in the `rtrv-e1` output in 2, the `force=yes` parameter cannot be used.

For this example, enter these commands.

```
ent-
e1:loc=1301:elport=1:encode=hdb3:eltset=external:si=1:sn=7:chanbrdg=on
```

```
ent-
e1:loc=1303:elport=1:crc4=on:encode=hdb3:eltset=recovered:chanbrdg=on
```

9. Verify the changes using the `rtrv-e1` command specifying the card location and the `elport` value specified in 8. For this example, enter these commands.

```
rtrv-e1:loc=1301:elport=1
```

```
rlghncxa03w 06-10-28 09:12:36 GMT EAGLE5 36.0.0
```

E1									LINK	MINSU
LOC	PORT	CRC4	CAS	ENCODE	EITSEL	SI	SN	CHANBRDG	CLASS	RATE
1301	1	OFF	OFF	HDB3	EXTERNAL	1	7	MASTER	CHAN	----
TS0	(N/A)	TS8	-----	TS16	-----	TS24	-----			
TS1	-----	TS9	-----	TS17	-----	TS25	-----			
TS2	-----	TS10	-----	TS18	-----	TS26	-----			
TS3	-----	TS11	-----	TS19	-----	TS27	-----			
TS4	-----	TS12	-----	TS20	-----	TS28	-----			
TS5	-----	TS13	-----	TS21	-----	TS29	-----			
TS6	-----	TS14	-----	TS22	-----	TS30	-----			
TS7	-----	TS15	-----	TS23	-----	TS31	-----			

```
rtrv-e1:loc=1303:elport=1
```

```
rlghncxa03w 06-10-28 09:12:36 GMT EAGLE5 36.0.0
```

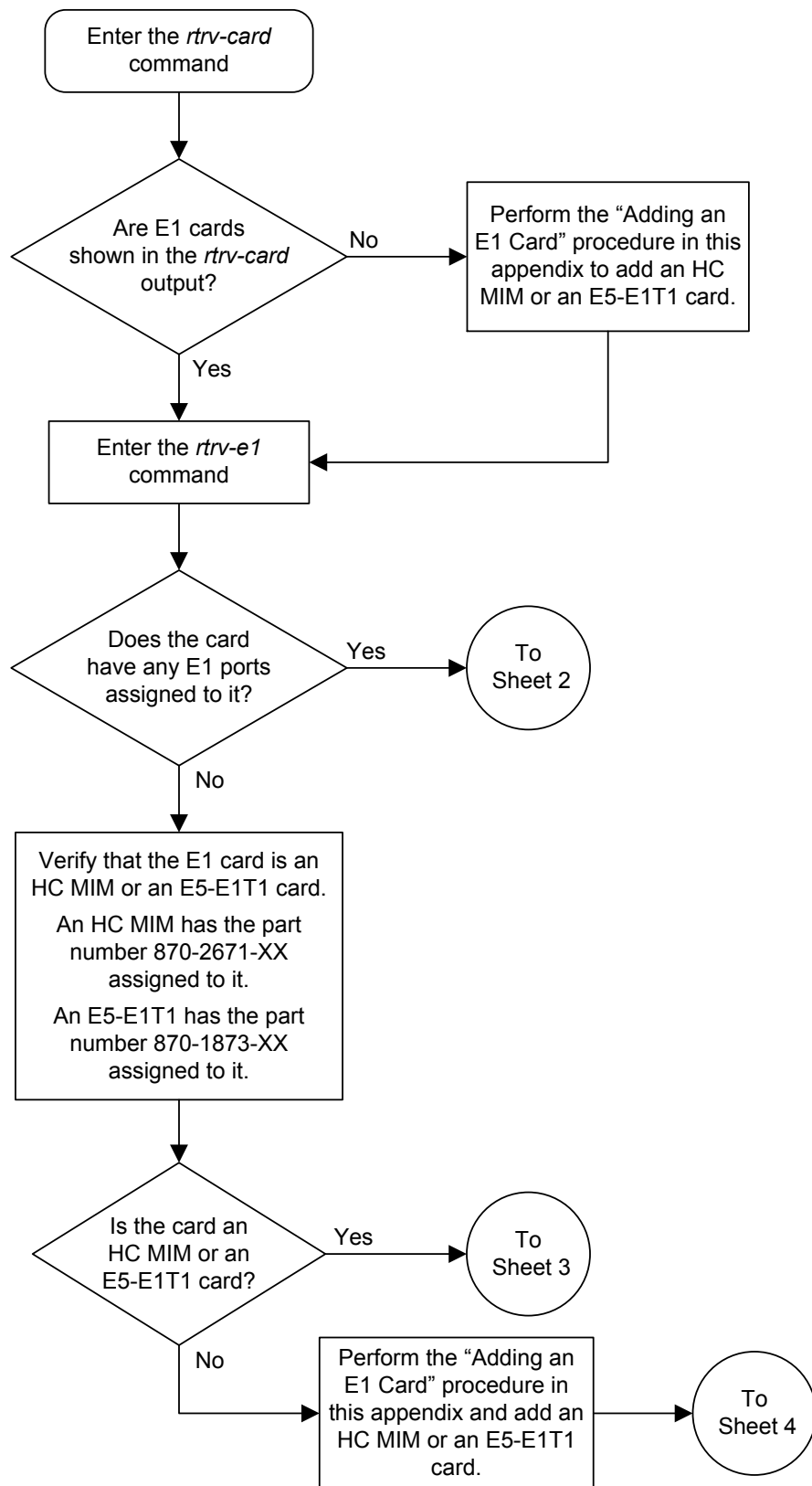
E1									LINK	MINSU
LOC	PORT	CRC4	CAS	ENCODE	EITSEL	SI	SN	CHANBRDG	CLASS	RATE
1303	1	ON	OFF	HDB3	RECOVERED	0	0	MASTER	CHAN	----

TS0	(N/A)	TS8	-----	TS16	-----	TS24	-----
TS1	-----	TS9	-----	TS17	-----	TS25	-----
TS2	-----	TS10	-----	TS18	-----	TS26	-----
TS3	-----	TS11	-----	TS19	-----	TS27	-----
TS4	-----	TS12	-----	TS20	-----	TS28	-----
TS5	-----	TS13	-----	TS21	-----	TS29	-----
TS6	-----	TS14	-----	TS22	-----	TS30	-----
TS7	-----	TS15	-----	TS23	-----	TS31	-----

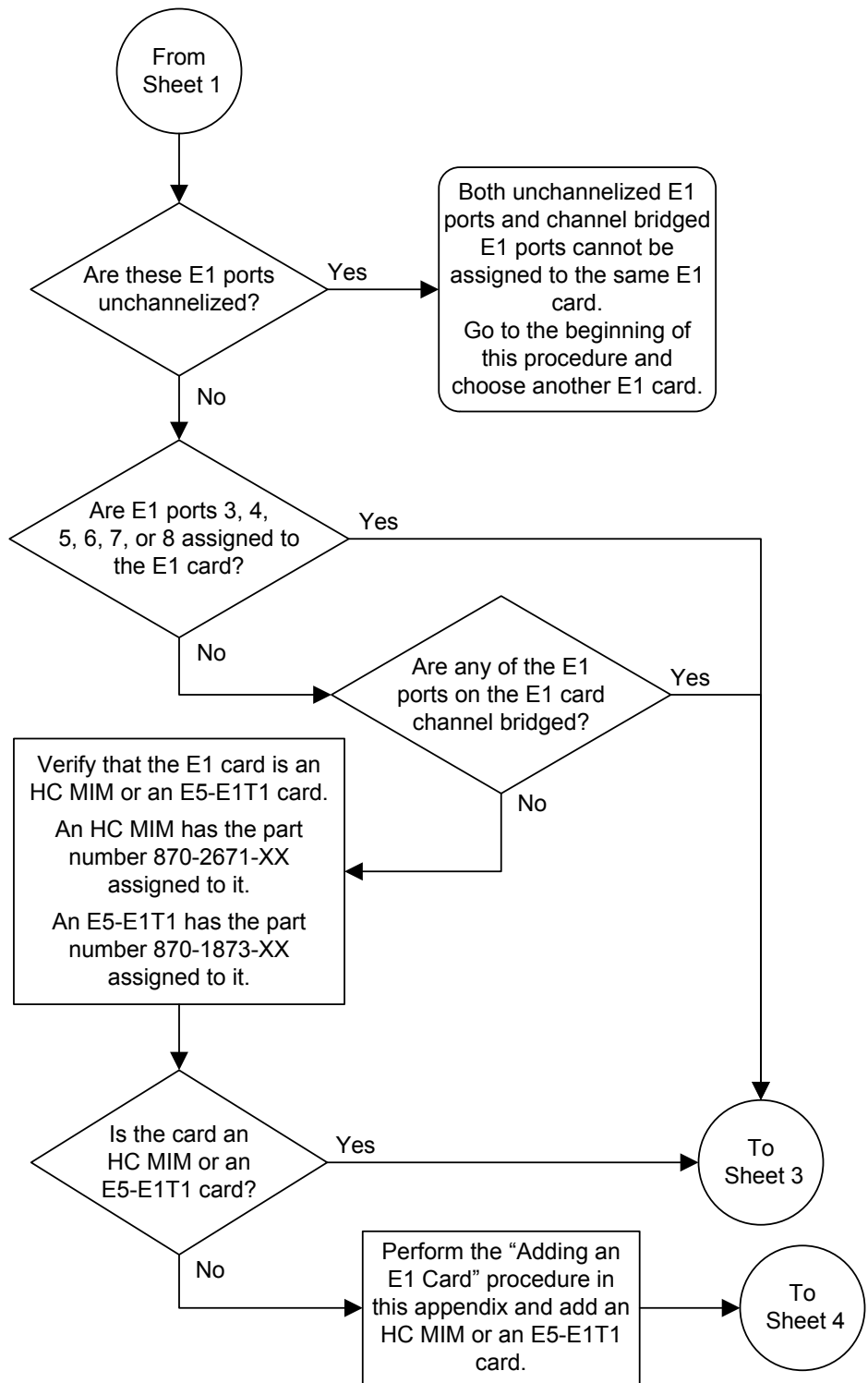
- 10.** Back up the new changes using the `chg-db:action=backup:dest=fixed` command. These messages should appear, the active **Maintenance and Administration Subsystem Processor (MASP)** appears first.

```
BACKUP (FIXED) : MASP A - Backup starts on active MASP.  
BACKUP (FIXED) : MASP A - Backup on active MASP to fixed disk complete.  
BACKUP (FIXED) : MASP A - Backup starts on standby MASP.  
BACKUP (FIXED) : MASP A - Backup on standby MASP to fixed disk complete.
```

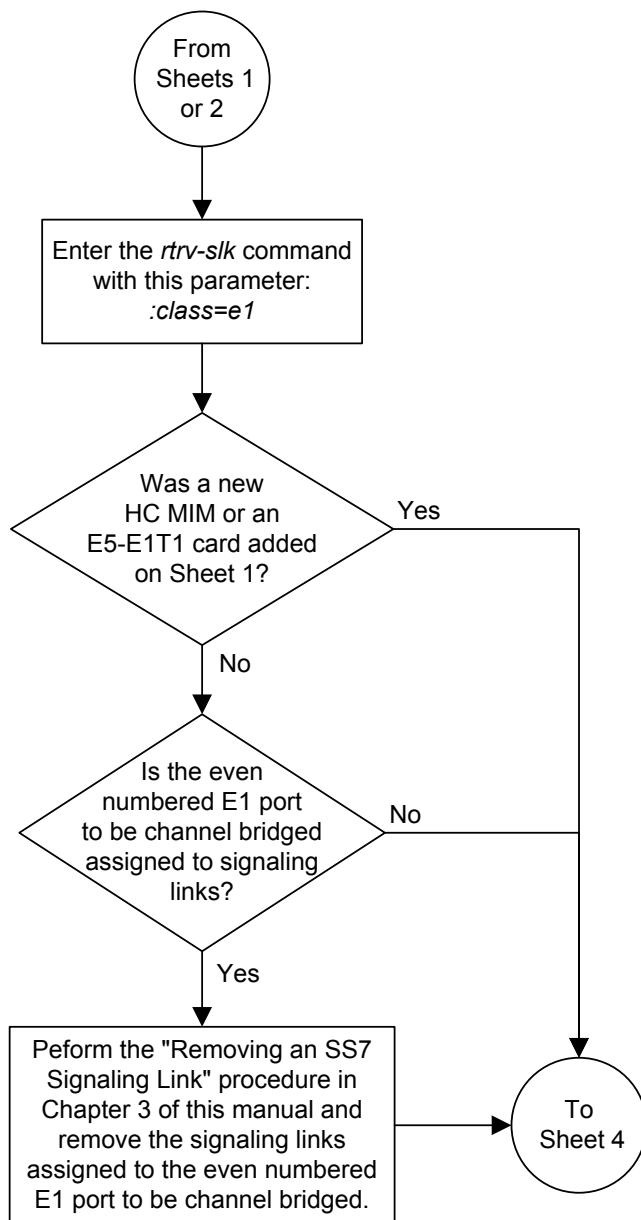
Figure A-7 Adding Channel Bridged E1 Ports



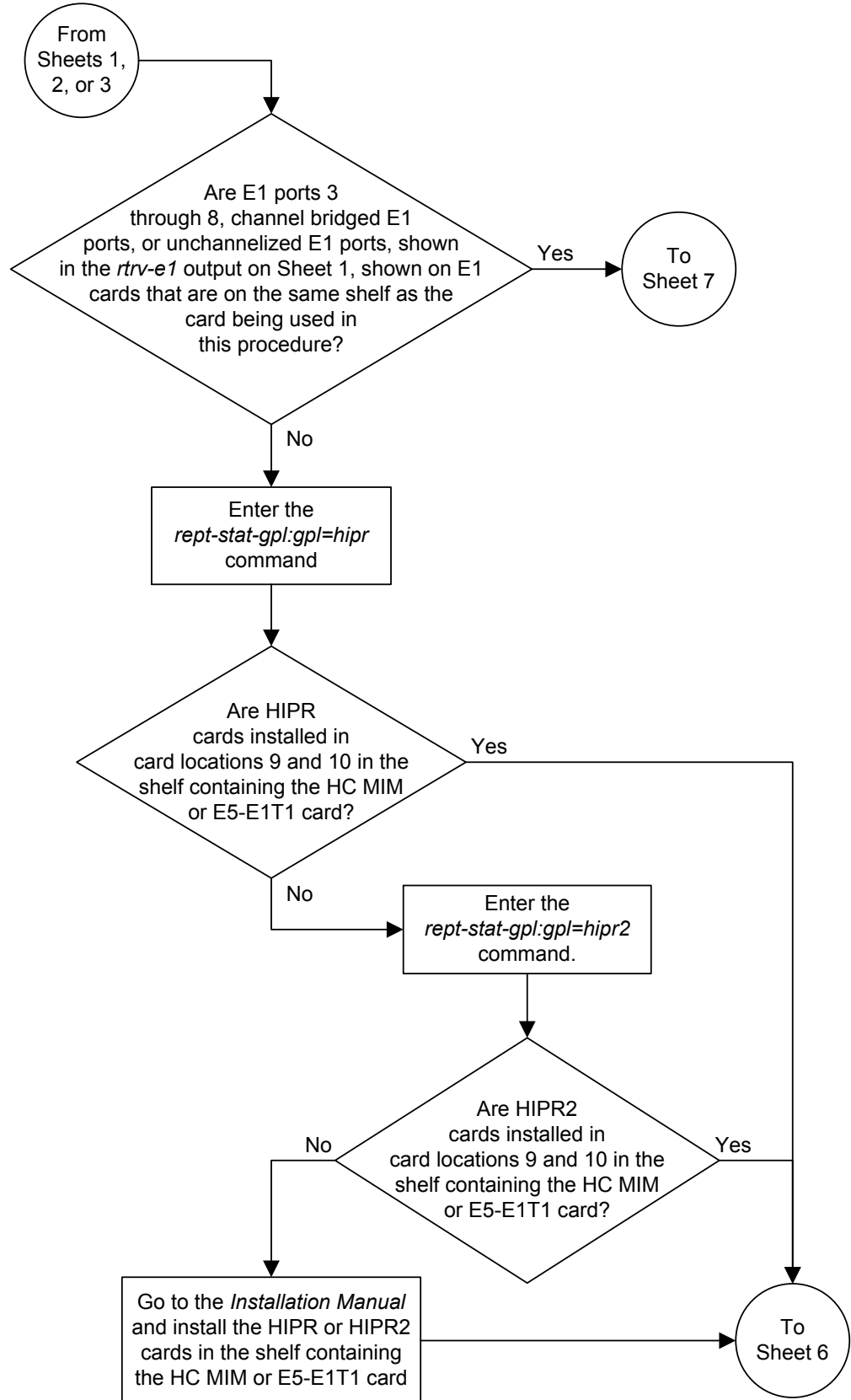
Sheet 1 of 6



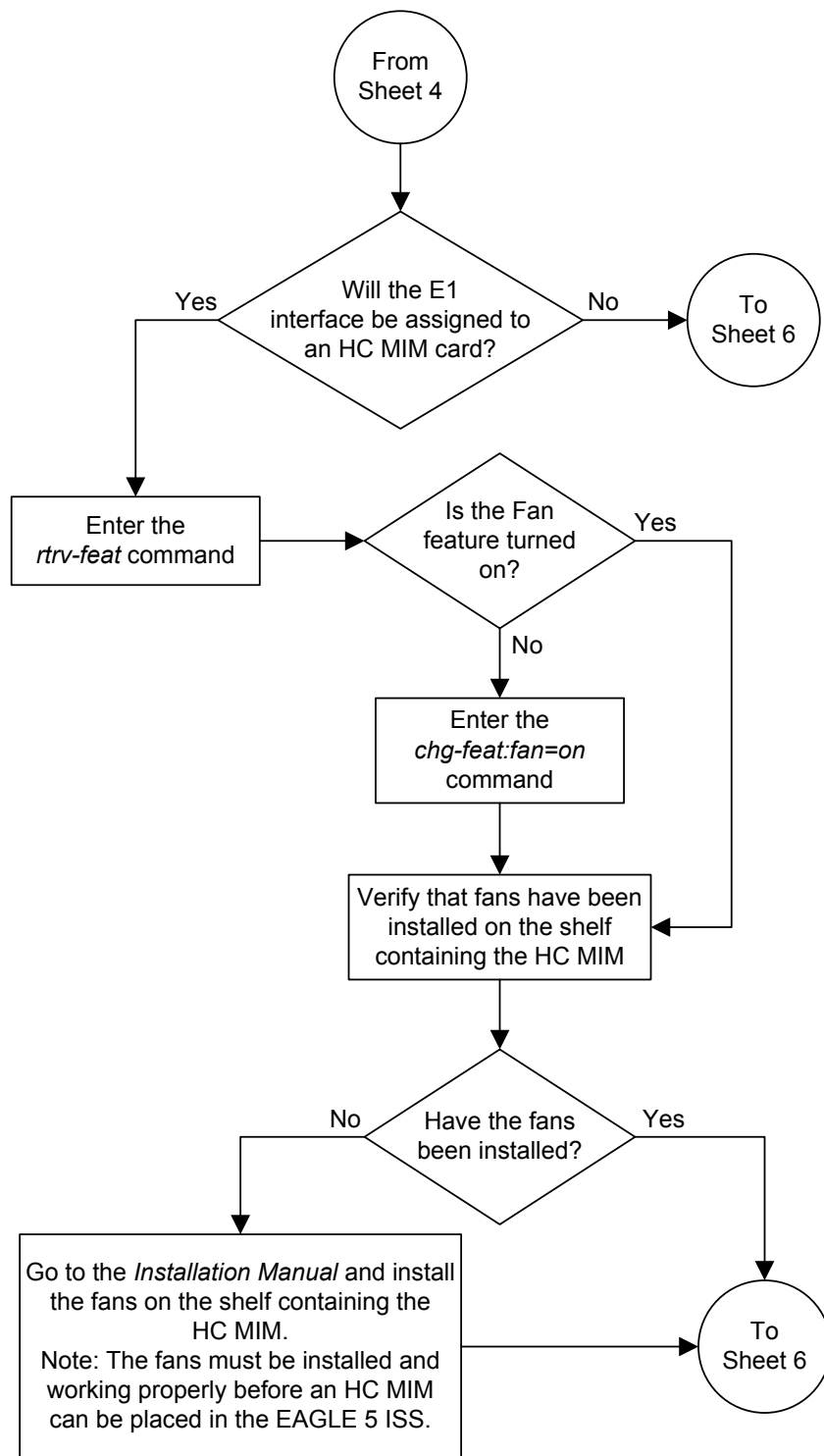
Sheet 2 of 6



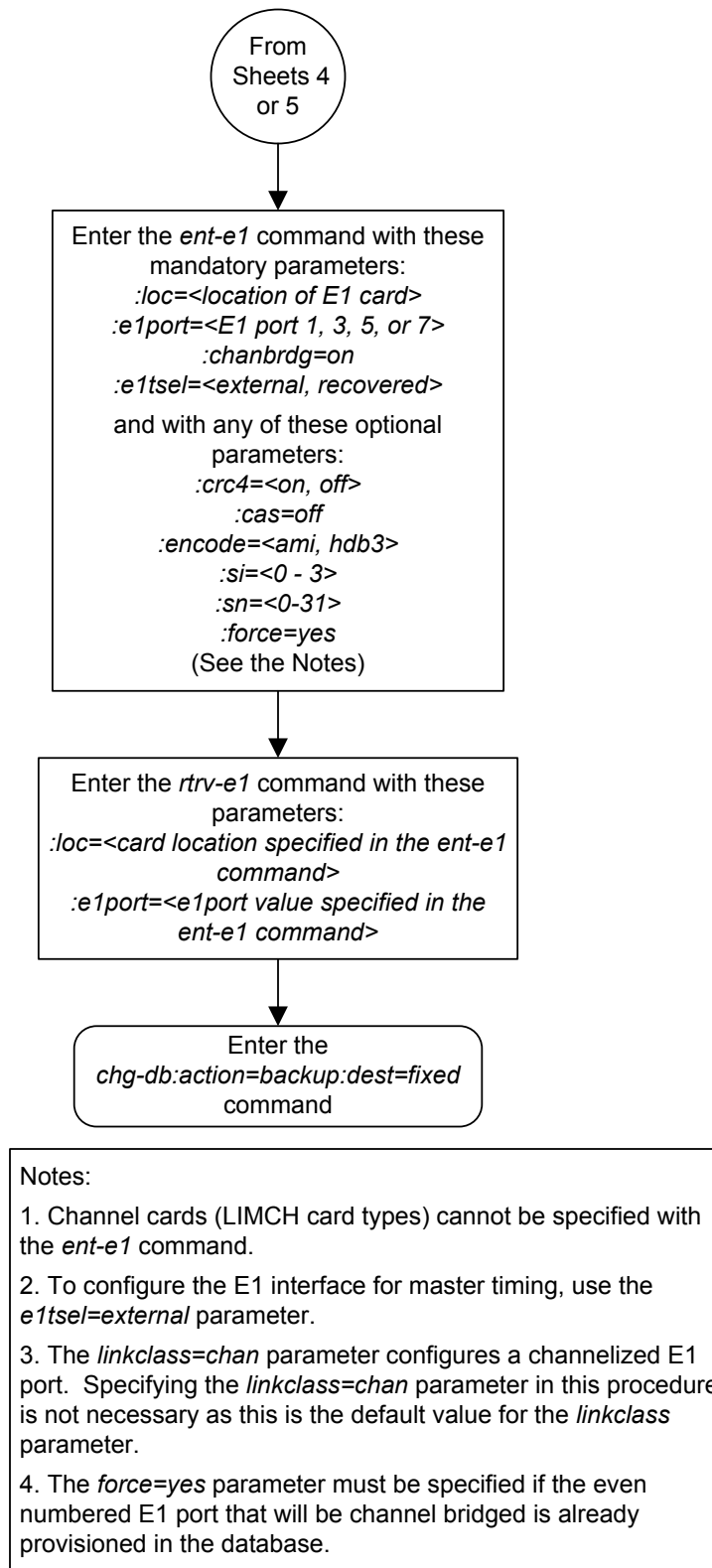
Sheet 3 of 6



Sheet 4 of 6



Sheet 5 of 6



Adding Unchannelized E1 Ports

The **E1** interface parameters are provisioned in the database using the `ent-e1` command using these parameters.

`:loc` – The location of the **E1** card (card type `lime1`) that is servicing the **E1** signaling link. The **E1** card must be an **HC-MIM** or an **E5-E1T1** card. The location of a channel card (card type `limch`) cannot be specified for this parameter.

`:e1port` – The **E1** port on the **E1** card used to service the **E1** signaling link. The `e1port` value cannot already be assigned to the **E1** card specified by the `loc` parameter.

`:crc4` – Specifies whether or not **CRC4** is enabled on the **E1** signaling link. The default value is `on` (`crc4=on`).

`:cas` – Specifies whether **CAS** or **CCS** is used on the **E1** signaling link. **CAS** is enabled with the `cas=on` parameter. **CCS** is enabled with the `cas=off` parameter. The default value is **CCS** enabled (`cas=off`). The `cas=on` parameter cannot be specified for an **HC-MIM** or an **E5-E1T1** card.

`:encode` – Specifies the type of encoding or decoding that is used on the **E1** signaling link, either **HDB3** or **AMI**. The default value is **HDB3** encoding (`encode=hdb3`).

`:eltset` – The timing source for the **E1** signaling link, master (external) or slave (line). The default value is slave timing (`eltset=line`).

Note: To use an external high-speed master clock source other than RS-422, TDMs 870-0774-15 or later must be installed in card locations 1114 and 1116, and the **TDM Global Timing Interface** options must be configured. For more information, see [Configuring the Options for the TDM Global Timing Interface](#).

`:si` – Specifies the value of the two spare international bits of **NFAS** data, from 0 to 3. The default value is 0 (`si=0`).

`:sn` – Specifies the value of the five spare national bits of **NFAS** data, from 0 to 31. The default value is 0 (`sn=0`).

`:linkclass` – Indicates whether the **E1** port supports channelized (`linkclass=chan`) or un-channelized (`linkclass=unchan`) **E1** signaling links.

`:minsurate` – Specifies the minimum number of signaling units (**FISUs** and **LSSUs**) per second that are transmitted on the outbound **E1** signaling link during idle periods or when there is an unused portion of the link's bandwidth. The value of this parameter is from 500 to 2000 signaling units per second, with the default value of 1000 signaling units per second. The `minsurate` parameter can be specified only when an unchannelized **E1** port (`linkclass=unchan` parameter) is being configured.

The `ent-e1` command contains the `eltset=recovered`, `chanbrdg`, and `force=yes` parameters. These parameters are not used in this procedure. These parameters and their usage are described in [Adding Channel Bridged E1 Ports](#).

The **E1** card specified in this procedure must be in the database. This can be verified with the `rtrv-card` command.

1. Display the cards in the **EAGLE 5 ISS** using the `rtrv-card` command.

```

rlghncxa03w 09-05-28 09:12:36 GMT EAGLE5 41.0.0
CARD   TYPE     APPL     LSET NAME   LINK SLC LSET NAME   LINK SLC
1102   TSM         GLS
1113   GSPM        OAM
1114   TDM-A
1115   GSPM        OAM
1116   TDM-B
1117   MDAL
1201   LIME1       CCS7ITU   lsn1        A    13   lsn1        B    12
1202   LIMCH       CCS7ITU   lsn1        A    0    lsn1        B    8
1203   LIME1       CCS7ITU   lsn1        A1   4    lsn1        B1   9
1204   LIMCH       CCS7ITU   lsn1        A2   5    lsn1        A3   6
1211   LIME1       CCS7ITU   lsn1        A    14
1212   LIMCH       CCS7ITU   lsn1        A    10   lsn1        B    11
1213   LIME1       CCS7ITU   lsn1        A4   1    lsn1        A5   7
                               lsn1        B5   2    lsn1        A6   3
1316   DCM         STPLAN
    
```

If there no **LIME1** cards shown in the `rtrv-card` output, perform [Adding a LIM-E1 Card](#) and add an **HC-MIM** or an **E5-E1T1** card to the database. After the card has been added, continue the procedure with [2](#).

2. Display the existing **E1** interfaces in the database using the `rtrv-e1` command with no parameters.

This is an example of the possible output.

```

rlghncxa03w 06-10-19 21:17:04 GMT EAGLE5 36.0.0
      E1
LOC  PORT  CRC4  CAS  ENCODE  E1TSEL  SI  SN  CHANBRDG  LINK  MINSU
CLASS  RATE
1201  1      ON    OFF  HDB3    EXTERNAL  2  6  -----  CHAN  ----
1201  2      ON    OFF  HDB3    EXTERNAL  3  5  -----  CHAN  ----
1202  1      ON    OFF  HDB3    EXTERNAL  1  10 -----  CHAN  ----
1203  1      ON    OFF  HDB3    EXTERNAL  1  11 -----  CHAN  ----
1203  2      ON    OFF  HDB3    EXTERNAL  3  7  -----  CHAN  ----
1204  1      ON    OFF  HDB3    EXTERNAL  3  8  -----  CHAN  ----
1211  2      ON    OFF  HDB3    EXTERNAL  0  0  -----  CHAN  ----
1212  1      ON    OFF  HDB3    EXTERNAL  1  1  -----  CHAN  ----
1213  1      ON    OFF  HDB3    EXTERNAL  2  2  -----  CHAN  ----
1213  5      ON    OFF  HDB3    EXTERNAL  3  3  -----  CHAN  ----
    
```

[Table A-11](#) shows the maximum number of unchannelized E1 ports that the EAGLE can contain. If the `rtrv-e1` output contains the maximum number of unchannelized **E1** ports, no other unchannelized **E1** ports can be added and this procedure cannot be performed.

If no **E1** ports are assigned to the **E1** card you wish to use in this procedure, verify that the **E1** card is an **HC-MIM** or an **E5-E1T1** card. The part number of the **HC-MIM** is 870-2671-XX. The part number of the **E5-E1T1** card is 870-1873-XX. If the **E1** card is not an **HC-MIM** or an **E5-E1T1** card, either select another **E1** card from the `rtrv-e1` output, or add a new **HC-MIM** by performing [Adding a LIM-E1 Card](#).

If the **E1** card is an **HC-MIM** or an **E5-E1T1** card, and contains no unchannelized **E1** ports, continue the procedure with [3](#).

If **E1** ports are assigned to the **E1** card you wish to use in this procedure, and the **E1** ports on the **E1** card are channelized, unchannelized **E1** ports cannot be assigned to this **E1** card. **Unchannelized E1** ports cannot be assigned to an **E1** card that contains channelized **E1** ports. If the **E1** ports on the **E1** card are channelized, either

select another **E1** card from the `rtrv-e1` output, or add a new **HC-MIM** or an **E5-E1T1** card by performing [Adding a LIM-E1 Card](#). If all the **E1** ports shown in the `rtrv-e1` output are channelized, add a new **HC-MIM** or an **E5-E1T1** card by performing [Adding a LIM-E1 Card](#).

An **HC-MIM** can contain a maximum of two unchannelized **E1** ports. An **E5-E1T1** card can contain only one unchannelized **E1** port. If the **E1** card you wish to use contains two unchannelized **E1** ports, the **E1** card is an **HC-MIM**. No additional unchannelized **E1** port cannot be added to this **E1** card. If the **E1** card you wish to use contains one unchannelized **E1** port, verify that the **E1** card is an **HC-MIM** or an **E5-E1T1** card. The part number of the **HC-MIM** is 870-2671-XX. The part number of the **E5-E1T1** card is 870-1873-XX. If the **E1** card is an **HC-MIM** with only one unchannelized **E1** port assigned, the unchannelized **E1** port can be added to this card. Continue the procedure with [3](#). If the **E1** card is an **E5-E1T1** card, the unchannelized **E1** port cannot be added to this **E1** card.

If the unchannelized **E1** port cannot be added to this card, repeat [1](#) and [2](#) to select another **E1** card to add the unchannelized **E1** port to, or add a new **HC-MIM** or **E5-E1T1** by performing [Adding a LIM-E1 Card](#).

3. Display the status of the SE-HSL SLK Capacity feature by entering the `rtrv-ctrl-feat` command.

```
rlghncxa03w 06-10-28 21:15:37 GMT EAGLE5 36.0.0
The following features have been permanently enabled:
```

Feature Name	Partnum	Status	Quantity
HC-MIM SLK Capacity	893012707	on	64
Command Class Management	893005801	on	----
LNP Short Message Service	893006601	on	----
Intermed GTT Load Sharing	893006901	on	----
XGTT Table Expansion	893006101	on	400000
XMAP Table Expansion	893007701	on	3000

The following features have been temporarily enabled:

Feature Name	Partnum	Status	Quantity	Trial Period Left
Zero entries found.				

The following features have expired temporary keys:

Feature Name	Partnum
Zero entries found.	

Continue the procedure by performing one of these substeps.

- a. If an **SE-HSLSLK** quantity is not enabled, continue the procedure with [4](#).

Note: If the `rtrv-ctrl-feat` output in this step shows any controlled features, continue the procedure with [8](#). If the `rtrv-ctrl-feat` output shows only the **HC-MIM SLK Capacity** feature with a quantity of 64, [4](#) through [7](#) must be performed.

- b. If an **SE-HSL SLK Capacity** is enabled, the entry **SE-HSL SLK Capacity** is shown in the `rtrv-ctrl-feat` output with one of the quantities shown in [Table A-11](#). This quantity is the number of unchannelized **E1** signaling links, and the number of unchannelized **E1** ports, the **EAGLE** can contain. If the

addition of the unchannelized E1 port in this procedure will not exceed the enabled SE-HSL SLK quantity, continue the procedure by performing one of these steps.

- If E1 cards are shown in the `rtrv-e1` output in 2 and these cards are on the same shelf as the card that will contain the E1 port that is being added, and these cards have E1 ports 3 through 8 provisioned, contain channel bridged E1 ports, or unchannelized E1 ports, continue the procedure with 14.
 - If E1 cards are shown in the `rtrv-e1` output in 2 and these cards are not on the same shelf as the card that will contain the E1 port that is being added, continue the procedure with 10.
 - If E1 cards are shown in the `rtrv-e1` output in 2 and these cards are on the same shelf as the card that will contain the E1 port that is being added, and these cards do not have E1 ports 3 through 8 provisioned, do not contain channel bridged E1 ports, or do not have unchannelized E1 ports, continue the procedure with 10.
- c. If an SE-HSL SLK quantity is enabled, and the addition of the unchannelized E1 port in this procedure will exceed the enabled SE-HSL SLK quantity, increase the enabled SE-HSL SLK quantity by performing 8.
4. Display the serial number in the database with the `rtrv-serial-num` command.

```
rlghncxa03w 06-10-28 21:15:37 GMT EAGLE5 36.0.0
System serial number = nt00001231
```

System serial number is not locked, yet.

Note: If the serial number is correct and locked, continue the procedure with 8. If the serial number is correct but not locked, continue the procedure with 7. If the serial number is not correct, but is locked, the SE-HSL SLK quantity cannot be enabled and the remainder of this procedure cannot be performed. Contact the Customer Care Center to get an incorrect and locked serial number changed. Refer to [My Oracle Support \(MOS\)](#) for the contact information. The serial number can be found on a label affixed to the control shelf (shelf 1100).

5. Enter the correct serial number into the database using the `ent-serial-num` command with the `serial` parameter.

For this example, enter this command.

```
ent-serial-num:serial=<EAGLE's correct serial number>
```

6. Verify that the serial number entered in 5 was entered correctly using the `rtrv-serial-num` command.

This is an example of the possible output.

```
rlghncxa03w 06-10-28 21:15:37 GMT EAGLE5 36.0.0
System serial number = nt00001231
```

System serial number is not locked, yet.

If the serial number was not entered correctly, repeat 4 and 5 and re-enter the correct serial number.

7. Lock the serial number in the database by entering the `ent-serial-num` command with the serial number shown in 4, if the serial number shown in 4 is correct, or with the serial number shown in 6, if the serial number was changed in 5, and with the `lock=yes` parameter.

For this example, enter this command.

```
ent-serial-num:serial=<EAGLE's serial number>;lock=yes
```

8. Enable the SE-HSL SLK quantity by entering the `enable-ctrl-feat` command specifying the part number for the desired SE-HSL SLK quantity and the feature access key.

The SE-HSL SLK quantity part numbers are shown in [Table A-11](#).

Table A-11 SE-HSL SLK QuantityPart Numbers

SE-HSL SLK Quantity	Part Number
4	893013001
8	893013002
16	893013003
24	893013004
32	893013005
40	893013006
48	893013007
56	893013008
64	893013009
72	893013010
80	893013011
88	893013012
96	893013013
104	893013014
112	893013015
120	893013016

For this example, enter this command.

```
enable-ctrl-feat:partnum=893013001:fak=<feature access key>
```

Note: A temporary feature access key cannot be specified to enable the unchannelized E1 signaling link quantity.

Note: The value for the feature access key (the fak parameter) is provided by Oracle. If you do not have the feature access key for the unchannelized E1 signaling link quantity, contact your Oracle Sales Representative or Account Representative.

9. Verify the changes by entering the `rtrv-ctrl-feat` command with the unchannelized E1 signaling link quantity (SE-HSLSLK Capacity feature) part number specified in 8.

Enter this command.

```
rtrv-ctrl-feat:partnum=893013001
```

```
rlghncxa03w 06-10-28 21:15:37 GMT EAGLE5 36.0.0
The following features have been permanently enabled:
```

Feature Name	Partnum	Status	Quantity
SE-HSL SLK Capacity	893013001	on	4

The following features have been temporarily enabled:

Feature Name	Partnum	Status	Quantity	Trial Period Left
Zero entries found.				

The following features have expired temporary keys:

Feature Name	Partnum
Zero entries found.	

Continue the procedure by performing one of these steps.

- If E1 cards are shown in the `rtrv-e1` output in 2 and these cards are on the same shelf as the card that will contain the E1 port that is being added, and these cards have E1 ports 3 through 8 provisioned, contain channel bridged E1 ports, or unchannelized E1 ports, continue the procedure with 14.
 - If E1 cards are shown in the `rtrv-e1` output in 2 and these cards are not on the same shelf as the card that will contain the E1 port that is being added, continue the procedure with 10.
 - If E1 cards are shown in the `rtrv-e1` output in 2 and these cards are on the same shelf as the card that will contain the E1 port that is being added, and these cards do not have E1 ports 3 through 8 provisioned, do not contain channel bridged E1 ports, or do not have unchannelized E1 ports, continue the procedure with 10.
10. Verify that **HIPR2** cards are installed in card locations 9 and 10 in the shelf containing the HC MIM or E5-E1T1 card that will contain the E1 port being added in this procedure by entering this command.

```
rept-stat-gpl:gpl=hipr2
```

This is an example of the possible output.

```

rlghncxa03w 09-07-05 08:12:53 GMT 41.1.0
GPL          CARD          RUNNING          APPROVED          TRIAL
HIPR2        1109          126-002-000          126-002-000          126-003-000
HIPR2        1110          126-002-000          126-002-000          126-003-000
HIPR2        1209          126-002-000          126-002-000          126-003-000
HIPR2        1210          126-002-000          126-002-000          126-003-000
HIPR2        1309          126-002-000          126-002-000          126-003-000
HIPR2        1310          126-002-000          126-002-000          126-003-000
HIPR2        2109          126-002-000          126-002-000          126-003-000
HIPR2        2110          126-002-000          126-002-000          126-003-000
Command Completed

```

If **HIPR2** cards are installed in the shelf containing the HC MIM or E5-E1T1 card, continue the procedure by performing one of these steps.

- If the card is an E5-E1T1 card, continue the procedure with [14](#).
- If the card is an HC MIM, continue the procedure with [11](#).

If HIPR2 cards are not installed on the shelf containing the HC MIM or E5-E1T1 card, go to *Installation Guide* and install the HIPR2 cards. Once the HIPR2 cards have been installed, continue the procedure by performing one of these steps.

- If the card is an E5-E1T1 card, continue the procedure with [14](#).
- If the card is an HC MIM, continue the procedure with [11](#).

11. Verify whether or not that the Fan feature is on, by entering the `rtrv-feat` command. If the Fan feature is on, the entry `FAN = on` appears in the `rtrv-feat` command output.

Note: The `rtrv-feat` command output contains other fields that are not used by this procedure. If you wish to see all the fields displayed by the `rtrv-feat` command, see the `rtrv-feat` command description in *Commands User's Guide*.

If the Fan feature is on, continue the procedure with [14](#).

If the Fan feature is off, continue the procedure with [Oracle](#).

12. Turn the Fan feature on by entering this command.

```
chg-feat : fan=on
```

Note: Once the Fan feature is turned on with the `chg-feat` command, it cannot be turned off.

The Fan feature must be purchased before you turn this feature on with the `chg-feat` command. If you are not sure if you have purchased the Fan feature, contact your Sales Representative or Account Representative.

When the `chg-feat` has successfully completed, this message appears.

```

rlghncxa03w 09-05-28 11:43:04 GMT EAGLE5 41.0.0
CHG-FEAT: MASP A - COMPLTD

```

13. The shelf containing the HC-MIM being added in this procedure must have fans installed. Verify whether or not fans are installed on the shelf.

If the fans are installed, continue the procedure with 14.

If the fans are not installed on the shelf containing the HC-MIM, go to *Installation Guide* and install the fans. After the fans have been installed and tested, continue the procedure with 14.

14. Add the unchannelized E1 port to the database using the `ent-e1` command and the parameter combinations shown in [Table A-12](#).

Table A-12 Unchannelized E1 Port Parameter Combinations

Mandatory Parameters		
:loc=card location of the HC-MIM or an E5-E1T1 card	:linkclass=unchan	:e1port=1, 2, 3, 4, 5, 6, 7, 8
Optional Parameters		
:cas=off Default value = off	:crc4=on, off Default value = on	:e1tsel=line, external Default value = line
:encode=ami, hdb3 Default value = hdb3	:si=0 - 3 Default value = 0	:sn=0 - 31 Default value = 0
:minsurate=500 - 2000 Default value = 1000		

For this example, enter these commands.

```
ent-
e1:loc=1305:e1port=2:encode=hdb3:e1tsel=line:si=1:sn=7 :linkc
lass=unchan
```

```
ent-
e1:loc=1307:e1port=2:crc4=on:encode=hdb3:e1tsel=external :lin
kclass=unchan
```

15. Verify the changes using the `rtrv-e1` command specifying the card location and the `e1port` value specified in 14.

For this example, enter these commands.

```
rtrv-e1:loc=1305:e1port=2
```

```
rlghncxa03w 06-10-28 09:12:36 GMT EAGLE5 36.0.0
      E1
LOC  PORT  CRC4  CAS  ENCODE  E1TSEL  SI  SN  CHANBRDG  CLASS  RATE
1305  2      OFF   OFF  HDB3    LINE    1  7  -----  UNCHAN 1000
```

```
rtrv-e1:loc=1307:e1port=2
```

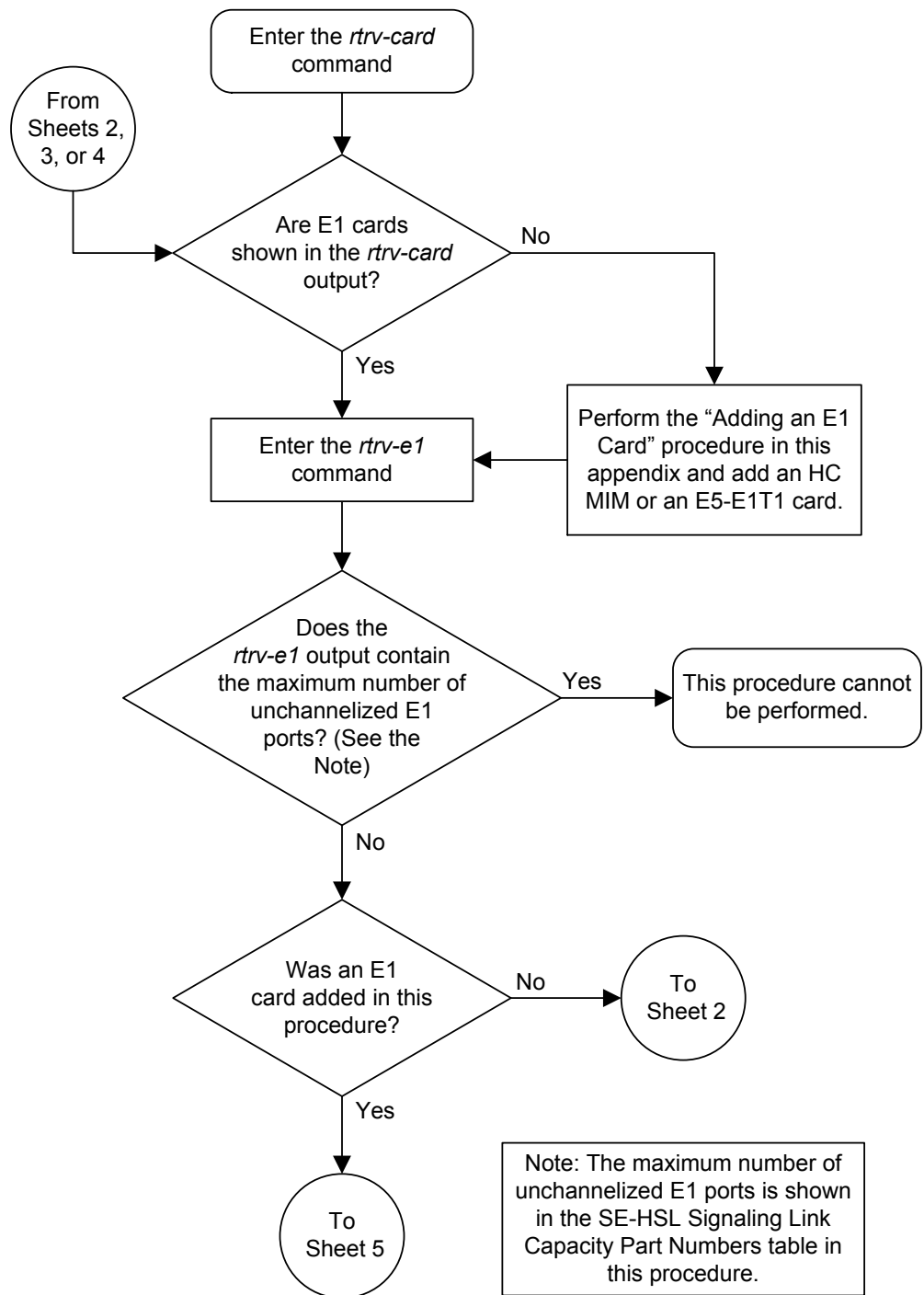
```
rlghncxa03w 06-10-28 09:12:36 GMT EAGLE5 36.0.0
      E1
LOC  PORT  CRC4  CAS  ENCODE  E1TSEL  SI  SN  CHANBRDG  CLASS  RATE
1307  2      ON    OFF  HDB3    EXTERNAL 0  0  -----  UNCHAN 1000
```


- 16.** Back up the new changes using the `chg-db:action=backup:dest=fixed` command.

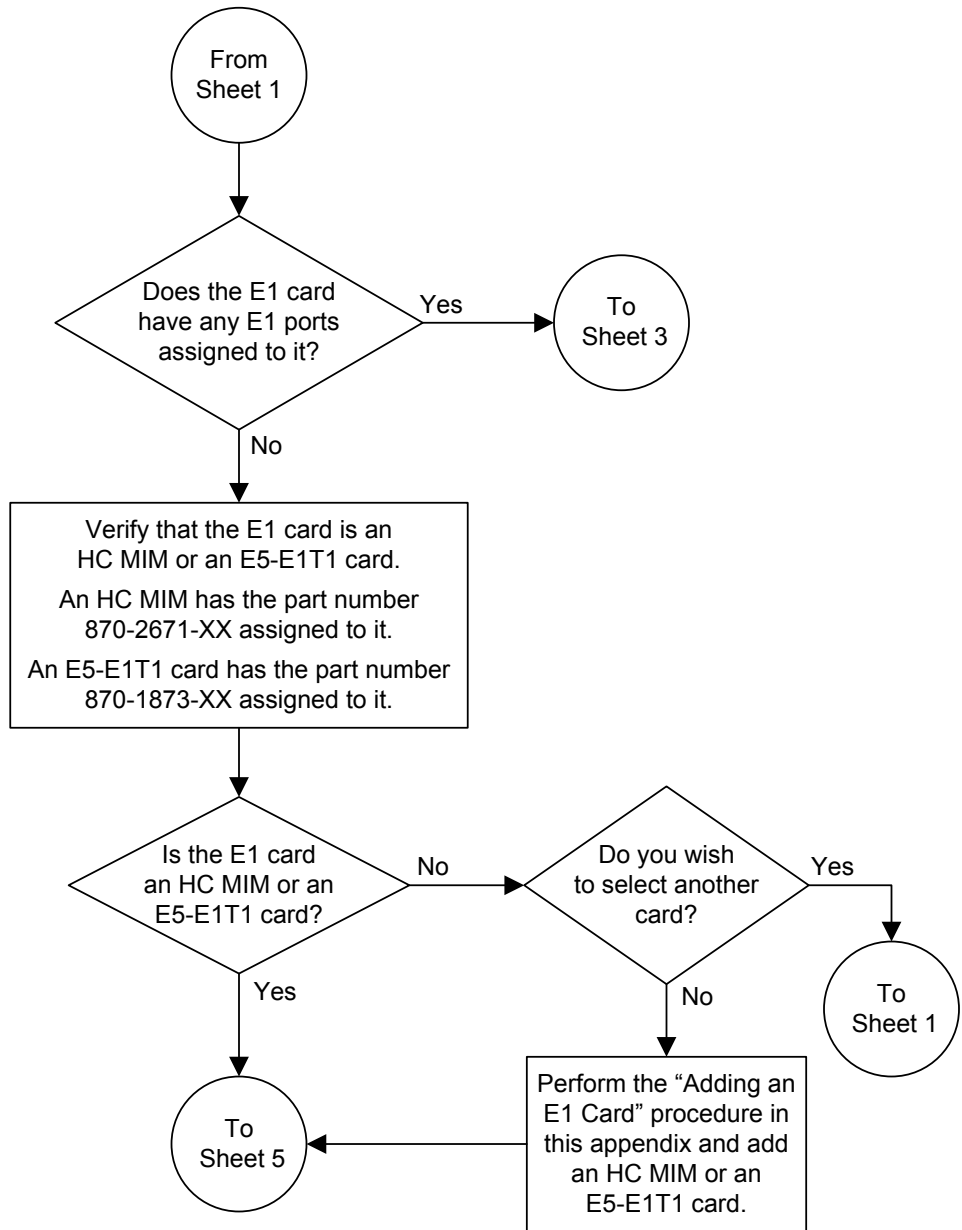
These messages should appear, the active **Maintenance and Administration Subsystem Processor (MASP)** appears first.

```
BACKUP (FIXED) : MASP A - Backup starts on active MASP.  
BACKUP (FIXED) : MASP A - Backup on active MASP to fixed disk complete.  
BACKUP (FIXED) : MASP A - Backup starts on standby MASP.  
BACKUP (FIXED) : MASP A - Backup on standby MASP to fixed disk complete.
```

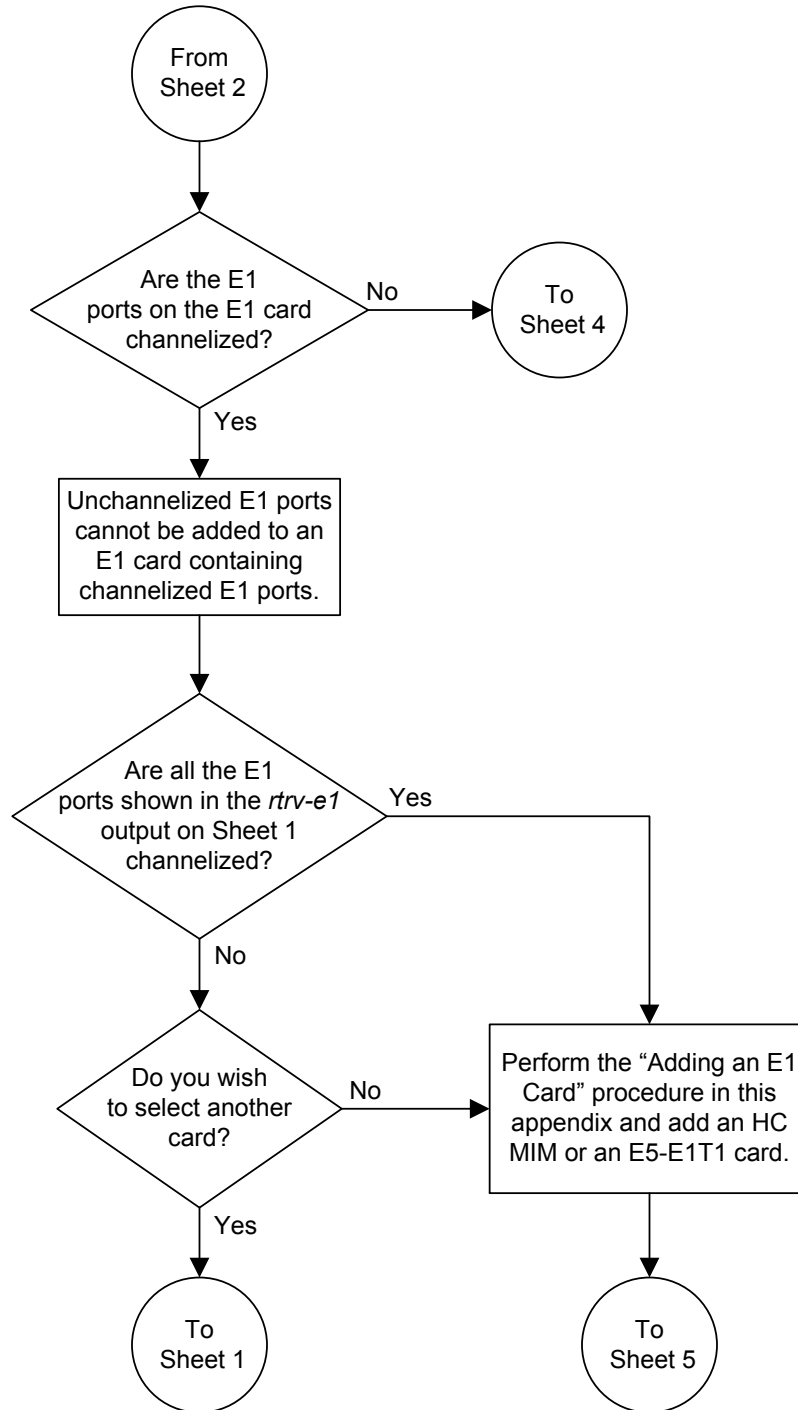
Figure A-8 Adding Unchannelized E1 Ports



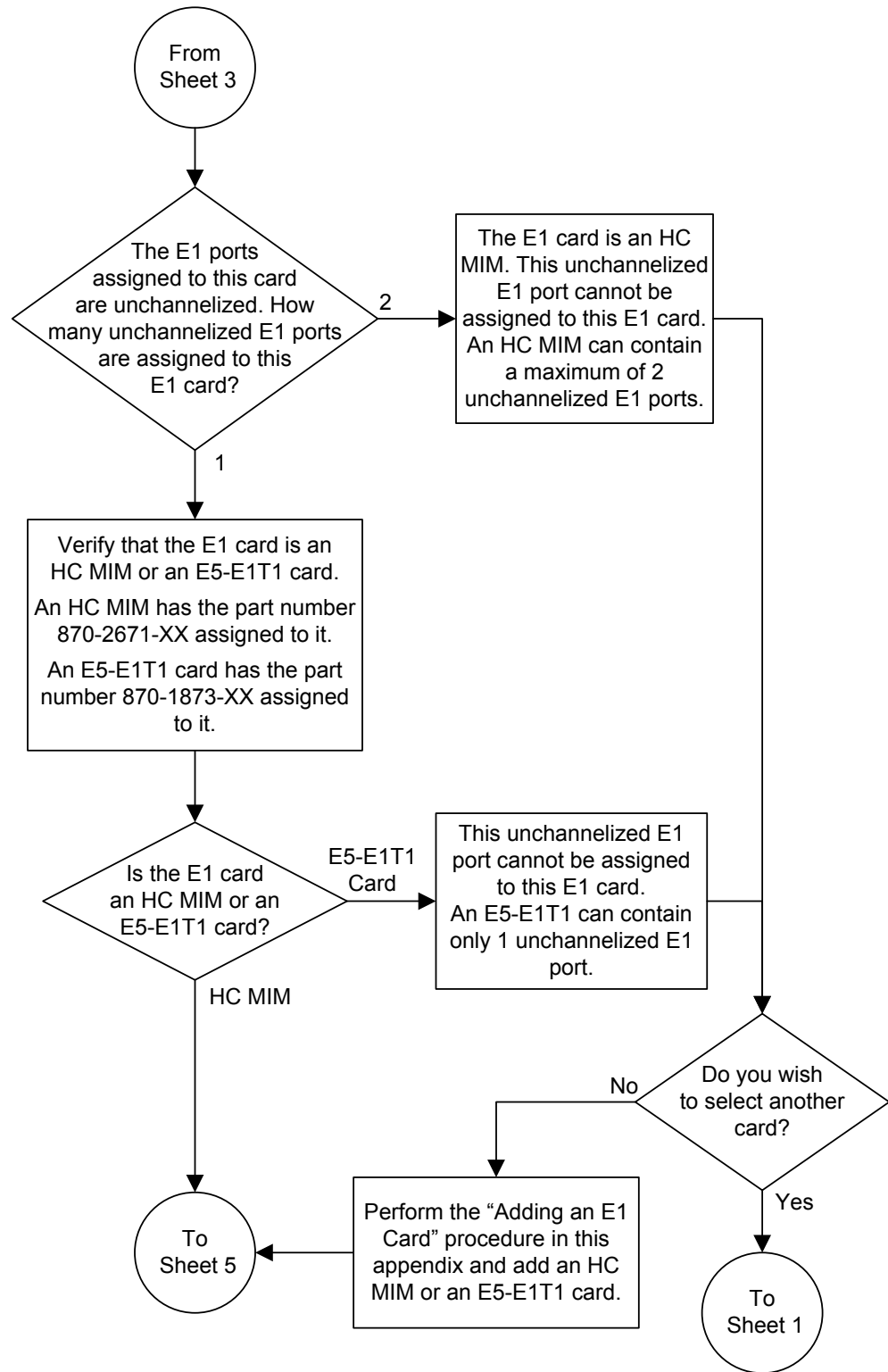
Sheet 1 of 10



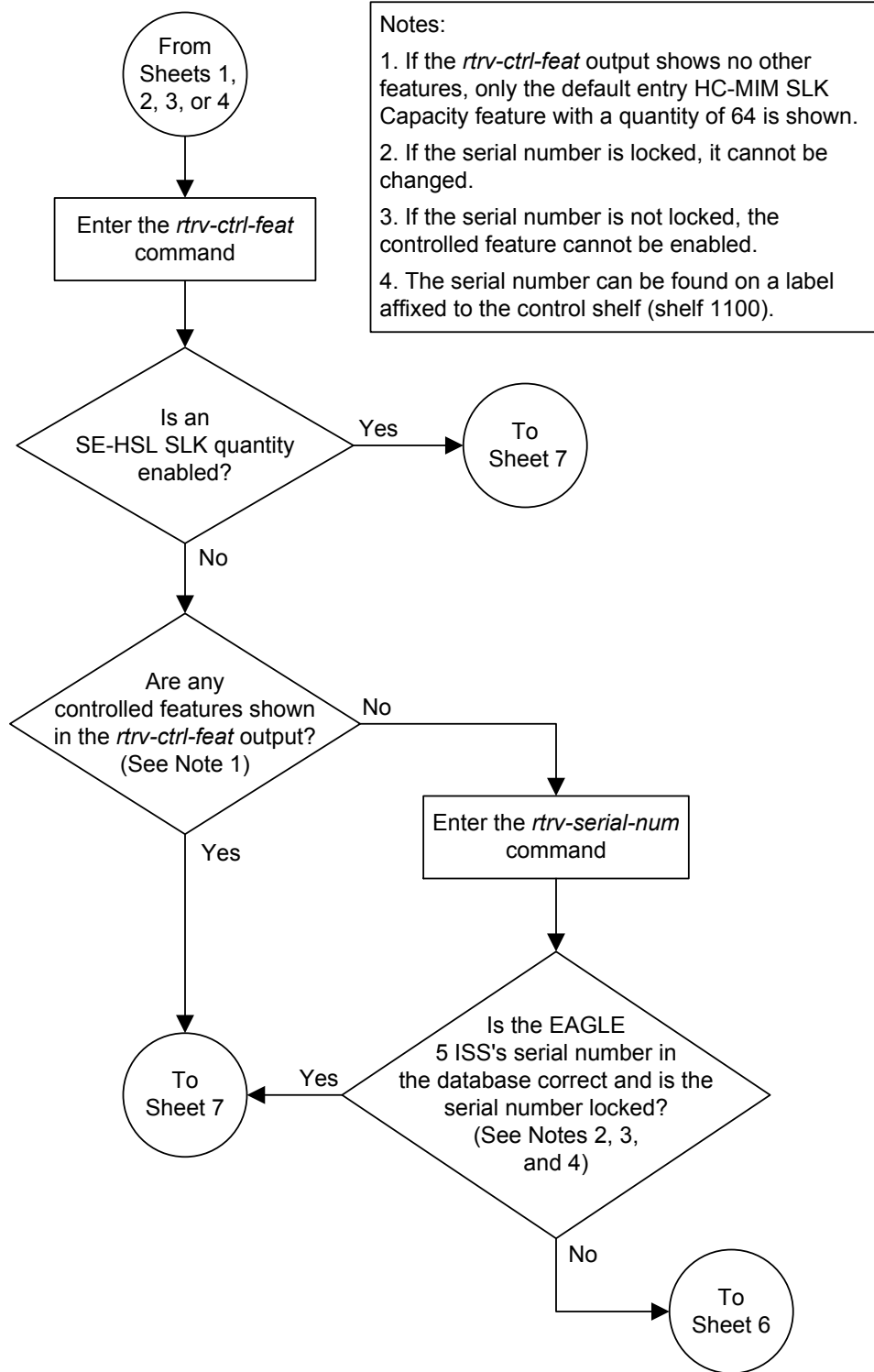
Sheet 2 of 10



Sheet 3 of 10



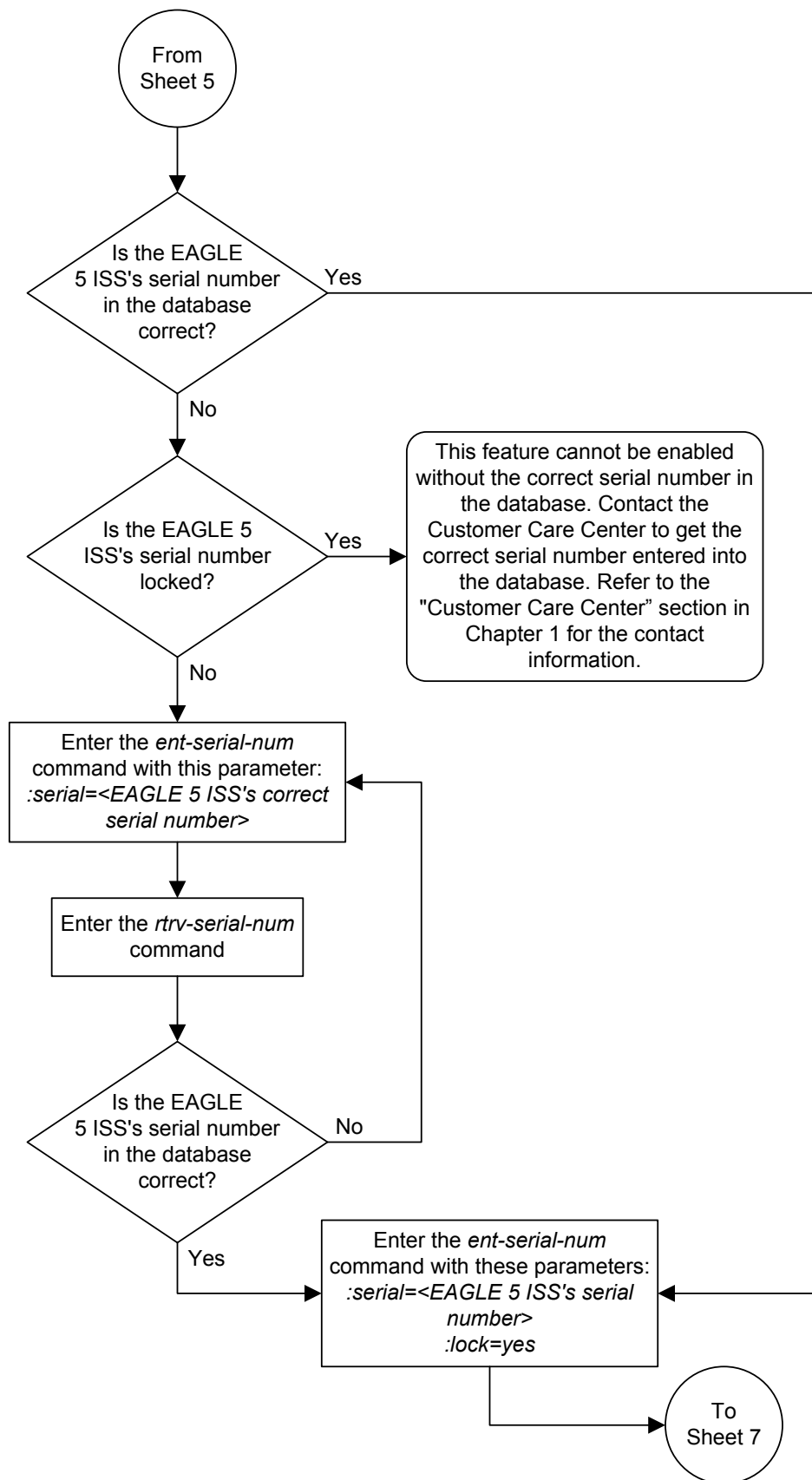
Sheet 4 of 10



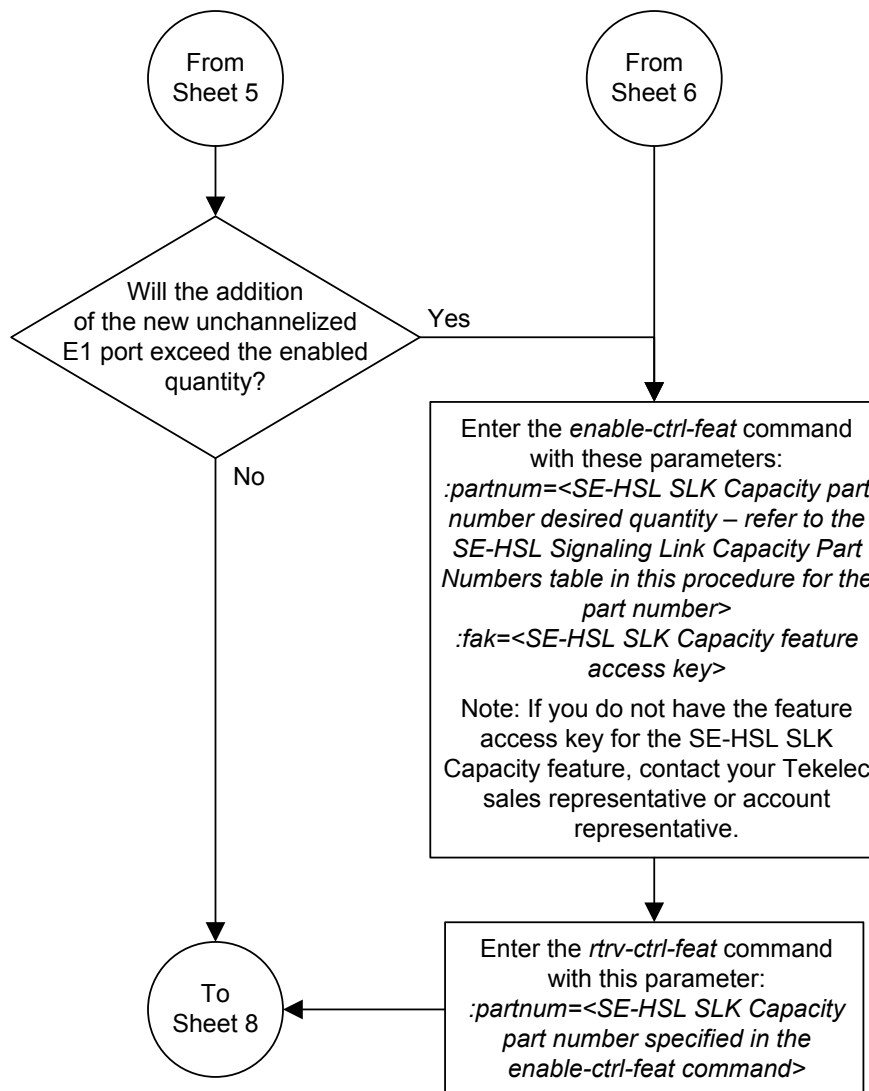
Notes:

1. If the *rtrv-ctrl-feat* output shows no other features, only the default entry HC-MIM SLK Capacity feature with a quantity of 64 is shown.
2. If the serial number is locked, it cannot be changed.
3. If the serial number is not locked, the controlled feature cannot be enabled.
4. The serial number can be found on a label affixed to the control shelf (shelf 1100).

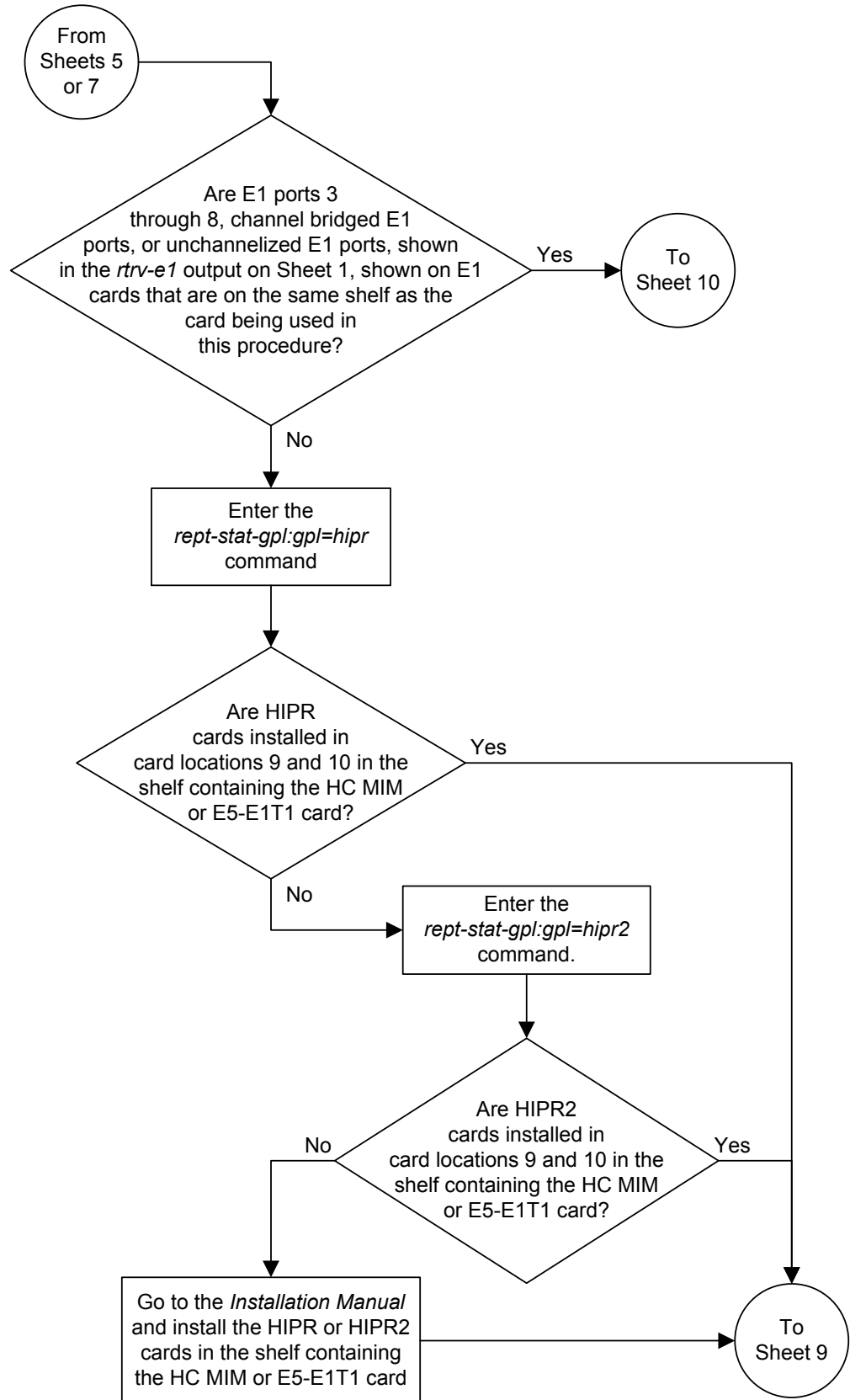
Sheet 5 of 10



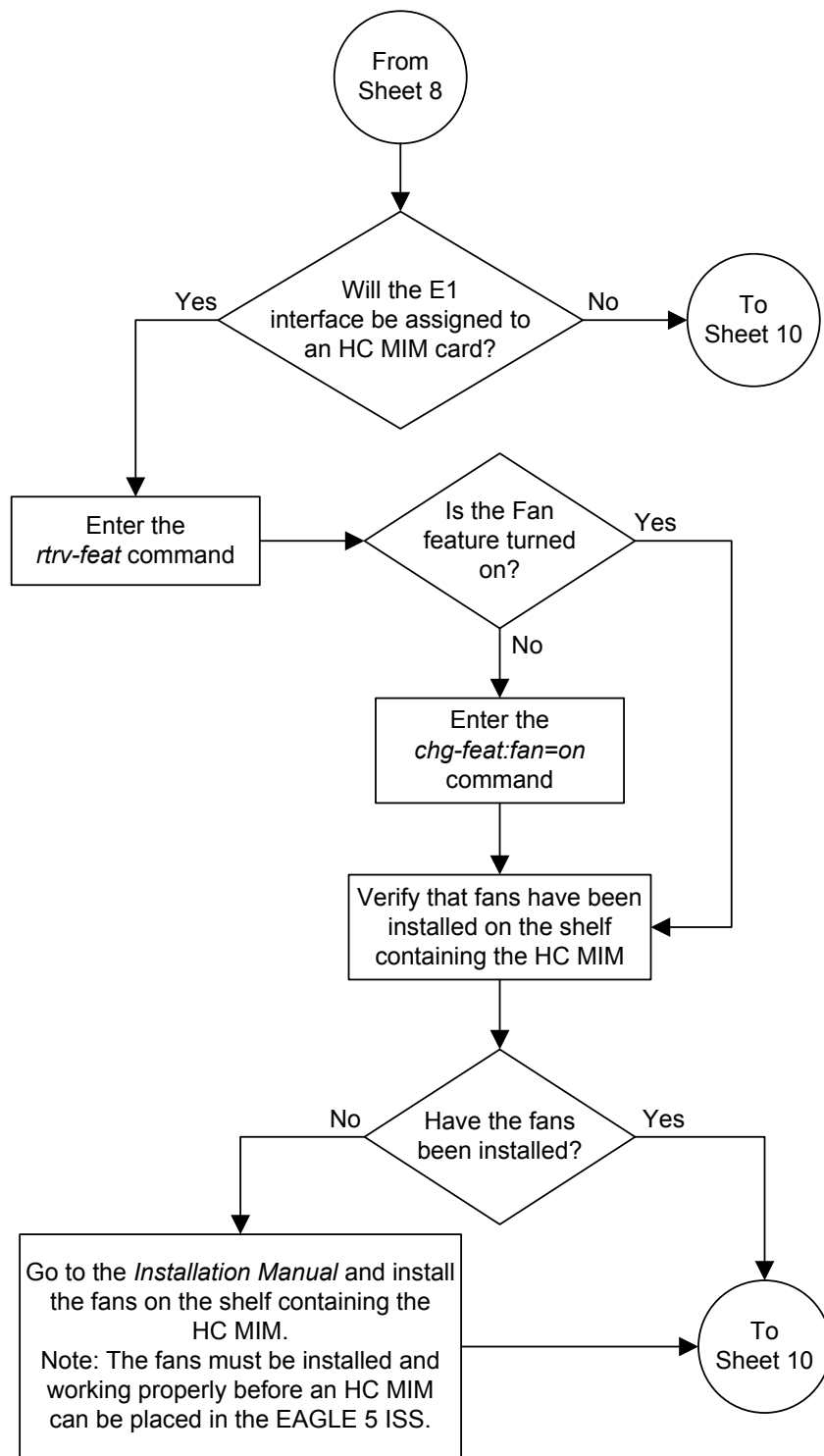
Sheet 6 of 10



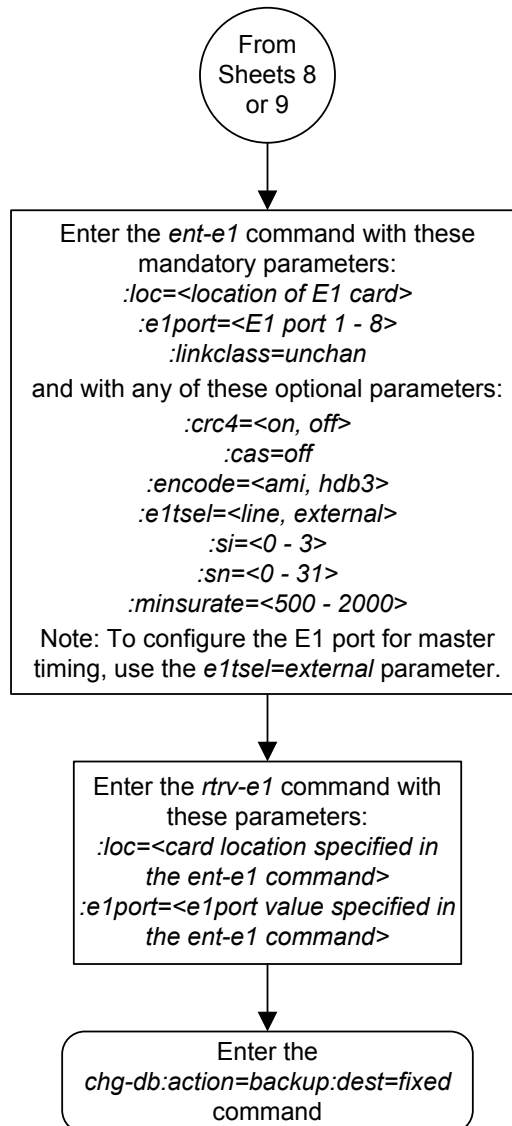
Sheet 7 of 10



Sheet 8 of 10



Sheet 9 of 10



Removing the E1 Interface Parameters

This procedure is used to remove an **E1** interface from the database using the `dlt-e1` command using these parameters.

`:loc` – The location of the **E1** card (card type `lime1`) containing the **E1** interface being removed.

`:elport` – The **E1** port on the **E1** card containing the **E1** interface being removed.

The **E1** interface to be removed must exist in the database. This can be verified in step 1.

To remove the **E1** interface information contained on an **E1** card, all signaling links serviced by that **E1** card must be removed from the database. This can be verified with the `rtrv-e1` command, specifying the card location and `E1PORT` on the **E1** card, and the `rtrv-slk` command, specifying the location of any cards (**E1** or channel cards) shown in the `rtrv-e1` output. If there are any signaling links being serviced by the **E1** card, go to the [Removing an SS7 Signaling Link](#) procedure and remove these signaling links.

Even numbered **E1** ports cannot be removed if the even numbered **E1** port is channel bridged. Remove the corresponding odd numbered **E1** port (see [Table A-5](#)) to remove the even numbered channel bridged **E1** port.

1. Display the existing **E1** interfaces in the database using the `rtrv-e1` command with no parameters.

```
rlghncxa03w 06-10-19 21:17:04 GMT EAGLE5 36.0.0
```

E1									LINK	MINSU
LOC	PORT	CRC4	CAS	ENCODE	E1TSEL	SI	SN	CHANBRDG	CLASS	RATE
1201	2	ON	OFF	HDB3	EXTERNAL	3	5	-----	CHAN	----
1203	2	OFF	OFF	HDB3	LINE	1	7	-----	CHAN	----
1211	2	ON	OFF	HDB3	LINE	0	0	-----	CHAN	----

If the **E1** port being removed is an even numbered **E1** port and is channel bridged, select the corresponding odd numbered **E1** port to remove (see [Table A-5](#)) and go to step 2.

If the even numbered **E1** port is not channel bridged, it can be removed with the `dlt-e1` command. go to step 2.

2. Display the timeslots that are serviced by the **E1** card containing the **E1** interface information to be removed using the `rtrv-e1` command specifying the card location and the `elport` value from step 1. For this example, enter this command.

```
rtrv-e1:loc=1201:elport=2
```

```
rlghncxa03w 06-10-28 09:12:36 GMT EAGLE5 36.0.0
```

E1									LINK	MINSU
LOC	PORT	CRC4	CAS	ENCODE	E1TSEL	SI	SN	CHANBRDG	CLASS	RATE
1201	2	ON	OFF	HDB3	EXTERNAL	3	5	-----	CHAN	----
TS0	(N/A)	TS8	-----	TS16	-----	TS24	-----			
TS1	1201,A	TS9	-----	TS17	-----	TS25	-----			

```

TS2  -----   TS10 -----   TS18 -----   TS26 -----
TS3  -----   TS11 -----   TS19 -----   TS27 -----
TS4  -----   TS12 -----   TS20 -----   TS28 -----
TS5  1202,A   TS13 -----   TS21 -----   TS29 -----
TS6  -----   TS14 -----   TS22 -----   TS30 -----
TS7  -----   TS15 -----   TS23 -----   TS31 -----

```

If this step shows any timeslots that are serviced by the **E1** card, go to the [Removing an SS7 Signaling Link](#) procedure and remove the timeslots and signaling links serviced by the **E1** card.

3. Remove the **E1** interface information to the database using the `dlt-e1` command specifying the card location of the **E1** card and the `E1PORT` on that card. For this example, enter these commands.

```
dlt-e1:loc=1201:elport=2
```

4. Verify the changes using the `rtrv-e1` command with the card location and the `elport` value specified in 3.

For this example, enter this command.

```
rtrv-e1:loc=1201:elport=2
```

```

rlghncxa03w 10-04-19 21:17:04 GMT EAGLE5 42.0.0
E4055 Cmd Rej: The E1PORT at the specified location is not equipped

```

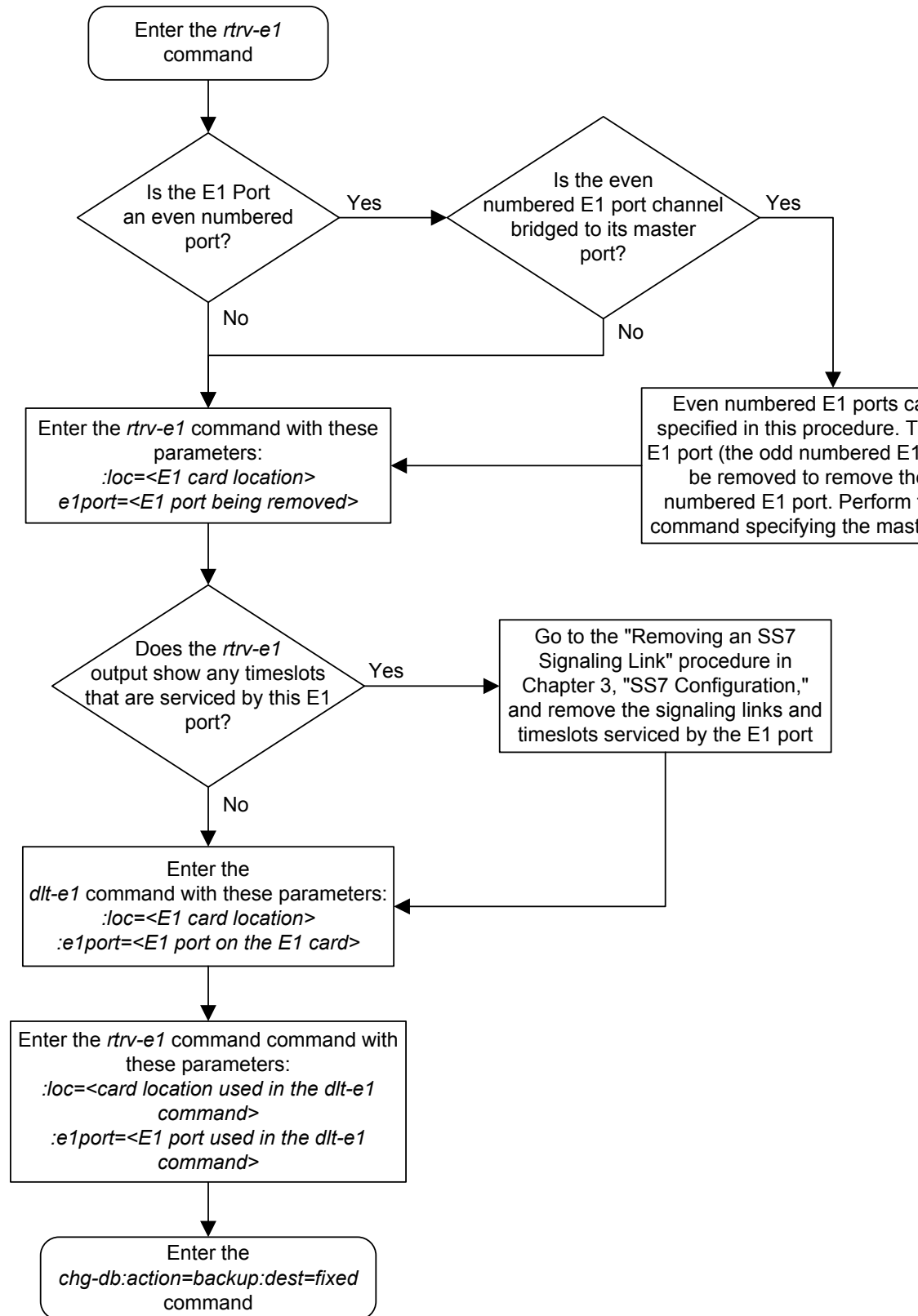
5. Back up the new changes using the `chg-db:action=backup:dest=fixed` command. These messages should appear, the active **Maintenance and Administration Subsystem Processor (MASP)** appears first.

```

BACKUP (FIXED) : MASP A - Backup starts on active MASP.
BACKUP (FIXED) : MASP A - Backup on active MASP to fixed disk complete.
BACKUP (FIXED) : MASP A - Backup starts on standby MASP.
BACKUP (FIXED) : MASP A - Backup on standby MASP to fixed disk complete.

```

Figure A-9 Removing the E1 Interface Parameters



Changing the Attributes of a Channelized E1 Port

This procedure is used to change the attributes of a channelized **E1** port using the `chg-e1` command. A channelized E1 port is an E1 port whose `LINKCLASS` value is `CHAN`, shown in the `LINKCLASS` column in the `rtrv-e1` output. Other actions can be performed on E1 ports. To perform these actions on the E1 ports, perform one of these procedures.

- To change the attributes of an unchannelized E1 port - [Changing the Attributes of an Unchannelized E1 Port](#)
- To make a channel bridged E1 port from a channelized E1 port - [Making a Channel Bridged E1 Port from a Channelized E1 Port](#)
- To make a non-channel bridged E1 port from a channel bridged E1 port - [Making a Non-Channel Bridged E1 Port from a Channel Bridged E1 Port](#)

To change the attributes of a channelized E1 port, these parameters are used with the `chg-e1` command.

`:loc` – The location of the E1 card (card type `lime1`) that is servicing the E1 signaling link. The location of a channel card (card type `limch`) cannot be specified for this parameter. The E1 card can be either an **E1/T1 MIM**, an **HC -MIM**, or an **E5-E1T1** card.

`:e1port` – The E1 port being changed in this procedure.

`:crc4` – Specifies whether or not **CRC4** is enabled on the E1 signaling link.

`:cas` – Specifies whether **CAS** or **CCS** is used on the E1 signaling link. **CAS** is enabled with the `cas=on` parameter. **CCS** is enabled with the `cas=off` parameter. The `cas=on` parameter cannot be specified for an **HC-MIM**, or an **E5-E1T1** card.

`:encode` – Specifies the type of encoding or decoding that is used on the E1 signaling link, either **HDB3** or **AMI**. **AMI** encoding can be specified only for an **E1/T1 MIM**, an **HC-MIM**, or an **E5-E1T1** card.

`:eltset` – The timing source for the E1 signaling link, master timing (`external`), slave timing (`line`), or `recovered`.

The `recovered` timing source can be used only with the `chanbrdg=on` parameter and uses the even numbered member of the bridged-pair as a clock source, ensuring that port in the pair can recover the timing from its partner.

Note: To use an external high-speed master clock source other than RS-422, TDMs 870-0774-15 or later must be installed in card locations 1114 and 1116, and the **TDM Global Timing Interface** options must be configured. For more information, see [Configuring the Options for the TDM Global Timing Interface](#).

`:si` – Specifies the value of the two spare international bits of **NFAS** data, from 0 to 3.

`:sn` – Specifies the value of the five spare national bits of **NFAS** data, from 0 to 31.

The **E1** card specified in this procedure must be in the database. This can be verified with the `rtrv-e1` command.

If either the `crc4`, `cas`, `encode`, or `eltset` values are being changed, all the signaling links serviced by the E1 card must be taken out of service.

If the signaling link being serviced by the E1 card is using timeslot 16, the `cas=on` parameter cannot be specified with the `chg-e1` command.

1. Display the existing **E1** interfaces in the database using the `rtrv-e1` command with no parameters.

```
rlghncxa03w 09-05-19 21:17:04 GMT EAGLE5 41.0.0
      E1
LOC  PORT  CRC4  CAS  ENCODE  E1TSEL  SI  SN  CHANBRDG  CLASS  RATE
1201 2      ON   OFF  HDB3    EXTERNAL 3  5  -----  CHAN  ----
1203 2      OFF  OFF  HDB3    LINE      1  7  -----  CHAN  ----
1211 2      ON   OFF  HDB3    LINE      0  0  -----  CHAN  ----
```

A channelized E1 port is an E1 port whose `LINKCLASS` value is `CHAN`.

If there are no channelized E1 ports shown in the `rtrv-e1` output, this procedure cannot be performed.

If there are channelized E1 ports shown in the `rtrv-e1` output, continue the procedure by performing one of these steps.

- If the `crc4`, `cas`, `encode`, or `e1tsel` parameters are being changed in this procedure, continue the procedure with [2](#).
 - If the `crc4`, `cas`, `encode`, or `e1tsel` parameters are not being changed in this procedure, continue the procedure by performing one of these steps.
 - If the E1 port is channel bridged (the entry `MASTER` is shown in the `CHANBRDG` column for the odd numbered E1 port in the `rtrv-e1` output), or if E1 ports 3 through 8 are assigned to the E1 card, the card is either an HC-MIM or an E5-E1T1 card. Continue the procedure with [7](#).
 - If the E1 port is not channel bridged, or if E1 ports 3 through 8 are not assigned to the E1 card, continue the procedure with [6](#) to verify the type of E1 card that the E1 port is assigned to.
2. Display the timeslots that are serviced by the **E1** card containing the E1port that is being changed using the `rtrv-e1` command specifying the card location and the `elport` value from [1](#).

For this example, enter this command.

```
rtrv-e1:loc=1201:elport=2
```

```
rlghncxa03w 09-05-28 09:12:36 GMT EAGLE5 41.0.0
      E1
LOC  PORT  CRC4  CAS  ENCODE  E1TSEL  SI  SN  CHANBRDG  CLASS  RATE
1201 2      ON   OFF  HDB3    EXTERNAL 3  5  -----  CHAN  ----

TS0  (N/A)   TS8  -----  TS16 -----  TS24 -----
TS1  1201,A   TS9  -----  TS17 -----  TS25 -----
TS2  -----  TS10 -----  TS18 -----  TS26 -----
TS3  -----  TS11 -----  TS19 -----  TS27 -----
TS4  -----  TS12 -----  TS20 -----  TS28 -----
TS5  1202,A   TS13 -----  TS21 -----  TS29 -----
TS6  -----  TS14 -----  TS22 -----  TS30 -----
TS7  -----  TS15 -----  TS23 -----  TS31 -----
```

3. Display the signaling links that are assigned to the E1 card by entering the `rtrv-slk` command with the card location specified in 2. For this example, enter this command.

```
rtrv-slk:loc=1201
```

```
rlghncxa03w 09-05-19 21:17:04 GMT EAGLE5 41.0.0
          L2T          PCR PCR  E1  E1
LOC  LINK LSN          SLC TYPE  SET  BPS  ECM  N1  N2  LOC  PORT TS
1201 A  lsn1          13 LIME1  1   56000 BASIC --- 1201 2  25
1201 B  lsn1          12 LIME1  1   56000 BASIC --- 1201 1  20
```

4. Check the status of the signaling links shown in 3 using the `rept-stat-slk` command with the card location and signaling link.

For this example, enter these commands.

```
rept-stat-slk:loc=1201:link=a
```

```
rlghncxa03w 09-05-23 13:06:25 GMT EAGLE5 41.0.0
SLK  LSN  CLLI  PST  SST  AST
1201,A lsn1  ----- IS-NR  Avail  ----
ALARM STATUS      = No Alarms
UNAVAIL REASON    = --
E1 status         = 1201, RCVRY-E1F:FAC-E1 Port 2 available
```

```
rept-stat-slk:loc=1201:link=b
```

```
rlghncxa03w 09-05-23 13:06:25 GMT EAGLE5 41.0.0
SLK  LSN  CLLI  PST  SST  AST
1201,B lsn1  ----- IS-NR  Avail  ----
ALARM STATUS      = No Alarms
UNAVAIL REASON    = --
E1 status         = 1201, RCVRY-E1F:FAC-E1 Port 1 available
```

If all the signaling links shown in this step are out of service, continue the procedure by performing one of these steps.

- If the E1 port is channel bridged (the entry `MASTER` is shown in the `CHANBRDG` column for the odd numbered E1 port in the `rtrv-e1` output), or if E1 ports 3 through 8 are assigned to the E1 card, the card is either an HC-MIM or an E5-E1T1 card. Continue the procedure with 7.
- If the E1 port is not channel bridged, or if E1 ports 3 through 8 are not assigned to the E1 card, continue the procedure with 6 to verify the type of E1 card that the E1 port is assigned to.

If any of the signaling links shown in this step are in service, continue the procedure with 5.

5. Deactivate the in service signaling links shown in 4 using the `dact-slk` command.

For this example, enter these commands.

```
dact-slk:loc=1201:link=a
```

```
dact-slk:loc=1201:link=b
```

After the signaling links have been deactivated, continue the procedure by performing one of these steps.

- If the E1 port is channel bridged (the entry MASTER is shown in the CHANBRDG column for the odd numbered E1 port in the `rtrv-e1` output), or if E1 ports 3 through 8 are assigned to the E1 card, the card is either an HC-MIM or an E5-E1T1 card. Continue the procedure with 7.
- If the E1 port is not channel bridged, or if E1 ports 3 through 8 are not assigned to the E1 card, continue the procedure with 6 to verify the type of E1 card that the E1 port is assigned to.

6. Display the LIME1 cards in the database by entering this command.

```
rtrv-stp:type=lime1
```

```
rlghncxa03w 09-05-30 11:07:17 EST EAGLE 41.0.0
```

Card	Part Number	Rev	Serial Number	Type	DB	APPL	GPL Version
----	-----	---	-----	----	--	----	-----
1201	870-2671-02	C	10145689323	LIME1	512M	SS7ANSI	126-034-000
1203	870-1873-01	C	10345690569	LIME1	512M	SS7ANSI	126-034-000
1211	870-1873-01	C	10346790570	LIME1	512M	SS7ANSI	126-034-000

Command Completed.

The part numbers and the card types of the E1 cards are shown in [Table A-4](#).

7. Change the E1 port using the `chg-e1` command and the parameter combinations shown in [Table A-13](#), based on the type of E1 card being used.

Table A-13 E1 Interface Parameter Combinations

E1/T1MIM	Non-Channel Bridged E1 Ports - HC-MIM or E5-E1T1 Card	Channel Bridged E1 Ports - HC-MIM or E5-E1T1 Card
Mandatory Parameters		
:loc=location of the E1 card	:loc=location of the E1 card	:loc=location of the E1 card
:e1port=E1 port being changed, either 1 or 2	:e1port=E1 port being changed, either 1, 2, 3, 4, 5, 6, 7, or 8	:e1port=E1 port being changed, either 1, 3, 5, or 7
Optional Parameters		
:cas=on, off (See the Note)	:cas=off	:cas=off
:crc4=on, off	:crc4=on, off	:crc4=on, off
:encode=ami, hdb3	:encode=ami, hdb3	:encode=ami, hdb3
:si=0 - 3	:si=0 - 3	:si=0 - 3
:sn=0 - 31	:sn=0 - 31	:sn=0 - 31
:e1tsel=line, external	:e1tsel=line, external	:e1tsel=external, recovered

Table A-13 (Cont.) E1 Interface Parameter Combinations

E1/T1MIM	Non-Channel Bridged E1 Ports - HC-MIM or E5-E1T1 Card	Channel Bridged E1 Ports - HC-MIM or E5-E1T1 Card
----------	-------------------------------------------------------	---------------------------------------------------

Note: If timeslot 16 is being used for the signaling link that is assigned to the E1 port, the cas value must be off.

For this example, enter this command.

```
chg-e1:loc=1201:e1port=2:crc4=off:encode=hdb3:si=1:sn=9
```

- Verify the changes using the `rtrv-e1` command specifying the card location and the `e1port` value specified in 7.

For this example, enter this command.

```
rtrv-e1:loc=1201:e1port=2
```

```
rlghncxa03w 09-05-28 09:12:36 GMT EAGLE5 41.0.0
```

E1									LINK	MINSU
LOC	PORT	CRC4	CAS	ENCODE	E1TSEL	SI	SN	CHANBRDG	CLASS	RATE
1201	2	OFF	OFF	HDB3	EXTERNAL	1	9	-----	CHAN	----
TS0	(N/A)	TS8	-----	TS16	-----	TS24	-----			
TS1	1201,A	TS9	-----	TS17	-----	TS25	-----			
TS2	-----	TS10	-----	TS18	-----	TS26	-----			
TS3	-----	TS11	-----	TS19	-----	TS27	-----			
TS4	-----	TS12	-----	TS20	-----	TS28	-----			
TS5	1202,A	TS13	-----	TS21	-----	TS29	-----			
TS6	-----	TS14	-----	TS22	-----	TS30	-----			
TS7	-----	TS15	-----	TS23	-----	TS31	-----			

If the signaling links were not deactivated in 5, continue the procedure with 10.

If the signaling links were deactivated in 5, continue the procedure with 9.

- Activate the signaling links that were deactivated in 5 using the `act-slk` command.

For this example, enter these commands.

```
act-slk:loc=1201:link=a
```

```
act-slk:loc=1201:link=b
```

When each of these commands have successfully completed, this message should appear.

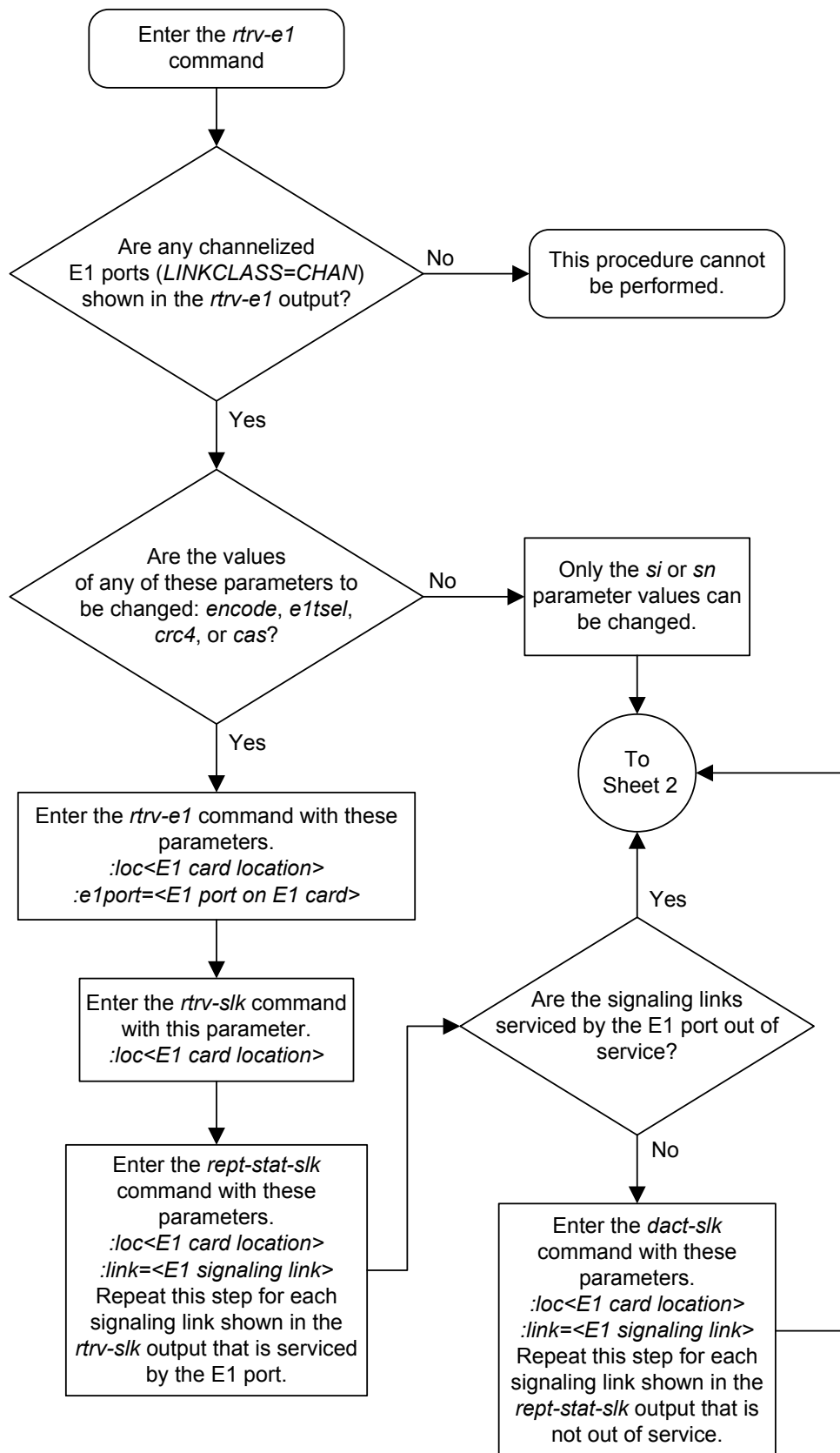
```
rlghncxa03w 09-05-07 08:41:12 GMT EAGLE5 41.0.0
Activate Link message sent to card
```

- Back up the new changes using the `chg-db:action=backup:dest=fixed` command.

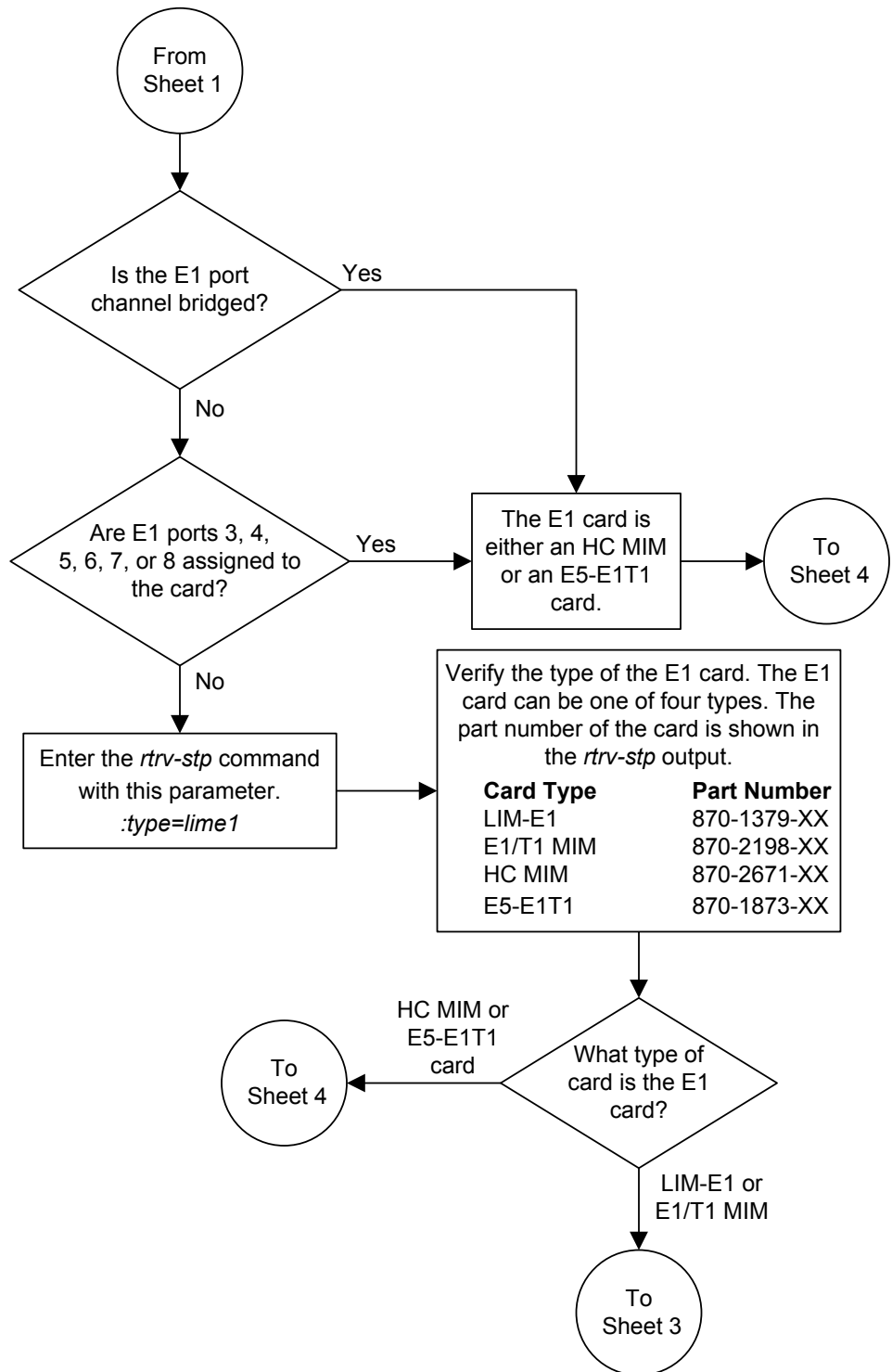
These messages should appear, the active **Maintenance and Administration Subsystem Processor (MASP)** appears first.

BACKUP (FIXED) : MASP A - Backup starts on active MASP.
BACKUP (FIXED) : MASP A - Backup on active MASP to fixed disk complete.
BACKUP (FIXED) : MASP A - Backup starts on standby MASP.
BACKUP (FIXED) : MASP A - Backup on standby MASP to fixed disk complete.

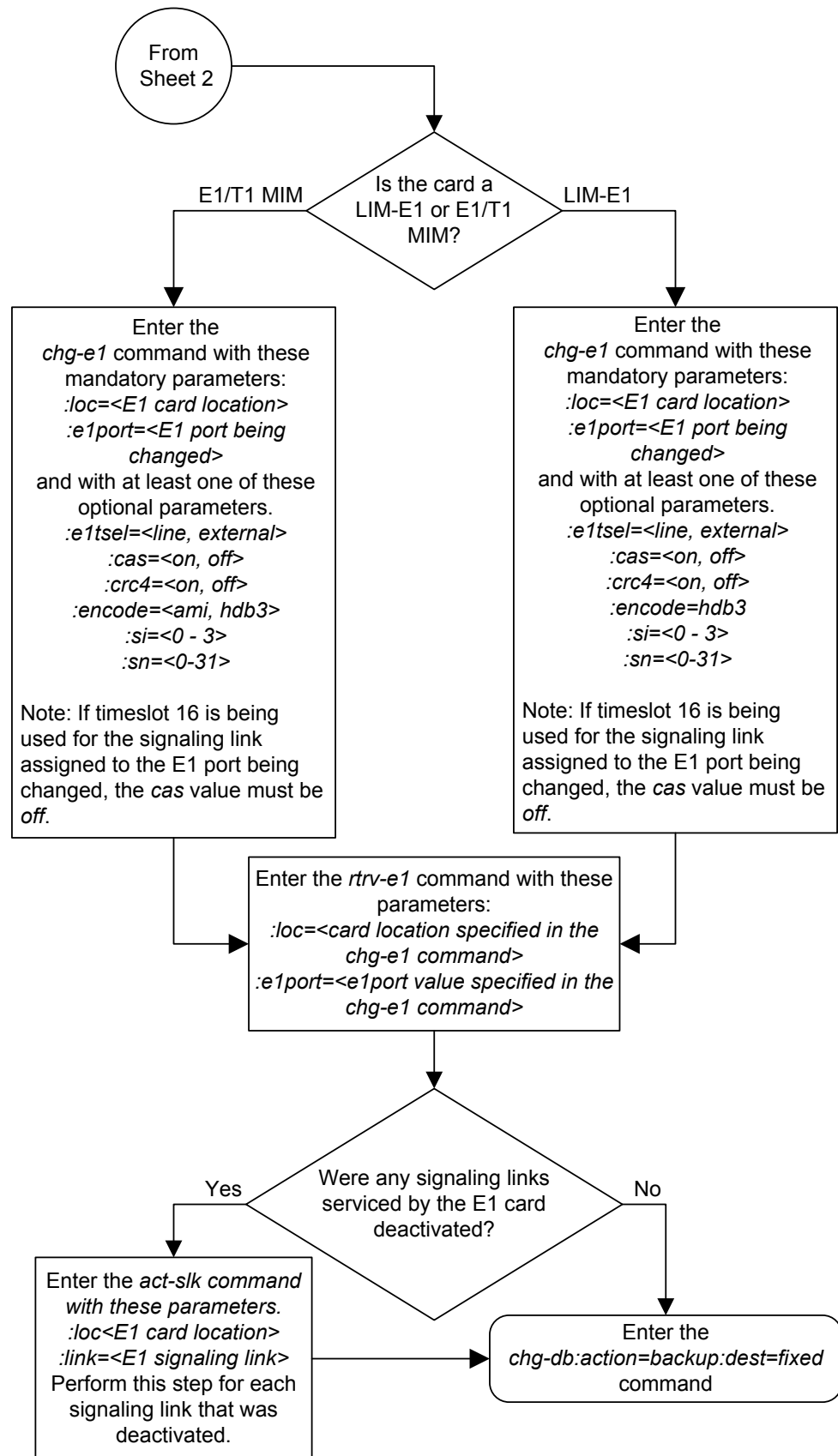
Figure A-10 Changing the Attributes of a Channelized E1 Port



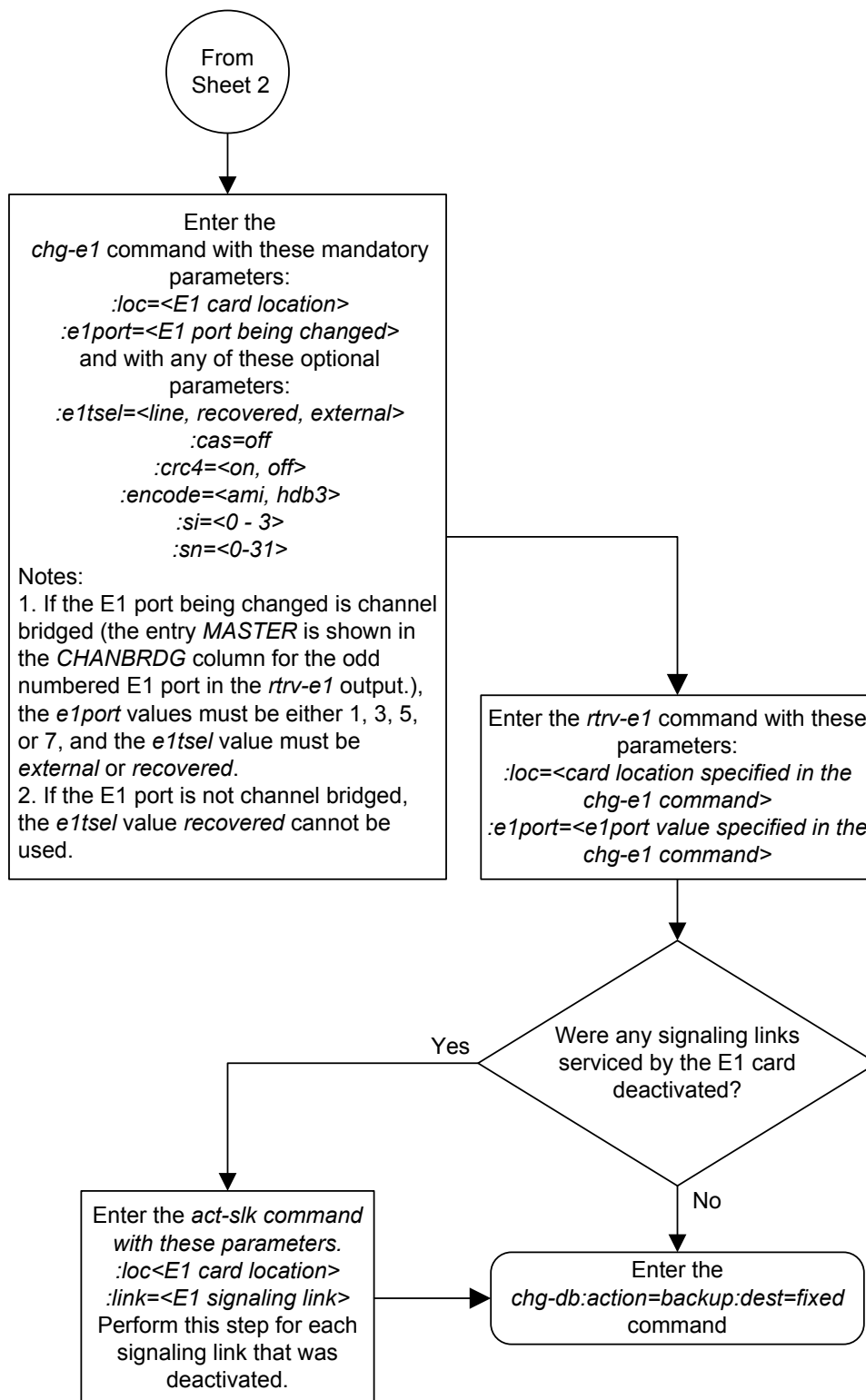
Sheet 1 of 4



Sheet 2 of 4



Sheet 3 of 4



Changing the Attributes of an Unchannelized E1 Port

This procedure is used to change the attributes of an unchannelized **E1** port using the `chg-e1` command. An unchannelized E1 port is an E1 port whose `LINKCLASS` value is `UNCHAN`, shown in the `LINKCLASS` column in the `rtrv-e1` output. Other actions can be performed on E1 ports. To perform these actions on the E1 ports, perform one of these procedures.

- To change the attributes of a channelized E1 port - [Changing the Attributes of a Channelized E1 Port](#)
- To make a channel bridged E1 port from a channelized E1 port - [Making a Channel Bridged E1 Port from a Channelized E1 Port](#)
- To make a non-channel bridged E1 port from a channel bridged E1 port - [Making a Non-Channel Bridged E1 Port from a Channel Bridged E1 Port](#)

To change the attributes of an unchannelized E1 port, these parameters are used with the `chg-e1` command.

`:loc` – The location of the E1 card that contains the unchannelized E1 port (card type `lime1`) that is servicing the E1 signaling link. The location of a channel card (card type `limch`) cannot be specified for this parameter. The E1 card can be either an HC-MIM or an E5-E1T1 card.

`:e1port` – The E1 port being changed in this procedure.

`:crc4` – Specifies whether or not **CRC4** is enabled on the E1 signaling link.

`:cas` – Specifies whether **CAS** or **CCS** is used on the E1 signaling link. CAS is enabled with the `cas=on` parameter. CCS is enabled with the `cas=off` parameter. For an unchannelized E1 port, the `cas` value must be `off`.

`:encode` – Specifies the type of encoding or decoding that is used on the E1 signaling link, either **HDB3** or **AMI**.

`:e1tsel` – The timing source for the E1 signaling link, master (`external`) or slave (`line`).

Note: To use an external high-speed master clock source other than RS-422, TDMs 870-0774-15 or later must be installed in card locations 1114 and 1116, and the **TDM Global Timing Interface** options must be configured. For more information, see [Configuring the Options for the TDM Global Timing Interface](#).

`:si` – Specifies the value of the two spare international bits of **NFAS** data, from 0 to 3.

`:sn` – Specifies the value of the five spare national bits of **NFAS** data, from 0 to 31.

`:minsurate` – Specifies the minimum number of signaling units (**FISUs** and **LSSUs**) per second that are transmitted on the outbound E1 signaling link during idle periods or when there is an unused portion of the link's bandwidth. The value of this parameter is from 500 to 2000 signaling units per second, with the default value of 1000 signaling units per second.

The E1 card specified in this procedure must be in the database. This can be verified with the `rtrv-e1` command.

If either the `crc4`, `cas`, `encode`, or `eltsel` values are being changed, all the signaling links serviced by the E1 card must be taken out of service.

1. Display the existing E1 interfaces in the database using the `rtrv-e1` command with no parameters.

```
rlghncxa03w 09-05-19 21:17:04 GMT EAGLE5 41.0.0
```

E1									LINK	MINSU
LOC	PORT	CRC4	CAS	ENCODE	E1TSEL	SI	SN	CHANBRDG	CLASS	RATE
1201	2	ON	---	HDB3	EXTERNAL	3	5	-----	UNCHAN	1300
1203	2	OFF	---	HDB3	LINE	1	7	-----	CHAN	----
1211	2	ON	---	HDB3	LINE	0	0	-----	CHAN	----

An unchannelized E1 port is an E1 port whose `LINKCLASS` value is `UNCHAN`.

If there are no unchannelized E1 ports shown in the `rtrv-e1` output, this procedure cannot be performed.

If there are unchannelized E1 ports shown in the `rtrv-e1` output, continue the procedure by performing one of these steps.

- If the `crc4`, `cas`, `encode`, or `eltsel` parameters are being changed in this procedure, continue the procedure with [2](#).
- If the `crc4`, `cas`, `encode`, or `eltsel` parameters are not being changed in this procedure, continue the procedure with [5](#).

2. Display the signaling links that are assigned to the E1 card by entering the `rtrv-slk` command with the card location shown in [1](#). For this example, enter this command.

```
rtrv-slk:loc=1201
```

```
rlghncxa03w 09-05-19 21:17:04 GMT EAGLE5 41.0.0
```

LOC	LINK	LSN	SLC	TYPE	L2T		ECM	PCR	PCR	E1	E1	TS
					SET	BPS						
1201	A	lsn1	13	LIME1	1	56000	BASIC	---	-----	1201	2	25

3. Check the status of the signaling links shown in [2](#) using the `rept-stat-slk` command with the card location and signaling link.

For this example, enter these commands.

```
rept-stat-slk:loc=1201:link=a
```

```
rlghncxa03w 09-05-23 13:06:25 GMT EAGLE5 41.0.0
```

SLK	LSN	CLLI	PST	SST	AST
1201,A	lsn1	-----	IS-NR	Avail	----
ALARM STATUS		= No Alarms			
UNAVAIL REASON		= --			
E1 status		= 1201, RCVRY-E1F:FAC-E1 Port 2 available			

If all the signaling links shown in this step are out of service, continue the procedure with [5](#).

If any of the signaling links shown in this step are in service, continue the procedure with [4](#).

- Deactivate the signaling links shown in 3 using the `dact-slk` command.

For this example, enter this command.

```
dact-slk:loc=1201:link=a
```

- Change the E1 port using the `chg-e1` command and the parameter combinations shown in Table A-14.

Table A-14 Unchannelized E1 Port Parameter Combinations

Mandatory Parameters

:loc=location of the E1 card

:e1port=E1 port being changed, either 1, 2, 3, 4, 5, 6, 7, or 8

Optional Parameters

:cas=off

:crc4=on, off

:encode=ami, hdb3

:si=0 - 3

:sn=0 - 31

:e1tsel=line, external

:minsurate=500 - 2000

For this example, enter this command.

```
chg-e1:loc=1201:e1port=2:crc4=off:encode=hdb3:si=1:sn=9
```

- Verify the changes using the `rtrv-e1` command specifying the card location and the `e1port` value specified in 5.

For this example, enter these commands.

```
rtrv-e1:loc=1201:e1port=2
```

```
rlghncxa03w 09-05-28 09:12:36 GMT EAGLE5 41.0.0
```

E1								LINK	MINSU	
LOC	PORT	CRC4	CAS	ENCODE	E1TSEL	SI	SN	CHANBRDG	CLASS	RATE
1201	2	OFF	---	HDB3	EXTERNAL	1	9	-----	UNCHAN	1300

If the signaling links were not deactivated in 4, continue the procedure with 8.

If the signaling links were deactivated in 4, continue the procedure with 7.

- Activate the signaling links that were deactivated in 4 using the `act-slk` command.

For this example, enter this command.

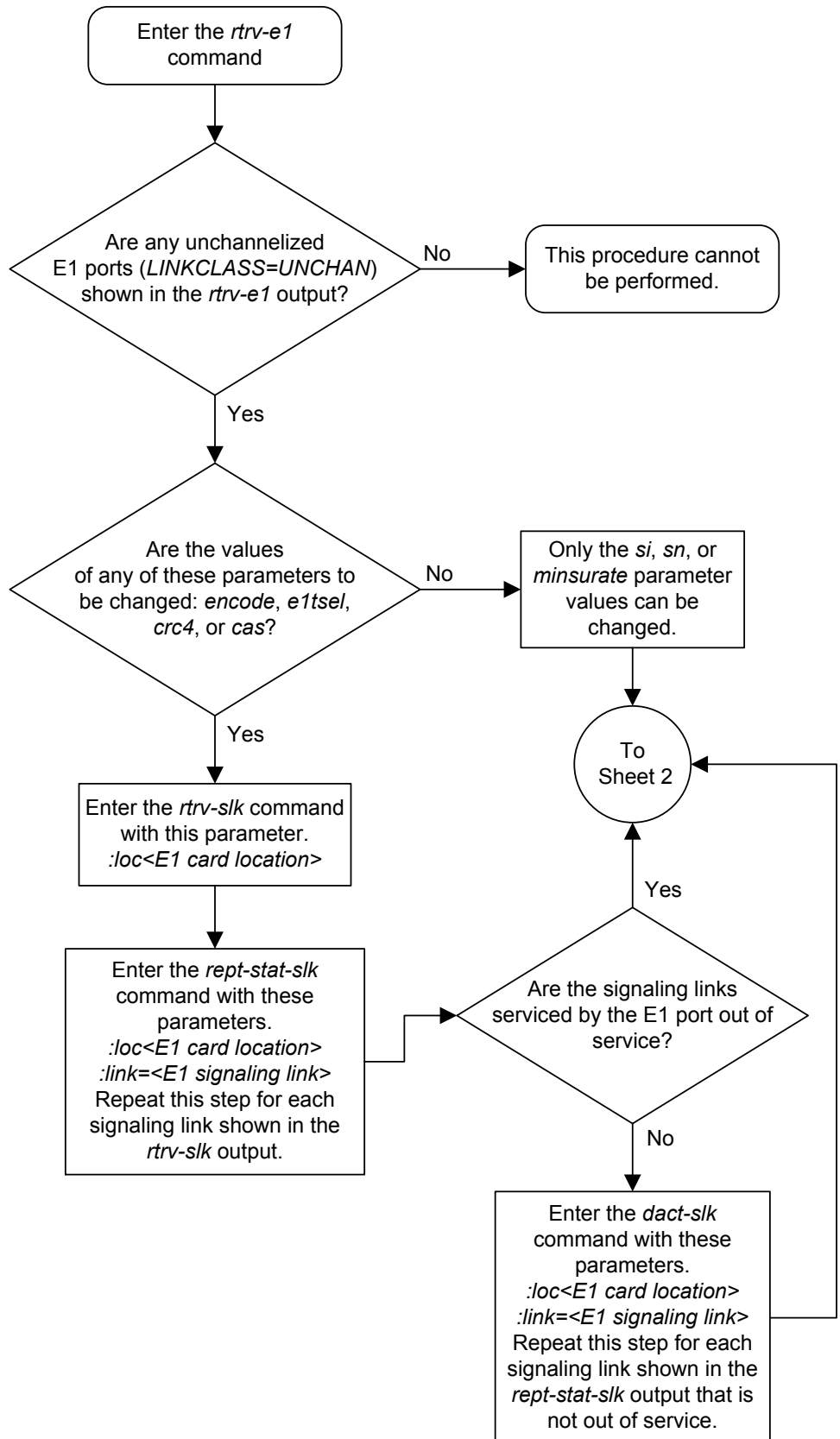
```
act-slk:loc=1201:link=a
```

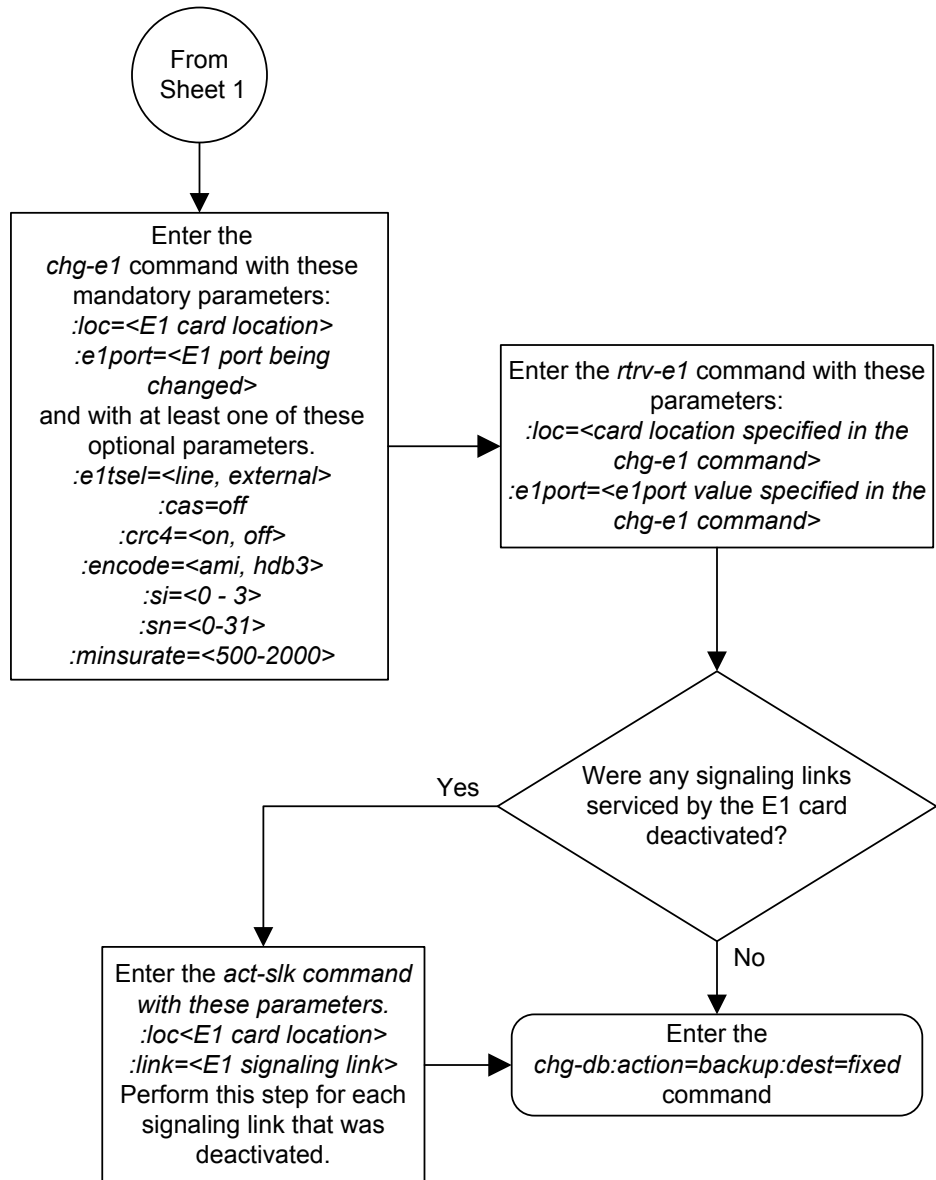
8. Back up the new changes using the `chg-db:action=backup:dest=fixed` command.

These messages should appear, the active **Maintenance and Administration Subsystem Processor (MASP)** appears first.

```
BACKUP (FIXED) : MASP A - Backup starts on active MASP.  
BACKUP (FIXED) : MASP A - Backup on active MASP to fixed disk complete.  
BACKUP (FIXED) : MASP A - Backup starts on standby MASP.  
BACKUP (FIXED) : MASP A - Backup on standby MASP to fixed disk complete.
```


Figure A-11 Changing the Attributes of an Unchannelized E1 Port





Making a Channel Bridged E1 Port from a Channelized E1 Port

This procedure is used to make a channel bridged E1 port from a channelized E1 port that is not channel bridged using the `chg-e1` command. A channelized E1 port is an E1 port whose `LINKCLASS` value is `CHAN`, shown in the `LINKCLASS` column in the `rtrv-e1` output. A non-channel bridged E1 port is an odd numbered E1 port that contains dashes in the `CHANBRDG` column in the `rtrv-e1` output. Other actions can be performed on E1 ports. To perform these actions on the E1 ports, perform one of these procedures.

- To change the attributes of a channelized E1 port - [Changing the Attributes of a Channelized E1 Port](#)
- To change the attributes of an unchannelized E1 port - [Changing the Attributes of an Unchannelized E1 Port](#)
- To make a non-channel bridged E1 port from a channel bridged E1 port - [Making a Non-Channel Bridged E1 Port from a Channel Bridged E1 Port](#)

To make a channel bridged E1 port from a channelized E1 port, these parameters are used with the `chg-e1` command.

`:loc` – The location of the E1 card (card type `1ime1`) that contains the odd numbered channelized E1 port. The location of a channel card (card type `1imch`) cannot be specified for this parameter. The E1 card can be either an **HC-MIM**, or an **E5-E1T1** card.

`:e1port` – The E1 port being changed in this procedure. Only the odd numbered E1 ports, 1, 3, 5, or 7, can be specified for a channel bridged E1 port.

`:crc4` – Specifies whether or not **CRC4** is enabled on the E1 signaling link.

`:cas` – Specifies whether **CAS** or **CCS** is used on the E1 signaling link. **CAS** is enabled with the `cas=on` parameter. **CCS** is enabled with the `cas=off` parameter. For a channel bridged E1 port, the `cas` parameter value must be `off`.

`:encode` – Specifies the type of encoding or decoding that is used on the E1 signaling link, either **HDB3** or **AMI**.

`:e1tsel` – The timing source for the E1 signaling link, master (`external`) or recovered.

The `recovered` timing source uses the even numbered member of the bridged-pair as a clock source, ensuring that port in the pair can recover the timing from its partner.

Note: To use an external high-speed master clock source other than RS-422, TDMs 870-0774-15 or later must be installed in card locations 1114 and 1116, and the **TDM Global Timing Interface** options must be configured. For more information, see the [Configuring the Options for the TDM Global Timing Interface](#) procedure.

`:si` – Specifies the value of the two spare international bits of **NFAS** data, from 0 to 3.

`:sn` – Specifies the value of the five spare national bits of **NFAS** data, from 0 to 31.

`:chanbrdg` – Specifies whether or not the odd numbered E1 port specified in this procedure is channel bridged to its adjacent even numbered E1 port. [Table A-15](#) shows

the E1 ports that can be specified with the `chanbrdg=on` parameter and the even-numbered E1 ports that are bridged to the odd numbered E1 port.

Table A-15 Channel Bridging Ports

Odd Numbered E1 Port	Even Numbered Bridged E1 Port
1	2
3	4
5	6
7	8

`:force=yes` – required when the even numbered E1 port being channel bridged is provisioned in the database before this procedure is performed.

The E1 card specified in this procedure must be in the database. This can be verified with the `rtrv-e1` command.

If either the `crc4`, `cas`, `encode`, or `eltsel` values are being changed, all the signaling links serviced by the E1 card must be taken out of service.

1. Display the existing E1 ports in the database using the `rtrv-e1` command with no parameters.

```
rlghncxa03w 09-05-19 21:17:04 GMT EAGLE5 41.0.0
E1
LOC  PORT  CRC4  CAS  ENCODE  E1TSEL  SI  SN  CHANBRDG  CLASS  RATE
1201 1      ON   OFF  HDB3    EXTERNAL 3  5  -----  CHAN  ----
1201 2      ON   OFF  HDB3    EXTERNAL 3  5  -----  CHAN  ----
1203 2      OFF  OFF  HDB3    LINE      1  7  -----  CHAN  ----
1211 2      ON   OFF  HDB3    LINE      0  0  -----  CHAN  ----
```

A channelized E1 port is an E1 port whose `LINKCLASS` value is `CHAN`.

If there are no odd numbered channelized E1 ports that are not channel bridged shown in the `rtrv-e1` output, this procedure cannot be performed.

If odd numbered channelized E1 ports that are not channel bridged are shown in the `rtrv-e1` output, continue the procedure by performing one of these steps.

- If the E1 card contains channel bridged E1 ports, or contains E1 ports 3 through 8, continue the procedure with by performing one of these steps.
 - If the `crc4`, `cas`, `encode`, or `eltsel` parameters are not being changed in this procedure, continue the procedure by performing one of these steps.
 - If E1 cards are shown in the `rtrv-e1` output in [1](#) that are on the same shelf as the card that contains the E1 port that is being changed, and these cards have E1 ports 3 through 8 provisioned, contain channel bridged E1 ports, or unchannelized E1 ports, continue the procedure by performing one of these steps.
 - If the adjacent E1 port is provisioned (see [Table A-15](#)), continue the procedure with [11](#).

- If the adjacent E1 port is not provisioned, continue the procedure with 12.
- If E1 cards are not shown in the `rtrv-e1` output in 1 that are on the same shelf as the card that will contain the E1 port that is being added, continue the procedure with 7.
- If E1 cards are shown in the `rtrv-e1` output in 1 that are on the same shelf as the card that contains the E1 port that is being changed, and these cards do not have E1 ports 3 through 8 provisioned, do not contain channel bridged E1 ports, or do not have unchannelized E1 ports, continue the procedure with 7.
- If the `crc4`, `cas`, `encode`, or `eltsel` parameters are being changed in this procedure, continue the procedure with 3.
- If the E1 card does not contain channel bridged E1 ports, or does not contain E1 ports 3 through 8, continue the procedure with 2.

2. Display the LIME1 cards in the database by entering this command.

```
rtrv-stp:type=lime1
```

```
rlghncxa03w 09-05-30 11:07:17 EST EAGLE 41.0.0
```

Card	Part Number	Rev	Serial Number	Type	DB	APPL	GPL Version
----	-----	---	-----	----	--	----	-----
1201	870-2671-02	C	10145689323	LIME1	512M	SS7ANSI	126-034-000
1203	870-1873-01	C	10345690569	LIME1	512M	SS7ANSI	126-034-000
1211	870-1873-01	C	10346790570	LIME1	512M	SS7ANSI	126-034-000

Command Completed.

The part numbers and the card types of the E1 cards are shown in [Table A-4](#).

If the E1 card is an E1/T1 MIM, this card cannot be used in this procedure, Choose another E1 port on another HC-MIM or E5-E1t1 card and repeat this procedure from 1. If no HC-MIMs or E5-E1T1 cards are present in the EAGLE 5 ISS, this procedure cannot be performed.

If the E1 card is either an HC-MIM card or an E5-E1T1 card, continue the procedure by performing one of these steps.

- If the `crc4`, `cas`, `encode`, or `eltsel` parameters are not being changed in this procedure, continue the procedure by performing one of these steps.
 - If E1 cards are shown in the `rtrv-e1` output in 1 that are on the same shelf as the card that contains the E1 port that is being changed, and these cards have E1 ports 3 through 8 provisioned, contain channel bridged E1 ports, or unchannelized E1 ports, continue the procedure by performing one of these steps.
 - If the adjacent E1 port is provisioned (see [Table A-15](#)), continue the procedure with 11.
 - If the adjacent E1 port is not provisioned, continue the procedure with 12.

- If E1 cards are not shown in the `rtrv-e1` output in 1 that are on the same shelf as the card that will contain the E1 port that is being added, continue the procedure with 7.
 - If E1 cards are shown in the `rtrv-e1` output in 1 that are on the same shelf as the card that contains the E1 port that is being changed, and these cards do not have E1 ports 3 through 8 provisioned, do not contain channel bridged E1 ports, or do not have unchannelized E1 ports, continue the procedure with 7.
- If the `crc4`, `cas`, `encode`, or `eltset` parameters are being changed in this procedure, continue the procedure with 3.
3. Display the timeslots that are serviced by the E1 card containing the E1 port being changed using the `rtrv-e1` command specifying the card location and the `e1port` value from 1.

For this example, enter this command.

```
rtrv-e1:loc=1201:e1port=1
```

```
rlghncxa03w 09-05-28 09:12:36 GMT EAGLE5 41.0.0
```

E1									LINK	MINSU
LOC	PORT	CRC4	CAS	ENCODE	E1TSEL	SI	SN	CHANBRDG	CLASS	RATE
1201	1	ON	OFF	HDB3	EXTERNAL	3	5	-----	CHAN	----
TS0	(N/A)	TS8	-----	TS16	-----	TS24	-----			
TS1	1201,A	TS9	-----	TS17	-----	TS25	-----			
TS2	-----	TS10	-----	TS18	-----	TS26	-----			
TS3	-----	TS11	-----	TS19	-----	TS27	-----			
TS4	-----	TS12	-----	TS20	-----	TS28	-----			
TS5	1202,A	TS13	-----	TS21	-----	TS29	-----			
TS6	-----	TS14	-----	TS22	-----	TS30	-----			
TS7	-----	TS15	-----	TS23	-----	TS31	-----			

4. Display the signaling links that are assigned to the E1 card by entering the `rtrv-slk` command with the card location specified in 3. For this example, enter this command.

```
rtrv-slk:loc=1201
```

```
rlghncxa03w 09-05-19 21:17:04 GMT EAGLE5 41.0.0
```

				L2T		PCR		PCR		E1	E1	
LOC	LINK	LSN	SLC	TYPE	SET	BPS	ECM	N1	N2	LOC	PORT	TS
1201	A	lsn1	13	LIME1	1	56000	BASIC	---	-----	1201	2	25
1201	B	lsn1	12	LIME1	1	56000	BASIC	---	-----	1201	1	20

5. Check the status of the signaling links shown in 3 using the `rept-stat-slk` command with the card location and signaling link.

For this example, enter these commands.

```
rept-stat-slk:loc=1201:link=a
```

```
rlghncxa03w 09-05-23 13:06:25 GMT EAGLE5 41.0.0
```

SLK	LSN	CLLI	PST	SST	AST
1201,A	lsn1	-----	IS-NR	Avail	----

```
ALARM STATUS      = No Alarms
UNAVAIL REASON    = --
E1 status         = 1201, RCVRY-E1F:FAC-E1 Port 2 available
```

```
rept-stat-slk:loc=1201:link=b
```

```
rlghncxa03w 09-05-23 13:06:25 GMT EAGLE5 41.0.0
SLK   LSN      CLLI      PST      SST      AST
1201,B lsn1    ----- IS-NR      Avail    ----
ALARM STATUS      = No Alarms
UNAVAIL REASON    = --
E1 status         = 1201, RCVRY-E1F:FAC-E1 Port 1 available
```

If all the signaling links shown in this step are out of service, continue the procedure by performing one of these steps.

- If E1 cards are shown in the `rtrv-e1` output in [1](#) that are on the same shelf as the card that contains the E1 port that is being changed, and these cards have E1 ports 3 through 8 provisioned, contain channel bridged E1 ports, or unchannelized E1 ports, continue the procedure by performing one of these steps.
 - If the adjacent E1 port is provisioned (see [Table A-15](#)), continue the procedure with [11](#).
 - If the adjacent E1 port is not provisioned, continue the procedure with [12](#).
- If E1 cards are not shown in the `rtrv-e1` output in [1](#) that are on the same shelf as the card that will contain the E1 port that is being added, continue the procedure with [7](#).
- If E1 cards are shown in the `rtrv-e1` output in [1](#) that are on the same shelf as the card that contains the E1 port that is being changed, and these cards do not have E1 ports 3 through 8 provisioned, do not contain channel bridged E1 ports, or do not have unchannelized E1 ports, continue the procedure with [7](#).

If any of the signaling links shown in this step are in service, continue the procedure with [6](#).

6. Deactivate the signaling links shown in [5](#) using the `dact-slk` command.

For this example, enter these commands.

```
dact-slk:loc=1201:link=a
dact-slk:loc=1201:link=b
```

Continue the procedure by performing one of these steps.

- If E1 cards are shown in the `rtrv-e1` output in [1](#) that are on the same shelf as the card that contains the E1 port that is being changed, and these cards have E1 ports 3 through 8 provisioned, contain channel bridged E1 ports, or unchannelized E1 ports, continue the procedure by performing one of these steps.
 - If the adjacent E1 port is provisioned (see [Table A-15](#)), continue the procedure with [11](#).
 - If the adjacent E1 port is not provisioned, continue the procedure with [12](#).

- If E1 cards are not shown in the `rtrv-e1` output in 1 that are on the same shelf as the card that will contain the E1 port that is being added, continue the procedure with 7.
 - If E1 cards are shown in the `rtrv-e1` output in 1 that are on the same shelf as the card that contains the E1 port that is being changed, and these cards do not have E1 ports 3 through 8 provisioned, do not contain channel bridged E1 ports, or do not have unchannelized E1 ports, continue the procedure with 7.
7. Verify that **HIPR2** cards are installed in card locations 9 and 10 in the shelf containing the HC MIM or E5-E1T1 card that will contain the E1 port being changed in this procedure by entering this command.

```
rept-stat-gpl:gpl=hipr2
```

This is an example of the possible output.

```
rlghncxa03w 09-07-05 08:12:53 GMT 41.1.0
GPL          CARD      RUNNING          APPROVED         TRIAL
HIPR2        1109      126-002-000     126-002-000     126-003-000
HIPR2        1110      126-002-000     126-002-000     126-003-000
HIPR2        1209      126-002-000     126-002-000     126-003-000
HIPR2        1210      126-002-000     126-002-000     126-003-000
HIPR2        1309      126-002-000     126-002-000     126-003-000
HIPR2        1310      126-002-000     126-002-000     126-003-000
HIPR2        2109      126-002-000     126-002-000     126-003-000
HIPR2        2110      126-002-000     126-002-000     126-003-000
Command Completed
```

If **HIPR2** cards are installed in the shelf containing the HC MIM or E5-E1T1 card, continue the procedure by performing one of these steps.

- If the card is an E5-E1T1 card, continue the procedure by performing one of these steps.
 - If the adjacent E1 port is provisioned (see [Table A-15](#)), continue the procedure with 11.
 - If the adjacent E1 port is not provisioned, continue the procedure with 12.
- If the card is an HC-MIM, continue the procedure with 8.

If HIPR2 cards are not installed on the shelf containing the HC MIM or E5-E1T1 card, go to *Installation Guide* and install the HIPR2 cards. Once the HIPR2 cards have been installed, continue the procedure by performing one of these steps.

- If the card is an E5-E1T1 card, continue the procedure by performing one of these steps.
 - If the adjacent E1 port is provisioned (see [Table A-15](#)), continue the procedure with 11.
 - If the adjacent E1 port is not provisioned, continue the procedure with 12.
 - If the card is an HC-MIM, continue the procedure with 8.
8. Verify whether or not that the Fan feature is on, by entering the `rtrv-feat` command. If the Fan feature is on, the entry `FAN = on` appears in the `rtrv-feat` command output.

Note: The `rtrv-feat` command output contains other fields that are not used by this procedure. If you wish to see all the fields displayed by the `rtrv-feat` command, see the `rtrv-feat` command description in the *Commands User's Guide*.

If the Fan feature is on, continue the procedure by performing one of these steps.

- If the adjacent E1 port is provisioned (see [Table A-15](#)), continue the procedure with [11](#).
- If the adjacent E1 port is not provisioned, continue the procedure with [12](#).

If the Fan feature is off, continue the procedure with [9](#).

9. Turn the Fan feature on by entering this command.

```
chg-feat : fan=on
```

Note: Once the Fan feature is turned on with the `chg-feat` command, it cannot be turned off.

The Fan feature must be purchased before you turn this feature on with the `chg-feat` command. If you are not sure if you have purchased the Fan feature, contact your Sales Representative or Account Representative.

10. The shelf containing the HC-MIM being added in this procedure must have fans installed. Verify whether or not fans are installed on the shelf.

If the fans are not installed on the shelf containing the HC-MIM, go to the *Installation User's Guide* and install the fans.

After the fans have been installed and tested, or if the fans were already installed, continue the procedure by performing one of these steps.

- If the adjacent E1 port is provisioned (see [Table A-15](#)), continue the procedure with [11](#).
- If the adjacent E1 port is not provisioned, continue the procedure with [12](#).

11. Display the E1 signaling links in the database by entering this command.

```
rtrv-slk:class=e1
```

```
rlghncxa03w 09-05-19 21:17:04 GMT EAGLE5 41.0.0
```

LOC	LINK	LSN	SLC	TYPE	SET	BPS	ECM	PCR	PCR	E1	E1	TS
					L2T			N1	N2	LOC	PORT	
1201	A	lsn1	13	LIME1	1	56000	BASIC	---	-----	1201	2	25
1201	B	lsn1	12	LIME1	1	56000	BASIC	---	-----	1201	1	20
1202	A	lsn1	0	LIMCH	1	56000	BASIC	---	-----	1201	1	5
1202	B	lsn1	8	LIMCH	1	56000	BASIC	---	-----	1201	1	1
1203	A1	lsn1	4	LIME1	1	56000	BASIC	---	-----	1203	2	20
1203	B1	lsn1	9	LIME1	1	56000	BASIC	---	-----	1203	1	2
1204	A2	lsn1	5	LIMCH	1	56000	BASIC	---	-----	1203	1	21
1204	A3	lsn1	6	LIMCH	1	56000	BASIC	---	-----	1203	1	22
1211	A	lsn1	14	LIME1	1	56000	BASIC	---	-----	1211	1	7
1212	A	lsn1	10	LIMCH	1	56000	BASIC	---	-----	1211	1	28
1212	B	lsn1	11	LIMCH	1	56000	BASIC	---	-----	1211	1	25

1213	A4	lsn1	1	LIME1	1	56000	BASIC	---	-----	1213	1	17
1213	A5	lsn1	7	LIME1	1	56000	BASIC	---	-----	1213	5	23
1213	B5	lsn1	2	LIME1	1	56000	BASIC	---	-----	1213	1	24
1213	A6	lsn1	3	LIME1	1	56000	BASIC	---	-----	1213	5	19

If an even numbered **E1** port is to be channel bridged, and that **E1** port is assigned to signaling links, these signaling links must be removed before the **E1** port can be channel bridged. Perform [Removing an SS7 Signaling Link](#) to remove these signaling links. After the signaling links have been removed, continue the procedure with [12](#).

If the even numbered **E1** port to be channel bridged is not assigned to signaling links, continue the procedure with [12](#).

12. Change the E1 port using the `chg-e1` command and the parameter combinations shown in [Table A-16](#).

Table A-16 Channel Bridged E1 Port Parameter Combinations

Mandatory Parameters

:loc=location of the **E1** card

:e1port=**E1** port being changed, either 1, 3, 5, or 7

:chanbrdg=on

Optional Parameters

:cas=off

:crc4=on, off

:encode=ami, hdb3

:si=0 - 3

:sn=0 - 31

:eltset=external, recovered (See Note 1)

:force=yes (See Note 2)

Notes:

1. The `eltset` value must be either `external` or `recovered`. If the current `eltset` parameter value is `line`, the `eltset` parameter value for the **E1** port being channel bridged must be changed.
2. The `force=yes` parameter must be used when the even numbered port being channel bridged is shown in the `rtrv-e1` output in [1](#). If the even numbered port being channel bridged is not shown in the `rtrv-e1` output in [1](#), the `force=yes` parameter cannot be used.

For this example, enter this command.

```
chg-
e1:loc=1201:e1port=1:crc4=off:encode=ami:si=1:sn=9:chanbrdg=on:force=yes
```

13. Verify the changes using the `rtrv-e1` command specifying the card location and the `e1port` value specified in [12](#).

For this example, enter these commands.

```
rtrv-e1:loc=1201:elport=1
```

```
rlghncxa03w 09-05-28 09:12:36 GMT EAGLE5 41.0.0
```

LOC	E1 PORT	CRC4	CAS	ENCODE	E1TSEL	SI	SN	CHANBRDG	LINK CLASS	MINS RATE
1201	1	OFF	OFF	AMI	EXTERNAL	1	9	MASTER	CHAN	----
TS0	(N/A)	TS8	-----	TS16	-----	TS24	-----			
TS1	1201,A	TS9	-----	TS17	-----	TS25	-----			
TS2	-----	TS10	-----	TS18	-----	TS26	-----			
TS3	-----	TS11	-----	TS19	-----	TS27	-----			
TS4	-----	TS12	-----	TS20	-----	TS28	-----			
TS5	1202,A	TS13	-----	TS21	-----	TS29	-----			
TS6	-----	TS14	-----	TS22	-----	TS30	-----			
TS7	-----	TS15	-----	TS23	-----	TS31	-----			

If the signaling links were not deactivated in 6, continue the procedure with 15.

If the signaling links were deactivated in 6, continue the procedure with 14.

14. Activate the signaling links that were deactivated in 6 using the `act-slk` command.

For this example, enter these commands.

```
act-slk:loc=1201:link=a
```

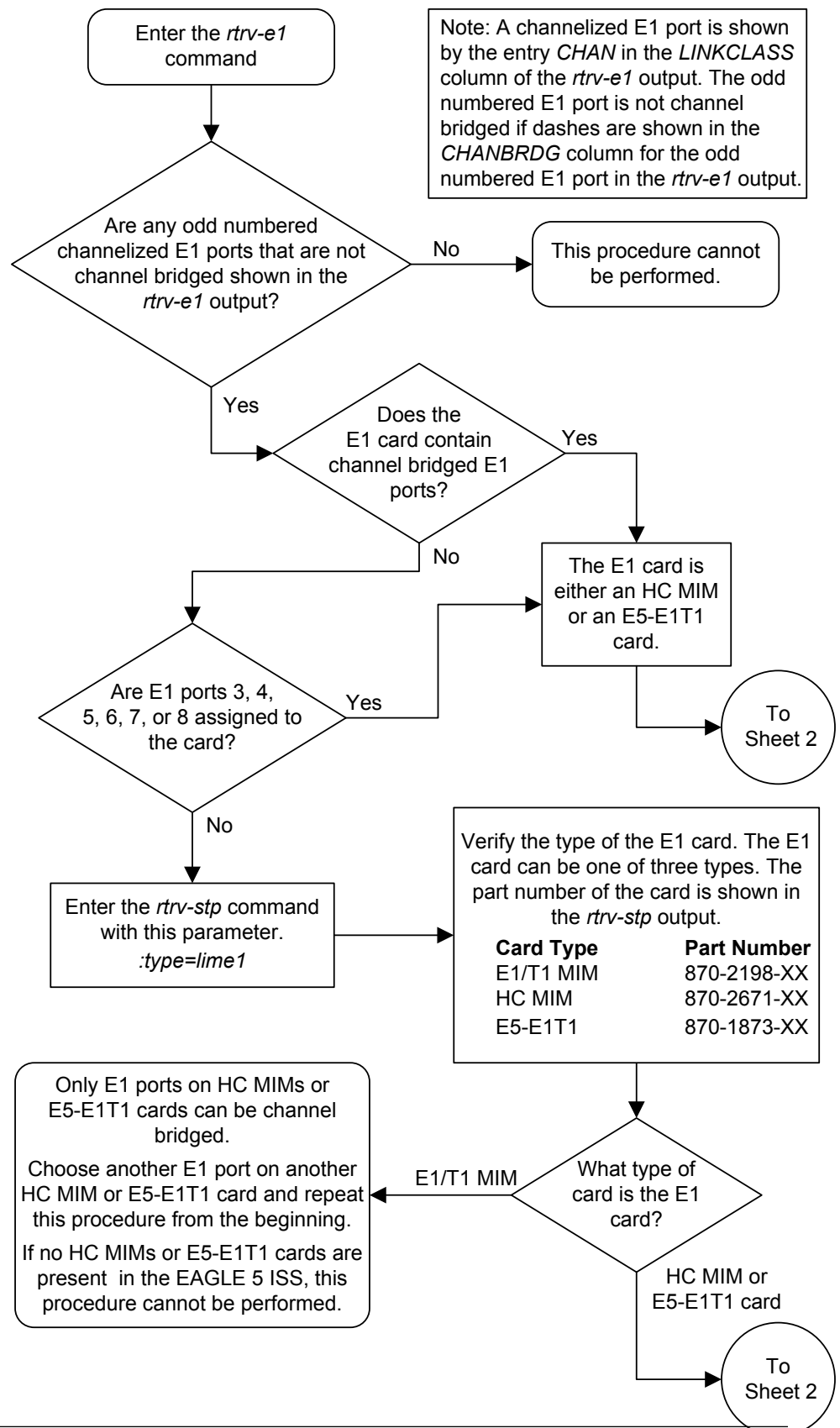
```
act-slk:loc=1202:link=a
```

15. Back up the new changes using the `chg-db:action=backup:dest=fixed` command.

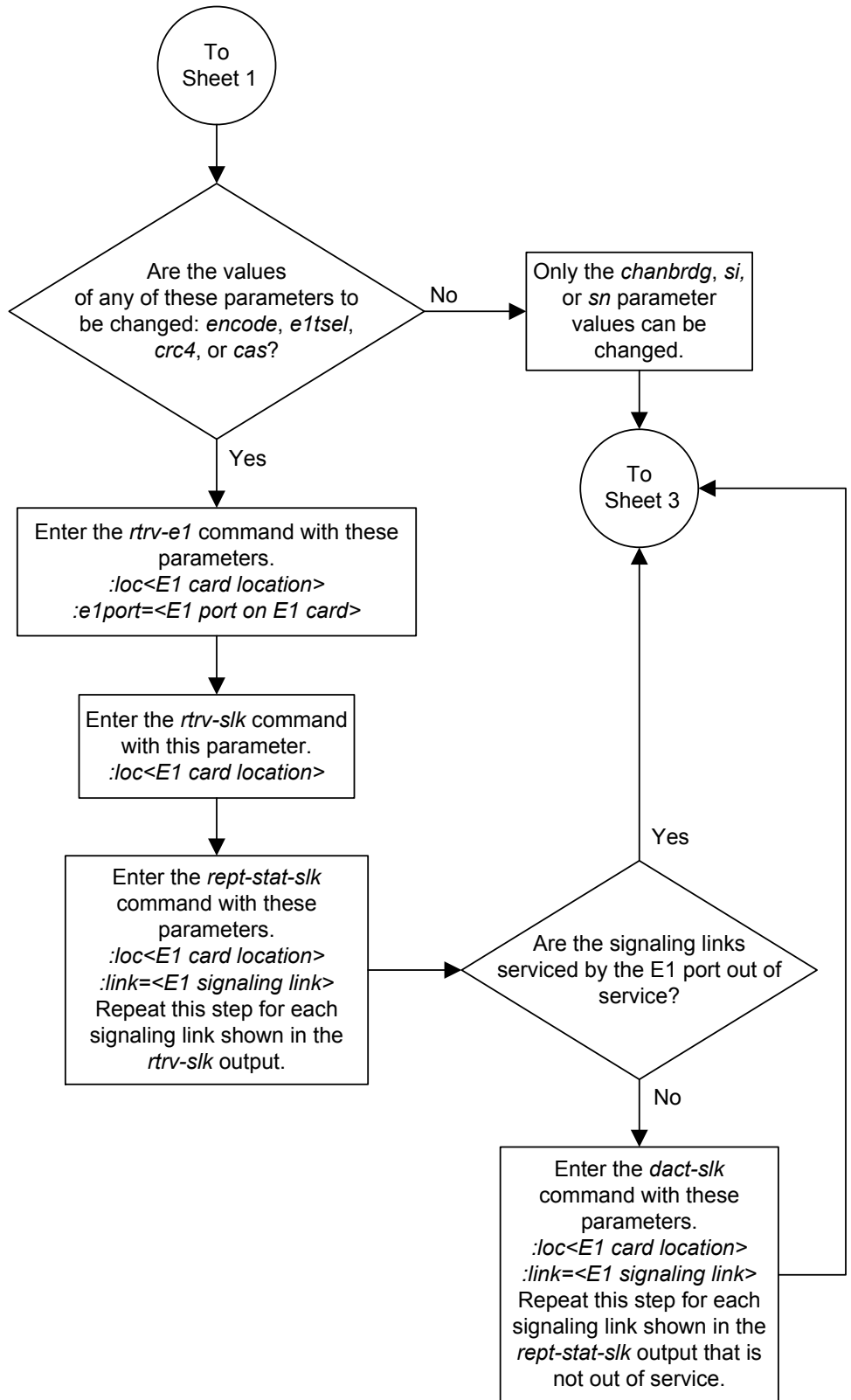
These messages should appear, the active **Maintenance and Administration Subsystem Processor (MASP)** appears first.

```
BACKUP (FIXED) : MASP A - Backup starts on active MASP.
BACKUP (FIXED) : MASP A - Backup on active MASP to fixed disk complete.
BACKUP (FIXED) : MASP A - Backup starts on standby MASP.
BACKUP (FIXED) : MASP A - Backup on standby MASP to fixed disk complete.
```

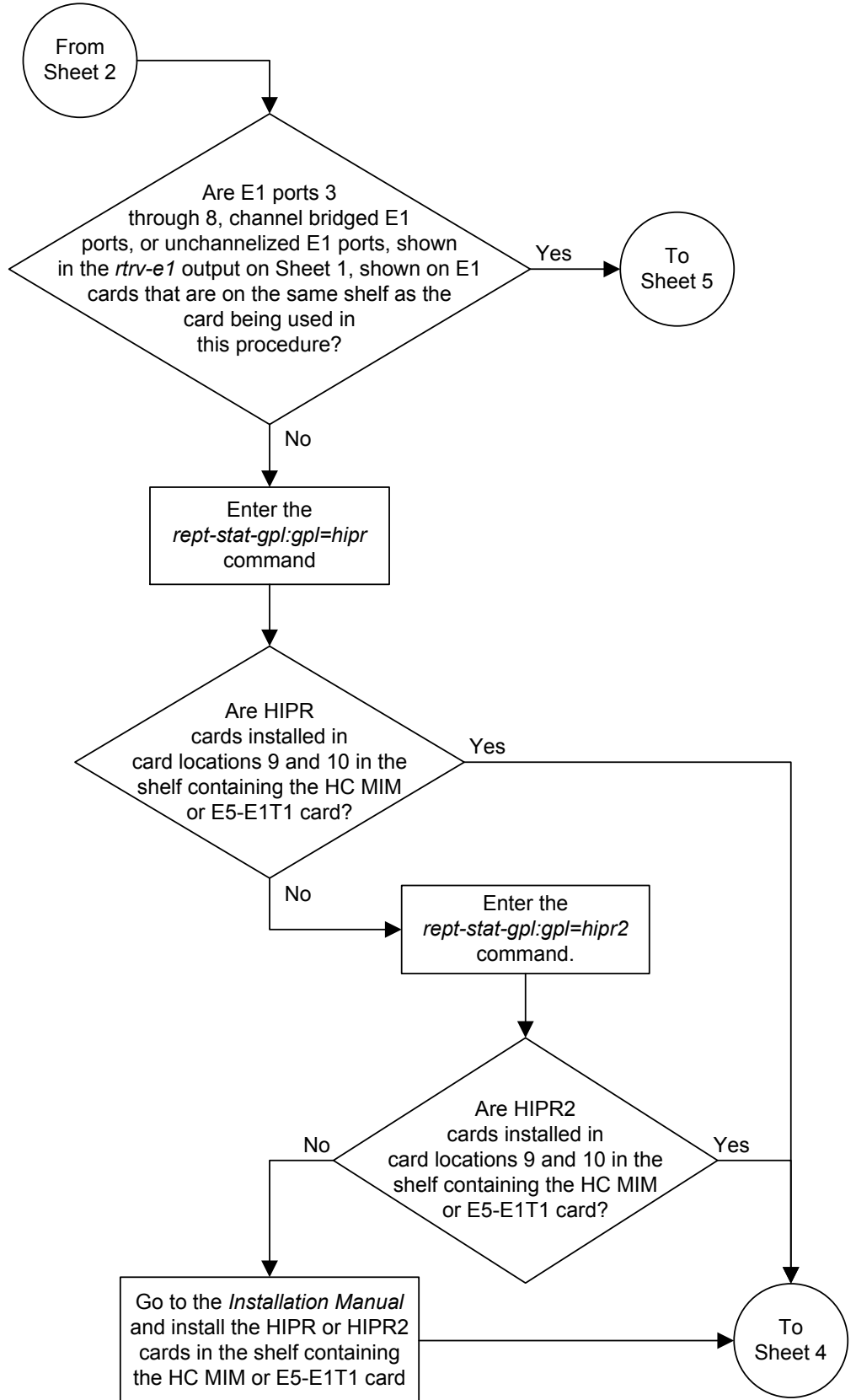
Figure A-12 Making a Channel Bridged E1 Port from a Channelized E1 Port

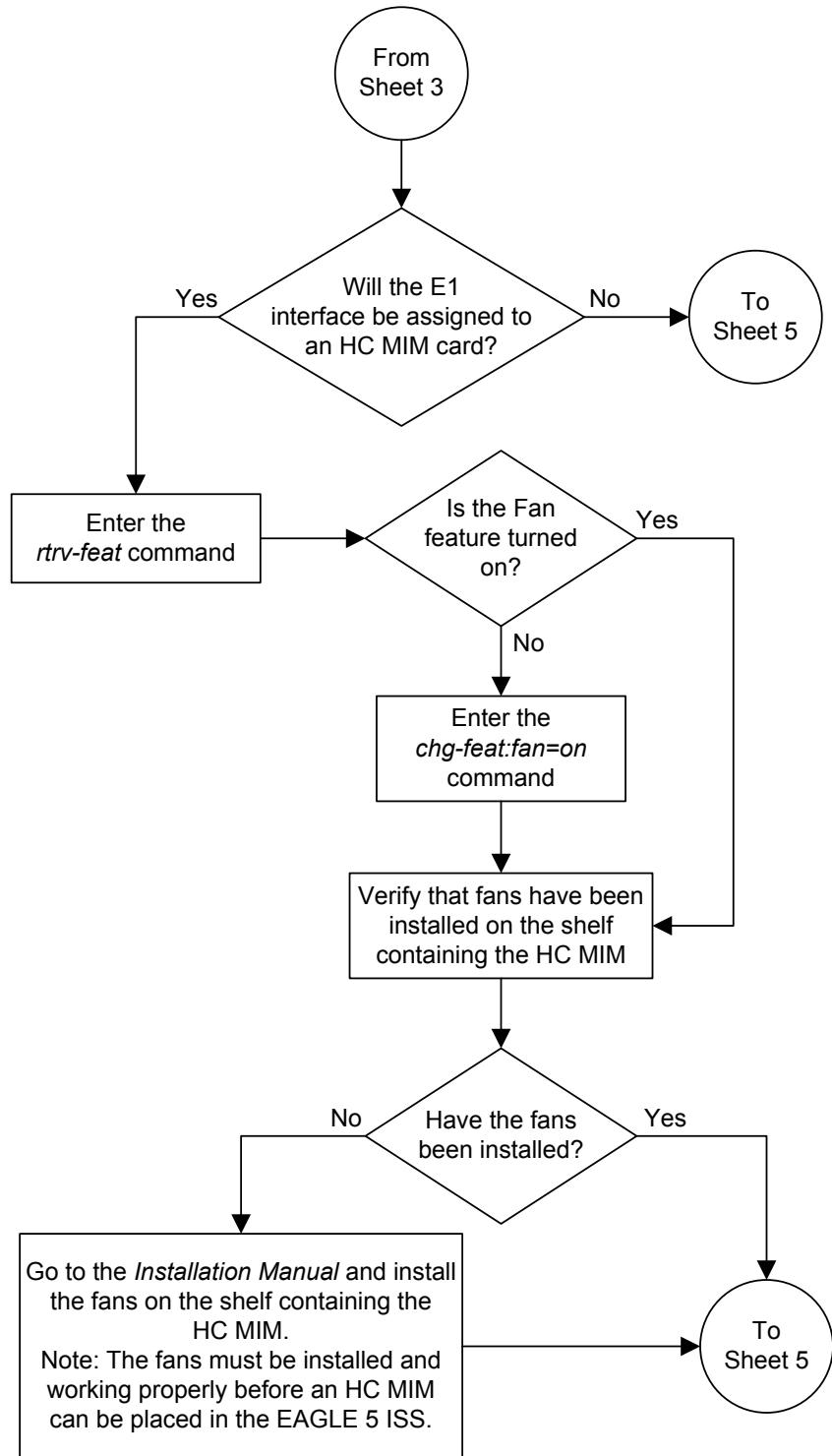


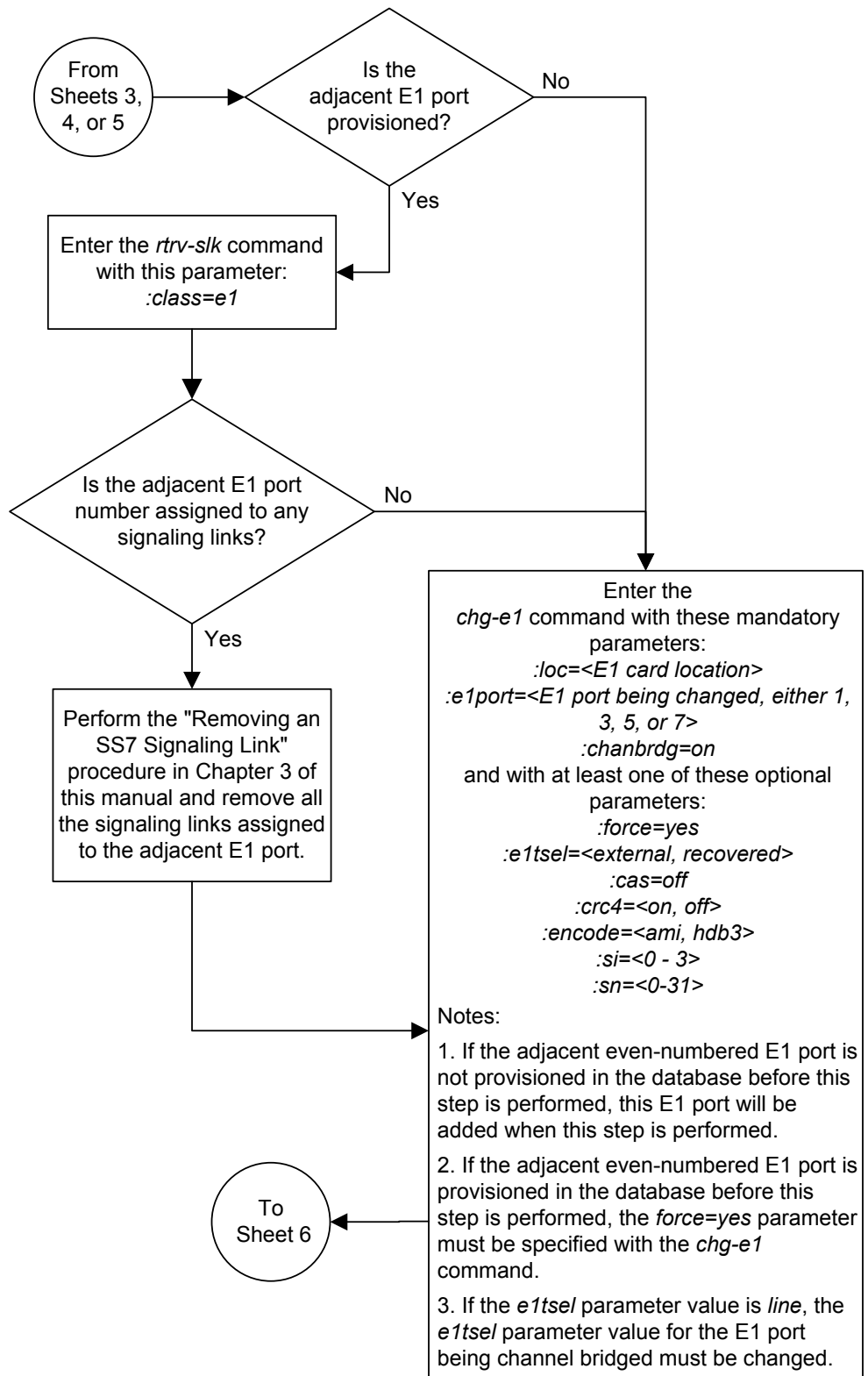
Sheet 1 of 6

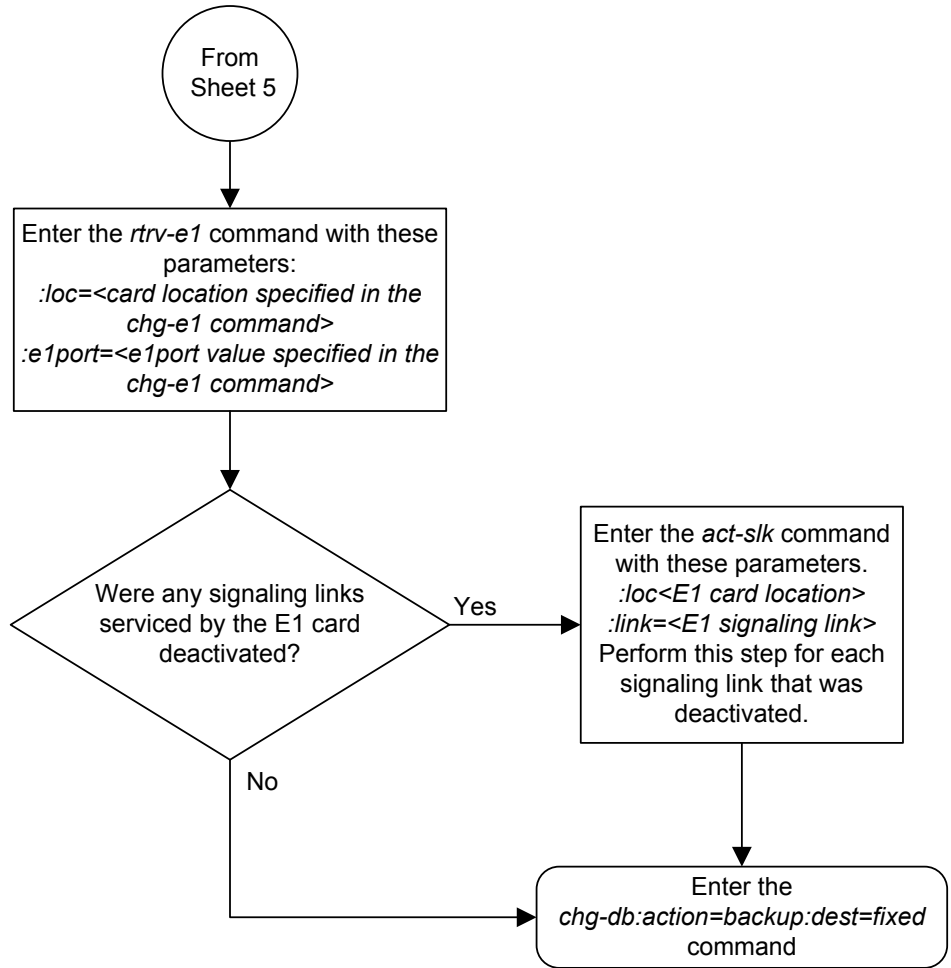


Sheet 2 of 6









Making a Non-Channel Bridged E1 Port from a Channel Bridged E1 Port

This procedure is used to make a non-channel bridged E1 port from a channel bridged E1 port using the `chg-e1` command. A channel bridged E1 port is an odd numbered E1 port that contains the entry `MASTER` in the `CHANBRDG` column in the `rtrv-e1` output. Other actions can be performed on E1 ports. To perform these actions on the E1 ports, perform one of these procedures.

- To change the attributes of a channelized E1 port - [Changing the Attributes of a Channelized E1 Port](#)
- To change the attributes of an unchannelized E1 port - [Changing the Attributes of an Unchannelized E1 Port](#)
- To make a channel bridged E1 port from a channelized E1 port that is not channel bridged - [Making a Channel Bridged E1 Port from a Channelized E1 Port](#)

To make a non-channel bridged E1 port from a channel bridged E1 port, these parameters are used with the `chg-e1` command.

`:loc` – The location of the E1 card (card type `lime1`) that contains the channel bridged E1 port. The location of a channel card (card type `limch`) cannot be specified for this parameter. The E1 card can be either an **HC-MIM** or an **E5-E1T1** card.

`:e1port` – The E1 port being changed in this procedure. Only the odd numbered E1 ports, 1, 3, 5, or 7, can be specified for a channel bridged E1 port.

`:crc4` – Specifies whether or not **CRC4** is enabled on the E1 signaling link.

`:cas` – Specifies whether **CAS** or **CCS** is used on the E1 signaling link. **CAS** is enabled with the `cas=on` parameter. **CCS** is enabled with the `cas=off` parameter. Only **HC-MIMs** or **E5-E1T1** cards can contain channel bridged E1 ports. For **HC-MIMs** or **E5-E1T1** cards, the `cas` parameter value must be `off`.

`:encode` – Specifies the type of encoding or decoding that is used on the E1 signaling link, either **HDB3** or **AMI**.

`:e1tsel` – The timing source for the E1 signaling link, master (`external`) or slave (`line`). If the `e1tsel` value for the channel bridged E1 port is `recovered`, the `e1tsel` value must be changed to either `line` or `external` when the channel bridged E1 port is changed to a non-channel bridged E1 port.

Note: To use an external high-speed master clock source other than RS-422, TDMs 870-0774-15 or later must be installed in card locations 1114 and 1116, and the **TDM Global Timing Interface** options must be configured. For more information, see [Configuring the Options for the TDM Global Timing Interface](#).

`:si` – Specifies the value of the two spare international bits of **NFAS** data, from 0 to 3.

`:sn` – Specifies the value of the five spare national bits of **NFAS** data, from 0 to 31.

`:chanbrdg=off` – Specifies that the odd numbered E1 port specified in this procedure is not channel bridged to its adjacent even numbered E1 port.

The E1 card specified in this procedure must be in the database. This can be verified with the `rtrv-e1` command.

If either the `crc4`, `cas`, `encode`, or `eltsel` values are being changed, all the signaling links serviced by the E1 card must be taken out of service.

1. Display the existing E1 interfaces in the database using the `rtrv-e1` command with no parameters.

```
rlghncxa03w 09-05-19 21:17:04 GMT EAGLE5 41.0.0
```

E1										LINK	MINSU
LOC	PORT	CRC4	CAS	ENCODE	E1TSEL	SI	SN	CHANBRDG	CLASS	RATE	
1201	1	ON	OFF	HDB3	EXTERNAL	1	9	MASTER	CHAN	----	
1201	2	ON	OFF	HDB3	EXTERNAL	1	9	SLAVE	CHAN	----	
1203	2	OFF	OFF	HDB3	LINE	1	7	-----	CHAN	----	
1211	2	ON	OFF	HDB3	LINE	0	0	-----	CHAN	----	

A channel bridged E1 port is an odd numbered E1 port that contains the entry MASTER in the CHANBRDG column in the `rtrv-e1` output.

If there are no channel bridged E1 ports shown in the `rtrv-e1` output, this procedure cannot be performed.

If channel bridged E1 ports shown in the `rtrv-e1` output, continue the procedure by performing one of these steps.

- If the `crc4`, `cas`, `encode`, or `eltsel` parameters are not being changed in this procedure, continue the procedure with 6.
 - If the `crc4`, `cas`, `encode`, or `eltsel` parameters are being changed in this procedure, continue the procedure with 2.
2. Display the timeslots that are serviced by the E1 card containing the E1 interface information to be changed using the `rtrv-e1` command specifying the card location and the `elport` value of the channel bridged E1 port from 1.

For this example, enter this command.

```
rtrv-e1:loc=1201:elport=1
```

```
rlghncxa03w 09-05-28 09:12:36 GMT EAGLE5 41.0.0
```

E1										LINK	MINSU
LOC	PORT	CRC4	CAS	ENCODE	E1TSEL	SI	SN	CHANBRDG	CLASS	RATE	
1201	1	ON	OFF	HDB3	EXTERNAL	1	9	MASTER	CHAN	----	
TS0	(N/A)	TS8	-----	TS16	-----	TS24	-----				
TS1	1201,A	TS9	-----	TS17	-----	TS25	-----				
TS2	-----	TS10	-----	TS18	-----	TS26	-----				
TS3	-----	TS11	-----	TS19	-----	TS27	-----				
TS4	-----	TS12	-----	TS20	-----	TS28	-----				
TS5	1202,A	TS13	-----	TS21	-----	TS29	-----				
TS6	-----	TS14	-----	TS22	-----	TS30	-----				
TS7	-----	TS15	-----	TS23	-----	TS31	-----				

3. Display the signaling links that are assigned to the E1 card by entering the `rtrv-slk` command with the card location specified in 2. For this example, enter this command.

```
rtrv-slk:loc=1201
```

```
rlghncxa03w 09-05-19 21:17:04 GMT EAGLE5 41.0.0
                                L2T                PCR PCR  E1  E1
LOC  LINK LSN          SLC TYPE  SET  BPS   ECM  N1  N2  LOC  PORT TS
1201 B   lsn1         12 LIME1   1   56000 BASIC ---  ---- 1201 1   20
```

4. Check the status of the signaling links shown in 3 using the `rept-stat-slk` command with the card location and signaling link.

For this example, enter these commands.

```
rept-stat-slk:loc=1201:link=b
```

```
rlghncxa03w 09-05-23 13:06:25 GMT EAGLE5 41.0.0
SLK   LSN      CLLI      PST      SST      AST
1201,B lsn1     ----- IS-NR      Avail     ----
ALARM STATUS      = No Alarms
UNAVAIL REASON    = --
E1 status         = 1201, RCVRY-E1F:FAC-E1 Port 1 available
```

If all the signaling links shown in this step are out of service, continue the procedure with 6.

If any of the signaling links shown in this step are in service, continue the procedure with 5.

5. Deactivate the signaling links shown in 4 using the `dact-slk` command.

For this example, enter this command.

```
dact-slk:loc=1201:link=b
```

When this command has successfully completed, this message should appear.

```
rlghncxa03w 09-05-07 08:41:12 GMT EAGLE5 41.0.0
Deactivate Link message sent to card
```

6. Change the E1 port using the `chg-e1` command and the parameter combinations shown in [Table A-17](#).

Table A-17 Non-Channel Bridged E1 Port Parameter Combinations

Mandatory Parameters

:loc=location of the E1 card

:e1port=E1 port being changed, either 1, 3, 5, or 7

:chanbrdg=off

Optional Parameters

:cas=off

:crc4=on, off

:encode=ami, hdb3

:si=0 - 3

Table A-17 (Cont.) Non-Channel Bridged E1 Port Parameter Combinations

```
:sn=0 - 31

:eltset=line, external. If the current eltset value is recovered, the eltset value
must be changed to either line or external.
```

For this example, enter this command.

```
chg-
e1:loc=1201:e1port=1:crc4=off:encode=ami:si=2:sn=6:chanbrdg=off
```

Note: When the `chanbrdg=off` parameter is specified with the `chg-e1` command, the even numbered E1 port that was channel bridged to the E1 port specified in this step is removed from the database.

- Verify the changes using the `rtrv-e1` command specifying the card location and the `e1port` value specified in 6.

For this example, enter these commands.

```
rtrv-e1:loc=1201:e1port=1
```

```
rlghncxa03w 09-05-28 09:12:36 GMT EAGLE5 41.0.0
```

E1								LINK	MINSU	
LOC	PORT	CRC4	CAS	ENCODE	E1TSEL	SI	SN	CHANBRDG	CLASS	RATE
1201	1	OFF	OFF	AMI	EXTERNAL	2	6	-----	CHAN	----
TS0	(N/A)	TS8	-----	TS16	-----	TS24	-----			
TS1	1201,A	TS9	-----	TS17	-----	TS25	-----			
TS2	-----	TS10	-----	TS18	-----	TS26	-----			
TS3	-----	TS11	-----	TS19	-----	TS27	-----			
TS4	-----	TS12	-----	TS20	-----	TS28	-----			
TS5	1202,A	TS13	-----	TS21	-----	TS29	-----			
TS6	-----	TS14	-----	TS22	-----	TS30	-----			
TS7	-----	TS15	-----	TS23	-----	TS31	-----			

If the signaling links were not deactivated in 5, continue the procedure with 9.

If the signaling links were deactivated in 5, continue the procedure with 8.

- Activate the signaling links that were deactivated in 5 using the `act-slk` command.

For this example, enter these commands.

```
act-slk:loc=1201:link=b
```

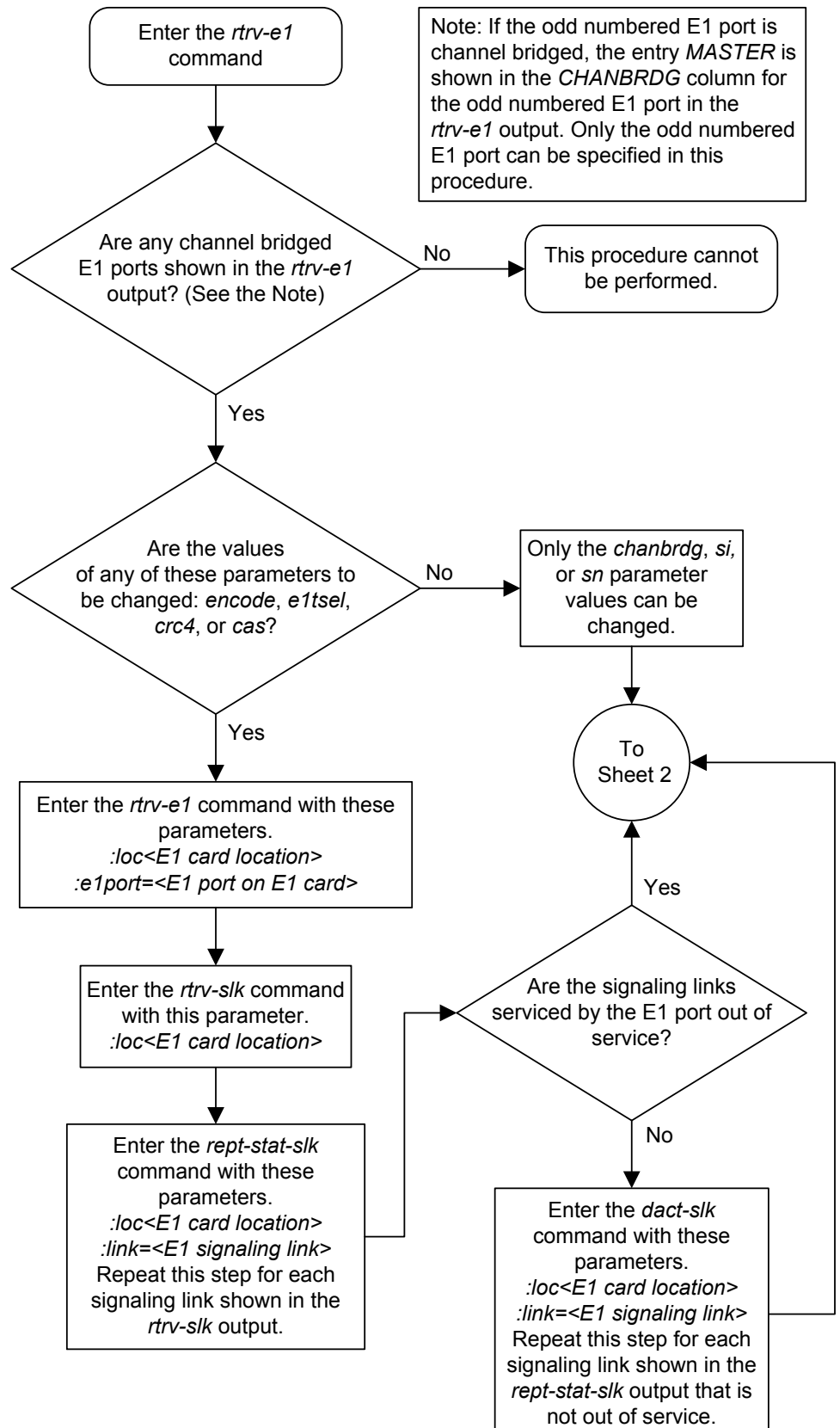
- Back up the new changes using the `chg-db:action=backup:dest=fixed` command.

These messages should appear, the active **Maintenance and Administration Subsystem Processor (MASP)** appears first.

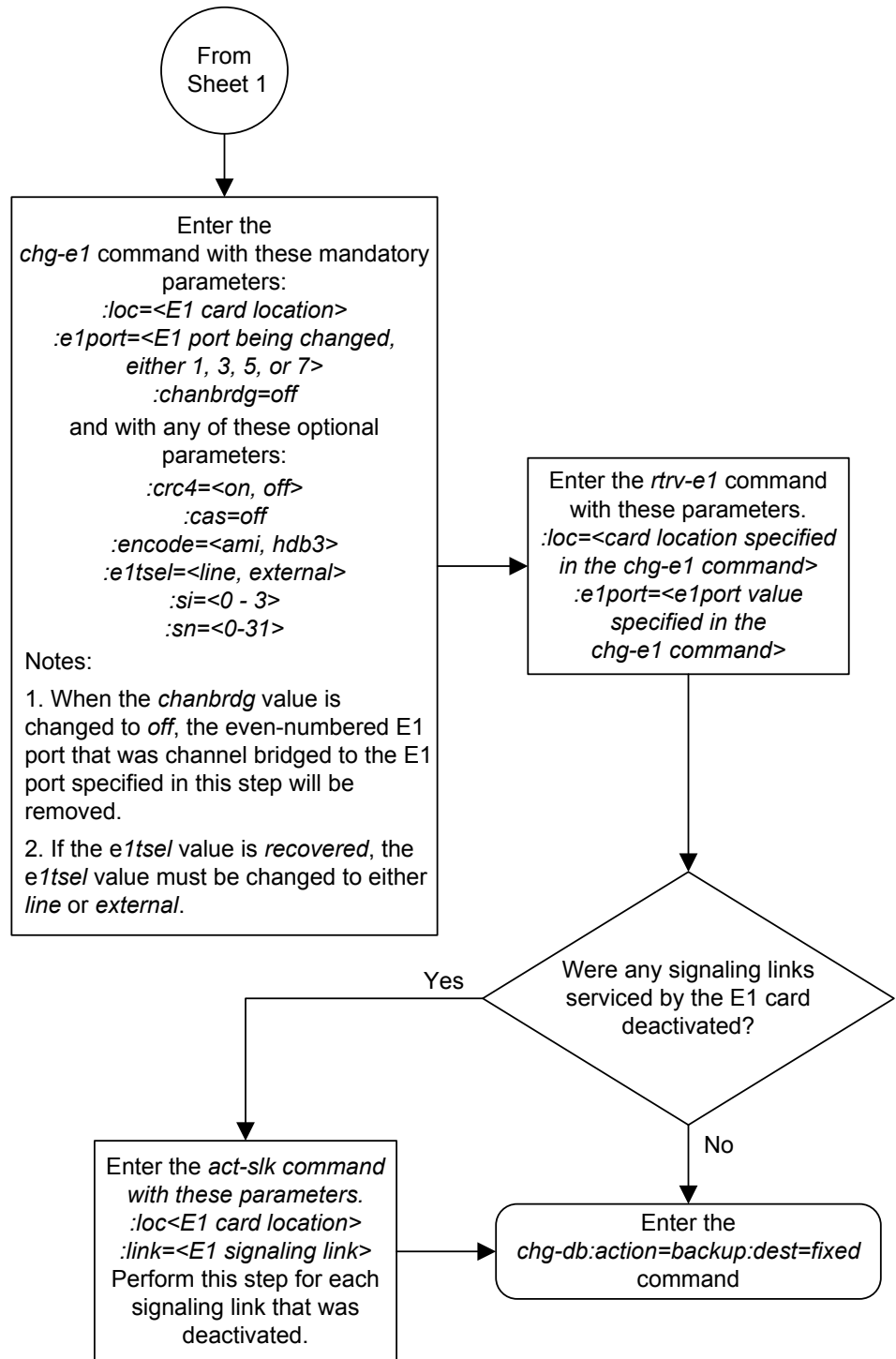
```
BACKUP (FIXED) : MASP A - Backup starts on active MASP.
BACKUP (FIXED) : MASP A - Backup on active MASP to fixed disk complete.
```

```
BACKUP (FIXED) : MASP A - Backup starts on standby MASP.  
BACKUP (FIXED) : MASP A - Backup on standby MASP to fixed disk complete.
```

Figure A-13 Making a Non-Channel Bridged E1 Port from a Channel Bridged E1 Port



Sheet 1 of 2



Adding an E1 Signaling Link

This procedure is used to add an **E1** signaling link to the database using the `ent-slk` command and these parameters.

`:loc` – The card location of the card that the **E1** signaling link will be assigned to.

`:link` – The signaling link on the card specified in the `loc` parameter.

`:lsn` – The name of the linkset that will contain the signaling link.

`:slc` – The signaling link code. The **SLC** must be unique within the linkset. It must be the same at both the **EAGLE** location and the distant node.

`:bps` – The transmission rate for the link in bits per second.

`:ecm` – Error correction method, either `basic` or `pcr`. The default value for this parameter is `basic`.

`:pcrn1` – The threshold of the number of **MSUs** available for retransmission. If the error correction method being used is **PCR** (`:ecm=pcr`), and this threshold is reached, no new **MSUs** or **FISUs** are sent. The retransmission cycle is continued up to the last **MSU** entered into the retransmission buffer in the order in which they were originally transmitted.

`:pcrn2` – The threshold of the number of **MSU** octets available for retransmission. If the error correction method being used is **PCR** (`:ecm=pcr`), and this threshold is reached, no new **MSUs** or **FISUs** are sent. The retransmission cycle is continued up to the last **MSU** entered into the retransmission buffer in the order in which they were originally transmitted.

`:ts` – The timeslot on the **E1** card or channel card being used for the **E1** signaling link.

`:elport` – The **E1** port on the **E1** card that is servicing the timeslot selected for the **E1** signaling link.

`:elloc` – The location of the **E1** card servicing the timeslot selected for the **E1** signaling link. This parameter can be specified only when provisioning **E1** signaling links on channel cards.

`:l2tset` – The level 2 timer set table assigned to the **E1** signaling link. The type of linkset the **E1** signaling link is assigned to and the **E1** card's application determines the value of the `l2tset` parameter. The level 2 timer set tables are defined in [Changing Level 2 Timers](#).

The `ent-slk` command contains other optional parameters that can be used to configure a signaling link. These parameters are not shown here because they are not necessary to provision an **E1** signaling link. These parameters are explained in more detail in [Adding an SS7 Signaling Link](#), or in the `ent-slk` command description in *Commands User's Guide*.

These items must be configured in the database before an **E1** signaling link can be added:

- **Shelf** – see *Adding a Shelf in Database Administration - System Management User's Guide*
- **E1 Card** (card type `lime1`) or **ChannelCard** (card type `limch`) running either the `ss7ansior` or `ccs7itu` applications – see [Adding a LIM-E1 Card](#) procedure

- Destination **Point Code** – see the [Adding a Destination Point Code](#) procedure.
- Linkset – [Adding an SS7 Linkset](#) .

Verify that the link has been physically installed (all cable connections have been made).

Timeslot 16 ($ts=16$) cannot be specified for an E1 signaling link if the E1 interface servicing this link has **CAS** enabled. This is shown by the entry on in the **CAS** field of the `rtrv-e1` output.

If the E1 signaling link is assigned to a channel card (card type `limch`), the `elport` parameter cannot be specified. The `elport` parameter value defaults to 1.

All E1 signaling links in a linkset can use either the 56000 or 64000 transmission rate. The transmission rate for the E1 signaling links in the linkset do not have to be the same.

The values for the `ts` parameter must be from 1 to 31.

The linkset must be in the database. The number of signaling links in a linkset cannot exceed 16. This can be verified with the `rtrv-ls` command.

The **APC** of the linkset assigned to the signaling link must be in the **SS7** domain. Use the `rtrv-dstn` command to verify the domain of the **APC** of the linkset.

The `pcrn1` or `pcrn2` parameters can only be specified if the `ecm=pcr` parameter is specified.

If the E1 signaling link is being assigned to an unchannelized E1 port (shown by the entry `UNCHAN` in the `LINKCLASS` field in the `rtrv-e1` output), you cannot specify the `ts` parameter. An E1 signaling link containing an unchannelized E1 port can be assigned only to an **HC-MIM** or an **E5-E1T1** card. A maximum of two E1 signaling links containing an unchannelized E1 port can be assigned to an **HC-MIM**. The `link` parameter value for these links must be either a or b. A maximum of one E1 signaling link containing an unchannelized E1 port can be assigned to an **E5-E1T1** card. The `link` parameter value for this link must be a. The transmission rate (`bps` parameter) for an unchannelized E1 signaling link is 1984000 bits per second. The `bps` parameter is optional, and if not specified with the `ent-slk` command, the `bps` parameter value defaults to 1984000 bits per seconds.

If the E1 signaling link is being assigned to a channel bridged E1 port (shown by the entries `MASTER` or `SLAVE` in the `CHANBRDG` field in the `rtrv-e1` output), the E1 port value for the signaling link must be the odd numbered (`MASTER`) E1 port.

If the E1 card is not an **HC-MIM** or an **E5-E1T1** card, a maximum of 2 or 8 E1 signaling links can be assigned to the card. The range of `link` parameter values is dependent on the type of E1 card the signaling link is assigned to. If the E1 card is an **E1/T1MIM**, the `link` parameter values are A - A3, or B - B3, allowing a maximum of 8 signaling links on the card.

If the E1 signaling link is being assigned to a channelized E1 port (shown by the entry `CHAN` in the `LINKCLASS` field in the `rtrv-e1` output) on an **HC-MIM**, the `link` parameter values are A - A31 or B - B31. An **HC-MIM** can contain a maximum of 64 channelized E1 signaling links. If signaling links A16 to A31, or B16 to B31 will be assigned to the card, the **FAN** feature must be turned on. The status of the **FAN** feature is shown in the `rtrv-feat` command output. The shelf containing the **HC-MIM** being added in this procedure must have fans installed. If the fans are not installed on the shelf containing the **HC-MIM**, go to *Installation Guide* and install the fans.

If the E1 signaling link is being assigned to a channelized E1 port (shown by the entry `CHAN` in the `LINKCLASS` field in the `rtrv-e1` output) on an **E5-E1T1** card, the `link`

parameter values are A - A15 or B - B15. An **E5-E1T1** card can contain a maximum of 32 channelized **E1** signaling links.

To configure the **EAGLE** to perform circular routing detection test on the signaling links, perform the [Configuring Circular Route Detection](#) procedure.

Note: Circular route detection is not supported in ITU networks.

To provision a **EAGLE** with more than 1200 signaling links, the **EAGLE** must have certain levels of hardware installed. See the [Requirements for EAGLEs Containing more than 1200 Signaling Links](#) section for more information on these hardware requirements.

The **EAGLE** can contain a mixture of low-speed, **E1**, **T1**, **ATM** high-speed, and **IP** signalling links. The [Determining the Number of High-Speed and Low-Speed Signaling Links](#) section describes how to determine the quantities of the different types of signaling links the **EAGLE** can have.

Configuring Signaling Links on LIM-E1 Cards

The main consideration for the provisioning of **LIM-E1** cards into the **EAGLE** is to determine the number of **LIM-E1** cards existing in the network and the equipment needed for expanding the signaling link capacity of the **EAGLE**. To utilize the flexibility of the **E1** interface feature, you may want to determine the minimum number of **LIM-E1** cards needed to process the total number of **SS7** links and then consider diversity for reliability reasons.

Use the following points as guidelines when considering diversity for **E1**:

- If possible, no two **LIM-E1** cards containing links from a common link set should be on the same **E1**/dual port **ChannelCard**.
- If possible, no two **LIM-E1** cards containing links from a common link set should be on adjacent **E1**/dual port **Channel** Cards where they are powered from the same fuse position.
- If possible, no two **LIM-E1** cards containing links from a common link set should be terminated on the same shelf because of the shelf clock cabling, and is only an issue if using master clocking sync to the network
- If possible, no two links in a link set should arrive at the **EAGLE** on the same **LIM-E1** card.
- If possible, for link sets containing more than two links, you should minimize the number of links in that link set on any given **LIM-E1** card.

As an example, consider a network consisting of 30 **LIM-E1** cards with a total number of 100 links where the largest link set size is 8. The most efficient way to provision the **EAGLE** would be to have 4 extension shelves equipped with the **E1** Cabling Backplane, 1 **E1Card**, and 12 **Channel** Cards per shelf. Utilizing 1 "B" bus on each shelf, 25 signaling links would be terminated on each shelf for a total of 100. *This is also the minimum number of **LIM-E1** Cards required for this example.*

With the same example but using the third and fifth bullets above as a consideration, the **EAGLE** would be provisioned with 8 extension shelves equipped with the **E1** Cabling Backplane. Four of the shelves would be equipped with 1 **E1Card** and 6 **Channel** Cards, and the other 4 shelves would be equipped with 1 **E1Card** and 5 **Channel** Cards. *Since the largest link set size is 8, a total of 8 **LIM-E1** Cards is required.*

Utilizing 1 “B” bus on each shelf, 13 signaling links would be terminated on each shelf with 6 **Channel Cards**, and 12 signaling links would be terminated on each shelf with 5 **Channel Cards**.

Example Signaling Link Configuration

This examples used in this procedure are based on [Table A-18](#).

Table A-18 E1 Signaling Link Configuration Table

SLK LOC	SLK LINK	LSN	SLC	TYPE	BPS	TS	E1PORT	E1LOC
1201	A	LSNE12	0	LIME1	64000	1	2	N/A
1202	A	LSNE12	1	LIMCH	64000	5	1	1201
1203	A	LSNE13	0	LIME1	64000	8	2	N/A
1204	A	LSNE13	1	LIMCH	64000	12	1	1203
1211	A	LSNE14 5	0	LIME1	56000	10	2	N/A
1212	A	LSNE14 5	1	LIMCH	56000	14	1	1211
1212	A	LSNE14 5	2	LIMCH	56000	20	1	1211
1301	A	LSN6	0	LIME1	1984000	N/A	4	N/A
1303	B	LSN7	0	LIME1	1984000	N/A	7	N/A

Canceling the REPT-STAT-SLK and RTRV-SLK Commands

Because the `rept-stat-slk` and `rtrv-slk` commands used in this procedure can output information for a long period of time, the `rept-stat-slk` and `rtrv-slk` commands can be canceled and the output to the terminal stopped. There are three ways that the `rept-stat-slk` and `rtrv-slk` commands can be canceled.

- Press the F9 function key on the keyboard at the terminal where the `rept-stat-slk` or `rtrv-slk` commands were entered.
- Enter the `canc-cmd` without the `trm` parameter at the terminal where the `rept-stat-slk` or `rtrv-slk` commands were entered.
- Enter the `canc-cmd:trm=<xx>`, where `<xx>` is the terminal where the `rept-stat-slk` or `rtrv-slk` commands were entered, from another terminal other than the terminal where the `rept-stat-slk` or `rtrv-slk` commands was entered. To enter the `canc-cmd:trm=<xx>` command, the terminal must allow Security Administration commands to be entered from it and the user must be allowed to enter Security Administration commands. The terminal’s permissions can be verified with the `rtrv-secu-trm` command. The user’s permissions can be verified with the `rtrv-user` or `rtrv-secu-user` commands.

For more information about the `canc-cmd` command, go to the *Commands User’s Guide*.

1. Display the cards in the database using the `rtrv-card` command.

```
rlghncxa03w 09-05-28 09:12:36 GMT EAGLE5 41.0.0
CARD   TYPE      APPL      LSET NAME   LINK SLC LSET NAME   LINK SLC
1102   TSM          GLS
1113   GSPM        OAM
1114   TDM-A
1115   GSPM        OAM
1116   TDM-B
1117   MDAL
1201   LIME1       CCS7ITU
1202   LIMCH       CCS7ITU
1203   LIME1       CCS7ITU
1204   LIMCH       CCS7ITU
1211   LIME1       CCS7ITU
1212   LIMCH       CCS7ITU
1316   DCM         STPLAN
```

If the required **E1** card or channel card is not in the database, perform [Adding a LIM-E1 Card](#) to add the required cards to the database.

2. Display the current linkset configuration using the `rtrv-ls` command.

```
rlghncxa03w 06-10-10 11:43:04 GMT EAGLE5 36.0.0

                                L3T SLT                                GWS GWS GWS
LSN      APCA  (SS7)  SCRNL  SET SET BEI LST LNKS  ACT MES DIS SLSCI NIS
lsnt145  150-075-038  scr4  1  1  yes a  0  on  on  off --- ---
lsnt265  200-150-067  scr2  1  1  yes a  3  on  on  off --- ---

                                L3T SLT                                GWS GWS GWS
LSN      APCI  (SS7)  SCRNL  SET SET BEI LST LNKS  ACT MES DIS SLSCI NIS
lsne12   2-150-7      scr1  1  1  no  a  2  on  on  off --- ---
lsne145  4-049-3      scr1  1  1  no  a  3  on  on  off --- ---
sp5      1-111-3      scr3  1  3  yes c  1  off off off --- ---
sp6      1-111-1      scr1  1  1  yes a  1  off off off --- ---
sp7      1-111-2      scr2  1  2  no  a  2  on  on  on  --- ---

                                L3T SLT                                GWS GWS GWS
LSN      APCN  (SS7)  SCRNL  SET SET BEI LST LNKS  ACT MES DIS SLSCI NIS
lsne13   14950       scr1  1  1  no  a  2  on  on  off --- off
nsp1     11111       scr1  1  1  yes a  2  off off off --- off
nsp3     11112       scr2  1  2  no  a  1  on  on  on  --- off
nsp4     11113       scr3  1  3  yes c  1  off off off --- off

Link set table is ( 11 of 1024) 1% full
```

If the desired linkset is not in the database, perform [Adding an SS7 Linkset](#) to add the linkset to the database. After the linkset has been added to the database, continue the procedure with [4](#).

If the desired linkset is in the database, continue the procedure with [3](#).

3. Display the attributes of the linkset that will contain the new signaling link by entering the `rtrv-ls` command with the name of the linkset shown in [2](#). For this example, enter these commands.

```
rtrv-ls:lsn=lsne12
```

rlghncxa03w 08-12-10 11:43:04 GMT EAGLE5 40.0.0

```

                L3T SLT                GWS GWS GWS
LSN            APCI  (SS7)  SCRN SET SET BEI LST LNKS ACT MES DIS SLSCI NIS
lsne12         2-150-7      scr1 1  1  yes A  2   on  on  off no   off

                SPCI            CLLI            TFATCABMLQ MTPRSE ASL8
                -----
                2                ---      ---

SLRSRB RANDSLS ITUTFR
1          off    off

IPSG  IPGWAPC  GTTMODE                CGGTMOD
no    no       CdPA                    no

                L2T                PCR PCR  E1  E1
LOC  LINK SLC TYPE  SET BPS  ECM  N1  N2  LOC  PORT TS
1201 A1  2  LIME1  11 56000 BASIC ---  ----- 1201 2  20
1201 B  3  LIME1  11 56000 BASIC ---  ----- 1201 2  10
    
```

Link set table is (11 of 1024) 1% full.

rtrv-ls:lsn=lsne13

rlghncxa03w 08-12-10 11:43:04 GMT EAGLE5 40.0.0

```

                L3T SLT                GWS GWS GWS
LSN            APCN  (SS7)  SCRN SET SET BEI LST LNKS ACT MES DIS SLSCI NIS
lsne13         14950      scr1 1  1  no  A  2   on  on  off no   off

                SPCN            CLLI            TFATCABMLQ MTPRSE ASL8
                -----
                1                ---      ---

SLRSRB RANDSLS ITUTFR
1          off    off

IPSG  IPGWAPC  GTTMODE                CGGTMOD
no    no       CdPA                    no

                L2T                PCR PCR  E1  E1
LOC  LINK SLC TYPE  SET BPS  ECM  N1  N2  LOC  PORT TS
1203 A1  2  LIME1  11 56000 BASIC ---  ----- 1203 2  4
1203 A3  3  LIME1  11 56000 BASIC ---  ----- 1203 2  3
    
```

Link set table is (11 of 1024) 1% full.

rtrv-ls:lsn=lsne145

rlghncxa03w 08-12-10 11:43:04 GMT EAGLE5 40.0.0

```

                L3T SLT                GWS GWS GWS
LSN            APCI  (SS7)  SCRN SET SET BEI LST LNKS ACT MES DIS SLSCI NIS
lsne145         4-049-3      scr1 1  1  yes A  3   on  on  off no   off

                SPCI            CLLI            TFATCABMLQ MTPRSE ASL8
                -----
                2                ---      ---

SLRSRB RANDSLS ITUTFR
    
```

```

1      off      off

IPSG  IPGWAPC  GTTMODE          CGGTMOD
no    no       CdPA              no

                L2T                PCR  PCR  E1  E1
LOC  LINK  SLC  TYPE      SET  BPS   ECM  N1  N2  LOC  PORT  TS
1211 A1   3   LIME1   11  56000 BASIC ---  ----- 1211 2   17
1211 B   4   LIME1   11  56000 BASIC ---  ----- 1211 2   13
1211 B1  5   LIME1   11  56000 BASIC ---  ----- 1211 2   2
    
```

Link set table is (11 of 1024) 1% full.

The signaling link cannot be assigned to a linkset whose IPSPG or IPGWAPC values are yes. If either the IPSPG or IPGWAPC value for the linkset is yes, repeat the procedure from 2 and choose another linkset.

If the IPSPG and IPGWAPC values for the linkset are no, continue the procedure with 4.

4. Display the current signaling link configuration using the `rtrv-slk` command.

```

rlghncxa03w 09-07-19 21:16:37 GMT EAGLE5 41.1.0

                L2T                PCR  PCR
LOC  LINK  LSN      SLC  TYPE      SET  BPS   ECM  N1  N2
1201 A   e3m1s1   0   LIMDS0   1   56000 BASIC ----  -----
1201 B   e3m1s2   0   LIMDS0   1   56000 BASIC ----  -----
1202 A   e3m1s1   1   LIMDS0   1   56000 BASIC ----  -----
1202 B   e3m1s2   1   LIMDS0   1   56000 BASIC ----  -----
1203 A   e3m1s1   2   LIMDS0   1   56000 BASIC ----  -----
1203 B   e3m1s2   2   LIMDS0   1   56000 BASIC ----  -----
1204 A   e3m1s1   3   LIMDS0   1   56000 BASIC ----  -----
1204 B   e3m1s2   3   LIMDS0   1   56000 BASIC ----  -----
1205 A   e3m1s1   4   LIMDS0   1   56000 BASIC ----  -----
1205 B   e3m1s2   4   LIMDS0   1   56000 BASIC ----  -----
1206 A   e3m1s1   5   LIMDS0   1   56000 BASIC ----  -----
1206 B   e3m1s2   5   LIMDS0   1   56000 BASIC ----  -----
1207 A   e3m1s1   6   LIMDS0   1   56000 BASIC ----  -----
1207 B   e3m1s2   6   LIMDS0   1   56000 BASIC ----  -----
1211 A   e3m2s1   0   LIMDS0  11   56000 BASIC ----  -----
1211 B   e3m2s2   0   LIMDS0  11   56000 BASIC ----  -----
1212 A   e3m2s1   1   LIMDS0  11   56000 BASIC ----  -----
1212 B   e3m2s2   1   LIMDS0  11   56000 BASIC ----  -----
1213 A   e3m2s1   2   LIMDS0  11   56000 BASIC ----  -----
1213 B   e3m2s2   2   LIMDS0  11   56000 BASIC ----  -----
1214 A   e3m2s1   3   LIMDS0  11   56000 BASIC ----  -----
1214 B   e3m2s2   3   LIMDS0  11   56000 BASIC ----  -----
1215 A   e3m2s1   4   LIMDS0  11   56000 BASIC ----  -----
1215 B   e3m2s2   4   LIMDS0  11   56000 BASIC ----  -----
1216 A   e3m2s1   5   LIMDS0  11   56000 BASIC ----  -----
1216 B   e3m2s2   5   LIMDS0  11   56000 BASIC ----  -----
1217 A   e3m2s1   6   LIMDS0  11   56000 BASIC ----  -----
1217 B   e3m2s2   6   LIMDS0  11   56000 BASIC ----  -----
    
```

SLK TABLE is (28 of 1200) 2% full.

If the addition of the new signaling link will exceed the maximum number of signaling links the EAGLE can have (in this example, the maximum number of signaling links is 1200), and the maximum number of signaling links is 2800, this

procedure cannot be performed. The EAGLE cannot contain more than 2800 signaling links.

If the addition of the new signaling link will exceed the maximum number of signaling links the EAGLE can have, and the maximum number of signaling links is less than 2800, perform the [Enabling the Large System # Links Controlled Feature](#) procedure to enable the desired quantity of signaling links.

If the addition of the new signaling link will not exceed the maximum number of signaling links the EAGLE can have, or if a new signaling link quantity was enabled, continue the procedure by performing one of these steps.

- If the signaling link will be assigned to a channel card (LIMCH), continue the procedure with [10](#).
 - If the signaling link will be assigned to a LIME1 card, continue the procedure with [5](#).
5. Display the E1 interfaces that will be assigned to the E1 signaling link using the `rtrv-e1` command with no parameters.

```
rlghncxa03w 06-10-19 21:17:04 GMT EAGLE5 36.0.0
E1
LOC  PORT  CRC4  CAS  ENCODE  E1TSEL  SI  SN  CHANBRDG  CLASS  RATE
1201  2      ON    OFF  HDB3    LINE    0  0  -----  CHAN  ----
1203  1      OFF   ON   HDB3    EXTERNAL 3  6  -----  CHAN  ----
1211  2      ON    OFF  HDB3    LINE    0  0  -----  CHAN  ----
```

If the desired E1 port and E1 card combination is shown in the `rtrv-e1` output, continue the procedure with [6](#).

If the desired E1 port and E1 card combination is not shown in the `rtrv-e1` output, add the E1 port and E1 card combination to the database by performing the one of these procedures:

- [Adding Channelized and non-Channel Bridged E1 Ports](#)
- [Adding Channel Bridged E1 Ports](#)
- [Adding Unchannelized E1 Ports.](#)

After the desired E1 port and E1 card combination has been added to the database, continue the procedure with [6](#).

6. Verify the card type of the card that will contain the new E1 signaling link by entering this command.

```
rtrv-stp:type=lime1
```

```
rlghncxa03w 08-12-30 11:07:17 EST EAGLE 40.0.0

Card  Part Number  Rev  Serial Number  Type    DB    APPL          GPL Version
----  -
1201  870-2671-02  C    10145689323   LIME1  512M  SS7ANSI      126-034-000
1203  870-1873-01  C    10345690569   LIME1  512M  SS7ANSI      126-034-000
1211  870-1873-01  C    10346790570   LIME1  512M  SS7ANSI      126-034-000
1301  870-2671-02  C    10145689327   LIME1  512M  SS7ANSI      126-033-000
1303  870-1873-01  C    10345691349   LIME1  512M  SS7ANSI      126-033-000
```

Command Completed.

The E1 card types and their part numbers are shown in [Table A-4](#).

If the new E1 signaling link will be assigned to an E1T1 MIM, or E5-E1T1 card, continue the procedure with [10](#).

If the new E1 signaling link will be assigned to an HC-MIM, and the link parameter value of the new signaling link is A-A15 or B-B15, continue the procedure with [10](#).

If the new E1 signaling link will be assigned to an HC-MIM, and the link parameter value of the new signaling link is A16-A31 or B16-B31, continue the procedure by performing one of these steps.

- If the link parameter values A16-A31 or B16-B31 are shown in the `rtrv-slk` output in [4](#), and the new signaling link will be assigned to a card on the same shelf as the cards that contain the link parameter values A16-A31 or B16-B31, continue the procedure with [10](#).
 - If the link parameter values A16-A31 or B16-B31 are shown in the `rtrv-slk` output in [4](#), and the new signaling link will be assigned to a card that is not on the same shelf as the cards that contain the link parameter values A16-A31 or B16-B31, continue the procedure with [9](#).
 - If the link parameter values A16-A31 or B16-B31 are not shown in the `rtrv-slk` output in [4](#), continue the procedure with [7](#).
7. Verify whether or not that the Fan feature is on, by entering the `rtrv-feat` command.

If the Fan feature is on, the entry `FAN = on` appears in the `rtrv-feat` command output.

Note: The `rtrv-feat` command output contains other fields that are not used by this procedure. If you wish to see all the fields displayed by the `rtrv-feat` command, see the `rtrv-feat` command description in *Commands User's Guide*.

If the Fan feature is on, continue the procedure with [9](#).

8. Turn the Fan feature on by entering this command.

```
chg-feat : fan=on
```

Note: Once the Fan feature is turned on with the `chg-feat` command, it cannot be turned off.

The Fan feature must be purchased before you turn this feature on with the `chg-feat` command. If you are not sure if you have purchased the Fan feature, contact your Oracle Sales Representative or Account Representative.

9. The shelf containing the **HC-MIM** being added in this procedure must have fans installed. Verify whether or not fans are installed on the shelf.

If the fans are installed, continue the procedure with [10](#).

If the fans are not installed on the shelf containing the **HC-MIM**, go to *Installation Guide* and install the fans. Once the fans have been installed and tested, 10. The fans must be working properly before an **HC-MIM** can be placed in the **EAGLE**.

10. Add the E1 signaling links using the `ent-slk` command.

Enter the `ent-slk` command with the parameter combinations shown in [Table A-19](#).

Table A-19 E1 Signaling Link Parameter Combinations

E1 Signaling Links assigned to a Channel Card	E1 Signaling Links assigned to an E1/T1 MIM	E1 Signaling Links assigned to an HC-MIM with a Channelized E1 Port	E1 Signaling Links assigned to an HC-MIM with an Unchannelized E1 Port	E1 Signaling Links assigned to an E5-E1T1 Card with a Channelized E1 Port	E1 Signaling Links assigned to an E5-E1T1 Card with an Unchannelized E1 Port
Mandatory Parameters					
:loc=<the location of the channel card>	:loc=<the location of the LIME1 card>	:loc=<the location of the LIME1 card>	:loc=<the location of the LIME1 card>	:loc=<the location of the LIME1 card>	:loc=<the location of the LIME1 card>
:link=A - A3, B - B3	:link=A - A3, B - B3	:link=A - A31, B - B31 (See Note 2)	:link=A or B	:link=A - A15, B - B15	:link=A
:lsn=<the name of the linkset>	:lsn=<the name of the linkset>	:lsn=<the name of the linkset>	:lsn=<the name of the linkset>	:lsn=<the name of the linkset>	:lsn=<the name of the linkset>
:slc= 0 - 15	:slc= 0 - 15	:slc= 0 - 15	:slc= 0 - 15	:slc= 0 - 15	:slc= 0 - 15
:e1loc=<the location of the LIME1 card>	:e1port= 1 or 2	:e1port= 1 - 8	:e1port= 1 - 8	:e1port= 1 - 8	:e1port= 1 - 8
:ts= 1 - 31 (See Note 1)	:ts= 1 - 31 (See Note 1)	:ts= 1 - 31		:ts= 1 - 31	
Optional Parameters					
:bps=56000, 64000 Default value = 56000	:bps=56000, 64000 Default value = 56000	:bps=56000, 64000 Default value = 56000	:bps=198400 0 Default value = 19840000	:bps=56000, 64000 Default value = 56000	:bps=198400 0 Default value = 19840000
:ecm=basic, pcr Default value = basic	:ecm=basic, pcr Default value = basic	:ecm=basic, pcr Default value = basic	:ecm=basic, pcr Default value = basic	:ecm=basic, pcr Default value = basic	:ecm=basic, pcr Default value = basic
:pcrn1= 1 - 127 (See Note 3) Default value = 76	:pcrn1= 1 - 127 (See Note 3) Default value = 76	:pcrn1= 1 - 127 (See Note 3) Default value = 76	:pcrn1= 1 - 127 (See Note 3) Default value = 76	:pcrn1= 1 - 127 (See Note 3) Default value = 76	:pcrn1= 1 - 1023 (See Note 3) Default value = 608

Table A-19 (Cont.) E1 Signaling Link Parameter Combinations

E1 Signaling Links assigned to a Channel Card	E1 Signaling Links assigned to an E1/T1 MIM	E1 Signaling Links assigned to an HC-MIM with a Channelized E1 Port	E1 Signaling Links assigned to an HC-MIM with an Unchannelized E1 Port	E1 Signaling Links assigned to an E5-E1T1 Card with a Channelized E1 Port	E1 Signaling Links assigned to an E5-E1T1 Card with an Unchannelized E1 Port
:pcrn2=300 - 35500 (See Note 3) Default value = 3800	:pcrn2=300 - 35500 (See Note 3) Default value = 3800	:pcrn2=300 - 35500 (See Note 3) Default value = 3800	:pcrn2=300 - 35500 (See Note 3) Default value = 3800	:pcrn2=300 - 35500 (See Note 3) Default value = 3800	:pcrn2=7200 - 287744 (See Note 3) Default value = 32224
:l2tset=See Table 3-16	:l2tset=See Table 3-16	:l2tset=See Table 3-16	:l2tset=See Table 3-16	:l2tset=See Table 3-16	:l2tset=See Table 3-16
Notes:					
1. Timeslot 16 cannot be used if the E1 interface, defined by the <code>e1loc</code> and <code>e1port</code> parameter values, has CAS enabled (<code>cas=on</code>). This is shown in the <code>rtrv-e1</code> output.					
2. If the Fan feature is not turned on, the link parameter values for an E1 signaling link are A - A15, B - B15.					
3. The <code>pcrn1</code> and <code>pcrn2</code> parameters can be specified only if the <code>ecm=pcr</code> parameter is specified.					

If the E1 signaling link is being assigned to an unchannelized E1 port (shown by the entries UNCHAN in the LINKCLASS field in the `rtrv-e1` output), you cannot specify the `ts` parameter. The transmission rate (`bps` parameter) for an unchannelized E1 signaling link is 1984000 bits per second. The `bps` parameter is optional, and if not specified with the `ent-slk` command, the `bps` parameter value defaults to 1984000 bits per seconds. It is recommended that unchannelized E1 signaling links are assigned to linksets that do not contain other types of signaling links.

For this example, enter these commands.

```
ent-
slk:loc=1201:link=a:lsn=lsne12:slc=2:bps=64000:ts=1:e1port=2

ent-
slk:loc=1202:link=a:lsn=lsne12:slc=3:bps=64000:ts=5:e1loc=1201

ent-
slk:loc=1203:link=a:lsn=lsne13:slc=2:bps=64000:ts=8:e1port=2

ent-
slk:loc=1204:link=a:lsn=lsne13:slc=3:bps=64000:ts=12:e1loc=1203

ent-
slk:loc=1211:link=a:lsn=lsne145:slc=3:bps=56000:ts=10:e1port=2

ent-
slk:loc=1212:link=a:lsn=lsne145:slc=4:bps=56000:ts=14:e1loc=1211
```

```
ent-
slk:loc=1212:link=a2:lsn=lsne145:slc=5:bps=56000:ts=20:elloc=
1211
ent-slk:loc=1301:link=a:lsn=lsn6:slc=0:elport=4
ent-slk:loc=1303:link=b:lsn=lsn7:slc=0:elport=7
```

Note: If adding the new signaling link will result in more than 700 signaling links in the database and the OAMHCMEAS value in the `rtrv-measopts` output is on, the scheduled UI measurement reports will be disabled.

11. Verify the changes using the `rtrv-slk` command, specifying the card location and signaling link entered in 10.

For this example, enter these commands.

```
rtrv-slk:loc=1201
```

```
rlghncxa03w 08-12-19 21:17:04 GMT EAGLE5 40.0.0
                                L2T                PCR PCR  E1  E1
LOC LINK LSN          SLC TYPE  SET  BPS   ECM  N1  N2  LOC PORT TS
1201 A   lsne12       2  LIME1   1   64000 BASIC ---  1201 2   1
```

```
rtrv-slk:loc=1202
```

```
rlghncxa03w 08-12-19 21:17:04 GMT EAGLE5 40.0.0
                                L2T                PCR PCR  E1  E1
LOC LINK LSN          SLC TYPE  SET  BPS   ECM  N1  N2  LOC PORT TS
1202 A   lsne12       3  LIMCH   1   64000 BASIC ---  1201 1   5
```

```
rtrv-slk:loc=1203
```

```
rlghncxa03w 08-12-19 21:17:04 GMT EAGLE5 40.0.0
                                L2T                PCR PCR  E1  E1
LOC LINK LSN          SLC TYPE  SET  BPS   ECM  N1  N2  LOC PORT TS
1203 A   lsne13       2  LIME1   1   64000 BASIC ---  1203 2   8
```

```
rtrv-slk:loc=1204
```

```
rlghncxa03w 08-12-19 21:17:04 GMT EAGLE5 40.0.0
                                L2T                PCR PCR  E1  E1
LOC LINK LSN          SLC TYPE  SET  BPS   ECM  N1  N2  LOC PORT TS
1204 A   lsne13       3  LIMCH   1   64000 BASIC ---  1203 1  12
```

```
rtrv-slk:loc=1211
```

```
rlghncxa03w 08-12-19 21:17:04 GMT EAGLE5 40.0.0
                                L2T                PCR PCR  E1  E1
LOC LINK LSN          SLC TYPE  SET  BPS   ECM  N1  N2  LOC PORT TS
1211 A   lsne145      3  LIME1   1   56000 BASIC ---  1211 2  10
```

```
rtrv-slk:loc=1212
```

```
rlghncxa03w 08-12-19 21:17:04 GMT EAGLE5 40.0.0
                                L2T                PCR PCR  E1  E1
```

```

LOC LINK LSN          SLC TYPE   SET BPS    ECM  N1  N2   LOC PORT TS
1212 A   lsne145      4  LIMCH    1  56000 BASIC ---  ----- 1211 1   14
1212 A2  lsne145      5  LIMCH    1  56000 BASIC ---  ----- 1211 1   20

```

```
rtrrv-slk:loc=1301
```

```

rlghncxa03w 06-10-19 21:17:04 GMT EAGLE5 36.0.0
                               L2T                               PCR PCR  E1  E1
LOC LINK LSN          SLC TYPE   SET BPS    ECM  N1  N2   LOC PORT TS
1301 A   lsn6         0  LIME1    1  1.984M BASIC ---  ----- 1301 4   --

```

```
rtrrv-slk:loc=1303
```

```

rlghncxa03w 06-10-19 21:17:04 GMT EAGLE5 36.0.0
                               L2T                               PCR PCR  E1  E1
LOC LINK LSN          SLC TYPE   SET BPS    ECM  N1  N2   LOC PORT TS
1303 B   lsn7         0  LIME1    1  1.984M BASIC ---  ----- 1303 7   --

```

If any of the cards shown in this step contain the first signaling link on a card, continue the procedure with [12](#).

If signaling links were assigned to all the cards shown in this step when [10](#) was performed, continue the procedure with [13](#).

- 12.** Bring the cards into service with the `rst-card` command, specifying the card location specified in [11](#) . For this example, enter these commands.

```

rst-card:loc=1202
rst-card:loc=1204
rst-card:loc=1212
rst-card:loc=1301
rst-card:loc=1303

```

When each of these commands have successfully completed, this message should appear.

```

rlghncxa03w 06-10-23 13:05:05 GMT EAGLE5 36.0.0
Card has been allowed.

```

- 13.** Activate all signaling links on the cards using the `act-slk` command, specifying the card location and signaling link specified in [11](#) . For this example, enter these commands.

```

act-slk:loc=1201:link=a
act-slk:loc=1202:link=a
act-slk:loc=1203:link=a
act-slk:loc=1204:link=a
act-slk:loc=1211:link=a
act-slk:loc=1212:link=a
act-slk:loc=1212:link=a2
act-slk:loc=1301:link=a

```

```
act-slk:loc=1303:link=b
```

When each of these commands have successfully completed, this message should appear.

```
rlghncxa03w 06-10-07 08:31:24 GMT EAGLE5 36.0.0
Activate Link message sent to card
```

14. Check the status of the signaling links added in 10 using the `rept-stat-slk` command with the card location and signaling link. The state of each signaling link should be in service normal (**IS-NR**) after the link has completed alignment (shown in the `PST` field). For this example, enter these commands.

```
rept-stat-slk:loc=1201:link=a
```

```
rlghncxa03w 06-10-23 13:06:25 GMT EAGLE5 36.0.0
SLK      LSN      CLLI      PST      SST      AST
1201,A  lsne12    -----  IS-NR    Avail    ----
  ALARM STATUS      = No Alarms
  UNAVAIL REASON    = --
  E1 status          = 1201, RCVRY-E1F:FAC-E1 Port 2 available
```

```
rept-stat-slk:loc=1202:link=a
```

```
rlghncxa03w 06-10-23 13:06:25 GMT EAGLE5 36.0.0
SLK      LSN      CLLI      PST      SST      AST
1202,A  lsne12    -----  IS-NR    Avail    ----
  ALARM STATUS      = No Alarms
  UNAVAIL REASON    = --
  E1 status          = 1201, RCVRY-E1F:FAC-E1 Port 1 available
```

```
rept-stat-slk:loc=1203:link=a
```

```
rlghncxa03w 06-10-23 13:06:25 GMT EAGLE5 36.0.0
SLK      LSN      CLLI      PST      SST      AST
1203,A  lsne12    -----  IS-NR    Avail    ----
  ALARM STATUS      = No Alarms
  UNAVAIL REASON    = --
  E1 status          = 1203, RCVRY-E1F:FAC-E1 Port 2 available
```

```
rept-stat-slk:loc=1204:link=a
```

```
rlghncxa03w 06-10-23 13:06:25 GMT EAGLE5 36.0.0
SLK      LSN      CLLI      PST      SST      AST
1204,A  lsne12    -----  IS-NR    Avail    ----
  ALARM STATUS      = No Alarms
  UNAVAIL REASON    = --
  E1 status          = 1203, RCVRY-E1F:FAC-E1 Port 1 available
```

```
rept-stat-slk:loc=1211:link=a
```

```
rlghncxa03w 06-10-23 13:06:25 GMT EAGLE5 36.0.0
SLK      LSN      CLLI      PST      SST      AST
1211,A  lsne145   -----  IS-NR    Avail    ----
  ALARM STATUS      = No Alarms
  UNAVAIL REASON    = --
  E1 status          = 1211, RCVRY-E1F:FAC-E1 Port 2 available
```

```
rept-stat-slk:loc=1212:link=a
```

```
rlghncxa03w 06-10-23 13:06:25 GMT EAGLE5 36.0.0
SLK      LSN      CLLI      PST      SST      AST
1212,A  lsne145  -----  IS-NR    Avail    ----
ALARM STATUS      = No Alarms
UNAVAIL REASON    = --
E1 status         = 1211, RCVRY-E1F:FAC-E1 Port 1 available
```

```
rept-stat-slk:loc=1212:link=a2
```

```
rlghncxa03w 06-10-23 13:06:25 GMT EAGLE5 36.0.0
SLK      LSN      CLLI      PST      SST      AST
1212,A2 lsne145  -----  IS-NR    Avail    ----
ALARM STATUS      = No Alarms
UNAVAIL REASON    = --
E1 status         = 1211, RCVRY-E1F:FAC-E1 Port 1 available
```

```
rept-stat-slk:loc=1301:link=a
```

```
rlghncxa03w 06-10-23 13:06:25 GMT EAGLE5 36.0.0
SLK      LSN      CLLI      PST      SST      AST
1303,A  lsn6     -----  IS-NR    Avail    ----
ALARM STATUS      = No Alarms
UNAVAIL REASON    = --
E1 status         = 1301, RCVRY-E1F:FAC-E1 Port 4 available
```

```
rept-stat-slk:loc=1303:link=b
```

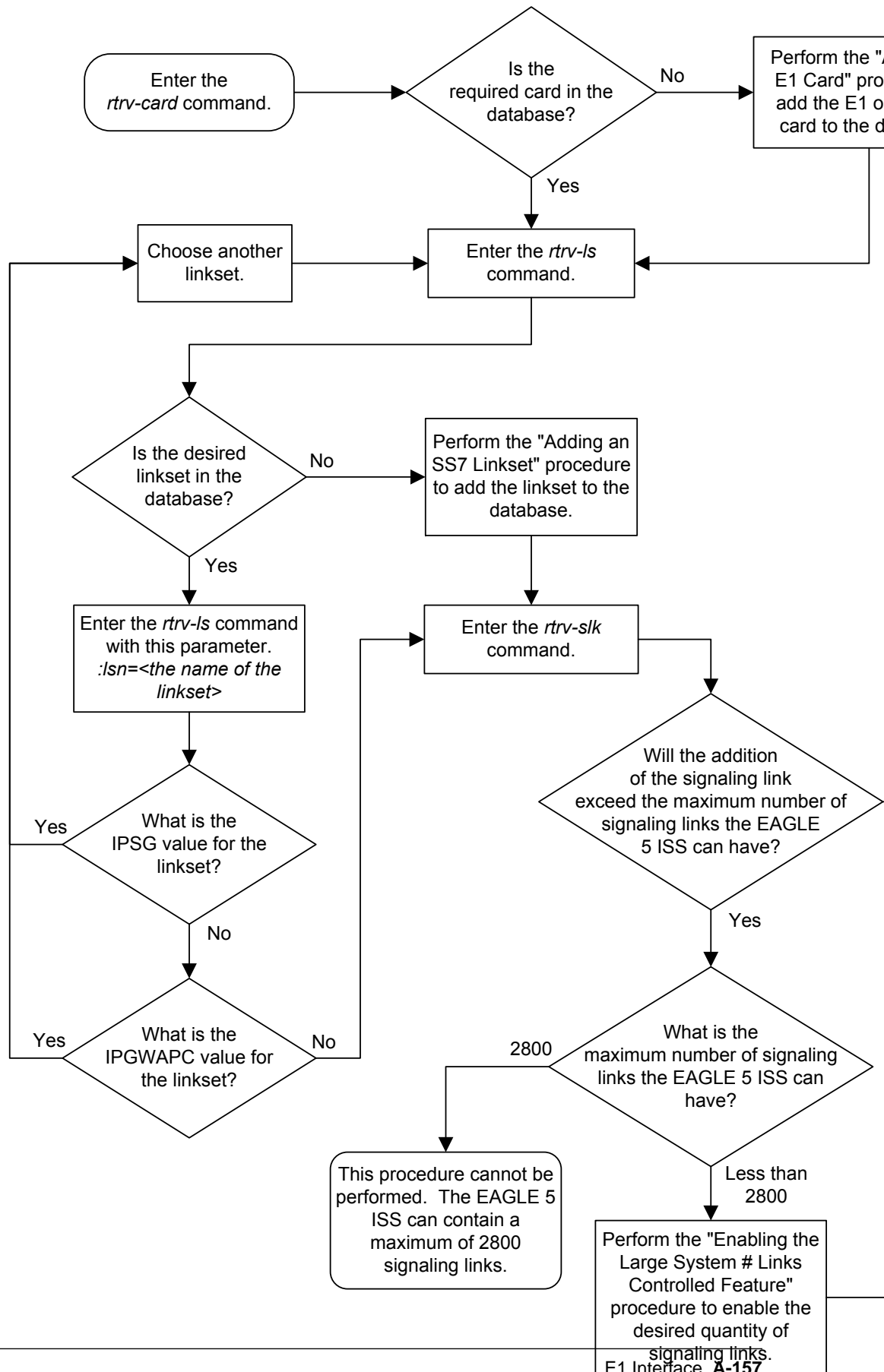
```
rlghncxa03w 06-10-23 13:06:25 GMT EAGLE5 36.0.0
SLK      LSN      CLLI      PST      SST      AST
1303,B  lsn7     -----  IS-NR    Avail    ----
ALARM STATUS      = No Alarms
UNAVAIL REASON    = --
E1 status         = 1303, RCVRY-E1F:FAC-E1 Port 7 available
```

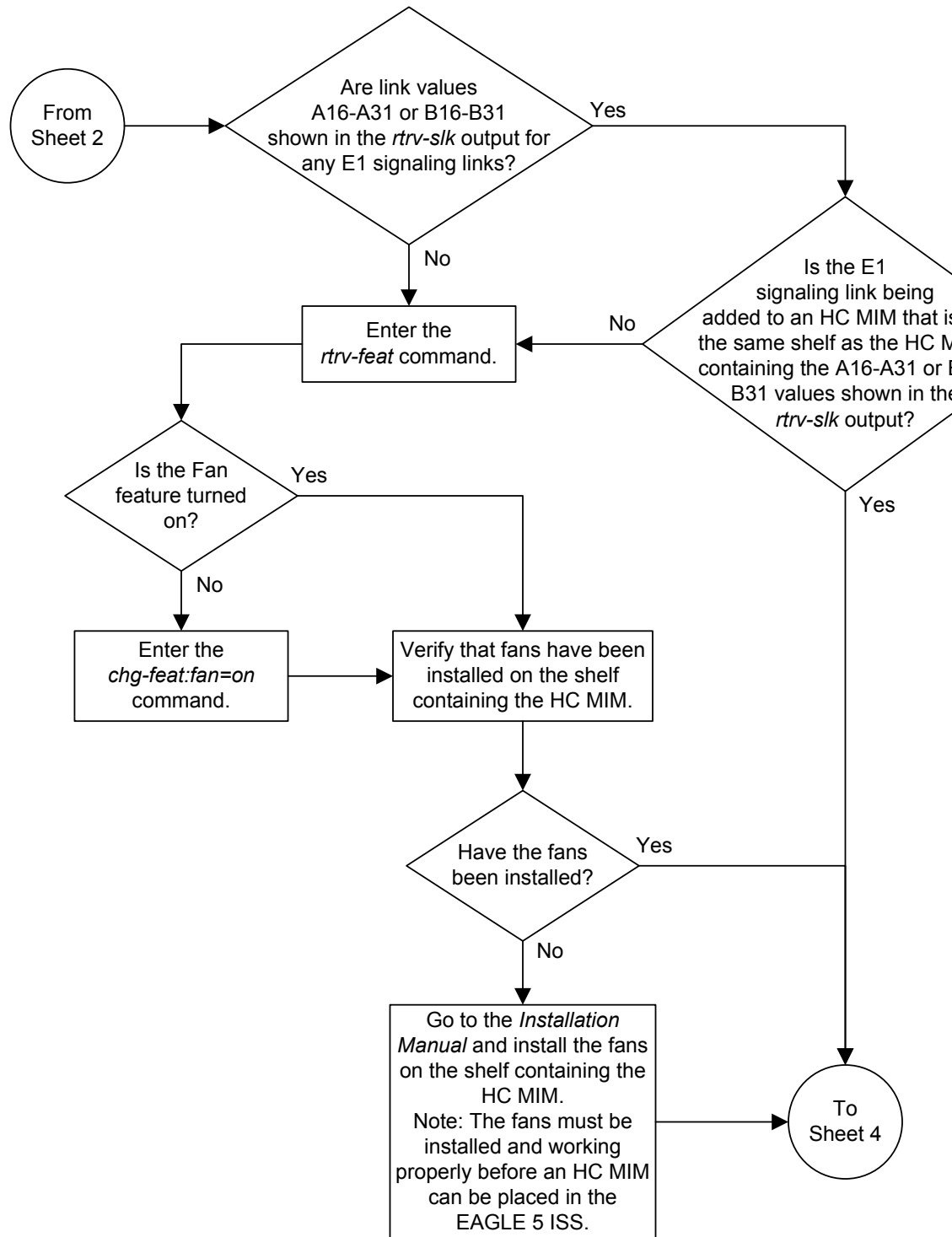
15. Back up the new changes using the `chg-db:action=backup:dest=fixed` command.

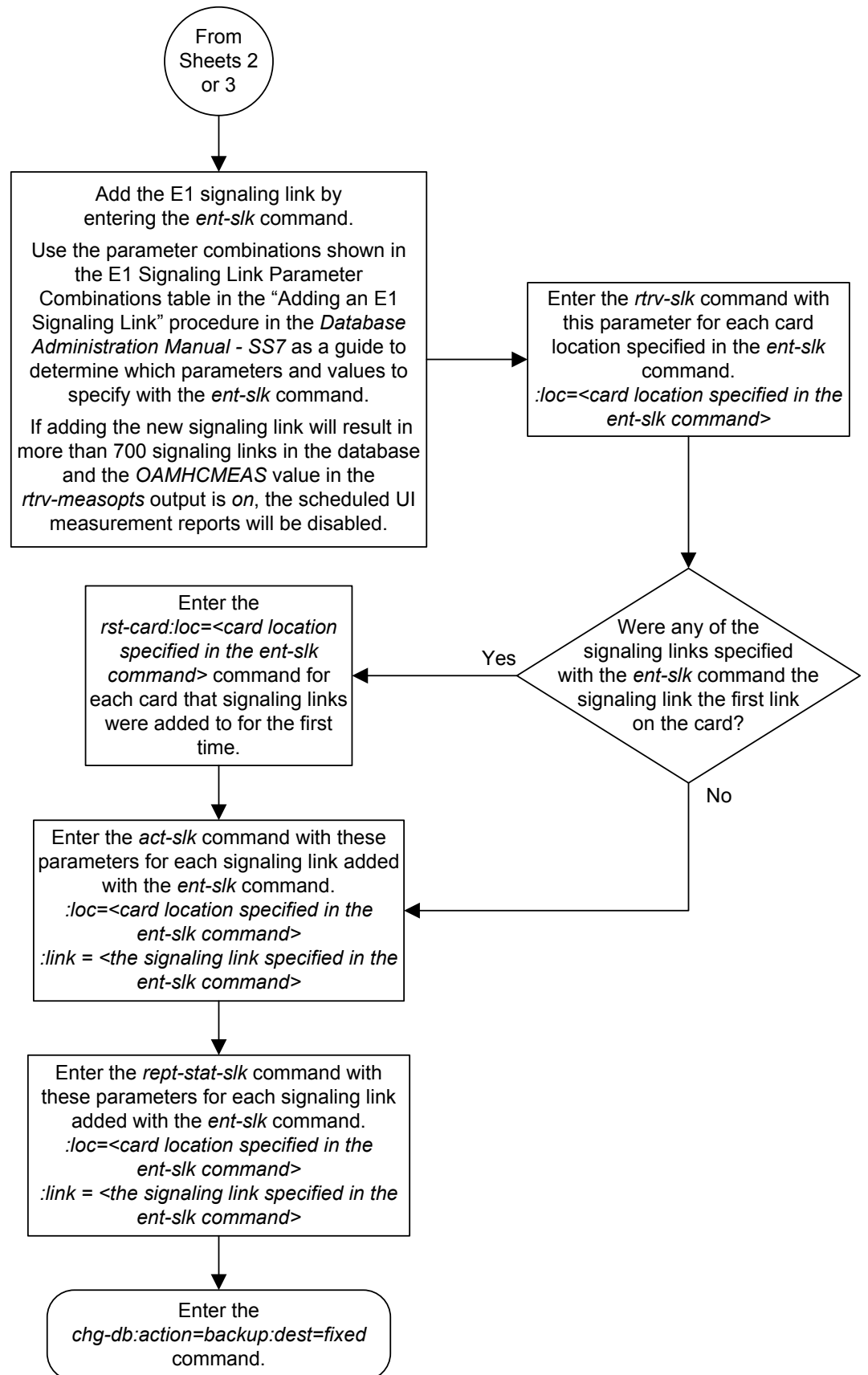
These messages should appear, the active **Maintenance and Administration Subsystem Processor (MASP)** appears first.

```
BACKUP (FIXED) : MASP A - Backup starts on active MASP.
BACKUP (FIXED) : MASP A - Backup on active MASP to fixed disk complete.
BACKUP (FIXED) : MASP A - Backup starts on standby MASP.
BACKUP (FIXED) : MASP A - Backup on standby MASP to fixed disk complete.
```

Figure A-14 Adding an E1 Signaling Link







T1 Interface

Appendix B, T1 Interface, contains general information about the T1 interface and how to provision it.

Introduction

The **T1** interface terminates or distributes **T1** facility signals for the purpose of processing the **SS7** signaling links carried by the **T1** carrier. The **T1** interface can be either an **E1/T1 MIM** or an **HC-MIM**, or an **E5-E1T1** card as shown in [Figure B-1](#) and [Figure B-2](#). The **E1/T1 MIM**, **HC-MIM**, or **E5-E1T1** card can also be used as an **E1** interface. This appendix describes how the **T1** interface is configured. The **E1** interface configuration is described in [E1 Interface](#). The **E1/T1 MIM** contain up to eight signaling links and allows the **EAGLE** to contain more than 500 signaling links.

Figure B-1 E1/T1 MIM Block Diagram

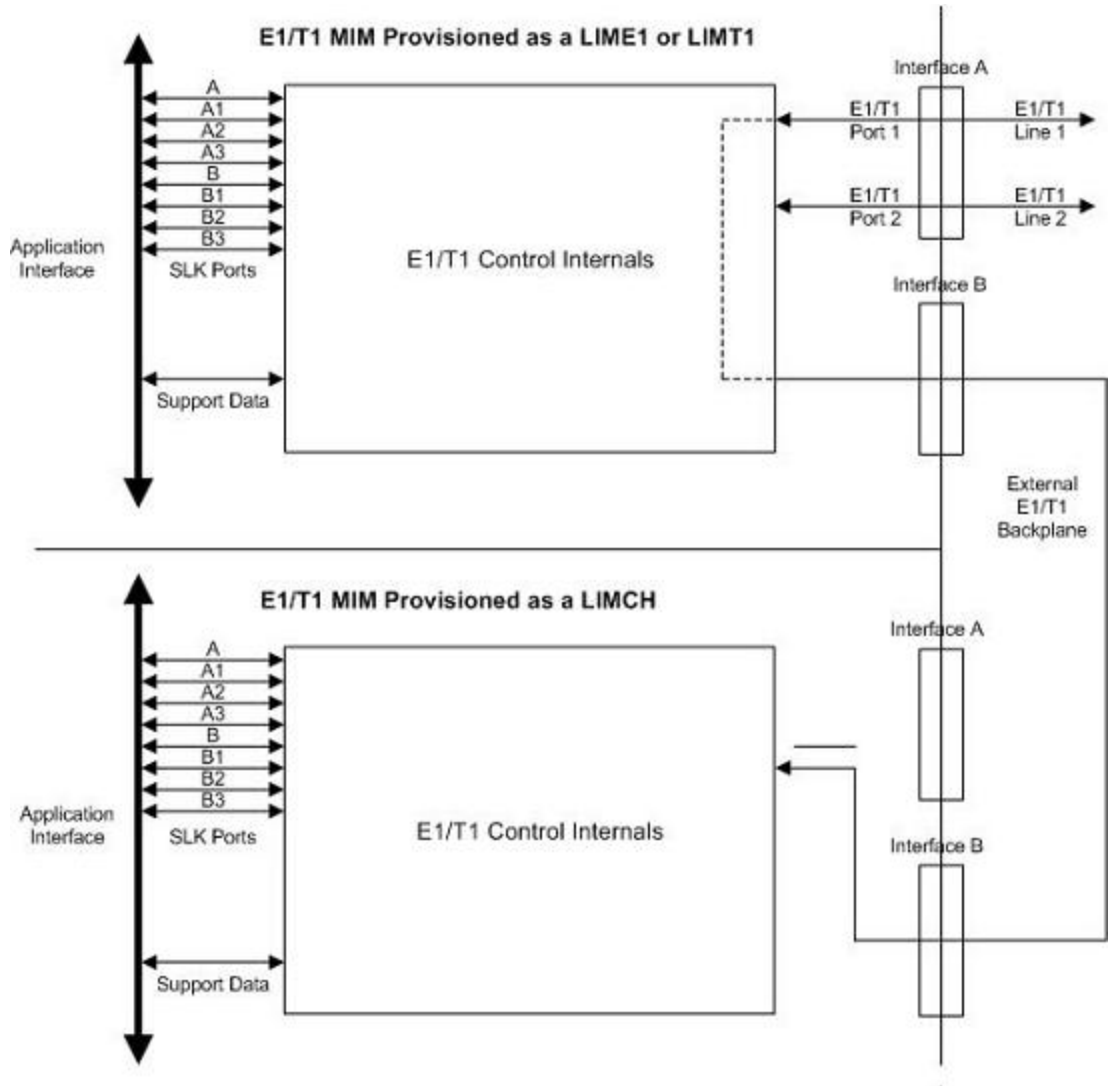


Figure B-2 HC MIM or E5-E1T1 Block Diagram

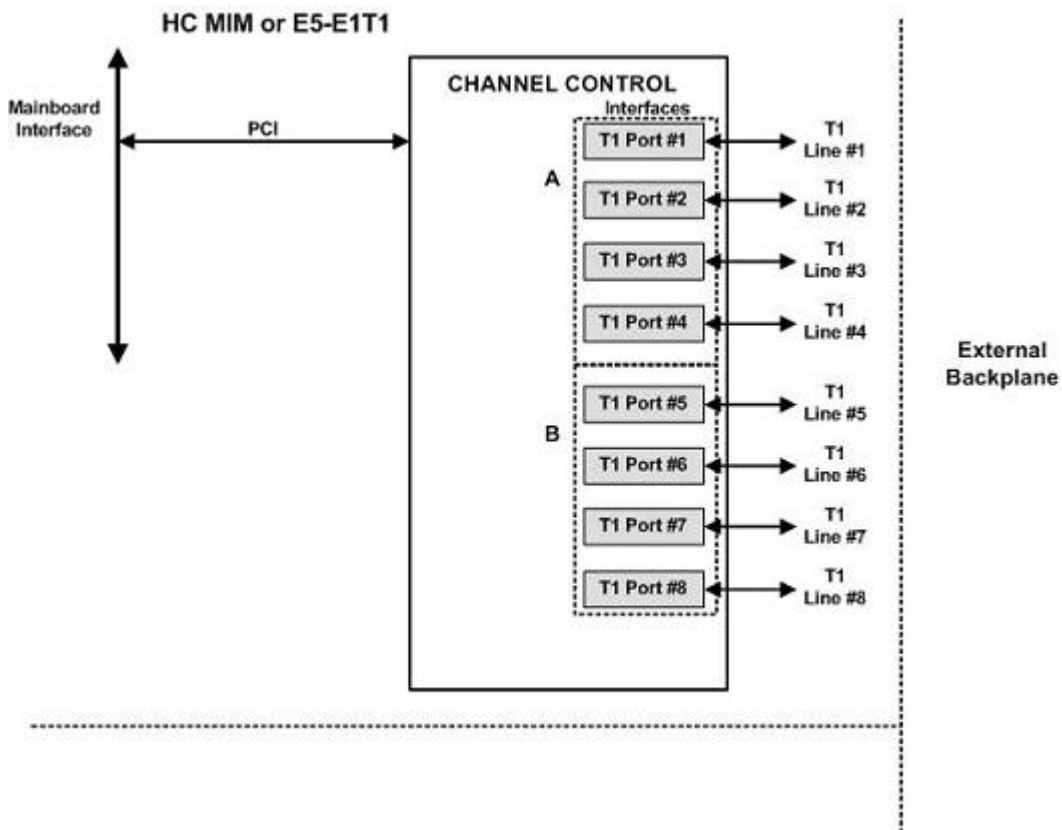


Table B-1 provides an overview of the functions of the T1 card and the channel card.

Table B-1 Functional Overview of the T1 and Channel Card

Card	Function
T1	<ul style="list-style-type: none"> Connectivity of both T1 interfaces to a 100 Ohm interface. Processing of a total of eight time slots from the T1 interfaces Interface T1 port 1 through an external backplane to channel cards for processing of additional time slots
Channel	<ul style="list-style-type: none"> Processing of eight time slots from the T1 interface Interface through an external backplane to a T1 card to process eight time slots

Configured as a T1 Card

Configured as a T1 card, two separate and independent T1 inputs can be terminated on a T1/channel card. From one or two bi-directional T1 facility inputs, one to eight bi-directional channels are extracted and processed as SS7 signaling links. Implemented as T1 Link Interface Modules, up to 24 separate and independent T1 inputs can be terminated in an extension shelf. The transmission rate of signaling links on the MIM card must be 56 kbps.

Configured as a Channel Card

In an extension shelf equipped with the T1 backplane, a T1 configured card terminates one or two T1 inputs and connects the T1 port 1 input to one of eight available busses on the T1 cabling backplane. Other T1 cards configured as channel cards also connected to the T1 cabling backplane are able to extract any eight signaling channels from the same T1 port 1 input. The transmission rate of signaling links on the MIM card configured as a channel card must be 56 kbps.

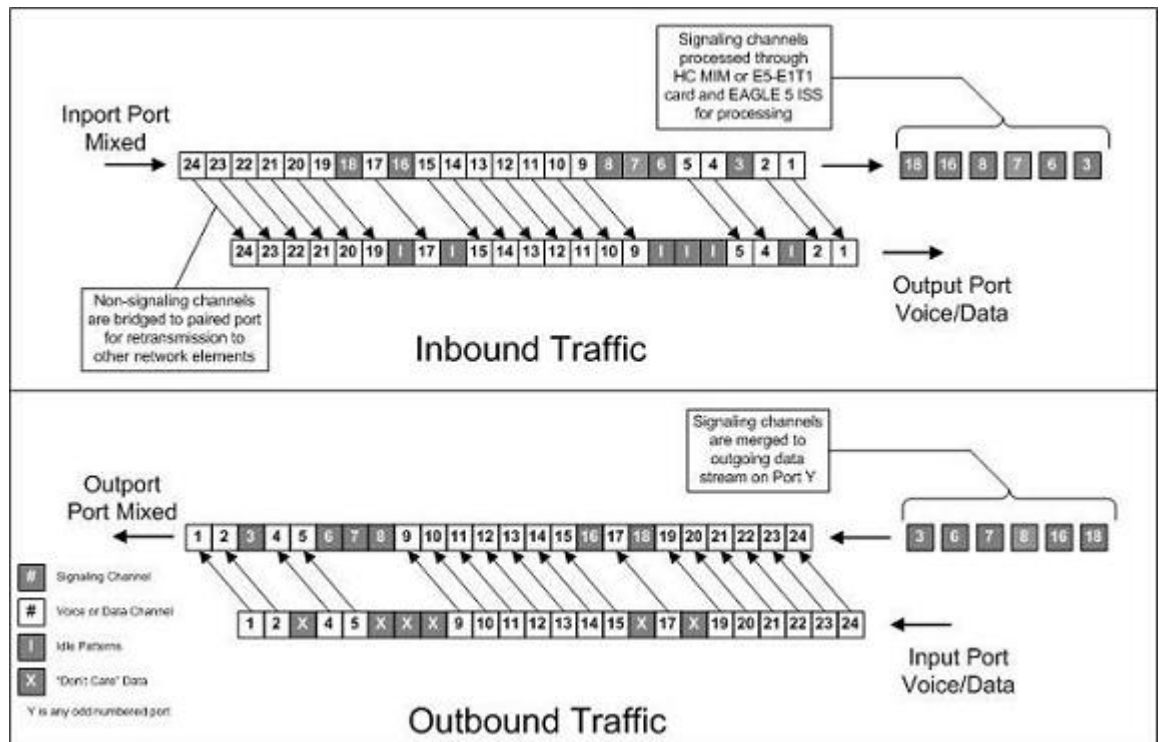
Note: An HCMIM or an E5-E1T1 card cannot be used as a channel card.

High Capacity Multi-Channel Interface Module (HC-MIM) and Eagle 5 - E1 T1 Interface (E5-E1T1)

The High Capacity Multi-Channel Interface Module (HC-MIM) and EAGLE 5 - E1 T1 Interface (E5-E1T1) provides access to eight T1 ports residing on backplane connectors A and B. Each data stream consists of 24 T1 DS0 signaling links assigned in a time-division multiplex manner. Each channel occupies a unique timeslot in the data stream and can be selected as a local signaling link on the interface card. A maximum of 64 T1 signaling links can be assigned to an HC-MIM. A maximum of 32 T1 signaling links can be assigned to an E5-E1T1 card.

To support the processing of signaling channels that are intermixed on trunks with voice or data channels, the HC-MIM and E5-E1T1 card allows T1 ports to be channel bridged. This allows better utilization of T1 bandwidth without dedicating entire trunks to signaling.

Figure B-3 Channel Bridging



Channel bridging is implemented by pairing odd and even T1 ports. The T1 port selected for channel bridging is the odd numbered port (1, 3, 5, 7). When the T1 port is

selected for channel bridging, it is paired with its adjacent even numbered port (2, 4, 6, 8) as shown in [Table B-2](#).

Table B-2 Channel Bridging T1 Port Pairing

Odd Numbered T1 Port (Bridging Master)	Even Numbered T1 Port Bridged to the Odd Numbered T1 Port (Bridging Slave)
1	2
3	4
5	6
7	8

By pairing T1 ports, the adjacent even numbered T1 port could be used to allow data received on the bridging master (odd) T1 port to reach downstream network elements. This interface is a bi-directional interface so data is also able to enter the bridging slave (even) T1 port and leave the EAGLE through the bridging master (odd) T1 port. There is a 1 to 1 correspondence between the timeslots on the bridging master and slave T1 ports.

In order to use channel bridging without facility errors, both T1 ports (bridging master and slave) must be synchronous (timed off the same clock source). This may be accomplished in one of the following ways:

- The bridging master T1 port and the bridging slave T1 port use timing recovered from each other (using the `tltsel=recovered` parameter with either the `ent-t1` or `chg-t1` command). When provisioning channel bridged T1 port, only the bridging master T1 port is provisioned with the `ent-t1` or `chg-t1` command. The bridging slave T1 port is automatically provisioned with the same attributes as the bridging master T1 port.
- Both the bridging master and slave T1 ports are using an external clock source (using the `tltsel=external` parameter when provisioning the channel bridged T1 port with either the `ent-t1` or `chg-t1` command).

Any other methods used for timing could cause problems on the T1 trunk and are not be supported.

Idle patterns on the shadow channels, that is, the timeslots located on the bridging slave T1 port that have been not been dropped from the bridging master T1 port, are provided by the EAGLE. All other idle timeslots that are not dropped by the EAGLE must contain an idle pattern provided by the remote network elements connected to both T1 ports (bridging master and slave). Without these patterns on the idle timeslots, instability of the T1 signaling link may occur.

Provisioning of signaling links on the bridging slave T1 port is not allowed while the bridging master T1 port is channel bridged.

Determining the Configuration

External Interface Descriptions

The T1 backplane provides a method for extending individual T1 channels from the T1-configured cards to any channel-configured cards in use. Note the following issues regarding the T1 backplane:

- Only one **T1**-configured card may be plugged into each bus on the backplane.
- When installing non-**T1** cards on the shelf equipped with the **T1** interface backplane, ensure that none of the slots to be used are cabled to the **T1** interface backplane. If a non-**T1** card is installed in a slot that is connected to the **T1** backplane, all **T1** cards on that bus may fail.
- Only one **T1** card may be connected (via the B port) to each bus of the **T1** backplane, and all **SS7** links derived from any particular **T1** must be processed on the same shelf on which the incoming **T1** is terminated.
- Due to cable congestion, Oracle does not recommend use of the **T1** cabling backplane on the control shelf.
- If the control shelf is used, a maximum of 20 **T1** interfaces can be utilized in the control shelf.

Descriptions of the **T1** hardware and the procedures for installing the **T1** hardware are contained in *Hardware Reference* and *Installation Guide*.

The procedure for removing a **T1** signaling link is the same as removing an **SS7** signaling link, so to remove a **T1** signaling link from the database, go to the [Removing an SS7 Signaling Link](#) procedure.

Possible Configurations

The **T1** backplane was designed to allow the maximum number of possible customer setups. It allows the customer to choose between several levels of diversity and convenience. Configurations depend on the number of cards configured as **T1** cards versus the number of cards configured as channel cards. The level of diversity required by the customer also affects the configuration requirements. Note that all signals labeled “**T1** input” may be one or two **T1** ports depending on the cable used.

Support of Two T1 Ports

The **E1/T1 MIM** will support two **T1** ports, which are independently configurable. On a **T1** card, **T1** port 1 will support channel cards. The second port of that **T1** card will only support up to a maximum of eight time slots and will not support channel cards.

Clocking Options

Each **T1** interface must independently operate in one of two clocking modes. When configured as a channel card, a **T1** card is required for the channel card’s clocking source.

- Slave Timing - The default receive clock on the **LIM-T1** card will be used as the source of the transmit clock.
- Master Timing - The transmit clock of the **LIM-T1** card. The Master Timing feature allows a **T1** signaling link to take its high-speed clock reference directly from an external high-speed master clock source.

Support of T1 Framing Options

The **T1** interfaces independently support either the **SF** (superframe format) or **ESF** (extended superframe format) **T1** framing options. Selection of these options is made by the `framing` parameter of either the `ent-t1` or `chg-t1` commands.

LIM-T1 Card to Channel Card Interface

Whether the **T1** card is operating as a **T1** card or a channel card, the card will map any eight channels from the **T1** interfaces to an **HDLC** controller (ports A, B, A1, A2, A3,

B1, B2, B3). These eight channels could be dropped either both from T1 port 1 or one from T1 port 1 and the other from T1 port 2. When the T1 card is configured as a T1 card, it will support the external T1 cabling backplane interface from T1 port 1 (*T1 port 2 will not have this capability*) to additional T1 cards, within the same shelf, configured as channel cards. Idle time slots not assigned to a T1 card or a channel card will be filled with a one's pattern.

T1 Configuration Form

Use the form provided below to record your T1 configuration. An example of the required input is shown in italics under each column heading.

Table B-3 T1 Signaling Link Configuration Form

Card Location and Port (1201 A)	Timeslot (1)	T1 Number (1)	T1 Card Location (1201)	Adjacent Point Code (4001)	Linkset (ST1ME)	SLC (1)
------------------------------------------	-----------------	------------------	-------------------------------	----------------------------------	--------------------	---------

Table B-3 (Cont.) T1 Signaling Link Configuration Form

Card Location and Port (1201 A)	Timeslot (1)	T1 Number (1)	T1 Card Location (1201)	Adjacent Point Code (4001)	Linkset (ST1ME)	SLC (1)
---------------------------------	--------------	---------------	-------------------------	----------------------------	-----------------	---------

T1 Interface Configuration Procedures

This appendix contains these procedures because they contain information specific to the T1 Interface:

- [Adding a LIM-T1 Card](#)
- [Removing a LIM-T1 Card](#)
- [Adding Channelized and non-Channel Bridged T1 Ports](#)
- [Adding Channel Bridged T1 Ports](#)
- [Adding Unchannelized T1 Ports](#)
- [Removing the T1 Interface Parameters](#)
- [Changing the Attributes of a Channelized T1 Port](#)
- [Changing the Attributes of an Unchannelized E1 Port](#)
- [Making a Channel Bridged T1 Port from a Channelized T1 Port](#)
- [Making a Non-Channel Bridged T1 Port from a Channel Bridged T1 Port](#)
- [Adding a T1 Signaling Link](#)

Procedures for configuring the linksets and routes, for removing SS7 signaling links (which includes T1 signaling links), and for configuring the HC MIM temperature alarms are contained in [SS7 Configuration](#). These procedures contain no information that is specific to the T1 interface, therefore, are not included in this appendix.

The procedures contained in this appendix use a variety of commands. If more information on these commands is needed, go to the *Commands Manual* to find the required information.

Adding a LIM-T1 Card

The LIM-T1 card is provisioned as either a T1 card or a channel card in the database using the `ent-card` command. The card being provisioned in the database can be one of these cards shown in [Table B-4](#).

Table B-4 T1 Card Part Numbers

Card Type	Part Number
E1/T1MIM	870-2198-XX

Table B-4 (Cont.) T1 Card Part Numbers

Card Type	Part Number
E5-E1T1	870-1873-XX

The `ent-card` command uses these parameters.

`:loc` – The location of the card being added to the database.

Note: The **HC-MIM** can be inserted in an odd-numbered card location only. The **HC-MIM** will not power up if it is inserted in an even-numbered card location. All **T1** backplane cabling should be removed from the B connector for the slot that the **HC-MIM** will occupy.

The **HC-MIM** occupies two card locations, so the even numbered card location adjacent to the odd numbered slot where the **HC-MIM** has been inserted must be empty, as shown in [Table B-5](#). The **HC-MIM** is connected to the network through the odd numbered card slot connector.

Table B-5 HC-MIM Card Locations

Location of the HC-MIM	Empty Card Location	Location of the HC-MIM	Empty Card Location
Slot 01	Slot 02	Slot 11	Slot 12
Slot 03	Slot 04	Slot 13	Slot 14
Slot 05	Slot 06	Slot 15	Slot 16
Slot 07	Slot 08	Slot 17	Slot 18

The **E1/T1 MIM** and **E5-E1T1** card occupies one card location. These cards can be placed in any card location except for even numbered card locations whose adjacent odd numbered card location is occupied by a card that occupies two card locations.

`:type` – The type of card being added to the database. For this procedure, the value of this parameter is `limt1` (**T1** card) or `limch` (channel card).

Note: The **E5-E1T1** card cannot be provisioned as a channel card.

`:appl` – The application software that is assigned to the card. For this procedure, the value of this parameter is either `ccs7itu` or `ss7ansi`.

`:force` – Allow the **LIM** to be added to the database even if there are not enough service modules in the **EAGLE** to support the number of **LIMs** in the **EAGLE**. This parameter is obsolete and is no longer used.

The shelf to which the card is to be added must already be in the database. This can be verified with the `rtrv-shlf` command. If the shelf is not in the database, see the Adding a Shelf procedure in *Database Administration - System Management User's Guide*.

The examples in this procedure are used to add the **LIM-T1** cards in card locations 1215 and 1216 to the database.

1. Display the cards in the **EAGLE** using the `rtrv-card` command.

```

rlghncxa03w 09-05-28 09:12:36 GMT EAGLE5 41.0.0
CARD   TYPE      APPL      LSET NAME   LINK SLC LSET NAME   LINK SLC
1102   TSM           GLS
1113   GSPM          OAM
1114   TDM-A
1115   GSPM          OAM
1116   TDM-B
1117   MDAL
1201   LIMDS0        SS7ANSI   lsne12      A    0
1202   LIMDS0        SS7ANSI   lsne12      A    1
1203   LIMDS0        SS7ANSI   lsne13      A    0
1204   LIMDS0        SS7ANSI   lsne13      A    1
1207   LIMT1         SS7ANSI   lsnt265     A    0
1208   LIMCH         SS7ANSI   lsnt265     A    1   lsnt265     A2    2
1211   LIMT1         CCS7ITU   lsne145     A    0
1212   LIMCH         CCS7ITU   lsne145     A    1   lsne145     A2    2
1316   DCM           STPLAN
    
```

The cards should be distributed throughout the **EAGLE** for proper power distribution. Refer to *Installation Guide* for the shelf power distribution.

2. Verify that the correct hardware has been installed on the **EAGLE** to support the **LIM-T1** card as shown in *Installation User's Guide*.
3. Physically verify that the T1 card has been installed into the card location that will be specified in 7.

If the T1 card is an HC-MIM, make sure the HC-MIM is installed according to the card location requirements shown in [Table B-5](#). If a card is installed and provisioned in the even-numbered card location adjacent to the desired odd numbered card, choose another card location to install and provision the HC-MIM, or remove the card in the even-numbered card location by performing the appropriate procedure shown in [Table B-6](#).

Note: Channel cards must be installed in the same shelf as the T1 card that is servicing the timeslots on those channel cards.

Table B-6 Card Removal Procedures

Card Application	Procedure
SS7ANSI, ATMANSI, CCS7ITU, ATMITU	"Removing an SS7 LIM " in Chapter 4, "System Configuration Procedures" in <i>Database Administration - System Management User's Guide</i> "Removing a LIM-E1Card" "Removing a LIM-T1Card"
VSCCP	Removing a Service Module in Chapter 2 in <i>Database Administration - GTT User's Guide</i>

Table B-6 (Cont.) Card Removal Procedures

Card Application	Procedure
GLS	Removing a GLS Card in Chapter 2, Gateway Screening (GWS) Overview, in <i>Database Administration - GWS User's Guide</i>
STPLAN	"Removing an STP LAN Card" in <i>Database Administration - Features User's Guide</i>
IPLIM, IPLIMI, SS7IPGW, IPGWI	"Removing an IPLIMx Card" or Removing an IPGWx Card" in <i>Database Administration - IP7 User's Guide</i>
IPSG	"Removing an IPSG Card" in <i>Database Administration - IP7 User's Guide</i>
EROUTE	"Removing an STC Card" in <i>Database Administration - Features User's Guide</i>
MCP	"Removing an MCPM" in Chapter 4, "System Configuration Procedures" in <i>Database Administration - System Management User's Guide</i>
IPS	"Removing an IPSM" in Chapter 4, "System Configuration Procedures" in <i>Database Administration - System Management User's Guide</i>

- If the card is an EPM-B based card (E5-E1T1-B), enter the `rtrv-stpopts` command to verify whether or not the MFC option is on. If the card is not an EPM-B based card, continue the procedure with 5

This is an example of the possible output.

```
rlghncxa03w 11-10-17 16:02:05 GMT EAGLE5 44.0.0
STP OPTIONS
-----
MFC                               off
```

The `rtrv-stpopts` command output contains other fields that are not used by this procedure. To see all fields displayed by the `rtrv-stpopts` command, see the `rtrv-stpopts` command description in *Commands User's Guide*.

If the **MFC** option is off, perform the Configuring the MFC Option procedure in *Database Administration - System Management User's Guide* to turn on the MFC option.

If the MFC option is on or the MFC Option procedure in *Database Administration - System Management User's Guide* was performed in this step, continue the procedure with 5.

- The Fan feature must be turned on. Enter the `rtrv-feat` command to verify that the Fan feature is on.

If the Fan feature is on, shown in the `rtrv-feat` output in this step, the **FAN** field should be set to on.

The `rtrv-feat` command output contains other fields that are not used by this procedure. To see all fields displayed by the `rtrv-feat` command, see the `rtrv-feat` command description in *Commands User's Guide*.

If the Fan feature is on, continue the procedure with 7.

If the Fan feature is off, continue the procedure with 6.

6. Turn the Fan feature on by entering this command.

```
chg-feat:fan=on
```

Note: Once the Fan feature is turned on with the `chg-feat` command, it cannot be turned off.

When the `chg-feat` has successfully completed, this message appears.

```
rlghncxa03w 11-10-28 11:43:04 GMT EAGLE5 44.0.0
CHG-FEAT: MASP A - COMPLTD
```

7. Add the card using the `ent-card` command. If the LIM-T1 card is an **HC-MIM**, the **HC-MIM** can be only in a odd-numbered card location, and cannot be provisioned as a channel card.

For this example, enter these commands.

```
ent-card:loc=1215:type=limt1:appl=ss7ansi
ent-card:loc=1216:type=limch:appl=ss7ansi
```

8. Verify the changes using the `rtrv-card` command with the card location specified in 7.

For this example, enter these commands.

```
rtrv-card:loc=1215
```

```
rlghncxa03w 06-10-28 09:12:36 GMT EAGLE5 36.0.0
CARD  TYPE      APPL      LSET NAME   LINK SLC LSET NAME   LINK SLC
1215  LIMT1        SS7ANSI
```

```
rtrv-card:loc=1216
```

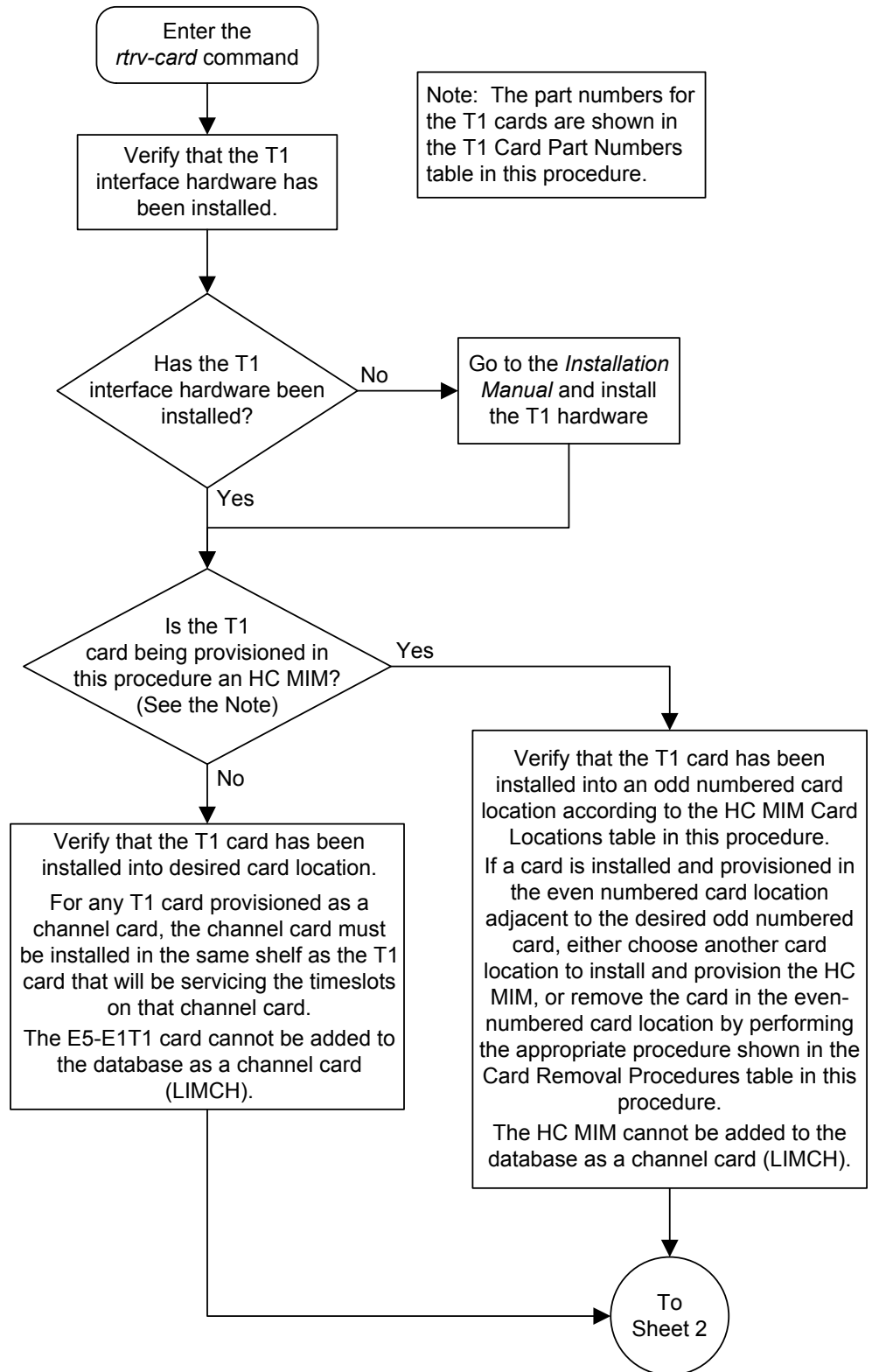
```
rlghncxa03w 06-10-28 09:12:36 GMT EAGLE5 36.0.0
CARD  TYPE      APPL      LSET NAME   LINK SLC LSET NAME   LINK SLC
1216  LIMCH        SS7ANSI
```

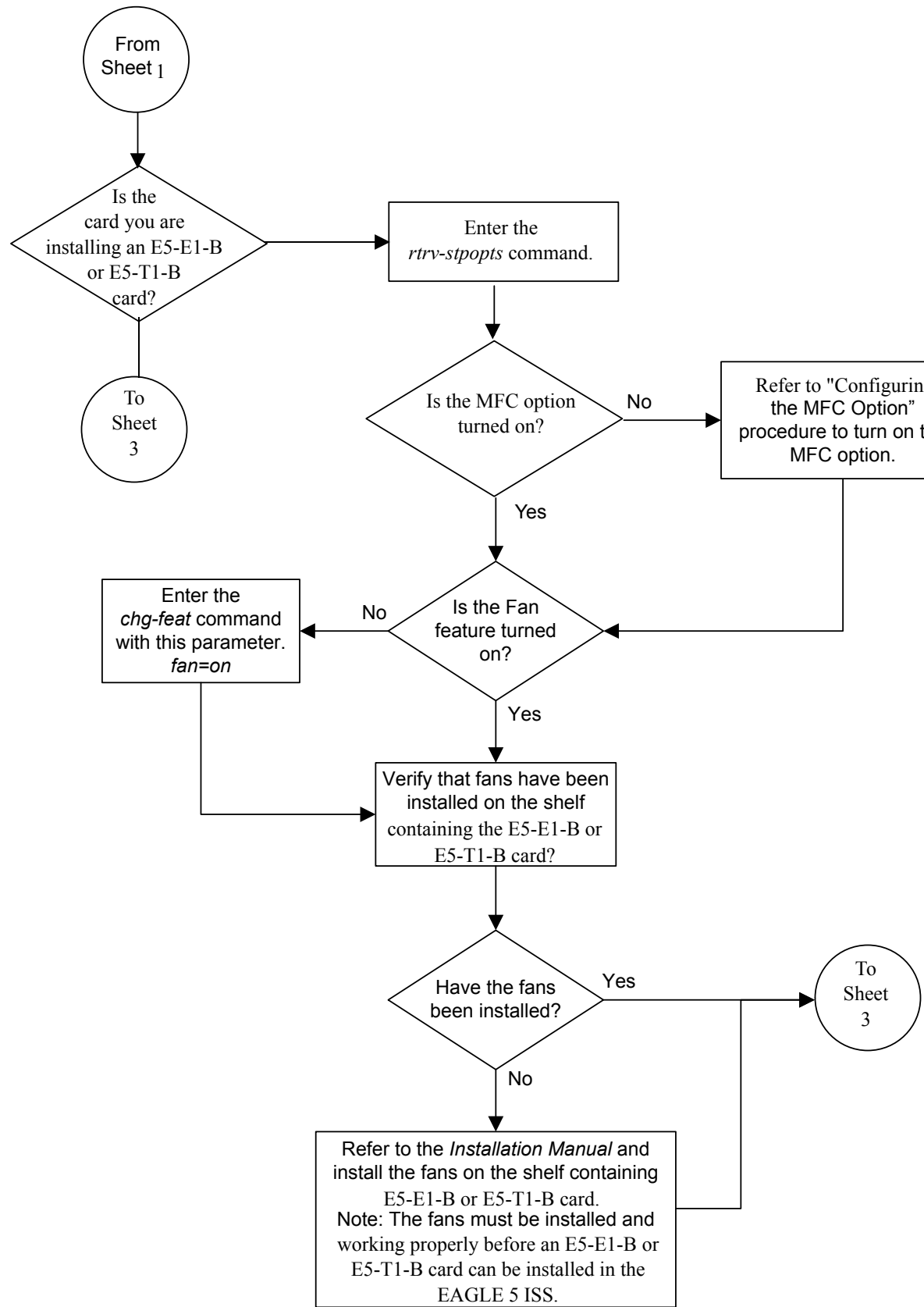
9. Back up the new changes using the `chg-db:action=backup:dest=fixed` command.

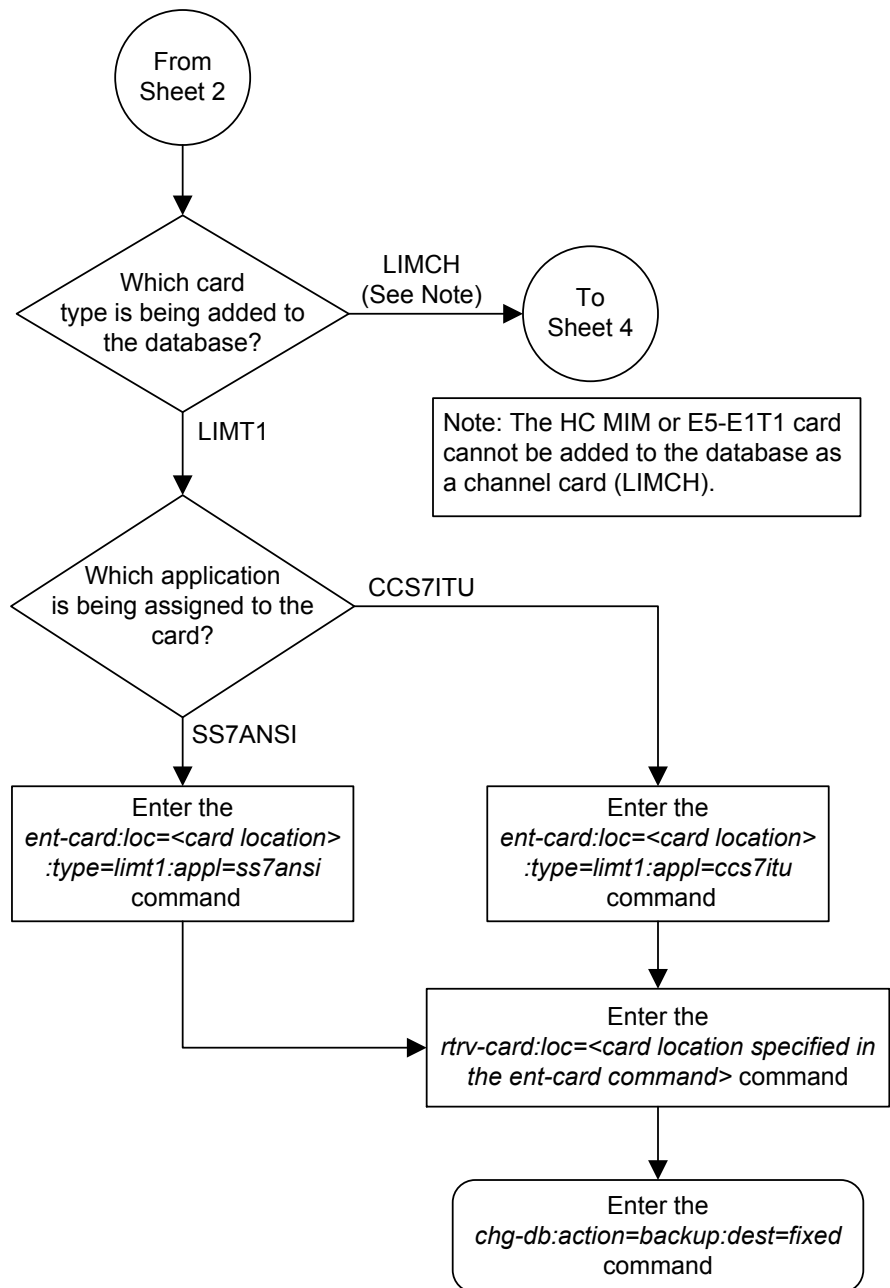
These messages should appear, the active **Maintenance and Administration Subsystem Processor (MASP)** appears first.

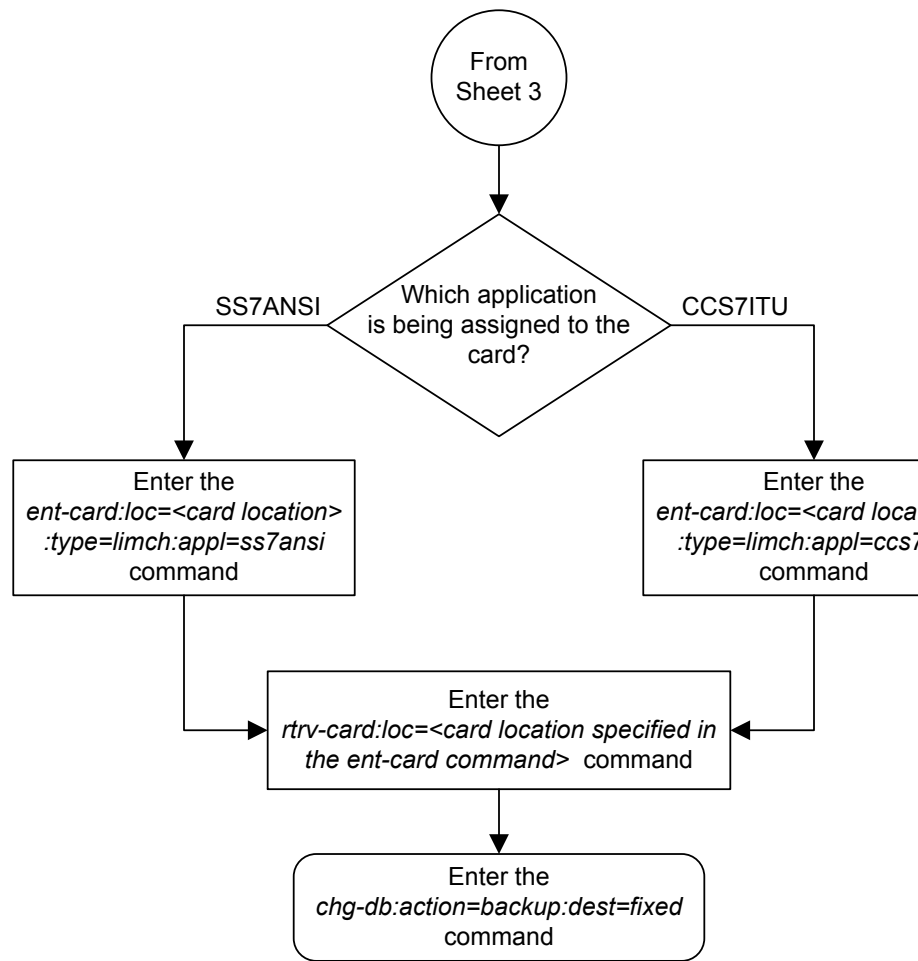
```
BACKUP (FIXED) : MASP A - Backup starts on active MASP.
BACKUP (FIXED) : MASP A - Backup on active MASP to fixed disk complete.
BACKUP (FIXED) : MASP A - Backup starts on standby MASP.
BACKUP (FIXED) : MASP A - Backup on standby MASP to fixed disk complete.
```

Figure B-4 Adding a LIM-T1 Card









Removing a LIM-T1 Card

This procedure is used to remove either a **T1** card or a channel card from the database using the `dlc-card` command. The card being removed must exist in the database.

If a **T1** card is being removed, then no **T1** interfaces can be assigned to the card. This can be verified with the `rtrv-t1` command. Go to the [Removing the T1 Interface Parameters](#) procedure to remove the **T1** interfaces assigned to the **T1** card being removed from the database.

If only a channel card is being removed from the database, then no **SS7** signaling links can be assigned to the card. This can be verified with the `rtrv-slk` command. Go to the [Removing an SS7 Signaling Link](#) procedure to remove the signaling links assigned to the channel card being removed from the database.

Caution: If the **T1** card or channel card is the last **SS7LIM** in service, removing this card from the database will cause **SS7** traffic to be lost and isolate the **EAGLE 5 ISS** from the network.

The examples in this procedure are used to remove the **T1** cards in card locations 1207 and 1208.

1. Display the cards in the database using the `rtrv-card` command. This is an example of the possible output.

```
rlghncxa03w 09-05-28 09:12:36 GMT EAGLE5 41.0.0
CARD  TYPE      APPL      LSET NAME  LINK SLC LSET NAME  LINK SLC
1102  TSM          GLS
1113  GSPM         OAM
1114  TDM-A
1115  GSPM         OAM
1116  TDM-B
1117  MDAL
1207  LIMT1       SS7ANSI  lsnt265    A    0
1208  LIMCH       SS7ANSI  lsnt265    A    1  lsnt265    A2    2
1211  LIME1       CCS7ITU  lsne145    A    0
1212  LIMCH       CCS7ITU  lsne145    A    1  lsne145    A2    2
1215  LIMT1       SS7ANSI  lsnt145    A    0
1216  LIMCH       SS7ANSI  lsnt145    A    1  lsnt145    A2    2
1316  DCM         STPLAN
```

Note: If a **T1** card is being removed from the database, skip step 2 and go to step 3.

2. Display the signaling links on the channel card you wish to remove by entering the `rtrv-slk` command, specifying the card location shown in the `rtrv-card` command output. For this example, enter this command.

```
rtrv-slk:loc=1208
```

```
rlghncxa03w 06-10-19 21:17:04 GMT EAGLE5 36.0.0
LOC  LINK LSN          SLC TYPE  L2T      SET  BPS    ECM  PCR  PCR  T1  T1
      LINK LSN          SLC TYPE  SET  BPS    ECM  N1   N2   LOC PORT TS
```

```

1208 A    lsnt265      1 LIMCH    1    56000 BASIC --- ----- 1207 1    6
1208 A2   lsnt265      2 LIMCH    1    56000 BASIC --- ----- 1207 1   17

```

Go to the [Removing an SS7 Signaling Link](#) procedure to remove the signaling links assigned to the channel card.

Note: If only a channel card is being removed from the database, skip step 3 and go to step 4.

3. Display the **T1** interfaces assigned to the **T1** card being removed from the database using the `rtrv-t1` command with no parameters.

```
rlghncxa03w 09-05-19 21:17:04 GMT EAGLE5 41.0.0
```

```

          T1
LOC  PORT  ENCODE  T1TSEL  FRAMING  LL  CHANBRDG  CLASS  RATE
1207  1     AMI     EXTERNAL  ESF      50  -----  CHAN  ----
1215  2     B8ZS    LINE      SF       100 -----  CHAN  ----

```

Go to the [Removing the T1 Interface Parameters](#) procedure to remove the **T1** interfaces assigned to the **T1** card.

4. Remove the card using the `dlt-card` command. The `dlt-card` command has only one parameter, `loc`, which is the location of the card. For this example, enter these commands.

```
dlt-card:loc=1207
```

```
dlt-card:loc=1208
```

5. Verify the changes using the `rtrv-card` command specifying the card that was removed in step 4. For this example, enter these commands.

```
rtrv-card:loc=1207
```

```
rtrv-card:loc=1208
```

When these commands have successfully completed, this message should appear.

```
E2144 Cmd Rej: Location invalid for hardware configuration
```

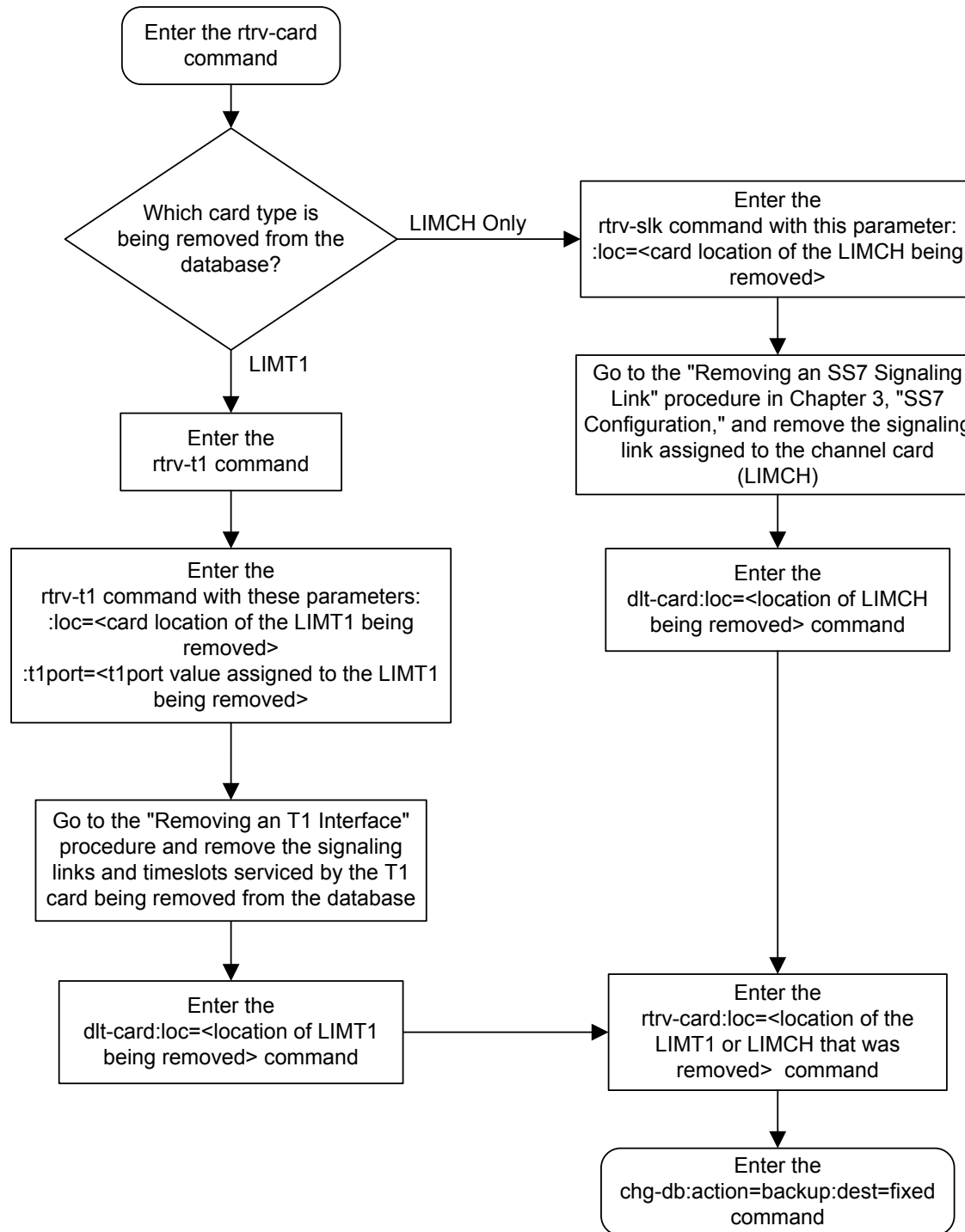
6. Back up the new changes using the `chg-db:action=backup:dest=fixed` command. These messages should appear, the active **Maintenance and Administration Subsystem Processor (MASP)** appears first.

```

BACKUP (FIXED) : MASP A - Backup starts on active MASP.
BACKUP (FIXED) : MASP A - Backup on active MASP to fixed disk complete.
BACKUP (FIXED) : MASP A - Backup starts on standby MASP.
BACKUP (FIXED) : MASP A - Backup on standby MASP to fixed disk complete.

```

Figure B-5 Removing a LIM-T1 Card



Adding Channelized and non-Channel Bridged T1 Ports

The channelized and non-channel bridged T1 ports are provisioned in the database using the `ent-t1` command using these parameters.

`:loc` – The location of the T1 card (card type `limt1`) that is servicing the T1 signaling link. The location of a channel card (card type `limch`) cannot be specified for this parameter.

`:t1port` – The T1 port on the T1 card used to service the T1 signaling link. The `t1port` value cannot already be assigned to the T1 card specified by the `loc` parameter.

`:encode` – Specifies the type of encoding or decoding that is used on the T1 signaling link, either **B8ZS** or **AMI**. The default value is **B8ZS** encoding (`encode=b8zs`).

`:t1tsel` – The timing source for the T1 signaling link, master (`external`), slave (`line`), or `recovered`. The default value is slave timing (`t1tsel=line`).

The `recovered` timing source can be used only with the `chanbrdg=on` parameter and cannot be used in this procedure.

Note: To use an external high-speed master clock source other than RS-422, TDMs 870-0774-15 or later must be installed in card locations 1114 and 1116, and the TDM Global Timing Interface options must be configured. For more information, refer to [Configuring the Options for the TDM Global Timing Interface](#).

`:framing` – Specifies the framing format to be used on the T1 signaling link, either `sf` or `esf`. The default value is `sf` (`framing=sf`).

`:ll` – The length of the cable, in feet, used for the T1 signaling link. The value of the `ll` parameter is from 0 to 655. The default value for this parameter is 133.

The `ent-t1` command contains other parameters that are not used in this procedure. These parameters and their usage are described in these sections:

- `t1tsel=recovered`, `chanbrdg`, and `force=yes` – [Adding Channel Bridged T1 Ports](#).
- `framing=esfperf`, `linkclass`, and `minsurate` – [Adding Unchannelized T1 Ports](#).

The T1 card specified in this procedure must be in the database. This can be verified with the `rtrv-card` command.

The T1 card cannot contain channelized and unchannelized T1 ports.

1. Display the existing T1 interfaces in the database using the `rtrv-t1` command with no parameters.

```
rlghncxa03w 09-05-19 21:17:04 GMT EAGLE5 41.0.0
```

T1							LINK	MINSU
LOC	PORT	ENCODE	T1TSEL	FRAMING	LL	CHANBRDG	CLASS	RATE
1207	1	AMI3	EXTERNAL	ESF	50	----	CHAN	----

Continue the procedure by performing one of these substeps.

- a. If the T1 card that the T1 port is being assigned to in this procedure is not shown in the `rtrv-t1` output, or if the T1 card has unchannelized T1 ports assigned to it, continue the procedure with 2 to verify if there are any T1 cards in the database that have no T1 ports assigned to them.
- b. If the `rtrv-t1` output shows that the T1 card has channel bridged T1 ports assigned to it, or that T1 ports 3, 4, 5, 6, 7, or 8 are assigned to the T1 card, the T1 card is an HC-MIM or an E5-E1T1 card. Continue the procedure with 7 to add the T1 port with the parameters allowed for an HC-MIM or an E5-E1T1 card.
- c. If the `rtrv-t1` output shows that the T1 card does not have channel bridged T1 ports assigned to it, or that T1 ports 3, 4, 5, 6, 7, or 8 are not assigned to the T1 card, verify the type of T1 card that the T1 port will be assigned to. The T1 card types and their part numbers are shown in Table B-4. If the T1 card is an HC-MIM or an E5-E1T1 card, continue the procedure by performing one of these steps.
 - If the T1 cards shown in this step are on the same shelf as the card that will contain the T1 port that is being added, and these cards have T1 ports 3 through 8 provisioned, contain channel bridged T1 ports, or unchannelized T1 ports, continue the procedure with 7.
 - If the T1 cards shown in this step are not on the same shelf as the card that will contain the T1 port that is being added, continue the procedure with 3.
 - If the T1 cards shown in this step are on the same shelf as the card that will contain the T1 port that is being added, and these cards do not have T1 ports 3 through 8 provisioned, do not contain channel bridged T1 ports, or do not have unchannelized T1 ports, continue the procedure with 3.
- d. If the T1 card you wish to use in this procedure has all the T1 ports that are allowed to be assigned to it, select another T1 card to add the T1 port to, or continue the procedure with 2 to verify if there are any T1 cards in the database that have no T1 ports assigned to them. Table B-7 shows the number of T1 ports that are allowed for the different T1 card types.

Table B-7 Maximum Number of T1 Ports

T1 Card Types	Maximum Number of T1 Ports
HC-MIM	8
E5-E1T1	8

2. Display the cards in the EAGLE using the `rtrv-card` command.

```
rlghncxa03w 09-05-28 09:12:36 GMT EAGLE5 41.0.0
CARD  TYPE      APPL      LSET NAME  LINK SLC LSET NAME  LINK SLC
1102  TSM          GLS
1113  GSPM         OAM
1114  TDM-A
1115  GSPM         OAM
1116  TDM-B
1117  MDAL
1207  LIMT1       SS7ANSI  lsnt265   A      0
```

1208	LIMCH	SS7ANSI	lsnt265	A	1	lsnt265	A2	2
1211	LIME1	CCS7ITU	lsne145	A	0			
1212	LIMCH	CCS7ITU	lsne145	A	1	lsne145	A2	2
1215	LIMT1	SS7ANSI						
1216	LIMCH	SS7ANSI						
1316	DCM	STPLAN						

Continue the procedure by performing one of these substeps.

- a. If the desired T1 card is not shown in the `rtrv-card` output, perform [Adding a LIM-T1 Card](#) to add the desired T1 card. If you wish to assign T1 ports 3, 4, 5, 6, 7, or 8 to the T1 card, the T1 card being added must be an HC-MIM or an E5-T1T1 card.
 - b. If the desired T1 card is shown in the `rtrv-card` output, verify the type of T1 card that the T1 port will be assigned to. The T1 card types and their part numbers are shown in [Table B-4](#).
 - c. If the T1 card that will be used in this procedure is an HC-MIM or an E5-E1T1 card, continue the procedure by performing one of these steps.
 - If T1 cards are shown in [1](#) that are on the same shelf as the card that will contain the T1 port that is being added, and these cards have T1 ports 3 through 8 provisioned, contain channel bridged T1 ports, or unchannelized T1 ports, continue the procedure with [7](#) to add the T1 port with the parameters allowed for an HC-MIM or an E5-E1T1 card.
 - If no T1 cards, shown in [1](#), are not on the same shelf as the card that will contain the T1 port that is being added, continue the procedure with [3](#).
 - If T1 cards are shown in [1](#) that are on the same shelf as the card that will contain the T1 port that is being added, and these cards do not have T1 ports 3 through 8 provisioned, do not contain channel bridged T1 ports, or do not have unchannelized T1 ports, continue the procedure with [3](#).
3. Verify that **HIPR2** cards are installed in card locations 9 and 10 in the shelf containing the HC MIM or E5-E1T1 card that will contain the T1 port being added in this procedure by entering this command.

```
rept-stat-gpl:gpl=hipr2
```

This is an example of the possible output.

```
rlghncxa03w 09-07-05 08:12:53 GMT 41.1.0
GPL          CARD          RUNNING          APPROVED          TRIAL
HIPR2        1109          126-002-000     126-002-000     126-003-000
HIPR2        1110          126-002-000     126-002-000     126-003-000
HIPR2        1209          126-002-000     126-002-000     126-003-000
HIPR2        1210          126-002-000     126-002-000     126-003-000
HIPR2        1309          126-002-000     126-002-000     126-003-000
HIPR2        1310          126-002-000     126-002-000     126-003-000
HIPR2        2109          126-002-000     126-002-000     126-003-000
HIPR2        2110          126-002-000     126-002-000     126-003-000
Command Completed
```

If **HIPR2** cards are installed in the shelf containing the HC MIM or E5-E1T1 card, continue the procedure by performing one of these steps.

- If the card is an E5-E1T1 card, continue the procedure with [7](#).

- If the card is an HC MIM, continue the procedure with 4.

If HIPR2 cards are not installed on the shelf containing the HC MIM or E5-E1T1 card, go to *Installation User's Guide* and install the HIPR2 cards. Once the HIPR2 cards have been installed, continue the procedure by performing one of these steps.

- If the card is an E5-E1T1 card, continue the procedure with 7.
 - If the card is an HC MIM, continue the procedure with 4.
4. Verify whether or not that the Fan feature is on, by entering the `rtrv-feat` command. If the Fan feature is on, the entry `FAN = on` appears in the `rtrv-feat` command output.

Note: The `rtrv-feat` command output contains other fields that are not used by this procedure. If you wish to see all the fields displayed by the `rtrv-feat` command, see the `rtrv-feat` command description in *Commands User's Guide*.

If the Fan feature is on, continue the procedure with 7.

If the Fan feature is off, continue the procedure with 5.

5. Turn the Fan feature on by entering this command.

```
chg-feat : fan=on
```

Note: Once the Fan feature is turned on with the `chg-feat` command, it cannot be turned off.

The Fan feature must be purchased before you turn this feature on with the `chg-feat` command. If you are not sure if you have purchased the Fan feature, contact your Sales Representative or Account Representative.

6. The shelf containing the HC-MIM being added in this procedure must have fans installed. Verify whether or not fans are installed on the shelf.

If the fans are installed, continue the procedure with 7.

If the fans are not installed on the shelf containing the HC-MIM, go to *Installation User's Guide* and install the fans. After the fans have been installed and tested, continue the procedure with 7.

7. Add the new T1 interface information to the database using the `ent-t1` command and the parameter combinations shown in [Table B-8](#), based on the type of T1 card being used.

Table B-8 T1 Interface Parameter Combinations

HC-MIM or an E5-E1T1 Card without Channel Bridging
Mandatory Parameters
:loc=location of the T1 card
:t1port=1, 2, 3, 4, 5, 6, 7, 8

Table B-8 (Cont.) T1 Interface Parameter Combinations

HC-MIM or an E5-E1T1 Card without Channel Bridging
Optional Parameters
:encode=ami, b8zs Default value = b8zs
:framing=sf, esf Default value = sf
:ll=0 - 655 Default value = 133
:t1tsel=line, external Default value = line
Notes: 1. Channel cards cannot be specified with the <code>ent-t1</code> command. 2. To configure the T1 port for master timing, use the <code>t1tsel=external</code> parameter. 3. The <code>linkclass=chan</code> parameter configures a channelized T1 port. Specifying the <code>linkclass=chan</code> parameter in this procedure is unnecessary as this is the default value for the <code>linkclass</code> parameter.

For this example, enter these commands.

```
ent-
t1:loc=1215:t1port=2:encode=b8zs:t1tsel=line:framing=sf:ll=10
0
```

8. Verify the changes using the `rtrv-t1` command specifying the card location and the `t1port` value specified in 7. For this example, enter this command.

```
rtrv-t1:loc=1215:t1port=2
```

```
rlghncxa03w 09-05-28 09:12:36 GMT EAGLE5 41.0.0
```

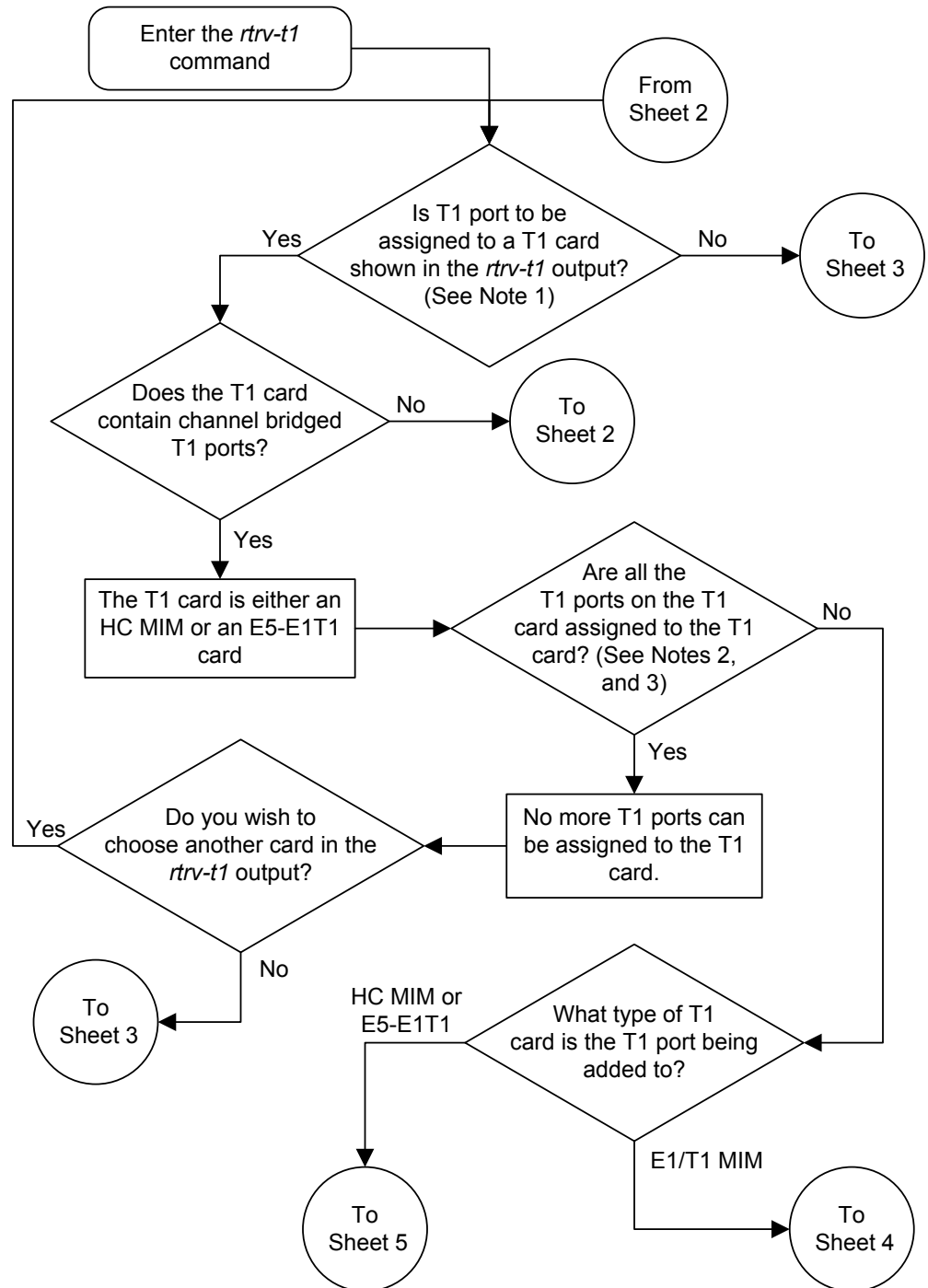
T1						LINK	MINSU	
LOC	PORT	ENCODE	T1TSEL	FRAMING	LL	CHANBRDG	CLASS	RATE
1215	2	B8ZS	LINE	SF	100	-----	CHAN	----
TS1	-----	TS9	-----	TS17	-----			
TS2	-----	TS10	-----	TS18	-----			
TS3	-----	TS11	-----	TS19	-----			
TS4	-----	TS12	-----	TS20	-----			
TS5	-----	TS13	-----	TS21	-----			
TS5	-----	TS14	-----	TS22	-----			
TS7	-----	TS15	-----	TS23	-----			
TS8	-----	TS16	-----	TS24	-----			

9. Back up the new changes using the `chg-db:action=backup:dest=fixed` command. These messages should appear, the active **Maintenance and Administration Subsystem Processor (MASP)** appears first.

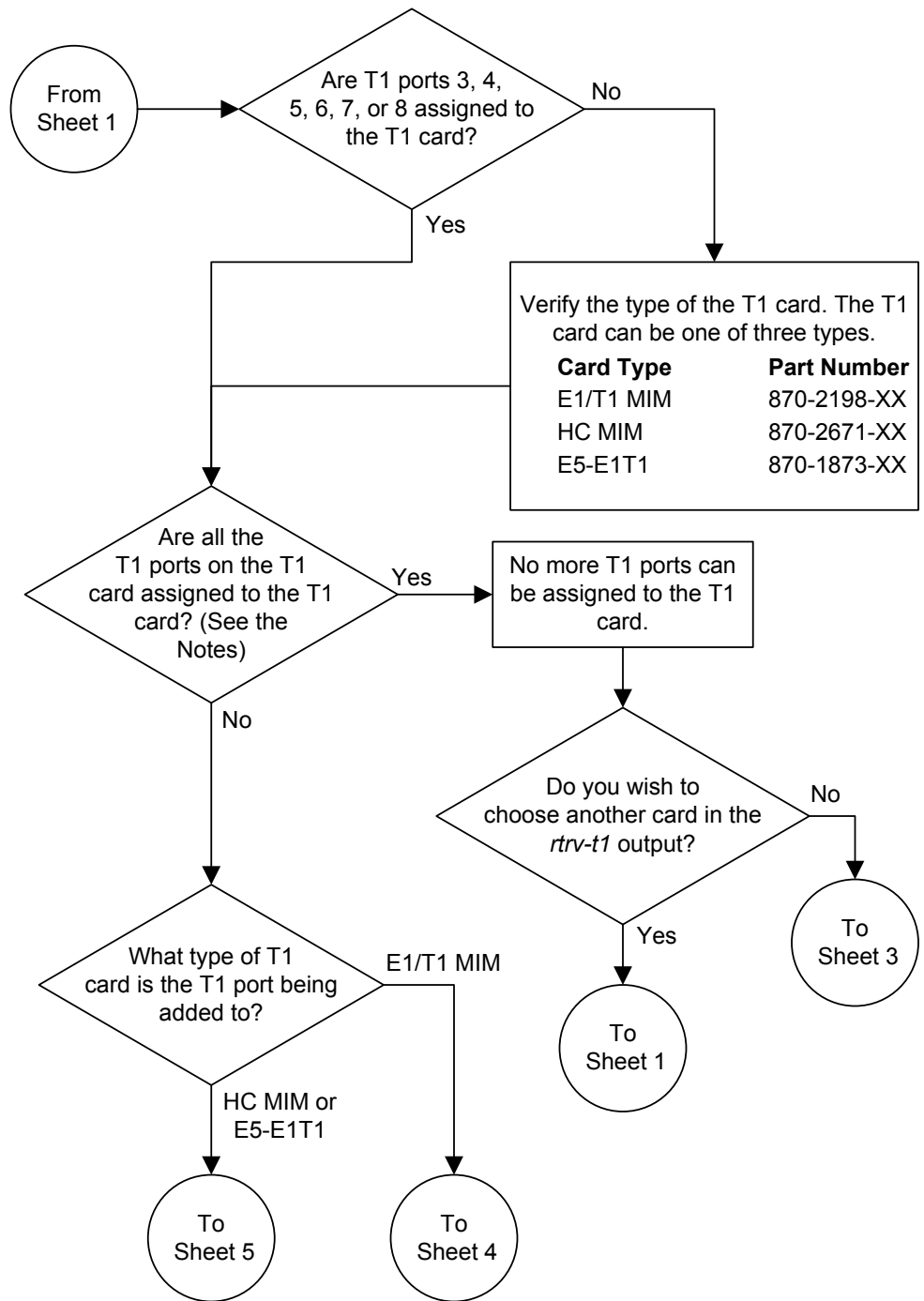
```
BACKUP (FIXED) : MASP A - Backup starts on active MASP.
```

```
BACKUP (FIXED) : MASP A - Backup on active MASP to fixed disk complete.  
BACKUP (FIXED) : MASP A - Backup starts on standby MASP.  
BACKUP (FIXED) : MASP A - Backup on standby MASP to fixed disk complete.
```

Figure B-6 Adding Channelized and non-Channel Bridged T1 Ports

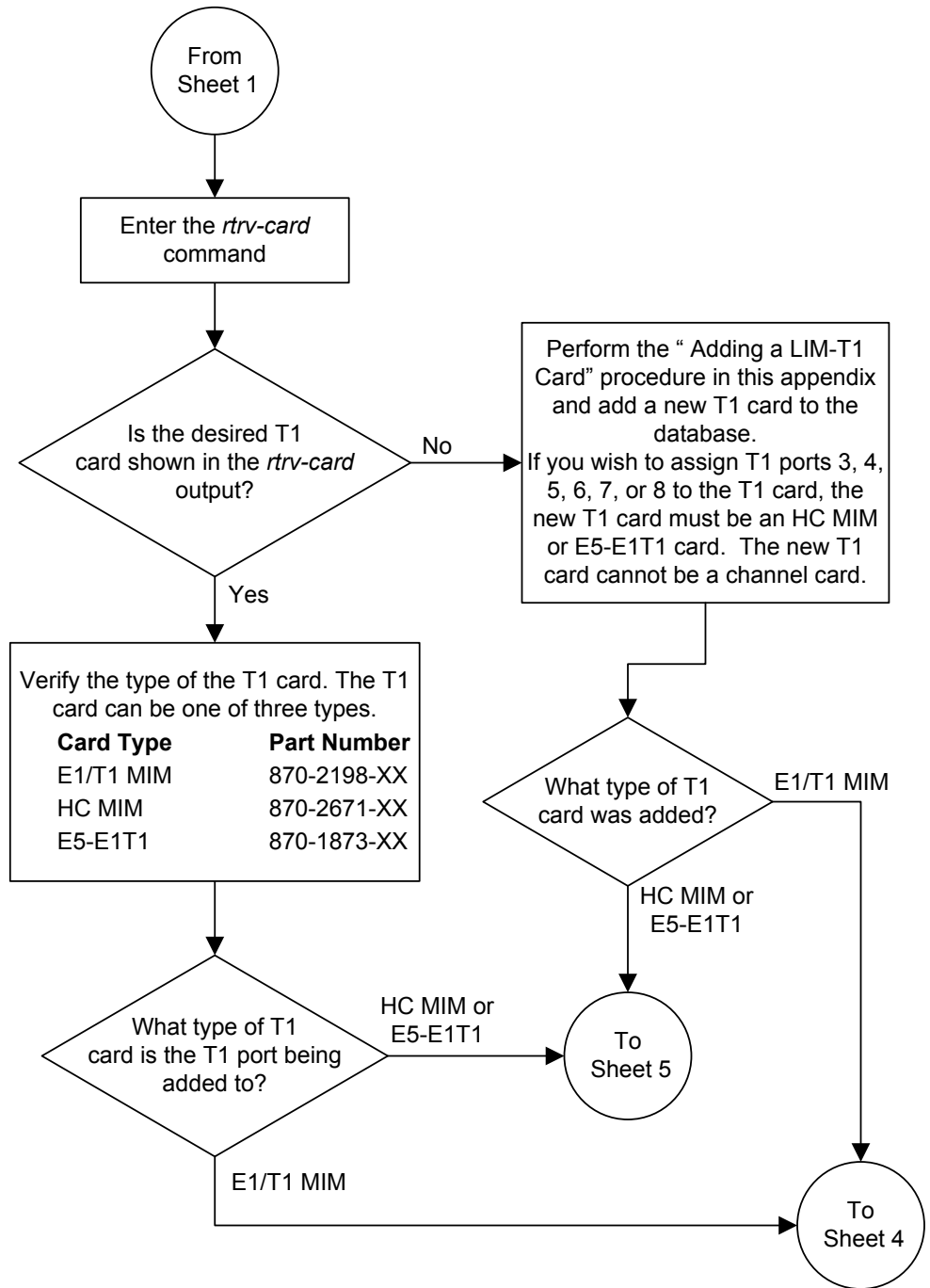


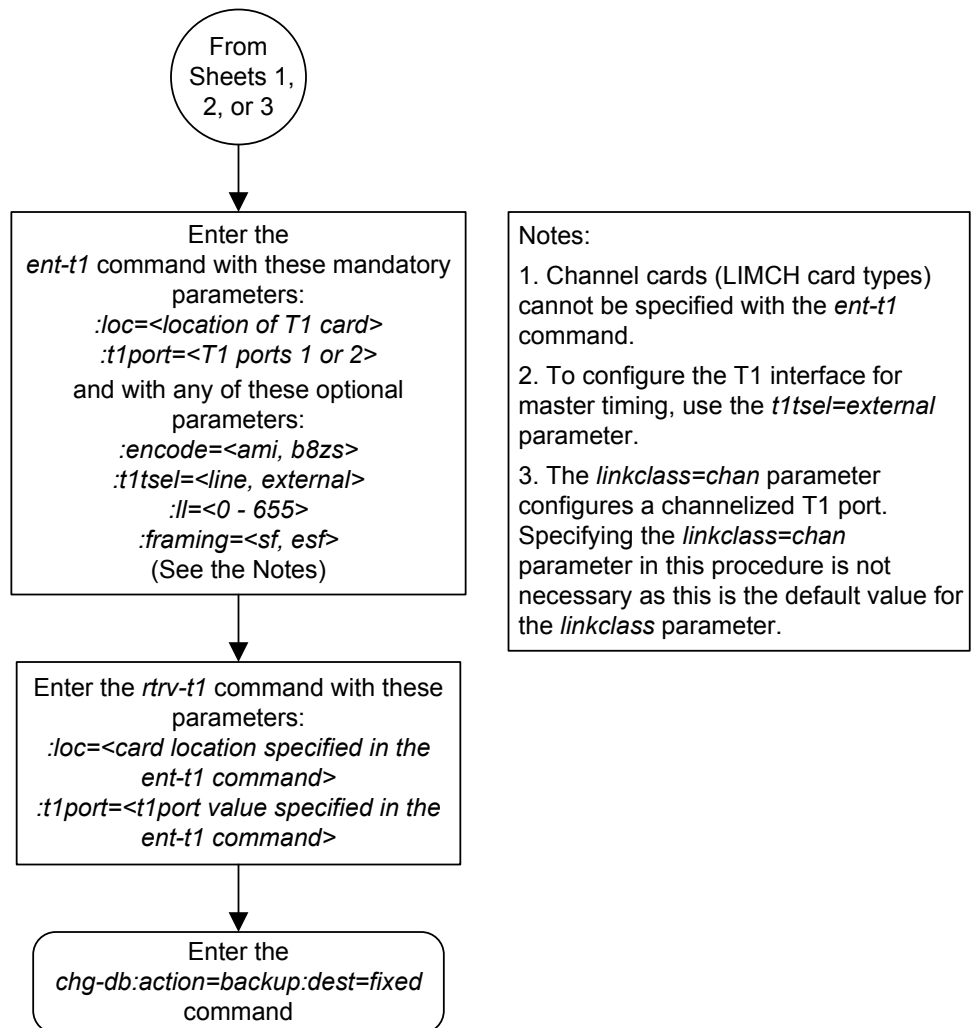
- Notes:**
1. T1 ports assigned in this procedure cannot be assigned to a T1 card containing unchannelized T1 ports.
 2. The E1/T1 MIM can have only T1 ports 1 and 2 assigned to it.
 3. The HC MIM or E5-E1T1 card can have T1 ports 1 through 8 assigned to it.

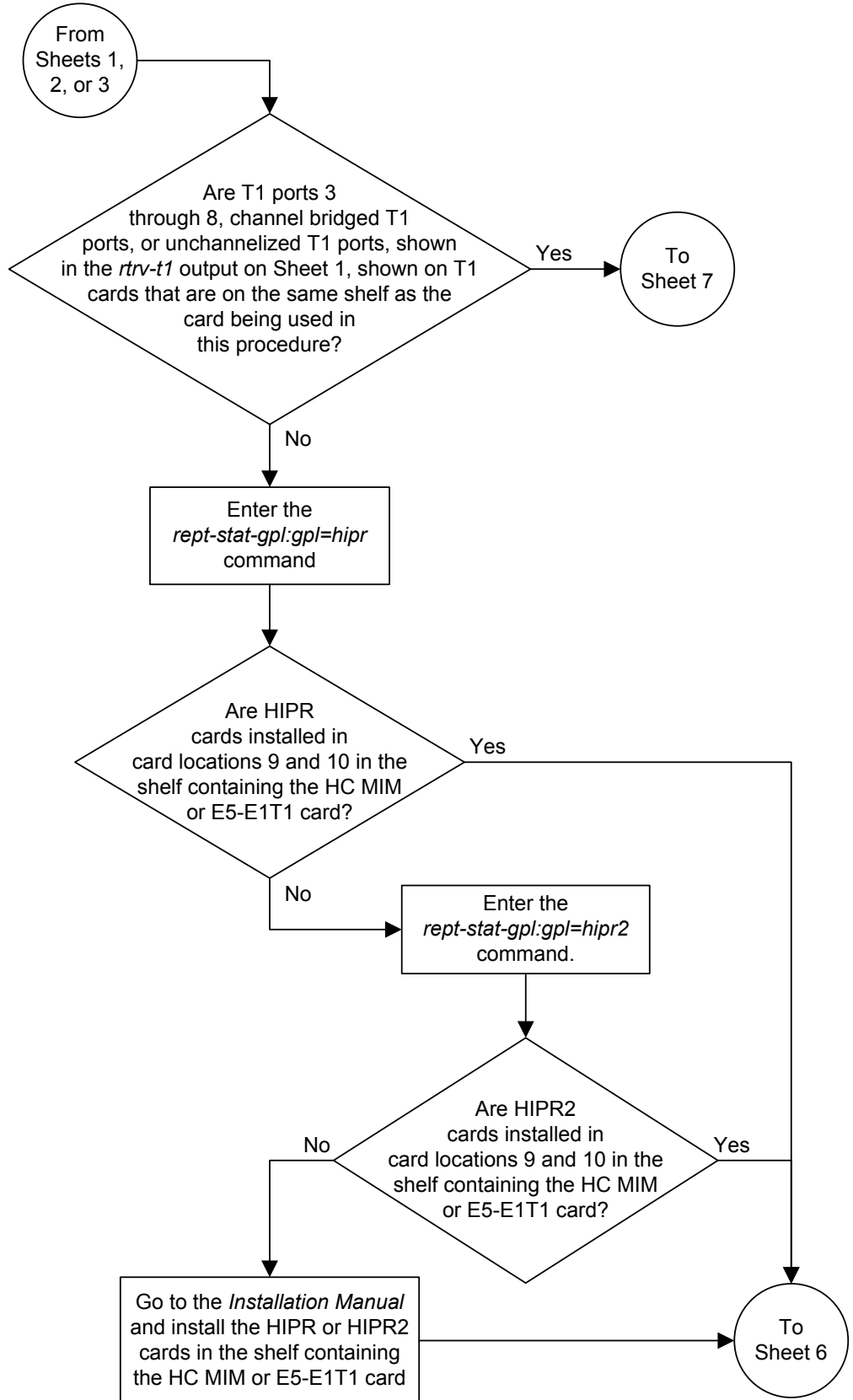


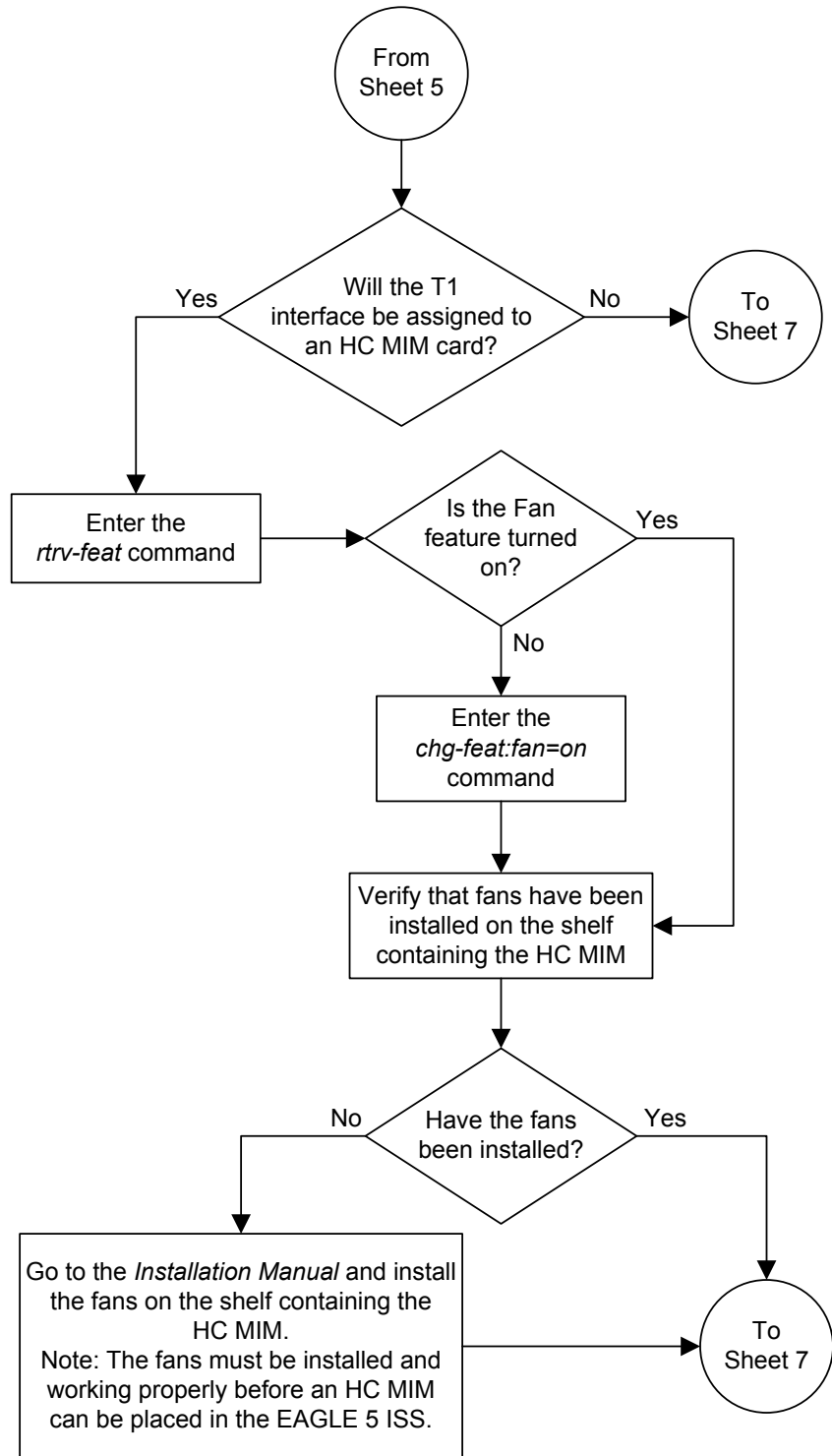
Notes:

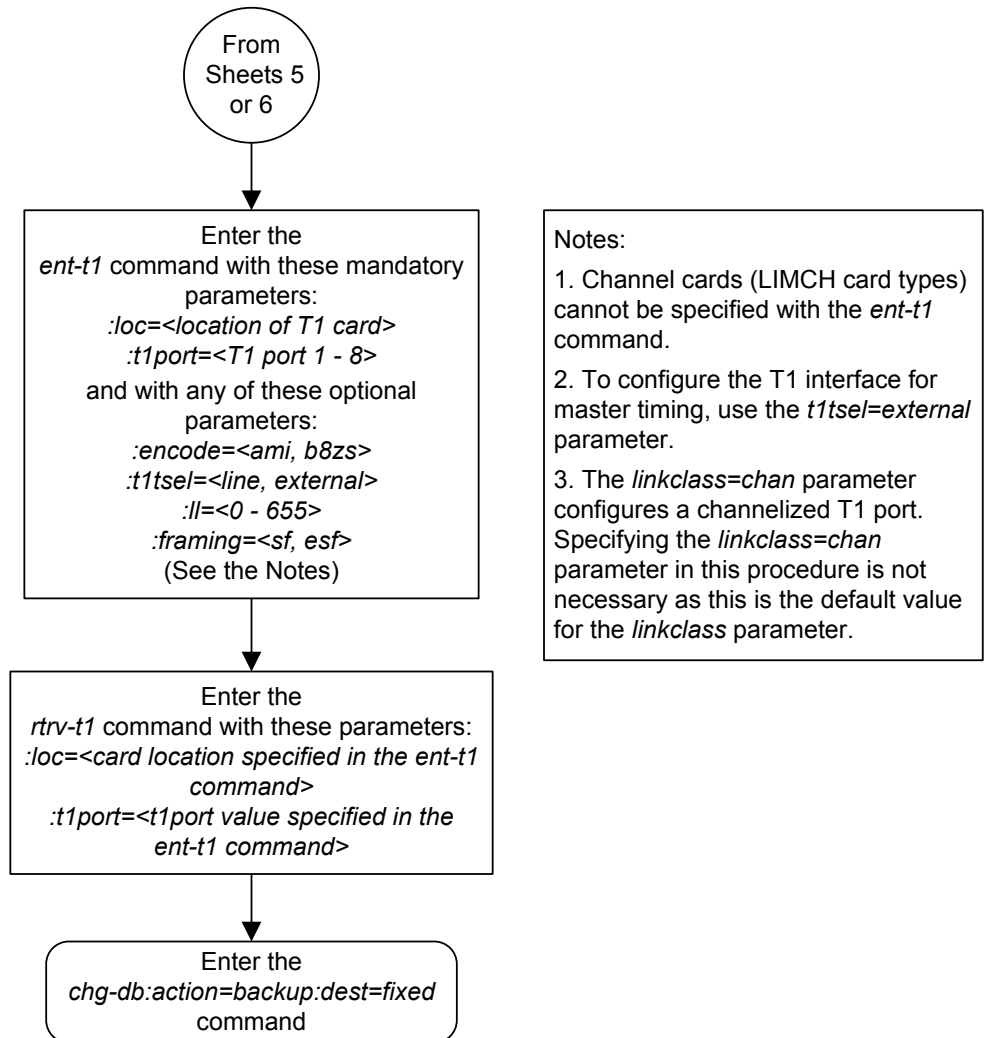
1. The E1/T1 MIM can have only T1 ports 1 and 2 assigned to it.
2. The HC MIM or E5-E1T1 card can have T1 ports 1 through 8 assigned to it.











Adding Channel Bridged T1 Ports

The channel bridged T1 ports are provisioned in the database using the `ent-t1` command using these parameters.

`:loc` – The location of the T1 card (card type `limt1`) that is servicing the T1 signaling link. The T1 card must be an **HC MIM** or an **E5-E1T1** card. The location of a channel card (card type `limch`) cannot be specified for this parameter.

`:t1port` – The T1 port on the T1 card used to service the T1 signaling link. The `t1port` value cannot already be assigned to the T1 card specified by the `loc` parameter.

`:encode` – Specifies the type of encoding or decoding that is used on the T1 signaling link, either **B8ZS** or **AMI**. The default value is B8ZS encoding (`encode=b8zs`).

`:t1tsel` – The timing source for the T1 signaling link, master (`external`) or recovered. The default value is slave timing (`t1tsel=line`) which cannot be used for a channel bridged t1 port.

The recovered timing source can be used only with the `chanbrdg=on` parameter and uses the even numbered member of the bridged-pair as a clock source, ensuring that port in the pair can recover the timing from its partner.

Note: To use an external high-speed master clock source other than RS-422, **TDMs** 870-0774-15 or later must be installed in card locations 1114 and 1116, and the TDM Global Timing Interface options must be configured. For more information, see [Configuring the Options for the TDM Global Timing Interface](#).

`:framing` – Specifies the framing format to be used on the T1 signaling link, either `sf` or `esf`. The default value is `sf` (`framing=sf`).

`:ll` – The length of the cable, in feet, used for the T1 signaling link. The value of the `ll` parameter is from 0 to 655. The default value for this parameter is 133.

`:force=yes` – Required when the even numbered T1 port being channel bridged is provisioned in the database before this procedure is performed.

`:chanbrdg` – Specifies whether or not the odd numbered T1 port specified in this procedure is channel bridged to its adjacent even numbered T1 port. [Table B-9](#) shows the T1 ports that can be specified with the `chanbrdg=on` parameter and the even-numbered T1 ports that are bridged to the odd numbered T1 port.

Table B-9 Channel Bridging Ports

Odd Numbered T1 Port	Even Numbered Bridged T1 Port
1	2
3	4
5	6
7	8

The `ent-t1` command contains the `framing=esfperf`, `linkclass`, and `minsurate` parameters that are not used in this procedure. These parameters and their usage are described in [Adding Unchannelized T1 Ports](#).

The T1 card specified in this procedure must be in the database. This can be verified with the `rtrv-card` command.

The T1 card cannot contain channelized and un-channelized T1 ports.

1. Display the cards in the **EAGLE** using the `rtrv-card` command.

```
rlghncxa03w 09-05-28 09:12:36 GMT EAGLE5 41.0.0
CARD  TYPE      APPL      LSET NAME  LINK SLC LSET NAME  LINK SLC
1102  TSM          GLS
1113  GSPM        OAM
1114  TDM-A
1115  GSPM        OAM
1116  TDM-B
1117  MDAL
1207  LIMT1       SS7ANSI  lsnt265   A    0
1208  LIMCH       SS7ANSI  lsnt265   A    1  lsnt265   A2    2
1211  LIME1       CCS7ITU  lsne145   A    0
1212  LIMCH       CCS7ITU  lsne145   A    1  lsne145   A2    2
1215  LIMT1       SS7ANSI
1216  LIMCH       SS7ANSI
1316  DCM         STPLAN
```

If there are no **LIMT1** cards shown in the `rtrv-card` output, perform [Adding a LIM-T1 Card](#) to add an HC-MIM or E5-E1T1 card to the database. Continue the procedure with [2](#).

If **LIMT1** cards are shown in the `rtrv-card` output, continue the procedure with [2](#).

2. Display the existing T1 interfaces in the database using the `rtrv-t1` command with no parameters.

```
rlghncxa03w 09-05-19 21:17:04 GMT EAGLE5 41.0.0

      T1
LOC  PORT  ENCODE  T1TSEL  FRAMING  LL  CHANBRDG  CLASS  RATE
1207  1      AMI     EXTERNAL  ESF      50  -----  CHAN   ----
```

Channel bridged T1 ports cannot be added to a T1 card containing unchannelized T1 ports. If the T1 card contains unchannelized T1 ports, choose another T1 card from [1](#) and repeat this step, or add a new H- MIM or an E5-E1T1 card by performing [Adding a LIM-T1 Card](#).

If the `rtrv-t1` output shows that the T1 card has T1 ports 3, 4, 5, 6, 7, or 8 assigned to it, or that T1 ports on the T1 card are channel bridged, continue the procedure with [3](#).

If the `rtrv-t1` output shows that the T1 card does not have T1 ports 3, 4, 5, 6, 7, or 8 assigned to it, or that T1 ports on the T1 card are not channel bridged, verify that the T1 card that the channel bridged T1 port will be assigned to is an HC-MIM or an E5-E1T1 card. The part number of the HC-MIM is 870-2671-XX. The part number of the E5-E1T1 is 870-1873-XX. If the T1 card is not an HC-MIM or an E5-

E1T1 card, add a new HC-MIM or an E5-E1T1 card by performing [Adding a LIM-T1 Card](#).

After the new HC-MIM or E5-E1T1 card has been added, continue the procedure with [8](#).

Continue the procedure by performing one of these substeps:

- a. If the `rtrv-t1` output shows that the T1 card has T1 ports 3, 4, 5, 6, 7, or 8 assigned to it, or that T1 ports on the T1 card are channel bridged, continue this procedure with [3](#).
 - b. Channel bridged T1 ports cannot be added to an T1 card containing unchannelized T1 ports. If the T1 card contains unchannelized T1 ports, choose another T1 card from [1](#) and repeat this step, or add a new HC-MIM or an E5-E1T1 card by performing [Adding a LIM-T1 Card](#).
 - c. If the `rtrv-t1` output shows that the T1 card does not have T1 ports 3, 4, 5, 6, 7, or 8 assigned to it, or that T1 ports on the T1 card are not channel bridged, verify that the T1 card that the channel bridged T1 port will be assigned to is an HC-MIM or an E5-E1T1 card. The part number of the HC-MIM is 870-2671-XX. The part number of the E5-E1T1 is 870-1873-XX. If the T1 card is not an HC-MIM or an E5-E1T1 card, add a new HC-MIM or an E5-E1T1 card by performing [Adding a LIM-T1 Card](#).
 - If an existing T1 card is being used in this procedure continue the procedure with [3](#).
 - If an HC-MIM or an E5-E1T1 card was added in this substep or substep b, continue the procedure by performing one of these steps.
 - If the T1 cards shown in this step are on the same shelf as the card that will contain the T1 port that is being added, and these cards have T1 ports 3 through 8 provisioned, contain channel bridged T1 ports, or unchannelized T1 ports, continue the procedure with [8](#).
 - If the T1 cards shown in this step are not on the same shelf as the card that will contain the T1 port that is being added, continue the procedure with [4](#).
 - If the T1 cards shown in this step are on the same shelf as the card that will contain the T1 port that is being added, and these cards do not have T1 ports 3 through 8 provisioned, do not contain channel bridged T1 ports, or do not have unchannelized T1 ports, continue the procedure with [4](#).
3. Display the T1 signaling links in the EAGLE by entering this command.

```
rtrv-slk:class=t1
```

```
rlghncxa03w 09-05-19 21:17:04 GMT EAGLE5 41.0.0
```

LOC	LINK	LSN	SLC	TYPE	L2T	BPS	ECM	PCR	PCR	T1	T1	TS
					SET			N1	N2	LOC	PORT	
1207	A	lsnt256	0	LIMT1	1	56000	BASIC	---	-----	1207	2	2
1208	A	lsnt256	1	LIMCH	1	56000	BASIC	---	-----	1207	1	4
1208	A2	lsnt256	2	LIMCH	1	56000	BASIC	---	-----	1207	1	6

If an even numbered T1 port is to be channel bridged, and that T1 port is assigned to signaling links, these signaling links must be removed before the T1 port can be

channel bridged. Perform [Removing an SS7 Signaling Link](#) to remove these signaling links. After the signaling links have been removed, continue the procedure with [4](#).

If the even numbered T1 port to be channel bridged is not assigned to signaling links, continue the procedure with [4](#).

- Verify that **HIPR2** cards are installed in card locations 9 and 10 in the shelf containing the HC MIM or E5-E1T1 card that will contain the T1 port being added in this procedure by entering this command.

```
rept-stat-gpl:gpl=hipr2
```

This is an example of the possible output.

```
rlghncxa03w 09-07-05 08:12:53 GMT 41.1.0
GPL          CARD      RUNNING      APPROVED     TRIAL
HIPR2       1109      126-002-000 126-002-000 126-003-000
HIPR2       1110      126-002-000 126-002-000 126-003-000
HIPR2       1209      126-002-000 126-002-000 126-003-000
HIPR2       1210      126-002-000 126-002-000 126-003-000
HIPR2       1309      126-002-000 126-002-000 126-003-000
HIPR2       1310      126-002-000 126-002-000 126-003-000
HIPR2       2109      126-002-000 126-002-000 126-003-000
HIPR2       2110      126-002-000 126-002-000 126-003-000
Command Completed
```

If **HIPR2** cards are installed in the shelf containing the HC MIM or E5-E1T1 card, continue the procedure by performing one of these steps.

- If the card is an E5-E1T1 card, continue the procedure with [8](#).
- If the card is an HC MIM, continue the procedure with [5](#).

If HIPR2 cards are not installed on the shelf containing the HC MIM or E5-E1T1 card, go to *Installation Guide* and install the HIPR2 cards. Once the HIPR2 cards have been installed, continue the procedure by performing one of these steps.

- If the card is an E5-E1T1 card, continue the procedure with [8](#).
- If the card is an HC MIM, continue the procedure with [5](#).

- Verify whether or not that the Fan feature is on, by entering the `rtrv-feat` command. If the Fan feature is on, the entry `FAN = on` appears in the `rtrv-feat` command output.

Note: The `rtrv-feat` command output contains other fields that are not used by this procedure. If you wish to see all the fields displayed by the `rtrv-feat` command, see the `rtrv-feat` command description in *Commands User's Guide*.

If the Fan feature is on, continue the procedure with [8](#).

If the Fan feature is off, continue the procedure with [6](#).

- Turn the Fan feature on by entering this command.

```
chg-feat:fan=on
```

Note: Once the Fan feature is turned on with the `chg-feat` command, it cannot be turned off.

The Fan feature must be purchased before you turn this feature on with the `chg-feat` command. If you are not sure if you have purchased the Fan feature, contact your Sales Representative or Account Representative.

When the `chg-feat` has successfully completed, this message appears.

```
rlghncxa03w 09-05-28 11:43:04 GMT EAGLE5 41.0.0
CHG-FEAT: MASP A - COMPLTD
```

- The shelf containing the HC-MIM being added in this procedure must have fans installed. Verify whether or not fans are installed on the shelf.

If the fans are installed, continue the procedure with 8.

If the fans are not installed on the shelf containing the HC-MIM, go to *Installation Guide* and install the fans. After the fans have been installed and tested, continue the procedure with 8.

- Add the new T1 interface information to the database using the `ent-t1` command and the parameter combinations shown in [Table B-10](#).

Table B-10 Channel Bridged T1 Port Combinations

Mandatory Parameters	
:loc=location of the T1 card	:t1tsel=external, recovered
:t1port=1, 3, 5, 7	:chanbrdg=on
Optional Parameters	
:framing=sf, esf Default value = sf	:ll=0 - 655 Default value = 133
:encode=ami, b8zs Default value = b8zs	:force=yes

Notes:

- Channel cards (LIMCH card type) cannot be specified with the `ent-t1` command.
- To configure the T1 port for master timing, use the `t1tsel=external` parameter.
- The `linkclass=chan` parameter configures a channelized T1 port. Specifying the `linkclass=chan` parameter in this procedure is unnecessary as this is the default value for the `linkclass` parameter.
- The T1 card cannot contain channelized and un-channelized T1 ports.
- The `force=yes` parameter must be used when the even numbered port being channel bridged is shown in the `rtrv-t1` output in 2. If the even numbered port being channel bridged is not shown in the `rtrv-t1` output in 2, the `force=yes` parameter cannot be used.

For this example, enter these commands.

```
ent-
t1:loc=1215:t1port=1:encode=b8zs:t1tsel=external:chanbrdg=on
```

```
ent-
t1:loc=1217:t1port=1:encode=ami:t1tsel=recovered :chanbrdg=on
```

9. Verify the changes using the `rtrv-t1` command specifying the card location and the `t1port` value specified in 8. For this example, enter these commands.

```
rtrv-t1:loc=1215:t1port=1
```

```
rlghncxa03w 09-05-28 09:12:36 GMT EAGLE5 41.0.0
```

T1							LINK	MINSU
LOC	PORT	ENCODE	T1TSEL	FRAMING	LL	CHANBRDG	CLASS	RATE
1215	1	B8ZS	EXTERNAL	SF	133	MASTER	CHAN	----
TS1	-----	TS9	-----	TS17	-----			
TS2	-----	TS10	-----	TS18	-----			
TS3	-----	TS11	-----	TS19	-----			
TS4	-----	TS12	-----	TS20	-----			
TS5	-----	TS13	-----	TS21	-----			
TS5	-----	TS14	-----	TS22	-----			
TS7	-----	TS15	-----	TS23	-----			
TS8	-----	TS16	-----	TS24	-----			

```
rtrv-t1:loc=1217:t1port=1
```

This is an example of the possible output.

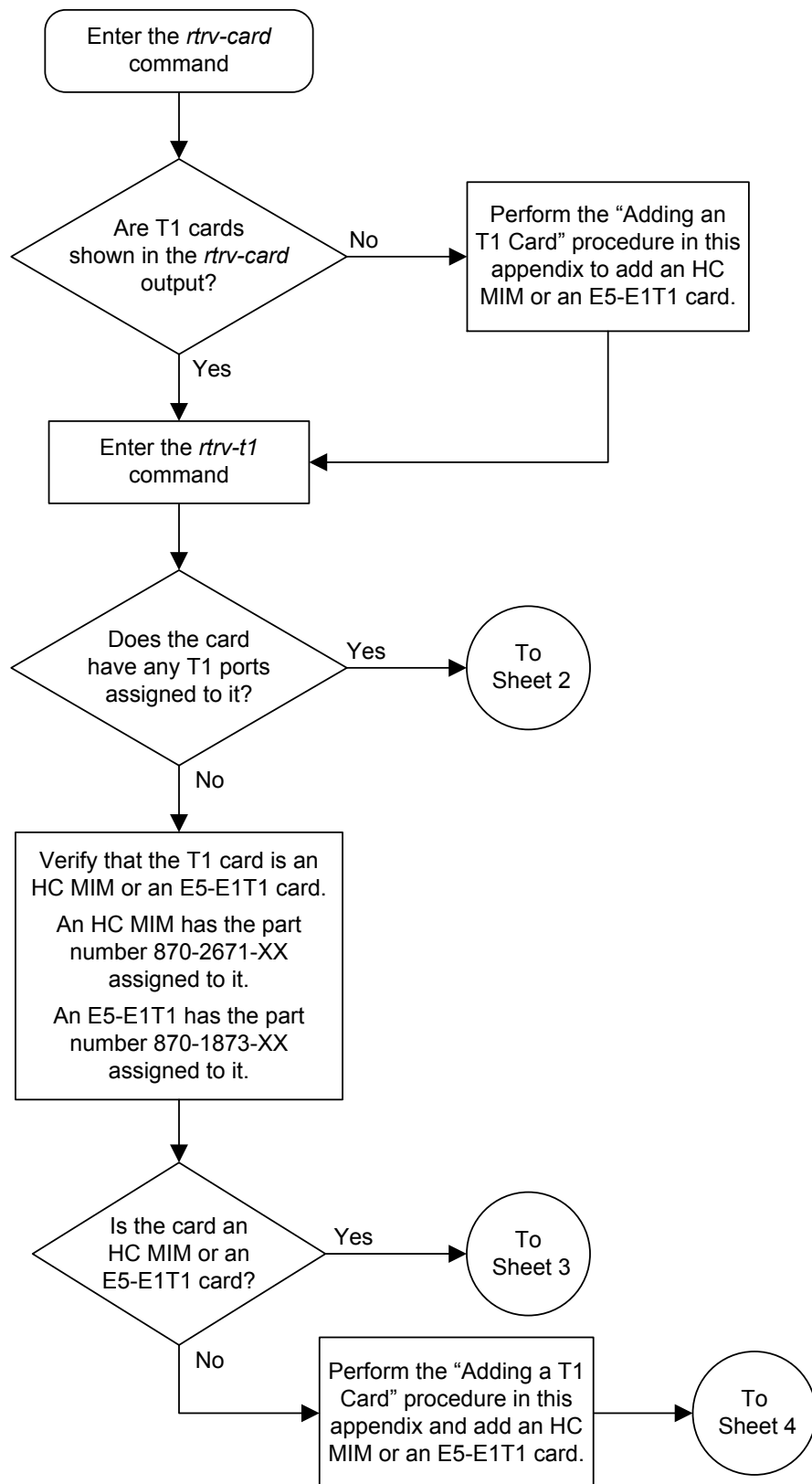
```
rlghncxa03w 09-05-28 09:12:36 GMT EAGLE5 41.0.0
```

T1							LINK	MINSU
LOC	PORT	ENCODE	T1TSEL	FRAMING	LL	CHANBRDG	CLASS	RATE
1217	1	AMI	RECOVERED	SF	133	MASTER	CHAN	----
TS1	-----	TS9	-----	TS17	-----			
TS2	-----	TS10	-----	TS18	-----			
TS3	-----	TS11	-----	TS19	-----			
TS4	-----	TS12	-----	TS20	-----			
TS5	-----	TS13	-----	TS21	-----			
TS5	-----	TS14	-----	TS22	-----			
TS7	-----	TS15	-----	TS23	-----			
TS8	-----	TS16	-----	TS24	-----			

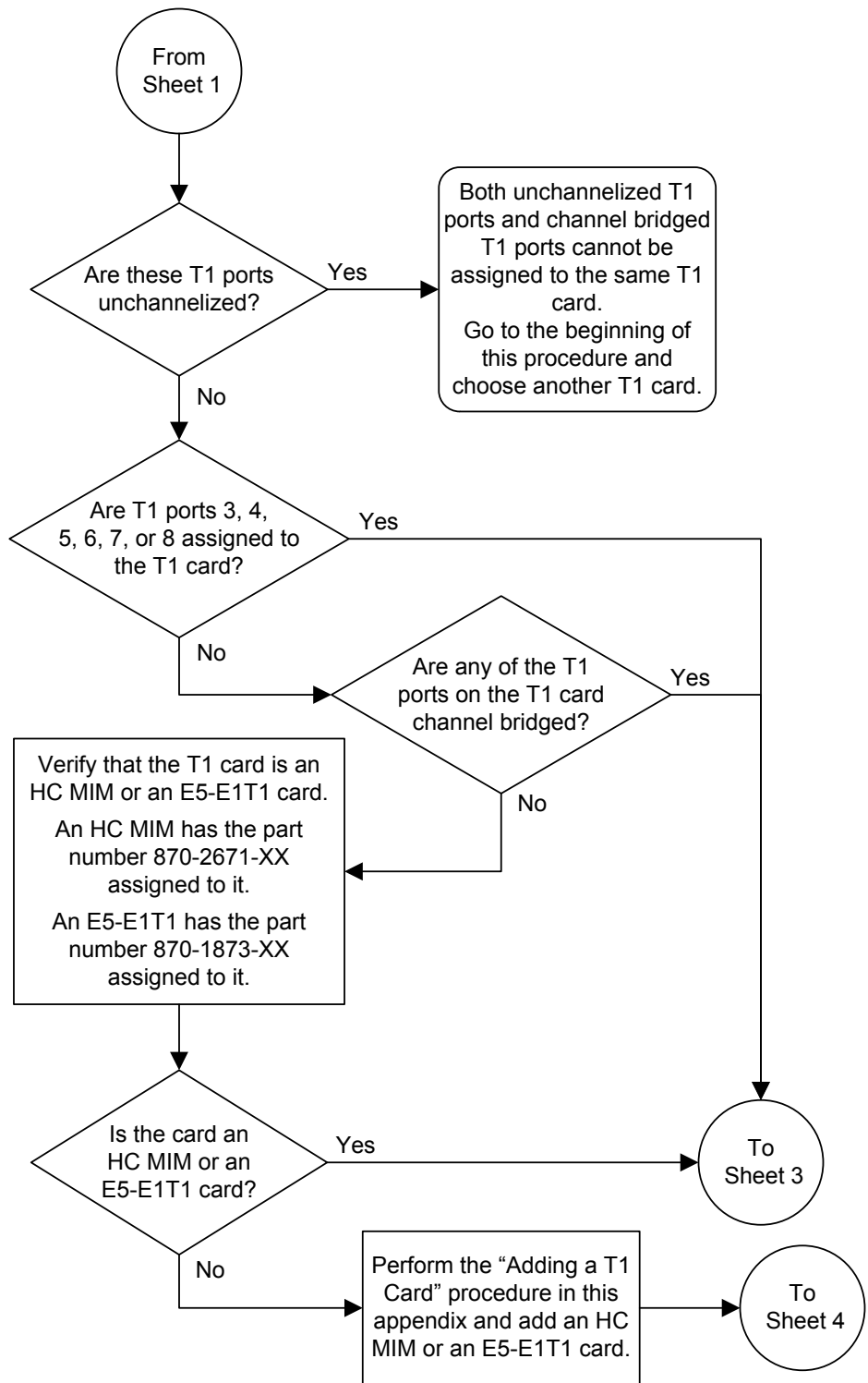
10. Back up the new changes using the `chg-db:action=backup:dest=fixed` command. These messages should appear, the active **Maintenance and Administration Subsystem Processor (MASP)** appears first.

```
BACKUP (FIXED) : MASP A - Backup starts on active MASP.
BACKUP (FIXED) : MASP A - Backup on active MASP to fixed disk complete.
BACKUP (FIXED) : MASP A - Backup starts on standby MASP.
BACKUP (FIXED) : MASP A - Backup on standby MASP to fixed disk complete.
```

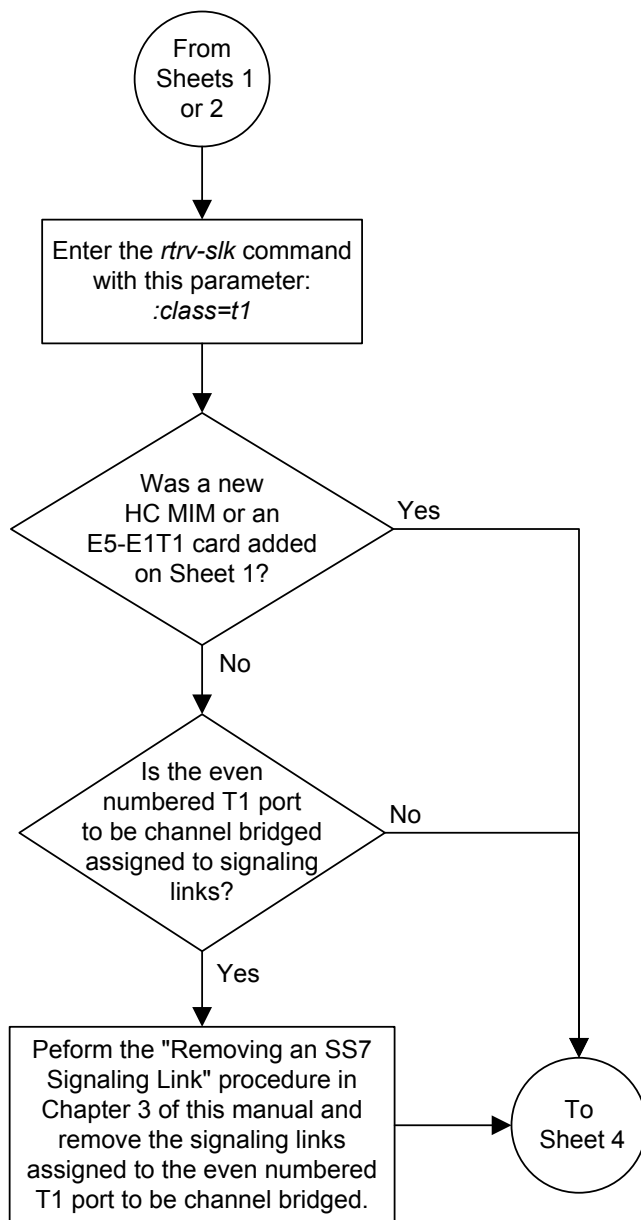
Figure B-7 Adding Channel Bridged T1 Ports



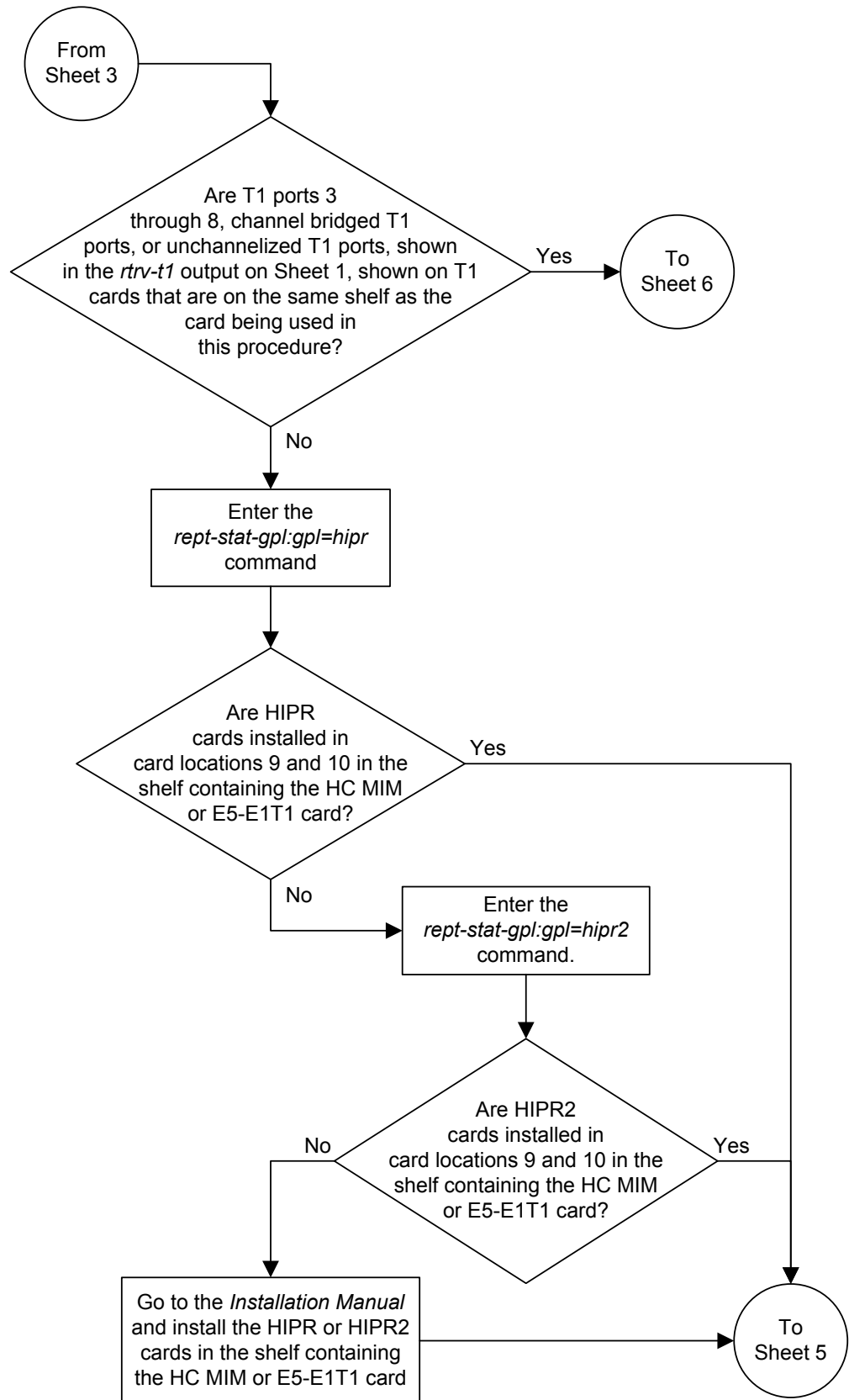
Sheet 1 of 6



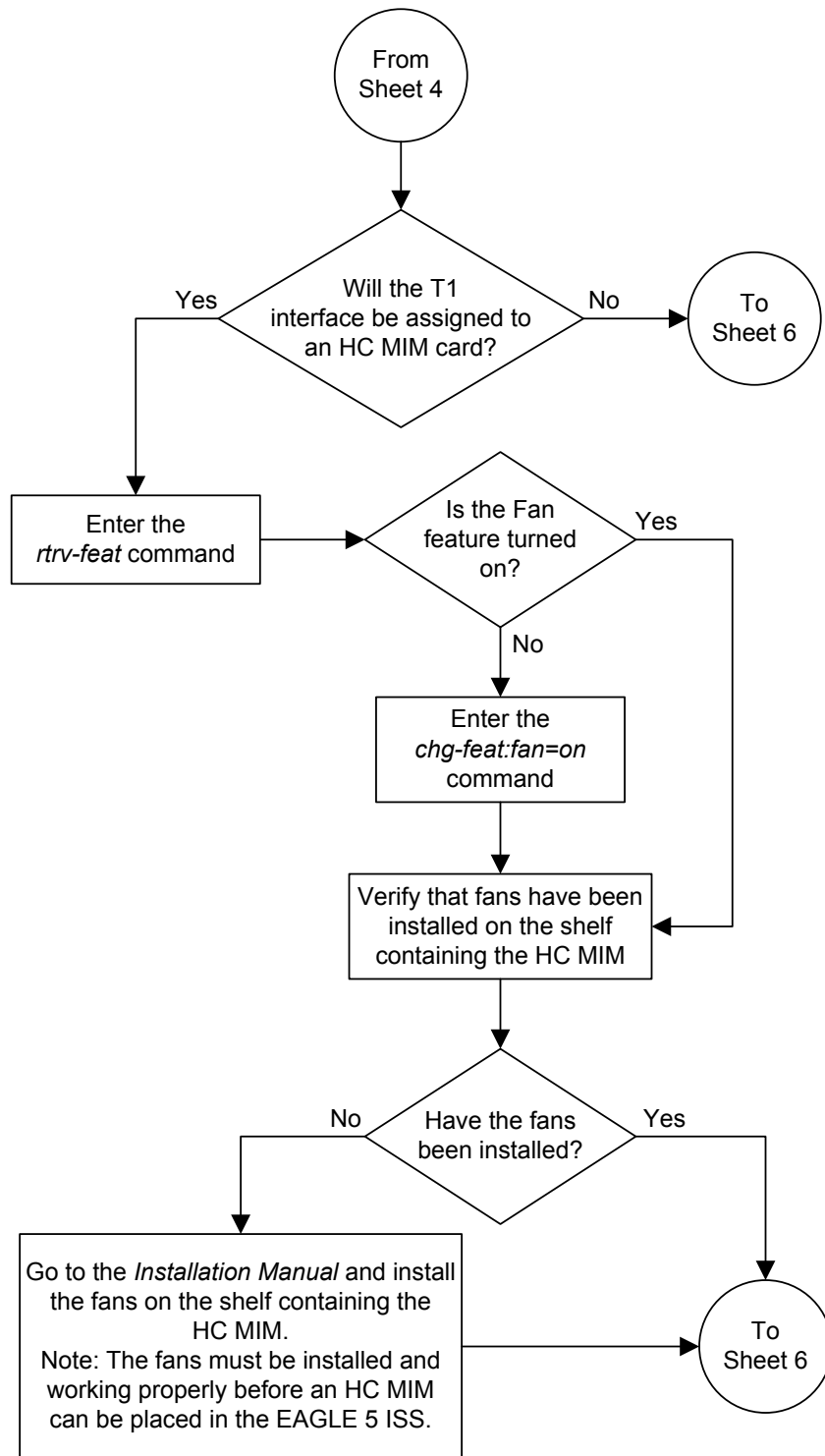
Sheet 2 of 6



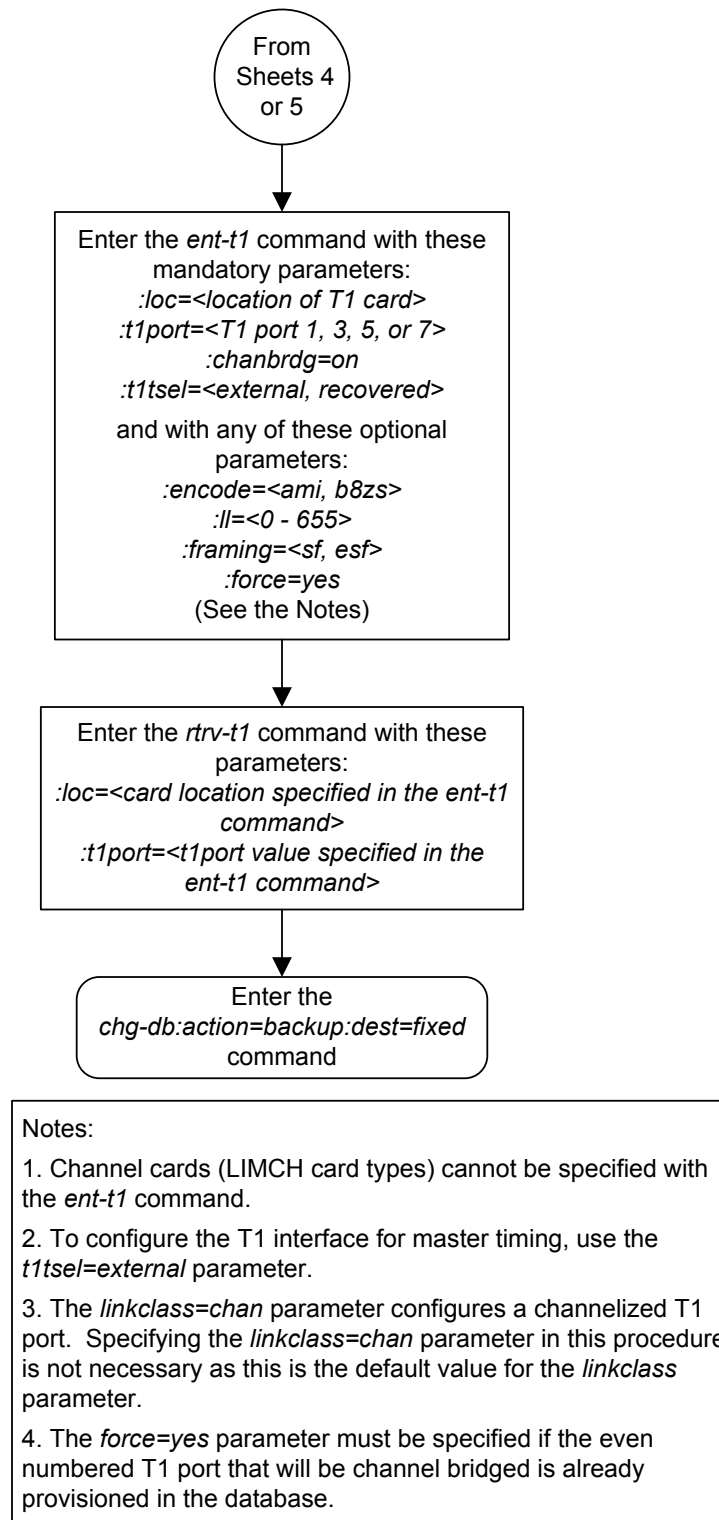
Sheet 3 of 6



Sheet 4 of 6



Sheet 5 of 6



Sheet 6 of 6

Adding Unchannelized T1 Ports

An unchannelized T1 port is provisioned in the database using the `ent-t1` command with these parameters.

`:loc` – The location of the **T1** card (card type `limt1`) that is servicing the **T1** signaling link. The **T1** card must be an **E5-E1T1** card. The location of a channel card (card type `limch`) cannot be specified for this parameter.

`:t1port` – The **T1** port on the **T1** card used to service the **T1** signaling link. The `t1port` value cannot already be assigned to the **T1** card specified by the `loc` parameter.

`:encode` – Specifies the type of encoding or decoding that is used on the T1 signaling link, either **B8ZS** or **AMI**. The default value is **B8ZS** encoding (`encode=b8zs`).

`:t1tsel` – The timing source for the T1 signaling link, master (`external`) or slave (`line`). The default value is slave timing (`t1tsel=line`).

The recovered timing source can be used only with the `chanbrdg=on` parameter and cannot be used in this procedure.

Note: To use an external high-speed master clock source other than RS-422, **TDMs** 870-0774-15 or later must be installed in card locations 1114 and 1116, and the TDM Global Timing Interface options must be configured. For more information, refer to [Configuring the Options for the TDM Global Timing Interface](#).

`:framing` – Specifies the framing format to be used on the T1 signaling link, either `sf`, `esf`, or `esfperf`. The `esfperf` value enables T1 performance monitoring for low level reports embedded in the transmit data stream of a T1 interface configured for ESF framing. The default value is `sf` (`framing=sf`).

`:l1` – The length of the cable, in feet, used for the T1 signaling link. The value of the `l1` parameter is from 0 to 655. The default value for this parameter is 133.

`:linkclass=unchan` – Indicates that the **T1** port supports un-channelized T1 signaling links.

`:minsurate` – Specifies the minimum number of signaling units (**FISUs** and **LSSUs**) per second that are transmitted on the outbound **T1** signaling link during idle periods or when there is an unused portion of the link's bandwidth. The value of this parameter is from 400 to 1600 signaling units per second, with the default value of 1000 signaling units per second. The `minsurate` parameter can be specified only when an unchannelized **T1** port (`linkclass=unchan` parameter) is being configured.

The `ent-t1` command contains the `t1tsel=recovered`, `chanbrdg`, and `force=yes` parameters. These parameters are not used in this procedure. These parameters and their usage are described in [Adding Channel Bridged T1 Ports](#).

The **T1** card specified in this procedure must be in the database. This can be verified with the `rtrv-card` command.

1. Display the cards in the **EAGLE** using the `rtrv-card` command.

```

rlghncxa03w 09-05-28 09:12:36 GMT EAGLE5 41.0.0
CARD   TYPE     APPL     LSET NAME   LINK SLC LSET NAME   LINK SLC
1102   TSM         GLS
1113   GSPM        OAM
1114   TDM-A
1115   GSPM        OAM
1116   TDM-B
1117   MDAL
1201   LIMT1      CCS7ITU  lsn1        A    13  lsn1        B    12
1202   LIMCH      CCS7ITU  lsn1        A    0   lsn1        B    8
1203   LIMT1      CCS7ITU  lsn1        A1   4   lsn1        B1   9
1204   LIMCH      CCS7ITU  lsn1        A2   5   lsn1        A3   6
1211   LIMT1      CCS7ITU  lsn1        A    14
1212   LIMCH      CCS7ITU  lsn1        A    10  lsn1        B    11
1213   LIMT1      CCS7ITU  lsn1        A4   1   lsn1        A5   7
                               lsn1        B5   2   lsn1        A6   3
1316   DCM        STPLAN
    
```

If there no **LIMT1** cards shown in the `rtrv-card` output, perform [Adding a LIM-T1 Card](#) to add an **E5-E1T1** card to the database. After the card has been added, continue the procedure with [2](#)

2. Display the existing **T1** interfaces in the database using the `rtrv-t1` command with no parameters.

```

rlghncxa03w 09-05-19 21:17:04 GMT EAGLE5 41.0.0

          T1
LOC  PORT  ENCODE  T1TSEL  FRAMING  LL  CHANBRDG  CLASS  MINSU
1201  1     AMI     EXTERNAL  ESF     50  -----  CHAN   ----
1201  2     B8ZS   EXTERNAL  ESF     50  -----  CHAN   ----
1202  1     B8ZS   EXTERNAL  ESF     50  -----  CHAN   ----
1203  1     B8ZS   EXTERNAL  ESF     50  -----  CHAN   ----
1203  2     B8ZS   EXTERNAL  ESF     50  -----  CHAN   ----
1204  1     B8ZS   EXTERNAL  ESF     50  -----  CHAN   ----
1211  2     B8ZS   EXTERNAL  ESF     50  -----  CHAN   ----
1212  1     B8ZS   EXTERNAL  ESF     50  -----  CHAN   ----
1213  1     B8ZS   EXTERNAL  ESF     50  -----  CHAN   ----
1213  5     B8ZS   EXTERNAL  ESF     50  -----  CHAN   ----
    
```

The EAGLE can contain a maximum of 180 unchannelized **T1** ports. If the `rtrv-t1` output shows that there are 180 unchannelized **T1** ports, no other unchannelized **T1** ports can be added and this procedure cannot be performed.

If no **T1** ports are assigned to the **T1** card you wish to use in this procedure, verify that the **T1** card is an **E5-E1T1** card. The part number of the **E5-E1T1** card is 870-1873-XX. An **E5-E1T1** card can contain only one unchannelized **T1** port. No other types of **T1** ports can be assigned to a **T1** card that contains an unchannelized **T1** port. If the **T1** card is not an **E5-E1T1** card, either select another **T1** card from the `rtrv-t1` output, or add a new **E5-E1T1** by performing [Adding a LIM-T1 Card](#). If the **T1** card is an **E5-E1T1** card, and contains no **T1** ports, continue the procedure with [3](#).

If the unchannelized **T1** port cannot be added to this card, repeat [1](#) and [2](#) to select another **T1** card to add the unchannelized **T1** port to, or add a new **E5-E1T1** by performing [Adding a LIM-T1 Card](#).

3. Display the status of the ST-HSL-A SLK Capacity feature by entering the `rtrv-ctrl-feat` command.

The following is an example of the possible output.

```
rlghncxa03w 09-05-28 21:15:37 GMT EAGLE5 41.0.0
The following features have been permanently enabled:
```

Feature Name	Partnum	Status	Quantity
HC-MIM SLK Capacity	893012707	on	64
Command Class Management	893005801	on	----
LNP Short Message Service	893006601	on	----
Intermed GTT Load Sharing	893006901	on	----
XGTT Table Expansion	893006101	on	400000
XMAP Table Expansion	893007701	on	3000

The following features have been temporarily enabled:

Feature Name	Partnum	Status	Quantity	Trial Period Left
Zero entries found.				

The following features have expired temporary keys:

Feature Name	Partnum
Zero entries found.	

Continue the procedure by performing one of these substeps.

- a. If an ST-HSL-A SLK quantity is not enabled, continue the procedure with [4](#).

Note: If the `rtrv-ctrl-feat` output shows only the HC-MIM SLK Capacity feature with a quantity of 64, [4](#) through [7](#) must be performed. If the `rtrv-ctrl-feat` output in this step shows any other controlled features, continue the procedure with [8](#).

- b. If an ST-HSL-A SLK quantity is enabled, the entry ST-HSL-A SLK Capacity is shown in the `rtrv-ctrl-feat` output with a quantity of 4 to 180 in increments of 8. The quantities that can be provisioned and their part numbers are shown in [Table B-11](#). This quantity is the number of unchannelized T1 signaling links, and the number of unchannelized T1 ports, the EAGLE 5 ISS can contain. If the addition of the unchannelized T1 port in this procedure will not exceed the enabled ST-HSL-A SLK quantity, continue the procedure by performing one of these steps.
 - If T1 cards are shown in the `rtrv-t1` output in [2](#) and these cards are on the same shelf as the card that will contain the T1 port that is being added, and these cards have T1 ports 3 through 8 provisioned, contain channel bridged T1 ports, or unchannelized T1 ports, continue the procedure with [11](#).
 - If T1 cards are shown in the `rtrv-t1` output in [2](#) and these cards are not on the same shelf as the card that will contain the T1 port that is being added, continue the procedure with [10](#).
 - If T1 cards are shown in the `rtrv-t1` output in [2](#) and these cards are on the same shelf as the card that will contain the T1 port that is being added, and these cards do not have T1 ports 3 through 8 provisioned, do not contain

channel bridged T1 ports, or do not have unchannelized T1 ports, continue the procedure with [10](#).

- c. If an ST-HSL-A SLK quantity is enabled, and the addition of the unchannelized T1 port in this procedure will exceed the enabled ST-HSL-A SLK quantity, increase the enabled ST-HSL-A SLK quantity by performing [8](#).
4. Display the serial number in the database with the `rtrv-serial-num` command.

```
rlghncxa03w 09-05-28 21:15:37 GMT EAGLE5 41.0.0
System serial number = nt00001231
```

System serial number is not locked, yet.

Note: If the serial number is correct and locked, continue the procedure with [8](#). If the serial number is correct but not locked, continue the procedure with [7](#). If the serial number is not correct, but is locked, the ST-HSL-A SLK quantity cannot be enabled and the remainder of this procedure cannot be performed. Contact the Customer Care Center to get an incorrect and locked serial number changed. Refer to [My Oracle Support \(MOS\)](#) for the contact information. The serial number can be found on a label affixed to the control shelf (shelf 1100).

5. Enter the correct serial number into the database using the `ent-serial-num` command with the `serial` parameter.

For this example, enter this command.

```
ent-serial-num:serial=<EAGLE's correct serial number>
```

6. Verify that the serial number entered in [5](#) was entered correctly using the `rtrv-serial-num` command.

```
rlghncxa03w 09-05-28 21:15:37 GMT EAGLE5 41.0.0
System serial number = nt00001231
```

System serial number is not locked, yet.

If the serial number was not entered correctly, repeat [4](#) and [5](#) and re-enter the correct serial number.

7. Lock the serial number in the database by entering the `ent-serial-num` command with the serial number shown in [4](#), if the serial number shown in [4](#) is correct, or with the serial number shown in [6](#), if the serial number was changed in [5](#), and with the `lock=yes` parameter.

For this example, enter this command.

```
ent-serial-num:serial=<EAGLE's serial number>:lock=yes
```

8. Enable an ST-HSL-A SLK quantity by entering the `enable-ctrl-feat` command specifying the part number for the desired ST-HSL-A SLK quantity and the feature access key.

The ST-HSL-A SLK quantity part numbers are shown in [Table B-11](#).

Table B-11 ST-HSL-A SLK Quantity Part Numbers

ST-HSL-A SLK Quantity	Part Number	ST-HSL-A SLK Quantity	Part Number
4	893027301	96	893027313
8	893027302	104	893027314
16	893027303	112	893027315
24	893027304	120	893027316
32	893027305	128	893027317
40	893027306	136	893027318
48	893027307	144	893027319
56	893027308	152	893027320
64	893027309	160	893027321
72	893027310	168	893027322
80	893027311	176	893027323
88	893027312	180	893027324

For this example, enter this command.

```
enable-ctrl-feat:partnum=893027301:fak=<feature access key>
```

Note: A temporary feature access key cannot be specified to enable the ST-HSL-A SLK quantity quantity.

Note: The value for the feature access key (the fak parameter) is provided by Oracle. If you do not have the feature access key for the ST-HSL-A SLK quantity, contact your Oracle Sales Representative or Account Representative.

- Verify the changes by entering the `rtrv-ctrl-feat` command with the ST-HSL-A SLK quantity part number specified in 8.

Enter this command.

```
rtrv-ctrl-feat:partnum=893027301
```

The following is an example of the possible output.

```
rlghncxa03w 09-05-28 21:15:37 GMT EAGLE5 41.0.0
The following features have been permanently enabled:
```

```
Feature Name          Partnum  Status  Quantity
ST-HSL-A SLK Capacity 893027301 on      4
```

The following features have been temporarily enabled:

```
Feature Name          Partnum  Status  Quantity  Trial Period Left
```

Zero entries found.

The following features have expired temporary keys:

Feature Name	Partnum
Zero entries found.	

Continue the procedure by performing one of these steps.

- If T1 cards are shown in the `rtrv-t1` output in 2 and these cards are on the same shelf as the card that will contain the T1 port that is being added, and these cards have T1 ports 3 through 8 provisioned, contain channel bridged T1 ports, or unchannelized T1 ports, continue the procedure with 11.
- If T1 cards are shown in the `rtrv-t1` output in 2 and these cards are not on the same shelf as the card that will contain the T1 port that is being added, continue the procedure with 10.
- If T1 cards are shown in the `rtrv-t1` output in 2 and these cards are on the same shelf as the card that will contain the T1 port that is being added, and these cards do not have T1 ports 3 through 8 provisioned, do not contain channel bridged T1 ports, or do not have unchannelized T1 ports, continue the procedure with 10.

10. Verify that **HIPR2** cards are installed in card locations 9 and 10 in the shelf containing the E5-E1T1 card that will contain the T1 port being added in this procedure by entering this command.

```
rept-stat-gpl:gpl=hipr2
```

This is an example of the possible output.

```
rlghncxa03w 09-07-05 08:12:53 GMT 41.1.0
GPL      CARD      RUNNING      APPROVED      TRIAL
HIPR2    1109    126-002-000 126-002-000 126-003-000
HIPR2    1110    126-002-000 126-002-000 126-003-000
HIPR2    1209    126-002-000 126-002-000 126-003-000
HIPR2    1210    126-002-000 126-002-000 126-003-000
HIPR2    1309    126-002-000 126-002-000 126-003-000
HIPR2    1310    126-002-000 126-002-000 126-003-000
HIPR2    2109    126-002-000 126-002-000 126-003-000
HIPR2    2110    126-002-000 126-002-000 126-003-000
Command Completed
```

If **HIPR2** cards are installed in the shelf containing the E5-E1T1 card, continue the procedure with 11.

If **HIPR2** cards are not installed on the shelf containing the E5-E1T1 card, go to *Installation Guide* and install the **HIPR2** cards. Once the **HIPR2** cards have been installed, continue the procedure with 11.

11. Add the unchannelized T1 port to the database using the `ent-t1` command and the parameter combinations shown in [Table B-12](#).

Table B-12 Unchannelized T1 Port Parameter Combinations

Mandatory Parameters

Table B-12 (Cont.) Unchannelized T1 Port Parameter Combinations

:loc=card location of the E5-E1T1 card	:linkclass=unchan	:t1port=1, 2, 3, 4, 5, 6, 7, 8
Optional Parameters		
:encode=ami, b8zs Default value = b8zs	:t1tsel=line, external Default value = line	:ll=0 - 655 Default value = 133
:framing=sf, esf, esfperf Default value = sf	:minsurate=400 - 1600 Default value = 1000	

For this example, enter these commands.

```
ent-
t1:loc=1305:t1port=2:encode=b8zs:t1tsel=line:framing=esfperf:
ll=200 :minsurate=1200:linkclass=unchan
```

```
ent-
t1:loc=1307:t1port=2:encode=ami:t1tsel=external:linkclass=unc
han
```

12. Verify the changes using the `rtrv-t1` command specifying the card location and the `t1port` value specified in 11.

For this example, enter these commands.

```
rtrv-t1:loc=1305:t1port=2
```

```
rlghncxa03w 09-05-28 09:12:36 GMT EAGLE5 41.0.0
```

```

          T1
LOC  PORT  ENCODE  T1TSEL   FRAMING  LL  CHANBRDG  CLASS  RATE
1305  2      B8ZS    LINE     ESFPERF  200  -----  UNCHAN  1200
```

```
rtrv-t1:loc=1307:t1port=2
```

```
rlghncxa03w 09-05-28 09:12:36 GMT EAGLE5 41.0.0
```

```

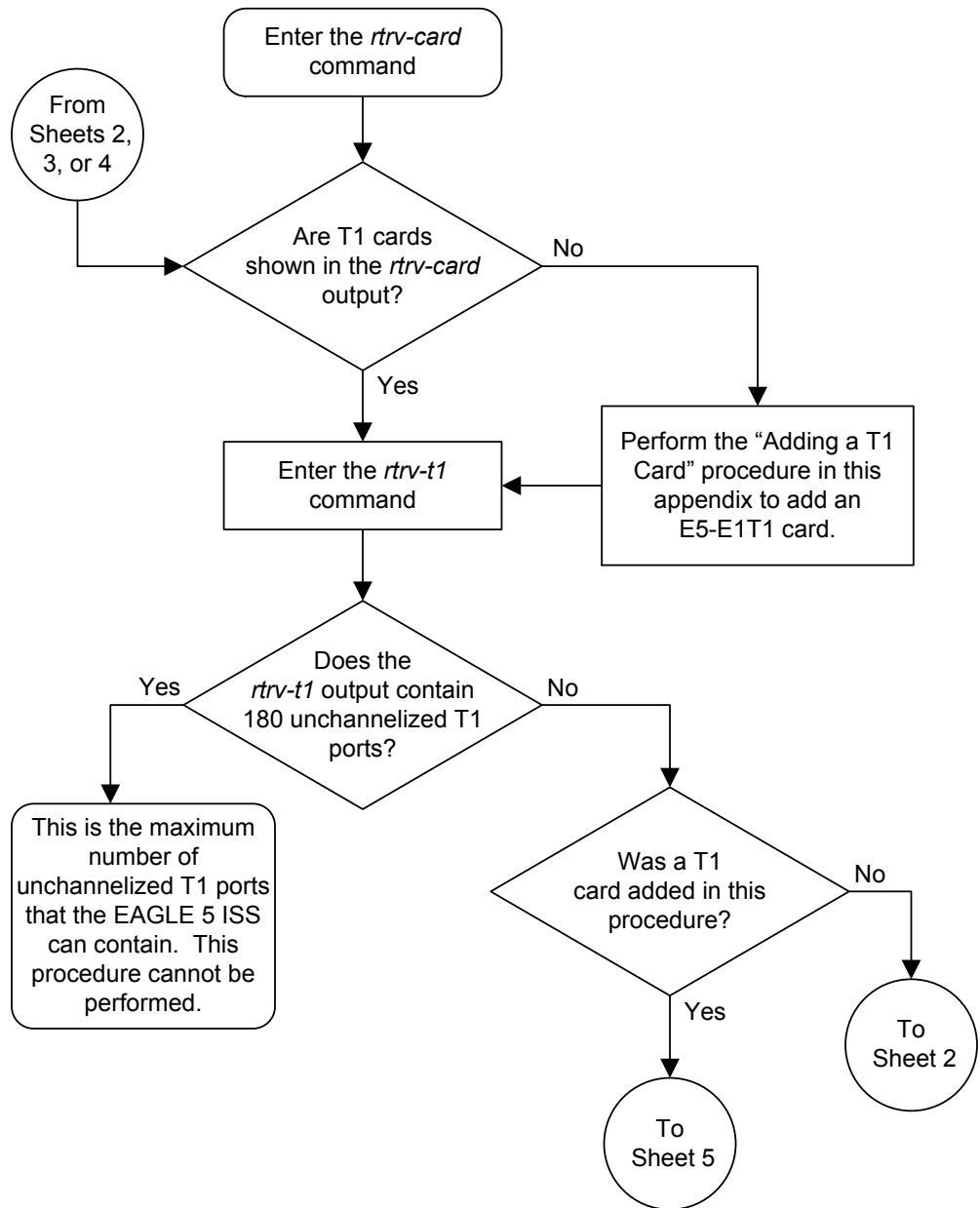
          T1
LOC  PORT  ENCODE  T1TSEL   FRAMING  LL  CHANBRDG  CLASS  RATE
1307  2      AMI     EXTERNAL SF       133  -----  UNCHAN  1000
```

13. Back up the new changes using the `chg-db:action=backup:dest=fixed` command.

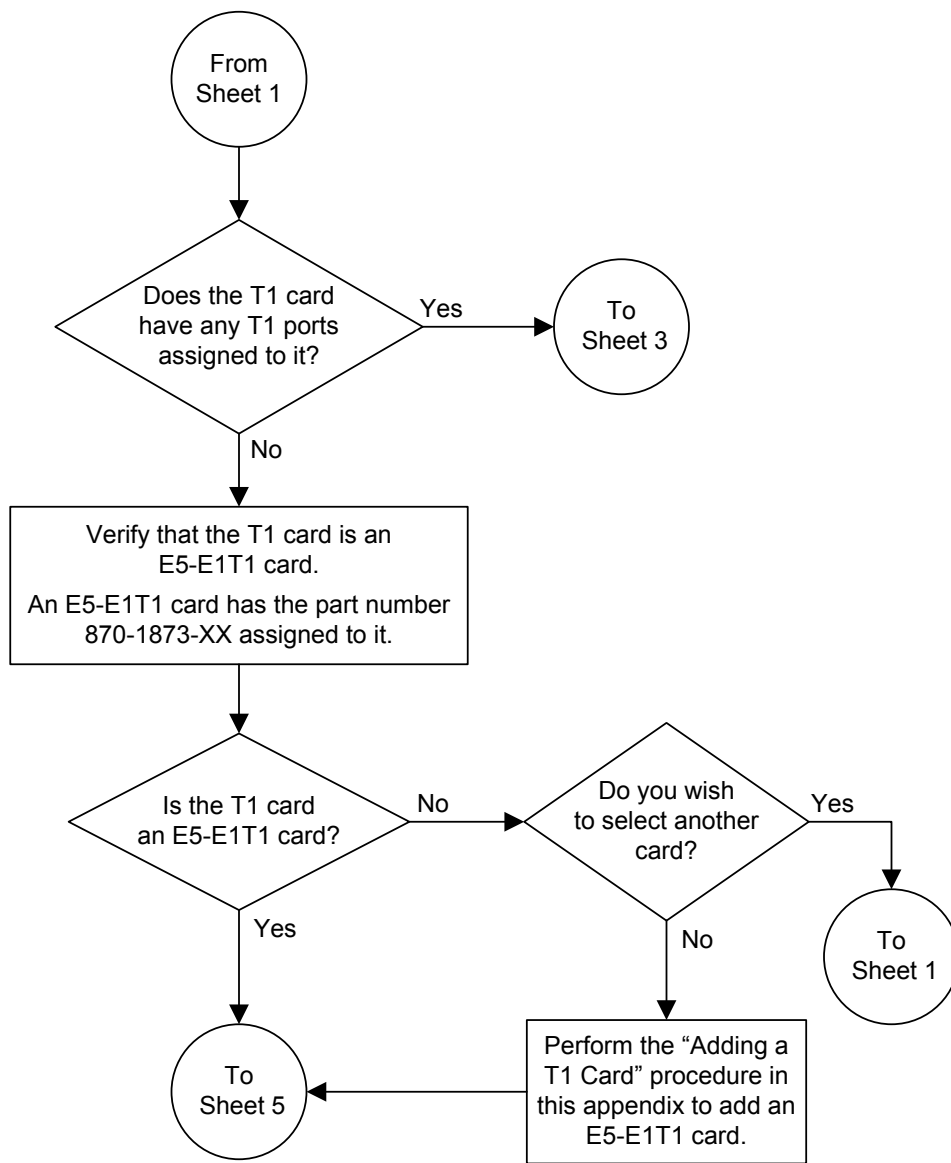
These messages should appear, the active **Maintenance and Administration Subsystem Processor (MASP)** appears first.

```
BACKUP (FIXED) : MASP A - Backup starts on active MASP.
BACKUP (FIXED) : MASP A - Backup on active MASP to fixed disk complete.
BACKUP (FIXED) : MASP A - Backup starts on standby MASP.
BACKUP (FIXED) : MASP A - Backup on standby MASP to fixed disk complete.
```

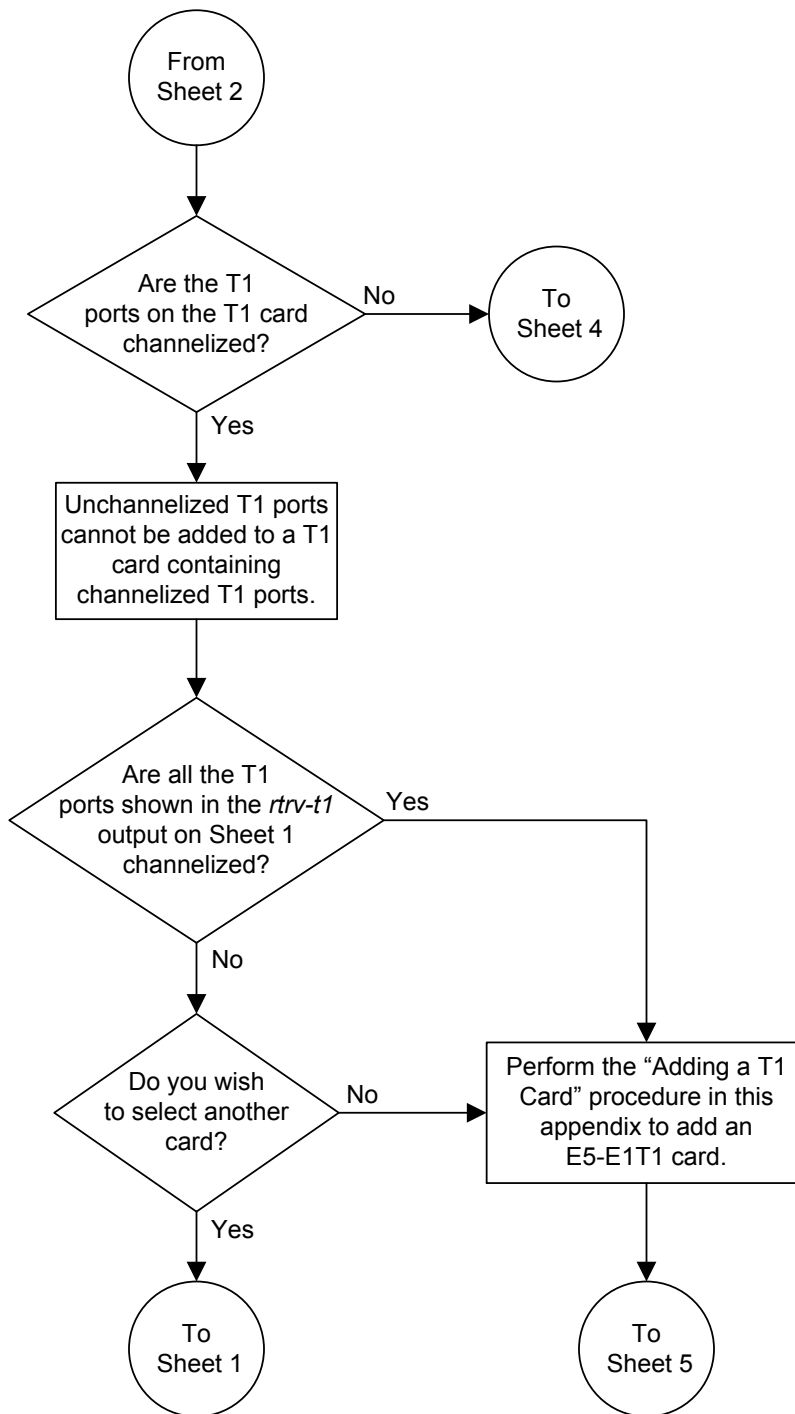
Figure B-8 Adding Unchannelized T1 Ports



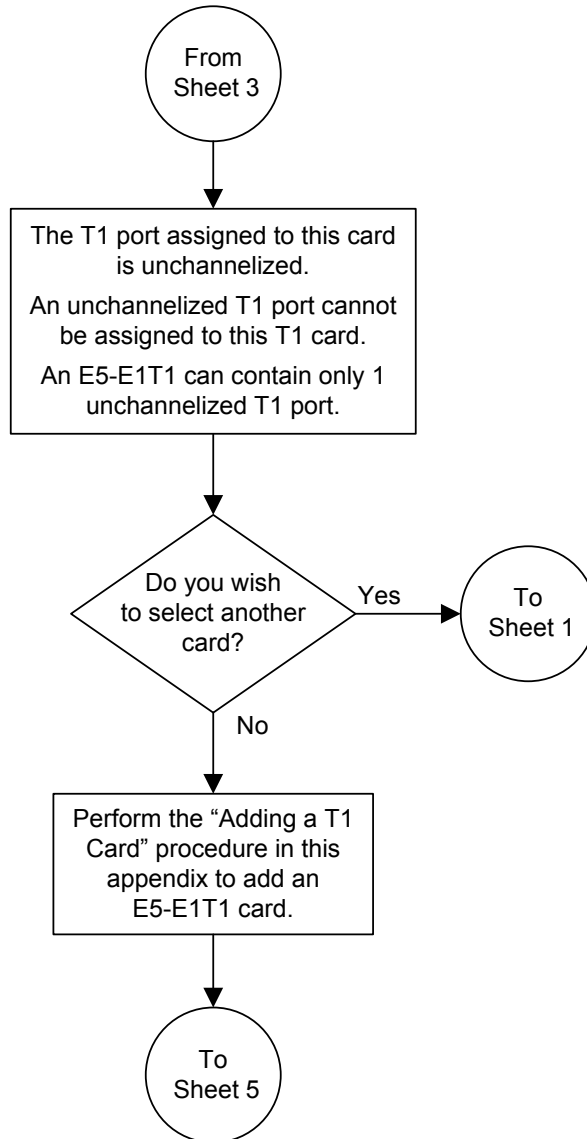
Sheet 1 of 9



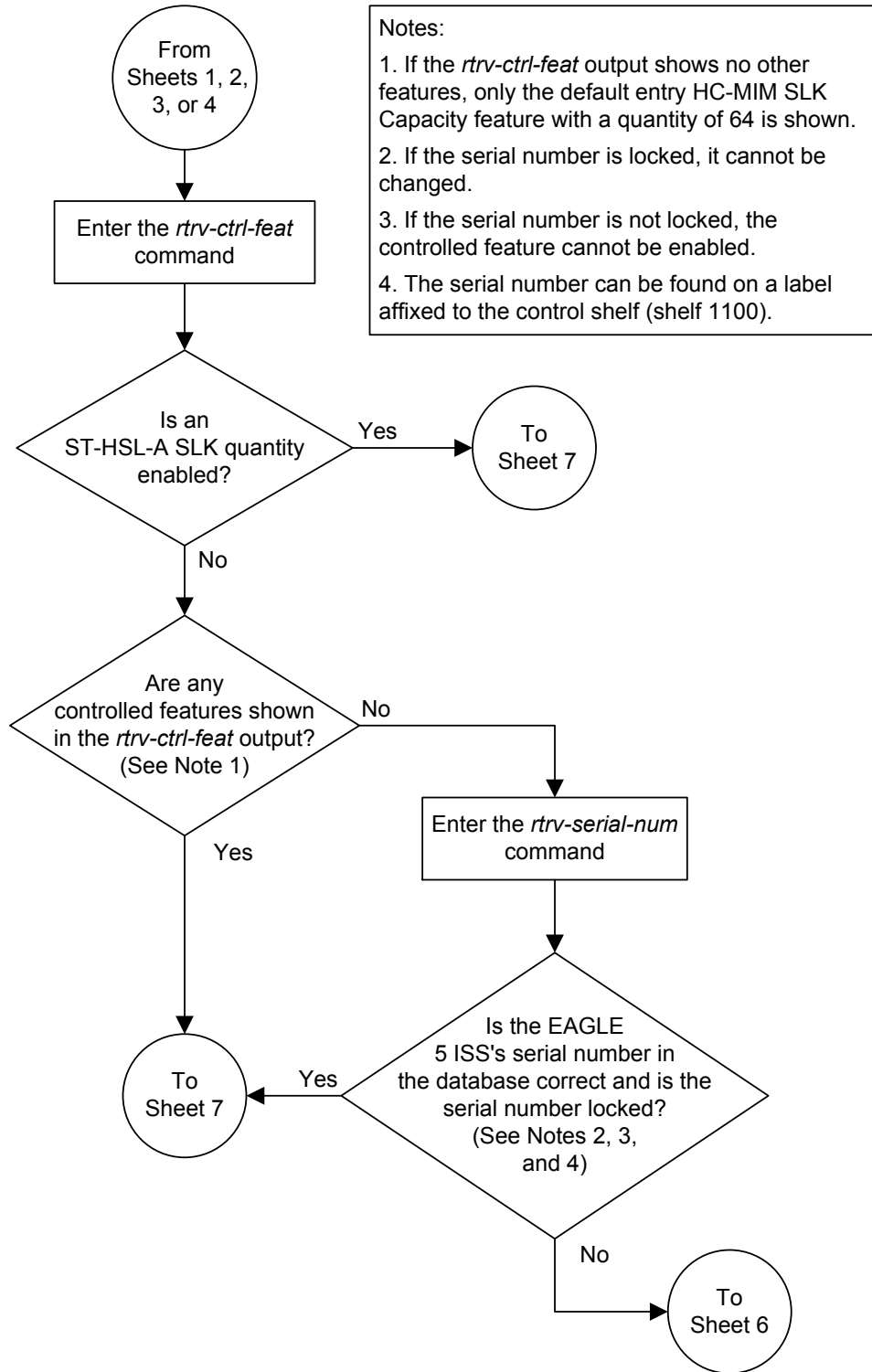
Sheet 2 of 9



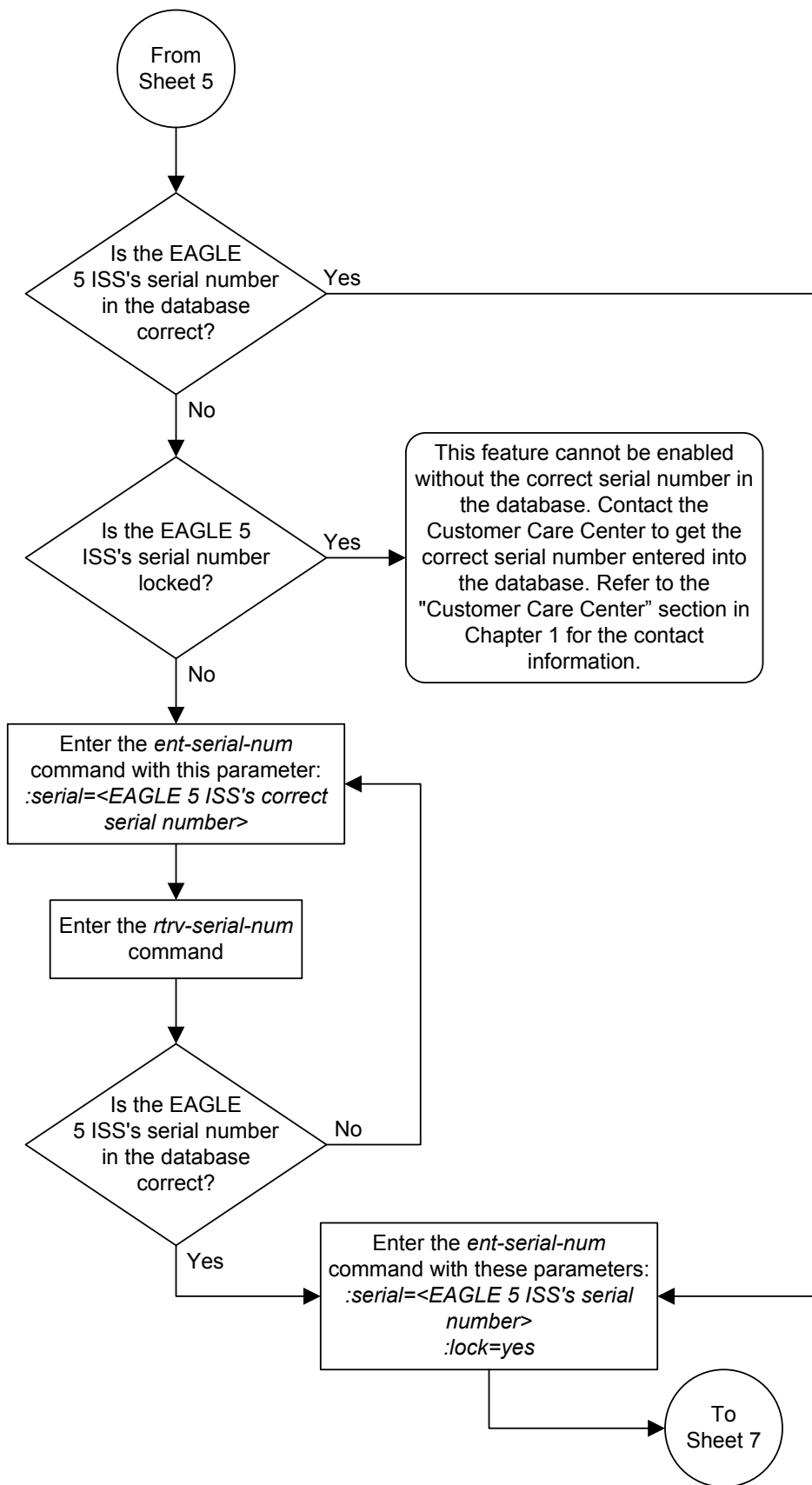
Sheet 3 of 9



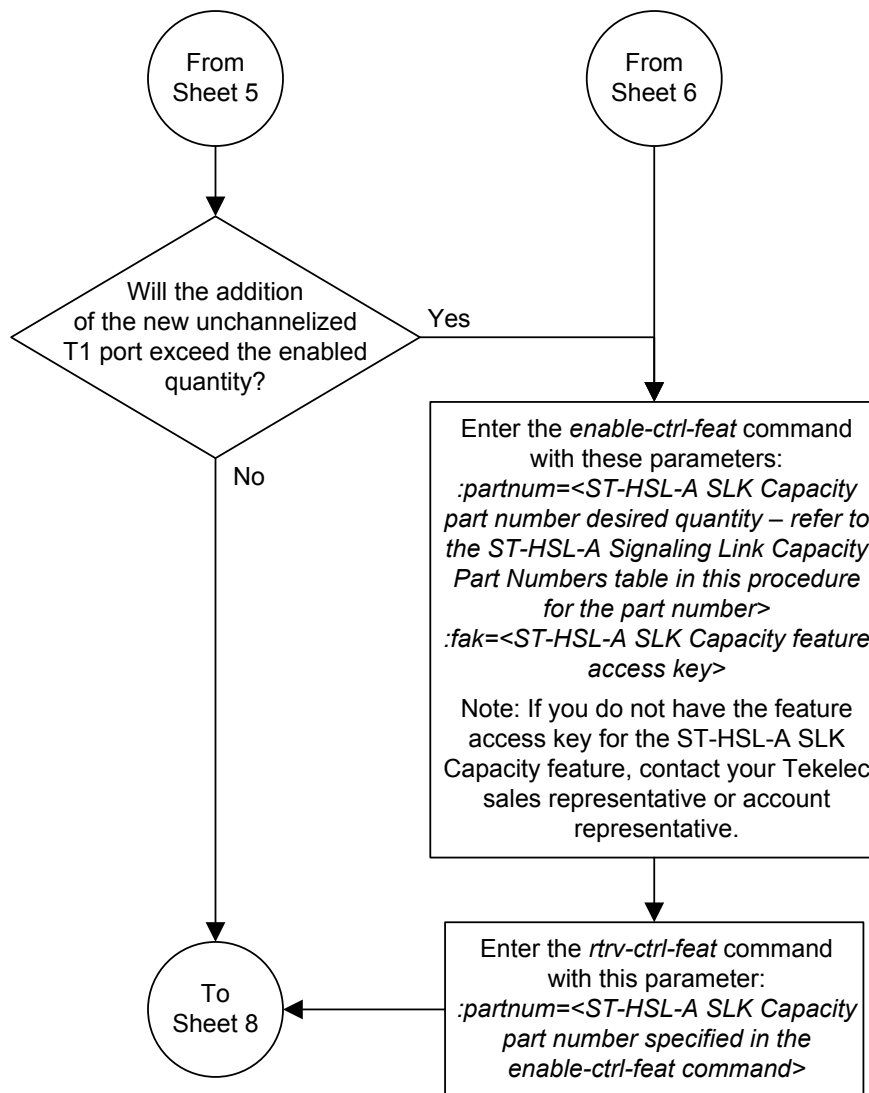
Sheet 4 of 9



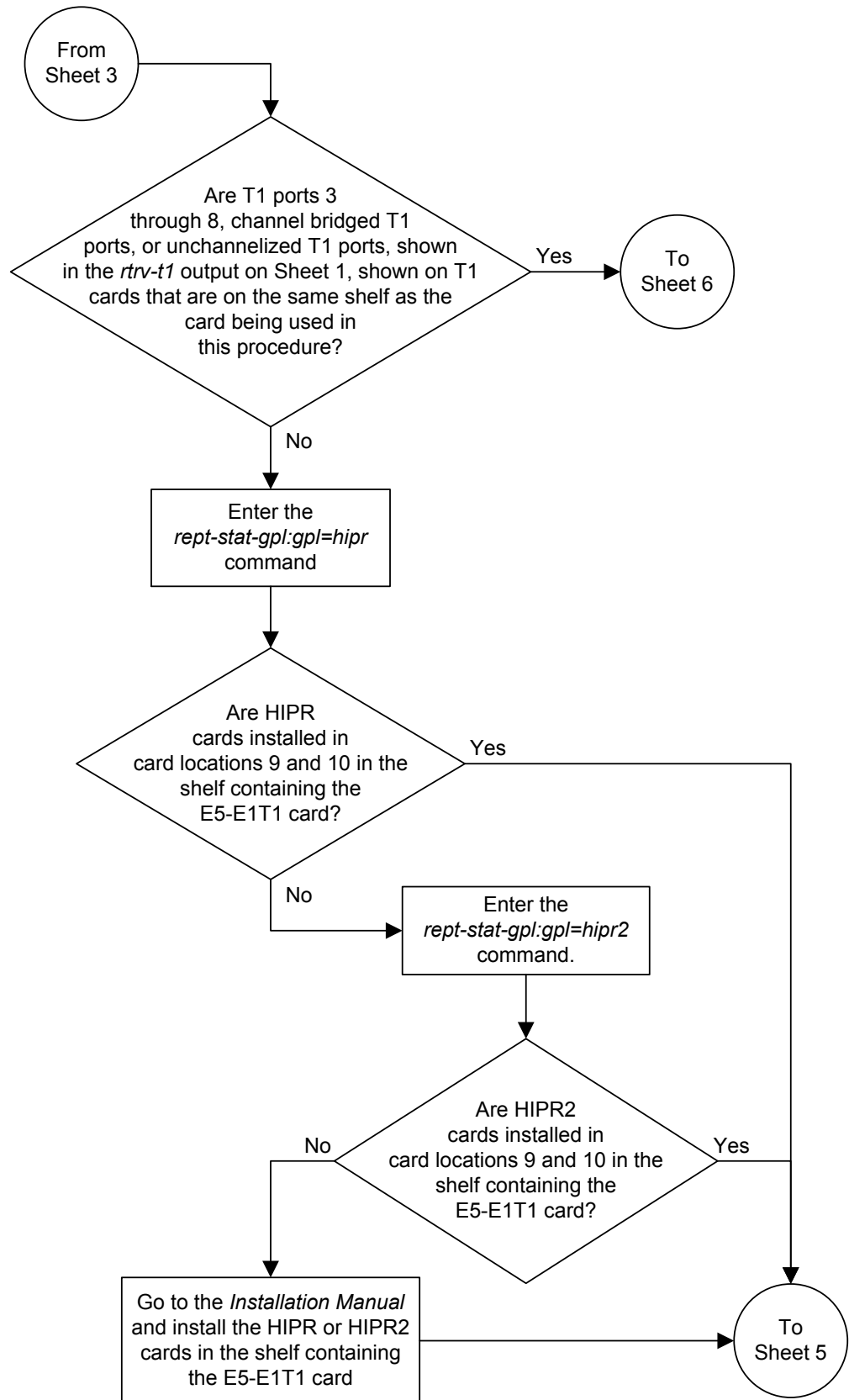
Sheet 5 of 9



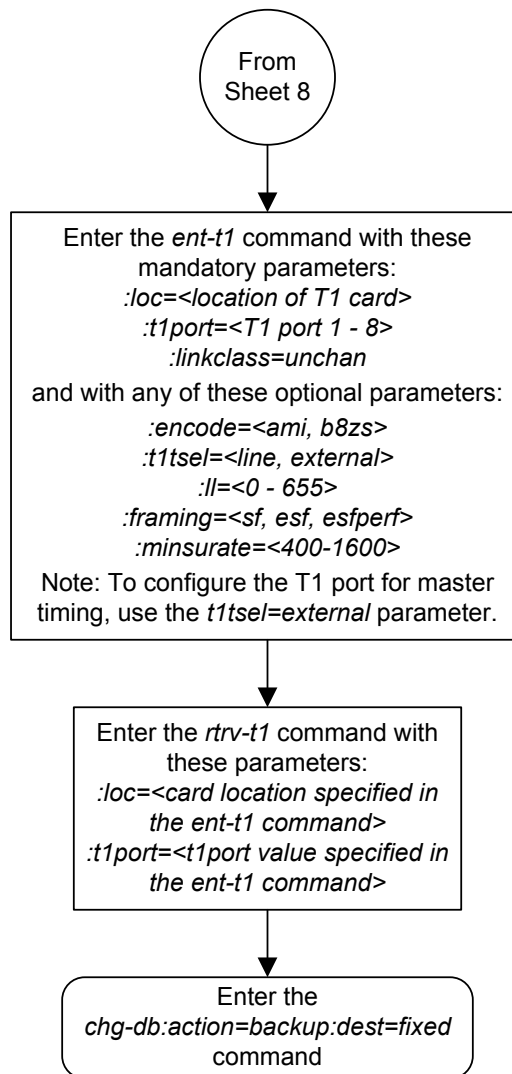
Sheet 6 of 9



Sheet 7 of 9



Sheet 8 of 9



Removing the T1 Interface Parameters

This procedure is used to remove a **T1** interface from the database using the `dlt-t1` command using these parameters.

`:loc` – The location of the **T1** card (card type `limt1`) containing the **T1** interface being removed.

`:t1port` – The **T1** port on the **T1** card containing the **T1** interface being removed.

The **T1** interface to be removed must exist in the database. This can be verified in step 1.

To remove the **T1** interface information contained on a **T1** card, all signaling links serviced by that **T1** card must be removed from the database. This can be verified with the `rtrv-t1` command, specifying the card location and `t1port` value on the **T1** card, and the `rtrv-slk` command, specifying the location of any cards (**T1** or channel cards) shown in the `rtrv-t1` output. If there are any signaling links being serviced by the **T1** card, go to the [Removing an SS7 Signaling Link](#) procedure and remove these signaling links.

Even numbered **T1** ports cannot be removed if the even numbered **T1** port is channel bridged. Remove the corresponding odd numbered **T1** port (see [Table B-5](#)) to remove the even numbered channel bridged **T1** port.

1. Display the existing **T1** interfaces in the database using the `rtrv-t1` command with no parameters.

```
rlghncxa03w 09-05-19 21:17:04 GMT EAGLE5 41.0.0
```

T1							LINK	MINSU
LOC	PORT	ENCODE	T1TSEL	FRAMING	LL	CHANBRDG	CLASS	RATE
1207	1	AMI	EXTERNAL	ESF	50	-----	CHAN	----
1215	2	B8ZS	LINE	SF	100	-----	CHAN	----

If the **T1** port being removed is an even numbered **T1** port and is channel bridged, select the corresponding odd numbered **T1** port to remove (see [Table B-5](#)) and go to step 2.

If the even numbered **T1** port is not channel bridged, it can be removed with the `dlt-t1` command. go to step 2.

2. Display the timeslots that are serviced by the **T1** card containing the **T1** interface information to be removed using the `rtrv-t1` command specifying the card location and the `t1port` value from step 1. For this example, enter this command.

```
rtrv-t1:loc=1207:t1port=1
```

```
rlghncxa03w 09-05-28 09:12:36 GMT EAGLE5 41.0.0
```

T1							LINK	MINSU
LOC	PORT	ENCODE	T1TSEL	FRAMING	LL	CHANBRDG	CLASS	RATE
1103	1	B8ZS	LINE	SF	133	-----	CHAN	----
TS1	-----	TS9	-----	TS17	1208,A2			
TS2	1207,A	TS10	-----	TS18	-----			
TS3	-----	TS11	-----	TS19	-----			

```

TS4  -----   TS12 -----   TS20 -----
TS5  -----   TS13 -----   TS21 -----
TS6  1208,A    TS14 -----   TS22 -----
TS7  -----   TS15 -----   TS23 -----
TS8  -----   TS16 -----   TS24 -----

```

If this step shows any timeslots that are serviced by the **T1** card, go to the [Removing an SS7 Signaling Link](#) procedure and remove the timeslots and signaling links serviced by the **T1** card.

3. Remove the **T1** interface information to the database using the `dlt-t1` command specifying the card location of the **T1** card and the **T1** port on that card. For this example, enter these commands.

```
dlt-t1:loc=1207:t1port=1
```

4. Verify the changes using the `rtrv-t1` command with the card location and the `t1port` value specified in 3.

For this example, enter this command.

```
rtrv-t1:loc=1207:t1port=1
```

```

rlghncxa03w 10-04-19 21:17:04 GMT EAGLE5 42.0.0
E2737 Cmd Rej: The T1PORT at the specified location is not equipped

```

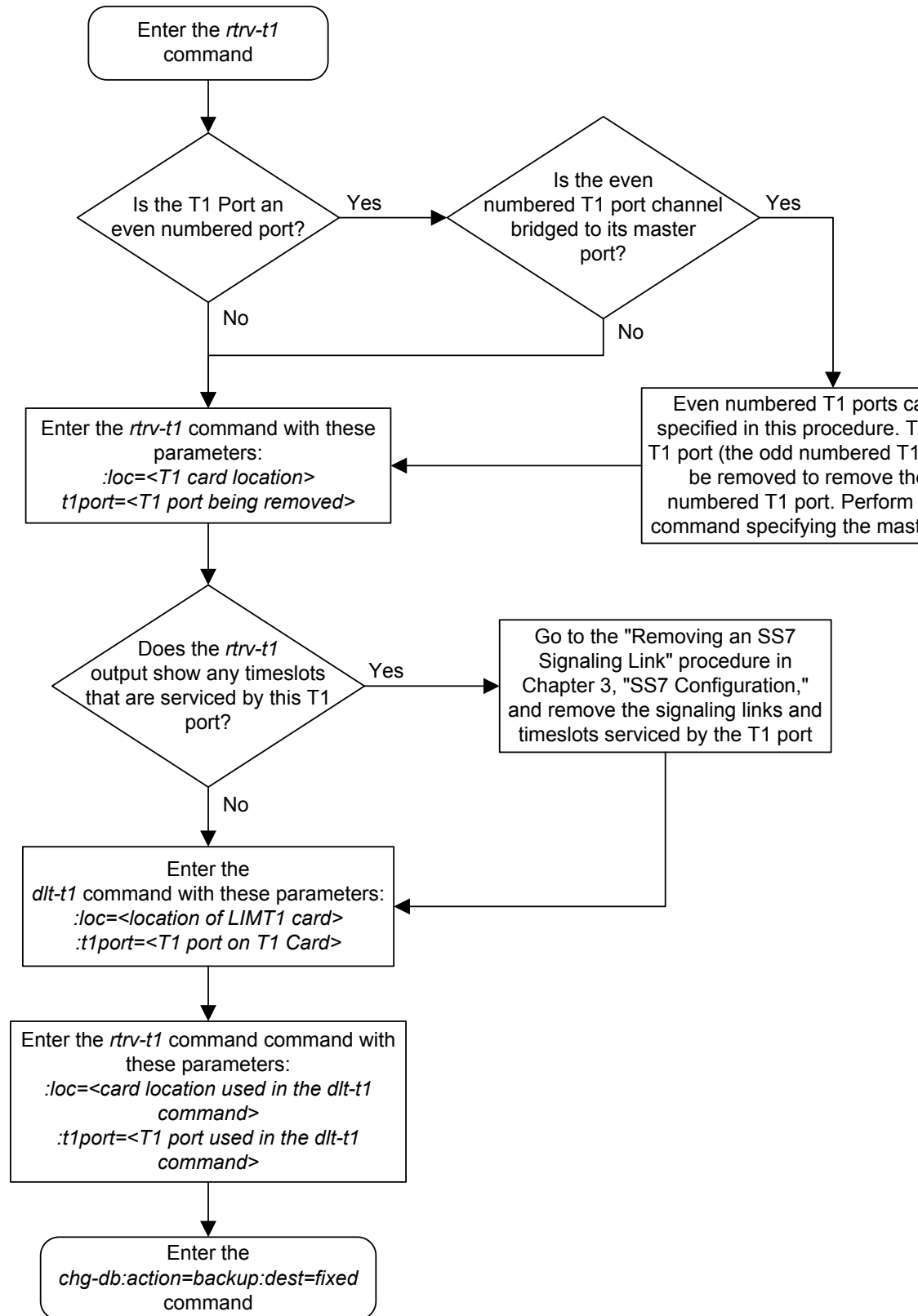
5. Back up the new changes using the `chg-db:action=backup:dest=fixed` command. These messages should appear, the active **Maintenance and Administration Subsystem Processor (MASP)** appears first.

```

BACKUP (FIXED) : MASP A - Backup starts on active MASP.
BACKUP (FIXED) : MASP A - Backup on active MASP to fixed disk complete.
BACKUP (FIXED) : MASP A - Backup starts on standby MASP.
BACKUP (FIXED) : MASP A - Backup on standby MASP to fixed disk complete.

```

Figure B-9 Removing the T1 Interface Parameters



Changing the Attributes of a Channelized T1 Port

This procedure is used to change the attributes of a channelized **T1** port using the `chg-t1` command. A channelized T1 port is a T1 port whose `LINKCLASS` value is `CHAN`, shown in the `LINKCLASS` column in the `rtrv-t1` output. Other actions can be performed on T1 ports. To perform these actions on the T1 ports, perform one of these procedures.

- To change the attributes of an unchannelized T1 port - [Changing the Attributes of an Unchannelized T1 Port](#)
- To make a channel bridged T1 port from a channelized T1 port - [Making a Channel Bridged T1 Port from a Channelized T1 Port](#)
- To make a non-channel bridged T1 port from a channel bridged T1 port - [Making a Non-Channel Bridged T1 Port from a Channel Bridged T1 Port](#)

To change the attributes of a channelized T1 port, these parameters are used with the `chg-t1` command.

`:loc` – The location of the T1 card (card type `1imt1`) that contains the T1 port that is being changed. The location of a channel card (card type `1imch`) cannot be specified for this parameter. The T1 card can be either an **E1/T1 MIM**, an **HC-MIM**, or an **E5-E1T1** card.

`:t1port` – The T1 port being changed in this procedure.

`:encode` – Specifies the type of encoding or decoding that is used on the T1 signaling link, either **B8ZS** or **AMI**.

`:t1tsel` – The timing source for the T1 signaling link, master (`external`), slave (`line`), or `recovered`.

The `recovered` timing source can be used only with the `chanbrdg=on` parameter and uses the even numbered member of the bridged-pair as a clock source, ensuring that port in the pair can recover the timing from its partner.

Note: To use an external high-speed master clock source other than RS-422, TDMs 870-0774-15 or later must be installed in card locations 1114 and 1116, and the **TDM Global Timing Interface** options must be configured. For more information, see [Configuring the Options for the TDM Global Timing Interface](#).

`:framing` – Specifies the framing format to be used on the T1 signaling link, either `sf` or `esf`.

`:l1` – The length of the cable, in feet, used for the T1 signaling link. The value of the `l1` parameter is from 0 to 655.

The T1 card specified in this procedure must be in the database. This can be verified with the `rtrv-t1` command.

If either the `encode`, `t1tsel`, `framing`, or `l1` values are being changed, all the signaling links serviced by the T1 card must be taken out of service.

1. Display the existing **T1** interfaces in the database using the `rtrv-t1` command with no parameters.

```
rlghncxa03w 09-05-19 21:17:04 GMT EAGLE5 41.0.0
```

T1							LINK	MINS
LOC	PORT	ENCODE	T1TSEL	FRAMING	LL	CHANBRDG	CLASS	RATE
1201	2	B8ZS	EXTERNAL	SF	133	-----	CHAN	----
1203	2	B8ZS	LINE	SF	133	-----	CHAN	----
1211	2	B8ZS	LINE	SF	133	-----	CHAN	----

A channelized T1 port is a T1 port whose LINKCLASS value is CHAN.

If there are no channelized T1 ports shown in the `rtrv-t1` output, this procedure cannot be performed.

If there are channelized T1 ports shown in the `rtrv-t1` output, continue the procedure with [2](#).

Note: At least one of the optional parameters `encode`, `t1tsel`, `framing`, or `ll` must be specified. If none of these parameters are specified with the `chg-t1` command, this procedure cannot be performed.

2. Display the timeslots that are serviced by the T1 card containing the T1 port that is being changed using the `rtrv-t1` command specifying the card location and the `t1port` value from [1](#).

For this example, enter this command.

```
rtrv-t1:loc=1201:t1port=2
```

```
rlghncxa03w 09-05-28 09:12:36 GMT EAGLE5 41.0.0
```

T1							LINK	MINS
LOC	PORT	ENCODE	T1TSEL	FRAMING	LL	CHANBRDG	CLASS	RATE
1201	2	B8ZS	EXTERNAL	SF	133	-----	CHAN	----
TS1	1201,A		TS9	-----		TS17	-----	
TS2	-----		TS10	-----		TS18	-----	
TS3	-----		TS11	-----		TS19	-----	
TS4	-----		TS12	-----		TS20	-----	
TS5	1202,A		TS13	-----		TS21	-----	
TS6	-----		TS14	-----		TS22	-----	
TS7	-----		TS15	-----		TS23	-----	
TS8	-----		TS16	-----		TS24	-----	

3. Display the signaling links that are assigned to the T1 card by entering the `rtrv-slk` command with the card location specified in [2](#). For this example, enter this command.

```
rtrv-slk:loc=1201
```

```
rlghncxa03w 09-05-19 21:17:04 GMT EAGLE5 41.0.0
```

LOC	LINK	LSN	SLC	TYPE	L2T	SET	BPS	ECM	PCR	PCR	T1	T1	TS
1201	A	lsn1	13	LIMT1	1	56000	BASIC	---	----	----	1201	2	10
1201	B	lsn1	12	LIMT1	1	56000	BASIC	---	----	----	1201	1	9

4. Check the status of the signaling links shown in [3](#) using the `rept-stat-slk` command with the card location and signaling link.

For this example, enter these commands.

```
rept-stat-slk:loc=1201:link=a
```

```
rlghncxa03w 09-05-23 13:06:25 GMT EAGLE5 41.0.0
SLK      LSN      CLLI      PST      SST      AST
1201,A  lsn1      -----  IS-NR      Avail      ----
ALARM STATUS      = No Alarms
UNAVAIL REASON    = --
T1 status          = 1201, RCVRY-T1F:FAC-T1 Port 2 available
```

```
rept-stat-slk:loc=1201:link=b
```

```
rlghncxa03w 09-05-23 13:06:25 GMT EAGLE5 41.0.0
SLK      LSN      CLLI      PST      SST      AST
1201,B  lsn1      -----  IS-NR      Avail      ----
ALARM STATUS      = No Alarms
UNAVAIL REASON    = --
T1 status          = 1201, RCVRY-T1F:FAC-T1 Port 1 available
```

If all the signaling links shown in this step are out of service, continue the procedure by performing one of these steps.

- If the T1 port is channel bridged (the entry MASTER is shown in the CHANBRDG column for the odd numbered T1 port in the `rtrv-t1` output), or if T1 ports 3 through 8 are assigned to the T1 card, the card is either an HC MIM or an E5-E1T1 card. Continue the procedure with 7.
- If the T1 port is not channel bridged, or if T1 ports 3 through 8 are not assigned to the T1 card, continue the procedure with 6 to verify the type of T1 card that the T1 port is assigned to.

If any of the signaling links shown in this step are in service, continue the procedure with 5.

5. Deactivate the signaling links shown in 4 using the `dact-slk` command.

For this example, enter these commands.

```
dact-slk:loc=1201:link=a
```

```
dact-slk:loc=1201:link=b
```

When each of these commands have successfully completed, this message should appear.

```
rlghncxa03w 09-05-07 08:41:12 GMT EAGLE5 41.0.0
Deactivate Link message sent to card
```

After the signaling links have been deactivated, continue the procedure by performing one of these steps.

- If the T1 port is channel bridged (the entry MASTER is shown in the CHANBRDG column for the odd numbered T1 port in the `rtrv-t1` output), or if T1 ports 3 through 8 are assigned to the T1 card, the card is either an HC-MIM or an E5-E1T1 card. Continue the procedure with 7.

- If the T1 port is not channel bridged, or if T1 ports 3 through 8 are not assigned to the T1 card, continue the procedure with 6 to verify the type of T1 card that the T1 port is assigned to.

6. Display the LIMT1 cards in the database by entering this command.

```
rtrv-stp:type=limt1
```

```
rlghncxa03w 09-05-30 11:07:17 EST EAGLE 41.0.0
```

Card	Part Number	Rev	Serial Number	Type	DB	APPL	GPL Version
1201	870-2671-02	C	10145689323	LIMT1	512M	SS7ANSI	126-034-000
1203	870-1873-01	C	10345690569	LIMT1	512M	SS7ANSI	126-034-000
1211	870-1873-01	C	10346790570	LIMT1	512M	SS7ANSI	126-034-000

Command Completed.

The part numbers and the card types of the T1 cards are shown in [Table B-4](#).

7. Change the T1 port using the `chg-t1` command and the parameter combinations shown in [Table B-13](#), based on the type of T1 card being used.

Table B-13 T1 Interface Parameter Combinations

E1/T1MIM	Non-Channel Bridged T1 Ports - HC-MIM or E5-E1T1 Card	Channel Bridged T1 Ports - HC-MIM or E5-E1T1 Card
Mandatory Parameters		
:loc=location of the T1 card	:loc=location of the T1 card	:loc=location of the T1 card
:t1port=T1 port being changed, either 1 or 2	:t1port=T1 port being changed, either 1, 2, 3, 4, 5, 6, 7, or 8	:t1port=T1 port being changed, either 1, 3, 5, or 7
Optional Parameters		
:encode=ami, b8zs	:encode=ami, b8zs	:encode=ami, b8zs
:t1tsel=line, external	:t1tsel=line, external	:t1tsel=external, recovered
:framing=sf, esf	:framing=sf, esf	:framing=sf, esf
:ll=0 - 655	:ll=0 - 655	:ll=0 - 655

For this example, enter this command.

```
chg-
t1:loc=1201:t1port=2:encode=ami:encode=line:framing=esf:ll=20
0
```

8. Verify the changes using the `rtrv-t1` command specifying the card location and the `t1port` value specified in 7.

For this example, enter these commands.

```
rtrv-t1:loc=1201:t1port=2
```

```
rlghncxa03w 09-05-28 09:12:36 GMT EAGLE5 41.0.0
```

LOC	T1 PORT	ENCODE	T1TSEL LINE	FRAMING	LL	CHANBRDG	LINK CLASS	MINS RATE
1201	2	AMI	LINE	ESF	200	-----	CHAN	----
TS1	1201,A	TS9	-----	TS17	-----			
TS2	-----	TS10	-----	TS18	-----			
TS3	-----	TS11	-----	TS19	-----			
TS4	-----	TS12	-----	TS20	-----			
TS5	1202,A	TS13	-----	TS21	-----			
TS6	-----	TS14	-----	TS22	-----			
TS7	-----	TS15	-----	TS23	-----			
TS8	-----	TS16	-----	TS24	-----			

If the signaling links were not deactivated in 5, continue the procedure with 10.

If the signaling links were deactivated in 5, continue the procedure with 9.

9. Activate the signaling links that were deactivated in 5 using the `act-slk` command.

For this example, enter these commands.

```
act-slk:loc=1201:link=a
```

```
act-slk:loc=1201:link=b
```

When each of these commands have successfully completed, this message should appear.

```
rlghncxa03w 09-05-07 08:41:12 GMT EAGLE5 41.0.0
```

```
Activate Link message sent to card
```

10. Back up the new changes using the `chg-db:action=backup:dest=fixed` command.

These messages should appear, the active **Maintenance and Administration Subsystem Processor (MASP)** appears first.

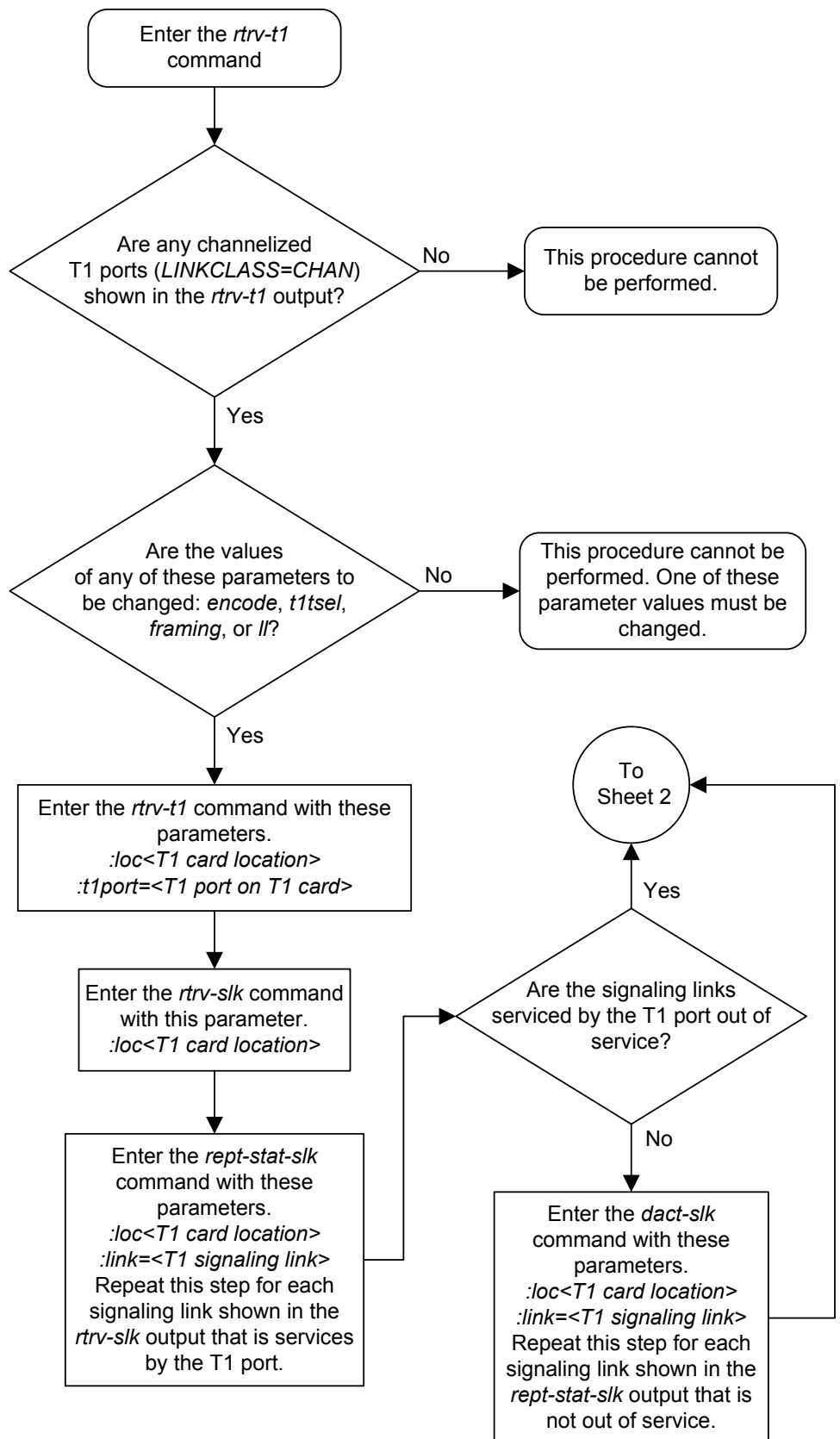
```
BACKUP (FIXED) : MASP A - Backup starts on active MASP.
```

```
BACKUP (FIXED) : MASP A - Backup on active MASP to fixed disk complete.
```

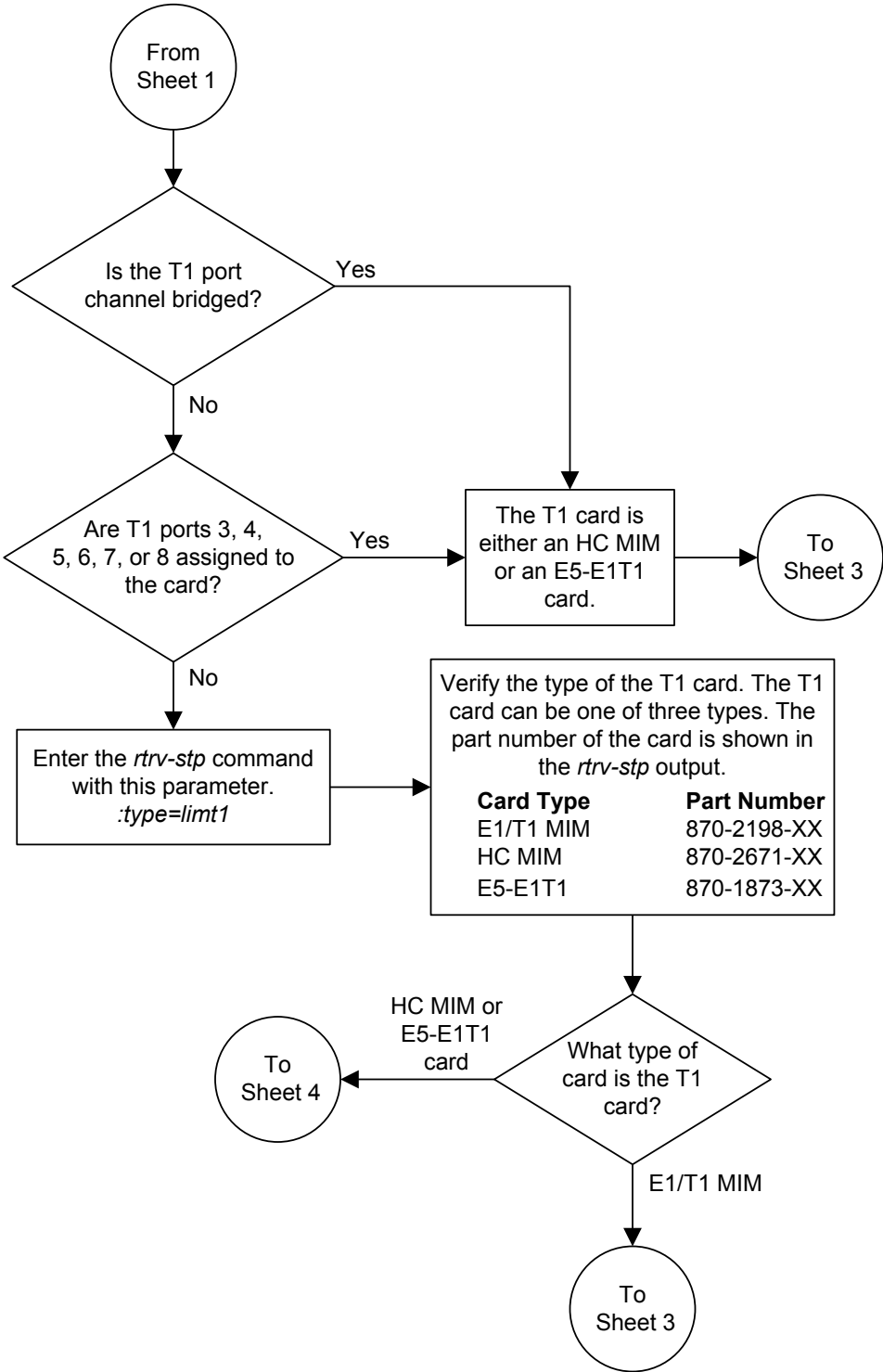
```
BACKUP (FIXED) : MASP A - Backup starts on standby MASP.
```

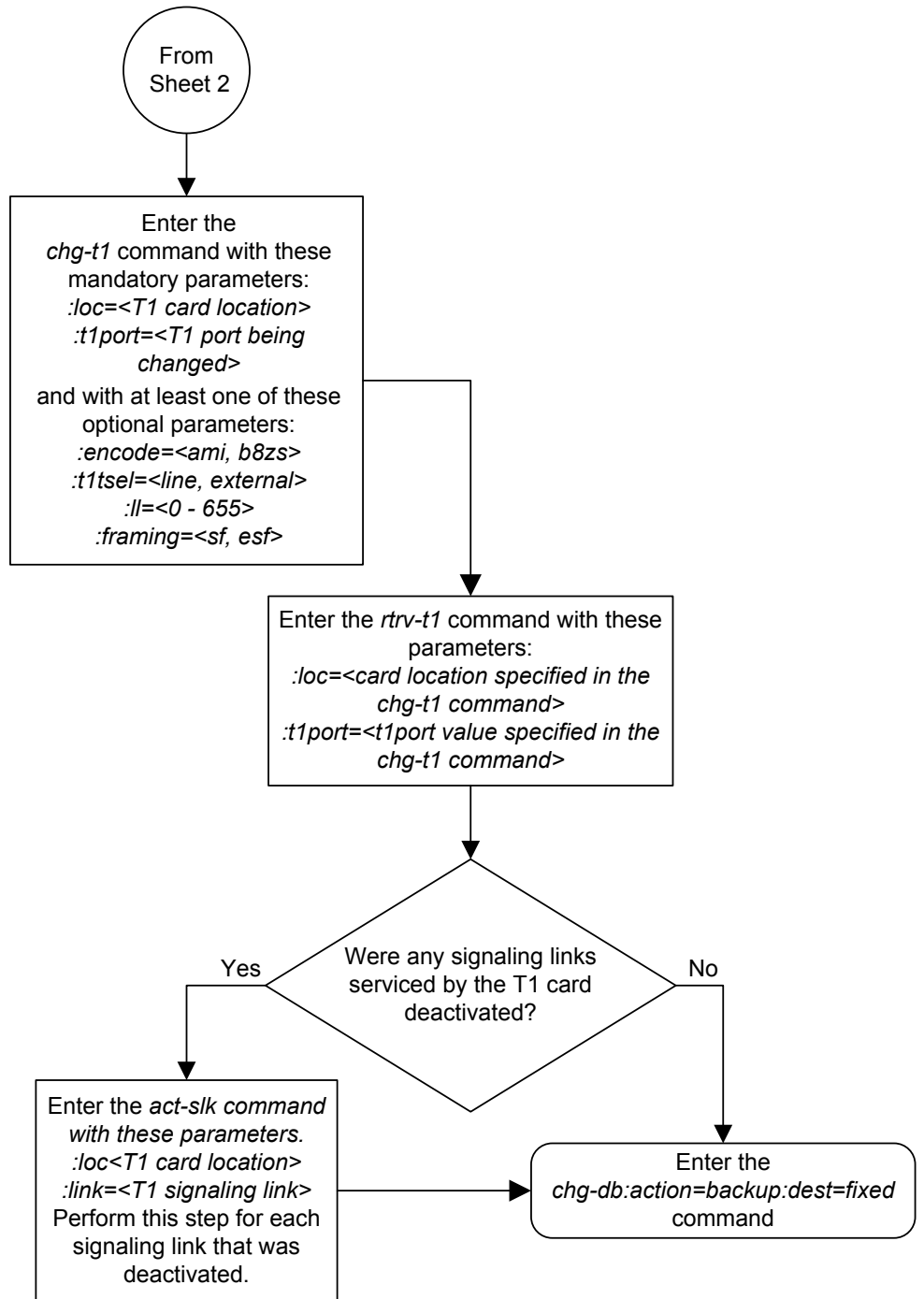
```
BACKUP (FIXED) : MASP A - Backup on standby MASP to fixed disk complete.
```

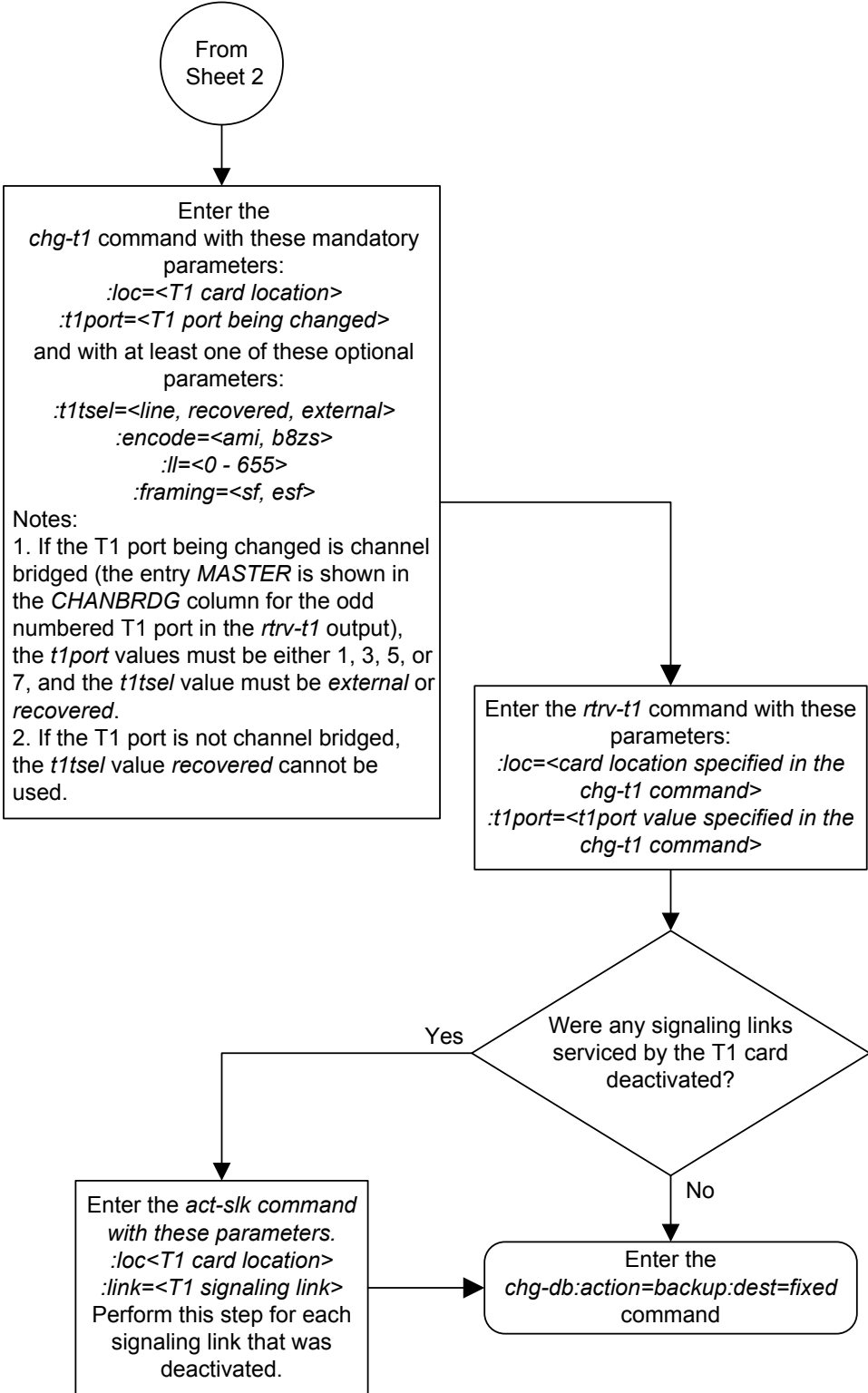

Figure B-10 Changing the Attributes of a Channelized T1 Port



Sheet 1 of 4







Changing the Attributes of an Unchannelized T1 Port

This procedure is used to change the attributes of an unchannelized **T1** port using the `chg-t1` command. An unchannelized T1 port is an T1 port whose `LINKCLASS` value is `UNCHAN`, shown in the `LINKCLASS` column in the `rtrv-t1` output. Other actions can be performed on T1 ports. To perform these actions on the T1 ports, perform one of these procedures.

- To change the attributes of a channelized T1 port - [Changing the Attributes of a Channelized T1 Port](#)
- To make a channel bridged T1 port from a channelized T1 port - [Making a Channel Bridged T1 Port from a Channelized T1 Port](#)
- To make a non-channel bridged T1 port from a channel bridged T1 port - [Making a Non-Channel Bridged T1 Port from a Channel Bridged T1 Port](#)

To change the attributes of an unchannelized T1 port, these parameters are used with the `chg-t1` command.

`:loc` – The location of the T1 card (card type `limt1`) that is servicing the T1 signaling link. The location of a channel card (card type `limch`) cannot be specified for this parameter. The T1 card can be either an HC-MIM or an E5-E1T1 card.

`:t1port` – The T1 port being changed in this procedure.

`:encode` – Specifies the type of encoding or decoding that is used on the T1 signaling link, either **B8ZS** or **AMI**.

`:t1tsel` – The timing source for the T1 signaling link, master (`external`) or slave (`line`).

Note: To use an external high-speed master clock source other than RS-422, TDMs 870-0774-15 or later must be installed in card locations 1114 and 1116, and the **TDM Global Timing Interface** options must be configured. For more information, see [Configuring the Options for the TDM Global Timing Interface](#).

`:framing` – Specifies the framing format to be used on the T1 signaling link, either `sf`, `esf`, or `esfperf`.

`:ll` – The length of the cable, in feet, used for the T1 signaling link. The value of the `ll` parameter is from 0 to 655.

`:minsurate` – Specifies the minimum number of signaling units (**FISUs** and **LSSUs**) per second that are transmitted on the outbound T1 signaling link during idle periods or when there is an unused portion of the link's bandwidth. The value of this parameter is from 400 to 1600 signaling units per second, with the default value of 1000 signaling units per second. The `minsurate` parameter can be specified only for an unchannelized T1 port (`linkclass=unchan` parameter).

The **T1** card specified in this procedure must be in the database. This can be verified with the `rtrv-t1` command.

If either the `encode`, `t1tsel`, `framing`, or `ll` values are being changed, all the signaling links serviced by the T1 card must be taken out of service.

1. Display the existing T1 interfaces in the database using the `rtrv-t1` command with no parameters.

```
rlghncxa03w 09-05-19 21:17:04 GMT EAGLE5 41.0.0
```

T1							LINK	MINS
LOC	PORT	ENCODE	T1TSEL	FRAMING	LL	CHANBRDG	CLASS	RATE
1201	2	B8ZS	EXTERNAL	SF	133	-----	UNCHAN	1200
1203	2	B8ZS	LINE	SF	133	-----	CHAN	----
1211	2	B8ZS	LINE	SF	133	-----	CHAN	----

An unchannelized T1 port is an T1 port whose `LINKCLASS` value is `UNCHAN`.

If there are no unchannelized T1 ports shown in the `rtrv-t1` output, this procedure cannot be performed.

If there are unchannelized T1 ports shown in the `rtrv-t1` output, continue the procedure by performing one of these steps.

- If the `encode`, `t1tsel`, `framing`, or `ll` parameters are being changed in this procedure, continue the procedure with [2](#).
 - If the `encode`, `t1tsel`, `framing`, or `ll` parameters are not being changed in this procedure, continue the procedure with [5](#).
2. Display the signaling links that are assigned to the T1 card by entering the `rtrv-slk` command with the card location shown in [1](#). For this example, enter this command.

```
rtrv-slk:loc=1201
```

```
rlghncxa03w 09-05-19 21:17:04 GMT EAGLE5 41.0.0
```

											L2T		PCR		E1		E1	
LOC	LINK	LSN	SLC TYPE		SET	BPS	ECM	N1	N2	LOC	PORT	TS						
1201	A	lsn1	13	LIMT1	1	56000	BASIC	---	-----	1201	2	10						

3. Check the status of the signaling links shown in [2](#) using the `rept-stat-slk` command with the card location and signaling link.

For this example, enter these commands.

```
rept-stat-slk:loc=1201:link=a
```

```
rlghncxa03w 09-05-23 13:06:25 GMT EAGLE5 41.0.0
```

SLK	LSN	CLLI	PST	SST	AST
1201,A	lsn1	-----	IS-NR	Avail	----
ALARM STATUS		= No Alarms			
UNAVAIL REASON		= --			
T1 status		= 1201, RCVRY-T1F:FAC-T1 Port 2 available			

If all the signaling links shown in this step are out of service, continue the procedure with [5](#).

If any of the signaling links shown in this step are in service, continue the procedure with [4](#).

4. Deactivate the signaling links shown in [3](#) using the `dact-slk` command.

For this example, enter these commands.

```
dact-slk:loc=1201:link=a
```

When this command has successfully completed, this message should appear.

```
rlghncxa03w 09-05-07 08:41:12 GMT EAGLE5 41.0.0
Deactivate Link message sent to card
```

5. Change the T1 port using the `chg-t1` command and the parameter combinations shown in [Table B-14](#).

Table B-14 Unchannelized T1 Port Parameter Combinations

Mandatory Parameters

:loc=location of the T1 card

:t1port=T1 port being changed, either 1, 2, 3, 4, 5, 6, 7, or 8

Optional Parameters

:encode=ami, b8zs

:t1tsel=line, external

:framing=sf, esf, esfperf

:ll=0 - 655

:minsurate=400 - 1600

For this example, enter this command.

```
rlghncxa03w 09-05-19 21:17:04 GMT EAGLE5 41.0.0
```

T1							LINK	MINS
LOC	PORT	ENCODE	T1TSEL	FRAMING	LL	CHANBRDG	CLASS	RATE
1201	2	B8ZS	EXTERNAL	SF	133	-----	UNCHAN	1200
1203	2	B8ZS	LINE	SF	133	-----	CHAN	----
1211	2	B8ZS	LINE	SF	133	-----	CHAN	----

```
chg-
```

```
t1:loc=1201:t1port=2:encode=ami:t1tsel=line:framing=esfperf:l
l=300:minsurate=700
```

6. Verify the changes using the `rtrv-t1` command specifying the card location and the `t1port` value specified in 5.

For this example, enter these commands.

```
rtrv-t1:loc=1201:t1port=2
```

```
rlghncxa03w 09-05-28 09:12:36 GMT EAGLE5 41.0.0
```

T1							LINK	MINS
LOC	PORT	ENCODE	T1TSEL	FRAMING	LL	CHANBRDG	CLASS	RATE
1201	2	AMI	LINE	ESF PERF	300	-----	UNCHAN	700

If the signaling links were not deactivated in 4, continue the procedure with 8.

If the signaling links were deactivated in 4, continue the procedure with 7.

7. Activate the signaling links that were deactivated in 4 using the `act-slk` command.

For this example, enter this command.

```
act-slk:loc=1201:link=a
```

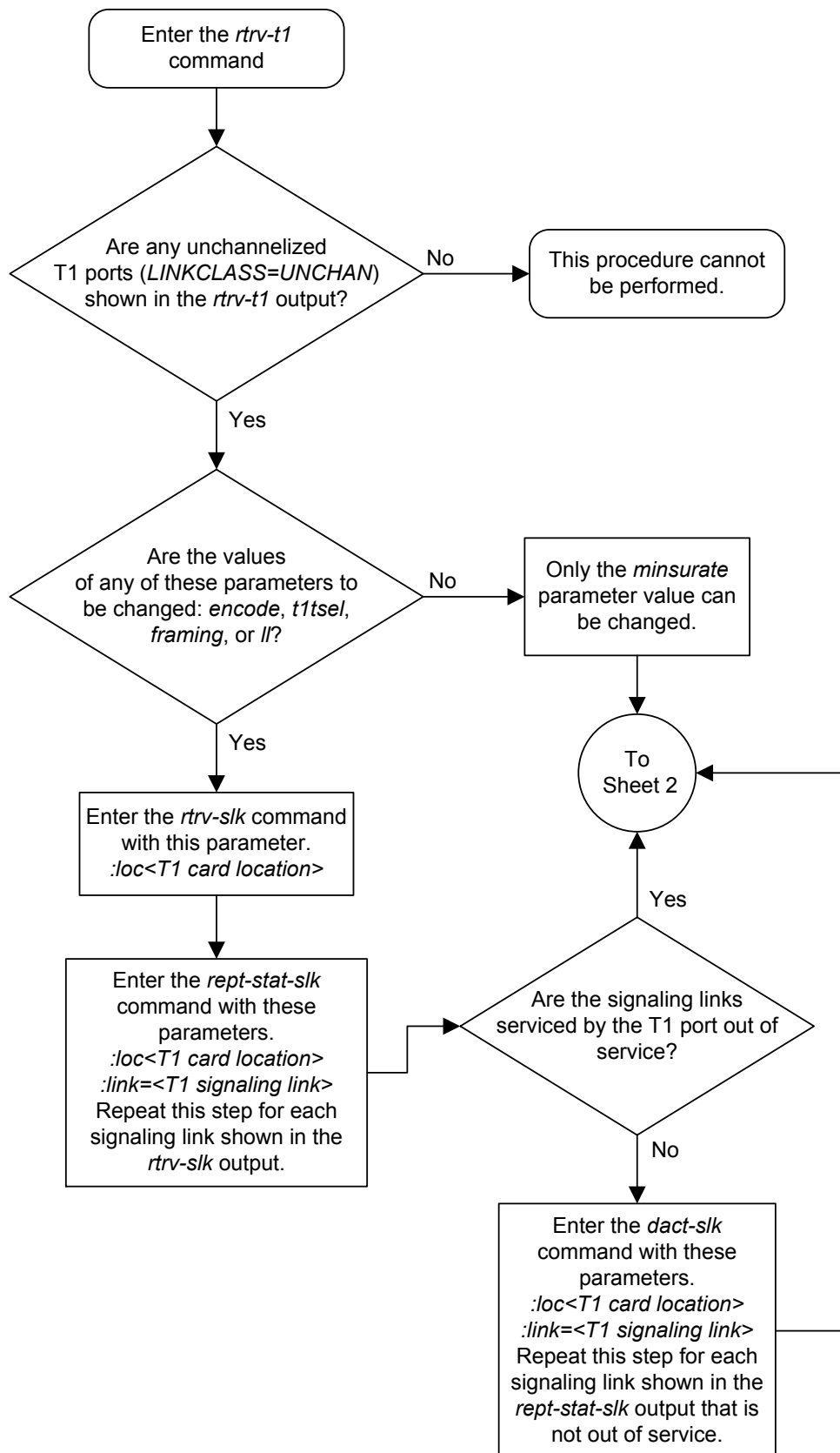
```
rlghncxa03w 09-05-07 08:41:12 GMT EAGLE5 41.0.0  
Activate Link message sent to card
```

8. Back up the new changes using the `chg-db:action=backup:dest=fixed` command.

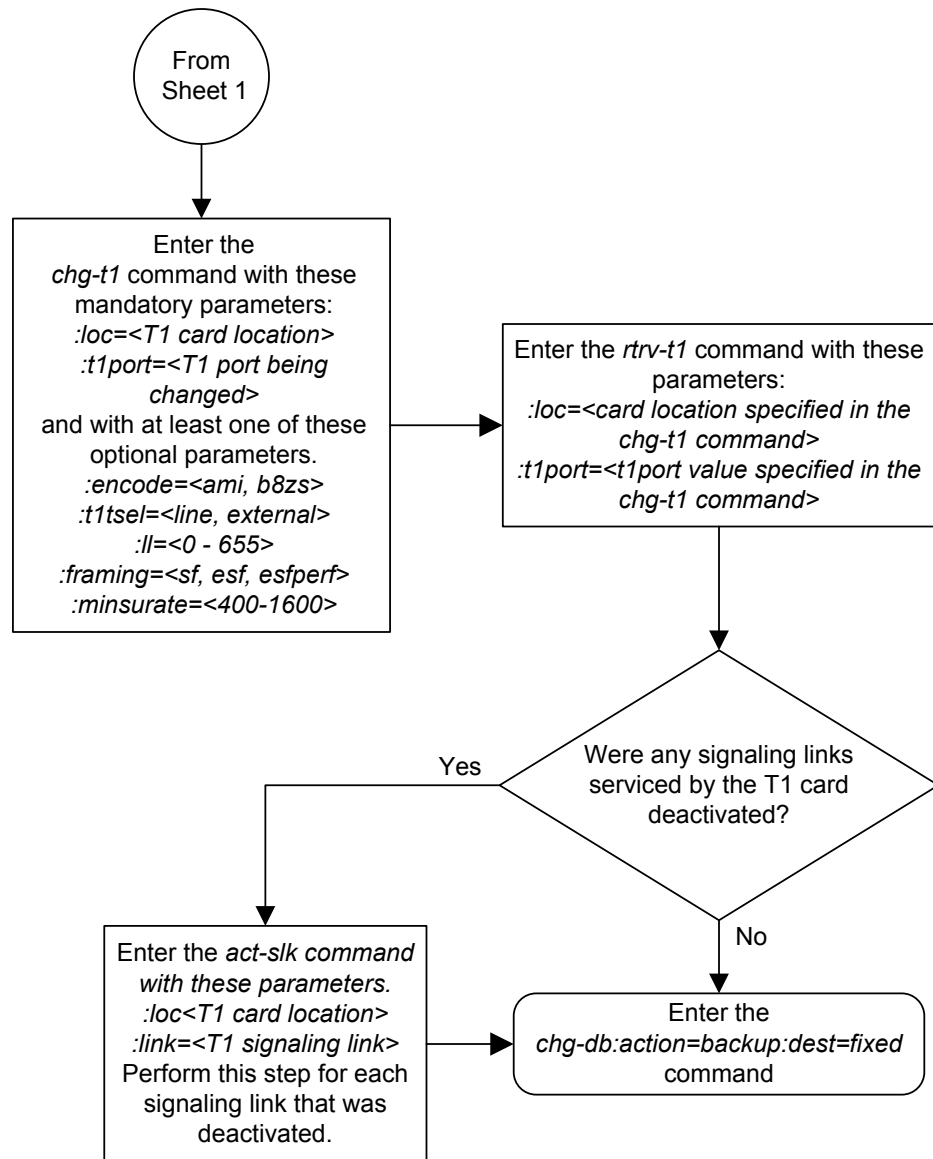
These messages should appear, the active **Maintenance and Administration Subsystem Processor (MASP)** appears first.

```
BACKUP (FIXED) : MASP A - Backup starts on active MASP.  
BACKUP (FIXED) : MASP A - Backup on active MASP to fixed disk complete.  
BACKUP (FIXED) : MASP A - Backup starts on standby MASP.  
BACKUP (FIXED) : MASP A - Backup on standby MASP to fixed disk complete.
```

Figure B-11 Changing the Attributes of an Unchannelized T1 Port



Sheet 1 of 2



Making a Channel Bridged T1 Port from a Channelized T1 Port

This procedure is used to make a channel bridged T1 port from a channelized T1 port that is not channel bridged using the `chg-t1` command. A channelized T1 port is a T1 port whose `LINKCLASS` value is `CHAN`, shown in the `LINKCLASS` column in the `rtrv-t1` output. A non-channel bridged T1 port is an odd numbered T1 port that contains dashes in the `CHANBRDG` column in the `rtrv-t1` output. Other actions can be performed on T1 ports. To perform these actions on the T1 ports, perform one of these procedures.

- To change the attributes of a channelized T1 port - [Changing the Attributes of a Channelized T1 Port](#)
- To change the attributes of an unchannelized T1 port - [Changing the Attributes of an Unchannelized T1 Port](#)
- To make a non-channel bridged T1 port from a channel bridged T1 port - [Making a Non-Channel Bridged T1 Port from a Channel Bridged T1 Port](#)

To make a channel bridged T1 port from a channelized T1 port, these parameters are used with the `chg-t1` command.

`:loc` – The location of the T1 card (card type `limt1`) that contains the odd numbered channelized T1 port. The location of a channel card (card type `limch`) cannot be specified for this parameter. The T1 card can be either an **HC-MIM** or an **E5-E1T1** card.

`:t1port` – The T1 port being changed in this procedure. Only the odd numbered T1 ports, 1, 3, 5, or 7, can be specified for a channel bridged T1 port.

`:encode` – Specifies the type of encoding or decoding that is used on the T1 signaling link, either **B8ZS** or **AMI**.

`:t1tsel` – The timing source for the T1 signaling link, master (external) or recovered.

The `recovered` timing source can be used only with the `chanbrdg=on` parameter and uses the even numbered member of the bridged-pair as a clock source, ensuring that port in the pair can recover the timing from its partner.

Note: To use an external high-speed master clock source other than RS-422, TDMs 870-0774-15 or later must be installed in card locations 1114 and 1116, and the **TDM Global Timing Interface** options must be configured. For more information, see [Configuring the Options for the TDM Global Timing Interface](#).

`:framing` – Specifies the framing format to be used on the T1 signaling link, either `sf` or `esf`. The default value is `sf` (`framing=sf`).

`:l1` – The length of the cable, in feet, used for the T1 signaling link. The value of the `l1` parameter is from 0 to 655.

`:chanbrdg` – Specifies whether or not the odd numbered T1 port specified in this procedure is channel bridged to its adjacent even numbered T1 port. [Table B-15](#) shows the T1 ports that can be specified with the `chanbrdg=on` parameter and the even-numbered T1 ports that are bridged to the odd numbered T1 port.

Table B-15 Channel Bridging Ports

Odd Numbered T1 Port	Even Numbered Bridged T1 Port
1	2
3	4
5	6
7	8

`:force=yes` – required when the even numbered T1 port being channel bridged is provisioned in the database before this procedure is performed.

The T1 card specified in this procedure must be in the database. This can be verified with the `rtrv-t1` command.

If either the `encode`, `t1tsel`, `framing`, or `ll` values are being changed, all the signaling links serviced by the T1 card must be taken out of service.

1. Display the existing T1 ports in the database using the `rtrv-t1` command with no parameters.

```
rlghncxa03w 09-05-19 21:17:04 GMT EAGLE5 41.0.0
```

T1							LINK	MINS
LOC	PORT	ENCODE	T1TSEL	FRAMING	LL	CHANBRDG	CLASS	RATE
1201	1	B8ZS	EXTERNAL	SF	133	-----	CHAN	----
1201	2	B8ZS	EXTERNAL	SF	133	-----	CHAN	----
1203	2	B8ZS	LINE	SF	133	-----	CHAN	----
1211	2	B8ZS	LINE	SF	133	-----	CHAN	----

A channelized T1 port is an T1 port whose `LINKCLASS` value is `CHAN`.

If there are no odd numbered channelized T1 ports that are not channel bridged shown in the `rtrv-t1` output, this procedure cannot be performed.

If odd numbered channelized T1 ports that are not channel bridged are shown in the `rtrv-t1` output, continue the procedure by performing one of these steps.

- If the T1 card contains channel bridged T1 ports, or contains T1 ports 3 through 8, continue the procedure with by performing one of these steps.
 - If the `encode`, `t1tsel`, `framing`, or `ll` parameters are not being changed in this procedure, continue the procedure by performing one of these steps.
 - If T1 cards are shown in the `rtrv-t1` output in [1](#) that are on the same shelf as the card that contains the T1 port that is being changed, and these cards have T1 ports 3 through 8 provisioned, contain channel bridged T1 ports, or unchannelized T1 ports, continue the procedure by performing one of these steps.
 - If the adjacent T1 port is provisioned (see [Table B-15](#)), continue the procedure with [11](#).

- If the adjacent T1 port is not provisioned, continue the procedure with 12.
- If T1 cards are not shown in the `rtrv-t1` output in 1 that are on the same shelf as the card that will contain the T1 port that is being added, continue the procedure with 7.
- If T1 cards are shown in the `rtrv-t1` output in 1 that are on the same shelf as the card that contains the T1 port that is being changed, and these cards do not have T1 ports 3 through 8 provisioned, do not contain channel bridged T1 ports, or do not have unchannelized T1 ports, continue the procedure with 7.
- If the `encode`, `t1tsel`, `framing`, or `ll` parameters are being changed in this procedure, continue the procedure with 3.
- If the T1 card does not contain channel bridged T1 ports, or does not contain T1 ports 3 through 8, continue the procedure with 2.

2. Display the LIMT1 cards in the database by entering this command.

```
rtrv-stp:type=limt1
```

```
rlghncxa03w 09-05-30 11:07:17 EST EAGLE 41.0.0
```

Card	Part Number	Rev	Serial Number	Type	DB	APPL	GPL Version
1201	870-2671-02	C	10145689323	LIMT1	512M	SS7ANSI	126-034-000
1203	870-1873-01	C	10345690569	LIMT1	512M	SS7ANSI	126-034-000
1211	870-1873-01	C	10346790570	LIMT1	512M	SS7ANSI	126-034-000

Command Completed.

The part numbers and the card types of the T1 cards are shown in [Table B-4](#).

If the T1 card is an E1/T1 MIM, this card cannot be used in this procedure. Choose another T1 port on another HC-MIM or E5-E1t1 card and repeat this procedure from 1. If no HC-MIMs or E5-E1T1 cards are present in the EAGLE, this procedure cannot be performed.

If the T1 card is either an HC-MIM card or an E5-E1T1 card, continue the procedure by performing one of these steps.

- If the `encode`, `t1tsel`, `framing`, or `ll` parameters are not being changed in this procedure, continue the procedure by performing one of these steps.
 - If T1 cards are shown in the `rtrv-t1` output in 1 that are on the same shelf as the card that contains the T1 port that is being changed, and these cards have T1 ports 3 through 8 provisioned, contain channel bridged T1 ports, or unchannelized T1 ports, continue the procedure by performing one of these steps.
 - If the adjacent T1 port is provisioned (see [Table B-15](#)), continue the procedure with 11.
 - If the adjacent T1 port is not provisioned, continue the procedure with 12.

- If T1 cards are not shown in the `rtrv-t1` output in 1 that are on the same shelf as the card that contains the T1 port that is being changed, continue the procedure with 7.
 - If T1 cards are shown in the `rtrv-t1` output in 1 that are on the same shelf as the card that contains the T1 port that is being changed, and these cards do not have T1 ports 3 through 8 provisioned, do not contain channel bridged T1 ports, or do not have unchannelized T1 ports, continue the procedure with 7.
 - If the `encode`, `t1tsel`, `framing`, or `ll` parameters are being changed in this procedure, continue the procedure with 3.
3. Display the timeslots that are serviced by the T1 card containing the T1 port being changed using the `rtrv-t1` command specifying the card location and the `tlport` value from 1.

For this example, enter this command.

```
rtrv-t1:loc=1201:tlport=1
```

```
rlghncxa03w 09-05-28 09:12:36 GMT EAGLE5 41.0.0
```

LOC	T1 PORT	ENCODE	T1TSEL	FRAMING	LL	CHANBRDG	LINK CLASS	MINS RATE
1201	1	B8ZS	EXTERNAL	SF	133	-----	CHAN	----
TS1	1201,A	TS9	-----	TS17	-----			
TS2	-----	TS10	-----	TS18	-----			
TS3	-----	TS11	-----	TS19	-----			
TS4	-----	TS12	-----	TS20	-----			
TS5	1202,A	TS13	-----	TS21	-----			
TS6	-----	TS14	-----	TS22	-----			
TS7	-----	TS15	-----	TS23	-----			
TS8	-----	TS16	-----	TS24	-----			

4. Display the signaling links that are assigned to the T1 card by entering the `rtrv-slk` command with the card location specified in 3. For this example, enter this command.

```
rtrv-slk:loc=1201
```

```
rlghncxa03w 09-05-19 21:17:04 GMT EAGLE5 41.0.0
```

LOC	LINK	LSN	SLC TYPE	SET	BPS	ECM	PCR N1	PCR N2	E1 LOC	E1 PORT	TS
1201	A	lsn1	13 LIMT1	1	56000	BASIC	---	-----	1201	2	25
1201	B	lsn1	12 LIMT1	1	56000	BASIC	---	-----	1201	1	20

5. Check the status of the signaling links shown in 3 using the `rept-stat-slk` command with the card location and signaling link.

For this example, enter these commands.

```
rept-stat-slk:loc=1201:link=a
```

```
rlghncxa03w 09-05-23 13:06:25 GMT EAGLE5 41.0.0
```

SLK	LSN	CLLI	PST	SST	AST
1201,A	lsn1	-----	IS-NR	Avail	----

```
ALARM STATUS      = No Alarms
UNAVAIL REASON    = --
T1 status         = 1201, RCVRY-T1F:FAC-T1 Port 2 available
```

```
rept-stat-slk:loc=1201:link=b
```

```
rlghncxa03w 09-05-23 13:06:25 GMT EAGLE5 41.0.0
SLK   LSN   CLLI   PST   SST   AST
1201,B lsn1  ----- IS-NR   Avail  ----
ALARM STATUS      = No Alarms
UNAVAIL REASON    = --
T1 status         = 1201, RCVRY-T1F:FAC-T1 Port 1 available
```

If all the signaling links shown in this step are out of service, continue the procedure by performing one of these steps.

- If T1 cards are shown in the `rtrv-t1` output in [1](#) that are on the same shelf as the card that contains the T1 port that is being changed, and these cards have T1 ports 3 through 8 provisioned, contain channel bridged T1 ports, or unchannelized T1 ports, continue the procedure by performing one of these steps.
 - If the adjacent T1 port is provisioned (see [Table B-15](#)), continue the procedure with [11](#).
 - If the adjacent T1 port is not provisioned, continue the procedure with [12](#).
- If T1 cards are not shown in the `rtrv-t1` output in [1](#) that are on the same shelf as the card that will contain the T1 port that is being added, continue the procedure with [7](#).
- If T1 cards are shown in the `rtrv-t1` output in [1](#) that are on the same shelf as the card that contains the T1 port that is being changed, and these cards do not have T1 ports 3 through 8 provisioned, do not contain channel bridged T1 ports, or do not have unchannelized T1 ports, continue the procedure with [7](#).

If any of the signaling links shown in this step are in service, continue the procedure with [6](#).

6. Deactivate the signaling links shown in [5](#) using the `dact-slk` command.

For this example, enter these commands.

```
dact-slk:loc=1201:link=a
```

```
dact-slk:loc=1201:link=b
```

When each of these commands have successfully completed, this message should appear.

```
rlghncxa03w 09-05-07 08:41:12 GMT EAGLE5 41.0.0
Deactivate Link message sent to card
```

Continue the procedure by performing one of these steps.

- If T1 cards are shown in the `rtrv-t1` output in [1](#) that are on the same shelf as the card that contains the T1 port that is being changed, and these cards have T1 ports 3 through 8 provisioned, contain channel bridged T1 ports, or

unchannelized T1 ports, continue the procedure by performing one of these steps.

- If the adjacent T1 port is provisioned (see [Table B-15](#)), continue the procedure with [11](#).
 - If the adjacent T1 port is not provisioned, continue the procedure with [12](#).
 - If T1 cards are not shown in the `rtrv-t1` output in [1](#) that are on the same shelf as the card that will contain the T1 port that is being added, continue the procedure with [7](#).
 - If T1 cards are shown in the `rtrv-t1` output in [1](#) that are on the same shelf as the card that contains the T1 port that is being changed, and these cards do not have T1 ports 3 through 8 provisioned, do not contain channel bridged T1 ports, or do not have unchannelized T1 ports, continue the procedure with [7](#).
7. Verify that **HIPR2** cards are installed in card locations 9 and 10 in the shelf containing the HC MIM or E5-E1T1 card that will contain the T1 port being changed in this procedure by entering this command.

```
rept-stat-gpl:gpl=hipr2
```

This is an example of the possible output.

```
rlghncxa03w 09-07-05 08:12:53 GMT 41.1.0
GPL          CARD      RUNNING          APPROVED          TRIAL
HIPR2        1109      126-002-000     126-002-000     126-003-000
HIPR2        1110      126-002-000     126-002-000     126-003-000
HIPR2        1209      126-002-000     126-002-000     126-003-000
HIPR2        1210      126-002-000     126-002-000     126-003-000
HIPR2        1309      126-002-000     126-002-000     126-003-000
HIPR2        1310      126-002-000     126-002-000     126-003-000
HIPR2        2109      126-002-000     126-002-000     126-003-000
HIPR2        2110      126-002-000     126-002-000     126-003-000
Command Completed
```

If HIPR2 cards are installed in the shelf containing the HC-MIM or E5-E1T1 card, continue the procedure by performing one of these steps.

- If the card is an E5-E1T1 card, continue the procedure by performing one of these steps.
 - If the adjacent T1 port is provisioned (see [Table B-15](#)), continue the procedure with [11](#).
 - If the adjacent T1 port is not provisioned, continue the procedure with [12](#).
- If the card is an HC-MIM, continue the procedure with [8](#).

If HIPR2 cards are not installed on the shelf containing the HC-MIM or E5-E1T1 card, go to *Installation Guide* and install the HIPR2 cards. Once the HIPR2 cards have been installed, continue the procedure by performing one of these steps.

- If the card is an E5-E1T1 card, continue the procedure by performing one of these steps.
 - If the adjacent T1 port is provisioned (see [Table B-15](#)), continue the procedure with [11](#).

- If the adjacent T1 port is not provisioned, continue the procedure with 12.
 - If the card is an HC-MIM, continue the procedure with 8.
8. Verify whether or not that the Fan feature is on, by entering the `rtrv-feat` command. If the Fan feature is on, the entry `FAN = on` appears in the `rtrv-feat` command output.

Note: The `rtrv-feat` command output contains other fields that are not used by this procedure. If you wish to see all the fields displayed by the `rtrv-feat` command, see the `rtrv-feat` command description in *Commands User's Guide*.

If the Fan feature is on, continue the procedure by performing one of these steps.

- If the adjacent T1 port is provisioned (see [Table B-15](#)), continue the procedure with 11.
- If the adjacent T1 port is not provisioned, continue the procedure with 12.

If the Fan feature is off, continue the procedure with [Oracle](#).

9. Turn the Fan feature on by entering this command.

```
chg-feat : fan=on
```

Note: Once the Fan feature is turned on with the `chg-feat` command, it cannot be turned off.

The Fan feature must be purchased before you turn this feature on with the `chg-feat` command. If you are not sure if you have purchased the Fan feature, contact your Sales Representative or Account Representative.

When the `chg-feat` has successfully completed, this message appears.

```
rlghncxa03w 09-05-28 11:43:04 GMT EAGLE5 41.0.0
CHG-FEAT: MASP A - COMPLTD
```

10. The shelf containing the HC-MIM being added in this procedure must have fans installed. Verify whether or not fans are installed on the shelf.

If the fans are not installed on the shelf containing the HC-MIM, go to *Installation Guide* and install the fans.

After the fans have been installed and tested, or if the fans were already installed, continue the procedure by performing one of these steps.

- If the adjacent T1 port is provisioned (see [Table B-15](#)), continue the procedure with 11.
- If the adjacent T1 port is not provisioned, continue the procedure with 12.

11. Display the T1 signaling links in the database by entering this command.

```
rtrv-slk:class=t1
```

```

rlghncxa03w 09-05-19 21:17:04 GMT EAGLE5 41.0.0

```

LOC	LINK	LSN	SLC	TYPE	L2T SET	BPS	ECM	PCR N1	PCR N2	T1 LOC	T1 PORT	TS
1201	A	lsn1	13	LIMT1	1	56000	BASIC	---	-----	1201	2	25
1201	B	lsn1	12	LIMT1	1	56000	BASIC	---	-----	1201	1	20
1202	A	lsn1	0	LIMCH	1	56000	BASIC	---	-----	1201	1	5
1202	B	lsn1	8	LIMCH	1	56000	BASIC	---	-----	1201	1	1
1203	A1	lsn1	4	LIMT1	1	56000	BASIC	---	-----	1203	2	20
1203	B1	lsn1	9	LIMT1	1	56000	BASIC	---	-----	1203	1	2
1204	A2	lsn1	5	LIMCH	1	56000	BASIC	---	-----	1203	1	21
1204	A3	lsn1	6	LIMCH	1	56000	BASIC	---	-----	1203	1	22
1211	A	lsn1	14	LIMT1	1	56000	BASIC	---	-----	1211	1	7
1212	A	lsn1	10	LIMCH	1	56000	BASIC	---	-----	1211	1	28
1212	B	lsn1	11	LIMCH	1	56000	BASIC	---	-----	1211	1	25
1213	A4	lsn1	1	LIMT1	1	56000	BASIC	---	-----	1213	1	17
1213	A5	lsn1	7	LIMT1	1	56000	BASIC	---	-----	1213	5	23
1213	B5	lsn1	2	LIMT1	1	56000	BASIC	---	-----	1213	1	24
1213	A6	lsn1	3	LIMT1	1	56000	BASIC	---	-----	1213	5	19

If an even numbered T1 port is to be channel bridged, and that T1 port is assigned to signaling links, these signaling links must be removed before the T1 port can be channel bridged. Perform [Removing an SS7 Signaling Link](#) to remove these signaling links. After the signaling links have been removed, continue the procedure with [12](#).

If the even numbered T1 port to be channel bridged is not assigned to signaling links, continue the procedure with [12](#).

- Change the T1 port using the `chg-t1` command and the parameter combinations shown in [Table B-16](#).

Table B-16 Channel Bridged T1 Port Parameter Combinations

Mandatory Parameters

- :loc=location of the T1 card
- :t1port=T1 port being changed, either 1, 3, 5, or 7
- :chanbrdg=on

Optional Parameters

- :encode=ami, b8zs
- :t1tsel=external, recovered (See Note 1)
- :framing=sf, esf
- :ll=0 - 655
- :force=yes (See Note 2)

Table B-16 (Cont.) Channel Bridged T1 Port Parameter Combinations

Notes:

1. The `t1tsel` value must be either `external` or `recovered`. If the current `t1tsel` parameter value is `line`, the `t1tsel` parameter value for the T1 port being channel bridged must be changed.
2. The `force=yes` parameter must be used when the even numbered port being channel bridged is shown in the `rtrv-t1` output in 1. If the even numbered port being channel bridged is not shown in the `rtrv-t1` output in 1, the `force=yes` parameter cannot be used.

For this example, enter this command.

```
chg-
t1:loc=1201:t1port=1:encode=ami:t1tsel=recovered:framing=esf:
ll=300:chanbrdg=on
```

13. Verify the changes using the `rtrv-t1` command specifying the card location and the `t1port` value specified in 12.

For this example, enter this command.

```
rtrv-t1:loc=1201:t1port=1
```

```
rlghncxa03w 09-05-28 09:12:36 GMT EAGLE5 41.0.0
```

T1		LINK	MINS
LOC	PORT	CLASS	RATE
1201	1	CHAN	----
TS1	1201,A	TS9	-----
TS2	-----	TS10	-----
TS3	-----	TS11	-----
TS4	-----	TS12	-----
TS5	1202,A	TS13	-----
TS6	-----	TS14	-----
TS7	-----	TS15	-----
TS8	-----	TS16	-----
		TS17	-----
		TS18	-----
		TS19	-----
		TS20	-----
		TS21	-----
		TS22	-----
		TS23	-----
		TS24	-----

If the signaling links were not deactivated in 6, continue the procedure with 15.

If the signaling links were deactivated in 6, continue the procedure with 14.

14. Activate the signaling links that were deactivated in 6 using the `act-slk` command.

For this example, enter these commands.

```
act-slk:loc=1201:link=a
act-slk:loc=1201:link=b
```

When each of these commands have successfully completed, this message should appear.

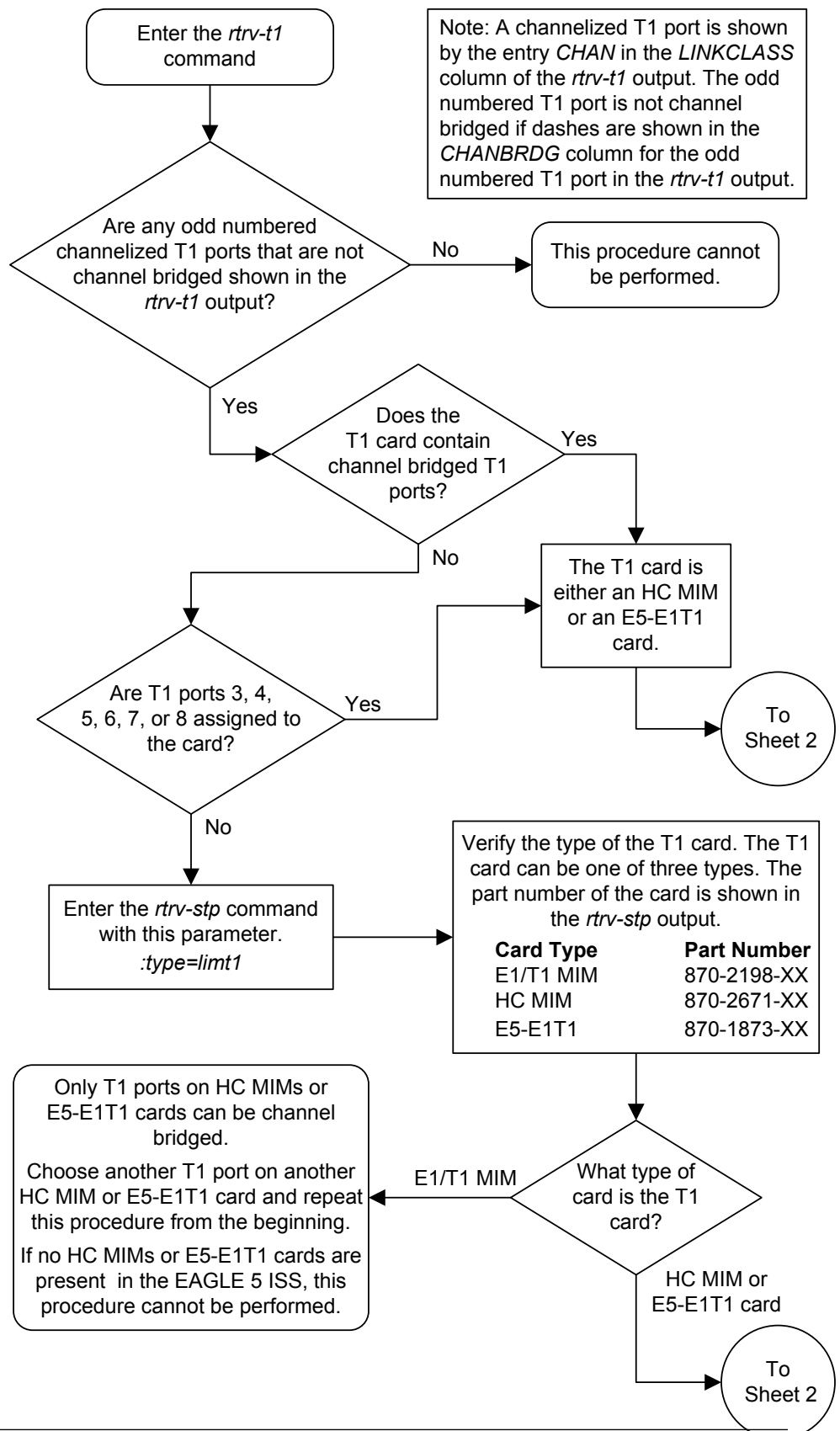
```
rlghncxa03w 09-05-07 08:41:12 GMT EAGLE5 41.0.0
Activate Link message sent to card
```

15. Back up the new changes using the `chg-db:action=backup:dest=fixed` command.

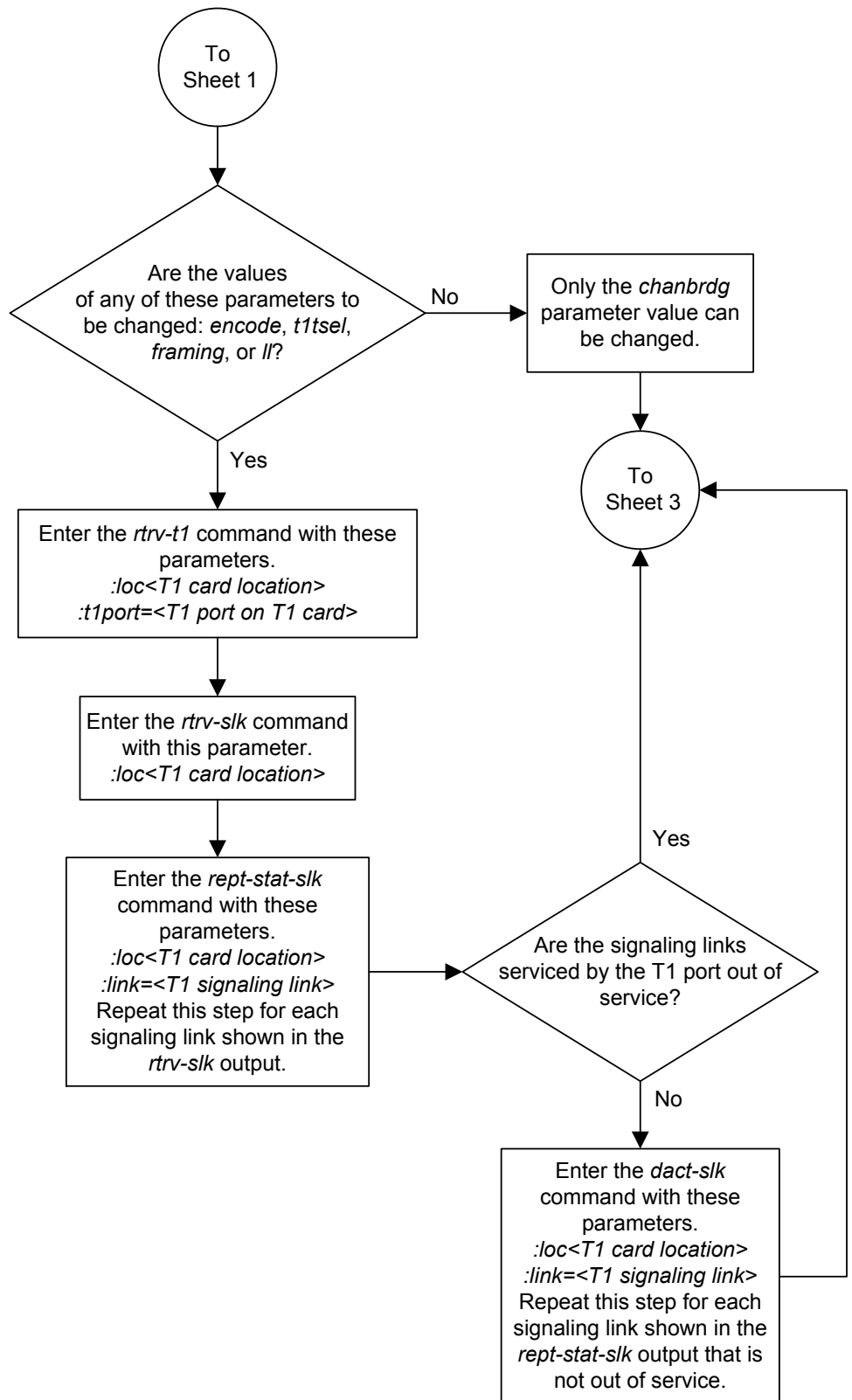
These messages should appear, the active **Maintenance and Administration Subsystem Processor (MASP)** appears first.

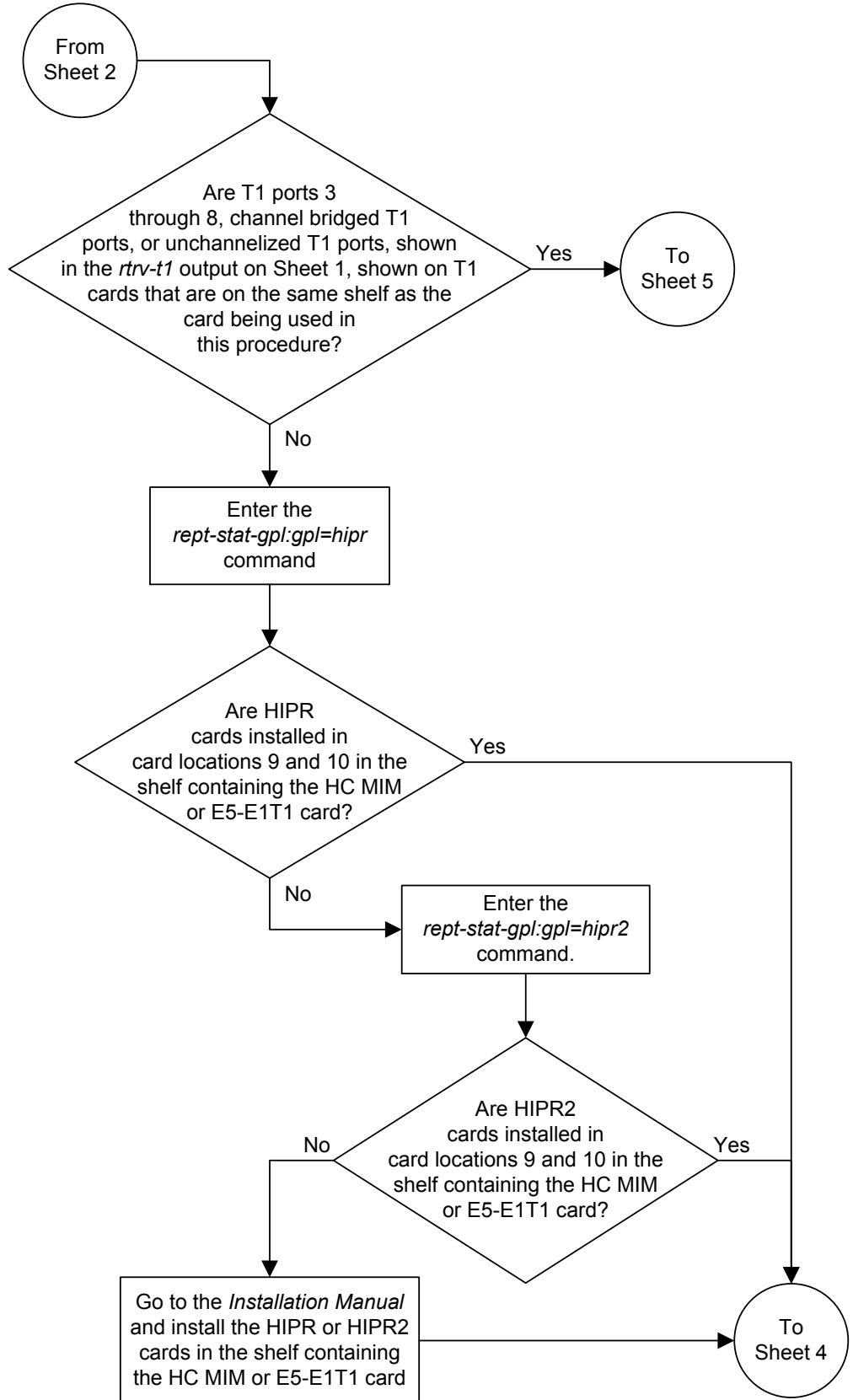
```
BACKUP (FIXED) : MASP A - Backup starts on active MASP.  
BACKUP (FIXED) : MASP A - Backup on active MASP to fixed disk complete.  
BACKUP (FIXED) : MASP A - Backup starts on standby MASP.  
BACKUP (FIXED) : MASP A - Backup on standby MASP to fixed disk complete.
```

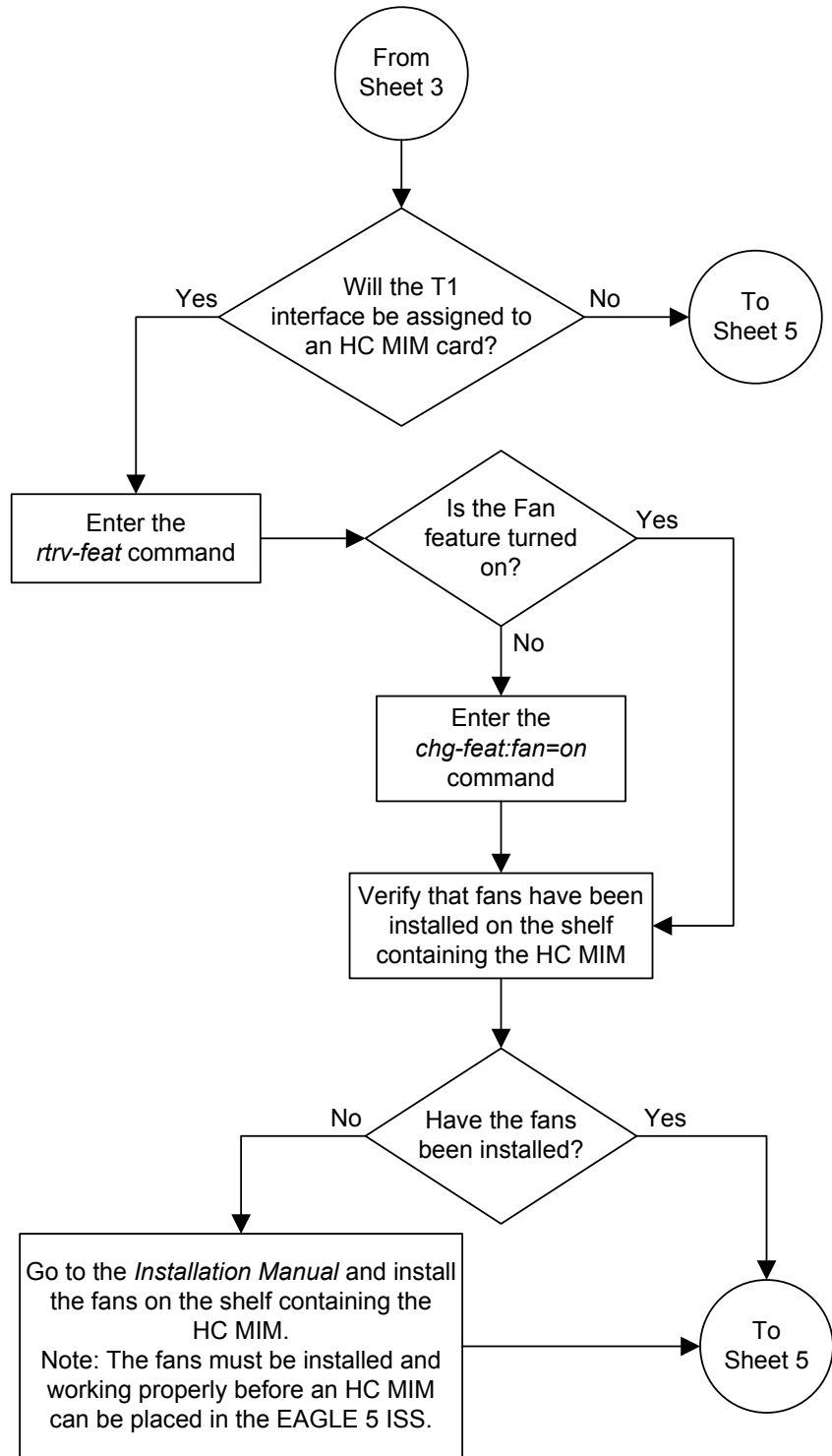

Figure B-12 Making a Channel Bridged T1 Port from a Channelized T1 Port

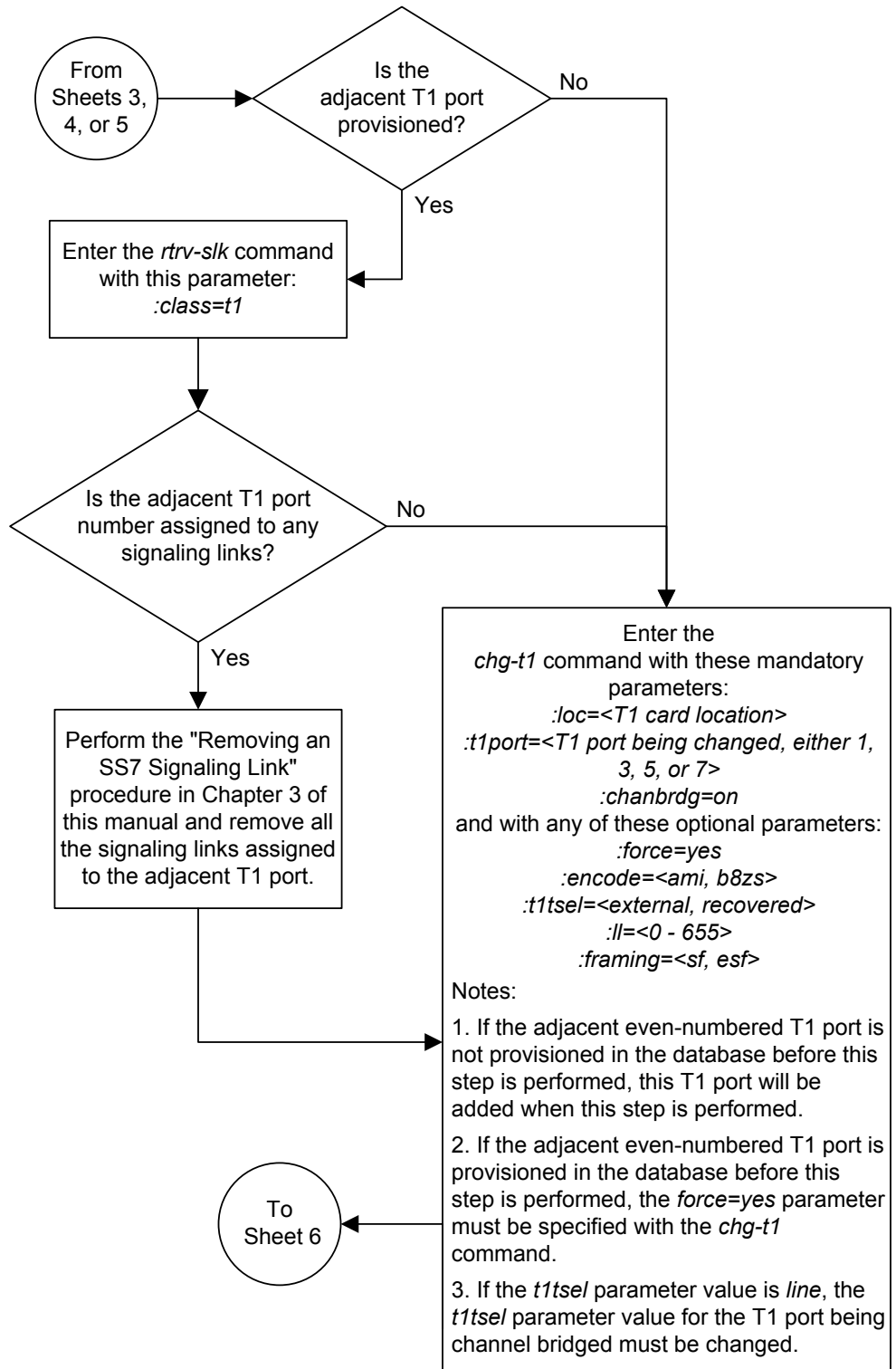


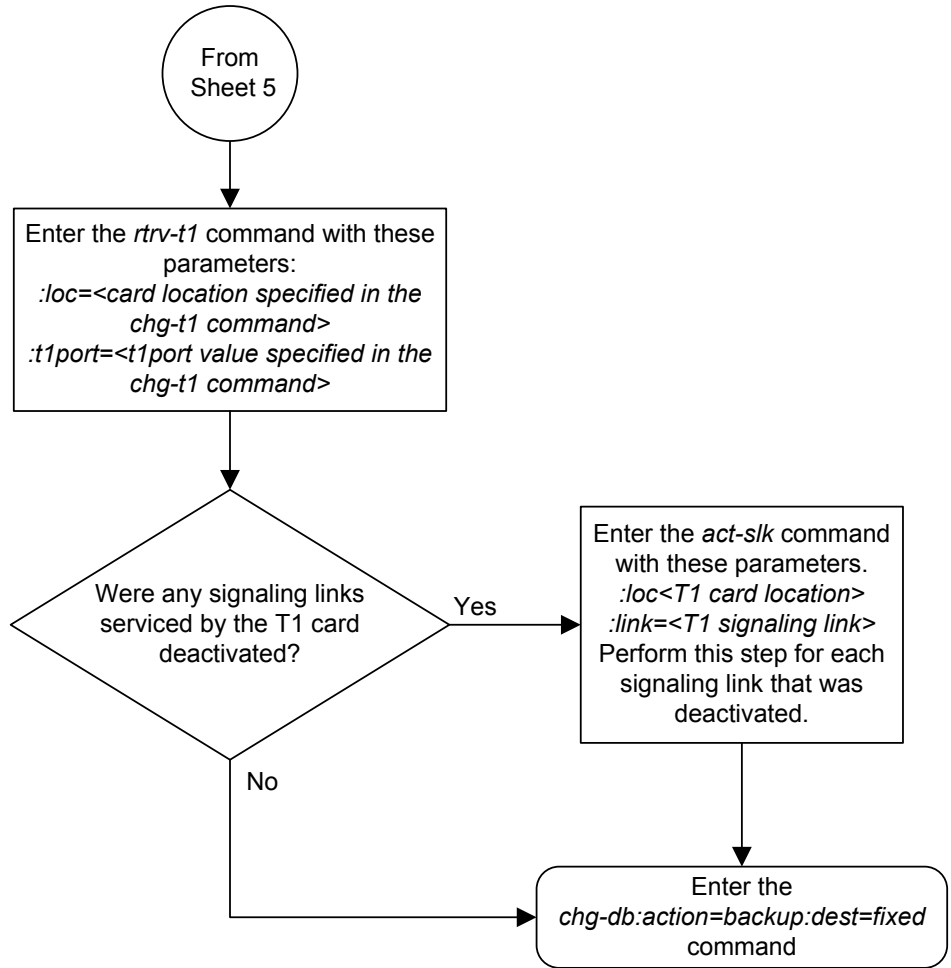
Sheet 1 of 6











Making a Non-Channel Bridged T1 Port from a Channel Bridged T1 Port

This procedure is used to make a non-channel bridged T1 port from a channel bridged T1 port using the `chg-t1` command. A channel bridged T1 port is an odd numbered T1 port that contains the entry `MASTER` in the `CHANBRDG` column in the `rtrv-t1` output. Other actions can be performed on T1 ports. To perform these actions on the T1 ports, perform one of these procedures.

- To change the attributes of a channelized T1 port - [Changing the Attributes of a Channelized T1 Port](#)
- To change the attributes of an unchannelized T1 port - [Changing the Attributes of an Unchannelized T1 Port](#)
- To make a channel bridged T1 port from a channelized T1 port that is not channel bridged - [Making a Channel Bridged T1 Port from a Channelized T1 Port](#)

To make a non-channel bridged T1 port from a channel bridged T1 port, these parameters are used with the `chg-t1` command.

`:loc` – The location of the T1 card (card type `limt1`) that contains the channel bridged T1 port. The location of a channel card (card type `limch`) cannot be specified for this parameter. The T1 card can be either an **HC-MIM** or an **E5-E1T1** card.

`:t1port` – The T1 port being changed in this procedure. Only the odd numbered T1 ports, 1, 3, 5, or 7, can be specified for a channel bridged T1 port.

`:encode` – Specifies the type of encoding or decoding that is used on the T1 signaling link, either **B8ZS** or **AMI**.

`:t1tsel` – The timing source for the T1 signaling link, master (`external`) or slave (`line`). If the `t1tsel` value for the channel bridged T1 port is `recovered`, the `t1tsel` value must be changed to either `line` or `external` when the channel bridged T1 port is changed to a non-channel bridged T1 port.

Note: To use an external high-speed master clock source other than RS-422, TDMs 870-0774-15 or later must be installed in card locations 1114 and 1116, and the **TDM Global Timing Interface** options must be configured. For more information, see [Configuring the Options for the TDM Global Timing Interface](#).

`:chanbrdg=off` – Specifies that the odd numbered T1 port specified in this procedure is not channel bridged to its adjacent even numbered T1 port.

The **T1** card specified in this procedure must be in the database. This can be verified with the `rtrv-t1` command.

If either the `encode`, `t1tsel`, `framing`, or `ll` values are being changed, all the signaling links serviced by the T1 card must be taken out of service.

1. Display the existing T1 interfaces in the database using the `rtrv-t1` command with no parameters.

```
rlghncxa03w 09-05-19 21:17:04 GMT EAGLE5 41.0.0
```

T1

LINK MINS

LOC	PORT	ENCODE	T1TSEL	FRAMING	LL	CHANBRDG	CLASS	RATE
1201	1	B8ZS	EXTERNAL	SF	133	MASTER	CHAN	----
1201	2	B8ZS	EXTERNAL	SF	133	SLAVE	CHAN	----
1203	2	B8ZS	LINE	SF	133	-----	CHAN	----
1211	2	B8ZS	LINE	SF	133	-----	CHAN	----

A channel bridged T1 port is an odd numbered T1 port that contains the entry MASTER in the CHANBRDG column in the `rtrv-t1` output.

If there are no channel bridged T1 ports shown in the `rtrv-t1` output, this procedure cannot be performed.

If channel bridged T1 ports shown in the `rtrv-t1` output, continue the procedure by performing one of these steps.

- If the `encode`, `t1tsel`, `framing`, or `ll` parameters are not being changed in this procedure, continue the procedure with 6.
 - If the `encode`, `t1tsel`, `framing`, or `ll` parameters are being changed in this procedure, continue the procedure with 2.
2. Display the timeslots that are serviced by the T1 card containing the T1 interface information to be changed using the `rtrv-t1` command specifying the card location and the `t1port` value from 1.

For this example, enter this command.

```
rtrv-t1:loc=1201:t1port=1
```

```
rlghncxa03w 09-05-28 09:12:36 GMT EAGLE5 41.0.0
```

T1								LINK	MINS
LOC	PORT	ENCODE	T1TSEL	FRAMING	LL	CHANBRDG	CLASS	RATE	
1201	1	B8ZS	EXTERNAL	SF	133	MASTER	CHAN	----	
TS1	1201,A	TS9	-----	TS17	-----				
TS2	-----	TS10	-----	TS18	-----				
TS3	-----	TS11	-----	TS19	-----				
TS4	-----	TS12	-----	TS20	-----				
TS5	1202,A	TS13	-----	TS21	-----				
TS6	-----	TS14	-----	TS22	-----				
TS7	-----	TS15	-----	TS23	-----				
TS8	-----	TS16	-----	TS24	-----				

3. Display the signaling links that are assigned to the T1 card by entering the `rtrv-slk` command with the card location specified in 2. For this example, enter this command.

```
rtrv-slk:loc=1201
```

```
rlghncxa03w 09-05-19 21:17:04 GMT EAGLE5 41.0.0
```

				L2T		PCR		PCR		E1		E1	
LOC	LINK	LSN	SLC	TYPE	SET	BPS	ECM	N1	N2	LOC	PORT	TS	TS
1201	B	lsn1	12	LIMT1	1	56000	BASIC	---	-----	1201	1	10	

4. Check the status of the signaling links shown in 3 using the `rept-stat-slk` command with the card location and signaling link.

For this example, enter these commands.

```
rept-stat-slk:loc=1201:link=b
```

```
rlghncxa03w 09-05-23 13:06:25 GMT EAGLE5 41.0.0
SLK      LSN      CLLI      PST      SST      AST
1201,B  lsn1      -----  IS-NR      Avail      ----
  ALARM STATUS      = No Alarms
  UNAVAIL REASON    = --
  T1 status         = 1201, RCVRY-T1F:FAC-T1 Port 1 available
```

If all the signaling links shown in this step are out of service, continue the procedure with [6](#).

If any of the signaling links shown in this step are in service, continue the procedure with [5](#).

- Deactivate the signaling links shown in [4](#) using the `dact-slk` command.

For this example, enter these commands.

```
dact-slk:loc=1201:link=b
```

When this command has successfully completed, this message should appear.

```
rlghncxa03w 09-05-07 08:41:12 GMT EAGLE5 41.0.0
Deactivate Link message sent to card
```

- Change the T1 port using the `chg-t1` command and the parameter combinations shown in [Table B-17](#).

Table B-17 Non-Channel Bridged T1 Port Parameter Combinations

Mandatory Parameters

:loc=location of the T1 card

:t1port=T1 port being changed, either 1, 3, 5, or 7

:chanbrdg=off

Optional Parameters

:encode=ami, b8zs

:framing=sf, esf

:ll=0 - 655

:t1tsel=line, external. If the current `t1tsel` value is recovered, the `t1tsel` value must be changed to either `line` or `external`.

For this example, enter this command.

```
chg-
t1:loc=1201:t1port=1:encode=ami:framing=esf:ll=500:t1tsel=lin
e:chanbrdg=off
```

Note: When the `chanbrdg=off` parameter is specified with the `chg-t1` command, the even numbered T1 port that was channel bridged to the T1 port specified in this step is removed from the database.

7. Verify the changes using the `rtrv-t1` command specifying the card location and the `t1port` value specified in 6.

For this example, enter these commands.

```
rtrv-t1:loc=1201:t1port=1
```

```
rlghncxa03w 09-05-28 09:12:36 GMT EAGLE5 41.0.0
```

LOC	T1 PORT	ENCODE	T1TSEL	FRAMING	LL	CHANBRDG	LINK CLASS	MINS RATE
1201	1	AMI	LINE	ESF	500	-----	CHAN	----
TS1	1201,A		TS9	-----		TS17	-----	
TS2	-----		TS10	-----		TS18	-----	
TS3	-----		TS11	-----		TS19	-----	
TS4	-----		TS12	-----		TS20	-----	
TS5	1202,A		TS13	-----		TS21	-----	
TS6	-----		TS14	-----		TS22	-----	
TS7	-----		TS15	-----		TS23	-----	
TS8	-----		TS16	-----		TS24	-----	

If the signaling links were not deactivated in 5, continue the procedure with 9.

If the signaling links were deactivated in 5, continue the procedure with 8.

8. Activate the signaling links that were deactivated in 5 using the `act-slk` command.

For this example, enter these commands.

```
act-slk:loc=1201:link=b
```

When this command has successfully completed, this message should appear.

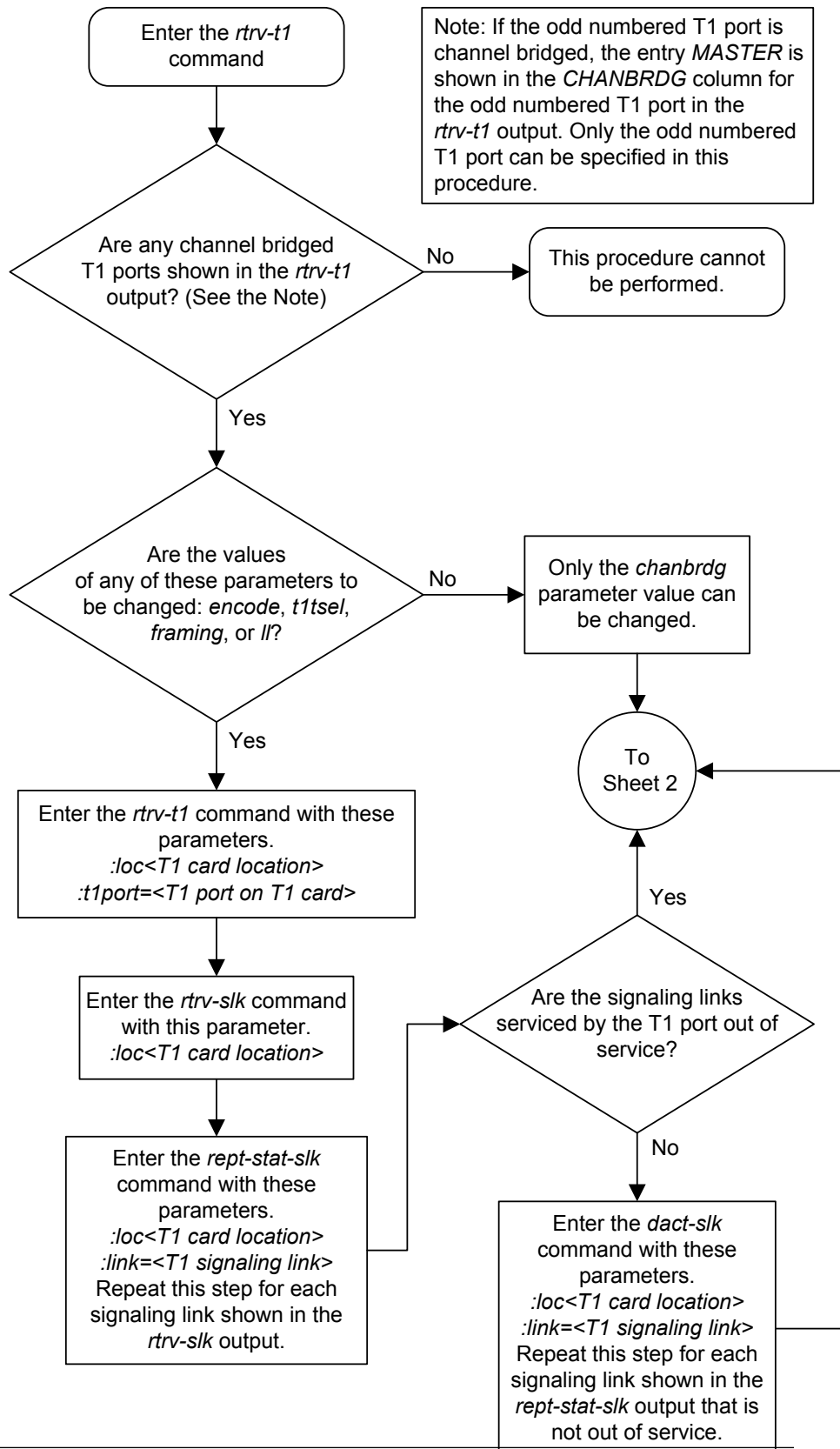
```
rlghncxa03w 09-05-07 08:41:12 GMT EAGLE5 41.0.0
Activate Link message sent to card
```

9. Back up the new changes using the `chg-db:action=backup:dest=fixed` command.

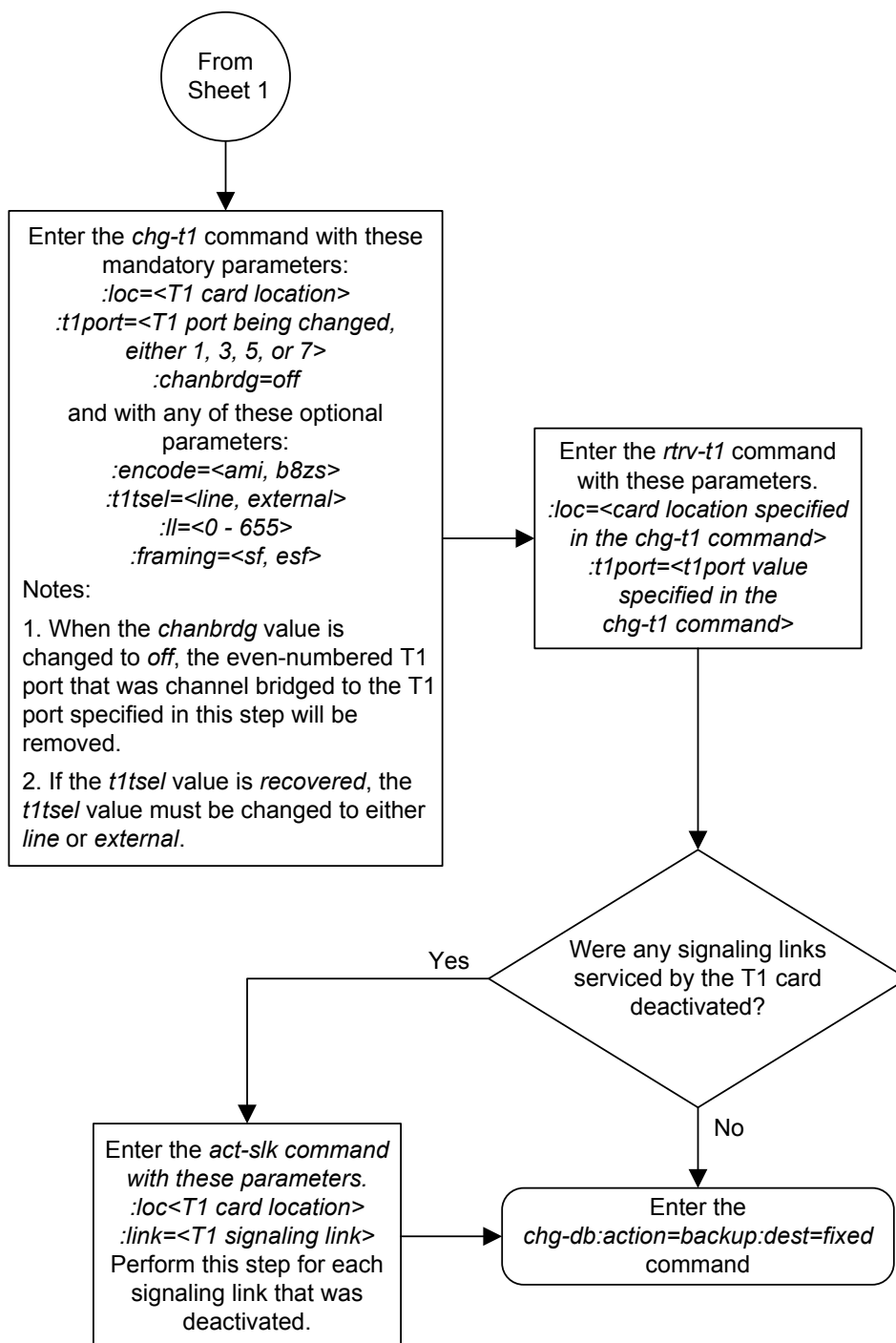
These messages should appear, the active **Maintenance and Administration Subsystem Processor (MASP)** appears first.

```
BACKUP (FIXED) : MASP A - Backup starts on active MASP.
BACKUP (FIXED) : MASP A - Backup on active MASP to fixed disk complete.
BACKUP (FIXED) : MASP A - Backup starts on standby MASP.
BACKUP (FIXED) : MASP A - Backup on standby MASP to fixed disk complete.
```

Figure B-13 Making a Non-Channel Bridged T1 Port from a Channel Bridged T1 Port



Sheet 1 of 2



Adding a T1 Signaling Link

This procedure is used to add a **T1** signaling link to the database using the `ent-slk` command and these parameters.

`:loc` – The card location of the card that the **T1** signaling link will be assigned to.

`:link` – The signaling link on the card specified in the `loc` parameter.

`:lsn` – The name of the linkset that will contain the signaling link.

`:slc` – The signaling link code. The **SLC** must be unique within the linkset. It must be the same at both the **EAGLE** location and the distant node.

`:bps` – The transmission rate for the link in bits per second.

`:ecm` – Error correction method, either `basic` or `pcr`. The default value for this parameter is `basic`.

`:pcrn1` – The threshold of the number of **MSUs** available for retransmission. If the error correction method being used is **PCR** (`:ecm=pcr`), and this threshold is reached, no new **MSUs** or **FISUs** are sent. The retransmission cycle is continued up to the last **MSU** entered into the retransmission buffer in the order in which they were originally transmitted.

`:pcrn2` – The threshold of the number of **MSU** octets available for retransmission. If the error correction method being used is **PCR** (`:ecm=pcr`), and this threshold is reached, no new **MSUs** or **FISUs** are sent. The retransmission cycle is continued up to the last **MSU** entered into the retransmission buffer in the order in which they were originally transmitted.

`:ts` – The timeslot on the **T1** card or channel card being used for the **T1** signaling link.

`:t1port` – The **T1** port on the **T1** card that is servicing the timeslot selected for the **T1** signaling link.

`:t1loc` – The location of the **T1** card servicing the timeslot selected for the **T1** signaling link. This parameter can be specified only when provisioning **T1** signaling links on channel cards.

`:l2tset` – The level 2 timer set table assigned to the **T1** signaling link. The type of linkset the **T1** signaling link is assigned to and the **T1** card's application determines the value of the `l2tset` parameter. The level 2 timer set tables are defined in the [Changing Level 2 Timers](#) procedure.

The `ent-slk` command contains other optional parameters that can be used to configure a signaling link. These parameters are not shown here because they are not necessary to provision a **T1** signaling link. These parameters are explained in more detail in the [Adding an SS7 Signaling Link](#) procedure, or in the `ent-slk` command description in the *Commands User's Guide*.

These items must be configured in the database before a **T1** signaling link can be added:

- **Shelf** – see "Adding a Shelf" in *Database Administration - System Management User's Guide*
- **T1 Card** (card type `limt1`) or **ChannelCard** (card type `limch`) running either the `ss7ansi` or `ccs7itu` applications – see [Adding a LIM-T1 Card](#) procedure

- Destination **Point Code** – see the [Adding a Destination Point Code](#) procedure.
- Linkset – [Adding an SS7 Linkset](#) .

Verify that the link has been physically installed (all cable connections have been made).

T1 port 2 (`t1port=2`) cannot be specified when the **T1** signaling link is assigned to a channel card (card type `1imch`).

The value of the `bps` parameter must be either 56000 or 64000.

The values for the `ts` parameter must be from 1 to 24.

The linkset must be in the database. The number of signaling links in a linkset cannot exceed 16. This can be verified with the `rtrv-ls` command.

The **APC** of the linkset assigned to the signaling link must be in the **SS7** domain. Use the `rtrv-dstn` command to verify the domain of the **APC** of the linkset.

The `pcrn1` or `pcrn2` parameters can only be specified if the `ecm=pcr` parameter is specified.

If the **T1** signaling link is being assigned to an unchannelized **T1** port (shown by the entry `UNCHAN` in the `LINKCLASS` field in the `rtrv-t1` output), you cannot specify the `ts` parameter. A **T1** signaling link containing an unchannelized **T1** port can be assigned only to an **E5-E1T1** card. A maximum of one **T1** signaling link containing an unchannelized **T1** port can be assigned to an **E5-E1T1** card. The `link` parameter value for this link must be `a`. The transmission rate (`bps` parameter) for an unchannelized **T1** signaling link is 1536000 bits per second. The `bps` parameter is optional, and if not specified with the `ent-slk` command, the `bps` parameter value defaults to 1536000 bits per seconds.

If the **T1** signaling link is being assigned to a channel bridged **T1** port (shown by the entries `MASTER` or `SLAVE` in the `CHANBRDG` field in the `rtrv-t1` output), the **T1** port value for the signaling link must be the odd numbered (`MASTER`) **T1** port.

If the **T1** card is an **E1/T1 MIM**, a maximum of 8 **T1** signaling links can be assigned to the card. The range of `link` parameter values is dependent on the type of **T1** card the signaling link is assigned to. The `link` parameter values for **T1** signaling links assigned to **E1/T1 MIMs** are `A - A3`, or `B - B3`, allowing a maximum of 8 signaling links on the card.

If the **T1** signaling link is being assigned to a channelized **T1** port (shown by the entry `CHAN` in the `LINKCLASS` field in the `rtrv-t1` output) on an **HC-MIM**, a maximum of 64 **T1** signaling links can be assigned to the card. The `link` parameter values for **T1** signaling links assigned to **HC-MIMs** are `A - A31`, or `B - B31`. If signaling links `A16` to `A31`, or `B16` to `B31` will be assigned to the card, the **FAN** feature must be turned on. The status of the **FAN** feature is shown in the `rtrv-feat` command output. The shelf containing the **HC-MIM** being added in this procedure must have fans installed. If the fans are not installed on the shelf containing the **HC-MIM**, go to *Installation Guide* and install the fans.

If the **T1** signaling link is being assigned to a channelized **T1** port (shown by the entry `CHAN` in the `LINKCLASS` field in the `rtrv-t1` output) on an **E5-E1T1** card, a maximum of 32 **T1** signaling links can be assigned to the card. The `link` parameter values for **T1** signaling links assigned to **E5-E1T1** cards are `A - A15` or `B - B15`.

To configure the **EAGLE** to perform circular routing detection test on the signaling links, perform the [Configuring Circular Route Detection](#) procedure.

Note: Circular route detection is not supported in ITU networks.

To provision a **EAGLE** with more than 1200 signaling links, the **EAGLE** must have certain levels of hardware installed. See the [Requirements for EAGLEs Containing more than 1200 Signaling Links](#) section for more information on these hardware requirements.

The **EAGLE** can contain a mixture of low-speed, **E1**, **T1**, **ATM** high-speed, and **IP** signaling links. The [Determining the Number of High-Speed and Low-Speed Signaling Links](#) section describes how to determine the quantities of the different types of signaling links the **EAGLE** can have.

Canceling the **REPT-STAT-SLK** and **RTRV-SLK** Commands

Because the `rept-stat-slk` and `rtrv-slk` commands used in this procedure can output information for a long period of time, the `rept-stat-slk` and `rtrv-slk` commands can be canceled and the output to the terminal stopped. There are three ways that the `rept-stat-slk` and `rtrv-slk` commands can be canceled.

- Press the F9 function key on the keyboard at the terminal where the `rept-stat-slk` or `rtrv-slk` commands were entered.
- Enter the `canc-cmd` without the `trm` parameter at the terminal where the `rept-stat-slk` or `rtrv-slk` commands were entered.
- Enter the `canc-cmd:trm=<xx>`, where `<xx>` is the terminal where the `rept-stat-slk` or `rtrv-slk` commands were entered, from another terminal other than the terminal where the `rept-stat-slk` or `rtrv-slk` commands were entered. To enter the `canc-cmd:trm=<xx>` command, the terminal must allow Security Administration commands to be entered from it and the user must be allowed to enter Security Administration commands. The terminal's permissions can be verified with the `rtrv-secu-trm` command. The user's permissions can be verified with the `rtrv-user` or `rtrv-secu-user` commands.

For more information about the `canc-cmd` command, go to *Commands User's Guide*.

1. Display the cards in the database using the `rtrv-card` command.

```
rlghncxa03w 09-05-28 09:12:36 GMT EAGLE5 41.0.0
CARD  TYPE      APPL      LSET NAME  LINK SLC LSET NAME  LINK SLC
1102  TSM           GLS
1113  GSPM         OAM
1114  TDM-A
1115  GSPM         OAM
1116  TDM-B
1117  MDAL
1207  LIMT1        SS7ANSI  lsnt265   A    0
1208  LIMCH        SS7ANSI  lsnt265   A    1  lsnt265   A2   2
1211  LIME1        CCS7ITU  lsne145   A    0
1212  LIMCH        CCS7ITU  lsne145   A    1  lsne145   A2   2
1215  LIMT1        SS7ANSI
1216  LIMCH        SS7ANSI
1316  DCM          STPLAN
```

If the required **T1** card or channel card is not in the database, perform [Adding a LIM-T1 Card](#) to add the required cards to the database.

2. Display the current linkset configuration using the `rtrv-ls` command. This is an example of the possible output.

```
rlghncxa03w 06-10-10 11:43:04 GMT EAGLE5 36.0.0

LSN          APCA  (SS7)  SCRN  SET  SET  BEI  LST  LNKS  ACT  MES  DIS  SLSCI  NIS
lsnt145     150-075-038  scr4  1   1   yes a   0   on  on  off  ---  ---
lsnt265     200-150-067  scr2  1   1   yes a   3   on  on  off  ---  ---

LSN          APCI  (SS7)  SCRN  SET  SET  BEI  LST  LNKS  ACT  MES  DIS  SLSCI  NIS
lsne12      2-150-7      scr1  1   1   no  a   2   on  on  off  ---  ---
lsne145     4-049-3      scr1  1   1   no  a   3   on  on  off  ---  ---
sp5         1-111-3      scr3  1   3   yes c   1   off off off  ---  ---
sp6         1-111-1      scr1  1   1   yes a   1   off off off  ---  ---
sp7         1-111-2      scr2  1   2   no  a   2   on  on  on   ---  ---

LSN          APCN  (SS7)  SCRN  SET  SET  BEI  LST  LNKS  ACT  MES  DIS  SLSCI  NIS
lsne13      14950        scr1  1   1   no  a   2   on  on  off  ---  off
nsp1        11111        scr1  1   1   yes a   2   off off off  ---  off
nsp3        11112        scr2  1   2   no  a   1   on  on  on   ---  off
nsp4        11113        scr3  1   3   yes c   1   off off off  ---  off
```

Link set table is (11 of 1024) 1% full

If the desired linkset is not in the database, perform [Adding an SS7 Linkset](#) to add the linkset to the database. After the linkset has been added to the database, continue the procedure with [4](#).

If the desired linkset is in the database, continue the procedure with [3](#).

3. Display the attributes of the linkset that will contain the new signaling link by entering the `rtrv-ls` command with the name of the linkset shown in [2](#). For this example, enter this command.

```
rtrv-ls:lsn=lsnt145
```

This is an example of the possible output.

```
rlghncxa03w 08-12-10 11:43:04 GMT EAGLE5 40.0.0

LSN          APCA  (SS7)  SCRN  SET  SET  BEI  LST  LNKS  ACT  MES  DIS  SLSCI  NIS
lsnt145     150-075-038  scr4  1   1   yes a   0   on  on  off  ---  ---

          SPCA          CLLI          TFATCABMLQ  MTPRSE  ASL8
          -----  -----  1          ---    no

RANDSLS
off

IPSG  IPGWAPC  GTTMODE          CGGTMOD
no    no      CdPA          no
```

Link set table is (11 of 1024) 1% full.

The signaling link cannot be assigned to a linkset whose IPSP or IPGWAPC values are *yes*. If either the IPSP or IPGWAPC value for the linkset is *yes*, repeat the procedure from 2 and choose another linkset.

If the IPSP and IPGWAPC values for the linkset are *no*, continue the procedure with 4.

4. Display the current signaling link configuration using the `rtrv-slk` command. This is an example of the possible output.

```
rlghncxa03w 09-07-19 21:16:37 GMT EAGLE5 41.1.0
```

LOC	LINK	LSN	SLC	TYPE	L2T		ECM	PCR		E1	E1	TS
					SET	BPS		N1	N2			
1201	A	e3m1s1	0	LIMDS0	1	56000	BASIC	----	-----			
1201	B	e3m1s2	0	LIMDS0	1	56000	BASIC	----	-----			
1202	A	e3m1s1	1	LIMDS0	1	56000	BASIC	----	-----			
1202	B	e3m1s2	1	LIMDS0	1	56000	BASIC	----	-----			
1203	A	e3m1s1	2	LIMDS0	1	56000	BASIC	----	-----			
1203	B	e3m1s2	2	LIMDS0	1	56000	BASIC	----	-----			
1204	A	e3m1s1	3	LIMDS0	1	56000	BASIC	----	-----			
1204	B	e3m1s2	3	LIMDS0	1	56000	BASIC	----	-----			
1205	A	e3m1s1	4	LIMDS0	1	56000	BASIC	----	-----			
1205	B	e3m1s2	4	LIMDS0	1	56000	BASIC	----	-----			
1206	A	e3m1s1	5	LIMDS0	1	56000	BASIC	----	-----			
1206	B	e3m1s2	5	LIMDS0	1	56000	BASIC	----	-----			
1213	A	e3m2s1	2	LIMDS0	11	56000	BASIC	----	-----			
1213	B	e3m2s2	2	LIMDS0	11	56000	BASIC	----	-----			
1214	A	e3m2s1	3	LIMDS0	11	56000	BASIC	----	-----			
1214	B	e3m2s2	3	LIMDS0	11	56000	BASIC	----	-----			
1215	A	e3m2s1	4	LIMDS0	11	56000	BASIC	----	-----			
1215	B	e3m2s2	4	LIMDS0	11	56000	BASIC	----	-----			
1216	A	e3m2s1	5	LIMDS0	11	56000	BASIC	----	-----			
1216	B	e3m2s2	5	LIMDS0	11	56000	BASIC	----	-----			
1217	A	e3m2s1	6	LIMDS0	11	56000	BASIC	----	-----			
1217	B	e3m2s2	6	LIMDS0	11	56000	BASIC	----	-----			

LOC	LINK	LSN	SLC	TYPE	L2T		ECM	PCR		E1	E1	TS
					SET	BPS		N1	N2			
1211	A	lsne145	0	LIME1	1	56000	BASIC	---	-----	1211	2	10
1212	A	lsne145	1	LIMCH	1	56000	BASIC	---	-----	1211	1	14
1212	A2	lsne145	2	LIMCH	1	56000	BASIC	---	-----	1211	1	20

LOC	LINK	LSN	SLC	TYPE	L2T		ECM	PCR		T1	T1	TS
					SET	BPS		N1	N2			
1207	A	lsnt265	0	LIMT1	1	56000	BASIC	---	-----	1207	2	2
1208	A	lsnt265	1	LIMCH	1	56000	BASIC	---	-----	1207	1	6
1208	A2	lsnt265	2	LIMCH	1	56000	BASIC	---	-----	1207	1	17

SLK TABLE is (28 of 1200) 2% full.

If the addition of the new signaling link will exceed the maximum number of signaling links the EAGLE can have (in this example, the maximum number of signaling links is 1200), and the maximum number of signaling links is 2800, this procedure cannot be performed. The EAGLE cannot contain more than 2800 signaling links.

If the addition of the new signaling link will exceed the maximum number of signaling links the EAGLE can have, and the maximum number of signaling links is less than 2800, perform the [Enabling the Large System # Links Controlled Feature](#) procedure to enable the desired quantity of signaling links.

If the addition of the new signaling link will not exceed the maximum number of signaling links the EAGLE can have, or if a new signaling link quantity was enabled, continue the procedure by performing one of these steps.

- If the signaling link will be assigned to a channel card (LIMCH), continue the procedure with [10](#).
 - If the signaling link will be assigned to a LIMT1 card, continue the procedure with [5](#).
5. Display the **T1** interfaces that will be assigned to the **T1** signaling link using the `rtrv-t1` command with no parameters.

```
rlghncxa03w 09-05-19 21:17:04 GMT EAGLE5 41.0.0
```

T1							LINK	MINSU
LOC	PORT	ENCODE	T1TSEL	FRAMING	LL	CHANBRDG	CLASS	RATE
1207	1	AMI	EXTERNAL	ESF	50	-----	CHAN	----
1215	2	B8ZS	LINE	SF	100	-----	CHAN	----

If the desired T1 port and T1 card combination is shown in the `rtrv-e1` output, continue the procedure with [6](#).

If the desired T1 port and T1 card combination is not shown in the `rtrv-t1` output, add the T1 port and T1 card combination to the database by performing one of these procedures.

- [Adding Channelized and non-Channel Bridged T1 Ports](#)
- [Adding Channel Bridged T1 Ports](#)
- [Adding Unchannelized T1 Ports](#)

After the desired T1 port and T1 card combination has been added to the database, continue the procedure with [6](#).

6. Verify the card type of the card that will contain the new T1 signaling link by entering this command.

```
rtrv-stp:type=limt1
```

```
rlghncxa03w 08-12-30 11:07:17 EST EAGLE 40.0.0
```

Card	Part Number	Rev	Serial Number	Type	DB	APPL	GPL Version
----	-----	---	-----	----	--	----	-----
1207	870-2671-02	C	10145689323	LIMT1	512M	SS7ANSI	126-034-000
1215	870-1873-01	C	10345690569	LIMT1	512M	SS7ANSI	126-034-000

Command Completed.

The **T1** card types and their part numbers are shown in [Table B-4](#).

If the new T1 signaling link will be assigned to a E1/T1 MIM or E5-E1T1 card, continue the procedure with [10](#).

If the new E1 signaling link will be assigned to an HC-MIM, and the link parameter value of the new signaling link is A-A15 or B-B15, continue the procedure with [10](#).

If the new E1 signaling link will be assigned to an HC-MIM, and the link parameter value of the new signaling link is A16-A31 or B16-B31, continue the procedure by performing one of these steps.

- If the link parameter values A16-A31 or B16-B31 are shown in the `rtrv-slks` output in 4, and the new signaling link will be assigned to a card on the same shelf as the cards that contain the link parameter values A16-A31 or B16-B31, continue the procedure with 10.
 - If the link parameter values A16-A31 or B16-B31 are shown in the `rtrv-slks` output in 4, and the new signaling link will be assigned to a card that is not on the same shelf as the cards that contain the link parameter values A16-A31 or B16-B31, continue the procedure with 9.
 - If the link parameter values A16-A31 or B16-B31 are not shown in the `rtrv-slks` output in 4, continue the procedure with 7.
7. Verify whether or not that the Fan feature is on, by entering the `rtrv-feat` command. If the Fan feature is on, the entry `FAN = on` appears in the `rtrv-feat` command output.

Note: The `rtrv-feat` command output contains other fields that are not used by this procedure. If you wish to see all the fields displayed by the `rtrv-feat` command, see the `rtrv-feat` command description in *Commands User's Guide*.

If the Fan feature is on, continue the procedure with 9.

8. Turn the Fan feature on by entering this command.

```
chg-feat : fan=on
```

Note: Once the Fan feature is turned on with the `chg-feat` command, it cannot be turned off.

The Fan feature must be purchased before you turn this feature on with the `chg-feat` command. If you are not sure if you have purchased the Fan feature, contact your Oracle Sales Representative or Account Representative.

9. The shelf containing the **HC-MIM** being added in this procedure must have fans installed. Verify whether or not fans are installed on the shelf.

If the fans are installed, continue the procedure with 10.

If the fans are not installed on the shelf containing the **HC-MIM**, go to *Installation Guide* and install the fans. Once the fans have been installed and tested, 10. The fans must be working properly before an **HC-MIM** can be placed in the **EAGLE**.

10. Add the T1 signaling links using the `ent-slks` command.

Enter the `ent-slks` command with the parameter combinations shown in [Table B-18](#).

Table B-18 T1 Signaling Link Parameter Combinations

T1 Signaling Links assigned to a Channel Card	T1 Signaling Links assigned to an E1/T1 MIM	T1 Signaling Links assigned to an HC-MIM	T1 Signaling Links assigned to an E5-E1T1 Card with a Channelized T1 Port	T1 Signaling Links assigned to an E5-E1T1 Card with an Unchannelized T1 Port
Mandatory Parameters				
:loc=<the location of the channel card>	:loc=<the location of the LIMT1 card>	:loc=<the location of the LIMT1 card>	:loc=<the location of the LIMT1 card>	:loc=<the location of the LIMT1 card>
:link=A - A3, B - B3	:link=A - A3, B - B3	:link=A - A31, B - B31 (See Note 1)	:link=A - A15, B - B15	:link=a
:lsn=<the name of the linkset>	:lsn=<the name of the linkset>	:lsn=<the name of the linkset>	:lsn=<the name of the linkset>	:lsn=<the name of the linkset>
:slc= 0 - 15	:slc= 0 - 15	:slc= 0 - 15	:slc= 0 - 15	:slc= 0 - 15
:t1loc=<the location of the LIMT1 card>	:t1port= 1 or 2	:t1port= 1 - 8	:t1port= 1 - 8	:t1port= 1 - 8
:ts= 1 - 24	:ts= 1 - 24	:ts= 1 - 24	:ts= 1 - 24	
Optional Parameters				
:bps=56000, 64000 Default value = 56000	:bps=56000, 64000 Default value = 56000	:bps=56000, 64000 Default value = 56000	:bps=56000, 64000 Default value = 56000	:bps=1536000 Default value = 1536000
:ecm=basic, pcr Default value = basic	:ecm=basic, pcr Default value = basic	:ecm=basic, pcr Default value = basic	:ecm=basic, pcr Default value = basic	:ecm=basic, pcr Default value = basic
:pcrn1= 1 - 127 (See Note 2) Default value = 76	:pcrn1= 1 - 127 (See Note 2) Default value = 76	:pcrn1= 1 - 127 (See Note 2) Default value = 76	:pcrn1= 1 - 127 (See Note 2) Default value = 76	:pcrn1= 1 - 1023 (See Note 2) Default value = 608
:pcrn2=300 - 35500 (See Note 2) Default value = 3800	:pcrn2=300 - 35500 (See Note 2) Default value = 3800	:pcrn2=300 - 35500 (See Note 2) Default value = 3800	:pcrn2=300 - 35500 (See Note 2) Default value = 3800	:pcrn2=7200 - 287744 (See Note 2) Default value = 32224
:l2tset=See Table 3-16	:l2tset=See Table 3-16	:l2tset=See Table 3-16	:l2tset=See Table 3-16	:l2tset=See Table 3-16
Notes:				
1. If the Fan feature is not turned on, the link parameter values for a T1 signaling link are A - A15, B - B15.				
2. The pcrn1 and pcrn2 parameters can be specified only if the ecm=pcr parameter is specified.				

For this example, enter these commands.

```

ent-
slk:loc=1215:link=a:lsn=lsnt145:slc=0:bps=56000:ts=3:t1port=2

ent-
slk:loc=1216:link=a:lsn=lsnt145:slc=1:bps=56000:ts=11:t1loc=1
215

ent-
slk:loc=1216:link=a2:lsn=lsnt145:slc=2:bps=56000:ts=19:t1loc=
1215

ent-
slk:loc=2211:link=a:t1port=1:lsn=lsnt1:slc=0:ecm=pcr:pcrn1=90
:pcrn2=9000

```

Note: If adding the new signaling link will result in more than 700 signaling links in the database and the OAMHCMEAS value in the `rtrv-measopts` output is on, the scheduled UI measurement reports will be disabled.

11. Verify the changes using the `rtrv-slk` command, specifying the card location and signaling link entered in 10. This is an example of the possible output.

```
rtrv-slk:loc=1215
```

```
rlghncxa03w 06-10-19 21:17:04 GMT EAGLE5 36.0.0
```

LOC	LINK	LSN	SLC	TYPE	L2T	BPS	ECM	PCR	PCR	T1	T1	TS
					SET			N1	N2	LOC	PORT	
1215	A	lsnt145	0	LIMT1	1	56000	BASIC	---	-----	1215	2	3

```
rtrv-slk:loc=1216
```

```
rlghncxa03w 06-10-19 21:17:04 GMT EAGLE5 36.0.0
```

LOC	LINK	LSN	SLC	TYPE	L2T	BPS	ECM	PCR	PCR	T1	T1	TS
					SET			N1	N2	LOC	PORT	
1216	A	lsnt145	1	LIMCH	1	56000	BASIC	---	-----	1215	1	11
1216	A2	lsnt145	2	LIMCH	1	56000	BASIC	---	-----	1215	1	19

```
rtrv-slk:loc=2211
```

```
rlghncxa03w 09-05-19 21:17:04 GMT EAGLE5 41.0.0
```

LOC	LINK	LSN	SLC	TYPE	L2T	BPS	ECM	PCR	PCR	T1	T1	TS
					SET			N1	N2	LOC	PORT	
2211	A	lsnt1	0	LIMT1	31	1.536M	PCR	90	9000	2211	1	1

If any of the cards shown in this step contain the first signaling link on a card, continue the procedure with 12.

If signaling links were assigned to all the cards shown in this step when 10 was performed, continue the procedure with 13.

12. Bring the cards into service with the `rst-card` command, specifying the card location specified in 10. For this example, enter these commands.

```
rst-card:loc=1215
```

```
rst-card:loc=1216
```

```
rst-card:loc=2211
```

When each of these commands have successfully completed, this message should appear.

```
rlghncxa03w 06-10-23 13:05:05 GMT EAGLE5 36.0.0
Card has been allowed.
```

13. Activate all signaling links on the cards using the `act-slk` command, specifying the card location and signaling link specified in 10. For this example, enter these commands.

```
act-slk:loc=1215:link=a
```

```
act-slk:loc=1216:link=a
```

```
act-slk:loc=1216:link=a2
```

```
act-slk:loc=2211:link=a
```

When each of these commands have successfully completed, this message should appear.

```
rlghncxa03w 06-10-07 08:31:24 GMT EAGLE5 36.0.0
Activate Link message sent to card
```

14. Check the status of the signaling links added in 10 using the `rept-stat-slk` command with the card location and signaling link. The state of each signaling link should be in service normal (**IS-NR**) after the link has completed alignment (shown in the **PST** field). For this example, enter these commands.

```
rept-stat-slk:loc=1215:link=a
```

```
rlghncxa03w 06-10-23 13:06:25 GMT EAGLE5 36.0.0
SLK   LSN   CLLI   PST   SST   AST
1215,A lsnt145 ----- IS-NR   Avail  ----
ALARM STATUS      = No Alarms
UNAVAIL REASON    = --
T1 status         = 1215, RCVRY-T1F:FAC-T1 Port 2 available
```

```
rept-stat-slk:loc=1216:link=a
```

```
rlghncxa03w 06-10-23 13:06:25 GMT EAGLE5 36.0.0
SLK   LSN   CLLI   PST   SST   AST
1216,A lsnt145 ----- IS-NR   Avail  ----
ALARM STATUS      = No Alarms
UNAVAIL REASON    = --
T1 status         = 1215, RCVRY-T1F:FAC-T1 Port 1 available
```

```
rept-stat-slk:loc=1216:link=a2
```

```
rlghncxa03w 06-10-23 13:06:25 GMT EAGLE5 36.0.0
SLK   LSN   CLLI   PST   SST   AST
1216,A2 lsnt145 ----- IS-NR   Avail  ----
ALARM STATUS      = No Alarms
UNAVAIL REASON    = --
T1 status         = 1215, RCVRY-T1F:FAC-T1 Port 1 available
```

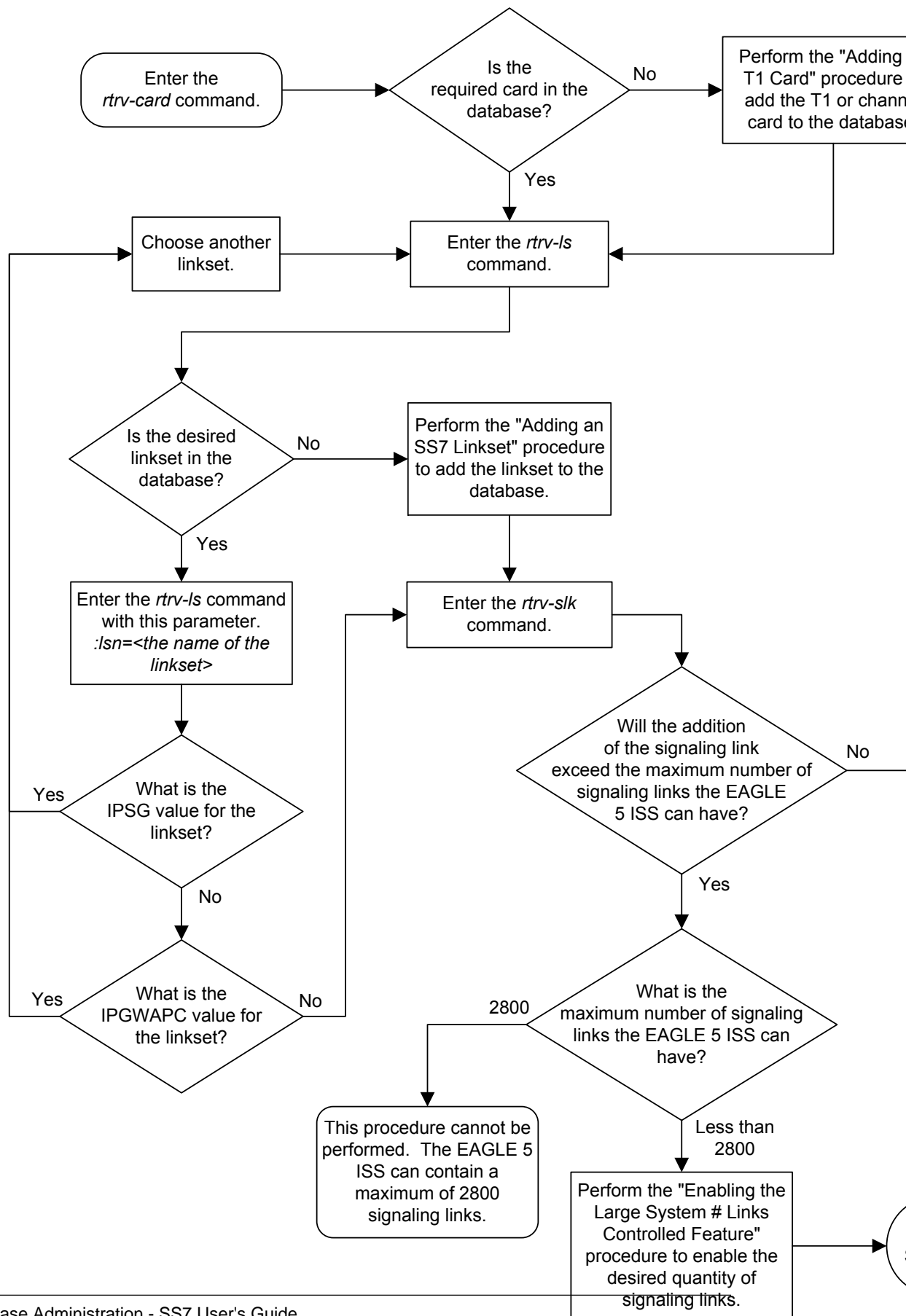
```
rept-stat-slk:loc=2211:link=a
```

```
rlghncxa03w 06-10-23 13:06:25 GMT EAGLE5 36.0.0
SLK      LSN      CLLI      PST      SST      AST
2211,A  lsnt1      -----  IS-NR      Avail     ----
ALARM STATUS      = No Alarms
UNAVAIL REASON    = --
T1 status         = 2211, RCVRY-T1F:FAC-T1 Port 1 available
```

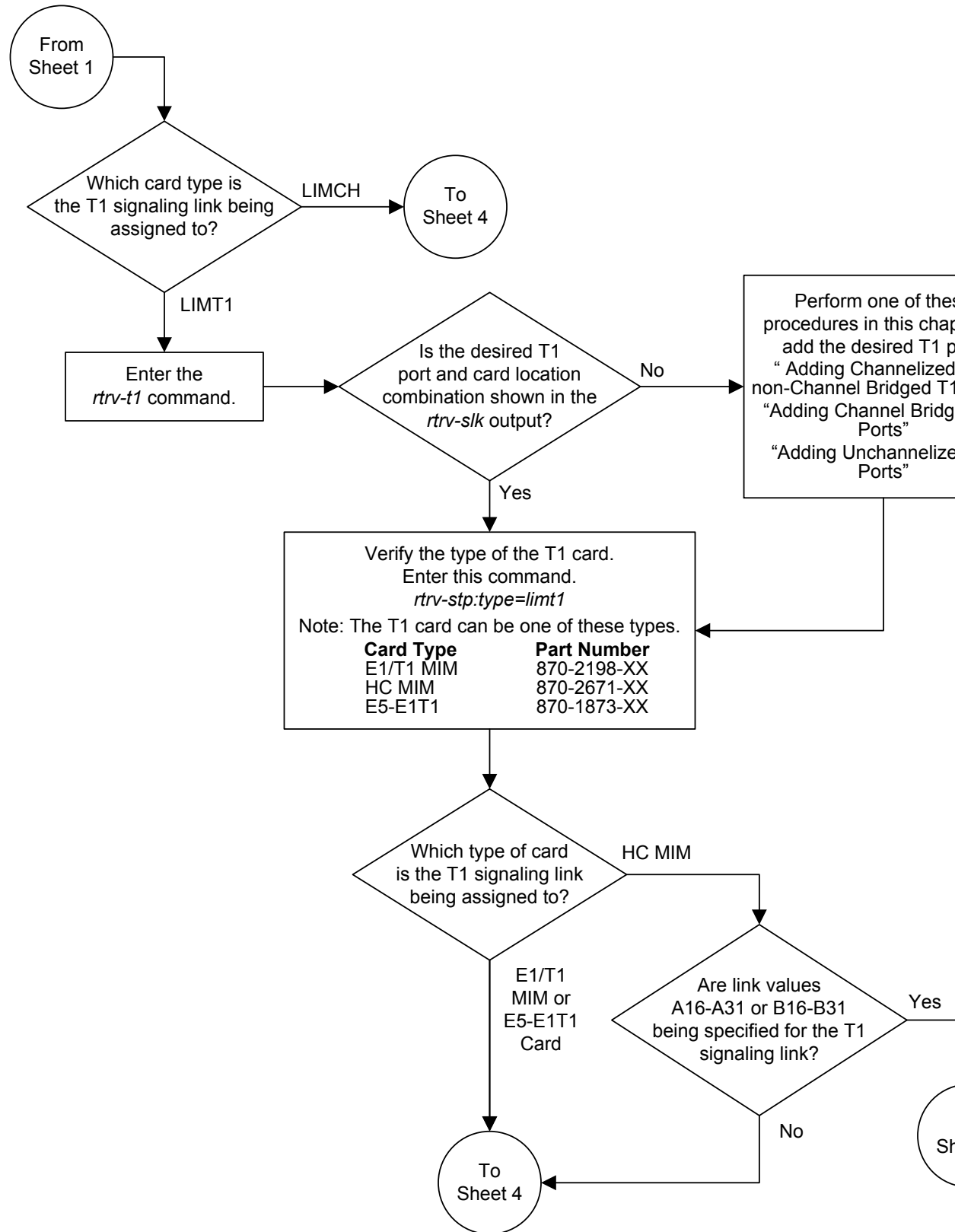
15. Back up the new changes using the `chg-db:action=backup:dest=fixed` command. These messages should appear, the active **Maintenance and Administration Subsystem Processor (MASP)** appears first.

```
BACKUP (FIXED) : MASP A - Backup starts on active MASP.
BACKUP (FIXED) : MASP A - Backup on active MASP to fixed disk complete.
BACKUP (FIXED) : MASP A - Backup starts on standby MASP.
BACKUP (FIXED) : MASP A - Backup on standby MASP to fixed disk complete.
```

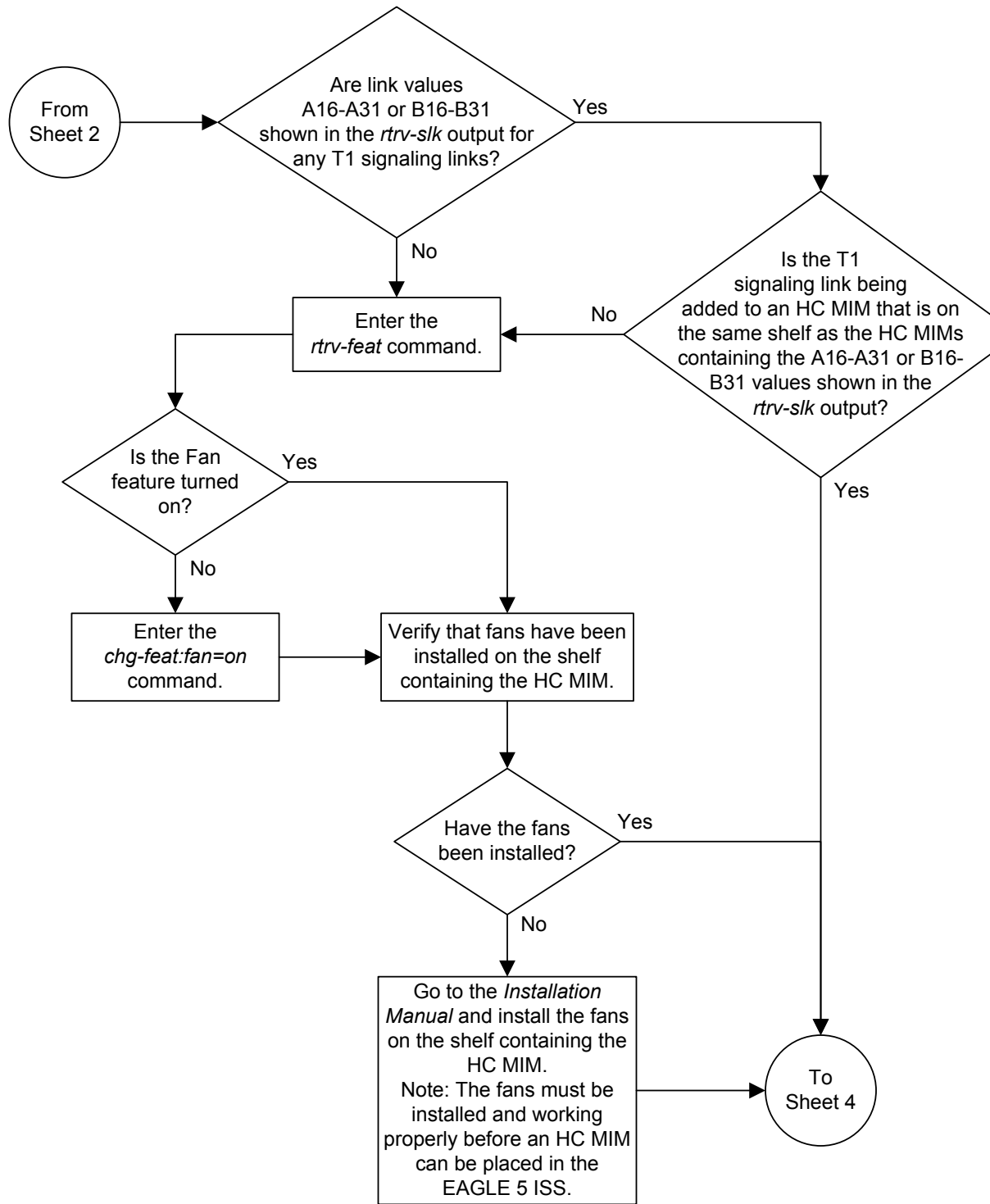
Figure B-14 Adding a T1 Signaling Link



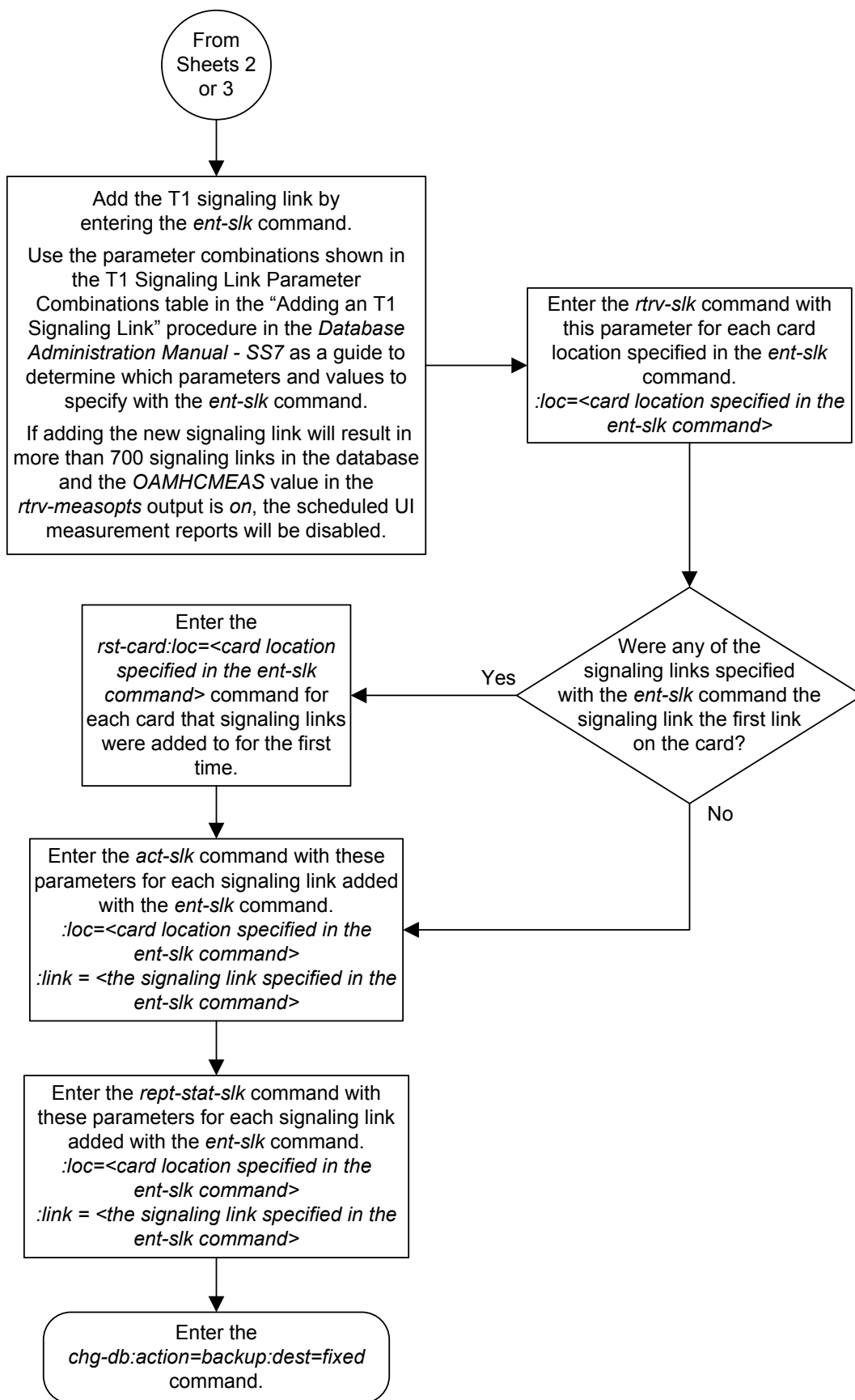
Sheet 1 of 4



Sheet 2 of 4



Sheet 3 of 4



Sheet 4 of 4

ATM Signaling Link Configuration

Appendix C, ATM Signaling Link Configuration, contains general information about the ATM high-speed signaling links and how to provision them.

Introduction

ATM (Asynchronous Transfer Mode) is a transport mechanism that uses virtual connections for transporting information across the network. The **ATM** layer uses the **VPI** and **VCI** fields to define multiple Virtual **Channel** Connections (**VCC**). Within each **VCC**, the **PTI** field is used to distinguish one type of traffic from another. A true **ATM** switch can support multiple **VPI/VCI** combinations. The **EAGLE** supports only a single **VPI/VCI** combination.

ATM is a specific packet-oriented transfer mode that uses an asynchronous time division multiplexing technique to multiplex information flow in fixed blocks, called cells. **ATM** replaces **MTP-1** (Signaling Data **Link** Functions) and **MTP-2** (**Signaling Link** Functions) in the **SS7** protocol stack.

Signaling data link functions (**MTP-1**) are provided by an appropriate physical layer in combination with the **ATM** layer, signaling link functions (**MTP-2**) are provided by the Signaling **ATM** Adaptation Layer (**SAAL**), and the signaling network functions are provided by **MTP** level 3. [Figure C-1](#) illustrates the high-speed link protocol model for **CCS NEs**.

Figure C-1 High-Speed Link Protocol Model for CCS Network Elements

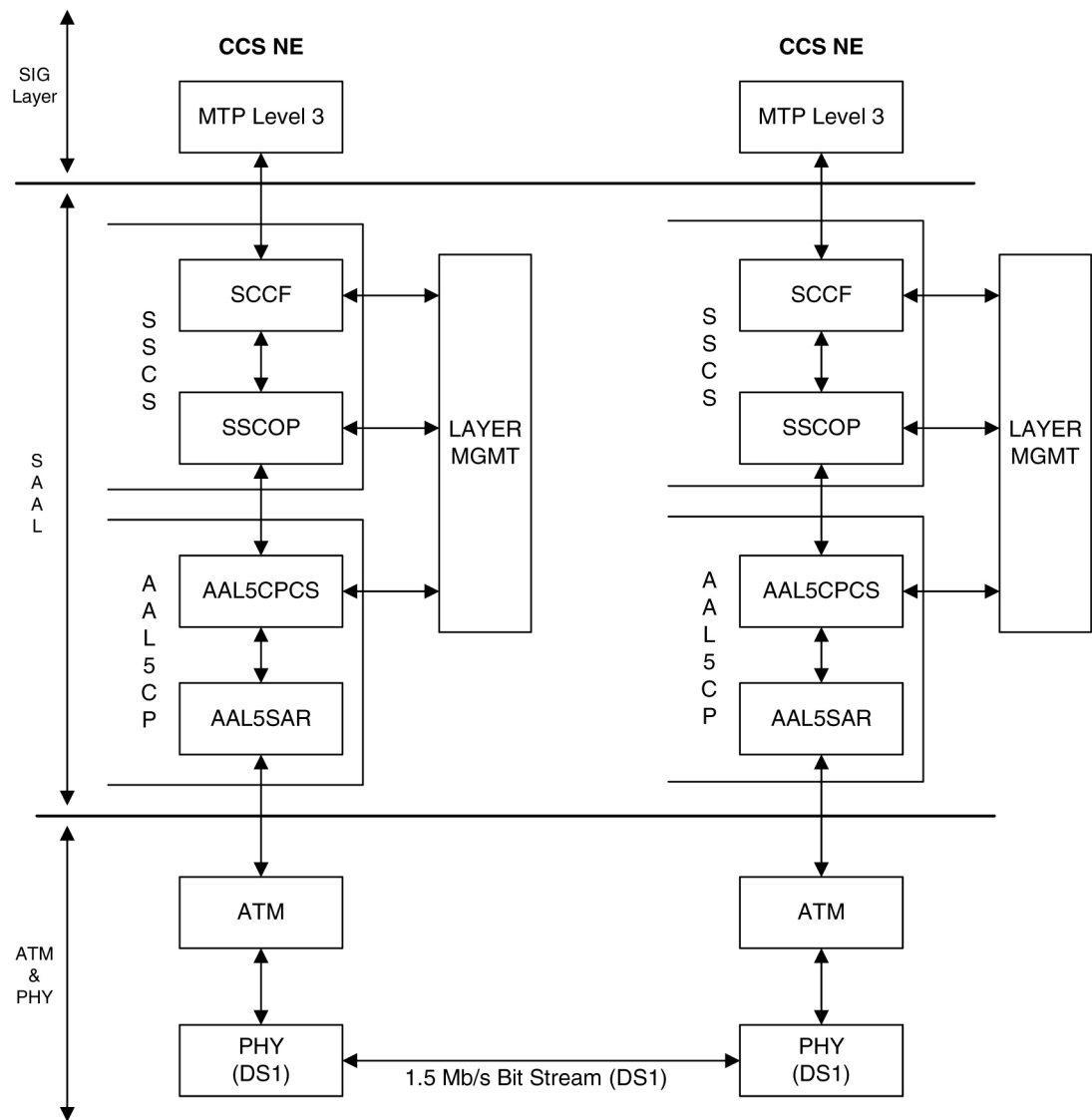


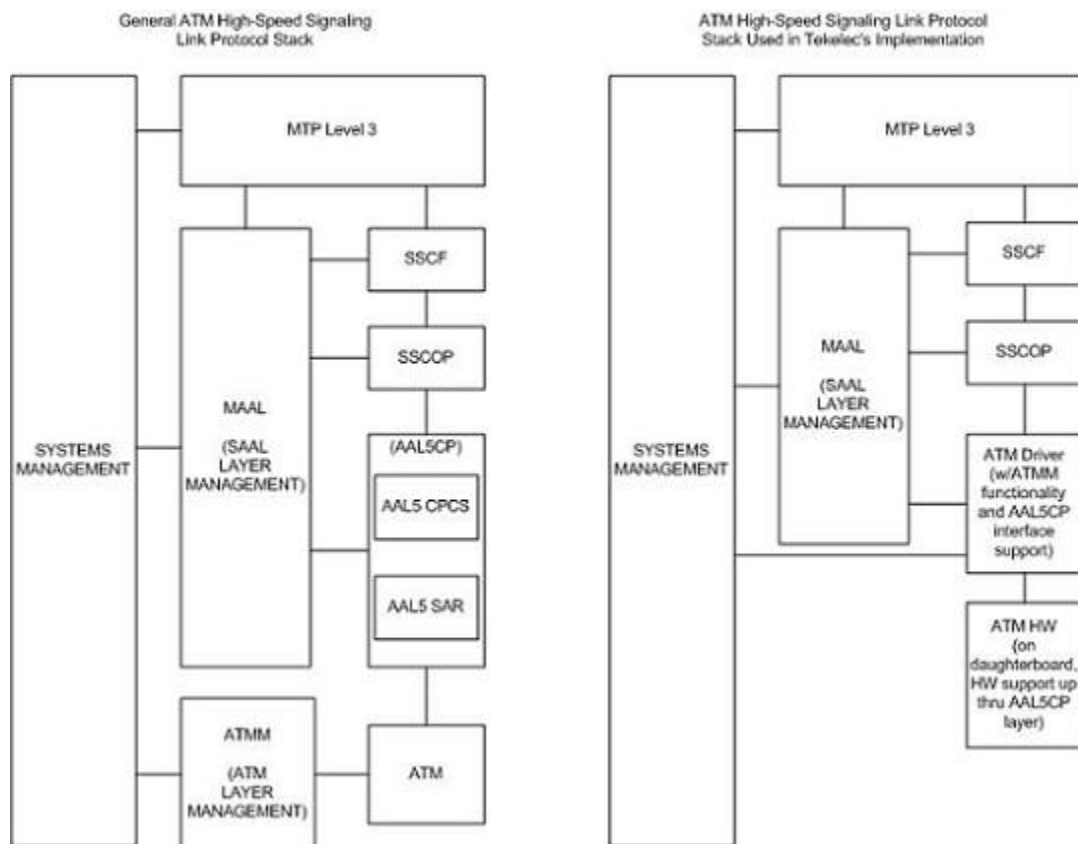
Figure C-2 illustrates some slight differences between the SAAL and ATM layers and the actual protocol stack used in the Oracle implementation. These differences are as a result of 3 reasons:

- The AATM hardware provides AAL5CP protocol support (primarily segmentation and reassembly of User Data PDUs), thus providing the AAL5CP functionality in hardware not software. The AATM hardware also provides CRC10 support for OAM F5 ATM cell flows.
- The ATM driver is not a defined block in the protocol model, but is needed in the Oracle implementation to control and interface with the AATM hardware. The ATM driver provides the software interface to the hardware AAL5CP functionality. The ATM driver also provides the ATMM (ATM Layer Management) functions that are supported in the EAGLE.
- As a part of providing ATM (MTP-level 2 equivalent) functionality into the existing EAGLE software (based on MTP-3 and MTP-2, not MTP-3 and SAAL),

some of the interfaces to and from **MTP level 3** will be to and from **MAAL** (rather than **SSCF** handling all **MTP-3** interaction).

The **EAGLE** implements an **ANSI ATM** high-speed signaling link, transmitting at a rate of 1.544 Mbps, and an **E1 ATM** high-speed signaling link, transmitting at a rate of 2.048 Mbps. Most of the **ANSI** and **E1 ATM** implementations are the same, but there are a few differences. The descriptions in this appendix apply to both implementations. Any differences between **ANSI** and **E1 ATM** are noted.

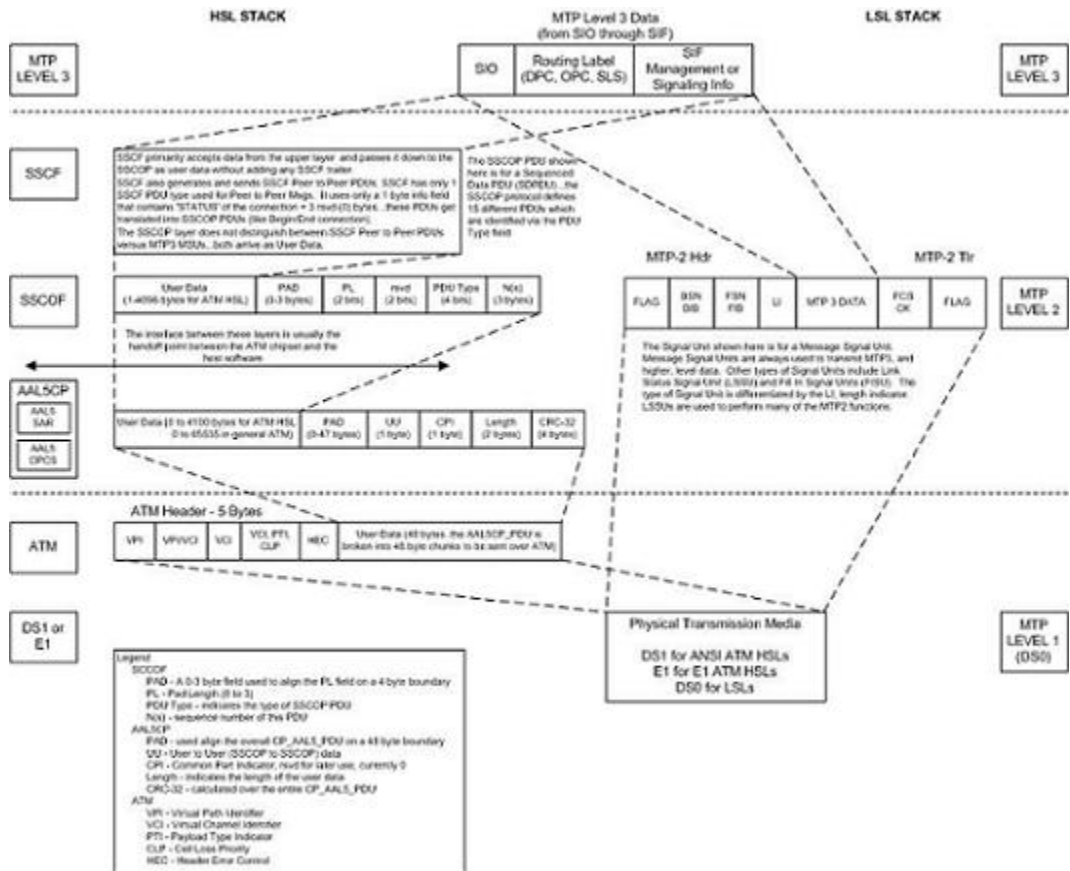
Figure C-2 ATM High-Speed Signaling Link Protocol Stack vs. Oracle Implementation in the EAGLE



Another way of viewing the high-speed signaling link implementation is to consider the frame formats of the data that is relevant at the various protocol stack layers.

[Figure C-3](#) illustrates the differences between the frame formats for high-speed signaling link layers versus the frame formats for traditional (**MTP-2** & **MTP-1**) low-speed signaling link layers.

Figure C-3 Frame Formats for High-Speed and Low-Speed Signaling Link Protocol Stacks



Based on Figure C-3, the following conclusions can be made regarding the ATM traffic and how ATM is used to carry MTP3 data:

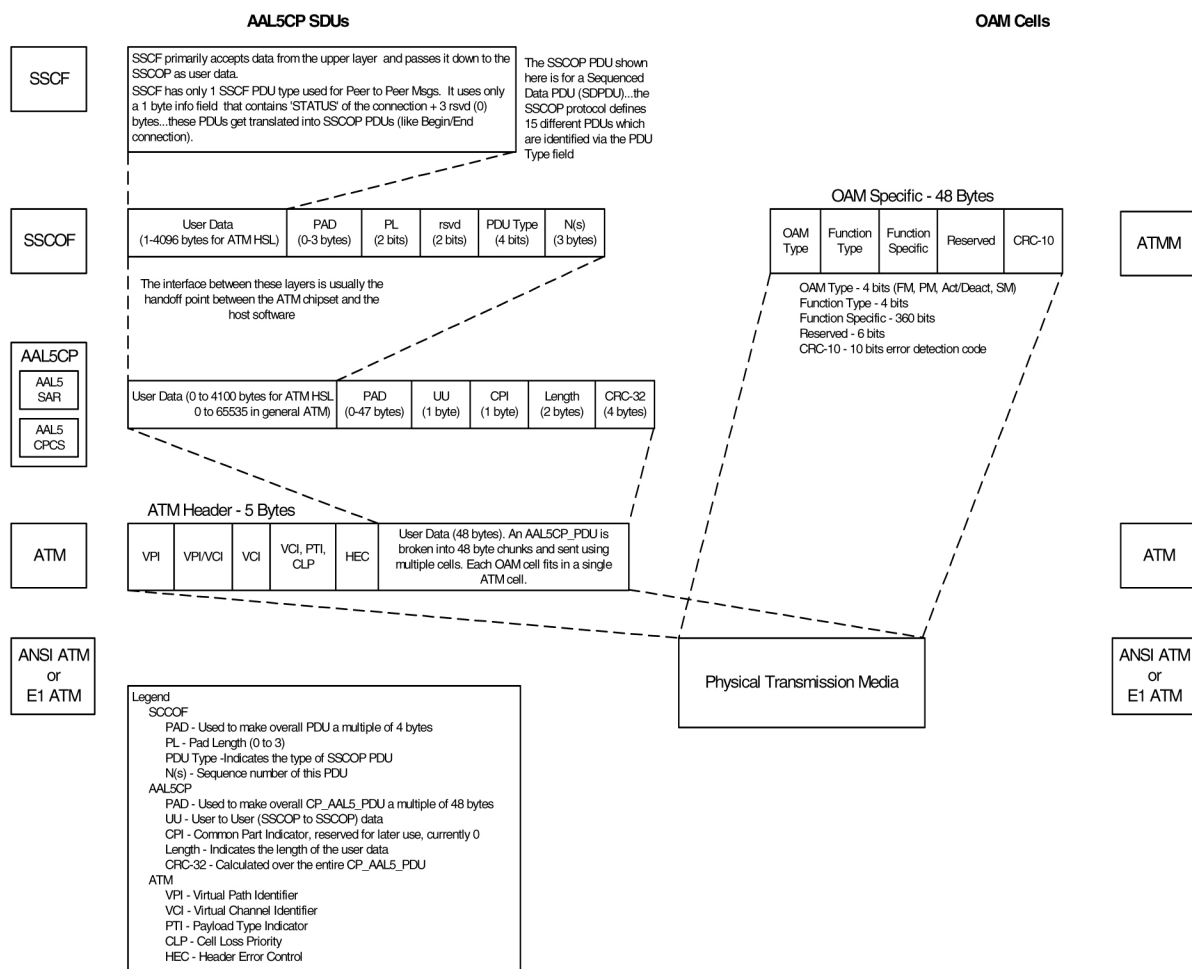
- The ATM layer uses the VPI and VCI fields to define multiple Virtual Channel Connections (VCC). Within each VCC, the PTI field is used to distinguish 1 type of traffic from another. A true ATM switch can support multiple VPI/VCI combinations. The EAGLE high-speed signaling link implementation needs to support only a single VPI/VCI combination.
- The ATM stack contains built in fields that are used to check the integrity of the data that is received across the T1 connection. The ATM cell HEC field and the AAL5CP CRC-32 fields are used for data integrity.
- MTP3 data (or MSUs) is transferred as User Data at the ATM cell level. A single MSU will require 1 or more ATM cells to transfer that MSU.
- A significant amount of ATM protocol overhead is involved in transferring MSUs. The overhead includes:
 - ATM cell headers
 - AAL5CP layer pad bytes and trailer
 - SSCOP layer pad bytes and trailer
- In addition to transferring MSUs, the ATM stack is capable of transferring

- **SSCOP Peer to Peer Messages** - these are used primarily for connection setup and tear down and the acknowledgment of transferred data
- **SSCF Peer to Peer Messages** - these are used primarily for high-speed signaling link alignment and proving

ATM Protocol Encapsulation

Two main types of data are delivered using ATM: **SDUs** and **OAM** cells. **SDUs** provide peer-to-peer information and user data (**MSUs**). **OAM** cells are used for operations and maintenance of the ATM connection. **Figure C-4** provides the data encapsulation through the ATM stack. **MTP3** is a user of **SSCF** and passes all **PDU**s directly to it.

Figure C-4 ATM Protocol Encapsulation



Payload Scrambling

Payload scrambling uses the $x^{43}+1$ scrambling function.

Idle Cells

Idle cells uses the following 5-byte header format:

0x00 0x00 0x00 0x01 0x52.

The content of the information field shall be 0x6A repeated 48 times.

Since idle cells are transmitted on VPI=0, VCI=0, they are immediately discarded by the receiving end.

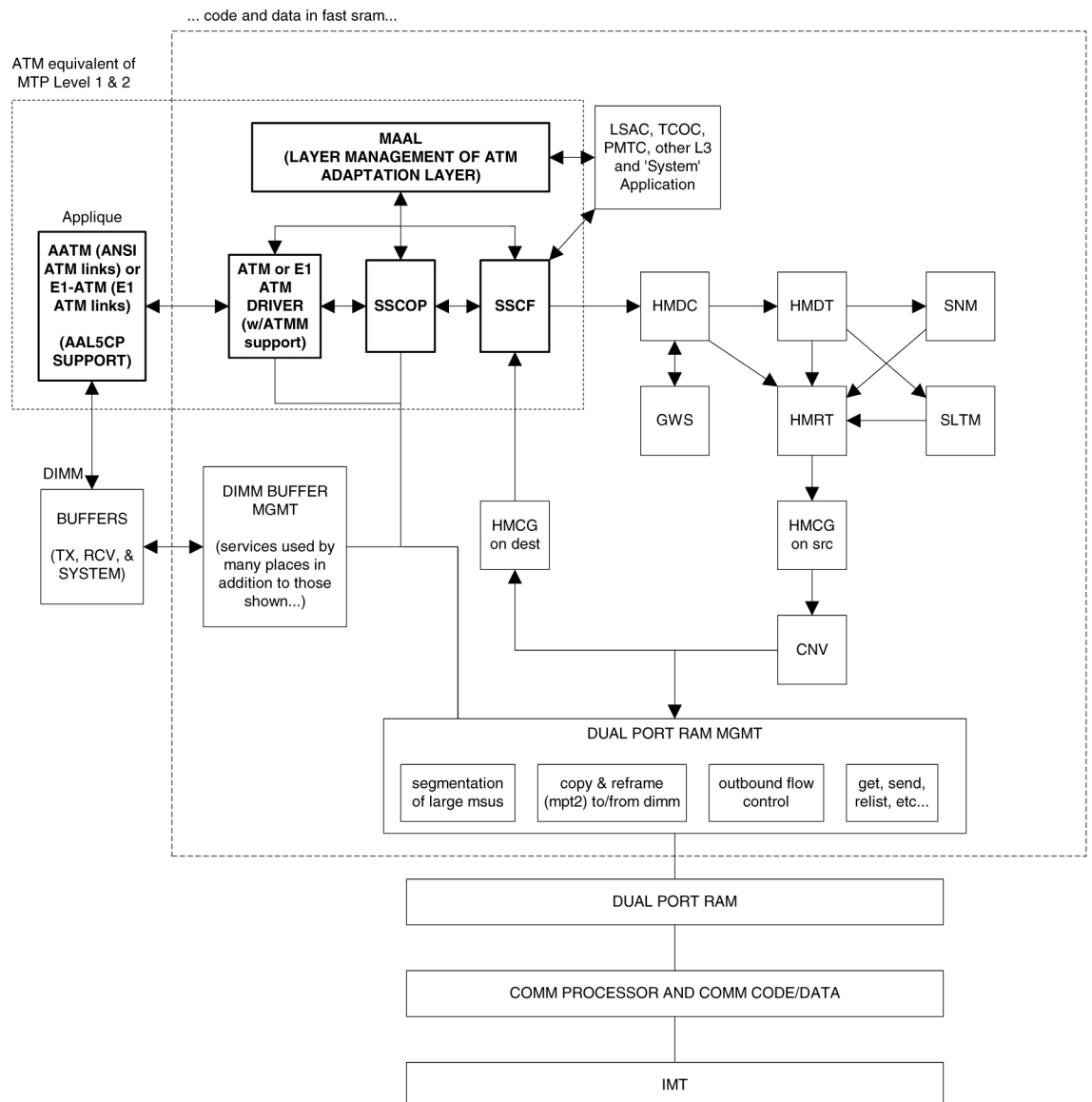
Overview of the ATM High-Speed Signaling Link LIM Operation

To other cards in the EAGLE, the ANSI ATM and E1 ATM high-speed signaling link cards look and operate similar to any other LIMs (with the exception of subtle differences related to load balancing for SCCP traffic), but has the potential for increased data throughput with respect to traditional EAGLE LIMs.

The ANSI and E1 ATM high-speed signaling link cards can perform gateway screening, copy and redirect, conversion and any of the other EAGLE features that any other LIM can perform (with the exception of link fault sectionalization).

A functional block diagram of the ATM high-speed signaling link is shown in Figure C-5.

Figure C-5 Functional Block Diagram of ATM High-Speed Signaling Link



The following sections provide more details for each of the new applications/processes (indicated by the bold boxes in [Figure C-5](#)) required for the ATM high-speed signaling link implementation. These sections will include information such as:

- the specification(s) that defines the layer
- highlights of the functionality provided by the application/process (what problems are being solved here)
- any limitations/restrictions from specifications that apply to the **EAGLE** implementation
- other information as appropriate

Applique

ANSI ATM

The **ANSI ATM** hardware consists of an **AATM** applique connected to an **HCAP** or **HCAP-T** main assembly. The **AATM** hardware provides the following functionality:

- support for the **DS1**, **ATM**, and **AAL5CP** layers of the ATM high-speed signaling link protocol stack as indicated in [Figure C-1](#).
- **DS1** Layer support
 - generate **DS1** signals
 - support for **DS1** defect reporting:
 - **LOS**
 - **LOF**
 - **LCD**
 - In-band **AIS** signals
 - support for loopback testing at the **DS1** level
 - support for **DS1** performance measurements and performance monitoring
- **ATM** Layer support
 - idle cell insertion/removal
 - provide adequate indications of **ATM** layer errors:
 - invalid **ATM** header patterns
 - unsupported **VPI/VCI** combinations
 - unsupported **PTI** values
 - cells discarded due to header error control
 - out of cell delineation anomalies
 - header error control field to be automatically inserted/checked by the hardware
 - **CLP** field of cells received is made available to software

- ability to **DMA** received cells directly to **DIMM** receive buffers
- ability to **DMA** cells to transmit directly from **DIMM** transmit buffers
- needs to support interleaved transmit/reception of data from different **VPI/VCI** combinations, or from **OAM F5** flows as opposed to user data flows, these need to each be passed to higher layers using different queues or data structures
- congestion indications for cells are made available to software; software can set the congestion indications for outbound traffic.
- **OAM F5** cell support
 - only end to End **OAM F5** cells for a **VCC** need to be supported
 - shall support generation (outbound) and processing (inbound) of **OAM** cell types for **VCC F5** flows
 - shall indicate reception of these cells in a distinct manner from user data cells
 - provide **CRC-10** checking/generation for these frames
- **AAL5CP** Layer support
 - perform the segmentation/reassembly required for user data cells and ability to pass user data to/from the **SSCOP** in an efficient manner (whether this is via some linked list of **ATM** cells that together make up 1 **AAL5CP_PDU**, or via regrouping **ATM** cells as they arrive into 1 continuous **AAL5CP_PDU** is implementation dependent).
 - provide **CRC-32** generation/checking for **AAL5CP_PDU**s
 - should stuff outbound **AAL5CP_PDU**s with 0 in the **CPI** field
 - appropriate error checking and indications for errors
 - **CRC** errors
 - Length errors
 - **CPI** errors
 - some fields of the **AAL5CP_PDU** need to be passed to/from the higher layers
 - **UU**
 - **CLP**
 - Congestion indication

E1 ATM

The **E1 ATM** hardware consists of an **E1 ATM** applique connected to an **HCAP** or **HCAP-T** main assembly. The **E1 ATM** hardware performs the same functions as the **ANSI ATM** hardware, with these exceptions:

- support for the **E1**, **ATM**, and **AAL5CP** layers of the **ATM** high-speed signaling link protocol stack as indicated in [Figure C-5](#).
- **E1** layer support

- Support **CRC-4**
- Support **Si** and **Sn** insertion in **Channel 0**
- Support **E1** defect reporting:
 - **LOS**
 - **LOF**
 - **LCD**
- **OAM F5** cell support - only end-to-end **OAM F5** cells for a **VCC** are required to be supported

E1 Overview

This section provides an overview of **E1**, its protocol and characteristics.

Frame Structure

E1 is a 2.048 Mbps interface. It has a frame structure of 256 bits that is repeated at a rate of 8 **KHz**. The 256-bit frame is broken into 32 eight-bit time timeslots, numbered 0 to 31, as shown in [Figure C-6](#). Timeslots can also be referred to as channels.

Figure C-6 E1 Frame Structure

align frame	Si 0 0 1 1 0 1 1	timeslot 1	timeslot 2	timeslot 30	timeslot 31
non-align frame	Si 1 A SnSnSnSnSn	timeslot 1	timeslot 2	timeslot 30	timeslot 31
align frame	Si 0 0 1 1 0 1 1	timeslot 1	timeslot 2	timeslot 30	timeslot 31
non-align frame	Si 1 A SnSnSnSnSn	timeslot 1	timeslot 2	timeslot 30	timeslot 31

Si - International Usage Spare Bit
 Sn - National Usage Spare Bit
 A - Alarm Bit

Timeslot 0

Timeslot 0 is used for frame alignment and **CRC** functions. Alternating frames contain the Frame Alignment Signal (**FAS**), X0011011, where X is supplied from the International Usage Spare Bit information (Si). Frames without the **FAS** carry Si, **Alarm**, and Sn information. Bit 1 is set to 1 to prevent accidental emulation of the **FAS**.

Si is reserved for international usage. **CRC-4** specified below is one specific use. If no use is specified, Si should be set to 1. Sn is a 5-bit field (value 0 – 31). ‘A’ is an alarm bit. If set, it indicates a remote alarm indication.

CRC-4

A **CRC-4** multi-frame structure is shown in [Figure C-7](#). **CRC-4** uses timeslot 0 primarily to aid in frame alignment validation but can be used to monitor error performance as well. A **CRC** multi-frame consists of timeslot 0 information from 16 consecutive frames. Each **CRC-4** multi-frame is divided into 2 eight-frame sub-multi-frames (**SMF**).

Bit 1 is used to carry 3 different pieces of information:

- A multi-frame alignment word is a repeating 6-bit code (001011) that is located in frames 1,3,5,7,9, and 11.

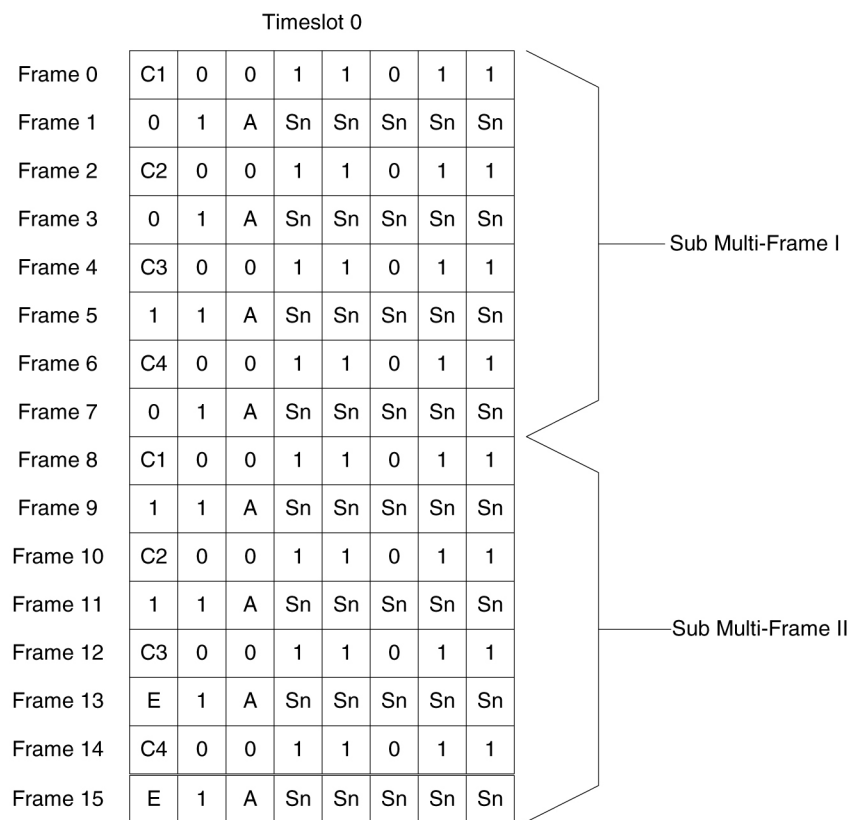
- A 4-bit **CRC** code word (C1, C2, C3, C4), which is a data check on the previous 8 **E1** frames. The check covers the data for all 32 timeslots. (8 frames * 256 bits/frame = 2048 bits) Each **SMF** has its own code word. The code word for **SMF I** is in frames 0, 2, 4 and 6. The code word for **SMF II** is in frames 8, 10, 12, and 14.
- E (CRC-4 Error indication) bits, present in frames 13 and 15.

The **Alarm** Indication Signal is received in **Channel 0**, Bit 3 of the non-alignment frame. If this bit is set, it indicates a Remote **Alarm** Indication. As with the **ANSI ATM**, this condition is ignored.

Bits 2 through 8 follow the standard **E1** frame structure.

If **CRC-4** in on, the provisioned Si information is not used. Instead, bit 0 is used for **CRC4** information, **CRC4** error reporting, and for multiframe alignment (see [Figure C-7](#)).

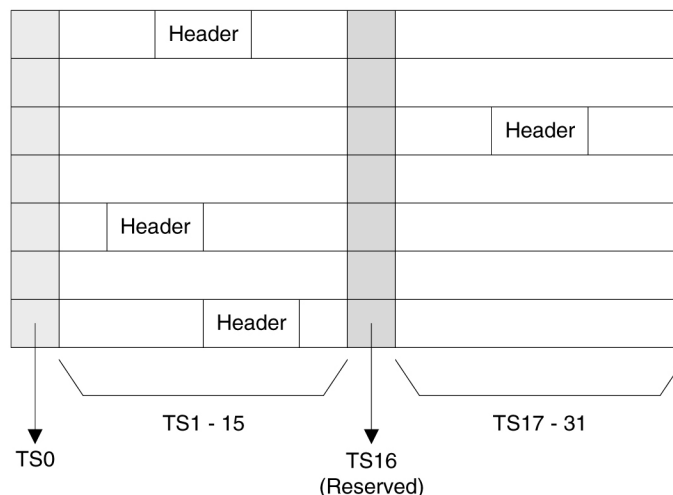
Figure C-7 CRC-4 Multiframe Structure



E - CRC-4 Error Indication Bits
 C1 to C4 - Cyclic Redundancy Check 4 bits
 Sn - National Spare Bits
 A - Remote Alarm Indication

ATM Mapping into E1

Data channels 1 – 15 and 17 - 31 carries the data for a single **ATM** channel, as shown in [Figure C-8](#). Note that the **ATM** cell size does not map directly over the **E1** frame format, so the **ATM** cell can start in any data channel. The data is octet-aligned.

Figure C-8 ATM Cell Mapping into E1 Frames**ATM Driver**

The **ATM** driver is a software module, residing as part of the **ATMANSI** or **ATMITU** applications, that provides the code required to interface between the **AATM** hardware and the **SSCOP** layer and **ATM Layer Management** interfaces. The primary functions of the driver include:

- initialization and control of the **AATM** hardware
- interface between **AATM** hardware signals and data structures and the relevant messages/data to/from the **SSCOP** and **ATM Layer Management** layers
- provide the **DIMM** buffer management interface required for the **AATM** hardware for user data received and transmitted (that is, provide free receive buffer lists for the **AATM** hardware after grabbing buffers from **DIMM** mgmt, provide information detailing where to transmit user data from, etc.)
- some of the functions listed above in the **AATM** hardware section (such as providing separate 'receive channels' for **OAM F5** vs. user data cells to/from higher levels) may actually be performed in this layer based on the actual **ATM** hardware solution selected
- the only type of **AAL** service needed is for **AAL Type 5 (AAL5)**
- the **AATM** hardware and **ATM** driver together make up the common part of the **SAAL** layer, also known as the **Common Part Convergence Sublayer (CPCS)** or **AAL5CP**, when the **AAL** type in question is **AAL5**.

E1 ATM Driver

The **E1 ATM** driver is a software module that provides the interface between the **E1 ATM** hardware, the **SSCOP** layer, and **ATM Layer Management** Module. The **E1 ATM** driver exists only in the **ATMITU** application. The basic structure is based upon the **ANSI ATM** driver present in the **ATMANSI** application. The primary changes to the existing **ANSI ATM** driver include:

- initialization and control of the new **E1 ATM** appliqué.
- remove **T1** support of 4 Kbps data link (**BOCs**, including performance reports and **T1** loopback tests)

- verify correct **E1 ATM** appliqué is installed and reboot if not

SSCOP

The primary task of the **SSCOP (Service Specific Connection Oriented Protocol)** is to provide assured data delivery between **AAL** connection endpoints. The **SSCOP** is 1 of 2 parts (the other being the **SSCF**) of the Service Specific part of the **SAAL** layer (also known as the **SSCS**, the **Service Specific Convergence Sublayer** of the **SAAL**). The other part of the **SAAL** Layer is the **CPCS** (which was just mentioned in the **ATM** driver). Breaking the **SSCS** into 2 sublayers allows a common connection oriented protocol with error recovery (the **SSCOP**) to provide a generic reliable data transfer service for different **AAL** interfaces defined by different **SSCF** layers. The primary functions of the **SSCOP** layer include:

- transfer of user data with sequence integrity
- error correction by selective retransmission
- flow control
- connection control
- error reporting to layer management
- connection maintenance in the prolonged absence of data transfer
- local data retrieval by the user of the **SSCOP**
- error detection of protocol control information
- status reporting

SSCF

The primary task of the **SSCF (Service Specific Coordination Function)** is to map the services provided by the lower layers of the **SAAL** to the needs of a specific higher layer user. For the **ATM** high-speed signaling link, the higher layer user is the **MTP-3** protocol.

- maps signals/primitives from **MTP-3 (SSCF user)** to **SSCOP**, and vice versa.
- performs local retrieve function, required by the changeover order.
- flow control on transmit direction (**SSCF** notifies the user of congestion levels)
- maintains and controls the link status
- generates necessary reports to **ATM Layer Management** (primarily the cause for the release of the **SSCOP** connection)
- implements some **SSCF** to **SSCF**, peer to peer messages primarily related to connection establishment and release
- controls local and remote processor outage and recovery
- controls the alignment procedure

For an **E1 ATM** high-speed signaling link, the link proving default values are significantly different compared to an **ANSI ATM** high-speed signaling link. [Table C-1](#) illustrates the different link proving values.

Table C-1 Link Proving Differences Between ITU and ANSI

CHG-ATM-LPS Parameter Name	Description	E1 ATM Default Values	ANSI ATM Default Values
N1	Number of PDU s sent during link proving	1000	64552
TmrT2	Time to attempt link proving	30 sec	120 sec
maxnrp	Maximum number of retransmitted PDU s during proving	0	1
TmrT3	Time between proving PDU s	925 sec	925 sec

The time required for normal **ANSI** proving is approximately 60 seconds (925 sec/pdu * 64552 **PDU**s = 60 seconds). This time is greater than **TmrT2** value for an **E1 ATM** high-speed signaling link (30 seconds), so a link with **E1 ATM** defaults would have gone out of service before a link with **ANSI ATM** defaults finishes proving. Thus, great care must be taken to ensure that compatible proving numbers are assigned to a signaling link.

ATM and SAAL Layer Management Interfaces

The primary task of the **ATM** and **SAAL** layer management layers is to map requests and indications between the system management for the **EAGLE** and the individual **ATM**, **AAL5CP**, **SSCOP**, and **SSCF** layers. This functionality is actually achieved using two management modules, which both interface to the system management.

ATM Layer Management

ATM layer management is achieved with the **ATMM** (**ATM** layer management module). The **ATMM** provides a supporting role for system management functions which include fault, performance, configuration, security and resource management functions. It is the job of the system management to coordinate with different layers locally to perform all tasks associated with these functions. The **ATMM** entity uses two types of interactions with the **ATM** entity to perform its functions. The first type of interaction is for the exchange of info between the **ATM** and **ATMM** entity. The second type of interaction is for peer to peer communication between **ATMM** entities (between the two nodes on both ends of the high-speed signaling link). This second interaction is achieved by sending and receiving and processing **OAM F5** cells in the **ATM** high-speed signaling link implementation. The primary functions provided by the **ATMM** for an **ANSI ATM** high-speed signaling link include:

- **OAM F5** fault management: includes alarm surveillance, loopback using **OAM** cells, and continuity check
- **OAM F5** performance management: includes activation and deactivation of performance monitoring, forward and backward monitoring and reporting of performance to system management.

Note:

The general **ATMM** layer is capable of performing performance management functionality. The **ATMM** layer implemented by **ATM** high-speed signaling link does not support this capability.

The primary functions provided by the **ATMM** for an **E1 ATM** high-speed signaling link include only **OAM F5** fault management: loopback by **OAM** cells. All other forms of **OAM F5** management and **OAM F5** performance management are not supported.

SAAL Layer Management

The **SAAL** layer management includes interfaces to and from **AAL5CP**, **SSCOP**, **SSCF**, and system management. **SAAL** layer management supports the following functions:

- error processing for these layers
- error monitoring for in-service links
- detection of excessive time with no credit
- detection of closely spaced **SSCOP** recoveries
- measurements
- duration of presence in the in-service state
- signaling link failures
- signaling link restoration
- handling of processor outage conditions
- management of signaling link proving

ATM High-Speed Signaling Link Testing Capability

Local Loopback Support

There are five link testing capabilities for an **ATM** high-speed signaling link. All five of these tests can be used for an **ANSI ATM** high-speed signaling link; three of these tests can be used for an **E1 ATM** high-speed signaling link. [Table C-2](#) gives a description of each test and shows which the type of **ATM** high-speed signaling link each test can be used. [Figure C-9](#) and [Figure C-10](#) show diagrams of each test.

Table C-2 ATM High-Speed Signaling Link Loopback Support

Loopback Type	ANSI ATM High-Speed Signaling Link	E1 High-Speed High-Speed Signaling Link	When can the Loopback Test be Performed	How does the Loopback test Work	What is Tested (Assume Near End Unless Specified)
SLTC	Yes	Yes	When the link is in service and activated	MTP-3 exchanges SLTM/SLTA messages with remote MTP-3. Appears as normal MSU traffic to SSCF and SSCOP.	MTP-3 layer, ATM protocol stack (near end and far end), and wire
OAM	Yes	Yes	When the link is connected to a remote STP. The state of the link is either activated or deactivated.	ATM driver exchanges OAM F5 Loopback cells with remote ATM driver. One OAM cell per request with a maximum of three attempts made.	ATM driver (near end and far end) and wire
LXVR	Yes	Yes	When the link is deactivated.	MTP-3 attempts to align link. If alignment fails, test fails. Appears as normal alignment request to SSCF and SSCOP.	SSCF, SSCOP, ATM driver and T1 hardware (for an ANSI ATM high-speed link) or E1 hardware (for an E1 ATM high-speed signaling link) on near end

Table C-2 (Cont.) ATM High-Speed Signaling Link Loopback Support

Loopback Type	ANSI ATM High-Speed Signaling Link	E1 High-Speed High-Speed Signaling Link	When can the Loopback Test be Performed	How does the Loopback test Work	What is Tested (Assume Near End Unless Specified)
Payload	Yes	No	When the link is deactivated, connected to remote STP and no Yellow Alarm BOC is being transmitted.	MTP-3 attempts to align link. If alignment fails, test fails. Appears as normal alignment request to SSCF and SSCOP .	SSCF , SSCOP , ATM driver (near end only) and T1 hardware (near end and far end) and wire
Line	Yes	No	When the link is deactivated and connected to remote STP and no Yellow Alarm BOC is being transmitted.	MTP-3 attempts to align link. If alignment fails, test fails. Appears as normal alignment request to SSCF and SSCOP .	SSCF , SSCOP , ATM driver (near end only) and T1 hardware (near end and far end) and wire

Figure C-9 ANSI ATM High-Speed Signaling Link Loopback Support

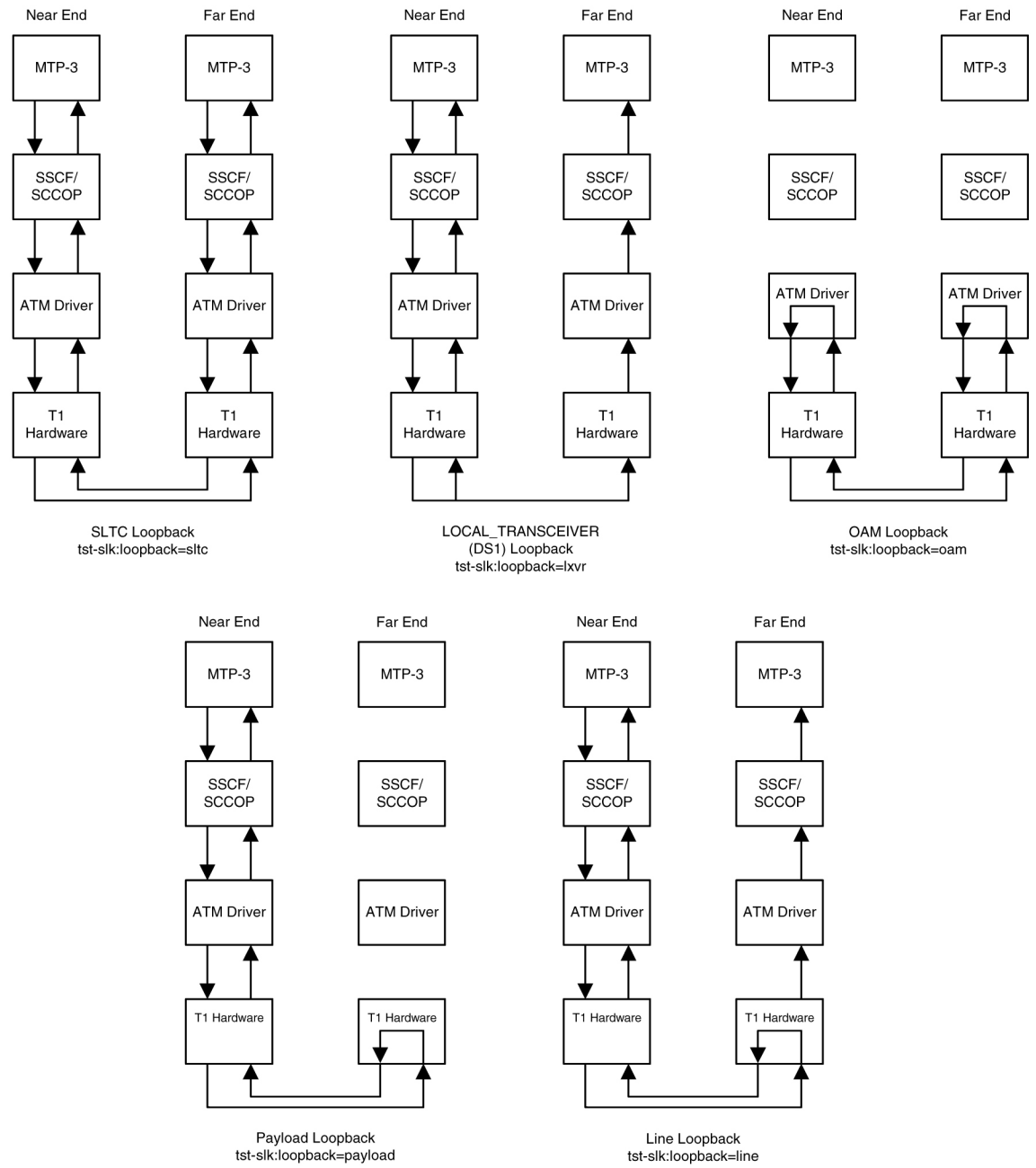
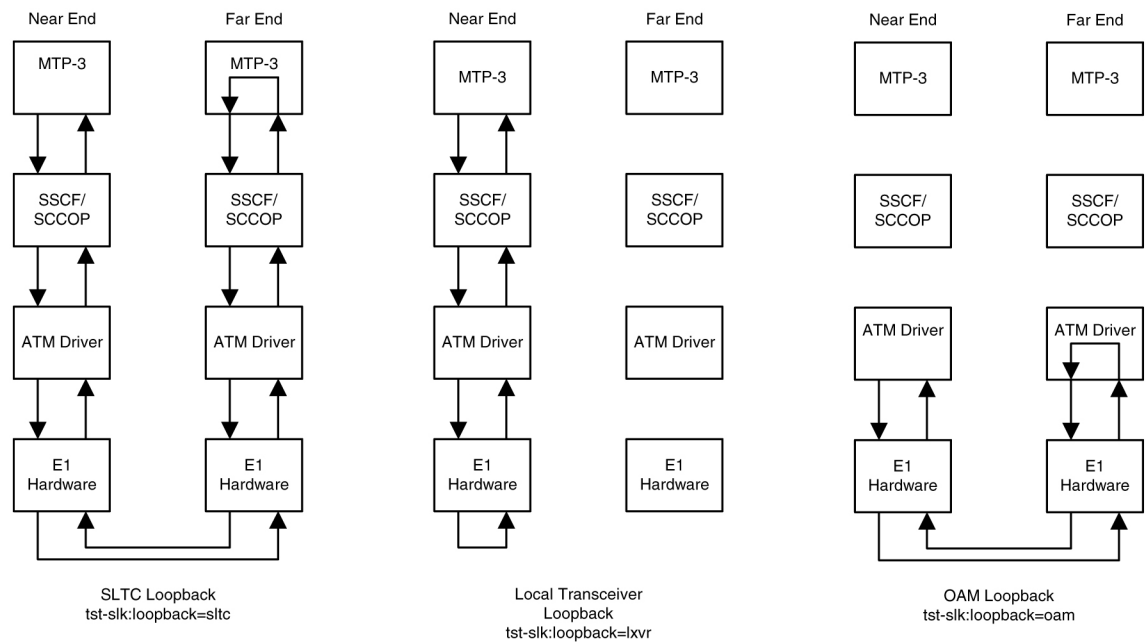


Figure C-10 E1 ATM High-Speed Signaling Link Loopback Support



Remote Loopback Support

The LIM containing the ATM high-speed signaling link must provide remote loopback support so that the EAGLE 5 ISS can act as the far end STP as shown in Figure C-9 or Figure C-10. The support provided for ATM high-speed signaling link cards is identical to low-speed signaling link cards by providing the same initialization and detection capabilities.

- **initialization** - The MTP-3 layer, independent of hardware interface, allows remote loopbacks when the link is deactivated. Upon receiving a bit-oriented code for a line or payload loopback, the ATM high-speed signaling link reprograms the AATM hardware if MTP-3 has determined a remote loopback is allowed.
- **detection** - Every 500 ms, the hardware is read to determine if remote loopback is in progress and the maintenance block is updated. This generates a UAM to the local node. For DS1 links, an AATM hardware register is read to determine if the T1 layer is currently configured for remote loopback.

Link Status Logging Capability

The Enhanced Link Diagnostics capability stores link status information. The link status information is divided into 2 categories: service data and alignment data. Currently, each logging routine can store up to 69 events, all of which can be displayed using the rept-stat-slk command. The service data and alignment data categories are described in the following sections.

Service Data Category

Service events and their timestamps are buffered during transitions between the In-Service/Data Transfer Ready states and all other states. This buffer contains a history of the link failure reasons (as seen from Level 2's point of view) and the subsequent realignments. Each entry in the buffer is either the link failure reason and time, or the time the link came back in service. Table C-3 provides a list of all high-speed signaling link failure reasons, however, not all of these failures will show up in the service data. Several types of failure that are recognized by Level 3 (like Changeover Order Received or Failed SLT) are mapped to a Stop Commanded event at Level 2. If the

history indicates the link did not realign after the failure, the alignment data buffer shows the reason the link was unable to be realigned.

The service data history contains only the high-speed signaling link failure reason as seen by Level 2. As highlighted above, there actual failure reason can be hidden from the Level 2 Service Data if it is an event that is detected by level 3. For example, there are many reasons why Level 3 sends a Stop command to Level 2, such as link deactivated by user, changeover order received, false link congestion, etc. Therefore, the service data should only be used as a guide in determining a link failure.

Table C-3 High-Speed Signaling Link vs. Low-Speed Signaling Link Unavailability Reasons by Priority

High-Speed Signaling Link Unavailability Reason	Low-Speed Signaling Link Unavailability Reason
Remote Loopback	Remote Loopback
LOS	
LOF	
LCD	
Too Many Interrupts	Too Many Interrupts
	Stopped Receiving Data
ISERM threshold exceeded	
	SUERM
Remote Out of Service	
Remote Protocol Error	
Remote Management Initiated	
Remote Processor Outage	
Local Processor Outage	
Timer_No_Credit expired	
Timer_No_Response expired	
	T1 expired(ready, not ready)
	T3 expired
	T2 expired
	Exceeded Proving Period Count
	SIO received
	SIN received
	SIE received

Table C-3 (Cont.) High-Speed Signaling Link vs. Low-Speed Signaling Link Unavailability Reasons by Priority

High-Speed Signaling Link Unavailability Reason	Low-Speed Signaling Link Unavailability Reason
	SIOS received
	SIPO received
	RC/BSNR link failure
	RC/FIBR link failure
	T6 expired
	T7 expired
COO Received	COO Received
False SLK Congestion	False SLK Congestion
SLK Restart Delayed	SLK Restart Delayed
Far End Loopback	Far End Loopback
Link Not Aligned (default)	Link Not Aligned (default)
Remote Blocked	Remote Blocked
Local Blocked	Local Blocked
Remote Inhibited	Remote Inhibited
Local Inhibited	Local Inhibited

Alignment Data Category

Alignment events are buffered at all times when link is not in service. Only the first unique occurrence of an event and its timestamp is buffered. High-speed signaling link alignment events are divided into:

- SSCOP, SSCF and MAAL state transitions
- SSCOP and SSCF transmitted PDUs
- SSCOP and SSCF received PDUs
- Special level 1 events.

Table C-4, Table C-5, and Table C-6 list all the possible alignment events sorted by event type.

Table C-4 High-Speed Signaling Link State Transition Alignment Events

SSCOP	SSCF	MAAL
Idle	OOS Idle	OOS

Table C-4 (Cont.) High-Speed Signaling Link State Transition Alignment Events

SSCOP	SSCF	MAAL
Outgoing Conn. Pending	OOS ODP	Alignment
Incoming Conn. Pending	Alignment Idle	Proving
Outgoing Disc. Pending	Alignment OCP	Aligned/Ready
Outgoing Resync Pending	Alignment ODP	In Service
Incoming Resync Pending	Proving Data Transfer Ready	
Outgoing Recovery Pending	Aligned/Ready Data Transfer Ready	
Recovery Response Pending	In Service/Data Transfer Ready	
Incoming Recovery Pending		
Data Transfer Ready		

Table C-5 High-Speed Signaling Link Transmitted/Received Alignment PDUs

SSCOP	SSCF
BGN	Out of Service
BGAK	Processor Outage
END	In Service
ENDAK	Normal
RS	Emergency
RSAK	Alignment Not Successful
BGREJ	Mgmt Initiated
SD	Protocol Error
ER	Proving Not Successful
POLL	
STAT	
USTAT	
UD	
MD	
ERAK	

Table C-6 High-Speed Signaling Link Special Level 1 Alignment Events

Special Events
LCD
LCD Cleared
LOF
LOF Cleared
LOS
LOS Cleared
Too Many Interrupts
Stop Commanded

Display of Buffered Data

The buffered data are displayed using the `rept-stat-slk` command. All events are buffered with the day and time of the event. The buffered timestamp is displayed in a day of year and time of day format (YY-MM-DD HH:MM:SS.sss). The time of day and day of year are passed to the LIM card when polling for the maintenance block. A timer on the LIM card, with a 5 millisecond granularity, provides the millisecond portion of the time displayed. The user has the ability to request either alignment data, service data or both be displayed. A maximum of 69 service and/or alignment events are displayed. However, the user has the ability to display only the last 10 alignment events. See the *Commands Manual* for a description of the `rept-stat-slk` command.

Large MSUs

As shown in [Figure C-3](#), a general purpose implementation of the ATM high-speed signaling link protocol stack would allow for large MSUs to be transferred across an ANSI or E1 ATM high-speed signaling link. The SSCOP layer can handle user data from SSCF that is up to 4096 bytes long. Since the SSCF layer does not add a trailer to MTP3 data, the ATM protocol stack is able to transfer MTP3 data packets up to 4096 bytes. When the SSCOP trailer is added, 4100 bytes of user data are handed to the AAL5CP layer.

These MSU sizes are much larger than the MTP3 data size currently supported by a low-speed signaling link. Currently, the largest MSU transferred on a low-speed signaling link is 279 bytes (2 flag bytes, 3 level 2 header bytes, 2 FCS bytes, and 272 bytes of MTP3 data). A large MSU is any MSU that contains 273 to 4096 bytes of MTP data.

The ATM high-speed signaling link (ANSI or E1) does not support large MSUs. Either UIM 1172 or 1173 is generated when a large MSU is received. See the [UIMs](#) section for more information on these UIMs.

Unsolicited Messages

There are two types of unsolicited messages that are generated, alarm messages (UAMs) and information messages (UIMs).

Link Unavailability UAMs

The signaling link UAM format includes a **CLASS** output. This identifies the corresponding link as either an **MTP2** or **SAAL** link class (the **SAAL** link class is used for high-speed signaling links).

Example:

```
0044.0200    SLK 1201,A sp1          RCVRY-LKF: link available
              SLC=01    FECLLI=A1234567890          CLASS=SAAL

0044.0200    SLK 1202,A sp2          RCVRY-LKF: link available
              SLC=01    FECLLI=A1234567890          CLASS=MTP2
```

[Table C-3](#) provides a summary of high-speed signaling link and low-speed signaling link unavailable reasons listed from highest priority to lowest.

[Table C-7](#) shows the UAMs that correspond link failures on an high-speed signaling link. All signaling link alarms have a severity level of major, except for UAM 200, which shows that the link failure has been cleared. All alarms are output to the **Link Maintenance** output group.

Table C-7 Signaling Link Unsolicited Alarm Messages

Link Failure	UAM Number	UAM Text
Recovery: Link Available	0200	RCVRY-LKF: link available
Failure: Remote NE Loopback	0201	REPT-LKF: remote NE loopback
Failure: Hardware Problems	0202	REPT-LKF: HWP - too many link interrupts
Failure: Failed Remote FE Loopback	0202	REPT-LKF: remote FE loopback
Failure: MTP3 Changeover Order (COO) Message Received	0218	REPT-LKF: COO - rcvd changeover order
Management Inhibit: Remote	0234	REPT-LKF: RMI remote inhibited
Management Inhibit: Local	0235	REPT-LINK-MGTINH: local inhibited
Failure: Unresolved - Default failure reason	0236	REPT-LKF: not aligned
Failure: False Congestion Restart	0236	REPT-LKF: false congestion restart
Failure: MTP Link Restart Delayed	0236	REPT-LKF: MTP link restart delayed
Excessive Duration of Far End Receiving Congestion	0237	REPT-LKF: LM Timer NO-CREDIT expired

Table C-7 (Cont.) Signaling Link Unsolicited Alarm Messages

Link Failure	UAM Number	UAM Text
Excessive Delay of Acknowledgment	0238	REPT-LKF: XDA - Timer NO-RESPONSE expired
Local Processor Outage(management initiated)	0239	REPT-LKF: MBL - local processor outage
SSCF Remote Release: Remote Processor Outage	0240	REPT-LKF: rcvd SSCOP END-proc. outage
SSCF Remote Release: Out of Service	0241	REPT-LKF: rcvd SSCOP END-out of service
SSCF Remote Release: Protocol Error	0242	REPT-LKF: rcvd SSCOP END-protocol error
SSCF Remote Release: Management Initiated	0243	REPT-LKF: rcvd SSCOP END-mgmt initiated
Facility Outage - DS1 Loss of Signal failure	0244	REPT-LKF: FAC - DS1 LOS failure
Facility Outage - DS1 Loss of Frame failure	0245	REPT-LKF: FAC - DS1 LOF failure
Facility Outage - DS1 Loss of Cell Delineation failure	0246	REPT-LKF: FAC - DS1 LCD failure
Excessive In Service Error Rate	0247	REPT-LKF: XER - ISERM threshold exceeded

UIMs

There are two types **UIMs** generated with **ATM** high-speed signaling links, **UIMs** for large **MSUs** and **UIMs** for the loopback tests. **UIMs** 1172 and 1173 are generated for **MTP MSUs** (1172) and **SCCP MSUs** (1173).

The large **MSUs** are discarded at the receiving **ATM** high-speed signaling link rather than the outbound link.

UIM 1172 Example

```
0018.1172   CARD 1103   INFO REPT-OVSZMSG: MTP MSU too large to route.
            LEN=279  SIO=03  DPC=001-001-001  OPC=002-002-002
            LSN=A1234567
            Report Date: 97-10-30  Time: 16:27:19
```

UIM 1173 Example

```
0018.1173   CARD 1103   INFO REPT-OVSZMSG: SCCP MSU too large to route.
            LEN=279  SIO=03  DPC=001-001-001  OPC=002-002-002  MSG TYPE=09
            CDPA:  AI=8B  PC=003-003-003  SSN=005  TT=250  ADDR=1234567890
            CGPA:  AI=8B  PC=004-004-004  SSN=006  TT=251  ADDR=0123456789
```

LSN=A1234567

Report Date: 97-10-30 Time: 16:27:19

The UIMs shown in [Table C-8](#) are generated when loopback tests performed on the ATM high-speed signaling link are completed.

Table C-8 Loopback Test UIMs

UIM #	Severity	Message Text	UIM is Generated When ...
1156	None	Loopback success	loopback test passes.
1157	None	Loopback failed	loopback test failed.
1158	None	Loopback aborted	request to activate link is received while running a loopback.
1159	None	Loopback in progress	loopback request received while the same loopback test is already in progress.
1170	None	Loopback prevented	loopback setup was not performed because the specified type of loopback requires a BOC to be transmitted and this function was prevented from transmitting a BOC .
1171	None	Loopback invalid	loopback setup was not performed because invalid parameters were provided.

ATM High-Speed Signaling Link Configuration

An ATM high-speed signaling link is configured using these commands:

- `ent-card` - Used to add the either the **ANSIATM** or **E1ATMLIMs**
- `ent-slk` - Used to add the signaling link
- `chg-atm-lps` - Used to change the **ATM** signaling link parameters. The **ATM** signaling link parameters control the behavior of the **ATM** high-speed signaling links. These parameters are not configured with the `ent-slk` command and are assigned default values when the **ATM** high-speed signaling link is added to the database.

To configure an **ATM** high-speed signaling link, perform these procedures:

- [Adding an ATM High-Speed LIM](#)

- [Adding an ATM High-Speed Signaling Link](#)
- [Changing an ATM High-Speed Signaling Link Parameter Set](#)

Procedures for configuring the linksets and routes, and for removing **SS7** signaling links (which includes **ATM** high-speed signaling links), are contained in [SS7 Configuration](#). The procedure for removing the **LIM** containing the **ATM** high-speed signaling link is contained in the *Database Administration Manual - System Management*. These procedures contain no information that is specific to **ATM** high-speed signaling links, therefore, are not included in this appendix.

The procedures contained in this appendix use a variety of commands. If more information on these commands is needed, go to the *Commands Manual* to find the required information.

Adding an ATM High-Speed LIM

This procedure is used to add an ATM high-speed LIM to the database using the `ent-card` command.

The `ent-card` command uses these parameters.

`:loc` – The location of the card being added to the database.

`:type` – The type of card being added to the database.

`:appl` – The application software that is assigned to the card.

`:force` – If the global title translation feature is on, the `force=yes` parameter allows the **LIM** to be added to the database even if the current **SCCP** transactions-per-second threshold is unable to support the additional **SCCP** transaction-per-second capacity created by adding the **LIM**. This parameter is obsolete and is no longer used.

Note: As of Release 46.6, E5-ATM refers to the E5-ATM-B (P/N 870-2972-xx) card.

[Table C-9](#) shows the valid card type (`type`) and card application (`appl`) combinations for the **ATM** high-speed **LIMs** being added to the database and the names and part numbers of the hardware. This can be used to verify that the **ATM** high-speed **LIM** being added to the database matches the card physically installed in the **EAGLE**. See the [Determining the Number of High-Speed and Low-Speed Signaling Links](#) section for information on the maximum number of **ATM** high-speed **LIMs** that can be configured in the database.

Table C-9 ATM High-Speed LIM Card Type and Card Application Combinations

Card Name	Part Number	Card Type (:type)	Application Type (:appl)
E5-ATM-B	870-2972-01	limatm	atmansi
		lime1tam	atmitu

The shelf to which the card is to be added, must already be in the database. This can be verified with the `rtrv-shlf` command. If the shelf is not in the database, go to the Adding a Shelf procedure in the *Database Administration - System Management User's Guide* and add the shelf.

The examples in this procedure are used to add the cards shown in [Table C-10](#) to the database.

Table C-10 Example Card Configuration

Card Type	Application	Card Location
limatm (E5-ATM)	atmansi	2207
lime1atm (E5-ATM)	atmitu	2205

Note: If an E5-ATM is being added as the ATM high-speed LIM, verify the temperature alarm threshold settings for the E5-ATM card by performing the [Changing the High-Capacity Card Temperature Alarm Thresholds](#) procedure.

1. Display the cards in the database using the `rtrv-card` command.

This is an example of the possible output.

```
rlghncxa03w 09-05-28 09:12:36 GMT EAGLE5 41.0.0
CARD  TYPE      APPL      LSET NAME  LINK SLC LSET NAME  LINK SLC
1102  TSM          GLS
1113  GSPM        OAM
1114  TDM-A
1115  GSPM        OAM
1116  TDM-B
1117  MDAL
1201  LIMDS0      SS7ANSI   sp2        A    0    sp1        B    0
1203  LIMDS0      SS7ANSI   sp3        A    0
1204  LIMDS0      SS7ANSI   sp3        A    1
1206  LIMDS0      SS7ANSI   nsp3       A    1    nsp4       B    1
1216  DCM         STPLAN
1301  DSM         VSCCP
1308  LIMDS0      SS7ANSI   sp6        A    1    sp7        B    0
1314  LIMDS0      SS7ANSI   sp7        A    1    sp5        B    1
1317  DCM         STPLAN
```

The cards should be distributed throughout the **EAGLE** for proper power distribution. Refer to *Installation Guide* for the shelf power distribution.

2. Using [Table C-9](#) as a reference, verify that the card has been physically installed into the proper location.
 - If an E5-ATM card is not being provisioned in this procedure, continue the procedure with [7](#).
 - If an E5-ATM card is being provisioned in this procedure, continue the procedure with the next step.
3. Verify that HIPR2 cards are installed at card locations 9 and 10 in the shelf where the E5-ATM card will be installed. Enter this command..

```
rept-stat-gpl:gpl=hipr2
```

This is an example of the possible output.

```
rlghncxa03w 09-07-05 08:12:53 GMT 41.1.0
```

GPL	CARD	RUNNING	APPROVED	TRIAL
HIPR2	1109	126-002-000	126-002-000	126-003-000
HIPR2	1110	126-002-000	126-002-000	126-003-000
HIPR2	1209	126-002-000	126-002-000	126-003-000
HIPR2	1210	126-002-000	126-002-000	126-003-000
HIPR2	1309	126-002-000	126-002-000	126-003-000
HIPR2	1310	126-002-000	126-002-000	126-003-000
HIPR2	2109	126-002-000	126-002-000	126-003-000
HIPR2	2110	126-002-000	126-002-000	126-003-000

Command Completed

If **HIPR2** cards are installed at card locations 9 and 10 in the shelf where the E5-ATM card will be installed, continue the procedure with 7.

If HIPR2 cards are not installed at card locations 9 and 10 in the shelf where the E5-ATM card will be installed, go to *Installation Guide* and install the HIPR2 cards. Once the HIPR2 cards have been installed, continue the procedure with 7.

- If the card is an EPM-B based card (E5-ATM-B), enter the `rtrv-stpopts` command to verify whether or not the MFC option is on. If the card is not an EPM-B based card, continue the procedure with 5

This is an example of the possible output.

```
r1ghncxa03w 11-10-17 16:02:05 GMT EAGLE5 44.0.0
STP OPTIONS
-----
MFC                               off
```

The `rtrv-stpopts` command output contains other fields that are not used by this procedure. To see all fields displayed by the `rtrv-stpopts` command, see the `rtrv-stpopts` command description in the *Commands User's Guide*.

If the **MFC** option is off, perform the Configuring the MFC Option procedure in *Database Administration - System Management User's Guide* to turn on the MFC option.

If the MFC option is on or the MFC Option procedure in *Database Administration - System Management User's Guide* was performed in this step, continue the procedure with 7.

- The Fan feature must be turned on. If the fan feature is off, enter the `rtrv-feat` command to verify that the Fan feature is on.

If the Fan feature is on, shown in the `rtrv-feat` output in this step, the FAN field should be set to on.

The `rtrv-feat` command output contains other fields that are not used by this procedure. To see all fields displayed by the `rtrv-feat` command, see the `rtrv-feat` command description in *Commands User's Guide*.

If the Fan feature is on, continue the procedure with 7.

If the Fan feature is off, continue the procedure with 6.

- Turn the Fan feature on by entering this command.

```
chg-feat : fan=on
```

Note: Once the Fan feature is turned on with the `chg-feat` command, it cannot be turned off.

When the `chg-feat` has successfully completed, this message appears.

```
rlghncxa03w 11-10-28 11:43:04 GMT EAGLE5 44.0.0
CHG-FEAT: MASP A - COMPLTD
```

7. Add the card using the `ent-card` command. For this example, enter these commands.

```
ent-card:loc=1318:type=limatm:appl=atmansi
ent-card:loc=2101:type=lime1atm:appl=atmitu
ent-card:loc=2207:type=limatm:appl=atmansi
ent-card:loc=2205:type=lime1atm:appl=atmitu
```

When each of these commands have successfully completed, this message should appear.

```
rlghncxa03w 06-10-12 09:12:36 GMT EAGLE5 36.0.0
ENT-CARD: MASP A - COMPLTD
```

8. Verify the changes using the `rtrv-card` command with the card location specified.

For this example, enter these commands.

```
rtrv-card:loc=1318
```

This is an example of the possible output.

```
rlghncxa03w 06-10-28 09:12:36 GMT EAGLE5 36.0.0
CARD  TYPE      APPL    LSET NAME  LINK SLC LSET NAME  LINK SLC
1318  LIMATM      ATMANSI
```

```
rtrv-card:loc=2101
```

This is an example of the possible output.

```
rlghncxa03w 06-10-28 09:12:36 GMT EAGLE5 36.0.0
CARD  TYPE      APPL    LSET NAME  LINK SLC LSET NAME  LINK SLC
2101  LIME1ATM    ATMITU
```

```
rtrv-card:loc=2207
```

This is an example of the possible output.

```
rlghncxa03w 06-10-28 09:12:36 GMT EAGLE5 36.0.0
CARD  TYPE      APPL    LSET NAME  LINK SLC LSET NAME  LINK SLC
2207  LIMATM      ATMANSI
```

```
rtrv-card:loc=2205
```

This is an example of the possible output.

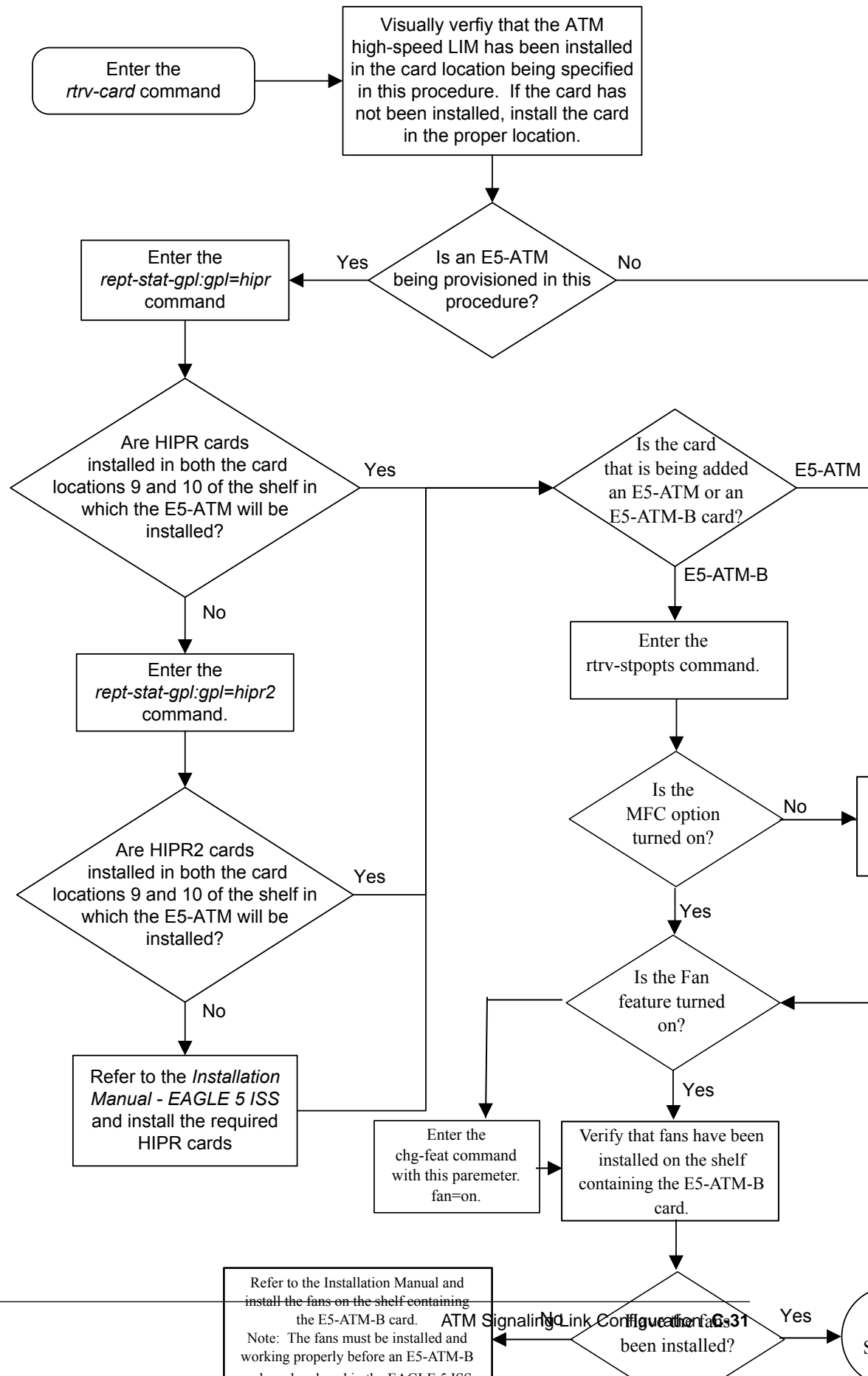
```
rlghncxa03w 06-10-28 09:12:36 GMT EAGLE5 36.0.0
CARD   TYPE      APPL      LSET NAME  LINK SLC LSET NAME  LINK SLC
2205   LIME1ATM  ATMITU
```

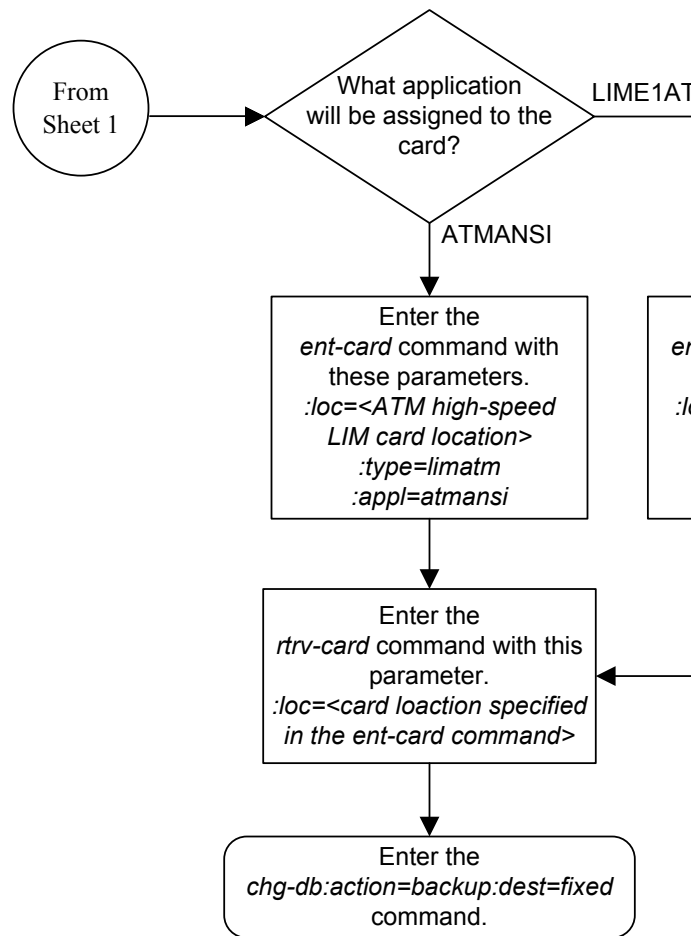
9. Back up the new changes using the `chg-db:action=backup:dest=fixed` command.

These messages should appear, the active **Maintenance and Administration Subsystem Processor (MASP)** appears first.

```
BACKUP (FIXED) : MASP A - Backup starts on active MASP.
BACKUP (FIXED) : MASP A - Backup on active MASP to fixed disk complete.
BACKUP (FIXED) : MASP A - Backup starts on standby MASP.
BACKUP (FIXED) : MASP A - Backup on standby MASP to fixed disk complete.
```

Figure C-11 Adding an ATM High-Speed LIM





Changing the Three Links per E5-ATM-B Card Quantity

This procedure is used to increase the number of E5-ATM-Bs that can contain three signaling links. There is maximum of 250 E5-ATM-Bs that can contain three signaling links. The EAGLE contains a maximum of 250 card slots for signaling links.

Note: As of Release 46.6, E5-ATM refers to the E5-ATM-B (P/N 870-2972-xx) card.

The `enable-ctrl-feat` command enables the Three Links per E5-ATM Card quantity, in groups of 5 E5-ATMs, by specifying the part number for the 3 Links per E5-ATM Card quantity and the Three Links per E5-ATM Card quantity's feature access key with these parameters:

: fak – The feature access key supplied by Oracle. The feature access key contains 13 alphanumeric characters and is not case sensitive. If you do not have the feature access key for the Three Links per E5-ATM Card quantity you wish to enable, contact your Oracle Sales Representative or Account Representative.

: partnum – The Oracle-issued part number for the Three Links per E5-ATM Card quantity shown in [Table C-11](#).

Table C-11 3 Links per E5-ATM-B Card Quantities and Part Numbers

Part Number	3 Links per E5-ATM Card Quantity	Part Number	3 Links per E5-ATM Card Quantity
893039101	5	893039126	130
893039102	10	893039127	135
893039103	15	893039128	140
893039104	20	893039129	145
893039105	25	893039130	150
893039106	30	893039131	155
893039107	35	893039132	160
893039108	40	893039133	165
893039109	45	893039134	170
893039110	50	893039135	175
893039111	55	893039136	180
893039112	60	893039137	185
893039113	65	893039138	190
893039114	70	893039139	195
893039115	75	893039140	200
893039116	80	893039141	205

Table C-11 (Cont.) 3 Links per E5-ATM-B Card Quantities and Part Numbers

Part Number	3 Links per E5-ATM Card Quantity	Part Number	3 Links per E5-ATM Card Quantity
893039117	85	893039142	210
893039118	90	893039143	215
893039119	95	893039144	220
893039120	100	893039145	225
893039121	105	893039146	230
893039122	110	893039147	235
893039123	115	893039148	240
893039124	120	893039149	245
893039125	125	893039150	250

The `enable-ctrl-feat` command requires a valid serial number for the EAGLE to be configured in the database, and that this serial number is locked. This can be verified with the `rtrv-serial-num` command. The EAGLE is shipped with a serial number in the database, but the serial number is not locked. The serial number can be changed, if necessary, and locked once the EAGLE is on-site, by using the `ent-serial-num` command. The `ent-serial-num` command uses these parameters.

`:serial` – The serial number assigned to the EAGLE. The serial number is not case sensitive.

`:lock` – Specifies whether or not the serial number is locked. This parameter has only one value, `yes`, which locks the serial number. Once the serial number is locked, it cannot be changed.

Note: To enter and lock the EAGLE's serial number, the `ent-serial-num` command must be entered twice, once to add the correct serial number to the database with the `serial` parameter, then again with the `serial` and the `lock=yes` parameters to lock the serial number. You should verify that the serial number in the database is correct before locking the serial number. The serial number can be found on a label affixed to the control shelf (shelf 1100).

Once the proxy point code quantity is enabled with the `enable-ctrl-feat` command, the proxy point code is also turned on. The `chg-ctrl-feat` command is not necessary to turn on the proxy point code quantity.

A 3 Links per E5-ATM quantity cannot be enabled for the first time if there are any ATM high-speed signaling links in the database whose VCI value is greater than 16383. These signaling links must be removed by performing the [Removing an SS7 Signaling Link](#) procedure. These signaling links can be added back to the database by performing the [Adding an ATM High-Speed Signaling Link](#) procedure. The VCI value for these signaling links must be 16383 or less. If a 3 Links per E5-ATM quantity is being increased from a currently enabled 3 Links per E5-ATM quantity, then there are no ATM high-speed signaling links in the database whose VCI value is greater than 16383.

1. Display the features that are enabled by entering the `rtrv-ctrl-feat` command.

The following is an example of the possible output.

```
rlghncxa03w 10-12-28 21:15:37 GMT EAGLE5 43.0.0
The following features have been permanently enabled:
```

Feature Name	Partnum	Status	Quantity
Command Class Management	893005801	on	----
LNP Short Message Service	893006601	on	----
Intermed GTT Load Sharing	893006901	on	----
XGTT Table Expansion	893006101	on	4000000
XMAP Table Expansion	893007710	on	3000
Large System # Links	893005901	on	1500
Routesets	893006401	on	6000
HC-MIM SLK Capacity	893012707	on	64
3 Links per E5-ATM Card	893039105	on	25

The following features have been temporarily enabled:

Feature Name	Partnum	Status	Quantity	Trial Period Left
Zero entries found.				

The following features have expired temporary keys:

Feature Name	Partnum
Zero entries found.	

If a 3 Links per E5-ATM Card quantity is enabled, the entry 3 Links per E5-ATM Card is shown in the `rtrv-ctrl-feat` output.

If a 3 Links per E5-ATM Card quantity is shown in the `rtrv-ctrl-feat` output and that quantity is 250, the new quantity cannot be enabled. This is the maximum number of E5-ATMs that can contain 3 signaling links.

If a 3 Links per E5-ATM Card quantity is shown in the `rtrv-ctrl-feat` output and that quantity is less than 250, continue the procedure with [Oracle](#).

If a 3 Links per E5-ATM Card quantity is not shown in the `rtrv-ctrl-feat` output, continue the procedure with [2](#).

If the `rtrv-ctrl-feat` output in [1](#) shows any controlled features, continue the procedure with [6](#). If the `rtrv-ctrl-feat` output shows only the HC-MIM SLK Capacity feature with a quantity of 64, [2](#) through [5](#) must be performed.

2. Display the serial number in the database with the `rtrv-serial-num` command.

This is an example of the possible output.

```
rlghncxa03w 10-12-28 21:15:37 GMT EAGLE5 43.0.0
System serial number = <EAGLE serial number>
```

```
System serial number is not locked.
```

Note: If the serial number is correct and locked, continue the procedure with 6. If the serial number is correct but not locked, continue the procedure with 5. If the serial number is not correct, but is locked, a 3 Links per E5-ATM quantity cannot be enabled and the remainder of this procedure cannot be performed. Contact the Customer Care Center to get an incorrect and locked serial number changed. Refer to [My Oracle Support \(MOS\)](#) for the contact information. The serial number can be found on a label affixed to the control shelf (shelf 1100).

3. Enter the correct serial number into the database using the `ent-serial-num` command with the `serial` parameter.

For this example, enter this command.

```
ent-serial-num:serial=<EAGLE's correct serial number>
```

When this command has successfully completed, the following message should appear.

```
rlghncxa03w 10-12-28 21:15:37 GMT EAGLE5 43.0.0
ENT-SERIAL-NUM: MASP A - COMPLTD
```

4. Verify that the serial number entered in 3 was entered correctly using the `rtrv-serial-num` command.

This is an example of the possible output.

```
rlghncxa03w 10-12-28 21:15:37 GMT EAGLE5 43.0.0
System serial number = <EAGLE correct serial number>
```

```
System serial number is not locked.
```

If the serial number was not entered correctly, repeat 3 and 4 and re-enter the correct serial number.

5. Lock the serial number in the database by entering the `ent-serial-num` command with the serial number shown in 2, if the serial number shown in 2 is correct, or with the serial number shown in 4, if the serial number was changed in 3, and with the `lock=yes` parameter.

For this example, enter this command.

```
ent-serial-num:serial=<EAGLE's serial number>:lock=yes
```

When this command has successfully completed, the following message should appear.

```
rlghncxa03w 10-12-28 21:15:37 GMT EAGLE5 43.0.0
ENT-SERIAL-NUM: MASP A - COMPLTD
```

6. Display the ATM high-speed signaling links by entering this command.

```
rtrv-slk:type=saal
```

This is an example of the possible output.

```
rlghncxa03w 10-12-19 21:16:37 GMT EAGLE5 43.0.0
```

```

LOC LINK LSN          SLC TYPE      LP          ATM
1303 A  lsnds0        1  LIMATM     1  1.544M LINE 5  0  0

LOC LINK LSN          SLC TYPE      LP          ATM          E1ATM
1306 A  lsnituatm    0  LIME1ATM  21  2.048M LINE 5  0  ON  3  0

```

SLK table is (29 of 1200) 2% full.

If no entries are displayed in the `rtrv-slk` output, continue the procedure with [Oracle](#).

If entries are displayed in the `rtrv-slk` output and the VCI value of all the signaling links is 16383 or less, continue the procedure with [Oracle](#).

If entries are displayed in the `rtrv-slk` output and the VCI value of any of the signaling links is greater than 16383, perform the [Removing an SS7 Signaling Link](#) to remove these signaling links. If you wish to add these signaling links back into the database, perform the [Adding an ATM High-Speed Signaling Link](#) procedure. The VCI value of these signaling links must be 16383 or less. After the signaling links have been removed, and added back into the database if desired, continue the procedure with [Oracle](#).

7. Enable a 3 Links per E5-ATM Card quantity with the `enable-ctrl-feat` command specifying the part number for the 3 Links per E5-ATM Card quantity and the feature access key.

The part numbers and 3 Links per E5-ATM Card quantities are shown in [Table C-11](#).

For this example, enter this command.

```
enable-ctrl-feat:partnum=893039106:fak=<3 Links per E5-ATM
Card feature access key for 30 E5-ATMs>
```

Note: A temporary feature access key cannot be specified to enable the 3 Links per E5-ATM Card quantity.

Note: The values for the feature access key (the `fak` parameter) are provided by Oracle. If you do not have the feature access key for the 3 Links per E5-ATM Card quantity you wish to enable, contact your Oracle Sales Representative or Account Representative.

When the `enable-ctrl-feat` command has successfully completed, this message should appear.

```
rlghncxa03w 10-12-28 21:15:37 GMT EAGLE5 43.0.0
ENABLE-CTRL-FEAT: MASP B - COMPLTD
```

8. Verify the changes by entering the `rtrv-ctrl-feat` command with the 3 Links per E5-ATM Card quantity part number specified in [Oracle](#).

For this example, enter this command.

```
rtrv-ctrl-feat:partnum=893039106
```

The following is an example of the possible output.

```
rlghncxa03w 10-12-28 21:15:37 GMT EAGLE5 43.0.0
```

The following features have been permanently enabled:

Feature Name	Partnum	Status	Quantity
3 Links per E5-ATM Card	893039106	on	30

The following features have been temporarily enabled:

Feature Name	Partnum	Status	Quantity	Trial Period Left
Zero entries found.				

The following features have expired temporary keys:

Feature Name	Partnum
Zero entries found.	

9. Back up the new changes, using the `chg-db:action=backup:dest=fixed` command.

These messages should appear; the active **Maintenance and Administration Subsystem Processor (MASP)** appears first.

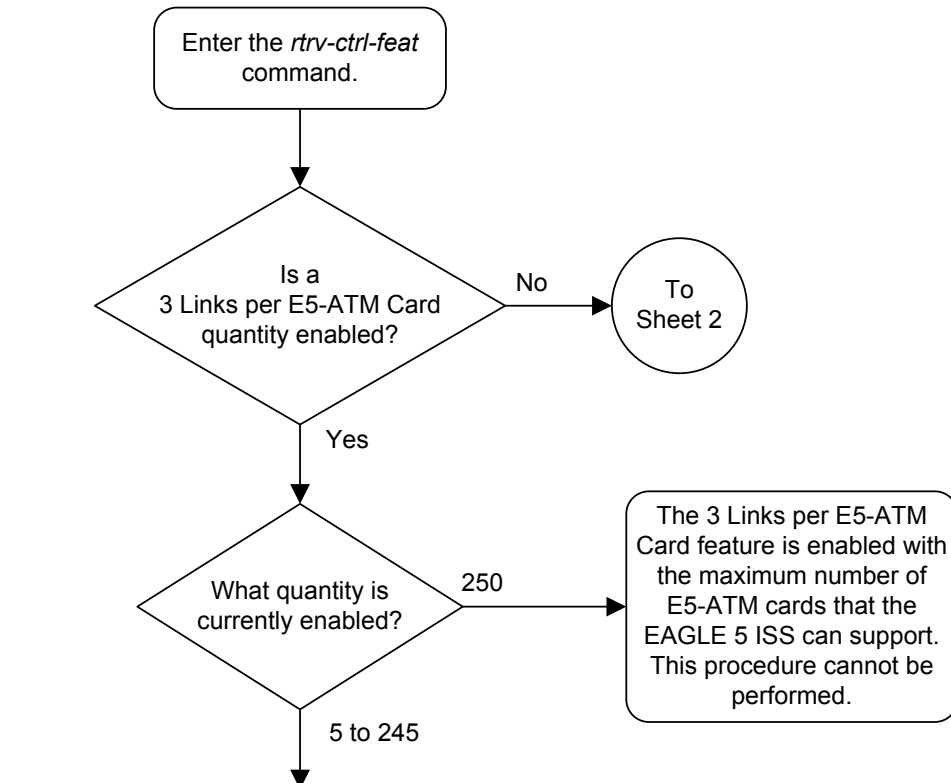
```
BACKUP (FIXED): MASP A - Backup starts on active MASP.
```

```
BACKUP (FIXED): MASP A - Backup on active MASP to fixed disk complete.
```

```
BACKUP (FIXED): MASP A - Backup starts on standby MASP.
```

```
BACKUP (FIXED): MASP A - Backup on standby MASP to fixed disk complete.
```

Figure C-12 Changing the Three Links per E5-ATM Card Quantity

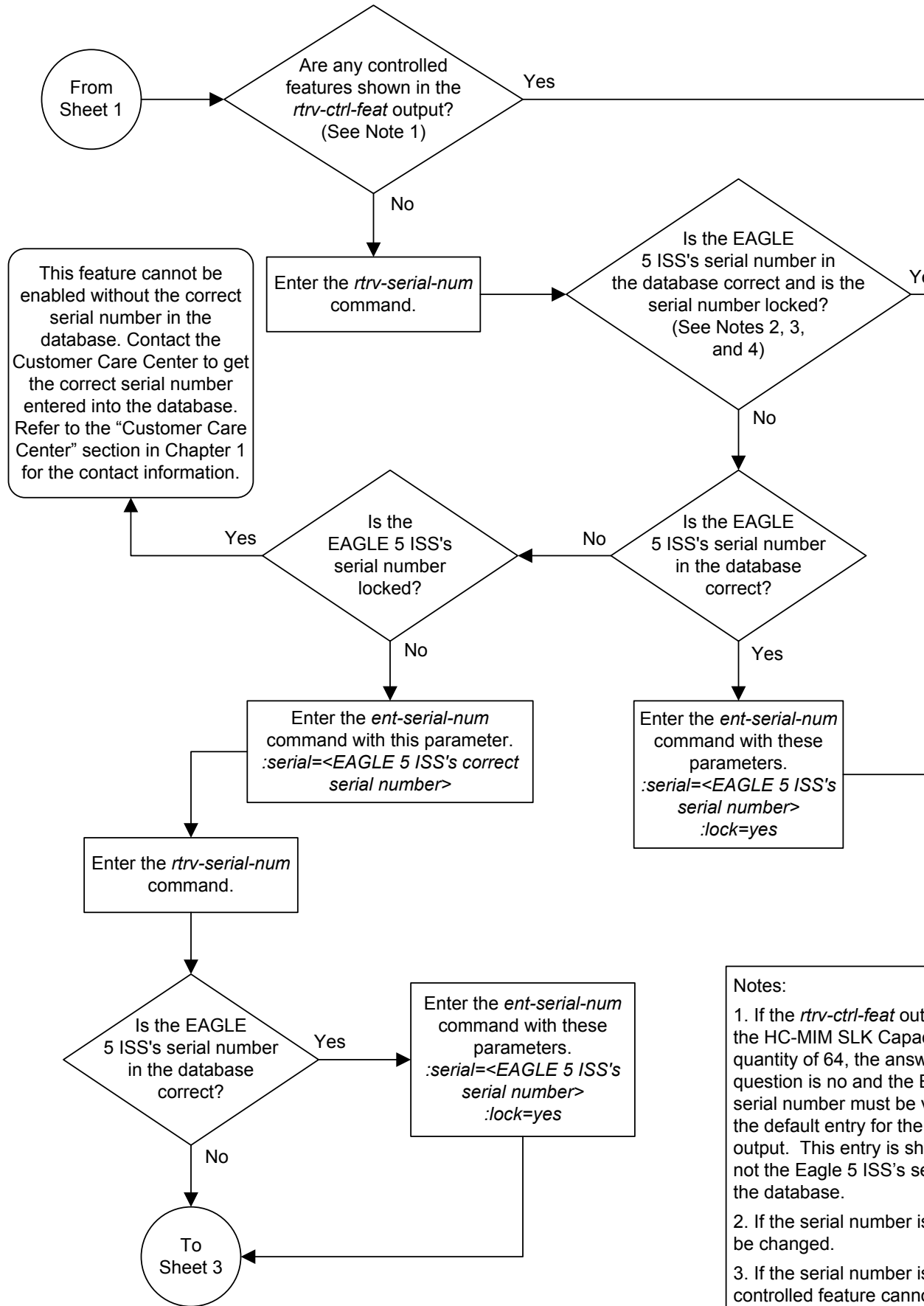


Enter the *enable-ctrl-feat* command with these parameters.
:*partnum*=<3 Links per E5-ATM Card quantity part number> (See the part number list on this sheet.)
:*fak*=<feature access key>

Notes:
1. If you do not have the feature access key for this feature, contact your Tekelec sales representative or account representative.
2. This feature can only be permanently enabled with a quantity that is greater than the current quantity.

Part Number	Number of E5-ATMs	Part Number
893039101	5	893039126
893039102	10	893039127
893039103	15	893039128
893039104	20	893039129
893039105	25	893039130
893039106	30	893039131
893039107	35	893039132
893039108	40	893039133
893039109	45	893039134
893039110	50	893039135
893039111	55	893039136
893039112	60	893039137
893039113	65	893039138
893039114	70	893039139
893039115	75	893039140
893039116	80	893039141
893039117	85	893039142
893039118	90	893039143
893039119	95	893039144
893039120	100	893039145
893039121	105	893039146
893039122	110	893039147
893039123	115	893039148
893039124	120	893039149
893039125	125	893039150

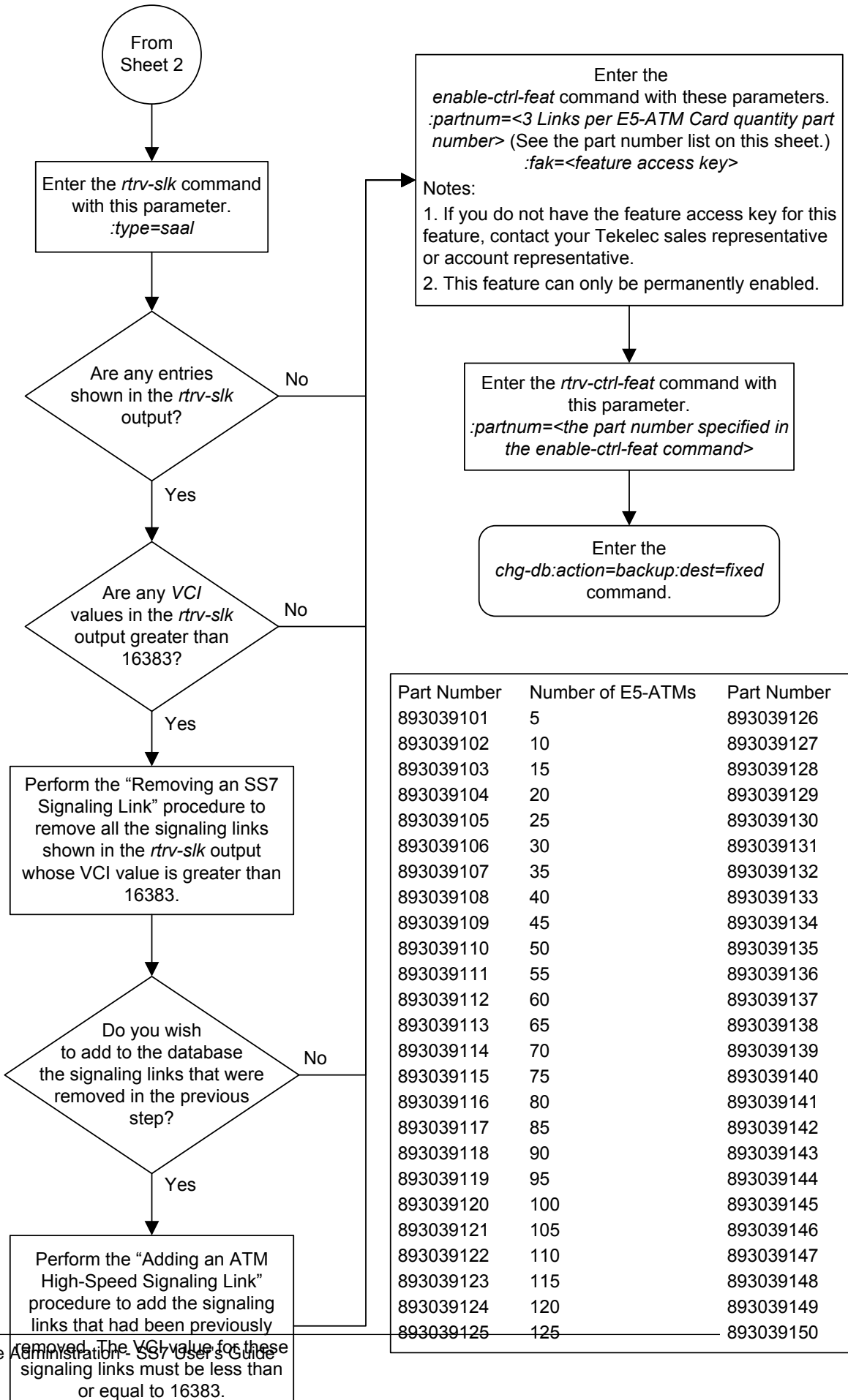
Sheet 1 of 3



Notes:

1. If the *rtrv-ctrl-feat* output shows the HC-MIM SLK Capable quantity of 64, the answer to this question is no and the EAGLE 5 ISS's serial number must be verified against the default entry for the EAGLE 5 ISS's serial number in the output. This entry is shown as "EAGLE 5 ISS's serial number" in the database.
2. If the serial number is incorrect, it must be changed.
3. If the serial number is incorrect, the controlled feature cannot be enabled.
4. The serial number cannot be changed if the label affixed to the controller is 1100).

Sheet 2 of 3



Part Number	Number of E5-ATMs	Part Number	Num
893039101	5	893039126	130
893039102	10	893039127	135
893039103	15	893039128	140
893039104	20	893039129	145
893039105	25	893039130	150
893039106	30	893039131	155
893039107	35	893039132	160
893039108	40	893039133	165
893039109	45	893039134	170
893039110	50	893039135	175
893039111	55	893039136	180
893039112	60	893039137	185
893039113	65	893039138	190
893039114	70	893039139	195
893039115	75	893039140	200
893039116	80	893039141	205
893039117	85	893039142	210
893039118	90	893039143	215
893039119	95	893039144	220
893039120	100	893039145	225
893039121	105	893039146	230
893039122	110	893039147	235
893039123	115	893039148	240
893039124	120	893039149	245
893039125	125	893039150	250

Adding an ATM High-Speed Signaling Link

This procedure is used to add an **ANSI ATM** or **E1 ATM** high-speed signaling link to the database using the `ent-slk` command. The `ent-slk` command uses these parameters.

`:loc` – The card location of the **LIM** that the **ATM** high-speed signaling link will be assigned to. The cards specified by this parameter are ATM high-speed LIMs.

`:link` – The signaling link on the card specified in the `loc` parameter.

`:lsn` – The name of the linkset that will contain the signaling link.

`:slc` – The signaling link code. The **SLC** must be unique within the linkset. It must be the same at both the EAGLE location and the distant node.

`:bps` – The transmission rate for the link in bits per second.

`:lpset` – link parameter set identifier – the ATM signaling parameter set. An ATM signaling link can be assigned to any of 30 parameter sets.

`:atmtsel` – ATM timing selector – The source of the timing for the ATM signaling link, internal, line, or external. Internal timing for an ANSI ATM signaling link is derived from an internal clock source operating at 1.544 MHz ± 50 ppm. For an E1 ATM signaling link, internal timing is derived from an internal clock source operating at 2.048 MHz ± 50 ppm. Line timing is derived from its received data stream, if present. External timing is derived from a clock source external to the EAGLE. Line timing is the default value for this parameter.

Caution: The `atmtsel=internal` parameter is only supported for lab use and not for live traffic.

Note: If the `atmtsel=external` parameter is specified with the `ent-slk` command, make sure that the correct **TDM** (P/N 870-0774-10 or later) is installed in card slots 1114 and 1116. Make sure that the external master clock source is connected to the EAGLE.

Note: To use an external high-speed master clock source other than RS-422, TDMs 870-0774-15 or later must be installed in card locations 1114 and 1116, and the TDM Global Timing Interface options must be configured. For more information, see the [Configuring the Options for the TDM Global Timing Interface](#) procedure.

`:vci` – virtual channel identifier – The identifier of the virtual channel used by the ATM signaling link for virtual channel connections.

`:vpi` – virtual path identifier – The identifier of the virtual path used by the ATM signaling link for virtual path connections.

`:l1` – The length of the cable used for the **ANSI ATM** signaling link. The value of the `l1` parameter is from 0 to 7, with each number representing a range of cable lengths, shown in [Table C-12](#). The default value for this parameter is 0.

Table C-12 ATM Signaling Link Cable Lengths

LL Parameter Value	ATMSignaling Link Cable Length
0	0 to 110 feet
1	110 to 220 feet
2	220 to 330 feet
3	330 to 440 feet
4	440 to 550 feet
5	550 to 660 feet
6	more than 660 feet
7	used for external line buildout networks

:e1atmcrc4 – Specifies whether or not **CRC4** is enabled on the E1 ATM high-speed signaling link.

:e1atmsi – Specifies the value of the two spare international bits of **NFAS** data, from 0 to 3 for the E1 ATM high-speed signaling link.

:e1atmsn – Specifies the value of the five spare national bits of **NFAS** data, from 0 to 31 for the E1 ATM high-speed signaling link.

The `ent-slk` command contains other optional parameters that can be used to configure a signaling link. These parameters are not shown here because they cannot be used to provision an ATM high-speed signaling link. These parameters are explained in more detail in the [Adding an SS7 Signaling Link](#) procedure, or in the `ent-slk` command description in the *Commands Manual*.

These items must be configured in the database before an ATM high-speed signaling link can be added:

- Shelf – see [Adding a Shelf](#) in the *Database Administration Manual - System Management*
- Card – see [Adding an ATM High-Speed LIM](#)
- Destination Point Code – see [Adding a Destination Point Code](#)
- Linkset – see [Adding an SS7 Linkset](#).

Adding the ATM high-speed signaling link cannot exceed the total provisioned system TPS shown in the `rtvr-tps` output. The amount of TPS for an ATM high-speed signaling link is shown in this list.

- ANSI ATM high-speed signaling link - 1630 TPS
- ITU ATM high-speed signaling link - 2038 TPS

If adding the ATM high-speed signaling link will exceed the maximum total provisioned system TPS, and the maximum total provisioned system TPS is 500,000, perform the "Activating the HIPR2 High Rate Mode" feature in the *Database Administration Manual - System Management* to enable and turn on the HIPR2 High

Rate Mode feature. When the HIPR2 High Rate Mode feature is enabled and turned on, the maximum total provisioned system TPS is increased to 750,000. If the maximum total provisioned system TPS is 750,000, or the maximum total provisioned system TPS is 500,000 and will not be increased, and adding the ATM high-speed signaling link will exceed the maximum total provisioned system TPS, the ATM high-speed signaling link cannot be added unless the amount of available TPS is reduced enough to allow the ATM high-speed signaling link to be added. The available TPS can be reduced by performing one or more of these actions.

- The IP TPS values of some IPGWx linksets have to be changed.
- The MAXSLKTPS values of some IPSG linksets (and the RSVDSLKTPS values if necessary) have to be changed.
- Some ATM high-speed signaling links have to be removed.
- An IPLIMx card that contains signaling links has to be removed.

Verify that the link has been physically installed (all cable connections have been made).

To configure the EAGLE to perform circular routing detection test on the signaling links, [Configuring Circular Route Detection](#) procedure.

Note: Circular route detection is not supported in ITU networks.

To provision a EAGLE with more than 1200 signaling links, the EAGLE must have certain levels of hardware installed. See the [Requirements for EAGLEs Containing more than 1200 Signaling Links](#) section for more information on these hardware requirements.

The EAGLE can contain a mixture of low-speed, E1, T1, ATM high-speed, and IP signaling links. The [Determining the Number of High-Speed and Low-Speed Signaling Links](#) section describes how to determine the quantities of the different types of signaling links the EAGLE can have.

ATM High-Speed Signaling Link Parameter Combinations

[Table C-13](#) shows the parameter combinations that can be specified for ATM high-speed signaling links with the `ent-slk` command, and the parameters and values that can be used to provision each type of ATM high-speed signaling link.

Table C-13 ATM High-Speed Signaling Link Parameter Combinations

ATM (ANSI) High-Speed Signaling Link	E1ATM High-Speed Signaling Link
Mandatory Parameters	
:loc = location of the LIM-ATMor E5-ATM with the ATMANSI application and the LIMATM card type.	:loc = location of the E1HSL card or E5-ATM with the ATMITU application and the LIME1ATM card type.
:link = A, B, A1 (See Notes 4 and 5) (See Notes 4, 5, and 6)	:link = A, B, A1 (See Notes 4 and 5) (See Notes 4, 5, and 6)
:lsn = linkset name (See Note 1)	:lsn = linkset name (See Notes 1 and 2)
:slc = 0 - 15	:slc = 0 - 15

Table C-13 (Cont.) ATM High-Speed Signaling Link Parameter Combinations

ATM (ANSI) High-Speed Signaling Link	E1ATM High-Speed Signaling Link
Optional Parameters	
:bps = 1544000 default value = 1544000	:bps = 2048000 default value = 2048000
:lpset = 1 - 30 default value = 1	:lpset = 1 - 30 default value = 1
:atmtsel = line, internal, external default value = line	:atmtsel = line, internal, external default value = line
:vci = 0 - 65535 (See Note 3)(See Notes 3 and 7) default value = 5	:vci = 0 - 65535 (See Note 3)(See Notes 3 and 7) default value = 5
:vpi = 0 - 4095 default value = 0	:vpi = 0 - 4095 default value = 0
:ll = 0 - 7 default value = 0	:e1atmcrc4 = on, off default value = off
	:e1atmsi = 0 - 3 default value = 3
	:e1atmsn = 0 - 31 default value = 0

Table C-13 (Cont.) ATM High-Speed Signaling Link Parameter Combinations

ATM (ANSI) High-Speed Signaling Link	E1ATM High-Speed Signaling Link
<p>Notes:</p> <ol style="list-style-type: none"> 1. The linkset adjacent point code (APC) type must match the card's application (ATMANSI - ANSI APC/ATMITU - ITU-I, ITU-N APC). The domain of the linkset adjacent point code must be SS7. A linkset can contain a maximum of 16 signaling links. 2. E1ATM signaling links (signaling links assigned to cards running the ATMITU application) cannot be assigned to linksets containing 24-bit ITU-N APCs (APCN24) or SAPCs (SAPCN24). 3. The values 0 - 4 and 6 - 31 cannot be specified for the <code>vci</code> parameter. These values are reserved. 4. The <code>port</code> parameter can be used in place of the <code>link</code> parameter to specify the signaling link on the card. 5. The <code>link</code> parameter value B can be used only if the ATM high-speed LIM is an E5-ATM card. 6. The <code>link</code> parameter value A1 can be used only if the ATM high-speed LIM is an E5-ATM card. A 3 Links per E5-ATM Card quantity must be enabled. 7. If a 3 Links per E5-ATM Card quantity is enabled, the <code>vci</code> value cannot be greater than 16383. 	

Canceling the `REPT-STAT-SLK` and `RTRV-SLK` Commands

Because the `rept-stat-slk` and `rtrv-slk` commands used in this procedure can output information for a long period of time, the `rept-stat-slk` and `rtrv-slk` commands can be canceled and the output to the terminal stopped. There are three ways that the `rept-stat-slk` and `rtrv-slk` commands can be canceled.

- Press the F9 function key on the keyboard at the terminal where the `rept-stat-slk` or `rtrv-slk` commands were entered.
- Enter the `canc-cmd` without the `trm` parameter at the terminal where the `rept-stat-slk` or `rtrv-slk` commands were entered.
- Enter the `canc-cmd:trm=<xx>`, where `<xx>` is the terminal where the `rept-stat-slk` or `rtrv-slk` commands were entered, from another terminal other than the terminal where the `rept-stat-slk` or `rtrv-slk` commands was entered. To enter the `canc-cmd:trm=<xx>` command, the terminal must allow Security Administration commands to be entered from it and the user must be allowed to enter Security Administration commands. The terminal's permissions can be verified with the `rtrv-secu-trm` command. The user's permissions can be verified with the `rtrv-user` or `rtrv-secu-user` commands.

For more information about the `canc-cmd` command, go to the *Commands Manual*.

1. Display the maximum number of signaling links the EAGLE can have and the number of signaling links that are currently provisioned by entering the `rtrv-tbl-capacity` command.

This is an example of the possible output.

```
rlghncxa03w 09-07-19 21:16:37 GMT EAGLE5 41.1.0
```

```
SLK      table is (          7 of          1200)  1% full
```

Note: Thertrv-tbl-capacity command output contains other fields that are not used by this procedure. If you wish to see all the fields displayed by thertrv-tbl-capacity command, refer to thertrv-tbl-capacity command description in the *Commands Manual*.

If the addition of the new signaling link will exceed the maximum number of signaling links the EAGLE can have (in this example, the maximum number of signaling links is 1200), and the maximum number of signaling links is 2800, this procedure cannot be performed. The EAGLE cannot contain more than 2800 signaling links.

If the addition of the new signaling link will exceed the maximum number of signaling links the EAGLE can have, and the maximum number of signaling links is less than 2800, perform the [Enabling the Large System # Links Controlled Feature](#) procedure to enable the desired quantity of signaling links. After the new quantity of signaling links has been enabled, continue the procedure with 3.

If the addition of the new signaling link will not exceed the maximum number of signaling links the EAGLE can have, continue the procedure with 3.

2. Display the current signaling link configuration using the rtrv-slk command.

This is an example of the possible output.

```
rlghncxa03w 10-07-19 21:16:37 GMT EAGLE5 42.0.0
```

LOC	LINK	LSN	SLC	TYPE	L2T SET	BPS	ECM	PCR N1	PCR N2
1312	A	lsnds0	0	LIMDS0	1	56000	BASIC	----	-----

LOC	LINK	LSN	SLC	TYPE	LP SET	BPS	ATM TSEL	VCI	VPI	LL
1305	A	lsnds0	1	LIMATM	1	1.544M	LINE	5	0	0

LOC	LINK	LSN	SLC	TYPE	LP SET	BPS	ATM TSEL	VCI	VPI	E1ATM CRC4	SI	SN
1306	A	lsnituatm	0	LIME1ATM	21	2.048M	LINE	5	0	ON	3	0

LOC	LINK	LSN	SLC	TYPE	ANAME	SLKTPS
1303	A	ipsglsn	0	IPSG	ipsgm2pa1	600
1303	A1	ipsglsn	1	IPSG	ipsgm2pa2	600
1303	B1	ipsglsn	2	IPSG	ipsgm2pa3	600
1303	A2	ipsglsn	3	IPSG	ipsgm2pa4	600
1303	A3	ipsglsn	4	IPSG	ipsgm2pa5	600
1303	B3	ipsglsn2	0	IPSG	ipsgm2pa6	1000
1307	A	ipsglsn	5	IPSG	m2pa2	600

LOC	LINK	LSN	SLC	TYPE	IPLIML2
1301	A	lsniplim	0	IPLIM	M2PA
1301	A1	lsniplim	1	IPLIM	M2PA
1301	B1	lsniplim	2	IPLIM	M2PA

LOC	LINK	LSN	SLC	TYPE
1201	A	ipgwx2	2	SS7IPGW
1202	A	ipgwx2	3	SS7IPGW
1203	A	ipgwx2	4	SS7IPGW
1204	A	ipgwx2	5	SS7IPGW
1205	A	ipgwx2	6	SS7IPGW
1206	A	ipgwx2	7	SS7IPGW
1101	A	ipgwx1	0	SS7IPGW
1102	A	ipgwx1	1	SS7IPGW
1103	A	ipgwx1	2	SS7IPGW
1104	A	ipgwx1	3	SS7IPGW
1105	A	ipgwx1	4	SS7IPGW
1106	A	ipgwx1	5	SS7IPGW
1107	A	ipgwx1	6	SS7IPGW
1108	A	ipgwx1	7	SS7IPGW
1111	A	ipgwx2	0	SS7IPGW
1112	A	ipgwx2	1	SS7IPGW

SLK table is (29 of 1200) 2% full.

If the addition of the new signaling link will exceed the maximum number of signaling links the EAGLE can have (in this example, the maximum number of signaling links is 1200), and the maximum number of signaling links is 2800, this procedure cannot be performed. The EAGLE cannot contain more than 2800 signaling links.

If the addition of the new signaling link will exceed the maximum number of signaling links the EAGLE can have, and the maximum number of signaling links is less than 2800, perform the [Enabling the Large System # Links Controlled Feature](#) procedure to enable the desired quantity of signaling links. After the new quantity of signaling links has been enabled, continue the procedure with 3.

If the addition of the new signaling link will not exceed the maximum number of signaling links the EAGLE can have, continue the procedure with 3.

3. Display the total provisioned system TPS by entering the `rtrv-tps` command. This is an example of the possible output.

```
rlghncxa03w 10-07-10 16:20:46 GMT EAGLE 42.0.0
```

CARD TYPE	NUM CARDS	NUM LINKS	RSVD TPS	MAX TPS
IPGW	17	16	48000	80000
IPSG	3	7	4200	8000
IPLIM	2	4	8000	8000
ATM	2	2	3668	3668

Total provisioned System TPS (99668 of 500000) 20%

Command Completed.

An ANSI ATM high-speed signaling link uses 1630 TPS. An ITU ATM high-speed signaling link uses 2038 TPS. If adding the ATM high-speed signaling link will not exceed the maximum total provisioned system TPS, continue the procedure with 98.

If adding the ATM high-speed signaling link will exceed the maximum total provisioned system TPS, and the maximum total provisioned system TPS is 500,000, perform the "Activating the HIPR2 High Rate Mode" feature in the

Database Administration Manual - System Management to enable and turn on the HIPR2 High Rate Mode feature. When the HIPR2 High Rate Mode feature is enabled and turned on, the maximum total provisioned system TPS is increased to 750,000. After the HIPR2 High Rate Mode feature has been enabled and turned on, continue the procedure with [98](#).

If the maximum total provisioned system TPS is 750,000, or the maximum total provisioned system TPS is 500,000 and will not be increased, and adding the ATM high-speed signaling link will exceed the maximum total provisioned system TPS, the ATM high-speed signaling link cannot be added unless the amount of available TPS is reduced enough to allow the ATM high-speed signaling link to be added. The available TPS can be increased by performing one or more of these actions.

- The IP TPS values of some IPGWx linksets have to be changed. To perform this action, continue the procedure with [6](#).
- The MAXSLKTPS values of some IPSG linksets (and the RSVDSLKTPS values if necessary) have to be changed. To perform this action, continue the procedure with [6](#).
- Some ATM high-speed signaling links have to be removed. To perform this action, continue the procedure with [4](#).
- An IPLIMx card that contains signaling links has to be removed. To perform this action, continue the procedure with [5](#).

Note: If none of these actions are performed, the ATM high-speed signaling link cannot be added and the remainder of this procedure cannot be performed.

4. Display the ATM high-speed signaling links by entering this command.

```
rtrv-slk:type=saal
```

This is an example of the possible output.

```
rlghncxa03w 10-07-19 21:16:37 GMT EAGLE5 42.0.0
```

LOC	LINK	LSN	SLC	TYPE	LP	ATM	VCI	VPI	LL
1303	A	lsnds0	1	LIMATM	1	1.544M	LINE	5	0

LOC	LINK	LSN	SLC	TYPE	LP	ATM	VCI	VPI	CRC4	SI	SN
1306	A	lsnituatm	0	LIME1ATM	21	2.048M	LINE	5	0	ON	3 0

SLK table is (29 of 1200) 2% full.

If ATM high-speed signaling links are shown in the `rtrv-slk` output, perform the [Removing an SS7 Signaling Link](#) procedure to remove some of the ATM high-speed signaling links.

If ATM high-speed signaling links are not displayed in the `rtrv-slk` output, perform one or more of these actions to increase the available TPS.

Note: If one or more of these actions are not performed to increase the available TPS and the available TPS will not allow the ATM high-speed signaling link to be added, the ATM high-speed signaling link cannot be added and the remainder of this procedure cannot be performed.

- The IP TPS values of some IPGWx linksets have to be changed. To perform this action, continue the procedure with 6.
- The MAXSLKTPS values of some IPSP linksets (and the RSVDSLKTPS values if necessary) have to be changed. To perform this action, continue the procedure with 6.
- Some ATM high-speed signaling links have to be removed. To perform this action, continue the procedure with 4.
- An IPLIMx card that contains signaling links has to be removed. To perform this action, continue the procedure with 5.

If you do not wish to perform other actions to increase the available TPS and the available TPS will allow the ATM high-speed signaling link to be added, continue the procedure with 98.

5. Display the signaling links that are assigned to IPLIMx cards by entering this command.

```
rtrv-slk:type=iplim
```

This is an example of the possible output.

```
rlghncxa03w 10-07-19 21:16:37 GMT EAGLE5 42.0.0
```

LOC	LINK	LSN	SLC	TYPE	ANAME	SLKTPS
1301	A	lsniplim	0	IPLIM	M2PA	
1301	A1	lsniplim	1	IPLIM	M2PA	
1301	B1	lsniplim	2	IPLIM	M2PA	

```
SLK table is (29 of 1200) 2% full.
```

If IPLIMx cards containing signaling links are shown in the `rtrv-slk` output, perform the "Removing an IPLIMx Card" procedure in the *Database Administration Manual - IP7 Secure Gateway* to remove an IPLIMx card and its associated signaling links.

If IPLIMx cards containing signaling links are not displayed in the `rtrv-slk` output, perform one or more of these actions to increase the available TPS.

Note: If one or more of these actions are not performed to increase the available TPS and the available TPS will not allow the ATM high-speed signaling link to be added, the ATM high-speed signaling link cannot be added and the remainder of this procedure cannot be performed.

- The IP TPS values of some IPGWx linksets have to be changed. To perform this action, continue the procedure with 6.

- The MAXSLKTPS values of some IPSG linksets (and the RSVDSLKTPS values if necessary) have to be changed. To perform this action, continue the procedure with 6.
- Some ATM high-speed signaling links have to be removed. To perform this action, continue the procedure with 4.

If you do not wish to perform other actions to increase the available TPS and the available TPS will allow the ATM high-speed signaling link to be added, continue the procedure with 98.

6. Display the IPGWx and IPSG linksets by entering this command.

```
rept-stat-iptps
```

This is an example of the possible output.

```
rlghncxa03w 10-07-19 21:16:37 GMT EAGLE5 42.0.0
IP TPS USAGE REPORT
```

	THRESH	CONFIG/ RSVD	CONFIG/ MAX		TPS	PEAK	PEAKTIMESTAMP

LSN							
ipgwx1	100%	----	32000	TX:	3700	4000	10-07-19 09:49:19
				RCV:	3650	4000	10-07-19 09:49:19
ipgwx2	100%	----	16000	TX:	4800	5000	10-07-19 09:49:09
				RCV:	4850	5000	10-07-19 09:49:09
ipgwx3	100%	----	32000	TX:	427	550	10-07-19 09:49:19
				RCV:	312	450	10-07-19 09:49:19
ipsglsn	100%	600	24000	TX:	4800	5000	10-07-19 09:49:19
				RCV:	4800	5000	10-07-19 09:49:19
ipsglsn2	100%	600	4000	TX:	427	550	10-07-19 09:49:19
				RCV:	312	450	10-07-19 09:49:19

Command Completed.

If linksets are displayed in the `rept-stat-iptps` output, continue the procedure with 7.

If linksets are not displayed in the `rept-stat-iptps` output, perform one or more of these actions to increase the available TPS.

Note: If one or more of these actions are not performed to increase the available TPS and the available TPS will not allow the ATM high-speed signaling link to be added, the ATM high-speed signaling link cannot be added and the remainder of this procedure cannot be performed.

- An IPLIMx card that contains signaling links has to be removed. To perform this action, continue the procedure with 5.
- Some ATM high-speed signaling links have to be removed. To perform this action, continue the procedure with 4.

If you do not wish to perform other actions to increase the available TPS and the available TPS will allow the ATM high-speed signaling link to be added, continue the procedure with 98.

7. Display the attributes of the linksets shown in 6 by entering the `rtrv-ls` command with the name of the linkset shown in 6.

For this example enter these commands.

```
rtrv-ls:lsn=ipgwx1
```

This is an example of the possible output.

```
rlghncxa03w 10-07-19 21:16:37 GMT EAGLE5 42.0.0
```

```

                                L3T SLT                GWS GWS GWS
LSN          APCA  (SS7)  SCR N SET SET BEI LST LNKS ACT MES DIS SLSCI NIS
ipgwx1       001-001-002  none 1  1  no  A  8   off off off no   off

                                SPCA          CLLI          TFATCABMLQ MTPRSE ASL8
                                -----
                                4              ---      no

RANDSLS
off

IPSG  IPGWAPC  GTTMODE          CGGTMOD
no    yes      CdPA              no

MATELSN  IPTPS  LSUSEALM  SLKUSEALM
-----  32000  100%      80%

LOC  LINK  SLC  TYPE
1101 A    0   SS7IPGW
1102 A    1   SS7IPGW
1103 A    2   SS7IPGW
1104 A    3   SS7IPGW
1105 A    4   SS7IPGW
1106 A    5   SS7IPGW
1107 A    6   SS7IPGW
1108 A    7   SS7IPGW

```

Link set table is (8 of 1024) 1% full.

```
rtrv-ls:lsn=ipgwx2
```

This is an example of the possible output.

```
rlghncxa03w 10-07-19 21:16:37 GMT EAGLE5 42.0.0
```

```

                                L3T SLT                GWS GWS GWS
LSN          APCA  (SS7)  SCR N SET SET BEI LST LNKS ACT MES DIS SLSCI NIS
ipgwx2       001-001-003  none 1  1  no  A  8   off off off no   off

                                SPCA          CLLI          TFATCABMLQ MTPRSE ASL8
                                -----
                                4              ---      no

RANDSLS
off

IPSG  IPGWAPC  GTTMODE          CGGTMOD
no    yes      CdPA              no

MATELSN  IPTPS  LSUSEALM  SLKUSEALM
-----  16000  100%      80%

```

```

LOC LINK SLC TYPE
1111 A 0 SS7IPGW
1112 A 1 SS7IPGW
1201 A 2 SS7IPGW
1202 A 3 SS7IPGW
1203 A 4 SS7IPGW
1204 A 5 SS7IPGW
1205 A 6 SS7IPGW
1206 A 7 SS7IPGW

```

Link set table is (8 of 1024) 1% full.

rtrv-ls:lsn=ipgwx3

This is an example of the possible output.

rlghncxa03w 10-07-19 21:16:37 GMT EAGLE5 42.0.0

```

LSN          APCA  (SS7)  L3T SLT          GWS GWS GWS
ipgwx3      001-001-004  none 1 1  no  A  0  off off off no  off

          SPCA          CLLI          TFATCABMLQ MTPRSE ASL8
-----
          1          ---  no

RANDSLS
off

IPSG  IPGWAPC  GTTMODE          CGGTMOD
no    yes     CdPA          no

MATELSN  IPTPS  LSUSEALM  SLKUSEALM
-----  32000  100%     80%

```

Link set table is (8 of 1024) 1% full.

rtrv-ls:lsn=ipsglsn

This is an example of the possible output.

rlghncxa03w 10-07-19 21:16:37 GMT EAGLE5 42.0.0

```

LSN          APCA  (SS7)  L3T SLT          GWS GWS GWS
ipsglsn      003-003-003  none 1 1  no  A  6  off off off no  off

          SPCA          CLLI          TFATCABMLQ MTPRSE ASL8
-----
          3          ---  no

RANDSLS
off

IPSG  IPGWAPC  GTTMODE          CGGTMOD
yes   no      CdPA          no

ADAPTER  RSVDSLKTPS  MAXSLKTPS
m2pa    600        4000

```

```

TPSALM    LSUSEALM    SLKUSEALM
rsvdslktps 100%      100%

LOC  LINK  SLC  TYPE    ANAME
1303 A    0    IPSE    ipsgm2pa1
1303 A1   1    IPSE    ipsgm2pa2
1303 B1   2    IPSE    ipsgm2pa3
1303 A2   3    IPSE    ipsgm2pa4
1303 A3   4    IPSE    ipsgm2pa5
1307 A    5    IPSE    m2pa2

```

Link set table is (8 of 1024) 1% full.

`rtrv-ls:lsn=ipsglsn2`

This is an example of the possible output.

rlghncxa03w 10-07-19 21:16:37 GMT EAGLE5 42.0.0

```

                                L3T  SLT
LSN          APCA  (SS7)  SCRN  SET  SET  BEI  LST  LNKS  ACT  MES  DIS  SLSCI  NIS
ipsglsn2    005-005-005  none  1    1    no  A    1    off  off  off  no    off

                                SPCA          CLLI          TFATCABMLQ  MTPRSE  ASL8
-----          -----          1          ---    no

RANDSLS
off

IPSE  IPGWAPC  GTTMODE          CGGTMOD
yes   no      CdPA          no

ADAPTER  RSVDSLKTPS  MAXSLKTPS
m2pa     600      4000

TPSALM    LSUSEALM    SLKUSEALM
rsvdslktps 100%      100%

LOC  LINK  SLC  TYPE    ANAME
1303 B3  0    IPSE    ipsgm2pa6

```

Link set table is (8 of 1024) 1% full.

Perform one of both of these actions as necessary.

- Perform the "Configuring an IPGWx Linkset" procedure in the *Database Administration Manual - IP7 Secure Gateway* to change the IPTPS value for any linksets shown in the `rtrv-ls` output whose IPGWAPC value is *yes*.
- Perform the "Changing an IPSE M2PA Linkset" procedure (for linkset whose IPSE value is *yes* and ADAPTER value is M2PA) or the "Changing an IPSE M3UA Linkset" procedure (for linkset whose IPSE value is *yes* and ADAPTER value is M3UA) in the *Database Administration Manual - IP7 Secure Gateway* to change the MAXSLKTPS value (and RSVDSLKTPS value if necessary) for any linksets shown in the `rtrv-ls` output.

Perform one of both of these actions to increase the available TPS if needed.

- An IPLIMx card that contains signaling links has to be removed. To perform this action, continue the procedure with 5.
- Some ATM high-speed signaling links have to be removed. To perform this action, continue the procedure with 4.

If you do not wish to perform other actions to increase the available TPS and the available TPS will allow the ATM high-speed signaling link to be added, continue the procedure with 98.

8. Display the current signaling link configuration using the `rtrv-slk` command.

This is an example of the possible output.

```

rlghncxa03w 10-07-19 21:16:37 GMT EAGLE5 42.0.0

LOC LINK LSN          SLC TYPE          L2T          PCR PCR
1312 A  lsnds0          0  LIMDS0          1  56000  BASIC  ----  -----

LOC LINK LSN          SLC TYPE          LP          ATM
1305 A  lsnds0          1  LIMATM          1  1.544M  LINE   5    0    0

LOC LINK LSN          SLC TYPE          LP          ATM          E1ATM
1306 A  lsnituatm      0  LIME1ATM        21  2.048M  LINE   5    0    ON  3  0

LOC LINK LSN          SLC TYPE          ANAME          SLKTPS
1303 A  ipsglsn          0  IPSEG          ipsgm2pa1      600
1303 A1 ipsglsn          1  IPSEG          ipsgm2pa2      600
1303 B1 ipsglsn          2  IPSEG          ipsgm2pa3      600
1303 A2 ipsglsn          3  IPSEG          ipsgm2pa4      600
1303 A3 ipsglsn          4  IPSEG          ipsgm2pa5      600
1303 B3 ipsglsn2        0  IPSEG          ipsgm2pa6     1000
1307 A  ipsglsn          5  IPSEG          m2pa2          600

LOC LINK LSN          SLC TYPE          IPLIML2
1301 A  lsniplim         0  IPLIM          M2PA
1301 A1 lsniplim         1  IPLIM          M2PA
1301 B1 lsniplim         2  IPLIM          M2PA

LOC LINK LSN          SLC TYPE
1201 A  ipgwx2          2  SS7IPGW
1202 A  ipgwx2          3  SS7IPGW
1203 A  ipgwx2          4  SS7IPGW
1204 A  ipgwx2          5  SS7IPGW
1205 A  ipgwx2          6  SS7IPGW
1206 A  ipgwx2          7  SS7IPGW
1101 A  ipgwx1          0  SS7IPGW
1102 A  ipgwx1          1  SS7IPGW
1103 A  ipgwx1          2  SS7IPGW
1104 A  ipgwx1          3  SS7IPGW
1105 A  ipgwx1          4  SS7IPGW
1106 A  ipgwx1          5  SS7IPGW
1107 A  ipgwx1          6  SS7IPGW
1108 A  ipgwx1          7  SS7IPGW
1111 A  ipgwx2          0  SS7IPGW
1112 A  ipgwx2          1  SS7IPGW

SLK table is (29 of 1200) 2% full.

```


9. Display the cards in the database using the `rtrv-card` command.

This is an example of the possible output.

```
rlghncxa03w 10-12-28 09:12:36 GMT EAGLE5 43.0.0
CARD  TYPE      APPL      LSET NAME  LINK SLC  LSET NAME  LINK SLC
1101  DCM          SS7IPGW   ipgwx1     A    0
1102  DCM          SS7IPGW   ipgwx1     A    1
1103  DCM          SS7IPGW   ipgwx1     A    2
1104  DCM          SS7IPGW   ipgwx1     A    3
1105  DCM          SS7IPGW   ipgwx1     A    4
1106  DCM          SS7IPGW   ipgwx1     A    5
1107  DCM          SS7IPGW   ipgwx1     A    6
1108  DCM          SS7IPGW   ipgwx1     A    7
1111  DCM          SS7IPGW   ipgwx2     A    0
1112  DCM          SS7IPGW   ipgwx2     A    1
1113  GPSM         OAM
1114  TDM-A
1115  GPSM         OAM
1116  TDM-B
1117  MDAL
1201  DCM          SS7IPGW   ipgwx2     A    2
1202  DCM          SS7IPGW   ipgwx2     A    3
1203  DCM          SS7IPGW   ipgwx2     A    4
1204  DCM          SS7IPGW   ipgwx2     A    5
1205  DCM          SS7IPGW   ipgwx2     A    6
1206  DCM          SS7IPGW   ipgwx2     A    7
1207  DSM          VSCCP
1208  TSM          GLS
1211  DCM          STPLAN
1301  DCM          IPLIM     lsniplim  A    0  lsniplim  A1  1
          lsniplim  B1  2
1302  LIMATM      ATMANSI
1303  ENET        IPSEG     ipsglsn   A    0  ipsglsn   A1  1
          ipsglsn   B1  2  ipsglsn   A2  3
          ipsglsn   A3  4  ipsglsn2  B3  0
1304  LIMATM      ATMANSI
1305  LIMATM      ATMANSI   lsnds0    A    1
1306  LIME1ATM    ATMITU    lsnituatm A    0
1307  ENET        IPSEG     ipsglsn   A    5
1311  DCM          IPLIM
1312  LIMDS0      SS7ANSI   lsnds0    A    0
1318  LIMATM      ATMANSI
2107  LIMATM      ATMANSI
```

If the ATM high-speed LIM is not shown in the `rtrv-card` output, perform the [Adding an ATM High-Speed LIM](#) procedure to add the ATM high-speed LIM to the database. If the link value of the new signaling link will be A1 or B, the card must be an E5-ATM. After the card has been added, perform one of these steps.

- If the link value of the new signaling link will be A or B, continue the procedure with [15](#).
- If the link value of the new signaling link will be A1, continue the procedure with [11](#).

After the [Adding an ATM High-Speed LIM](#) procedure has been performed, or if the ATM high-speed LIM is shown in the `rtrv-card` output, continue the procedure with [15](#).

If the ATM high-speed LIM is shown in the `rtrv-card` output, perform one of these steps.

- If the link value of the new signaling link will be A, continue the procedure with [15](#).
- If the link value of the new signaling link will be A1 or B, continue the procedure with [10](#).

- 10.** Display the status of the card that the new signaling link will be assigned to by entering the `rept-stat-card` command with the location of the card from [9](#). For this example, enter this command.

```
rept-stat-card:loc=2107
```

This is an example of the possible output.

```
rlghncxa03w 10-12-28 09:12:36 GMT EAGLE5 43.0.0
CARD  VERSION      TYPE      GPL      PST      SST      AST
2107  133-045-000  LIMATM   ATMHC   IS-NR    Active   -----
ALARM STATUS      = No Alarms.
IMTPCI  GPL version = 133-002-000
BLVXW6  GPL version = 133-002-000
BLDIAG6 GPL version = 133-002-000
BLBEPM  GPL version = 133-002-000
BLCPLD  GPL version = 133-002-000
IMT BUS A      = Conn
IMT BUS B      = Conn
CURRENT TEMPERATURE = 38C (101F)
PEAK TEMPERATURE:  = 38C (101F)      [07-11-23 06:10]
SIGNALING LINK STATUS
      SLK  PST      LS      CLLI
      A   IS-NR    lsnatm1  -----
Command Completed.
```

If the GPL value is ATMHC, the card is an E5-ATM. Continue the procedure by performing one of these steps.

- If the link value of the new signaling link will be B, continue the procedure with [15](#).
- If the link value of the new signaling link will be A1, continue the procedure with [11](#).

If the GPL value is ATMANSI or ATMITU, the card is not an E5-ATM. Repeat [9](#) and choose another card.

- 11.** Display the status of the EAGLE features by entering the `rtrv-ctrl-feat` command.

This is an example of the possible output.

```
rlghncxa03w 10-12-28 21:15:37 GMT EAGLE5 43.0.0
The following features have been permanently enabled:
```

Feature Name	Partnum	Status	Quantity
Command Class Management	893005801	on	----
LNP Short Message Service	893006601	on	----
Intermed GTT Load Sharing	893006901	on	----
XGTT Table Expansion	893006101	on	4000000
XMAP Table Expansion	893007710	on	3000
Large System # Links	893005901	on	1500
Routesets	893006401	on	6000
HC-MIM SLK Capacity	893012707	on	64
3 Links per E5-ATM Card	893039105	on	25

The following features have been temporarily enabled:

Feature Name	Partnum	Status	Quantity	Trial Period Left
Zero entries found.				

The following features have expired temporary keys:

Feature Name	Partnum
Zero entries found.	

To specify the link value A1 for the new signaling link, a 3 Links per E5-ATM Card quantity must be enabled. A 3 Links per E5-STM Card quantity is shown in the `rtrv-ctrl-feat` output with the entry `3 Links per E5-ATM Card`.

Perform the [Changing the Three Links per E5-ATM-B Card Quantity](#) procedure to enable a 3 Links per E5-ATM Card quantity, if a 3 Links per E5-ATM Card quantity is not enabled. After the 3 Links per E5-ATM Card quantity has been enabled, continue the procedure by performing one of these steps.

- If [10](#) was not performed, continue the procedure with [12](#).
- If [10](#) was performed, continue the procedure by performing one of these steps.
 - If the card's state is OOS-MT-DSBLD, continue the procedure with [15](#).
 - If the card's state is not OOS-MT-DSBLD, continue the procedure with [13](#). Before the card's state can be OOS-MT-DSBLD, the state of the signaling links that are assigned to the card must be OOS-MT-DSBLD.

If a 3 Links per E5-ATM Card quantity is enabled, continue the procedure by performing one of these steps.

- If adding the new signaling link will not exceed the enabled quantity, continue the procedure with [12](#).
- If adding the new signaling link will exceed the enabled quantity, continue the procedure by performing one of these steps.
 - If the enabled quantity is 250, the signaling link with the link value A1 cannot be added. The EAGLE can contain a maximum of 250 E5-ATMs that have signaling links with the link value A1. Continue the procedure by performing one of these steps.
 - If the E5-ATM contains signaling links with the link values A and B, continue the procedure with [9](#) to choose another card to add the signaling link to.

- If the E5-ATM does not contain signaling links with the LINK values A and B, continue the procedure with 15 and add the signaling link to the E5-ATM with the link value A or B (the link value on the E5-ATM that is not assigned to a signaling link).
- If the enabled quantity is less than 250, perform the [Changing the Three Links per E5-ATM-B Card Quantity](#) procedure to enable a 3 Links per E5-ATM Card quantity. After the 3 Links per E5-ATM Card quantity has been enabled, continue the procedure by performing one of these steps.
 - If 10 was not performed, continue the procedure with 12.
 - If 10 was performed, continue the procedure by performing one of these steps.
 - If the card's state is OOS-MT-DSBLD, continue the procedure with 15.
 - If the card's state is not OOS-MT-DSBLD, continue the procedure with 13. Before the card's state can be OOS-MT-DSBLD, the state of the signaling links that are assigned to the card must be OOS-MT-DSBLD.

12. Display the status of the card that the new signaling link will be assigned to by entering the `rept-stat-card` command with the location of the card from 9. For this example, enter this command.

```
rept-stat-card:loc=2107
```

This is an example of the possible output.

```
rlghncxa03w 10-12-28 09:12:36 GMT EAGLE5 43.0.0
CARD  VERSION      TYPE      GPL      PST      SST      AST
2107  133-045-000  LIMATM   ATMHC   IS-NR    Active  -----
ALARM STATUS          = No Alarms.
IMTPCI  GPL version = 133-002-000
BLVXW6  GPL version = 133-002-000
BLDIAG6 GPL version = 133-002-000
BLBEPM  GPL version = 133-002-000
BLCPLD  GPL version = 133-002-000
IMT BUS A          = Conn
IMT BUS B          = Conn
CURRENT TEMPERATURE = 38C (101F)
PEAK TEMPERATURE:  = 38C (101F)    [07-11-23 06:10]
SIGNALING LINK STATUS
  SLK  PST          LS          CLLI
  A    IS-NR       lsnatm1    -----
Command Completed.
```

If the card's state is OOS-MT-DSBLD, continue the procedure with 15.

If the card's state is not OOS-MT-DSBLD, continue the procedure with 13. Before the card's state can be OOS-MT-DSBLD, the state of the signaling links that are assigned to the card must be OOS-MT-DSBLD.

13. Deactivate the signaling links that are assigned to the card shown in 10 or 12 by entering the `dact-slk` command. For this example, enter this command.

```
dact-slk:loc=2107:link=a
```

When the command has successfully completed, this message should appear.

```
rlghncxa03w 10-12-07 08:41:12 GMT EAGLE5 43.0.0
Deactivate Link message sent to card
```

Repeat this step for each signaling link shown in [10](#) or [12](#) whose state is not OOS-MT-DSBLD.

- Place that card that was specified in [13](#) out of service by entering the `inh-card` or the `rmv-card` command. The function of the `inh-card` and the `rmv-card` commands are the same. For this example, enter this command.

```
inh-card:loc=2107
```

When this command has successfully completed, this message should appear.

```
rlghncxa03w 10-12-07 11:11:28 GMT EAGLE5 43.0.0
Card has been inhibited.
```

- Display the current linkset configuration using the `rtrv-ls` command.

This is an example of the possible output.

```
rlghncxa03w 10-12-10 11:43:04 GMT EAGLE5 43.0.0
```

LSN	APCA (SS7)	SCRN	L3T SLT			LST	LNKS	GWS GWS GWS			SLSCI	NIS
			SET	SET	BEI			ACT	MES	DIS		
ipgwx1	001-001-002	none	1	1	no	A	8	off	off	off	no	off
ipgwx2	001-001-003	none	1	1	no	A	8	off	off	off	no	off
ipgwx3	001-001-004	none	1	1	no	A	0	off	off	off	no	off
lsniplim	002-002-002	none	1	1	no	A	3	off	off	off	no	off
ipsglsn	003-003-003	none	1	1	no	A	6	off	off	off	no	off
ipsglsn2	005-005-005	none	1	1	no	A	1	off	off	off	no	off
lsnatm1	006-007-008	none	1	1	no	A	1	off	off	off	no	off
lsnds0	009-009-009	none	1	1	no	A	2	off	off	off	no	off

LSN	APCI (SS7)	SCRN	L3T SLT			LST	LNKS	GWS GWS GWS			SLSCI	NIS
			SET	SET	BEI			ACT	MES	DIS		
lsnituatm	1-002-3	none	1	2	no	A	1	off	off	off	no	off
atmitul	3-111-3	none	1	1	no	A	0	off	off	off	---	off

Link set table is (10 of 1024) 1% full.

If the desired linkset is not in the database, perform [Adding an SS7 Linkset](#) to add the linkset to the database. After the linkset has been added to the database, continue the procedure by performing one of these steps.

- If the `lpset` parameter will be specified for the signaling link, continue the procedure with [17](#).

- If the `lpset` parameter will not be specified for the signaling link, continue the procedure with 18.

If the desired linkset is in the database, continue the procedure with 16.

16. Display the linkset that the signaling link is being assigned to using the `rtrv-ls` command, specifying the name of the linkset that the signaling link is being assigned to.

For this example, enter this command.

```
rtrv-ls:lsn=atmitul
```

This is an example of the possible output.

```
rlghncxa03w 06-10-17 11:43:04 GMT EAGLE5 36.0.0

LSN          APCI  (SS7)  SCRN  L3T  SLT  BEI  LST  LNKS  GWS  GWS  GWS
atmitul      3-111-3  none   1    1    no   A    0    off  off  off  no  off

          SPCI          CLLI          TFATCABMLQ  MTPRSE  ASL8
-----
          SLSOCBIT  SLSRSB  RANDSLS  MULTGC  ITUTFR
          none     1       off      yes     off

          IPGSG  IPGWAPC  GTTMODE          CGGTMOD
          no    no       CdPA          no

          SAPCN
          1234-aa
          1235-bb
          1200-zz
```

Link set table is (9 of 1024) 1% full.

Linksets containing 24-bit ITU-N adjacent point codes (APCN24) or secondary adjacent point codes (SAPCN24) cannot be assigned to a E1ATM high-speed signaling link. Go back to 15 and choose another linkset, or perform the [Adding an SS7 Linkset](#) procedure to add the linkset to the database that does not contain either a 24-bit ITU-N APC or SAPC.

The signaling link cannot be assigned to a linkset whose IPGSG or IPGWAPC values are yes. If either the IPGSG or IPGWAPC value for the linkset is yes, repeat the procedure from 15 and choose another linkset.

If the IPGSG and IPGWAPC values for the linkset are no, continue the procedure by performing one of these steps.

- If the `lpset` parameter will be specified for the signaling link, continue the procedure with 17.
- If the `lpset` parameter will not be specified for the signaling link, continue the procedure with 18.

17. Display the existing values for the ATM link parameter set that will be assigned to the signaling link using the `rtrv-atm-lps` command specifying the link parameter set.

For this example, enter this command.

```
rtrv-atm-lps:lpset=25
```

This is an example of the possible output.

```
rlghncxa03w 06-10-28 16:02:05 GMT EAGLE5 36.0.0
ATM LINK PARAMETER SET TIMERS AND PARAMETERS (TIMERS IN SECONDS)

                                SSCOP PARAMETERS
                                TMR  TMR    TMR    TMR    TMR
LPSET  MAXCC  MAXPD  MAXSTAT  CC  KALIVE  NORSP  POLL  IDLE
25     4      500   67       0.2  0.125  1.5    0.150  0.125

                                SSCF-NNI PARAMETERS
                                TMRT1  TMRT2  TMRT3  N1
05.0   30.0   0.000925  1000

                                SAAL PARAMETERS
                                MAX  TMR  TNRNO  TMR  N  TMR
NRP  SREC  CRED  ERM  BLK  PROV
0    3600  1.5   0.125  3    0600.0

                                NONCONFIGURABLE PARAMETERS
                                SDU  UU    FC  FC
SIZE  SIZE  N  NR  BC  TSUP  TLOSS  ERMSM  THRES
272   4    9  --  --  120  1.3   0.1    0.244
```

If you wish to change the values in this ATM parameter set, perform [Changing an ATM High-Speed Signaling Link Parameter Set](#).

Caution: Changing the values in this ATM link parameter set will impact the performance of all the signaling links using this ATM parameter set.

After the [Changing an ATM High-Speed Signaling Link Parameter Set](#) procedure has been performed, or if the values in this ATM parameter set were not changed, continue the procedure with [18](#).

18. Add the signaling link to the database using the `ent-slk` command.

Use [Table C-13](#) as a guide for the parameters that can be specified with the `ent-slk` command. For this example, enter these commands.

```
ent-
slk:loc=1302:link=a:lsn=atmansio:slc=0:bps=1544000:lpset=3 :a
tmtsel=external:vci=35:vpi=15:ll=0

ent-
slk:loc=1304:link=a:lsn=atmansil:slc=0:bps=1544000:lpset=4 :a
tmtsel=internal:vci=100:vpi=20:ll=2

ent-
slk:loc=1318:link=a:lsn=atmansil:slc=1:bps=1544000:lpset=9 :a
tmtsel=line:vci=150:vpi=25:ll=4

ent-
slk:loc=2101:link=a:lsn=atmitul:slc=0:bps=2048000:lpset=25 :a
tmtsel=line:vci=150:vpi=25:elatmcr4=on:elatmsi=1:elatmsn=20
```

```

ent-
slk:loc=2105:link=a:lsn=atmitu1:slc=1:bps=2048000:lpset=25 :a
tmtsel=line:vci=35:vpi=15:elatmcrc4=on:elatmsi=2:elatmsn=15

ent-
slk:loc=2205:link=a:lsn=atmitu2:slc=0:bps=2048000:lpset=20 :a
tmtsel=external:vci=200:vpi=100:elatmcrc4=on:elatmsi=3:elatms
n=10

ent-
slk:loc=2205:link=b:lsn=atmitu2:slc=1:bps=2048000:lpset=18 :a
tmtsel=line:vci=250:vpi=200:elatmcrc4=on:elatmsi=1:elatmsn=30

ent-
slk:loc=2207:link=a:lsn=atmans2:slc=0:bps=1544000:lpset=12 :
atmtsel=external:vci=200:vpi=100:ll=4

ent-
slk:loc=2207:link=b:lsn=atmans2:slc=1:bps=1544000:lpset=14 :
atmtsel=line:vci=300:vpi=150:ll=4

ent-
slk:loc=2107:link=a1:lsn=atmans2:slc=2:bps=1544000:lpset=13
:atmtsel=line:vci=300:vpi=150:ll=4
    
```

When each of these commands have successfully completed, this message should appear.

```

rlghncxa03w 06-10-07 08:29:03 GMT EAGLE5 36.0.0
ENT-SLK: MASP A - COMPLTD
    
```

Note: If adding the new signaling link will result in more than 700 signaling links in the database and the OAMHCMEAS value in the `rtrv-measopts` output is on, the scheduled UI measurement reports will be disabled.

19. Verify the changes using the `rtrv-slk` command with the `loc` and `link` parameter values specified in 18.

For this example, enter these commands.

```
rtrv-slk:loc=1302
```

This is an example of the possible output.

```

rlghncxa03w 06-10-19 21:16:37 GMT EAGLE5 36.0.0

LOC LINK LSN          SLC TYPE      LP      ATM
          SET  BPS      TSEL      VCI   VPI   LL
1302 A   atmansi0    0  LIMATM    3   1.544M  EXTERNAL  35   15   0
    
```

```
rtrv-slk:loc=1304
```

This is an example of the possible output.

```

rlghncxa03w 10-07-19 21:16:37 GMT EAGLE5 42.0.0

LOC LINK LSN          SLC TYPE      LP      ATM
          SET  BPS      TSEL      VCI   VPI   LL
1304 A   atmansi1    0  LIMATM    4   1.544M  INTERNAL  100  20   2
    
```



```
rtrv-slk:loc=1318
```

This is an example of the possible output.

```
rlghncxa03w 06-10-19 21:16:37 GMT EAGLE5 36.0.0
                                LP          ATM
LOC LINK LSN          SLC TYPE   SET BPS    TSEL      VCI   VPI   LL
1318 A  atmansi0      1 LIMATM   9   1.544M   LINE      150   25   4
```

```
rtrv-slk:loc=2101
```

This is an example of the possible output.

```
rlghncxa03w 06-10-19 21:16:37 GMT EAGLE5 36.0.0
                                LP          ATM          ELATM
LOC LINK LSN          SLC TYPE   SET BPS    TSEL      VCI   VPI   CRC4 SI SN
2101 A  atmitu1       0 LIME1ATM 5   2.048M   LINE      150   2    ON   1  20
```

```
rtrv-slk:loc=2105
```

This is an example of the possible output.

```
rlghncxa03w 06-10-19 21:16:37 GMT EAGLE5 36.0.0
                                LP          ATM          ELATM
LOC LINK LSN          SLC TYPE   SET BPS    TSEL      VCI   VPI   CRC4 SI SN
2105 A  atmitu1       1 LIME1ATM 5   2.048M   LINE      35    15   ON   2  15
```

```
rtrv-slk:loc=2205
```

This is an example of the possible output.

```
rlghncxa03w 06-10-19 21:16:37 GMT EAGLE5 36.0.0
                                LP          ATM          ELATM
LOC LINK LSN          SLC TYPE   SET BPS    TSEL      VCI   VPI   CRC4 SI SN
2205 A  atmitu2       0 LIME1ATM 20  2.048M   EXTERNAL  200   100  ON   3  10
2205 B  atmitu2       1 LIME1ATM 18  2.048M   LINE      250   200  ON   1  30
```

```
rtrv-slk:loc=2207
```

This is an example of the possible output.

```
rlghncxa03w 06-10-19 21:16:37 GMT EAGLE5 36.0.0
                                LP          ATM
LOC LINK LSN          SLC TYPE   SET BPS    TSEL      VCI   VPI   LL
2207 A  atmansi2       0 LIMATM   12  1.544M   EXTERNAL  200   100   4
2207 B  atmansi2       1 LIMATM   14  1.544M   LINE      300   150   4
```

```
rtrv-slk:loc=2107:link=a1
```

This is an example of the possible output.

```
rlghncxa03w 10-12-19 21:16:37 GMT EAGLE5 43.0.0
                                LP          ATM
LOC LINK LSN          SLC TYPE   SET BPS    TSEL      VCI   VPI   LL
2107 A1 atmansi2       2 LIMATM   13  1.544M   LINE      300   150   4
```

If any of the cards shown in this step contain the first signaling link on a card, or if [14](#) was performed, continue the procedure with [20](#).

If signaling links were assigned to all the cards shown in this step when [18](#) was performed, or if [14](#) was not performed, continue the procedure with [21](#).

20. Bring into service the cards that contain the first signaling link on that card or that were taken out of service in [14](#) by entering either the `alw-card` or `rst-card` command with the location of the card specified in [18](#). The function of the `alw-card` and the `rst-card` commands are the same. If the signaling link added in [18](#) was the first signaling link assigned to the card, that card must be brought into service with the `rst-card` command, specifying the location of the card specified in [18](#).

For this example, enter these commands.

```
rst-card:loc=1302
rst-card:loc=1304
rst-card:loc=1318
rst-card:loc=2101
rst-card:loc=2105
rst-card:loc=2205
rst-card:loc=2207
```

When each of these commands have successfully completed, this message should appear.

```
rlghncxa03w 06-10-23 13:05:05 GMT EAGLE5 36.0.0
Card has been allowed.
```

21. Activate all signaling links on the cards using the `act-slk` command, specifying the card location and signaling link specified in [18](#).

For this example, enter these commands.

```
act-slk:loc=1302:link=a
act-slk:loc=1304:link=a
act-slk:loc=1318:link=a
act-slk:loc=2101:link=a
act-slk:loc=2105:link=a
act-slk:loc=2205:link=a
act-slk:loc=2205:link=b
act-slk:loc=2207:link=a
act-slk:loc=2207:link=b
act-slk:loc=2107:link=a1
```

When each of these commands have successfully completed, this message should appear.

```
rlghncxa03w 06-10-07 08:31:24 GMT EAGLE5 36.0.0
Activate Link message sent to card
```

- 22.** Check the status of the signaling links added in 18 using the `rept-stat-slk` command with the `loc` and `link` parameter values specified in 18.

The state of each signaling link should be in service normal (IS-NR) after the link has completed alignment (shown in the PST field). For this example, enter these commands.

```
rept-stat-slk:loc=1302:link=a
```

This is an example of the possible output.

```
rlghncxa03w 06-10-19 21:16:37 GMT EAGLE5 36.0.0
SLK      LSN      CLLI      PST      SST      AST
1302,A   atmansi0  -----  IS-NR    Avail    ----
  ALARM STATUS      = No Alarms
  UNAVAIL REASON    = --
Command Completed.
```

```
rept-stat-slk:loc=1304:link=a
```

This is an example of the possible output.

```
rlghncxa03w 06-10-19 21:16:37 GMT EAGLE5 36.0.0
SLK      LSN      CLLI      PST      SST      AST
1304,A   atmansi1  -----  IS-NR    Avail    ----
  ALARM STATUS      = No Alarms
  UNAVAIL REASON    = --
Command Completed.
```

```
rept-stat-slk:loc=1318:link=a
```

This is an example of the possible output.

```
rlghncxa03w 06-10-19 21:16:37 GMT EAGLE5 36.0.0
SLK      LSN      CLLI      PST      SST      AST
1318,A   atmansi1  -----  IS-NR    Avail    ----
  ALARM STATUS      = No Alarms
  UNAVAIL REASON    = --
Command Completed.
```

```
rept-stat-slk:loc=2101:link=a
```

This is an example of the possible output.

```
rlghncxa03w 06-10-19 21:16:37 GMT EAGLE5 36.0.0
SLK      LSN      CLLI      PST      SST      AST
2101,A   atmitul1  -----  IS-NR    Avail    ----
  ALARM STATUS      = No Alarms
  UNAVAIL REASON    = --
Command Completed.
```

```
rept-stat-slk:loc=2105:link=a
```

This is an example of the possible output.

```
rlghncxa03w 06-10-19 21:16:37 GMT EAGLE5 36.0.0
SLK      LSN      CLLI      PST      SST      AST
2105,A   atmitu1   -----  IS-NR    Avail    ----
  ALARM STATUS      = No Alarms
  UNAVAIL REASON    = --
Command Completed.
```

rept-stat-slk:loc=2205:link=a

This is an example of the possible output.

```
rlghncxa03w 06-10-19 21:16:37 GMT EAGLE5 36.0.0
SLK      LSN      CLLI      PST      SST      AST
2205,A   atmitu2   -----  IS-NR    Avail    ----
  ALARM STATUS      = No Alarms
  UNAVAIL REASON    = --
Command Completed.
```

rept-stat-slk:loc=2205:link=b

This is an example of the possible output.

```
rlghncxa03w 06-10-19 21:16:37 GMT EAGLE5 36.0.0
SLK      LSN      CLLI      PST      SST      AST
2205,B   atmitu2   -----  IS-NR    Avail    ----
  ALARM STATUS      = No Alarms
  UNAVAIL REASON    = --
Command Completed.
```

rept-stat-slk:loc=2207:link=a

This is an example of the possible output.

```
rlghncxa03w 06-10-19 21:16:37 GMT EAGLE5 36.0.0
SLK      LSN      CLLI      PST      SST      AST
2207,A   atmansi2  -----  IS-NR    Avail    ----
  ALARM STATUS      = No Alarms
  UNAVAIL REASON    = --
Command Completed.
```

rept-stat-slk:loc=2207:link=b

This is an example of the possible output.

```
rlghncxa03w 06-10-19 21:16:37 GMT EAGLE5 36.0.0
SLK      LSN      CLLI      PST      SST      AST
2207,B   atmansi2  -----  IS-NR    Avail    ----
  ALARM STATUS      = No Alarms
  UNAVAIL REASON    = --
Command Completed.
```

rept-stat-slk:loc=2107:link=a1

This is an example of the possible output.

```
rlghncxa03w 10-12-19 21:16:37 GMT EAGLE5 43.0.0
SLK      LSN      CLLI      PST      SST      AST
2107,A1  atmansi2  -----  IS-NR    Avail    ----
```

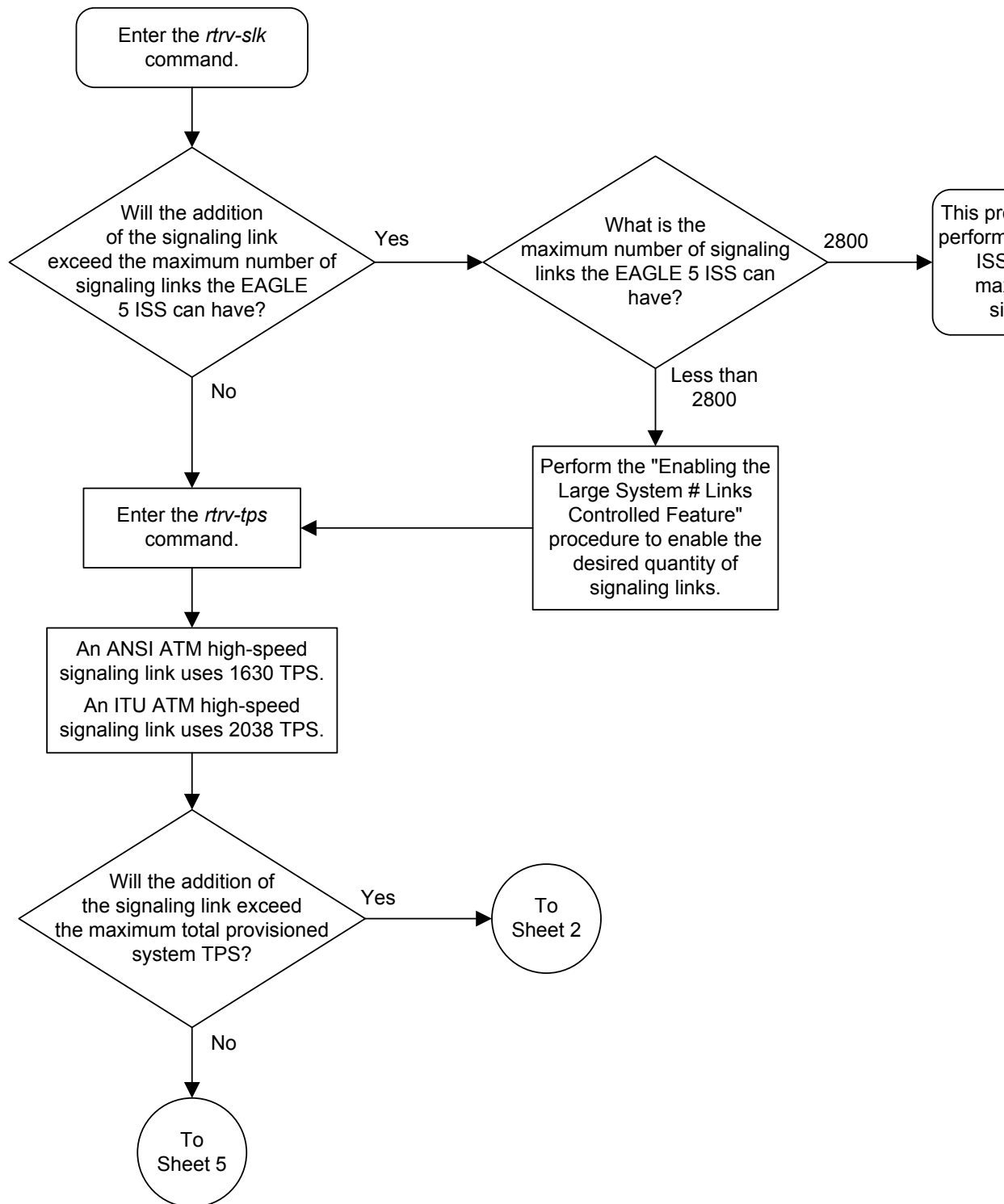
```
ALARM STATUS      = No Alarms
UNAVAIL REASON    = --
Command Completed.
```

- 23.** Back up the new changes using the `chg-db:action=backup:dest=fixed` command.

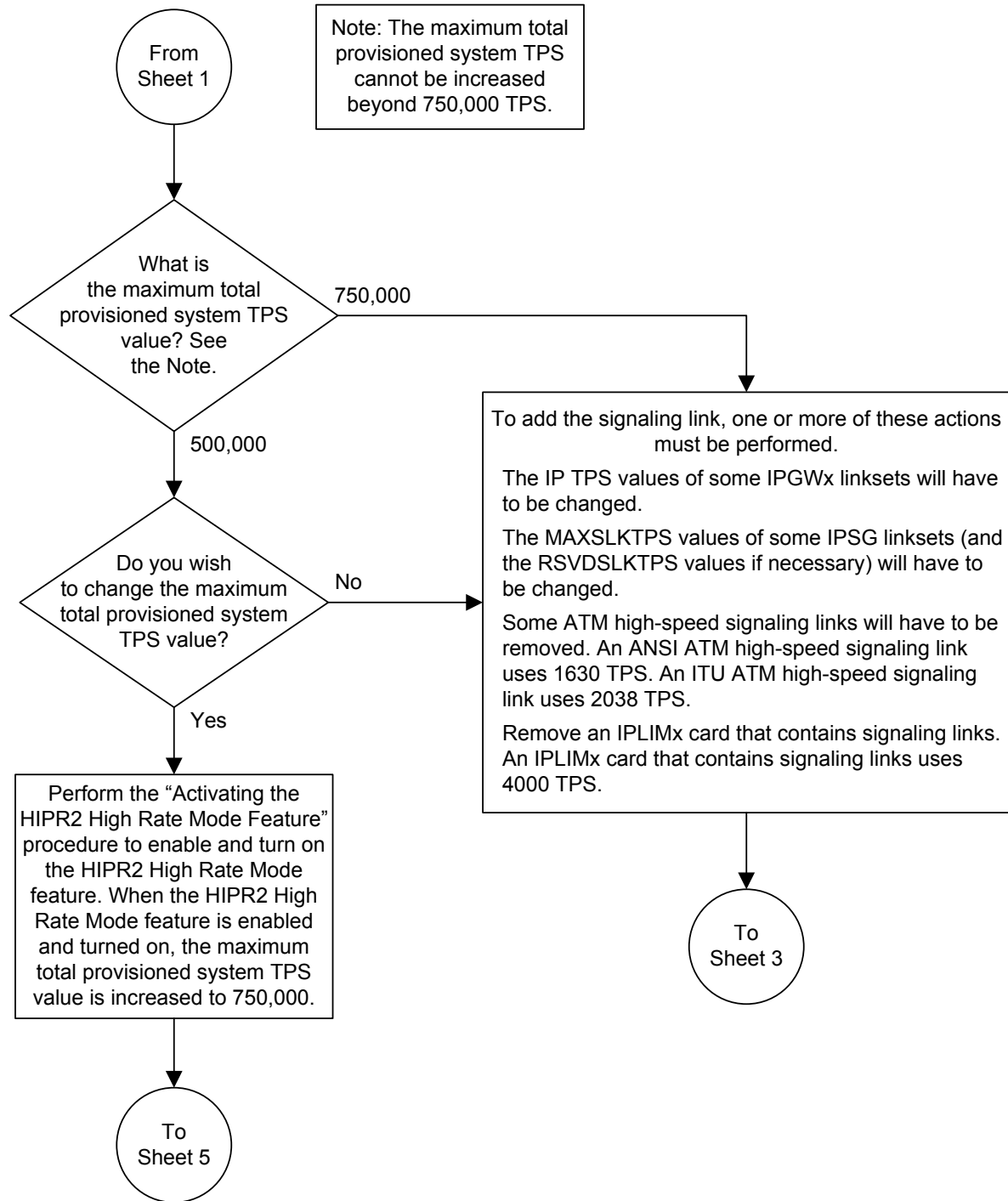
These messages should appear, the active **Maintenance and Administration Subsystem Processor (MASP)** appears first.

```
BACKUP (FIXED) : MASP A - Backup starts on active MASP.
BACKUP (FIXED) : MASP A - Backup on active MASP to fixed disk complete.
BACKUP (FIXED) : MASP A - Backup starts on standby MASP.
BACKUP (FIXED) : MASP A - Backup on standby MASP to fixed disk complete.
```

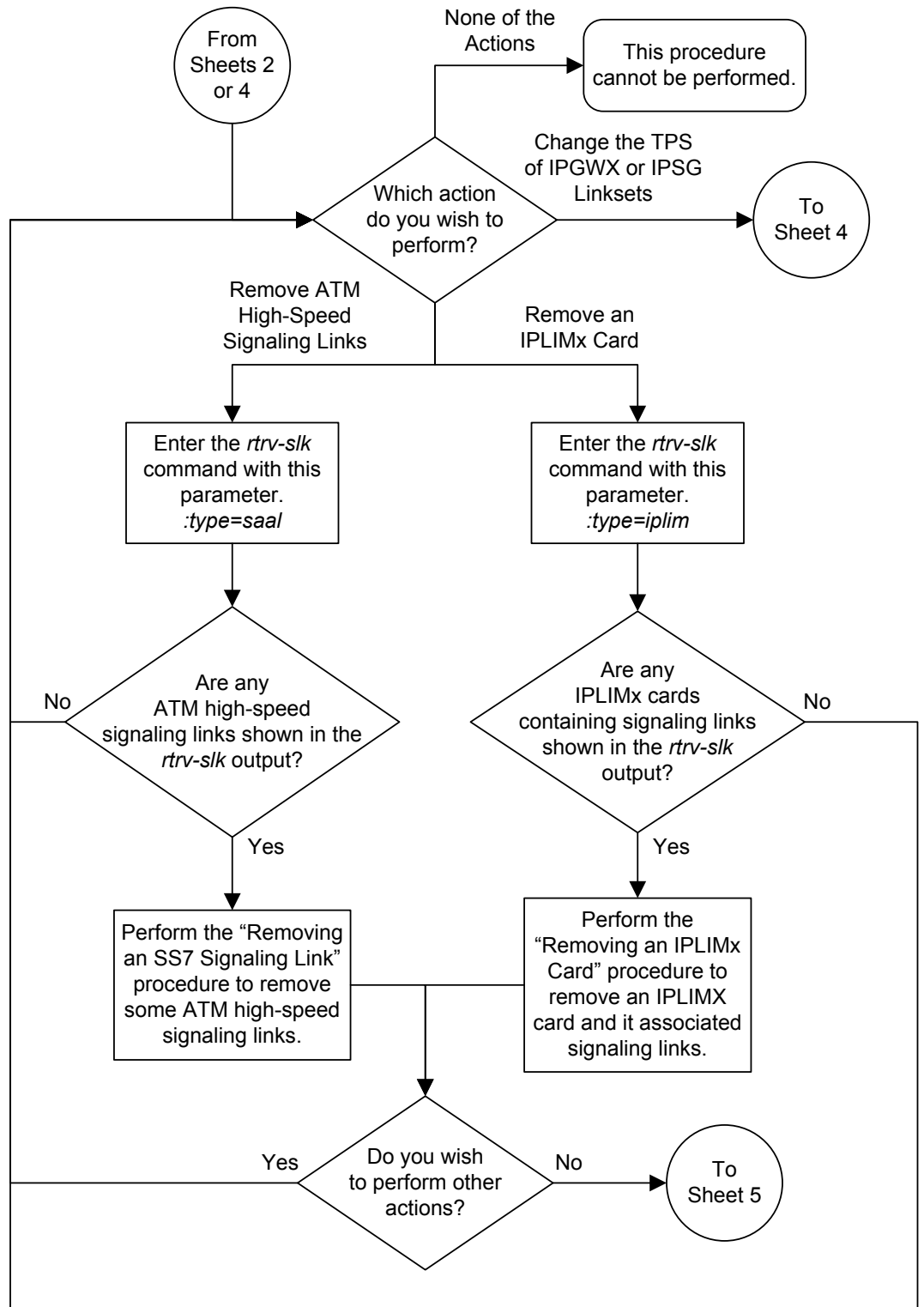
Figure C-13 Adding an ATM High-Speed Signaling Link



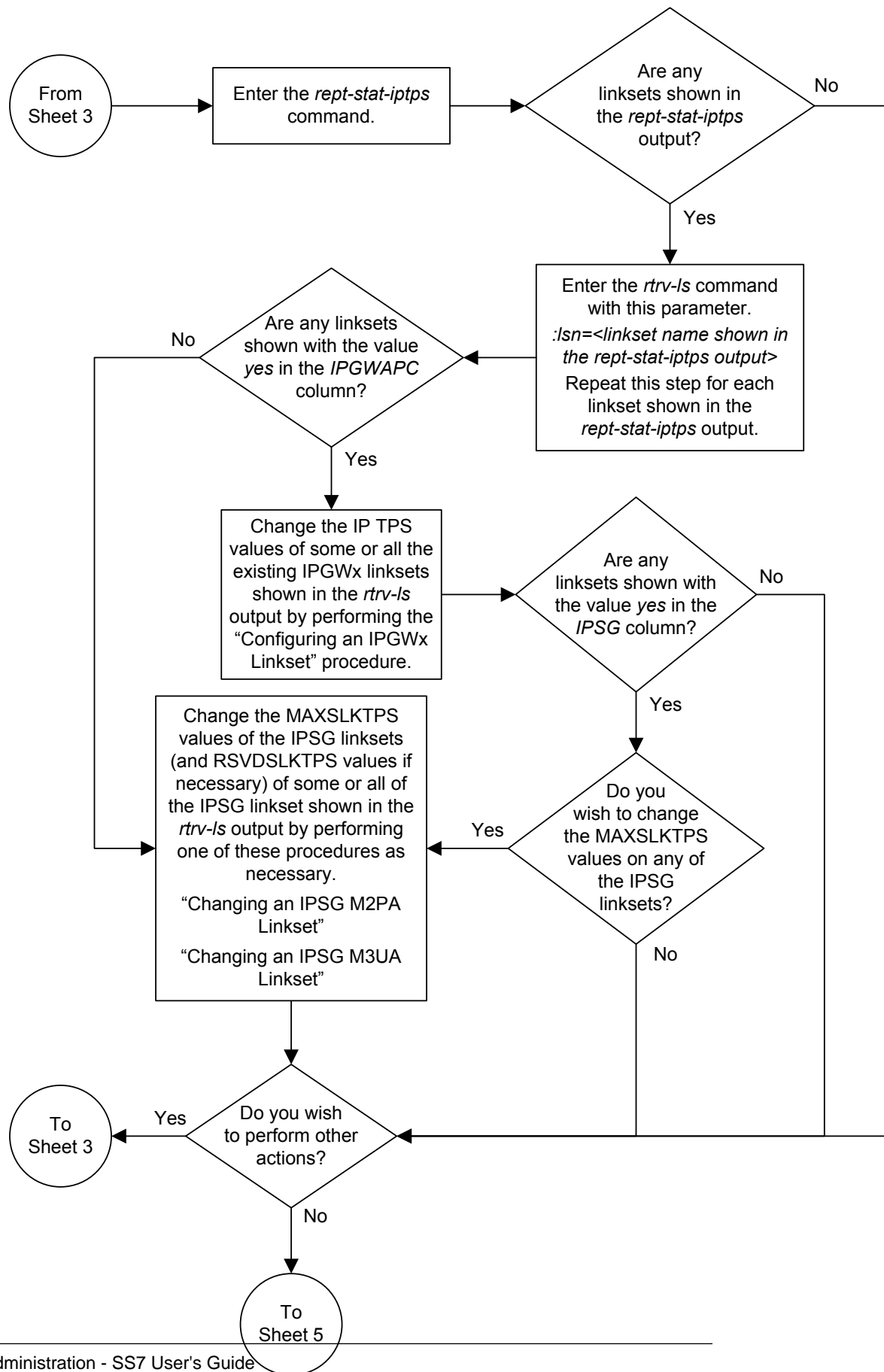
Sheet 1 of 10



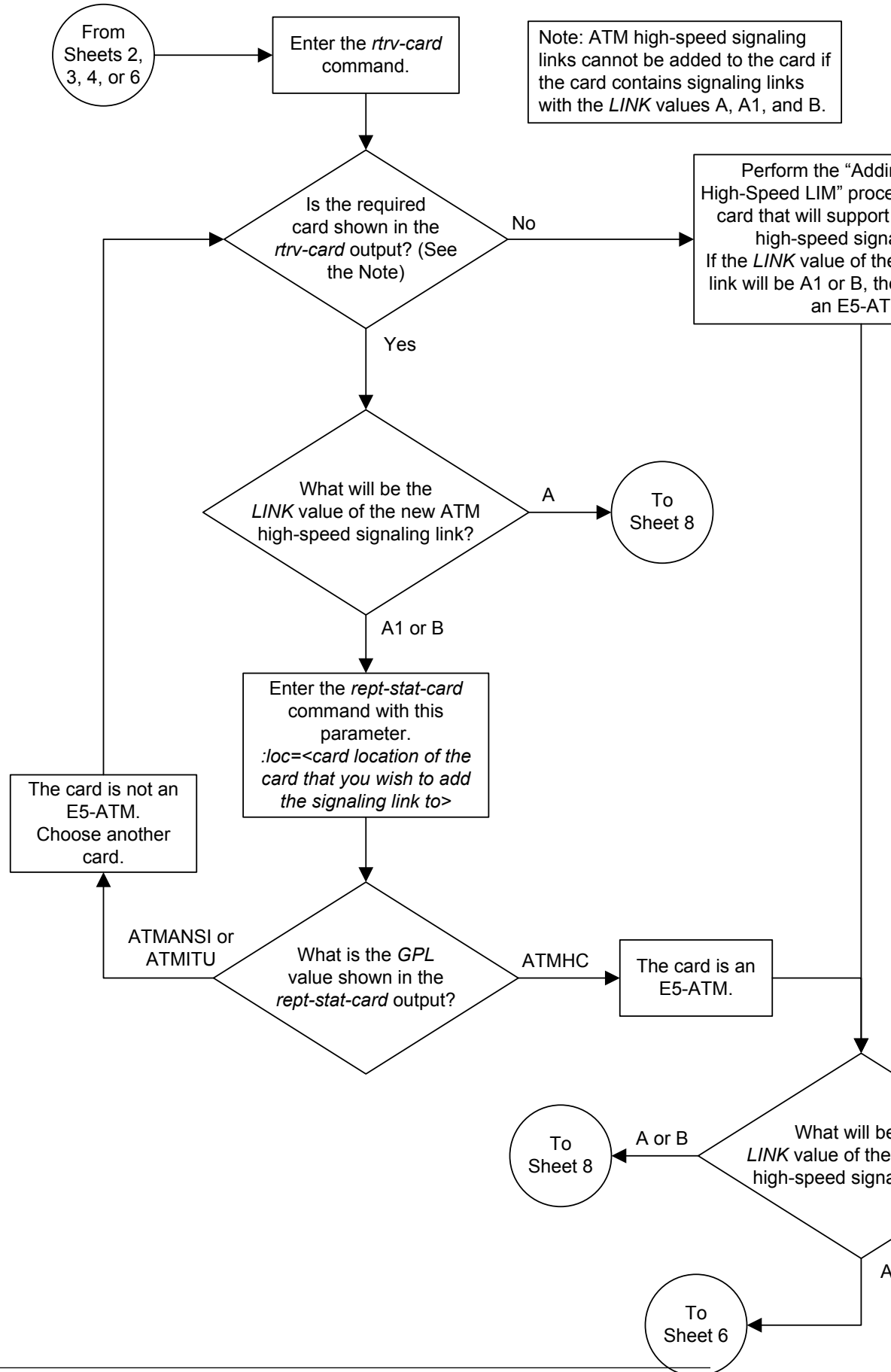
Sheet 2 of 10



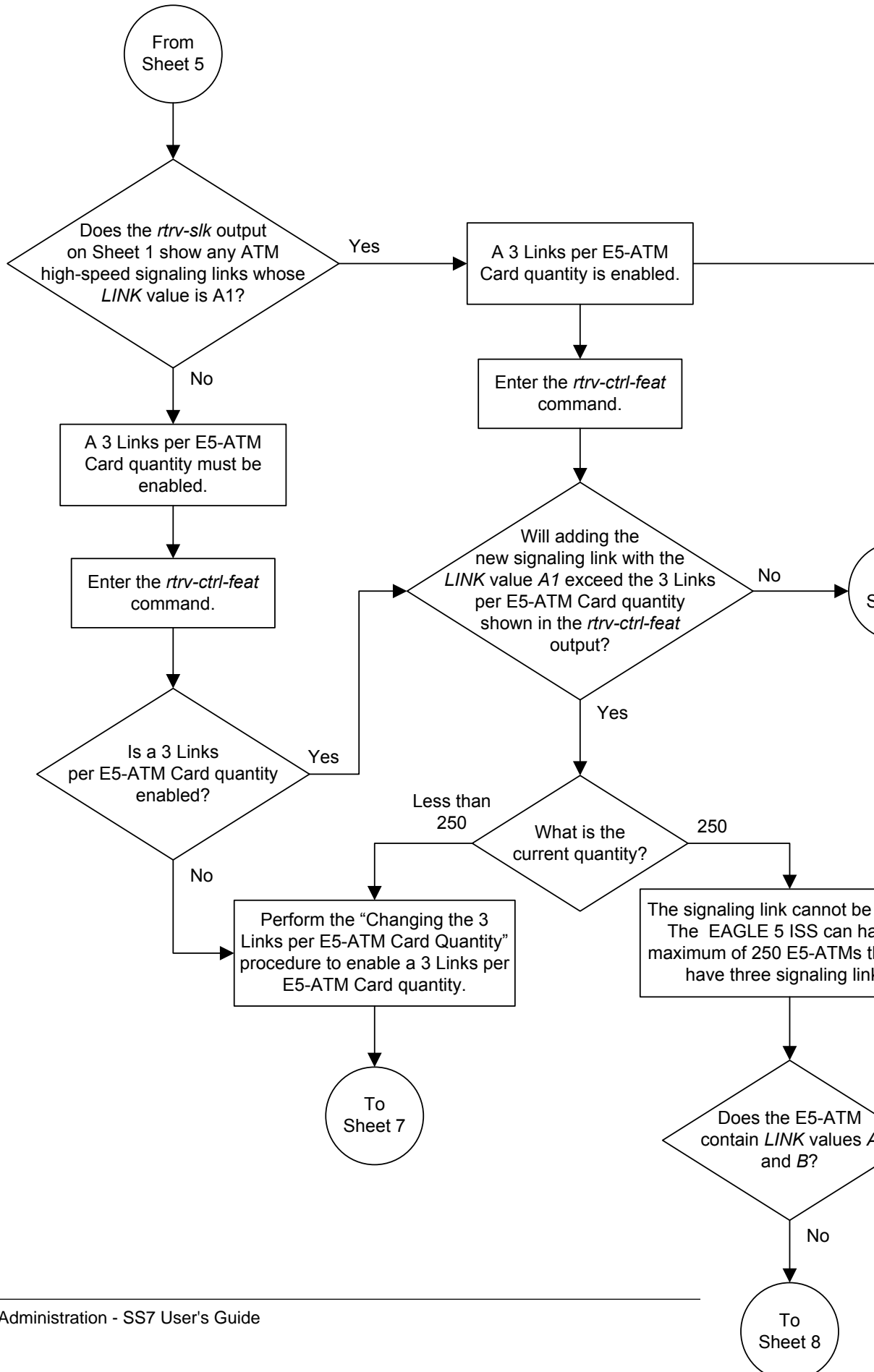
Sheet 3 of 10



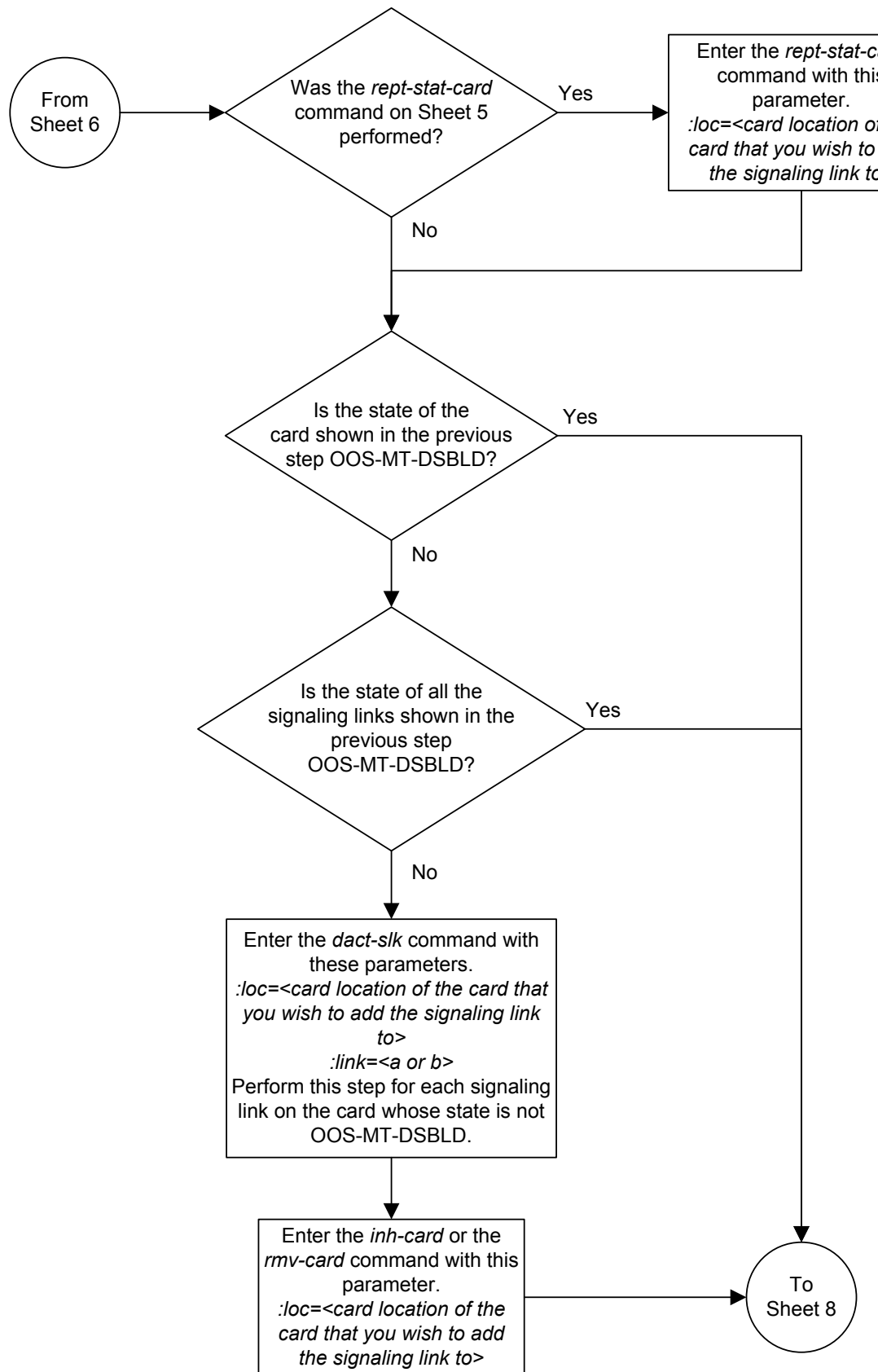
Sheet 4 of 10



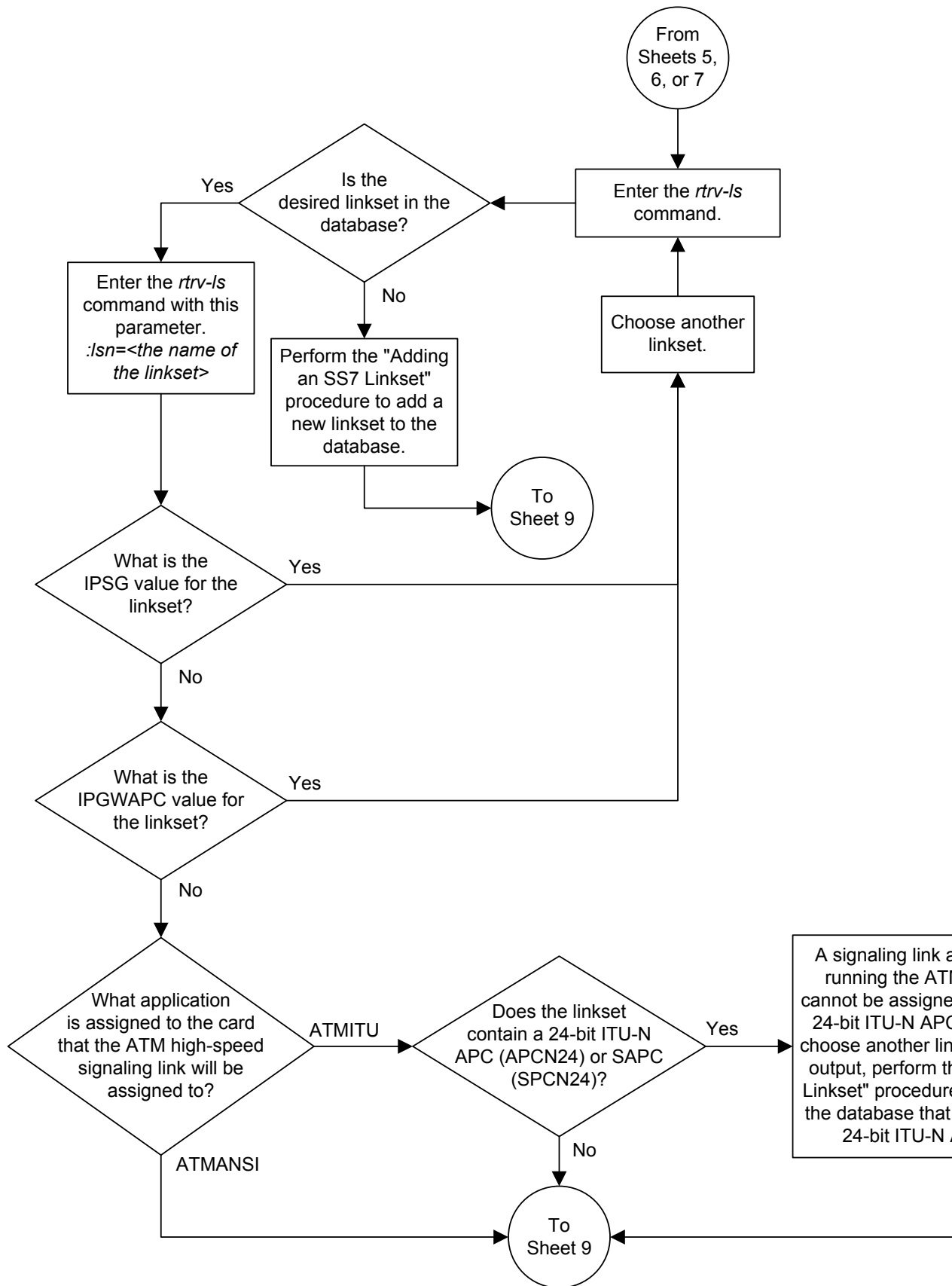
Sheet 5 of 10



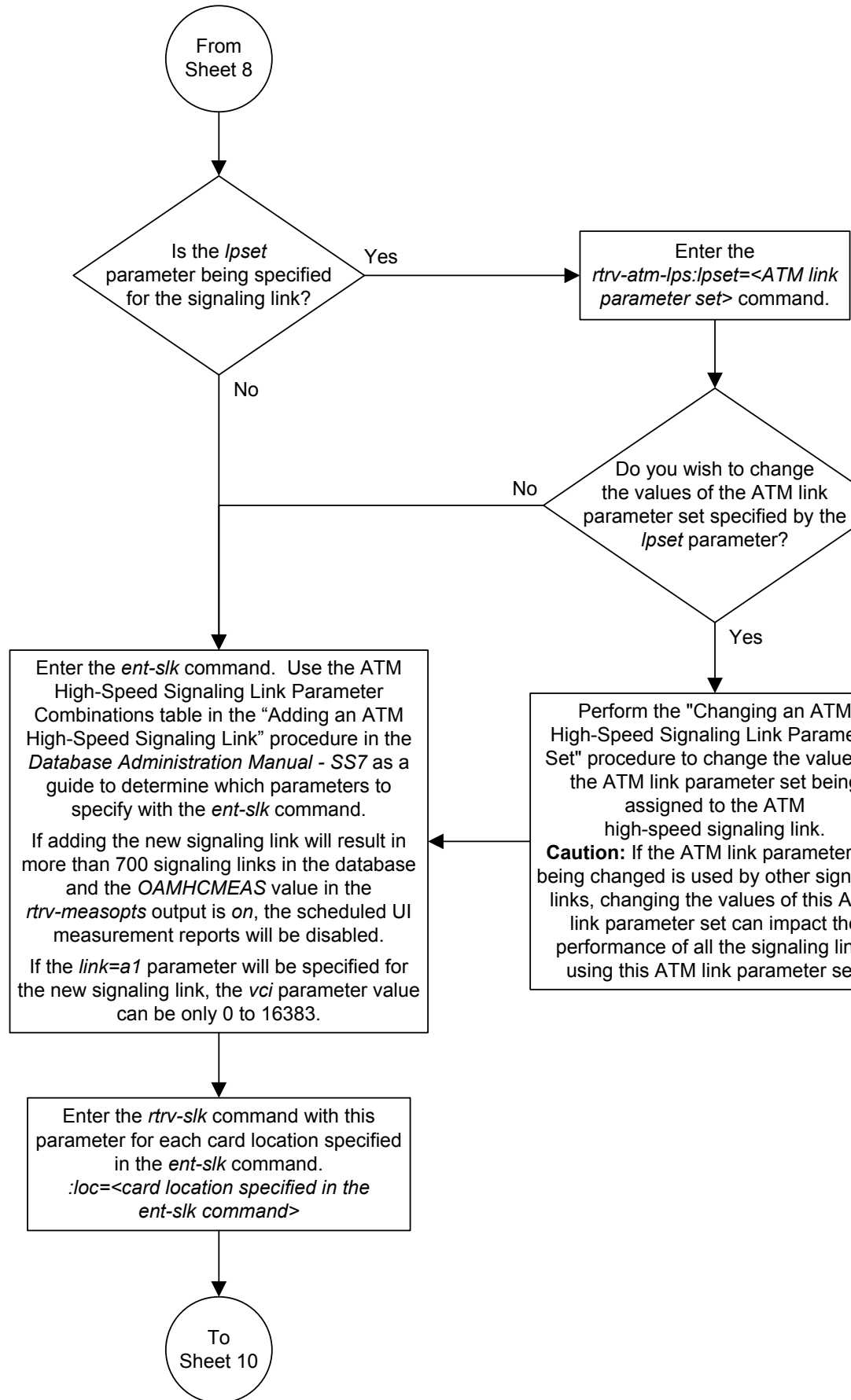
Sheet 6 of 10



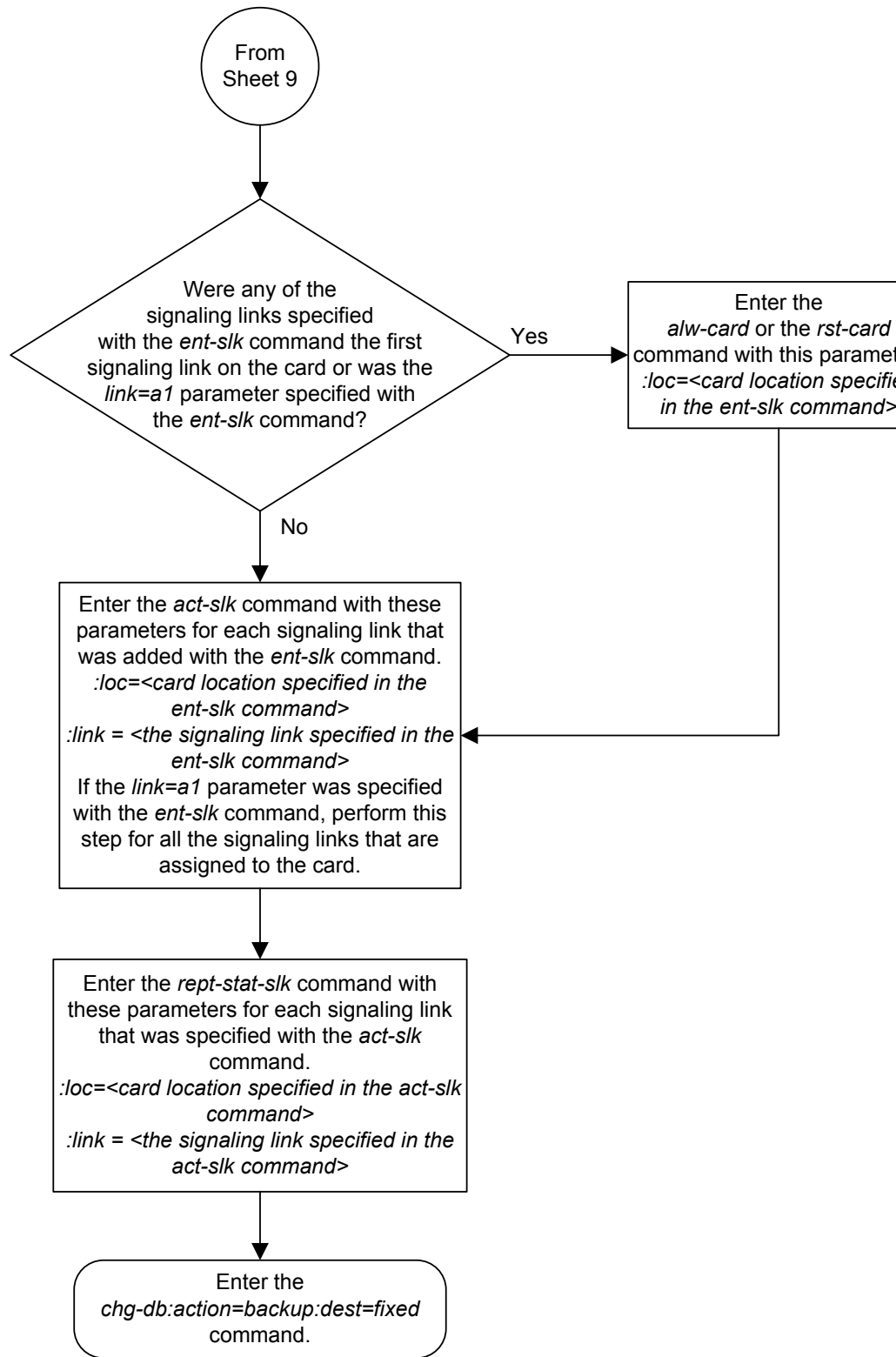
Sheet 7 of 10



Sheet 8 of 10



Sheet 9 of 10



Changing an ATM High-Speed Signaling Link Parameter Set

This procedure is used to change any of the ATM signaling link parameters using the `chg-atm-lps` command or to copy the values from one link parameter set to another.

Caution: Changing the values in an ATM link parameter set will impact the performance of all the signaling links using the ATM parameter set being changed.

The `chg-atm-lps` command uses these parameters.

`:lpsset` – the link parameter set being changed.

Range of values – 1 - 30

`:action` – copy a set of ATM signaling link parameters from one parameter set to another.

Value – copy

`:srclpsset` – the ATM signaling link parameter set used as a source for the `action=copy` parameter.

Range of values – 1 - 30

`:maxcc` – the maximum number of transmissions of a **BGN**, **END**, **ER**, or **RS PDU**

Range of values – 1 - 10

System default – 4

`:maxpd` – the maximum number of **SD PDUs** that can be sent before a **POLL** is sent

Range of values – 5 - 2120

System default – 500

`:maxstat` – the maximum number of list elements in a **STAT PDU**

Range of values – 3 - 67

System default – 67

`:tmrcc` – the timer, in milliseconds, used during the connection phase to guard against unacknowledged **BGN**, **END**, **ER** or **RS PDUs**

Range of values – 100 - 2000

System default – 200

`:tmrkalive` – the timer, in milliseconds, used during the transient phase when no **SD PDUs** are being sent to keep connection up

Range of values – 25 - 500

System default – 100

`:tmrnorsp` – the timer, in milliseconds, used to check that **STAT PDUs** are arriving often enough

Range of values – 500 - 2000

System default – 1500

:tmrpoll – the timer, in milliseconds, used to guarantee that **POLL PDUs** are sent often enough

Range of values – 25 - 500

System default – 100

:tmridle – the timer, in milliseconds, used during the idle phase when no **SD PDUs** are being sent to limit time in the idle phase

Range of values – 25 - 1000

System default – 100

:tmrt1 – the time, in milliseconds, between link release action and the next link reestablish action during alignment

Range of values – 1000 - 15000

System default – 5000

:tmrt2 – the total time, in milliseconds, that **SSCF** will attempt alignment

Range of values – 15000 - 180000

System default (**ANSI ATM**) – 120000

System default (**E1 ATM**) – 30000

:tmrt3 – the time, in microseconds, between proving **PDUs**

Range of values – 450 - 23000

System default – 925

:n1 – the number of **PDUs** sent during proving

Range of values – 500 - 64552

System default (**ANSI ATM**) – 64552

System default (**E1 ATM**) – 1000

:maxnrxp – the maximum number of retransmitted **PDUs** during proving

Range of values (**ANSI ATM**) – 1 - 10

Range of values (**E1 ATM**) – 0 - 10

System default (**ANSI ATM**) – 1

System default (**E1 ATM**) – 0

:tmrsrec – the timer, in milliseconds, used to prohibit closely spaced **SSCOP** recoveries from occurring

Range of values – 60000 - 10800000

System default – 3600000

:tmrnocred – the timer, in milliseconds, used when no credit exists and **PDUs** are available to be sent

Range of values – 1000 - 6000

System default – 1500

:tmrerm – the error rate monitor interval, in milliseconds

Range of values – 25 - 500

System default – 100

:nblk – the number of monitoring intervals per block

Range of values – 1 - 10

System default – 3

:tmrprov – the timer, in milliseconds, used to monitor the status of a link after it is placed into service

Range of values – 60000 - 1200000

System default – 600000

Link parameter sets 20 and 30 cannot be changed. The values in link parameter set 20 are set to the **ANSI** default values. The values in link parameter set 30 are set to the **ITU** default values. The values in link parameter set 20 and 30 can be copied to another link parameter set.

The values of the `lpset` and `srclpset` parameters cannot be the same.

The `action` and the `srclpset` parameters must be specified together.

If the `action` parameter is specified, only the `lpset` and `srclpset` parameters can be specified.

For any parameters not specified with the `chg-atm-lps` command, the values for those parameters are not changed.

The ATM parameter set values applied to ATM high-speed signaling links are displayed with the `rtrv-atm-lps` and `rtrv-atm-prm` commands. The values displayed with the `rtrv-atm-prm` command are not configurable. These values are:

PCR – The maximum or peak cell rate for the **VCL** (virtual channel link).

DS1 PCR value – 3622

E1 PCR value – 4528

SCR – The average or sustainable cell rate supported on the **VCL**.

DS1 SCR value – 3622

E1 PCR value – 4528

BT – Burst tolerance. The number of consecutive cells on the **VCL** permitted on the **ATM** interface by the enforcement process, given the **PCR** and the line speed.

Value – 210

CDVT – The amount of cell delay variation, in microseconds, for the **VCL** in the network ingress direction.

Value – 100

QoS – Quality of service. The performance objectives that must be met by the **ATM VCL** when it must discard cells during enforcement of the traffic parameters.

Value – 3

MaxVPC – The maximum number of simultaneously active Virtual Path Connections (**VPCs**) supported (by the **ATM** interface).

Value – 0

MAXVCC – The maximum number of simultaneously active Virtual Circuit Connections (**VCCs**) supported.

Value – 1

AllocVPI BITS – The number of bits to be used in the **VPIs** in the **ATM** cells for the **VPLs** terminated on the **ATM** interface.

Value – 12

AllocVCI BITS – The number of allocated **VCI** bits to be used in the **VPIs** in the **ATM** cells for the **VCLs** supported on the **ATM** interface.

Value – 16.

The `rtrv-atm-lps` command shows parameter values that cannot be configured with the `chg-atm-lps` command. These values are:

SDU SIZE – The maximum size, in octets, of the **SDU**

Value – 272

UU SIZE – The size, in octets of the **SSCOP UU**

Value – 4

N – The monitoring intervals needed to span the time when messages are not released from buffers as a result of a 400 millisecond error event.

Value – 9

FCNR – The moving credit increment value

Value – **NULL**

FCBC – The moving credit allocation frequency

Value – **NULL**

TSUP – The superblock timer value, in seconds

Value – 120

TLOSS – the stat loss limit timer value, in seconds

Value – 1.3

ERMSM – The exponential smoothing factor using in **ERM**

Value – 0.1

THRES – The threshold for comparing the running QoS computation by the **ERM**

Value – 0.244

For this example, the values **ATM** link parameter set 5 are being changed to these values.

maxcc = 8 **PDU**s

maxpd = 2000 **PDU**s

maxstat = 45 **PDU**s

tmrcc = 1500 milliseconds

tmrkalive = 500 milliseconds

tmrnorsp = 1000 milliseconds

tmrt1 = 10000 milliseconds

tmrt2 = 19000 milliseconds

```

tmrt3 = 3000 microseconds
n1 = 10000 PDUs
maxnrp = 7 attempts
tmrsrec = 750000 milliseconds
nblk = 6 monitoring intervals per block

```

1. Display the existing values for the ATM link parameter set being changed using the `rtrv-atm-lps` command specifying the link parameter set being changed. For this example, enter this command.

```
rtrv-atm-lps:lpset=5
```

This is an example of the possible output.

```

rlghncxa03w 06-10-28 16:02:05 GMT EAGLE5 36.0.0
ATM LINK PARAMETER SET TIMERS AND PARAMETERS (REAL NUMBERS IN SECONDS)
          SSCOP PARAMETERS
          TMR  TMR    TMR    TMR    TMR
LPSET  MAXCC  MAXPD  MAXSTAT  CC  KALIVE  NORSP  POLL  IDLE
5      4      500    67      0.2  0.1    1.5    0.1   0.1

          SSCF-NNI PARAMETERS
          TMRT1  TMRT2  TMRT3    N1
          05.0   120.0  0.000925 64552

          SAAL PARAMETERS
          MAX  TMR    TNRNO  TMR  N    TMR
          NRP  SREC   CRED   ERM  BLK  PROV
          1    3600.0  1.5    0.1  3    0600.0

          NONCONFIGURABLE PARAMETERS
          SDU  UU      FC  FC
          SIZE SIZE  N  NR  BC  TSUP  TLOSS  ERMSM  THRES
          272  4    9  --  --  120  1.3    0.1    0.244

```

2. Change the values of the ATM link parameter set with the `chg-atm-lps` command specifying the link parameter set. For this example, enter this command.

```

chg-atm-
lps:lpset=5:maxcc=8:maxpd=2000:maxstat=45:tmrcc=1500 :tmrkali
ve=500:tmrnorsp=1000:tmrt1=10000:tmrt2=19000 :tmrt3=3000:n1=1
0000:maxnrp=7:tmrsrec=750000:nblk=6

```

This message should appear.

```

rlghncxa03w 06-10-28 00:22:57 GMT EAGLE5 36.0.0
CHG-ATM-LPS: MASP A - COMPLTD

```

3. Verify the changes using the `rtrv-atm-lps` command and the link parameter set specified in step 2. For this example, enter this command.

```
rtrv-atm-lps:lpset=5
```

This is an example of the possible output.

```

rlghncxa03w 06-10-28 16:02:05 GMT EAGLE5 36.0.0
ATM LINK PARAMETER SET TIMERS AND PARAMETERS (REAL NUMBERS IN SECONDS)

```

```

                                SSCOP PARAMETERS
                                TMR  TMR    TMR  TMR  TMR
LPSET  MAXCC  MAXPD  MAXSTAT  CC  KALIVE  NORSP  POLL  IDLE
5      8      2000  45      1.5  0.5    1.0    0.1  0.1

```

```

                                SSCF-NNI PARAMETERS
                                TMRT1  TMRT2  TMRT3  N1
                                10.0    019.0  0.003000  10000

```

```

                                SAAL PARAMETERS
                                MAX  TMR    TNRNO  TMR  N  TMR
                                NRP  SREC   CRED   ERM  BLK  PROV
                                7    0750.0  1.5    0.1  6    0600.0

```

```

                                NONCONFIGURABLE PARAMETERS
                                SDU  UU      FC  FC
                                SIZE  SIZE  N  NR  BC  TSUP  TLOSS  ERMSM  THRES
                                272  4      9  --  --  120  1.3    0.1    0.244

```

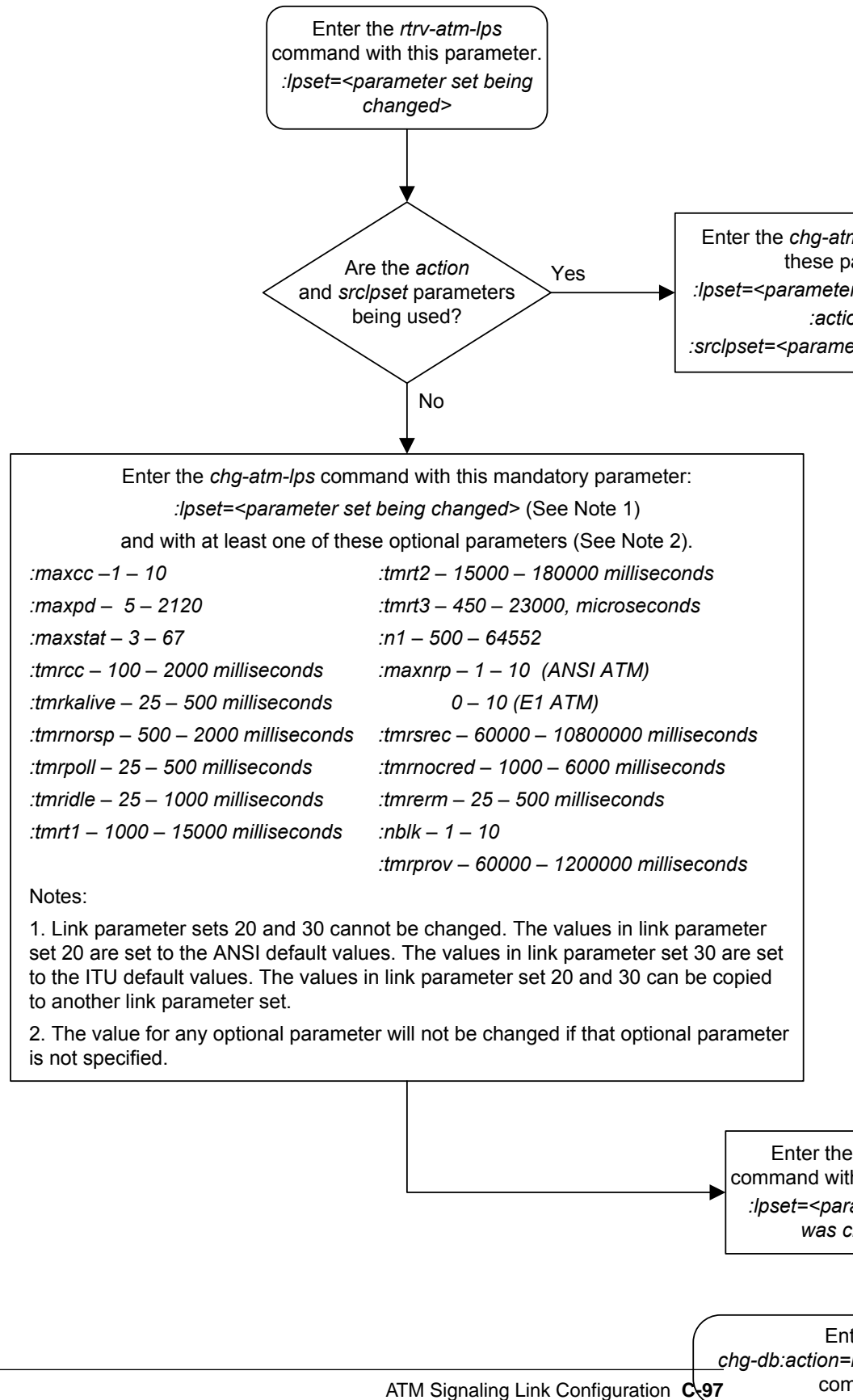
4. Back up the new changes using the `chg-db:action=backup:dest=fixed` command. These messages should appear, the active **Maintenance and Administration Subsystem Processor (MASP)** appears first.

```

BACKUP (FIXED) : MASP A - Backup starts on active MASP.
BACKUP (FIXED) : MASP A - Backup on active MASP to fixed disk complete.
BACKUP (FIXED) : MASP A - Backup starts on standby MASP.
BACKUP (FIXED) : MASP A - Backup on standby MASP to fixed disk complete.

```

Figure C-14 Changing an ATM High-Speed Signaling Link Parameter Set



Reference Information

Appendix D, Reference Information, contains the following information that is used by more than one procedure in this manual: Requirements for EAGLEs Containing more than 700 Signaling Links Determining the Number of High-Speed and Low-Speed Signaling Links

Requirements for EAGLEs Containing more than 1200 Signaling Links

To provision an EAGLE with more than 1200 signaling links (currently the EAGLE can have maximum capacities of 1200, 1500, 2000, or 2800 signaling links), the following additional requirements must be met:

- The Measurements Platform feature must be enabled. Perform these procedures in *Database Administration - System Management User's Guide* to enable the Measurements Platform Feature:
 - Adding an MCPM
 - Configuring the IP Communications Link for the Measurements Platform Feature
 - Adding an FTP Server
- To provision more than 1200 signaling links, the Large System # Links controlled feature must be enabled for 1500, 2000, or 2800 signaling links. For more information on enabling this feature, go to the [Enabling the Large System # Links Controlled Feature](#) procedure.

Determining the Number of High-Speed and Low-Speed Signaling Links

The EAGLE can contain these quantities of signaling links.

- The maximum number of IP signaling links (signaling links assigned to IPLIMx cards, IPGWx cards, or IPSP cards) or ATM high-speed signaling links (signaling links assigned to cards running either **ATMANSI** or **ATMITU** applications), is limited by the total provisioned system TPS (transactions per second). If the HIPR2 High Rate Mode feature is not enabled or turned on, the total provisioned system TPS is 500,000 TPS. If the HIPR2 High Rate Mode feature is enabled and turned on, the total provisioned system TPS is 1,000,000 (1M) TPS. The total provisioned system TPS is shown in the `rtrv-tps` output. The EAGLE supports these quantities.
 - 187 IPLIMx cards with each card supporting 4000 TPS. An IPLIMx card can contain up to 16 signaling links. For more information about configuring an IPLIMx signaling link, see the "Adding an IPLIMx Signaling Link" procedure in *Database Administration - IP7 User's Guide*. The EAGLE can support a

maximum of 250 IPLIMx cards but not all the IPLIMx cards can contain provisioned signaling links.

- 187 IPGWx cards with each card supporting 4000 TPS. An IPGWx card can contain one signaling link. For more information about configuring an IPGWx signaling link, see the "Adding an IPGWx Signaling Link" procedure in *Database Administration - IP7 User's Guide*. The EAGLE can support a maximum of 250 IPGWx cards if the TPS that is assigned to some of the IPGWx cards is less than 4000, and there are no other types of cards are in the database other than the control cards.
- 150 IPGS cards with each card supporting 5000 TPS. An IPGS card can contain up to 32 (128 for SLIC) signaling links. For more information about configuring an IPGS signaling link, see the "Adding an IPGS M2PA Signaling Link" procedure or "Adding an IPGS M3UA Signaling Link" procedure in *Database Administration - IP7 User's Guide*. The EAGLE can support a maximum of 250 IPGS cards if the TPS that is assigned to some of the IPGS cards is less than 5000, and there are no other types of cards are in the database other than the control cards.
- The amount of TPS for an ANSI ATM high-speed signaling link is 1630. The amount of TPS for an ITU ATM high-speed signaling link is 2038. The EAGLE supports a maximum of 460 ANSI ATM high-speed signaling links and a maximum or 368 ITU ATM high-speed signaling links.
- A maximum of 80 unchannelized E1 signaling links. An HC MIM can contain two unchannelized E1 signaling links. An E5-E1T1 card can contain one unchannelized E1 signaling link.
- A maximum of 180 unchannelized T1 signaling links. An unchannelized T1 signaling link can be assigned only to an E5-E1T1 card. An E5-E1T1 card can contain one unchannelized T1 signaling link.

The EAGLE can contain a maximum of 250 cards. This quantity does not include the control cards. The sum of the quantities of the signaling links shown in this list cannot be provisioned in the EAGLE as the EAGLE cannot contain enough cards to support the sum of the quantities of these signaling links.

Other signaling links, not shown in this list, can be provisioned if there is space in the shelves for the cards that support these signaling links, and the enabled signaling link quantity is not exceeded.

This hardware is the only hardware that is supported for an EAGLE containing 2001 to 2800 signaling links.

- **E5-E1T1-B**
- **E5-ATM-B**
- **E5-SM8G**
- **E5-ENET-B**
- **E5-SLAN** card for the STPLAN feature
- **E5-STC** card for the EAGLE 5 Integrated Monitoring Support feature

Index

Symbols

1500 Signaling Links, [3-2](#)
2000 Signaling Links, [3-2](#)
6-Way Loadsharing on Routesets feature, [3-586](#), [3-589](#)

A

alternate point code, [2-1](#)

B

bit rotation
 ITU SLS enhancement, [3-47](#)

C

card
 E5-MCAP, [1-5](#)
 E5-MDAL, [1-5](#)
 E5-TDM, [1-5](#)
cards
 control, [1-4](#)
 E5-MASP, [1-5](#)
 MASP, [1-4](#)
changing
 Origin-Based MTP Routing SCCP OPC, [3-447](#),
 [3-448](#)
changing options
 Origin-Based MTP Routing SCCP OPC, [3-447](#),
 [3-448](#)
chg-sccpopts command, [3-448](#)
chg-ss7opts command, [3-415](#), [3-418](#), [3-422](#), [3-583](#),
 [3-584](#)
circular routing
 network routing, [2-214](#)
cluster destination point code, [2-2](#)
control cards
 E5-based, [1-5](#)
 EAGLE ISS, [1-4](#)
CPC, [2-108](#)
CPCA, [2-108](#)
CPCI, [2-108](#), [2-109](#)

CPCN, [2-108](#), [2-109](#)
credit card flash drive, [1-5](#)

D

destination, [2-1](#)
destination point code, [2-2](#)
DISCARDTFCI Option, [3-422](#)
DISCARDTFCN Option, [3-422](#)
drive
 credit card flash, [1-5](#)
 E5-TDM fixed SATA, [1-5](#)
 removable media flash, [1-5](#)

E

E1 backplane, [A-6](#)
E5-based control cards, [1-5](#)
E5-MASP cards, [1-5](#)
E5-MCAP card
 USB ports, [1-5](#)
E5-MDAL card, [1-5](#)
E5-TDM card, [1-5](#)

F

fixed drive
 E5-TDM, [1-5](#)
full point code, [2-2](#)

I

International Spare network indicator values, [2-7](#)
ITU National and International Spare Point Code
 Support feature, [2-7](#), [2-55](#), [2-56](#), [2-58](#), [2-97](#),
 [2-100](#), [2-107](#), [3-21](#), [3-140](#)
ITU SLS enhancement
 bit rotation, [3-47](#)

L

linksets, [3-1](#)
LSRESTRICT Option, [3-151](#), [3-152](#), [3-415–3-418](#)

M

Maintenance and Administration Subsystem (MAS),
[1-4](#)
Maintenance and Administration Subsystem Processor
(MASP), [1-4](#)
Maintenance Communication Application Processor
(MCAP), [1-5](#)
Maintenance Disk and Alarm (MDAL), [1-5](#)
MAS, [1-4](#)
MASP, [1-4](#)
mobrscpopc parameter
Origin-Based MTP Routing SCCP OPC, [3-447](#),
[3-448](#)
MSGPRI2ITUI Option, [3-583](#), [3-584](#)
MSGPRI2ITUN Option, [3-583](#), [3-584](#)
Multiple Linksets to Single Adjacent PC (MLS) feature,
[3-565](#), [3-569](#)

N

National Spare network indicator values, [2-7](#)
NCPC, [2-108](#)
NCPA, [2-108](#)
NCPCL, [2-108](#), [2-109](#)
NCPCLN, [2-108](#), [2-109](#)
network
types, [2-1](#)
network routing
circular routing, [2-214](#)
network routing point code, [2-2](#)

O

Option
DISCARDTFCL, [3-422](#)
DISCARDTFCLN, [3-422](#)
LSRESTRICT, [3-151](#), [3-152](#), [3-415-3-418](#)
MSGPRI2ITUI, [3-583](#), [3-584](#)
MSGPRI2ITUN, [3-583](#), [3-584](#)
options
changing, [3-447](#), [3-448](#)
Origin-Based MTP Routing feature, [3-431](#),
[3-436-3-438](#)
Origin-Based MTP Routing SCCP OPC

Origin-Based MTP Routing SCCP OPC (*continued*)
mobrscpopc parameter, [3-447](#), [3-448](#)

P

point code
alternate, [2-1](#)
cluster destination, [2-2](#)
destination, [2-2](#)
full, [2-2](#)
network routing, [2-2](#)
proxy, [2-2](#)
true, [2-1](#)
private point code, [2-7](#), [2-107](#), [3-20](#), [3-139](#), [3-207](#)
private spare point code, [3-201](#), [3-207](#)
proxy point code, [2-2](#)

R

removable media, [1-5](#)

S

SATA fixed drive, E5-TDM, [1-5](#)
secondary point codes, [2-2](#)
signaling links, 1500, [3-2](#)
signaling links, 2000, [3-2](#)
spare point code, [2-73](#), [2-96](#), [2-97](#), [2-107](#), [2-111](#), [2-113](#),
[3-19](#), [3-20](#), [3-138](#), [3-207](#)
SS7 linksets, [3-1](#)

T

Terminal Disk Module (TDM), [1-5](#)
tfatcabmlq parameter, [3-25](#), [3-140](#), [3-415-3-417](#)
timers
default values, [3-64](#)
true point code, [2-1](#)
types of networks, [2-1](#)

U

USB port
flush-mounted, [1-5](#)
latched, [1-5](#)