

EAGLE

Database Administration - System Management User's Guide

Release 46.6

E93319 Revision 1

March 2018

Copyright © 1993, 2018, Oracle and/or its affiliates. All rights reserved.

This software and related documentation are provided under a license agreement containing restrictions on use and disclosure and are protected by intellectual property laws. Except as expressly permitted in your license agreement or allowed by law, you may not use, copy, reproduce, translate, broadcast, modify, license, transmit, distribute, exhibit, perform, publish, or display any part, in any form, or by any means. Reverse engineering, disassembly, or decompilation of this software, unless required by law for interoperability, is prohibited.

The information contained herein is subject to change without notice and is not warranted to be error-free. If you find any errors, please report them to us in writing.

If this is software or related documentation that is delivered to the U.S. Government or anyone licensing it on behalf of the U.S. Government, then the following notice is applicable:

U.S. GOVERNMENT END USERS: Oracle programs, including any operating system, integrated software, any programs installed on the hardware, and/or documentation, delivered to U.S. Government end users are "commercial computer software" pursuant to the applicable Federal Acquisition Regulation and agency-specific supplemental regulations. As such, use, duplication, disclosure, modification, and adaptation of the programs, including any operating system, integrated software, any programs installed on the hardware, and/or documentation, shall be subject to license terms and license restrictions applicable to the programs. No other rights are granted to the U.S. Government.

This software or hardware is developed for general use in a variety of information management applications. It is not developed or intended for use in any inherently dangerous applications, including applications that may create a risk of personal injury. If you use this software or hardware in dangerous applications, then you shall be responsible to take all appropriate fail-safe, backup, redundancy, and other measures to ensure its safe use. Oracle Corporation and its affiliates disclaim any liability for any damages caused by use of this software or hardware in dangerous applications.

Oracle and Java are registered trademarks of Oracle and/or its affiliates. Other names may be trademarks of their respective owners.

Intel and Intel Xeon are trademarks or registered trademarks of Intel Corporation. All SPARC trademarks are used under license and are trademarks or registered trademarks of SPARC International, Inc. AMD, Opteron, the AMD logo, and the AMD Opteron logo are trademarks or registered trademarks of Advanced Micro Devices. UNIX is a registered trademark of The Open Group.

This software or hardware and documentation may provide access to or information about content, products, and services from third parties. Oracle Corporation and its affiliates are not responsible for and expressly disclaim all warranties of any kind with respect to third-party content, products, and services unless otherwise set forth in an applicable agreement between you and Oracle. Oracle Corporation and its affiliates will not be responsible for any loss, costs, or damages incurred due to your access to or use of third-party content, products, or services, except as set forth in an applicable agreement between you and Oracle.

This documentation is in preproduction status and is intended for demonstration and preliminary use only. It may not be specific to the hardware on which you are using the software. Oracle Corporation and its affiliates are not responsible for and expressly disclaim all warranties of any kind with respect to this documentation and will not be responsible for any loss, costs, or damages incurred due to the use of this documentation.

The information contained in this document is for informational sharing purposes only and should be considered in your capacity as a customer advisory board member or pursuant to your beta trial agreement only. It is not a commitment to deliver any material, code, or functionality, and should not be relied upon in making purchasing decisions. The development, release, and timing of any features or functionality described in this document remains at the sole discretion of Oracle.

This document in any form, software or printed matter, contains proprietary information that is the exclusive property of Oracle. Your access to and use of this confidential material is subject to the terms and conditions of your Oracle Master Agreement, Oracle License and Services Agreement, Oracle PartnerNetwork Agreement, Oracle distribution agreement, or other license agreement which has been executed by you and Oracle and with which you agree to comply. This document and information contained herein may not be disclosed, copied, reproduced, or distributed to anyone outside Oracle without prior written consent of Oracle. This document is not part of your license agreement nor can it be incorporated into any contractual agreement with Oracle or its subsidiaries or affiliates.

Contents

1 Introduction

Overview	1-1
Scope and Audience	1-2
Documentation Admonishments	1-2
Manual Organization	1-2
My Oracle Support (MOS).....	1-3
Emergency Response.....	1-4
Related Publications	1-4
Customer Training	1-4
Locate Product Documentation on the Oracle Help Center Site	1-4
Maintenance and Administration Subsystem	1-5
EAGLE Database Partitions	1-6

2 Database Management Procedures

Introduction	2-1
Removable USB Drive.....	2-2
Verifying the Database	2-4
Backing Up the Database Locally	2-8
Making a Backup of the Database on the Fixed Disk.....	2-8
Making a Backup of the Database to the Removable Media	2-12
Restoring the Database Locally.....	2-22
Restoring the Database from the Backup Partition of the Fixed Disk	2-22
Restoring the Database from the Removable Media.....	2-27
Repairing the Database	2-30
Copying the Database from the Active to the Standby Fixed Disk.....	2-36
Backing Up System Data to the Removable Media	2-50
Restoring System Data from a Removable Media	2-52
Formatting the Fixed Disk of the Standby E5-TDM	2-63
Formatting Removable Media	2-77

3 GPL Management Procedures

Introduction	3-1
--------------------	-----

Updating the BLMCAP and OAMHC GPLs	3-14
Updating the Signaling Link and Data Link GPLs	3-27
Updating the Service GPLs	3-50
Updating the Flash GPLs.....	3-76
Updating the HIPR2 GPL	3-107
Making the Trial Utility GPL the Approved Utility GPL.....	3-123
Reloading the TDM LCA Clock Bitfile	3-131
Updating the BLIXP GPL.....	3-145
Updating a High-Capacity Card to Run the BLIXP GPL.....	3-184
Conversion of SM8G-B Cards	3-212
SM8G-B Bootloader Swap	3-212
SM8G-B 32-bit to 64-bit Conversion	3-212
SM8G-B 64-bit to 32-bit Conversion	3-213
Conversion of SLIC Cards	3-213
SLIC 32-bit to 64-bit Conversion	3-213
SLIC 64-bit to 32-bit Conversion	3-214

4 System Administration Procedures

Introduction	4-1
Setting the Clock and Date on the EAGLE.....	4-1
Changing the Security Defaults.....	4-6
Configuring the Unauthorized Use Warning Message	4-11
Changing the Security Log Characteristics.....	4-17
Copying the Security Log to the File Transfer Area	4-20
Adding a User to the System	4-25
Removing a User from the System.....	4-35
Changing User Information	4-38
Changing a Password.....	4-50
Changing Terminal Characteristics.....	4-53
Changing Terminal Command Class Assignments.....	4-83
Configuring Command Classes.....	4-91
Adding a Shelf.....	4-99
Removing a Shelf	4-102
Adding an SS7 LIM	4-108
Removing an SS7 LIM.....	4-112
Configuring the UIM Threshold.....	4-123
Removing a UIM Threshold.....	4-126
Configuring the Measurements Terminal for an EAGLE Containing 700 Signaling Links.....	4-129
Adding a Measurement Collection and Polling Module (MCPM)	4-135
Removing an MCPM.....	4-142
Activating the Fan Feature	4-146
Configuring the Measurements Platform Feature	4-146
Adding an FTP Server.....	4-158

Removing an FTP Server	4-164
Changing an FTP Server	4-167
Adding an E5-IPSM.....	4-173
Removing an E5-IPSM	4-194
Configuring the Options for the Network Security Enhancements Feature.....	4-203
Configuring the Restore Device State Option	4-207
Adding an Entry to the Frame Power Alarm Threshold Table.....	4-210
Removing an Entry from the Frame Power Alarm Threshold Table	4-217
Changing an Entry in the Frame Power Alarm Threshold Table	4-223
Configuring the IMT Bus Alarm Thresholds.....	4-227
Configuring the Integrated Measurements Feature	4-231
Configuring the MFC Option.....	4-246
5 SEAS Over IP Configuration Procedures	
Introduction	5-1
Activating the SEAS over IP Feature	5-3
Performing the Initial SEAS Configuration	5-12
Configuring SEAS Terminals	5-19
Changing the Existing SEAS Configuration	5-32
Turning Off the SEAS Over IP Feature	5-42
A Controlled Feature Activation Procedures	
Introduction	A-1
Activating Controlled Features.....	A-2
Activating the EAGLE OA&M IP Security Enhancement Controlled Feature.....	A-10
Unmute IP Security for Terminal and Measurements	A-29
Activating the 15 Minute Measurements Controlled Feature	A-29
Clearing a Temporary FAK Alarm	A-44
Deactivating Controlled Features.....	A-46
Activating the HIPR2 High Rate Mode Feature.....	A-50
Turning Off the HIPR2 High Rate Mode Feature.....	A-65
B Setting Up a Secure Telnet Connection to the EAGLE using PuTTY	
Setting Up a Secure Telnet Connection to the EAGLE using PuTTY	B-1
C Setting Up a Secure Telnet Connection to the EAGLE using OpenSSH	
Introduction	C-1
Install the Windows OpenSSH Software.....	C-2
Establishing a Secure Telnet Connection to the EAGLE using Windows OpenSSH	C-2
Install the UNIX/Solaris OpenSSH Software.....	C-3
Establishing a Secure Telnet Connection to the EAGLE using UNIX/Solaris OpenSSH	C-4

D Remote Database Backup and Restore Procedures

Introduction	D-1
Making a Backup of the Database to the FTP Server.....	D-2
Restoring the Database from the FTP Server	D-9
Configuring the Archive Build ID Option	D-14

List of Figures

1-1	EAGLE Database Partitions (E5-Based Control Cards).....	1-7
2-1	Removable USB Drive LOCKED.....	2-3
2-2	Removable USB Drive UNLOCKED.....	2-3
2-3	Backup Action on the Fixed Disk.....	2-9
2-4	Making a Backup of the Database on the Fixed Disk.....	2-11
2-5	Making a Backup of the Database to the Removable Cartridge or Removable Media...	2-15
2-6	Restore Action on the Fixed Disk.....	2-24
2-7	Restoring the Database from the Backup Partition of the Fixed Disk.....	2-26
2-8	Action of the Repair Procedure.....	2-31
2-9	Repairing the Database.....	2-35
2-10	Action of the Copy Disk Procedure.....	2-36
2-11	Copying the Database from the Active to the Standby Fixed Disk.....	2-45
2-12	Restoring System Data from a Removable Cartridge or Removable Media.....	2-60
2-13	Formatting the Fixed Disk of the Standby E5-TDM.....	2-70
2-14	Formatting Removable Media.....	2-83
3-1	Updating the BLMCAP and OAMHC GPLs.....	3-25
3-2	Updating the Signaling Link and Data Link GPLs.....	3-38
3-3	Updating the Service GPLs.....	3-60
3-4	Updating the Flash GPLs.....	3-97
3-5	Updating the HIPR2 GPL.....	3-114
3-6	Making the Trial Utility GPL the Approved Utility GPL.....	3-126
3-7	Reloading the TDM LCA Clock Bitfile.....	3-140
3-8	Updating the BLIXP GPL.....	3-170
3-9	Updating a High-Capacity Card to Run the BLIXP GPL.....	3-203
4-1	Setting the Clock and Date on the EAGLE 5 ISS.....	4-5
4-2	Changing the Security Defaults.....	4-10
4-3	Configuring the Unauthorized Use Warning Message.....	4-16
4-4	Changing the Security Log Characteristics.....	4-19
4-5	Copying the Security Log to the File Transfer Area.....	4-22
4-6	Adding a User to the System.....	4-32
4-7	Removing a User from the System.....	4-37
4-8	Changing User Information.....	4-45
4-9	Changing a Password.....	4-52
4-10	Changing Terminal Characteristics.....	4-72
4-11	Changing Terminal Command Class Assignments.....	4-88
4-12	Configuring Command Classes.....	4-96
4-13	Adding a Shelf.....	4-101
4-14	Removing a Shelf.....	4-107
4-15	Adding an SS7 LIM.....	4-111
4-16	Removing an SS7 LIM.....	4-120
4-17	Configuring the UIM Threshold.....	4-125
4-18	Removing a UIM Threshold.....	4-128
4-19	Configuring the Measurements Terminal for an EAGLE Containing 700 Signaling Links.....	4-134
4-20	Adding a Measurement Collection and Polling Module (MCPM).....	4-139
4-21	Removing a MCPM.....	4-145
4-22	Configuring the Measurements Platform Feature.....	4-153
4-23	Adding an FTP Server.....	4-161
4-24	Removing an FTP Server.....	4-166
4-25	Changing an FTP Server.....	4-170
4-26	Adding an E5-IPSM.....	4-183

4-27	Removing an IPSM.....	4-200
4-28	Configuring the Options for the Network Security Enhancements Feature.....	4-206
4-29	Configuring the Restore Device State Option.....	4-209
4-30	Adding an Entry to the Frame Power Alarm Threshold Table.....	4-214
4-31	Removing an Entry from the Frame Power Alarm Threshold Table.....	4-220
4-32	Changing an Entry in the Frame Power Alarm Threshold Table.....	4-226
4-33	Configuring the IMT Bus Alarm Thresholds.....	4-230
4-34	Configuring the Integrated Measurements Feature.....	4-243
5-1	Dual SEAS Terminals with Single CCS MR SEAS Configuration.....	5-2
5-2	Dual SEAS Terminals with Dual CCS MRs SEAS Configuration.....	5-2
5-3	Simplex SEAS Terminal Configuration.....	5-3
5-4	Activating the SEAS over IP Feature.....	5-9
5-5	Performing the Initial SEAS Configuration.....	5-17
5-6	Configuring SEAS Terminals.....	5-29
5-7	Changing the Existing SEAS Configuration.....	5-38
5-8	Turning Off the SEAS Over IP Feature.....	5-45
A-1	Activating Controlled Features.....	A-7
A-2	Activating the EAGLE OA&M IP Security Enhancement Controlled Feature.....	A-22
A-3	Activating the 15 Minute Measurements Controlled Feature.....	A-37
A-4	Clearing a Temporary FAK Alarm.....	A-45
A-5	Deactivating Controlled Features.....	A-49
A-6	Activating the HIPR2 High Rate Mode Feature.....	A-56
A-7	Turning Off the HIPR2 High Rate Mode Feature	A-68
B-1	PuTTY Configuration Window - Initial Session Setup.....	B-2
B-2	PuTTY Configuration Window - SSH Connection Setup.....	B-3
B-3	PuTTY Configuration Window - SSH Auth Setup.....	B-4
B-4	PuTTY Configuration Window - SSH Tunnel/Port Forwarding Setup.....	B-5
B-5	PuTTY Configuration Window - SSH Tunnel/Port Forwarding Completion.....	B-6
B-6	Key Acceptance Dialog Box.....	B-6
B-7	PuTTY Login Window.....	B-7
B-8	Logged in Window for SSH Session.....	B-7
B-9	Telnet Connection to Local Host Forwarded Port.....	B-7
C-1	OpenSSH Warning Window.....	C-2
D-1	Backup of the Database to the FTP Server.....	D-2
D-2	Restoring the Database from the FTP Server.....	D-2
D-3	Making a Backup of the Database to the FTP Server.....	D-6
D-4	Restoring the Database from the FTP Server.....	D-13
D-5	Configuring the Archive Build ID Option.....	D-16

List of Tables

1-1	Admonishments.....	1-2
3-1	SS7 LIM Card Types.....	3-28
3-2	Data Link Card Types.....	3-28
3-3	Service GPL Card Types.....	3-50
3-4	EAGLE Card Applications and GPLs.....	3-76
3-5	High-Capacity Cards.....	3-145
3-6	High-Capacity Card Applications.....	3-145
3-7	High-Capacity Cards.....	3-184
3-8	High-Capacity Card Applications.....	3-184
4-1	Time Zones	4-2
4-2	UIMRD Parameter Combinations.....	4-55
4-3	Card Removal Procedures	4-102
4-4	Effect of Removing the Last In-Service Card Type from the Database	4-103
4-5	Example UIM Threshold Configuration.....	4-123
4-6	Frame Power Alarm Threshold Table Frame Designations.....	4-210
4-7	Power Level to Generate a Minor Alarm.....	4-223

Introduction

Chapter 1, Introduction, contains general information about the database and the organization of this manual.

Overview

Database Administration – System Management User’s Guide describes the procedures used to manage and configure these items.

- **EAGLE’s database and GPLs**
- The date and time
- User **IDs** and passwords
- Terminal configuration
- Shelves
- SS7 LIMs
- Security Log
- Unauthorized Use Warning Message
- **UIM** Thresholds
- **MCPMs**, **IP** links, and **FTP** servers for the Measurements Platform
- **IPSMs** for the **IP** User Interface (Telnet) feature
- Configuring the Network Security Options
- Configuring the Restore Device State Option
- Configuring the Frame Power **Alarm** Threshold
- SEAS over IP Configuration
- Using PuTTY or OpenSSH to set up a secure telnet connection to the EAGLE.

Note: Database administration privileges are password restricted. Only those persons with access to the command class “Database Administration” can execute the administrative functions. Other command classes and the commands allowed by those classes are listed in the *Commands User’s Guide*.

Throughout this manual, these terms are used to refer to either the original card or the EPM-B version or other replacement version of the card unless one of the card types is specifically required.

- E5-ENET - the original E5-ENET or the E5-ENET-B card
- E5-E1T1 - the original E5-E1T1 or the E5-E1T1-B card
- E5-ATM - the original E5-ATM or the E5-ATM-B card
- E5-IPSM - the original E5-IPSM or the E5-ENET-B card that is running the IPSHC GPL
- E5-SM4G - the original E5-SM4G or the E5-SM8G-B card (not an EPM-B card)
- MCPM - the original MCPM or the E5-MCPM-B card





Scope and Audience

This manual is intended for database administration personnel or translations personnel responsible for managing the items shown in the [Overview](#) section.

Documentation Admonishments

Admonishments are icons and text throughout this manual that alert the reader to assure personal safety, to minimize possible service interruptions, and to warn of the potential for equipment damage.

Table 1-1 Admonishments

Icon	Description
 DANGER	Danger: (This icon and text indicate the possibility of <i>personal injury</i> .)
 WARNING	Warning: (This icon and text indicate the possibility of <i>equipment damage</i> .)
 CAUTION	Caution: (This icon and text indicate the possibility of <i>service interruption</i> .)
 TOPPLE	Topple: (This icon and text indicate the possibility of <i>personal injury and equipment damage</i> .)

Manual Organization

Throughout this document, the terms database and system software are used. **Database** refers to all data that can be administered by the user, including shelves, cards, links, routes, global title translation tables, and gateway screening tables.

System software refers to data that cannot be administered by the user, including generic program loads (GPLs).

This document is organized into these sections:

[Introduction](#) contains general information about the database and the organization of this manual.

[Database Management Procedures](#) describes the different options for managing the database, such as backing up data and copying database tables from one disk to another, and provides procedures for tasks associated with database applications.

[GPL Management Procedures](#) describes the procedures used for managing the system data (GPLs) on the **EAGLE**.

[System Administration Procedures](#) describes the procedures used to administer the items shown in the [Introduction](#).

[SEAS Over IP Configuration Procedures](#) describes the procedures used to configure the **EAGLE** to support the SEAS over IP feature.

[Controlled Feature Activation Procedures](#) describes the procedures necessary to activate and deactivate the controlled features (features that require a feature access key to be activated) contained in this guide.

[Setting Up a Secure Telnet Connection to the EAGLE using PuTTY](#) describes the steps to set up a secure telnet connection to the **EAGLE** using the PuTTY client program.

[Setting Up a Secure Telnet Connection to the EAGLE using OpenSSH](#) describes the steps to set up a secure telnet connection to the **EAGLE** using OpenSSH.

[Remote Database Backup and Restore Procedures](#) describes the procedures for backing up the database to the DB FTP server and restoring the database from the DB FTP server.

My Oracle Support (MOS)

MOS (<https://support.oracle.com>) is your initial point of contact for all product support and training needs. A representative at Customer Access Support (CAS) can assist you with MOS registration.

Call the CAS main number at 1-800-223-1711 (toll-free in the US), or call the Oracle Support hotline for your local country from the list at <http://www.oracle.com/us/support/contact/index.html>. When calling, make the selections in the sequence shown below on the Support telephone menu:

1. Select 2 for New Service Request
2. Select 3 for Hardware, Networking and Solaris Operating System Support
3. Select one of the following options:
 - For Technical issues such as creating a new Service Request (SR), Select 1
 - For Non-technical issues such as registration or assistance with MOS, Select 2

You will be connected to a live agent who can assist you with MOS registration and opening a support ticket.

MOS is available 24 hours a day, 7 days a week, 365 days a year.

Emergency Response

In the event of a critical service situation, emergency response is offered by the Customer Access Support (CAS) main number at 1-800-223-1711 (toll-free in the US), or by calling the Oracle Support hotline for your local country from the list at <http://www.oracle.com/us/support/contact/index.html>. The emergency response provides immediate coverage, automatic escalation, and other features to ensure that the critical situation is resolved as rapidly as possible.

A critical situation is defined as a problem with the installed equipment that severely affects service, traffic, or maintenance capabilities, and requires immediate corrective action. Critical situations affect service and/or system operation resulting in one or several of these situations:

- A total system failure that results in loss of all transaction processing capability
- Significant reduction in system capacity or traffic handling capability
- Loss of the system's ability to perform automatic system reconfiguration
- Inability to restart a processor or the system
- Corruption of system databases that requires service affecting corrective actions
- Loss of access for maintenance or recovery operations
- Loss of the system ability to provide any required critical or major trouble notification

Any other problem severely affecting service, capacity/traffic, billing, and maintenance capabilities may be defined as critical by prior discussion and agreement with Oracle.

Related Publications

For information about additional publications related to this document, refer to the Oracle Help Center site. See [Locate Product Documentation on the Oracle Help Center Site](#) for more information on related product publications.

Customer Training

Oracle University offers training for service providers and enterprises. Visit our web site to view, and register for, Oracle Communications training:

<http://education.oracle.com/communication>

To obtain contact phone numbers for countries or regions, visit the Oracle University Education web site:

www.oracle.com/education/contacts

Locate Product Documentation on the Oracle Help Center Site

Oracle Communications customer documentation is available on the web at the Oracle Help Center (OHC) site, <http://docs.oracle.com>. You do not have to register to access these documents. Viewing these files requires Adobe Acrobat Reader, which can be downloaded at <http://www.adobe.com>.

1. Access the Oracle Help Center site at <http://docs.oracle.com>.
2. Click `Industries`.
3. Under the Oracle Communications subheading, click the Oracle Communications documentation link.

The Communications Documentation page appears. Most products covered by these documentation sets will appear under the headings "Network Session Delivery and Control Infrastructure" or "Platforms."

4. Click on your Product and then the Release Number.

A list of the entire documentation set for the selected product and release appears.

5. To download a file to your location, right-click the PDF link, select `Save target as` (or similar command based on your browser), and save to a local folder.

Maintenance and Administration Subsystem

The Maintenance and Administration Subsystem (MAS) is the central management point for the EAGLE. The MAS provides user interface, maintenance communication, peripheral services, alarm processing, system disk interface, and measurements. Management and redundancy are provided by use of two separate subsystem processors.

The MAS resides on two separate sets of Maintenance and Administration Subsystem Processor (MASP) cards and a Maintenance Disk and Alarm card (collectively referred to as **control cards**). The control cards are located in slots 1113 through 1118 of the EAGLE control shelf. The control cards must be E5-based cards.

E5-based Control Cards

The E5-based set of EAGLE control cards consists of the following cards:

- Two Maintenance and Administration Subsystem Processor cards (E5-MASP) cards. Each dual-slot **E5-MASP card** is made up of the following two modules:
 - Maintenance Communication Application Processor (E5-MCAP) card
 - Terminal Disk Module (E5-TDM) card
- One Maintenance Disk and Alarm card (E5-MDAL card)

Maintenance Communication Application Processor (E5-MCAP) Card

The **E5-MCAP card** contains the Communications Processor and Applications Processor and provides connections to the IMT bus. The card controls the maintenance and database administration activity and performs both application and communication processing. E5-MCAP cards are located in slots 1113 and 1115 of the control shelf.

Each E5-MCAP card contains two **USB ports**. One **latched USB port** is used with removable flash media ("thumb drives"), and one **flush-mounted USB port** is used with a plug-in flash drive. The **removable media** drive in the latched USB port is used to install and back up customer data. The flush-mounted USB port is used for upgrade and could be used for disaster recovery.

Terminal Disk Module (E5-TDM) Card

The **E5-TDM card** provides the Terminal Processor for the 16 I/O ports, and interfaces to the Maintenance Disk and Alarm (E5-MDAL) card and fixed disk storage. The E5-TDM card also distributes Composite Clocks and High Speed Master clocks throughout the EAGLE, and distributes Shelf ID to the EAGLE. Each E5-TDM card contains one fixed SATA drive that is used to store primary and backup system databases, measurements, and Generic Program Loads (GPLs). E5-TDM cards are located in slots 1114 and 1116 of the control shelf.

Maintenance Disk and Alarm (E5-MDAL) Card

The **E5-MDAL card** processes alarm requests and provides fan control. There is only one E5-MDAL card in a control card set. Critical, major, and minor system alarms are provided for up to 6 individual frames. In addition to the 3 system alarms, the E5-MDAL card provides the system audible alarm. The E5-MDAL card provides control of fans on a per-frame basis, and allows for each fan relay to be set individually. The E5-MDAL card is located in slots 1117 and 1118 of the control shelf.

EAGLE Database Partitions

The data that the **EAGLE** uses to perform its functions are stored in two separate areas: the fixed disk drives, and the removable media. The following sections describe these areas and data that is stored on them. These areas and their partitions are shown in [Figure 1-1](#).

Figure 1-1 EAGLE Database Partitions (E5-Based Control Cards)

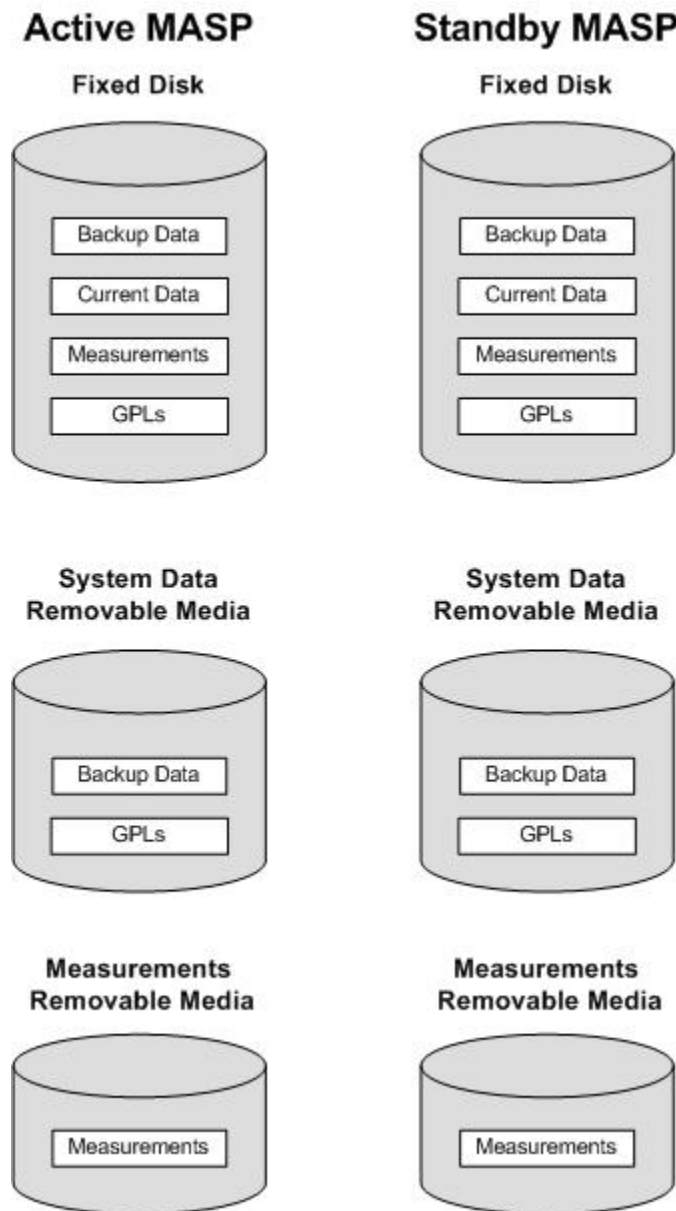

Fixed Disk Drive

There are two fixed disk drives on the **EAGLE**. The fixed disk drives contain the “master” set of data and programs for the **EAGLE**. The two fixed disk drives are located on the terminal disk modules (**E5-TDMs**). Both disks have the same files. The data stored on the fixed disks is partially replicated on the various cards in the **EAGLE**. Changes made during database administration sessions are sent to the appropriate cards.

The data on the fixed disks can be viewed as four partitions.

- Current partition
- Backup partition
- Measurements partition

- Generic program loads (**GPLs**) partition

The data which can be administered by users is stored in two partitions on the fixed disk, a current database partition which has the tables which are changed by on-line administration, and a backup database partition which is a user-controlled copy of the current partition.

All of the on-line data administration commands affect the data in the current partition. The purpose of the backup partition is to provide the users with a means of rapidly restoring the database to a known good state if there has been a problem while changing the current partition.

A full set of **GPLs** is stored on the fixed disk, in the **GPL** partition. There is an approved **GPL** and a trial **GPL** for each type of **GPL** in this set and a utility **GPL**, which has only an approved version. Copies of these **GPLs** are downloaded to the **EAGLE** cards. The **GPL** provides each card with its functionality. For example, the `ss7ansi` **GPL** provides **MTP** functionality for link interface modules (**LIMs**).

Measurement tables are organized as a single partition on the fixed disk. These tables are used as holding areas for the measurement counts.

Removable Media

The removable media is used with the E5-MCAP card portion of the E5-MASP in card locations 1113 and 1115.

The removable media is used for two purposes.

- To hold an off-line backup copy of the administered data and system **GPLs**
- To hold a copy of the measurement tables

Because of the size of the data stored on the fixed disk drives on the **E5-TDMs**, a single removable media cannot store all of the data in the database, **GPL** and measurements partitions.

To use a removable media to hold the system data, it must be formatted for system data. To use a removable media to hold measurements data, it must be formatted for measurements data. The **EAGLE** provides the user the ability to format a removable media for either of these purposes. A removable media can be formatted on the **EAGLE** by using the `format-disk` command. More information on the `format-disk` command can be found in *Commands User's Guide*. More information on the removable media drives can be found in *Hardware Guide*.

Additional and preformatted removable media are available from the [My Oracle Support \(MOS\)](#).

Database Management Procedures

Chapter 2, Database Management Procedures, describes the different options for managing the database, such as backing up data and copying database tables from one disk to another, and provides procedures for tasks associated with database applications.

Introduction

This chapter contains procedures for creating database backups or backups of the system data, and restoring the database or system data. The term “database” refers to all data that can be administered by the user including shelves, cards, links, routes, global title translation tables, and gateway screening tables. The term “system data” refers to data that cannot be administered by the user including maintenance software and generic program loads (GPLs).

These procedures are to be used as they are presented in this chapter. If these procedures are not followed, and a database backup or restore is attempted, a system failure could result.

The procedures shown in this chapter use a variety of commands. If more information on these commands is needed, go to *Commands User's Guide* to find the necessary information.

The database management procedures are used to perform these functions:

- Verifying the database
- Backing up the database
 - on the fixed disk
 - to the removable media.
 - to the FTP server
- Restoring the database
 - from the backup partition of the fixed disk
 - from the removable media.
 - from the FTP server
- Repairing the database
- Copying the database from the active to the standby fixed disk
- Backing up system data to the removable media
- Restoring system data from a removable media

- Formatting the fixed disk of the standby **TDM**
- Formatting the removable media.

The procedures for performing database backups to the FTP server and restoring the database from the FTP server are in [Remote Database Backup and Restore Procedures](#).

The procedures in this chapter refer to the **Maintenance and Administration Subsystem Processor (MASP)**, **Terminal Disk Module (TDM)** and the Maintenance Disk and Alarm Card (**MDAL**), and E5-MCAP cards.

The **TDM** is associated with a specific E5-MCAP card. For example, the **TDM** in location 1114 is associated with the E5-MCAP card in location 1113 and the combination of these two cards is designated as **MASP A**. The **TDM** in location 1116 is associated with the E5-MCAP card in location 1115 and the combination of these two cards designated as **MASP B**. When **MASP A** is active, the E5-MCAP card in location 1113 and **TDM** in location 1114 are active. When **MASP A** is standby, the E5-MCAP card in location 1113 and **TDM** in location 1114 are standby. One **MASP** is always active and the other **MASP** is always standby.

To determine which **MASP** is active, enter the `rept-stat-db` command, the `rept-stat-card` command.

The output of the `rept-stat-db` command shows which **MASP** is active with the indicator (`ACTV`) following the **TDM** card location. The indicator (`STDBY`) following the **TDM** card location shows which **MASP** is standby.

The output of the `rept-stat-card` command shows which **MASP** is active with the entry `ACTIVE` in the `SST` field for the E5-MCAP card. The entry `STANDBY` in the `SST` field for the E5-MCAP card shows which **MASP** is standby.

The database commands, such as `rept-stat-db`, refer to the **TDM** because the **TDM** contains the fixed disk drive for the **MASP**.

Refer to [Maintenance and Administration Subsystem](#) for more information about the Maintenance and Administration Subsystem.

Refer to *Hardware Guide* for more information about the cards that make up the Maintenance and Administration Subsystem.

Removable USB Drive

Purpose:

This section is referenced in this manual by many procedures requiring the use of the removable USB thumb disk in the E5-MASP card. The procedures found in this section are recommended procedures for handling the removable USB drive in the E5-MASP card.

Requirements:

None

Procedure - Remove USB Drive

1. Verify that the removable USB drive is locked in position and in use.

The removable drive latch (SW1) is in the LOCKED position and the Removable Media Status **LED** on the E5-MASP is Off. Refer to [Figure 2-1](#).

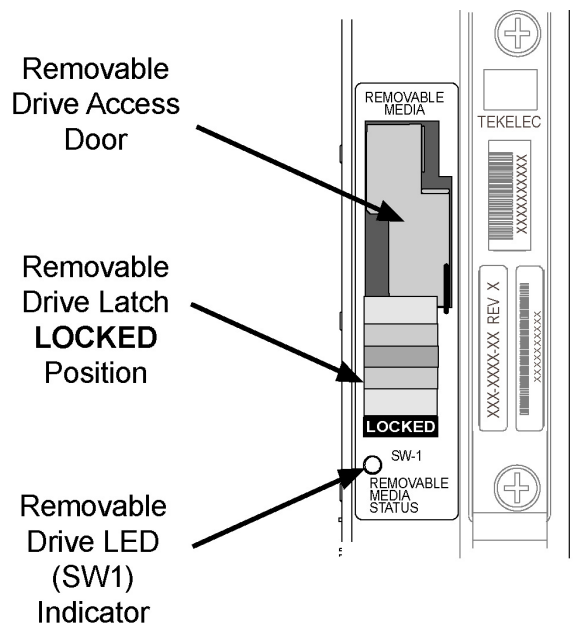
Figure 2-1 Removable USB Drive LOCKED

2. Move SW1 from the LOCKED to the unlocked position and wait for the LED to indicate a steady blue state. See [Figure 2-2](#).

When SW1 is transitioned from locked to unlocked, the LED will flash blue to indicate the drive is unlocked and in process of shutting down.

Caution: Removal of the drive prior to the LED indicating steady blue could result in drive corruption.

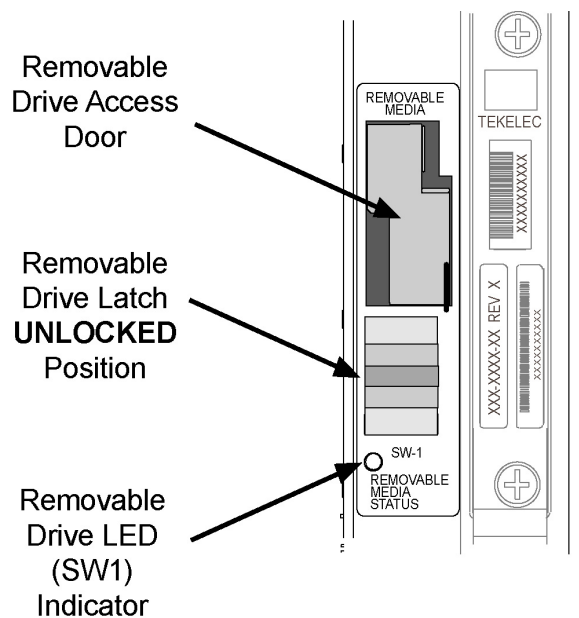
Figure 2-2 Removable USB Drive UNLOCKED

3. When the LED indicates a steady blue state, the removable USB drive can be safely removed. The LED is off when the USB drive is fully ejected from the drive media.

The USB drive can now be removed from the drive media.

4. Lift the access door up, swing it past the detent position so that the door remains open on its own.
5. Grasp the pull tab of the slide and pull the slide out slowly until it stops (it travels about a half inch).

Caution: The full travel of the slide is less than an inch, do not try to pull the assembly to expose the full length of the thumb drive as this is beyond the slide's designed travel.

6. The USB drive is disengaged and can be taken from the inject eject assembly.
7. Insert a USB drive into the inject-eject assembly.
8. Grasp the pull tab of the slide and push the slide in slowly until you feel the USB drive is seated in its slot (it travels about a half inch).
9. Close the access door.
10. Move SW1 from the unlocked to the LOCKED position.

When SW1 is transitioned from unlocked to locked, the LED will flash blue to indicate the drive is locked and in process of coming online.

11. When the LED turns Off, the removable USB drive is ready for use.

Verifying the Database

Verifying the database means to check the operational status of the database. The `rept-stat-db` command is used to check the operational status of the database. The `rept-stat-db` command has three optional parameters that can be used with it, `display`, `loc`, and `db`.

The `display` parameter can use four values: `brief` (the default value), `except`, `all`, and `version`. The value for the `loc` parameter is the card location of the card, based on the **GPL** assigned to the card, whose database you wish to verify. These card locations are shown in *Hardware Reference*. The `db` parameter specifies which database to display: `stp` (the **EAGLE** databases), `mpps` (the **MPS** databases) and `all` (both **STP** and **MPS** databases).

The operational status of the database is shown by the indicator **C**. This indicator shows whether the database is coherent. **Coherency** is an indication of whether the update to the database was successful. Each database has a coherency indicator. When an update is attempted, the coherency indicator is set to "incoherent" before the actual update is executed. When the update has been successfully completed, the coherency indicator is changed to coherent. If the update is not successful, the coherency indicator is not changed. If the coherency indicator is incoherent, this could be an indication of possible internal coherency problems when a restart is executed (for example, an index table was updated, but the corresponding data storage table was not modified).

For more information about the `rept-stat-db` command, refer to the `rept-stat-db` command description in *Commands User's Guide*.

```

rlghncxa03w 09-03-01 16:07:48 GMT EAGLE5 40.1.0
DATABASE STATUS: >> NOT OK <<
      TDM 1114 ( STDBY)                TDM 1116 ( ACTV )
      C  LEVEL      TIME LAST BACKUP   C  LEVEL      TIME LAST BACKUP
      - - - - -
FD BKUP Y          35 09-02-01 10:19:18 GMT Y          35 09-02-01 10:19:18 GMT
FD CRNT Y          106                                Y          106
      MDAL 1117
      - - - - -
RD BKUP N          106 INCOHERENT

```

If the E5-MASP is being used, this is an example of the `rept-stat-db` output.

```

rlghncxa03w 09-03-01 16:07:48 GMT EAGLE5 40.1.0
DATABASE STATUS: >> NOT OK <<
      TDM 1114 ( STDBY)                TDM 1116 ( ACTV )
      C  LEVEL      TIME LAST BACKUP   C  LEVEL      TIME LAST BACKUP
      - - - - -
FD BKUP Y          35 09-02-01 10:19:18 GMT Y          35 09-02-01 10:19:18 GMT
FD CRNT Y          106                                Y          106
      MCAP 1113                                MCAP 1115
      - - - - -
RD BKUP N          106 INCOHERENT            N          106 INCOHERENT
USB BKP -          -          -          -          Y          3 09-02-01 01:11:22 GMT

```

The `chg-db:action=backup:dest=remove` command is also used to backup the current database on both fixed disks to the removable cartridge.

- If the backup partition of both fixed disks are coherent and the current partition of both fixed disks are not coherent, use the `chg-db:action=restore:src=fixed` command. For more information, refer to [Restoring the Database from the Backup Partition of the Fixed Disk](#). This condition is shown in this example output of the `rept-stat-db` command.

```

rlghncxa03w 09-03-01 16:07:48 GMT EAGLE5 40.1.0
DATABASE STATUS: >> NOT OK <<
      TDM 1114 ( STDBY)                TDM 1116 ( ACTV )
      C  LEVEL      TIME LAST BACKUP   C  LEVEL      TIME LAST BACKUP
      - - - - -
FD BKUP Y          35 09-02-01 10:19:18 GMT Y          35 09-02-01 10:19:18 GMT
FD CRNT Y          35 DIFF LEVEL            N          68 INCOHERENT
      MDAL 1117
      - - - - -
RD BKUP -          -          -          -

```

If the E5-MASP is being used, this is an example of the `rept-stat-db` output.

```

rlghncxa03w 09-03-01 16:07:48 GMT EAGLE5 40.1.0
DATABASE STATUS: >> NOT OK <<
      TDM 1114 ( STDBY)                TDM 1116 ( ACTV )
      C  LEVEL      TIME LAST BACKUP   C  LEVEL      TIME LAST BACKUP
      - - - - -
FD BKUP Y          35 09-02-01 10:19:18 GMT Y          35 09-02-01 10:19:18 GMT
FD CRNT Y          35 DIFF LEVEL            N          68 INCOHERENT
      MCAP 1113                                MCAP 1115
      - - - - -

```



```

FD BKUP  N          35 INCOHERENT                Y          55 DIFF LEVEL
FD CRNT  N          106 INCOHERENT                Y          55 DIFF LEVEL
          MCAP 1113                               MCAP 1115
          - - - - -
RD BKUP  Y          106 09-01-31 14:29:03 GMT    Y          106 09-01-31 14:29:03 GMT
USB BKP  -          -    -    -                Y          3 09-01-15 01:11:22 GMT
    
```

If, after executing the appropriate change database command, the database is still not coherent, contact the Customer Care Center. Refer to [My Oracle Support \(MOS\)](#) for the contact information.

Backing Up the Database Locally

The **backup** procedures should be performed according to the preventive maintenance procedures in Chapter 2, “Preventive Maintenance,” of *Maintenance Guide*. The procedures copy the current database to either the inactive (backup) partition on the fixed disk or to the removable media. To backup a database, the `chg-db` command uses these parameters.

`:action=backup` – the operation to perform on the database, a backup of the current database

`:dest` – the destination of the backup operation.

- `fixed` – the backup partition of the fixed disk.
- `remove` – the removable media for E5-based control cards installed in the EAGLE.

The database can also be backed up to the FTP server. Perform the procedure [Making a Backup of the Database to the FTP Server](#) to backup the database to the FTP server.

Making a Backup of the Database on the Fixed Disk

This procedure is used to make a backup of the database on the fixed disk using the `chg-db` command with `action=backup` and `dest=fixed` parameters.

The databases in the current partitions of both **MASPs (FD CRNT)** must be coherent. For more information on verifying the database, refer to [Verifying the Database](#).

1. Verify that the databases in the current partitions of both **MASPs (FDCRNT)** are coherent using the `rept-stat-db` command.

This is an example of the possible output.

```

rlghncxa03w 06-10-01 16:07:48 GMT  EAGLE5 36.0.0
DATABASE STATUS: >> OK <<
          TDM 1114 ( STDBY)                TDM 1116 ( ACTV )
          C  LEVEL      TIME LAST BACKUP    C  LEVEL      TIME LAST BACKUP
          - - - - -
FD BKUP  Y          35 04-06-01 10:19:18 GMT  Y          35 04-06-01 10:19:18 GMT
FD CRNT  Y          106                        Y          106
          MDAL 1117
          - - - - -
RD BKUP  Y          106 04-05-31 14:29:03 GMT
    
```

If E5-based control cards are installed in the EAGLE, this is an example of the possible output.

```

rlghncxa03w 09-03-01 16:07:48 GMT  EAGLE5 40.1.0
    
```

```

DATABASE STATUS: >> OK <<
          TDM 1114 ( STDBY )                TDM 1116 ( ACTV )
          C LEVEL      TIME LAST BACKUP    C LEVEL      TIME LAST BACKUP
          -----
FD BKUP Y          35 09-02-19 10:19:18 GMT Y          35 09-02-19 10:19:18 GMT
FD CRNT Y          106
          MCAP 1113                          MCAP 1115
          -----
RD BKUP -          -          -          -          Y          106 09-02-08 14:29:03 GMT
USB BKP -          -          -          -          Y           3 09-02-07 01:11:22 GMT

```

2. Enter the `chg-db:action=backup:dest=fixed` command.

This command can take up to 30 minutes to execute, depending on other system activity that is in progress when this command is entered. The action of this command is shown in [Figure 2-3](#).

Note: If this command takes more than 60 minutes to execute, contact [My Oracle Support \(MOS\)](#).

Figure 2-3 Backup Action on the Fixed Disk

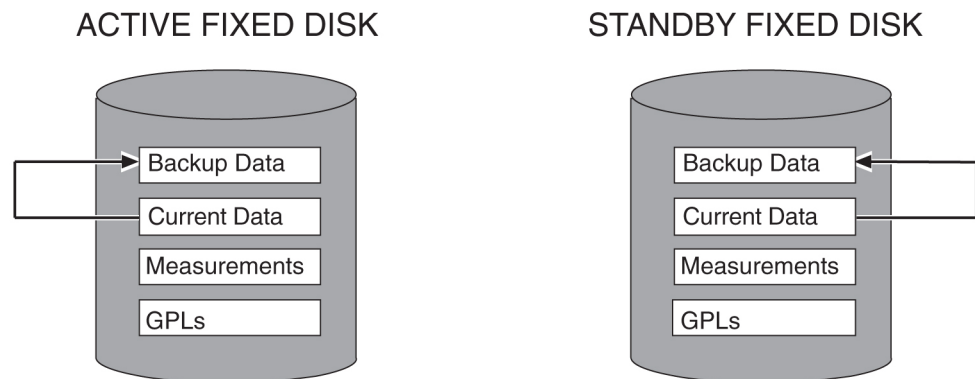

During command execution, these messages appear (the active **MASP** is displayed first):

```

BACKUP (FIXED) : MASP A - Backup starts on active MASP.
BACKUP (FIXED) : MASP A - Backup on active MASP to fixed disk complete.
BACKUP (FIXED) : MASP A - Backup starts on standby MASP.
BACKUP (FIXED) : MASP A - Backup on standby MASP to fixed disk complete.

```

3. Verify that the databases of both **MASPs** are coherent using the `rept-stat-db` command.

This is an example of the possible output.

```

rlghncxa03w 06-10-01 16:07:48 GMT EAGLE5 36.0.0
DATABASE STATUS: >> OK <<
          TDM 1114 ( STDBY )                TDM 1116 ( ACTV )
          C LEVEL      TIME LAST BACKUP    C LEVEL      TIME LAST BACKUP
          -----
FD BKUP Y          106 04-06-01 16:09:17 GMT Y          106 04-06-01 16:09:17 GMT
FD CRNT Y          106                          Y          106
          MDAL 1117

```

```

- -----
RD BKUP  Y      106 04-05-31 14:29:03 GMT

```

If E5-based control cards are installed in the EAGLE, this is an example of the possible output.

```

rlghncxa03w 09-03-01 16:07:48 GMT  EAGLE5 40.1.0
DATABASE STATUS: >> OK <<
      TDM 1114 ( STDBY )                TDM 1116 ( ACTV )
      C  LEVEL      TIME LAST BACKUP    C  LEVEL      TIME LAST BACKUP
      - -----
FD BKUP Y      106 09-03-01 16:09:18 GMT Y      106 09-03-01 16:09:18 GMT
FD CRNT Y      106
      MCAP 1113                          MCAP 1115
      - -----
RD BKUP -      -      -      -      Y      106 09-02-08 14:29:03 GMT
USB BKP -      -      -      -      Y      3 09-02-07 01:11:22 GMT

```

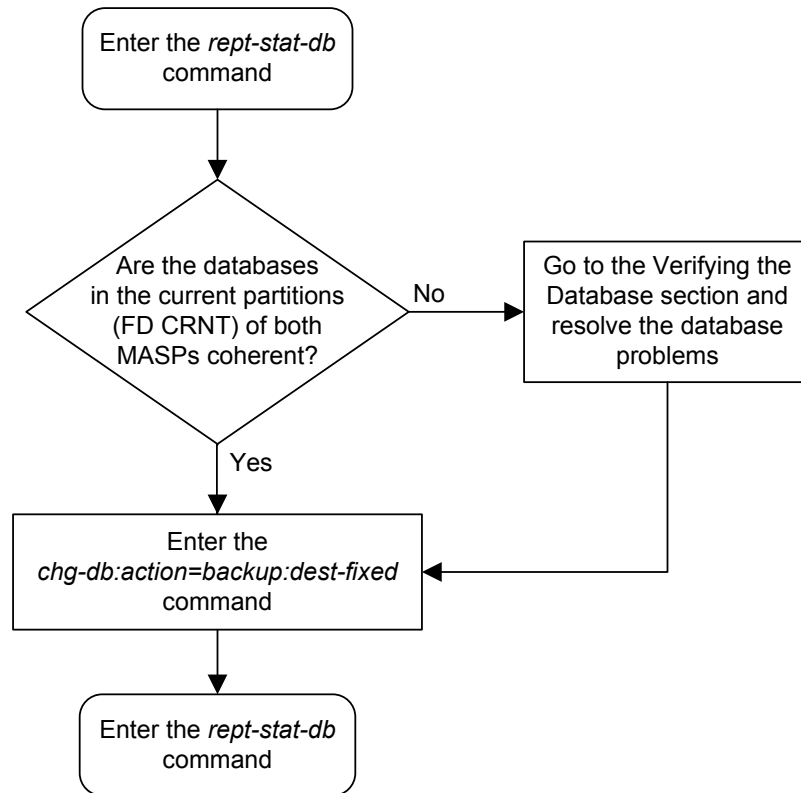
Figure 2-4 Making a Backup of the Database on the Fixed Disk

Making a Backup of the Database to the Removable Media

This procedure is used to make a backup of the database to the or removable media using the `chg-db` command with the `action=backup` and `dest=remove` parameters.

The database in the current partition of the active **MASP (FD CRNT)** must be coherent. For more information on verifying the database, refer to [Verifying the Database](#).

Formatting blank removable media for E5-based control cards that are installed in the EAGLE is required. If the removable media is not formatted, perform [Formatting Removable Media](#) to format the media.

1. Verify that the database in the current partition of the active **MASP (FDCRNT)** is coherent using the `rept-stat-db` command.

This is an example of the possible output.

```
rlghncxa03w 06-10-13 16:07:48 GMT EAGLE5 45.0.0
DATABASE STATUS: >> OK <<
      E5TDM 1114 ( STDBY )           E5TDM 1116 ( ACTV )
      C  LEVEL      TIME LAST BACKUP  C  LEVEL      TIME LAST BACKUP
      - - - - -
FD BKUP Y          35 04-06-01 10:19:18 GMT Y          35 04-06-01 10:19:18 GMT
FD CRNT Y          106
      E5MDAL 1117
      - - - - -
RD BKUP -          -          -          -
```

The following is an example of the possible output.

```
rlghncxa03w 06-03-13 16:07:48 GMT EAGLE5 45.0.0
DATABASE STATUS: >> OK <<
      E5TDM 1114 ( STDBY )           E5TDM 1116 ( ACTV )
      C  LEVEL      TIME LAST BACKUP  C  LEVEL      TIME LAST BACKUP
      - - - - -
FD BKUP Y          35 09-02-19 10:19:18 GMT Y          35 09-02-19 10:19:18 GMT
FD CRNT Y          106
      E5MCAP 1113
      - - - - -
RD BKUP -          -          -          -
USB BKP -          -          -          -
```

If the database in the current partition of the active MASP is not coherent, refer to [Verifying the Database](#) to resolve the database problem.

If the database in the current partition of the active MASP is coherent, or after the database problem has been resolved, continue the procedure by performing one of these steps.

2. The database can be backed up to the removable media in the active MASP or in both MASPs (if the removable media is present in both MASPs).

Perform one of these substeps.

- a. If the database will be backed up to the removable media in both MASPs, check the removable media drives in both MASPs for removable media.

If removable media is present in both MASP, continue the procedure by performing one of these steps.

- If the removable media will be used for the backup, continue the procedure with 3. When the backup is performed, the database in the current partition of each fixed disk is copied to the corresponding removable media on each MASP.
- If the removable media will not be used for the backup, remove the media that will not be used for the backup and insert the media that will be used for the backup. Refer to [Removable USB Drive](#) for information about removing and inserting the removable media. After the media has been inserted into the removable media drives, continue the procedure with 3.

If the removable media drives in both MASP are empty, insert the media that will be used for the backup. Refer to [Removable USB Drive](#) for information about inserting the removable media. After the media has been inserted into the removable media drives, continue the procedure with 3.

If the removable media drive in only one MASP contains removable media, continue the procedure by performing one of these steps.

- If the removable media that is present will be used for the backup, insert the media that will be used for the backup into the empty removable media drive. Refer to [Removable USB Drive](#) for information about inserting the removable media. After the media has been inserted into the removable media drive, continue the procedure with 3.
 - If the removable media that is present will not be used for the backup, remove the media from that removable media drive and insert the media that will be used for the backup into both removable media drives. Refer to [Removable USB Drive](#) for information about removing and inserting the removable media. After the media has been inserted into the removable media drives, continue the procedure with 3.
- b. If the database will be backed up to the removable media in only one MASP, the removable media must be inserted in the removable media drive on the active MASP. Check the removable media drives in both MASP for removable media.

If removable media is inserted into the removable media drive on active MASP and no removable media is inserted into the removable media drive on the standby MASP, and this media will be used for the backup, continue the procedure with 3. When the backup is performed, the database in the current partition of the fixed disk on the active MASP is copied to the removable media on the active MASP.

If removable media is inserted into the removable media drive on active MASP and no removable media is inserted into the removable media drive on the standby MASP, and this media will not be used for the backup, remove the media from the removable media drive and insert the media that will be used for the backup into the removable media drive on the active MASP. After the media has been inserted, continue the procedure with 3.

If removable media is inserted into the removable media drive on standby MASP and no removable media is inserted into the removable media drive on the active MASP, remove the media from the removable media drive and insert the media that will be used for the backup into the removable media drive on

the active MASP. After the media has been inserted, continue the procedure with 3.

If removable media drives in both MASPs are empty, insert the media that will be used for the backup into the removable media drive on the active MASP. After the media has been inserted, continue the procedure with 3.

3. Backup the database by entering this command.

```
chg-db:action=backup:dest=remove
```

During command execution, these messages should appear.

```
BACKUP (REMOVABLE) : MASP A - Backup starts on active MASP.
BACKUP (REMOVABLE) : MASP A - Backup to removable device complete.
```

Note: This command can take up to 30 minutes to execute, depending on the size of the database and other system activity that is in progress when this command is entered. If this command takes more than 60 minutes to execute, contact the Customer Care Center for assistance. Refer to [My Oracle Support \(MOS\)](#) for the contact information.

4. Verify that the databases on the removable media (RD BKUP on both MASPs or the active MASP if the backup was performed only to the removable media on the active MASP) and the current partition of the active MASP (FD CRNT) are coherent using the `rept-stat-db` command.

If the database was backed up to the removable media, this is an example of the possible output.

```
rlghncxa03w 06-03-13 16:07:48 GMT EAGLE5 45.5.0
DATABASE STATUS: >> OK <<
      E5TDM 1114 ( STDBY )                E5TDM 1116 ( ACTV )
      C  LEVEL      TIME LAST BACKUP    C  LEVEL      TIME LAST BACKUP
      - - - - -
FD BKUP Y          35 09-02-19 10:19:18 GMT Y          35 09-02-19 10:19:18 GMT
FD CRNT Y           106
      E5MCAP 1113                          E5MCAP 1115
      - - - - -
RD BKUP Y           106 09-03-23 16:09:53 GMT Y           106 09-03-23 16:09:53 GMT
USB BKP -           -           -           -           -           -
```

Note: If the database was backed up to only the removable media on the active MASP, then only the RD BKUP entry for the active MASP (in this example, MCAP 1115) is displayed.

5. If the database was backed up to the removable media, remove the removable media from the removable media drives on the MASPs. For more information on removing the removable media from the removable media drives, refer to [Removable USB Drive](#).
6. Label the removable media 1 through 4 if the backup is performed weekly or monthly, A through D if the backup is performed quarterly.

For more information on labeling the removable media, see Chapter 2, "Preventive Maintenance," in *Maintenance Guide*.

Figure 2-5 Making a Backup of the Database to the Removable Cartridge or Removable Media

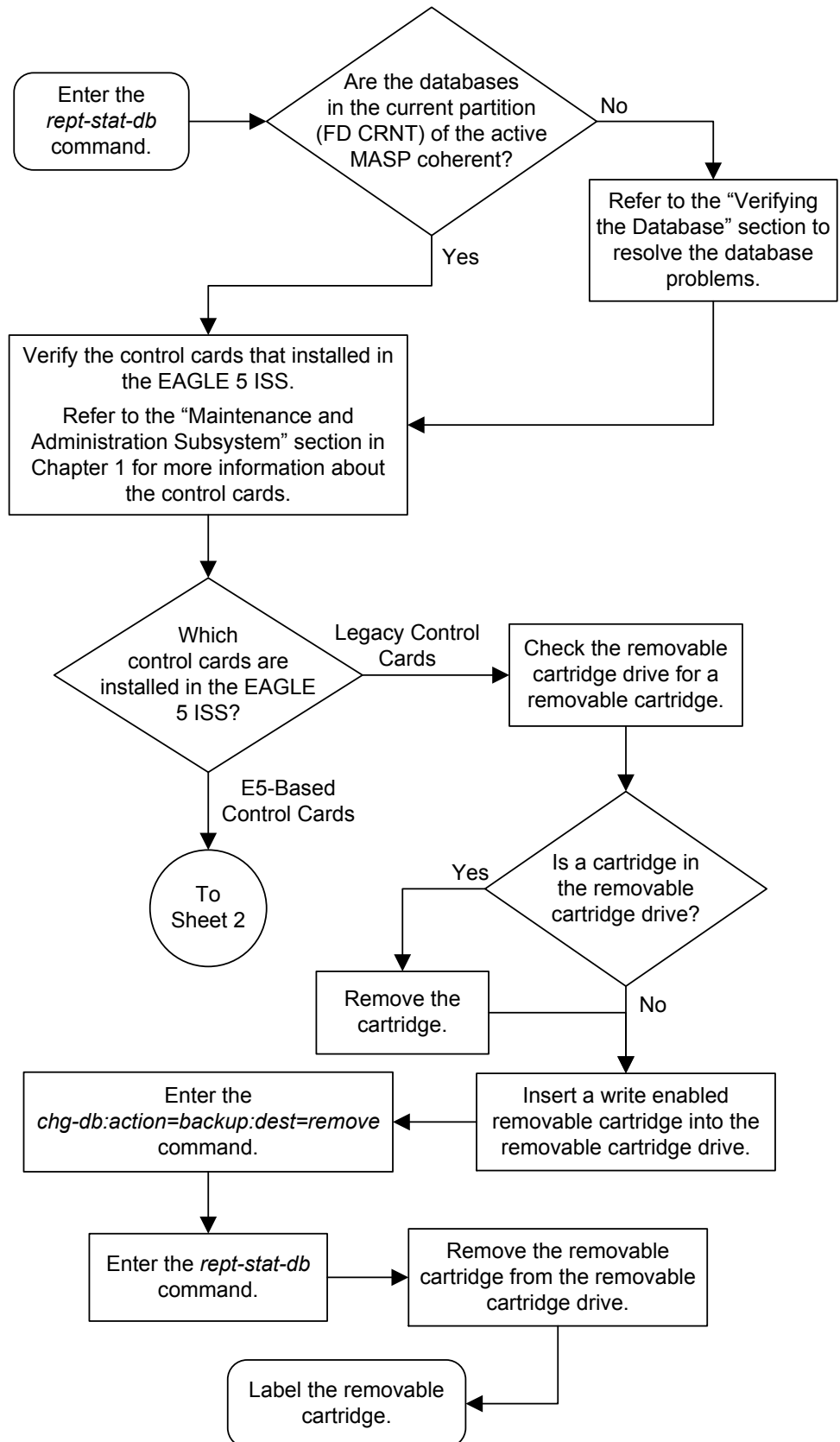

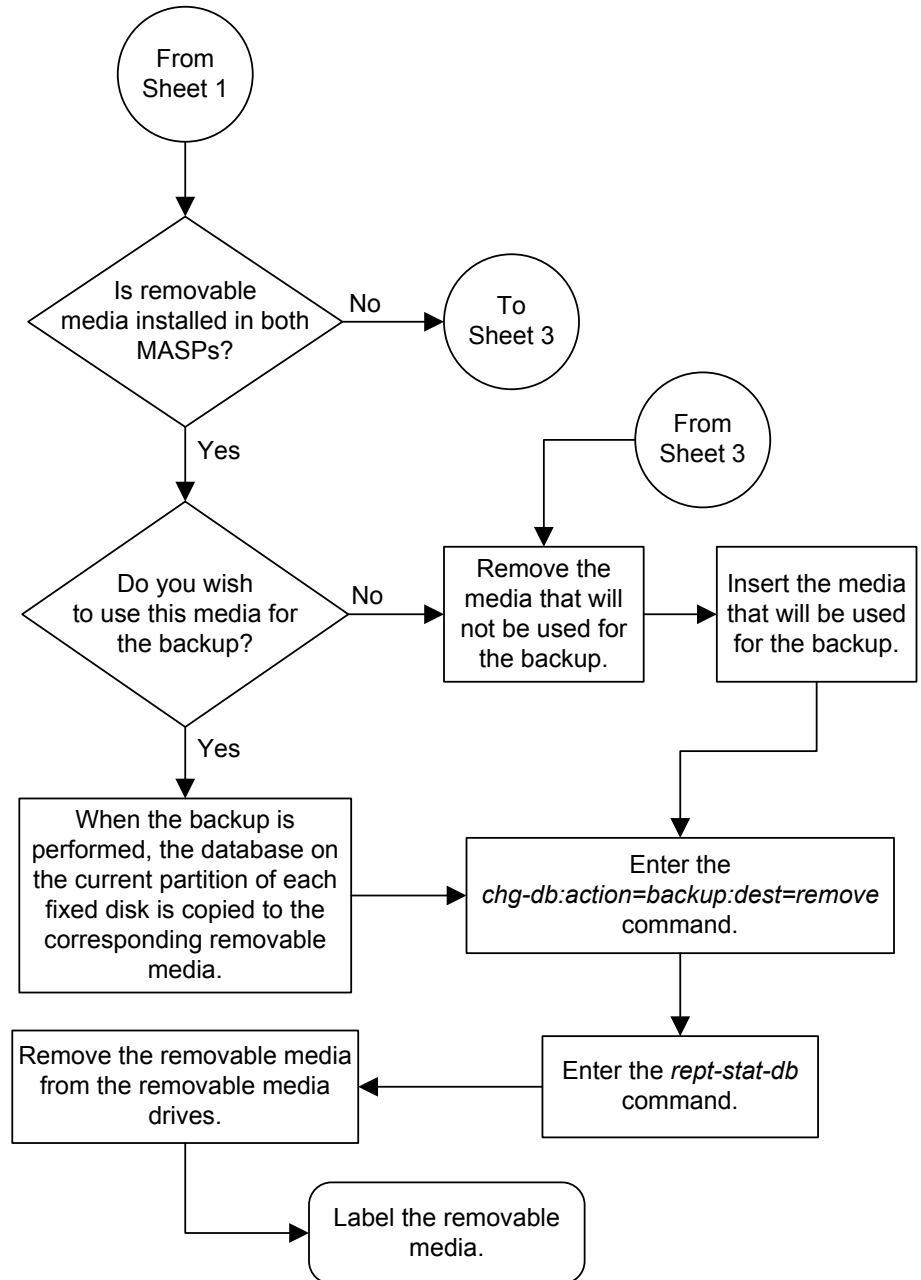

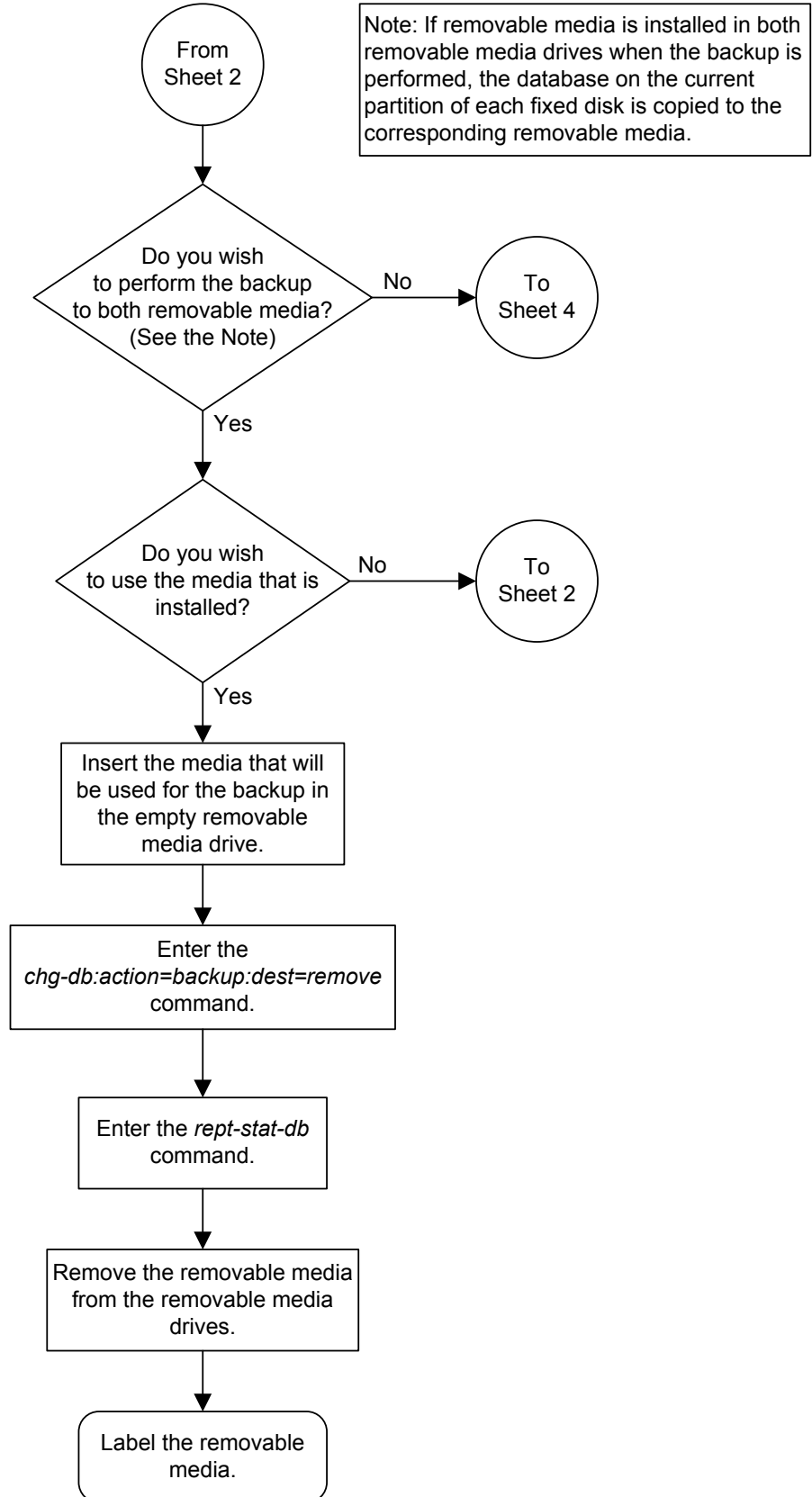

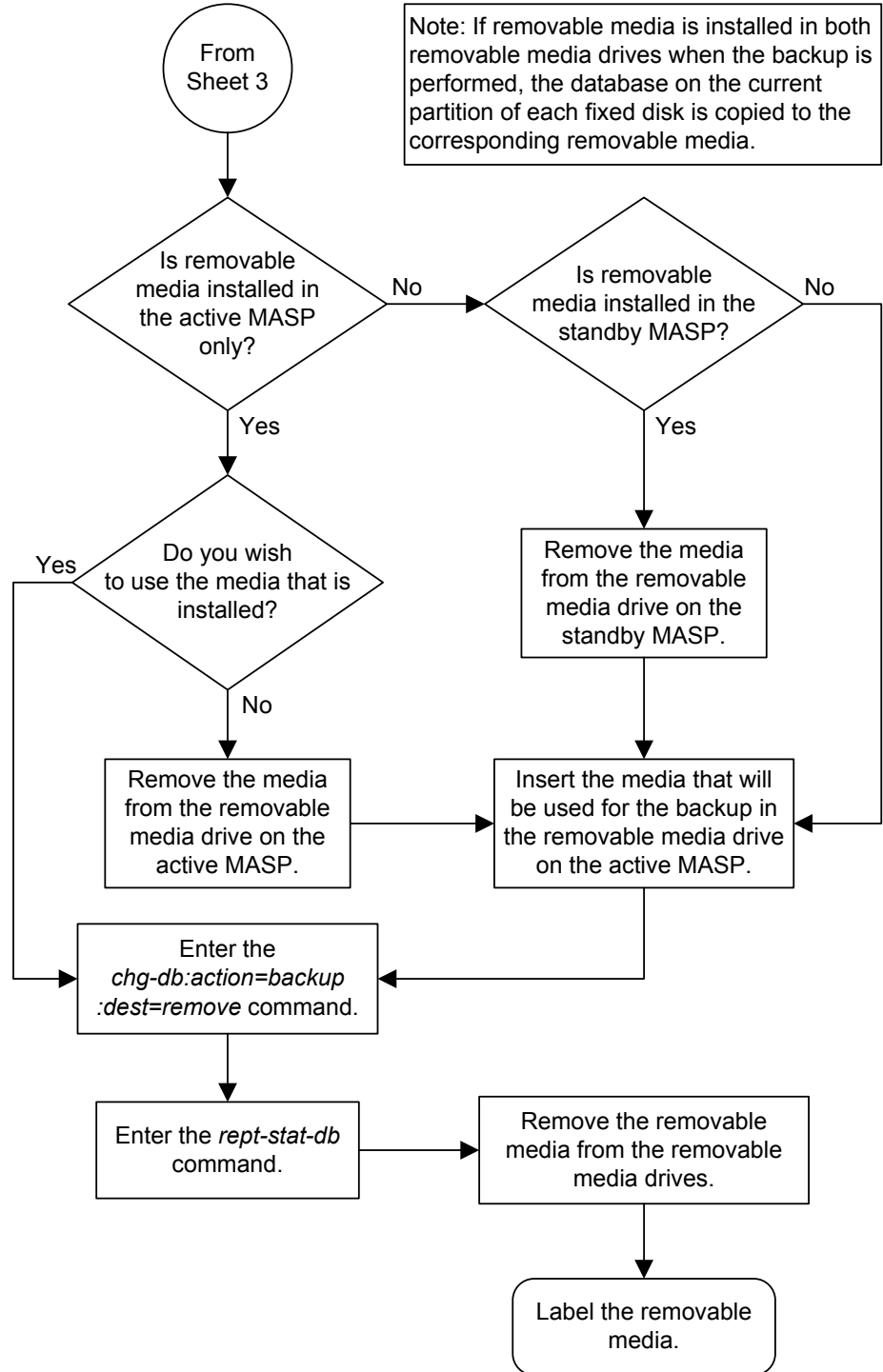

Restoring the Database Locally

The **restore** procedures are used to bring a database from the backup partition of both **MASPs** and load the database onto the current partitions of both **MASPs**. It is also used to load a database from a removable media on to the current partitions of both **MASPs**. To restore a database, the `chg-db` command uses these parameters.

`:action=restore` – the operation to perform on the database, restoring a previously backed up database

`:src` – the source of the database that is being restored.

- `fixed` – the backup partition of the fixed disk.
- `remove` – the removable media for E5-based control cards installed in the EAGLE.
- `sloc` – the source location (either 1113 or 1115) of the MASP that contains the removable media from which the database will be restored. The `sloc` parameter can be specified only with the `src=remove` parameter.

The database can also be restored from the FTP server. Perform the procedure [Restoring the Database from the FTP Server](#), to restore the database from the FTP server.

Caution: If the restore device state option is on, shown by the ON value for the RSTRDEV field in the `rtrv-stpopts` command output, the state of the cards, **SS7** signaling links, **TCP/IP** data links, and terminals before the `chg-db:action=restore` and `init-sys` commands are performed will not be maintained after these commands are performed. The persistent device state table becomes obsolete and is disabled. **UIM 1257** is generated.

```
rlghncxa03w 06-10-01 16:07:48 GMT EAGLE5 36.0.0
1234.1257 SYSTEM INFO DB Restore has cleared and disabled PDS
```

Restoring the Database from the Backup Partition of the Fixed Disk

This procedure is used to restore the database from the backup partition of the fixed disk using the `chg-db` command with the `action=restore` and `src=fixed` parameters.

The databases in the backup partitions of both **MASPs (RD BKUP)** must be coherent. For more information on verifying the database, refer to [Verifying the Database](#).

Caution: Using the `action=restore` parameter with the `chg-db` command is an emergency recovery procedure, and requires the `init-sys` command to download the restored database to all the cards in the EAGLE 5

1. Verify that the databases in the backup partitions of both **MASPs (FD BKUP)** are coherent using the `rept-stat-db` command.

The following is an example of the possible output:

```
rlghncxa03w 13-07-01 16:07:48 GMT EAGLE5 45.0.0
```

```

DATABASE STATUS: >> OK <<
      E5TDM 1114 ( STDBY )                E5TDM 1116 ( ACTV )
      C  LEVEL      TIME LAST BACKUP      C  LEVEL      TIME LAST BACKUP
      - - - - -
FD BKUP Y          35 04-06-01 10:19:18 GMT Y          35 04-06-01 10:19:18 GMT
FD CRNT Y          106
      E5MDAL 1117
      - - - - -
RD BKUP - - - - -

```

The following is an example of the possible output:

```

rlghncxa03w 13-06-01 16:07:48 GMT EAGLE5 45.0.0
DATABASE STATUS: >> OK <<
      E5TDM 1114 ( STDBY )                E5TDM 1116 ( ACTV )
      C  LEVEL      TIME LAST BACKUP      C  LEVEL      TIME LAST BACKUP
      - - - - -
FD BKUP Y          35 09-02-19 10:19:18 GMT Y          35 09-02-19 10:19:18 GMT
FD CRNT Y          106
      E5MCAP 1113                          E5MCAP 1115
      - - - - -
RD BKUP - - - - -
USB BKP - - - - -

```

2. Enter the `chg-db:action=restore:src=fixed` command.

This command can take up to 30 minutes to execute, depending on other system activity that is in progress when this command is entered.

Note: If this command takes more than 60 minutes to execute, contact the Customer Care Center for assistance. Refer to [My Oracle Support \(MOS\)](#) for the contact information.

During command execution, these messages appear (the active **MASP** is displayed first):

```

RESTORE (FIXED) : MASP A - Restore starts on active MASP.
RESTORE (FIXED) : MASP A - Restore from fixed disk on active MASP complete.
RESTORE (FIXED) : MASP A - Restore starts on standby MASP.
RESTORE (FIXED) : MASP A - MASP(s) will reboot to load data.
RESTORE (FIXED) : MASP A - Restore from fixed disk on stdby MASP complete.

```

The action of this command is shown in [Figure 2-6](#).

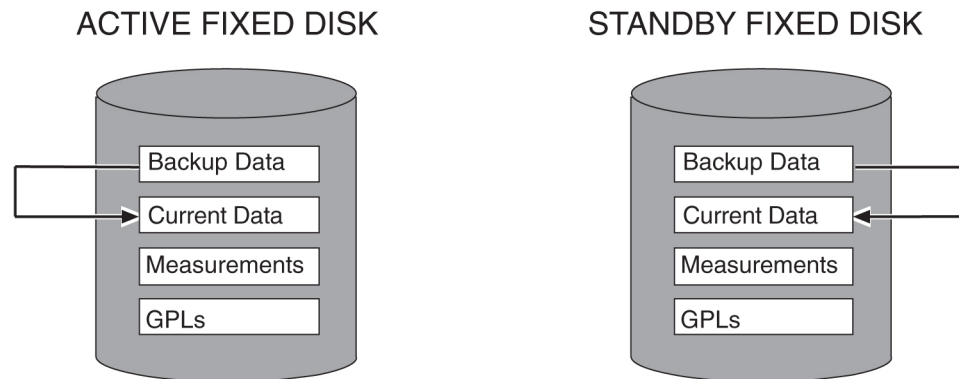
Figure 2-6 Restore Action on the Fixed Disk

- When the commands have successfully completed, re-initialize the **EAGLE 5** using the `init-sys` command.

Caution: The `init-sys` command causes a complete reload of the **EAGLE 5**, and should only be used during periods of low traffic. Using this command ensures that all cards are running the same database, but will interrupt service.

Note: The `init-sys` command must be entered twice within 30 seconds for the **EAGLE 5** to be re-initialized. If the `init-sys` command is not executed twice within 30 seconds, the attempt to re-initialize the **EAGLE 5** is aborted.

When the `init-sys` command is first entered, this message should appear.

```
rlghncxa03w 06-10-01 07:05:01 GMT EAGLE5 36.0.0
CAUTION: This command causes a complete system reload, and
will result in traffic loss.
Re-enter command within 30 seconds to confirm.
```

When the `init-sys` command is re-entered within the 30 second time limit, this message should appear.

```
rlghncxa03w 06-10-01 07:05:17 GMT EAGLE5 36.0.0
Init System command issued at terminal #3
```

From the time that the `init-sys` command is accepted, you must wait approximately 2 minutes before you can perform step 4 (logging into the **EAGLE 5**). If the **EAGLE 5** terminal is in the **VT-100/VT-320** mode, the terminal display will be refreshed with non-zero alarm counts. During this 2 minutes interval, an intermediate screen refresh caused by the **MASPs** role change from active to standby, and from standby to active. This screen refresh is typically a partial refresh and the alarm indicators are set to zero.

If you are logged into the **EAGLE 5** in the **KSR** mode, the only response you will receive that you are now able to log into the **EAGLE 5** is that you will receive **UAM 0009, MASP became active**. **UAM 0009** could be issued twice due to possible transient **MASP** role change (switching from active to standby). Following the execution of the `init-sys` command, the **MASP** that was active before the `init-`

sys command was entered will be the active **MASP** when the **EAGLE 5** has finished reinitializing.

4. Log into the **EAGLE 5** using the `login` or `act-user` command.

This is an example of the messages that appear when you have successfully logged onto the **EAGLE 5**.

```
NOTICE: This is a private computer system.
Unauthorized access or use may lead to prosecution.
```

```
0 LOGIN failures since last successful LOGIN
Last successful LOGIN was on port 4 on 04-06-01 @ 09:34:56
```

5. Verify that the databases of both **MASPs** are coherent using the `rept-stat-db` command.

This is an example of the possible output.

```
rlghncxa03w 13-06-01 16:07:48 GMT EAGLE5 45.0.0
DATABASE STATUS: >> OK <<
      E5TDM 1114 ( STDBY )                E5TDM 1116 ( ACTV )
      C  LEVEL      TIME LAST BACKUP    C  LEVEL      TIME LAST BACKUP
      - - - - -
FD BKUP Y          35 04-06-01 10:19:18 GMT Y          35 04-06-01 10:19:18 GMT
FD CRNT Y           35                      Y           35
      E5MDAL 1117
      - - - - -
RD BKUP -          -          -          -          -          -
```

The following is an example of the possible output:

```
rlghncxa03w 13-07-01 16:07:48 GMT EAGLE5 45.0.0
DATABASE STATUS: >> OK <<
      E5TDM 1114 ( STDBY )                E5TDM 1116 ( ACTV )
      C  LEVEL      TIME LAST BACKUP    C  LEVEL      TIME LAST BACKUP
      - - - - -
FD BKUP Y          35 09-02-19 10:19:18 GMT Y          35 09-02-19 10:19:18 GMT
FD CRNT Y           35                      Y           35
      E5MCAP 1113                E5MCAP 1115
      - - - - -
RD BKUP -          -          -          -          -          -
USB BKP -          -          -          -          -          -
```

Figure 2-7 Restoring the Database from the Backup Partition of the Fixed Disk

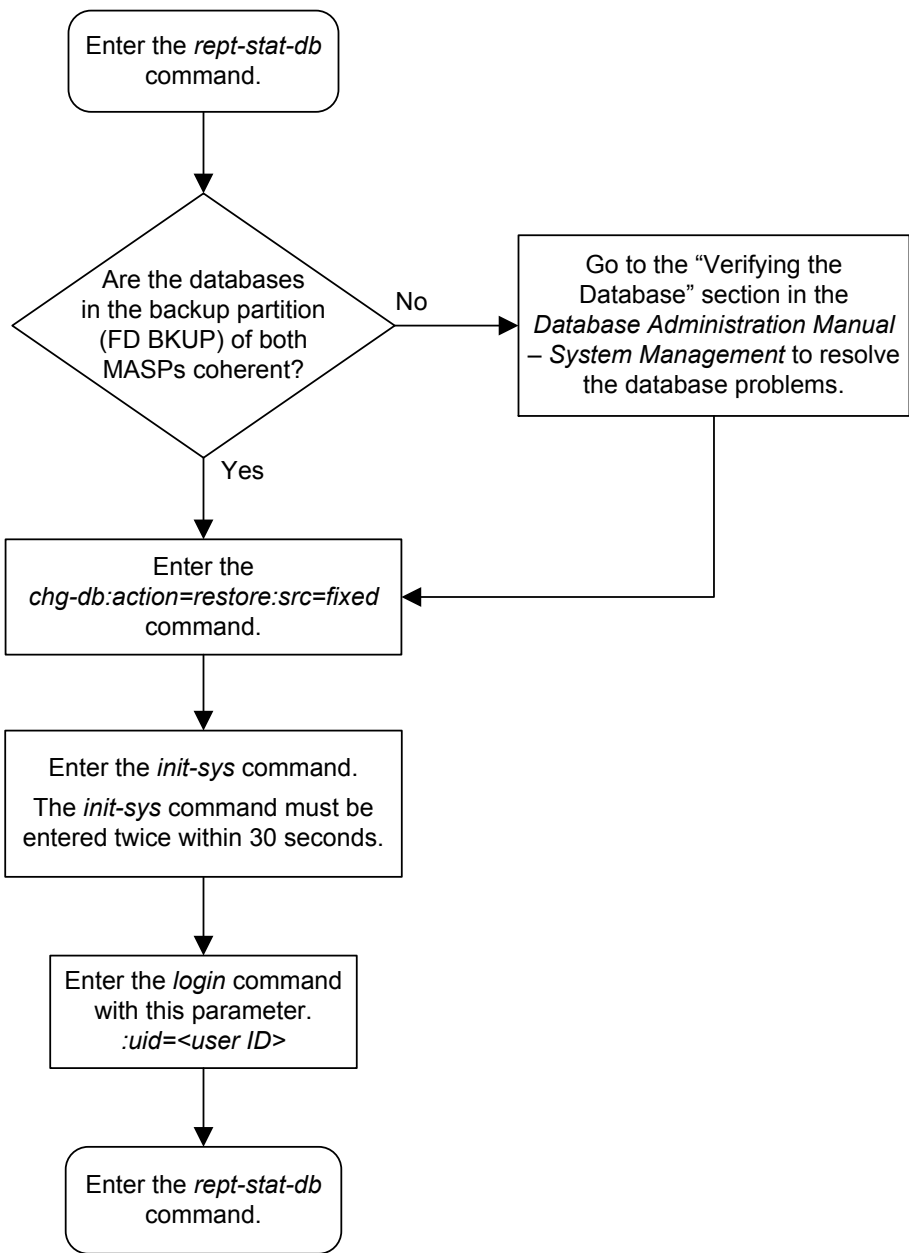

Restoring the Database from the Removable Media

This procedure is used to restore the database from the removable media using the `chg-db` command with the `action=restore` and `src=remove` parameters.

Removable media that contains the database being restored must be inserted into the removable media drive in one or both of the MASP. When the database is being restored, the database on the removable media in one of the MASP is copied to the current partition of both fixed disks. The removable media to copy the database from is specified with the `sloc` parameter. The value of the `sloc` parameter is the location of the MASP that contains the removable media, either 1113 or 1115, that the database will be copied from. The `sloc` parameter is optional. If the `sloc` parameter is not specified, the database will be copied from the removable media in the active MASP. If removable media is installed in both MASP, and the database levels of the removable media are not the same, the `sloc` parameter must be specified with the `chg-db` command. The database on the removable media (RD BKUP) must be coherent. If the database on the removable media is not coherent, contact the Customer Care Center for assistance. Refer to [My Oracle Support \(MOS\)](#) for the contact information.

Caution: Using the `action=restore` parameter with the `chg-db` command is an emergency recovery procedure, and requires the `init-sys` command to download the restored database to all the cards in the EAGLE.

1. Verify the control cards that are installed in the EAGLE.

Refer to [Maintenance and Administration Subsystem](#) for information about the control cards.

2. Verify that the database on the removable media (**RD BKUP**) is coherent using the `rept-stat-db` command.

- a. The following is an example of the possible output.

```
rlghncxa03w 06-10-13 16:07:48 GMT EAGLE5 45.0.0
DATABASE STATUS: >> OK <<
      E5TDM 1114 ( STDBY )                E5TDM 1116 ( ACTV )
      C LEVEL      TIME LAST BACKUP      C LEVEL      TIME LAST BACKUP
      -----
FD BKUP Y          35 09-10-01 10:19:18 GMT Y          35 09-10-01 10:19:18 GMT
FD CRNT Y           95
      E5MCAP 1113                          E5MCAP 1115
      -----
RD BKUP Y          106 09-09-30 16:09:53 GMT Y          106 09-09-30 16:09:53
GMT
USB BKP - - - - -
```

If removable media is installed in the MASP that you wish to use to restore the database, and you wish to use this media to restore the database, continue the procedure by performing one of these actions.

- If the database is coherent, continue the procedure with [3](#).
- If the database is not coherent, contact the Customer Care Center for assistance. Refer to [My Oracle Support \(MOS\)](#) for the contact information.

If removable media is installed in the MASP that you wish to use to restore the database, but you do not wish to use this media to restore the database, continue the procedure by performing these actions.

- Remove the media from the removable media drive.
- Insert the removable media that does contain the database that you wish to use to restore the database into the removable media drive that you wish to use.
- Enter the `rept-stat-db` command.
- If the database is coherent, continue the procedure with 3.
- If the database is not coherent, contact the Customer Care Center for assistance. Refer to [My Oracle Support \(MOS\)](#) for the contact information.

If removable media is not installed in the MASP that you wish to use to restore the database, continue the procedure by performing these actions.

- Insert the removable media that does contain the database that you wish to use to restore the database into the removable media drive that you wish to use.
- Enter the `rept-stat-db` command.
- If the database is coherent, continue the procedure with 3.
- If the database is not coherent, contact the Customer Care Center for assistance. Refer to [My Oracle Support \(MOS\)](#) for the contact information.

3. Restore the database by performing one of these substeps.

a. Enter the following command.

```
chg-db:action=restore:src=remove
```

During command execution, these messages should appear.

```
RESTORE (REMOVABLE) : MASP A - Restore starts on active MASP.  
RESTORE (REMOVABLE) : MASP A - Restore starts on standby MASP.  
RESTORE (REMOVABLE) : MASP A - MASP(s) will reboot to load data.  
RESTORE (REMOVABLE) : MASP A - Restore from removable drive complete.
```

Note: This command can take up to 30 minutes to execute, depending on the size of the database and other system activity that is in progress when this command is entered. If this command takes more than 60 minutes to execute, contact the Customer Care Center for assistance. Refer to [My Oracle Support \(MOS\)](#) for the contact information.

After this command has completed, continue the procedure with 4.

b. When the database is being restored from removable media, the database on the removable media in one of the MASPs is copied to the current partition of both fixed disks.

The removable media to copy the database from can be specified with the `sloc` parameter. The value of the `sloc` parameter is the location of the MASP that

contains the removable media, either 1113 or 1115, that the database will be copied from. The `sloc` parameter is optional. If the `sloc` parameter is not specified, the database will be copied from the removable media in the active MASP. If removable media is installed in both MASPs, and the database levels of the removable media are not the same, the `sloc` parameter must be specified with the `chg-db` command.

For this example, enter this command.

```
chg-db:action=restore:src=remove:sloc=1113
```

During command execution, these messages should appear.

```
RESTORE (REMOVABLE) : MASP A - Restore starts on active MASP.
RESTORE (REMOVABLE) : MASP A - Restore starts on standby MASP.
RESTORE (REMOVABLE) : MASP A - MASP(s) will reboot to load data.
RESTORE (REMOVABLE) : MASP A - Restore from removable drive complete.
```

Note: This command can take up to 30 minutes to execute, depending on the size of the database and other system activity that is in progress when this command is entered. If this command takes more than 60 minutes to execute, contact My Oracle Support for assistance. Refer to [My Oracle Support \(MOS\)](#) for the contact information.

After this command has completed, continue the procedure with 4.

4. When the commands have successfully completed, re-initialize the **EAGLE** using the `init-sys` command.

Caution: The `init-sys` command causes a complete reload of the **EAGLE**, and should only be used during periods of low traffic. Using this command ensures that all cards are running the same database, but will interrupt service.

Note: The `init-sys` command must be entered twice within 30 seconds for the **EAGLE** to be re-initialized. If the `init-sys` command is not executed twice within 30 seconds, the attempt to re-initialize the **EAGLE** is aborted.

When the `init-sys` command is first entered, this message should appear.

```
rlghncxa03w 06-10-01 07:05:01 GMT EAGLE5 36.0.0
CAUTION: This command causes a complete system reload, and
will result in traffic loss.
Re-enter command within 30 seconds to confirm.
```

When the `init-sys` command is re-entered within the 30 second time limit, this message should appear.

```
rlghncxa03w 06-10-01 07:05:17 GMT EAGLE5 36.0.0
Init System command issued at terminal #3
```

From the time that the `init-sys` command is accepted, you must wait approximately 2 minutes before you can perform 5 (logging into the **EAGLE**). If the **EAGLE** terminal is in the **VT-100/VT-320** mode, the terminal display will be refreshed with non-zero alarm counts. During this 2 minutes interval, an intermediate screen refresh caused by the **MASPs** role change from active to standby, and from standby to active. This screen refresh is typically a partial refresh and the alarm indicators are set to zero.

If you are logged into the **EAGLE** in the **KSR** mode, the only response you will receive that you are now able to log into the **EAGLE** is that you will receive **UAM 0009, MASP became active. UAM 0009** could be issued twice due to possible transient **MASP** role change (switching from active to standby). Following the execution of the `init-sys` command, the **MASP** that was active before the `init-sys` command was entered will be the active **MASP** when the **EAGLE** has finished reinitializing.

5. Log into the **EAGLE** using the `login` or `act-user` command.

This is an example of the messages that appear when you have successfully logged into the **EAGLE**.

```
NOTICE: This is a private computer system.
Unauthorized access or use may lead to prosecution.
```

```
0 LOGIN failures since last successful LOGIN
Last successful LOGIN was on port 4 on 04-06-01 @ 09:34:56
```

6. Verify that the databases on the removable media (RD BKUP), and the current partitions of both **MASPs** (**FD CRNT**) are coherent using the `rept-stat-db` command.

The following is an example of the possible output:

```
rlghncxa03w 06-10-13 16:07:48 GMT EAGLE5 45.0.0
DATABASE STATUS: >> OK <<
      E5TDM 1114 ( STDBY )                E5TDM 1116 ( ACTV )
      C LEVEL      TIME LAST BACKUP      C LEVEL      TIME LAST BACKUP
      - - - - -
FD BKUP Y          35 09-10-01 10:19:18 GMT Y          35 09-10-01 10:19:18 GMT
FD CRNT Y           95                    Y           95
      E5MCAP 1113                        E5MCAP 1115
      - - - - -
RD BKUP Y          106 09-09-30 16:09:53 GMT Y          106 09-09-30 16:09:53 GMT
USB BKP -          - - - - -              -          - - - - -
```

This procedure is finished.

7. Remove the removable media from the removable media drive on the **E5-MDAL** card.

Repairing the Database

Perform the **repair** procedure whenever the two fixed disks have a different database image, such as after a **MASP** failure. This procedure copies the fixed disk image of the database associated with the active **MASP** to the fixed disk of the standby **MASP**.

[Figure 2-8](#) illustrates this action. To repair a database, The `chg-db` command uses only

one parameter, `action=repair` – the operation to perform on the database, repairing a database

Figure 2-8 Action of the Repair Procedure

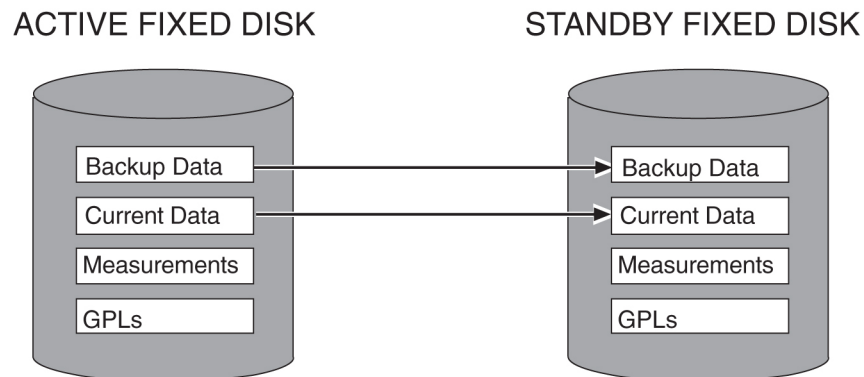

To repair the database, perform this procedure.

The databases in the current (**FD CRNT**) and the backup (**FD BKUP**) partitions of the active **MASP** must be coherent. For more information on verifying the database, refer to [Verifying the Database](#).

Caution: To prevent any potential database corruption when performing this procedure, the terminals must be placed out of service with the `rmv-trm` command before executing the `chg-db:action=repair` command.

1. Verify that the databases in the current (**FDCRNT**) and the backup (**FDBKUP**) partitions of the active **MASP** are coherent using the `rept-stat-db` command.

This is an example of the possible output.

```
rlghncxa03w 13-07-01 16:07:48 GMT EAGLE5 45.0.0
DATABASE STATUS: >> NOT OK <<
      E5TDM 1114 ( STDBY )           E5TDM 1116 ( ACTV )
      C LEVEL      TIME LAST BACKUP   C LEVEL      TIME LAST BACKUP
      -----
FD BKUP  N         35 INCOHERENT       Y         55 DIFF LEVEL
FD CRNT  N         106 INCOHERENT      Y         55
      E5MDAL 1117
      -----
RD BKUP  -         -         -         -
```

If E5-based control cards are installed in the EAGLE, this is an example of the possible output.

```
rlghncxa03w 13-07-01 16:07:48 GMT EAGLE5 45.0.0
DATABASE STATUS: >> OK <<
      E5TDM 1114 ( STDBY )           E5TDM 1116 ( ACTV )
      C LEVEL      TIME LAST BACKUP   C LEVEL      TIME LAST BACKUP
      -----
FD BKUP  N         35 INCOHERENT       Y         55 DIFF LEVEL
FD CRNT  N         106 INCOHERENT      Y         55
      E5MCAP 1113                     E5MCAP 1115
      -----
```

```
RD BKUP - - - - - - - - GMT
USB BKP - - - - - - - - GMT
```

2. Display the terminal configuration in the database with the `rtrv-trm` command.

The SEAS terminals are shown in the output with the entry SEAS in the TYPE field. This is an example of the possible output. In this example, the SEAS terminals are terminals 18 and 27. If no SEAS terminals are shown in the `rtrv-trm` command output, go to step 5.

```
r1ghncxa03w 10-07-01 16:02:08 GMT EAGLE5 42.0.0
TRM  TYPE      COMM      FC      TMOUT  MXINV  DURAL
1    VT320      9600-7-E-1 SW      30     5      99:59:59
2    KSR        9600-7-E-1 HW      30     5      INDEF
3    PRINTER   4800-7-E-1 HW      30     0      00:00:00
4    VT320      2400-7-E-1 BOTH   30     5      00:30:00
5    VT320      9600-7-O-1 NONE   30     5      00:00:30
6    VT320      9600-7-O-1 NONE   30     5      00:00:30
7    PRINTER   9600-7-N-2 HW      30     5      00:30:00
8    KSR        19200-7-E-2 BOTH   30     5      00:30:00
9    VT320      9600-7-O-1 NONE   30     5      00:00:30
10   VT320      9600-7-E-1 HW      30     5      00:30:00
11   VT320      4800-7-E-1 HW      30     5      00:30:00
12   PRINTER   9600-7-E-1 HW      30     4      00:30:00
13   VT320      9600-7-O-1 NONE   30     5      00:30:00
14   VT320      9600-7-E-2 SW      30     8      00:30:00
15   VT320      9600-7-N-2 HW      30     5      00:30:00
16   VT320      9600-7-E-2 BOTH   30     3      00:30:00

TRM  TYPE      LOC      TMOUT  MXINV  DURAL      SECURE
17   TELNET    1201     60     5      00:30:00  yes
18   SEAS      1201     60     5      00:30:00  yes
19   TELNET    1201     60     5      00:30:00  yes
20   TELNET    1201     60     5      00:30:00  yes
21   TELNET    1201     60     5      00:30:00  yes
22   TELNET    1201     60     5      00:30:00  yes
23   TELNET    1201     60     5      00:30:00  yes
24   TELNET    1201     60     5      00:30:00  yes
25   TELNET    1203     60     5      00:30:00  yes
26   TELNET    1203     60     5      00:30:00  yes
27   SEAS      1203     60     5      00:30:00  yes
28   TELNET    1203     60     5      00:30:00  yes
29   TELNET    1203     60     5      00:30:00  yes
30   TELNET    1203     60     5      00:30:00  yes
31   TELNET    1203     60     5      00:30:00  yes
32   TELNET    1203     60     5      00:30:00  yes
33   TELNET    1205     60     5      00:30:00  yes
34   TELNET    1205     60     5      00:30:00  yes
35   TELNET    1205     60     5      00:30:00  yes
36   TELNET    1205     60     5      00:30:00  yes
37   TELNET    1205     60     5      00:30:00  yes
38   TELNET    1205     60     5      00:30:00  yes
39   TELNET    1205     60     5      00:30:00  yes
40   TELNET    1205     60     5      00:30:00  yes
```

Note: The `rtrv-trm` command output contains other fields that are not used by this procedure. If you wish to see all the fields displayed by the `rtrv-trm` command, see the `rtrv-trm` command description in *Commands User's Guide*.

3. Display the status of the terminals with the `rept-stat-trm` command with the terminal number of the SEAS terminals.

For this example, enter these commands.

```
rept-stat-trm:trm=18
```

This is an example of the possible output.

```
rlghncxa03w 06-10-01 15:08:45 GMT EAGLE5 36.0.0
TRM  PST          SST          AST
18   IS-NR        Active      -----
Command Completed.
```

```
rept-stat-trm:trm=27
```

This is an example of the possible output.

```
rlghncxa03w 06-10-01 15:08:45 GMT EAGLE5 36.0.0
TRM  PST          SST          AST
27   IS-NR        Active      -----
Command Completed.
```

4. Place the SEAS terminals out of service using the `rmv-trm` command with the number of the terminal displayed in step 3 whose state is not OOS-MT-DSBLD.

The `force=yes` parameter must be used when placing the last SEAS terminal out of service.

For this example, enter these commands.

```
rmv-trm:trm=18
```

```
rmv-trm:trm=27:force=yes
```

If the status of the SEAS terminals shown in the `PST` field in step 3 is **OOS-MT-DSBLD** (out-of-service maintenance disabled), the terminal is already out of service and the `rmv-trm` command does not need to be executed for that terminal.

This message should appear when each of these commands have successfully completed.

```
rlghncxa03w 06-10-01 15:08:45 GMT EAGLE5 36.0.0
Inhibit message sent to terminal
```

```
rlghncxa03w 06-10-01 15:08:45 GMT EAGLE5 36.0.0
Command Completed.
```

5. Enter the `chg-db:action=repair` command.

This command can take up to 30 minutes to execute, depending on the size of the database and other system activity that is in progress when this command is entered.

Note: If this command takes more than 60 minutes to execute, contact [My Oracle Support \(MOS\)](#).

During command execution, these messages appear:

```
REPAIR: MASP A - Repair starts on standby MASP.
REPAIR: MASP A - Standby MASP will reboot to load data.
REPAIR: MASP A - Repair from fixed disk complete.
```

6. Verify that the databases of both **MASPs** are coherent using the `rept-stat-dbcommand`.

The following is an example of the possible output:

```
rlghncxa03w 13-07-01 16:07:48 GMT EAGLE5 45.0.0
DATABASE STATUS: >> OK <<
      E5TDM 1114 ( STDBY )           E5TDM 1116 ( ACTV )
      C LEVEL      TIME LAST BACKUP   C LEVEL      TIME LAST BACKUP
      - - - - -
FD BKUP  N          55 09-03-01 13:11:43 GMT  Y          55 09-03-01 13:11:43 GMT
FD CRNT  N          55                      Y          55
      E5MCAP 1113                      E5MCAP 1115
      - - - - -
RD BKUP  -          -          -          -          -          -          -          - GMT
USB BKP  -          -          -          -          -          -          -          - GMT
```

If SEAS terminals are shown in the `rtrv-trm` command output in step 2, go to step 7. Otherwise this procedure is completed.

7. Put the SEAS terminals back into service with the `rst-trm` command with the number of the terminals specified in step 4.

For this example, enter these commands.

```
rst-trm:trm=18
rst-trm:trm=27
```

This message should appear when each command has successfully completed.

```
rlghncxa03w 06-10-01 15:08:45 GMT EAGLE5 36.0.0
Allow message sent to terminal

rlghncxa03w 06-10-01 15:08:45 GMT EAGLE5 36.0.0
Command Completed.
```

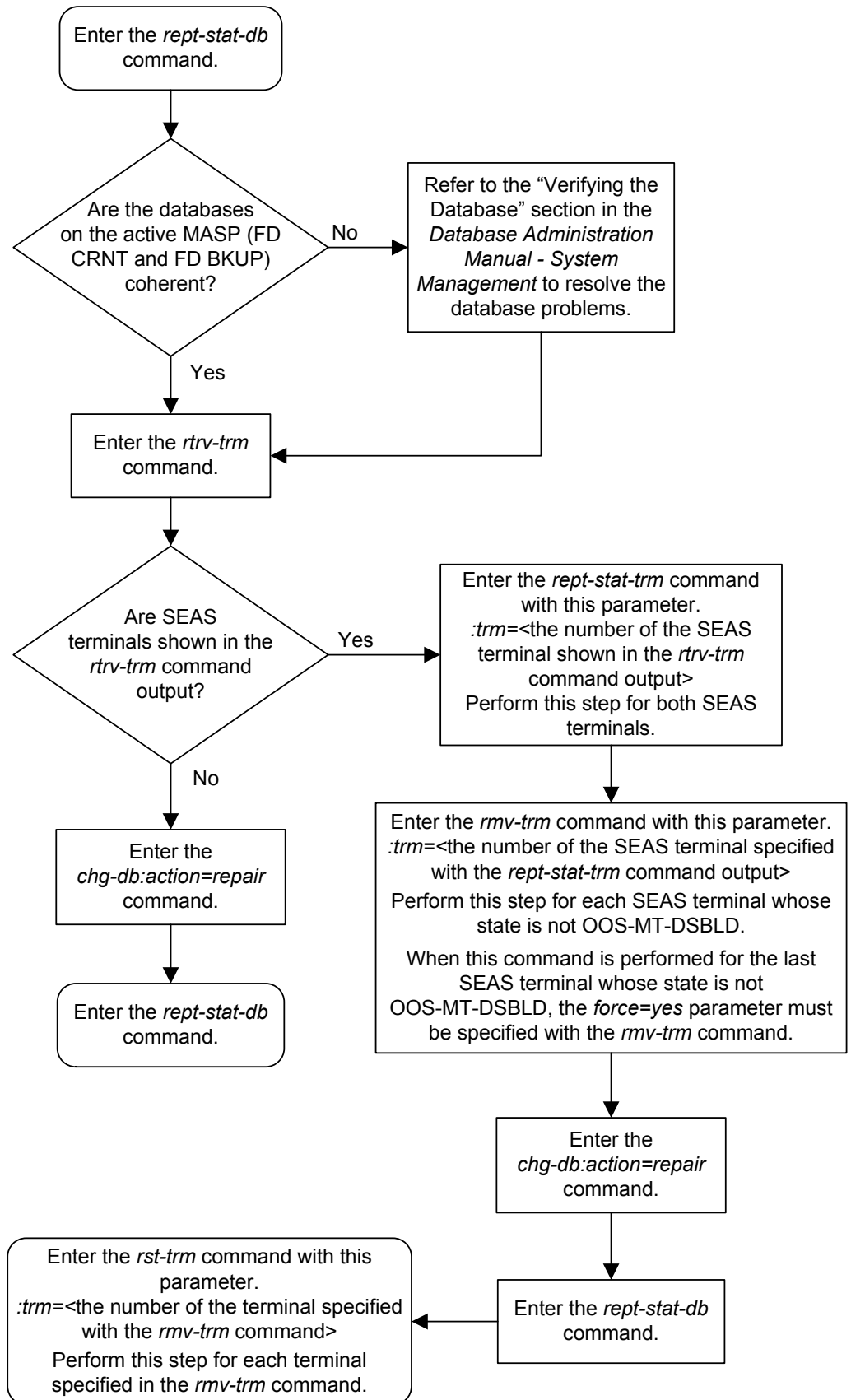
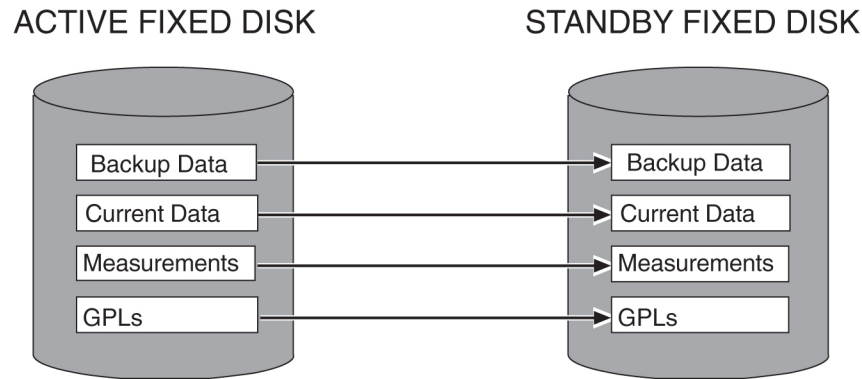

Figure 2-9 Repairing the Database



Copying the Database from the Active to the Standby Fixed Disk

This procedure copies everything on the active fixed disk to the standby fixed disk using the `copy-disk` command. [Figure 2-10](#) shows the action of the `copy-disk` command.

Figure 2-10 Action of the Copy Disk Procedure



The `copy-disk` command uses these parameters.

`:sloc` – the card location of the active fixed disk

`:dloc` – the card location of the standby fixed disk

`:force` – does the standby fixed disk contain system data? This parameter provides some protection against data loss from copying over a fixed disk containing system data. If the standby fixed disk contains system data, you must specify the `force=yes` parameter. The default value for this parameter is `no`.

`:format` – is the standby fixed disk to be formatted before the data from the active fixed disk is copied to the standby fixed disk? The default value for this parameter is `yes`, the standby fixed disk will be formatted before copying.

Specify the `format=no` parameter with the `copy-disk` command to copy to the standby fixed disk without formatting the standby fixed disk. The standby fixed disk must be properly formatted to specify the `format=no` parameter. If the standby fixed disk is not properly formatted and the `format=no` parameter is specified, the `copy-disk` command will be rejected with this message.

```
E2819 Cmd Rej: Destination disk is unformatted
```

Note: The performance time required to copy a fixed disk to another fixed disk varies depending on database size and system activity. This operation should typically take no longer than 2.5 hours. If you are not performing the low-level format (`format=no`), the operation should take no longer than 1 hour. If the `copy-disk` operation exceeds 3 hours, contact My Oracle Support for assistance. Refer to [My Oracle Support \(MOS\)](#) for the contact information. If the `copy-disk` operation without the low-level format exceeds 1.5 hours, contact My Oracle Support.

The databases in the current (**FD CRNT**) and the backup (**FD BKUP**) partitions of the active **MASP** must be coherent. For more information on verifying the database, refer to the [Verifying the Database](#) section. Measurements must be inhibited.

```
SYSTOTSTP      = off
SYSTOTTT      = off
```

Note: The `rtrv-measopts` command output contains other fields that are not used by this procedure. If you wish to see all the fields displayed by the `rtrv-measopts` command, see the `rtrv-measopts` command description in *Commands User's Guide*.

- If the Measurements Platform is enabled, continue the procedure with 5.
 - If the Measurements Platform is not enabled, continue the procedure with 3.
3. Verify that measurement collection is on or off using the `rtrv-meas-sched` command.

This is an example of the possible output. The `COLLECT` field shows whether measurement collection is on or off. In this example, measurement collection is on.

```
rlghncxa03w 06-10-01 12:22:55 GMT EAGLE5 36.0.0
COLLECT      = on
GTWYLSFLTR   = both
-----
SYSTOT-STP   = off
SYSTOT-TT    = off
SYSTOT-STPLAN = on
COMP-LNKSET  = off
COMP-LINK    = on
GTWY-STP     = on
GTWY-LNKSET  = on
MTCD-STP     = on
MTCD-LINK    = on
MTCD-STPLAN  = on
MTCD-LNKSET  = on
```

- If measurement collection is off, continue the procedure with 5.
 - If measurement collection is on, continue the procedure with 4.
4. Inhibit all measurements using the `chg-meas:collect=off` command.

Caution: Measurement collection must be turned off or the `copy-disk` command cannot be executed. The `chg-meas:collect=on` command should not be executed while the `copy-disk` command is in progress. If possible, do not turn off measurement collection at midnight since doing so can cause the loss of an entire day of measurements. For the period of time that measurement collection is turned off, those measurements will be lost.

This message should appear.

```
rlghncxa03w 06-10-01 16:12:50 GMT EAGLE5 36.0.0
CHG-MEAS: MASP A - COMPLTD
```

5. Verify that the security log on the standby **MASP** contains no entries that must be copied to the **FTA** area of the fixed disk with the `rept-stat-seculog` command.

This is an example of the possible output.

```
rlghncxa03w 06-10-01 15:59:06 GMT EAGLE5 36.0.0
-- SINCE LAST UPLOAD -- OLDEST  NEWEST  LAST
LOC  ROLE    ENTRIES %FULL OFLO FAIL RECORD  RECORD  UPLOAD
1114 Active  8312    84    No   No   03-12-05 04-06-01 04-05-30
                                     11:23:56 15:59:06 14:02:22

1116 Standby 693     7     No   No   03-12-05 04-06-01 04-05-30
                                     11:24:12 14:00:06 14:02:13
```

If the number shown in the ENTRIES field for the standby **MASP** (shown with the entry Standby in the ROLE field) is 0, continue the procedure with 7.

If the number shown in the ENTRIES field for the standby **MASP** is greater than 0, these entries must be copied to the **FTA** area of the fixed disk. To copy these entries, continue the procedure with 6.

- Copy the security log entries on the standby **MASP** to the **FTA** area on the fixed disk with the `copy-seculog` command.

For this example, enter the `copy-seculog:slog=stb` command. This is an example of the message that should appear.

```
rlghncxa03w 06-10-01 15:59:06 GMT EAGLE5 36.0.0
Security log on E5TDM 1116 copied to file 961004s.log on E5TDM 1114
```

- Display the terminal configuration in the database with the `rtrv-trm` command.

The SEAS terminals are shown in the output with the entry SEAS in the TYPE field. This is an example of the possible output. In this example, the SEAS terminals are terminals 18 and 27. If no SEAS terminals are shown in the `rtrv-trm` command output, continue the procedure with 10.

```
rlghncxa03w 10-07-01 16:02:08 GMT EAGLE5 42.0.0
TRM  TYPE    COMM          FC   TMOUT MXINV DURAL
1    VT320    9600-7-E-1   SW   30    5    99:59:59
2    KSR      9600-7-E-1   HW   30    5    INDEF
3    PRINTER 4800-7-E-1   HW   30    0    00:00:00
4    VT320    2400-7-E-1   BOTH 30    5    00:30:00
5    VT320    9600-7-O-1   NONE 30    5    00:00:30
6    VT320    9600-7-O-1   NONE 30    5    00:00:30
7    PRINTER 9600-7-N-2   HW   30    5    00:30:00
8    KSR      19200-7-E-2  BOTH 30    5    00:30:00
9    VT320    9600-7-O-1   NONE 30    5    00:00:30
10   VT320    9600-7-E-1   HW   30    5    00:30:00
11   VT320    4800-7-E-1   HW   30    5    00:30:00
12   PRINTER 9600-7-E-1   HW   30    4    00:30:00
13   VT320    9600-7-O-1   NONE 30    5    00:30:00
14   VT320    9600-7-E-2   SW   30    8    00:30:00
15   VT320    9600-7-N-2   HW   30    5    00:30:00
16   VT320    9600-7-E-2   BOTH 30    3    00:30:00

TRM  TYPE    LOC          TMOUT MXINV DURAL  SECURE
17   TELNET  1201         60    5    00:30:00  yes
18   SEAS    1201         60    5    00:30:00  yes
19   TELNET  1201         60    5    00:30:00  yes
20   TELNET  1201         60    5    00:30:00  yes
21   TELNET  1201         60    5    00:30:00  yes
22   TELNET  1201         60    5    00:30:00  yes
```

23	TELNET	1201	60	5	00:30:00	yes
24	TELNET	1201	60	5	00:30:00	yes
25	TELNET	1203	60	5	00:30:00	yes
26	TELNET	1203	60	5	00:30:00	yes
27	SEAS	1203	60	5	00:30:00	yes
28	TELNET	1203	60	5	00:30:00	yes
29	TELNET	1203	60	5	00:30:00	yes
30	TELNET	1203	60	5	00:30:00	yes
31	TELNET	1203	60	5	00:30:00	yes
32	TELNET	1203	60	5	00:30:00	yes
33	TELNET	1205	60	5	00:30:00	yes
34	TELNET	1205	60	5	00:30:00	yes
35	TELNET	1205	60	5	00:30:00	yes
36	TELNET	1205	60	5	00:30:00	yes
37	TELNET	1205	60	5	00:30:00	yes
38	TELNET	1205	60	5	00:30:00	yes
39	TELNET	1205	60	5	00:30:00	yes
40	TELNET	1205	60	5	00:30:00	yes

Note: The `rtrv-trm` command output contains other fields that are not used by this procedure. If you wish to see all the fields displayed by the `rtrv-trm` command, see the `rtrv-trm` command description in *Commands User's Guide*.

If SEAS terminals are not shown in the `rtrv-trm` output, continue the procedure with 10.

If SEAS terminals are shown in the `rtrv-trm` output, continue the procedure with 8.

8. Display the status of the SEAS terminals with the `rept-stat-trm` command with the terminal number of the SEAS terminals.

For this example, enter these commands.

```
rept-stat-trm:trm=18
```

This is an example of the possible output.

```
rlghncxa03w 06-10-01 15:08:45 GMT EAGLE5 36.0.0
TRM  PST          SST          AST
18   IS-NR        Active         -----
Command Completed.
```

```
rept-stat-trm:trm=27
```

This is an example of the possible output.

```
rlghncxa03w 06-10-01 15:08:45 GMT EAGLE5 36.0.0
TRM  PST          SST          AST
27   IS-NR        Active         -----
Command Completed.
```

9. Place the SEAS terminals out of service using the `rmv-trm` command with the number of the terminal displayed in 8 whose state is not OOS-MT-DSBLD.

The `force=yes` parameter must be used when placing the last SEAS terminal out of service.

For this example, enter these commands.

```
rmv-trm:trm=18
rmv-trm:trm=27:force=yes
```

If the status of the SEAS terminals shown in the `PST` field in 8 is `OOS-MT-DSBLD` (out-of-service maintenance disabled), the terminal is already out of service and the `rmv-trm` command does not need to be executed for that terminal.

This message should appear when each of these commands have successfully completed.

```
rlghncxa03w 06-10-01 15:08:45 GMT EAGLE5 36.0.0
Inhibit message sent to terminal
```

```
rlghncxa03w 06-10-01 15:08:45 GMT EAGLE5 36.0.0
Command Completed.
```

10. Enter the `copy-disk` command along with the card location of the standby **E5-TDM** (shown by the indicator `STDBY` in the `rept-stat-db` command output in 1) that the data is being copied to.

If the standby fixed disk contains system data, the `force=yes` parameter must be specified with the `copy-disk` command. If you do not wish to format the standby fixed disk before copying, specify the `format=no` parameter with the `copy-disk` command.

For this example, enter this command.

```
copy-disk:dloc=1114:sloc=1116:force=yes:format=yes
```

In this example, the standby fixed disk contains **EAGLE** data and will be formatted before any data is copied to the standby fixed disk.

Note: The performance time required to copy a fixed disk to another fixed disk varies depending on database size and system activity. This operation should typically take no longer than 2.5 hours. If you are not performing the low-level format (`format=no`), the operation should take no longer than 1 hour. If the `copy-disk` operation exceeds 3 hours, contact My Oracle Support for assistance. Refer to [My Oracle Support \(MOS\)](#) for the contact information. If the `copy-disk` operation without the low-level format exceeds 1.5 hours, contact My Oracle Support.

warning: Failure of the `copy-disk` command may result in corrupted **E5-TDMs**. If you experience a `copy-disk` command failure, contact the My Oracle Support for assistance. Refer to [My Oracle Support \(MOS\)](#) for the contact information.

When the command has been executed and completed, these messages should appear.

```
rlghncxa03w 06-10-01 10:22:05 GMT EAGLE5 36.0.0
copy-disk:sloc=1116:dloc=1114:force=yes
Command entered at terminal #3.
;
```

```
rlghncxa03w 06-10-01 10:22:06 GMT EAGLE5 36.0.0
Copy-disk (fixed): from active (1116) to standby (1114) started.
Extended processing required, please wait.
;

rlghncxa03w 06-10-01 10:22:08 GMT EAGLE5 36.0.0
Copy-disk (fixed): format of standby disk started
;

rlghncxa03w 06-10-01 10:27:08 GMT EAGLE5 36.0.0
Copy-disk (fixed): format in progress
;

rlghncxa03w 06-10-01 10:32:08 GMT EAGLE5 36.0.0
Copy-disk (fixed): format in progress
;

rlghncxa03w 06-10-01 11:07:05 GMT EAGLE5 36.0.0
Copy-disk (fixed): format of standby disk completed
;

rlghncxa03w 06-10-01 11:07:06 GMT EAGLE5 36.0.0
Copy-disk (fixed): copying to standby disk started
;

rlghncxa03w 06-10-01 11:12:06 GMT EAGLE5 36.0.0
Copy-disk (fixed): copy in progress
;

rlghncxa03w 06-10-01 11:27:10 GMT EAGLE5 36.0.0
Copy-disk (fixed): from active (1116) to standby (1114) completed.
Measurements collection may be turned on now if desired.
```

If the `format=no` parameter was specified in this example, these messages should appear when the `copy-disk` command has successfully completed.

```
copy-disk:dloc=1114:sloc=1116:force=yes:format=no
```

```
rlghncxa03w 06-10-01 10:22:06 GMT EAGLE5 36.0.0
Copy-disk (fixed): from active (1116) to standby (1114) started.
Extended processing required, please wait.
;

rlghncxa03w 06-10-01 11:07:08 GMT EAGLE5 36.0.0
Copy-disk (fixed): copying to standby disk started
;

rlghncxa03w 06-10-01 11:12:06 GMT EAGLE5 36.0.0
Copy-disk (fixed): copy in progress
;

rlghncxa03w 06-10-01 11:17:06 GMT EAGLE5 36.0.0
Copy-disk (fixed): copy in progress
;

rlghncxa03w 06-10-01 11:22:06 GMT EAGLE5 36.0.0
Copy-disk (fixed): copy in progress
;

rlghncxa03w 06-10-01 11:27:08 GMT EAGLE5 36.0.0
```

- Put the SEAS terminals back into service using the `rst-trm` command with the number of the terminals specified in 9.

For this example, enter these commands.

```
rst-trm:trm=18
```

```
rst-trm:trm=27
```

This message should appear when each command has successfully completed.

```
rlghncxa03w 06-10-01 15:08:45 GMT EAGLE5 36.0.0  
Allow message sent to terminal
```

```
rlghncxa03w 06-10-01 15:08:45 GMT EAGLE5 36.0.0  
Command Completed.
```

Figure 2-11 Copying the Database from the Active to the Standby Fixed Disk

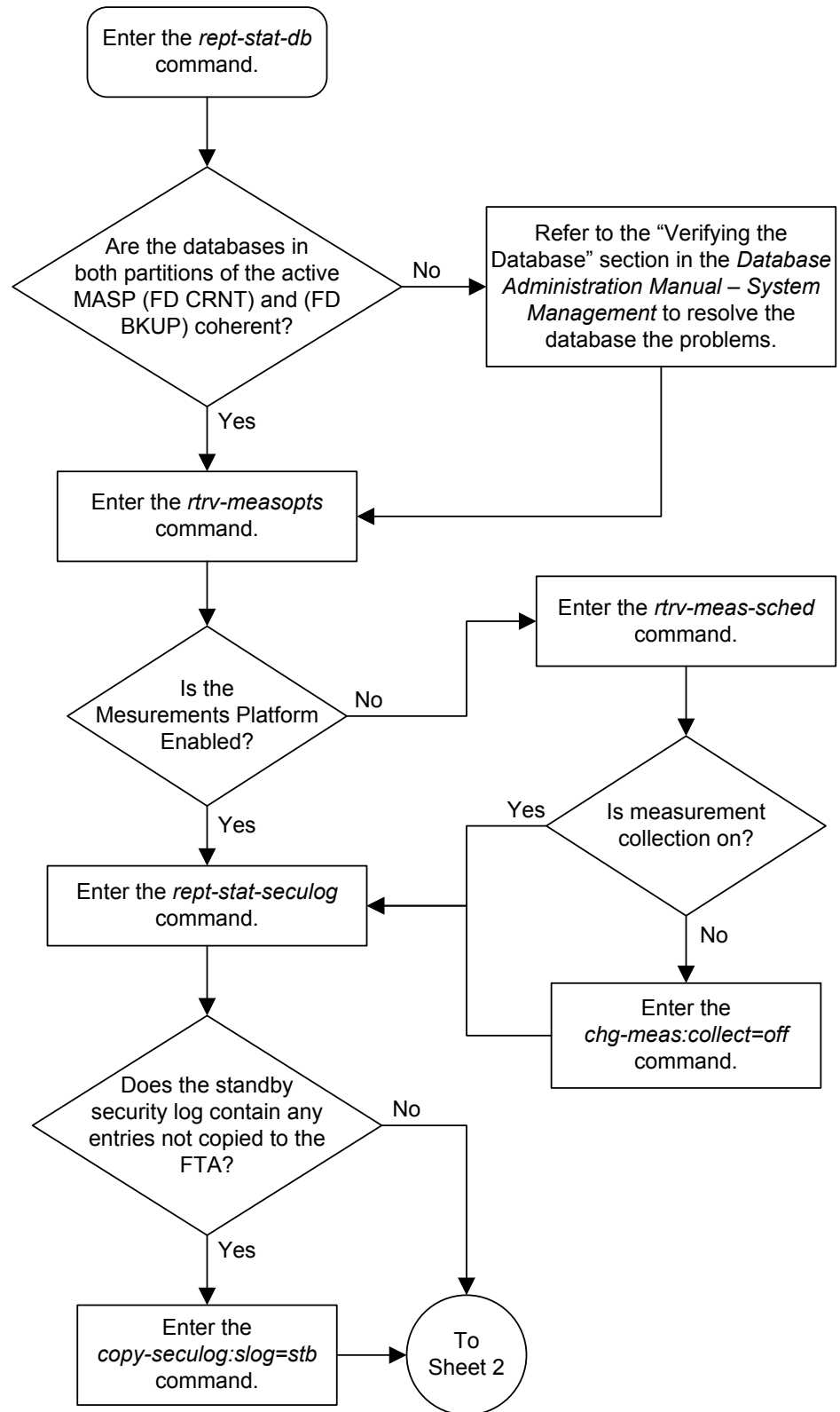

Sheet 1 of 3

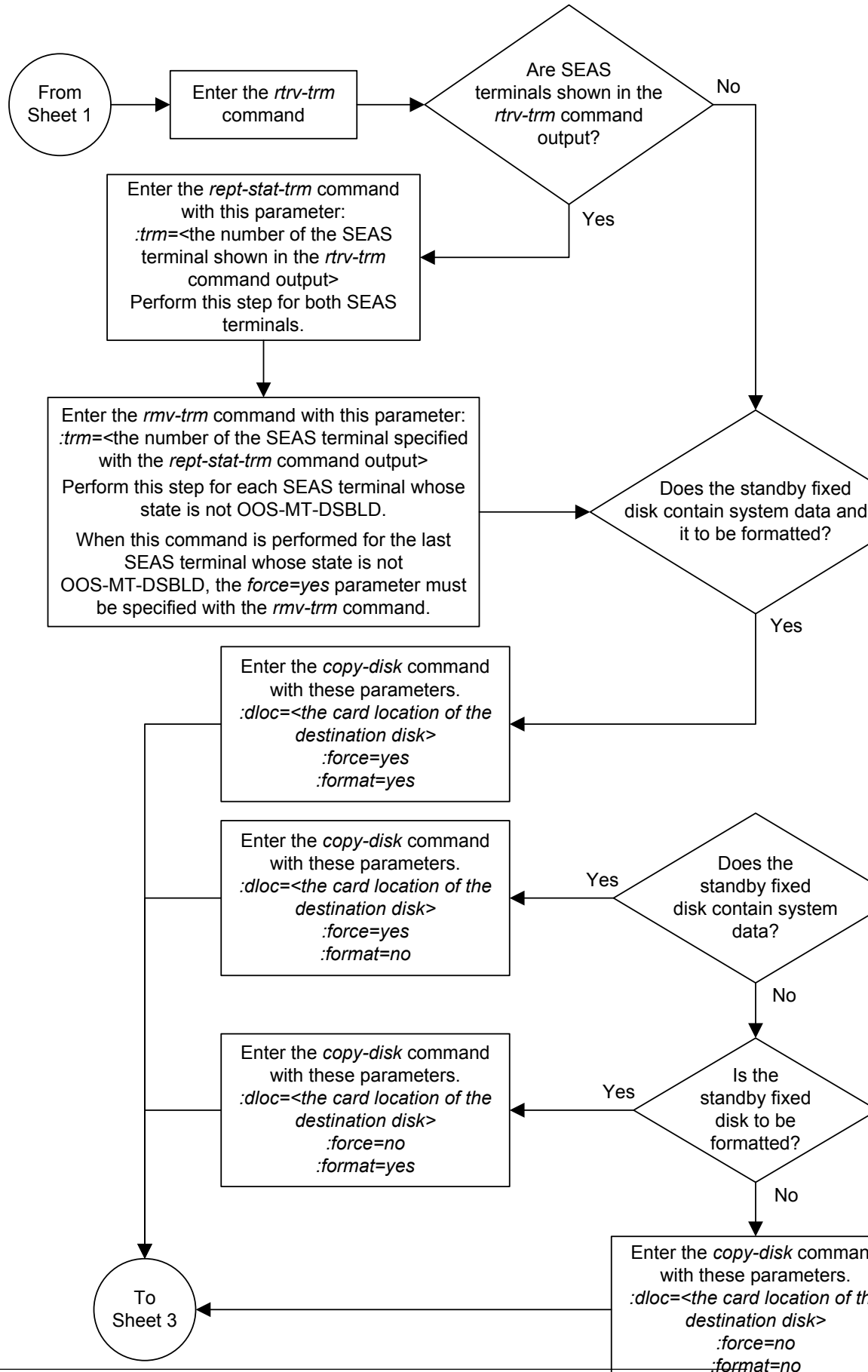

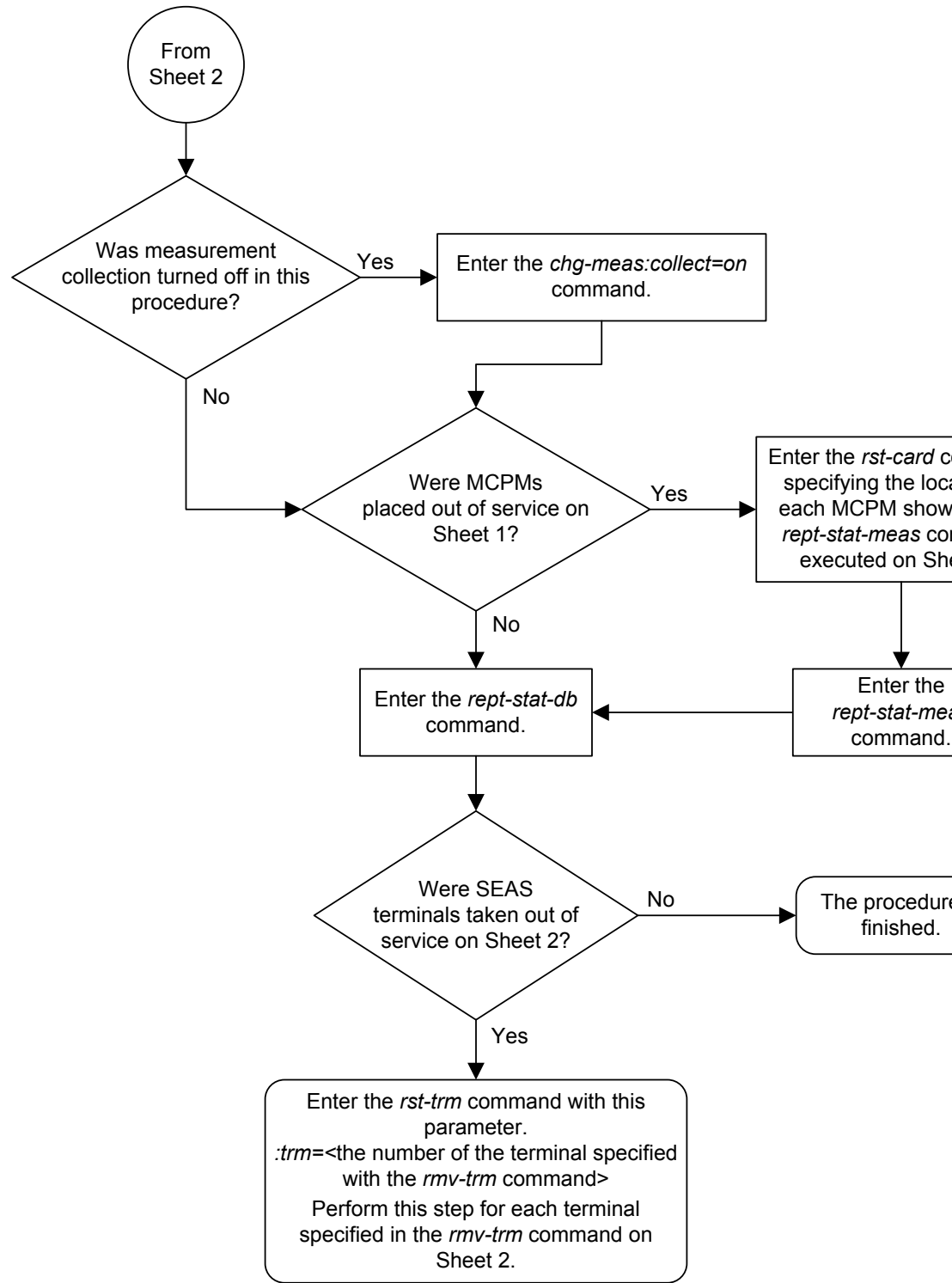

Backing Up System Data to the Removable Media

This section details the procedure used to make a backup copy of the system data in addition to the database.

The term “database” refers to all data that can be administered by the user, including shelves, cards, links, routes, global title translation tables, and gateway screening tables. The term “system data” refers to data that cannot be administered by the user, including maintenance software modules and generic program loads (**GPLs**).

1. Perform [Making a Backup of the Database to the Removable Media](#) to make a backup of the database to the removable cartridge or removable media. Perform this procedure without performing the last two steps (removing the media) and labeling the media. After the backup of the database has been made, continue the procedure with 2.
2. Make a backup copy of the **GPLs** on the fixed disk of the active **E5-TDM** to the removable media using the `copy-gpl` command. Perform the following substep.
 - a. If the removable media was used to make the backup of the database, the **GPLs** are copied from the active E5-TDM to the removable media on the active MASP. For this example, enter this command.

```
copy-gpl:sloc=1116:dloc=1115:ddrv=remove
```

During command execution, these messages should appear.

```
rlghncxa03w 09-03-01 14:50:46 GMT EAGLE5 40.1.0
COPY-GPL: MASP B - COPY STARTS ON ACTIVE MASP
;
```

```
rlghncxa03w 09-03-01 14:50:46 GMT EAGLE5 40.1.0
COPY GPL: MASP B - COPY TO REMOVABLE DRIVE COMPLETE
```

3. Verify the **GPLs** on the removable media with the `rtrv-gpl` command.

This is an example of the possible output.

```
tekelecstp 18-01-18 21:23:11 EST EAGLE 46.5.1.5.0-73.10.0
rtrv-gpl
Command entered at terminal #18.
;
```

Command Accepted - Processing

```
tekelecstp 18-01-18 21:23:11 EST EAGLE 46.5.1.5.0-73.10.0
GPL Auditing ON
```

GPL	CARD	RELEASE	APPROVED	TRIAL	REMOVE TRIAL
OAMHC	1114	143-010-000	143-010-000	ALM	-----
OAMHC	1116	143-010-000	143-010-000	ALM	-----
OAMHC	1115	-----	-----	-----	-----
OAMHC69	1114	143-010-000	143-010-000	ALM	-----
OAMHC69	1116	143-010-000	143-010-000	ALM	-----
OAMHC69	1115	-----	-----	-----	-----
IPSG32	1114	143-010-000	143-010-000	143-010-000	-----
IPSG32	1116	143-010-000	143-010-000	143-010-000	-----
IPSG32	1115	-----	-----	-----	-----

BLMCAP	1114	143-010-000	143-010-000	143-010-000	-----
BLMCAP	1116	143-010-000	143-010-000	143-010-000	-----
BLMCAP	1115	-----	-----	-----	-----
HIPR2	1114	143-010-000	143-010-000	143-010-000	-----
HIPR2	1116	143-010-000	143-010-000	143-010-000	-----
HIPR2	1115	-----	-----	-----	-----
SFAPP	1114	143-010-000	143-010-000	ALM 143-010-000	-----
SFAPP	1116	143-010-000	143-010-000	ALM 143-010-000	-----
SFAPP	1115	-----	-----	-----	-----
SS7HC	1114	143-010-000	143-010-000	143-010-000	-----
SS7HC	1116	143-010-000	143-010-000	143-010-000	-----
SS7HC	1115	-----	-----	-----	-----
SCCPHC	1114	143-010-000	143-010-000	143-010-000	-----
SCCPHC	1116	143-010-000	143-010-000	143-010-000	-----
SCCPHC	1115	-----	-----	-----	-----
ERTHC	1114	143-010-000	143-010-000	143-010-000	-----
ERTHC	1116	143-010-000	143-010-000	143-010-000	-----
ERTHC	1115	-----	-----	-----	-----
IPSHC	1114	143-010-000	143-010-000	143-010-000	-----
IPSHC	1116	143-010-000	143-010-000	143-010-000	-----
IPSHC	1115	-----	-----	-----	-----
ATMHC	1114	143-010-000	143-010-000	143-010-000	-----
ATMHC	1116	143-010-000	143-010-000	143-010-000	-----
ATMHC	1115	-----	-----	-----	-----
IPSG	1114	143-010-000	143-010-000	143-010-000	-----
IPSG	1116	143-010-000	143-010-000	143-010-000	-----
IPSG	1115	-----	-----	-----	-----
PKTGHC	1114	143-010-000	143-010-000	-----	-----
PKTGHC	1116	143-010-000	143-010-000	-----	-----
PKTGHC	1115	-----	-----	-----	-----
BLIXP	1114	143-010-000	143-010-000	143-010-000	-----
BLIXP	1116	143-010-000	143-010-000	143-010-000	-----
BLIXP	1115	-----	-----	-----	-----
MCPHC	1114	143-010-000	143-010-000	143-010-000	-----
MCPHC	1116	143-010-000	143-010-000	143-010-000	-----
MCPHC	1115	-----	-----	-----	-----
SIPHC	1114	143-010-000	143-010-000	143-010-000	-----
SIPHC	1116	143-010-000	143-010-000	143-010-000	-----
SIPHC	1115	-----	-----	-----	-----
DEIRHC	1114	143-010-000	143-010-000	143-010-000	-----
DEIRHC	1116	143-010-000	143-010-000	143-010-000	-----
DEIRHC	1115	-----	-----	-----	-----
ENUMHC	1114	143-010-000	143-010-000	143-010-000	-----
ENUMHC	1116	143-010-000	143-010-000	143-010-000	-----
ENUMHC	1115	-----	-----	-----	-----
PKTG64	1114	143-010-000	143-010-000	-----	-----
PKTG64	1116	143-010-000	143-010-000	-----	-----
PKTG64	1115	-----	-----	-----	-----
BLDC64	1114	143-010-000	-----	143-010-000	-----
BLDC64	1116	143-010-000	000-000-000	ALM 143-010-000	-----
BLDC64	1115	-----	-----	-----	-----
SCCP64	1114	143-010-000	143-010-000	143-010-000	-----
SCCP64	1116	143-010-000	143-010-000	143-010-000	-----
SCCP64	1115	-----	-----	-----	-----
BLSLC32	1114	143-010-000	143-010-000	143-010-000	-----
BLSLC32	1116	143-010-000	143-010-000	143-010-000	-----
BLSLC32	1115	-----	-----	-----	-----
BLSLC64	1114	143-010-000	143-010-000	143-010-000	-----
BLSLC64	1116	143-010-000	143-010-000	143-010-000	-----
BLSLC64	1115	-----	-----	-----	-----
SIP64	1114	143-010-000	143-010-000	143-010-000	-----

SIP64	1116	143-010-000	143-010-000	143-010-000	-----
SIP64	1115	-----	-----	-----	-----
DEIR64	1114	143-010-000	143-010-000	143-010-000	-----
DEIR64	1116	143-010-000	143-010-000	143-010-000	-----
DEIR64	1115	-----	-----	-----	-----
ENUM64	1114	143-010-000	143-010-000	143-010-000	-----
ENUM64	1116	143-010-000	143-010-000	143-010-000	-----
ENUM64	1115	-----	-----	-----	-----
BLDC32	1114	143-010-000	-----	143-010-000	-----
BLDC32	1116	143-010-000	-----	143-010-000	-----
BLDC32	1115	-----	-----	-----	-----
MCPHC69	1114	143-010-000	143-010-000	143-010-000	-----
MCPHC69	1116	143-010-000	143-010-000	143-010-000	-----
MCPHC69	1115	-----	-----	-----	-----
IPSHC69	1114	143-010-000	143-010-000	143-010-000	-----
IPSHC69	1116	143-010-000	143-010-000	143-010-000	-----
IPSHC69	1115	-----	-----	-----	-----
BLSL932	1114	143-010-000	143-010-000	143-010-000	-----
BLSL932	1116	143-010-000	143-010-000	143-010-000	-----
BLSL932	1115	-----	-----	-----	-----

;

Command Executed

This example shows GPLs on an EAGLE that has E5-based control cards installed. The GPLs were copied to the removable media in both MASP. The USB credit card flash media is not inserted into the USB credit card flash media drive in the E5-MCAP card of the active MASP (card location 1115). If the GPLs were copied only to the removable media on the active MASP, the removable media is not inserted in the standby MASP and the GPL version number for the standby MASP is not displayed.

4. Perform the following action:

Remove the removable media from the removable media drives on the MASPs. For more information on removing the removable media from the removable media drives, refer to [Removable USB Drive](#).

5. Label the removable media, 1 through 4 if the backup is performed weekly or monthly, A through D if the backup is performed quarterly.

For more information on labeling the removable media, see Chapter 2, "Preventive Maintenance," in *Maintenance Guide*.

Restoring System Data from a Removable Media

This section presents the procedure for restoring system data from a system backup removable media that was made by performing [Backing Up System Data to the Removable Media](#).

Caution: Using the `action=restore` parameter with the `chg-db` command is an emergency recovery procedure, and requires the `init-sys` command to download the restored database to all the cards in the EAGLE.

Caution: If the restore device state option is on, shown by the ON value for the RSTRDEV field in the `rtrv-stpopts` command output, the state of the cards, SS7 signaling links, TCP/IP data links, and terminals before the `chg-db:action=restore` and `init-sys` commands are performed will not be maintained after these commands are performed. The persistent device state table becomes obsolete and is disabled. UIM 1257 is generated.

```
rlghncxa03w 09-10-01 16:07:48 GMT EAGLE5 41.1.0
1234.1257    SYSTEM          INFO  DB Restore has cleared and disabled PDS
```

1. Perform [Restoring the Database from the Removable Media](#) to restore the database from the removable media. If the database is being restored from a removable media, do not remove the removable media. After the database has been restored, continue the procedure with the next step.
2. Copy the GPLs from the removable media to the standby E5-TDM using the `copy-gpl` command. Perform the following substep.
 - a. If the removable media was used to restore the database, the GPLs are copied from the removable media on the active MASP to the standby E5-TDM. For this example, enter this command.

```
copy-gpl:sloc=1115:dloc=1114:sdrv=remove
```

During command execution, these messages should appear.

```
rlghncxa03w 09-10-01 14:50:46 GMT EAGLE5 41.1.0
COPY-GPL: MASP A - COPY STARTS ON REMOVABLE DRIVE
;
```

```
rlghncxa03w 09-10-01 14:50:46 GMT EAGLE5 41.1.0
COPY GPL: MASP A - COPY TO STANDBY MASP COMPLETE
```

3. Verify the GPLs on the standby E5-TDM and removable media with the `rtrv-gpl` command.

This is an example of the possible output:

```
rlghncxa03w 8-12-13 07:01:08 GMT EAGLE5 45.0.0
GPL Auditing ON
```

GPL	CARD	RELEASE	APPROVED	TRIAL	REMOVE TRIAL
SIPHC	1114	134-003-000	134-003-000	134-002-000	134-003-000
SIPHC	1116	134-003-000	134-002-000	134-002-000	134-003-000
SIPHC	1115	-----	-----	-----	-----
GLS	1114	134-003-000	134-003-000	134-002-000	134-003-000
GLS	1116	134-003-000	134-002-000	134-002-000	134-003-000
GLS	1115	-----	-----	-----	-----
CDU	1114	163-001-000	163-001-000	163-000-000	163-001-000
CDU	1116	163-001-000	163-000-000	163-000-000	163-001-000
CDU	1115	-----	-----	-----	-----
IMT	1114	134-003-000	134-003-000	134-002-000	134-003-000
IMT	1116	134-003-000	134-002-000	134-002-000	134-003-000
IMT	1115	-----	-----	-----	-----
ATMANSI	1114	134-003-000	134-003-000	134-002-000	134-003-000
ATMANSI	1116	134-003-000	134-002-000	134-002-000	134-003-000
ATMANSI	1115	-----	-----	-----	-----

BPHCAP	1114	134-003-000	134-003-000	134-002-000	134-003-000
BPHCAP	1116	134-003-000	134-002-000	134-002-000	134-003-000
BPHCAP	1115	-----	-----	-----	-----
BPDCM	1114	134-003-000	134-003-000	134-002-000	134-003-000
BPDCM	1116	134-003-000	134-002-000	134-002-000	134-003-000
BPDCM	1115	-----	-----	-----	-----
BLMCAP	1114	134-003-000	134-003-000	134-002-000	134-003-000
BLMCAP	1116	134-003-000	134-002-000	134-002-000	134-003-000
BLMCAP	1115	-----	-----	-----	-----
OAMHC	1114	134-003-000	134-003-000	134-002-000	134-003-000
OAMHC	1116	134-003-000	134-002-000	134-002-000	134-003-000
OAMHC	1115	-----	-----	-----	-----
HIPR2	1114	134-003-000	134-003-000	134-002-000	134-003-000
HIPR2	1116	134-003-000	134-002-000	134-002-000	134-003-000
HIPR2	1115	-----	-----	-----	-----
VXWSLAN	1114	134-003-000	134-003-000	134-002-000	134-003-000
VXWSLAN	1116	134-003-000	134-002-000	134-002-000	134-003-000
VXWSLAN	1115	-----	-----	-----	-----
IPLIM	1114	134-003-000	134-003-000	134-002-000	134-003-000
IPLIM	1116	134-003-000	134-002-000	134-002-000	134-003-000
IPLIM	1115	-----	-----	-----	-----
IPLIMI	1114	134-003-000	134-003-000	134-002-000	134-003-000
IPLIMI	1116	134-003-000	134-002-000	134-002-000	134-003-000
IPLIMI	1115	-----	-----	-----	-----
SS7IPGW	1114	134-003-000	134-003-000	134-002-000	134-003-000
SS7IPGW	1116	134-003-000	134-002-000	134-002-000	134-003-000
SS7IPGW	1115	-----	-----	-----	-----
VSCCP	1114	134-003-000	134-003-000	134-002-000	134-003-000
VSCCP	1116	134-003-000	134-002-000	134-002-000	134-003-000
VSCCP	1115	-----	-----	-----	-----
ATMITU	1114	134-003-000	134-003-000	134-002-000	134-003-000
ATMITU	1116	134-003-000	134-002-000	134-002-000	134-003-000
ATMITU	1115	-----	-----	-----	-----
VCDU	1114	163-001-000	163-001-000	163-000-000	163-001-000
VCDU	1116	163-001-000	163-000-000	163-000-000	163-001-000
VCDU	1115	-----	-----	-----	-----
BPMPPL	1114	134-003-000	134-003-000	134-002-000	134-003-000
BPMPPL	1116	134-003-000	134-002-000	134-002-000	134-003-000
BPMPPL	1115	-----	-----	-----	-----
SS7ML	1114	134-003-000	134-003-000	134-002-000	134-003-000
SS7ML	1116	134-003-000	134-002-000	134-002-000	134-003-000
SS7ML	1115	-----	-----	-----	-----
BPHMUX	1114	134-003-000	134-003-000	134-002-000	134-003-000
BPHMUX	1116	134-003-000	134-002-000	134-002-000	134-003-000
BPHMUX	1115	-----	-----	-----	-----
IPGWI	1114	134-003-000	134-003-000	134-002-000	134-003-000
IPGWI	1116	134-003-000	134-002-000	134-002-000	134-003-000
IPGWI	1115	-----	-----	-----	-----
IPS	1114	134-003-000	134-003-000	134-002-000	134-003-000
IPS	1116	134-003-000	134-002-000	134-002-000	134-003-000
IPS	1115	-----	-----	-----	-----
BPDCM2	1114	134-003-000	134-003-000	134-002-000	134-003-000
BPDCM2	1116	134-003-000	134-002-000	134-002-000	134-003-000
BPDCM2	1115	-----	-----	-----	-----
EROUTE	1114	134-003-000	134-003-000	134-002-000	134-003-000
EROUTE	1116	134-003-000	134-002-000	134-002-000	134-003-000
EROUTE	1115	-----	-----	-----	-----
BPMPPLT	1114	134-003-000	134-003-000	134-002-000	134-003-000
BPMPPLT	1116	134-003-000	134-002-000	134-002-000	134-003-000
BPMPPLT	1115	-----	-----	-----	-----
MCP	1114	134-003-000	134-003-000	134-002-000	134-003-000

MCP	1116	134-003-000	134-002-000	134-002-000	134-003-000
MCP	1115	-----	-----	-----	-----
BPHCAPT	1114	134-003-000	134-003-000	134-002-000	134-003-000
BPHCAPT	1116	134-003-000	134-002-000	134-002-000	134-003-000
BPHCAPT	1115	-----	-----	-----	-----
SS7HC	1114	134-003-000	134-003-000	134-002-000	134-003-000
SS7HC	1116	134-003-000	134-002-000	134-002-000	134-003-000
SS7HC	1115	-----	-----	-----	-----
BLBIOS	1114	134-003-000	134-003-000	134-002-000	134-003-000
BLBIOS	1116	134-003-000	134-002-000	134-002-000	134-003-000
BLBIOS	1115	-----	-----	-----	-----
BLCPLD	1114	134-003-000	134-003-000	134-002-000	134-003-000
BLCPLD	1116	134-003-000	134-002-000	134-002-000	134-003-000
BLCPLD	1115	-----	-----	-----	-----
GLSHC	1114	134-003-000	134-003-000	134-002-000	134-003-000
GLSHC	1116	134-003-000	134-002-000	134-002-000	134-003-000
GLSHC	1115	-----	-----	-----	-----
IMTPCI	1114	134-003-000	134-003-000	134-002-000	134-003-000
IMTPCI	1116	134-003-000	134-002-000	134-002-000	134-003-000
IMTPCI	1115	-----	-----	-----	-----
PLDPMC1	1114	134-003-000	134-003-000	134-002-000	134-003-000
PLDPMC1	1116	134-003-000	134-002-000	134-002-000	134-003-000
PLDPMC1	1115	-----	-----	-----	-----
IPLHC	1114	134-003-000	134-003-000	134-002-000	134-003-000
IPLHC	1116	134-003-000	134-002-000	134-002-000	134-003-000
IPLHC	1115	-----	-----	-----	-----
IPGHC	1114	134-003-000	134-003-000	134-002-000	134-003-000
IPGHC	1116	134-003-000	134-002-000	134-002-000	134-003-000
IPGHC	1115	-----	-----	-----	-----
SS7EPM	1114	134-003-000	134-003-000	134-002-000	134-003-000
SS7EPM	1116	134-003-000	134-002-000	134-002-000	134-003-000
SS7EPM	1115	-----	-----	-----	-----
BLBEPM	1114	134-003-000	134-003-000	134-002-000	134-003-000
BLBEPM	1116	134-003-000	134-002-000	134-002-000	134-003-000
BLBEPM	1115	-----	-----	-----	-----
BLVXW6	1114	134-003-000	134-003-000	134-002-000	134-003-000
BLVXW6	1116	134-003-000	134-002-000	134-002-000	134-003-000
BLVXW6	1115	-----	-----	-----	-----
BLDIAG6	1114	134-003-000	134-003-000	134-002-000	134-003-000
BLDIAG6	1116	134-003-000	134-002-000	134-002-000	134-003-000
BLDIAG6	1115	-----	-----	-----	-----
SCCPHC	1114	134-003-000	134-003-000	134-002-000	134-003-000
SCCPHC	1116	134-003-000	134-002-000	134-002-000	134-003-000
SCCPHC	1115	-----	-----	-----	-----
BLBSMG	1114	134-003-000	134-003-000	134-002-000	134-003-000
BLBSMG	1116	134-003-000	134-002-000	134-002-000	134-003-000
BLBSMG	1115	-----	-----	-----	-----
SLANHC	1114	134-003-000	134-003-000	134-002-000	134-003-000
SLANHC	1116	134-003-000	134-002-000	134-002-000	134-003-000
SLANHC	1115	-----	-----	-----	-----
ERTHC	1114	134-003-000	134-003-000	134-002-000	134-003-000
ERTHC	1116	134-003-000	134-002-000	134-002-000	134-003-000
ERTHC	1115	-----	-----	-----	-----
IPSHC	1114	134-003-000	134-003-000	134-002-000	134-003-000
IPSHC	1116	134-003-000	134-002-000	134-002-000	134-003-000
IPSHC	1115	-----	-----	-----	-----
ATMHC	1114	134-003-000	134-003-000	134-002-000	134-003-000
ATMHC	1116	134-003-000	134-002-000	134-002-000	134-003-000
ATMHC	1115	-----	-----	-----	-----
IPSG	1114	134-003-000	134-003-000	134-002-000	134-003-000
IPSG	1116	134-003-000	134-002-000	134-002-000	134-003-000

IPSG	1115	-----	-----	-----	-----
BLROM1	1114	134-003-000	134-003-000	134-002-000	134-003-000
BLROM1	1116	134-003-000	134-002-000	134-002-000	134-003-000
BLROM1	1115	-----	-----	-----	-----
BLIXP	1114	163-003-000	163-003-000	163-002-000	163-003-000
BLIXP	1116	163-003-000	163-002-000	163-002-000	163-003-000
BLIXP	1115	-----	-----	-----	-----

This example shows GPLs on an EAGLE that has E5-based control cards installed. The GPLs were copied from the removable media in on the active MASP. The USB credit card flash media is not inserted into the USB credit card flash media drive in the E5-MCAP card of the active MASP (card location 1115).

4. Enter the `init-card` command specifying the location of the E5-MCAP card making up active **MASP**.

This step makes the standby MASP the active MASP. The MASP that was active is now the standby MASP.

For this example, enter this command.

```
init-card:loc=1115
```

This message should appear.

```
rlghncxa03w 09-10-01 11:11:28 GMT EAGLE5 41.1.0
Init Card command issued to card 1115
```

5. Copy the GPLs from the removable media to the standby E5-TDM using the `copy-gpl` command. Perform the following substep:
 - a. If the removable media was used to restore the database, the GPLs are copied from the removable media on on the active MASP to the standby E5-TDM. For this example, enter this command.

```
copy-gpl:sloc=1113:dloc=1116:sdrv=remove
```

During command execution, these messages should appear.

```
rlghncxa03w 09-10-01 14:50:46 GMT EAGLE5 41.1.0
COPY-GPL: MASP A - COPY STARTS ON REMOVABLE DRIVE
;
```

```
rlghncxa03w 09-10-01 14:50:46 GMT EAGLE5 41.1.0
COPY GPL: MASP A - COPY TO STANDBY MASP COMPLETE
```

6. Verify the **GPLs** on the standby E5-TDM and the removable media with the `rtrv-gpl` command.

This is an example of the possible output.

```
rlghncxa03w 8-12-13 07:01:08 GMT EAGLE5 45.0.0
GPL Auditing ON
```

GPL	CARD	RELEASE	APPROVED	TRIAL	REMOVE TRIAL
SIPHC	1114	134-003-000	134-003-000	134-002-000	134-003-000
SIPHC	1116	134-003-000	134-003-000	134-002-000	134-003-000
SIPHC	1115	-----	-----	-----	-----
GLS	1114	134-003-000	134-003-000	134-002-000	134-003-000
GLS	1116	134-003-000	134-003-000	134-002-000	134-003-000

GLS	1115	-----	-----	-----	-----
CDU	1114	163-001-000	163-001-000	163-000-000	163-001-000
CDU	1116	163-001-000	163-001-000	163-000-000	163-001-000
CDU	1115	-----	-----	-----	-----
IMT	1114	134-003-000	134-003-000	134-002-000	134-003-000
IMT	1116	134-003-000	134-003-000	134-002-000	134-003-000
IMT	1115	-----	-----	-----	-----
ATMANSI	1114	134-003-000	134-003-000	134-002-000	134-003-000
ATMANSI	1116	134-003-000	134-003-000	134-002-000	134-003-000
ATMANSI	1115	-----	-----	-----	-----
BPHCAP	1114	134-003-000	134-003-000	134-002-000	134-003-000
BPHCAP	1116	134-003-000	134-003-000	134-002-000	134-003-000
BPHCAP	1115	-----	-----	-----	-----
BPDCM	1114	134-003-000	134-003-000	134-002-000	134-003-000
BPDCM	1116	134-003-000	134-003-000	134-002-000	134-003-000
BPDCM	1115	-----	-----	-----	-----
BLMCAP	1114	134-003-000	134-003-000	134-002-000	134-003-000
BLMCAP	1116	134-003-000	134-003-000	134-002-000	134-003-000
BLMCAP	1115	-----	-----	-----	-----
OAMHC	1114	134-003-000	134-003-000	134-002-000	134-003-000
OAMHC	1116	134-003-000	134-003-000	134-002-000	134-003-000
OAMHC	1115	-----	-----	-----	-----
HIPR2	1114	134-003-000	134-003-000	134-002-000	134-003-000
HIPR2	1116	134-003-000	134-003-000	134-002-000	134-003-000
HIPR2	1115	-----	-----	-----	-----
VXWSLAN	1114	134-003-000	134-003-000	134-002-000	134-003-000
VXWSLAN	1116	134-003-000	134-003-000	134-002-000	134-003-000
VXWSLAN	1115	-----	-----	-----	-----
IPLIM	1114	134-003-000	134-003-000	134-002-000	134-003-000
IPLIM	1116	134-003-000	134-003-000	134-002-000	134-003-000
IPLIM	1115	-----	-----	-----	-----
IPLIMI	1114	134-003-000	134-003-000	134-002-000	134-003-000
IPLIMI	1116	134-003-000	134-003-000	134-002-000	134-003-000
IPLIMI	1115	-----	-----	-----	-----
SS7IPGW	1114	134-003-000	134-003-000	134-002-000	134-003-000
SS7IPGW	1116	134-003-000	134-003-000	134-002-000	134-003-000
SS7IPGW	1115	-----	-----	-----	-----
VSCCP	1114	134-003-000	134-003-000	134-002-000	134-003-000
VSCCP	1116	134-003-000	134-003-000	134-002-000	134-003-000
VSCCP	1115	-----	-----	-----	-----
ATMITU	1114	134-003-000	134-003-000	134-002-000	134-003-000
ATMITU	1116	134-003-000	134-003-000	134-002-000	134-003-000
ATMITU	1115	-----	-----	-----	-----
VCDU	1114	163-001-000	163-001-000	163-000-000	163-001-000
VCDU	1116	163-001-000	163-001-000	163-000-000	163-001-000
VCDU	1115	-----	-----	-----	-----
BPMPPL	1114	134-003-000	134-003-000	134-002-000	134-003-000
BPMPPL	1116	134-003-000	134-003-000	134-002-000	134-003-000
BPMPPL	1115	-----	-----	-----	-----
SS7ML	1114	134-003-000	134-003-000	134-002-000	134-003-000
SS7ML	1116	134-003-000	134-003-000	134-002-000	134-003-000
SS7ML	1115	-----	-----	-----	-----
BPHMUX	1114	134-003-000	134-003-000	134-002-000	134-003-000
BPHMUX	1116	134-003-000	134-003-000	134-002-000	134-003-000
BPHMUX	1115	-----	-----	-----	-----
IPGWI	1114	134-003-000	134-003-000	134-002-000	134-003-000
IPGWI	1116	134-003-000	134-003-000	134-002-000	134-003-000
IPGWI	1115	-----	-----	-----	-----
IPS	1114	134-003-000	134-003-000	134-002-000	134-003-000
IPS	1116	134-003-000	134-003-000	134-002-000	134-003-000
IPS	1115	-----	-----	-----	-----

BPDCM2	1114	134-003-000	134-003-000	134-002-000	134-003-000
BPDCM2	1116	134-003-000	134-003-000	134-002-000	134-003-000
BPDCM2	1115	-----	-----	-----	-----
EROUTE	1114	134-003-000	134-003-000	134-002-000	134-003-000
EROUTE	1116	134-003-000	134-003-000	134-002-000	134-003-000
EROUTE	1115	-----	-----	-----	-----
BPMPLT	1114	134-003-000	134-003-000	134-002-000	134-003-000
BPMPLT	1116	134-003-000	134-003-000	134-002-000	134-003-000
BPMPLT	1115	-----	-----	-----	-----
MCP	1114	134-003-000	134-003-000	134-002-000	134-003-000
MCP	1116	134-003-000	134-003-000	134-002-000	134-003-000
MCP	1115	-----	-----	-----	-----
BPHCAPT	1114	134-003-000	134-003-000	134-002-000	134-003-000
BPHCAPT	1116	134-003-000	134-003-000	134-002-000	134-003-000
BPHCAPT	1115	-----	-----	-----	-----
SS7HC	1114	134-003-000	134-003-000	134-002-000	134-003-000
SS7HC	1116	134-003-000	134-003-000	134-002-000	134-003-000
SS7HC	1115	-----	-----	-----	-----
BLBIOS	1114	134-003-000	134-003-000	134-002-000	134-003-000
BLBIOS	1116	134-003-000	134-003-000	134-002-000	134-003-000
BLBIOS	1115	-----	-----	-----	-----
BLCPLD	1114	134-003-000	134-003-000	134-002-000	134-003-000
BLCPLD	1116	134-003-000	134-003-000	134-002-000	134-003-000
BLCPLD	1115	-----	-----	-----	-----
GLSHC	1114	134-003-000	134-003-000	134-002-000	134-003-000
GLSHC	1116	134-003-000	134-003-000	134-002-000	134-003-000
GLSHC	1115	-----	-----	-----	-----
IMTPCI	1114	134-003-000	134-003-000	134-002-000	134-003-000
IMTPCI	1116	134-003-000	134-003-000	134-002-000	134-003-000
IMTPCI	1115	-----	-----	-----	-----
PLDPMC1	1114	134-003-000	134-003-000	134-002-000	134-003-000
PLDPMC1	1116	134-003-000	134-003-000	134-002-000	134-003-000
PLDPMC1	1115	-----	-----	-----	-----
IPLHC	1114	134-003-000	134-003-000	134-002-000	134-003-000
IPLHC	1116	134-003-000	134-003-000	134-002-000	134-003-000
IPLHC	1115	-----	-----	-----	-----
IPGHC	1114	134-003-000	134-003-000	134-002-000	134-003-000
IPGHC	1116	134-003-000	134-003-000	134-002-000	134-003-000
IPGHC	1115	-----	-----	-----	-----
SS7EPM	1114	134-003-000	134-003-000	134-002-000	134-003-000
SS7EPM	1116	134-003-000	134-003-000	134-002-000	134-003-000
SS7EPM	1115	-----	-----	-----	-----
BLBEPM	1114	134-003-000	134-003-000	134-002-000	134-003-000
BLBEPM	1116	134-003-000	134-003-000	134-002-000	134-003-000
BLBEPM	1115	-----	-----	-----	-----
BLVXW6	1114	134-003-000	134-003-000	134-002-000	134-003-000
BLVXW6	1116	134-003-000	134-003-000	134-002-000	134-003-000
BLVXW6	1115	-----	-----	-----	-----
BLDIAG6	1114	134-003-000	134-003-000	134-002-000	134-003-000
BLDIAG6	1116	134-003-000	134-003-000	134-002-000	134-003-000
BLDIAG6	1115	-----	-----	-----	-----
SCCPHC	1114	134-003-000	134-003-000	134-002-000	134-003-000
SCCPHC	1116	134-003-000	134-003-000	134-002-000	134-003-000
SCCPHC	1115	-----	-----	-----	-----
BLBSMG	1114	134-003-000	134-003-000	134-002-000	134-003-000
BLBSMG	1116	134-003-000	134-003-000	134-002-000	134-003-000
BLBSMG	1115	-----	-----	-----	-----
SLANHC	1114	134-003-000	134-003-000	134-002-000	134-003-000
SLANHC	1116	134-003-000	134-003-000	134-002-000	134-003-000
SLANHC	1115	-----	-----	-----	-----
ERTHC	1114	134-003-000	134-003-000	134-002-000	134-003-000

ERTHC	1116	134-003-000	134-003-000	134-002-000	134-003-000
ERTHC	1115	-----	-----	-----	-----
IPSHC	1114	134-003-000	134-003-000	134-002-000	134-003-000
IPSHC	1116	134-003-000	134-003-000	134-002-000	134-003-000
IPSHC	1115	-----	-----	-----	-----
ATMHC	1114	134-003-000	134-003-000	134-002-000	134-003-000
ATMHC	1116	134-003-000	134-003-000	134-002-000	134-003-000
ATMHC	1115	-----	-----	-----	-----
IPSG	1114	134-003-000	134-003-000	134-002-000	134-003-000
IPSG	1116	134-003-000	134-003-000	134-002-000	134-003-000
IPSG	1115	-----	-----	-----	-----
BLROM1	1114	134-003-000	134-003-000	134-002-000	134-003-000
BLROM1	1116	134-003-000	134-003-000	134-002-000	134-003-000
BLROM1	1115	-----	-----	-----	-----
BLIXP	1114	163-003-000	163-003-000	163-002-000	163-003-000
BLIXP	1116	163-003-000	163-003-000	163-002-000	163-003-000
BLIXP	1115	-----	-----	-----	-----

This example shows GPLs on an EAGLE that has E5-based control cards installed. The GPLs were copied from the removable media in on the active MASP.

This procedure is finished.

Figure 2-12 Restoring System Data from a Removable Cartridge or Removable Media

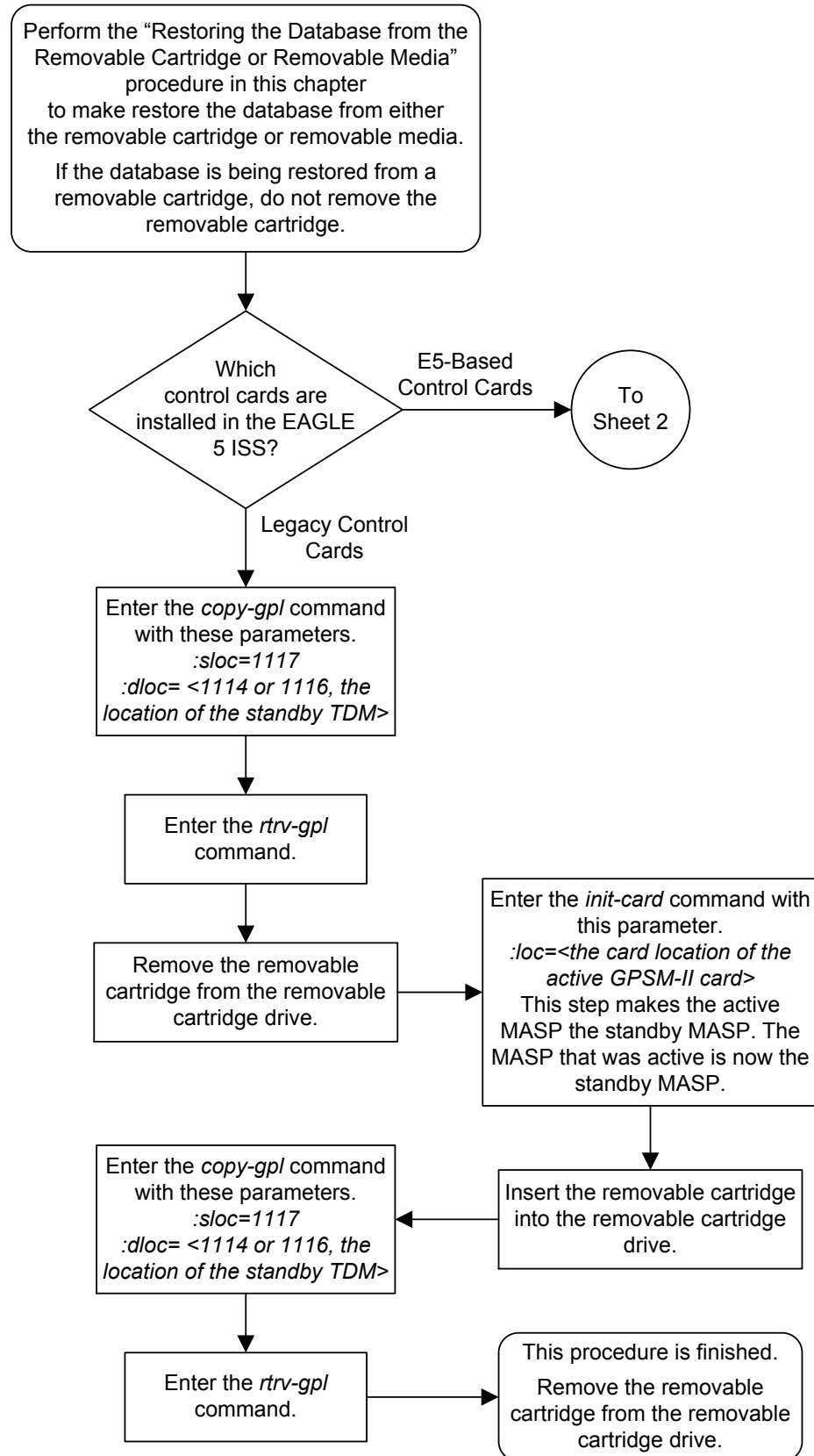

Sheet 1 of 2

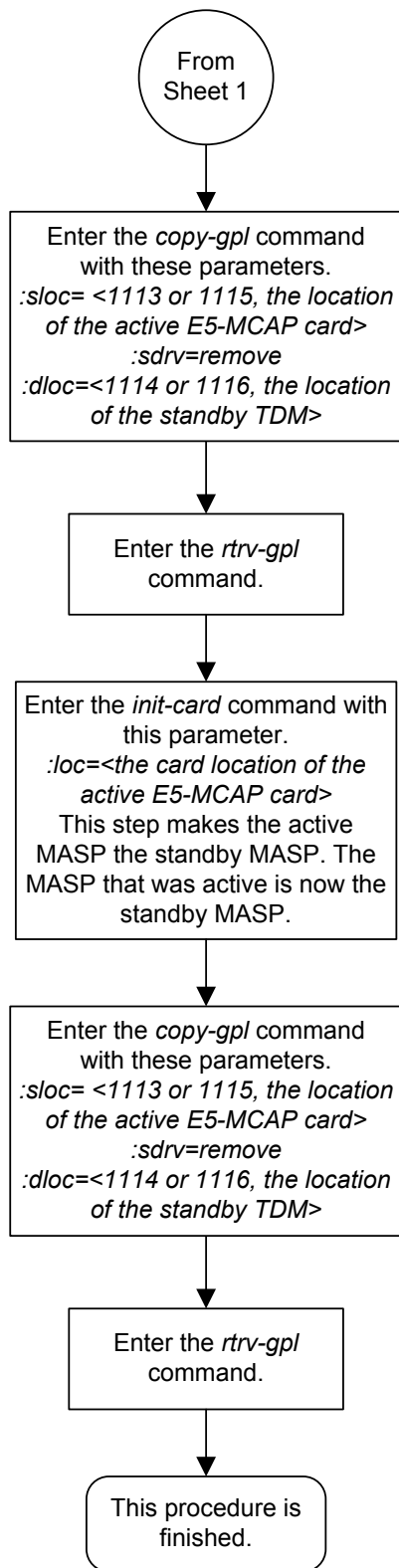

Formatting the Fixed Disk of the Standby E5-TDM

Use this procedure to format the fixed disk of the standby **E5-TDM** using the `format-disk` command.

The `format-disk` command uses these parameters.

`:type` – The type of disk or media being formatted.

- `system` – A removable media containing system data (**GPLs** and the database). To format removable media, perform [Formatting Removable Media](#).
- `fixed` – The fixed disk of the standby **E5-TDM**.

Note: If a `format-disk:type=fixed` command failure causes the standby **E5-TDM** to boot continuously, insert a removable disk that has the same release as the active **E5-TDM** into the **E5-MDAL**. The standby **E5-TDM** can then boot off of the removable disk.

`:loc` – The location of the standby E5-TDM, either 1114 or 1116.

`:low` – Is a check of the disk or media being performed and any problems found on the disk or media being repaired, *yes* or *no*? The `low=yes` parameter performs a check of the disk or media and any problems that are found are repaired. As an E5-TDM, no data is destroyed during this operation. If the `low=no` parameter is specified, the check of the disk or media is not performed. The default value for this parameter is *no*.

`:force` – Format the disk if the disk contains system data, *yes* or *no*. The default value for this parameter is *no*.

Note: Reduce extended execution time when specifying the `force=yes` option by also using the `low=no` option.

`:prtnggrp` – Indicates which disk partition group is being formatted, the active partition group (`prtnggrp=active`) or the inactive partition group (`prtnggrp=inactive`). The default value for the `prtnggrp` parameter is *active*. The `prtnggrp` parameter can be specified only with the `low=no` parameter. Contact [My Oracle Support \(MOS\)](#) before using the `prtnggrp=inactive` parameter.

The database in the current (**FD CRNT**) partition of the active **MASP** must be coherent. For more information on verifying the database, refer to [Verifying the Database](#).

Measurement collection must be turned off before the `format-disk` command can be executed.

The standby fixed disk cannot be formatted if the security log on the standby fixed disk contains any entries that have not been copied to the **FTA** area of the fixed disk. This can be verified with the `rept-stat-seculog` command. If the security log on the standby fixed disk contains entries that have not been copied to the file transfer area of the fixed disk, copy these entries to the file transfer area using the `copy-seculog` command.

```
rlghncxa03w 06-10-01 16:12:50 GMT EAGLE5 36.0.0
CHG-MEAS: MASP A - COMPLTD
```

4. Verify whether or not the Measurements Platform option is enabled (PLATFORMENABLE = on) using the `rtrv-measopts` command. If `platformenable` is ON, no further check is required for the `format-disk` command (as MCP will take care of measurement once `platformenable` is on). If `PLATFORMENABLE` is off, check to see if `COLLECT` is on using the `rtrv-meas-sched` command. If `COLLECT` is on, turn it off. If `COLLECT` is off, run the `format-disk` command, and turn it on.

```
rlghncxa03w 06-10-01 16:02:05 GMT EAGLE5 36.0.0
PLATFORMENABLE = on
COLLECT15MIN = off
CLLIBASEDNAME = off
-----
SYSTOTSTP = off
SYSTOTT = off
```

Note: The `rtrv-measopts` command output contains other fields that are not used by this procedure. To view all fields displayed by the `rtrv-measopts` command, see the `rtrv-measopts` command description in *Commands User's Guide*.

Note: If 4 shows that the Measurements Platform is not enabled, go to 7.

5. Use the `rept-stat-meas` command to display the status of **MCPMs** in the database .

This is an example of the possible output.

```
rlghncxa03w 09-02-01 16:43:42 GMT EAGLE5 40.0.0

MEAS SS          PST          SST          AST
                IS-NR        Active      -----
ALARM STATUS =  No Alarms

CARD  VERSION    TYPE  PST          SST          AST
2107 P 101-009-000  EDSM  IS-NR        Active      -----
      IP Link A                IS-NR        Active      Available
2108 101-009-000  EDSM  IS-NR        Active      -----
      IP Link A                IS-NR        Active      Available
2111 101-009-000  EDSM  IS-NR        Active      -----
      IP Link A                IS-NR        Active      Available

CARD 2107 ALARM STATUS = No Alarms
CARD 2108 ALARM STATUS = No Alarms
CARD 2111 ALARM STATUS = No Alarms
```

6. Use the `rmv-card` command, specifying the card location of the MCPM, to place all **MCPMs** out of service .

If the **MCPM** to be placed out of service is the last **MCPM** that is in service, the `force=yes` parameter must also be specified. For this example, enter these commands.

```
rmv-card:loc=2107
rmv-card:loc=2108
rmv-card:loc=2111:force=yes
```

When each of these commands have successfully completed, this message should appear.

```
rlghncxa03w 06-10-01 09:12:36 GMT EAGLE5 36.0.0
Card has been inhibited.
```

7. Verify that the security log on the standby **MASP** contains no entries that must be copied to the **FTA** area of the fixed disk with the `rept-stat-seculog` command.

This is an example of the possible output.

```
rlghncxa03w 06-10-01 15:59:06 GMT EAGLE5 36.0.0
-- SINCE LAST UPLOAD -- OLDEST NEWEST LAST
LOC  ROLE  ENTRIES %FULL OFLO FAIL RECORD RECORD UPLOAD
1114 Active  8312   84   No   No   03-12-05 04-06-01 04-05-30
                               11:23:56 15:59:06 14:02:22

1116 Standby 693     7     No   No   03-12-05 04-06-01 04-05-30
                               11:24:12 14:00:06 14:02:13
```

If the number shown in the **ENTRIES** field for the standby **MASP** (shown with the entry **Standby** in the **ROLE** field) is 0, go to step 9.

If the number shown in the **ENTRIES** field for the standby **MASP** is greater than 0, these entries must be copied to the **FTA** area of the fixed disk. To copy these entries, go to step 8.

For this example, go to 8.

8. Copy the security log entries on the standby **MASP** to the **FTA** area on the fixed disk with the `copy-seculog` command.

For this example, enter the `copy-seculog:slog=stb` command. This is an example of the message that should appear.

```
rlghncxa03w 06-10-01 15:59:06 GMT EAGLE5 36.0.0
Security log on E5TDM 1116 copied to file 961004s.log on E5TDM 1114
```

9. Enter the `format-disk` command to format the fixed disk of the standby **E5-TDM**.

For this example, the fixed disk of the standby **E5-TDM** contains system data and a check of the fixed disk of the standby **E5-TDM** for problems is not performed.

```
format-disk:type=fixed:force=yes:low=no:loc=1114
```

Note:

- a. The `force=yes` parameter must be specified with the `format-disk` command if the fixed disk of the standby **E5-TDM** to be formatted contains system data. All data on the fixed disk of the standby **E5-TDM** will be lost.
- b. The `low=no` parameter specified in this command example does not allow a check of the fixed disk of the standby **E5-TDM** for problems to be performed. If you wish to perform a check of the fixed disk of the standby **E5-TDM** for problems, specify the `low=yes` parameter with the `format-disk` command. Because the default value for the `low` parameter is `no`, the `low` parameter can be omitted when entering the `format-disk` command if you do not wish to perform a check of the fixed disk of the standby **E5-TDM** for problems.
- c. If a `format-disk:type=fixed` command failure causes the standby **E5-TDM** to boot continuously, insert a removable disk that has the same release as the active **E5-TDM** into the **E5-MDAL**. The standby **E5-TDM** can then boot off of the removable disk.
- d. The optional parameter `prtnggrp` parameter can be specified with this command. The `prtnggrp` parameter indicates which disk partition group is being formatted, the active partition group (`prtnggrp=active`) or the inactive partition group (`prtnggrp=inactive`). The default value for the `prtnggrp` parameter is `active`. The `prtnggrp` parameter can be specified only with the `low=no` parameter. Contact the Customer Care Center before using the `prtnggrp=inactive` parameter. Refer to [My Oracle Support \(MOS\)](#) for the contact information.

Formatting the fixed disk of the standby **E5-TDM** can take from 14 minutes to 1 hour and 25 minutes to execute. It may take longer depending on other system activity that is in progress when this command is entered. When this command has successfully completed, these messages should appear.

```

rlghncxa03w 06-10-01 09:44:08 GMT EAGLE5 36.0.0
format-disk:type=fixed:low=no:force=yes
Command entered at terminal #3.
;

rlghncxa03w 06-10-01 09:44:08 GMT EAGLE5 36.0.0
Format-disk of standby fixed disk started.
Extended processing required, please wait.
;

rlghncxa03w 06-10-01 09:44:08 GMT EAGLE5 36.0.0
Format-disk (fixed) format in progress.
;

rlghncxa03w 06-10-01 09:44:08 GMT EAGLE5 36.0.0
Format-disk (fixed) format is complete.
;

rlghncxa03w 06-10-01 09:44:08 GMT EAGLE5 36.0.0
Format-disk of standby fixed disk completed.
```

To turn measurement collection on, go to step 10, otherwise, this procedure is finished.

If measurement collection was not turned off in step 3, skip steps 10 and 11, and go to step 12.

- 10.** To turn measurement collection on, enter this command.

```
chg-meas:collect=on
```

This message should appear.

```
rlghncxa03w 06-10-01 16:12:50 GMT EAGLE5 36.0.0
CHG-MEAS: MASP A - COMPLTD
```

- 11.** Verify that measurement collection is on using the `rtrv-meas-sched` command, shown by the `COLLECT = on` field in the output.

This is an example of the possible output.

```
rlghncxa03w 06-10-01 12:22:55 GMT EAGLE5 36.0.0
COLLECT          = on
GTWYLSFLTR      = both
-----
SYSTOT-STP      = off
SYSTOT-TT       = off
COMP-LNKSET     = off
COMP-LINK       = on
GTWY-STP        = on
GTWY-LNKSET     = on
MTCD-STP        = on
MTCD-LINK       = on
MTCD-LNKSET     = on
```

Note: MCPMs were not placed out of service in step 6, skip steps 12 and step 13. This procedure is finished.

- 12.** Place the **MCPMs** back into service using the `rst-card` specifying the location of each **MCPM**.

For this example, enter these commands.

```
rst-card:loc=2107
rst-card:loc=2108
rst-card:loc=2111
```

When each of these commands have successfully completed, this message should appear.

```
rlghncxa03w 06-10-01 21:20:37 GMT EAGLE5 36.0.0
Card has been allowed.
```

- 13.** Display the status of the **MCPMs** in the database with the `rept-stat-meas` command.

This is an example of the possible output.

rlghncxa03w 09-02-01 16:43:42 GMT EAGLE5 40.0.0

```

                PST          SST          AST
MEAS SS         IS-NR       Active      -----
    ALARM STATUS =   No Alarms
    
```

CARD	VERSION	TYPE	PST	SST	AST
2107	P 101-009-000	EDSM	IS-NR	Active	-----
	IP Link A		IS-NR	Active	Available
2108	101-009-000	EDSM	IS-NR	Active	-----
	IP Link A		IS-NR	Active	Available
2111	101-009-000	EDSM	IS-NR	Active	-----
	IP Link A		IS-NR	Active	Available

```

CARD 2107 ALARM STATUS = No Alarms
CARD 2108 ALARM STATUS = No Alarms
CARD 2111 ALARM STATUS = No Alarms
    
```

Figure 2-13 Formatting the Fixed Disk of the Standby E5-TDM

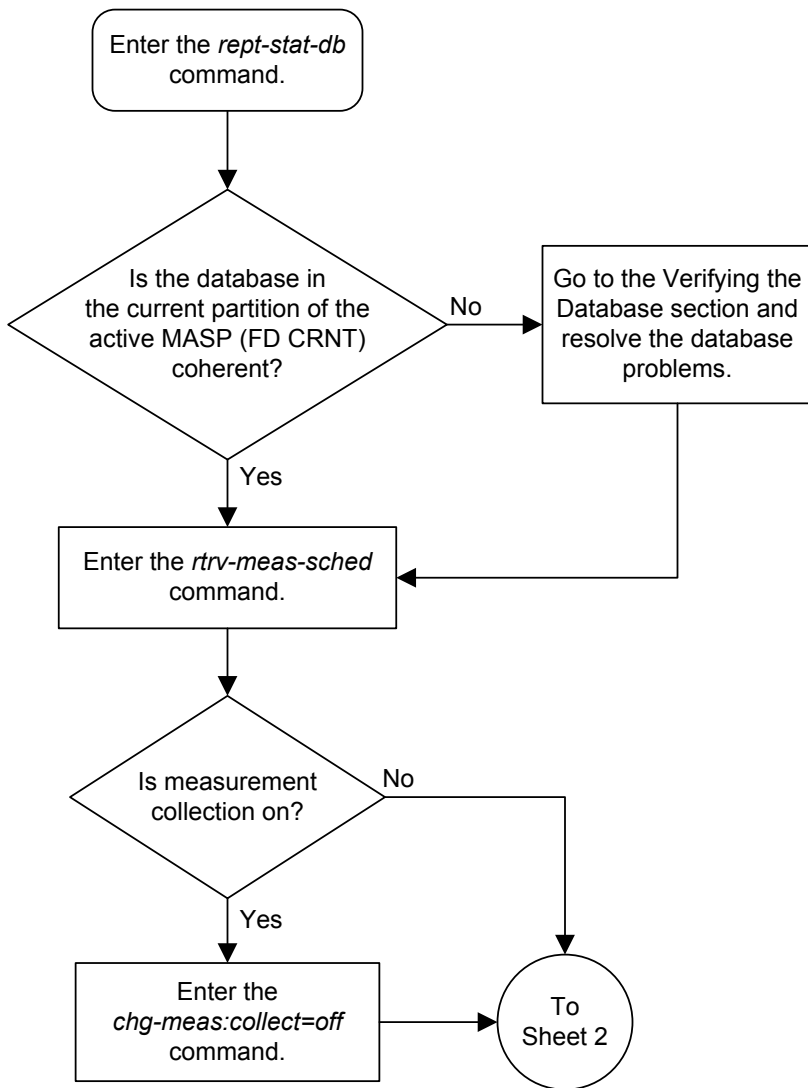

Sheet 1 of 4

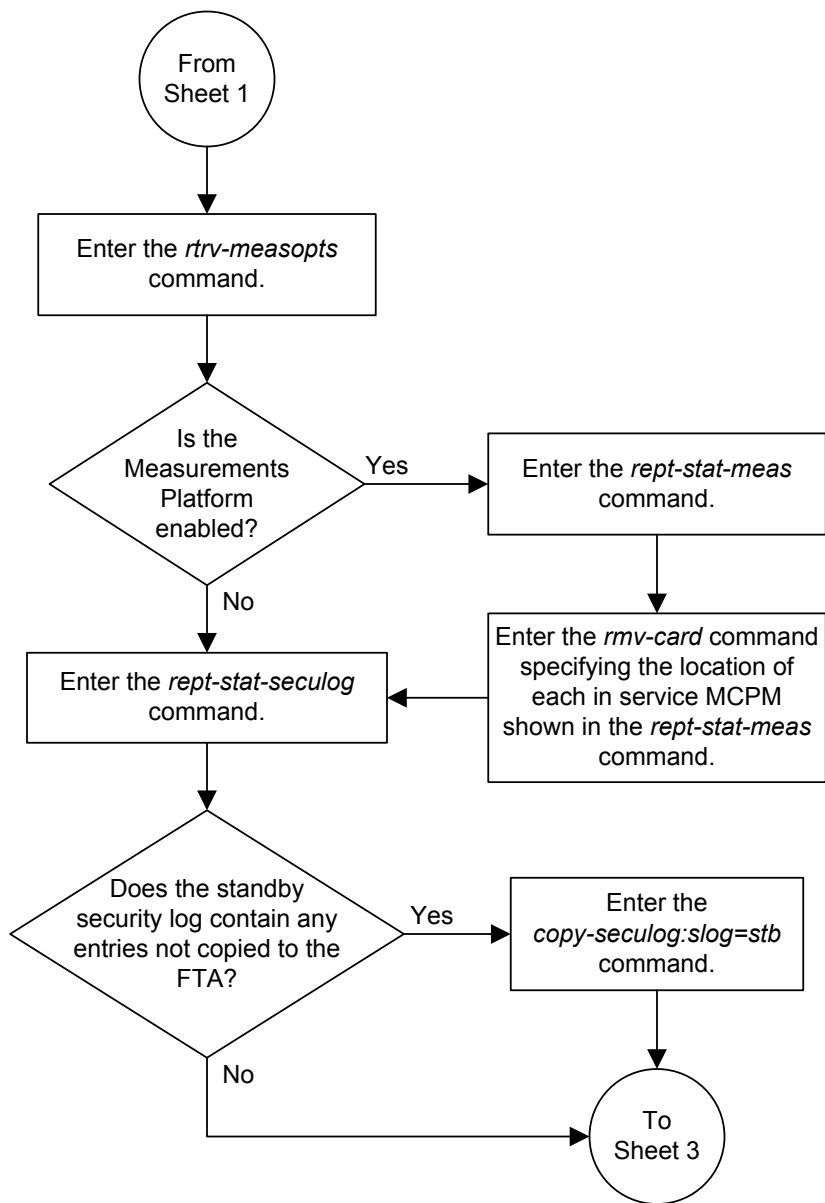

Sheet 2 of 4

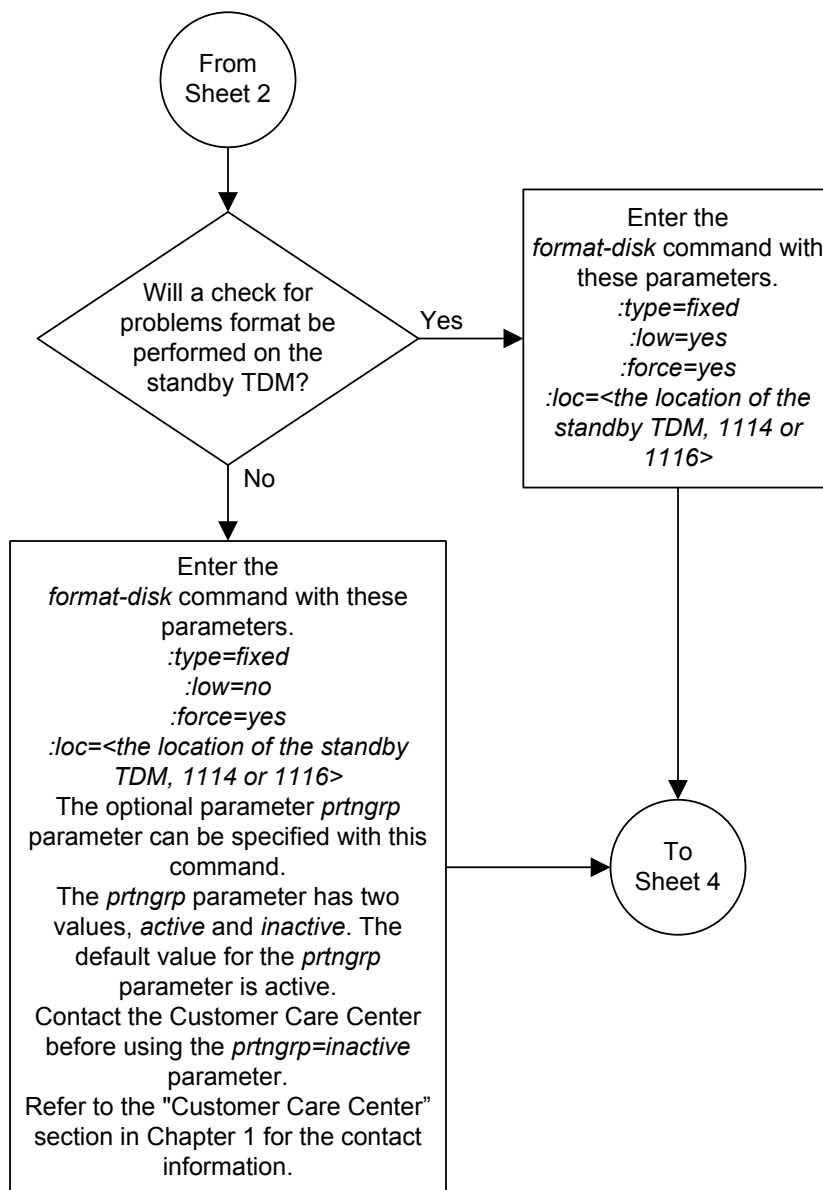

Sheet 3 of 4

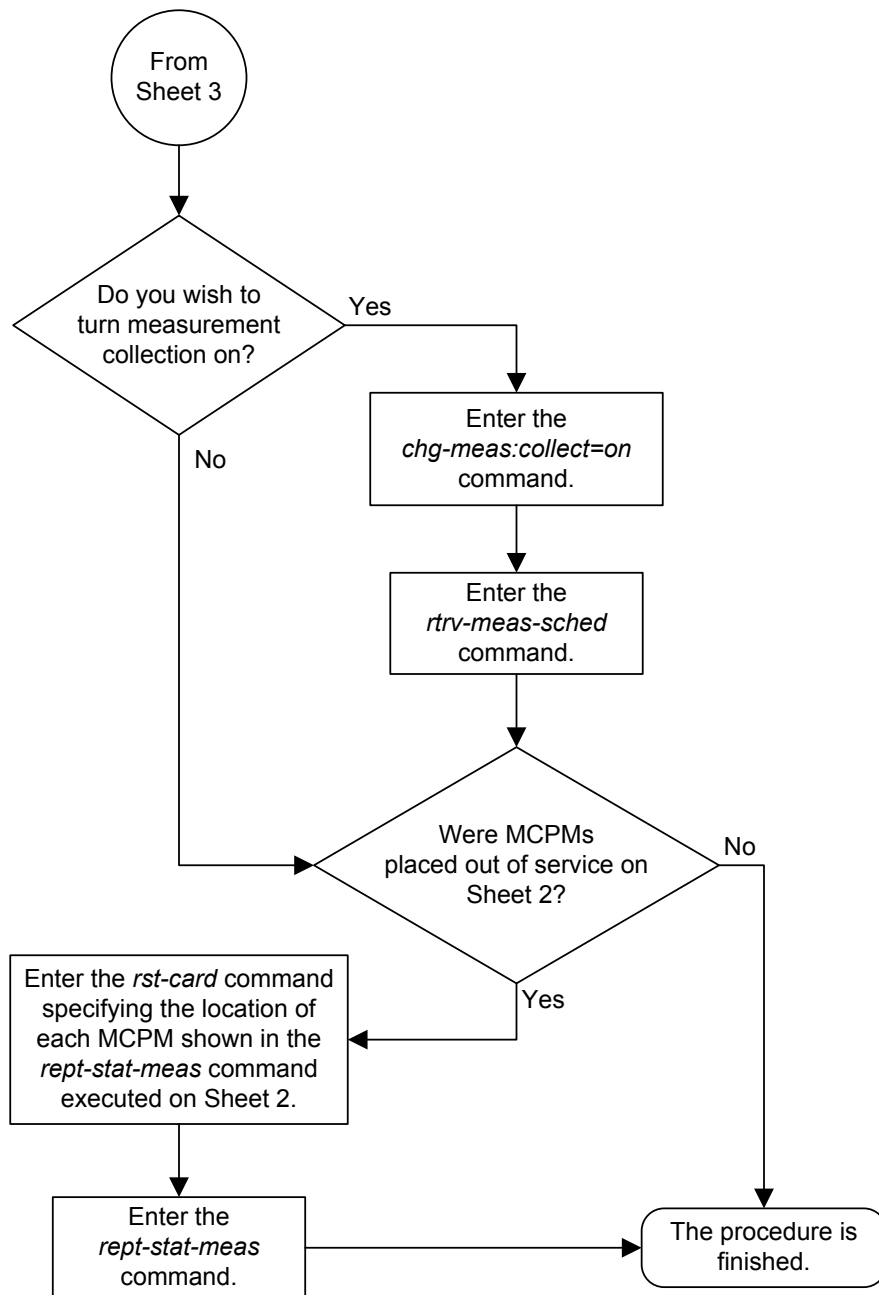

Formatting Removable Media

Use this procedure to prepare removable media for use on the EAGLE for holding system data or measurements data using the `format-disk` command. The `format-disk` command uses these parameters.

Note: This procedure can be performed only if E5-based control cards are installed in the EAGLE. Refer to [Maintenance and Administration Subsystem](#) for more information about the control cards.

`:type` – The type of media that is being formatted.

- `system` – Removable media containing system data (**GPLs** and the database)
- `meas` – Removable media containing measurements data
- `fixed` – The fixed disk of the standby **E5-TDM**. To format the fixed disk of the standby **E5-TDM**, perform [Formatting the Fixed Disk of the Standby E5-TDM](#).

`:loc` – The location of the E5-MCAP card that contains the media that is being formatted, either 1113 or 1115.

`:low` – Is a check of the media being performed and any problems found on the media being repaired, `yes` or `no`? The `low=yes` parameter performs a check of the media and any problems that are found are repaired. No data is destroyed during this operation. If the `low=no` parameter is specified, the check of the media is not performed. The default value for this parameter is `no`.

`:force` – Format the media if the media contains system data, `yes` or `no`. The default value for this parameter is `no`.

`:prtnggrp` – Indicates which disk partition group is being formatted, the active partition group (`prtnggrp=active`) or the inactive partition group (`prtnggrp=inactive`). The default value for the `prtnggrp` parameter is `active`. The removable media does not contain an inactive partition group, so the `prtnggrp=inactive` cannot be specified in this procedure.

Note: Reduce extended execution time when specifying the `force=yes` option by also using the `low=no` option.

The database in the current (**FD CRNT**) partition of the active **MASP** must be coherent. If the current partition of the active **MASP** is not coherent, contact the customer care center. Refer to [My Oracle Support \(MOS\)](#) for the contact information.

Measurement collection must be turned off before the `format-disk` command can be executed.

1. Check the removable media drives on each **MASP** for removable media.

Perform one of these substeps.

- a. If there is no removable media in both removable media drives, insert the removable media that will be formatted into one of the removable media drives.

Continue the procedure with 2. Refer to [Removable USB Drive](#) for more information about removing the removable media.

- b. If removable media is in the removable media drives, and the media in these drives will be formatted, continue the procedure with 2.
 - c. If removable media is in the removable media drives, and the media in these drives will not be formatted, remove the removable media from the removable media drive that will be used to format the removable media. Insert the removable media that will be formatted into this drive. Continue the procedure with 2. Refer to [Removable USB Drive](#) for more information about removing and inserting the removable media.
2. Verify that the database in the current (FDCRNT) partition of the active MASP is coherent using the `rept-stat-db` command.

This is an example of the possible output.

```
rlghncxa03w 09-03-01 16:07:48 GMT EAGLE5 40.1.0
DATABASE STATUS: >> OK <<
      E5TDM 1114 ( STDBY )                E5TDM 1116 ( ACTV )
      C  LEVEL      TIME LAST BACKUP    C  LEVEL      TIME LAST BACKUP
-----
FD BKUP Y          35 09-02-19 10:19:18 GMT Y          35 09-02-19 10:19:18 GMT
FD CRNT Y           106                      Y           106
      E5MCAP 1113                          E5MCAP 1115
-----
RD BKUP Y           106 09-02-15 16:09:53 GMT Y           106 09-02-15 16:09:53 GMT
USB BKP -           -      -      -      Y           95 09-02-13 16:09:53 GMT
```

If the current partition of the active MASP is not coherent, contact the customer care center. Refer to [My Oracle Support \(MOS\)](#) for the contact information.

If the current partition of the active MASP is coherent and removable media will be formatted, continue the procedure with 4.

3. Verify whether or nor the Measurements Platform option is enabled (PLATFORMENABLE = on) using the `rtrv-measopts` command.

```
rlghncxa03w 09-03-01 16:02:05 GMT EAGLE5 40.1.0
PLATFORMENABLE      = on
COLLECT15MIN        = off
CLLIBASEDNAME       = off
-----
SYSTOTSTP           = off
SYSTOTTT            = off
```

Note: The `rtrv-measopts` command output contains other fields that are not used by this procedure. If you wish to see all the fields displayed by the `rtrv-measopts` command, see the `rtrv-measopts` command description in *Commands User's Guide*.

If the Measurements Platform is enabled, continue the procedure with 8

If the Measurements Platform is not enabled, go to 4.

- Verify that measurement collection is on or off using the `rtrv-meas-sched` command.

This is an example of the possible output. The `COLLECT` field shows whether measurement collection is on or off. In this example, measurement collection is on.

```
rlghncxa03w 09-03-01 12:22:55 GMT EAGLE5 40.1.0
COLLECT          = on
GTWYLSFLTR      = both
-----
SYSTOT-STP      = off
SYSTOT-TT       = off
COMP-LNKSET     = off
COMP-LINK       = on
GTWY-STP        = on
GTWY-LNKSET     = on
MTCD-STP        = on
MTCD-LINK       = on
MTCD-LNKSET     = on
```

If measurement collection is off, continue the procedure with [3](#).

If measurement collection is on, continue the procedure with [5](#).

- Turn measurement collection off using the `chg-meas:collect=off` command.

Caution: Measurement collection must be turned off or the `format-disk` command cannot be executed. The `chg-meas:collect=on` command should not be executed while the `format-disk` command is in progress. If possible, do not turn off measurement collection at midnight since doing so can cause the loss of an entire day of measurements. For the period of time that measurement collection is turned off, those measurements will be lost.

This message should appear.

```
rlghncxa03w 09-03-01 16:12:50 GMT EAGLE5 40.1.0
CHG-MEAS: MASP A - COMPLTD
```

- Display the status of the **MCPMs** in the database with the `rept-stat-meas` command.

This is an example of the possible output.

```
rlghncxa03w 09-03-01 16:43:42 GMT EAGLE5 40.1.0

MEAS SS          PST          SST          AST
                IS-NR        Active      -----
ALARM STATUS =  No Alarms

CARD  VERSION      TYPE  PST          SST          AST
2107 P 101-009-000  EDSM  IS-NR        Active      -----
      IP Link A      IS-NR        Active      Available
2108 101-009-000  EDSM  IS-NR        Active      -----
      IP Link A      IS-NR        Active      Available
2111 101-009-000  EDSM  IS-NR        Active      -----
      IP Link A      IS-NR        Active      Available
```

```
CARD 2107 ALARM STATUS = No Alarms
CARD 2108 ALARM STATUS = No Alarms
CARD 2111 ALARM STATUS = No Alarms
```

7. Place all the **MCPMs** out of service using the `rmv-card` command, specifying the card location of the **MCPM**.

If the **MCPM** to be placed out of service is the last **MCPM** that is in service, the `force=yes` parameter must also be specified. For this example, enter these commands.

```
rmv-card:loc=2107
rmv-card:loc=2108
rmv-card:loc=2111:force=yes
```

When each of these commands have successfully completed, this message should appear.

```
rlghncxa03w 09-03-01 09:12:36 GMT EAGLE5 40.1.0
Card has been inhibited.
```

8. Format the removable media by performing one of these substeps.

- a. To format removable media for system data, for this example, enter this command.

```
format-disk:type=system:loc=1113
```

If a check of the media for problems will be performed, specify the `low=yes` parameter with the `format-disk` command. If the `low=yes` parameter is not specified, a check of the media for problems will not be performed.

If the media contains system data, the `force=yes` parameter must be specified with the `format-disk` command. All data on the removable media will be lost.

When this command has successfully completed, these messages should appear.

```
rlghncxa03w 09-03-01 09:44:08 GMT EAGLE5 40.1.0
format-disk:type=system
Command entered at terminal #3.
;

rlghncxa03w 09-03-01 09:44:08 GMT EAGLE5 40.1.0
Format disk of system removable media started.
;

rlghncxa03w 09-03-01 09:44:08 GMT EAGLE5 40.1.0
Format disk in progress.
;

rlghncxa03w 09-03-01 09:44:08 GMT EAGLE5 40.1.0
Format disk in progress.
;

rlghncxa03w 09-03-01 09:44:08 GMT EAGLE5 40.1.0
Format disk (removable media) format is complete.
;

rlghncxa03w 09-03-01 09:44:08 GMT EAGLE5 40.1.0
Format disk of system removable media completed.
Measurements collection may be turned on now if desired.
```

- b.** To format removable media for measurements data, for this example, enter this command.

```
format-disk:type=meas:loc=1113
```

If a low level format of the media will be performed, specify the `low=yes` parameter with the `format-disk` command. If the `low=yes` parameter is not specified, a low level format of the media will not be performed.

If the media contains system data, the `force=yes` parameter must be specified with the `format-disk` command. All data on the removable media will be lost.

When this command has successfully completed, these messages should appear.

```
rlghncxa03w 09-03-01 09:44:08 GMT EAGLE5 40.1.0
format-disk:type=meas
Command entered at terminal #3.
;

rlghncxa03w 09-03-01 09:44:08 GMT EAGLE5 40.1.0
Format disk of measurements removable media started.
;

rlghncxa03w 09-03-01 09:44:08 GMT EAGLE5 40.1.0
Format disk in progress.
;

rlghncxa03w 09-03-01 09:44:08 GMT EAGLE5 40.1.0
Format disk in progress.
;

rlghncxa03w 09-03-01 09:44:08 GMT EAGLE5 40.1.0
Format disk (removable media) format is complete.
;

rlghncxa03w 09-03-01 09:44:08 GMT EAGLE5 40.1.0
Format disk of measurements removable media completed.
Measurements collection may be turned on now if desired.
```

If **5** was not performed, continue the procedure with .

If **5** was performed, continue the procedure with **9**.

- 9.** Turn measurement collection on using the `chg-meas:collect=on` command.

This message should appear.

```
rlghncxa03w 09-03-01 16:12:50 GMT EAGLE5 40.1.0
CHG-MEAS: MASP A - COMPLTD
```

- 10.** Verify that measurement collection is on using the `rtrv-meas-sched` command, shown by the `COLLECT = on` field in the output.

This is an example of the possible output.

```
rlghncxa03w 09-03-01 12:22:55 GMT EAGLE5 40.1.0
COLLECT          = on
GTWYLSFLTR      = both
-----
SYSTOT-STP      = off
```

```

SYSTOT-TT      = off
COMP-LNKSET    = off
COMP-LINK      = on
GTWY-STP      = on
GTWY-LNKSET    = on
MTCD-STP      = on
MTCD-LINK      = on
MTCD-LNKSET    = on
    
```

11. Place the MCPMs back into service using the `rst-card` specifying the location of each MCPM.

For this example, enter these commands.

```

rst-card:loc=2107
rst-card:loc=2108
rst-card:loc=2111
    
```

When each of these commands have successfully completed, this message should appear.

```

rlghncxa03w 09-03-01 21:20:37 GMT EAGLE5 40.1.0
Card has been allowed.
    
```

12. Display the status of the MCPMs in the database with the `rept-stat-meas` command.

This is an example of the possible output.

```

rlghncxa03w 09-03-01 16:43:42 GMT EAGLE5 40.1.0

MEAS SS          PST          SST          AST
                IS-NR          Active       -----
ALARM STATUS =  No Alarms

CARD  VERSION    TYPE  PST      SST      AST
2107 P 101-009-000  EDSM  IS-NR    Active   -----
      IP Link A                IS-NR    Active   Available
2108  101-009-000  EDSM  IS-NR    Active   -----
      IP Link A                IS-NR    Active   Available
2111  101-009-000  EDSM  IS-NR    Active   -----
      IP Link A                IS-NR    Active   Available

CARD 2107 ALARM STATUS = No Alarms
CARD 2108 ALARM STATUS = No Alarms
CARD 2111 ALARM STATUS = No Alarms
    
```

Figure 2-14 Formatting Removable Media

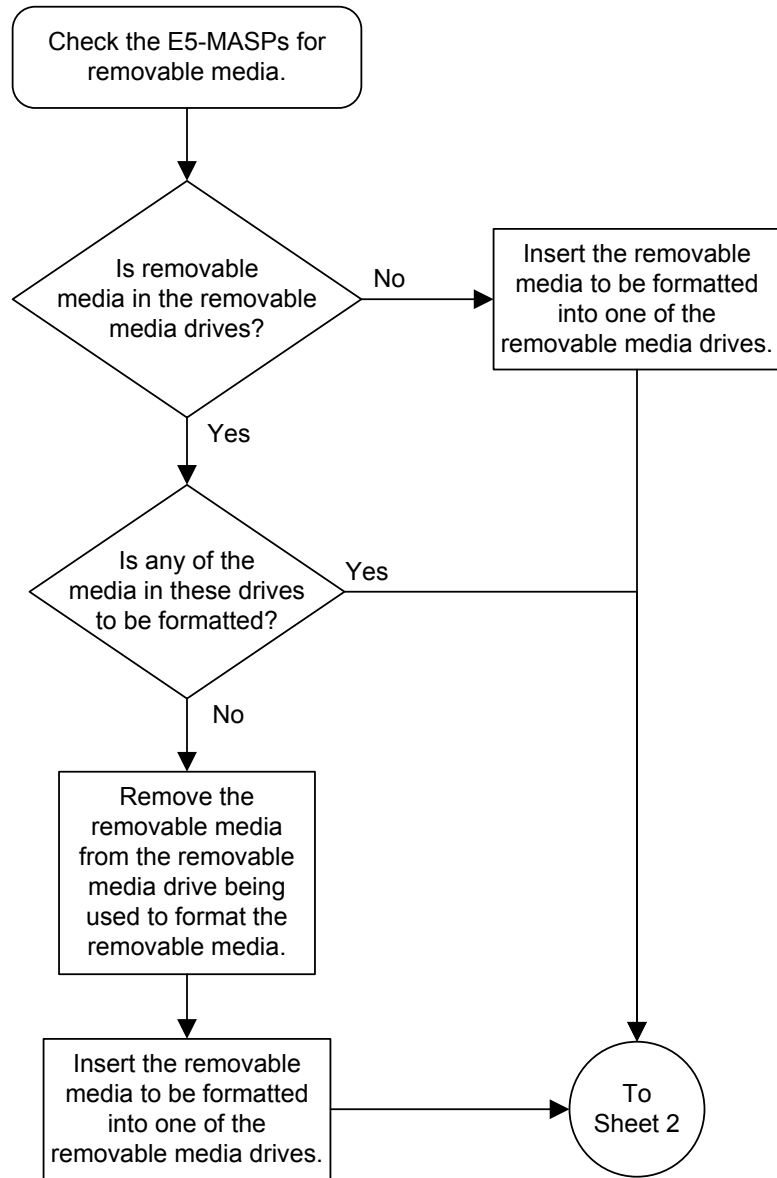

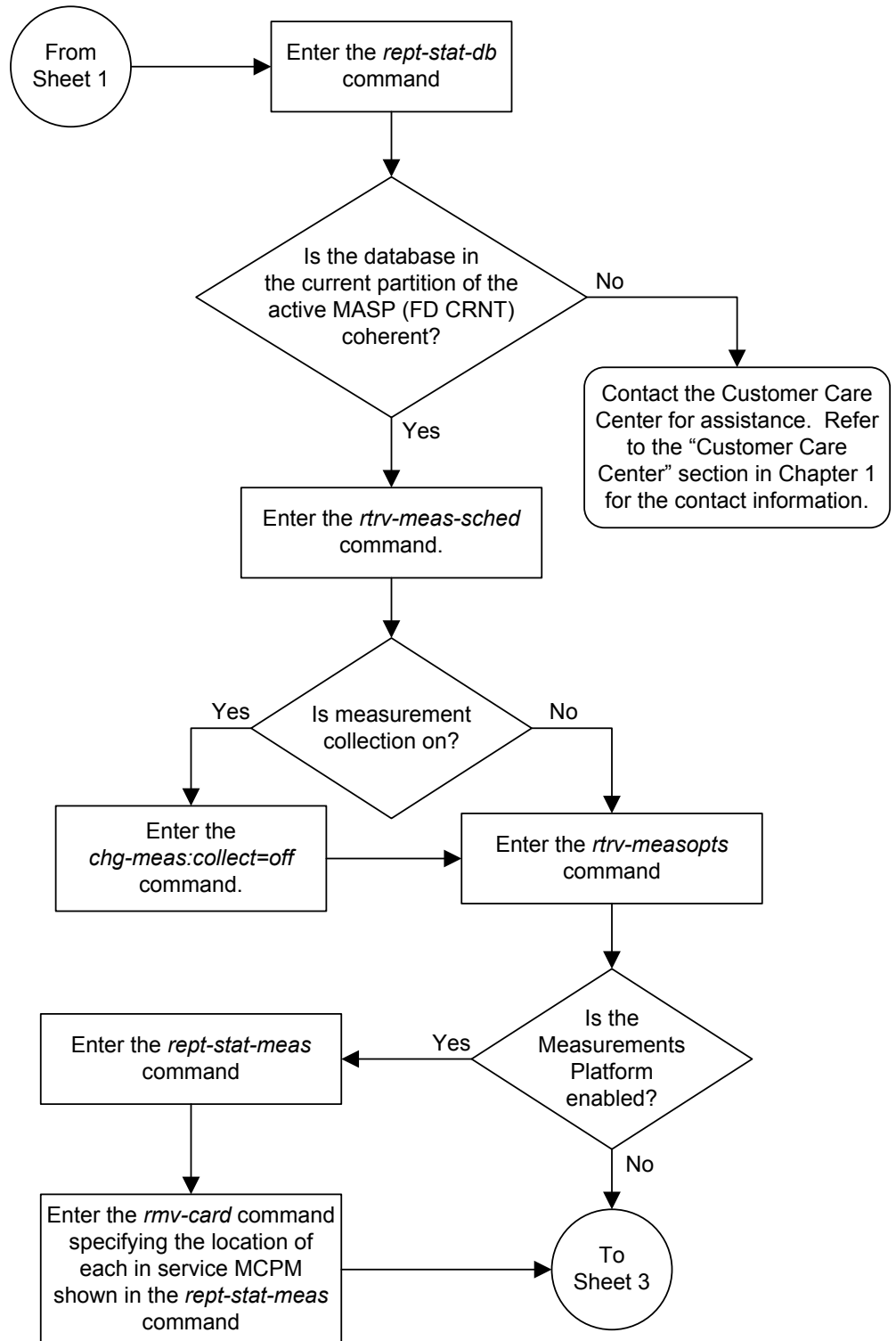

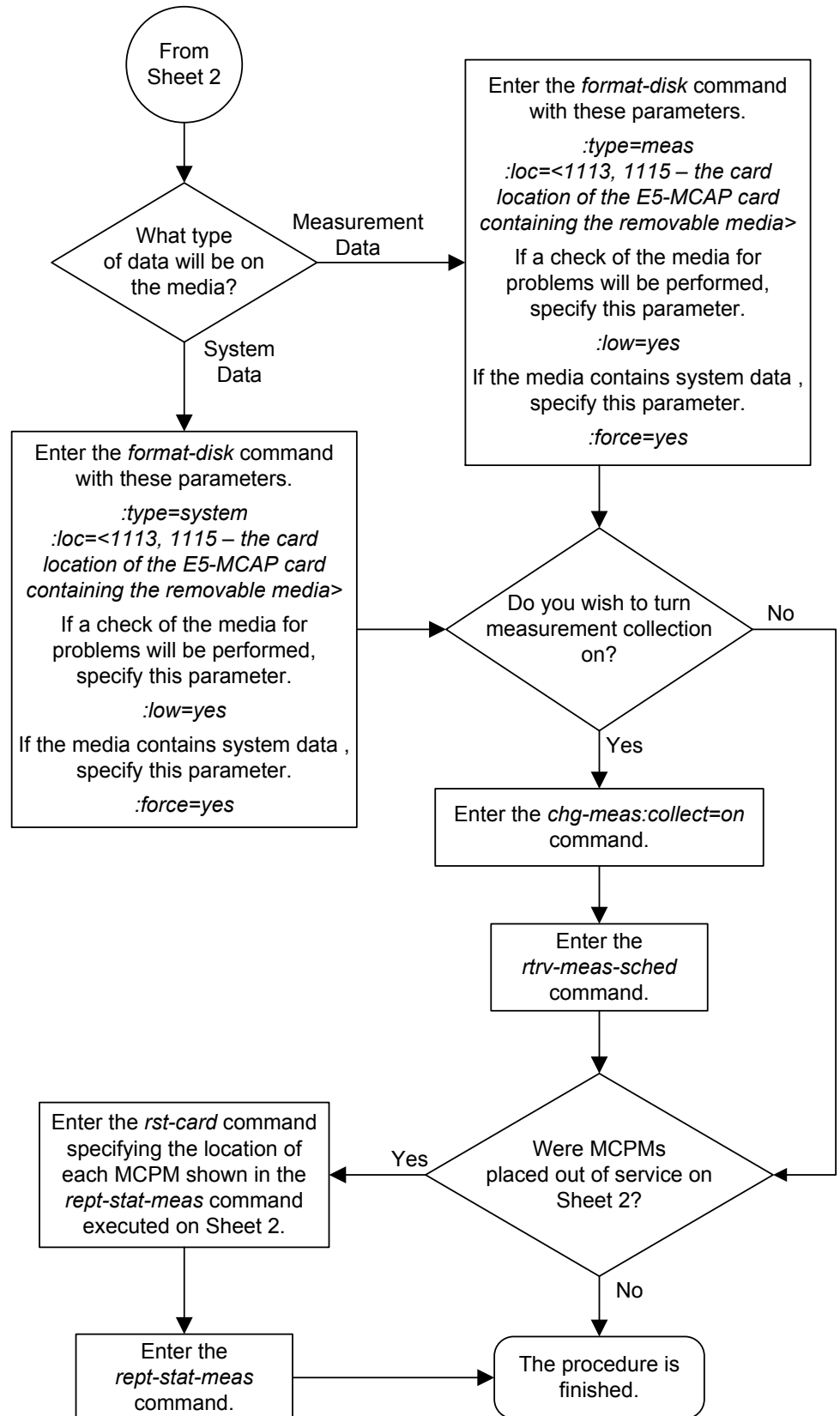

GPL Management Procedures

Chapter 3, GPL Management Procedures, describes the procedures used for managing the system data (GPLs) on the EAGLE.

Introduction

A **GPL** is the software that is loaded onto a card that allows the various features in the EAGLE to work. The EAGLE currently uses the following GPLs:

- **ATMHC**– The application GPL used for high-speed ANSI and E1 **ATM** signaling links that are assigned to E5-ATM-B cards.
- **BLDC32**–A flash GPL containing a tar image with all code required on E5-MCAP cards to support VxWorks6.9 32-bit application, as in OAMHC69, E5-ENET-B for running IPSHC69, and E5-MCPM-B for running MCPHC69.
- **BLDC64**–A flash GPL containing a tar image of 64-bit code required on E5-SM8GB cards for SCCP64, ENUM64, SIP64 and DEIR64 applications.
- **BLMCAP**–A flash GPL containing a tar image of 32-bit code for the following cards: E5-MCAP, E5-E1T1-B, E5-ENET-B, E5-ATM-B, E5-MCPMB, and SM8GB.
- **BLSLC32**– A flash GPL containing a tar image of 32-bit code required on SLIC cards for 32-bit applications.
- **BLSLC64**–A flash GPL containing a tar image of 64-bit code required on SLIC cards for 64-bit applications, as in SCCP64, ENUM64, SIP64, and DEIR64.
- **BLSL932**–A flash GPL containing a tar image with all code required on SLIC card for 32-bit application on VxWorks6.9, as in IPSHC69 and MCPHC69.
- **DEIR64**–The 64-bit application GPL used on the E5-SM8G-B and SLIC cards to support the S13/S13' EIR feature.
- **DEIRHC**–The 32-bit application GPL used on the E5-SM8G-B and SLIC cards to support the S13/S13' EIR feature.
- **ENUM64**–The 64-bit application GPL used on the E5-SM8G-B and SLIC cards for the ENUM Mobile Number Portability and Tier One Address Resolution feature.
- **ENUMHC**–The 32-bit application GPL used on the E5-SM8G-B and SLIC cards for the ENUM Mobile Number Portability and Tier One Address Resolution feature .
- **ERTHC**–The application GPL used on E5-ENET-B cards for the EAGLE 5 Integrated Monitoring Support feature.
- **HIPR2** –The communication GPL used on the High-Speed IMT Packet Router (HIPR2) card.

- **IPSG** –The application GPL used for the IP Signaling Gateway M2PA and M3UA signaling links.
- **IPSG32**–The 32-bit application GPL used on SLIC cards that combines GTT and IPSG capabilities.
- **IPSHC** –The application GPL used on E5-ENET-B or SLIC cards for the IP User Interface and FTP Retrieve and Replace features.
- **IPSHC69**–Used by E5-ENET-B and SLIC cards to support the IPS application when running on VxWorks69.
- **MCPHC**– The application GPL used on the **E5-MCPM-B** (Measurement Collection & Polling Module) and SLIC cards for the Measurements Platform feature.
- **MCPHC69**– Used by E5-MCPM-B and SLIC cards for the Measurements Platform feature when running on VxWorks69.
- **OAMHC**–The application GPL used by the **E5-MCAP** card for enhanced OAM functions.
- **OAMHC69**–Used by E5-MCAP cards for enhanced OAM functions, when running on VxWorks 69
- **SCCP64**–The 64-bit application GPL used on E5-SM8G-B and SLIC cards to support EPAP-based features and the LNP ELAP Configuration feature. If no EPAP-based or LNP ELAP Configuration feature is turned on and an E5-SM8G-B card is present, then the GPL processes normal global title translation traffic.
- **SCCPHC**– The 32-bit application GPL used on E5-SM8G-B and SLIC cards to support EPAP-based features and the LNP ELAP Configuration feature. If no EPAP-based or LNP ELAP Configuration feature is turned on and an E5-SM8G-B card is present, then the GPL processes normal global title translation traffic.
- **SFAPP**–Used by SLIC cards to support Stateful Firewall Application.
- **SIP64**–The 64-bit application GPL used on the E5-SM8G-B and SLIC cards to support a SIP stack of TCP.
- **SIPHC**– The 32-bit application GPL used on the E5-SM8G-B and SLIC cards to support a SIP stack of TCP.
- **SS7HC**– The application GPL used by E5-E1T1-B and SLIC cards to support E1 and T1 signaling links.

Managing GPLs

Managing these GPLs consists of loading them onto the EAGLE from a removable media, downloading these GPLs to the appropriate cards in the EAGLE, then allowing the cards to run these GPLs. The GPLs can be in one of two states, trial and approved.

Note: Refer to the [Maintenance and Administration Subsystem](#) section for more information about the control cards.

A trial GPL is a GPL that has not been approved for use and does not match the version number in the system release **ID** table. The trial GPL is the GPL that the EAGLE is not running.

The approved GPL is the GPL that the EAGLE should be running and has been approved for use. The approved GPL version number should match the version number of the GPL contained in the system release ID table.

The system release ID table contains the version numbers of the approved GPLs that the EAGLE should be running. The system release ID table is contained on the E5-TDMs (Terminal Disk Modules) and on the removable media containing the GPLs that are being loaded onto the EAGLE. The GPLs are loaded onto the EAGLE from a removable media. To get the GPLs from the removable media onto the EAGLE in the approved state, two commands are used, `chg-gpl` and `act-gpl`.

CHG-GPL Command

The `chg-gpl` command copies a GPL from the removable media to the E5-TDMs. The new GPL becomes the trial version on each of the E5-TDMs. This command also copies the system release ID table from the removable media to the E5-TDMs. The `chg-gpl` command uses these parameters.

`gpl` – the GPL being loaded onto the EAGLE

`ver` – the version number of the GPL

`audit` – Specifies whether the active **MASP** system release version is to be audited every 90 seconds.

`src` – Specifies the source drive containing the GPL that is being copied. This parameter has two values.

- `remove` – the removable media flash drive on the E5-MCAP card.
- `usb` – This parameter is to be used by Oracle personnel only and cannot be used with the `chg-gpl` command.

If you are loading a GPL onto the EAGLE, the `gpl` and `ver` parameters must be specified with the `chg-gpl` command and a removable media containing the GPL being loaded must be in the removable media drive on the E5-MCAP card of the active MASP.

The `audit` parameter is required only when turning the GPL auditing on or off.

ACT-GPL Command

The `act-gpl` command changes the state of the trial GPL from “trial” to “approved.” This is also referred to as activating the GPL. The state of the previously approved GPL is changed from “approved” to “trial.”

The version of the GPL shown in the `RELEASE` column of the `rtrv-gpl` output (the GPL version in the system release ID table) is updated to the new approved version when this command is performed.

The `act-gpl` command uses these parameters:

`gpl` – the GPL being loaded onto the EAGLE

`ver` – the version number of the GPL

Displaying GPL Information

Two commands can be used to display the GPL information in the database, `rept-stat-gpl` and `rtrv-gpl`. The `rept-stat-gpl` command shows the versions of the GPLs that are running on the cards in the EAGLE. The `rtrv-gpl` command shows the versions of the GPLs contained on the fixed disks.

REPT-STAT-GPL Command

The `rept-stat-gpl` command output contains these five columns and displays this information.

- **GPL** – The GPLs contained on the TDMs (Terminal Disk Modules). The TDMs contain the fixed disks.
- **CARD** – The cards that are running the GPLs
- **RUNNING** – The version number of the GPLs the cards are running
- **APPROVED** – The version numbers of the approved GPLs
- **TRIAL** – The version numbers of the trial GPLs

The following is an example of the `rept-stat-gpl` command output.

```
rept-stat-gpl:loc=1103
tklc9010801 16-09-07 00:21:39 EST EAGLE 46.4.0.0.0-69.10.0
GPL Auditing ON

      GPL          CARD      RUNNING          APPROVED      TRIAL
      SS7HC        1103      139-010-000      139-010-000      139-010-000
                BLMCAP          139-010-000          139-010-000      085-009-009

Command Completed.
```

The example `rept-stat-gpl` output shows that the card in slot 1103 is running the SS7HC GPL, version number 139-010-000, which is also the approved version of the SS7HC GPL. The trial version number of the SS7HC GPL is also 139-010-000.

You can display all the GPLs used by all the cards in the EAGLE except the flash (or communication) GPLs, a specific GPL, or all application and flash GPLs used by all the cards in the EAGLE. The flash GPLs are the BLMCAP, BLDC32, BLDC64, BLSLC32, BLSLC64, BLSLC932, and HIPR2 GPLs. The application GPLs are the other GPLs in the EAGLE.

If you specify the `rept-stat-gpl` command with no parameters, all the GPLs on all the cards in the EAGLE are displayed except for the communication GPLs, as shown in this example.

```
tklc9010801 16-09-07 00:22:18 EST EAGLE 46.4.0.0.0-69.10.0
GPL Auditing ON

      GPL          CARD      RUNNING          APPROVED      TRIAL
      OAMHC        1113      139-010-000      139-010-000      139-010-000
      OAMHC        1115      139-010-000      139-010-000      139-010-000
      SS7HC        1103      139-010-000      139-010-000      139-010-000
      SS7HC        1104      139-010-000      139-010-000      139-010-000
      SS7HC        1107      139-010-000      139-010-000      139-010-000
      SS7HC        1108      139-010-000      139-010-000      139-010-000
      SS7HC        1203      139-010-000      139-010-000      139-010-000
      SS7HC        1207      139-010-000      139-010-000      139-010-000
      SS7HC        1208      139-010-000      139-010-000      139-010-000
      SS7HC        1213      139-010-000      139-010-000      139-010-000
      SS7HC        1303      139-010-000      139-010-000      139-010-000
      SS7HC        1304      139-010-000      139-010-000      139-010-000
      SS7HC        1307      139-010-000      139-010-000      139-010-000
      SS7HC        1308      139-010-000      139-010-000      139-010-000
```

SS7HC	1313	139-010-000	139-010-000	139-010-000
SS7HC	1314	139-010-000	139-010-000	139-010-000
GLSHC	1102	139-010-000	139-010-000	139-010-000
IPLHC	1205	139-010-000	139-010-000	139-010-000
IPLHC	1206	139-010-000	139-010-000	139-010-000
IPGHC	2311	139-010-000	139-010-000	139-010-000
IPGHC	5102	139-010-000	139-010-000	139-010-000
SCCPHC	1215	139-010-000	139-010-000	139-010-000
SCCPHC	1217	139-010-000	139-010-000	139-010-000
SLANHC	1202	139-010-000	139-010-000	139-010-000
SLANHC	2312	139-010-000	139-010-000	139-010-000
SLANHC	5108	139-010-000	139-010-000	139-010-000
SLANHC	5202	139-010-000	139-010-000	139-010-000
SLANHC	5303	139-010-000	139-010-000	139-010-000
SLANHC	5304	139-010-000	139-010-000	139-010-000
IPSHC	1302	139-010-000	139-010-000	139-010-000
ATMHC	2102	139-010-000	139-010-000	139-010-000
ATMHC	3306	139-010-000	139-010-000	139-010-000
ATMHC	6101	139-010-000	139-010-000	139-010-000
ATMHC	6102	139-010-000	139-010-000	139-010-000
IPSG	1101	139-010-000	139-010-000	139-010-000
IPSG	1105	139-010-000	139-010-000	139-010-000
IPSG	1106	139-010-000	139-010-000	139-010-000
IPSG	1201	139-010-000	139-010-000	139-010-000
IPSG	1211	139-010-000	139-010-000	139-010-000
IPSG	1301	139-010-000	139-010-000	139-010-000
IPSG	1305	139-010-000	139-010-000	139-010-000
IPSG	1306	139-010-000	139-010-000	139-010-000
MCPHC	1212	139-010-000	139-010-000	139-010-000
MCPHC	5302	139-010-000	139-010-000	139-010-000
ENUMHC	2305	139-010-000	139-010-000	139-010-000
ENUMHC	3105	139-010-000	139-010-000	139-010-000
ENUMHC	3115	139-010-000	139-010-000	139-010-000
ENUMHC	3117	139-010-000	139-010-000	139-010-000
DEIR64	3215	139-010-000	139-010-000	042-010-003
DEIR64	3217	139-010-000	139-010-000	042-010-003
DEIR64	3315	139-010-000	139-010-000	042-010-003

Command Completed.

If a specific GPL, including the communication GPLs, is specified, then all the cards running that GPL are displayed. For example, if the `rept-stat-gpl:gpl=ss7hc` command is entered, then all cards running the SS7HC GPL are displayed as shown in the following example.

```
tklc9010801 16-09-07 00:22:40 EST EAGLE 46.4.0.0-69.10.0
  GPL Auditing ON
```

GPL	CARD	RUNNING	APPROVED	TRIAL
SS7HC	1103	139-010-000	139-010-000	139-010-000
SS7HC	1104	139-010-000	139-010-000	139-010-000
SS7HC	1107	139-010-000	139-010-000	139-010-000
SS7HC	1108	139-010-000	139-010-000	139-010-000
SS7HC	1203	139-010-000	139-010-000	139-010-000
SS7HC	1207	139-010-000	139-010-000	139-010-000
SS7HC	1208	139-010-000	139-010-000	139-010-000
SS7HC	1213	139-010-000	139-010-000	139-010-000
SS7HC	1303	139-010-000	139-010-000	139-010-000
SS7HC	1304	139-010-000	139-010-000	139-010-000

```

SS7HC      1307      139-010-000      139-010-000      139-010-000
SS7HC      1308      139-010-000      139-010-000      139-010-000
SS7HC      1313      139-010-000      139-010-000      139-010-000
SS7HC      1314      139-010-000      139-010-000      139-010-000

```

Command Completed.

If a communication GPL (BLMCAP) is specified with the `rept-stat-gpl` command, for example, `rept-stat-gpl:gpl=blmcap`, then all cards running the communication GPL are displayed. In the following example, all the cards running the BLMCAP GPL are displayed as the output for the `rept-stat-gpl:gpl=blmcap` command.

```

eagle1 16-09-09 18:53:40 MST EAGLE 46.4.0.0.0-69.8.0
GPL Auditing ON

```

GPL	CARD	RUNNING	APPROVED	TRIAL
BLMCAP	1101	138-022-000 ALM	139-002-000	139-002-000
BLMCAP	1102	138-011-000 ALM	139-002-000	139-002-000
BLMCAP	1112	139-001-000 ALM	139-002-000	139-002-000
BLMCAP	1205	138-011-000 ALM	139-002-000	139-002-000
BLMCAP	1206	138-011-000 ALM	139-002-000	139-002-000
BLMCAP	1207	139-010-000 ALM	139-002-000	139-002-000

Command Completed.

If the `display=all` parameter is specified with the `rept-stat-gpl` command, then all GPLs, application and communication GPLs used by all the cards in the EAGLE are displayed as shown in these examples.

This example shows the output when the `display=all` parameter is specified. IMT and application GPL information is shown.:

```

tekelecstp 18-01-18 21:30:11 EST EAGLE 46.5.1.5.0-73.10.0
rept-stat-gpl:display=all
Command entered at terminal #18.
;

```

Command Accepted - Processing

```

tekelecstp 18-01-18 21:30:11 EST EAGLE 46.5.1.5.0-73.10.0
GPL Auditing ON

```

GPL	CARD	RUNNING	APPROVED	TRIAL
OAMHC	1113	033-010-001	033-010-001	----- *
	BLMCAP	033-010-001	033-010-001	033-010-001
OAMHC	1115	033-010-001	033-010-001	----- *
	BLMCAP	033-010-001	033-010-001	033-010-001
HIPR2	1109	141-003-000 ALM	143-005-000	143-005-000
HIPR2	1110	141-003-000 ALM	143-005-000	143-005-000
SFAPP	1103	009-011-001	009-011-001	033-010-000
	BLDC64	143-006-000 ALM	000-000-000	033-010-001
SS7HC	1106	033-010-000	033-010-000	033-010-000
	BLMCAP	077-005-000 ALM	033-010-001	033-010-001
IPSHC	1112	033-010-000	033-010-000	033-010-000
	BLIXP	077-005-000 ALM	033-010-001	033-010-001
SCCP64	1107	033-010-000	033-010-000	033-010-000
	BLDC64	064-011-000 ALM	000-000-000	033-010-001

```

Command Completed.
;
Command Executed

```

If the `loc` parameter is specified with the `rept-stat-gpl` command, all the GPLs running on the specified card are displayed. For HC MIMs, this includes all non-activated flash GPLs, as shown in the following example.

```

eagle1 16-09-09 18:52:13 MST EAGLE 46.4.0.0-69.8.0
  GPL Auditing ON

  GPL          CARD      RUNNING          APPROVED      TRIAL
  SS7HC        1102      139-006-000      139-006-000  139-008-000
  BLMCAP                139-002-000 +    139-002-000  139-002-000

Command Completed.

```

Notes:

The `display=all`, `gpl`, and `loc` parameters cannot be specified in the same command.

If GPL auditing is on, a minor alarm is generated, and ALM is displayed for each GPL in the `RUNNING` column whose version does not match the version of the GPL shown in the system release ID table. The GPL versions in the system release ID table are shown in the `RELEASE` column of the `rtrv-gpl` command output.

If GPL auditing is `off`, the minor alarm is not generated, but ALM is displayed for each GPL whose version does not match the version of the GPL shown in the system release ID table. The detection, marking, and reporting of corrupt GPLs continues to be performed and is not affected by turning GPL auditing off.

If a GPL is not found, a version of "-----" is displayed.

If a card is inhibited, "-----" is displayed in the `RUNNING` column.

A plus (+) symbol appears in the output when any of the communication or flash GPLs are specified for the `rept-stat-gpl` command. The plus symbol indicates that the specified GPL currently running on the card has not yet been activated on the card.

RTRV-GPL Command

The `rtrv-gpl` command output contains these six columns and displays this information.

- `GPL` – The GPLs contained on the TDMs.
- `CARD` – The card location of the TDMs, either card locations 1114 or 1116
- `RELEASE` – The version number of the GPL contained in the system release ID table.
- `APPROVED` – The version numbers of the approved GPLs
- `TRIAL` – The version numbers of the trial GPLs
- `REMOVE TRIAL` – The version number of the GPLs contained on the removable media. Entries in the `REMOVE TRIAL` column are shown only if the removable

media is inserted into the removable media drive. If the removable media is not inserted in an E5-MCAP card, dashes are shown in the REMOVE TRIAL column. Dashes are displayed in the RELEASE, APPROVED, and TRIAL columns.

For E5-based control cards installed in the EAGLE installed in the E5-MCAP card of the active MASP (card location 1113), the following is an example of the `rtrv-gpl` command output. In this example, removable media is installed in the E5-MCAP card of the active MASP (card location 1113), shown by the GPL version number in the REMOVE TRIAL column for card location 1114. Removable media is not installed in the E5-MCAP card of the standby MASP (card location 1115), shown by the dashes in the REMOVE TRIAL column for card location 1116.

```
tklc9010801 16-09-07 00:26:49 EST  EAGLE 46.4.0.0.0-69.10.0
      GPL Auditing  ON

      GPL      CARD  RELEASE      APPROVED      TRIAL      REMOVE TRIAL
      SS7HC    1114  139-010-000  139-010-000  139-010-000  139-010-000
      SS7HC    1116  139-010-000  139-010-000  139-010-000  -----
      SS7HC    1113  -----      -----      -----      -----
```

You can display all the GPLs in the EAGLE or a specific GPL in the EAGLE.

If you specify the `rtrv-gpl` command with no parameters, all the GPLs in the EAGLE are displayed as shown in this example. This is an example of the `rtrv-gpl` output when E5-based control cards are installed in the EAGLE.

```
tklc9010801 16-09-07 00:28:42 EST  EAGLE 46.4.0.0.0-69.10.0
      GPL Auditing  ON

      GPL      CARD  RELEASE      APPROVED      TRIAL      REMOVE TRIAL
      BLMCAP    1114  139-010-000  139-010-000  085-009-012  085-009-012
      BLMCAP    1116  139-010-000  139-010-000  085-009-012  085-009-012
      BLMCAP    1113  -----      -----      -----      -----
      OAMHC     1114  139-010-000  139-010-000  139-010-000  139-010-000
      OAMHC     1116  139-010-000  139-010-000  139-010-000  139-010-000
      OAMHC     1113  -----      -----      -----      -----
      HIPR2     1114  139-009-000  139-009-000  139-009-000  139-009-000
      HIPR2     1116  139-009-000  139-009-000  139-009-000  139-009-000
      HIPR2     1113  -----      -----      -----      -----
      SS7HC     1114  139-010-000  139-010-000  139-010-000  139-010-000
      SS7HC     1116  139-010-000  139-010-000  139-010-000  139-010-000
      SS7HC     1113  -----      -----      -----      -----
      GLSHC     1114  139-010-000  139-010-000  139-010-000  139-010-000
      GLSHC     1116  139-010-000  139-010-000  139-010-000  139-010-000
      GLSHC     1113  -----      -----      -----      -----
      IPLHC     1114  139-010-000  139-010-000  139-010-000  139-010-000
      IPLHC     1116  139-010-000  139-010-000  139-010-000  139-010-000
      IPLHC     1113  -----      -----      -----      -----
      IPGHC     1114  139-010-000  139-010-000  139-010-000  139-010-000
      IPGHC     1116  139-010-000  139-010-000  139-010-000  139-010-000
      IPGHC     1113  -----      -----      -----      -----
      SCCPHC    1114  139-010-000  139-010-000  139-010-000  139-010-000
      SCCPHC    1116  139-010-000  139-010-000  139-010-000  139-010-000
      SCCPHC    1113  -----      -----      -----      -----
      SLANHC    1114  139-010-000  139-010-000  139-010-000  139-010-000
      SLANHC    1116  139-010-000  139-010-000  139-010-000  139-010-000
      SLANHC    1113  -----      -----      -----      -----
      ERTHC     1114  139-010-000  139-010-000  139-010-000  139-010-000
      ERTHC     1116  139-010-000  139-010-000  139-010-000  139-010-000
```

ERTHC	1113	-----	-----	-----	-----
IPSHC	1114	139-010-000	139-010-000	139-010-000	139-010-000
IPSHC	1116	139-010-000	139-010-000	139-010-000	139-010-000
IPSHC	1113	-----	-----	-----	-----
ATMHC	1114	139-010-000	139-010-000	139-010-000	139-010-000
ATMHC	1116	139-010-000	139-010-000	139-010-000	139-010-000
ATMHC	1113	-----	-----	-----	-----
IPSG	1114	139-010-000	139-010-000	139-010-000	139-010-000
IPSG	1116	139-010-000	139-010-000	139-010-000	139-010-000
IPSG	1113	-----	-----	-----	-----
PKTGHC	1114	169-010-000	169-010-000	169-010-000	169-010-000
PKTGHC	1116	169-010-000	169-010-000	169-010-000	169-010-000
PKTGHC	1113	-----	-----	-----	-----
BLMCAP	1114	139-010-000	139-010-000	085-009-009	139-010-000
BLMCAP	1116	139-010-000	139-010-000	085-009-009	139-010-000
BLMCAP	1113	-----	-----	-----	-----
MCPHC	1114	139-010-000	139-010-000	139-010-000	139-010-000
MCPHC	1116	139-010-000	139-010-000	139-010-000	139-010-000
MCPHC	1113	-----	-----	-----	-----
SIPHC	1114	139-010-000	139-010-000	139-010-000	139-010-000
SIPHC	1116	139-010-000	139-010-000	139-010-000	139-010-000
SIPHC	1113	-----	-----	-----	-----
DEIRHC	1114	139-010-000	139-010-000	139-010-000	139-010-000
DEIRHC	1116	139-010-000	139-010-000	139-010-000	139-010-000
DEIRHC	1113	-----	-----	-----	-----
ENUMHC	1114	139-010-000	139-010-000	139-010-000	139-010-000
ENUMHC	1116	139-010-000	139-010-000	139-010-000	139-010-000
ENUMHC	1113	-----	-----	-----	-----
PKTG64	1114	169-010-000	169-010-000	169-010-000	169-010-000
PKTG64	1116	169-010-000	169-010-000	169-010-000	169-010-000
PKTG64	1113	-----	-----	-----	-----
BLDC64	1114	139-010-000	139-010-000	085-009-006	139-010-000
BLDC64	1116	139-010-000	139-010-000	085-009-006	139-010-000
BLDC64	1113	-----	-----	-----	-----
SCCP64	1114	139-010-000	139-010-000	139-010-000	139-010-000
SCCP64	1116	139-010-000	139-010-000	139-010-000	139-010-000
SCCP64	1113	-----	-----	-----	-----
BLSLC32	1114	139-010-000	139-010-000	085-009-009	139-010-000
BLSLC32	1116	139-010-000	139-010-000	085-009-009	139-010-000
BLSLC32	1113	-----	-----	-----	-----
BLSLC64	1114	139-010-000	139-010-000	042-010-003	139-010-000
BLSLC64	1116	139-010-000	139-010-000	042-010-003	139-010-000
BLSLC64	1113	-----	-----	-----	-----
SIP64	1114	139-010-000	139-010-000	139-010-000	139-010-000
SIP64	1116	139-010-000	139-010-000	139-010-000	139-010-000
SIP64	1113	-----	-----	-----	-----
DEIR64	1114	139-010-000	139-010-000	042-010-003	139-010-000
DEIR64	1116	139-010-000	139-010-000	042-010-003	139-010-000
DEIR64	1113	-----	-----	-----	-----
ENUM64	1114	139-010-000	139-010-000	139-010-000	139-010-000
ENUM64	1116	139-010-000	139-010-000	139-010-000	139-010-000
ENUM64	1113	-----	-----	-----	-----

;

Command Executed

In this example, removable media is installed in both MASP.

If a specific GPL is specified, then only that GPL is displayed. For example, if the `rtrv-gpl:gpl=ss7hc` command is entered, then only the SS7HC GPL is displayed as shown in the following example.

```
eagle1 16-09-12 12:03:53 MST EAGLE 46.4.0.0.0-69.8.0
  GPL Auditing ON
```

GPL	CARD	RELEASE	APPROVED	TRIAL	REMOVE TRIAL
SS7HC	1114	139-010-000	139-010-000	139-010-000	139-010-000
SS7HC	1116	139-010-000	139-010-000	139-010-000	139-010-000
SS7HC	1113	-----	-----	-----	-----

If GPL auditing is on, a minor alarm is generated, and ALM is displayed for each approved GPL version that does not match the GPL version shown in the `RELEASE` column. If GPL auditing is off, the minor alarm is not generated, but ALM is displayed for each GPL version that does not match the GPL version shown in the `RELEASE` column. The detection, marking, and reporting of corrupt GPLs continues to be performed and is not affected by turning GPL auditing off. The GPL version shown in the `RELEASE` column is updated when the `act-gpl` command is performed.

If a GPL is not found, a version of "-----" is displayed.

Loading a GPL onto the System

This section gives a general overview as to how a GPL is loaded onto the EAGLE to be used by the applicable cards. The requirements and steps for each GPL are different and are detailed in the procedures contained in this chapter. The `rtrv-gpl` examples shown in this section are examples that are shown when E5-based control cards are installed in the EAGLE.

1. A removable media is inserted into the removable media drive on the E5-MCAP card of the active MASP. If a specific GPL is displayed with the `rtrv-gpl` command, for example the SS7HC GPL, the following would be displayed.

```
eagle1 16-09-09 18:30:48 MST EAGLE 46.4.0.0.0-69.6.0
  GPL Auditing ON
```

GPL	CARD	RELEASE	APPROVED	TRIAL	REMOVE TRIAL
SS7HC	1114	139-006-000	139-006-000	139-004-000	-----
SS7HC	1116	139-006-000	139-006-000	139-004-000	139-008-000
SS7HC	1115	-----	-----	-----	-----

```
;
Command Executed
```

Displaying the SS7HC GPL with the `rept-stat-gpl` command would display all the cards running the SS7HC GPL, as shown in this example.

```
eagle1 16-09-09 18:31:17 MST EAGLE 46.4.0.0.0-69.6.0
  GPL Auditing ON
```

GPL	CARD	RUNNING	APPROVED	TRIAL
SS7HC	1102	139-006-000	139-006-000	139-004-000
SS7HC	1205	139-006-000	139-006-000	139-004-000
SS7HC	1206	139-006-000	139-006-000	139-004-000
SS7HC	1207	139-006-000	139-006-000	139-004-000

```
Command Completed
```

- When the `chg-gpl` command is executed, the specific GPL is copied from the removable media to the fixed disks. The specific GPL and the version number of the GPL on the removable media must be specified with the `chg-gpl` command. The version number is found in the `REMOVE TRIAL` column of the `rtrv-gpl` output. For this example the `chg-gpl :gpl:ss7hc:ver=139-008-000` command would be entered at the EAGLE terminal.
- The new version of the GPL is now the trial version of the GPL as shown in the examples of the `rtrv-gpl` and `rept-stat-gpl` outputs.

```
rtrv-gpl:gpl=ss7hc
```

```
eagle1 16-09-09 18:33:48 MST EAGLE 46.4.0.0.0-69.6.0
GPL Auditing ON
```

GPL	CARD	RELEASE	APPROVED	TRIAL	REMOVE TRIAL
SS7HC	1114	139-006-000	139-006-000	139-008-000	-----
SS7HC	1116	139-006-000	139-006-000	139-008-000	139-008-000
SS7HC	1115	-----	-----	-----	-----

```
rept-stat-gpl:gpl=ss7hc
```

```
eagle1 16-09-09 18:34:26 MST EAGLE 46.4.0.0.0-69.6.0
GPL Auditing ON
```

GPL	CARD	RUNNING	APPROVED	TRIAL
SS7HC	1102	139-006-000	139-006-000	139-008-000
SS7HC	1205	139-006-000	139-006-000	139-008-000
SS7HC	1206	139-006-000	139-006-000	139-008-000
SS7HC	1207	139-006-000	139-006-000	139-008-000

```
Command Completed.
```

- To make the trial version of the GPL the approved version, the `act-gpl` command is executed after the GPL has been copied from the removable media with the `chg-gpl` command (steps 1 to 3). The trial and approved versions of the specific GPL are swapped as shown in these `rtrv-gpl` and `rept-stat-gpl` output examples.

```
rtrv-gpl:gpl=ss7hc
```

```
eagle1 16-09-09 18:35:31 MST EAGLE 46.4.0.0.0-69.8.0
GPL Auditing ON
```

GPL	CARD	RELEASE	APPROVED	TRIAL	REMOVE TRIAL
SS7HC	1114	139-008-000	139-008-000	139-006-000	-----
SS7HC	1116	139-008-000	139-008-000	139-006-000	139-008-000
SS7HC	1115	-----	-----	-----	-----

The system release ID table is updated with the version of the GPL specified with the `act-gpl` command. This GPL version is shown in the `RELEASE` column of the `rtrv-gpl` output after the `act-gpl` command is performed.

The ALM indicator is not displayed in the `rtrv-gpl` output because the approved version of the GPL matches the version in the system release ID table.

```
rept-stat-gpl:gpl=ss7hc
```

```
eagle1 16-09-09 18:35:52 MST EAGLE 46.4.0.0.0-69.8.0
GPL Auditing ON
```

GPL	CARD	RUNNING	APPROVED	TRIAL
SS7HC	1102	139-006-000 ALM	139-008-000	139-006-000
SS7HC	1205	139-006-000 ALM	139-008-000	139-006-000
SS7HC	1206	139-006-000 ALM	139-008-000	139-006-000
SS7HC	1207	139-006-000 ALM	139-008-000	139-006-000

Command Completed.

The ALM indicator is displayed for the cards that are running the version of the GPL that does not match the version in the system release ID table (shown in the `RELEASE` column of the `rtrv-gpl` output). In this example, the cards are running the trial version which does not match the version in the system release ID table.

- To load the card with the new version of the application GPL, the card must be inhibited with the `inh-card` command, then placed back into service with the `alw-card` command. To load the approved version of the GPL onto the card, the `code=appr` parameter can be specified with the `alw-card` command. It is not necessary to specify the `code=appr` parameter to load the approved version of the GPL. Entering the `alw-card` command without the `code` parameter loads the approved version of the GPL onto the card.

If you wish to load the trial version of the GPL onto the card, the `code=trial` parameter must be specified with the `alw-card` command.

To load the card with the new version of the flash GPL, the card must be inhibited with the `inh-card` command and flashed with the `init-flash` command. The new flash GPL on the card should be activated with the `act-flash` command and then placed back into service with the `alw-card` command.

The following examples show the outputs of the `rtrv-gpl` and `rept-stat-gpl` commands after the card has been reloaded. The outputs will vary depending on whether or not the new version of the GPL has been made the approved version with the `act-gpl` command, and which version (trial or approved) of the GPL is loaded onto the card.

Example 1

The new GPL is the `APPROVED` version and the card 1102 was reloaded with the `APPROVED` version of the GPL. Card 1102 is now running the `APPROVED` and `RELEASE` versions of the GPL. The ALM indicator is not shown in the `rtrv-gpl` output and is not shown for card 1102 in `rept-stat-gpl` output. The ALM indicator is shown for cards 1205, 1206, and 1207 because they are not running the `RELEASE` version of the GPL.

RTRV-GPL Output

```
eagle1 16-09-09 18:36:26 MST EAGLE 46.4.0.0.0-69.8.0
GPL Auditing ON
```

GPL	CARD	RELEASE	APPROVED	TRIAL	REMOVE TRIAL
SS7HC	1114	139-008-000	139-008-000	139-006-000	-----
SS7HC	1116	139-008-000	139-008-000	139-006-000	139-008-000
SS7HC	1115	-----	-----	-----	-----

REPT-STAT-GPL Output

```
eagle1 16-09-09 18:38:34 MST EAGLE 46.4.0.0.0-69.8.0
GPL Auditing ON
```

GPL	CARD	RUNNING	APPROVED	TRIAL
SS7HC	1102	139-008-000	139-008-000	139-006-000
SS7HC	1205	139-006-000 ALM	139-008-000	139-006-000
SS7HC	1206	139-006-000 ALM	139-008-000	139-006-000
SS7HC	1207	139-006-000 ALM	139-008-000	139-006-000

Command Completed.

Example 2

The new GPL is the APPROVED version and the card 1102 was reloaded with the TRIAL version of the GPL. The card is now running the TRIAL version of the GPL which is not the RELEASE version of the GPL. The ALM indicator is not shown in the `rtrv-gpl` output, but is shown for all the cards in `rept-stat-gpl` output because they are not running the RELEASE version of the GPL.

RTRV-GPL Output

```
eagle1 16-09-09 18:41:06 MST EAGLE 46.4.0.0.0-69.8.0
GPL Auditing ON
```

GPL	CARD	RELEASE	APPROVED	TRIAL	REMOVE TRIAL
SS7HC	1114	139-008-000	139-008-000	139-006-000	-----
SS7HC	1116	139-008-000	139-008-000	139-006-000	139-008-000
SS7HC	1115	-----	-----	-----	-----

REPT-STAT-GPL Output

```
eagle1 16-09-09 18:41:59 MST EAGLE 46.4.0.0.0-69.8.0
GPL Auditing ON
```

GPL	CARD	RUNNING	APPROVED	TRIAL
SS7HC	1102	139-006-000 ALM	139-008-000	139-006-000
SS7HC	1205	139-006-000 ALM	139-008-000	139-006-000
SS7HC	1206	139-006-000 ALM	139-008-000	139-006-000
SS7HC	1207	139-006-000 ALM	139-008-000	139-006-000

Command Completed.

Example 3

The new GPL is the TRIAL version and the card 1102 was reloaded with the TRIAL version of the GPL. Card 1102 is now running the TRIAL version of the GPL, but not the RELEASE version of the GPL. The ALM indicator is not shown in the `rtrv-gpl` output because the RELEASE version of the GPL has not changed. The ALM indicator is shown for card 1102 in the `rept-stat-gpl` output because card 1102 is not running the RELEASE version of the GPL.

RTRV-GPL Output

```
eagle1 16-09-09 18:43:39 MST EAGLE 46.4.0.0.0-69.6.0
GPL Auditing ON
```

GPL	CARD	RELEASE	APPROVED	TRIAL	REMOVE TRIAL
SS7HC	1114	139-006-000	139-006-000	139-008-000	-----

```

SS7HC      1116  139-006-000  139-006-000      139-008-000  139-008-000
SS7HC      1115  -----

```

REPT-STAT-GPL Output

```

eagle1 16-09-09 18:44:12 MST  EAGLE 46.4.0.0.0-69.6.0
GPL Auditing  ON

```

GPL	CARD	RUNNING	APPROVED	TRIAL
SS7HC	1102	139-008-000 ALM	139-006-000	139-008-000
SS7HC	1205	139-006-000	139-006-000	139-008-000
SS7HC	1206	139-006-000	139-006-000	139-008-000
SS7HC	1207	139-006-000	139-006-000	139-008-000

Command Completed.

Example 4

The new GPL is the TRIAL version and the card 1102 was reloaded with the APPROVED version of the GPL. Card 1102 is now running the APPROVED version of the GPL which is the RELEASE version of the GPL. The ALM indicator is not shown in the `rtrv-gpl` output, and for all the cards in `rept-stat-gpl` output because they are running the RELEASE version of the GPL.

RTRV-GPL Output

```

eagle1 16-09-09 18:46:20 MST  EAGLE 46.4.0.0.0-69.6.0
GPL Auditing  ON

```

GPL	CARD	RELEASE	APPROVED	TRIAL	REMOVE TRIAL
SS7HC	1114	139-006-000	139-006-000	139-008-000	-----
SS7HC	1116	139-006-000	139-006-000	139-008-000	139-008-000
SS7HC	1115	-----	-----	-----	-----

REPT-STAT-GPL Output

```

eagle1 16-09-09 18:46:41 MST  EAGLE 46.4.0.0.0-69.6.0
GPL Auditing  ON

```

GPL	CARD	RUNNING	APPROVED	TRIAL
SS7HC	1102	139-006-000	139-006-000	139-008-000
SS7HC	1205	139-006-000	139-006-000	139-008-000
SS7HC	1206	139-006-000	139-006-000	139-008-000
SS7HC	1207	139-006-000	139-006-000	139-008-000

Command Completed

Updating the BLMCAP and OAMHC GPLs

This procedure updates the BLMCAP and OAMHC GPLs on the E5-MCAP cards in card locations 1113 and 1115 as a trial version from the removable media, then making the trial version of these GPLs the approved version of these GPLs. The **E5-MCAP** card in card locations 1113 and 1115 is used in combination with the **TDM** to form the **Maintenance and Administration Subsystem Processor (MASP)**.

The BLMCAP GPL is updated using the `chg-gpl`, `act-gpl`, and `flash-card` commands.

4. Display the BLMCAP and OAM HC GPLs on the fixed disk and on the removable media using the `rtrv-gpl` command with the `gpl` parameter value equal to the GPL being updated. Perform these substeps.

- a. Display the BLMCAP GPL by entering this command.

```
rtrv-gpl:gpl=blmcap
```

This is an example of the possible output.

```
eagle1 16-09-09 18:28:48 MST EAGLE 46.4.0.0.0-69.6.0
  GPL Auditing ON

  GPL      CARD  RELEASE      APPROVED      TRIAL      REMOVE TRIAL
  BLMCAP   1114  139-005-000  139-005-000   139-005-000  -----
  BLMCAP   1116  139-005-000  139-005-000   139-005-000  139-008-000
  BLMCAP   1115  -----      -----      -----      -----
```

- b. Display the OAMHC GPL by entering this command.

```
rtrv-gpl:gpl=oamhc
```

This is an example of the possible output.

```
eagle1 16-09-09 18:30:03 MST EAGLE 46.4.0.0.0-69.6.0
  GPL Auditing ON

  GPL      CARD  RELEASE      APPROVED      TRIAL      REMOVE TRIAL
  OAMHC    1114  139-006-000  139-006-000   -----      -----
  OAMHC    1116  139-006-000  139-006-000   139-008-000  139-008-000
  OAMHC    1115  -----      -----      -----      -----
```

If the version of either **GPL** shown in the `REMOVE TRIAL` column of the `rtrv-gpl` output is not the version that is to be loaded onto the cards, remove the removable media from the active MASP.

Insert the removable media that contains the GPLs that are being updated into the removable media drive in the active MASP. If 3 was performed, repeat this step. If 3 was not performed, repeat this procedure from 3.

For more information about inserting removable media in the removable media drive, or removing removable media from the removable media drive, refer to [Removable USB Drive](#).

If the versions of the GPLs shown in the `REMOVE TRIAL` column of the `rtrv-gpl` output are the versions that are to be loaded onto the cards, continue the procedure with 5.

5. Change the BLMCAP and OAMHC GPLs using the `chg-gpl` command and specifying the value for the trial BLMCAP and OAMHC GPLs shown in the `REMOVE TRIAL` column in the output of the `rtrv-gpl` command (in 4). Perform these substeps.

- a. For the BLMCAP GPL in this example, enter this command.

```
chg-gpl:gpl=blmcap:ver=139-008-000
```

These messages should appear.

```
eagle1 16-09-09 18:47:55 MST EAGLE 46.4.0.0.0-69.6.0
```

```

BLMCAP upload to 1116 completed
BLMCAP upload to 1114 completed
System Release ID table upload to 1116 completed
System Release ID table upload to 1114 completed

```

- b.** For the OAMHC GPL in this example, enter this command.

```
chg-gpl:gpl=oamhc:ver=139-008-000
```

These messages should appear.

```

eagle1 16-09-09 18:48:30 MST EAGLE 46.4.0.0.0-69.6.0
OAMHC upload to 1116 completed
OAMHC upload to 1114 completed
System Release ID table upload to 1116 completed
System Release ID table upload to 1114 completed

```

- 6.** Activate the trial BLMCAP GPL, using the `act-gpl` command and specifying the name and version of the trial BLMCAP GPL specified in Substep a in 5. Enter this command.

```
act-gpl:gpl=blmcap:ver=139-008-000
```

These messages should appear.

```

eagle1 16-09-09 18:48:53 MST EAGLE 46.4.0.0.0-69.8.0
BLMCAP activate on 1116 completed
BLMCAP activate on 1114 completed

```

- 7.** Verify that the trial BLMCAP and OAM HC GPLs have been made the approved GPLs using the `rtrv-gpl` command. Perform these substeps.

- a.** For the BLMCAP GPL, enter the `rtrv-gpl:gpl=blmcap` command.

This is an example of the possible output.

```

eagle1 16-09-09 18:49:10 MST EAGLE 46.4.0.0.0-69.8.0
GPL Auditing ON

  GPL      CARD  RELEASE      APPROVED      TRIAL      REMOVE TRIAL
  BLMCAP   1114  139-008-000  139-008-000   139-005-000  -----
  BLMCAP   1116  139-008-000  139-008-000   139-005-000  139-008-000
  BLMCAP   1115  -----      -----      -----      -----

```

- b.** For the OAMHC GPL, enter the `rtrv-gpl:gpl=oamhc` command.

This is an example of the possible output.

```

eagle1 16-09-09 18:49:10 MST EAGLE 46.4.0.0.0-69.8.0
GPL Auditing ON

  GPL      CARD  RELEASE      APPROVED      TRIAL      REMOVE TRIAL
  OAMHC    1114  139-008-000  139-008-000   139-005-000  139-008-000
  OAMHC    1116  139-008-000  139-008-000   139-005-000  139-008-000
  OAMHC    1115  -----      -----      -----      -----

```

8. Verify the GPLs that are running on the E5-MCAP cards by performing these substeps.

- a. For the BLMCAP GPL, enter the `rept-stat-gpl:gpl=blmcap` command.

This is an example of the possible output.

```
eagle1 16-09-09 18:49:10 MST EAGLE 46.4.0.0.0-69.8.0
GPL Auditing ON

GPL      CARD  RUNNING          APPROVED          TRIAL
BLMCAP  1113  139-005-000 ALM  139-008-000  139-005-000
BLMCAP  1115  139-005-000 ALM  139-008-000  139-005-000

Command Completed
```

The `flash-card` command will load only the BLMCAP GPLs whose approved versions are different from the versions that the card is running. The version of the BLMCAP GPL that the card is running is shown in the `RUNNING` column in the `rept-stat-gpl` output. The approved version of the BLMCAP GPL is shown in the `APPROVED` column of the `rept-stat-gpl` output. If the running and approved versions of a BLMCAP GPL are the same, the `flash-card` command will not load that BLMCAP GPL.

- b. For the OAMHC GPL, enter the `rept-stat-gpl:gpl=oamhc` command.

This is an example of the possible output.

```
eagle1 16-09-09 18:49:10 MST EAGLE 46.4.0.0.0-69.8.0
GPL      CARD  RUNNING          APPROVED          TRIAL
OAMHC    1113  139-005-000 ALM  139-008-000  139-005-000
OAMHC    1115  139-005-000 ALM  139-008-000  139-005-000

Command Completed
```

9. Display the terminal configuration in the database with the `rtrv-trm` command.

All the SEAS terminals must be placed out of service in order to load the BLMCAP and OAMHC GPLs onto the E5-MCAP cards. The SEAS terminals are shown in the output with the entry `SEAS` in the `TYPE` field. This is an example of the possible output. In this example, the SEAS terminals are terminals 18 and 27.

```
eagle1 16-09-09 18:49:10 MST EAGLE 46.4.0.0.0-69.8.0
TRM  TYPE  COMM          FC  TMOUT  MXINV  DURAL
1    VT320  9600-7-E-1 SW  30  5      99:59:59
2    KSR    9600-7-E-1 HW  30  5      INDEF
3    PRINTER 4800-7-E-1 HW  30  0      00:00:00
4    VT320  2400-7-E-1 BOTH 30  5      00:30:00
5    VT320  9600-7-O-1 NONE 30  5      00:00:30
6    VT320  9600-7-O-1 NONE 30  5      00:00:30
7    PRINTER 9600-7-N-2 HW  30  5      00:30:00
8    KSR    19200-7-E-2 BOTH 30  5      00:30:00
9    VT320  9600-7-O-1 NONE 30  5      00:00:30
10   VT320  9600-7-E-1 HW  30  5      00:30:00
11   VT320  4800-7-E-1 HW  30  5      00:30:00
12   PRINTER 9600-7-E-1 HW  30  4      00:30:00
13   VT320  9600-7-O-1 NONE 30  5      00:30:00
14   VT320  9600-7-E-2 SW  30  8      00:30:00
15   VT320  9600-7-N-2 HW  30  5      00:30:00
16   VT320  9600-7-E-2 BOTH 30  3      00:30:00
```

TRM	TYPE	LOC	TMOUT	MXINV	DURAL
17	TELNET	1303	60	5	00:30:00
18	SEAS	1201	60	5	00:30:00
19	TELNET	1303	60	5	00:30:00
20	TELNET	1303	60	5	00:30:00
21	TELNET	1303	60	5	00:30:00
22	TELNET	1303	60	5	00:30:00
23	TELNET	1303	60	5	00:30:00
24	TELNET	1303	60	5	00:30:00
25	TELNET	1203	60	5	00:30:00
26	TELNET	1203	60	5	00:30:00
27	SEAS	1203	60	5	00:30:00
28	TELNET	1203	60	5	00:30:00
39	TELNET	1203	60	5	00:30:00
30	TELNET	1203	60	5	00:30:00
31	TELNET	1203	60	5	00:30:00
32	TELNET	1203	60	5	00:30:00
33	TELNET	1208	60	5	00:30:00
34	TELNET	1208	60	5	00:30:00
35	TELNET	1208	60	5	00:30:00
36	TELNET	1208	60	5	00:30:00
37	TELNET	1208	60	5	00:30:00
38	TELNET	1208	60	5	00:30:00
39	TELNET	1208	60	5	00:30:00
40	TELNET	1208	60	5	00:30:00

Note: The `rtrv-trm` command output contains other fields that are not used by this procedure. If you wish to see all the fields displayed by the `rtrv-trm` command, see the `rtrv-trm` command description in *Commands User's Guide*.

If SEAS terminals are shown in the `rtrv-trm` command output, continue the procedure with [10](#).

If no SEAS terminals are shown in the `rtrv-trm` command output, perform one of these steps to continue the procedure.

- If the `rept-stat-db` command in [3](#) was not performed, continue the procedure with [13](#).
- If the `rept-stat-db` command in [3](#) was performed, continue the procedure with [14](#).

10. Display the status of the terminals with the `rept-stat-trm` command with the terminal number of the SEAS terminals.

For this example, enter these commands.

```
rept-stat-trm:trm=18
```

This is an example of the possible output.

```
eagle1 16-09-09 18:49:10 MST EAGLE 46.4.0.0-69.8.0
TRM  PST      SST      AST
18   IS-NR      Active    -----
Command Completed.
```

```
rept-stat-trm:trm=27
```

This is an example of the possible output.

```
eagle1 16-09-09 18:49:10 MST EAGLE 46.4.0.0.0-69.8.0
TRM  PST          SST          AST
27   IS-NR        Active      -----
Command Completed.
```

11. Place the SEAS terminals out of service using the `rmv-trm` command with the number of the terminal displayed in [10](#) whose state is not OOS-MT-DSBLD.

The `force=yes` parameter must be used when placing the last SEAS terminal out of service. For this example, enter these commands.

For this example, enter these commands.

```
rmv-trm:trm=18
rmv-trm:trm=27:force=yes
```

If the status of the SEAS terminals shown in the `PST` field in [10](#) is **OOS-MT-DSBLD** (out-of-service maintenance disabled), the terminal is already out of service and the `rmv-trm` command does not need to be executed for that terminal.

This message should appear when each of these commands have successfully completed.

```
eagle1 16-09-09 18:49:10 MST EAGLE 46.4.0.0.0-69.8.0
Inhibit message sent to terminal

eagle1 16-09-09 18:49:10 MST EAGLE 46.4.0.0.0-69.8.0
Command Completed.
```

12. Change the terminal type of the SEAS terminals to **NONE** with the `chg-trm` command, the `type=none` parameter, and with the values of the SEAS terminals used in [11](#).

For this example, enter these commands.

```
chg-trm:trm=18:type=none
chg-trm:trm=27:type=none
```

This message should appear when these commands have successfully completed.

```
eagle1 16-09-09 18:49:10 MST EAGLE 46.4.0.0.0-69.8.0
CHG-TRM: MASP B - COMPLTD
```

Continue the procedure with by performing one of these steps.

- If the `rept-stat-db` command in [3](#) was not performed, continue the procedure with [13](#).
- If the `rept-stat-db` command in [3](#) was performed, continue the procedure with [14](#).

13. To load the BLMCAP and OAMHC GPLs, they must be loaded on the standby **MASP (E5-MCAP)** first.

To determine which **MASP** is active, enter the `rept-stat-db` command. This is an example of the possible output.

```
eagle1 16-09-09 18:49:10 MST EAGLE 46.4.0.0.0-69.8.0
DATABASE STATUS: >> OK <<
      E5TDM 1114 ( STDBY)                E5TDM 1116 ( ACTV )
      C   LEVEL    TIME LAST BACKUP      C   LEVEL    TIME LAST BACKUP
      - - - - -
FD BKUP Y        36 09-02-19 09:38:25 GMT Y        36 09-02-19 09:38:25 GMT
FD CRNT Y         39                          Y         39
      E5MCAP 1113                          E5MCAP 1115
      - - - - -
RD BKUP -        -        -        -      Y        36 09-02-19 09:27:17 GMT
USB BKP -        -        -        -      Y         3 09-02-07 01:11:22 GMT
```

The output of the `rept-stat-db` command shows which **MASP** is active with the indicator (`ACTV`) following the **TDM** card location. The indicator (`STDBY`) following the **TDM** card location shows which **MASP** is standby.

For this example, the **MASP** associated with **TDM 1116** is active and the **MASP** associated with **TDM 1114** is standby.

14. Using the outputs of [8](#) and either [3](#) or [13](#) as a guide, place the **E5-MCAP** card making up the standby **MASP** card out of service using the `rmv-card` command.

For this example, enter this command.

```
rmv-card:loc=1113
```

When this command has successfully completed, this message should appear.

```
eagle1 16-09-09 18:49:10 MST EAGLE 46.4.0.0.0-69.8.0
Card has been inhibited.
```

15. Load the approved version of the BLMCAP GPLs onto the card inhibited in [14](#) using the `flash-card` command with the `code=appr` parameter.

Caution: The `flash-card` command cannot be entered if the IMT Rate Change sequence or the Extended Bit Error Rate Test (**BERT**) is being performed.

The `flash-card` command will load only those BLMCAP GPLs whose approved versions are different from the versions that the card is running. The version of the BLMCAP GPL that the card is running is shown in the `RUNNING` column in the `rept-stat-gpl` output. The approved version of the BLMCAP GPL is shown in the `APPROVED` column of the `rept-stat-gpl` output. If the running and approved versions of an BLMCAP GPL are the same, the `flash-card` command will not load that BLMCAP GPL.

For this example, enter this command.

```
flash-card:code=appr:loc=1113
```

When this command has successfully completed, these messages should appear.

```
eagle1 16-09-09 18:49:10 MST EAGLE 46.4.0.0.0-69.8.0
Flash Card: FLASH GPL(s) required to be downloaded on card 1113
  BLMCAP   : Running version 134-015-000 Expected version 134-016-000
```

```
;
```

```

eagle1 16-09-09 18:49:10 MST EAGLE 46.4.0.0.0-69.8.0
Flash Card: Downloading BLMCAP on card 1113
Flash Card: Card(s) will reset after the flash GPL download.

;

eagle1 16-09-09 18:49:10 MST EAGLE 46.4.0.0.0-69.8.0
Flash Card: Card 1113 download BLMCAP complete.

;

eagle1 16-09-09 18:49:10 MST EAGLE 46.4.0.0.0-69.8.0
Flash Card: FLASH GPL(s) required to be activated on card 1113
      BLMCAP : Running inactive version 134-016-000

;

eagle1 16-09-09 18:49:10 MST EAGLE 46.4.0.0.0-69.8.0
Flash Card: Activating BLMCAP on card 1113

;

eagle1 16-09-09 18:49:10 MST EAGLE 46.4.0.0.0-69.8.0
Flash Card: Card 1113 activation BLMCAP complete.

;

eagle1 16-09-09 18:49:10 MST EAGLE 46.4.0.0.0-69.8.0
Command Completed.

;

```

The E5-MCAP card specified in the `flash-card` command will be re-initialized when the BLMCAP **GPL** download is complete.

16. Put the card that was taken out of service in 14 back into service using the `rst-card` command.

The `rst-card` command also loads the approved version of the BLMCAP and OAMHC GPLs onto the card.

For this example, enter this command.

```
rst-card:loc=1113
```

When this command has successfully completed, this message should appear.

```

eagle1 16-09-09 18:49:10 MST EAGLE 46.4.0.0.0-69.8.0
Card has been allowed.

```

17. Verify that the BLMCAP and OAMHC GPLs from 15 have been loaded and that the card has returned to its in-service normal (**IS-NR**) state using the `rept-stat-card` command.

For this example, enter this command.

```
rept-stat-card:loc=1113
```

This is an example of the possible output.

```
eagle1 16-09-09 18:49:10 MST EAGLE 46.4.0.0.0-69.8.0
```

```

CARD   VERSION   TYPE   GPL       PST       SST       AST
1113  139-008-000 E5MCAP OAMHC    IS-NR     Active    -----
ALARM STATUS      = No Alarms.
BLMCAP GPL version = 139-008-000
IMT BUS A         = Conn
IMT BUS B         = Conn
CURRENT TEMPERATURE = 30C ( 86F)
PEAK TEMPERATURE:  = 33C ( 92F)    [02-01-05 07:18]
Command Completed.

```

Note: If the versions of the BLMCAP or OAMHC GPLs shown in the `rept-stat-card` command output are not the versions specified in 6, contact the Customer Care Center. Refer to [My Oracle Support \(MOS\)](#) for the contact information. The remainder of this procedure should not be performed.

- 18.** To load the new BLMCAP and OAMHC GPLs onto the **E5-MCAP** card making up the active **MASP**, enter the `init-card` command specifying the location of the **E5-MCAP** card making up active **MASP**. For this example, enter the `init-card:loc=1115` command. This message should appear.

```

eagle1 16-09-09 18:49:10 MST EAGLE 46.4.0.0.0-69.8.0
Init Card command issued to card 1115

```

After this step has been performed, repeat steps 14, 15, 16, and 17 using the card location specified in this step as the `loc` parameter value in these steps. After these steps have been performed, continue the procedure with either 19 or 21 based on the following conditions:

- If SEAS terminals were not shown in the `rtrv-trm` command output in 9, continue the procedure with 21.
- If SEAS terminals were shown in the `rtrv-trm` command output in 9, continue the procedure with 19.

- 19.** Change the terminal type of the terminals that were changed to **NONE** in 12 to the terminal type **SEAS** with the `chg-trm` command and the `type=seas` parameter.

The terminal type is shown in the **TYPE** field in the `rtrv-trm` command output in 9.

For this example, enter these commands.

```
chg-trm:trm=18:type=seas
```

```
chg-trm:trm=27:type=seas
```

This message should appear when these commands have successfully completed.

```

eagle1 16-09-09 18:49:10 MST EAGLE 46.4.0.0.0-69.8.0
CHG-TRM: MASP B - COMPLTD

```

- 20.** Put the SEAS terminals back into service using the `rst-trm` command with the number of the terminals specified in 19.

```
rst-trm:trm=18
```

```
rst-trm:trm=27
```

This message should appear when each of these commands have successfully completed.

```
eagle1 16-09-09 18:49:10 MST EAGLE 46.4.0.0.0-69.8.0  
Allow message sent to terminal
```

```
eagle1 16-09-09 18:49:10 MST EAGLE 46.4.0.0.0-69.8.0  
Command Completed.
```

21. This procedure is finished.

Figure 3-1 Updating the BLMCAP and OAMHC GPLs

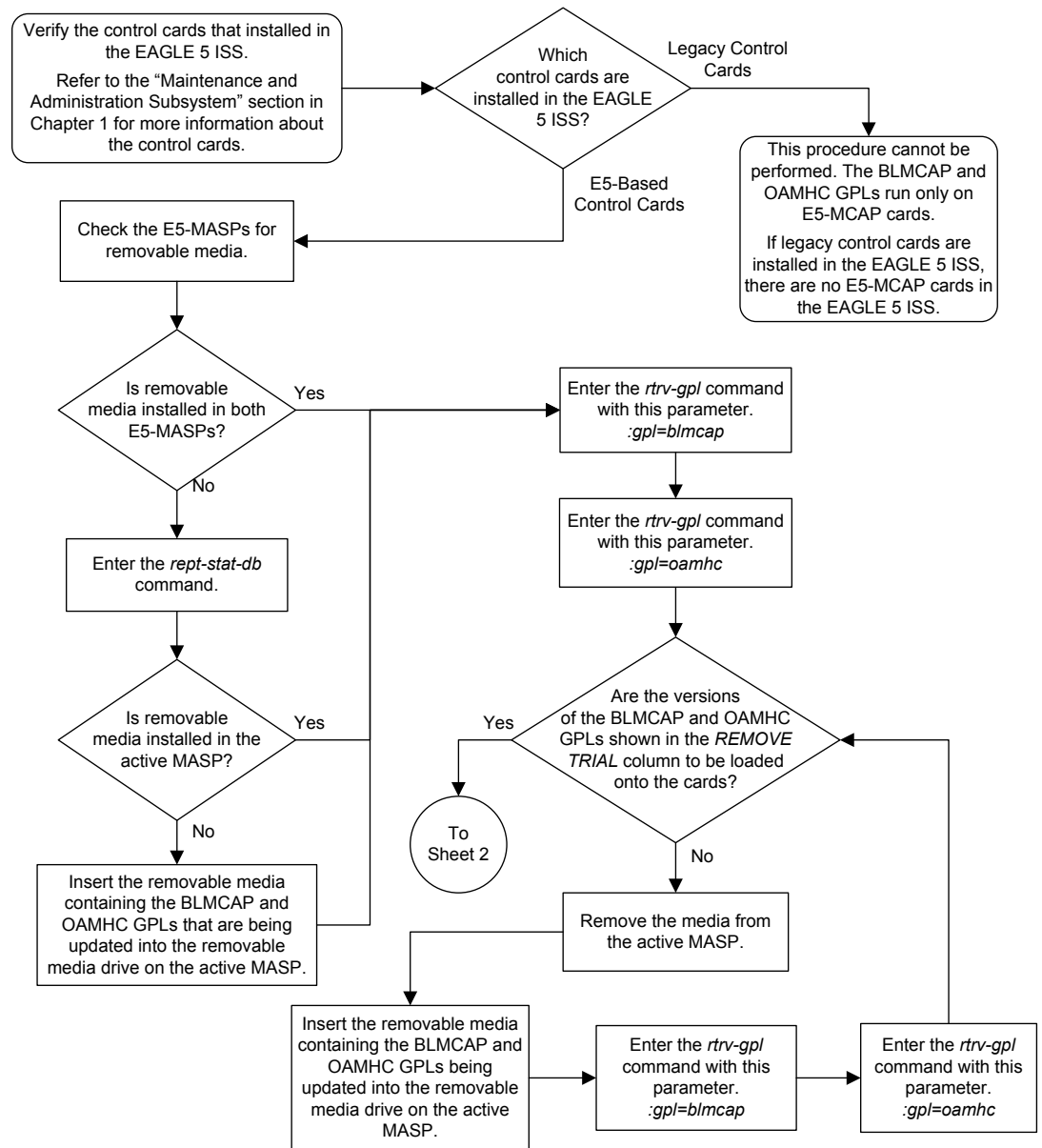

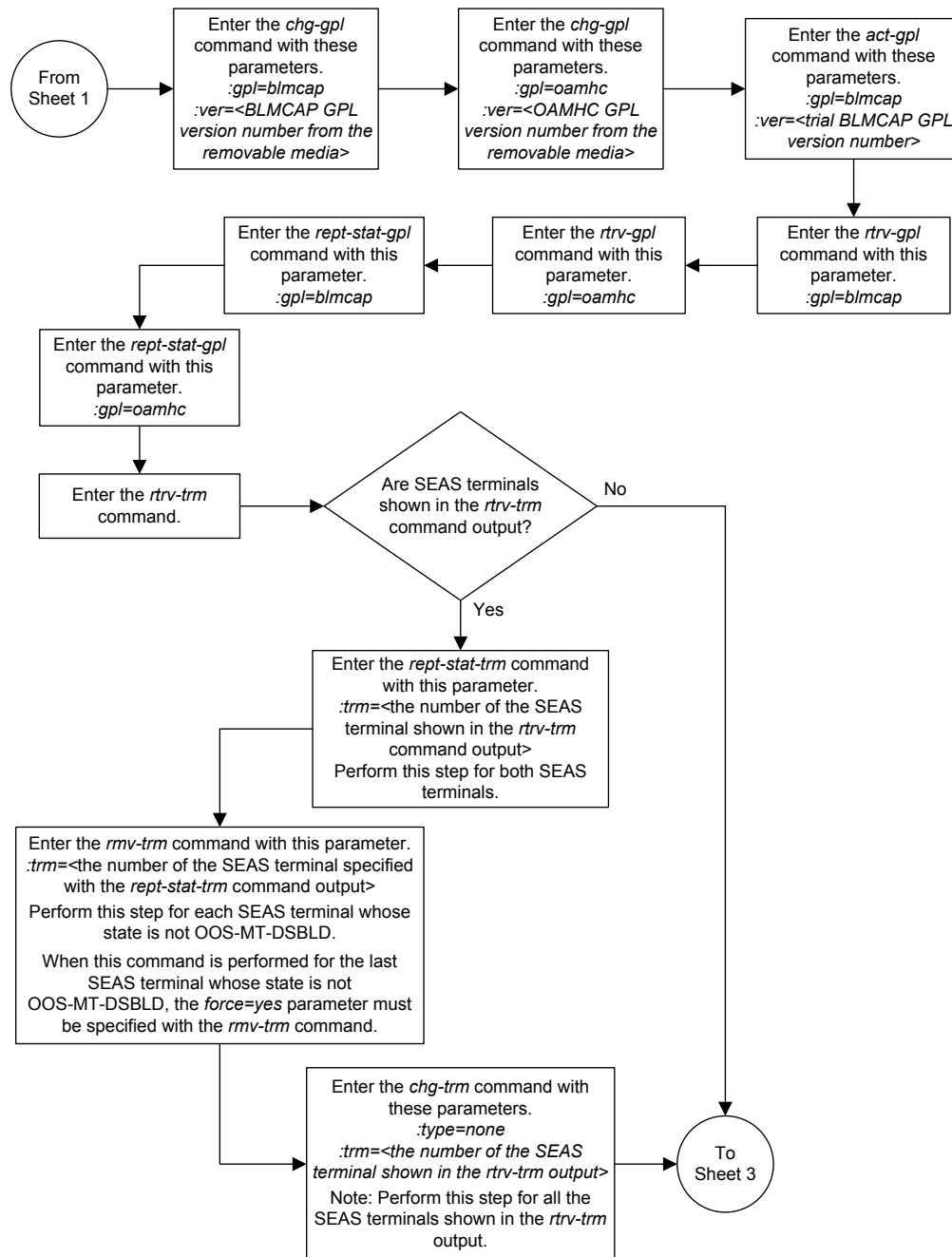

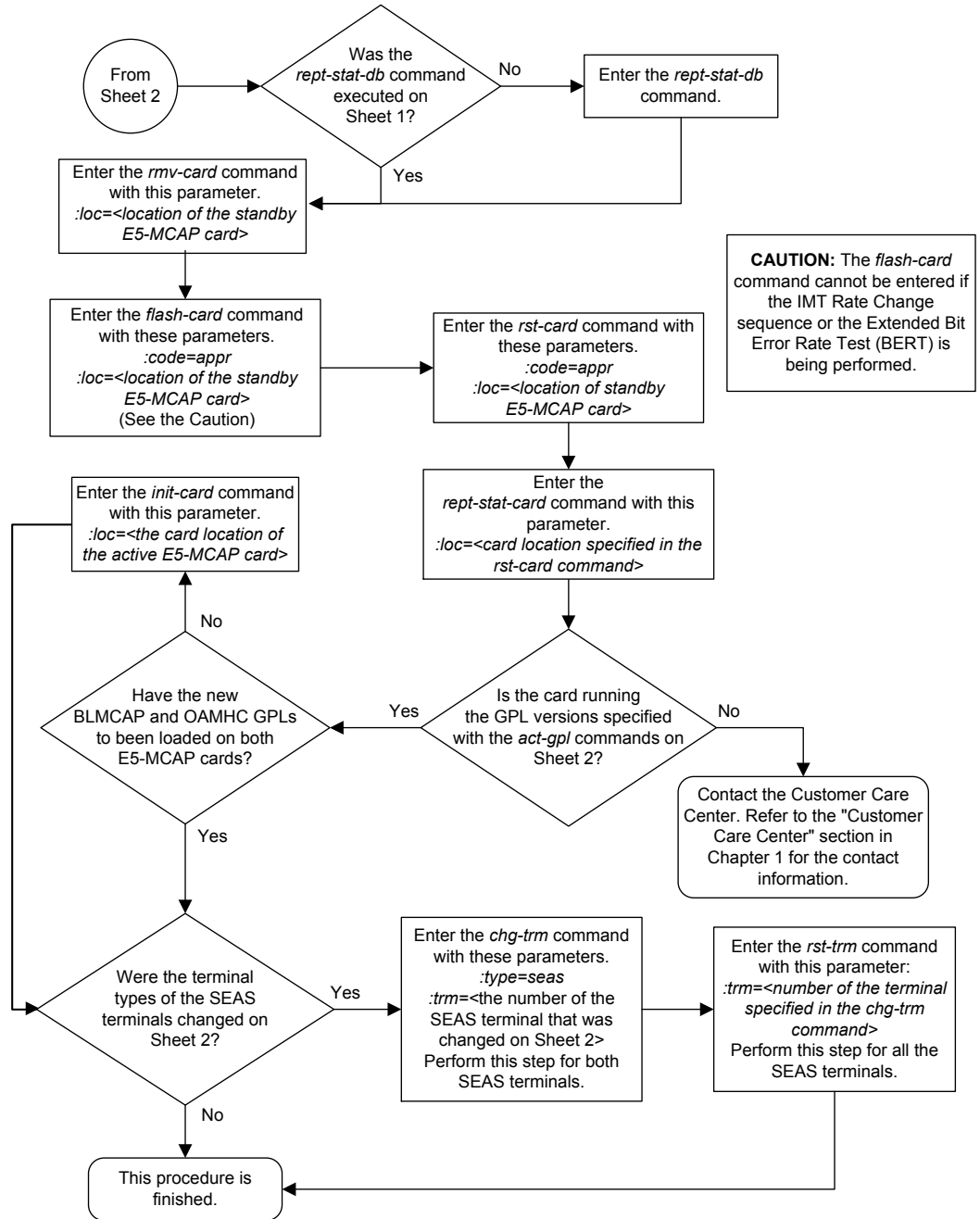

Sheet 3 of 3

Updating the Signaling Link and Data Link GPLs

This procedure is used to update the following **GPLs**: SS7IPGW, IPGWI, SLANHC, SS7HC, SS7EPM, IPLHC, IPGHC, ATMHC, and IPSG. These names are used as the

value of the `gpl` parameter of the `chg-gpl`, `act-gpl`, `rept-stat-gpl`, and `rtrv-gpl` commands.

Signaling links are assigned to cards running the following **GPLs**: `SS7IPGW`, `IPGWI`, `SS7HC`, `SS7EPM`, `IPLHC`, `IPGHC`, `ATMHC`, and `IPSG`. The signaling link **GPLs** are assigned to the card types shown in [Table 3-1](#).

Table 3-1 SS7 LIM Card Types

GPL	Card Type
<code>atmansi</code> , <code>atmhc</code>	<code>limatm</code> (cards running the <code>atmhc</code> GPL must be E5-ATM cards)
<code>atmitu</code> , <code>atmhc</code>	<code>lime1atm</code> (cards running the <code>atmhc</code> GPL must be E5-ATM cards)
<code>ss7ipgw</code> , <code>ipgwi</code> , <code>iplhc</code> , <code>ipghc</code> , <code>ipsg</code>	<code>dcm</code> (cards running the <code>iplhc</code> , <code>ipghc</code> , or <code>ipsg</code> GPLs must be E5-ENET cards)
<code>ss7hc</code>	<code>lime1</code> , <code>limt1</code> (these cards can be HC MIMs or E5-E1T1 cards)

Data links are assigned to cards running the `SLANHC` **GPLs**. The data link **GPLs** are assigned to the card types shown in [Table 3-2](#).

Table 3-2 Data Link Card Types

GPL	Card Type
<code>slanhc</code>	<code>dcm</code> (these cards must be E5-ENET, E5-ENET-B, or SLIC cards)

The card types shown in [Table 3-1](#) and [Table 3-2](#) are the values used for the `type` parameter of the `ent-card` command.

The cards running the `SS7HC` **GPL** are E5-E1T1-B cards. E5-E1T1-B cards are single-slot cards that can support up to 32 signaling links. These cards are either **LIM-E1** or **LIM-T1** cards. The `rtrv-card` output shows these cards running either the `SS7ANSI` or `CCS7ITU` applications, but the `rept-stat-card` and `rept-stat-gpl` output shows that these cards are actually running the `SS7HC` **GPL**.

The cards running the `SS7EPM` **GPL** are **E5-E1T1** cards which are single-slot cards that can support up to 32 signaling links. The **E5-E1T1** cards are either **LIM-E1** or **LIM-T1** cards. The `rtrv-card` output shows these cards running either the `SS7ANSI` or `CCS7ITU` applications, but the `rept-stat-card` and `rept-stat-gpl` output shows that these cards are actually running the `SS7EPM` **GPL**.

The cards running the `IPLHC` and `IPGHC` **GPLs** are **E5-ENET**, E5-ENET-B and SLIC cards supporting **IP** signaling links. The `rtrv-card` output shows this card running either the `IPLIM` or `IPLIMI` applications, but the `rept-stat-card` and `rept-stat-gpl` output shows that these cards are actually running the `IPLHC` **GPL**. The `IPGHC` **GPL** allows the **E5-ENET** card to support `SS7IPGW` (**ANSI IP Gateway**) or `IPGWI` (**ITU IP Gateway**) signaling links. The `rtrv-card` output shows this card running either the `SS7IPGW` or `IPGWI` applications, but the `rept-stat-card` and `rept-stat-gpl` output shows that these cards are actually running the `IPGHC` **GPL**.

The cards running the `ATMHC` **GPL** are cards that can contain the ATM high-speed signaling links on E5-ATM cards. The `rtrv-card` output shows these cards running either the `ATMANSI` or `ATMITU` applications, but the `rept-stat-card` and `rept-stat-gpl` output shows that these cards are actually running the `ATMHC` **GPL**.

The cards running the SLANHC GPLs are the STPLAN cards supporting the STPLAN feature. E5-SLAN cards run the SLANHC GPL. The `rtrv-card` output shows these cards running the STPLAN application, but the `rept-stat-card` and `rept-stat-gpl` output shows that these cards are actually running the SLANHC GPLs.

If the **GPL** is being updated to a new version, a removable media containing the **GPL** being updated is required.

If any card is not running the version of the **GPL** shown in the `RELEASE` column of the `rtrv-gpl` output, the indicator `ALM` is displayed next to the **GPL** version in the `RUNNING` column of the `rept-stat-gpl` output, and next to the **GPL** version in the `APPROVED` column in the `rtrv-gpl` output.

Canceling the **REPT-STAT-SLK** and **RTRV-SLK** Commands

Because the `rept-stat-slk` and `rtrv-slk` commands used in this procedure can output information for a long period of time, the `rept-stat-slk` and `rtrv-slk` commands can be canceled and the output to the terminal stopped. There are three ways that the `rept-stat-slk` and `rtrv-slk` commands can be canceled.

- Press the F9 function key on the keyboard at the terminal where the `rept-stat-slk` or `rtrv-slk` commands were entered.
- Enter the `canc-cmd` without the `trm` parameter at the terminal where the `rept-stat-slk` or `rtrv-slk` commands were entered.
- Enter the `canc-cmd:trm=<xx>`, where `<xx>` is the terminal where the `rept-stat-slk` or `rtrv-slk` commands were entered, from another terminal other than the terminal where the `rept-stat-slk` or `rtrv-slk` commands were entered. To enter the `canc-cmd:trm=<xx>` command, the terminal must allow Security Administration commands to be entered from it and the user must be allowed to enter Security Administration commands. The terminal's permissions can be verified with the `rtrv-secu-trm` command. The user's permissions can be verified with the `rtrv-user` or `rtrv-secu-user` commands.

For more information about the `canc-cmd` command, go to *Commands User's Guide*.

1. Verify the control cards that are installed in the EAGLE.

Refer to [Maintenance and Administration Subsystem](#) for information about the control cards.

2. Check the E5-MASPs for removable media.

If removable media is installed in both E5-MASPs, continue the procedure with [4](#).

If removable media is not installed in both E5-MASPs, continue the procedure with [3](#).

3. Verify the active MASP by entering the `rept-stat-db` command.

This is an example of the possible output.

```
rlghncxa03w 09-03-16 15:25:40 GMT EAGLE 46.3.0
DATABASE STATUS: >> OK <<
      E5TDM 1114 ( STDBY)                E5TDM 1116 ( ACTV )
      C  LEVEL    TIME LAST BACKUP      C  LEVEL    TIME LAST BACKUP
-----
FD BKUP Y        36 09-02-19 09:38:25 GMT Y        36 09-02-19 09:38:25 GMT
FD CRNT Y         39                               Y         39
      E5MCAP 1113                            E5MCAP 1115
```

```

RD BKUP - - - - - Y 36 09-02-19 09:27:17 GMT
USB BKP - - - - - Y 3 09-02-07 01:11:22 GMT

```

If removable media is installed in the active MASP, continue the procedure with 4.

If removable media is not installed in the active MASP, insert the removable media in the removable media drive in the active MASP. For more information about inserting removable media in the removable media drive, refer to [Removable USB Drive](#). After the removable media has been inserted in the removable media drive in the active MASP, continue the procedure with 4.

4. Display the **GPLs** on the fixed disk using the `rtrv-gpl` command with the `gpl` parameter value equal to the **GPL** being updated. These are examples of the possible output.

```
rtrv-gpl:gpl=ss7hc
```

```
rlghncxa03w 09-03-16 11:34:04 GMT EAGLE 46.3.0
GPL Auditing ON
```

GPL	CARD	RELEASE	APPROVED	TRIAL	REMOVE TRIAL
SS7HC	1114	132-002-000	132-002-000	132-001-000	132-003-000
SS7HC	1116	132-002-000	132-002-000	132-001-000	132-003-000
SS7HC	1115	-----	-----	-----	-----

```
rtrv-gpl:gpl=slanhc
```

```
rlghncxa03w 09-03-16 11:34:04 GMT EAGLE 46.3.0
GPL Auditing ON
```

GPL	CARD	RELEASE	APPROVED	TRIAL	REMOVE TRIAL
SLANHC	1114	132-002-000	132-002-000	132-001-000	132-003-000
SLANHC	1116	132-002-000	132-002-000	132-001-000	132-003-000
SLANHC	1115	-----	-----	-----	-----

If the version of the **GPL** shown in the `REMOVE TRIAL` column of the `rtrv-gpl` output is not the version that is to be loaded onto the cards, remove the removable media from the active MASP.

Insert the removable media that contains the **GPL** that is being updated into the removable media drive in the active MASP and repeat this step.

For more information about inserting removable media in the removable media drive, or removing removable media from the removable media drive, refer to [Removable USB Drive](#).

If the version of the **GPL** shown in the `REMOVE TRIAL` column of the `rtrv-gpl` output is the version that is to be loaded onto the cards, continue the procedure with 5.

5. Change the **GPLs**, using the `chg-gpl` command and specifying the value for the trial **GPL** shown in the `REMOVE TRIAL` column in the output of the `rtrv-gpl` command used in 4.

For this example, enter these commands.

```
chg-gpl:gpl=ss7hc:ver=123-003-000
```

These messages should appear.

```
rlghncxa03w 09-03-16 11:43:04 GMT EAGLE 46.3.0
GPL Auditing ON
```

```
SS7HC upload on 1114 completed
SS7HC upload on 1116 completed
System Release ID table upload 1114 completed
System Release ID table upload 1116 completed
```

```
chg-gpl:gpl=slanhc:ver=123-003-000
```

These messages should appear.

```
rlghncxa03w 09-03-16 11:43:04 GMT EAGLE5 46.3.0
GPL Auditing ON
```

```
SLANHC upload on 1114 completed
SLANHC upload on 1116 completed
System Release ID table upload 1114 completed
System Release ID table upload 1116 completed
```

6. Activate the trial **GPL**, using the `act-gpl` command and specifying the value for the trial **GPL** shown in 5.

For this example, enter this command.

```
act-gpl:gpl=ss7hc:ver=123-003-000
```

These messages should appear.

```
rlghncxa03w 09-03-16 06:54:39 GMT EAGLE 46.3.0
SS7HC activate on 1114 completed
SS7HC activate on 1116 completed
```

```
act-gpl:gpl=slanhc:ver=123-003-000
```

These messages should appear.

```
rlghncxa03w 09-03-16 06:54:39 GMT EAGLE 46.3.0
SLANHC activate on 1114 completed
SLANHC activate on 1116 completed
```

7. Verify that the trial **GPL** has been made the approved **GPL** using the `rtrv-gpl` command with the `gpl` parameter value specified in 5 and 6.

For this example, enter these commands.

```
rtrv-gpl:gpl=ss7hc
```

This is an example of the possible output.

```
rlghncxa03w 09-03-16 11:34:04 GMT EAGLE 46.3.0
GPL Auditing ON
```

GPL	CARD	RELEASE	APPROVED	TRIAL	REMOVE TRIAL
SS7HC	1114	132-003-000	132-003-000	132-002-000	132-003-000
SS7HC	1116	132-003-000	132-003-000	132-002-000	-----

If E5-based control cards are installed in the EAGLE, this is an example of the possible output.

```
rlghncxa03w 09-03-16 11:34:04 GMT EAGLE 46.3.0
GPL Auditing ON
```

GPL	CARD	RELEASE	APPROVED	TRIAL	REMOVE TRIAL
SS7HC	1114	132-003-000	132-003-000	132-002-000	132-003-000
SS7HC	1116	132-003-000	132-003-000	132-002-000	132-003-000
SS7HC	1115	-----	-----	-----	-----

```
rtrv-gpl:gpl=slanhc
```

This is an example of the possible output.

```
rlghncxa03w 09-03-16 11:34:04 GMT EAGLE 46.3.0
GPL Auditing ON
```

GPL	CARD	RELEASE	APPROVED	TRIAL	REMOVE TRIAL
SLANHC	1114	132-003-000	132-003-000	132-002-000	132-003-000
SLANHC	1116	132-003-000	132-003-000	132-002-000	-----

If E5-based control cards are installed in the EAGLE, this is an example of the possible output.

```
rlghncxa03w 09-03-16 11:34:04 GMT EAGLE 40.1.0
GPL Auditing ON
```

GPL	CARD	RELEASE	APPROVED	TRIAL	REMOVE TRIAL
SLANHC	1114	132-003-000	132-003-000	132-002-000	132-003-000
SLANHC	1116	132-003-000	132-003-000	132-002-000	132-003-000
SLANHC	1115	-----	-----	-----	-----

8. Verify which cards are running the **GPL** using the `rept-stat-gpl` command with the `gpl` parameter value specified in 7.

For this example, enter these commands.

```
rept-stat-gpl:gpl=ss7hc
```

This is an example of the possible output.

```
rlghncxa03w 09-03-16 11:40:26 GMT EAGLE 46.3.0
GPL      CARD  RUNNING      APPROVED      TRIAL
SS7HC   1201  132-002-000 ALM  132-003-000  132-002-000
SS7HC   1204  132-002-000 ALM  132-003-000  132-002-000
SS7HC   1211  132-002-000 ALM  132-003-000  132-002-000
SS7HC   1215  132-002-000 ALM  132-003-000  132-002-000
SS7HC   1307  132-002-000 ALM  132-003-000  132-002-000
SS7HC   2111  132-002-000 ALM  132-003-000  132-002-000
SS7HC   2112  132-002-000 ALM  132-003-000  132-002-000
SS7HC   2115  132-002-000 ALM  132-003-000  132-002-000
SS7HC   2116  132-002-000 ALM  132-003-000  132-002-000
Command Completed
```

Continue the procedure by performing one of these steps.

- If one of these GPLs is being updated: SS7IPGW, IPGWI, SS7HC, SS7EPM, IPLHC, IPGHC, ATMHC, or IPSG, continue the procedure with 9.
- If one of these GPLs is being updated: SLANHC, continue the procedure with 11.

9. Display the signaling links associated with the cards shown in 8.

Enter the `rtrv-slk` command. This is an example of the possible output.

```
rlghncxa03w 09-07-16 21:16:37 GMT EAGLE 41.1.0
```

LOC	LINK	LSN	SLC	TYPE	L2T SET	BPS	ECM	PCR N1	PCR N2
1201	A	lsnmp11	0	LIMDS0	2	56000	BASIC	---	-----
1201	B	lsnmp12	0	LIMDS0	3	56000	PCR	76	3800
1201	A1	lsnmp13	0	LIMDS0	2	56000	PCR	120	5034
1201	B1	lsnmp14	0	LIMDS0	1	56000	BASIC	---	-----
1204	A	lsnmp11	1	LIMDS0	2	56000	BASIC	---	-----
1204	B	lsnmp12	1	LIMDS0	3	56000	PCR	76	3800
1204	A2	lsnmp13	1	LIMDS0	2	56000	PCR	120	5034
1204	B2	lsnmp15	0	LIMDS0	3	56000	PCR	76	3800
1211	A	lsnmp11	2	LIMDS0	2	56000	BASIC	---	-----
1211	B	lsnmp13	2	LIMDS0	2	56000	PCR	120	5034
1211	A3	lsnmp15	1	LIMDS0	3	56000	PCR	76	3800
1211	B3	lsnmp16	0	LIMDS0	1	56000	PCR	120	5034
1215	A1	lsnmp17	0	LIMDS0	1	56000	BASIC	---	-----
1215	B2	lsnmp11	3	LIMDS0	2	56000	BASIC	---	-----
1215	A3	lsnmp16	1	LIMDS0	1	56000	PCR	120	5034
1215	B3	lsnmp17	1	LIMDS0	1	56000	BASIC	---	-----
1307	A	lsnmp16	2	LIMDS0	1	56000	PCR	120	5034
1307	B2	lsnmp17	2	LIMDS0	1	56000	BASIC	---	-----
1307	A3	lsnmp16	3	LIMDS0	1	56000	PCR	120	5034
1307	B3	lsnmp17	3	LIMDS0	1	56000	BASIC	---	-----

LOC	LINK	LSN	SLC	TYPE	LP SET	BPS	ATM TSEL	VCI	VPI	LL
1302	A	atm1302a	5	LIMATM	3	1544000	INTERNAL	35	15	0
1305	A	atm1305a	5	LIMATM	5	1544000	LINE	5	0	2

LOC	LINK	LSN	SLC	TYPE	LP SET	BPS	ATM TSEL	VCI	VPI	E1ATM CRC4	SI	SN
2101	A	atmitul	0	LIME1ATM	5	2.048M	LINE	150	2	ON	1	20
2105	A	atmitul	1	LIME1ATM	5	2.048M	LINE	35	15	ON	2	15

LOC	LINK	LSN	SLC	TYPE	L2T SET	BPS	ECM	PCR N1	PCR N2	E1 LOC	E1 PORT	TS
2111	A	lsne145	0	LIME1	1	56000	BASIC	---	-----	2111	2	10
2112	A	lsne145	1	LIMCH	1	56000	BASIC	---	-----	2111	1	14
2112	A2	lsne145	2	LIMCH	1	56000	BASIC	---	-----	2111	1	20

LOC	LINK	LSN	SLC	TYPE	L2T SET	BPS	ECM	PCR N1	PCR N2	T1 LOC	T1 PORT	TS
2115	A	lsnt145	0	LIMT1	1	56000	BASIC	---	-----	2115	2	3
2116	A	lsnt145	1	LIMCH	1	56000	BASIC	---	-----	2115	1	11
2116	A2	lsnt145	2	LIMCH	1	56000	BASIC	---	-----	2115	1	19

SLK table is (30 of 1200) 3% full.

10. Using the outputs of 8 and 9 as a guide, select a card to load the approved GPL onto.

Deactivate the SS7 signaling links on that card using the `dact-slk` command. For this example, enter these commands.

```
dact-slk:loc=1201:link=a
```

```
dact-slk:loc=1201:link=b  
dact-slk:loc=1201:link=a1  
dact-slk:loc=1201:link=b1
```

Caution: These command examples place the **SS7** signaling links on card 1201 out of service. This will interrupt service on the **SS7** signaling links on card 1201 and allow the approved **GPL** to be loaded on to card 1201.

Do not deactivate all the **SS7** signaling links in the **EAGLE** at the same time. Doing so will take all the **SS7** signaling links out of service and isolate the **EAGLE** from the network.

When each of these commands have successfully completed, this message should appear.

```
rlghncxa03w 09-03-16 11:45:18 GMT EAGLE 46.3.0  
Deactivate SLK message sent to card
```

Continue the procedure with [13](#).

11. Display the data links, and their status, associated with the cards shown in [8](#).

Enter the `rept-stat-dlk` command. This is an example of the possible output.

```
rlghncxa03w 09-03-16 17:00:36 GMT EAGLE 46.3.0  
DLK   PST       SST       AST  
2105  IS-NR       Avail     ---  
2113  IS-NR       Avail     ---  
2301  IS-NR       Avail     ---  
Command Completed.
```

12. Deactivate the **TCP/IP** data link on the card (shown in [11](#)) that you wish to load the trial **GPL** onto, using the `canc-dlk` command.

For this example, enter this command.

```
canc-dlk:loc=2105
```

Caution: This command example places the **TCP/IP** data link on card 2105 out of service. This will interrupt service on the **TCP/IP** data link on card 2105 and allow the trial **GPL** to be loaded on to card 2105.

Do not deactivate all the **TCP/IP** data links in the **EAGLE** at the same time. Doing so will take all the **TCP/IP** data links out of service and cause the **STPLAN** feature to be disabled.

If there is only one **TCP/IP** data link in the **EAGLE**, placing the card out of service will cause the **STPLAN** feature to be disabled.

When this command has successfully completed, this message should appear.

```
rlghncxa03w 09-03-16 11:45:18 GMT EAGLE 46.3.0
```

Deactivate Link message sent to card.
Command Completed.

13. Place the card specified in either 10 or 12 out of service using the `rmv-card` command.

If the card contains the last signaling link in a linkset, the `force=yes` parameter must be specified. For this example, enter this command.

```
rmv-card:loc=1201:force=yes
rmv-card:loc=2105
```

When this command has successfully completed, this message should appear.

```
rlghncxa03w 09-03-16 11:11:28 GMT EAGLE 46.3.0
Card has been inhibited.
```

14. Put the cards that were inhibited in 13 back into service using the `rst-card` command.

The `rst-card` command also loads the approved version of the **GPL** onto the card.

For this example, enter this command.

```
rst-card:loc=1201
rst-card:loc=2105
```

When this command has successfully completed, this message should appear.

```
rlghncxa03w 09-03-16 11:11:28 GMT EAGLE 46.3.0
Card has been allowed.
```

15. Verify the **GPLs** on the cards using the `rept-stat-gpl` command with the `gpl` parameter value specified in 8.

If any card is not running the release version of the **GPL**, shown in the `RELEASE` column of the `rtrv-gpl` output in 7, the indicator `ALM` is displayed next to the **GPL** version in the `RUNNING` column of the `rept-stat-gpl` output. For this example, enter these commands.

```
rept-stat-gpl:gpl=ss7hc
```

This is an example of the possible output.

```
rlghncxa03w 09-03-16 11:40:26 GMT EAGLE 46.3.0
GPL      CARD      RUNNING      APPROVED      TRIAL
SS7HC    1201    132-003-000      132-003-000    132-002-000
SS7HC    1204    132-002-000 ALM  132-003-000    132-002-000
SS7HC    1211    132-002-000 ALM  132-003-000    132-002-000
SS7HC    1215    132-002-000 ALM  132-003-000    132-002-000
SS7HC    1307    132-002-000 ALM  132-003-000    132-002-000
SS7HC    2111    132-002-000 ALM  132-003-000    132-002-000
SS7HC    2112    132-002-000 ALM  132-003-000    132-002-000
SS7HC    2115    132-002-000 ALM  132-003-000    132-002-000
SS7HC    2116    132-002-000 ALM  132-003-000    132-002-000
Command Completed
```

```
rept-stat-gpl:gpl=slanhc
```

This is an example of the possible output.

```
rlghncxa03w 09-03-16 11:40:26 GMT EAGLE 46.3.0
GPL      CARD  RUNNING      APPROVED      TRIAL
SLANHC  2105  132-003-000      132-003-000  132-002-000
SLANHC  2113  132-002-000 ALM  132-003-000  132-002-000
SLANHC  2301  132-002-000 ALM  132-003-000  132-002-000
Command Completed
```

Continue the procedure by performing one of these steps.

- If one of these GPLs is being updated: SS7IPGW, IPGWI, SS7HC, SS7EPM, IPLHC, IPGHC, ATMHC, or IPSP, continue the procedure with [16](#).
- If one of these GPLs is being updated: SLANHC, continue the procedure with [18](#).

- 16.** Place the signaling links that were deactivated in [10](#) back into service using the `act-slk` command.

For this example, enter these commands.

```
act-slk:loc=1201:link=a
act-slk:loc=1201:link=b
act-slk:loc=1201:link=a1
act-slk:loc=1201:link=b1
```

When each of these commands have successfully completed, this message should appear.

```
rlghncxa03w 09-03-16 11:55:49 GMT EAGLE 46.3.0
Activate SLK message sent to card
```

- 17.** Verify that the signaling links activated in [16](#) are back in service using the `rept-stat-slk` command with the card location and signaling link.

For this example, enter these commands.

```
rept-stat-slk:loc=1201:link=a
```

This is an example of the possible output.

```
rlghncxa03w 09-03-16 13:06:25 GMT EAGLE 46.3.0
SLK      LSN      CLLI      PST      SST      AST
1201,A  lsnmp11  -----  IS-NR      Avail      ----
ALARM STATUS      = No Alarms.
UNAVAIL REASON    = --
```

```
rept-stat-slk:loc=1201:link=b
```

This is an example of the possible output.

```
rlghncxa03w 09-03-16 13:06:25 GMT EAGLE 46.3.0
SLK      LSN      CLLI      PST      SST      AST
1201,B  lsnmp12  -----  IS-NR      Avail      ----
ALARM STATUS      = No Alarms.
UNAVAIL REASON    = --
```

```
rept-stat-slk:loc=1201:link=a1
```

This is an example of the possible output.

```
rlghncxa03w 09-03-16 13:06:25 GMT EAGLE 46.3.0
SLK      LSN      CLLI      PST      SST      AST
1201,A1 lsnmpl3  ----- IS-NR      Avail    ----
  ALARM STATUS      = No Alarms.
  UNAVAIL REASON    = --
```

```
rept-stat-slk:loc=1201:link=b1
```

This is an example of the possible output.

```
rlghncxa03w 09-03-16 13:06:25 GMT EAGLE 46.3.0
SLK      LSN      CLLI      PST      SST      AST
1201,B1 lsnmpl4  ----- IS-NR      Avail    ----
  ALARM STATUS      = No Alarms.
  UNAVAIL REASON    = --
Command Completed.
```

- 18.** Place the **TCP/IP** data link that was deactivated in [12](#) back into service using the `act-dlk` command.

For this example, enter this command.

```
act-dlk:loc=2105
```

When this command has successfully completed, this message should appear.

```
rlghncxa03w 09-03-16 11:55:49 GMT EAGLE 46.3.0
Activate Link message sent to card.
```

- 19.** Verify that the **TCP/IP** data links activated in [18](#) are back in service with the `rept-stat-dlk` command.

This is an example of the possible output.

```
rlghncxa03w 09-03-16 12:57:50 GMT EAGLE 46.3.0
DLK      PST      SST      AST
2105    IS-NR      Avail    ---
2113    IS-NR      Avail    ---
2301    IS-NR      Avail    ---
Command Completed.
```

- 20.** Continue the procedure by performing these actions.

When the E5-based control cards are installed in the EAGLE, continue the procedure by performing one of these actions:

- If you wish to load the new **GPL** onto the other cards shown in [8](#), repeat this procedure from either [10](#) or [12](#) for each card shown in [8](#).
- If the new GPL will not be loaded onto other cards but other GPLs will be updated, repeat this procedure from [1](#).
- If the new GPL will not be loaded onto other cards and no other GPLs are being updated, then this procedure is finished.

Figure 3-2 Updating the Signaling Link and Data Link GPLs

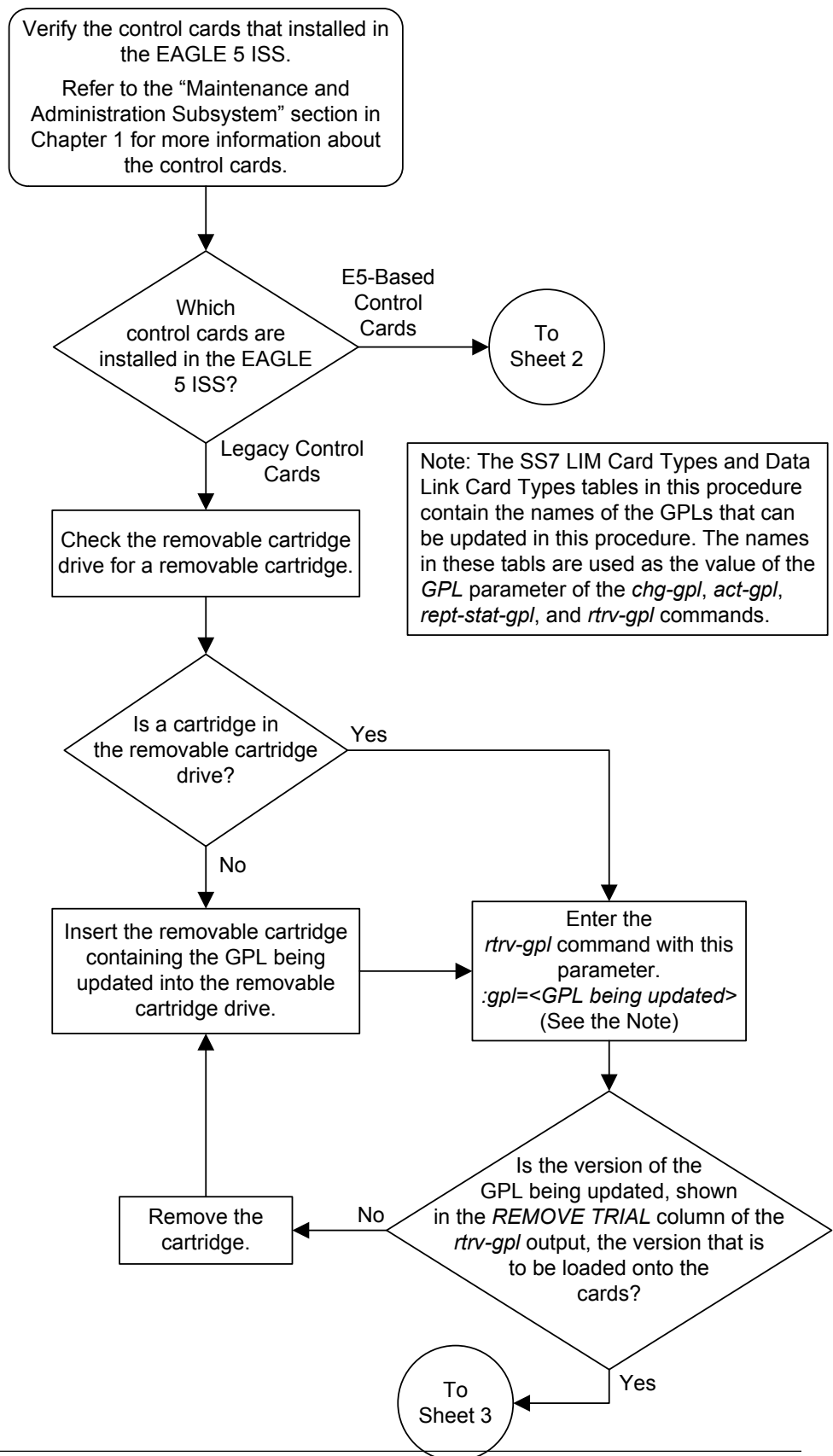

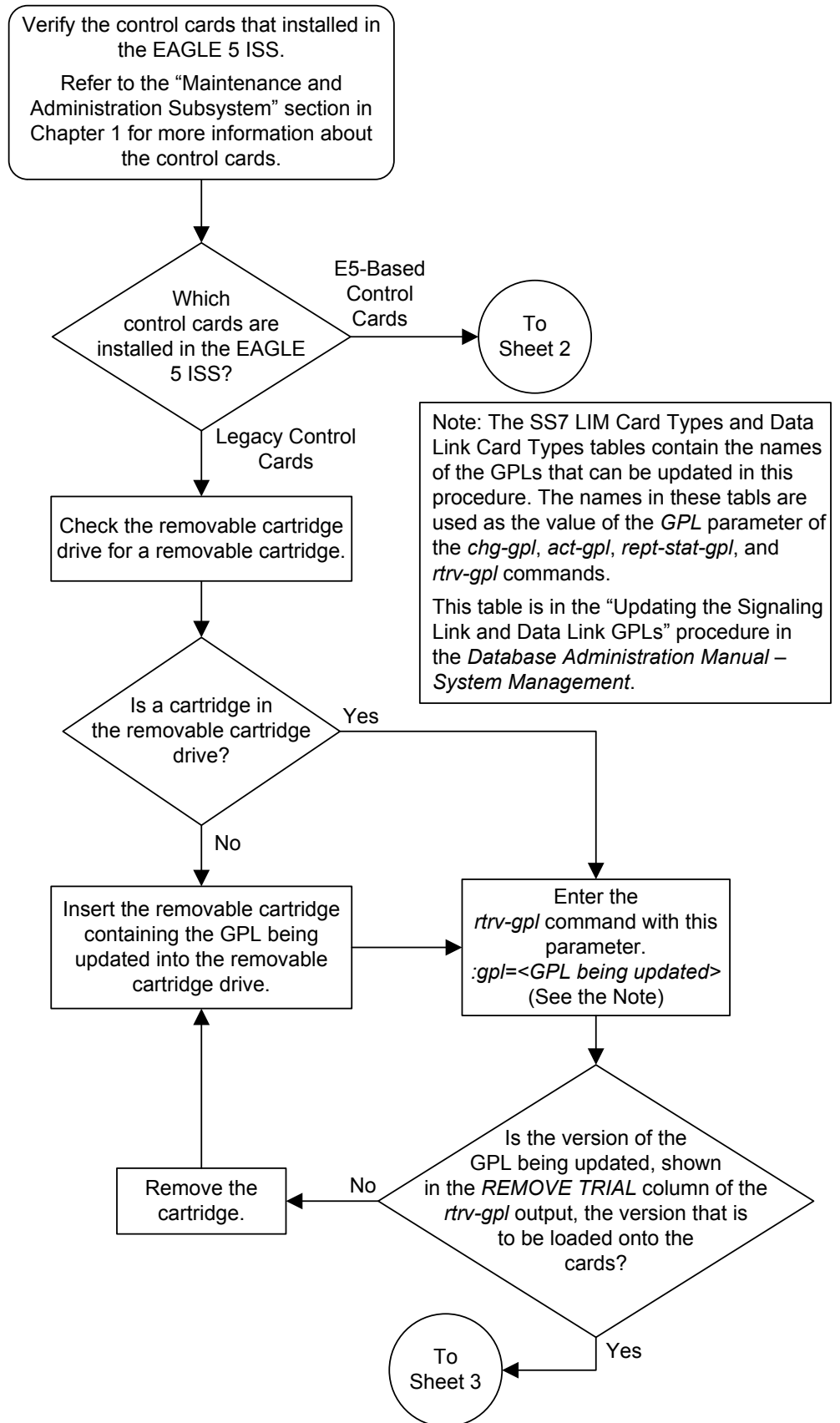

Sheet 1 of 5

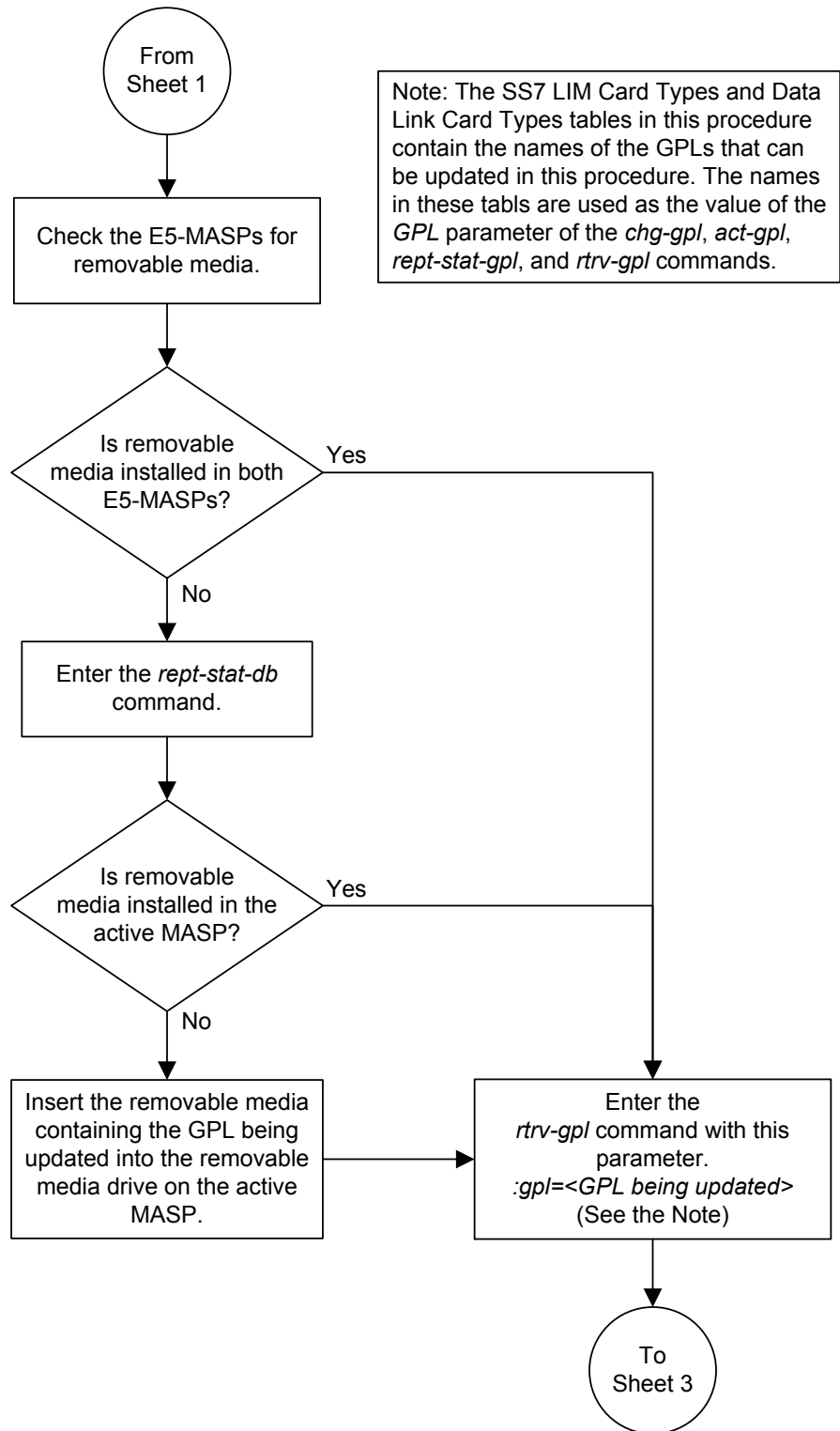

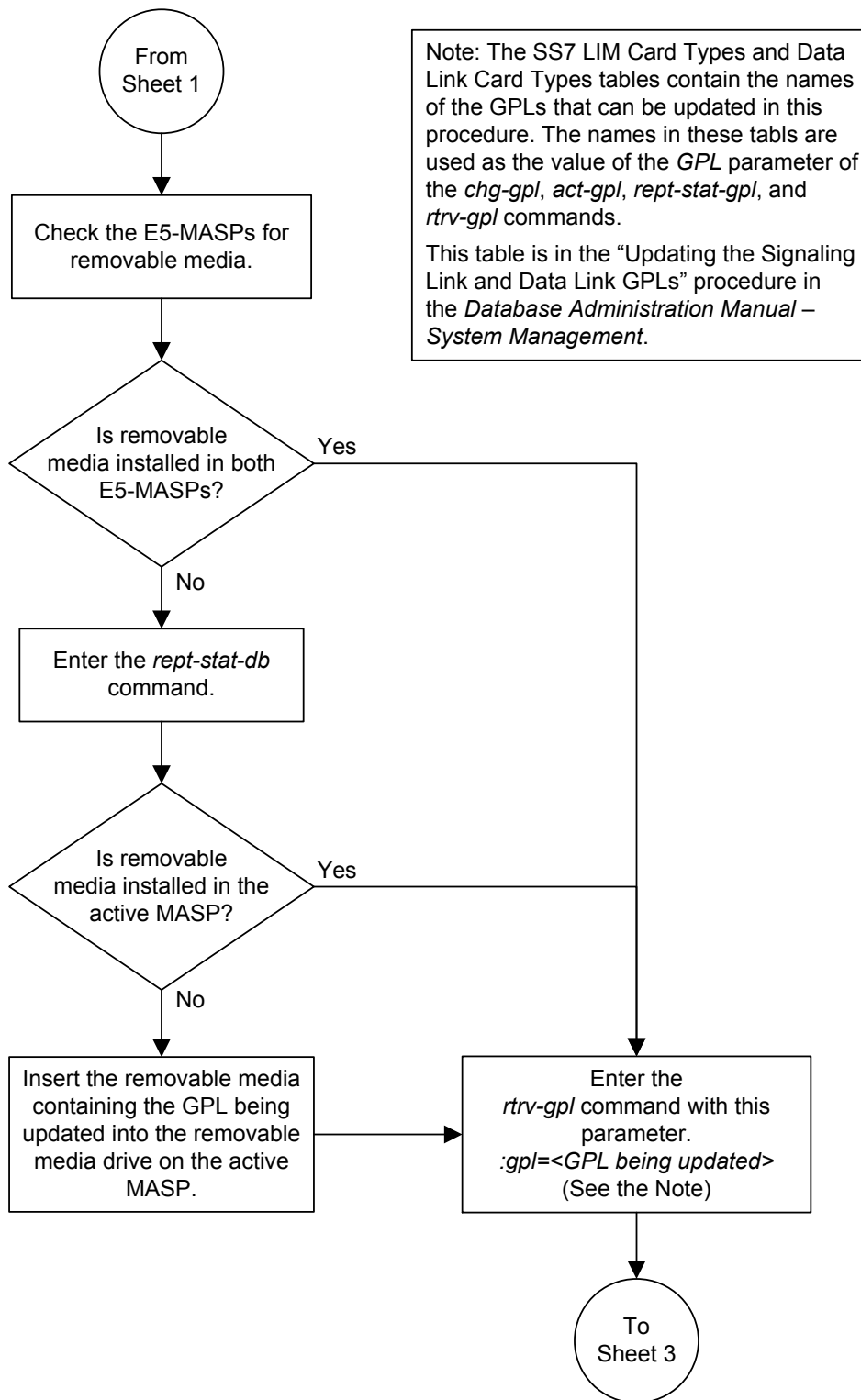

Note: The SS7 LIM Card Types and Data Link Card Types tables contain the names of the GPLs that can be updated in this procedure. The names in these tabs are used as the value of the *GPL* parameter of the *chg-gpl*, *act-gpl*, *rept-stat-gpl*, and *rtrv-gpl* commands.

This table is in the “Updating the Signaling Link and Data Link GPLs” procedure in the *Database Administration Manual – System Management*.

Sheet 2 of 5

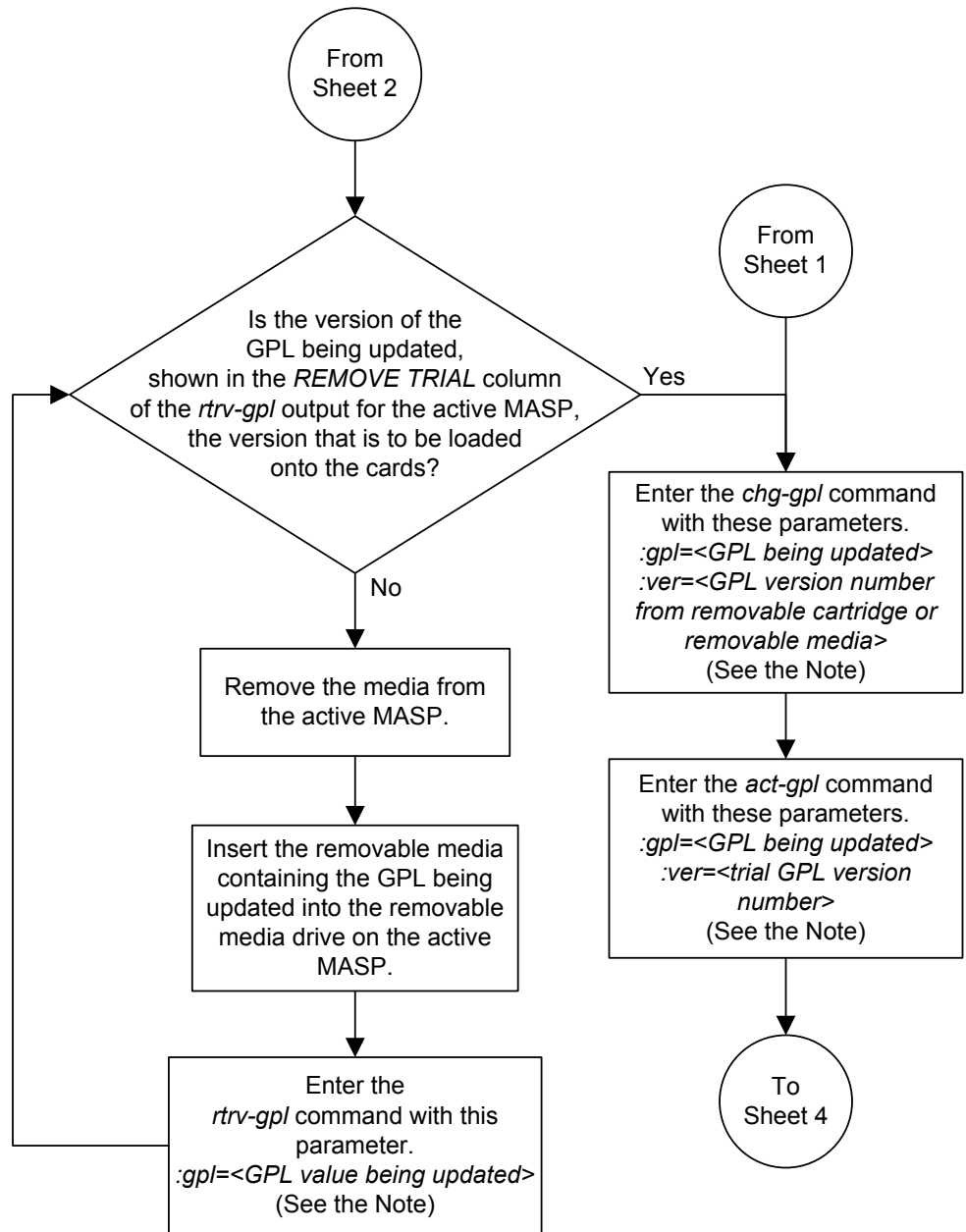

Note: The SS7 LIM Card Types and Data Link Card Types tables in this procedure contain the names of the GPLs that can be updated in this procedure. The names in these tabs are used as the value of the *GPL* parameter of the *chg-gpl*, *act-gpl*, *rept-stat-gpl*, and *rtrv-gpl* commands.

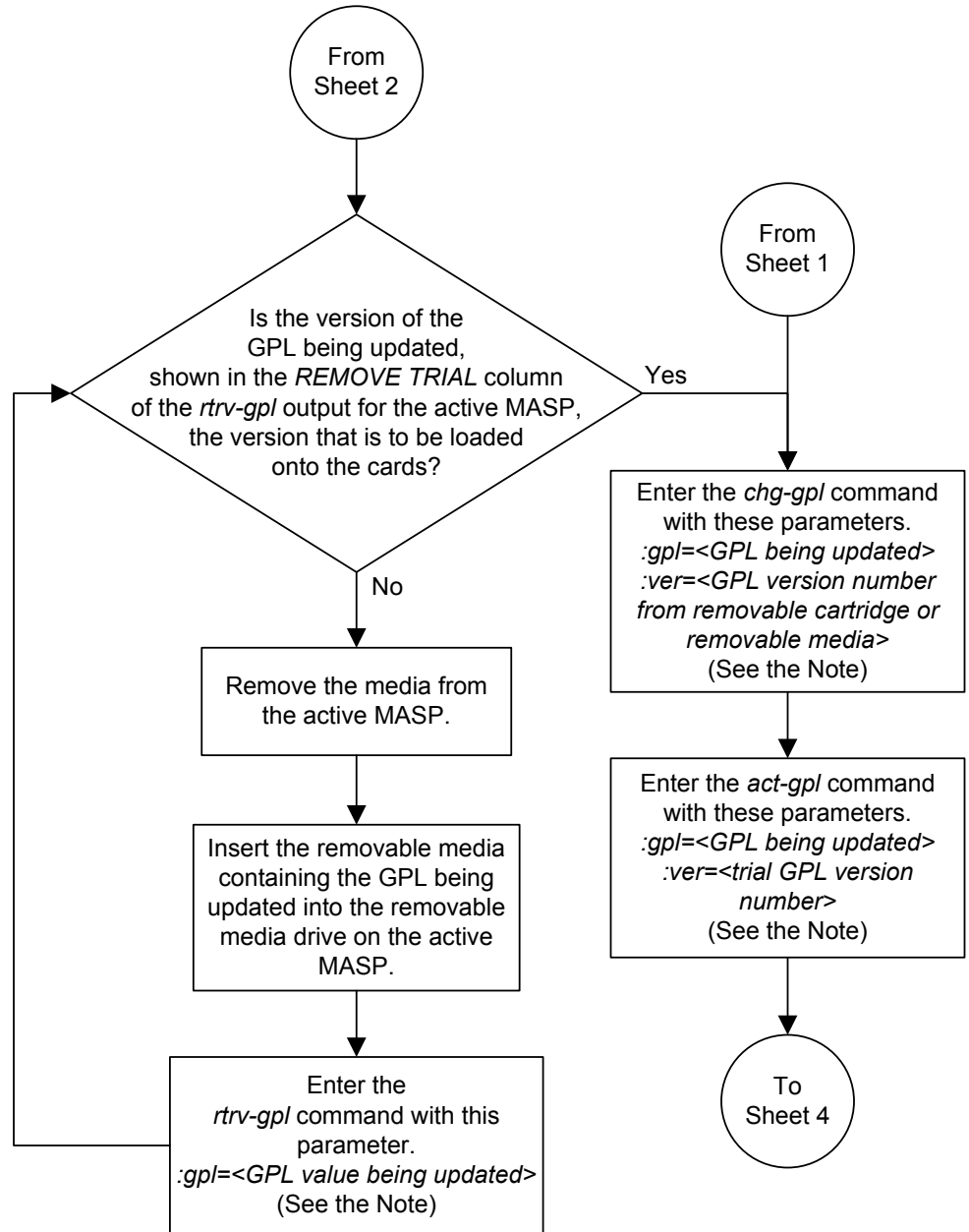

Note: The SS7 LIM Card Types and Data Link Card Types tables contain the names of the GPLs that can be updated in this procedure. The names in these tables are used as the value of the *GPL* parameter of the *chg-gpl*, *act-gpl*, *rept-stat-gpl*, and *rtrv-gpl* commands.

This table is in the "Updating the Signaling Link and Data Link GPLs" procedure in the *Database Administration Manual – System Management*.

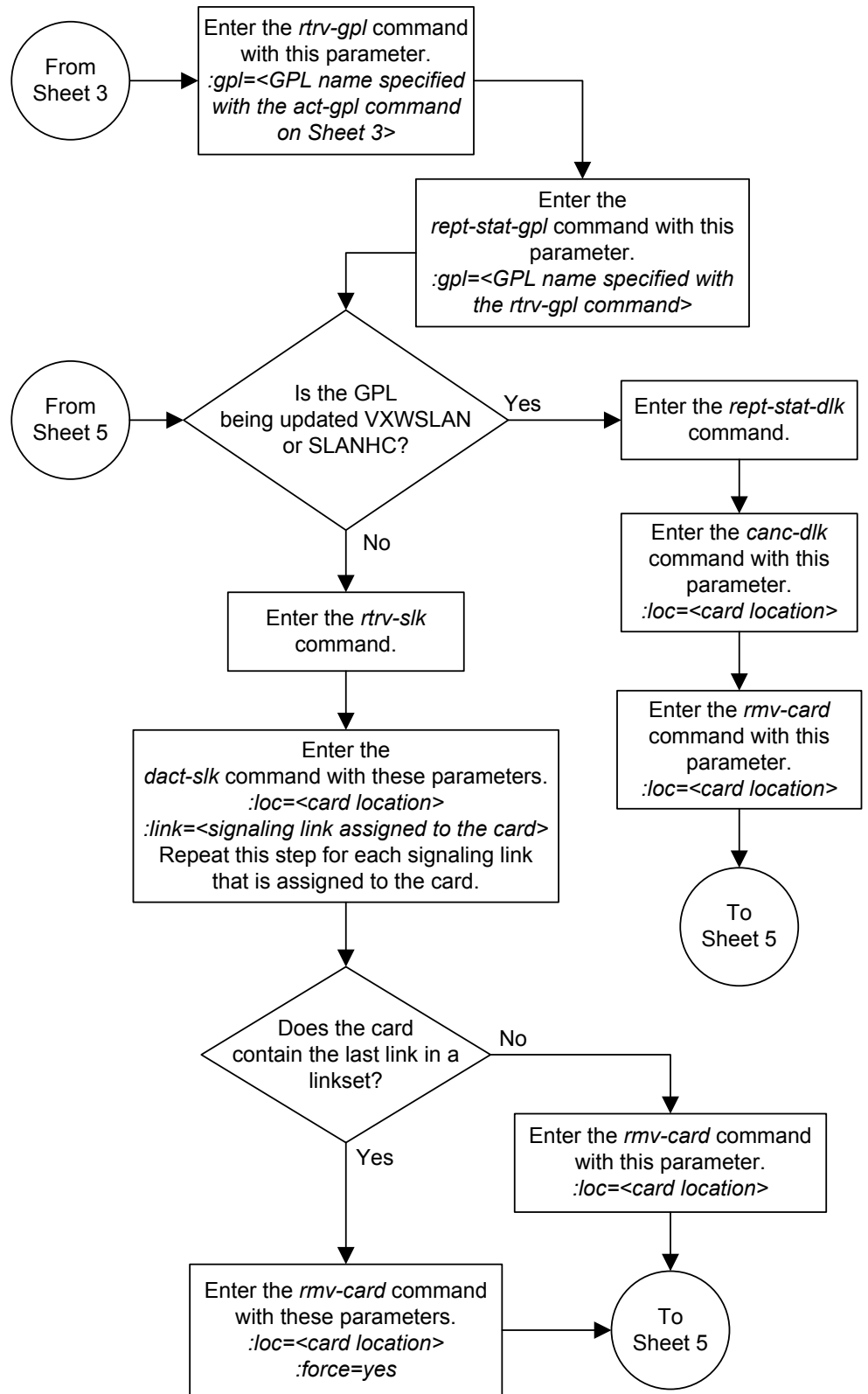

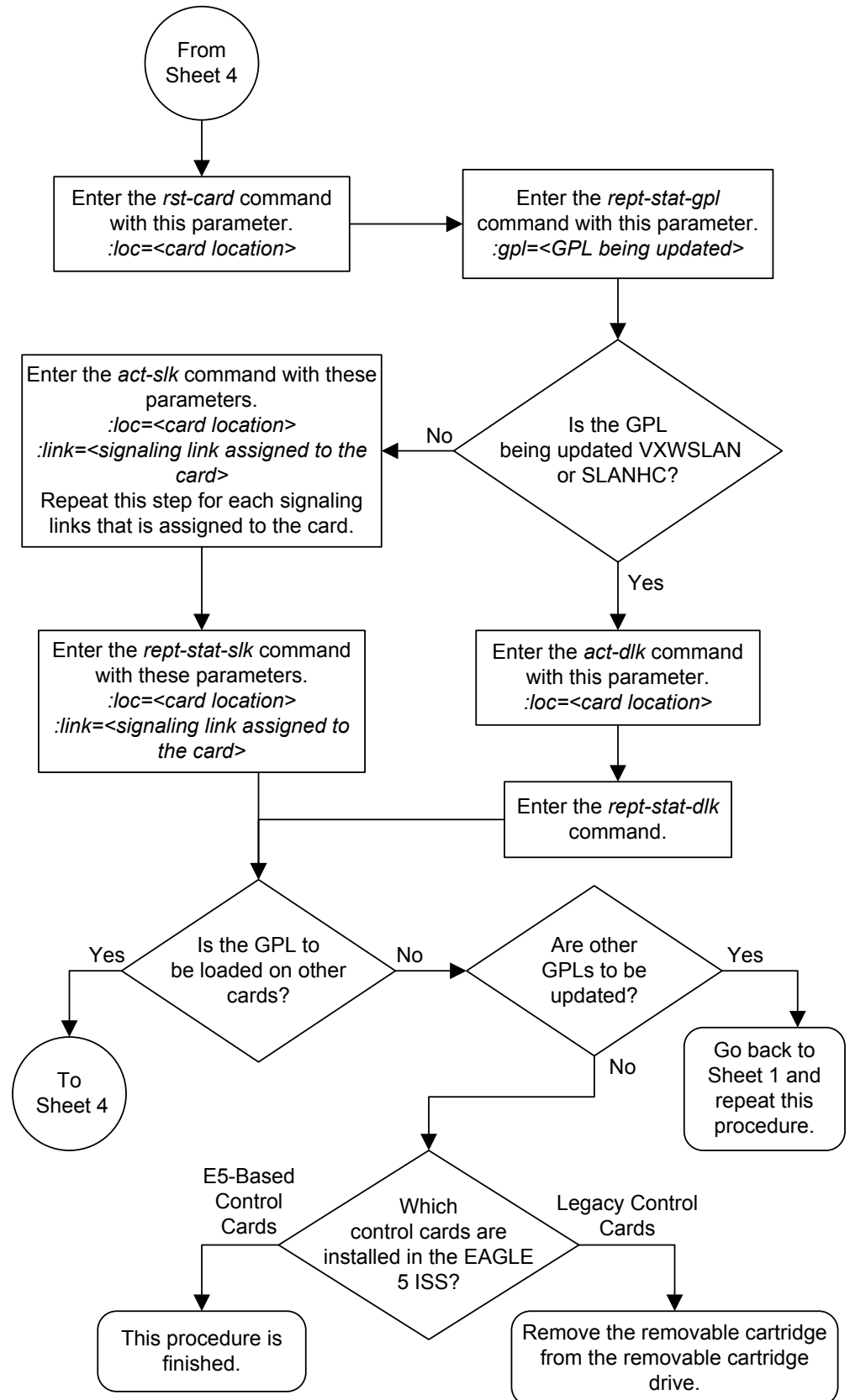

If removable media is not installed in the active MASP, insert the removable media in the removable media drive in the active MASP. For more information about inserting removable media in the removable media drive, refer to [Removable USB Drive](#). After the removable media has been inserted in the removable media drive in the active MASP, continue the procedure with 4.

4. Display the **GPLs** on the fixed disk and on the removable cartridge using the `rtrv-gpl` command with the `gpl` parameter value equal to the **GPL** being updated. These are examples of the possible output.

```
rtrv-gpl:gpl=vsccp
```

```
rlghncxa03w 09-03-01 11:34:04 GMT EAGLE5 40.1.0
GPL Auditing ON
```

GPL	CARD	RELEASE	APPROVED	TRIAL	REMOVE TRIAL
VSCCP	1114	132-002-000	132-002-000	132-001-000	132-003-000
VSCCP	1116	132-002-000	132-002-000	132-001-000	132-003-000
VSCCP	1115	-----	-----	-----	-----

If the version of the **GPL** shown in the `REMOVE TRIAL` column of the `rtrv-gpl` output is not the version that is to be loaded onto the cards, remove the removable media from the active MASP.

Insert the removable media that contains the **GPL** that is being updated into the removable media drive in the active MASP and repeat this step.

For more information about inserting removable media in the removable media drive, or removing removable media from the removable media drive, refer to [Removable USB Drive](#).

If the version of the **GPL** shown in the `REMOVE TRIAL` column of the `rtrv-gpl` output is the version that is to be loaded onto the cards, continue the procedure with 5.

5. Change the **GPLs**, using the `chg-gpl` command and specifying the value for the trial **GPL** shown in the `REMOVE TRIAL` column in the output of the `rtrv-gpl` command.

For this example, enter this command.

```
chg-gpl:gpl=vsccp:ver=132-003-000
```

These messages should appear.

```
rlghncxa03w 09-03-01 11:43:04 GMT EAGLE5 40.1.0
GPL Auditing ON
```

```
VSCCP upload on 1114 completed
VSCCP upload on 1116 completed
System Release ID table upload 1114 completed
System Release ID table upload 1116 completed
```

6. Activate the trial **GPL**, using the `act-gpl` command and specifying the value for the trial **GPL** shown in 5.

For this example, enter this command.

```
act-gpl:gpl=vsccp:ver=132-003-000
```

These messages should appear.

```
rlghncxa03w 09-03-01 06:54:39 GMT EAGLE5 40.1.0
VSSCP activate on 1114 completed
VSSCP activate on 1116 completed
```

- Verify that the trial **GPL** has been made the approved **GPL** using the `rtrv-gpl` command with the `gpl` parameter value specified in 5 and 6.

For this example, enter this command.

```
rtrv-gpl:gpl=vsscp
```

This is an example of the possible output.

```
rlghncxa03w 09-03-01 11:34:04 GMT EAGLE5 40.1.0
GPL Auditing ON

GPL      CARD  RELEASE      APPROVED      TRIAL      REMOVE TRIAL
VSSCP    1114  132-003-000  132-003-000   132-002-000 132-003-000
VSSCP    1116  132-003-000  132-003-000   132-002-000 -----
```

If E5-based control cards are installed in the EAGLE, this is an example of the possible output.

```
rlghncxa03w 09-03-01 11:34:04 GMT EAGLE5 40.1.0
GPL Auditing ON

GPL      CARD  RELEASE      APPROVED      TRIAL      REMOVE TRIAL
VSSCP    1114  132-003-000  132-003-000   132-002-000 132-003-000
VSSCP    1116  132-003-000  132-003-000   132-002-000 132-003-000
VSSCP    1115  -----      -----      -----      -----
```

- Verify which cards are running the **GPL** using the `rept-stat-gpl` command with the `gpl` parameter value specified in 7.

For this example, enter this command.

```
rept-stat-gpl:gpl=vsscp
```

This is an example of the possible output.

```
rlghncxa03w 09-03-01 11:40:26 GMT EAGLE5 40.1.0
GPL      CARD  RUNNING      APPROVED      TRIAL
VSSCP    1101  132-002-000 ALM  132-003-000  132-002-000
VSSCP    1102  132-002-000 ALM  132-003-000  132-002-000
VSSCP    1103  132-002-000 ALM  132-003-000  132-002-000
Command Completed
```

If the **GLSHC** GPL is being loaded onto the cards, continue the procedure with 16.

If the GPL that is being loaded onto the card is not **GLSHC**, continue the procedure with 9.

- 10 through 15 are performed based on the **GPL** being updated (shown in the `rept-stat-gpl` output in 8).

The following list shows the steps that are performed for the **GPL** being updated.

- **SCCPHC** – Perform 10, then continue the procedure with 16.

- **MCP** – Perform 11, then continue the procedure with 16.
- **IPSHC** – Continue the procedure with 12.

10. Display the status of the service modules by entering the `rept-stat-sccp` command.

This is an example of the possible output.

```
rlghncxa03w 09-03-01 09:57:31 GMT EAGLE5 40.1.0

CARD  VERSION      PST           SST           AST           MSU USAGE  CPU USAGE
-----
1101  132-002-001  IS-NR        Active        -----        47%         81%
1102  132-002-001  IS-NR        Active        -----        34%         50%
1103  132-002-001  IS-NR        Active        -----        21%         29%
-----
SCCP Service Average MSU Capacity = 36%      Average CPU Capacity = 56%
Command Completed.
```

Continue the procedure with 16.

Note: The `rept-stat-sccp` command output contains other fields that are not used by this procedure. If you wish to see all the fields displayed by the `rept-stat-sccp` command, see the `rept-stat-sccp` command description in *Commands User's Guide*.

11. Display the status of the **MCPMs** in the database by entering the `rept-stat-meas` command.

This is an example of the possible output.

```
rlghncxa03w 09-03-01 16:43:42 GMT EAGLE5 40.1.0

MEAS SS           PST           SST           AST
IS-NR            Active        -----
ALARM STATUS =   No Alarms

CARD  VERSION      TYPE  PST           SST           AST
2107 P 132-002-000  EDSM  IS-NR        Active        -----
      IP Link A      IS-NR        Active        Available
2108  132-200-000  EDSM  IS-NR        Active        -----
      IP Link A      IS-NR        Active        Available
2111  132-002-000  EDSM  IS-NR        Active        -----
      IP Link A      IS-NR        Active        Available

CARD 2107 ALARM STATUS = No Alarms
CARD 2108 ALARM STATUS = No Alarms
CARD 2111 ALARM STATUS = No Alarms
```

Continue the procedure with 16.

12. Display the status of the **IPSMs** (if the **IPSHCGPL** is being updated) using the `rept-stat-card` command and specifying the location of the card shown in the `rept-stat-gpl` output in 8.

For this example, enter this command.

```
rept-stat-card:loc=2301
```

This is an example of the possible output.

```
rlghncxa03w 09-03-01 09:12:36 GMT EAGLE5 40.1.0
CARD  VERSION      TYPE      GPL      PST      SST      AST
2301  132-001-000  IPSM     IPS      IS-NR    Active   -----
```

```
ALARM STATUS      = No Alarms.
BPDCM GPL         = 132-002-000
IMT BUS A        = Conn
IMT BUS B        = Conn
Command Completed.
```

13. Display the terminal configuration in the database with the `rtrv-trm` command.

The **IP** terminals are shown by the terminal numbers 17 through 40. The `rtrv-trm` output shows the location of the **IPSM** associated with the **IP** terminals. This is an example of the possible output.

```
rlghncxa03w 10-07-01 16:02:08 GMT EAGLE5 42.0.0
TRM  TYPE      COMM      FC      TMOUT  MXINV  DURAL
1   VT320     9600-7-E-1 SW      30     5      99:59:59
2   KSR      9600-7-E-1 HW      30     5      INDEF
3   PRINTER  4800-7-E-1 HW      30     0      00:00:00
4   VT320     2400-7-E-1 BOTH   30     5      00:30:00
5   VT320     9600-7-O-1 NONE   30     5      00:00:30
6   VT320     9600-7-O-1 NONE   30     5      00:00:30
7   PRINTER  9600-7-N-2 HW      30     5      00:30:00
8   KSR      19200-7-E-2 BOTH   30     5      00:30:00
9   VT320     9600-7-O-1 NONE   30     5      00:00:30
10  VT320     9600-7-E-1 HW      30     5      00:30:00
11  VT320     4800-7-E-1 HW      30     5      00:30:00
12  PRINTER  9600-7-E-1 HW      30     4      00:30:00
13  VT320     9600-7-O-1 NONE   30     5      00:30:00
14  VT320     9600-7-E-2 SW      30     8      00:30:00
15  VT320     9600-7-N-2 HW      30     5      00:30:00
16  VT320     9600-7-E-2 BOTH   30     3      00:30:00
```

```
TRM  TYPE      LOC      TMOUT  MXINV  DURAL
17  TELNET    3101     60     5      00:30:00
18  TELNET    3101     60     5      00:30:00
19  TELNET    3101     60     5      00:30:00
20  TELNET    3101     60     5      00:30:00
21  TELNET    3101     60     5      00:30:00
22  TELNET    3101     60     5      00:30:00
23  TELNET    3101     60     5      00:30:00
24  TELNET    3101     60     5      00:30:00
25  TELNET    3105     60     5      00:30:00
26  TELNET    3105     60     5      00:30:00
27  TELNET    3105     60     5      00:30:00
28  TELNET    3105     60     5      00:30:00
29  TELNET    3105     60     5      00:30:00
30  TELNET    3105     60     5      00:30:00
31  TELNET    3105     60     5      00:30:00
32  TELNET    3105     60     5      00:30:00
33  TELNET    3111     60     5      00:30:00
34  TELNET    3111     60     5      00:30:00
35  TELNET    3111     60     5      00:30:00
36  TELNET    3111     60     5      00:30:00
```

37	TELNET	3111	60	5	00:30:00
38	TELNET	3111	60	5	00:30:00
39	TELNET	3111	60	5	00:30:00
40	TELNET	3111	60	5	00:30:00

Note: The `rtrv-trm` command output contains other fields that are not used by this procedure. If you wish to see all the fields displayed by the `rtrv-trm` command, see the `rtrv-trm` command description in *Commands User's Guide*.

14. Display the status of the terminals with the `rept-stat-trm` command.

This is an example of the possible output.

```
rlghncxa03w 09-03-01 15:08:45 GMT EAGLE5 40.1.0
TRM  PST      SST      AST
1    IS-NR     Active   -----
2    IS-NR     Active   -----
3    IS-NR     Active   -----
4    IS-NR     Active   -----
5    IS-NR     Active   -----
6    IS-NR     Active   -----
7    IS-NR     Active   -----
8    IS-NR     Active   -----
9    IS-NR     Active   -----
10   IS-NR     Active   -----
11   IS-NR     Active   -----
12   IS-NR     Active   -----
13   IS-NR     Active   -----
14   IS-NR     Active   -----
15   IS-NR     Active   -----
16   IS-NR     Active   -----
17   IS-NR     Active   -----
18   IS-NR     Active   -----
19   IS-NR     Active   -----
20   IS-NR     Active   -----
21   IS-NR     Active   -----
22   IS-NR     Active   -----
23   IS-NR     Active   -----
24   IS-NR     Active   -----
25   IS-NR     Active   -----
26   IS-NR     Active   -----
27   IS-NR     Active   -----
28   IS-NR     Active   -----
29   IS-NR     Active   -----
30   IS-NR     Active   -----
31   IS-NR     Active   -----
32   IS-NR     Active   -----
33   IS-NR     Active   -----
34   IS-NR     Active   -----
35   IS-NR     Active   -----
36   IS-NR     Active   -----
37   IS-NR     Active   -----
38   IS-NR     Active   -----
39   IS-NR     Active   -----
40   IS-NR     Active   -----
```

Command Completed.

15. Place the terminals associated with the **IPSM** that will be updated with the new **IPSHCGPL** out of service using the `rmv-trm` command.

If the last in service SEAS terminal is assigned to the card containing the terminals that are being inhibited in this step, the `force=yes` parameter must be specified for that terminal.

For this example, enter these commands.

```
rmv-trm:trm=17
rmv-trm:trm=18
rmv-trm:trm=19
rmv-trm:trm=20
rmv-trm:trm=21
rmv-trm:trm=22
rmv-trm:trm=23
rmv-trm:trm=24
```

Caution: Placing these terminals out of service will disable any sessions running on these terminals.

If the status of any of the terminals shown in the `PST` field in 14 is **OOS-MT-DSBLD** (out-of-service maintenance disabled), that terminal is already out of service and the `rmv-trm` command does not need to be executed for that terminal.

This message should appear when each of these commands have successfully completed.

```
rlghncxa03w 09-03-01 15:08:45 GMT EAGLE5 40.1.0
Inhibit message sent to terminal

rlghncxa03w 09-03-01 15:08:45 GMT EAGLE5 40.1.0
Command Completed.
```

16. The card that the new version of the **GPL** will be loaded onto must be out of service.

Place the card, selected from the outputs of 8, 10, 11, or 12, out of service using the `rmv-card` command. If there is only one of these cards running these **GPLs** in service (GLSHC), the `force=yes` parameter must be specified with the `rmv-card` command.

For this example, enter this command.

```
rmv-card:loc=1101
```

Caution: Do not place all the cards running the same **GPL** in the **EAGLE** out of service at the same time. Doing so will cause all traffic carried by these cards to be lost and disable the feature associated with these cards.

Caution: If there is only one in service card running the **GPL** being updated in the **EAGLE**, placing the card out of service will cause the traffic carried by this card to be lost and disable the feature associated with this card.

When this command has successfully completed, this message should appear.

```
rlghncxa03w 09-03-01 11:11:28 GMT EAGLE5 40.1.0
Card has been inhibited.
```

17. Put the card that was inhibited in 16 back into service using the `rst-card` command.

The `rst-card` command also loads the approved version of the **GPL** onto the card.

For this example, enter this command.

```
rst-card:loc=1101
```

When this command has successfully completed, this message should appear.

```
rlghncxa03w 09-03-01 11:11:28 GMT EAGLE5 40.1.0
Card has been allowed.
```

18. Verify the **GPLs** on the cards using the `rept-stat-gpl` command with the `gpl` parameter value equal to the `gpl` parameter value specified in 8.

If any card is not running the release version of the **GPL**, shown in the **RELEASE** column of the `rtrv-gpl` output in 7, the indicator **ALM** is displayed next to the **GPL** version in the **RUNNING** column of the `rept-stat-gpl` output. For this example, enter these commands.

```
rept-stat-gpl:gpl=vscpp
```

This is an example of the possible output.

```
rlghncxa03w 09-03-01 11:40:26 GMT EAGLE5 40.1.0
GPL      CARD  RUNNING          APPROVED      TRIAL
VSCCP    1101  132-003-000      132-003-000  132-002-000
VSCCP    1102  132-002-000 ALM  132-003-000  132-002-000
VSCCP    1103  132-002-000 ALM  132-003-000  132-002-000
Command Completed
```

Note: If the **IPSHC** **GPL** is not being updated in this procedure, continue the procedure with 21.

19. Put the terminals that were placed out of service in 15 back into service using the `rst-trm` command.

For this example, enter these commands.

```
rst-trm:trm=17
```

```
rst-trm:trm=18
```

```
rst-trm:trm=19
```

```
rst-trm:trm=20
```

```
rst-trm:trm=21
rst-trm:trm=22
rst-trm:trm=23
rst-trm:trm=24
```

This message should appear when each of these commands have successfully completed.

```
rlghncxa03w 09-03-01 15:08:45 GMT EAGLE5 40.1.0
Allow message sent to terminal
```

```
rlghncxa03w 09-03-01 15:08:45 GMT EAGLE5 40.1.0
Command Completed.
```

20. Verify that the terminals are in service with the `rept-stat-trm` command.

This is an example of the possible output.

```
rlghncxa03w 09-03-01 15:08:45 GMT EAGLE5 40.1.0
TRM  PST      SST      AST
1    IS-NR     Active   -----
2    IS-NR     Active   -----
3    IS-NR     Active   -----
4    IS-NR     Active   -----
5    IS-NR     Active   -----
6    IS-NR     Active   -----
7    IS-NR     Active   -----
8    IS-NR     Active   -----
9    IS-NR     Active   -----
10   IS-NR     Active   -----
11   IS-NR     Active   -----
12   IS-NR     Active   -----
13   IS-NR     Active   -----
14   IS-NR     Active   -----
15   IS-NR     Active   -----
16   IS-NR     Active   -----
17   IS-NR     Active   -----
18   IS-NR     Active   -----
19   IS-NR     Active   -----
20   IS-NR     Active   -----
21   IS-NR     Active   -----
22   IS-NR     Active   -----
23   IS-NR     Active   -----
24   IS-NR     Active   -----
25   IS-NR     Active   -----
26   IS-NR     Active   -----
27   IS-NR     Active   -----
28   IS-NR     Active   -----
29   IS-NR     Active   -----
30   IS-NR     Active   -----
31   IS-NR     Active   -----
32   IS-NR     Active   -----
33   IS-NR     Active   -----
34   IS-NR     Active   -----
35   IS-NR     Active   -----
36   IS-NR     Active   -----
37   IS-NR     Active   -----
38   IS-NR     Active   -----
```

39	IS-NR	Active	-----
40	IS-NR	Active	-----

Command Completed.

21. Continue the procedure by performing these actions.

When the E5-based control cards are installed in the EAGLE, continue the procedure by performing one of these actions.

- If you wish to load the new **GPL** onto the other cards shown in [8](#), repeat this procedure from [9](#) for each card shown in [8](#).
- If the new GPL will not be loaded onto other cards but other GPLs will be updated, repeat this procedure from [1](#).
- If the new GPL will not be loaded onto other cards and no other GPLs are being updated, then this procedure is finished.

Figure 3-3 Updating the Service GPLs

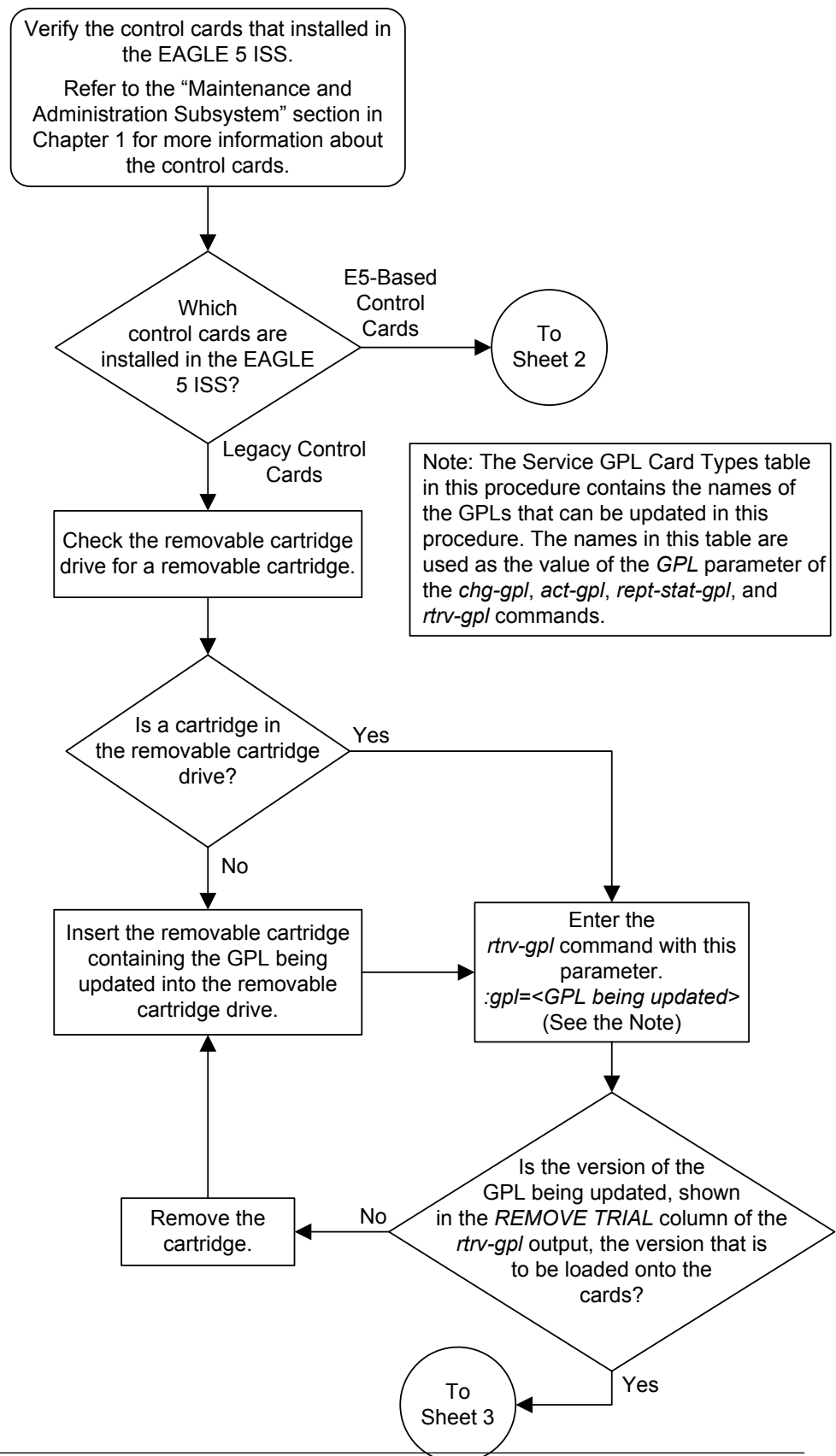

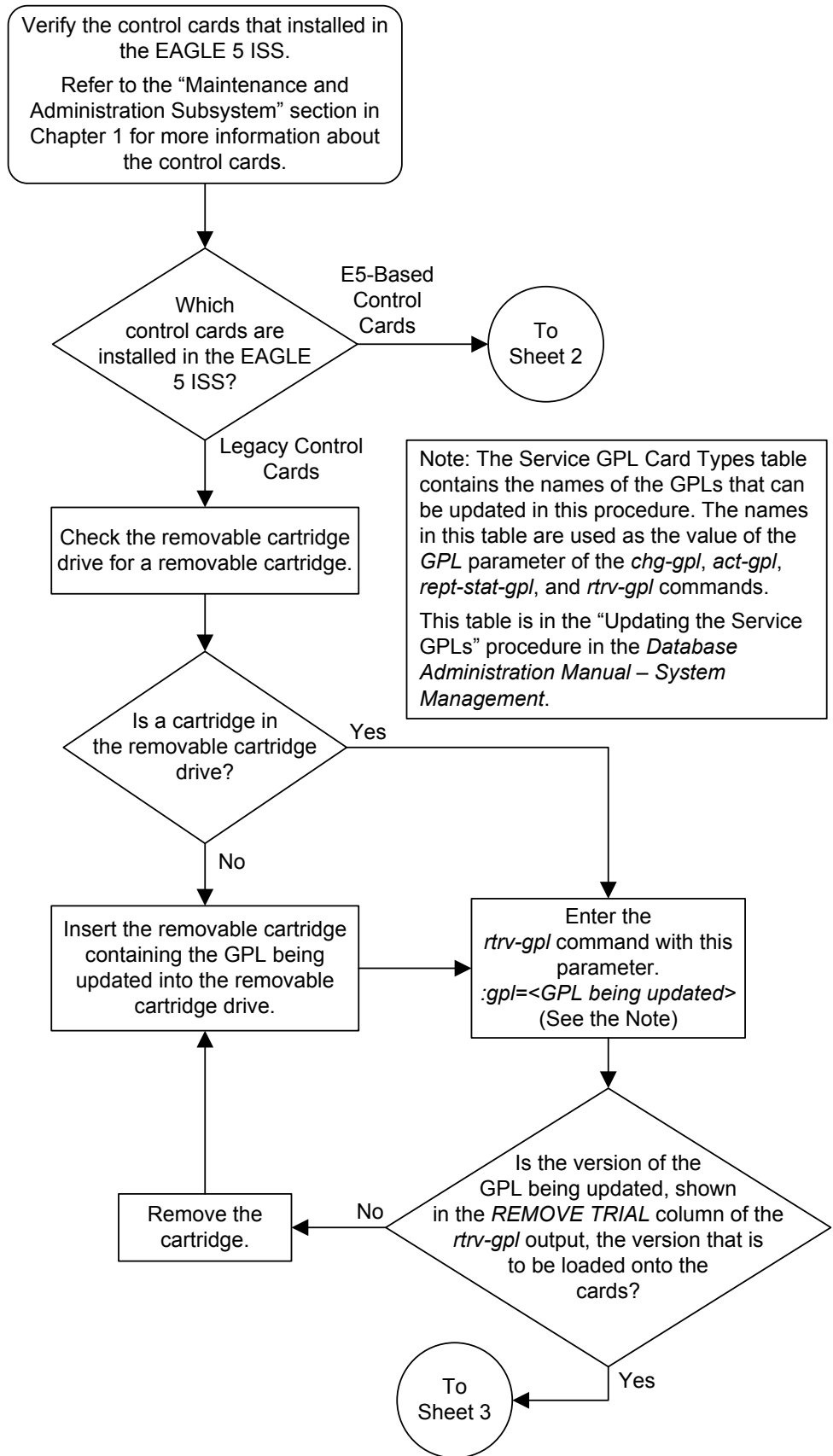

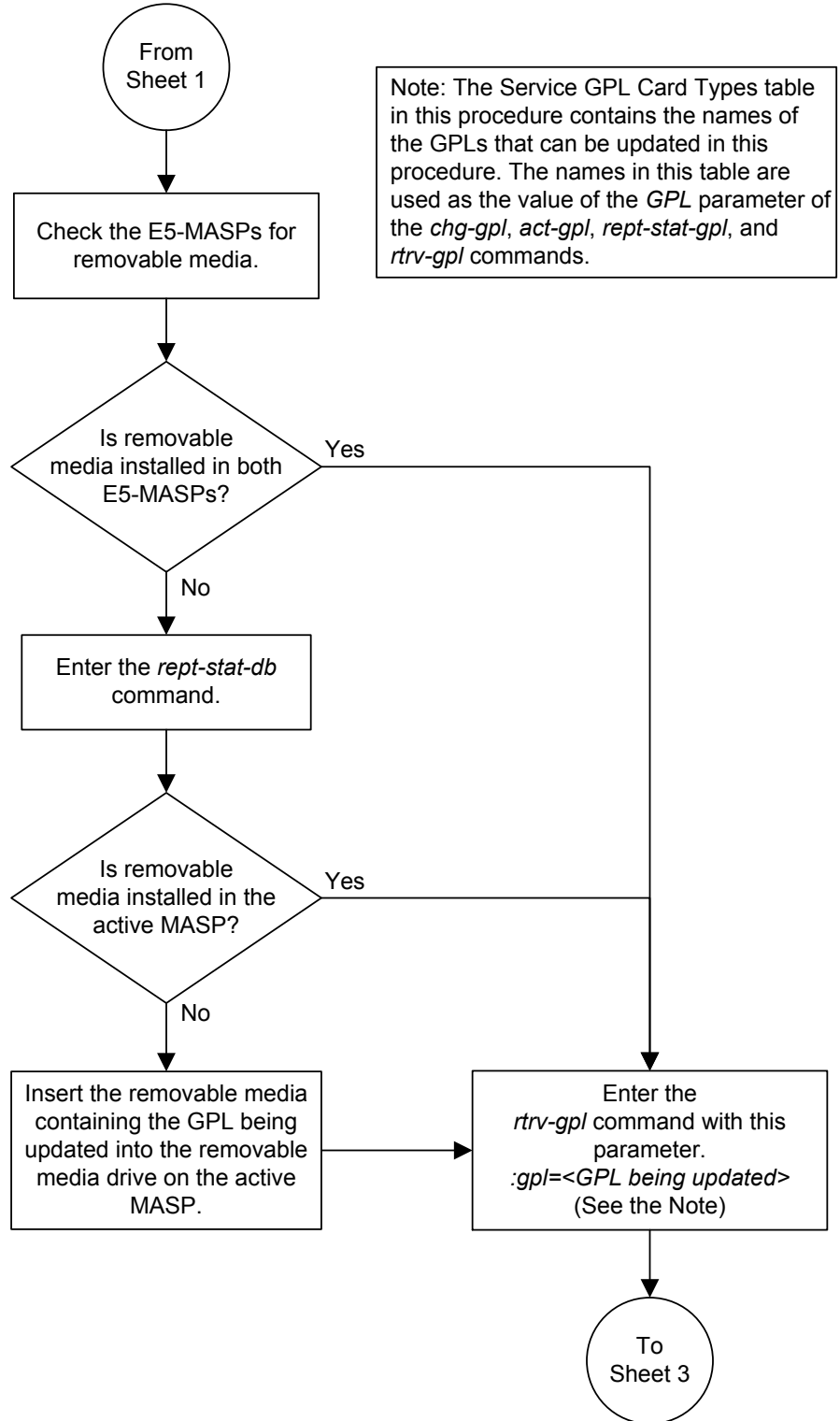

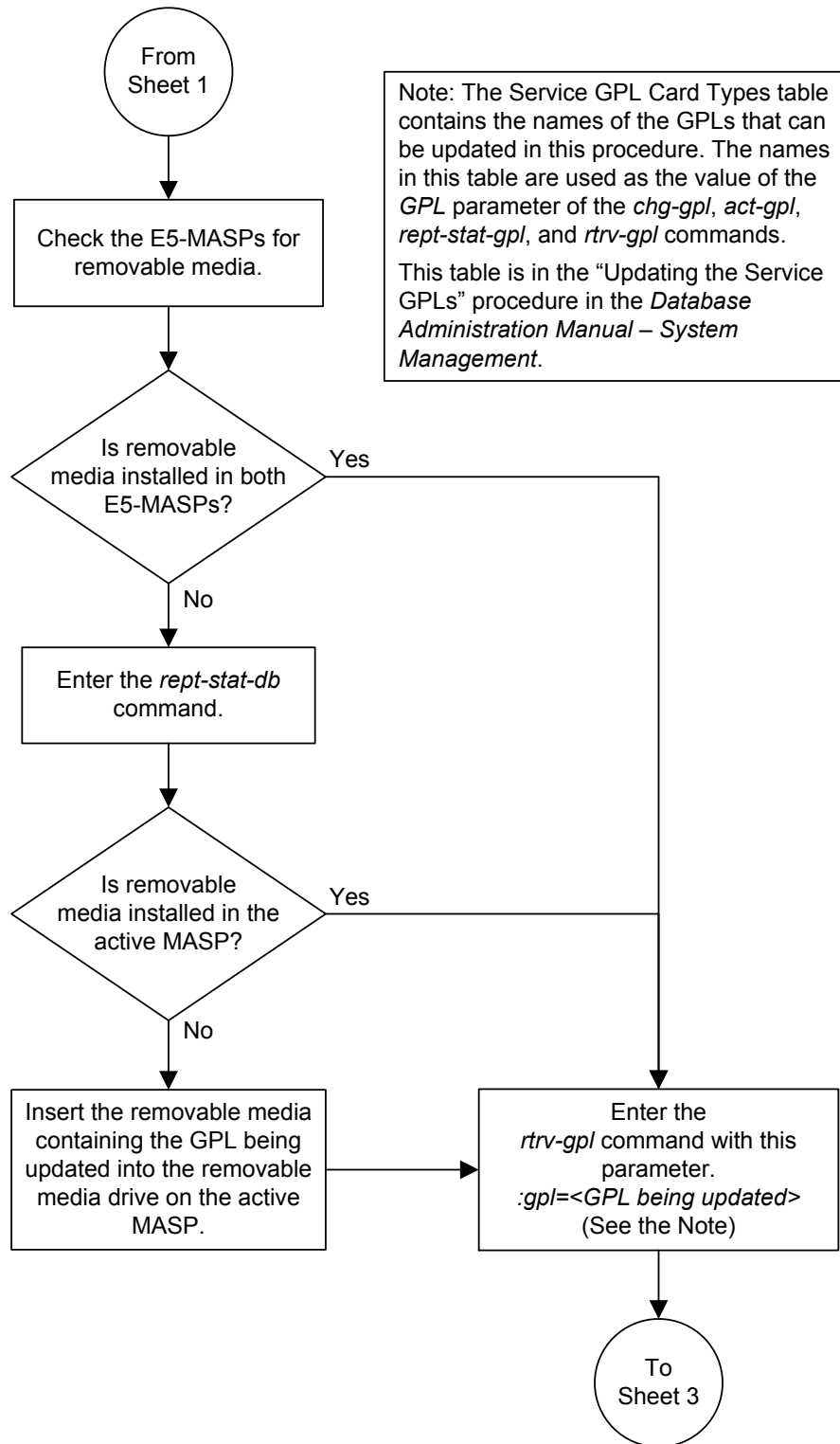

Note: The Service GPL Card Types table contains the names of the GPLs that can be updated in this procedure. The names in this table are used as the value of the *GPL* parameter of the *chg-gpl*, *act-gpl*, *rept-stat-gpl*, and *rtrv-gpl* commands. This table is in the “Updating the Service GPLs” procedure in the *Database Administration Manual – System Management*.

Sheet 2 of 7

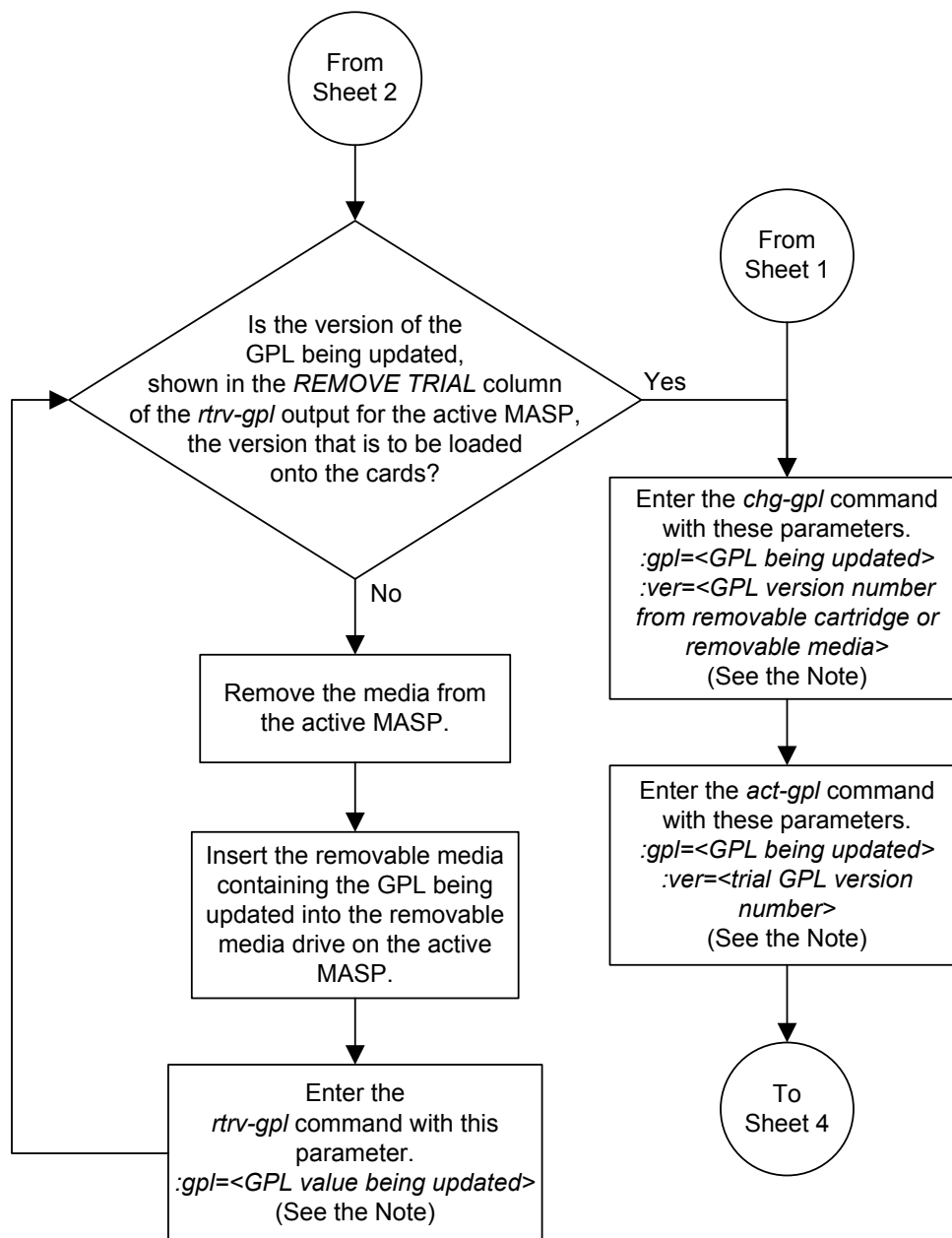

Note: The Service GPL Card Types table in this procedure contains the names of the GPLs that can be updated in this procedure. The names in this table are used as the value of the *GPL* parameter of the *chg-gpl*, *act-gpl*, *rept-stat-gpl*, and *rtrv-gpl* commands.

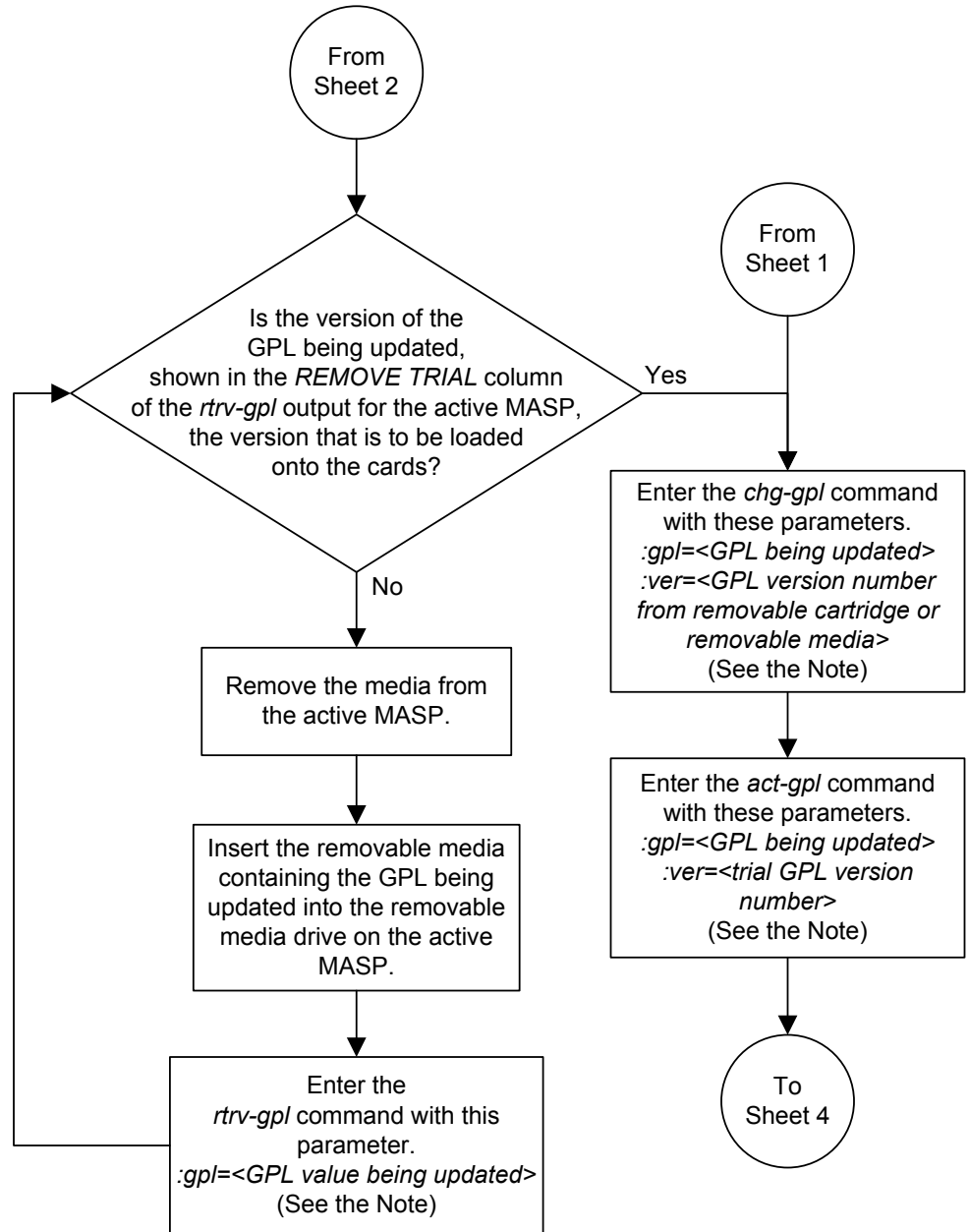

Note: The Service GPL Card Types table contains the names of the GPLs that can be updated in this procedure. The names in this table are used as the value of the *GPL* parameter of the *chg-gpl*, *act-gpl*, *rept-stat-gpl*, and *rtrv-gpl* commands. This table is in the "Updating the Service GPLs" procedure in the *Database Administration Manual – System Management*.

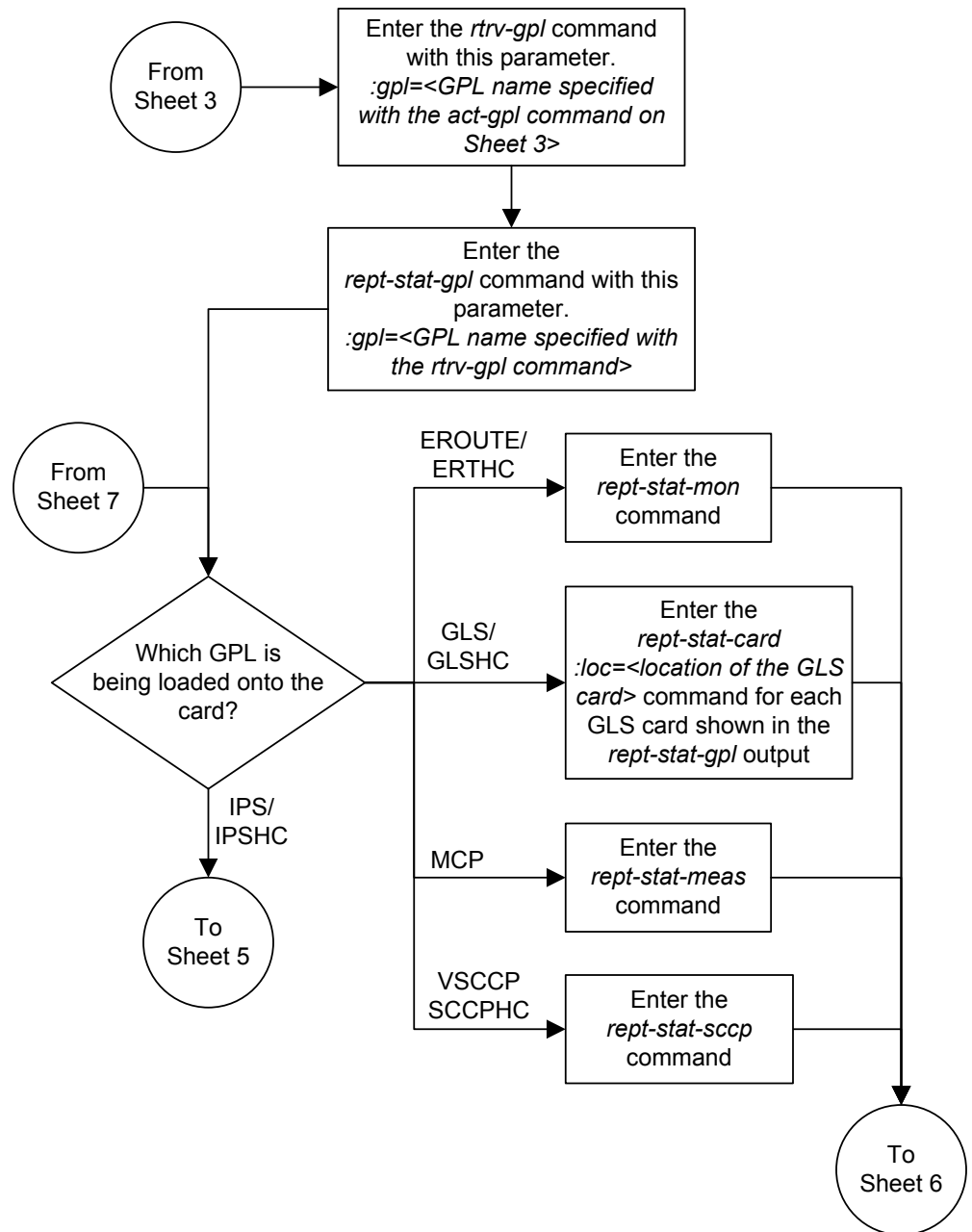

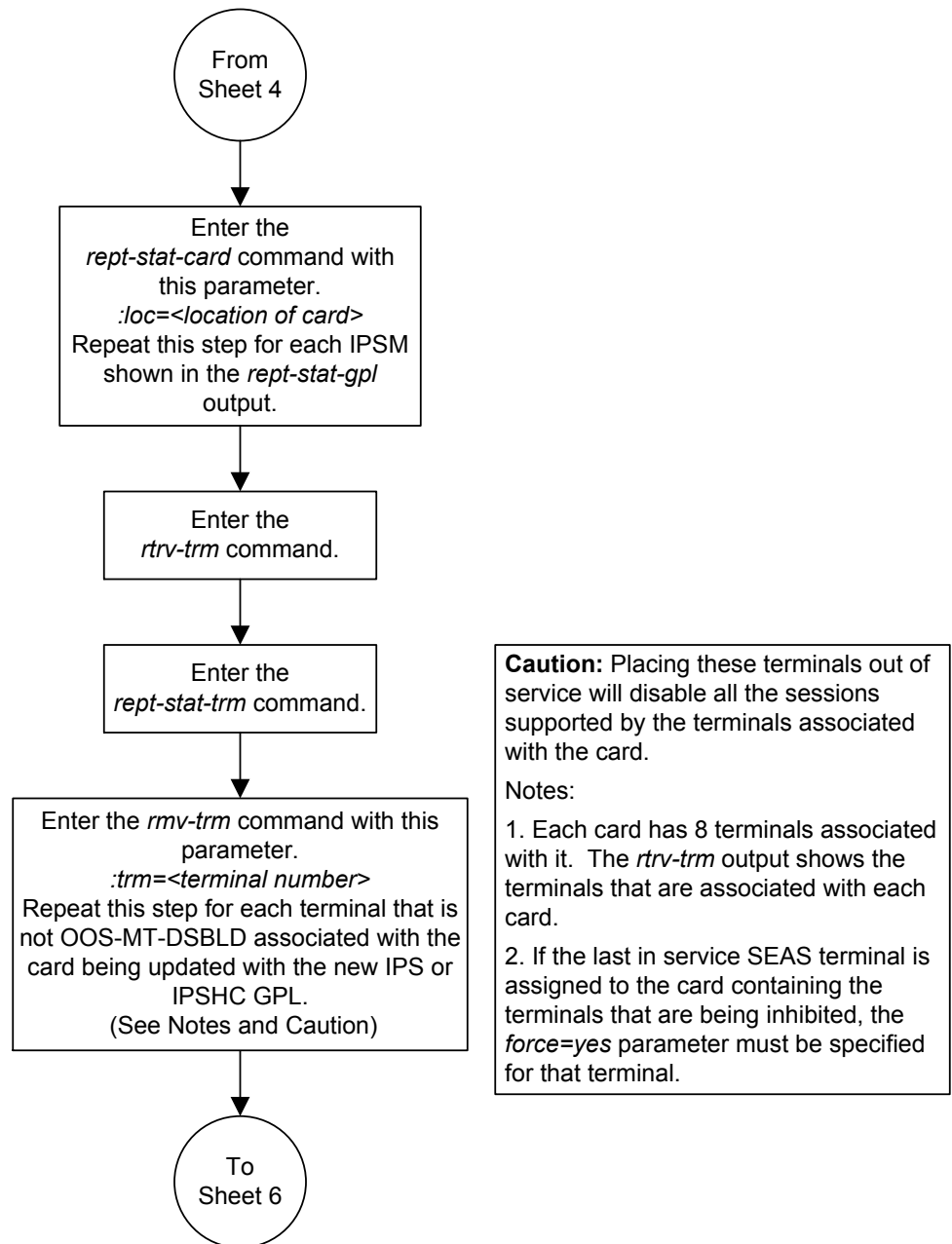

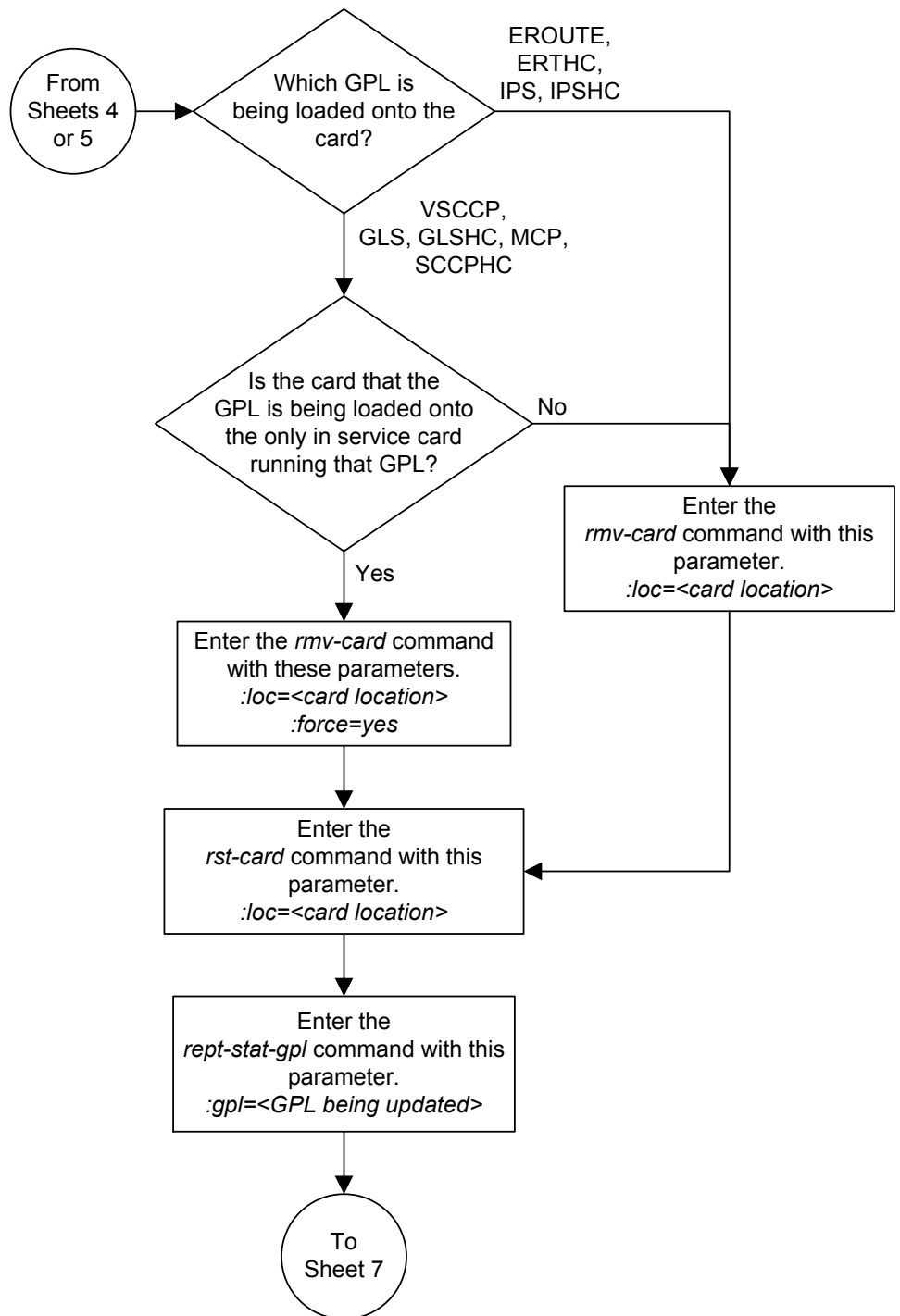

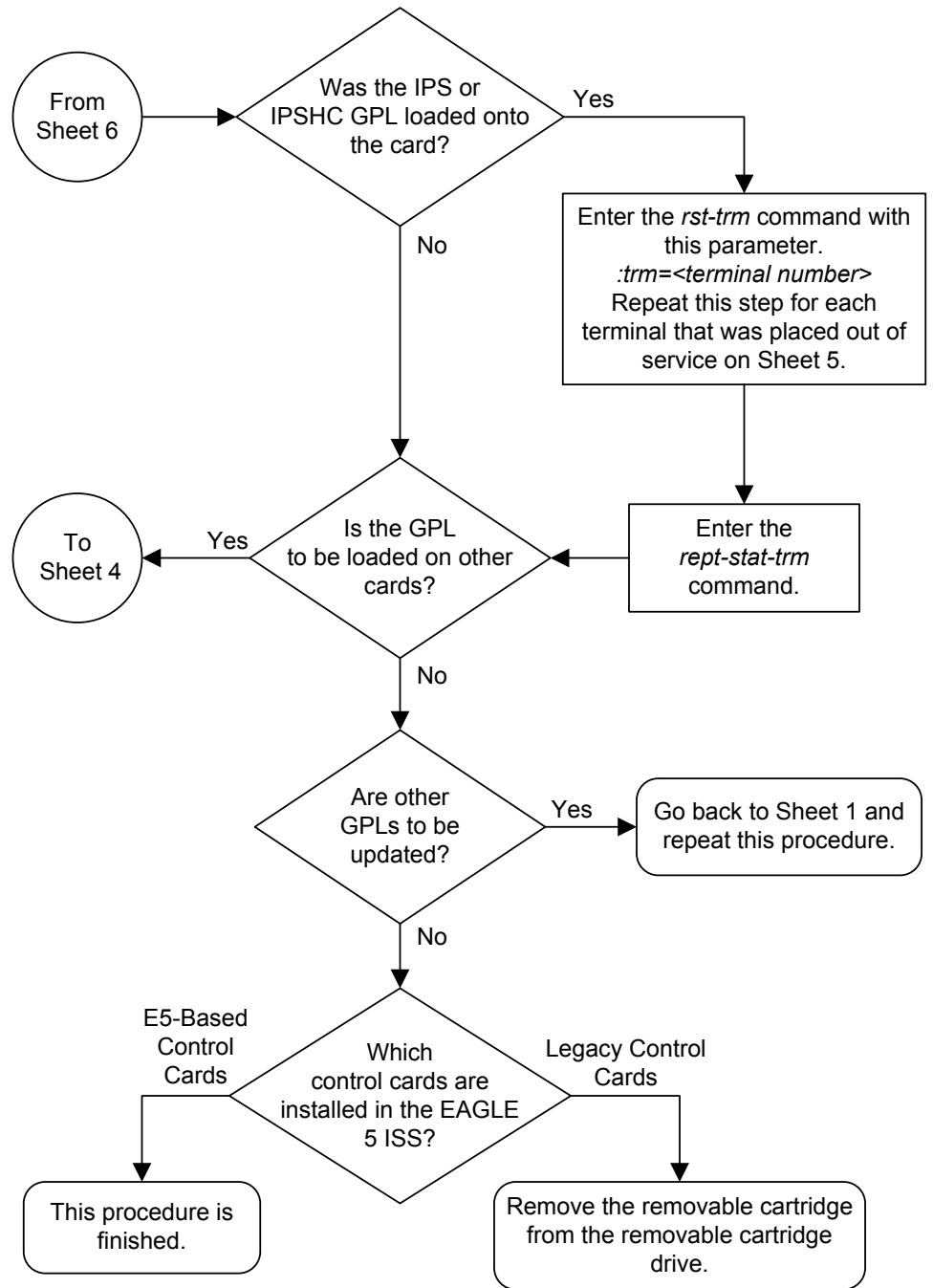

Updating the Flash GPLs

This procedure is used to update **GPLs**: The GPLs are used as the value of the `gpl` parameter of the `chg-gpl`, `act-gpl`, `rept-stat-gpl`, and `rtrv-gpl` commands.

Table 3-4 EAGLE Card Applications and GPLs

Intended Application GPL	Card configuration (<code>rtrv-card</code>)		Hardware Type Used	Required Flash GPL
	APPL	Type		
SCCP64	VSCCP	DSM	SM8G-B	BLDC64
	VSCCP	DSM/SLIC	SLIC	BLSLC64
IPSG	IPSG	ENET/ENETB	E5-ENET-B	BLMCAP
	IPSG	ENET/ENETB/SLIC	SLIC	BLSLC32
IPSG32	IPSG	SLIC	SLIC	BLSLC32
IPSHC69	IPS	IPSM	E5-ENET-B	BLDC32
	IPS	IPSM	SLIC	BLSL932
MCPHC69	MCP	MCPM	E5-MCPM-B	BLDC32
	MCP	MCPM	SLIC	BLSL932
OAMHC69	OAM	E5-MCAP	E5-MASP	BLDC32
SIP64	SIPHC	DSM	SM8G-B	BLDC64
	SIPHC	DSM/SLIC	SLIC	BLSLC64
DEIR64	DEIRHC	DSM	SM8G-B	BLDC64
	DEIRHC	DSM/SLIC	SLIC	BLSLC64
ENUM64	ENUMHC	DSM	SM8G-B	BLDC64
	ENUMHC	DSM/SLIC	SLIC	BLSLC64
SFAPP	SFAPP	SLIC	SLIC	BLSLC64
ATMHC	ATMITU	LIME1ATM	E5-ATM-B	BLMCAP
	ATMANSI	LIMATM	E5-ATM-B	BLMCAP
ERTHC	EROUTE	STC	E5-ENET-B	BLMCAP
	EROUTE	STC	SLIC	BLSLC32
SS7HC	CCS7ITU	LIME1	E5-E1T1-B	BLMCAP
			SLIC	BLSLC32
	SS7ANSI	LIMT1	E5-E1T1-B	BLMCAP

Table 3-4 (Cont.) EAGLE Card Applications and GPLs

Intended Application GPL	Card configuration (rtrv-card)	Hardware Type Used	Required Flash GPL
		SLIC	BLSLC32

Updating the BLMCAP GPL for the E5-MASPs is not covered in this procedure. To update the OAMHC GPLs, perform [Updating the BLMCAP and OAMHC GPLs](#).

If the GPL is being updated to a new version, removable media containing the GPL being updated is required.

Canceling the REPT-STAT-SLK and RTRV-SLK Commands

Because the `rept-stat-slk` and `rtrv-slk` commands used in this procedure can output information for a long period of time, the `rept-stat-slk` and `rtrv-slk` commands can be canceled and the output to the terminal stopped. There are three ways that the `rept-stat-slk` and `rtrv-slk` commands can be canceled.

- Press the F9 function key on the keyboard at the terminal where the `rept-stat-slk` or `rtrv-slk` commands were entered.
- Enter the `canc-cmd` without the `trm` parameter at the terminal where the `rept-stat-slk` or `rtrv-slk` commands were entered.
- Enter the `canc-cmd:trm=<xx>`, where `<xx>` is the terminal where the `rept-stat-slk` or `rtrv-slk` commands were entered, from another terminal other than the terminal where the `rept-stat-slk` or `rtrv-slk` commands were entered. To enter the `canc-cmd:trm=<xx>` command, the terminal must allow Security Administration commands to be entered from it and the user must be allowed to enter Security Administration commands. The terminal's permissions can be verified with the `rtrv-secu-trm` command. The user's permissions can be verified with the `rtrv-user` or `rtrv-secu-user` commands.

For more information about the `canc-cmd` command, go to *Commands User's Guide*.

1. Verify the control cards that are installed in the EAGLE.

Refer to [Maintenance and Administration Subsystem](#) for information about the control cards.

If E5-based control cards are installed in the EAGLE, continue the procedure with [2](#).

2. Check the E5-MASPs for removable media.

If removable media is installed in both E5-MASPs, continue the procedure with [5](#).

If removable media is not installed in both E5-MASPs, continue the procedure with [3](#).

3. Verify the active MASP by entering the `rept-stat-db` command.

This is an example of the possible output.

```
rlghncxa03w 09-03-01 15:25:40 GMT EAGLE5 40.1.0
DATABASE STATUS: >> OK <<
                E5-MASP 1114 ( STDBY)                E5-MASP 1116 ( ACTV )
```

```

          C   LEVEL   TIME LAST BACKUP   C   LEVEL   TIME LAST BACKUP
-----
FD BKUP Y       36 09-02-19 09:38:25 GMT Y       36 09-02-19 09:38:25 GMT
FD CRNT Y       39                               Y       39
          MCAP 1113                               MCAP 1115
-----
RD BKUP -       -       -       -       Y       36 09-02-19 09:27:17 GMT
USB BKP -       -       -       -       Y       3 09-02-07 01:11:22 GMT

```

If removable media is installed in the active MASP, continue the procedure with 5.

If removable media is not installed in the active MASP, insert the removable media in the removable media drive in the active MASP. For more information about inserting removable media in the removable media drive, refer to [Removable USB Drive](#). After the removable media has been inserted in the removable media drive in the active MASP, continue the procedure with 5.

4. Determine the flash GPL for the card location by entering the `rtrv-card:loc<xxxx>` command:

```
rtrv-card:loc=1203
```

```
Command Accepted - Processing
```

```

eagle1 18-02-20 11:27:40 EST  EAGLE 46.6.0.0.0-73.13.0
rtrv-card:loc=1203
Command entered at terminal #13.
;

```

```

eagle1 18-02-20 11:27:40 EST  EAGLE 46.6.0.0.0-73.13.0
CARD  TYPE      APPL      DATA  LSET NAME  LINK SLC LSET NAME  LINK
SLC
 1203  LIME1      CCS7ITU          mgtsitu    A    0
;

```

followed by the `rtrv-bip:loc<xxxx>` command:

```
rtrv-bip:loc=1203
```

```
Command Accepted - Processing
```

```

eagle1 18-02-20 11:27:49 EST  EAGLE 46.6.0.0.0-73.13.0
rtrv-bip:loc=1203
Command entered at terminal #13.
;

```

```
eagle1 18-02-20 11:27:49 EST  EAGLE 46.6.0.0.0-73.13.0
```

```
-----
Location: 1203 - MBD
```

```

Part Number: 7094646
Revision: 17                               Week/Year: 15/2017
Serial Number: 10217152084

```

```

Software Match ID: EG - 001                 Max Power Rating : 826mA
-----

```

```
END OF REPORT
;

```

View the table in the EAGLE Card Applications and GPLs table in order to determine the appropriate GPL for the location.

5. Display the flash GPLs on the fixed disk and on the removable media using the `rtrv-gpl` command with the `gpl` parameter value equal to the flash **GPL** being updated. For this example, enter this command.

```
rtrv-gpl:gpl=xxxx
```

This is an example of the possible output:

```
tekelecstp 18-01-18 21:23:11 EST EAGLE 46.5.1.5.0-73.10.0
GPL Auditing ON

GPL      CARD  RELEASE      APPROVED      TRIAL      REMOVE TRIAL
BLMCAP   1114  143-010-000  143-010-000  143-010-000  -----
BLMCAP   1116  143-010-000  143-010-000  143-010-000  -----
BLMCAP   1115  -----      -----      -----      -----
```

If the version of the flash **GPL** shown in the REMOVE TRIAL column of the `rtrv-gpl` output is not the version that is to be loaded onto the cards, remove the removable media from the active MASP.

Insert the removable media that contains the flash GPL that is being updated into the removable media drive in the active MASP and repeat this step.

For more information about inserting removable media in the removable media drive, or removing removable media from the removable media drive, refer to [Removable USB Drive](#).

If the version of the flash **GPL** shown in the REMOVE TRIAL column of the `rtrv-gpl` output is the version that is to be loaded onto the cards, continue the procedure with 6.

6. Change the flash **GPLs**, using the `chg-gpl` command and specifying the value for the flash **GPL** shown in the REMOVE TRIAL column in the output of the `rtrv-gpl` command.

For this example, enter this command.

```
chg-gpl:gpl=blmcap:ver=002-003-000
```

These messages should appear.

```
tekelecstp 18-01-18 21:23:11 EST EAGLE 46.5.1.5.0-73.10.0
GPL Auditing ON

BLMCAP upload on 1114 completed
BLMCAP upload on 1116 completed
System Release ID table upload 1114 completed
System Release ID table upload 1116 completed
```

7. Activate the trial flash **GPL**, using the `act-gpl` command and specifying the name and version of the trial flash **GPL** specified in 6.

For this example, enter this command.

```
act-gpl:gpl=blmcap:ver=002-003-000
```

These messages should appear.

```
tekelecstp 18-01-18 21:23:11 EST EAGLE 46.5.1.5.0-73.10.0
BLMCAP activate on 1114 completed
BLMCAP activate on 1116 completed
```

- Verify that the flash **GPL** on the or removable media is the approved flash **GPL** on the fixed disk using the `rtrv-gpl` command with the `gpl` parameter value specified in 7.

For this example, enter this command.

```
rtrv-gpl:gpl=blmcap
```

If E5-based control cards are installed in the EAGLE, this is an example of the possible output.

```
tekelecstp 18-01-18 21:23:11 EST EAGLE 46.5.1.5.0-73.10.0
GPL Auditing ON
```

GPL	CARD	RELEASE	APPROVED	TRIAL	REMOVE TRIAL
BLMCAP	1114	143-010-000	143-010-000	143-010-000	-----
BLMCAP	1116	143-010-000	143-010-000	143-010-000	-----
BLMCAP	1115	-----	-----	-----	-----

- Display the status of the card, shown in the `rept-stat-gpl` output, that the flash **GPL** will be loaded onto using the `rept-stat-card` command and specifying the location of the card.

For this example, enter this command.

```
rept-stat-card:loc=2105
```

This is an example of the possible output.

```
tekelecstp 18-01-18 21:23:11 EST EAGLE 46.5.1.5.0-73.10.0
CARD VERSION      TYPE   GPL      PST      SST      AST
2105 132-003-000  DCM    VXWSLAN  IS-NR    Active  -----
ALARM STATUS      = No Alarms.
BLMCAP GPL        = 143-010-000
IMT BUS A         = Conn
IMT BUS B         = Conn
SLK A PST         = IS-NR      LS=lsnssp2  CLLI=-----
SCCP SERVICE CARD = 1212
SLAN SERVICE CARD = ----
Command Completed.
```

10. rtrv-card

- Display the signaling links associated with the card shown in 9.

Enter the `rtrv-slk` command with the card location specified in 9. This is an example of the possible output.

```
rlghncxa03w 09-07-01 21:16:37 GMT EAGLE5 41.1.0
```

LOC	LINK	LSN	SLC TYPE	L2T SET	BPS	ECM	PCR N1	PCR N2

```

1201 A   lsn1201a   0 LIMDS0  1  56000  BASIC --- -----
1201 B   lsn1201b   0 LIMDS0  1  56000  BASIC --- -----
1201 A1  lsn1201a   1 LIMDS0  1  56000  BASIC --- -----
1201 B1  lsn1201b   1 LIMDS0  1  56000  BASIC -  -----

```

12. Deactivate the **SS7** signaling links on the card using the `dact-slk` command.

For this example, enter these commands.

```

dact-slk:loc=1201:link=a
dact-slk:loc=1201:link=b
dact-slk:loc=1201:link=a1
dact-slk:loc=1201:link=b1

```

Caution: These command examples place the **SS7** signaling links on card 1201 out of service. This will interrupt service on the **SS7** signaling links on card 1201 and allow the approved flash **GPL** to be loaded on to card 1201.

Caution: Do not deactivate all the **SS7** signaling links in the **EAGLE** at the same time. Doing so will take all the **SS7** signaling links out of service and isolate the **EAGLE** from the network.

When each of these commands have successfully completed, this message should appear.

```

tekelecstp 18-01-18 21:23:11 EST  EAGLE 46.5.1.5.0-73.10.0
Deactivate SLK message sent to card

```

Continue the procedure with [22](#).

13. Display the **TCP/IP** data links, and their status, associated with the cards.

Enter the `rept-stat-dlk` command. This is an example of the possible output.

```

rlghncxa03w 06-10-01 17:00:36 GMT  EAGLE5 36.0.0
DLK   PST           SST           AST
1303  IS-NR         Avail        ---
2101  IS-NR         Avail        ---
2103  IS-NR         Avail        ---
2105  IS-NR         Avail        ---
2113  IS-NR         Avail        ---
2301  IS-NR         Avail        ---
Command Completed.

```

14. Deactivate the **TCP/IP** data link on the card that you wish to load the flash **GPL** onto, shown in [13](#), using the `canc-dlk` command.

For this example, enter this command.

```

canc-dlk:loc=2105

```

Caution: This command example places the **TCP/IP** data link on card 2105 out of service. This will interrupt service on the **TCP/IP** data link on card 2105 and allow the trial flash **GPL** to be loaded on to card 2105.

Caution: Do not deactivate all the **TCP/IP** data links in the **EAGLE** at the same time. Doing so will take all the **TCP/IP** data links out of service and cause the **STPLAN** feature to be disabled.

Caution: If there is only one **TCP/IP** data link in the **EAGLE**, placing the card out of service will cause the **STPLAN** feature to be disabled.

When this command has successfully completed, this message should appear.

```
rlghncxa03w 06-10-01 11:45:18 GMT EAGLE5 36.0.0
Deactivate Link message sent to card.
Command Completed.
```

Continue the procedure with [22](#).

15. Display the status of the service modules by entering the `rept-stat-sccp` command.

This is an example of the possible output.

```
rlghncxa03w 06-10-01 09:57:31 GMT EAGLE5 36.0.0
```

CARD	VERSION	PST	SST	AST	MSU USAGE	CPU USAGE
2311	132-002-001	IS-NR	Active	-----	47%	81%
3101	132-002-001	IS-NR	Active	-----	34%	50%
3103	132-002-001	IS-NR	Active	-----	21%	29%

```
-----
SCCP Service Average MSU Capacity = 34%      Average CPU Capacity = 54%
Command Completed.
```

Continue the procedure with [22](#).

Note: The `rept-stat-sccp` command output contains other fields that are not used by this procedure. If you wish to see all the fields displayed by the `rept-stat-sccp` command, see the `rept-stat-sccp` command description in *Commands User's Guide*.

16. Display the status of the **MCPMs** in the database with the `rept-stat-meas` command.

This is an example of the possible output.

```
rlghncxa03w 09-02-01 16:43:42 GMT EAGLE5 40.0.0
```

MEAS SS	PST	SST	AST
	IS-NR	Active	-----

```
ALARM STATUS = No Alarms
```

CARD	VERSION	TYPE	PST	SST	AST
2107	P 132-002-000	EDSM	IS-NR	Active	-----
	IP Link A		IS-NR	Active	Available
2108	132-002-000	EDSM	IS-NR	Active	-----
	IP Link A		IS-NR	Active	Available
2111	132-002-000	EDSM	IS-NR	Active	-----
	IP Link A		IS-NR	Active	Available

CARD 2107 ALARM STATUS = No Alarms

CARD 2108 ALARM STATUS = No Alarms

CARD 2111 ALARM STATUS = No Alarms

Continue the procedure with [22](#).

- 17.** To load the BLMCAP GPL on the E5-MASP, it must be loaded on the standby MASP (E5-MASP) first.

To determine which MASP is active, enter the `rept-stat-db` command. This is an example of the possible output.

```
rlghncxa03w 06-10-01 16:07:48 GMT EAGLE5 36.0.0
DATABASE STATUS: >> OK <<
E5-MASP 1114 ( STDBY) E5-MASP 1116 ( ACTV )
C LEVEL TIME LAST BACKUP C LEVEL TIME LAST BACKUP
-----
FD BKUP Y 35 05-03-01 10:19:18 GMT Y 35 05-03-01 10:19:18 GMT
FD CRNT Y 106 Y 106
E5-MDAL 1117
-----
RD BKUP Y 106 05-02-31 20:27:53 GMT
```

The output of the `rept-stat-db` command shows which MASP is active with the indicator (ACTV) following the E5-MASP card location. The indicator (STDBY) following the E5-MASP card location shows which MASP is standby.

For this example, the MASP associated with E5-MASP 1116 is active and the MASP associated with E5-MASP 1114 is standby.

- 18.** Display the terminal configuration in the database with the `rtrv-trm` command.

If the application GPL running on the card is **IPS**, the Telnet terminals associated with the card shown in [9](#) must be taken out of service. The Telnet terminals are shown in the output with the entry `TELNET` in the `TYPE` field.

This is an example of the possible output. In this example, the SEAS terminals are terminals 27 and 36. The Telnet terminals that must be taken out of service are terminals 17 to 24.

```
rlghncxa03w 10-07-01 16:02:08 GMT EAGLE5 42.0.0
TRM  TYPE      COMM          FC    TMOUT  MXINV  DURAL
1    VT320      9600-7-E-1    SW     30     5     99:59:59
2    KSR        9600-7-E-1    HW     30     5     INDEF
3    PRINTER    4800-7-E-1    HW     30     0     00:00:00
4    VT320      2400-7-E-1    BOTH   30     5     00:30:00
5    VT320      9600-7-O-1    NONE   30     5     00:00:30
6    VT320      9600-7-O-1    NONE   30     5     00:00:30
7    PRINTER    9600-7-N-2    HW     30     5     00:30:00
8    KSR        19200-7-E-2   BOTH   30     5     00:30:00
9    VT320      9600-7-O-1    NONE   30     5     00:00:30
```

10	VT320	9600-7-E-1	HW	30	5	00:30:00
11	VT320	4800-7-E-1	HW	30	5	00:30:00
12	PRINTER	9600-7-E-1	HW	30	4	00:30:00
13	VT320	9600-7-O-1	NONE	30	5	00:30:00
14	VT320	9600-7-E-2	SW	30	8	00:30:00
15	VT320	9600-7-N-2	HW	30	5	00:30:00
16	VT320	9600-7-E-2	BOTH	30	3	00:30:00

TRM	TYPE	LOC	TMOUT	MXINV	DURAL	SECURE
17	TELNET	1201	60	5	00:30:00	yes
18	TELNET	1201	60	5	00:30:00	yes
19	TELNET	1201	60	5	00:30:00	yes
20	TELNET	1201	60	5	00:30:00	yes
21	TELNET	1201	60	5	00:30:00	yes
22	TELNET	1201	60	5	00:30:00	yes
23	TELNET	1201	60	5	00:30:00	yes
24	TELNET	1201	60	5	00:30:00	yes
25	TELNET	1203	60	5	00:30:00	yes
26	TELNET	1203	60	5	00:30:00	yes
27	SEAS	1203	60	5	00:30:00	yes
28	TELNET	1203	60	5	00:30:00	yes
29	TELNET	1203	60	5	00:30:00	yes
30	TELNET	1203	60	5	00:30:00	yes
31	TELNET	1203	60	5	00:30:00	yes
32	TELNET	1203	60	5	00:30:00	yes
33	TELNET	1205	60	5	00:30:00	yes
34	TELNET	1205	60	5	00:30:00	yes
35	TELNET	1205	60	5	00:30:00	yes
36	SEAS	1205	60	5	00:30:00	yes
37	TELNET	1205	60	5	00:30:00	yes
38	TELNET	1205	60	5	00:30:00	yes
39	TELNET	1205	60	5	00:30:00	yes
40	TELNET	1205	60	5	00:30:00	yes

Note: The `rtrv-trm` command output contains other fields that are not used by this procedure. If you wish to see all the fields displayed by the `rtrv-trm` command, see the `rtrv-trm` command description in *Commands User's Guide*.

19. Display the status of the terminals with the `rept-stat-trm` command.

This is an example of the possible output.

```
rlghncxa03w 06-10-01 15:08:45 GMT EAGLE5 36.0.0
TRM  PST      SST      AST
1    IS-NR     Active   -----
2    IS-NR     Active   -----
3    IS-NR     Active   -----
4    IS-NR     Active   -----
5    IS-NR     Active   -----
6    IS-NR     Active   -----
7    IS-NR     Active   -----
8    IS-NR     Active   -----
9    IS-NR     Active   -----
10   IS-NR     Active   -----
11   IS-NR     Active   -----
12   IS-NR     Active   -----
13   IS-NR     Active   -----
14   IS-NR     Active   -----
15   IS-NR     Active   -----
```

16	IS-NR	Active	-----
17	IS-NR	Active	-----
18	IS-NR	Active	-----
19	IS-NR	Active	-----
20	IS-NR	Active	-----
21	IS-NR	Active	-----
22	IS-NR	Active	-----
23	IS-NR	Active	-----
24	IS-NR	Active	-----
25	IS-NR	Active	-----
26	IS-NR	Active	-----
27	IS-NR	Active	-----
28	IS-NR	Active	-----
29	IS-NR	Active	-----
30	IS-NR	Active	-----
31	IS-NR	Active	-----
32	IS-NR	Active	-----
33	IS-NR	Active	-----
34	IS-NR	Active	-----
35	IS-NR	Active	-----
36	IS-NR	Active	-----
37	IS-NR	Active	-----
38	IS-NR	Active	-----
39	IS-NR	Active	-----
40	IS-NR	Active	-----

Command Completed.

20. Place the required terminals out of service using the `rmv-trm` command.

To place the SEAS terminals out of service in this example, enter these commands.

```
rmv-trm:trm=27
```

```
rmv-trm:trm=36:force=yes
```

Caution: Placing the SEAS terminals out of service will disable the SEAS feature on the EAGLE.

To place the Telnet terminals out of service in this example, enter these commands.

```
rmv-trm:trm=17
```

```
rmv-trm:trm=18
```

```
rmv-trm:trm=19
```

```
rmv-trm:trm=20
```

```
rmv-trm:trm=21
```

```
rmv-trm:trm=22
```

```
rmv-trm:trm=23
```

```
rmv-trm:trm=24
```

Caution: Placing the Telnet terminals out of service will disable any Telnet sessions running on these terminals.

If the status of any of the terminals shown in the `PST` field in 19 is **OOS-MT-DSBLD** (out-of-service maintenance disabled), the terminal is already out of service and the `rmv-trm` command does not need to be executed for that terminal.

This message should appear when each of these commands have successfully completed.

```
rlghncxa03w 06-10-01 15:08:45 GMT EAGLE5 36.0.0  
Inhibit message sent to terminal
```

```
rlghncxa03w 06-10-01 15:08:45 GMT EAGLE5 36.0.0  
Command Completed.
```

- 21 is performed only if the SEAS terminals were placed out of service in this step. If the SEAS terminals were not placed out of service in this step, continue the procedure with 22.
- If the SEAS terminals were placed out of service in this step, continue the procedure with 21.

21. Change the terminal type of the SEAS terminals to **NONE** with the `chg-trm` command, the `type=none` parameter, and with the values of the SEAS terminals used in 20.

For this example, enter these commands.

```
chg-trm:trm=27:type=none
```

```
chg-trm:trm=36:type=none
```

This message should appear when these commands have successfully completed.

```
rlghncxa03w 06-10-01 11:11:28 GMT EAGLE5 36.0.0  
CHG-TRM: MASP B - COMPLTD
```

22. Place the card shown in 9 out of service using the `rmv-card` command.

Caution: Multiple cards running the same flash **GPL** can be updated at the same time with the `init-flash` command (25). This requires that the cards in the locations specified with the `init-flash` command in 25 are out of service. All the cards running one of these application GPLs (OAMHC or BLMCAP) can be placed out of service. However, it is recommended that only some of the cards running a specific application GPL are placed out of service. Placing all the cards running a specific application GPL out of service will cause the traffic carried by these cards to be lost and disable the features supported by these cards.

Caution: If the EOAM GPL is being updated, the card being placed out of service must be the **E5-MASP** associated with the standby **MASP**. Both cards running the EOAM GPL cannot be placed out of service at the same time.

Caution: If there is only one card running these application GPLs (OAMHC or BLMCAP), shown in the GPL column in the `rept-stat-card` output in 9, in the EAGLE, placing the card out of service will cause the traffic carried by this card to be lost and disable the feature that this card supports.

For this example, enter this command.

```
rmv-card:loc=2105
```

Note: If more than one card running the same flash GPL is to be updated in 25, repeat this step for those cards.

When this command has successfully completed, this message should appear.

```
rlghncxa03w 06-10-01 11:11:28 GMT EAGLE5 36.0.0
Card has been inhibited.
```

If the card is running the OAMHC or BLMCAP application GPLs, and the card contains the last signaling link in a linkset, the `force=yes` parameter must be specified.

Note: If you do not wish to reload the TDM clock LCA bitfile, continue the procedure with 25.

23. Verify the status of the high-speed clocks by entering the `rept-stat-clk` command.

This is an example of the possible output.

```
rlghncxa03w 08-06-01 11:34:04 GMT EAGLE5 39.0.0
COMPOSITE                               PST           SST           AST
  SYSTEM CLOCK                          IS-NR         Active        -----
ALARM STATUS = No Alarms.
  Primary Comp Clk 1114 (CLK A)          IS-NR         Active        -----
  Primary Comp Clk 1116 (CLK B)          IS-NR         Active        -----
  Secondary Comp Clk 1114 (CLK A)        IS-NR         Idle          -----
  Secondary Comp Clk 1116 (CLK B)        IS-NR         Idle          -----

Clock      Using      Bad
CLK A      9           0
CLK B      0           0
CLK I      0           --

HIGH SPEED                               PST           SST           AST
  SYSTEM CLOCK                          IS-NR         Idle          -----
ALARM STATUS = No Alarms.
  Primary HS Clk 1114 (HS CLK A)          IS-NR         Active        -----
  Primary HS Clk 1116 (HS CLK B)          IS-NR         Active        -----
  Secondary HS Clk 1114 (HS CLK A)        IS-NR         Idle          -----
  Secondary HS Clk 1116 (HS CLK B)        IS-NR         Idle          -----

HS CLK TYPE 1114      = RS422
HS CLK LINELEN 1114   = LONGHAUL
HS CLK TYPE 1116      = RS422
```

```
HS CLK LINELEN 1116 = LONGHAUL
```

Clock	Using	Bad
HS CLK A	2	0
HS CLK B	0	0
HS CLK I	0	--

Command Completed

If the `rept-stat-clk` output does not show any high-speed clocks (HIGH SPEED SYSTEM CLOCK, Primary HS Clk, Secondary HS Clk, HS CLK TYPE, and HS CLK LINELEN fields), the **EAGLE** does not contain any cards that are capable of using high-speed master timing.

Note: If the HS CLK TYPE and HS CLK LINELEN values are set to the system default values (HS CLK TYPE = RS422 and HS CLK LINELEN = LONGHAUL), continue the procedure with [25](#).

24. Visually verify the part numbers of both **E5-OAMs** in the **EAGLE**.

To load the **E5-OAM** clock **LCA** bitfile, the part numbers of both **E5-OAMs** must be either an E5-MDAL or E5-MASP.

Proceed to [26](#).

25. Load the flash **GPL** onto the card inhibited in [22](#) using the `init-flash` command with the `code=appr` parameter to load the approved version of the flash **GPL** onto the card.

Caution: The `init-flash` command cannot be entered if the IMT Rate Change sequence or the Extended Bit Error Rate Test (**BERT**) is being performed.

For this example, enter this command.

```
init-flash:code=appr:loc=2105
```

When this command has successfully completed, these messages should appear.

```
rlghncxa03w 06-10-01 11:11:28 GMT EAGLE5 36.0.0
FLASH Memory Downloading for card 2105 Started.
;
rlghncxa03w 06-10-01 11:11:28 GMT EAGLE5 36.0.0
BPHCAP Downloading for card 2105 Complete.
;
rlghncxa03w 06-10-01 11:11:28 GMT EAGLE5 36.0.0
Command Completed.
```

Caution: If reloading the clock **LCA** bitfile would cause a system clock outage, the `force=yes` parameter must be used with the `init-flash` command. A system clock outage can be caused by either the **EAGLE** having only one **E5-OAM** (a simplex **MASP** configuration) or if the status of the high-speed clocks, shown in the `rept-stat-clk` output in 23, on the **TDM** which is not being reset is Fault. A system clock outage will result in a loss of traffic on some or all signaling links.

The following command example loads the flash **GPL** onto the **E5-OAM** card and reloads the clock **LCA** bitfile.

```
init-flash:initclk=yes:loc=1113:code=appr
```

When this command has successfully completed, these messages should appear.

```
rlghncxa03w 06-10-01 11:11:28 GMT EAGLE5 36.0.0
FLASH Memory Download for card 1113 Started.
;
rlghncxa03w 06-10-01 11:11:28 GMT EAGLE5 36.0.0
FLASH Memory Download for card 1113 Completed.
```

Updating more than One Card at the Same Time

If more than one card running the same flash **GPL** is being updated, enter the `init-flash` command with these parameters along with the `code=appr` parameter:

`sloc` – the first card location in the range of card locations

`eloc` – the last card location in the range of card locations

`gpl` – the flash **GPL** being updated

Note: The `sloc`, `eloc`, and `gpl` parameters cannot be specified with the `loc` parameter. When the `sloc`, `eloc`, and `gpl` parameters are specified, only the cards running the flash **GPL** specified by the `gpl` parameter and within the range specified by the `sloc` and `eloc` parameters are updated. All other cards in the range specified by the `sloc` and `eloc` parameters are skipped.

Entering this example command will update the cards in the locations 1101 to 2115 running the OAMHC flash **GPL** with the approved version of the OAMHC **GPL**.

```
init-flash:code=appr:sloc=1101:eloc=2115:gpl=blmcap
```

When this command has successfully completed, these messages should appear.

```
rlghncxa03w 06-10-01 11:11:28 GMT EAGLE5 36.0.0
FLASH Memory Download for cards 1101 - 2115 Started.
;
rlghncxa03w 06-10-01 11:11:28 GMT EAGLE5 36.0.0
FLASH Memory Download for cards 1101 - 2115 Completed.
LOC 1101 : PASSED
LOC 1102 : PASSED
LOC 1112 : PASSED
LOC 2105 : PASSED
```

```
LOC 2107 : PASSED
LOC 2111 : PASSED
LOC 2112 : PASSED
LOC 2115 : PASSED

ALL CARD RESULTS PASSED
;
rlghncxa03w 06-10-01 11:11:28 GMT EAGLE5 36.0.0
Command Completed.
```

When the `init-flash` command has completed successfully, the card specified in the `init-flash` command is rebooted.

26. Put the cards that were inhibited in 22 back into service using the `alw-card` command.

For this example, enter this command:

```
alw-card:loc=2105
```

When this command has successfully completed, this message should appear.

```
rlghncxa03w 06-10-01 11:11:28 GMT EAGLE5 36.0.0
Card has been allowed.
```

27. Verify that the flash **GPL** from 25 has loaded and that the card has returned to its in-service normal (**IS-NR**) state using the `rept-stat-card` command.

For this example, enter this command.

```
rept-stat-card:loc=2105

tekelecstp 18-01-18 21:23:11 EST EAGLE 46.5.1.5.0-73.10.0
CARD VERSION      TYPE   GPL      PST      SST      AST
2105 132-003-000 DCM    VXWSLAN IS-NR      Active  -----
ALARM STATUS      = No Alarms.
BLMCAP GPL        = 143-010-000 +
IMT BUS A         = Conn
IMT BUS B         = Conn
SLK A PST         = IS-NR      LS=lsnsspn2  CLLI=-----
SCCP SERVICE CARD = 1212
SLAN SERVICE CARD = ----
Command Completed.
```

The '+' symbol indicates that the flash **GPL** has not been activated.

Note: If the version number of the OAMHC **GPL** shown in the `rept-stat-card` command output is different than the version specified in 9, contact the Customer Care Center. Refer to [My Oracle Support \(MOS\)](#) for the contact information.

28. Activate the approved flash **GPL** loaded onto the cards in 25 using the `act-flash` command.

Caution: The `act-flash` command cannot be entered if the Extended Bit Error Rate Test (**BERT**) is being performed.

For this example, enter this command.

```
act-flash:loc=2105
```

When this command has successfully completed, these messages should appear.

```
rlghncxa03w 06-10-01 11:11:28 GMT EAGLE5 36.0.0
FLASH Memory Activation for card 2105 Completed.
;
rlghncxa03w 06-10-01 11:11:28 GMT EAGLE5 36.0.0
Command Completed.
```

Activating more than One Card at the Same Time

If more than one card running the same flash **GPL** was updated in [25](#), enter the `act-flash` command with these parameters:

`sloc` – the first card location in the range of card locations

`eloc` – the last card location in the range of card locations

`gpl` – the flash **GPL** being activated

Note: The `sloc`, `eloc`, and `gpl` parameters cannot be specified with the `loc` parameter. When the `sloc`, `eloc`, and `gpl` parameters are specified, only the cards running the flash **GPL** specified by the `gpl` parameter and within the range specified by the `sloc` and `eloc` parameters are updated. All other cards in the range specified by the `sloc` and `eloc` parameters are skipped.

Entering this example command will activate the flash **GPLs** on the cards in the locations 1101 to 2115.

```
act-flash:sloc=1101:eloc=2115:gpl=blmcap
```

When this command has successfully completed, these messages should appear.

```
rlghncxa03w 06-10-01 11:11:28 GMT EAGLE5 36.0.0
FLASH Memory Activation for cards 1101 - 2115 Started.
;
rlghncxa03w 06-10-01 11:11:28 GMT EAGLE5 36.0.0
FLASH Memory Activation for cards 1101 - 2115 Completed.
LOC 1101 : PASSED
LOC 1102 : PASSED
LOC 1112 : PASSED
LOC 2105 : PASSED
LOC 2107 : PASSED
LOC 2111 : PASSED
LOC 2112 : PASSED
LOC 2115 : PASSED

ALL CARD RESULTS PASSED
;
rlghncxa03w 06-10-01 11:11:28 GMT EAGLE5 36.0.0
Command Completed.
```

29. Verify the flash **GPLs** on the cards using the `rept-stat-gpl` command with the `gpl` parameter value specified in [7](#).

If any card is not running the release version of the flash **GPL**, shown in the **RELEASE** column of the `rtrv-gpl` output in [8](#), the indicator **ALM** is displayed next to the flash **GPL** version in the **RUNNING** column of the `rept-stat-gpl` output. For this example, enter this command.

```
rept-stat-gpl:gpl=oamhc
```

This is an example of the possible output.

```
rlghncxa03w 06-10-01 11:40:26 GMT EAGLE5 46.3.0
GPL      CARD  RUNNING          APPROVED      TRIAL
OAMHC    1113  132-002-000 ALM  132-003-000  132-002-000
OAMHC    1115  132-002-000 ALM  132-003-000  132-002-000
OAMHC    1303  132-002-000 ALM  132-003-000  132-002-000
OAMHC    1307  132-002-000 ALM  132-003-000  132-002-000
OAMHC    2101  132-002-000 ALM  132-003-000  132-002-000
OAMHC    2103  132-002-000 ALM  132-003-000  132-002-000
OAMHC    2105  132-003-000      132-003-000  132-002-000
OAMHC    2113  132-002-000 ALM  132-003-000  132-002-000
OAMHC    2205  132-002-000 ALM  132-003-000  132-002-000
OAMHC    2207  132-002-000 ALM  132-003-000  132-002-000
OAMHC    2213  132-002-000 ALM  132-003-000  132-002-000
OAMHC    2301  132-002-000 ALM  132-003-000  132-002-000
OAMHC    2303  132-002-000 ALM  132-003-000  132-002-000
OAMHC    2305  132-002-000 ALM  132-003-000  132-002-000
OAMHC    2307  132-002-000 ALM  132-003-000  132-002-000
OAMHC    2311  132-002-000 ALM  132-003-000  132-002-000
OAMHC    3101  132-002-000 ALM  132-003-000  132-002-000
OAMHC    3103  132-002-000 ALM  132-003-000  132-002-000
OAMHC    3105  132-002-000 ALM  132-003-000  132-002-000
OAMHC    3107  132-002-000 ALM  132-003-000  132-002-000
Command Completed
```

Note: If the flash **GPL** being displayed by the `rept-stat-gpl` command is the **OAMHC GPL**, the output of the `rept-stat-gpl` command will show any **E5-OAM** cards that are inserted in the **EAGLE**, whether they are configured in the database or not.

Note: If the card's application **GPL**, shown in the `rept-stat-card` output in [9](#), is **OAMHC** or **BLMCAP** perform [30](#) and [31](#), then go to [38](#). Skip [32](#) through [37](#).

- 30.** Place the signaling links that were deactivated in [12](#) back into service using the `act-slk` command.

For this example, enter these commands.

```
act-slk:loc=1201:link=a
```

```
act-slk:loc=1201:link=b
```

```
act-slk:loc=1201:link=a1
```

```
act-slk:loc=1201:link=b1
```

When each of these commands have successfully completed, this message should appear.

```
rlghncxa03w 06-10-01 11:55:49 GMT EAGLE5 36.0.0
Activate SLK message sent to card
```

- 31.** Verify that the signaling links activated in [30](#) are back in service using the `rept-stat-slk` command with the card location and signaling link.

For this example, enter these commands.

```
rept-stat-slk:loc=1201:link=a
```

This is an example of the possible output.

```
rlghncxa03w 06-10-01 13:06:25 GMT EAGLE5 36.0.0
SLK      LSN      CLLI      PST      SST      AST
1201,A  lsnmpl1  -----  IS-NR    Avail    ----
ALARM STATUS      = No Alarms.
UNAVAIL REASON    = --
```

```
rept-stat-slk:loc=1201:link=b
```

This is an example of the possible output.

```
rlghncxa03w 06-10-01 13:06:25 GMT EAGLE5 36.0.0
SLK      LSN      CLLI      PST      SST      AST
1201,B  lsnmpl2  -----  IS-NR    Avail    ----
ALARM STATUS      = No Alarms.
UNAVAIL REASON    = --
```

```
rept-stat-slk:loc=1201:link=a1
```

This is an example of the possible output.

```
rlghncxa03w 06-10-01 13:06:25 GMT EAGLE5 36.0.0
SLK      LSN      CLLI      PST      SST      AST
1201,A1 lsnmpl3  -----  IS-NR    Avail    ----
ALARM STATUS      = No Alarms.
UNAVAIL REASON    = --
```

```
rept-stat-slk:loc=1201:link=b1
```

This is an example of the possible output.

```
rlghncxa03w 06-10-01 13:06:25 GMT EAGLE5 36.0.0
SLK      LSN      CLLI      PST      SST      AST
1201,B1 lsnmpl4  -----  IS-NR    Avail    ----
ALARM STATUS      = No Alarms.
UNAVAIL REASON    = --
```

Command Completed.

Note: If the card's application GPL, shown in the `rept-stat-card` output in [9](#), is `vxwslan`, perform [32](#) and [33](#), then go to [38](#). Skip [34](#) through [37](#).

- 32.** Place the **TCP/IP** data link that was deactivated in [14](#) back into service using the `act-dlk` command.

For this example, enter this command.

```
act-dlk:loc=2105
```

When this command has successfully completed, this message should appear.

```
rlghncxa03w 06-10-01 11:55:49 GMT EAGLE5 36.0.0
Activate Link message sent to card.
```

- 33.** Verify that the **TCP/IP** data links activated in [32](#) are back in service with the `rept-stat-dlk` command.

This is an example of the possible output.

```
rlghncxa03w 06-10-01 17:00:36 GMT EAGLE5 36.0.0
DLK   PST      SST      AST
1303  IS-NR     Avail    ---
2101  IS-NR     Avail    ---
2103  IS-NR     Avail    ---
2105  IS-NR     Avail    ---
2113  IS-NR     Avail    ---
2301  IS-NR     Avail    ---
```

Note: If the application GPL running on the card is not **EOAM**, continue the procedure with [38](#).

Note: If the application GPL running on the card is **IPS**, perform [36](#) and [37](#), then go to [38](#). Skip [34](#) and [35](#).

- 34.** If you wish to load the new **GPL** onto the **E5-OAM** card making up the active **MASP**, enter the `init-card` command specifying the location of the **E5-OAM** card making up active **MASP**.

For this example, enter the `init-card:loc=1115` command. This message should appear.

```
rlghncxa03w 06-10-01 11:11:28 GMT EAGLE5 36.0.0
Init Card command issued to card 1115
```

After the `init-card` command has completed, repeat this procedure from [22](#), specifying the card location used in the `init-card` command.

If you did not wish to load the new version of the **OAMHC GPL** onto the other **E5-OAM** card running the **EOAM** application, continue this procedure with either [35](#) or [38](#) based on the following conditions:

- If SEAS terminals were not shown in the `rtrv-trm` command output in [18](#), continue the procedure with [38](#).
- If SEAS terminals were shown in the `rtrv-trm` command output in [18](#), continue the procedure with [35](#).

- 35.** Change the terminal type of the terminals that were changed to **NONE** in [21](#) to the terminal type **SEAS** with the `chg-trm` command and the `type=seas` parameter.

The terminal type is shown in the **TYPE** field in the `rtrv-trm` command output in [18](#).

For this example, enter these commands.

```
chg-trm:trm=27:type=seas
```

```
chg-trm:trm=36:type=seas
```

This message should appear when these commands have successfully completed.

```
rlghncxa03w 06-10-01 11:11:28 GMT EAGLE5 36.0.0
CHG-TRM: MASP B - COMPLTD
```

36. Put the required terminals back into service with the `rst-trm` command.

For this example, enter these commands.

```
rst-trm:trm=27
```

```
rst-trm:trm=36
```

If Telnet terminals were placed out of service in [20](#), for this example, enter these commands.

```
rst-trm:trm=17
```

```
rst-trm:trm=18
```

```
rst-trm:trm=19
```

```
rst-trm:trm=20
```

```
rst-trm:trm=21
```

```
rst-trm:trm=22
```

```
rst-trm:trm=23
```

```
rst-trm:trm=24
```

This message should appear when each of these commands have successfully completed.

```
rlghncxa03w 06-10-01 15:08:45 GMT EAGLE5 36.0.0
Allow message sent to terminal
```

```
rlghncxa03w 06-10-01 15:08:45 GMT EAGLE5 36.0.0
Command Completed.
```

37. Verify that the terminals are in service with the `rept-stat-trm` command.

This is an example of the possible output.

```
rlghncxa03w 06-10-01 15:08:45 GMT EAGLE5 36.0.0
TRM   PST           SST           AST
1     IS-NR          Active        -----
2     IS-NR          Active        -----
3     IS-NR          Active        -----
4     IS-NR          Active        -----
5     IS-NR          Active        -----
6     IS-NR          Active        -----
7     IS-NR          Active        -----
```

8	IS-NR	Active	-----
9	IS-NR	Active	-----
10	IS-NR	Active	-----
11	IS-NR	Active	-----
12	IS-NR	Active	-----
13	IS-NR	Active	-----
14	IS-NR	Active	-----
15	IS-NR	Active	-----
16	IS-NR	Active	-----
17	IS-NR	Active	-----
18	IS-NR	Active	-----
19	IS-NR	Active	-----
20	IS-NR	Active	-----
21	IS-NR	Active	-----
22	IS-NR	Active	-----
23	IS-NR	Active	-----
24	IS-NR	Active	-----
25	IS-NR	Active	-----
26	IS-NR	Active	-----
27	IS-NR	Active	-----
28	IS-NR	Active	-----
29	IS-NR	Active	-----
30	IS-NR	Active	-----
31	IS-NR	Active	-----
32	IS-NR	Active	-----
33	IS-NR	Active	-----
34	IS-NR	Active	-----
35	IS-NR	Active	-----
36	IS-NR	Active	-----
37	IS-NR	Active	-----
38	IS-NR	Active	-----
39	IS-NR	Active	-----
40	IS-NR	Active	-----

Command Completed.

38. Continue the procedure by performing these actions.

If E5-based control cards are installed in the EAGLE, continue the procedure by performing one of these actions.

- If the GPL will be loaded onto other cards, repeat this procedure from [8](#).
- If the GPL will not be loaded onto other cards, but other flash GPLs will be updated, repeat this procedure from [1](#).
- If the GPL will not be loaded onto other cards, and other flash GPLs will not be updated, this procedure is finished.

Figure 3-4 Updating the Flash GPLs

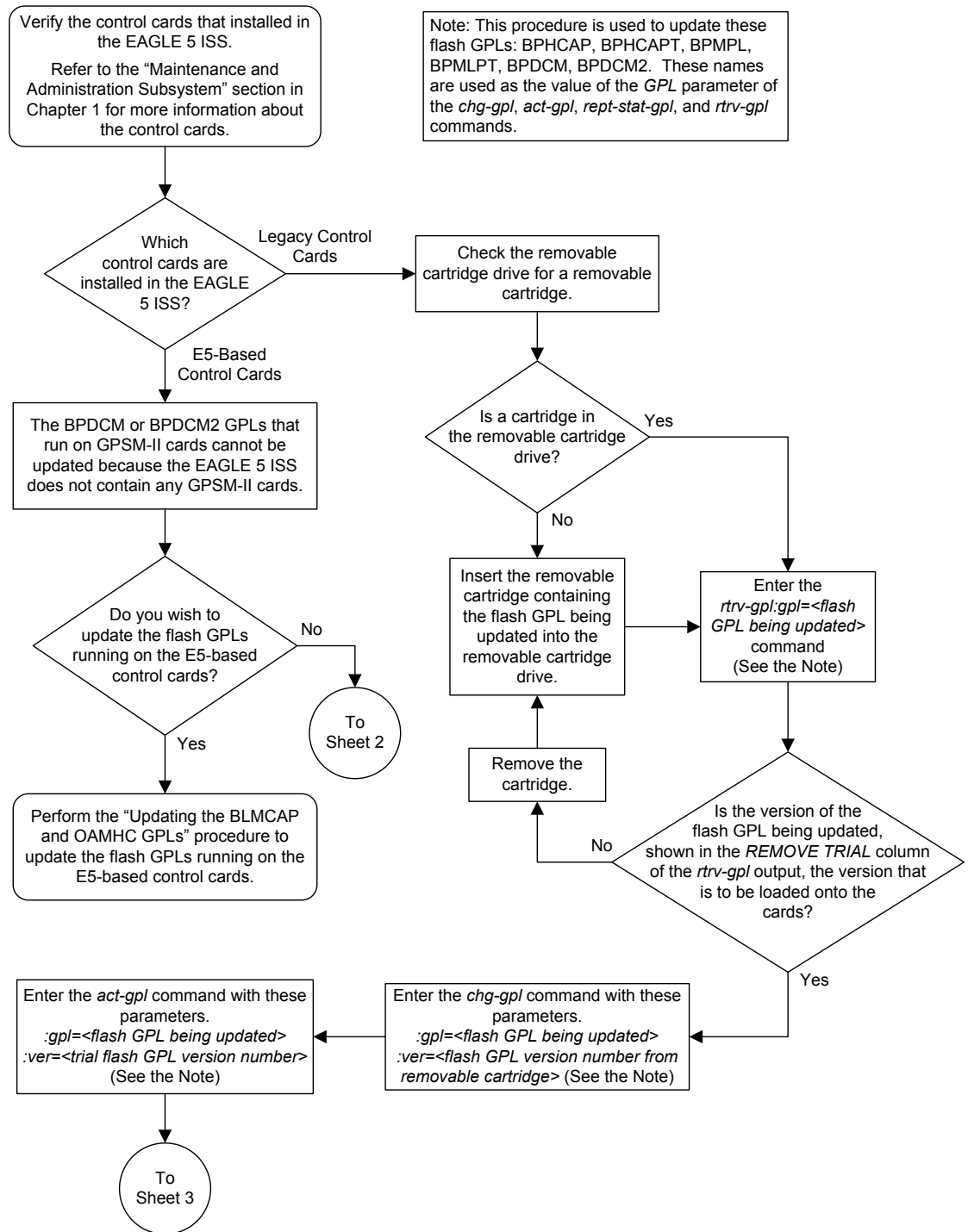

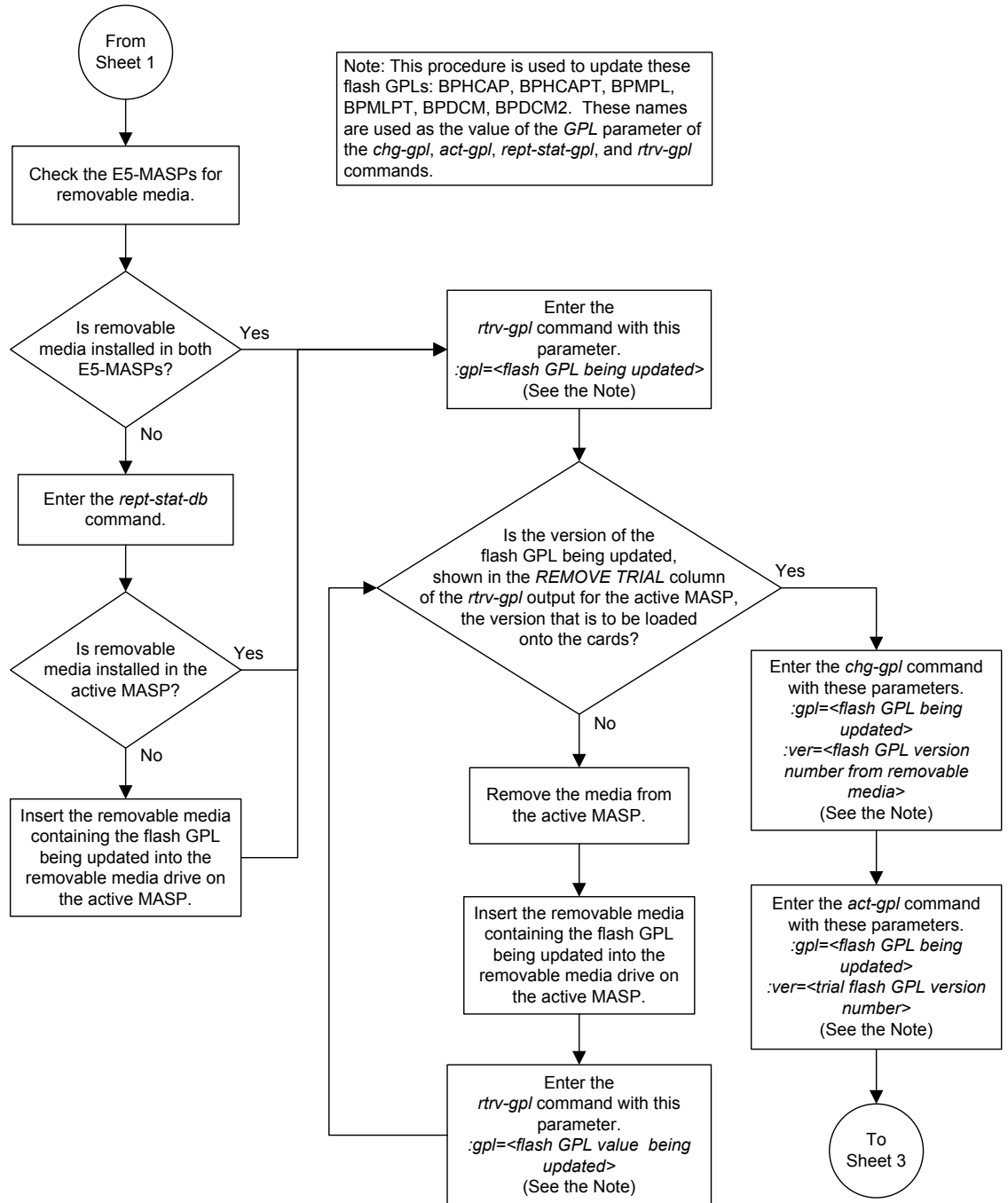

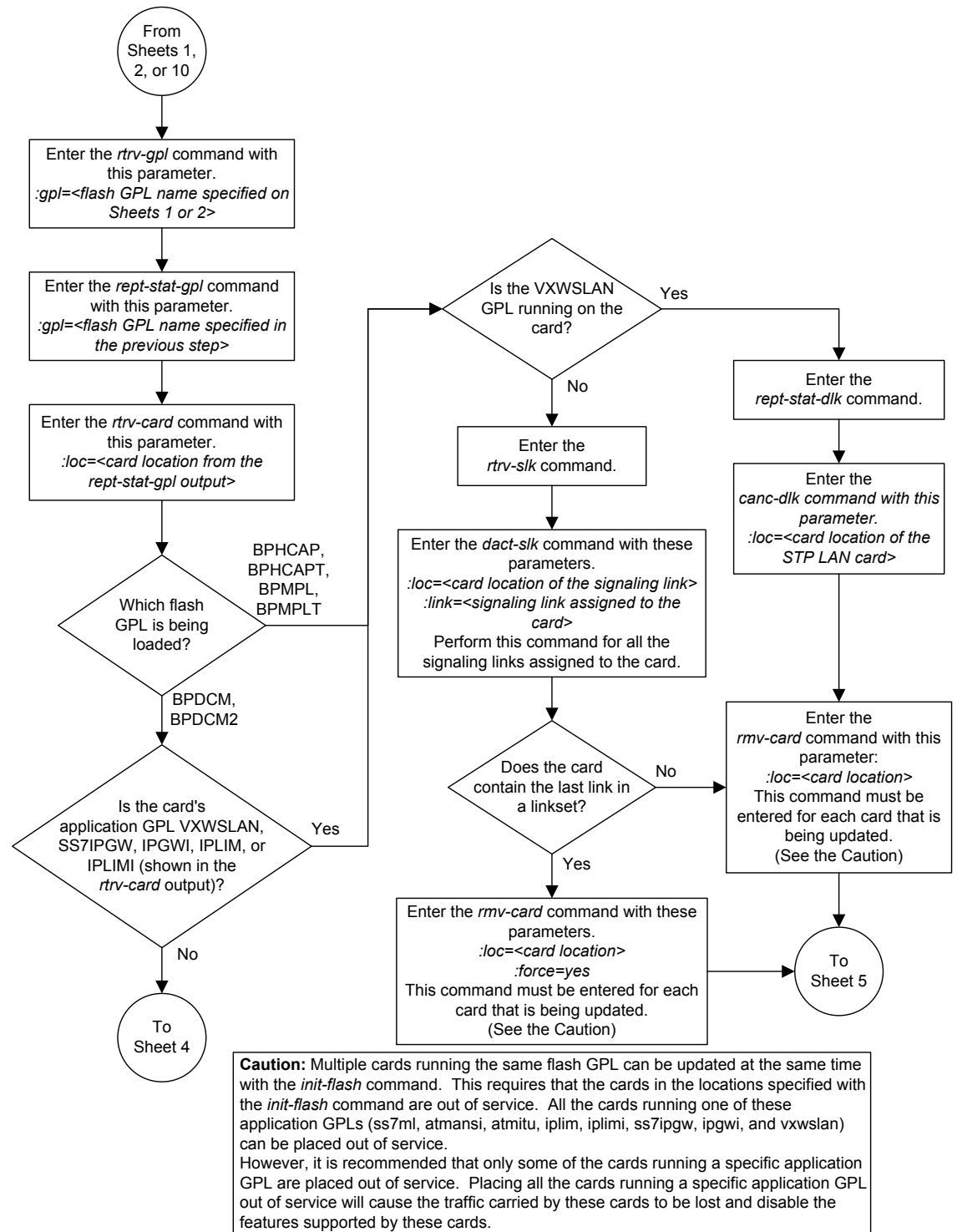

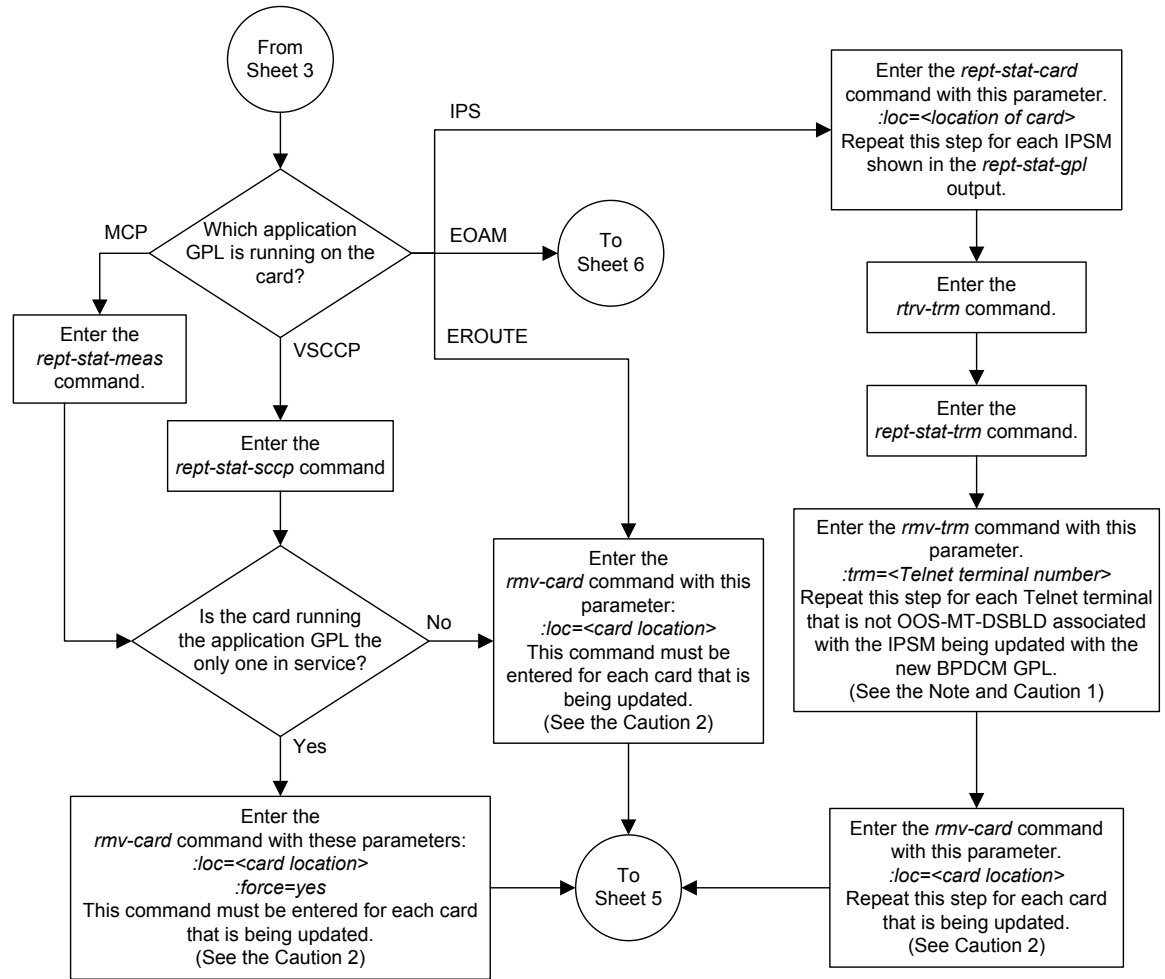

Note: Each IPSM has 8 Telnet terminals associated with it. The *rtrv-trm* output shows the Telnet terminals that are associated with each IPSM.

Cautions:

1. Placing the Telnet terminals out of service will disable all Telnet sessions supported by the terminals associated with the IPSM.
2. Multiple cards running the same flash GPL can be updated at the same time with the *init-flash* command. This requires that the cards in the locations specified with the *init-flash* command are out of service. All the cards running a one of these application GPLs (vsccp, mcp, eroute, ips) can be placed out of service. However, it is recommended that only some of the cards running a specific application GPL are placed out of service. Placing all the cards running a specific application GPL out of service will cause the traffic carried by these cards to be lost and disable the features supported by these cards.

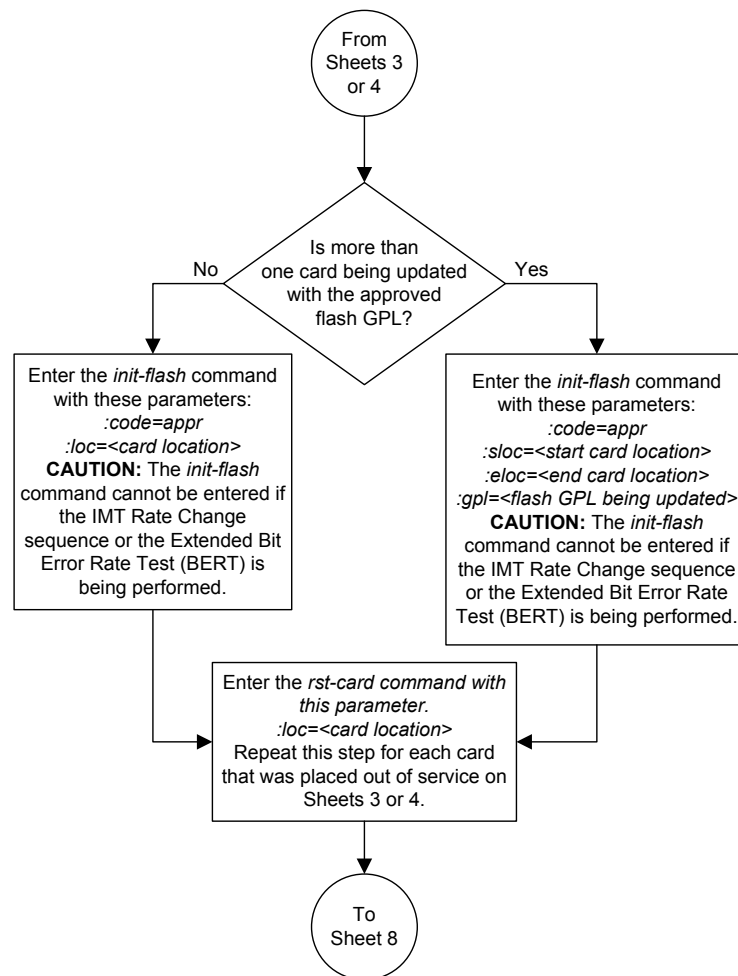

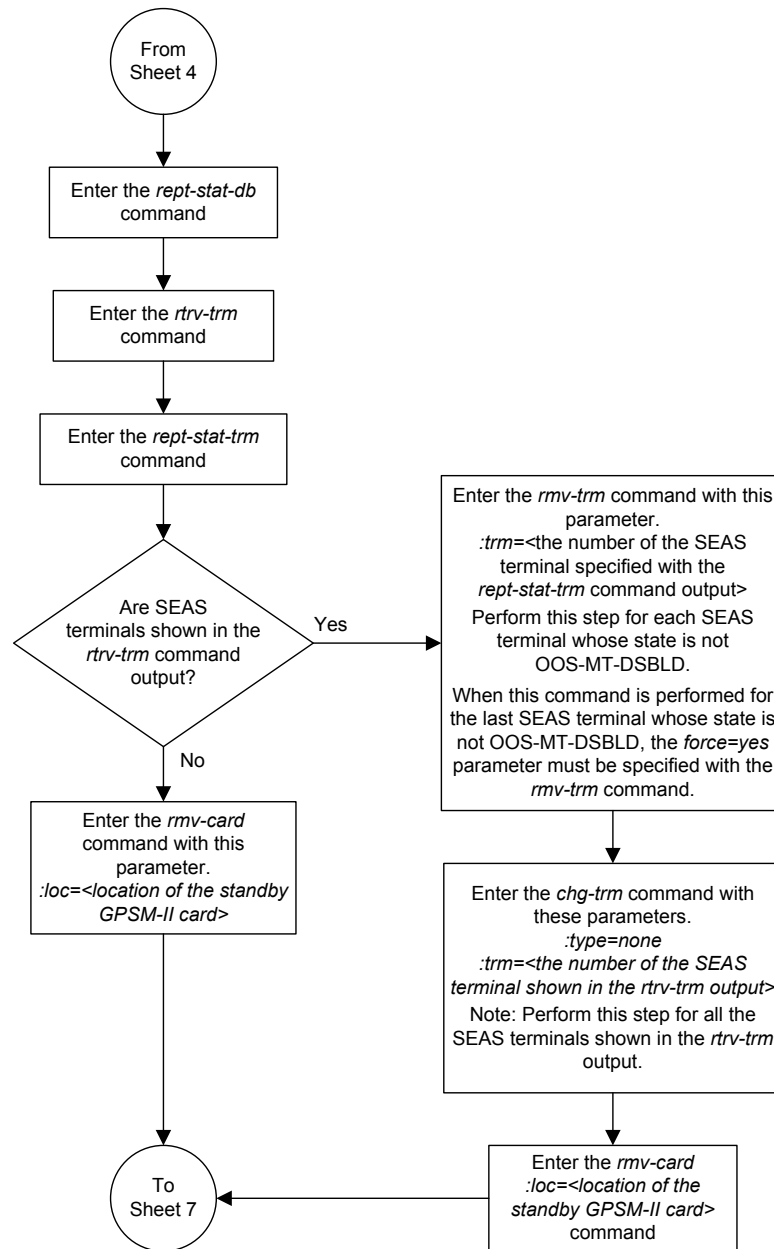

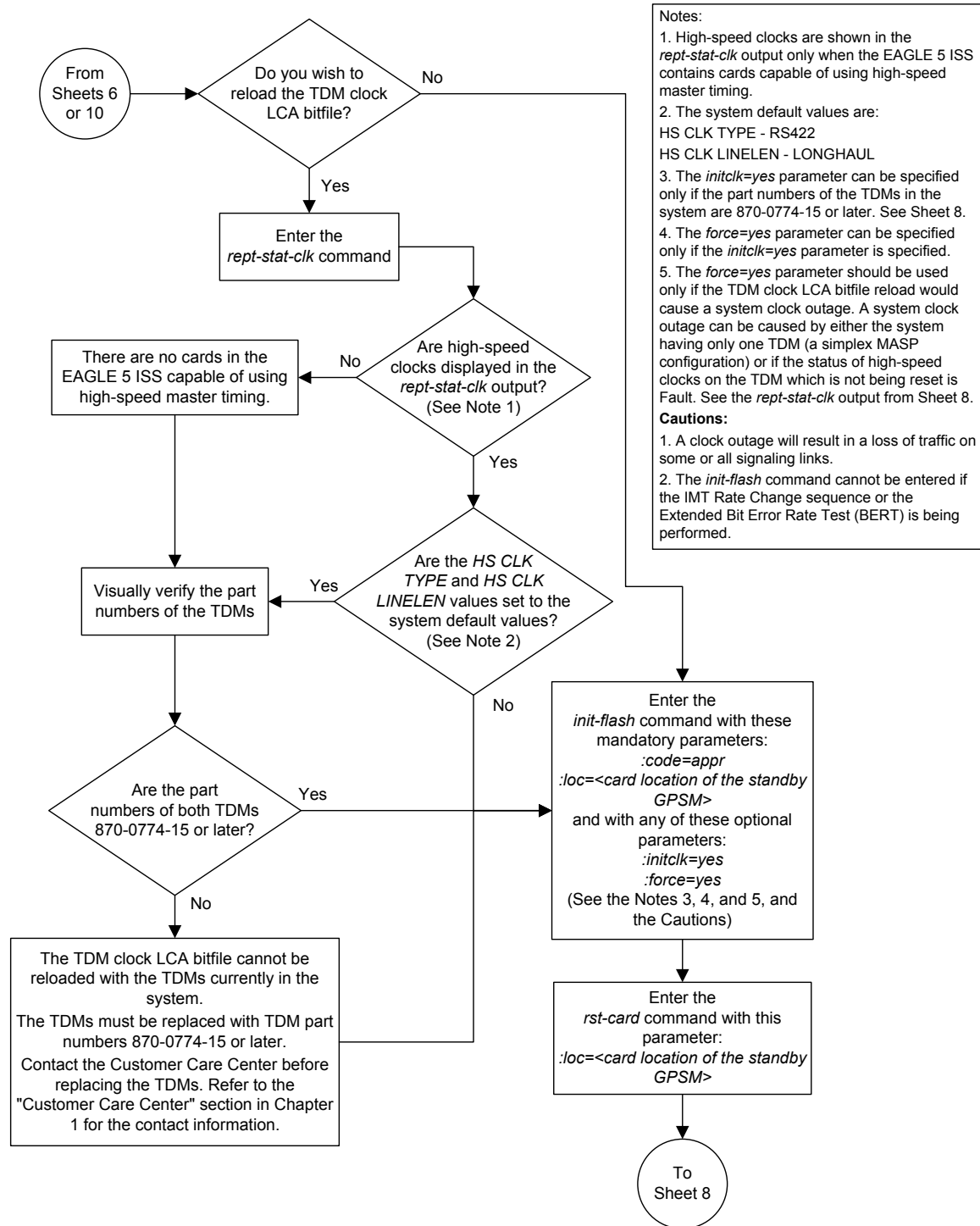

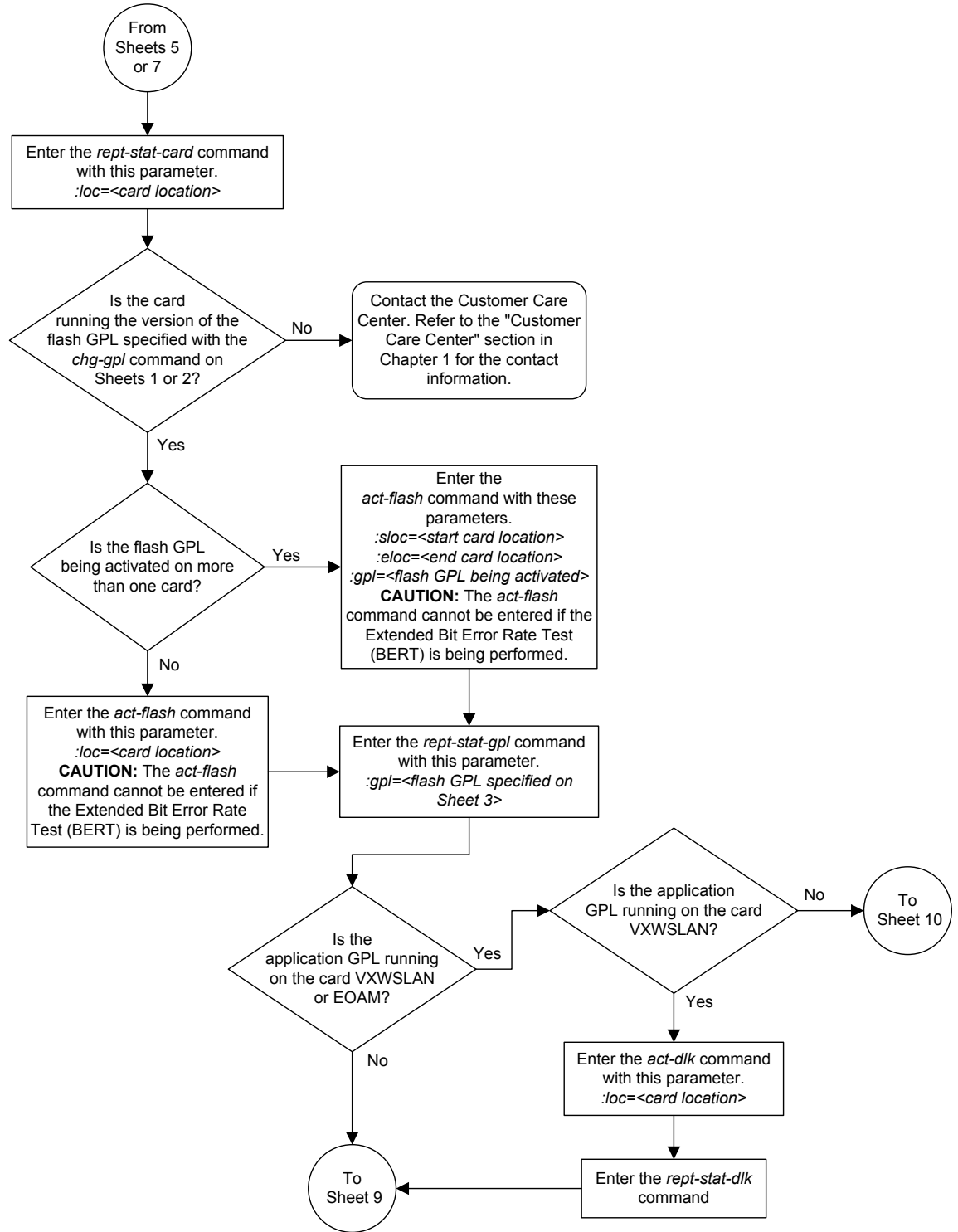

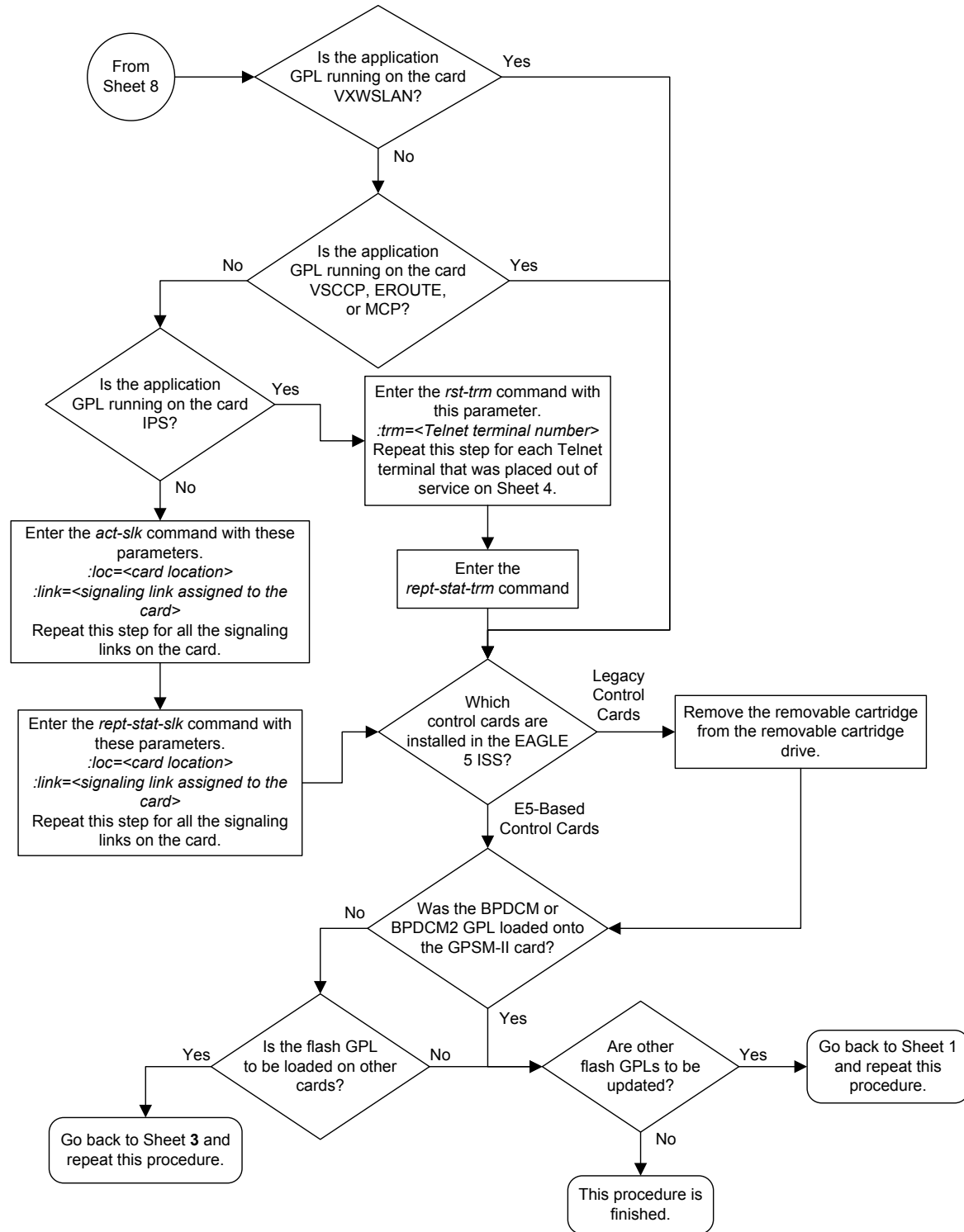

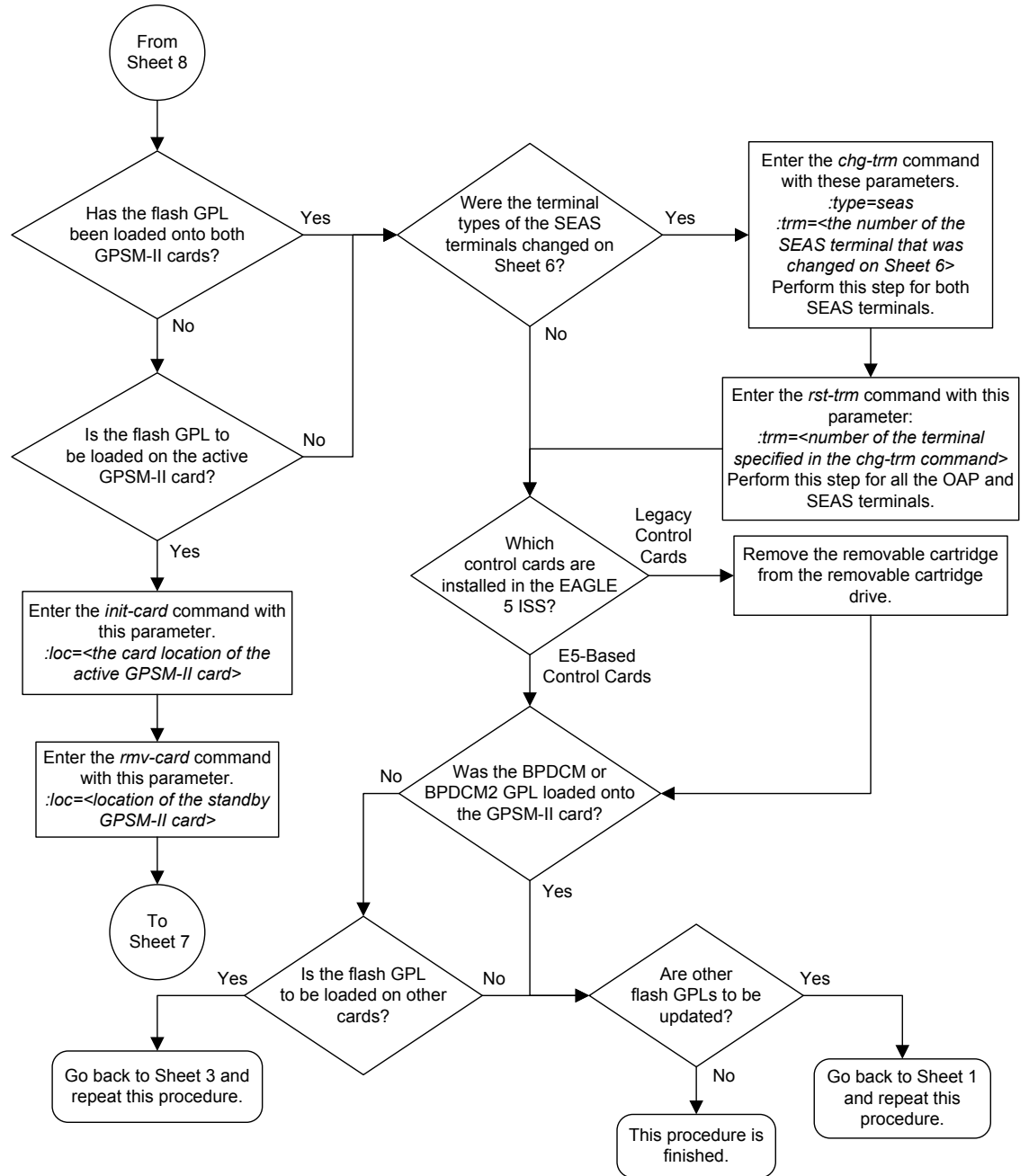

Updating the HIPR2 GPL

This section presents the procedure for updating the HIPR2 generic program load (GPL). The HIPR2 GPL is used by the High-Speed IMT Packet Router 2 (HIPR2) card to control the IMT bus and resides on the fixed disk. The HIPR2 card resides only in slots 9 and 10 in each shelf in the EAGLE.

This section presents the procedure for loading the HIPR2 GPL onto the EAGLE as a trial version from a removable media, then making the trial version of the HIPR2 GPL the approved version.

If any card is not running the approved version of the GPL shown in the RELEASE column of the `rtrv-gpl` output, the indicator ALM is displayed next to the GPL version in the RUNNING column of the `rept-stat-gpl` output, and next to the GPL version in the APPROVED column in the `rtrv-gpl` output.

The removable media that contains the HIPR2 GPL to be loaded on to the EAGLE is required.

1. Verify the control cards that are installed in the EAGLE.

Refer to [Maintenance and Administration Subsystem](#) for information about the control cards.

If E5-based control cards are installed in the EAGLE, continue the procedure with [2](#).

2. Check the E5-MASPs for removable media.

If removable media is installed in both E5-MASPs, continue the procedure with [4](#).

If removable media is not installed in both E5-MASPs, continue the procedure with [3](#).

3. Verify the active MASP by entering the `rept-stat-db` command.

This is an example of the possible output.

```
r1ghncxa03w 09-07-01 15:25:40 GMT EAGLE5 41.1.0
DATABASE STATUS: >> OK <<
          TDM 1114 ( STDBY)                TDM 1116 ( ACTV )
          C  LEVEL    TIME LAST BACKUP    C  LEVEL    TIME LAST BACKUP
          - - - - -
FD BKUP Y      36 09-06-19 09:38:25 GMT  Y      36 09-06-19 09:38:25 GMT
FD CRNT Y      39
          MCAP 1113                        MCAP 1115
          - - - - -
RD BKUP -      -      -      -      Y      36 09-06-19 09:27:17 GMT
USB BKP -      -      -      -      Y      3 09-06-07 01:11:22 GMT
```

If removable media is installed in the active MASP, continue the procedure with [4](#).

If removable media is not installed in the active MASP, insert the removable media in the removable media drive in the active MASP. For more information about inserting removable media in the removable media drive, refer to [Removable USB Drive](#). After the removable media has been inserted in the removable media drive in the active MASP, continue the procedure with [4](#).

4. Display the HIPR2 GPLs on the fixed disk and on the removable media using the `rtrv-gpl:gpl=hipr2` command.

This is an example of the possible output.

```
rlghncxa03w 09-07-01 11:34:04 GMT EAGLE5 41.1.0
GPL Auditing ON
```

GPL	CARD	RELEASE	APPROVED	TRIAL	REMOVE TRIAL
HIPR2	1114	132-002-000	132-002-000	132-001-000	132-003-000
HIPR2	1116	132-002-000	132-002-000	132-001-000	132-003-000
HIPR2	1115	-----	-----	-----	-----

If the version of the HIPR2 GPL shown in the REMOVE TRIAL column of the `rtrv-gpl` output is not the version that is to be loaded onto the cards, remove the removable media from the active MASP.

Insert the removable media that contains the HIPR2 GPL that is being updated into the removable media drive in the active MASP and repeat this step.

For more information about inserting removable media in the removable media drive, or removing removable media from the removable media drive, refer to [Removable USB Drive](#).

If the version of the HIPR2 GPL shown in the REMOVE TRIAL column of the `rtrv-gpl` output is the version that is to be loaded onto the cards, continue the procedure with 5.

5. Change the **GPLs**, using the `chg-gpl` command and specifying the value for the trial HIPR2 GPL shown in the REMOVE TRIAL column in the output of the `rtrv-gpl` command used in 4.

For this example, enter this command.

```
chg-gpl:gpl=hipr2:ver=132-003-000
```

These messages should appear.

```
rlghncxa03w 09-07-01 11:43:04 GMT EAGLE5 41.1.0
GPL Auditing ON
```

```
HIPR2 upload on 1114 completed
HIPR2 upload on 1116 completed
System Release ID table upload 1114 completed
System Release ID table upload 1116 completed
```

Note: If you wish to leave the **HIPR2** cards running the trial version of the HIPR2 GPL, continue the procedure with 8.

6. Activate the trial **GPL**, using the `act-gpl` command and specifying the value for the trial HIPR2 GPL shown in 5.

For this example, enter this command.

```
act-gpl:gpl=hipr2:ver=132-003-000
```

These messages should appear.

```
rlghncxa03w 09-07-01 06:54:39 GMT EAGLE5 41.1.0
HIPR2 activate on 1114 completed
HIPR2 activate on 1116 completed
```

- Verify that the HIPR2 GPL on the removable media is the approved GPL on the fixed disk using the `rtrv-gpl:gpl=hipr2` command.

This is an example of the possible output.

```
rlghncxa03w 09-07-01 11:34:04 GMT EAGLE5 41.1.0
GPL Auditing ON

GPL      CARD  RELEASE      APPROVED      TRIAL      REMOVE TRIAL
HIPR2    1114  132-003-000  132-003-000  132-002-000  132-003-000
HIPR2    1116  132-003-000  132-003-000  132-002-000  -----
```

If E5-based control cards are installed in the EAGLE, this is an example of the possible output.

```
rlghncxa03w 09-07-01 11:34:04 GMT EAGLE5 41.1.0
GPL Auditing ON

GPL      CARD  RELEASE      APPROVED      TRIAL      REMOVE TRIAL
HIPR2    1114  132-003-000  132-003-000  132-002-000  132-003-000
HIPR2    1116  132-003-000  132-003-000  132-002-000  132-003-000
HIPR2    1115  -----      -----      -----      -----
```

- Verify the HIPR2 GPLs on the fixed disk and the cards that are running the HIPR2 GPLs using the `rept-stat-gpl:gpl=hipr2` command.

This is an example of the possible output.

```
rlghncxa03w 09-07-01 11:40:26 GMT EAGLE5 41.1.0
GPL      CARD  RUNNING      APPROVED      TRIAL
HIPR2    1109  132-002-000 ALM  132-003-000  132-002-000
HIPR2    1110  132-002-000 ALM  132-003-000  132-002-000
HIPR2    1209  132-002-000 ALM  132-003-000  132-002-000
HIPR2    1210  132-002-000 ALM  132-003-000  132-002-000
HIPR2    1309  132-002-000 ALM  132-003-000  132-002-000
HIPR2    1310  132-002-000 ALM  132-003-000  132-002-000
HIPR2    2109  132-002-000 ALM  132-003-000  132-002-000
HIPR2    2110  132-002-000 ALM  132-003-000  132-002-000
Command Completed
```

- Load the approved HIPR2 GPL onto a card selected from the cards shown in 8 using the `init-flash:code=appr` command.

Caution: The `init-flash` command cannot be entered if the IMT Rate Change sequence or the Extended Bit Error Rate Test (BERT) is being performed.

For this example, enter this command.

```
init-flash:code=appr:loc=1109
```

When this command has successfully completed, these messages should appear.

```
rlghncxa03w 09-07-01 11:11:28 GMT EAGLE5 41.1.0
FLASH Memory Downloading for card 1109 Started.
;
rlghncxa03w 09-07-01 11:11:28 GMT EAGLE5 41.1.0
```

```
    HIPR2 Downloading for card 1109 Complete.
;

    rlghncxa03w 09-07-01 11:11:28 GMT EAGLE5 41.1.0
    Command Completed.
```

Updating more than One HIPR2 Card at the Same Time

Multiple **HIPR2** cards can be updated at the same time with the `init-flash` command. The multiple **HIPR2** cards being updated must be on the same **IMT** bus. Specifying card locations **XX09** for the `sloc` and `eloc` parameters specifies the **HIPR2** cards on **IMT** bus A. Specifying card locations **XX10** for the `sloc` and `eloc` parameters specifies the **HIPR2** cards on **IMT** bus B.

To update more than one **HIPR2** card on the same **IMT** bus, enter the `init-flash` command with these parameters along with the `code=appr` parameter:

`sloc` – the first card location in the range of card locations

`eloc` – the last card location in the range of card locations

`gpl` – `hipr2`

Note: The `sloc`, `eloc`, and `gpl` parameters cannot be specified with the `loc` parameter.

For example, to update the **HIPR2** cards on **IMT Bus B** shown in 8 with the approved version of the HIPR2 GPL, enter this command.

```
init-flash:code=appr:sloc=1110:eloc=2110:gpl=hipr2
```

To update the **HIPR2** cards on **IMT** bus A shown in 8, the `sloc=1109` and `eloc=2109` parameters would be specified with the `init-flash` command.

When this command has successfully completed, these messages should appear.

```
    rlghncxa03w 09-07-01 11:11:28 GMT EAGLE5 41.1.0
    FLASH Memory Download for cards 1110 - 2110 Started.
;

    rlghncxa03w 09-07-01 13:07:15 GMT EAGLE5 41.1.0
    FLASH Memory Download for cards 1110 - 2110 Completed.
    LOC 1110 : PASSED
    LOC 1210 : PASSED
    LOC 1310 : PASSED
    LOC 2110 : PASSED

    ALL CARD RESULTS PASSED
;

    rlghncxa03w 09-07-01 11:11:28 GMT EAGLE5 41.1.0
    Command Completed.
```

10. Re-initialize the **HIPR2** cards specified in 9 using the `init-mux` command with the `loc` parameter.

Caution: The `init-mux` command cannot be entered if the **IMT** Rate Change sequence or the Extended Bit Error Rate Test (**BERT**) is being performed.

For this example, enter this command.

```
init-mux:loc=1109
```

If more than one **HMUX** card was specified in 9, re-initialize the **IMT** bus containing the cards specified in 9 by entering `init-mux` command and specifying the **IMT** bus (the `bus` parameter) containing the cards specified in 9. Specifying card locations **XX09** for the `sloc` and `eloc` parameters in 9 requires that **IMT** bus A is re-initialized. Specifying card locations **XX10** for the `sloc` and `eloc` parameters in 9 requires that **IMT** bus B is re-initialized.

For this example, enter this command.

```
init-mux:bus=a
```

When this command has successfully completed, this message should appear.

```
rlghncxa03w 09-07-01 11:11:28 GMT EAGLE5 41.1.0
Command Completed.
```

Note: Executing this command produces two alarms: 0002 - Card is not running approved GPL, indicating that the version of the HIPR2 GPL running on the card is not the approved version, and 0004 - Card is running non-activated GPL, indicating that the new version of the HIPR2 GPL running on the card has not been activated.

11. Verify that the approved HIPR2 GPL from 10 has loaded and that the state of the card is in-service normal (**IS-NR**) state using the `rept-stat-card` command.

If more than one card was specified in 9 and 10, enter the `rept-stat-card` command for each specified card. For this example, enter this command.

```
rept-stat-card:loc=1109:mode=full
```

```
rlghncxa03w 09-07-01 11:11:28 GMT EAGLE5 41.1.0
CARD  VERSION      TYPE      GPL          PST          SST          AST
1109  132-003-000  HIPR2    HIPR2        IS-NR        Active       -----
ALARM STATUS      = No Alarms
TRIAL VERSION     = 132-003-000
FPGA VERSION      = 022-005
Command Completed.
```

Note: If the version number of the HIPR2 GPL shown in the `rept-stat-card` command output is different than the version specified in 5, contact the Customer Care Center. Refer to [My Oracle Support \(MOS\)](#) for the contact information.

12. Activate the approved HIPR2 GPL loaded onto the card in 9 using the `act-flash` command.

Caution: The `act-flash` command cannot be entered if the Extended Bit Error Rate Test (**BERT**) is being performed.

For this example, enter this command.

```
act-flash:loc=1109
```

When this command has successfully completed, these messages should appear.

```

rlghncxa03w 09-07-01 11:11:28 GMT EAGLE5 41.1.0
FLASH Memory Activation for card 1109 Completed.
;
rlghncxa03w 09-07-01 11:11:28 GMT EAGLE5 41.1.0
Command Completed.

```

Activating the HIPR2 GPL on more than One HIPR2 card at the Same Time

If more than one **HIPR2** card was specified in 9, enter the `act-flash` command with these parameters:

`sloc` – the first card location in the range of card locations

`eloc` – the last card location in the range of card locations

`gpl` – `hipr2`

Note: The `sloc`, `eloc`, and `gpl` parameters cannot be specified with the `loc` parameter.

For example, to activate the HIPR2 GPL on the **HIPR2** cards on **IMT Bus B** shown in 8 with the trial version of the HIPR2 GPL, enter this command.

```
act-flash:sloc=1110:eloc=2110:gpl=hipr2
```

To activate the HIPR2 GPL on the **HIPR2** cards on **IMT bus A** shown in 8, the `sloc=1109` and `eloc=2109` parameters would be specified with the `act-flash` command.

When this command has successfully completed, these messages should appear.

```

rlghncxa03w 09-07-01 11:11:28 GMT EAGLE5 41.1.0
FLASH Memory Activation for cards 1110 - 2110 Started.
;
rlghncxa03w 09-07-01 13:07:15 GMT EAGLE5 41.1.0
FLASH Memory Activation for cards 1110 - 2110 Completed.
LOC 1110 : PASSED
LOC 1210 : PASSED
LOC 1310 : PASSED
LOC 2110 : PASSED

ALL CARD RESULTS PASSED
;
rlghncxa03w 09-07-01 11:11:28 GMT EAGLE5 41.1.0
Command Completed.

```

- Verify the HIPR2 GPLs on the fixed disk and the cards that are running the HIPR2 GPLs using the `rept-stat-gpl:gpl=hipr2` command.

This is an example of the possible output.

```

rlghncxa03w 09-07-01 11:40:26 GMT EAGLE5 41.1.0
GPL      CARD  RUNNING      APPROVED      TRIAL
HIPR2    1109  132-003-000    132-003-000    132-002-000
HIPR2    1110  132-002-000 ALM  132-003-000    132-002-000
HIPR2    1209  132-002-000 ALM  132-003-000    132-002-000
HIPR2    1210  132-002-000 ALM  132-003-000    132-002-000
HIPR2    1309  132-002-000 ALM  132-003-000    132-002-000
HIPR2    1310  132-002-000 ALM  132-003-000    132-002-000

```

```
HIPR2 2109 132-002-000 ALM 132-003-000 132-002-000  
HIPR2 2110 132-002-000 ALM 132-003-000 132-002-000  
Command Completed
```

14. Continue the procedure by performing these actions.

- If you wish to load the new HIPR2 GPL onto the other cards shown in [8](#), repeat this procedure from [9](#) for each card shown in [8](#).
- If the new HIPR2 GPL has been loaded onto all the cards shown in [8](#), or if the new HIPR2 GPL will not be loaded onto the other cards shown in [8](#), then this procedure is finished.

Figure 3-5 Updating the HIPR2 GPL

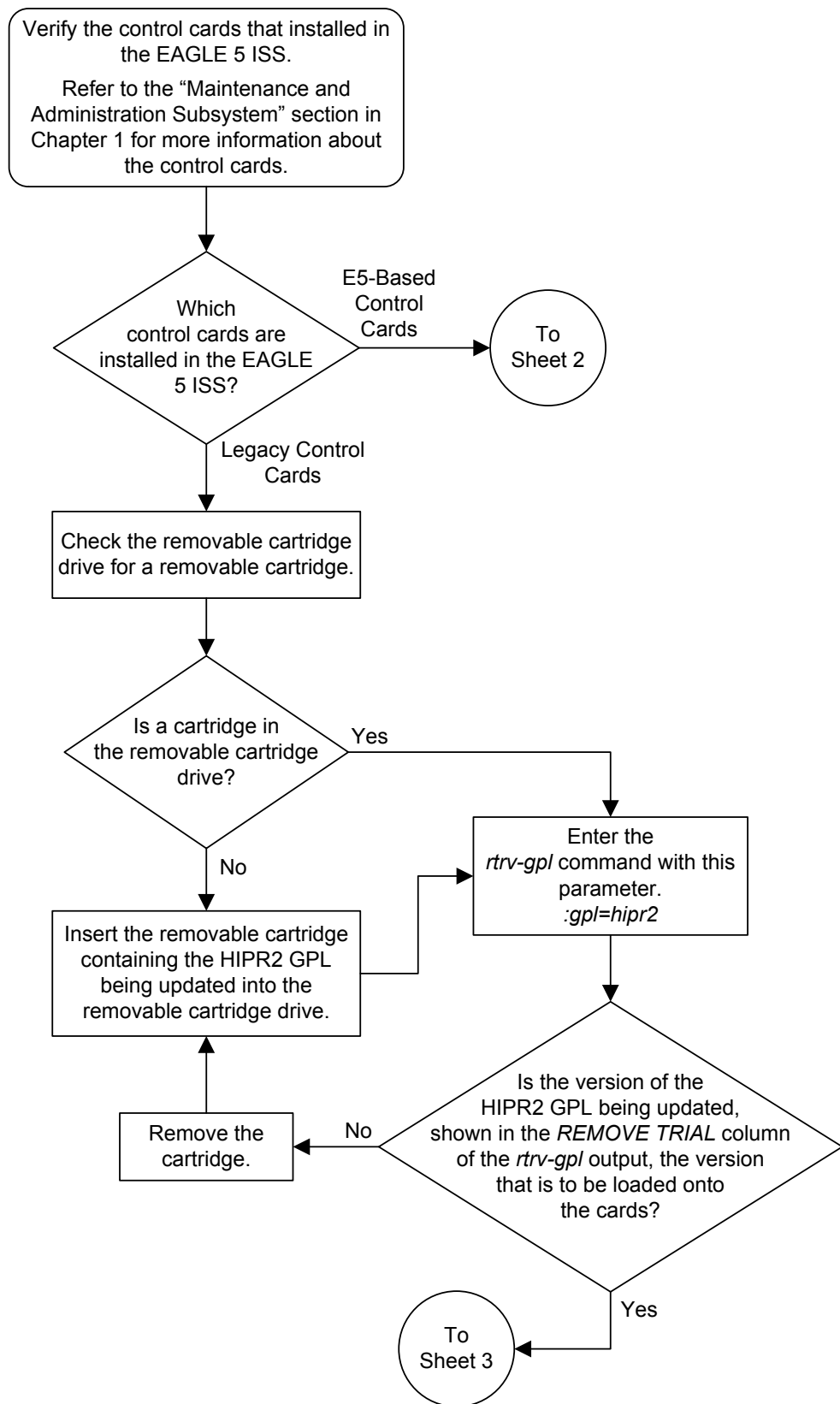

Sheet 1 of 5

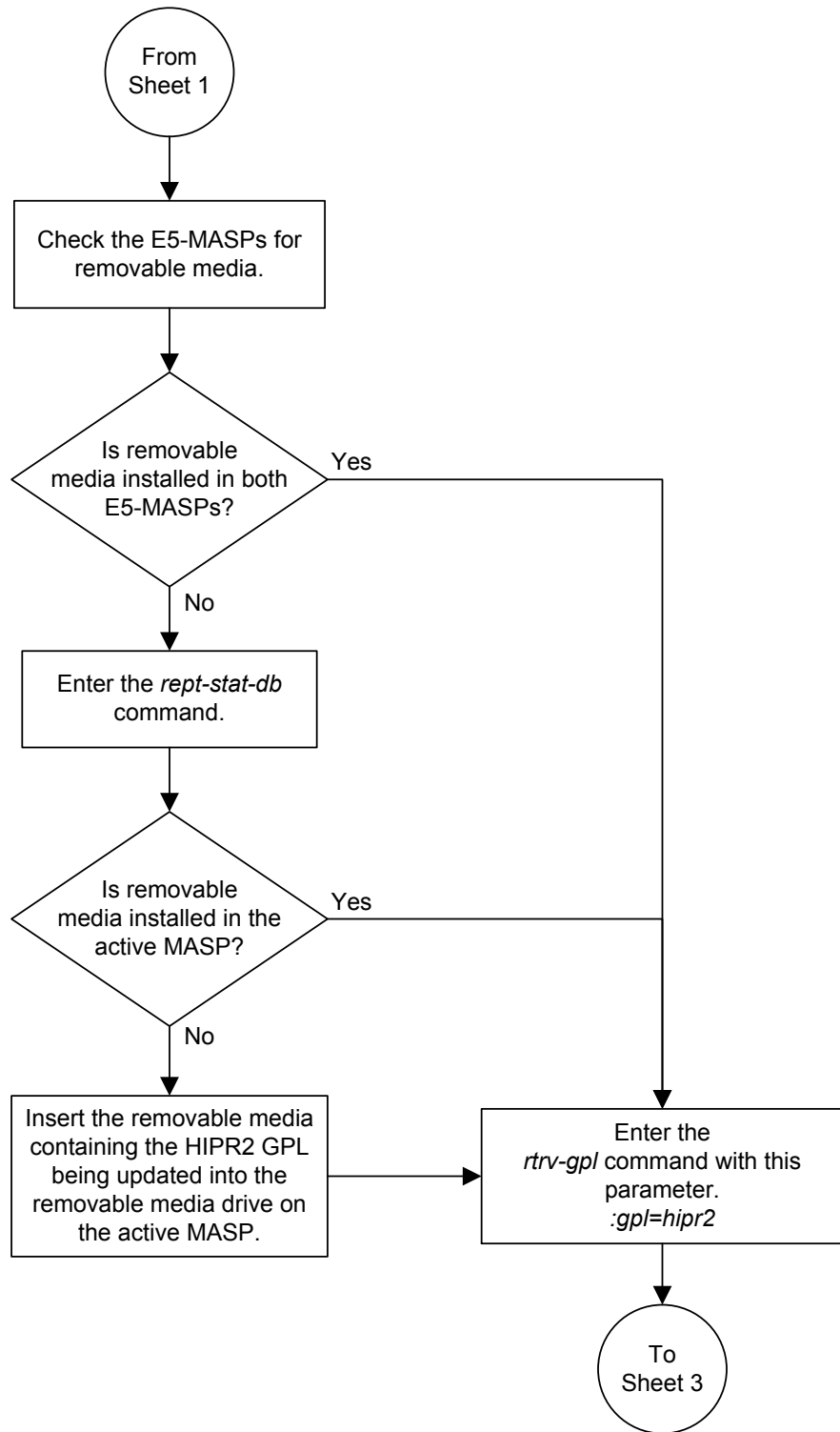

Sheet 2 of 5

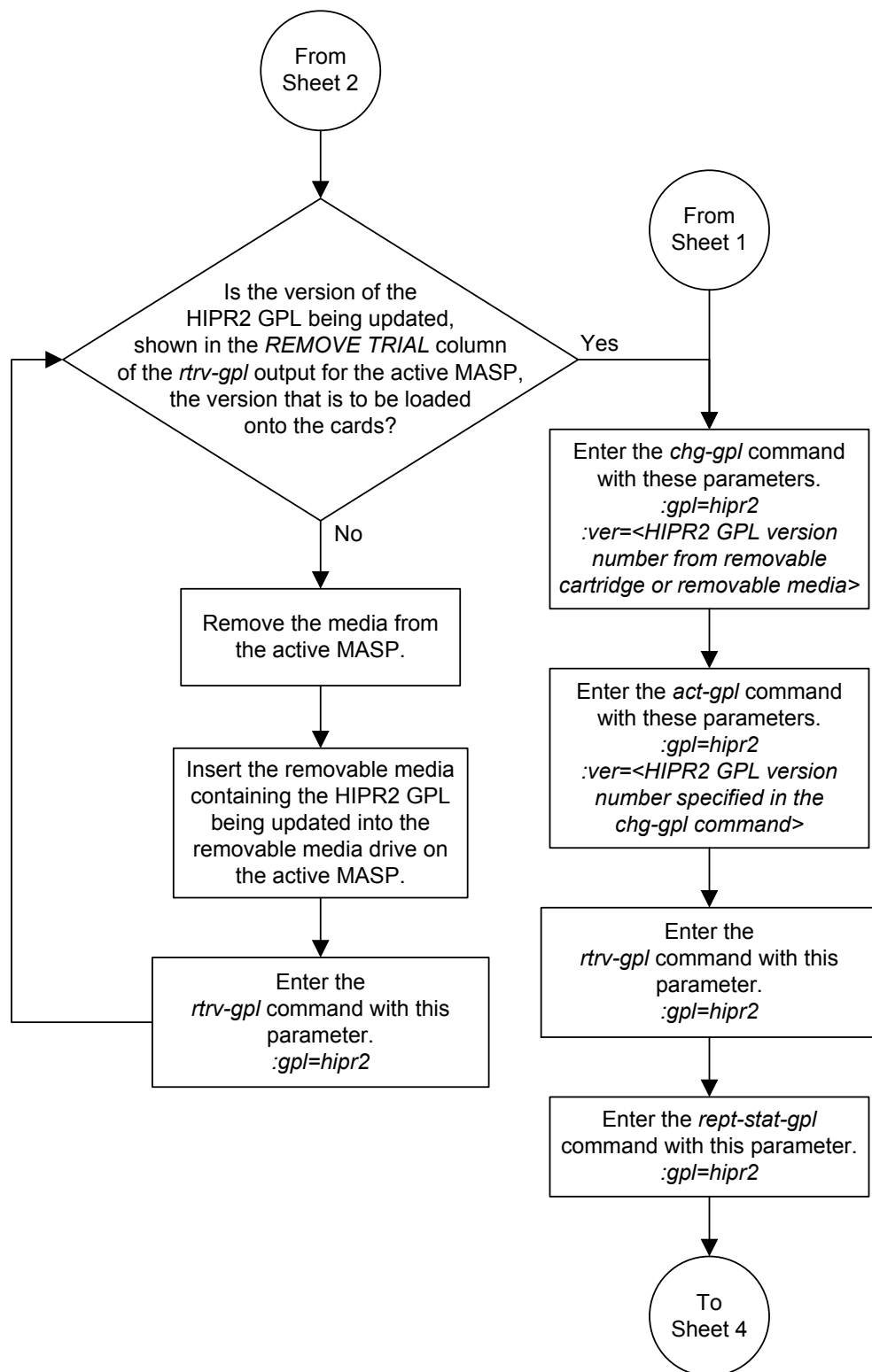

Sheet 3 of 5

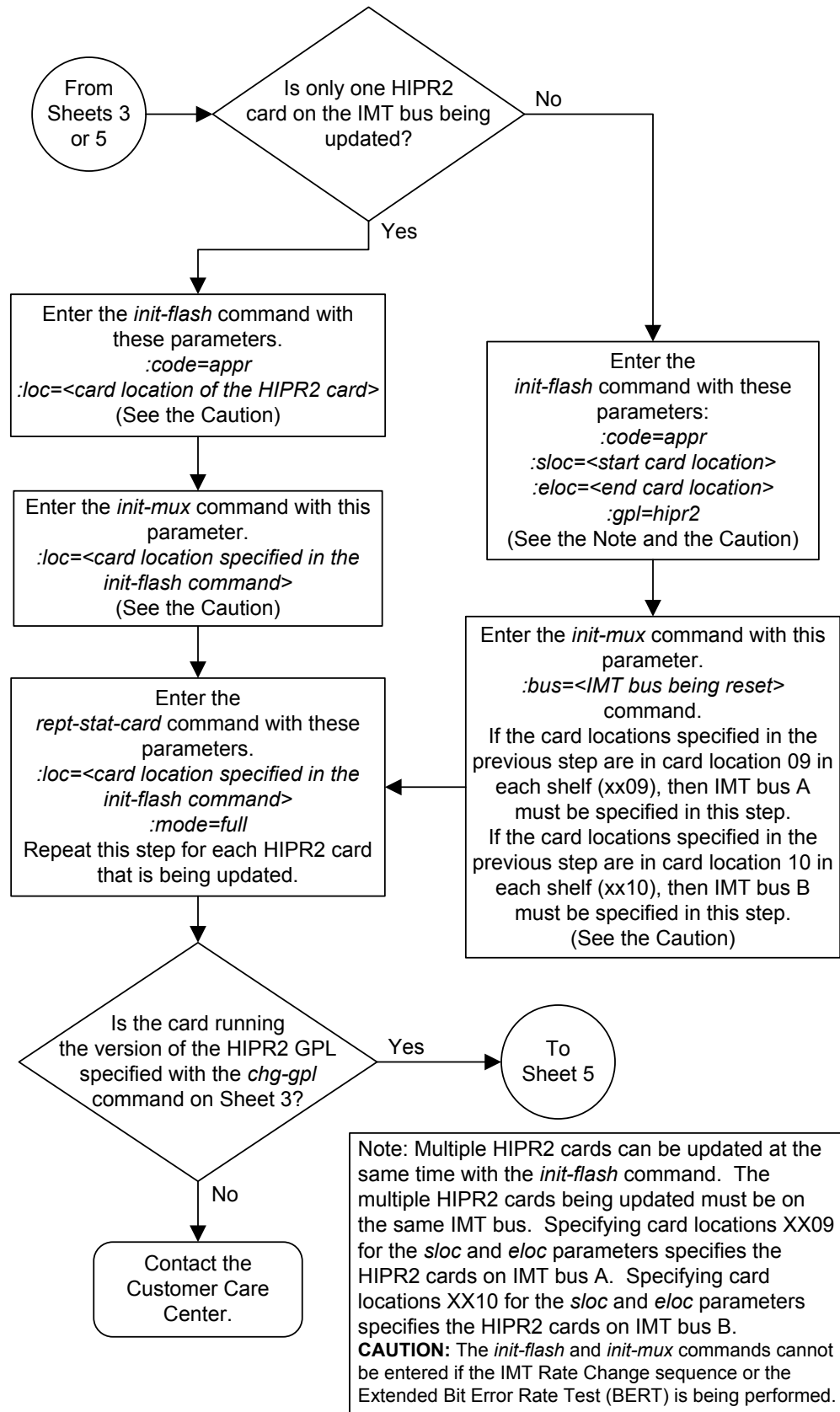

Sheet 4 of 5

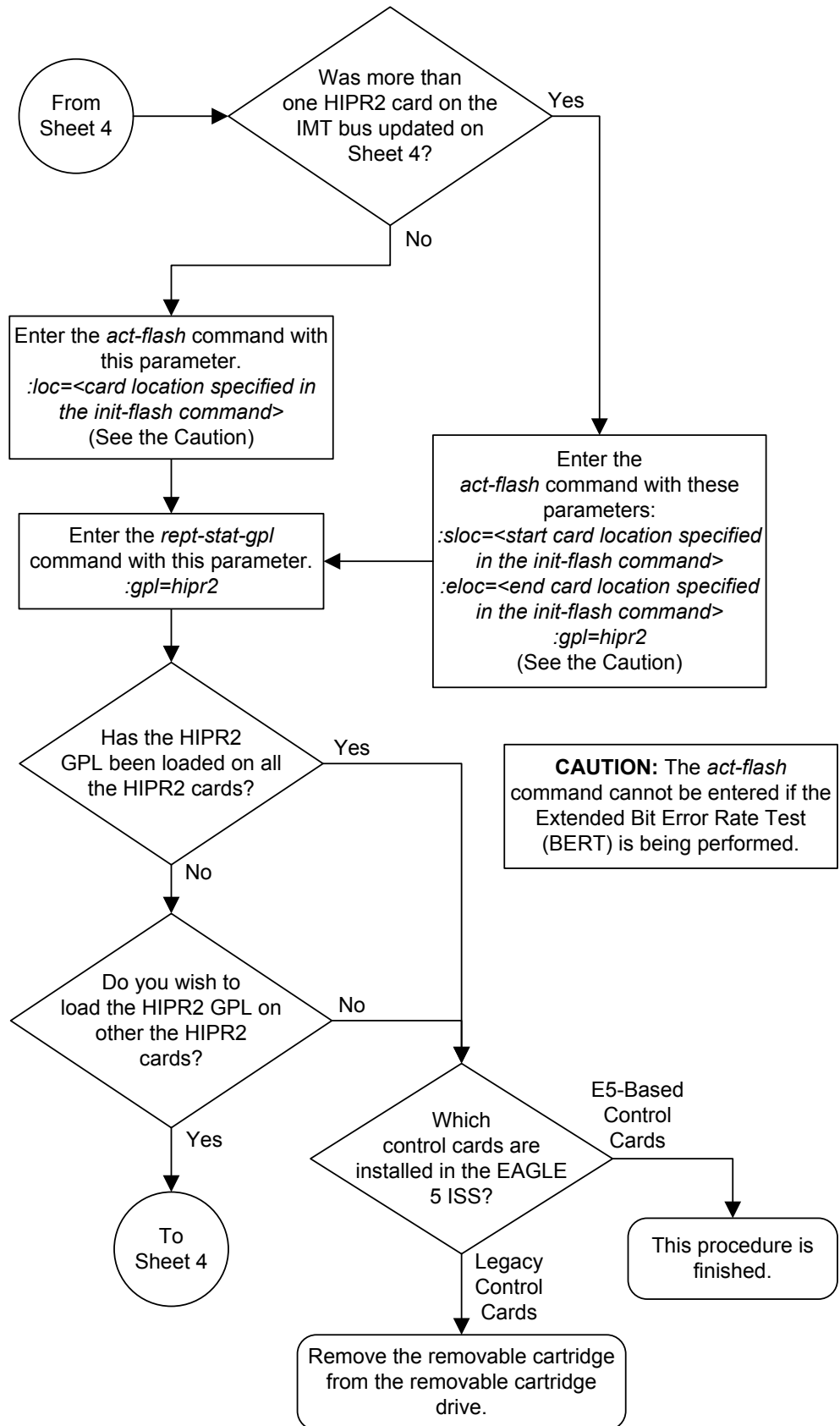

```
rlghncxa03w 09-03-01 07:01:08 GMT EAGLE5 40.1.0
GPL Auditing ON
```

GPL	CARD	RELEASE	APPROVED	TRIAL	REMOVE TRIAL
CDU	1114	162-000-000	162-000-000	162-001-000	162-001-000
CDU	1116	162-000-000	162-000-000	162-001-000	162-001-000
CDU	1115	-----	-----	-----	-----

If the version of the UTILITY GPL shown in the REMOVE TRIAL column of the `rtrv-gpl` output is not the version that is to be loaded onto the cards, remove the removable media from the active MASP.

Insert the removable media that contains the UTILITY GPL that is being updated into the removable media drive in the active MASP and repeat this step.

For more information about inserting or removing removable media in the media drive, refer to [Removable USB Drive](#).

If the version of the UTILITY GPL shown in the REMOVE TRIAL column of the `rtrv-gpl` output is the version that is to be loaded onto the cards, continue the procedure with 5.

- Change the **GPLs**, using the `chg-gpl` command and specifying the value for the trial UTILITY GPL shown in the output of the `rtrv-gpl` command used in 4.

For this example, enter this command.

```
chg-gpl:gpl=utility:ver=162-001-000
```

This message should appear.

```
rlghncxa03w 09-03-01 06:52:20 GMT EAGLE5 40.1.0
GPL Auditing ON
```

```
UTILITY upload to 1114 completed
UTILITY upload to 1116 completed
System Release ID table upload 1114 completed
System Release ID table upload 1116 completed
```

- Display the UTILITY GPLs on the fixed disk and on the removable cartridge using the `rtrv-gpl:gpl=utility` command.

This is an example of the possible output.

```
rlghncxa03w 09-03-01 07:01:08 GMT EAGLE5 40.1.0
GPL Auditing ON
```

GPL	CARD	RELEASE	APPROVED	TRIAL	REMOVE TRIAL
CDU	1114	162-001-000	162-001-000	162-001-000	162-001-000
CDU	1116	162-001-000	162-001-000	-----	-----

This is an example of the possible output.

```
rlghncxa03w 09-03-01 07:01:08 GMT EAGLE5 40.1.0
GPL Auditing ON
```

GPL	CARD	RELEASE	APPROVED	TRIAL	REMOVE TRIAL
CDU	1114	162-001-000	162-001-000	162-001-000	162-001-000

CDU	1116	162-001-000	162-001-000	162-001-000	162-001-000
CDU	1115	-----	-----	-----	-----

7. This procedure is finished.

Figure 3-6 Making the Trial Utility GPL the Approved Utility GPL

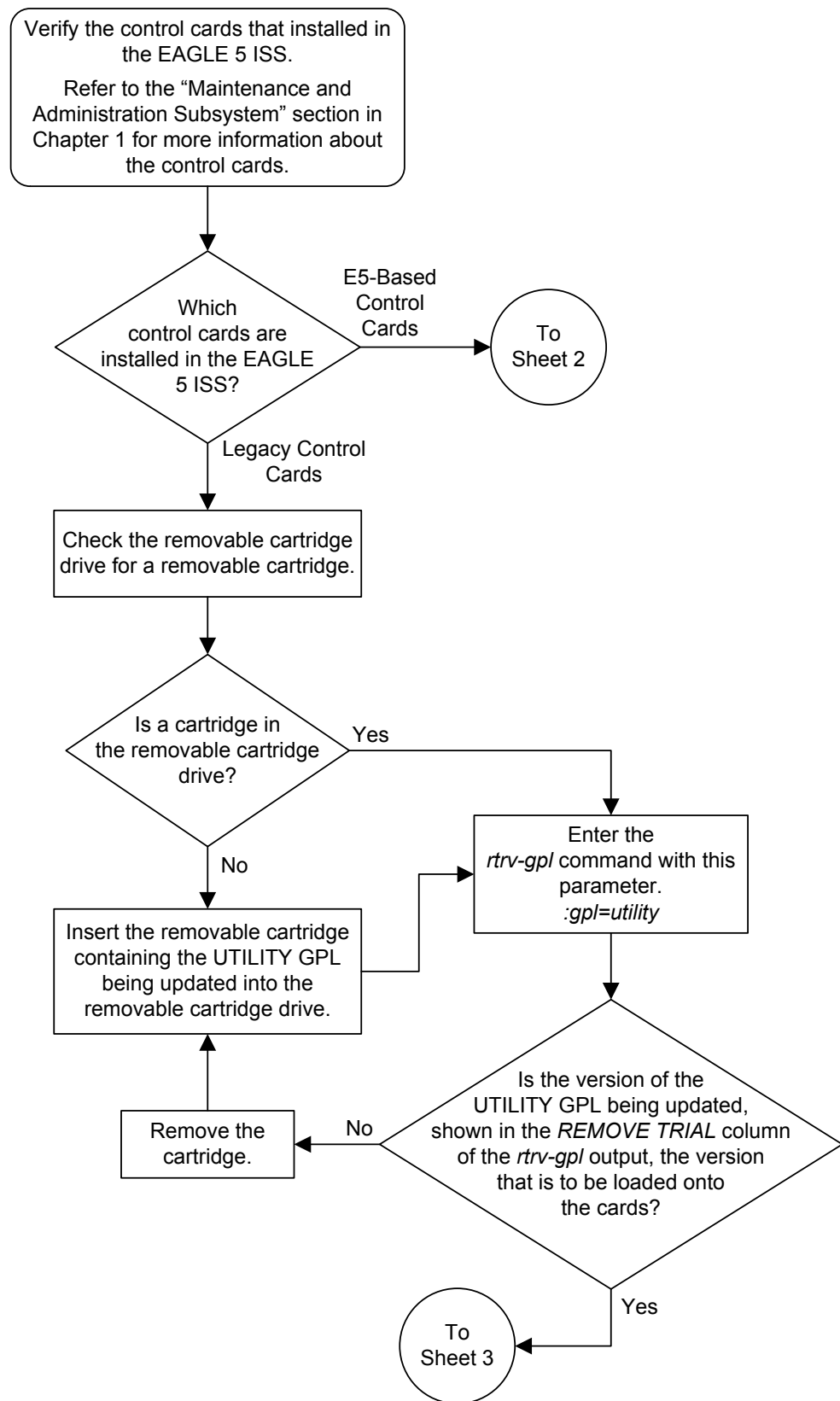

Sheet 1 of 3

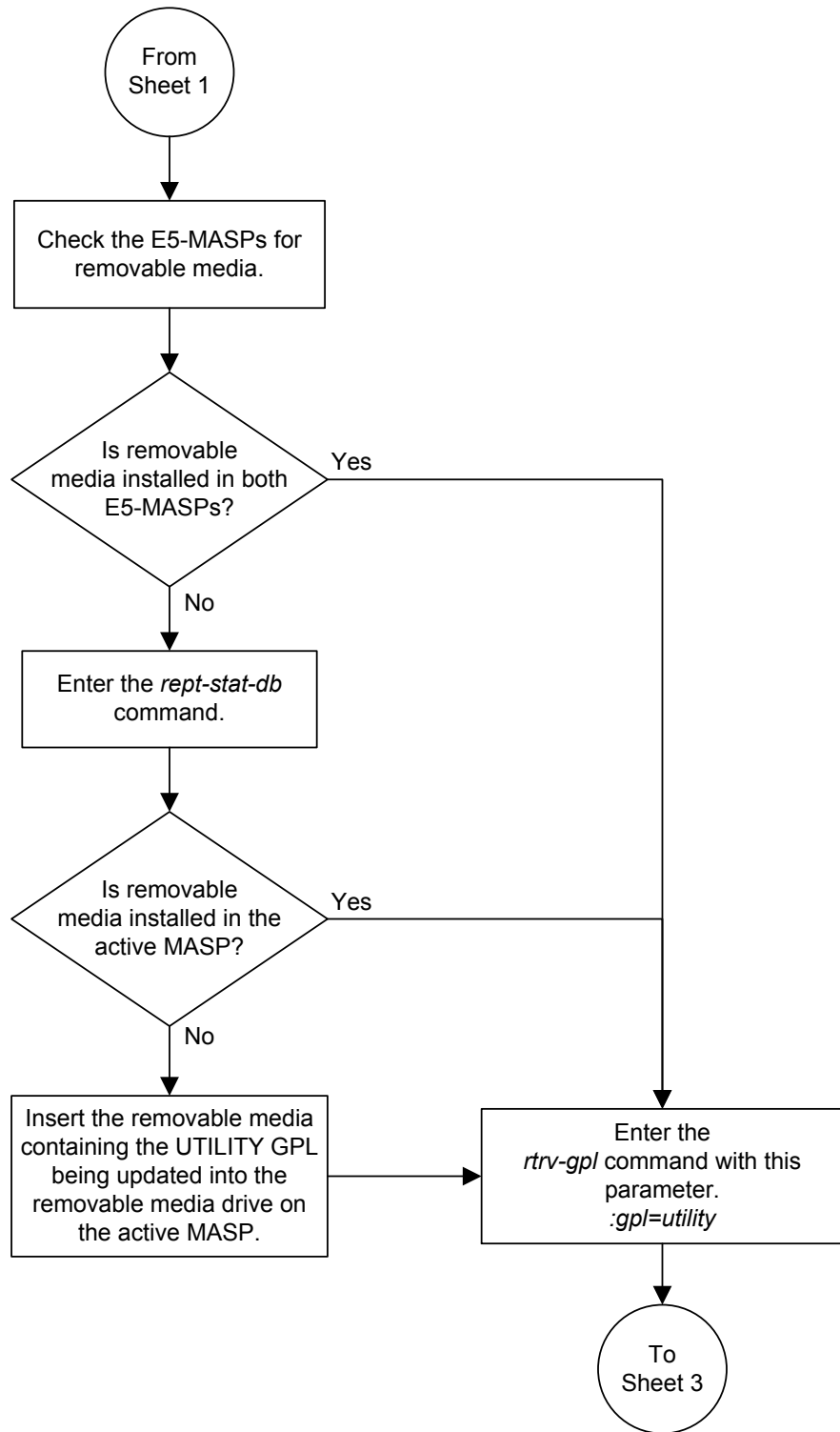

Sheet 2 of 3

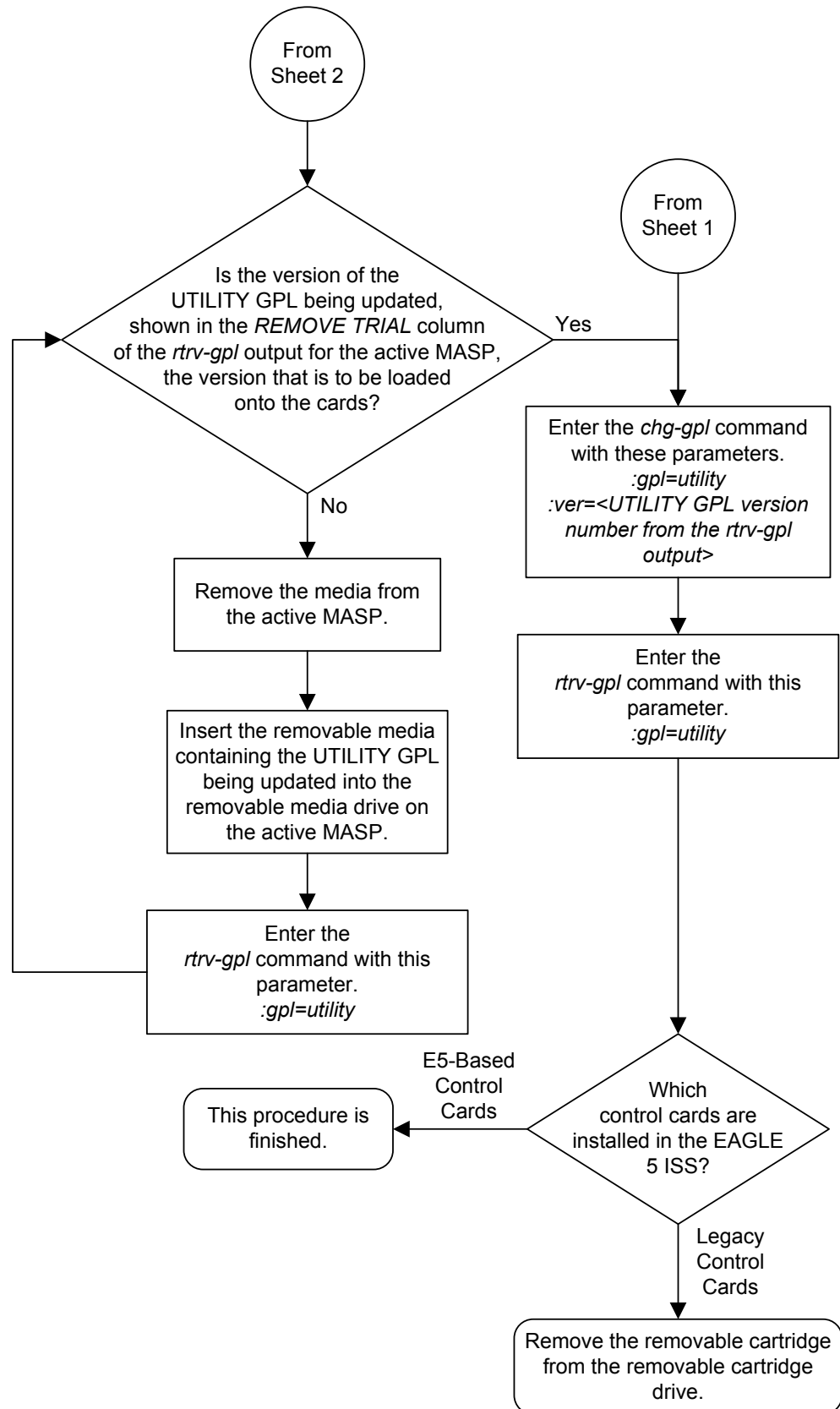

Reloading the TDM LCA Clock Bitfile

This procedure is used to reload the clock **LCA** (logic cell array) bitfile on the **TDMs** using the `init-card` command. To reload the **TDM** clock **LCA** bitfile, the E5-MCAP card associated with the **TDM** being reloaded is initialized by entering the `init-card` command with the `initclk=yes` parameter.

It is recommended that the card specified in the `init-card` command is the **GPSM-II** or E5-MCAP card in the standby **MASP**. The `rept-stat-db` output in 7 shows which **TDM** is the standby **TDM** with the indicator (`STDBY`) after the **TDM**'s card location. If the **TDM** in card location 1114 is the standby **TDM**, card location 1113 must be specified. If the **TDM** in card location 1116 is the standby **TDM**, card location 1115 must be specified.

The **TDM** clock **LCA** bitfile can be reloaded only on **TDMs** with part numbers 870-0774-15 or later. If the **EAGLE** contains older **TDMs**, these **TDMs** must be replaced with **TDMs** 870-0774-15 or later to perform this procedure.

Note: Contact [My Oracle Support \(MOS\)](#) before replacing the **TDMs**.

The `init-card` also contains the `force=yes` parameter. The `force=yes` parameter can be used only with the `initclk=yes` parameter. The `force=yes` parameter must be used if reloading the **TDM** clock **LCA** bitfile would cause a system clock outage.

Caution: A system clock outage can be caused by either the **EAGLE** having only one **TDM** (a simplex **MASP** configuration) or if the status of the high-speed clocks, shown in the `rept-stat-clk` output in 1, on the **TDM** which is not being reset is Fault. A system clock outage will result in a loss of traffic on some or all signaling links.

1. Verify the status of the high-speed clocks by entering the `rept-stat-clk` command. This is an example of the possible output.

```
rlghncxa03w 09-03-01 11:34:04 GMT  EAGLE5 40.1.0
COMPOSITE                               PST           SST           AST
  SYSTEM CLOCK                          IS-NR         Active        -----
ALARM STATUS = No Alarms.
  Primary Comp Clk 1114 (CLK A)         IS-NR         Active        -----
  Primary Comp Clk 1116 (CLK B)         IS-NR         Active        -----
  Secondary Comp Clk 1114 (CLK A)       IS-NR         Idle          -----
  Secondary Comp Clk 1116 (CLK B)       IS-NR         Idle          -----

Clock      Using      Bad
CLK A      9           0
CLK B      0           0
CLK I      0           --

HIGH SPEED                               PST           SST           AST
  SYSTEM CLOCK                          IS-NR         Idle          -----
ALARM STATUS = No Alarms.
  Primary HS Clk 1114 (HS CLK A)         IS-NR         Active        -----
  Primary HS Clk 1116 (HS CLK B)         IS-NR         Active        -----
```

```

Secondary HS Clk 1114 (HS CLK A) IS-NR      Idle      -----
Secondary HS Clk 1116 (HS CLK B) IS-NR      Idle      -----

```

```

HS CLK TYPE 1114      = RS422
HS CLK LINELEN 1114   = LONGHAUL
HS CLK TYPE 1116      = RS422
HS CLK LINELEN 1116   = LONGHAUL

```

```

Clock      Using      Bad
HS CLK A   2          0
HS CLK B   0          0
HS CLK I   0          --

```

Command Completed

If the `rept-stat-clk` output does not show any high-speed clocks (HIGH SPEED SYSTEM CLOCK, Primary HS Clk, Secondary HS Clk, HS CLK TYPE, and HS CLK LINELEN fields), the EAGLE does not contain any cards that are capable of using high-speed master timing.

- If the HS CLK TYPE and HS CLK LINELEN values shown in 1 are set to the system default values (HS CLK TYPE = RS422 and HS CLK LINELEN = LONGHAUL), continue the procedure with 3.
- If the HS CLK TYPE and HS CLK LINELEN values shown in 1 are not set to the system default values (HS CLK TYPE = RS422 and HS CLK LINELEN = LONGHAUL), continue the procedure with 2.

2. Visually verify the part numbers of both TDMs in the EAGLE. To load the TDM clock LCA bitfile, the part numbers of both TDMs must be 870-0774-15 or later.

If the TDM part numbers are 870-0774-15 or later, continue the procedure with 3.

If the TDM part numbers are not 870-0774-15 or later, the TDMs must be replaced with TDM part numbers 870-0774-15 or later. Contact the Customer Care Center before replacing the TDMs. Refer to [My Oracle Support \(MOS\)](#) for the contact information. If the older TDMs are not replaced, this procedure cannot be performed.

3. Display the terminal configuration in the database with the `rtrv-trm` command.

If any SEAS terminals are present, they must be taken out of service. The SEAS terminals are shown in the output with the entry SEAS in the TYPE field. If no SEAS terminals are shown in the `rtrv-trm` command output, continue the procedure with 7.

This is an example of the possible output. In this example, the SEAS terminals are terminals 18 and 27.

```

rlghncxa03w 10-07-01 16:02:08 GMT EAGLE5 42.0.0
TRM  TYPE      COMM          FC      TMOUT  MXINV  DURAL
1    VT320      9600-7-E-1   SW      30     5      99:59:59
2    KSR        9600-7-E-1   HW      30     5      INDEF
3    PRINTER    4800-7-E-1   HW      30     0      00:00:00
4    VT320      2400-7-E-1   BOTH    30     5      00:30:00
5    VT320      9600-7-O-1   NONE    30     5      00:00:30
6    VT320      9600-7-O-1   NONE    30     5      00:00:30
7    PRINTER    9600-7-N-2   HW      30     5      00:30:00
8    KSR        19200-7-E-2  BOTH    30     5      00:30:00
9    VT320      9600-7-O-1   NONE    30     5      00:00:30

```

```

10 VT320 9600-7-E-1 HW 30 5 00:30:00
11 VT320 4800-7-E-1 HW 30 5 00:30:00
12 PRINTER 9600-7-E-1 HW 30 4 00:30:00
13 VT320 9600-7-O-1 NONE 30 5 00:30:00
14 VT320 9600-7-E-2 SW 30 8 00:30:00
15 VT320 9600-7-N-2 HW 30 5 00:30:00
16 VT320 9600-7-E-2 BOTH 30 3 00:30:00

```

TRM	TYPE	LOC	TMOUT	MXINV	DURAL	SECURE
17	TELNET	1201	60	5	00:30:00	yes
18	SEAS	1201	60	5	00:30:00	yes
19	TELNET	1201	60	5	00:30:00	yes
20	TELNET	1201	60	5	00:30:00	yes
21	TELNET	1201	60	5	00:30:00	yes
22	TELNET	1201	60	5	00:30:00	yes
23	TELNET	1201	60	5	00:30:00	yes
24	TELNET	1201	60	5	00:30:00	yes
25	TELNET	1203	60	5	00:30:00	yes
26	TELNET	1203	60	5	00:30:00	yes
27	SEAS	1203	60	5	00:30:00	yes
28	TELNET	1203	60	5	00:30:00	yes
29	TELNET	1203	60	5	00:30:00	yes
30	TELNET	1203	60	5	00:30:00	yes
31	TELNET	1203	60	5	00:30:00	yes
32	TELNET	1203	60	5	00:30:00	yes
33	TELNET	1205	60	5	00:30:00	yes
34	TELNET	1205	60	5	00:30:00	yes
35	TELNET	1205	60	5	00:30:00	yes
36	TELNET	1205	60	5	00:30:00	yes
37	TELNET	1205	60	5	00:30:00	yes
38	TELNET	1205	60	5	00:30:00	yes
39	TELNET	1205	60	5	00:30:00	yes
40	TELNET	1205	60	5	00:30:00	yes

Note: The `rtrv-trm` command output contains other fields that are not used by this procedure. If you wish to see all the fields displayed by the `rtrv-trm` command, see the `rtrv-trm` command description in *Commands User's Guide*.

4. Display the status of the terminals with the `rept-stat-trm` command. This is an example of the possible output.

```

rlghncxa03w 09-03-01 15:08:45 GMT EAGLE5 40.1.0
TRM  PST      SST      AST
1    IS-NR    Active  -----
2    IS-NR    Active  -----
3    IS-NR    Active  -----
4    IS-NR    Active  -----
5    IS-NR    Active  -----
6    IS-NR    Active  -----
7    IS-NR    Active  -----
8    IS-NR    Active  -----
9    IS-NR    Active  -----
10   IS-NR    Active  -----
11   IS-NR    Active  -----
12   IS-NR    Active  -----
13   IS-NR    Active  -----
14   IS-NR    Active  -----
15   IS-NR    Active  -----
16   IS-NR    Active  -----
17   IS-NR    Active  -----

```

18	IS-NR	Active	-----
19	IS-NR	Active	-----
20	IS-NR	Active	-----
21	IS-NR	Active	-----
22	IS-NR	Active	-----
23	IS-NR	Active	-----
24	IS-NR	Active	-----
25	IS-NR	Active	-----
26	IS-NR	Active	-----
27	IS-NR	Active	-----
28	IS-NR	Active	-----
29	IS-NR	Active	-----
30	IS-NR	Active	-----
31	IS-NR	Active	-----
32	IS-NR	Active	-----
33	IS-NR	Active	-----
34	IS-NR	Active	-----
35	IS-NR	Active	-----
36	IS-NR	Active	-----
37	IS-NR	Active	-----
38	IS-NR	Active	-----
39	IS-NR	Active	-----
40	IS-NR	Active	-----

Command Completed.

- Place the SEAS terminals out of service using the `rmv-trm` command with the number of the terminal displayed in 4 whose state is not OOS-MT-DSBLD.

The `force=yes` parameter must be used when placing the last SEAS terminal out of service.

If SEAS terminals are shown in the `rtrv-trm` output in 3, for this example, enter these commands.

```
rmv-trm:trm=18
rmv-trm:trm=27:force=yes
```

Caution: Placing the SEAS terminals out of service will disable the SEAS feature on the EAGLE.

If the status of any of the terminals shown in the `PST` field in 4 is OOS-MT-DSBLD (out-of-service maintenance disabled), the terminal is already out of service and the `rmv-trm` command does not need to be executed for that terminal.

This message should appear when each of these commands have successfully completed.

```
rlghncxa03w 09-03-01 15:08:45 GMT EAGLE5 40.1.0
Inhibit message sent to terminal

rlghncxa03w 09-03-01 15:08:45 GMT EAGLE5 40.1.0
Command Completed.
```

- 6 is performed only if the SEAS terminals were placed out of service in this step. If the SEAS terminals were not placed out of service in this step, continue the procedure with 7.

- If the SEAS terminals were placed out of service in this step, continue the procedure with 6.
6. Change the terminal type of the SEAS terminals to **NONE** with the `chg-trm` command, the `type=none` parameter, and with the values of the SEAS terminals used in 5.

If SEAS terminals are shown in the `rtrv-trm` output in 3, for this example, enter these commands.

```
chg-trm:trm=18:type=none
```

```
chg-trm:trm=27:type=none
```

This message should appear when these commands have successfully completed.

```
rlghncxa03w 09-03-01 11:11:28 GMT EAGLE5 40.1.0
CHG-TRM: MASP B - COMPLTD
```

7. Enter the `rept-stat-db` command, to determine which **MASP** is active, This is an example of the possible output.

```
rlghncxa03w 09-03-01 16:07:48 GMT EAGLE5 40.1.0
DATABASE STATUS: >> OK <<
      TDM 1114 ( ACTV )                TDM 1116 ( STDBY)
      C LEVEL      TIME LAST BACKUP    C LEVEL      TIME LAST BACKUP
      - - - - -
FD BKUP Y          35 09-02-19 10:19:18 GMT Y          35 09-02-19 10:19:18 GMT
FD CRNT Y          106                    Y          106
      MDAL 1117
      - - - - -
RD BKUP -          -          -          -
```

If E5-based control cards are installed in the EAGLE, this is an example of the possible output.

```
rlghncxa03w 09-03-01 16:07:48 GMT EAGLE5 40.1.0
DATABASE STATUS: >> OK <<
      TDM 1114 ( ACTV )                TDM 1116 ( STDBY)
      C LEVEL      TIME LAST BACKUP    C LEVEL      TIME LAST BACKUP
      - - - - -
FD BKUP Y          35 09-02-19 10:19:18 GMT Y          35 09-02-19 10:19:18 GMT
FD CRNT Y          106                    Y          106
      MCAP 1113                        MCAP 1115
      - - - - -
RD BKUP -          -          -          -
USB BKP -          -          -          Y          3 09-02-07 01:11:22 GMT
```

The output of the `rept-stat-db` command shows which **MASP** is active with the indicator (`ACTV`) following the **TDM** card location. The indicator (`STDBY`) following the **TDM** card location shows which **MASP** is standby.

For this example, the **MASP** associated with **TDM 1114** is active and the **MASP** associated with **TDM 1116** is standby.

8. Place the E5-MCAP card in the standby MASP out of service using the `rmv-card` command.

The `rept-stat-db` output in 7 shows which TDM is the standby TDM with the entry (`Standby`) after the TDMs card location. If the TDM in card location 1114

is the standby TDM, card location 1113 must be specified in this step. If the TDM in card location 1116 is the standby TDM, card location 1115 must be specified in this step.

For this example, enter this command.

```
rmv-card:loc=1115
```

When this command has successfully completed, this message should appear.

```
rlghncxa03w 09-03-01 11:11:28 GMT EAGLE5 40.1.0
Card has been inhibited.
```

9. Load the TDM clock LCA bitfile onto the TDM associated with the E5-MCAP card inhibited in 8 using the `init-card` command with the `initclk=yes` parameter and the card location of the standby E5-MCAP card.

Caution: If reloading the TDM clock LCA bitfile would cause a system clock outage, the `force=yes` parameter must be used with the `init-card` command. A system clock outage can be caused by either the EAGLE having only one TDM (a simplex MASP configuration) or if the status of the high-speed clocks, shown in the `rept-stat-clk` output in 1, on the TDM which is not being reset is Fault. A system clock outage will result in a loss of traffic on some or all signaling links.

For this example, enter this command.

```
init-card:initclk=yes:loc=1115
```

When this command has successfully completed, these messages should appear.

```
rlghncxa03w 09-03-01 13:01:59 GMT EAGLE5 40.1.0
Init Card command issued to card 1115
;

rlghncxa03w 09-03-01 13:01:59 GMT EAGLE5 40.1.0
* 3021.0013 * CARD 1115 EOAM Card is isolated from the system
;

rlghncxa03w 09-03-01 13:03:10 GMT EAGLE5 40.1.0
3022.0014 CARD 1115 EOAM Card is present
ASSY SN: 1216115
```

If E5-based control cards are installed in the EAGLE, this is an example of the possible output.

```
rlghncxa03w 09-03-01 13:01:59 GMT EAGLE5 40.1.0
Init Card command issued to card 1115
;

rlghncxa03w 09-03-01 13:01:59 GMT EAGLE5 40.1.0
* 3021.0013 * CARD 1115 OAMHC Card is isolated from the system
;

rlghncxa03w 09-03-01 13:03:10 GMT EAGLE5 40.1.0
3022.0014 CARD 1115 OAMHC Card is present
ASSY SN: 1216115
```

10. Put the E5-MCAP card that was inhibited in 9 back into service using the `rst-card` command with the card location specified in 9. For this example, enter this command.

```
rst-card:loc=1115
```

When this command has successfully completed, this message should appear.

```
rlghncxa03w 09-03-01 11:11:28 GMT EAGLE5 40.1.0
Card has been allowed.
```

- If the TDM clock LCA bitfile will not be loaded on the other TDM in the EAGLE, continue the procedure with 12.
- If the TDM clock LCA bitfile will be loaded on the other TDM in the EAGLE, continue the procedure with 11.

11. If you wish to load the TDM clock LCA bitfile onto the TDM making up the active MASP, enter the `init-card` command specifying the location of the E5-MCAP card making up active MASP. Initializing the E5-MCAP card of the active MASP makes the MASPs switch roles. The active MASP becomes the standby MASP, and the standby (text is missing from this point).

For this example, enter the `init-card:loc=1113` command. This message should appear.

```
rlghncxa03w 09-03-01 11:11:28 GMT EAGLE5 40.1.0
Init Card command issued to card 1113
```

After the `init-card` command has completed, repeat the procedure from 8, specifying the card location used in the `init-card` command.

12. Verify the status of the high-speed clocks by entering the `rept-stat-clk` command. This is an example of the possible output.

```
rlghncxa03w 09-03-01 11:34:04 GMT EAGLE5 40.1.0
COMPOSITE                                PST          SST          AST
  SYSTEM CLOCK                            IS-NR        Active       -----
ALARM STATUS = No Alarms.
  Primary Comp Clk 1114 (CLK A)           IS-NR        Active       -----
  Primary Comp Clk 1116 (CLK B)           IS-NR        Active       -----
  Secondary Comp Clk 1114 (CLK A)         IS-NR        Idle         -----
  Secondary Comp Clk 1116 (CLK B)         IS-NR        Idle         -----

Clock      Using      Bad
CLK A      9             0
CLK B      0             0
CLK I      0             --

HIGH SPEED                                PST          SST          AST
  SYSTEM CLOCK                            IS-NR        Idle         -----
ALARM STATUS = No Alarms.
  Primary HS Clk 1114 (HS CLK A)           IS-NR        Active       -----
  Primary HS Clk 1116 (HS CLK B)           IS-NR        Active       -----
  Secondary HS Clk 1114 (HS CLK A)         IS-NR        Idle         -----
  Secondary HS Clk 1116 (HS CLK B)         IS-NR        Idle         -----

HS CLK TYPE 1114      = RS422
HS CLK LINELEN 1114  = LONGHAUL
HS CLK TYPE 1116      = RS422
```

```
HS CLK LINELEN 1116 = LONGHAUL
```

Clock	Using	Bad
HS CLK A	2	0
HS CLK B	0	0
HS CLK I	0	--

Command Completed

- If 6 was not performed, continue the procedure with 16.
- If 6 was performed, continue the procedure with 13.

13. If SEAS terminals were changed in 6, for this example, enter these commands.

```
chg-trm:trm=18:type=seas
```

```
chg-trm:trm=27:type=seas
```

This message should appear when these commands have successfully completed.

```
rlghncxa03w 09-03-01 11:11:28 GMT EAGLE5 40.1.0
CHG-TRM: MASP B - COMPLTD
```

14. Put the SEAS terminals back into service using the `rst-trm` command with the number of the terminals specified in 13. For this example, enter these commands.

```
rst-trm:trm=18
```

```
rst-trm:trm=27
```

This message should appear when each of these commands have successfully completed.

```
rlghncxa03w 09-03-01 15:08:45 GMT EAGLE5 40.1.0
Allow message sent to terminal
```

```
rlghncxa03w 09-03-01 15:08:45 GMT EAGLE5 40.1.0
Command Completed.
```

15. Verify that the terminals are in service with the `rept-stat-trm` command. This is an example of the possible output.

```
rlghncxa03w 09-03-01 15:08:45 GMT EAGLE5 40.1.0
TRM  PST          SST          AST
1    IS-NR         Active       -----
2    IS-NR         Active       -----
3    IS-NR         Active       -----
4    IS-NR         Active       -----
5    IS-NR         Active       -----
6    IS-NR         Active       -----
7    IS-NR         Active       -----
8    IS-NR         Active       -----
9    IS-NR         Active       -----
10   IS-NR         Active       -----
11   IS-NR         Active       -----
12   IS-NR         Active       -----
13   IS-NR         Active       -----
14   IS-NR         Active       -----
15   IS-NR         Active       -----
16   IS-NR         Active       -----
17   IS-NR         Active       -----
18   IS-NR         Active       -----
```

```
19 IS-NR Active -----
20 IS-NR Active -----
21 IS-NR Active -----
22 IS-NR Active -----
23 IS-NR Active -----
24 IS-NR Active -----
25 IS-NR Active -----
26 IS-NR Active -----
27 IS-NR Active -----
28 IS-NR Active -----
29 IS-NR Active -----
30 IS-NR Active -----
31 IS-NR Active -----
32 IS-NR Active -----
33 IS-NR Active -----
34 IS-NR Active -----
35 IS-NR Active -----
36 IS-NR Active -----
37 IS-NR Active -----
38 IS-NR Active -----
39 IS-NR Active -----
40 IS-NR Active -----
```

Command Completed.

- 16.** Back up the new changes using the `chg-db:action=backup:dest=fixed` command. These messages should appear, the active Maintenance and Administration Subsystem Processor (MASP) appears first.

```
BACKUP (FIXED) : MASP A - Backup starts on active MASP.
BACKUP (FIXED) : MASP A - Backup on active MASP to fixed disk complete.
BACKUP (FIXED) : MASP A - Backup starts on standby MASP.
BACKUP (FIXED) : MASP A - Backup on standby MASP to fixed disk complete.
```

Figure 3-7 Reloading the TDM LCA Clock Bitfile

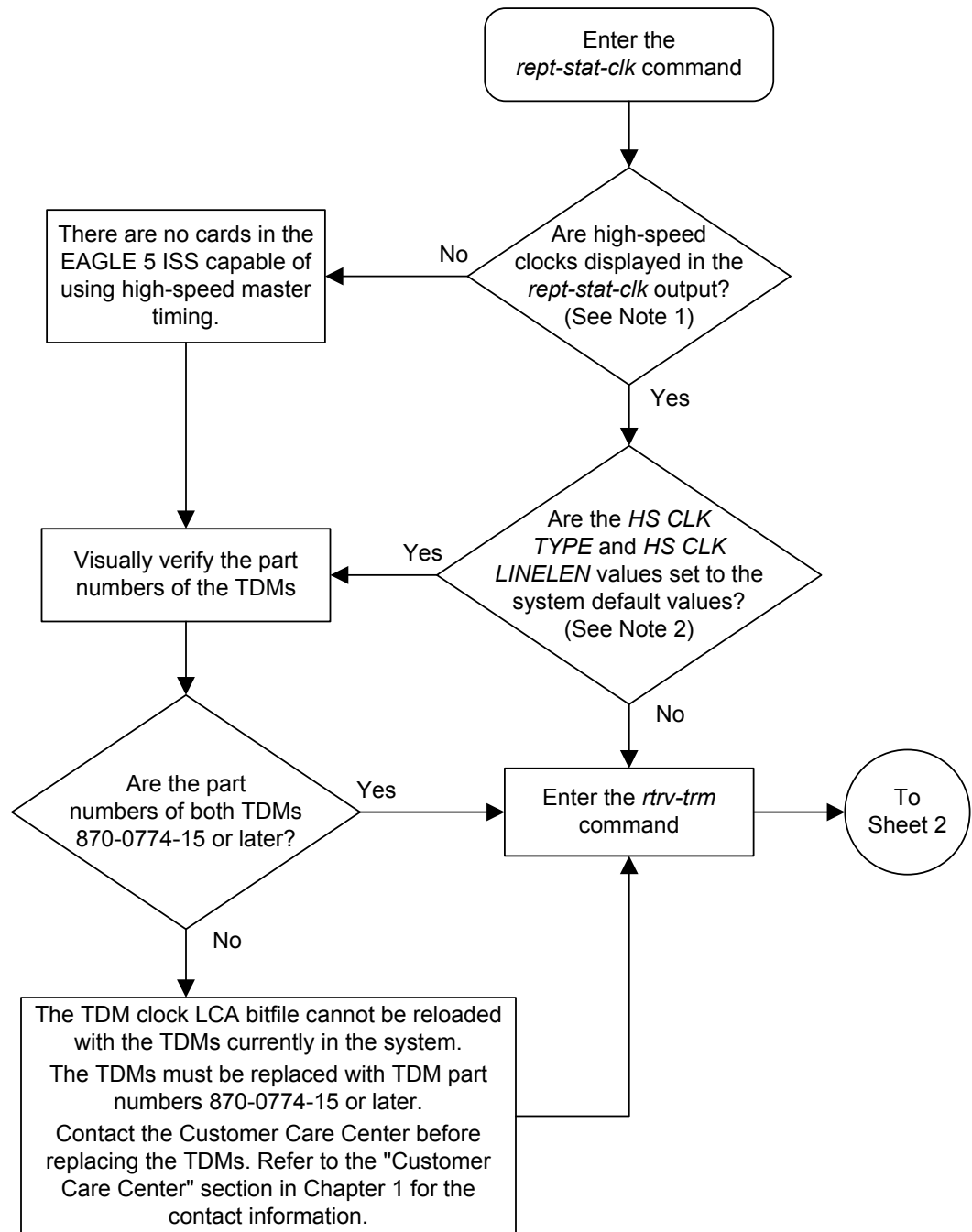

Notes:

1. High-speed clocks (the HS SYSTEM CLOCK, HS PRIMARY CLK, HS SECONDARY CLK, HS CLK TYPE, and HS CLK LINELEN fields) are shown in the *rept-stat-clk* output only when the EAGLE 5 ISS contains cards capable of using high-speed master timing.

2. The system default values are:

HS CLK TYPE - RS422

HS CLK LINELEN - LONGHAUL

Sheet 1 of 3

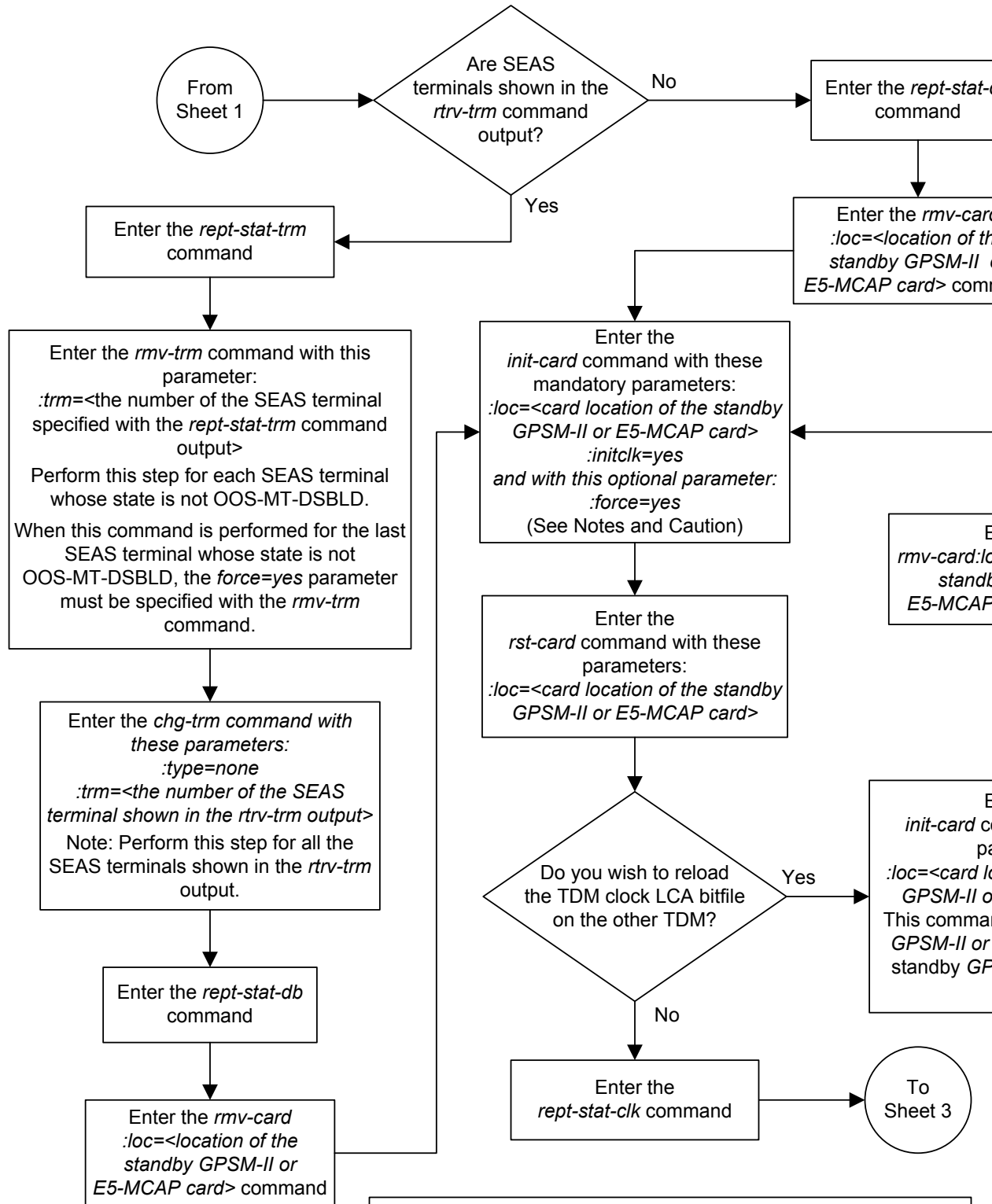

Notes:

1. The *initclk=yes* parameter can be specified only if the part numbers of the TDMs in the EAGLE 5 ISS are 870-0774-15 or later. See Sheet 1.
2. The *force=yes* parameter should be used only if the TDM clock LCA bitfile reload would cause a system clock outage. A system clock outage can be caused by either the EAGLE 5 ISS having only one TDM (a simplex MASP configuration) or if the status of the high-speed clocks on the TDM which is not being reset is Fault. See the *rept-stat-clk* output from Sheet 1.

Caution: A clock outage will result in a loss of traffic on some or all signaling links.

Sheet 2 of 3

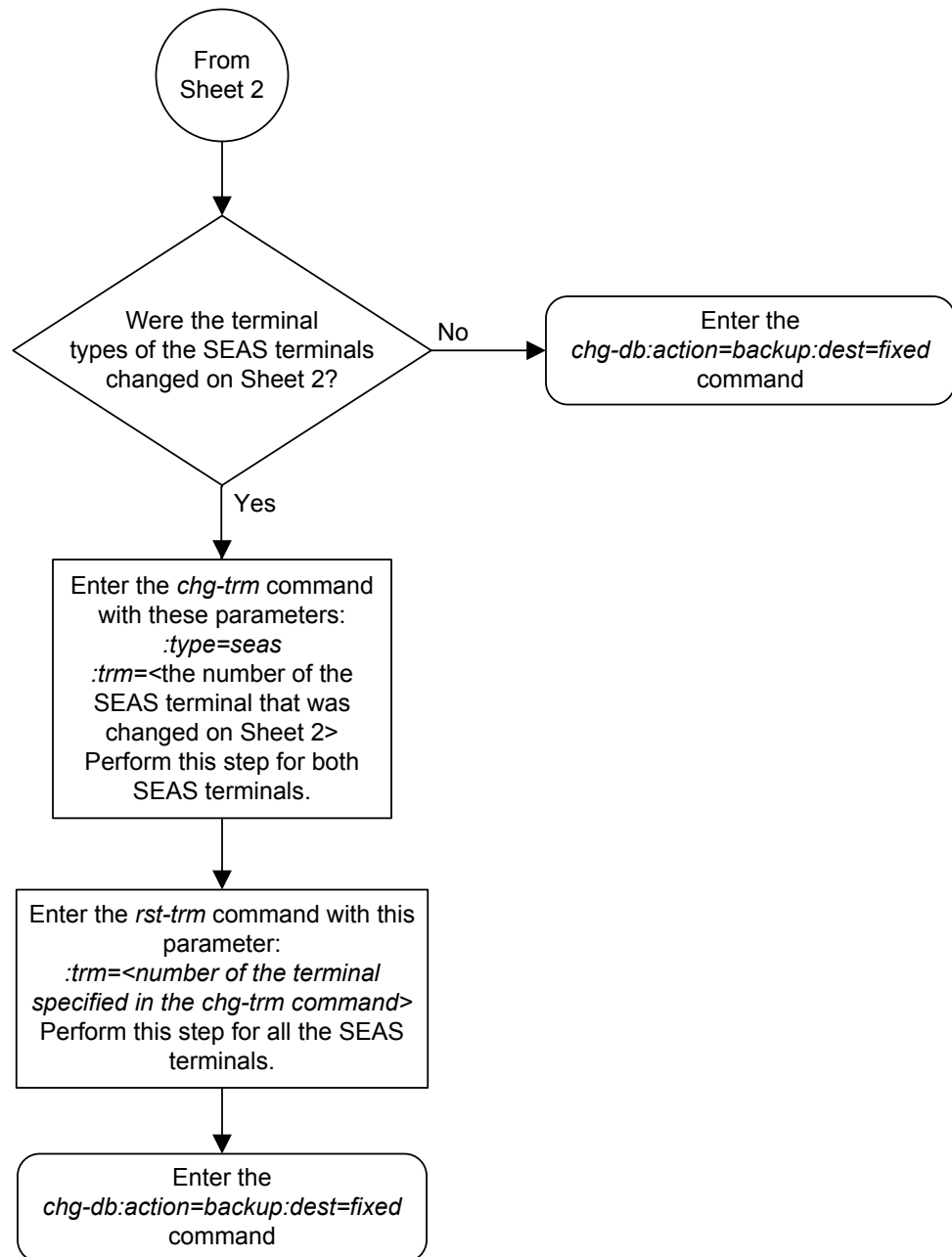

Updating the BLIXP GPL

The BLIXP GPL is a tar image of all the flash GPLs that are necessary to operate the cards shown in [Table 3-5](#). When the BLIXP GPL is downloaded to the card, the tar image is un-archived and the flash GPLs are loaded onto the card.

Table 3-5 High-Capacity Cards

HC MIM	E5-E1T1	E5-ENET
E5-STC	E5-SLAN	E5-SM4G
E5-ATM	E5-TSM	

This procedure updates the BLIXP GPL using the `init-flash` and `act-flash` commands.

Caution: The `init-flash` command cannot be entered if the IMT Rate Change sequence or the Extended Bit Error Rate Test (BERT) is being performed. The `act-flash` command cannot be entered if the Extended Bit Error Rate Test (BERT) is being performed.

The applications and entities supported by the high-capacity cards are shown in [Table 3-6](#).

Table 3-6 High-Capacity Card Applications

High-Capacity Card	Card Name (as shown on the card label)	Application	Application GPL Running on the Card	Supported Entities
HC MIM	HC MIM	SS7ANSI, CCS71TU	SS7HC	E1 or T1 signaling links
E5-E1T1	E5-E1T1	SS7ANSI, CCS71TU	SS7HC	E1 or T1 signaling links
E5-ENET	E5-ENET	SS7IPGW, IPLIM, IPLIMI, IPGWI, IPSG	IPLHC, IPGHC, IPSG	IP signaling links
E5-STC	E5-ENET	EROUTE	ERTHC	EAGLE 5 Integrated Monitoring Support
E5-SM4G	E5-SM4G	VSCCP	SCCPHC	GTT-related features
E5-SLAN	E5-ENET	STPLAN	SLANHC	TCP/IP data links for the STPLAN feature

Table 3-6 (Cont.) High-Capacity Card Applications

High-Capacity Card	Card Name (as shown on the card label)	Application	Application GPL Running on the Card	Supported Entities
E5-ENET-B/ SLIC	E5-ENET-B SLIC	IPS	IPSHC	Telnet sessions for remote connections to the EAGLE and SEAS terminals for the SEAS over IP feature
E5-ATM	E5-ATM	ATMANSI, ATMITU	ATMHC	ANSI and ITU ATM high-speed signaling links
E5-TSM	E5-TSM	GLS	GLSHC	Gateway Screening related features

A removable cartridge or removable media containing the BLIXP GPL that is being updated is required.

Caution: Before any high-capacity card can be updated with the BLIXP GPL, all the traffic hosted by the high-capacity card must be stopped, and the high-capacity card must be taken out of service.

Canceling the REPT-STAT-SLK and RTRV-SLK Commands

Because the `rept-stat-slk` and `rtrv-slk` commands used in this procedure can output information for a long period of time, the `rept-stat-slk` and `rtrv-slk` commands can be canceled and the output to the terminal stopped. There are three ways that the `rept-stat-slk` and `rtrv-slk` commands can be canceled.

- Press the F9 function key on the keyboard at the terminal where the `rept-stat-slk` or `rtrv-slk` commands command were entered.
- Enter the `canc-cmd` without the `trm` parameter at the terminal where the `rept-stat-slk` or `rtrv-slk` commands were entered.
- Enter the `canc-cmd:trm=<xx>`, where `<xx>` is the terminal where the `rept-stat-slk` or `rtrv-slk` commands were entered, from another terminal other than the terminal where the `rept-stat-slk` or `rtrv-slk` commands were entered. To enter the `canc-cmd:trm=<xx>` command, the terminal must allow Security Administration commands to be entered from it and the user must be allowed to enter Security Administration commands. The terminal's permissions can be verified with the `rtrv-secu-trm` command. The user's permissions can be verified with the `rtrv-user` or `rtrv-secu-user` commands.

For more information about the `canc-cmd` command, go to Commands User's Guide.

1. Verify the control cards that are installed in the EAGLE.

Refer to [Maintenance and Administration Subsystem](#) for information about the control cards.

If E5-based control cards are installed in the EAGLE, continue the procedure with [2](#).

2. Check the E5-MASPs for removable media.

If removable media is installed in both E5-MASPs, continue the procedure with [4](#).

If removable media is not installed in both E5-MASPs, continue the procedure with [3](#).

3. Verify the active MASP by entering the `rept-stat-db` command.

This is an example of the possible output.

```
rlghncxa03w 10-12-01 15:25:40 GMT EAGLE5 43.0.0
DATABASE STATUS: >> OK <<
          TDM 1114 ( STDBY)          TDM 1116 ( ACTV )
          C  LEVEL    TIME LAST BACKUP  C  LEVEL    TIME LAST BACKUP
          - - - - -
FD BKUP Y          36 10-11-19 09:38:25 GMT Y          36 10-11-19 09:38:25 GMT
FD CRNT Y          39                      Y          39
          MCAP 1113                      MCAP 1115
          - - - - -
RD BKUP -          -          -          Y          36 10-11-19 09:27:17 GMT
USB BKP -          -          -          Y          3 10-11-07 01:11:22 GMT
```

If removable media is installed in the active MASP, continue the procedure with [4](#).

If removable media is not installed in the active MASP, insert the removable media in the removable media drive in the active MASP. For more information about inserting removable media in the removable media drive, refer to [Removable USB Drive](#). After the removable media has been inserted in the removable media drive in the active MASP, continue the procedure with [4](#).

4. Display the BLIXP GPL on the fixed disk and on the removable media by entering this command.

```
rtrv-gpl:gpl=blixp
```

This is an example of the possible output.

```
rlghncxa03w 10-12-01 11:34:04 GMT EAGLE5 43.0.0
GPL Auditing ON

GPL      CARD  RELEASE      APPROVED      TRIAL      REMOVE TRIAL
BLIXP    1114  133-002-000  133-002-000  133-001-000  133-003-000
BLIXP    1116  133-002-000  133-002-000  133-001-000  133-003-000
BLIXP    1115  -----      -----      -----      -----
```

If the version of the BLIXP GPL shown in the REMOVE TRIAL column of the `rtrv-gpl` output is not the version that is to be loaded onto the cards, remove the removable media from the active MASP. Insert the removable media that contains the BLIXP GPL that is being updated into the removable media drive in the active MASP and repeat this step. For more information about inserting removable media in the removable media drive, or removing removable media from the removable media drive, refer to [Removable USB Drive](#).

If the version of the BLIXP GPL shown in the REMOVE TRIAL column of the `rtrv-gpl` output is the version that is to be loaded onto the cards, continue the procedure with 133-.

- Change the BLIXP GPL by entering the `chg-gpl` command with the `gpl=blixp` parameter and the version of the BLIXP GPL shown in the REMOVE TRIAL column in the output of the `rtrv-gpl` command used in 4.

For this example, enter this command.

```
chg-gpl:gpl=blixp:ver=133-003-000
```

These messages should appear.

```
rlghncxa03w 10-12-01 11:43:04 GMT EAGLE5 43.0.0
GPL Auditing ON
```

```
BLIXP upload on 1114 completed
BLIXP upload on 1116 completed
System Release ID table upload 1114 completed
System Release ID table upload 1116 completed
```

- Activate the trial GPL by entering the `act-gpl` command with the `gpl=blixp` parameter and the version of the trial GPL specified in 133-.

For this example, enter this command.

```
act-gpl:gpl=blixp:ver=133-003-000
```

These messages should appear.

```
rlghncxa03w 10-12-01 06:54:39 GMT EAGLE5 43.0.0
BLIXP activate on 1114 completed
BLIXP activate on 1116 completed
```

- Verify that the trial GPL has been made the approved GPL by entering this command.

```
rtrv-gpl:gpl=blixp
```

This is an example of the possible output.

```
rlghncxa03w 10-12-01 11:34:04 GMT EAGLE5 43.0.0
GPL Auditing ON
```

GPL	CARD	RELEASE	APPROVED	TRIAL	REMOVE TRIAL
BLIXP	1114	133-003-000	133-003-000	133-002-000	133-003-000
BLIXP	1116	133-003-000	133-003-000	133-002-000	-----

If E5-based control cards are installed in the EAGLE, this is an example of the possible output.

```
rlghncxa03w 10-12-01 11:34:04 GMT EAGLE5 43.0.0
GPL Auditing ON
```

GPL	CARD	RELEASE	APPROVED	TRIAL	REMOVE TRIAL
BLIXP	1114	133-003-000	133-003-000	133-002-000	133-003-000
BLIXP	1116	133-003-000	133-003-000	133-002-000	133-003-000
BLIXP	1115	-----	-----	-----	-----

8. Verify the cards that are running the BLIXP GPL by entering this command

```
rept-stat-gpl:gpl=blixp
```

This is an example of the possible output.

```
rlghncxa03w 10-12-01 11:40:26 GMT EAGLE5 43.0.0
GPL      CARD    RUNNING      APPROVED      TRIAL
BLIXP   1303   133-002-000 ALM   133-003-000   133-002-000
BLIXP   2101   133-002-000 ALM   133-003-000   133-002-000
BLIXP   2103   133-002-000 ALM   133-003-000   133-002-000
BLIXP   2205   133-002-000 ALM   133-003-000   133-002-000
BLIXP   2207   133-002-000 ALM   133-003-000   133-002-000
BLIXP   2211   133-002-000 ALM   133-003-000   133-002-000
Command Completed
```

9. Display the status of the card, shown in the `rept-stat-gpl` output in 8, that the GPL will be loaded onto using the `rept-stat-card` command and specifying the location of the card.

For this example, enter this command.

```
rept-stat-card:loc=1303
```

For an **HC MIM** or **E5-E1T1** card, this is an example of the possible output.

```
rlghncxa03w 10-12-01 09:12:36 GMT EAGLE5 43.0.0
CARD  VERSION      TYPE      GPL      PST      SST      AST
1303  134-003-000  LIME1    SS7HC    IS-NR    Active   -----
ALARM STATUS      = No Alarms.
BLIXP  GPL version = 133-002-000
IMT BUS A          = Conn
IMT BUS B          = Conn
SIGNALING LINK STATUS
  SLK  PST          LS          CLLI
  A    IS-NR        e11303a    -----
  B    IS-NR        e11303b    -----
  A1   IS-NR        e11303a    -----
  B3   IS-NR        e11303b    -----
Command Completed.
```

```
rlghncxa03w 10-12-01 09:12:36 GMT EAGLE5 43.0.0
CARD  VERSION      TYPE      GPL      PST      SST      AST
1303  134-003-000  LIME1    SS7HC    IS-NR    Active   -----
ALARM STATUS      = No Alarms.
BLIXP  GPL version = 133-002-000
BLBIOS GPL version = 133-002-000
PLDPMC1 GPL version = 133-002-000
BLROM1 GPL version = 133-002-000
IMT BUS A          = Conn
IMT BUS B          = Conn
SIGNALING LINK STATUS
  SLK  PST          LS          CLLI
  A    IS-NR        e11303a    -----
  B    IS-NR        e11303b    -----
  A1   IS-NR        e11303a    -----
  B3   IS-NR        e11303b    -----
Command Completed.
```

For an **E5-E1T1** card, this is an example of the possible output.

```

rlghncxa03w 10-12-01 09:12:36 GMT EAGLE5 43.0.0
CARD  VERSION      TYPE      GPL      PST      SST      AST
1303  134-003-000  LIME1    SS7EPM   IS-NR     Active   -----
ALARM STATUS      = No Alarms.
BLIXP  GPL version = 133-002-000
IMT BUS A          = Conn
IMT BUS B          = Conn
CURRENT TEMPERATURE = 32C ( 90F)    [ALARM TEMP: 60C (140F)]
PEAK TEMPERATURE:  = 39C (103F)    [06-05-02 13:40]
SIGNALING LINK STATUS
SLK  PST          LS          CLLI
A    IS-NR        e11303a    -----
B    IS-NR        e11303b    -----
A1   IS-NR        e11303a    -----
B3   IS-NR        e11303b    -----
Command Completed.

```

```

rlghncxa03w 10-12-01 09:12:36 GMT EAGLE5 43.0.0
CARD  VERSION      TYPE      GPL      PST      SST      AST
1303  134-003-000  LIME1    SS7EPM   IS-NR     Active   -----
ALARM STATUS      = No Alarms.
BLIXP  GPL version = 133-002-000
PLDPMC1 GPL version = 133-002-000
IMT BUS A          = Conn
IMT BUS B          = Conn
CURRENT TEMPERATURE = 32C ( 90F)    [ALARM TEMP: 60C (140F)]
PEAK TEMPERATURE:  = 39C (103F)    [06-05-02 13:40]
SIGNALING LINK STATUS
SLK  PST          LS          CLLI
A    IS-NR        e11303a    -----
B    IS-NR        e11303b    -----
A1   IS-NR        e11303a    -----
B3   IS-NR        e11303b    -----
Command Completed.

```

For an E5-ENET card, this is an example of the possible output.

```

rlghncxa03w 10-12-01 09:12:36 GMT EAGLE5 43.0.0
CARD  VERSION      TYPE      GPL      PST      SST      AST
1303  134-003-000  DCM      IPLHC    IS-NR     Active   -----
ALARM STATUS      = No Alarms.
BLIXP  GPL version = 133-002-000
IMT BUS A          = Conn
IMT BUS B          = Conn
CURRENT TEMPERATURE = 32C ( 90F)    [ALARM TEMP: 60C (140F)]
PEAK TEMPERATURE:  = 39C (103F)    [06-05-02 13:40]
SIGNALING LINK STATUS
SLK  PST          LS          CLLI
A    IS-NR        e11303a    -----
B    IS-NR        e11303b    -----
A1   IS-NR        e11303a    -----
B3   IS-NR        e11303b    -----
Command Completed.

```

```

rlghncxa03w 10-12-01 09:12:36 GMT EAGLE5 43.0.0
CARD  VERSION      TYPE      GPL      PST      SST      AST
1303  134-003-000  DCM      IPLHC    IS-NR     Active   -----

```

```

ALARM STATUS      = No Alarms.
BLIXP  GPL version = 133-002-000
PLDPMC1 GPL version = 133-002-000
IMT BUS A        = Conn
IMT BUS B        = Conn
CURRENT TEMPERATURE = 32C ( 90F)    [ALARM TEMP: 60C (140F)]
PEAK TEMPERATURE:  = 39C (103F)    [06-05-02 13:40]
SIGNALING LINK STATUS
  SLK   PST           LS           CLLI
  A     IS-NR         e11303a     -----
  B     IS-NR         e11303b     -----
  A1    IS-NR         e11303a     -----
  B3    IS-NR         e11303b     -----
Command Completed.

```

For an **E5-STC** card, this is an example of the possible output.

```

rlghncxa03w 10-12-01 09:12:36 GMT EAGLE5 43.0.0
CARD  VERSION      TYPE      GPL      PST      SST      AST
1303  134-003-000  STC      ERTHC   IS-NR    Active   -----
ALARM STATUS      = No Alarms.
BLIXP  GPL version = 133-002-000
IMT BUS A        = Conn
IMT BUS B        = Conn
CURRENT TEMPERATURE = 61C (142F)
PEAK TEMPERATURE:  = 61C (142F)    [06-05-02 13:40]
NTP broadcast = VALID
STC IP PORT A:           OOS-MT      Unavail   -----
ALARM STATUS = ** 0084 IP Connection Unavailable
ERROR STATUS = DHCP Lease. Physical Link.
STC IP PORT B:           OOS-MT      Unavail   -----
ALARM STATUS = ** 0084 IP Connection Unavailable
ERROR STATUS = DHCP Lease. Physical Link.
Command Completed.

```

For an **E5-SLAN** card, this is an example of the possible output.

```

rlghncxa03w 10-12-01 09:12:36 GMT EAGLE5 43.0.0
CARD  VERSION      TYPE      GPL      PST      SST      AST
1303  134-003-000  DCM      SLANHC  IS-NR    Active   -----
ALARM STATUS      = No Alarms.
BLIXP  GPL version = 133-002-000
IMT BUS A        = Conn
IMT BUS B        = Conn
CURRENT TEMPERATURE = 60C (140F)
PEAK TEMPERATURE:  = 63C (146F)    [00-02-12 21:58]
DLK A   PST        = IS-NR          SST = Avail   AST = -----
SLAN % EAGLE CAPACITY = 57%
SLAN % HOST CAPACITY  = 49%
Command Completed.

```

For an **E5-SM4G** card, this is an example of the possible output.

```

rlghncxa03w 10-12-01 09:12:36 GMT EAGLE5 43.0.0
CARD  VERSION      TYPE      GPL      PST      SST      AST
1303  134-003-000  DSM      SCCPHC  IS-NR    Active   -----
ALARM STATUS      = No Alarms.
BLIXP  GPL version = 133-002-000
IMT BUS A        = Conn

```

```

IMT BUS B           = Conn
CURRENT TEMPERATURE = 31C ( 88F)
PEAK TEMPERATURE:  = 32C ( 90F)    [07-05-12 15:55]
SCCP % OCCUP        = 1%
    
```

Command Completed.

```

rlghncxa03w 10-12-01 09:12:36 GMT EAGLE5 43.0.0
CARD  VERSION  TYPE      GPL      PST      SST      AST
1303  134-003-000 DSM      SCCPHC   IS-NR    Active   -----
ALARM STATUS      = No Alarms.
BLIXP  GPL version = 133-002-000
BLBSMG GPL version = 133-002-000
IMT BUS A         = Conn
IMT BUS B         = Conn
CURRENT TEMPERATURE = 31C ( 88F)
PEAK TEMPERATURE:  = 32C ( 90F)    [07-05-12 15:55]
SCCP % OCCUP      = 1%
    
```

Command Completed.

For an **E5-ENET-B/SLIC** card, this is an example of the possible output.

```

rlghncxa03w 10-12-01 09:12:36 GMT EAGLE5 43.0.0
CARD  VERSION  TYPE      GPL      PST      SST      AST
1303  134-003-000 IPSM     IPSHC    IS-NR    Active   -----
ALARM STATUS      = No Alarms.
BLIXP  GPL version = 133-002-000
IMT BUS A         = Conn
IMT BUS B         = Conn
CURRENT TEMPERATURE = 32C ( 90F)
PEAK TEMPERATURE:  = 39C (103F)    [06-05-02 13:40]
Command Completed.
    
```

For an **E5-ATM** card, this is an example of the possible output.

```

rlghncxa03w 10-12-01 09:12:36 GMT EAGLE5 43.0.0
CARD  VERSION  TYPE      GPL      PST      SST      AST
1303  134-003-000 LIMATM   ATMHC    IS-NR    Active   -----
ALARM STATUS      = No Alarms.
BLIXP  GPL version = 133-002-000
IMT BUS A         = Conn
IMT BUS B         = Conn
CURRENT TEMPERATURE = 38C (101F)
PEAK TEMPERATURE:  = 38C (101F)    [07-11-23 06:10]
SIGNALING LINK STATUS
  SLK  PST          LS          CLLI
  A    IS-NR        ls1         -----
    
```

Command Completed.

For an **E5-TSM** card, this is an example of the possible output.

```

rlghncxa03w 10-12-01 09:12:36 GMT EAGLE5 43.0.0
CARD  VERSION  TYPE      GPL      PST      SST      AST
1303  134-003-000 TSM      GLSHC    IS-NR    Active   -----
ALARM STATUS      = No Alarms.
    
```

```

BLIXP  GPL version = 133-002-000
IMT BUS A           = Conn
IMT BUS B           = Conn
CURRENT TEMPERATURE = 38C (101F)
PEAK TEMPERATURE:  = 38C (101F)    [07-11-23 06:10]

```

Command Completed.

Continue the procedure by performing one of these actions:

- If card is running one of these application GPLs: SS7HC, SS7EPM, IPLHC, IPGHC, ATMHC, IPSG (shown in the GPL column in the `rept-stat-card` output in 9), continue the procedure with 12.
- If card is running the ERTHC application GPL, (shown in the GPL column in the `rept-stat-card` output in 9), continue the procedure with 19.
- If the card is running the SLANHC application GPL (shown in the GPL column in the `rept-stat-card` output in 9), continue the procedure with 14.
- If the card is running the IPSHC application GPL, (shown in the GPL column in the `rept-stat-card` output in 9), continue the procedure with 16.
- If card is running the GLSHC application GPL, (shown in the GPL column in the `rept-stat-card` output in 9), continue the procedure with 10.
- If card is running the SCCPHC application GPL, (shown in the GPL column in the `rept-stat-card` output in 9), continue the procedure with 11.

10. Display the GLS cards by entering this command.

```
rept-stat-card:appl=glS
```

The output from this command will display the TSMs that are running the GLS GPL and the E5-TSMs that are running the GLSHC GPL.

This is an example of the possible output.

```

rlghncxa03w 10-12-01 09:12:36 GMT EAGLE5 43.0.0
CARD  VERSION      TYPE      GPL      PST      SST      AST
1207  133-003-000    TSM      GLSHC    IS-NR    Active   -----
1211  133-003-000    TSM      GLSHC    IS-NR    Active   -----
1303  133-003-000    TSM      GLSHC    IS-NR    Active   -----

```

Command Completed.

Continue the procedure with 19.

11. Display the service modules by entering the `rept-stat-sccp` command.

The output from this command will display the DSMs that are running the VSCCP GPL and the E5-SM4G cards that are running the SCCPHC GPL.

This is an example of the possible output.

```
rlghncxa03w 10-12-01 09:12:36 GMT EAGLE5 43.0.0
```

CARD	VERSION	PST	SST	AST	MSU USAGE	CPU USAGE
1303	133-003-000	IS-NR	Active	-----	47%	81%
2103	133-003-000	IS-NR	Active	-----	34%	50%
2111	133-003-000	IS-NR	Active	-----	21%	29%
2115	133-003-000	IS-NR	Active	-----	35%	52%
2117	133-003-000	IS-NR	Active	-----	40%	71%

 SCCP Service Average MSU Capacity = 36% Average CPU Capacity = 56%
 Command Completed.

Note: The `rept-stat-sccp` command output contains other fields that are not used by this procedure. If you wish to see all the fields displayed by the `rept-stat-sccp` command, refer to the `rept-stat-sccp` command description in *Commands User's Guide*.

Continue the procedure with [19](#).

12. Display the signaling links associated with the card shown in [9](#).

Enter the `rtrv-slk` command with the card location specified in [9](#). For this example, enter this command.

```
rtrv-slk:loc=1303
```

This is an example of the possible output for an HC MIM or E5-E1T1 card.

```
rlghncxa03w 10-12-01 09:12:36 GMT EAGLE5 43.0.0
```

LOC	LINK	LSN	SLC	TYPE	L2T	SET	BPS	ECM	PCR	PCR	E1	E1	TS
1303	A	e11303a	0	LIME1	1	64000	PCR	76	3800	1303	2	12	
1303	B	e11303b	0	LIME1	1	56000	BASIC	---	-----	1303	1	2	
1303	A1	e11303a	1	LIME1	1	56000	BASIC	---	-----	1303	1	3	
1303	B3	e11303b	1	LIME1	1	56000	BASIC	---	-----	1303	1	7	

This is an example of the possible output for an E5-ENET card.

```
rlghncxa03w 10-12-01 09:12:36 GMT EAGLE5 43.0.0
```

LOC	LINK	LSN	SLC	TYPE	IPLIML2
1303	A	e11303a	0	IPLIM	M2PA
1303	B	e11303b	0	IPLIM	M2PA
1303	A1	e11303a	1	IPLIM	M2PA
1303	B3	e11303b	1	IPLIM	M2PA

This is an example of the possible output for an E5-ATM card.

```
rlghncxa03w 10-12-01 09:12:36 GMT EAGLE5 43.0.0
```

LOC	LINK	LSN	SLC	TYPE	LP	SET	BPS	ATM	VCI	VPI
LL										
1303	A	ls2	2	LIMATM	1	1544000	LINE	5	0	0
1303	B	ls1	3	LIMATM	1	1544000	LINE	5	0	0

13. Deactivate the SS7 signaling links on the card using the `dact-slk` command.

For this example, enter these commands.

```
dact-slk:loc=1303:link=a
dact-slk:loc=1303:link=b
dact-slk:loc=1303:link=a1
dact-slk:loc=1303:link=b3
```

Caution: These command examples place the signaling links on card 1303 out of service. This will interrupt service on the signaling links on card 1303 and allow the BLIXP GPL to be loaded on to card 1303.

Caution: Do not deactivate all the signaling links assigned to these cards: HC MIMs, E5-E1T1, E5-ENET, E5-ATM, at the same time. Doing so will take all the E1, T1, IP, and ATM signaling links out of service, and the traffic on these signaling links could be lost.

Caution: If the EAGLE contains only signaling links assigned to the card that is specified in this step, deactivating all of the signaling links that are assigned to the card will take all of these signaling links out of service and will isolate the EAGLE from the network.

When each of these commands have successfully completed, this message should appear.

```
rlghncxa03w 10-12-01 09:12:36 GMT EAGLE5 43.0.0
Deactivate SLK message sent to card
```

Continue the procedure with 19.

14. Display the data link, and its status, associated with the card shown in 9. Enter the `rept-stat-dlk` command with the card location specified in 9.

For this example, enter this command.

```
rept-stat-dlk:loc=1303
```

This is an example of the possible output.

```
rlghncxa03w 10-12-01 09:12:36 GMT EAGLE5 43.0.0
DLK          PST          SST          AST
1303         IS-NR        Active      ----
Alarm Status = No Alarms.
Command Completed.
```

15. Deactivate the TCP/IP data link on the card that you wish to load the GPL onto using the `canc-dlk` command. For this example, enter this command.

```
canc-dlk:loc=1303
```

Caution: This command example places the TCP/IP data link on card 1303 out of service. This will interrupt service on the TCP//IP data link on card 1303 and allow the flash GPL to be loaded onto card 1303.

Caution: If there is only one TCP/IP data link in the EAGLE, placing the card out of service will cause the STPLAN feature to be disabled.

When this command has successfully completed, these messages should appear.

```
rlghncxa03w 10-12-01 09:12:36 GMT EAGLE5 43.0.0
Deactivate Link message sent to card.
Command Completed.
```

Continue the procedure with [19](#).

16. Display the terminal configuration in the database with the `rtrv-trm` command.

The Telnet terminals associated with the card shown in [9](#) must be taken out of service. The Telnet terminals are shown in the output with the entry TELNET in the TYPE field. This is an example of the possible output. In this example, the Telnet terminals that must be taken out of service are terminals 17 to 24.

```
rlghncxa03w 10-12-01 09:12:36 GMT EAGLE5 43.0.0
TRM  TYPE      COMM      FC      TMOUT  MXINV  DURAL
1    VT320      9600-7-E-1 SW      30      5      99:59:59
2    KSR        9600-7-E-1 HW      30      5      INDEF
3    PRINTER   4800-7-E-1 HW      30      0      00:00:00
4    VT320      2400-7-E-1 BOTH   30      5      00:30:00
5    VT320      9600-7-O-1 NONE   30      5      00:00:30
6    VT320      9600-7-O-1 NONE   30      5      00:00:30
7    PRINTER   9600-7-E-2 HW      30      5      00:30:00
8    KSR        19200-7-E-2 BOTH  30      5      00:30:00
9    VT320      9600-7-O-1 NONE   30      5      00:00:30
10   VT320      9600-7-E-1 HW      30      5      00:30:00
11   VT320      4800-7-E-1 HW      30      5      00:30:00
12   PRINTER   9600-7-E-1 HW      30      4      00:30:00
13   VT320      9600-7-O-1 NONE   30      5      00:30:00
14   VT320      9600-7-E-2 SW      30      8      00:30:00
15   VT320      9600-7-E-2 HW      30      5      00:30:00
16   VT320      9600-7-E-2 BOTH  30      3      00:30:00

TRM  TYPE      LOC      TMOUT  MXINV  DURAL
17   TELNET    1303     60     5      00:30:00
18   TELNET    1303     60     5      00:30:00
19   TELNET    1303     60     5      00:30:00
20   TELNET    1303     60     5      00:30:00
21   TELNET    1303     60     5      00:30:00
22   TELNET    1303     60     5      00:30:00
23   TELNET    1303     60     5      00:30:00
24   TELNET    1303     60     5      00:30:00
25   TELNET    1203     60     5      00:30:00
26   TELNET    1203     60     5      00:30:00
27   TELNET    1203     60     5      00:30:00
28   TELNET    1203     60     5      00:30:00
39   TELNET    1203     60     5      00:30:00
30   TELNET    1203     60     5      00:30:00
```

31	TELNET	1203	60	5	00:30:00
32	TELNET	1203	60	5	00:30:00
33	TELNET	1208	60	5	00:30:00
34	TELNET	1208	60	5	00:30:00
35	TELNET	1208	60	5	00:30:00
36	TELNET	1208	60	5	00:30:00
37	TELNET	1208	60	5	00:30:00
38	TELNET	1208	60	5	00:30:00
39	TELNET	1208	60	5	00:30:00
40	TELNET	1208	60	5	00:30:00

Note: The `rtrv-trm` command output contains other fields that are not used by this procedure. If you wish to see all the fields displayed by the `rtrv-trm` command, see the `rtrv-trm` command description in *Commands User's Guide*.

17. Display the status of the terminals with the `rept-stat-trm` command. This is an example of the possible output.

```
rlghncxa03w 10-12-01 09:12:36 GMT EAGLE5 43.0.0
TRM  PST      SST      AST
1    IS-NR    Active   -----
2    IS-NR    Active   -----
3    IS-NR    Active   -----
4    IS-NR    Active   -----
5    IS-NR    Active   -----
6    IS-NR    Active   -----
7    IS-NR    Active   -----
8    IS-NR    Active   -----
9    IS-NR    Active   -----
10   IS-NR    Active   -----
11   IS-NR    Active   -----
12   IS-NR    Active   -----
13   IS-NR    Active   -----
14   IS-NR    Active   -----
15   IS-NR    Active   -----
16   IS-NR    Active   -----
17   IS-NR    Active   -----
18   IS-NR    Active   -----
19   IS-NR    Active   -----
20   IS-NR    Active   -----
21   IS-NR    Active   -----
22   IS-NR    Active   -----
23   IS-NR    Active   -----
24   IS-NR    Active   -----
25   IS-NR    Active   -----
26   IS-NR    Active   -----
27   IS-NR    Active   -----
28   IS-NR    Active   -----
29   IS-NR    Active   -----
30   IS-NR    Active   -----
31   IS-NR    Active   -----
32   IS-NR    Active   -----
33   IS-NR    Active   -----
34   IS-NR    Active   -----
35   IS-NR    Active   -----
36   IS-NR    Active   -----
37   IS-NR    Active   -----
38   IS-NR    Active   -----
39   IS-NR    Active   -----
```

```
40    IS-NR          Active      -----
```

```
Command Completed.
```

- 18.** Place the required terminals out of service using the `rmv-trm` or `inh-trm` command. The function of the `rmv-trm` and the `inh-trm` commands are the same. For this example, enter these commands.

```
rmv-trm:trm=17
rmv-trm:trm=18
rmv-trm:trm=19
rmv-trm:trm=20
rmv-trm:trm=21
rmv-trm:trm=22
rmv-trm:trm=23
rmv-trm:trm=24
```

Note: If the terminal that is being taken out of service is the last in service SEAS terminal, the `force=yes` parameter must be specified with the `rmv-trm` command for that terminal.

Caution: Placing the Telnet terminals out of service will disable any Telnet sessions running on these terminals.

If the status of any of the terminals shown in the `PST` field in [17](#) is `OOS-MT-DSBLD` (out-of-service maintenance disabled), the terminal is already out of service and the `rmv-trm` command does not need to be executed for that terminal.

This message should appear when each of these commands have successfully completed.

```
rlghncxa03w 10-12-01 09:12:36 GMT EAGLE5 43.0.0
Inhibit message sent to terminal
```

```
rlghncxa03w 10-12-01 09:12:36 GMT EAGLE5 43.0.0
Command Completed.
```

- 19.** Place the card shown in [9](#) out of service using the `rmv-card` or `inh-card` command. The function of the `rmv-card` and the `inh-card` commands are the same.

Caution: Multiple cards running the BLIXP GPL can be updated at the same time with the `init-flash` command ([20](#)). This requires that the cards in the locations specified with the `init-flash` command in [20](#) are out of service. All the high-capacity cards running the BLIXP GPL being updated can be placed out of service. However it is recommended that only some of these high-capacity cards are placed out of service. Placing all these high-capacity cards out of service will cause all traffic hosted by high-capacity cards to be lost.

Caution: If there is only one high-capacity card running the BLIXP GPL being updated, placing this card out of service will cause all the traffic hosted by this high-capacity card to be lost.

For this example, enter this command.

```
rmv-card:loc=1303
```

If more than one card running the same flash GPL is to be updated in 20, repeat this step for those cards.

When this command has successfully completed, this message should appear.

```
rlghncxa03w 10-12-01 11:11:28 GMT EAGLE5 43.0.0
Card has been inhibited.
```

The `force=yes` parameter must be specified in this step if any of these conditions exist.

- The HC MIM, E5-E1T1, E5-ATM, or E5-ENET card contains the last signaling link in a linkset.
- The E5-TSM is the last GLS card that is in service.
- The service module is the last service module that is in service.

20. Load the approved version of the BLIXP GPL onto the card inhibited in 19 using the `init-flash` command with the `code=appr` parameter.

Caution: The `flash-card` command cannot be entered if the IMT Rate Change sequence or the Extended Bit Error Rate Test (BERT) is being performed.

For this example, enter this command.

```
init-flash:code=appr:loc=1303:gpl=blixp
```

When this command has successfully completed, these messages should appear.

```
rlghncxa03w 10-12-01 09:12:36 GMT EAGLE5 43.0.0
FLASH Memory Downloading for card 1303 Started.
;
rlghncxa03w 10-12-01 09:12:36 GMT EAGLE5 43.0.0
BLIXP Downloading for card 1303 Complete.
;
rlghncxa03w 10-12-01 09:12:36 GMT EAGLE5 43.0.0
Command Completed.
```

Updating more than One Card at the Same Time

If more than one card running the BLIXP GPL is being updated, enter the `init-flash` command with these parameters along with the `code=appr` parameter:

`sloc` - the first card location in the range of card locations

`eloc` - the last card location in the range of card locations

`gpl` - blixp

Note: The `sloc`, `eloc`, and `gpl` parameters cannot be specified with the `loc` parameter. When the `sloc`, `eloc`, and `gpl` parameters are specified, only the cards running the BLIXP GPL and within the range specified by the `sloc` and `eloc` parameters are updated. All other cards in the range specified by the `sloc` and `eloc` parameters are skipped.

Entering the example command will update the cards in the locations 1303 to 2103 running the BLIXP GPL with the approved version of the BLIXP GPL.

```
init-flash:code=appr:sloc=1303:eloc=2103:gpl=blixp
```

When this command has successfully completed, these messages should appear.

```
rlghncxa03w 10-12-01 09:12:36 GMT EAGLE5 43.0.0
FLASH Memory Download for cards 1303 - 2103 Started.
;
rlghncxa03w 10-12-01 09:12:36 GMT EAGLE5 43.0.0
FLASH Memory Download for cards 1303 - 2103 Completed.
LOC 1303 : PASSED
LOC 2101 : PASSED
LOC 2103 : PASSED

ALL CARD RESULTS PASSED
;
rlghncxa03w 10-12-01 09:12:36 GMT EAGLE5 43.0.0
Command Completed.
```

- 21.** Put the cards that were inhibited in [19](#) back into service using the `rst-card` or `alw-card` command. The function of the `rst-card` and the `alw-card` commands are the same.

The `rst-card` command also loads the approved version of the **GPL** onto the card.

For this example, enter this command.

```
rst-card:code=appr:loc=1303
```

When this command has successfully completed, this message should appear.

```
rlghncxa03w 10-12-01 09:12:36 GMT EAGLE5 43.0.0
Card has been allowed.
```

- 22.** Verify that the BLIXP GPL from [21](#) has loaded and that the card has returned to its in-service normal (**IS-NR**) state using the `rept-stat-card` command.

For this example, enter this command.

```
rept-stat-card:loc=1303
```

For an E5-E1T1 card, this is an example of the possible output.

```
rlghncxa03w 10-12-01 09:12:36 GMT EAGLE5 43.0.0
CARD  VERSION      TYPE      GPL      PST      SST      AST
1303  134-003-000  LIME1    SS7HC    IS-NR    Active   -----
ALARM STATUS      = No Alarms.
BLIXP  GPL version = 133-003-000 +
IMT BUS A          = Conn
IMT BUS B          = Conn
```

```

SIGNALING LINK STATUS
  SLK  PST           LS           CLLI
  A    OOS-MT-DSBLD e11303a  -----
  B    OOS-MT-DSBLD e11303b  -----
  A1   OOS-MT-DSBLD e11303a  -----
  B3   OOS-MT-DSBLD e11303b  -----
Command Completed.

```

```

rlghncxa03w 10-12-01 09:12:36 GMT EAGLE5 43.0.0
CARD  VERSION      TYPE      GPL      PST      SST      AST
1303  134-003-000  LIME1    SS7HC    IS-NR    Active   -----
ALARM STATUS      = No Alarms.
BLIXP  GPL version = 133-003-000 +
BLBIOS GPL version = 133-002-000
PLDPMC1 GPL version = 133-002-000
BLROM1 GPL version = 133-002-000
IMT BUS A        = Conn
IMT BUS B        = Conn
SIGNALING LINK STATUS
  SLK  PST           LS           CLLI
  A    OOS-MT-DSBLD e11303a  -----
  B    OOS-MT-DSBLD e11303b  -----
  A1   OOS-MT-DSBLD e11303a  -----
  B3   OOS-MT-DSBLD e11303b  -----
Command Completed.

```

For an E5-E1T1 card, this is an example of the possible output.

```

rlghncxa03w 10-12-01 09:12:36 GMT EAGLE5 43.0.0
CARD  VERSION      TYPE      GPL      PST      SST      AST
1303  134-003-000  IPLIM    SS7EPM   IS-NR    Active   -----
ALARM STATUS      = No Alarms.
BLIXP  GPL version = 133-003-000 +
IMT BUS A        = Conn
IMT BUS B        = Conn
CURRENT TEMPERATURE = 32C ( 90F)  [ALARM TEMP: 60C (140F)]
PEAK TEMPERATURE:  = 39C (103F) [06-05-02 13:40]
SIGNALING LINK STATUS
  SLK  PST           LS           CLLI
  A    IS-NR         e11303a  -----
  B    IS-NR         e11303b  -----
  A1   IS-NR         e11303a  -----
  B3   IS-NR         e11303b  -----
Command Completed.

```

```

rlghncxa03w 10-12-01 09:12:36 GMT EAGLE5 43.0.0
CARD  VERSION      TYPE      GPL      PST      SST      AST
1303  134-003-000  IPLIM    SS7EPM   IS-NR    Active   -----
ALARM STATUS      = No Alarms.
BLIXP  GPL version = 133-003-000 +
PLDPMC1 GPL version = 133-002-000
IMT BUS A        = Conn
IMT BUS B        = Conn
CURRENT TEMPERATURE = 32C ( 90F)  [ALARM TEMP: 60C (140F)]
PEAK TEMPERATURE:  = 39C (103F) [06-05-02 13:40]
SIGNALING LINK STATUS
  SLK  PST           LS           CLLI
  A    IS-NR         e11303a  -----

```

```

      B      IS-NR      e11303b      -----
      A1     IS-NR      e11303a      -----
      B3     IS-NR      e11303b      -----

```

Command Completed.

For an E5-ENET card, this is an example of the possible output.

```

rlghncxa03w 10-12-01 09:12:36 GMT EAGLE5 43.0.0
CARD  VERSION      TYPE      GPL      PST      SST      AST
1303  134-003-000  DCM      IPLHC    IS-NR    Active   -----
ALARM STATUS      = No Alarms.
BLIXP  GPL version = 133-003-000 +
IMT BUS A          = Conn
IMT BUS B          = Conn
CURRENT TEMPERATURE = 32C ( 90F)    [ALARM TEMP: 60C (140F)]
PEAK TEMPERATURE:  = 39C (103F)    [06-05-02 13:40]
SIGNALING LINK STATUS
SLK    PST          LS          CLLI
A      IS-NR        e11303a    -----
B      IS-NR        e11303b    -----
A1     IS-NR        e11303a    -----
B3     IS-NR        e11303b    -----

```

Command Completed.

```

rlghncxa03w 10-12-01 09:12:36 GMT EAGLE5 43.0.0
CARD  VERSION      TYPE      GPL      PST      SST      AST
1303  134-003-000  DCM      IPLHC    IS-NR    Active   -----
ALARM STATUS      = No Alarms.
BLIXP  GPL version = 133-003-000 +
PLDPMC1 GPL version = 133-002-000
IMT BUS A          = Conn
IMT BUS B          = Conn
CURRENT TEMPERATURE = 32C ( 90F)    [ALARM TEMP: 60C (140F)]
PEAK TEMPERATURE:  = 39C (103F)    [06-05-02 13:40]
SIGNALING LINK STATUS
SLK    PST          LS          CLLI
A      IS-NR        e11303a    -----
B      IS-NR        e11303b    -----
A1     IS-NR        e11303a    -----
B3     IS-NR        e11303b    -----

```

Command Completed.

For an E5-STC card, this is an example of the possible output.

```

rlghncxa03w 10-12-01 09:12:36 GMT EAGLE5 43.0.0
CARD  VERSION      TYPE      GPL      PST      SST      AST
1303  134-003-000  STC      ERTHC    IS-NR    Active   -----
ALARM STATUS      = No Alarms.
BLIXP  GPL version = 133-003-000 +
IMT BUS A          = Conn
IMT BUS B          = Conn
CURRENT TEMPERATURE = 61C (142F)
PEAK TEMPERATURE:  = 61C (142F)    [06-05-02 13:40]
NTP broadcast = VALID
STC IP PORT A:          OOS-MT          Unavail   -----
ALARM STATUS = ** 0084 IP Connection Unavailable
ERROR STATUS = DHCP Lease. Physical Link.
STC IP PORT B:          OOS-MT          Unavail   -----
ALARM STATUS = ** 0084 IP Connection Unavailable

```

ERROR STATUS = DHCP Lease. Physical Link.
Command Completed.

For an E5-SLAN card, this is an example of the possible output.

```
rlghncxa03w 10-12-01 09:12:36 GMT EAGLE5 43.0.0
CARD  VERSION      TYPE      GPL      PST      SST      AST
1303  134-003-000    DCM      SLANHC   IS-NR    Active   -----
ALARM STATUS      = No Alarms.
BLIXP  GPL version = 133-003-000 +
IMT BUS A          = Conn
IMT BUS B          = Conn
CURRENT TEMPERATURE = 60C (140F)
PEAK TEMPERATURE:  = 63C (146F)      [00-02-12 21:58]
DLK A  PST          = IS-NR          SST = Avail   AST = -----
SLAN % EAGLE CAPACITY = 57%
SLAN % HOST CAPACITY  = 49%
Command Completed.
```

For an E5-SM4G card, this is an example of the possible output.

```
rlghncxa03w 10-12-01 09:12:36 GMT EAGLE5 43.0.0
CARD  VERSION      TYPE      GPL      PST      SST      AST
1303  134-003-000    DSM      SCCPHC   IS-NR    Active   -----
ALARM STATUS      = No Alarms.
BLIXP  GPL version = 133-003-000 +
IMT BUS A          = Conn
IMT BUS B          = Conn
CURRENT TEMPERATURE = 31C ( 88F)
PEAK TEMPERATURE:  = 32C ( 90F)      [07-05-12 15:55]
SCCP % OCCUP      = 1%
Command Completed.
```

Command Completed.

```
rlghncxa03w 10-12-01 09:12:36 GMT EAGLE5 43.0.0
CARD  VERSION      TYPE      GPL      PST      SST      AST
1303  134-003-000    DSM      SCCPHC   IS-NR    Active   -----
ALARM STATUS      = No Alarms.
BLIXP  GPL version = 133-003-000 +
BLBSMG GPL version = 133-002-000
IMT BUS A          = Conn
IMT BUS B          = Conn
CURRENT TEMPERATURE = 31C ( 88F)
PEAK TEMPERATURE:  = 32C ( 90F)      [07-05-12 15:55]
SCCP % OCCUP      = 1%
Command Completed.
```

Command Completed.

For an E5-ENET-B or SLIC card, this is an example of the possible output.

```
rlghncxa03w 10-12-01 09:12:36 GMT EAGLE5 43.0.0
CARD  VERSION      TYPE      GPL      PST      SST      AST
1303  134-003-000    IPSM     IPSHC    IS-NR    Active   -----
ALARM STATUS      = No Alarms.
BLIXP  GPL version = 133-003-000 +
IMT BUS A          = Conn
IMT BUS B          = Conn
CURRENT TEMPERATURE = 32C ( 90F)
Command Completed.
```

```
PEAK TEMPERATURE:      = 39C (103F)      [06-05-02 13:40]
Command Completed.
```

For an E5-ATM card, this is an example of the possible output.

```
rlghncxa03w 10-12-01 09:12:36 GMT EAGLE5 43.0.0
CARD  VERSION      TYPE      GPL      PST      SST      AST
1303  134-003-000  LIMATM  ATMHC    IS-NR     Active   -----
ALARM STATUS        = No Alarms.
BLIXP  GPL version = 133-003-000 +
IMT BUS A           = Conn
IMT BUS B           = Conn
CURRENT TEMPERATURE = 38C (101F)
PEAK TEMPERATURE:  = 38C (101F)      [07-11-23 06:10]
SIGNALING LINK STATUS
SLK   PST           LS           CLLI
A     IS-NR         ls1         -----
```

Command Completed.

For an E5-TSM card, this is an example of the possible output.

```
rlghncxa03w 10-12-01 09:12:36 GMT EAGLE5 43.0.0
CARD  VERSION      TYPE      GPL      PST      SST      AST
1303  134-003-000  TSM      GLSHC    IS-NR     Active   -----
ALARM STATUS        = No Alarms.
BLIXP  GPL version = 133-003-000 +
IMT BUS A           = Conn
IMT BUS B           = Conn
CURRENT TEMPERATURE = 38C (101F)
PEAK TEMPERATURE:  = 38C (101F)      [07-11-23 06:10]
```

Command Completed.

The '+' symbol indicates that the BLIXP GPL has not been activated.

Note: If the version number of the BLIXP GPL that is shown in this step is not the version specified in 1, contact the Customer Care Center. Refer to the [My Oracle Support \(MOS\)](#) section for the contact information.

23. Activate the BLIXP GPL loaded onto the cards specified in 20 by entering the `act-flash` command with the card location and the `gpl=bli xp` parameter.

Caution: The `act-flash` command cannot be entered if the Extended Bit Error Rate Test (BERT) is being performed.

For this example, enter this command.

```
act-flash:loc=1303:gpl=bli xp
```

When this command has successfully completed, these messages should appear.

```
rlghncxa03w 10-12-01 09:12:36 GMT EAGLE5 43.0.0
FLASH Memory Activation for card 1303 Completed.
```

```

;
rlghncxa03w 10-12-01 09:12:36 GMT EAGLE5 43.0.0
Command Completed.

```

Activating more than One Card at the Same Time

If more than one card running the BLIXP GPL was updated in 20, enter the `act-flash` command with these parameters:

`sloc` – the first card location in the range of card locations

`eloc` – the last card location in the range of card locations

`gpl` – blixp

Note: The `sloc`, `eloc`, and `gpl` parameters cannot be specified with the `loc` parameter. When the `sloc`, `eloc`, and `gpl` parameters are specified, only the cards running the BLIXP GPL and within the range specified by the `sloc` and `eloc` parameters are updated. All other cards in the range specified by the `sloc` and `eloc` parameters are skipped.

Entering this example command will activate the BLIXP GPL on the cards in the locations 1303 to 2103.

```
act-flash:sloc=1303:eloc=2103:gpl=blixp
```

When this command has successfully completed, these messages should appear.

```

rlghncxa03w 10-12-01 09:12:36 GMT EAGLE5 43.0.0
FLASH Memory Activation for cards 1303 - 2103 Started.
;
rlghncxa03w 10-12-01 09:12:36 GMT EAGLE5 43.0.0
FLASH Memory Activation for cards 1303 - 2103 Completed.
LOC 1303 : PASSED
LOC 2101 : PASSED
LOC 2103 : PASSED

ALL CARD RESULTS PASSED
;
rlghncxa03w 10-12-01 09:12:36 GMT EAGLE5 43.0.0
Command Completed.

```

24. Verify the flash GPLs on the cards by entering this command.

If any card is not running the release version of the BLIXP GPL, shown in the `RELEASE` column of the `rtrv-gpl` output in 7, the indicator `ALM` is displayed next to the BLIXP GPL version in the `RUNNING` column of the `rept-stat-gpl` output. For this example, enter this command.

```
rept-stat-gpl:gpl=blixp
```

This is an example of the possible output.

```

rlghncxa03w 10-12-01 09:12:36 GMT EAGLE5 43.0.0
GPL      CARD  RUNNING      APPROVED      TRIAL
BLIXP    1303  133-003-000  133-003-000  133-002-000
BLIXP    2101  133-002-000  133-003-000  133-002-000
BLIXP    2103  133-002-000  133-003-000  133-002-000
BLIXP    2205  133-002-000 ALM  133-003-000  133-002-000
BLIXP    2207  133-002-000 ALM  133-003-000  133-002-000

```

```
BLIXP      2211    133-002-000 ALM    133-003-000    133-002-000
Command Completed
```

Continue the procedure by performing one of these actions.

- If card is running one of these application GPLs: SS7HC, SS7EPM, IPLHC, IPGHC, ATMHC, IPSG (shown in the GPL column in the `rept-stat-card` output in 22), continue the procedure with 25.
- If card is running one of these application GPLs: ERTHC, GLSHC, or SCCPHC, (shown in the GPL column in the `rept-stat-card` output in 22), continue the procedure with 31.
- If the card is running the SLANHC application GPL, (shown in the GPL column in the `rept-stat-card` output in 22), continue the procedure with 27.
- If the card is running the IPSHC application GPL, (shown in the GPL column in the `rept-stat-card` output in 22), continue the procedure with 29.

- 25.** Place the signaling links that were deactivated in 13 back into service using the `act-slk` command.

For this example, enter these commands.

```
act-slk:loc=1303:link=a
act-slk:loc=1303:link=b
act-slk:loc=1303:link=a1
act-slk:loc=1303:link=b3
```

When each of these commands have successfully completed, this message should appear.

```
rlghncxa03w 10-12-01 09:12:36 GMT EAGLE5 43.0.0
Activate SLK message sent to card
```

- 26.** Verify that the signaling links activated in 25 are back in service using the `rept-stat-slk` command with the card location and signaling link.

For this example, enter these commands.

```
rept-stat-slk:loc=1303:link=a
```

This is an example of the possible output.

```
rlghncxa03w 10-12-01 09:12:36 GMT EAGLE5 43.0.0
SLK      LSN      CLLI      PST      SST      AST
1303,A   e11303a   -----  IS-NR    Avail    ----
ALARM STATUS      = No Alarms.
UNAVAIL REASON    = --
```

```
rept-stat-slk:loc=1303:link=b
```

This is an example of the possible output.

```
rlghncxa03w 10-12-01 09:12:36 GMT EAGLE5 43.0.0
SLK      LSN      CLLI      PST      SST      AST
1303,B   e11303b   -----  IS-NR    Avail    ----
```

```
ALARM STATUS      = No Alarms.
UNAVAIL REASON    = --
```

```
rept-stat-slk:loc=1303:link=a1
```

This is an example of the possible output.

```
rlghncxa03w 10-12-01 09:12:36 GMT EAGLE5 43.0.0
SLK      LSN      CLLI      PST      SST      AST
1303,A1  e11303a  ----- IS-NR      Avail    -----
ALARM STATUS      = No Alarms.
UNAVAIL REASON    = --
```

```
rept-stat-slk:loc=1303:link=b3
```

This is an example of the possible output.

```
rlghncxa03w 10-12-01 09:12:36 GMT EAGLE5 43.0.0
SLK      LSN      CLLI      PST      SST      AST
1303,B3  e11303b  ----- IS-NR      Avail    -----
ALARM STATUS      = No Alarms.
UNAVAIL REASON    = --
Command Completed.
```

Continue the procedure with [31](#).

- 27.** Place the TCP/IP data link that was deactivated in [15](#) back into using the `act-dlk` command. For this example, enter this command.

```
act-dlk:loc=1303
```

When this command has successfully completed, this message should appear.

```
rlghncxa03w 10-12-01 09:12:36 GMT EAGLE5 43.0.0
Activate Link message sent to card.
```

- 28.** Verify that the TCP/IP data link activated in [27](#) is back in service with the `rept-stat-dlk` command. For this example, enter this command.

```
rept-stat-dlk:loc=1303
```

This is an example of the possible output.

```
rlghncxa03w 10-12-01 09:12:36 GMT EAGLE5 43.0.0
DLK      PST      SST      AST
1303      IS-NR      Active    -----
Alarm Status      = No Alarms.
Command Completed.
```

Continue the procedure with [31](#).

- 29.** Put the required terminals back into service with the `rst-trm` or `alw-trm` command. The function of the `rst-trm` and the `alw-trm` commands are the same. For this example, enter these commands.

```
rst-trm:trm=17
```

```
rst-trm:trm=18
```

```
rst-trm:trm=19
rst-trm:trm=20
rst-trm:trm=21
rst-trm:trm=22
rst-trm:trm=23
rst-trm:trm=24
```

This message should appear when each of these commands have successfully completed.

```
rlghncxa03w 10-12-01 09:12:36 GMT EAGLE5 43.0.0
Allow message sent to terminal

rlghncxa03w 10-12-01 09:12:36 GMT EAGLE5 43.0.0
Command Completed.
```

- 30.** Verify that the terminals are in service with the `rept-stat-trm` command. This is an example of the possible output.

```
rlghncxa03w 10-12-01 09:12:36 GMT EAGLE5 43.0.0
TRM   PST           SST           AST
1     IS-NR         Active        -----
2     IS-NR         Active        -----
3     IS-NR         Active        -----
4     IS-NR         Active        -----
5     IS-NR         Active        -----
6     IS-NR         Active        -----
7     IS-NR         Active        -----
8     IS-NR         Active        -----
9     IS-NR         Active        -----
10    IS-NR         Active        -----
11    IS-NR         Active        -----
12    IS-NR         Active        -----
13    IS-NR         Active        -----
14    IS-NR         Active        -----
15    IS-NR         Active        -----
16    IS-NR         Active        -----
17    IS-NR         Active        -----
18    IS-NR         Active        -----
19    IS-NR         Active        -----
20    IS-NR         Active        -----
21    IS-NR         Active        -----
22    IS-NR         Active        -----
23    IS-NR         Active        -----
24    IS-NR         Active        -----
25    IS-NR         Active        -----
26    IS-NR         Active        -----
27    IS-NR         Active        -----
28    IS-NR         Active        -----
29    IS-NR         Active        -----
30    IS-NR         Active        -----
31    IS-NR         Active        -----
32    IS-NR         Active        -----
33    IS-NR         Active        -----
34    IS-NR         Active        -----
```

35	IS-NR	Active	-----
36	IS-NR	Active	-----
37	IS-NR	Active	-----
38	IS-NR	Active	-----
39	IS-NR	Active	-----
40	IS-NR	Active	-----

Command Completed.

31. Continue the procedure by performing one of these actions.

If you wish to load the new BLIXP GPL onto the other cards shown in [8](#), repeat this procedure from [9](#) for each card shown in [8](#).

If the new BLIXP GPL will not be loaded onto other cards, then this procedure is finished.

Figure 3-8 Updating the BLIXP GPL

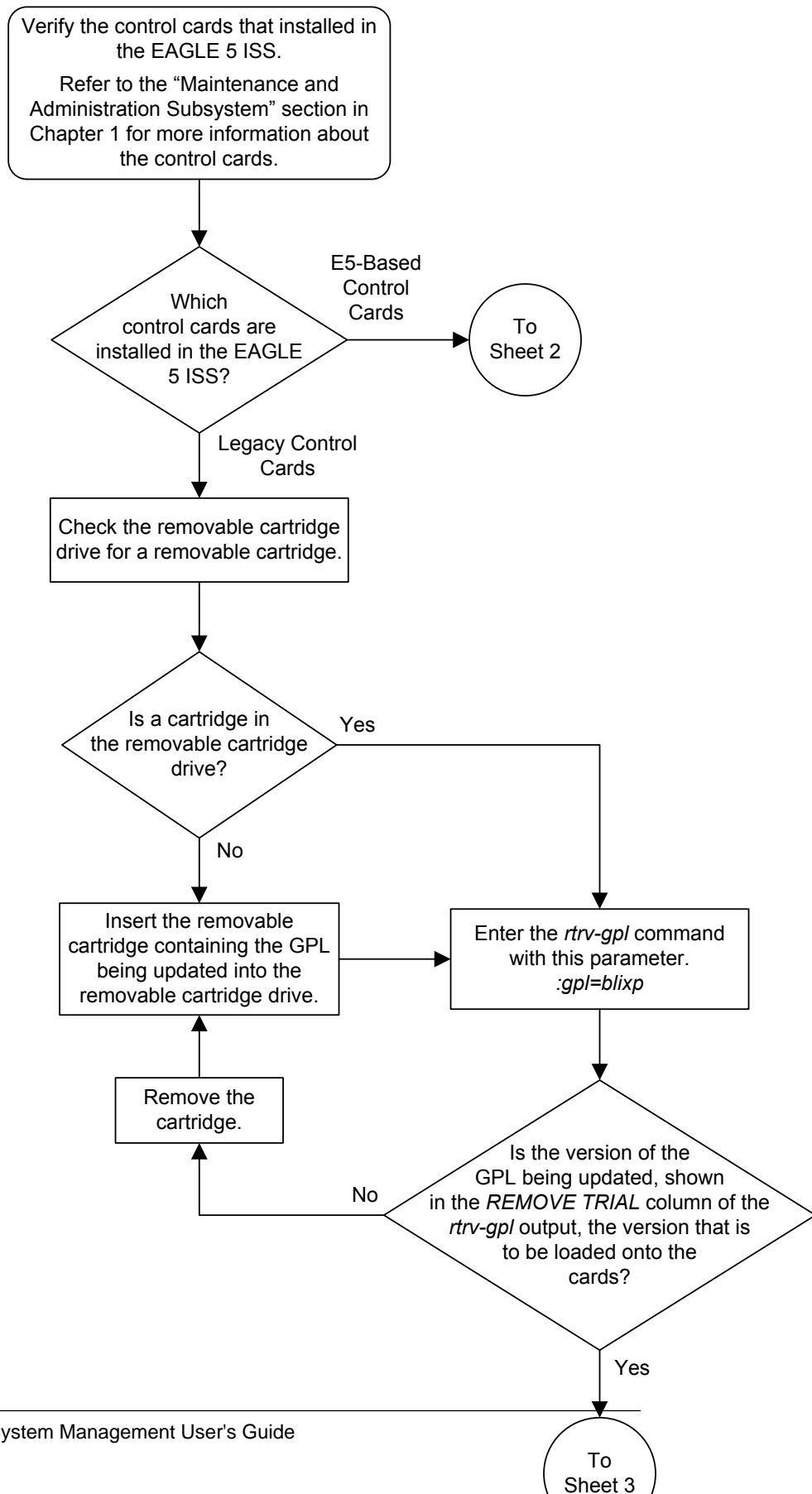

Sheet 1 of 7

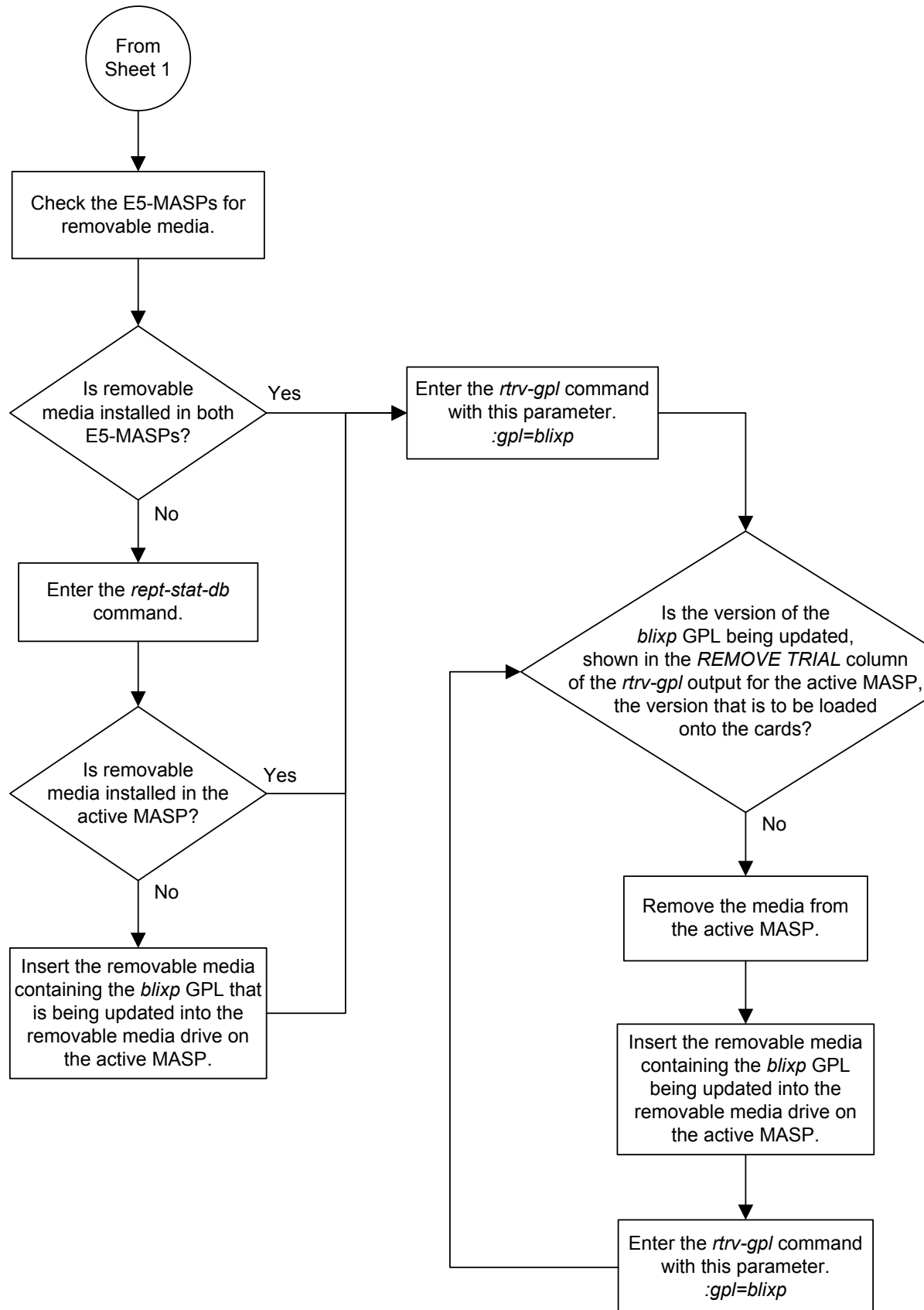

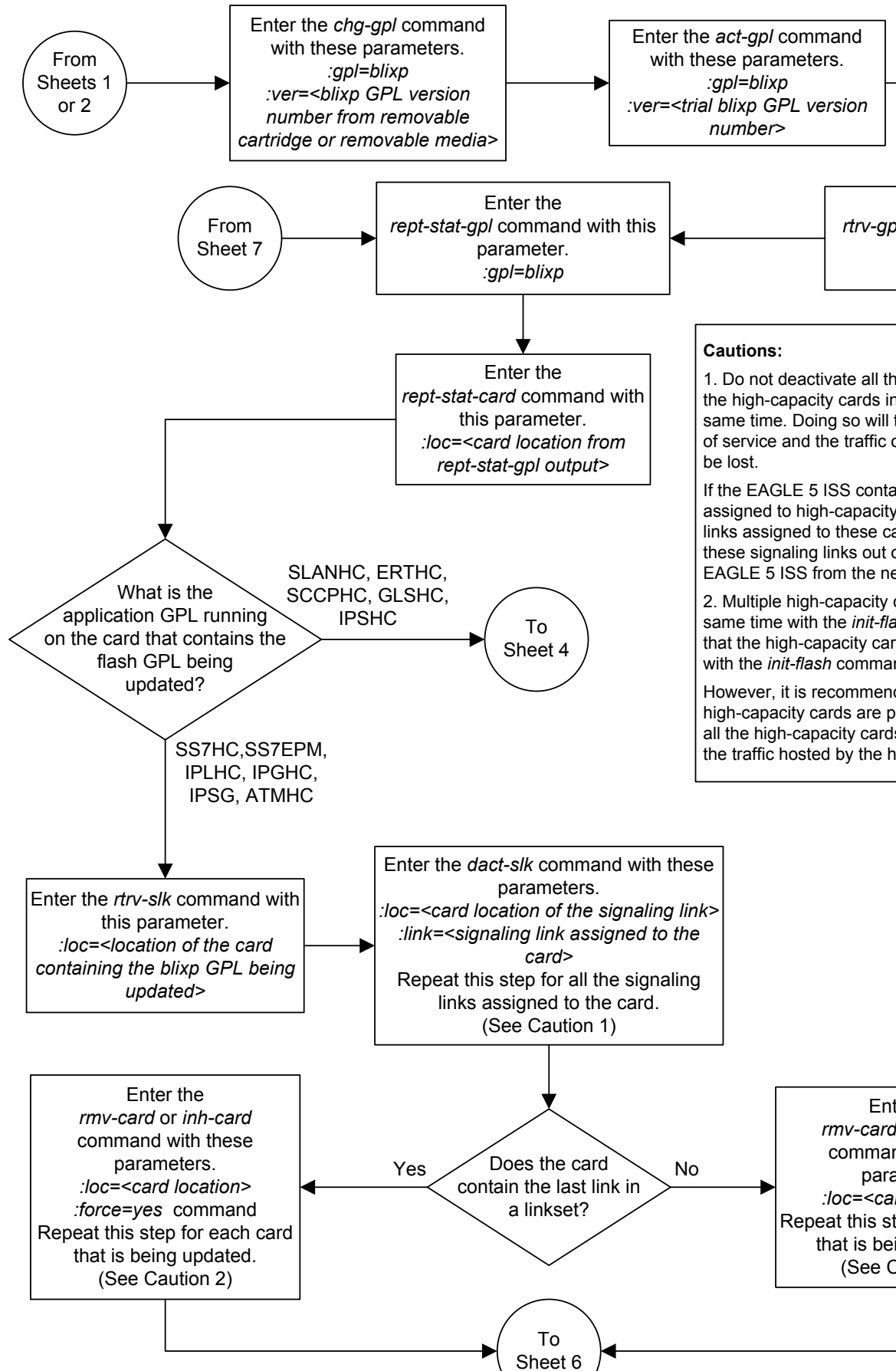

Cautions:

- Do not deactivate all the high-capacity cards in the same time. Doing so will result in a loss of service and the traffic on the cards will be lost.
If the EAGLE 5 ISS contains high-capacity cards assigned to high-capacity signaling links assigned to these cards, deactivate these signaling links out of the EAGLE 5 ISS from the network.
- Multiple high-capacity cards can be deactivated at the same time with the *init-flash* command, but ensure that the high-capacity cards are not deactivated with the *init-flash* command.
However, it is recommended that all high-capacity cards are powered off before all the high-capacity cards are deactivated to ensure the traffic hosted by the high-capacity cards is not lost.

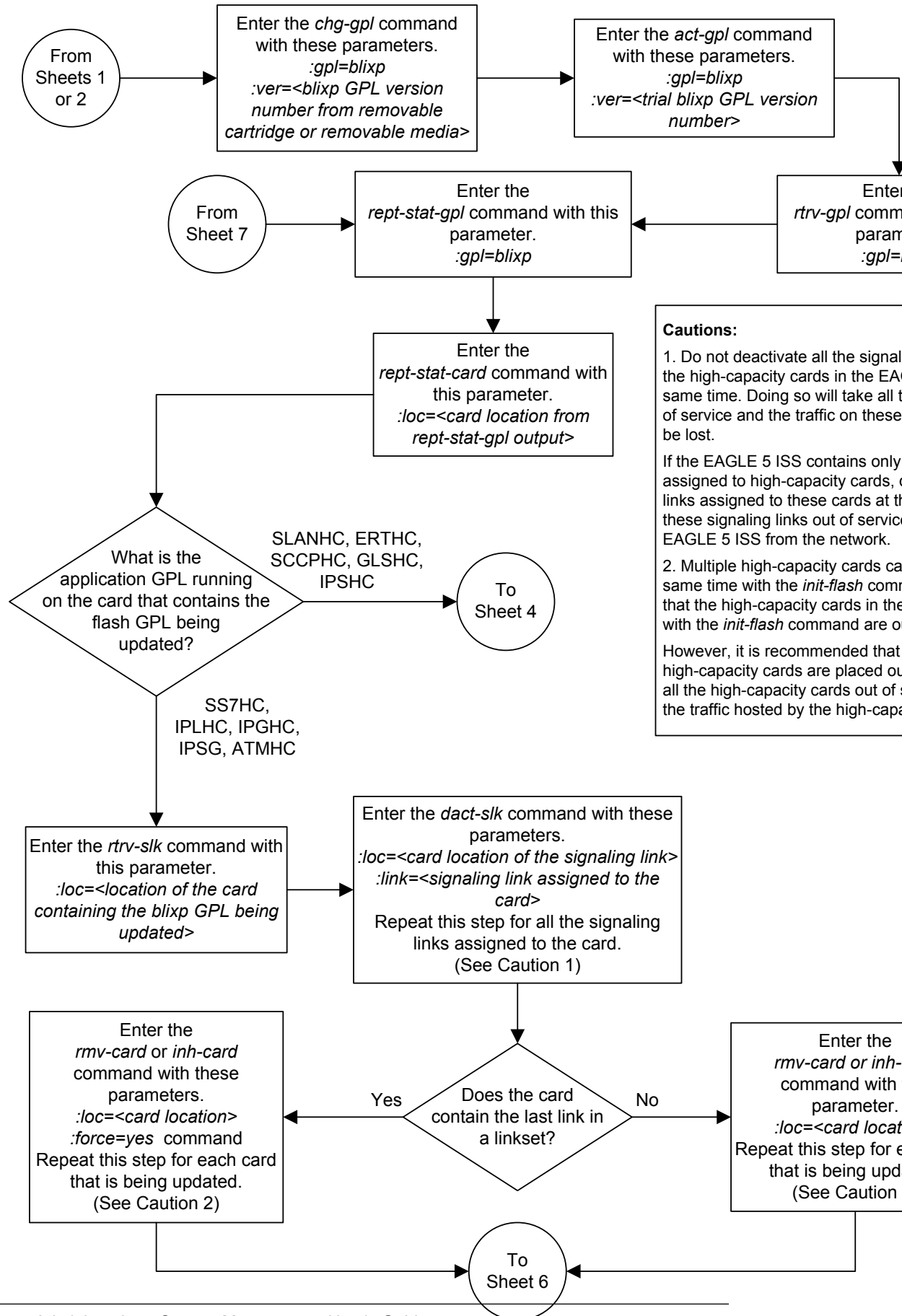

Cautions:

1. Do not deactivate all the signaling links or deactivate all the high-capacity cards in the EAGLE 5 ISS at the same time. Doing so will take all the signaling links out of service and the traffic on these links will be lost.
- If the EAGLE 5 ISS contains only high-capacity cards, do not deactivate all the high-capacity cards at the same time. Doing so will take all the signaling links out of service and the traffic on these links will be lost.
2. Multiple high-capacity cards can be deactivated at the same time with the *init-flash* command. However, it is recommended that only one high-capacity card is placed out of service at a time. Doing so will take all the high-capacity cards out of service and the traffic hosted by the high-capacity cards will be lost.

Sheet 3 of 7

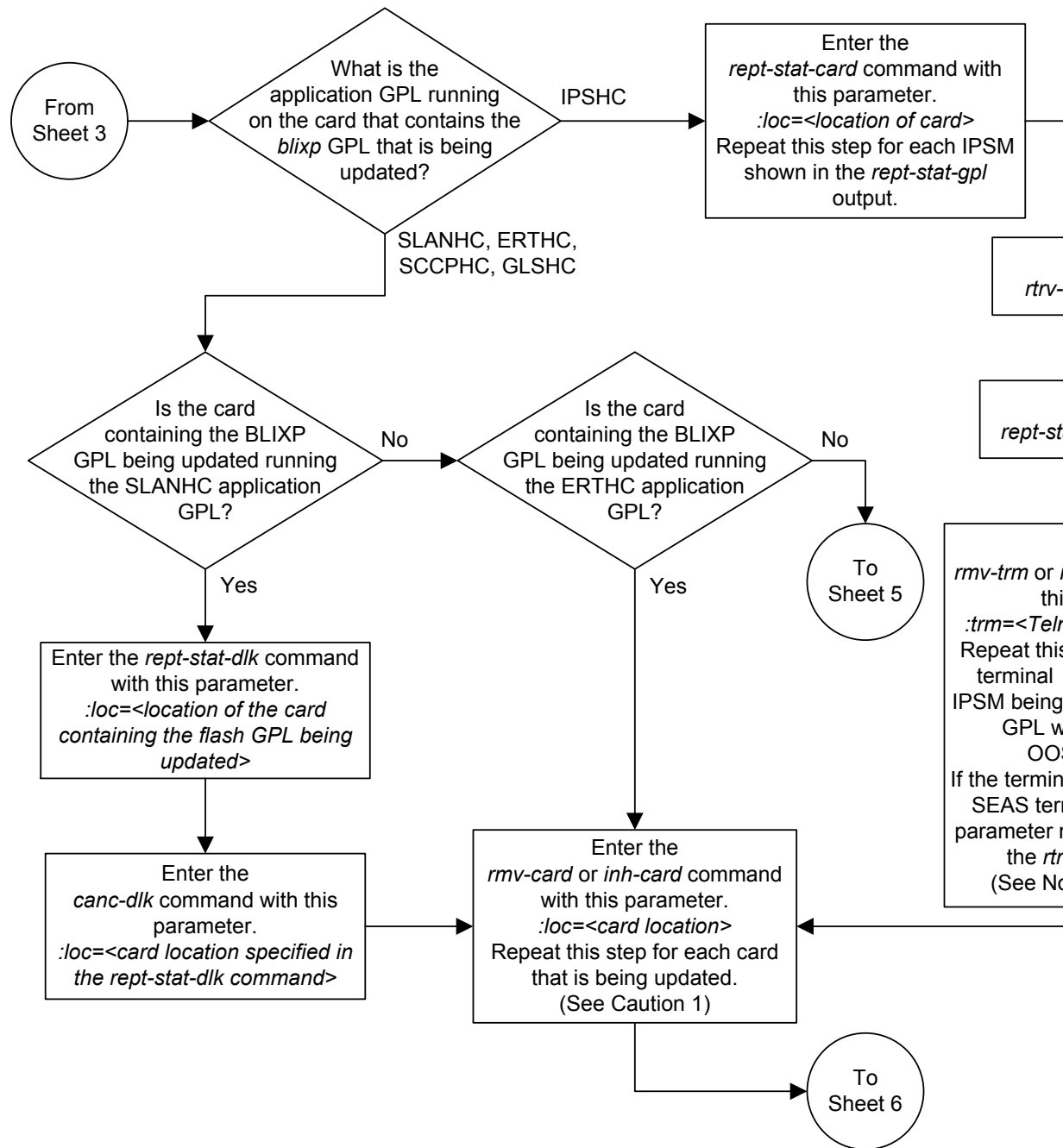

Note: Each IPSM has 8 Telnet terminals associated with it. The *rtv-trm* output shows the Telnet terminals that are associated with each IPSM.

Caution:

1. Multiple high-capacity cards can be updated at the same time with the *init-flash* command. This requires that the high-capacity cards in the locations specified with the *init-flash* command are out of service.

However, it is recommended that only some of the high-capacity cards are placed out of service. Placing all the high-capacity cards out of service will cause all the traffic hosted by the high-capacity cards to be lost.

2. Placing the Telnet terminals out of service will disable all Telnet sessions supported by the terminals associated with the IPSM.

Sheet 4 of 7

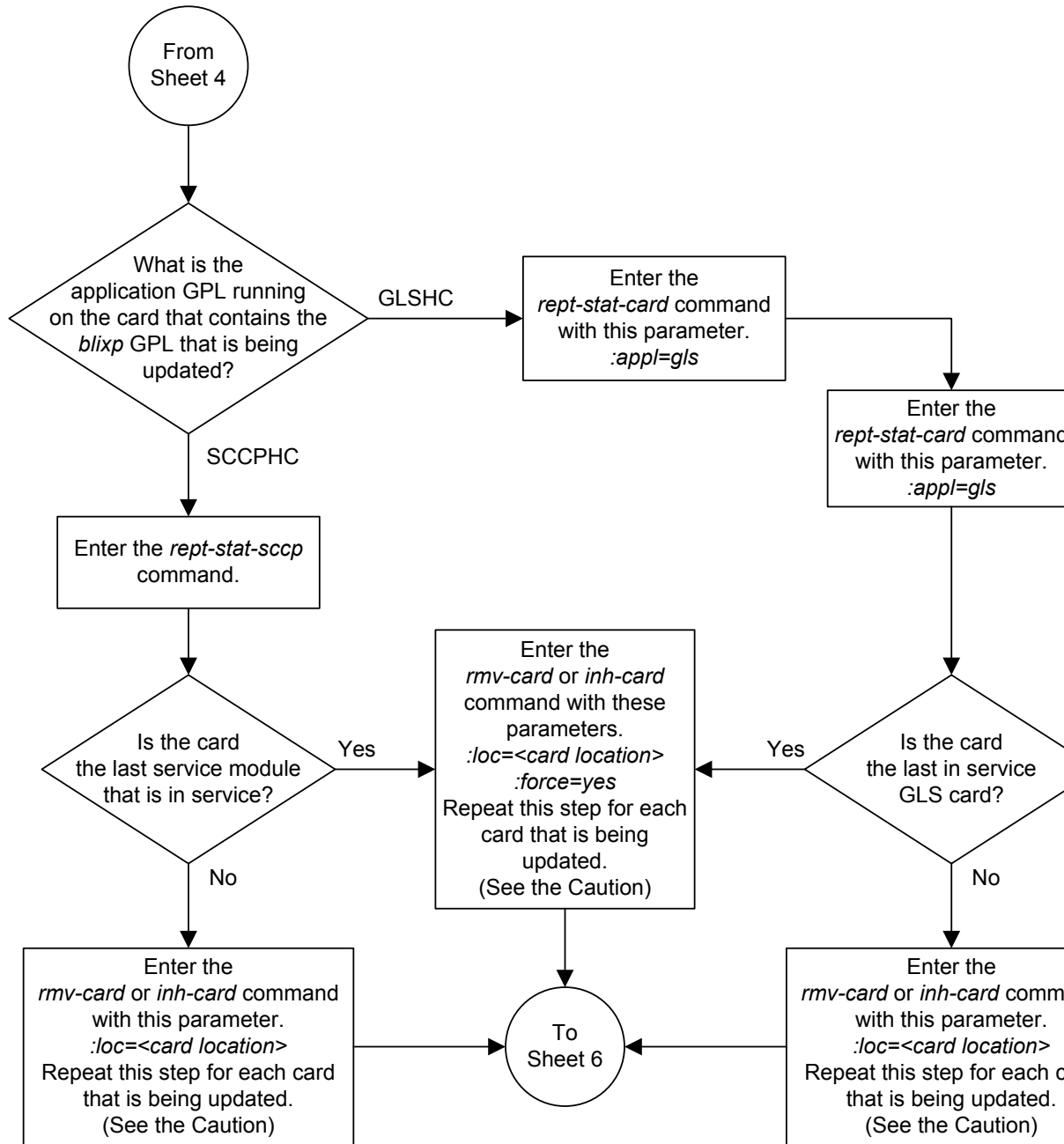

Caution: Multiple high-capacity cards can be updated at the same time with the *init-flash* command. This requires that the high-capacity cards in the locations specified with the *init-flash* command are out of service. However, it is recommended that only some of the high-capacity cards are placed out of service. Placing all the high-capacity cards out of service will cause all the traffic hosted by the high-capacity cards to be lost.

Sheet 5 of 7

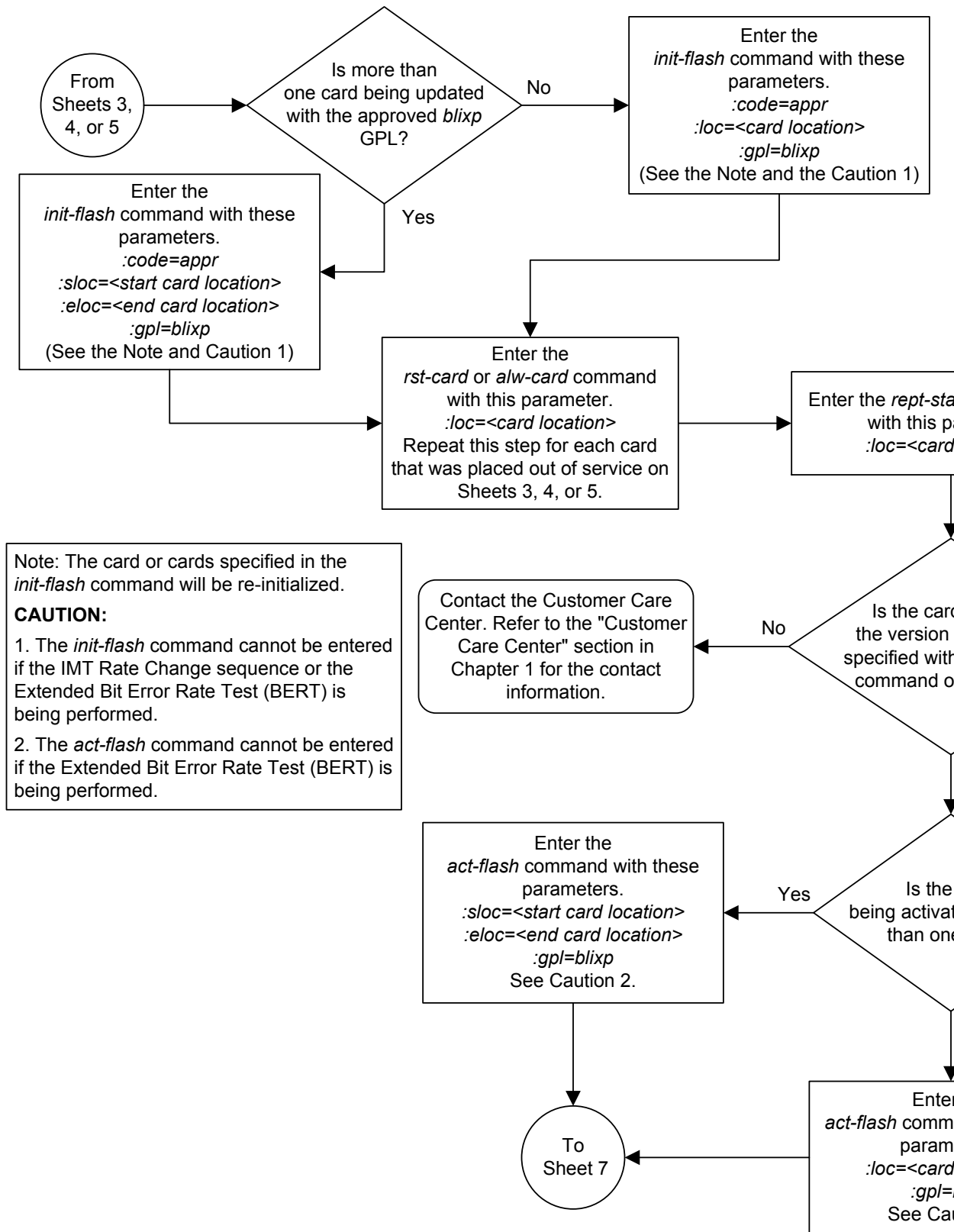

Sheet 6 of 7

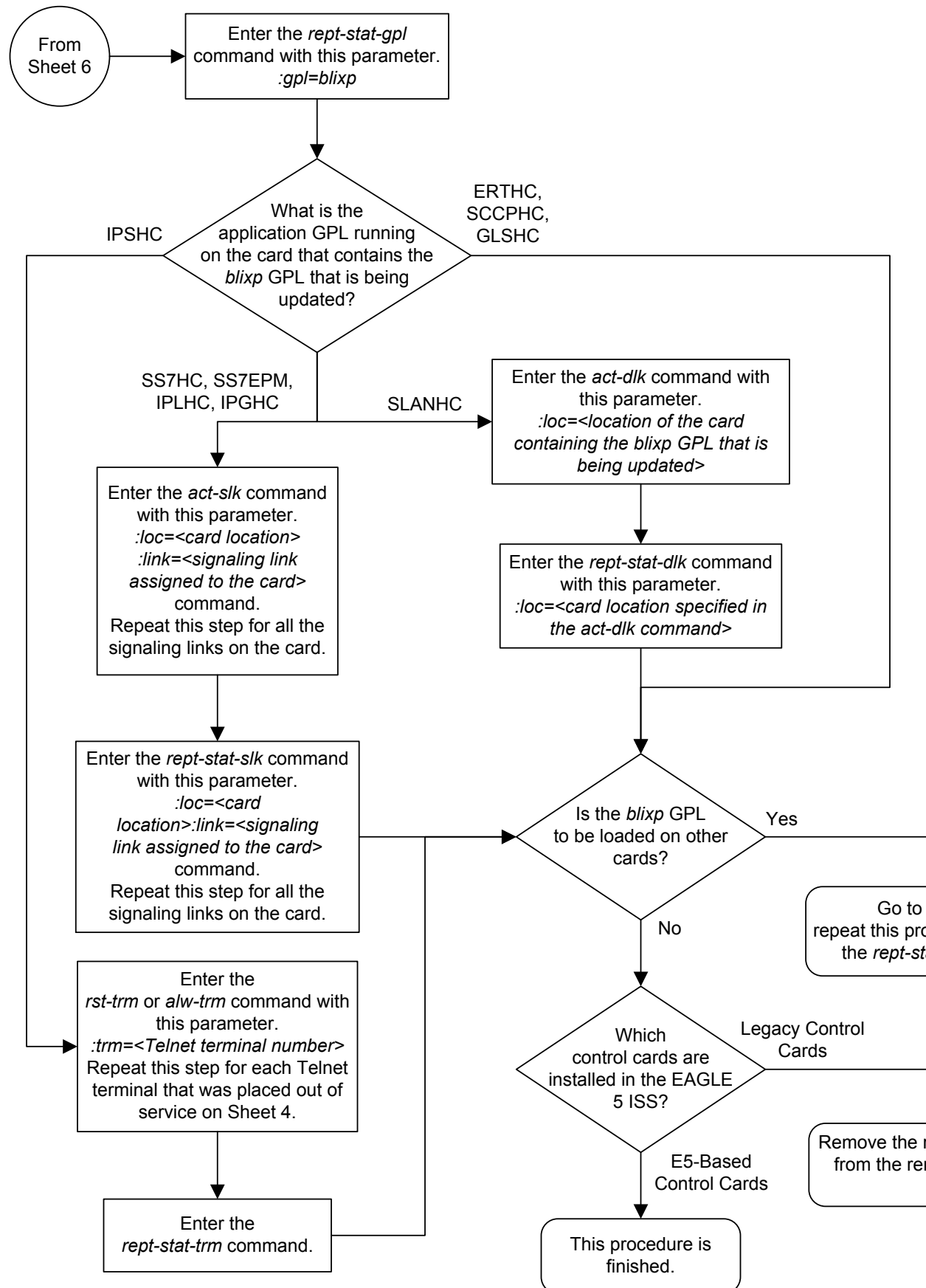

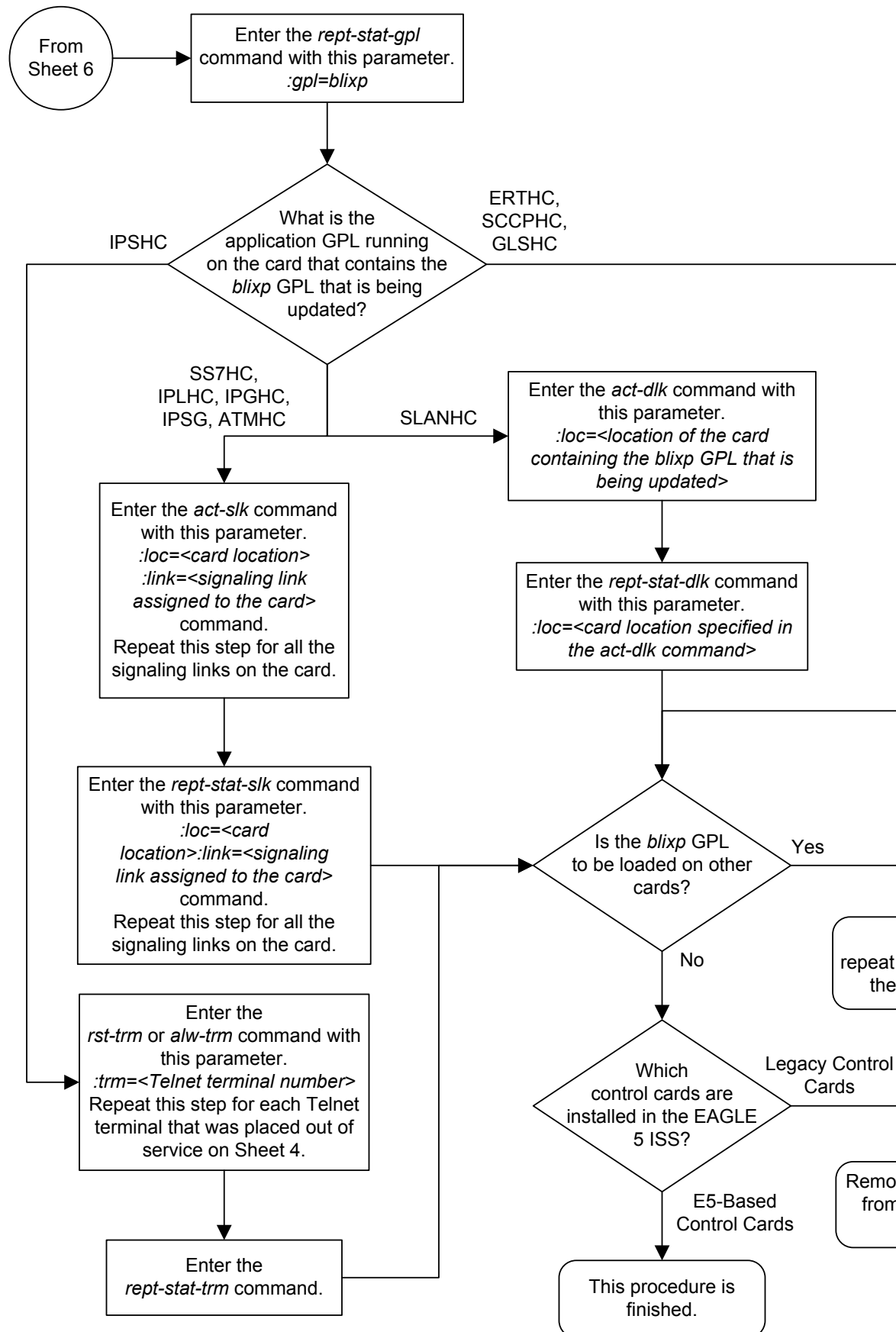

Updating a High-Capacity Card to Run the BLIXP GPL

High-capacity cards that were issued before EAGLE Release 43.0 may not be loaded with the BLIXP GPL. This procedure updates the high-capacity card with the BLIXP GPL using the `flash-card` command. The BLIXP GPL is a tar image of all the flash GPLs that are necessary to operate the high-capacity cards. The high-capacity cards are shown in [Table 3-7](#). When the BLIXP GPL is downloaded to the card, the tar image is un-archived and the flash GPLs are loaded onto the card.

Table 3-7 High-Capacity Cards

HC MIM	E5-E1T1	E5-ENET
E5-STC	E5-SLAN	E5-SM4G
E5-ATM	E5-TSM	

Caution: The `flash-card` command cannot be entered if the IMT Rate Change sequence or the Extended Bit Error Rate Test (**BERT**) is being performed.

The applications and entities supported by the high-capacity cards are shown in [Table 3-8](#).

Table 3-8 High-Capacity Card Applications

High-Capacity Card	Card Name (as shown on the card label)	Application	Application GPL Running on the Card	Supported Entities
HC MIM	HC MIM	SS7ANSI, CCS71TU	SS7HC	E1 or T1 signaling links
E5-E1T1	E5-E1T1	SS7ANSI, CCS71TU	SS7HC	E1 or T1 signaling links
E5-ENET	E5-ENET	SS7IPGW, IPLIM, IPLIMI, IPGWI, IPSG	IPLHC, IPGHC, IPSG	IP signaling links
E5-STC	E5-ENET	EROUTE	ERTHC	EAGLE 5 Integrated Monitoring Support
E5-SM4G	E5-SM4G	VSCCP	SCCPHC	GTT-related features
E5-SLAN	E5-ENET	STPLAN	SLANHC	TCP/IP data links for the STPLAN feature

Table 3-8 (Cont.) High-Capacity Card Applications

High-Capacity Card	Card Name (as shown on the card label)	Application	Application GPL Running on the Card	Supported Entities
E5-ENET-B/ SLIC	E5-ENET-B SLIC	IPS	IPSHC	Telnet sessions for remote connections to the EAGLE and SEAS terminals for the SEAS over IP feature
E5-ATM	E5-ATM	ATMANSI, ATMITU	ATMHC	ANSI and ITU ATM high-speed signaling links
E5-TSM	E5-TSM	GLS	GLSHC	Gateway Screening related features

Caution: Before any high-capacity card can be updated with the BLIXP GPL, all the traffic hosted by the high-capacity card must be stopped, and the high-capacity card must be taken out of service.

Canceling the **REPT-STAT-SLK** and **RTRV-SLK** Commands

Because the `rept-stat-slk` and `rtrv-slk` commands used in this procedure can output information for a long period of time, the `rept-stat-slk` and `rtrv-slk` commands can be canceled and the output to the terminal stopped. There are three ways that the `rept-stat-slk` and `rtrv-slk` commands can be canceled.

- Press the F9 function key on the keyboard at the terminal where the `rept-stat-slk` or `rtrv-slk` commands command were entered.
- Enter the `canc-cmd` without the `trm` parameter at the terminal where the `rept-stat-slk` or `rtrv-slk` commands were entered.
- Enter the `canc-cmd:trm=<xx>`, where `<xx>` is the terminal where the `rept-stat-slk` or `rtrv-slk` commands were entered, from another terminal other than the terminal where the `rept-stat-slk` or `rtrv-slk` commands were entered. To enter the `canc-cmd:trm=<xx>` command, the terminal must allow Security Administration commands to be entered from it and the user must be allowed to enter Security Administration commands. The terminal's permissions can be verified with the `rtrv-secu-trm` command. The user's permissions can be verified with the `rtrv-user` or `rtrv-secu-user` commands.

For more information about the `canc-cmd` command, go to *Commands User's Guide*.

1. Display the BLIXP GPL on the fixed disk by entering this command.

```
rtrv-gpl:gpl=blixp
```

If E5-based control cards are installed in the EAGLE, this is an example of the possible output.

```
rlghncxa03w 10-12-01 11:34:04 GMT EAGLE5 43.0.0
GPL Auditing ON
```

GPL	CARD	RELEASE	APPROVED	TRIAL	REMOVE TRIAL
BLIXP	1114	133-003-000	133-003-000	133-002-000	133-003-000
BLIXP	1116	133-003-000	133-003-000	133-002-000	133-003-000
BLIXP	1115	-----	-----	-----	-----

2. Display the status of the card that is being updated using the `rept-stat-card` command and specifying the location of the card.

For this example, enter this command.

```
rept-stat-card:loc=1303
```

For an **HC MIM** or **E5-E1T1** card, this is an example of the possible output.

```
rlghncxa03w 10-12-01 09:12:36 GMT EAGLE5 43.0.0
CARD  VERSION      TYPE      GPL      PST      SST      AST
1303  133-003-000  LIME1    SS7HC    IS-NR    Active   -----
ALARM STATUS      = No Alarms.
IMTPCI  GPL version = 133-002-000
BLCPLD  GPL version = 133-002-000
BLDIAG6 GPL version = 133-002-000
BLBIOS  GPL version = 133-002-000
BLVXW6  GPL version = 133-002-000
BLROM1  GPL version = 133-002-000
PLDPMC1 GPL version = 133-002-000
IMT BUS A      = Conn
IMT BUS B      = Conn
SIGNALING LINK STATUS
SLK      PST      LS      CLLI
A        IS-NR    e11303a  -----
B        IS-NR    e11303b  -----
A1       IS-NR    e11303a  -----
B3       IS-NR    e11303b  -----
```

Command Completed.

For an **E5-E1T1** card, this is an example of the possible output.

```
rlghncxa03w 10-12-01 09:12:36 GMT EAGLE5 43.0.0
CARD  VERSION      TYPE      GPL      PST      SST      AST
1303  133-003-000  LIME1    SS7EPM   IS-NR    Active   -----
ALARM STATUS      = No Alarms.
IMTPCI  GPL version = 133-002-000
BLCPLD  GPL version = 133-002-000
BLDIAG6 GPL version = 133-002-000
BLBEPM  GPL version = 133-002-000
PLDPMC1 GPL version = 133-002-000
BLVXW6  GPL version = 133-002-000
IMT BUS A      = Conn
IMT BUS B      = Conn
CURRENT TEMPERATURE = 32C ( 90F)   [ALARM TEMP: 60C (140F)]
PEAK TEMPERATURE:   = 39C (103F)  [06-05-02 13:40]
SIGNALING LINK STATUS
SLK      PST      LS      CLLI
A        IS-NR    e11303a  -----
B        IS-NR    e11303b  -----
A1       IS-NR    e11303a  -----
```



```

B3      IS-NR      e11303b      -----
Command Completed.

```

For an **E5-ENET** card, this is an example of the possible output.

```

rlghncxa03w 10-12-01 09:12:36 GMT EAGLE5 43.0.0
CARD  VERSION      TYPE      GPL      PST      SST      AST
1303  133-003-000  DCM      IPLHC    IS-NR    Active   -----
ALARM STATUS      = No Alarms.
IMTPCI  GPL version = 133-002-000
BLCPLD  GPL version = 133-002-000
BLDIAG6 GPL version = 133-002-000
BLBEPM  GPL version = 133-002-000
PLDPMC1 GPL version = 133-002-000
BLVXW6  GPL version = 133-002-000
IMT BUS A      = Conn
IMT BUS B      = Conn
CURRENT TEMPERATURE = 32C ( 90F)      [ALARM TEMP: 60C (140F)]
PEAK TEMPERATURE:  = 39C (103F)      [06-05-02 13:40]
SIGNALING LINK STATUS
SLK     PST              LS              CLLI
A       IS-NR            e11303a         -----
B       IS-NR            e11303b         -----
A1      IS-NR            e11303a         -----
B3      IS-NR            e11303b         -----
Command Completed.

```

For an **E5-STC** card, this is an example of the possible output.

```

rlghncxa03w 10-12-01 09:12:36 GMT EAGLE5 43.0.0
CARD  VERSION      TYPE      GPL      PST      SST      AST
1303  133-003-000  STC      ERTHC    IS-NR    Active   -----
ALARM STATUS      = No Alarms.
IMTPCI  GPL version = 133-002-000
BLVXW6  GPL version = 133-002-000
BLDIAG6 GPL version = 133-002-000
BLBEPM  GPL version = 133-002-000
BLCPLD  GPL version = 133-002-000
IMT BUS A      = Conn
IMT BUS B      = Conn
CURRENT TEMPERATURE = 61C (142F)
PEAK TEMPERATURE:  = 61C (142F)      [00-02-14 10:33]
EROUTE % OCCUP    = 0%
NTP broadcast = VALID
STC IP PORT A:      OOS-MT      Unavail   -----
ALARM STATUS = ** 0084 IP Connection Unavailable
ERROR STATUS = DHCP Lease. Physical Link.
STC IP PORT B:      OOS-MT      Unavail   -----
ALARM STATUS = ** 0084 IP Connection Unavailable
ERROR STATUS = DHCP Lease. Physical Link.
Command Completed.

```

For an **E5-SLAN** card, this is an example of the possible output.

```

rlghncxa03w 10-12-01 09:12:36 GMT EAGLE5 43.0.0
CARD  VERSION      TYPE      GPL      PST      SST      AST
1303  133-003-000  DCM      SLANHC   IS-NR    Active   -----
ALARM STATUS      = No Alarms.

```

```

IMTPCI  GPL version = 133-002-000
BLVXW6  GPL version = 133-002-000
BLDIAG6 GPL version = 133-002-000
BLBEPM  GPL version = 133-002-000
BLCPLD  GPL version = 133-002-000
IMT BUS A      = Conn
IMT BUS B      = Conn
CURRENT TEMPERATURE = 60C (140F)
PEAK TEMPERATURE:  = 63C (146F)      [00-02-12 21:58]
DLK A  PST      = IS-NR      SST = Avail      AST = -----
SLAN % EAGLE CAPACITY = 57%
SLAN % HOST CAPACITY  = 49%

```

Command Completed.

For an **E5-SM4G** card, this is an example of the possible output.

```

rlghncxa03w 10-12-01 09:12:36 GMT EAGLE5 43.0.0
CARD  VERSION      TYPE      GPL      PST      SST      AST
1303  133-003-000  DSM      SCCPHC   IS-NR     Active   -----
ALARM STATUS      = No Alarms.
IMTPCI  GPL version = 133-002-000
BLVXW6  GPL version = 133-002-000
BLDIAG6 GPL version = 133-002-000
BLBSMG  GPL version = 133-002-000
BLCPLD  GPL version = 133-002-000
IMT BUS A      = Conn
IMT BUS B      = Conn
CURRENT TEMPERATURE = 31C ( 88F)
PEAK TEMPERATURE:  = 32C ( 90F)      [07-05-12 15:55]
SCCP % OCCUP      = 1%

```

Command Completed.

For an **E5-ENET-B/SLIC** card, this is an example of the possible output.

```

rlghncxa03w 10-12-01 09:12:36 GMT EAGLE5 43.0.0
CARD  VERSION      TYPE      GPL      PST      SST      AST
1303  133-003-000  IPSM     IPSHC   IS-NR     Active   -----
ALARM STATUS      = No Alarms.
IMTPCI  GPL version = 133-002-000
BLVXW6  GPL version = 133-002-000
BLDIAG6 GPL version = 133-002-000
BLBEPM  GPL version = 133-002-000
BLCPLD  GPL version = 133-002-000
IMT BUS A      = Conn
IMT BUS B      = Conn
CURRENT TEMPERATURE = 32C ( 90F)
PEAK TEMPERATURE:  = 39C (103F)      [06-05-02 13:40]
Command Completed.

```

For an **E5-ATM** card, this is an example of the possible output.

```

rlghncxa03w 10-12-01 09:12:36 GMT EAGLE5 43.0.0
CARD  VERSION      TYPE      GPL      PST      SST      AST
1303  133-003-000  LIMATM  ATMHC   IS-NR     Active   -----
ALARM STATUS      = No Alarms.
IMTPCI  GPL version = 133-002-000
BLVXW6  GPL version = 133-002-000

```

```

BLDIAG6 GPL version = 133-002-000
BLBEPM  GPL version = 133-002-000
BLCPLD  GPL version = 133-002-000
IMT BUS A          = Conn
IMT BUS B          = Conn
CURRENT TEMPERATURE = 38C (101F)
PEAK TEMPERATURE:  = 38C (101F)    [07-11-23 06:10]
SIGNALLING LINK STATUS
      SLK   PST           LS           CLLI
      A     IS-NR        ls1          -----

```

Command Completed.

For an **E5-TSM** card, this is an example of the possible output.

```

rlghncxa03w 10-12-01 09:12:36 GMT EAGLE5 43.0.0
CARD  VERSION      TYPE      GPL          PST          SST          AST
1303  133-003-000  TSM       GLSHC        IS-NR        Active       -----
ALARM STATUS      = No Alarms.
IMTPCI  GPL version = 133-002-000
BLVXW6  GPL version = 133-002-000
BLDIAG6 GPL version = 133-002-000
BLBEPM  GPL version = 133-002-000
BLCPLD  GPL version = 133-002-000
IMT BUS A          = Conn
IMT BUS B          = Conn
CURRENT TEMPERATURE = 38C (101F)
PEAK TEMPERATURE:  = 38C (101F)    [07-11-23 06:10]

```

Command Completed.

Continue the procedure by performing one of these actions:

- If the card is running one of these application GPLs: SS7HC, SS7EPM, IPLHC, IPGHC, ATMHC, IPSG (shown in the GPL column in the `rept-stat-card` output in [2](#)), continue the procedure with [5](#).
- If the card is running the ERTHC application GPL, (shown in the GPL column in the `rept-stat-card` output in [2](#)), continue the procedure with [12](#).
- If the card is running the SLANHC application GPL (shown in the GPL column in the `rept-stat-card` output in [2](#)), continue the procedure with [7](#).
- If the card is running the IPSHC application GPL, (shown in the GPL column in the `rept-stat-card` output in [2](#)), continue the procedure with [9](#).
- If the card is running the SCCPHC application GPL, (shown in the GPL column in the `rept-stat-card` output in [2](#)), continue the procedure with [4](#).
- If the card is running the GLSHC application GPL (shown in the GPL column in the `rept-stat-card` output in [2](#)), continue the procedure with [3](#).

3. Display the GLS cards by entering this command.

```
rept-stat-card:appl=glS
```

The output from this command will display the TSMs that are running the GLS GPL and the E5-TSMs that are running the GLSHC GPL.

This is an example of the possible output.

```
rlghncxa03w 10-12-01 09:12:36 GMT EAGLE5 43.0.0
CARD  VERSION      TYPE      GPL      PST      SST      AST
1207  133-003-000    TSM      GLSHC    IS-NR    Active   -----
1211  133-003-000    TSM      GLSHC    IS-NR    Active   -----
1303  133-003-000    TSM      GLSHC    IS-NR    Active   -----
```

Command Completed.

Continue the procedure with [12](#).

4. Display the service modules by entering the `rept-stat-sccp` command.

The output from this command will display the DSMs that are running the VSCCP GPL and the E5-SM4G cards that are running the SCCPHC GPL.

This is an example of the possible output.

```
rlghncxa03w 10-12-01 09:12:36 GMT EAGLE5 43.0.0

CARD  VERSION      PST      SST      AST      MSU USAGE  CPU USAGE
-----
1303  133-003-000    IS-NR    Active   -----    47%        81%
2103  133-003-000    IS-NR    Active   -----    34%        50%
2111  133-003-000    IS-NR    Active   -----    21%        29%
2115  133-003-000    IS-NR    Active   -----    35%        52%
2117  133-003-000    IS-NR    Active   -----    40%        71%
-----
```

SCCP Service Average MSU Capacity = 36% Average CPU Capacity = 56%
Command Completed.

Note: The `rept-stat-sccp` command output contains other fields that are not used by this procedure. If you wish to see all the fields displayed by the `rept-stat-sccp` command, refer to the `rept-stat-sccp` command description in *Commands User's Guide*.

Continue the procedure with [12](#).

5. Display the signaling links associated with the card shown in [2](#).

Enter the `rtrv-slk` command with the card location specified in [2](#). For this example, enter this command.

```
rtrv-slk:loc=1303
```

This is an example of the possible output for an HC MIM or E5-E1T1 card.

```
rlghncxa03w 10-12-01 09:12:36 GMT EAGLE5 43.0.0

LOC  LINK  LSN      SLC TYPE      L2T      PCR  PCR  E1  E1
      SET  BPS      ECM  N1   N2   LOC  PORT TS
1303 A  e11303a  0  LIME1  1   64000 PCR  76  3800 1303 2  12
1303 B  e11303b  0  LIME1  1   56000 BASIC ---  ----- 1303 1  2
```

```
1303 A1 e11303a 1 LIME1 1 56000 BASIC --- ----- 1303 1 3
1303 B3 e11303b 1 LIME1 1 56000 BASIC --- ----- 1303 1 7
```

This is an example of the possible output for an E5-ENET card.

```
rlghncxa03w 10-12-01 09:12:36 GMT EAGLE5 43.0.0
```

LOC	LINK	LSN	SLC	TYPE	IPLIML2
1303	A	e11303a	0	IPLIM	M2PA
1303	B	e11303b	0	IPLIM	M2PA
1303	A1	e11303a	1	IPLIM	M2PA
1303	B3	e11303b	1	IPLIM	M2PA

This is an example of the possible output for an E5-ATM card.

```
rlghncxa03w 10-12-01 09:12:36 GMT EAGLE5 43.0.0
```

LOC	LINK	LSN	SLC	TYPE	LP		ATM			
					SET	BPS	TSEL	VCI	VPI	
LL										
1303	A	ls2	2	LIMATM	1	1544000	LINE	5	0	0
1303	B	ls1	3	LIMATM	1	1544000	LINE	5	0	0

6. Deactivate the SS7 signaling links on the card using the `dact-slk` command.

For this example, enter these commands.

```
dact-slk:loc=1303:link=a
dact-slk:loc=1303:link=b
dact-slk:loc=1303:link=a1
dact-slk:loc=1303:link=b3
```

Caution: These command examples place the signaling links on card 1303 out of service. This will interrupt service on the signaling links on card 1303 and allow the BLIXP GPL to be loaded on to card 1303.

Caution: If the EAGLE contains only signaling links assigned to the card that is specified in this step, deactivating all of the signaling links that are assigned to the card will take all of these signaling links out of service and will isolate the EAGLE from the network.

When each of these commands have successfully completed, this message should appear.

```
rlghncxa03w 10-12-01 09:12:36 GMT EAGLE5 43.0.0
Deactivate SLK message sent to card
```

Continue the procedure with [12](#).

7. Display the data link, and its status, associated with the card shown in [2](#). Enter the `rept-stat-dlk` command with the card location specified in [2](#).

For this example, enter this command.

```
rept-stat-dlk:loc=1303
```

This is an example of the possible output.

```
rlghncxa03w 10-12-01 09:12:36 GMT EAGLE5 43.0.0
DLK          PST          SST          AST
1303         IS-NR        Active       ----
Alarm Status = No Alarms.
Command Completed.
```

8. Deactivate the TCP/IP data link on the card that you wish to load the GPL onto using the `canc-dlk` command. For this example, enter this command.

```
canc-dlk:loc=1303
```

Caution: This command example places the TCP/IP data link on card 1303 out of service. This will interrupt service on the TCP//IP data link on card 1303 and allow the flash GPL to be loaded onto card 1303.

Caution: If there is only one TCP/IP data link in the EAGLE, placing the card out of service will cause the STPLAN feature to be disabled.

When this command has successfully completed, these messages should appear.

```
rlghncxa03w 10-12-01 09:12:36 GMT EAGLE5 43.0.0
Deactivate Link message sent to card.
Command Completed.
```

Continue the procedure with [12](#).

9. Display the terminal configuration in the database with the `rtrv-trm` command.

The Telnet terminals associated with the card shown in [9](#) must be taken out of service. The Telnet terminals are shown in the output with the entry TELNET in the TYPE field. This is an example of the possible output. In this example, the Telnet terminals that must be taken out of service are terminals 17 to 24.

```
rlghncxa03w 10-12-01 09:12:36 GMT EAGLE5 43.0.0
TRM  TYPE    COMM          FC  TMOUT  MXINV  DURAL
1    VT320    9600-7-E-1 SW   30    5    99:59:59
2    KSR      9600-7-E-1 HW   30    5    INDEF
3    PRINTER  4800-7-E-1 HW   30    0    00:00:00
4    VT320    2400-7-E-1 BOTH 30    5    00:30:00
5    VT320    9600-7-O-1 NONE 30    5    00:00:30
6    VT320    9600-7-O-1 NONE 30    5    00:00:30
7    PRINTER  9600-7-E-2 HW   30    5    00:30:00
8    KSR      19200-7-E-2 BOTH 30    5    00:30:00
9    VT320    9600-7-O-1 NONE 30    5    00:00:30
10   VT320    9600-7-E-1 HW   30    5    00:30:00
11   VT320    4800-7-E-1 HW   30    5    00:30:00
12   PRINTER  9600-7-E-1 HW   30    4    00:30:00
13   VT320    9600-7-O-1 NONE 30    5    00:30:00
14   VT320    9600-7-E-2 SW   30    8    00:30:00
15   VT320    9600-7-E-2 HW   30    5    00:30:00
16   VT320    9600-7-E-2 BOTH 30    3    00:30:00
```

TRM	TYPE	LOC	TMOUT	MXINV	DURAL
17	TELNET	1303	60	5	00:30:00
18	TELNET	1303	60	5	00:30:00
19	TELNET	1303	60	5	00:30:00
20	TELNET	1303	60	5	00:30:00
21	TELNET	1303	60	5	00:30:00
22	TELNET	1303	60	5	00:30:00
23	TELNET	1303	60	5	00:30:00
24	TELNET	1303	60	5	00:30:00
25	TELNET	1203	60	5	00:30:00
26	TELNET	1203	60	5	00:30:00
27	TELNET	1203	60	5	00:30:00
28	TELNET	1203	60	5	00:30:00
39	TELNET	1203	60	5	00:30:00
30	TELNET	1203	60	5	00:30:00
31	TELNET	1203	60	5	00:30:00
32	TELNET	1203	60	5	00:30:00
33	TELNET	1208	60	5	00:30:00
34	TELNET	1208	60	5	00:30:00
35	TELNET	1208	60	5	00:30:00
36	TELNET	1208	60	5	00:30:00
37	TELNET	1208	60	5	00:30:00
38	TELNET	1208	60	5	00:30:00
39	TELNET	1208	60	5	00:30:00
40	TELNET	1208	60	5	00:30:00

Note: The `rtrv-trm` command output contains other fields that are not used by this procedure. If you wish to see all the fields displayed by the `rtrv-trm` command, see the `rtrv-trm` command description in *Commands User's Guide*.

10. Display the status of the terminals with the `rept-stat-trm` command. This is an example of the possible output.

```
rlghncxa03w 10-12-01 09:12:36 GMT EAGLE5 43.0.0
TRM  PST      SST      AST
1    IS-NR     Active   -----
2    IS-NR     Active   -----
3    IS-NR     Active   -----
4    IS-NR     Active   -----
5    IS-NR     Active   -----
6    IS-NR     Active   -----
7    IS-NR     Active   -----
8    IS-NR     Active   -----
9    IS-NR     Active   -----
10   IS-NR     Active   -----
11   IS-NR     Active   -----
12   IS-NR     Active   -----
13   IS-NR     Active   -----
14   IS-NR     Active   -----
15   IS-NR     Active   -----
16   IS-NR     Active   -----
17   IS-NR     Active   -----
18   IS-NR     Active   -----
19   IS-NR     Active   -----
20   IS-NR     Active   -----
21   IS-NR     Active   -----
22   IS-NR     Active   -----
23   IS-NR     Active   -----
```

```

24   IS-NR      Active      -----
25   IS-NR      Active      -----
26   IS-NR      Active      -----
27   IS-NR      Active      -----
28   IS-NR      Active      -----
29   IS-NR      Active      -----
30   IS-NR      Active      -----
31   IS-NR      Active      -----
32   IS-NR      Active      -----
33   IS-NR      Active      -----
34   IS-NR      Active      -----
35   IS-NR      Active      -----
36   IS-NR      Active      -----
37   IS-NR      Active      -----
38   IS-NR      Active      -----
39   IS-NR      Active      -----
40   IS-NR      Active      -----

```

Command Completed.

11. Place the required terminals out of service using the `rmv-trm` or the `inh-trm` command. The function of the `rmv-trm` and the `inh-trm` commands are the same. For this example, enter these commands.

```

rmv-trm:trm=17
rmv-trm:trm=18
rmv-trm:trm=19
rmv-trm:trm=20
rmv-trm:trm=21
rmv-trm:trm=22
rmv-trm:trm=23
rmv-trm:trm=24

```

Note: If the terminal that is being taken out of service is the last in service SEAS terminal, the `force=yes` parameter must be specified with the `rmv-trm` command for that terminal.

Caution: Placing the Telnet terminals out of service will disable any Telnet sessions running on these terminals.

If the status of any of the terminals shown in the `PST` field in 10 is `OOS-MT-DSBLD` (out-of-service maintenance disabled), the terminal is already out of service and the `rmv-trm` command does not need to be executed for that terminal.

This message should appear when each of these commands have successfully completed.

```

rlghncxa03w 10-12-01 09:12:36 GMT EAGLE5 43.0.0
Inhibit message sent to terminal

rlghncxa03w 10-12-01 09:12:36 GMT EAGLE5 43.0.0
Command Completed.

```

12. Place the card shown in 2 out of service using the `rmv-card` or `inh-card` command. The function of the `rmv-card` and the `inh-card` commands are the same.

For this example, enter this command.

```
rmv-card:loc=1303
```

When this command has successfully completed, this message should appear.

```
rlghncxa03w 10-12-01 11:11:28 GMT EAGLE5 43.0.0
Card has been inhibited.
```

The `force=yes` parameter must be specified in this step if any of these conditions exist.

- The HC MIM, E5-E1T1, E5-ATM, or E5-ENET card contains the last signaling link in a linkset.
 - The E5-TSM is the last GLS card that is in service.
 - The service module is the last service module that is in service.
13. Load the approved version of the BLIXP GPL onto the card that was inhibited in 12 using the `flash-card` command with the `code=appr` and the card location parameters.

Caution: The `flash-card` command cannot be entered if the IMT Rate Change sequence or the Extended Bit Error Rate Test (BERT) is being performed.

For this example, enter this command.

```
flash-card:code=appr:loc=1303
```

When this command has successfully completed, these messages should appear.

```
rlghncxa03w 10-12-01 09:12:36 GMT EAGLE5 43.0.0
Flash Card: Downloading BLIXP on card 1303.
;
rlghncxa03w 10-12-01 09:12:36 GMT EAGLE5 43.0.0
Flash Card: Card 1303 download BLIXP complete.
;
rlghncxa03w 10-12-01 09:12:36 GMT EAGLE5 43.0.0
Flash Card: Activating BLIXP on card 1113.
;
rlghncxa03w 10-12-01 09:12:36 GMT EAGLE5 43.0.0
Flash Card: Card 1303 activation BLIXP complete.
;
rrlghncxa03w 10-12-01 09:12:36 GMT EAGLE5 43.0.0
Command Completed.
```

14. Put the card that was inhibited in 12 back into service using the `rst-card` or `alw-card` command. The function of the `rst-card` and the `alw-card` commands are the same.

The `rst-card` or `alw-card` command also loads the approved version of the BLIXP GPL onto the card.

For this example, enter this command.

```
rst-card:code=appr:loc=1303
```

When this command has successfully completed, this message should appear.

```
rlghncxa03w 10-12-01 09:12:36 GMT EAGLE5 43.0.0
Card has been allowed.
```

- Verify that the BLIXP GPL from 14 has loaded and that the card has returned to its in-service normal (**IS-NR**) state using the `rept-stat-card` command.

For this example, enter this command.

```
rept-stat-card:loc=1303
```

For an HC MIM or E5-E1T1 card, this is an example of the possible output.

```
rlghncxa03w 10-12-01 09:12:36 GMT EAGLE5 43.0.0
CARD  VERSION      TYPE      GPL      PST      SST      AST
1303  133-003-000  LIME1    SS7HC    IS-NR    Active   -----
ALARM STATUS      = No Alarms.
BLIXP  GPL version = 133-003-000
IMT BUS A          = Conn
IMT BUS B          = Conn
SIGNALING LINK STATUS
  SLK  PST          LS          CLLI
  A    OOS-MT-DSBLD e11303a    -----
  B    OOS-MT-DSBLD e11303b    -----
  A1   OOS-MT-DSBLD e11303a    -----
  B3   OOS-MT-DSBLD e11303b    -----
Command Completed.
```

For an E5-E1T1 card, this is an example of the possible output.

```
rlghncxa03w 10-12-01 09:12:36 GMT EAGLE5 43.0.0
CARD  VERSION      TYPE      GPL      PST      SST      AST
1303  133-003-000  IPLIM    SS7EPM   IS-NR    Active   -----
ALARM STATUS      = No Alarms.
BLIXP  GPL version = 133-003-000
IMT BUS A          = Conn
IMT BUS B          = Conn
CURRENT TEMPERATURE = 32C ( 90F)    [ALARM TEMP: 60C (140F)]
PEAK TEMPERATURE:  = 39C (103F)    [06-05-02 13:40]
SIGNALING LINK STATUS
  SLK  PST          LS          CLLI
  A    IS-NR        e11303a    -----
  B    IS-NR        e11303b    -----
  A1   IS-NR        e11303a    -----
  B3   IS-NR        e11303b    -----
Command Completed.
```

For an E5-ENET card, this is an example of the possible output.

```
rlghncxa03w 10-12-01 09:12:36 GMT EAGLE5 43.0.0
CARD  VERSION      TYPE      GPL      PST      SST      AST
1303  133-003-000  DCM      IPLHC    IS-NR    Active   -----
```

```

ALARM STATUS      = No Alarms.
BLIXP  GPL version = 133-003-000
IMT BUS A        = Conn
IMT BUS B        = Conn
CURRENT TEMPERATURE = 32C ( 90F)    [ALARM TEMP: 60C (140F)]
PEAK TEMPERATURE: = 39C (103F)    [06-05-02 13:40]
SIGNALING LINK STATUS
  SLK   PST           LS           CLLI
  A     IS-NR         e11303a     -----
  B     IS-NR         e11303b     -----
  A1    IS-NR         e11303a     -----
  B3    IS-NR         e11303b     -----
Command Completed.

```

For an E5-STC card, this is an example of the possible output.

```

rlghncxa03w 10-12-01 09:12:36 GMT EAGLE5 43.0.0
CARD  VERSION      TYPE      GPL      PST      SST      AST
1303  133-003-000  STC      ERTHC    IS-NR     Active   -----
ALARM STATUS      = No Alarms.
BLIXP  GPL version = 133-003-000
IMT BUS A        = Conn
IMT BUS B        = Conn
CURRENT TEMPERATURE = 61C (142F)
PEAK TEMPERATURE: = 61C (142F)    [06-05-02 13:40]
NTP broadcast = VALID
STC IP PORT A:           OOS-MT      Unavail   -----
ALARM STATUS = ** 0084 IP Connection Unavailable
ERROR STATUS = DHCP Lease. Physical Link.
STC IP PORT B:           OOS-MT      Unavail   -----
ALARM STATUS = ** 0084 IP Connection Unavailable
ERROR STATUS = DHCP Lease. Physical Link.
Command Completed.

```

For an E5-SLAN card, this is an example of the possible output.

```

rlghncxa03w 10-12-01 09:12:36 GMT EAGLE5 43.0.0
CARD  VERSION      TYPE      GPL      PST      SST      AST
1303  133-003-000  DCM      SLANHC    IS-NR     Active   -----
ALARM STATUS      = No Alarms.
BLIXP  GPL version = 133-003-000
IMT BUS A        = Conn
IMT BUS B        = Conn
CURRENT TEMPERATURE = 60C (140F)
PEAK TEMPERATURE: = 63C (146F)    [00-02-12 21:58]
DLK A  PST         = IS-NR           SST = Avail   AST = -----
SLAN % EAGLE CAPACITY = 57%
SLAN % HOST CAPACITY  = 49%
Command Completed.

```

For an E5-SM4G card, this is an example of the possible output.

```

rlghncxa03w 10-12-01 09:12:36 GMT EAGLE5 43.0.0
CARD  VERSION      TYPE      GPL      PST      SST      AST
1303  133-003-000  DSM      SCCPHC    IS-NR     Active   -----
ALARM STATUS      = No Alarms.
BLIXP  GPL version = 133-003-000
IMT BUS A        = Conn
IMT BUS B        = Conn

```

```

CURRENT TEMPERATURE = 31C ( 88F)
PEAK TEMPERATURE:   = 32C ( 90F)   [07-05-12 15:55]
SCCP % OCCUP         = 1%
    
```

Command Completed.

For an E5-ENET-B or SLIC card, this is an example of the possible output.

```

rlghncxa03w 10-12-01 09:12:36 GMT EAGLE5 43.0.0
CARD  VERSION      TYPE      GPL      PST      SST      AST
1303  133-003-000  IPSM      IPSHC    IS-NR    Active   -----
ALARM STATUS      = No Alarms.
BLIXP  GPL version = 133-003-000
IMT BUS A         = Conn
IMT BUS B         = Conn
CURRENT TEMPERATURE = 32C ( 90F)
PEAK TEMPERATURE: = 39C (103F)   [06-05-02 13:40]
Command Completed.
    
```

For an E5-ATM card, this is an example of the possible output.

```

rlghncxa03w 10-12-01 09:12:36 GMT EAGLE5 43.0.0
CARD  VERSION      TYPE      GPL      PST      SST      AST
1303  133-003-000  LIMATM   ATMHC    IS-NR    Active   -----
ALARM STATUS      = No Alarms.
BLIXP  GPL version = 133-003-000
IMT BUS A         = Conn
IMT BUS B         = Conn
CURRENT TEMPERATURE = 38C (101F)
PEAK TEMPERATURE:  = 38C (101F)   [07-11-23 06:10]
SIGNALING LINK STATUS
SLK   PST          LS          CLLI
A     IS-NR        ls1        -----
    
```

Command Completed.

For an E5-TSM card, this is an example of the possible output.

```

rlghncxa03w 10-12-01 09:12:36 GMT EAGLE5 43.0.0
CARD  VERSION      TYPE      GPL      PST      SST      AST
1303  133-003-000  TSM      GLSHC    IS-NR    Active   -----
ALARM STATUS      = No Alarms.
BLIXP  GPL version = 133-003-000
IMT BUS A         = Conn
IMT BUS B         = Conn
CURRENT TEMPERATURE = 38C (101F)
PEAK TEMPERATURE:  = 38C (101F)   [07-11-23 06:10]
    
```

Command Completed.

Note: If the version number of the BLIXP GPL that is shown in this step is not the version specified in 1, contact the Customer Care Center. Refer to the [My Oracle Support \(MOS\)](#) section for the contact information.

Continue the procedure by performing one of these actions.

- If card is running one of these application GPLs: SS7HC, SS7EPM, IPLHC, IPGHC, ATMHC, IPSG (shown in the GPL column in the `rept-stat-card` output in 15), continue the procedure with 16.
 - If card is running one of these application GPLs: ERTHC, GLSHC, or SCCPHC, (shown in the GPL column in the `rept-stat-card` output in 15), continue the procedure with 22.
 - If the card is running the SLANHC application GPL, (shown in the GPL column in the `rept-stat-card` output in 15), continue the procedure with 18.
 - If the card is running the IPSHC application GPL, (shown in the GPL column in the `rept-stat-card` output in 15), continue the procedure with 20.
16. Place the signaling links that were deactivated in 6 back into service using the `act-slk` command.

For this example, enter these commands.

```
act-slk:loc=1303:link=a
act-slk:loc=1303:link=b
act-slk:loc=1303:link=a1
act-slk:loc=1303:link=b3
```

When each of these commands have successfully completed, this message should appear.

```
rlghncxa03w 10-12-01 09:12:36 GMT EAGLE5 43.0.0
Activate SLK message sent to card
```

17. Verify that the signaling links activated in 16 are back in service using the `rept-stat-slk` command with the card location and signaling link.

For this example, enter these commands.

```
rept-stat-slk:loc=1303:link=a
```

This is an example of the possible output.

```
rlghncxa03w 10-12-01 09:12:36 GMT EAGLE5 43.0.0
SLK      LSN      CLLI      PST      SST      AST
1303,A   e11303a   -----  IS-NR    Avail    ----
ALARM STATUS      = No Alarms.
UNAVAIL REASON    = --
```

```
rept-stat-slk:loc=1303:link=b
```

This is an example of the possible output.

```
rlghncxa03w 10-12-01 09:12:36 GMT EAGLE5 43.0.0
SLK      LSN      CLLI      PST      SST      AST
1303,B   e11303b   -----  IS-NR    Avail    ----
ALARM STATUS      = No Alarms.
UNAVAIL REASON    = --
```

```
rept-stat-slk:loc=1303:link=a1
```

This is an example of the possible output.

```
rlghncxa03w 10-12-01 09:12:36 GMT EAGLE5 43.0.0
SLK      LSN      CLLI      PST      SST      AST
1303,A1  e11303a  -----  IS-NR    Avail    ----
  ALARM STATUS      = No Alarms.
  UNAVAIL REASON    = --
```

```
rept-stat-slk:loc=1303:link=b3
```

This is an example of the possible output.

```
rlghncxa03w 10-12-01 09:12:36 GMT EAGLE5 43.0.0
SLK      LSN      CLLI      PST      SST      AST
1303,B3  e11303b  -----  IS-NR    Avail    ----
  ALARM STATUS      = No Alarms.
  UNAVAIL REASON    = --
Command Completed.
```

Continue the procedure with [22](#).

- Place the TCP/IP data link that was deactivated in [8](#) back into using the `act-dlk` command. For this example, enter this command.

```
act-dlk:loc=1303
```

When this command has successfully completed, this message should appear.

```
rlghncxa03w 10-12-01 09:12:36 GMT EAGLE5 43.0.0
Activate Link message sent to card.
```

- Verify that the TCP/IP data link activated in [18](#) is back in service with the `rept-stat-dlk` command. For this example, enter this command.

```
rept-stat-dlk:loc=1303
```

This is an example of the possible output.

```
rlghncxa03w 10-12-01 09:12:36 GMT EAGLE5 43.0.0
DLK      PST      SST      AST
1303     IS-NR    Active    ----
  Alarm Status      = No Alarms.
Command Completed.
```

Continue the procedure with [22](#).

- Put the required terminals back into service with the `rst-trm` or `alw-trm` command. The function of the `rst-trm` and the `alw-trm` commands are the same. For this example, enter these commands.

```
rst-trm:trm=17
```

```
rst-trm:trm=18
```

```
rst-trm:trm=19
```

```
rst-trm:trm=20
```

```
rst-trm:trm=21
```

```
rst-trm:trm=22
```

```
rst-trm:trm=23
```

```
rst-trm:trm=24
```

This message should appear when each of these commands have successfully completed.

```
rlghncxa03w 10-12-01 09:12:36 GMT EAGLE5 43.0.0
Allow message sent to terminal
```

```
rlghncxa03w 10-12-01 09:12:36 GMT EAGLE5 43.0.0
Command Completed.
```

- 21.** Verify that the terminals are in service with the `rept-stat-trm` command. This is an example of the possible output.

```
rlghncxa03w 10-12-01 09:12:36 GMT EAGLE5 43.0.0
TRM  PST      SST      AST
1    IS-NR     Active   -----
2    IS-NR     Active   -----
3    IS-NR     Active   -----
4    IS-NR     Active   -----
5    IS-NR     Active   -----
6    IS-NR     Active   -----
7    IS-NR     Active   -----
8    IS-NR     Active   -----
9    IS-NR     Active   -----
10   IS-NR     Active   -----
11   IS-NR     Active   -----
12   IS-NR     Active   -----
13   IS-NR     Active   -----
14   IS-NR     Active   -----
15   IS-NR     Active   -----
16   IS-NR     Active   -----
17   IS-NR     Active   -----
18   IS-NR     Active   -----
19   IS-NR     Active   -----
20   IS-NR     Active   -----
21   IS-NR     Active   -----
22   IS-NR     Active   -----
23   IS-NR     Active   -----
24   IS-NR     Active   -----
25   IS-NR     Active   -----
26   IS-NR     Active   -----
27   IS-NR     Active   -----
28   IS-NR     Active   -----
29   IS-NR     Active   -----
30   IS-NR     Active   -----
31   IS-NR     Active   -----
32   IS-NR     Active   -----
33   IS-NR     Active   -----
34   IS-NR     Active   -----
35   IS-NR     Active   -----
36   IS-NR     Active   -----
37   IS-NR     Active   -----
38   IS-NR     Active   -----
39   IS-NR     Active   -----
40   IS-NR     Active   -----
```

Command Completed.

22. This procedure is finished.

Figure 3-9 Updating a High-Capacity Card to Run the BLIXP GPL

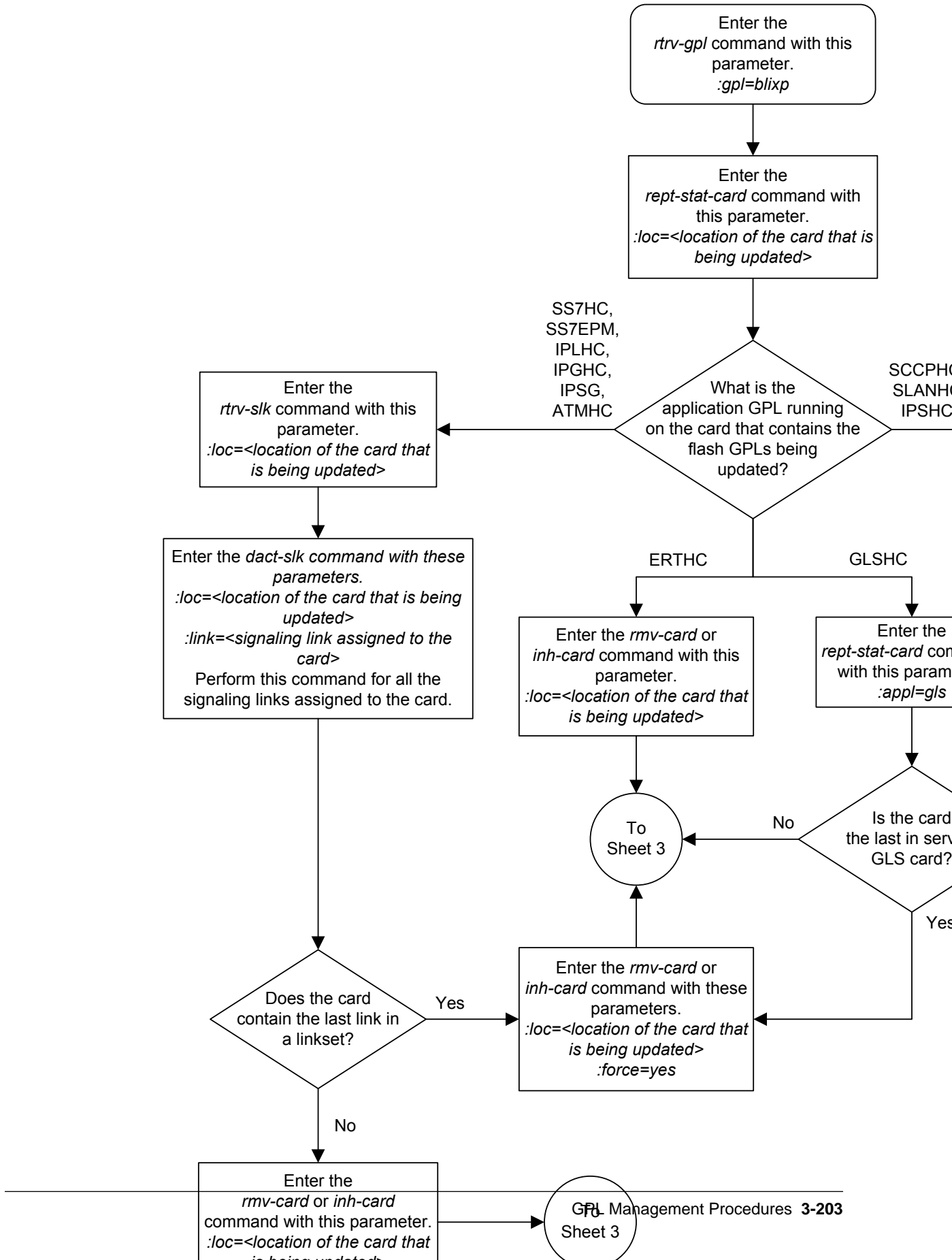

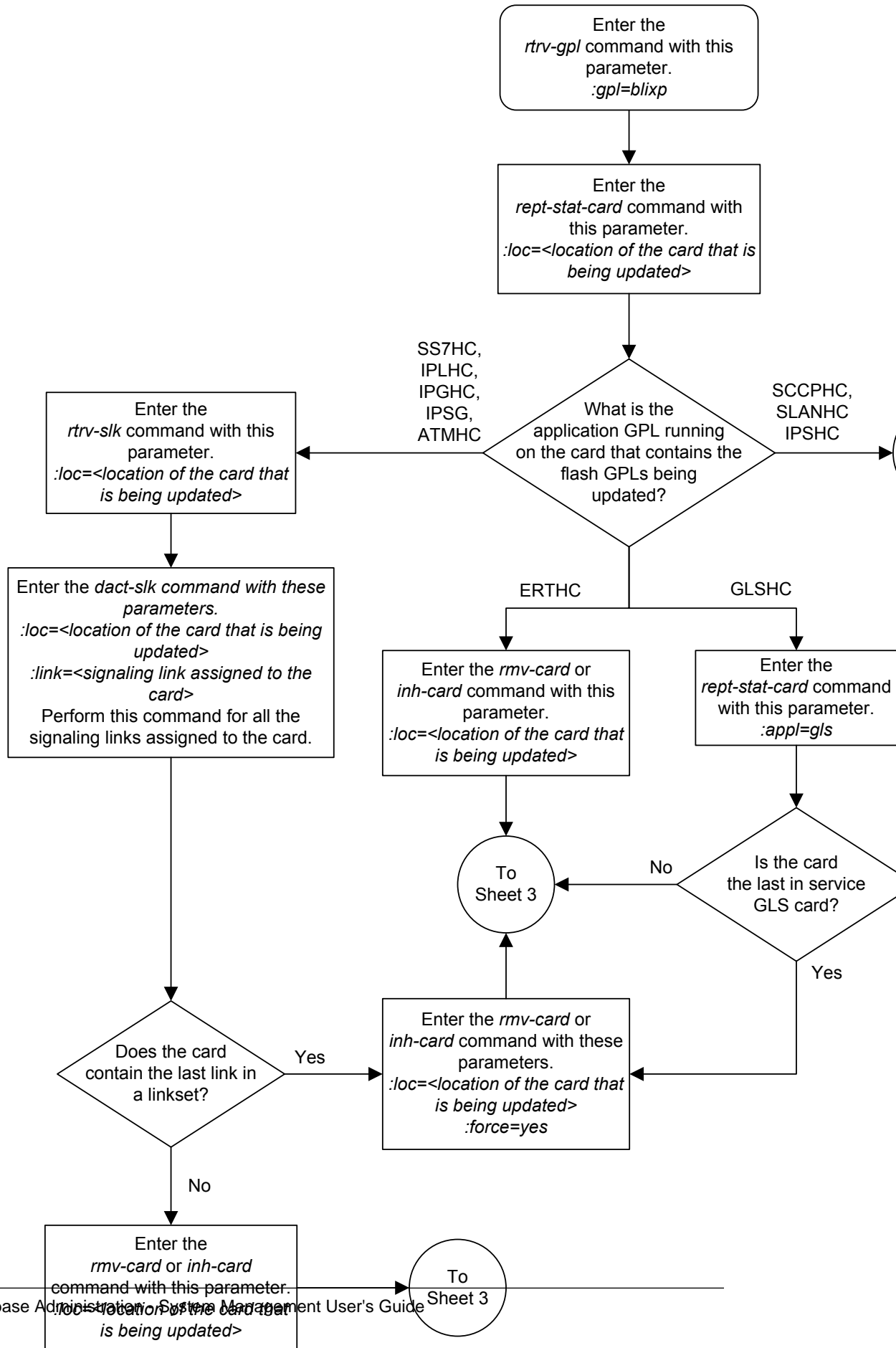

Sheet 1 of 4

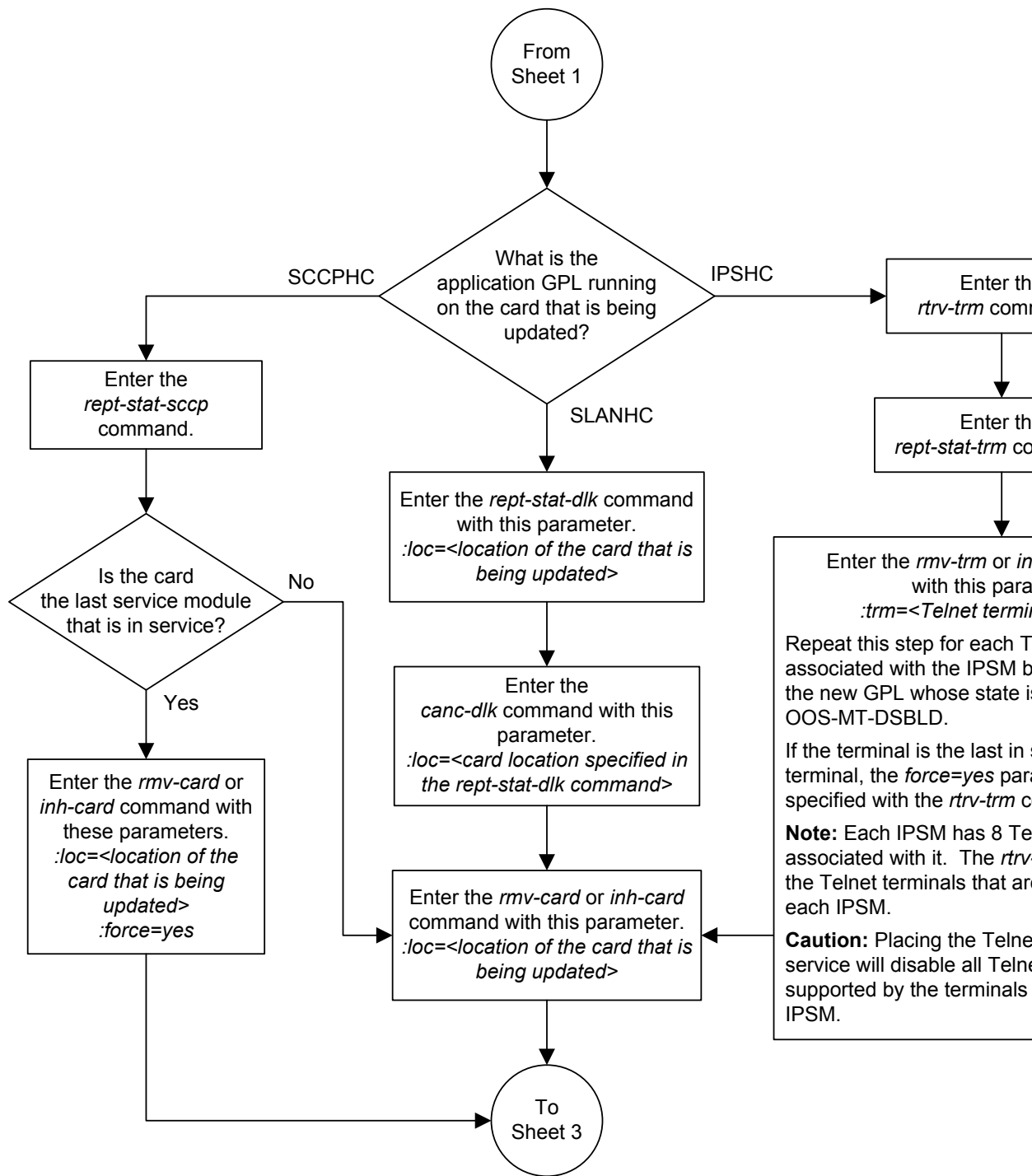

Sheet 2 of 4

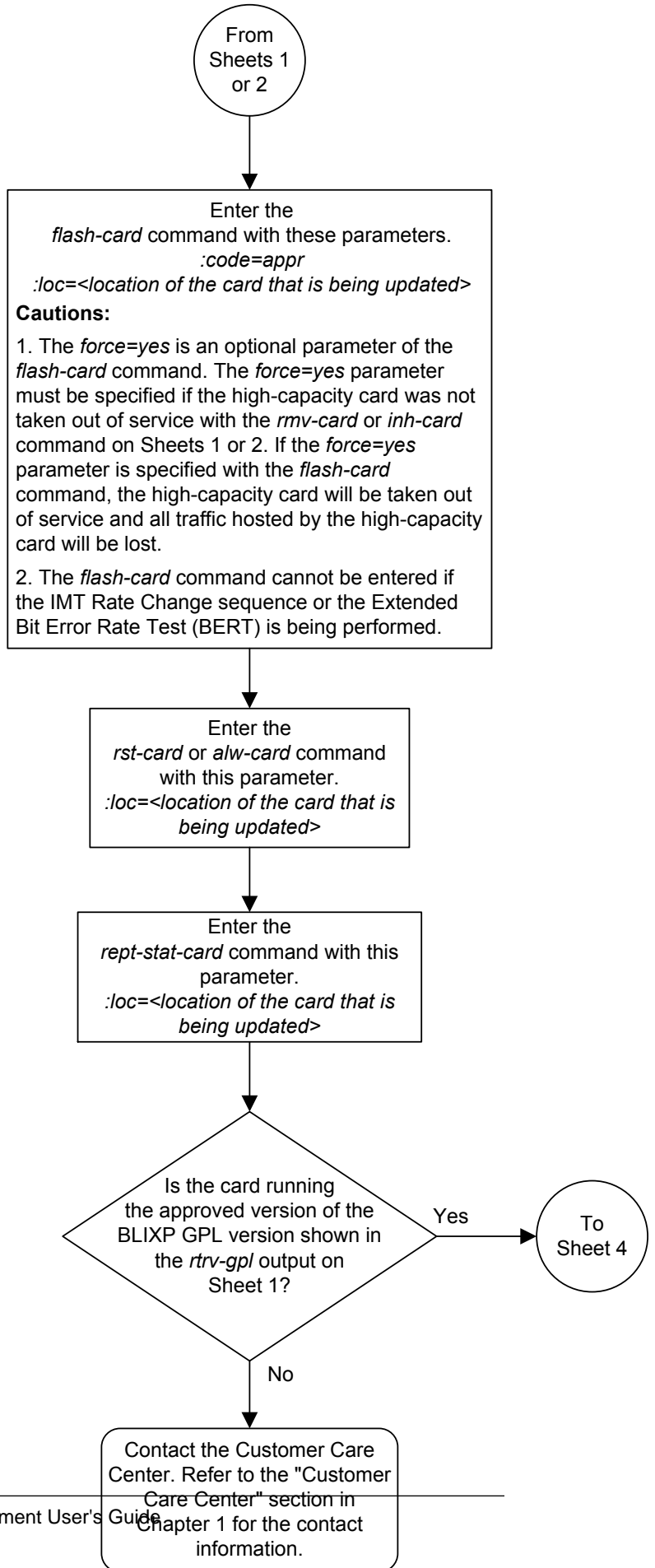

Sheet 3 of 4

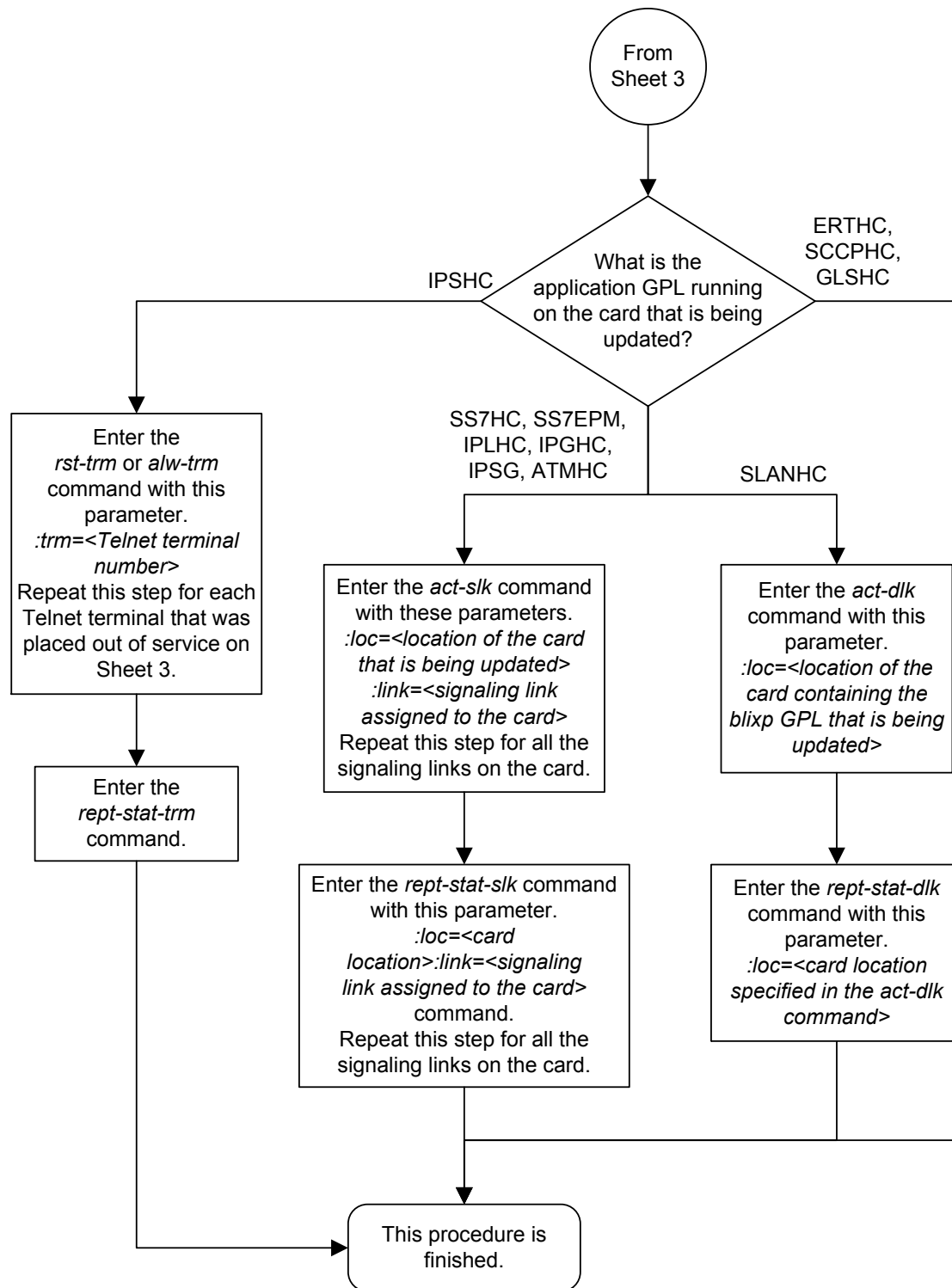

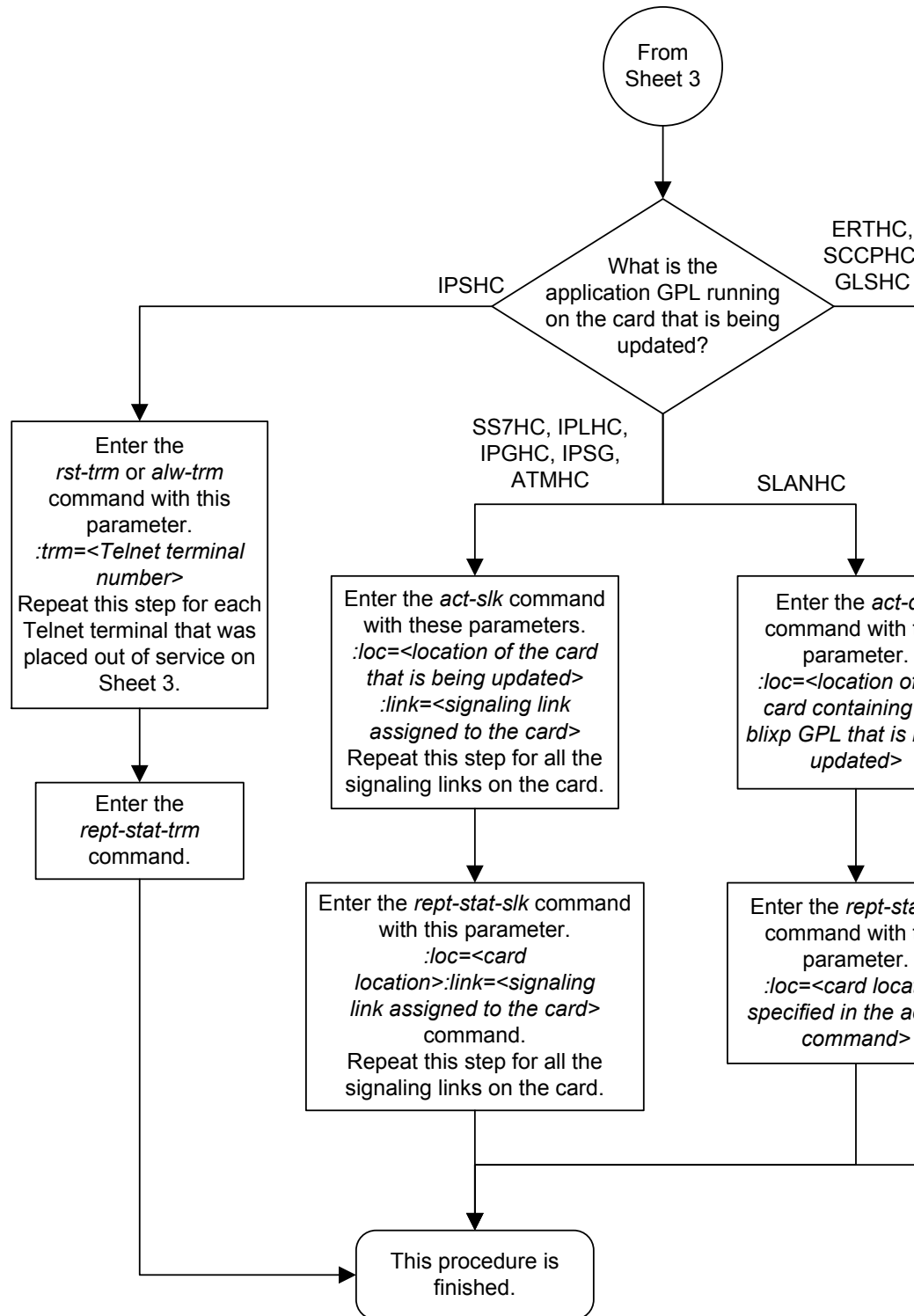

Conversion of SM8G-B Cards

There are two types of cards that can operate in 32-bit or 64-bit mode: SM8G-B and SLIC cards. SM8G-B cards are equipped with 8G bytes of RAM. The operator must convert the cards to operate on 64-bit mode in order to enable access to memory ranges beyond the 4G byte, the memory range limit for 32-bit mode cards.

Because the GPL image contains either 32-bit or 64-bit mode code, the card must be flashed with the correct version before being able to run on the desired mode. Follow the steps in [SM8G-B 32-bit to 64-bit Conversion](#) or [SM8G-B 64-bit to 32-bit Conversion](#) in order to convert an SM8G-B card to operate from one mode to the other.

SM8G-B Bootloader Swap

An SM8G-B card running on a BLMCAP version from a release prior to EAGLE 46.3 may contain the 32-bit mode only bootloader. This bootloader must be updated before converting to 64-bit mode. The following procedure is used to update the 32-bit mode bootloader to 64-bit. Skip this procedure if the card is already running the BLDC64 GPL.

1. Inhibit the target card with the `inh-card:loc=<card_loc>:force=yes`.

The card will boot and return to state OOS-MT-DSBLD within 60 seconds.

2. Flash the card with the `init-flash:loc=<card_loc>:code=appr:gpl=blmcap` command.

After the flashing operations complete, the card will boot and return to state OOS-MT-DSBLD.

3. Activate the new BLMCAP GPL with the `act-flash:loc=<card_loc>` command.

4. Replace the card's bootloader with the `init-flash:loc=xxxx:mode=rplcebl:bits=64` command.

If the card was already running with the desired bootloader, the command does nothing.

SM8G-B 32-bit to 64-bit Conversion

The following procedure is used to convert the 32-bit mode to 64-bit. The target card must already be running on the BLMCAP GPL and had its bootloader swapped, as completed in [SM8G-B Bootloader Swap](#). Skip this procedure if the card is already running the BLDC64 GPL.

1. Inhibit the target card with the `inh-card:loc=<card_loc>:force=yes`.

The card will boot and return to state OOS-MT-DSBLD within 60 seconds.

2. Flash the card with the `init-flash:loc=<card_loc>:code=appr:mode=cnvrtbit:bits=64` command.

After the flashing operations complete, the card will boot and return to state OOS-MT-DSBLD.

3. Activate the new BLDC64 GPL with the `act-flash:loc=<card_loc>` command.

The card will now run on 64-bit mode and will accept 64-bit mode applications from the OAM.

SM8G-B 64-bit to 32-bit Conversion

The following procedure is used to convert the 64-bit mode to 32-bit. The target card must already be running on the BLDC64 GPL and contain the correct bootloader, as completed in [SM8G-B Bootloader Swap](#). Skip this procedure if the card is already running the BLMCAP GPL.

1. Inhibit the target card with the `inh-card:loc=<card_loc>:force=yes`.

The card will boot and return to state OOS-MT-DSBLD within 60 seconds.

2. Flash the card with the `init-flash:loc=<card_loc>:code=appr:mode=cnvrtbit:bits=32` command.

After the flashing operations complete, the card will boot and return to state OOS-MT-DSBLD.

3. Activate the new BLMCAP GPL with the `act-flash:loc=<card_loc>` command.

The card will now run on 32-bit mode and will accept 32-bit mode applications from the OAM.

Conversion of SLIC Cards

SLIC cards are equipped with 16G bytes of RAM. They can run on either the 32-bit mode BLSLC32 flash GPL or on the 64-bit mode BLSLC64 flash GPL.

Follow the steps in [SLIC 32-bit to 64-bit Conversion](#) or [SLIC 64-bit to 32-bit Conversion](#) in order to convert a SLIC card to operate from one mode to the other.

SLIC 32-bit to 64-bit Conversion

The following procedure is used to convert the 32-bit mode to 64-bit. The target card should already be running on the BLSLC32 GPL. Skip this procedure if the card is already running the BLSLC64 GPL.

1. Inhibit the target card with the `inh-card:loc=<card_loc>:force=yes`.

The card will boot and return to state OOS-MT-DSBLD within 60 seconds.

2. Flash the card with the `init-flash:loc=<card_loc>:code=appr:gpl=BLSLC64` command.

After the flashing operations complete, the card will boot and return to state OOS-MT-DSBLD.

3. Activate the new BLSLC64 GPL with the `act-flash:loc=<card_loc>` command.

The card will now run on 64-bit mode and will accept 64-bit mode applications from the OAM.

4. Update/verify the SLIC bootloader using the `init-flash:loc=<card_loc>:mode=rplcebl:bits=64` command.

If the card was already running with the desired bootloader, the command has no effect; otherwise, the bootloader will be updated.

SLIC 64-bit to 32-bit Conversion

The following procedure is used to convert the 64-bit mode to 32-bit. The target card should already be running on the BLSLC64 GPL. Skip this procedure if the card is already running the BLSLC32 GPL.

1. Inhibit the target card with the `inh-card:loc=<card_loc>:force=yes`.

The card will boot and return to state OOS-MT-DSBLD within 60 seconds.

2. Flash the card with the `init-flash:loc=<card_loc>:code=appr:gpl=BLSLC32` command.

After the flashing operations complete, the card will boot and return to state OOS-MT-DSBLD.

3. Activate the new BLSLC32 GPL with the `act-flash:loc=<card_loc>` command.

The card will now run on 32-bit mode and will accept 32-bit mode applications from the OAM.

4. A card previously running on the BLSLC64 should already be using the correct bootloader. If in doubt, update/verfiy the SLIC bootloader with the `init-flash:loc=<card_loc>:mode=rplcebl:bits=64` command.

If the card was already running with the desired bootloader, the command has no effect; otherwise, the bootloader will be updated.

System Administration Procedures

Chapter 4, System Administration Procedures, describes the procedures used to administer the items shown in the [Introduction](#).

Introduction

This chapter contains system administration procedures. The items discussed in this section are:

- The date and time
- User IDs and passwords
- Terminal configuration
- Shelves
- Cards
- **Security Log**
- Unauthorized Use Warning Message
- UIM Thresholds
- MCPMs, IP links, and FTP servers for the Measurements Platform
- IPSMs for the IP User Interface (Telnet) feature
- Configuring the Network Security Options
- Configuring the Restore Device State Option
- Configuring the Frame Power **Alarm** Threshold

The procedures shown in this chapter use a variety of commands. If more information on these commands is needed, go to *Commands User's Guide* to find the required information.

Setting the Clock and Date on the EAGLE

This procedure is used to set the EAGLE's clock and date.

1. To set the date, use the `set-date` command.

The date must be entered in the form **YYMMDD** (YY for the year, MM for the month, and DD for the day of the month). For example, to set the date to March 7, 2003, enter this command.

```
set-date:date=030307
```

When this command has successfully completed, this message should appear.

```
rlghncxa03w 06-10-01 09:33:19 GMT EAGLE5 36.0.0
Date set complete.
```

2. To set the clock, use the `set-time` command.

The time must be entered in the form **HHMM** (**HH** for the hour, and **MM** for the minutes). The hour is based on a 24-hour clock. The time zone can also be specified. If the time zone is not specified, then the **EAGLE** uses the time zone that was entered with the previous `set-time` command. The values for the time zone parameter are shown in [Table 4-1](#). The entry in the Abbreviation column of [Table 4-1](#) is the value to be specified for the time zone parameter.

Table 4-1 Time Zones

Time Zone	Abbreviation	Offset from GMT (hours)
Greenwich Mean Time	GMT	0
US Eastern Daylight Time	EDT	-4
US Eastern Standard Time	EST	-5
US Pacific Daylight Time	PDT	-7
US Pacific Standard Time	PST	-8
US Mountain Daylight Time	MDT	-6
US Mountain Standard Time	MST	-7
US Central Daylight Time	CDT	-5
US Central Standard Time	CST	-6
US Hawaiian Daylight Time	HDT	-9
US Hawaiian Standard Time	HST	-10
Atlantic Daylight Time	ADT	-3
Atlantic Standard Time	AST	-4
Western European Time	WET	0
Universal Time Coordinated	UTC	0
British Summer Time	BST	+1
Western European Summer Time	WEST	+1
Central European Time	CET	+1
Central European Summer Time	CEST	+2
Eastern European Time	EET	+2
Eastern European Summer Time	EEST	+3

Table 4-1 (Cont.) Time Zones

Time Zone	Abbreviation	Offset from GMT (hours)
French Summer Time	FST	+ 2
French Winter Time	FWT	+ 1
Brazil Standard Time	BRA	- 3
Middle European Time	MET	+ 1
Middle European Summer Time	MEST	+ 2
Moscow Time	MSK	+ 3
Moscow Summer Time	MSD	+ 4
Australian Eastern Standard Time	AEST	+ 10
Australian Eastern Daylight Time	AEDT	+ 11
Australian Western Standard Time	AWST	+ 8
Australian Western Daylight Time	AWDT	+ 9
Australian Central Standard Time	ACST	+ 9.5
Australian Central Daylight Time	ACDT	+ 10.5
New Zealand Standard Time	NZST	+ 12
New Zealand Daylight Time	NZDT	+ 13
South African Standard Time	SAST	+ 2
China Coast Time	CCT	+ 8
Republic of Korea	ROK	+ 9
India Standard Time	IST	+ 5.5
India Daylight Time	IDT	+ 6.5
Alaska Standard Time	AKST	-9
Alaska Daylight Time	AKDT	-8
Newfoundland Standard Time	NST	-3.5
Newfoundland Daylight Time	NDT	-2.5

For example, to set the time to 14:20 (2:20 PM) in the Greenwich Mean time zone, enter this command.

```
set-time:time = 1420:tz=gmt
```

When this command has successfully completed, this message should appear.

```
rlghncxa03w 06-10-01 14:20:00 GMT EAGLE5 36.0.0
Time set complete.
```

3. Back up the new changes using the `chg-db:action=backup:dest=fixed` command.

These messages should appear, the active **Maintenance and Administration Subsystem Processor (MASP)** appears first.

```
BACKUP (FIXED) : MASP A - Backup starts on active MASP.  
BACKUP (FIXED) : MASP A - Backup on active MASP to fixed disk complete.  
BACKUP (FIXED) : MASP A - Backup starts on standby MASP.  
BACKUP (FIXED) : MASP A - Backup on standby MASP to fixed disk complete.
```

Figure 4-1 Setting the Clock and Date on the EAGLE 5 ISS

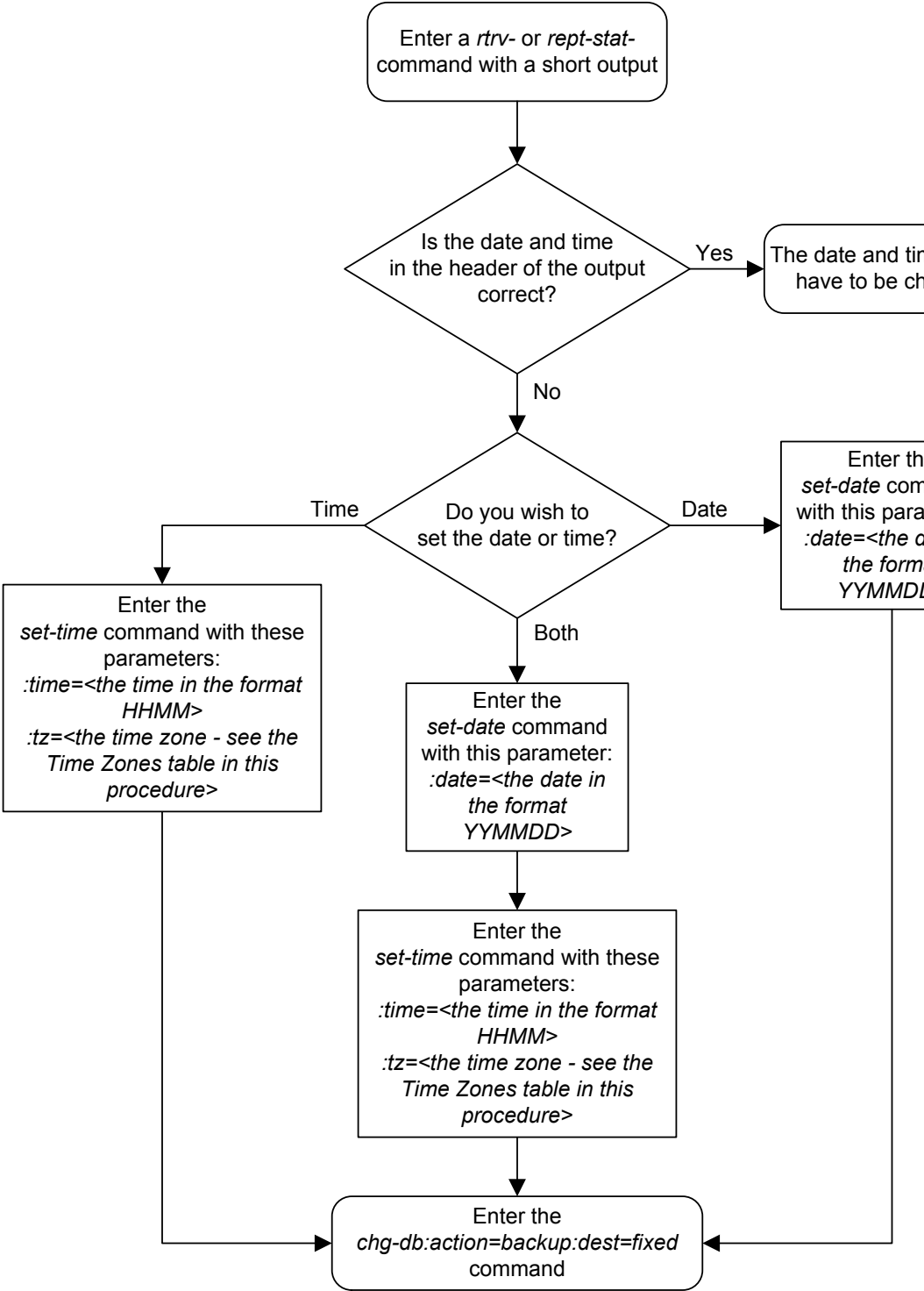

Changing the Security Defaults

This procedure is used to change the user **ID** and password requirements for the **EAGLE** using the `chg-secu-dflt` command. The `chg-secu-dflt` command uses these parameters.

`:page` – The amount of time, in days, that the specified user's password can be used before the user must change their password. The value of this parameter applies to all **EAGLE** user **IDs** unless a different value is specified for a specific user **ID** with the `ent-user` or `chg-user` command.

`:uout` – The number of consecutive days that a user **ID** can remain active in the **EAGLE** and not be used. When the user **ID** has not been used for the number of days specified by the `uout` parameter, that user **ID** is no longer valid and the **EAGLE** rejects any attempt to log into the **EAGLE** with that user **ID**. The value of this parameter applies to all user **IDs** in the **EAGLE** unless a different value is specified for a specific user **ID** with the `ent-user` or `chg-user` command.

`:multlog` – are the user **IDs** allowed to log on to more than one terminal at any given time.

`:minlen` – the minimum length of the password

`:alpha` – the minimum number of alpha characters (a - z)

`:num` – the minimum number of numeric characters (0 - 9)

`:punc` – the minimum number of punctuation characters (any printable character that is not an alphabetic character, a numeric character, the space bar)

`:minintrvl` – the minimum number of days before a password can be changed again.

`:pchreuse` – the number of characters that cannot be reused from the current password when setting the new password. For example, if the `pchreuse` parameter value is 5, no more than five characters of the current password can be reused in the new password.

`:pgrace` – the number of days after password expiration during which the user can login without changing their password.

`:pnotify` – the number of days before password expiration that the user is notified about the expiration.

`:preuse` – the number of previous passwords that cannot be used. If the `preuse` parameter value is 6, the previous six passwords cannot be used.

The `chg-secu-dflt` command also contains the `wrnln,wrnmtx`, and `clrwrmtx` parameters. These parameters are used to configure the unauthorized use warning message that is displayed when a user logs into the **EAGLE**. To configure the unauthorized use warning message, go to the [Configuring the Unauthorized Use Warning Message](#) procedure.

Even though the `minlen` parameter specifies the minimum length of a password, the password must also contain the minimum number characters defined by the `alpha`, `num`, and `punc` parameters.

The examples in this procedure are used to change the security defaults to these values.

`page = 100 days`

uout = 50 days
multlog = yes, to allow the user **IDs** in the **EAGLE** to log onto more than one terminal at any given time.
minlen = 12 characters
alpha = 2 characters
num = 2 characters
punc = 2 characters
minintrvl = 5 days
pnotify = 14 days
pgrace = 2 days
preuse = 6 passwords
pchreuse = 5 characters

Note: When the EAGLE is delivered to the user, the database will contain these security default values.

:page = 90 days
:uout = 90 days
:multlog = no
:minlen = 8 characters
:alpha = 1 character
:num = 1 character
:punc = 1 character
:minintrvl = 1 day
:pnotify = 7 days
:pgrace = 3 days
:preuse = 5 passwords
:pchreuse = 4 characters

The `rtrv-secu-dflt` command uses the `msg` parameter to specify whether the unauthorized use warning message text is displayed in the command output. The `msg` parameter has two values.

`yes` – the unauthorized use warning message text is displayed.

`no` – the unauthorized use warning message text is not displayed.

The default value for this parameter is `no`.

Regardless of the value specified for the `msg` parameter, the user **ID** and password security defaults are displayed in the `rtrv-secu-dflt` command output.

1. Display the current security defaults by entering the `rtrv-secu-dflt` command.

This is an example of the possible output.

```
rlghncxa03w 10-04-01 16:02:05 GMT EAGLE5 42.0.0
SECURITY DEFAULTS
-----
PAGE          60
UOUT          90
MULTLOG       NO
MINLEN        8
ALPHA         1
NUM           1
PUNC          1
MININTRVL     1
PNOTIFY       7
PGRACE        3
PREUSE        5
PCHREUSE      4
```

2. Change the current security defaults by entering the `chg-secu-dflt` command.

For this example, enter this command.

```
chg-secu-
dflt:page=100:uout=50:multlog=yes:minlen=12:alpha=2 :num=2:pu
nc=2:minintrvl=5:pchreuse=5:pgrace=2:pnotify=14:preuse=6
```

When this command has successfully completed, this message should appear.

```
rlghncxa03w 06-10-01 11:43:04 GMT EAGLE5 36.0.0
CHG-SECU-DFLT: MASP A - COMPLTD
```

3. Verify the changes with the `rtrv-secu-dflt` command.

This is an example of the possible output.

```
rlghncxa03w 10-04-01 16:02:05 GMT EAGLE5 42.0.0
SECURITY DEFAULTS
-----
PAGE          100
UOUT          50
MULTLOG       YES
MINLEN        12
ALPHA         2
NUM           2
PUNC          2
MININTRVL     5
PNOTIFY       14
PGRACE        2
PREUSE        6
PCHREUSE      5
```

4. Back up the new changes using the `chg-db:action=backup:dest=fixed` command.

These messages should appear, the active **Maintenance and Administration Subsystem Processor (MASP)** appears first.

```
BACKUP (FIXED) : MASP A - Backup starts on active MASP.
BACKUP (FIXED) : MASP A - Backup on active MASP to fixed disk complete.
```

BACKUP (FIXED) : MASP A - Backup starts on standby MASP.
BACKUP (FIXED) : MASP A - Backup on standby MASP to fixed disk complete.

Figure 4-2 *Changing the Security Defaults*

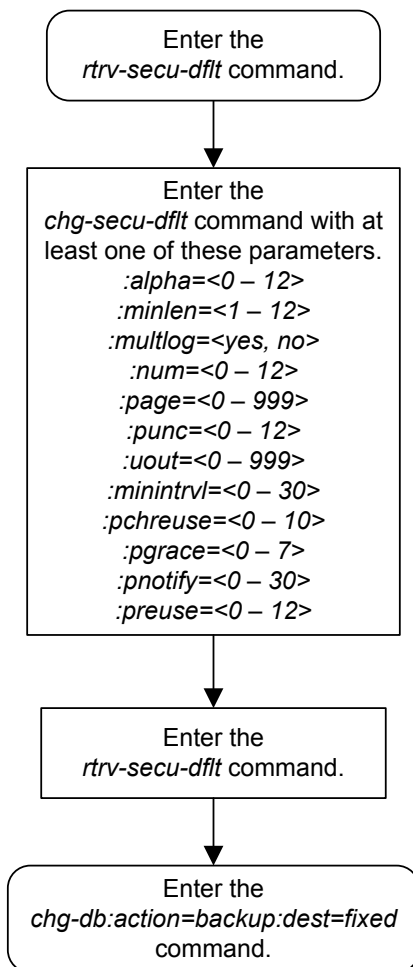

Configuring the Unauthorized Use Warning Message

This procedure is used to configure the unauthorized use warning message that is displayed after a user successfully logs into the **EAGLE**.

These parameters are used in this procedure.

`:wrnln` – the line number of the text of the unauthorized use warning message. The unauthorized use warning message can contain from 1 to 20 lines of text.

`:wrntx` – the text of the line number of the unauthorized use warning message. The each line of text can contain up to 70 alphanumeric characters and must be enclosed in quotes (“”). A blank line is specified with this text string, “ ”, the blank space character enclosed in double quotes.

`:clrwrntx` - This parameter specifies whether or not the text of the warning message is removed and will not be displayed. This parameter has three values.

- `no` - the text of a specific line in the warning message is not removed.
- `yes` - the text of a specific line in the warning message is removed and will not be displayed.
- `all` - the text in all the lines of the warning message are removed and no warning message will be displayed.

The `clrwrntx=yes` parameter can be specified only with the `wrnln` parameter.

The `chg-secu-dflt` command contains other parameters that are not used in this procedure. These parameters are used to change the user ID and password security defaults on the **EAGLE**. To change the user ID and password security defaults, perform the [Changing the Security Defaults](#) procedure.

Note: When the **EAGLE** is delivered to the user, the database will contain this login warning message.

```
NOTICE: This is a private computer system.
Unauthorized access or use may lead to prosecution.
```

The example in this procedure is used to change the unauthorized use warning message from the system default message to this message.

```
*****
* NOTICE: This is a private computer system.          *
* UNAUTHORIZED ACCESS OR USE WILL BE PROSECUTED       *
*                                                       *
*                                                       *
* 03/17/08 Notice!!! System will be upgraded between  *
* the hours of 2am-3am on 04/01/08                    *
*                                                       *
*                                                       *
*****
```

The `rtrv-secu-dflt` command uses the `msg` parameter to specify whether the unauthorized use warning message text is displayed in the command output. The `msg` parameter has two values.

`yes` – the unauthorized use warning message text is displayed.

no – the unauthorized use warning message text is not displayed.

The default value for this parameter is no.

Regardless of the value specified for the msg parameter, the user ID and password security defaults are displayed in the rtrv-secu-dflt command output.

1. Display the current text of the unauthorized use warning message by entering the rtrv-secu-dflt command with the msg=yes parameter.

This is an example of the possible output.

```
rlghncxa03w 10-04-01 16:02:05 GMT EAGLE5 42.0.0
```

```
SECURITY DEFAULTS
```

```
-----
```

```
PAGE          60
UOUT          90
MULTLOG       NO
MINLEN        8
ALPHA         1
NUM           1
PUNC          1
MININTRVL     1
PNOTIFY       7
PGRACE        3
PREUSE        5
PCHREUSE      4
```

```
rlghncxa03w 10-04-01 16:02:05 GMT EAGLE5 42.0.0
```

```
WARNING MESSAGE
```

```
-----
```

```
1:"NOTICE: This is a private computer system."
2:"Unauthorized access or use may lead to prosecution."
3:" "
4:" "
5:" "
6:" "
7:" "
8:" "
9:" "
10:" "
11:" "
12:" "
13:" "
14:" "
15:" "
16:" "
17:" "
18:" "
19:" "
20:" "
```

2. Change the unauthorized use warning message by entering the chg-secu-dflt command with the wrnl n, wrntx, and clrwrntx parameters.

For this example, to configure a new warning message, enter these commands.

```
chg-secu-
dflt:wrnl n=1:wrntx="*****
*****"
```



```

chg-secu-dflt:wrnl=2:wrntx="* NOTICE: This is a private
computer system. *"

chg-secu-dflt:wrnl=3:wrntx="* UNAUTHORIZED ACCESS OR USE
WILL BE PROSECUTED *"

chg-secu-
dflt:wrnl=4:wrntx="*.....
.....*"

chg-secu-
dflt:wrnl=5:wrntx="*.....
.....*"

chg-secu-dflt:wrnl=6:wrntx="* 11/17/97 Notice!!! System will
be upgraded between*"

chg-secu-dflt:wrnl=7:wrntx="* the hours of 2am-3am on
02/07/00 *"

chg-secu-dflt:wrnl=6:wrntx="* 03/17/08 Notice!!! System will
be upgraded between*"

chg-secu-dflt:wrnl=7:wrntx="* the hours of 2am-3am on
04/01/08 *"

chg-secu-
dflt:wrnl=8:wrntx="*.....
.....*"

chg-secu-
dflt:wrnl=9:wrntx="*.....
.....*"

chg-secu-
dflt:wrnl=10:wrntx="*****
*****"

chg-secu-dflt:wrnl=11:wrntx=" "

chg-secu-dflt:wrnl=12:clrwrntx=yes
chg-secu-dflt:wrnl=13:clrwrntx=yes
chg-secu-dflt:wrnl=14:clrwrntx=yes
chg-secu-dflt:wrnl=15:clrwrntx=yes
chg-secu-dflt:wrnl=16:clrwrntx=yes
chg-secu-dflt:wrnl=17:clrwrntx=yes
chg-secu-dflt:wrnl=18:clrwrntx=yes
chg-secu-dflt:wrnl=19:clrwrntx=yes
chg-secu-dflt:wrnl=20:clrwrntx=yes

```

If you wish to remove the current warning message, enter this command.

```
chg-secu-dflt:clrwrntx=all
```

If you wish to configure a new warning message after removing the current warning message, repeat this step with the `wrnl`, `wrntx`, and `clrwrntx=yes` parameters as needed.

When each of these commands has successfully completed, this message should appear.

```
rlghncxa03w 06-10-01 16:02:05 GMT EAGLE5 36.0.0
CHG-SECU-DFLT: MASP A - COMPLTD
```

3. Verify the changes with the `rtrv-secu-dflt:msg=yes` command.

This is an example of the possible output.

```
rlghncxa03w 10-04-01 16:02:05 GMT EAGLE5 42.0.0
SECURITY DEFAULTS
```

```
-----
PAGE             60
UOUT             90
MULTLOG          NO
MINLEN           8
ALPHA            1
NUM              1
PUNC             1
MININTRVL        1
PNOTIFY          7
PGRACE           3
PREUSE           5
PCHREUSE         4
```

```
rlghncxa03w 10-04-01 16:02:05 GMT EAGLE5 42.0.0
WARNING MESSAGE
```

```
-----
1:"*****"
2:"*  NOTICE: This is a private computer system.      *"
3:"*  UNAUTHORIZED ACCESS OR USE WILL BE PROSECUTED    *"
4:"*"
5:"*"
6:"* 03/17/08 Notice!!! System will be upgraded between *"
7:"*                the hours of 2am-3am on 04/01/08  *"
8:"*"
9:"*"
10:"*****"
11:" "
12:" "
13:" "
14:" "
15:" "
16:" "
17:" "
18:" "
19:" "
20:" "
```

4. Back up the new changes using the `chg-db:action=backup:dest=fixed` command.

These messages should appear, the active **Maintenance and Administration Subsystem Processor (MASP)** appears first.

```
BACKUP (FIXED) : MASP A - Backup starts on active MASP.
BACKUP (FIXED) : MASP A - Backup on active MASP to fixed disk complete.
```

```
BACKUP (FIXED) : MASP A - Backup starts on standby MASP.  
BACKUP (FIXED) : MASP A - Backup on standby MASP to fixed disk complete.
```

Figure 4-3 Configuring the Unauthorized Use Warning Message

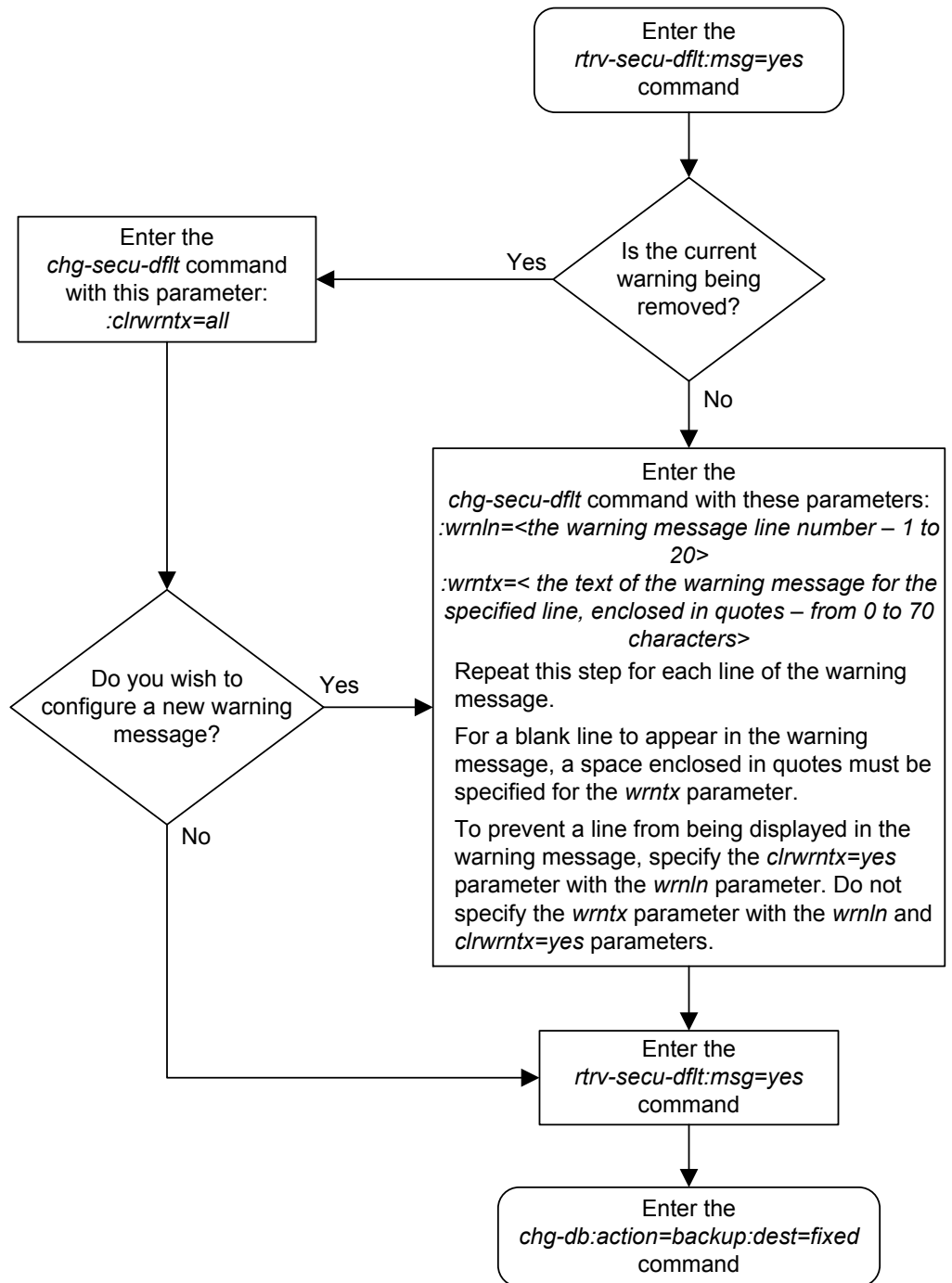

Changing the Security Log Characteristics

This procedure is used to change the characteristics of the **EAGLE**'s security log using the `chg-attr-secu-log` command. The `chg-attr-secu-log` command uses these parameters.

:upldalm – whether the security log alarms are on. The security log alarms are:

- upload required – the percentage of the maximum capacity of the security log exceeds the value of the `upslg` parameter. The security log entries need to be copied to the file transfer area of the fixed disk.
- log overflowed – the security log has become 100% full and log entries are being lost. The security log entries must be copied to the file transfer area of the fixed disk.
- standby log contains >0 un-uploaded entries – the security log on the standby fixed disk contains entries that have not been copied to the file transfer area of the fixed disk. Usually, the security log on the standby fixed disk contains no entries, but for some reason, for example, a **MASP** switchover resulting in the active **MASP** security log becoming the standby **MASP** security log, the security log on the standby fixed disk contains uncopied security log entries.

The `upldalm=yes` parameter turns the security log alarms on. The `upldalm=no` turns the security log alarms off. If a security log alarm has been generated, the `upldalm=no` parameter lowers the alarm.

:upslg – the threshold at which the **EAGLE** generates the upload required security log alarm, if the `upldalm=yes` parameter has been specified. The threshold is the percentage of the maximum capacity of the security log.

When the **EAGLE** is delivered to the user, the security log characteristics will be set to these values:

```
:upldalm = yes
```

```
:upslg = 90
```

1. Display the current characteristics of the security log by entering the `rtrv-attr-secu-log` command.

This is an example of the possible output.

```
rlghncxa03w 06-10-01 16:02:05 GMT EAGLE5 36.0.0
Security log attributes
-----
UPLDALM      no
UPSLG        80
```

2. Change the characteristics of the security log by entering the `chg-attr-secu-log` command.

For this example, enter this command.

```
chg-attr-secu-log:upldalm=yes:upslg=90
```

When this command has successfully completed, this message should appear.

```
rlghncxa03w 06-10-01 16:02:05 GMT EAGLE5 36.0.0
CHG-ATTR-SECULOG: MASP A - COMPLTD
```

3. Verify the changes with the `rtrv-attr-seculog` command.

This is an example of the possible output.

```
rlghncxa03w 06-10-01 16:02:05 GMT  EAGLE5 36.0.0
Security log attributes
-----
UPLDALM      yes
UPSLG        90
```

4. Back up the new changes using the `chg-db:action=backup:dest=fixed` command.

These messages should appear, the active **Maintenance and Administration Subsystem Processor (MASP)** appears first.

```
BACKUP (FIXED) : MASP A - Backup starts on active MASP.
BACKUP (FIXED) : MASP A - Backup on active MASP to fixed disk complete.
BACKUP (FIXED) : MASP A - Backup starts on standby MASP.
BACKUP (FIXED) : MASP A - Backup on standby MASP to fixed disk complete.
```

Figure 4-4 *Changing the Security Log Characteristics*

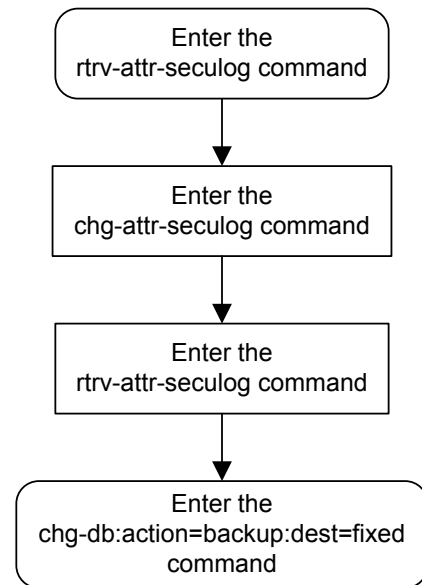

Copying the Security Log to the File Transfer Area

This procedure is used to copy the **EAGLE**'s security log to the file transfer area of the fixed disk using the `copy-secu` command. The `copy-secu` command uses these parameters.

`:dfile` – the name of the file created in the file transfer area containing the security log entries copied with the `copy-secu` command.

The filename can contain from 1 to 32 characters. If the filename contains special characters such as blank spaces, colons, dashes, periods, ampersands (&), etc. (for example, `eagle123.doc`), the filename must be enclosed in double quotes. For example, `:dfile="eagle123.doc"`.

If a filename is not specified, the **EAGLE** specifies its own filename with this format, `yyymmddx.log`, where `yyymmdd` are the current year/month/day that the security log file was created, and `x` is either `a` if the security log on the active fixed disk is copied (`slog=act`) or `s` if the security log on the standby fixed disk is copied (`slog=stb`).

`:slog` – the security log that is copied to the file transfer area, the security log on the active fixed disk (`slog=act`) or the standby fixed disk (`slog=stb`). The default value for this parameter is `act`.

`:dloc` – the file transfer area that is receiving the copy of the security log, the file transfer area on the active fixed disk (`dloc=act`) or the file transfer area on the standby fixed disk (`dloc=stb`). The default value for this parameter is `act`.

If a filename is not specified, the **EAGLE** specifies its own filename with this format, `yyymmddx.log`, where `yyymmdd` are the current year/month/day that the security log file was created, and `x` is either `a` for the copy of the security log on the active fixed disk or `s` for the copy of the security log on the standby fixed disk.

The `copy-secu` command can be specified with no parameters. If the `copy-secu` command is specified with no parameters, the security log on the active fixed disk is copied to the file transfer area on the active fixed disk and is given a default name. The default name is in this format, `yyymmdda.log`, where `yyymmdd` are the current year/month/day that the security log file was created, and `a` for the copy of the security log on the active fixed disk.

1. Verify the card that is card location 1113 by entering this command.

```
rept-stat-card:loc=1113
```

This is an example of the possible output.

```
rlghncxa03w 09-03-28 21:15:37 GMT EAGLE5 40.1.0
CARD  VERSION      TYPE      GPL      PST      SST      AST
1113  132-013-000    E5MCAP    OAMHC    IS-NR    Active   -----
ALARM STATUS      = No Alarms.
BLMCAP  GPL version = 132-005-000
IMT BUS A          = Conn
IMT BUS B          = Conn
CURRENT TEMPERATURE = 30C ( 86F)
PEAK TEMPERATURE:  = 33C ( 92F)      [02-01-05 07:18]
```

Command Completed.

2. Verify the card that is in card location 1115 by entering this command.

```
rept-stat-card:loc=1115
```

This is an example of the possible output.

```
rlghncxa03w 09-03-28 21:15:37 GMT EAGLE5 40.1.0
CARD  VERSION      TYPE      GPL      PST      SST      AST
1113  132-013-000    E5MCAP    OAMHC    IS-NR    Active   -----
ALARM STATUS      = No Alarms.
BLMCAP GPL version = 132-005-000
IMT BUS A          = Conn
IMT BUS B          = Conn
CURRENT TEMPERATURE = 30C ( 86F)
PEAK TEMPERATURE:  = 33C ( 92F) [02-01-05 07:18]
```

Command Completed.

Ensure that both card locations contain the same type of card (E5-OAM).

3. Display the current characteristics of the security log by entering the `rept-stat-seculog` command.

This is an example of the possible output.

```
rlghncxa03w 09-03-04 16:02:05 GMT EAGLE5 40.1.0
-- SINCE LAST UPLOAD -- OLDEST  NEWEST  LAST
LOC  ROLE  ENTRIES %FULL OFLO FAIL RECORD RECORD UPLOAD
1114 Active 8312   84   No   No   09-01-25 09-03-04 09-02-15
                                08:25:21 09:02:44 02:47:17

1116 Standby 693    7    No   No   09-01-25 09-03-04 09-02-15
                                08:25:21 09:02:44 02:47:17
```

4. Copy the security log to the file transfer area by entering the `copy-seculog` command.

For this example, copy the security log on the active fixed disk to the file transfer area on the fixed disk. Enter this command.

```
copy-seculog:dfile=security1.log:slog=act:dloc=act
```

When this command has successfully completed, this message should appear.

```
rlghncxa03w 09-03-04 16:02:37 GMT EAGLE5 40.1.0
Security log on TDM 1114 copied to file security1.log on TDM 1114
```

5. Verify the changes with the `rept-stat-seculog` command.

This is an example of the possible output.

```
rlghncxa03w 09-03-04 16:04:43 GMT EAGLE5 40.1.0
-- SINCE LAST UPLOAD -- OLDEST  NEWEST  LAST
LOC  ROLE  ENTRIES %FULL OFLO FAIL RECORD RECORD UPLOAD
1114 Active 1       1    No   No   09-03-04 09-03-04 09-03-04
                                09:02:44 09:02:44 16:02:37

1116 Standby 0       0    No   No   09-01-25 09-03-04 09-02-15
                                08:25:21 09:02:44 02:47:17
```

Figure 4-5 Copying the Security Log to the File Transfer Area

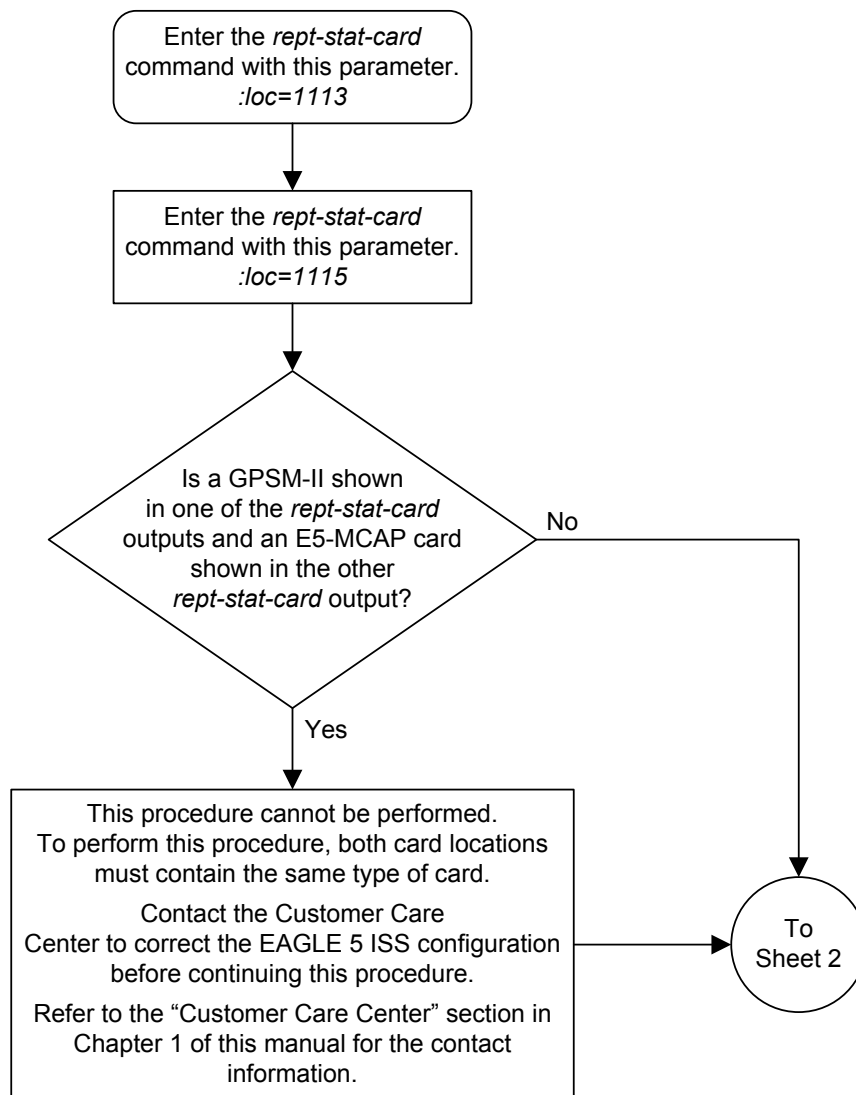

Sheet 1 of 2

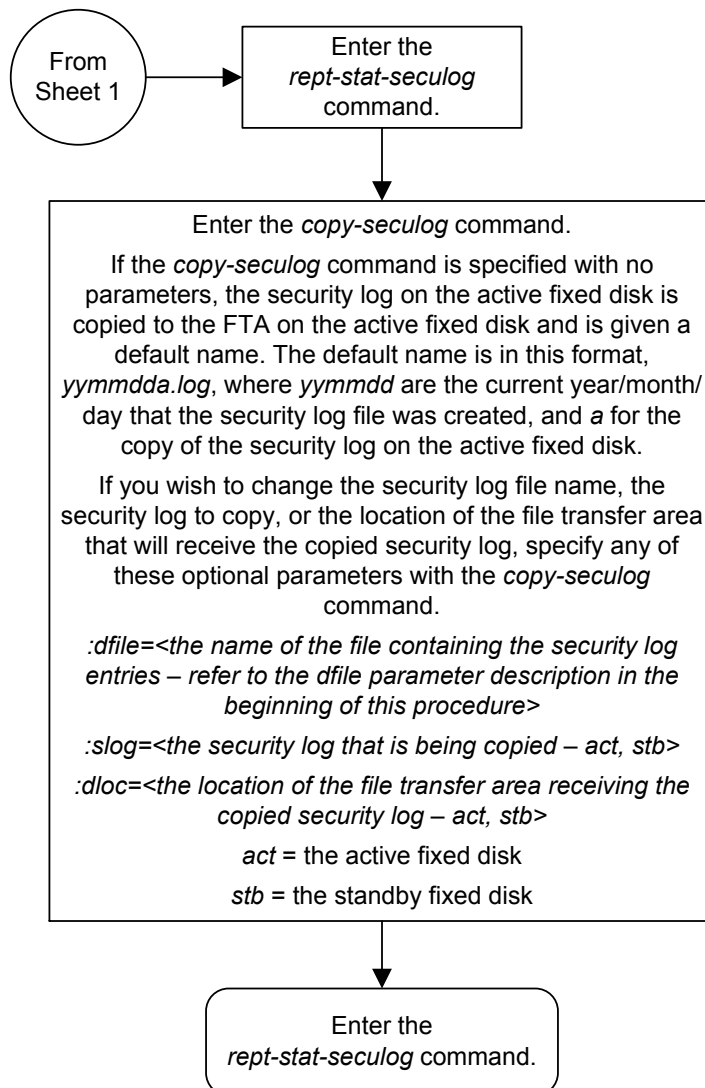

Adding a User to the System

This procedure is used to add a user to the **EAGLE** using the `ent-user` command. This procedure can only be performed if you have been assigned the command class "Security Administration." If the user **ID** does not exist in the database, the user's characteristics cannot be changed.

Note: This procedure can be performed on all terminals (1 - 40) if the Eagle **OA&M IP Security Enhancements** feature is on. If this feature is on, the entry **YES** is shown for terminals 17 through 40 in the **SECURE** column in the `rtrv-trm` output. The output of the `rtrv-ctrl-feat` command also shows if this feature is on or off. If this feature is off, this procedure can be performed only on terminals 1 through 16. If you wish to use the Eagle **OA&M IP Security Enhancements** feature, and the feature is not on, perform [Activating the EAGLE OA&M IP Security Enhancement Controlled Feature](#) to enable and turn on this feature.

The `ent-user` command uses these parameters.

- `:uid` – The user **ID** to be added to the database
- `:all` – The user has access to all commands in all non-configurable command classes (`dbg`, `link`, `sys`, `sa`, `pu`, `db`).
- `:dbg` – The user has access to all commands in the command class "Debug."
- `:link` – The user has access to all commands in the command class "**Link** Maintenance."
- `:sys` – The user has access to all commands in the command class "System Maintenance."
- `:sa` – The user has access to all commands in the command class "Security Administration."
- `:pu` – The user has access to all commands in the command class "Program Update."
- `:db` – The user has access to all commands in the command class "Database Administration."
- `:cc1 - :cc8` – Eight configurable command classes. These parameters specified whether or not the user has access to the commands in the specified configurable command class. The value of these parameters consist of the configurable command class name (1 alphabetic character followed by 2 alphanumeric characters), and either yes or no. The command class name and the yes or no values are separated by a dash. For example, to assign a user the permission to use the commands in configurable command class `db1`, the `cc1=db1=yes` parameter would be specified.

To specify any configurable command classes, the **Command Class Management** feature must be enabled and turned on. Enter the `rtrv-ctrl-feat` command to verify whether or not the **Command Class Management** feature is enabled. If the **Command Class Management** feature is not enabled or turned on, perform [Activating Controlled Features](#) to enable and turn on the **Command Class Management** feature. Up to 32 configurable command classes can be assigned to users. When the **Command Class Management** feature is enabled and turned on, the configurable command class names are given the names `u01 - u32`. These command class names, the descriptions

of these command classes, and the commands assigned to these command classes can be changed using [Configuring Command Classes](#).

The `ent-user` command allows up to eight configurable command classes to be assigned to the user. Perform [Changing User Information](#) to assign the other 24 configurable command classes to the user, if desired.

`:page` – The amount of time, in days, that the specified user’s password can be used before the user must change their password.

If the `page` parameter is not specified with the `ent-user` command, the **EAGLE** uses the value configured for the `page` parameter specified by the `chg-secu-dflt` command to determine the age of the user’s password.

`:uout` – The number of consecutive days that a user **ID** can remain active in the **EAGLE** and not be used. When the user **ID** has not been used for the number of days specified by the `uout` parameter, that user **ID** is no longer valid and the **EAGLE** rejects any attempt to log into the **EAGLE** with that user **ID**.

If the `uout` parameter is not specified with the `ent-user` command, the **EAGLE** uses the value configured for the `uout` parameter specified by the `chg-secu-dflt` command to determine the number of consecutive days that a user **ID** can remain active on the **EAGLE** and not be used

`:revoke` – Is the specified user **ID** in service? Any login attempts using a revoked user **ID** are rejected by the **EAGLE**. The `revoke=yes` parameter cannot be specified for a user **ID** assigned to the security administration command class.

The words `seas` or `none` cannot be used for user **IDs** to prevent any conflict with the use of these words in the **UID** field of the security log. The word `none` in the **UID** field of the security log refers to any command that was logged that had no user **ID** associated with it. The word `seas` refers to any command logged in the security log that entered the **EAGLE** on either of the **SEAS** terminals.

This example shows an `rtrv-secu-user` command output when the **Command Class Management** feature is enabled and turned on. If the **Command Class Management** feature is not enabled and turned on, the 32 configurable command classes, shown in the following example as fields `U01 - U32`, are not shown in the `rtrv-secu-user` command output.

An asterisk (*) displayed after the value in the `PAGE` or `UOUT` fields indicates that the system-wide default `page` or `uout` parameter values, as configured on the `chg-secu-dflt` command, is in effect for the user **ID**.

```
rlghncxa03w 09-03-01 08:33:48 GMT EAGLE5 40.1.0
```

```

USER ID          AGE PAGE UOUT REV LINK SA  SYS PU  DB  DBG
frodo            750 0    0    NO YES  YES YES YES YES YES
                U01 U02 U03 U04 U05 U06 U07 U08 U09 U10 U11 U12 U13 U14 U15 U16
                YES YES YES YES YES YES YES YES YES YES YES YES YES YES YES NO
                U17 U18 U19 U20 U21 U22 U23 U24 U25 U26 U27 U28 U29 U30 U31 U32
                YES YES YES YES YES YES YES YES YES YES YES YES NO NO NO NO YES

USER ID          AGE PAGE UOUT REV LINK SA  SYS PU  DB  DBG
manny            36 60   60   NO YES  YES YES YES YES YES
                U01 U02 U03 U04 U05 U06 U07 U08 U09 U10 U11 U12 U13 U14 U15 U16
                NO NO NO NO YES YES YES YES YES YES YES YES YES YES YES YES
                U17 U18 U19 U20 U21 U22 U23 U24 U25 U26 U27 U28 U29 U30 U31 U32
    
```

```

                YES YES YES YES YES YES YES YES YES YES YES YES NO NO NO NO YES
USER ID          AGE PAGE UOUT REV LINK SA  SYS PU  DB  DBG
moe              100 30   60   YES YES  YES YES YES YES YES YES
                U01 U02 U03 U04 U05 U06 U07 U08 U09 U10 U11 U12 U13 U14 U15 U16
                YES YES YES YES YES YES YES YES YES YES YES YES YES YES YES NO
                U17 U18 U19 U20 U21 U22 U23 U24 U25 U26 U27 U28 U29 U30 U31 U32
                YES YES YES YES YES YES YES YES YES YES YES YES YES YES NO NO NO
USER ID          AGE PAGE UOUT REV LINK SA  SYS PU  DB  DBG
jack             10   30 * 30 * NO  YES  YES YES YES YES YES
                U01 U02 U03 U04 U05 U06 U07 U08 U09 U10 U11 U12 U13 U14 U15 U16
                YES YES YES YES YES YES YES YES YES YES YES YES YES YES YES YES
                U17 U18 U19 U20 U21 U22 U23 U24 U25 U26 U27 U28 U29 U30 U31 U32
                YES YES YES YES YES YES NO  NO  NO  NO  YES YES YES YES YES NO

```

Canceling the **RTRV-SECU-USER** Command

Because the `rtrv-secu-user` command used in this procedure can output information for a long period of time, the `rtrv-secu-user` command can be canceled and the output to the terminal stopped. There are three ways that the `rtrv-secu-user` command can be canceled.

- Press the F9 function key on the keyboard at the terminal where the `rtrv-secu-user` command was entered.
- Enter the `canc-cmd` without the `trm` parameter at the terminal where the `rtrv-secu-user` command was entered.
- Enter the `canc-cmd:trm=<xx>`, where `<xx>` is the terminal where the `rtrv-secu-user` command was entered, from another terminal other than the terminal where the `rtrv-secu-user` command was entered. To enter the `canc-cmd:trm=<xx>` command, the terminal must allow Security Administration commands to be entered from it and the user must be allowed to enter Security Administration commands. The terminal's permissions can be verified with the `rtrv-secu-trm` command. The user's permissions can be verified with the `rtrv-user` or `rtrv-secu-user` commands.

For more information about the `canc-cmd` command, go to *Commands User's Guide*.

1. Verify whether or not the user **ID** you wish to add to the database is in the database by entering the `rtrv-secu-user` command and specifying the desired user **ID** with the `uid` parameter.

For this example, enter this command.

```
rtrv-secu-user:uid=frodo
```

If the user **ID** being added to the database is displayed in the `rtrv-secu-user` output, the user **ID** cannot be used in this procedure. The attributes of the user **ID** shown in the `rtrv-secu-user` output can be changed in the [Changing User Information](#).

If the user **ID** being added to the database is not in the database, the error message E2199 is displayed.

E2199 Cmd Rej: The specified user identification is not defined

Continue the procedure by performing one of these steps.

- If the `cc1` through `cc8` parameters are not being specified in this procedure, continue the procedure with 4.
 - If the `cc1` through `cc8` parameters will be specified in this procedure, continue the procedure by performing one of these steps.
 - If configurable command classes are shown in the `rtrv-secu-user` output, continue the procedure with 3.
 - If configurable command classes are not shown in the `rtrv-secu-user` output, continue the procedure with 2.
2. Verify that the **Command Class** Management feature is enabled and turned on, by entering the `rtrv-ctrl-feat` command with the `partnum=893005801` parameter.

This is an example of the possible output.

```
rlghncxa03w 06-10-01 21:15:37 GMT EAGLE5 36.0.0
The following features have been permanently enabled:
Feature Name          Partnum    Status  Quantity
Command Class Management 893005801 off     ----
```

Note: The `rtrv-ctrl-feat` command output contains other fields that are not used by this procedure. If you wish to see all the fields displayed by the `rtrv-ctrl-feat` command, see the `rtrv-ctrl-feat` command description in *Commands User's Guide*.

If the **Command Class** Management feature is enabled and turned on (`status = on`), continue the procedure with 3.

If the **Command Class** Management feature is not enabled or turned on, perform [Activating Controlled Features](#) to enable and turn on the **Command Class** Management feature.

Caution: If the **Command Class** Management feature is temporarily enabled, the configurable command classes can be assigned and used only for the amount of time shown in the `Trial Period Left` column in the `rtrv-ctrl-feat` output.

3. Display the descriptions of the configurable command classes in the database by entering the `rtrv-cmd` command.

This is an example of the possible output.

```
rlghncxa03w 09-05-01 21:15:37 GMT EAGLE5 41.0.0
CMD          CLASS
alw-slk      link, ull
ent-user     sa
unhb-slk     link
```



```

rtrv-attr-seculog sa, u31
inh-slk link, abc
rtrv-meas-sched link, abc, def
act-lbp link
act-dlk link
act-slk link
rtrv-seculog sa, abc, def, ghi
act-lpo link
blk-slk link, abc, u23, u31
dact-lbp link
canc-dlk link
inh-card sys
canc-lpo link, u01, u02, u03, u04, u05, u06, u07, u08, u09, u10,
u11, u12, u13
canc-slk link
ublk-slk link, u01, u02, u03, u04, u05, u06, u07, u08, u09, u10,
u11, u12, u13, u14, u15, u16, u17, u18, u19, u20, u21,
u22, u23, u24, u25, u26, u27, u28, u29, u30, u31, u32
inh-trm sys, krb
rept-meas link
.
.
.
chg-meas link
tst-dlk link, krb
tst-slk link

```

If the desired configurable command class descriptions are not in the database, perform [Configuring Command Classes](#) to configure the desired command classes.

4. After you enter the `ent-user` command, you will be prompted for a password for the user that is being added.

The password must meet the requirements defined by the `chg-secu-dflt` command. Once you enter the `ent-user` command, you will not be able to enter any other commands until the user **ID** and password combination has been accepted by the **EAGLE**. The password requirements must be verified before the `ent-user` command is executed. Display the password requirements by entering the `rtrv-secu-dflt` command. This is an example of the possible output.

```

rlghncxa03w 10-07-01 16:02:05 GMT EAGLE5 42.0.0
SECURITY DEFAULTS
-----
MINLEN      8
ALPHA       1
NUM         1
PUNC        1

```

The `rtrv-secu-dflt` command output contains other fields that are not used by this procedure. If you wish to see all the fields displayed by the `rtrv-secu-dflt` command, refer to the `rtrv-secu-dflt` command description in *Commands User's Guide*.

The password can contain from one to twelve characters. For this example, the password must contain at least eight characters, no more than twelve, with at least one alpha character (a-z), at least one numeric character (0-9), and at least one punctuation character (any printable character that is not an alphabetic character, a numeric character, the space bar). The password requirements are shown in these fields in the `rtrv-secu-dflt` command output.

- MINLEN – the minimum length of the password
- ALPHA – the minimum number of alpha characters
- NUM – the minimum number of numeric characters
- PUNC – the minimum number of punctuation characters

The password is not case sensitive. For security reasons, the password is never displayed on the terminal.

5. Add the new user **ID** to the database using the `ent-user` command.

The user **ID** must contain 1 alpha character and up to 15 alphanumeric characters. The first character of a user **ID** must be an alpha character. Even though a period is not an alphanumeric character, one of the 15 alphanumeric characters can be a period.

The other parameters assign command class permissions to the user **ID**. If `yes` is entered for any of these parameters, the user will have access to that class of commands. If `no` is entered, the user will not have access to that class of commands. These parameters are optional and if not specified, the user is not assigned to that command class. The user is assigned to the Basic command class whether any of these other parameters are specified. Refer to *Commands User's Guide* for a list of commands permitted with each command class. For this example, the user **ID**`frodo` is being added with access to these command classes: link maintenance, system maintenance, database administration, and debug.

The `frodo` user **ID** will use the values for the `page` and `uout` parameters configured with the `chg-secu-dflt` command. For this example, enter this command.

```
ent-user:uid=frodo:link=yes:sys=yes:db=yes:dbg=yes:cc1=db1-yes
```

This message should appear.

```
rlghncxa03w 06-10-01 09:12:36 GMT EAGLE5 36.0.0
ENT-USER: MASP A - COMPLTD
```

6. You are prompted for a password for the user that is being added.

Enter the new password. Make sure that the password meets the password requirements displayed in the output of the `rtrv-secu-dflt` command, executed in [4](#).

7. At the prompt `verify password`, re-enter the password that was entered in [6](#) again.
8. When the `command executed` message appears, the execution of the command has been completed, and the user **ID** and password has been added to the database.
9. Verify the changes using the `rtrv-secu-user` command with the user **ID** specified in [5](#).

For this example, enter this command.

```
rtrv-secu-user:uid=frodo
```

This is an example of the possible output.

rlghncxa03w 09-03-01 08:33:48 GMT EAGLE5 40.1.0

USER ID	AGE	PAGE	UOUT	REV	LINK	SA	SYS	PU	DB	DBG		
frodo	0	60	*	90	*	NO	YES	NO	YES	NO	YES	YES

DB1	U02	U03	U04	U05	U06	U07	U08	U09	U10	U11	U12	U13	U14	U15	U16
YES	NO	NO	NO	NO	NO	NO	NO	NO	NO	NO	NO	NO	NO	NO	NO

U17	U18	U19	U20	U21	U22	U23	U24	U25	U26	U27	U28	U29	U30	U31	U32
NO	NO	NO	NO	NO	NO	NO	NO	NO	NO	NO	NO	NO	NO	NO	NO

- 10.** Back up the new changes using the `chg-db:action=backup:dest=fixed` command.

These messages should appear, the active **Maintenance and Administration Subsystem Processor (MASP)** appears first.

```
BACKUP (FIXED) : MASP A - Backup starts on active MASP.  
BACKUP (FIXED) : MASP A - Backup on active MASP to fixed disk complete.  
BACKUP (FIXED) : MASP A - Backup starts on standby MASP.  
BACKUP (FIXED) : MASP A - Backup on standby MASP to fixed disk complete.
```

Figure 4-6 Adding a User to the System

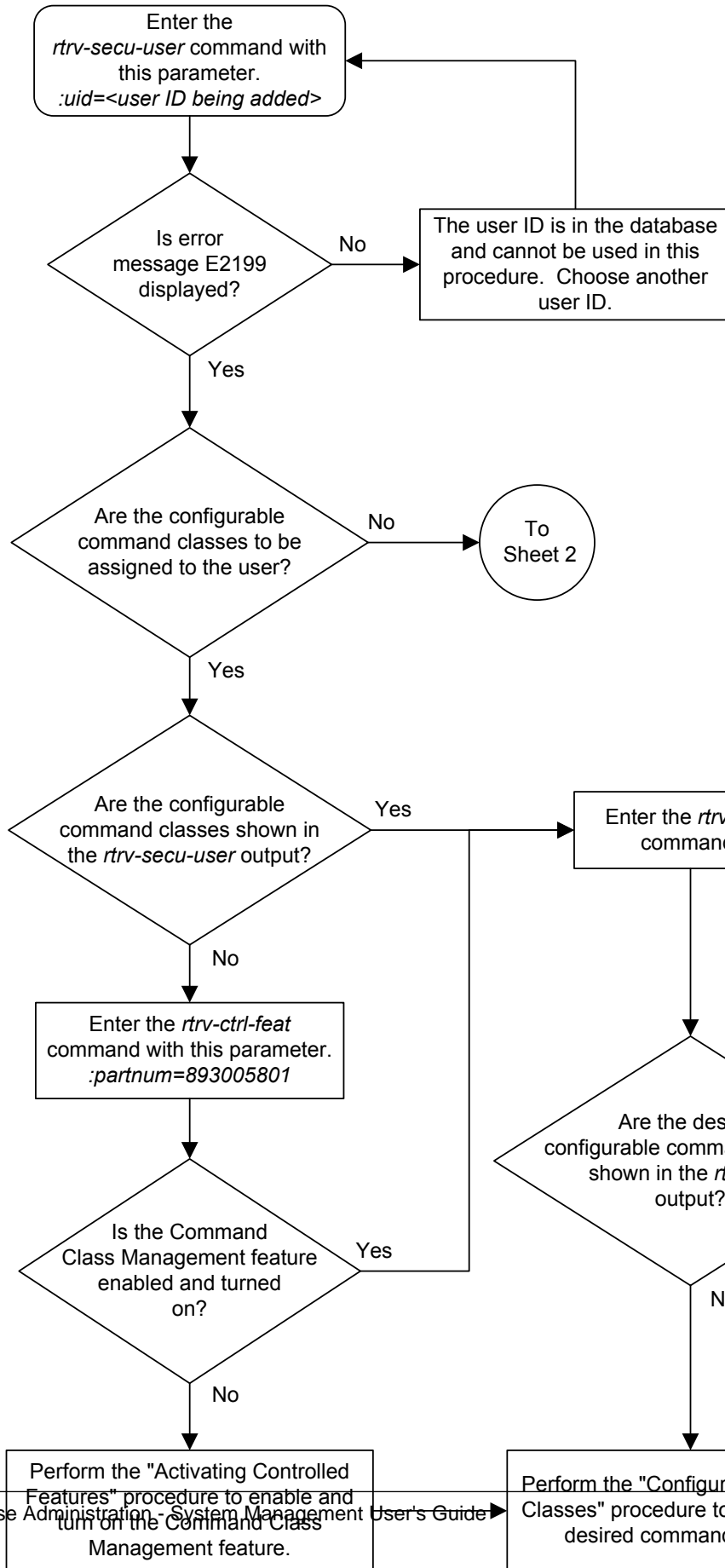

Note: This procedure can be performed on all terminals (1 - 40) if the Eagle IP Security Enhancements feature is on. If the entry YES is shown for terminal 40 in the SECURE column in the output of the rtrv-ctrl-feat command, this procedure can be performed on terminals 1 through 16. If you have the Eagle OA&M IP Security Enhancements feature on and the feature is not on, perform the "Eagle OA&M IP Security Enhancements - System Management User's Guide" procedure to turn on this feature.

Sheet 1 of 2

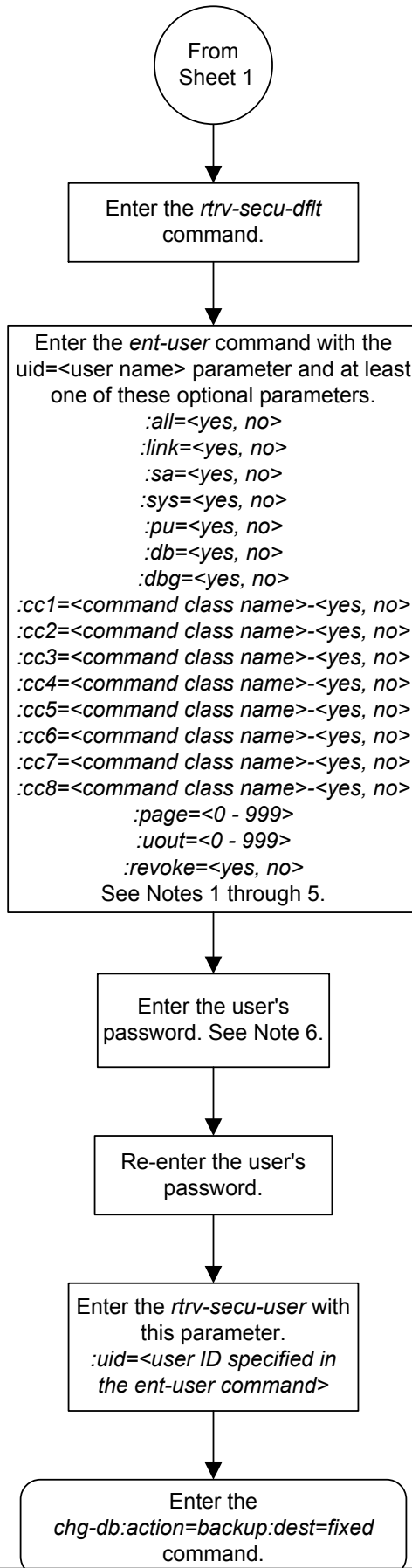

Notes:

1. The *revoke=yes* parameter cannot be specified with the *sa* parameter. If *sa* is *yes*.
2. To specify the *cc1* through *cc8* parameters, the Command Management feature must be enabled and turned on.
3. The user can have a maximum of 32 configurable command classes assigned. The *ent-user* command can assign up to 8 configurable command classes. Perform the "Changing User Information" procedure to assign the other 24 configurable command classes to the user.
4. The *all* parameter specifies whether or not all non-configurable command classes (*link*, *sa*, *sys*, *pu*, *db*, *dbg*) can be used by the user.
5. If the *all* parameter and individual non-configurable command classes are specified with the *ent-user* command, the value of the specific non-configurable command classes overrides the value of the *all* parameter.
6. The password must adhere to all password provisioning rules displayed in the *rtrv-secu-dflt* output. These rules are displayed on the screen when the *ent-user* command is entered.

Removing a User from the System

This procedure is used to remove a user from the **EAGLE** using the `dlt-user` command. This procedure can only be performed if you have been assigned the command class "Security Administration." If the user **ID** does not exist in the database, the user's characteristics cannot be changed.

1. Display the user **IDs** in the database using the `rtrv-secu-user` command.

This is an example of the possible output.

```
rlghncxa03w 09-03-01 08:33:48 GMT EAGLE5 40.1.0
```

```

USER ID                AGE PAGE UOUT REV LINK SA  SYS PU  DB  DBG
frodo                   0   60 * 90 * NO  YES NO  YES NO  YES YES

                        DB1 U02 U03 U04 U05 U06 U07 U08 U09 U10 U11 U12 U13 U14 U15 U16
                        YES NO  NO  NO  NO  NO  NO  NO  NO  NO  NO  NO  NO  NO  NO  NO

                        U17 U18 U19 U20 U21 U22 U23 U24 U25 U26 U27 U28 U29 U30 U31 U32
                        NO  NO  NO  NO  NO  NO  NO  NO  NO  NO  NO  NO  NO  NO  NO  NO

```

```

USER ID                AGE PAGE UOUT REV LINK SA  SYS PU  DB  DBG
manny                   36   60   60   NO  YES  YES YES YES YES YES YES

                        U01 U02 U03 U04 U05 U06 U07 U08 U09 U10 U11 U12 U13 U14 U15 U16
                        NO  NO  NO  NO  YES YES YES YES YES YES YES YES YES YES YES YES

                        U17 U18 U19 U20 U21 U22 U23 U24 U25 U26 U27 U28 U29 U30 U31 U32
                        YES YES YES YES YES YES YES YES YES YES YES YES NO  NO  NO  YES

```

```

USER ID                AGE PAGE UOUT REV LINK SA  SYS PU  DB  DBG
fred                    750  0    0    NO  YES  YES YES YES YES YES YES

                        DB1 U02 U03 U04 U05 U06 U07 U08 U09 U10 U11 U12 U13 U14 U15 U16
                        YES YES YES YES YES YES YES YES YES YES YES YES YES YES YES NO

                        U17 U18 U19 U20 U21 U22 U23 U24 U25 U26 U27 U28 U29 U30 U31 U32
                        YES YES YES YES YES YES YES YES YES YES YES YES YES YES NO  NO  NO

```

```

USER ID                AGE PAGE UOUT REV LINK SA  SYS PU  DB  DBG
travist                 101  60 * 90 * NO  YES NO  YES NO  NO  YES

                        DB1 U02 U03 U04 U05 U06 U07 U08 U09 U10 U11 U12 U13 U14 U15 U16
                        YES YES YES YES YES YES YES YES YES YES YES YES YES YES YES YES

                        U17 U18 U19 U20 U21 U22 U23 U24 U25 U26 U27 U28 U29 U30 U31 U32
                        YES YES YES YES YES YES NO  NO  NO  NO  YES YES YES YES YES NO

```

2. Remove the user **ID** from the database by using the `dlt-user` command.

The `dlt-user` command has only one parameter, `uid`, which is the user **ID** that you wish to remove from the database. For this example, enter this command.

```
dlt-user:uid=travist
```

When this command has successfully completed, this message should appear.

```
rlghncxa03w 06-10-01 09:12:36 GMT EAGLE5 36.0.0
DLT-USER: MASP A - COMPLTD
```

3. Verify the changes using the `rtrv-secu-user` command and specifying the user **ID** used in step 2 with the `uid` parameter.

For this example, enter this command.

```
rtrv-secu-user:uid=travist
```

If the user **ID** was removed in step 2, error message E2199 is displayed.

```
E2199 Cmd Rej: The specified user identification is not defined
```

4. Back up the new changes using the `chg-db:action=backup:dest=fixed` command.

These messages should appear, the active **Maintenance and Administration Subsystem Processor (MASP)** appears first.

```
BACKUP (FIXED) : MASP A - Backup starts on active MASP.
BACKUP (FIXED) : MASP A - Backup on active MASP to fixed disk complete.
BACKUP (FIXED) : MASP A - Backup starts on standby MASP.
BACKUP (FIXED) : MASP A - Backup on standby MASP to fixed disk complete.
```

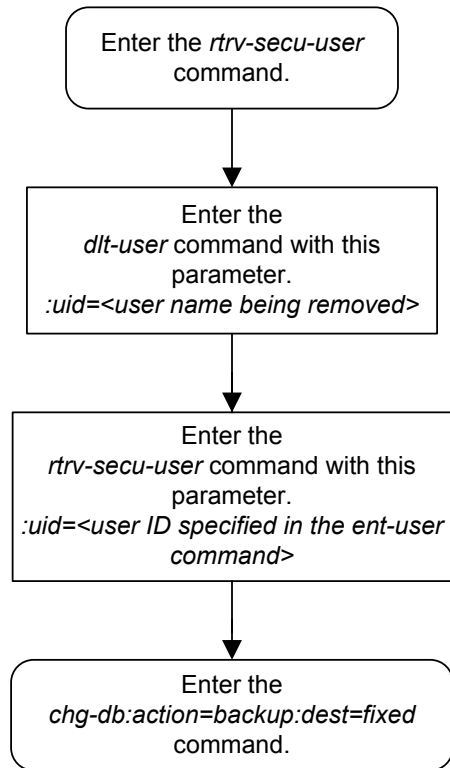
Figure 4-7 Removing a User from the System

Changing User Information

This procedure is used to change the characteristics of a user on the **EAGLE** using the `chg-user` command. This procedure can only be performed if you have been assigned the command class "Security Administration." If the user **ID** does not exist in the database, the user's characteristics cannot be changed.

Note: The `pid` parameter can be specified for this procedure on all terminals (1 - 40) if the Eagle **OA&M IP Security Enhancements** feature is on. If this feature is on, the entry **YES** is shown for terminals 17 through 40 in the **SECURE** column in the `rtrv-trm` output. The output of the `rtrv-ctrl-feat` command also shows if this feature is on or off. If this feature is off, the `pid` parameter can be specified for this procedure only on terminals 1 through 16. If you wish to use the Eagle **OA&M IP Security Enhancements** feature, and the feature is not on, perform [Activating the EAGLE OA&M IP Security Enhancement Controlled Feature](#) to enable and activate this feature.

The `chg-user` command uses these parameters.

- `:uid` – The **ID** of a user in the database
- `:nuid` – New user **ID** – The new **ID** of the user specified by the `uid` parameter.
- `:pid` – Password **ID** (only required if changing the password of a user) – The password of the user specified by the `uid` parameter.
- `:all` – The user has access to all commands in all command classes.
- `:dbg` – The user has access to all commands in the command class "Debug."
- `:link` – The user has access to all commands in the command class "**Link Maintenance**."
- `:sys` – The user has access to all commands in the command class "System Maintenance."
- `:sa` – The user has access to all commands in the command class "Security Administration."
- `:pu` – The user has access to all commands in the command class "Program Update."
- `:db` – The user has access to all commands in the command class "Database Administration."
- `:cc1 - :cc8` – Eight configurable command classes. These parameters specified whether or not the user has access to the commands in the specified configurable command class. The value of these parameters consist of the configurable command class name (1 alphabetic character followed by 2 alphanumeric characters), and either yes or no. The command class name and the yes or no values are separated by a dash. For example, to assign a user the permission to use the commands in configurable command class `db1`, the `cc1=db1=yes` parameter would be specified.

To specify any configurable command classes, the **Command Class Management** feature must be enabled and turned on. Enter the `rtrv-ctrl-feat` command to verify whether or not the **Command Class Management** feature is enabled. If the **Command Class Management** feature is not enabled or turned on, perform [Activating Controlled Features](#) to enable and turn on the **Command Class Management** feature. Up to 32 configurable command classes can be assigned to users. When the **Command**

Class Management feature is enabled and turned on, the configurable command class names are given the names `u01 - u32`. These command class names, the descriptions of these command classes, and the commands assigned to these command classes can be changed using the [Configuring Command Classes](#).

The `chg-user` command can assign a maximum of eight configurable command classes to the user each time the `chg-user` command is performed.

`:page` – The amount of time, in days, that the specified user’s password can be used before the user must change their password.

If the `page` parameter is not specified with the `ent-user` command, the **EAGLE** uses the value configured for the `page` parameter specified by the `chg-secu-dflt` command to determine the age of the user’s password.

`:uout` – The number of consecutive days that a user **ID** can remain active on the **EAGLE** and not be used. When the user **ID** has not been used for the number of days specified by the `uout` parameter, that user **ID** is no longer valid and the **EAGLE** rejects any attempt to log into the **EAGLE** with that user **ID**.

If the `uout` parameter is not specified with the `ent-user` command, the **EAGLE** uses the value configured for the `uout` parameter specified by the `chg-secu-dflt` command to determine the number of consecutive days that a user **ID** can remain active on the **EAGLE** and not be used

`:revoke` – Is the specified user **ID** in service? Any login attempts using a revoked user **ID** are rejected by the **EAGLE**. The `revoke=yes` parameter cannot be specified for a user **ID** assigned to the security administration command class.

`:rstlsl` – resets the last successful login date for a user **ID** to the current date. If the user **ID** is out of service because the user **ID** has been idle longer than the value of the `uout` parameter defined by either the `ent-user` or `chg-secu-dflt` commands, this parameter brings that user **ID** back into service.

This example shows an `rtrv-secu-user` command output when the **Command Class Management** feature is enabled and turned on. If the **Command Class Management** feature is not enabled and activated, the 32 configurable command classes, shown in the following example as fields `U01 - U32`, are not shown in the `rtrv-secu-user` command output.

An asterisk (*) displayed after the value in the `PAGE` or `UOUT` fields indicates that the system-wide default `page` or `uout` parameter values, as configured on the `chg-secu-dflt` command, is in effect for the user **ID**.

```
rlghncxa03w 09-03-01 08:33:48 GMT EAGLE5
40.1.0
USER ID          AGE PAGE UOUT REV LINK SA  SYS PU  DB  DBG
frodo           750 0   0   NO  YES  YES YES YES YES YES

                U01 U02 U03 U04 U05 U06 U07 U08 U09 U10 U11 U12 U13 U14 U15 U16
                YES YES YES YES YES YES YES YES YES YES YES YES YES YES YES NO

                U17 U18 U19 U20 U21 U22 U23 U24 U25 U26 U27 U28 U29 U30 U31 U32
                YES YES YES YES YES YES YES YES YES YES YES YES NO  NO  NO  YES

USER ID          AGE PAGE UOUT REV LINK SA  SYS PU  DB  DBG
manny           36 60  60   NO  YES  YES YES YES YES YES

                U01 U02 U03 U04 U05 U06 U07 U08 U09 U10 U11 U12 U13 U14 U15 U16
                NO  NO  NO  NO  YES YES YES YES YES YES YES YES YES YES YES YES
```

```

U17 U18 U19 U20 U21 U22 U23 U24 U25 U26 U27 U28 U29 U30 U31 U32
YES YES YES YES YES YES YES YES YES YES YES NO NO NO YES

USER ID          AGE PAGE UOUT REV LINK SA  SYS PU  DB  DBG
moe              100 30   60   YES YES  YES YES YES YES YES

U01 U02 U03 U04 U05 U06 U07 U08 U09 U10 U11 U12 U13 U14 U15 U16
YES YES YES YES YES YES YES YES YES YES YES YES YES YES YES NO

U17 U18 U19 U20 U21 U22 U23 U24 U25 U26 U27 U28 U29 U30 U31 U32
YES YES YES YES YES YES YES YES YES YES YES YES YES YES NO NO NO

USER ID          AGE PAGE UOUT REV LINK SA  SYS PU  DB  DBG
jack             10  30 * 30 * NO  YES  YES YES YES YES YES

U01 U02 U03 U04 U05 U06 U07 U08 U09 U10 U11 U12 U13 U14 U15 U16
YES YES YES YES YES YES YES YES YES YES YES YES YES YES YES YES

U17 U18 U19 U20 U21 U22 U23 U24 U25 U26 U27 U28 U29 U30 U31 U32
YES YES YES YES YES YES NO  NO  NO  NO  YES YES YES YES YES NO

```

1. Display the user IDs in the database using the `rtrv-secu-user` command.

This is an example of the possible output.

```
rlghncxa03w 09-03-01 08:33:48 GMT EAGLE5 40.1.0
```

```

USER ID          AGE PAGE UOUT REV LINK SA  SYS PU  DB  DBG
frodo            0  60 * 90 * NO  YES  NO  YES NO  YES YES

DB1 U02 U03 U04 U05 U06 U07 U08 U09 U10 U11 U12 U13 U14 U15 U16
YES NO  NO  NO  NO  NO  NO  NO  NO  NO  NO  NO  NO  NO  NO NO

U17 U18 U19 U20 U21 U22 U23 U24 U25 U26 U27 U28 U29 U30 U31 U32
NO NO  NO  NO  NO  NO  NO  NO  NO  NO  NO  NO  NO  NO  NO NO

USER ID          AGE PAGE UOUT REV LINK SA  SYS PU  DB  DBG
manny           36  60   60   NO  YES  YES YES YES YES YES

DB1 U02 U03 U04 U05 U06 U07 U08 U09 U10 U11 U12 U13 U14 U15 U16
NO NO  NO  NO  YES YES YES YES YES YES YES YES YES YES YES YES

U17 U18 U19 U20 U21 U22 U23 U24 U25 U26 U27 U28 U29 U30 U31 U32
YES YES YES YES YES YES YES YES YES YES YES YES YES YES YES YES

USER ID          AGE PAGE UOUT REV LINK SA  SYS PU  DB  DBG
fred            750 0    0    NO  YES  YES YES YES YES YES

DB1 U02 U03 U04 U05 U06 U07 U08 U09 U10 U11 U12 U13 U14 U15 U16
NO  YES YES YES YES YES YES YES YES YES YES YES YES YES YES YES NO

U17 U18 U19 U20 U21 U22 U23 U24 U25 U26 U27 U28 U29 U30 U31 U32
YES YES YES YES YES YES YES YES YES YES YES YES YES YES YES YES NO NO NO

USER ID          AGE PAGE UOUT REV LINK SA  SYS PU  DB  DBG
travist         101 60 * 90 * NO  YES  NO  YES NO  NO  YES

DB1 U02 U03 U04 U05 U06 U07 U08 U09 U10 U11 U12 U13 U14 U15 U16
YES YES YES YES YES YES YES YES YES YES YES YES YES YES YES YES

```

```

U17 U18 U19 U20 U21 U22 U23 U24 U25 U26 U27 U28 U29 U30 U31 U32
YES YES YES YES YES YES NO NO NO NO YES YES YES YES YES NO

```

Continue the procedure by performing one of these steps.

- If the `cc1` through `cc8` parameters are not being specified in this procedure, continue the procedure with [4](#).
 - If the `cc1` through `cc8` parameters will be specified in this procedure, continue the procedure by performing one of these steps.
 - If configurable command classes are shown in the `rtrv-secu-user` output, continue the procedure with [3](#).
 - If configurable command classes are not shown in the `rtrv-secu-user` output, continue the procedure with [2](#).
2. Verify that the **Command Class Management** feature is enabled and activated, by entering the `rtrv-ctrl-feat` command with the `partnum=89005801` parameter.

This is an example of the possible output.

```

rlghncxa03w 06-10-01 21:15:37 GMT EAGLE5 36.0.0
The following features have been permanently enabled:
Feature Name          Partnum    Status  Quantity
Command Class Management 893005801 off      ----

```

Note: The `rtrv-ctrl-feat` command output contains other fields that are not used by this procedure. If you wish to see all the fields displayed by the `rtrv-ctrl-feat` command, see the `rtrv-ctrl-feat` command description in *Commands User's Guide*.

If the **Command Class Management** feature is enabled and turned on (status = on), [3](#).

If the **Command Class Management** feature is not enabled or turned on, perform [Activating Controlled Features](#) to enable and turn on the **Command Class Management** feature.

Caution: If the **Command Class Management** feature is temporarily enabled, the configurable command classes can be assigned and used only for the amount of time shown in the `Trial Period Left` column in the `rtrv-ctrl-feat` output.

3. Display the descriptions of the configurable command classes in the database by entering the `rtrv-cmd` command.

This is an example of the possible output.

```

rlghncxa03w 09-05-01 21:15:37 GMT EAGLE5 41.0.0
CMD          CLASS
alw-slk      link, ull
ent-user     sa
unhb-slk     link

```

```

rtrv-attr-seculog  sa, u31
inh-slk           link, abc
rtrv-meas-sched   link, abc, def
act-lbp          link
act-dlk          link
act-slk          link
rtrv-seculog     sa, abc, def, ghi
act-lpo          link
blk-slk          link, abc, u23, u31
dact-lbp         link
canc-dlk         link
inh-card         sys
canc-lpo         link, u01, u02, u03, u04, u05, u06, u07, u08, u09, u10,
                u11, u12, u13
canc-slk         link
ublk-slk         link, u01, u02, u03, u04, u05, u06, u07, u08, u09, u10,
                u11, u12, u13, u14, u15, u16, u17, u18, u19, u20, u21,
                u22, u23, u24, u25, u26, u27, u28, u29, u30, u31, u32
inh-trm          sys, krb
rept-meas        link
.
.
.
chg-meas         link
tst-dlk          link, krb
tst-slk          link

```

If the desired configurable command class descriptions are not in the database, perform [Configuring Command Classes](#) to configure the desired command classes.

Note: A user ID cannot be changed while the user is logged on, except when the `revoke=yes` parameter is specified with the `chg-user` command. It is assumed that if the user is being revoked, the intent is to immediately deny the user access to the EAGLE. In this case, the user will be logged off when the database is updated.

4. Verify that the user is not logged on the **EAGLE** using the `rept-stat-user` command.

If the user is logged on to the **EAGLE**, the `chg-user` command will log the user off the **EAGLE** when the command is executed. Notify the user to log off the **EAGLE**. This is an example of the possible output.

```

rlghncxa03w 09-05-01 09:12:15 GMT  EAGLE5 41.0.0
REPT-STAT-USER COMPLTD
USER ID      TERM #  IDLE SINCE      COMMAND          STATE
fred         3      09-04-19 05:06:43  rept-stat-user  PROCESSING
frodo        13      09-04-20 08:12:23  chg-db          IDLE
manny        1       09-04-27 04:37:56  ent-dlk         IDLE
travist      7       09-04-30 10:06:22  rtrv-meas      IDLE

```

5. Change the user's characteristics using the `chg-user` command.

The `nuid` parameter changes the user **ID** of a user. This parameter is optional and if not specified, the user **ID** is not changed. The user **ID** must contain 1 alpha character and up to 15 alphanumeric characters. The first character of a user **ID** must be an alpha character. Even though a period is not an alphanumeric character, one of the 15 alphanumeric characters can be a period.

The `pid` parameter specifies whether the password is to be changed. If `no` is selected, the password is not changed. If `yes` is entered, you will be prompted for a new password for the user. Enter the new password for the user. You do not need to know the old password with this command. The password must meet the requirements defined by the `chg-secu-dflt` command. Display the password requirements by entering the `rtrv-secu-dflt` command.

This is an example of the possible output.

```
rlghncxa03w 10-07-01 16:02:05 GMT EAGLE5 42.0.0
SECURITY DEFAULTS
-----
MINLEN          8
ALPHA           1
NUM             1
PUNC            1
```

The `rtrv-secu-dflt` command output contains other fields that are not used by this procedure. If you wish to see all the fields displayed by the `rtrv-secu-dflt` command, refer to the `rtrv-secu-dflt` command description in *Commands User's Guide*.

The password can contain from one to twelve characters. For this example, the password must contain at least eight characters, no more than twelve, with at least one alpha character (a-z), at least one numeric character (0-9), and at least one punctuation character (any printable character that is not an alphabetic character, a numeric character, the space bar). The password requirements are shown in these fields in the `rtrv-secu-dflt` command output.

- `MINLEN` – the minimum length of the password
- `ALPHA` – the minimum number of alpha characters
- `NUM` – the minimum number of numeric characters
- `PUNC` – the minimum number of punctuation characters

The password is not case sensitive. For security reasons, the password is never displayed on the terminal.

At the prompt `verify password`, enter the new password again. This `pid` parameter is optional and the default value is `no`.

The other parameters assign command class permissions to the user **ID**. If `yes` is selected for any of these parameters, the user will have access to that class of commands. If `no` is entered, the user will not have access to that class of commands. These parameters are optional and if not specified, the values are not changed.

For this example, the user **ID** `manny` is being changed to `bilbo`, and the **PU**, **DB**, **DBG**, and **DB1** command class values are changed. Enter this command.

```
chg-user:uid=manny:nuid=bilbo:pu=no:db=no:dbg=no:db1=yes
```

When this command has successfully completed, this message should appear.

```
rlghncxa03w 06-10-01 09:12:36 GMT EAGLE5 36.0.0
CHG-USER: MASP A - COMPLTD
```

6. Verify the changes using the `rtrv-secu-user` command and specifying the user ID used in 5 with the `uid` parameter.

If the user ID was changed in 5, specify the new user ID. For this example, enter this command.

```
rtrv-secu-user:uid=bilbo
```

This is an example of the possible output.

```
rlghncxa03w 09-03-01 08:33:48 GMT EAGLE5 40.1.1.0

USER ID          AGE PAGE UOUT REV LINK SA  SYS PU  DB  DBG
bilbo            36  60   60   NO  YES  YES YES NO  NO  NO

                DB1 U02 U03 U04 U05 U06 U07 U08 U09 U10 U11 U12 U13 U14 U15 U16
                YES NO  NO  NO  YES YES YES YES YES YES YES YES YES YES YES YES
                U17 U18 U19 U20 U21 U22 U23 U24 U25 U26 U27 U28 U29 U30 U31 U32
                YES YES YES YES YES YES YES YES YES YES YES YES NO  NO  NO  NO  YES
```

7. Back up the new changes using the `chg-db:action=backup:dest=fixed` command.

These messages should appear, the active **Maintenance and Administration Subsystem Processor (MASP)** appears first.

```
BACKUP (FIXED) : MASP A - Backup starts on active MASP.
BACKUP (FIXED) : MASP A - Backup on active MASP to fixed disk complete.
BACKUP (FIXED) : MASP A - Backup starts on standby MASP.
BACKUP (FIXED) : MASP A - Backup on standby MASP to fixed disk complete.
```

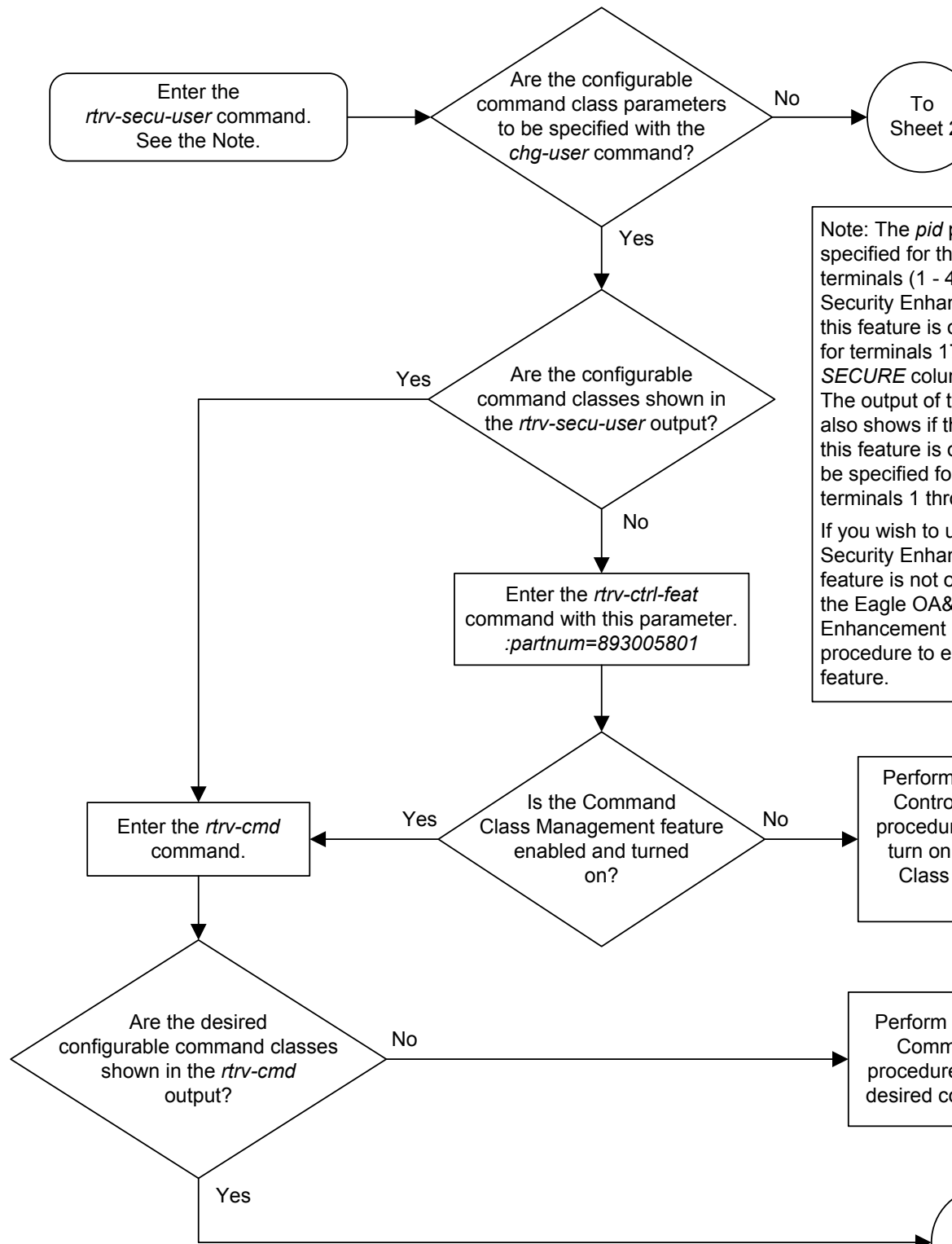
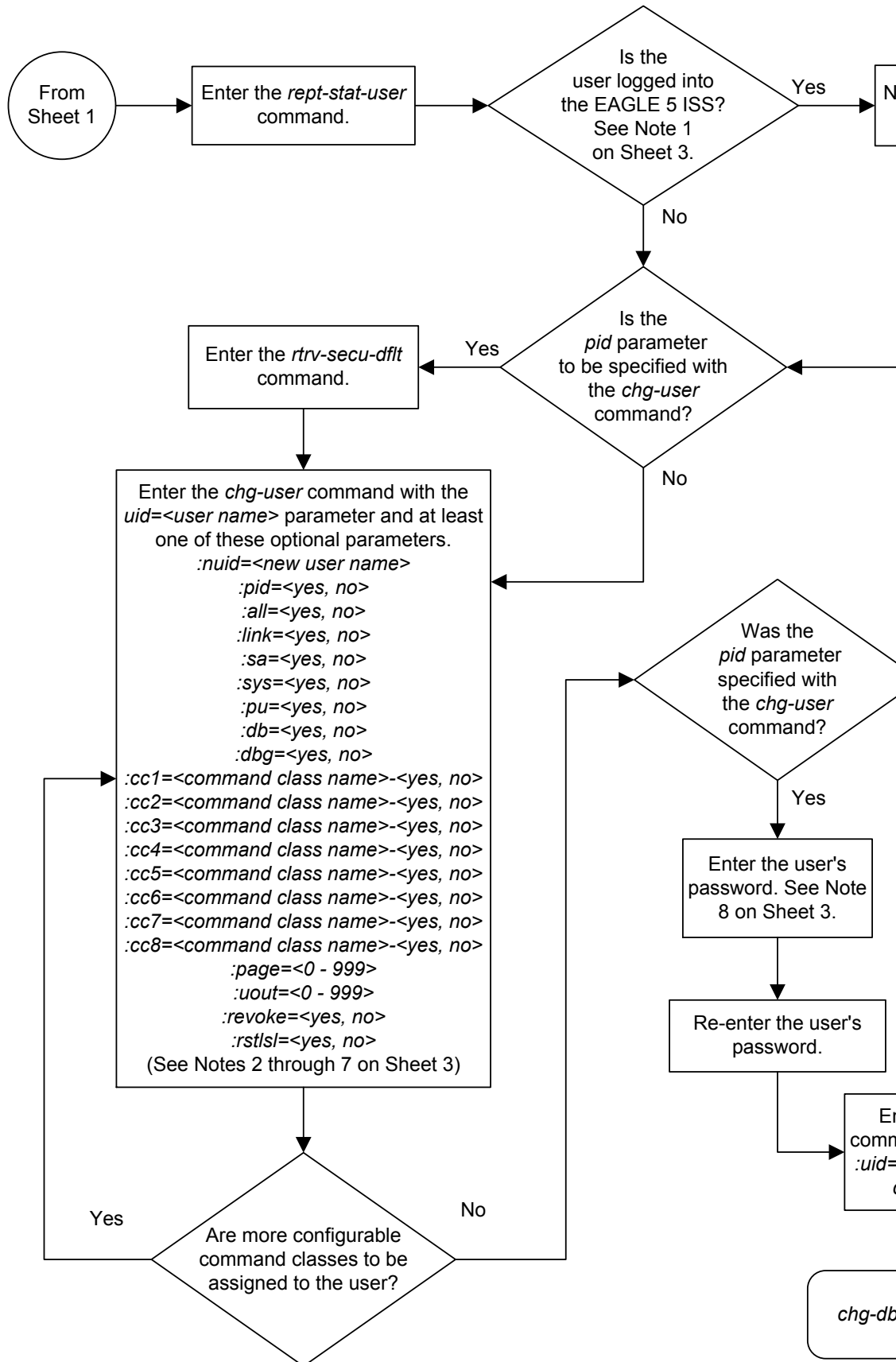

Figure 4-8 Changing User Information



Note: The `pid` specified for the terminals (1 - 4) Security Enhancement this feature is only for terminals 1 through 4. The output of the `rtrv-secu-user` also shows if this feature is enabled. This feature can be specified for terminals 1 through 4. If you wish to use Security Enhancement feature is not on the Eagle OA& Enhancement procedure to enable feature.

Perform Control procedure to turn on Command Class

Perform Command procedure to get desired classes



Notes:

1. A user ID cannot be changed while the user is logged on, except when the *revoke=yes* parameter is specified with the *chg-user* command. It is assumed that if the user ID is being revoked, the intent is to immediately deny the user access to the EAGLE 5 ISS. In this case, the user will be logged off when the database is updated.
2. The words SEAS and NONE are reserved by the EAGLE 5 ISS and cannot be specified as values for the *nuid* parameter.
3. The *revoke=yes* parameter cannot be specified when the *sa* parameter value is *yes*.
4. To specify the *cc1* through *cc8* parameters, the Command Class Management feature must be enabled and activated.
5. The user can have a maximum of 32 configurable command classes assigned.
6. The *all* parameter specifies whether or not all non-configurable command classes (*link, sa, sys, pu, db, dbg*) can be used by the user.
7. If the *all* parameter and individual non-configurable command classes are specified with the *ent-user* command, the value of the specified individual non-configurable command classes overrides the value of the *all* parameter.
8. The password must adhere to all password provisioning rules as shown in the *rtv-secu-dflt* output. These rules are displayed on the screen after the *chg-user* command is entered with the *pid=yes* parameter.

Changing a Password

There are two different procedures that can be used to change passwords. This procedure allows a specific user to change their own password using the `chg-pid` command. The other procedure is for the **EAGLE** administrator to change the password of any user (see the [Changing User Information](#) procedure).

Rules for Changing a Password

The rules for the format of the password are determined by the `chg-secu-dflt` command (see the [Changing the Security Defaults](#) procedure for more information) and are displayed in the scroll area of the terminal before the password prompt is issued, or by entering the `rtrv-secu-dflt` command.

The `minintrvl` parameter of the `chg-secu-dflt` command defines the minimum number of days between attempts to change a password. If this attempt occurs during this interval, the password cannot be changed.

The `pchreuse` parameter of the `chg-secu-dflt` command defines the number of characters that cannot be reused from the current password when setting the new password. For example, if the `pchreuse` parameter value is 5, no more than five characters of the current password can be reused in the new password. If the new password contains more the five characters from the current password, the new password will be rejected.

The `preuse` parameter defines the number of previous passwords that cannot be used. If the `preuse` parameter value is 6, the previous six passwords cannot be used. If the new password is one of the number of previous passwords defined by the `preuse` parameter, the new password will be rejected.

When the password is being changed with the `chg-pid` command, the minimum requirements for passwords are displayed after the current password is entered at the `Enter Old Password:` prompt.

The password is not case sensitive. For security reasons, the password is never displayed on the terminal.

Note: This procedure can be performed on all terminals (1 - 40) if the Eagle **OA&M IP Security Enhancements** feature is on. If this feature is on, the entry YES is shown for terminals 17 through 40 in the SECURE column in the `rtrv-trm` output. The output of the `rtrv-ctrl-feat` command also shows if this feature is on or off. If this feature is off, this procedure can be performed only on terminals 1 through 16. If you wish to use the EAGLE **OA&M IP Security Enhancements** feature, and the feature is not on, go to the [Activating the EAGLE OA&M IP Security Enhancement Controlled Feature](#) procedure to enable and activate this feature.

1. Log into the **EAGLE** using the `login` or `act-user` command.

This is an example of the messages that appear when you have successfully logged onto the **EAGLE**.

```
NOTICE: This is a private computer system.  
Unauthorized access or use may lead to prosecution.
```

```
0 LOGIN failures since last successful LOGIN
Last successful LOGIN was on port 4 on 04-06-01 @ 09:12:36
```

2. Enter the `chg-pid` command.
3. At the prompt enter `old password`, enter your current password.

This is a security feature of this command. It prevents another user from changing the password of the user that is logged in to the **EAGLE** who may have stepped away from the terminal without logging off.

4. At the prompt enter `new password`, the minimum requirements for passwords are displayed as shown in the following example.

```
rlghncxa03w 10-07-01 09:12:36 GMT EAGLE5 42.0.0
New password must contain:
- between 8 and 12 characters
- at least 1 alphabetic character(s) ('a'-'z')
- at least 1 numeric character(s) ('0'-'9')
- at least 1 punctuation character(s) (e.g. $%#@#)
New password must:
- be unique from the old password
- be unique from the last 6 historical passwords
- not reuse more than 4 characters from the old password
```

Enter your new password making sure that the password meets the minimum requirements for passwords on your **EAGLE**.

If the password is rejected, it did not meet the minimum requirements for passwords. Go back to [2](#) and start the process of changing the password again making sure that the new password meets the minimum character requirements.

5. At the prompt verify `new password`, enter the password that was entered in [4](#) again.

If the password is rejected, either the new password entered in this step did not match the password entered in [4](#), or the password entered in [3](#) did not match the original password. Go back to [2](#) and start the process of changing the password again making sure that the current password entered in [3](#) is correct and that the new password meets the minimum character requirements shown at the `enter new password` prompt.

6. When the command executed message appears, the execution of the command has been completed, and the new password has been entered into the **EAGLE** database.

This message should also appear.

7. Back up the new changes using the `chg-db:action=backup:dest=fixed` command.

These messages should appear, the active **Maintenance and Administration Subsystem Processor (MASP)** appears first.

```
BACKUP (FIXED) : MASP A - Backup starts on active MASP.
BACKUP (FIXED) : MASP A - Backup on active MASP to fixed disk complete.
BACKUP (FIXED) : MASP A - Backup starts on standby MASP.
BACKUP (FIXED) : MASP A - Backup on standby MASP to fixed disk complete.
```

Figure 4-9 Changing a Password

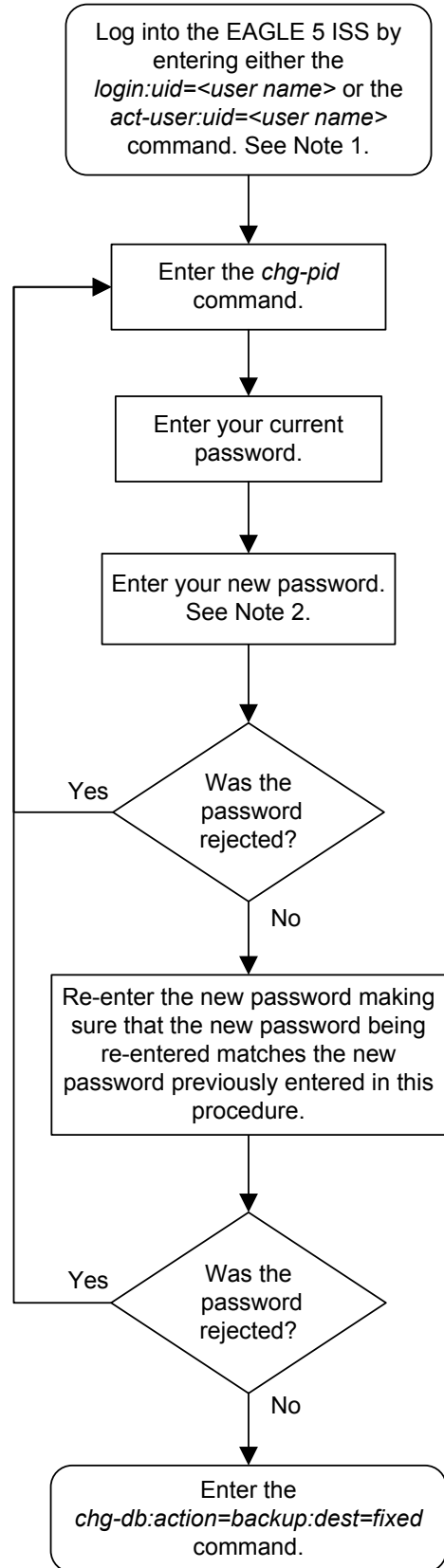

Notes:

1. This procedure can be performed on all terminals where the Eagle OAM IP Security Enhancements feature is on. If the feature is not on, the entry YES is shown for terminals 17 through 20 in the SECURE column in the *rtv-trm* output. The output of the *chg-pid* command also shows if this feature is on or off. If this feature is not on, this procedure can be performed only on terminals 1 through 16. If you wish to use the Eagle OAM IP Security Enhancements feature and the feature is not on, go to the “Activating the Eagle OAM IP Security Enhancement Controlled Feature” procedure in the *Database Administration - System Management* to activate this feature.

2. When you are prompted to enter the new password, the password requirements for passwords are displayed after the current password is entered at the *Enter Old Password:* prompt. Make sure the new password meets these requirements and the requirements listed in the Rules for Changing a Password section of the “Changing a Password” procedure in the *Database Administration - System Management*.

Changing Terminal Characteristics

This procedure is used to change the characteristics of a terminal, except for the SEAS terminal and a measurements terminal for an **EAGLE** containing a maximum of 700 signaling links, using the `chg-trm` command.

To configure a measurements terminal for an **EAGLE** containing a maximum of 700 signaling links, go to the [Configuring the Measurements Terminal for an EAGLE Containing 700 Signaling Links](#) procedure.

To configure a **SEAS** terminal, refer to the [Configuring SEAS Terminals](#) procedure.

The communication attributes can be changed on any terminal except on the terminal you are logged on to. The message output group assignments can be changed on any terminal, including the terminal you are logged on to. The `chg-trm` command uses these parameters.

:trm – terminal numbers (1 - 40, terminals 1-16 are serial terminals, terminals 17-40 are telnet terminals).

:baud – Serial port baud rate (2400, 4800, 9600, or 19200, 38400, 57600, 115200). Values 38400, 57600, and 115200 are only valid when the OAMHC is used.

:sb – The number of stop bits used in communications with the device (1 or 2).

:prty – Parity used by the device (odd, even, none).

:type – The type of device being connected (See the "Terminal Types" section).

:fc – The type of flow control used between the **EAGLE** and the output devices. (sw - software, hw - hardware, both - hardware and software, none).

Note: Hardware flow control (`fc=hw`) and both hardware and software flow control (`fc=both`) are not supported for the terminal if the **EAGLE** contains E5-TDMs. Part of the terminal output may be lost if hardware flow control or both hardware and software flow control are specified for the terminal when the **EAGLE** contains E5-TDMs.

:tmout – The maximum amount of time, in minutes, that a login session on the specified port can remain idle (that is, no user input) on the port before being automatically logged off. (0 - 99, see the "Security Parameters" section).

:mxinv – The login failure threshold – The number of login attempt failures or attempts to unlock a terminal that can occur on the terminal before the terminal is disabled. (0 - 9, see the "Security Parameters" section).

:dural – The length of time that the terminal is disabled after the login failure threshold has been exceeded. (See the "Security Parameters" section).

:all – Specifies whether or not all unsolicited messages are displayed on the specified terminal (yes or no).

:traf – Specifies whether or not traffic related unsolicited messages are displayed on the specified terminal (yes or no).

:link – Specifies whether or not link maintenance related unsolicited messages are displayed on the specified terminal (yes or no).

:sa – Specifies whether or not security administration related unsolicited messages are displayed on the specified terminal (yes or no).

:db – Specifies whether or not database related unsolicited messages are displayed on the specified terminal (yes or no).

:sys – Specifies whether or not system maintenance related unsolicited messages are displayed on the specified terminal (yes or no).

:pu – Specifies whether or not program update related unsolicited messages are displayed on the specified terminal (yes or no).

:uimrd – Specifies whether or not **UIM** redirect related unsolicited messages are displayed on the specified terminal (yes or no).

:appserv – Specifies whether or not application server related unsolicited messages are displayed on the specified terminal. (yes or no).

:appss – Specifies whether or not application subsystem related unsolicited messages are displayed on the specified terminal (yes or no).

:card – Specifies whether or not card related unsolicited messages are displayed on the specified terminal (yes or no).

:clk – Specifies whether or not clock related unsolicited messages are displayed on the specified terminal (yes or no).

:dbg – Specifies whether or not debug related unsolicited messages are displayed on the specified terminal (yes or no).

:gtr – Specifies whether or not global title translation related unsolicited messages are displayed on the specified terminal (yes or no).

:gws – Specifies whether or not gateway screening related unsolicited messages are displayed on the specified terminal (yes or no).

:meas – Specifies whether or not measurements maintenance related unsolicited messages are displayed on the specified terminal (yes or no).

:mon – Specifies whether or not unsolicited messages related to the Sentinel monitoring functions are displayed on the specified terminal (yes or no).

:mps – Specifies whether or not **MPS** related unsolicited messages are displayed on the specified terminal (yes or no).

:seas – Specifies whether or not **SEAS** maintenance related unsolicited messages are displayed on the specified terminal (yes or no).

:slan – Specifies whether or not **SLAN** maintenance related unsolicited messages are displayed on the specified terminal (yes or no).

:logintmr – the login timer. This parameter specifies the maximum time for logging on to the telnet terminal after selecting the terminal. This timer makes sure the user logs in with in the configured time and terminal does not remain idle. The value for this timer can be from 3 seconds to 600 seconds. An additional value none indicates that the user has an indefinite amount of time to login on the telnet terminal. The system default value for this parameter is none. This parameter can be specified only for telnet terminals (type=telnet).

:logouttmr – the logout timer. This parameter specifies the maximum time the telnet session remains open after the user manually or automatically logs out. The value for this timer can be from 0 to 1200 seconds. An additional value none indicates that the telnet session is never closed when the user logs out. The system default value for this parameter is none. This parameter can be specified only for telnet terminals (type=telnet).

`:pngtimeint` – the ping timer interval. This parameter specifies the amount of time that must pass before the IPSM initiates a new ping cycle. The value for this timer can be from 100 to 1200000 milliseconds. An additional value `none` indicates that pinging does not occur. The system default value for this parameter is `none`. This parameter can be specified only for telnet terminals (`type=telnet`) and EMSALM terminals (`type=emsalm`).

`:pngfailcnt` – This parameter specifies the number of consecutive ping fails that must occur before the telnet connection is dropped. The value for this timer can be from 1 to 10. The system default value for this parameter is 1. This parameter can be specified only for telnet terminals (`type=telnet`) and EMSALM terminals (`type=emsalm`).

The messages assigned to the output message groups defined by the `traf`, `db`, `link`, `sa`, `sys`, `pu`, `uimrd`, `appserv`, `appss`, `card`, `clk`, `dbg`, `gnt`, `gws`, `meas`, `mon`, `mps`, `seas`, and `slan` parameters are listed in *Unsolicited Alarm and Information Messages Reference*.

Certain **UIMs** (unsolicited information messages) can be assigned to the **UIM Redirect** output group or remain in their original output message group. The `uimrd` parameter of the `chg-trm` command and the `on=uimrd` and `off=uimrd` parameters of the `chg-stpopts` command determine which output groups these UIMs are assigned to and how the EAGLE handles them.

The `on=uimrd` parameter of the `chg-stpopts` command tells the EAGLE to put these UIMs in the unsolicited **UIM Redirect** output message group. If the `off=uimrd` parameter is specified with the `chg-stpopts` command, the messages remain in their original output message group. The `on=uimrd` parameter value of the `chg-stpopts` command is shown in the `UIMRD` row of the `rtrv-stpopts` output as the value `yes`. The `off=uimrd` parameter value of the `chg-stpopts` command is shown in the `UIMRD` row of the `rtrv-stpopts` output as the value `no`. The `uimrd=yes` parameter of the `chg-trm` command allows the specified terminals to receive unsolicited UIM redirect output messages.

[Table 4-2](#) shows the combination of the values of both `uimrd` values and how the EAGLE handles the messages. The unsolicited output group message assignments are listed in *Unsolicited Alarm and Information Messages Reference*.

Table 4-2 UIMRD Parameter Combinations

UIMRD value of the terminal	UIMRD STP option value	Action
No	No (See Note 1)	The UIMs remain in their original output message group and are output to terminals receiving messages from the original output message group.
No	Yes (See Note 2)	The UIMs are in the UIM Redirect output group but are not output to any terminal.

Table 4-2 (Cont.) UIMRD Parameter Combinations

UIMRD value of the terminal	UIMRD STP option value	Action
Yes	No (See Note 1)	The UIMs remain in their original output message group and are output to terminals receiving messages from the original output message group. Even though the UIMRD value for the terminal is <i>yes</i> , there are no messages in the UIM redirect output group because the UIMRD value in the <i>rtrv-stpopts</i> output is <i>no</i> . No UIM redirect messages are output to any terminal.
Yes	Yes (See Note 2)	The UIMs are in the UIM Redirect output group and are output to terminals receiving unsolicited UIM redirect messages.

Notes:

1. This value is set with the *off=uimrd* parameter of the *chg-stpopts* command.
2. This value is set with the *on=uimrd* parameter of the *chg-stpopts* command.

If the *type=vt320* or *type=sccs* parameters are specified, the value of the *pty* parameter cannot be *none*. The value of the *pty* parameter must be either *odd* or *even*.

The EAGLE requires at least two terminals assigned to the Security Administration command class. The terminal type of a terminal assigned to the Security Administration command class cannot be changed to these terminal types, *printer* (*:type=printer*) or *none* (*:type=none*) if the change would leave the EAGLE with only one terminal assigned to the Security Administration command class. The command class assignments of the terminal are shown with the *rtrv-secu-trm* command. If the terminal type is being changed to either *printer* or *none*, go to the [Changing Terminal Command Class Assignments](#) procedure and make sure that the command class assignment for the terminal being changed does not have the Security Administration command class assigned to it, or change the command class assignment of another terminal to include the Security Administration command class.

If the *all=yes* parameter and the *traf*, *db*, *link*, *sa*, *sys*, *pu*, *uimrd*, *appserv*, *appss*, *card*, *clk*, *dbg*, *gtd*, *gws*, *meas*, *mon*, *mps*, *seas*, or *slan* parameters are specified, for example, *chg-trm:trm=1:all=yes:pu=no*; all the message output groups are set to *yes* with the exception of the message output groups specified in the *chg-trm* command which are set to *no*. In this example, the value of all the message output groups is *yes* (*all=yes*) with the exception of the program update message output group which has the value *no* (*pu=no*).

If the *all=no* parameter is specified for a SEAS terminal (*type=seas*), all the output group values are changed to *NO* except for the SEAS output group. The SEAS output group value remains set to *YES* and this message is displayed.

SEAS Output Group is SET for SEAS terminal <terminal number>

The total value of the terminals' baud rate cannot be greater than 172,032. If the total baud rate of the terminals exceeds 172,032, change the baud rates of the terminals so that the total baud rate is not greater than 172,032.

Only four terminals should be configured to receive unsolicited system maintenance messages (:sys=yes).

If the communication attributes (baud, sb, prty, and fc) or the terminal type (type) for the terminal are being changed, the terminal must be placed out of service with the rmv-trm command before the changes can be made.

If only the output message group or security (tmout, mxinv, dural) parameters are being changed, the terminal can remain in service when the chg-trm command is executed.

Terminal Types

There are nine terminal types that can be used on the **EAGLE**.

The VT320 type is the standard terminal used for entering commands, displaying command responses, displaying periodic system status information at screen specific locations, and scrolling unsolicited messages.

The PRINTER type is used with printers for recording **UAMs**, **UIMs** and echoed command responses.

The KSR type mimics older style teleprinters (that is, printers with a keyboard).

The SCCS type is used for some network monitoring and surveillance applications. **SCCS** terminals are the same as **KSR** terminals, except a pre-defined "start-of-message" character is added to indicate the beginning of a new command response or unsolicited message.

The NONE type is typically used to indicate unused terminals.

The MGMT terminal type, or management terminal, provides a machine to machine messaging interface between the **EAGLE** and the customer's network to provide network surveillance.

The TELNET terminal type provides up to 24 IP based connections to the **EAGLE**'s user interface using a telnet client, in addition to the 16 RS-232 terminals. The telnet terminals are numbered from 17 to 40. The telnet terminals are configured automatically when the IP User Interface (Telnet) feature is enabled and activated, and when the **IPSMs** are configured in the database. The **EAGLE** can have 3 **IPSMs**, with each **IPSM** supporting eight telnet terminals. The baud, prty, sb, and fc parameters cannot be specified with the chg-trm command for a telnet terminal, but all other terminal parameters can be specified and changed for a telnet terminal. For terminals 17 to 40, the values for the type parameter can be only telnet, none, or emsalm.

Note: If the chg-trm command is executed from a telnet terminal (terminals 17 to 40), only the output group parameters (all, traf, link, sa, db, sys, pu, uimrd, appserv, appss, card, clk, dbg, gtt, gws, meas, mon, mps, seas, slan) and the terminal type can be changed.

The EMSALM terminal type provides an alarm monitoring capability that displays only **UAMs** and system alive messages generated by the **EAGLE**. **UIMs** and autonomous reports are not displayed on the **EMSALM** terminals, even if the output group settings for these terminals would allow these messages to be displayed on these terminals.

Caution: **EMSALM** terminals can accept login requests and commands; however, these operations may interfere with the alarm monitoring functions of the **EMSALM** terminals and should be performed on another terminal.

The **EMSALM** terminal type can be assigned to any terminal, serial (terminals 1 to 16) or telnet (terminals 17 to 40). When the terminal type is changed to `emsalm`, all the output message group settings for that terminal are set to `yes`, even if any of the output message groups were set to `no` before the terminal type change. These output message group settings can be changed, if desired. The communications attributes (`baud`, `prty`, `sb`, `fc`) and security parameter values (`tmout`, `mxinv`, `dural`) are not changed.

Caution: It is recommended that all the output message group settings for an **EMSALM** terminal are set to `yes`. Changing any of the output message group settings to `no` could prevent alarm messages controlled by the output message group from being displayed on the **EMSALM** terminal.

Caution: If a terminal dedicated to measurements collection is configured (see the [Configuring the Measurements Terminal for an EAGLE Containing 700 Signaling Links](#) procedure), it is recommended that this terminal is not changed to an **EMSALM** terminal.

When the terminal type is changed from `emsalm` to another terminal type, the output message group settings, communications attributes, and security parameter values are not changed.

When assigning the **EMSALM** terminal type to a serial terminal, the communication attribute (`baud`, `prty`, `sb`, `fc`), security (`tmout`, `mxinv`, `dural`), and output group (`traf`, `db`, `link`, `sa`, `sys`, `uimrd`, `appserv`, `appss`, `card`, `clk`, `dbg`, `gtt`, `gws`, `meas`, `mon`, `mps`, `seas`, `slan`) parameters values can be changed.

When assigning the **EMSALM** terminal type to a telnet terminal, only the security (`tmout`, `mxinv`, `dural`), and output group (`traf`, `db`, `link`, `sa`, `sys`, `pu`, `uimrd`, `appserv`, `appss`, `card`, `clk`, `dbg`, `gtt`, `gws`, `meas`, `mon`, `mps`, `seas`, `slan`) parameters values can be changed.

The **SEAS** terminal type is used to provide a path between the EAGLE and the **CCS MR** to support the SEAS over IP feature. The **SEAS** terminal type is not used in this procedure. To configure a terminal as a **SEAS** terminal, refer to the [Configuring SEAS Terminals](#) procedure.

Security Parameters

The monitoring of a terminal's idle time (`tmout`) and the automatic logout function only applies to terminal types **VT320** (`type=vt320`), **KSR**, (`type=ksr`), **SCCS** (`type=sccs`), and **MGMT** (`type=mgmt`). The `tmout` parameter can be specified with other terminal types, but it will have no effect. The system default value for the `tmout` parameter is 30 minutes. The `tmout=0` parameter value allows the terminal to remain idle indefinitely without being automatically logged off.

To impose a temporary lockout of a terminal after a particular number of login attempt failures or a particular number of attempts to unlock a terminal have occurred, the `mxinv` and `dural` values for that terminal must be greater than 0.

The `mxinv=0` parameter value prevents any temporary lockout of the terminal regardless of the number of successive failed login or unlock attempts that were made at the terminal. No messages are issued regarding the temporary lockout. This action applies even if the `dural` parameter value is greater than 0.

The `dural=0` parameter prevents the terminal from being temporarily locked out. If the `mxinv` parameter value is greater than 0 and the `dural` parameter value is 0, the **EAGLE** issues messages concerning login failure threshold, but the terminal will not be locked out.

The value of the `dural` parameter can be expressed in seconds (0 - 59), minutes and seconds (0 - 5959), or hours, minutes, and seconds (0 - 995959). The value 999999 for the `dural` parameter disables the terminal, when the login failure threshold has been exceeded, for an indefinite period of time. A terminal that is disabled for an indefinite period of time is identified by the entry `INDEF` in the `DURAL` field of the `rtrv-trm` command output. A terminal disabled indefinitely can only be restored to service by inhibiting the terminal with the `rmv-trm` command, then placing it into service with the `rst-trm` command.

When the **EAGLE** is delivered to the user, the `mxinv` and `dural` parameters will be set to these values:

```
:mxinv = 5
:dural = 0100 (1 minute, 0 seconds)
```

The RTRV-TRM Output

The output of the `rtrv-trm` command is displayed in two parts. The first part displays the communication and security attributes of the terminal. The communication attributes of the terminal, `BAUD`, `PRTY` (parity), `SB` (stop bits), and `DBTS` (data bits), are displayed in the `COMM` field of the `rtrv-trm` output and are displayed in this format: **BAUD-DBTS-PRTY-SB**. The type of flow control used by the terminal is shown in the `FC` field. The security attributes of the terminal are shown in the `TMOU`, `MXINV`, and `DURAL` fields. The second part of the `rtrv-trm` command output displays the types of unsolicited messages the terminal may receive. An example of the `rtrv-trm` command output is shown in this example.

```
rlghncxa03w 06-10-01 16:02:08 GMT EAGLE5 36.0.0
TRM TYPE COMM FC TMOU MXINV DURAL
3 VT320 9600-7-E-1 SW 30 5 99:59:59

TRM TRAF LINK SA SYS PU DB UIMRD
3 NO YES NO YES NO YES YES
APP APP

TRM SERV SS CARD CLK DBG GTT GWS MEAS MON MPS SEAS SLAN
3 YES YES YES YES YES YES YES YES YES YES NO NO
```

In this example, terminal 3 is running at 9600 baud with 7 data bits, even parity, and 1 stop bit.

For terminals 17 to 40, the `COMM` and `FC` fields are not displayed in the `rtrv-trm` output. The following items are displayed for these terminals in addition to the security attributes and the types of unsolicited messages the terminal may receive. An example `rtrv-trm` output example follows the list.

- The card location of the **IPSM** associated with the terminals.

- The security status of the terminal is displayed in the `SECURE` field. If the Eagle OA&M IP Security Enhancements feature is on, the terminal is secure. The entry `yes` is shown in the `SECURE` field. If the Eagle OA&M IP Security Enhancements feature is off, the terminal is not secure. The entry `no` is shown in the `SECURE` field. [Controlled Feature Activation Procedures](#) contains the procedures to enable and turn on, or turn off the Eagle OA&M IP Security Enhancements feature.
- The login timer (`LOGINTMR`), logout timer (`LOGOUTTMR`), ping time out timer (`PNGTIMEINT`), and the ping fail count (`PNGFAILCNT`) values.

```

rlghncxa03w 06-10-01 16:02:08 GMT EAGLE5 39.0.0
TRM  TYPE      LOC          TMOUT MXINV DURAL      SECURE
30   TELNET    1204          60    0      00:00:00   no

TRM  LOGINTMR LOGOUTTMR PNGTIMEINT PNGFAILCNT
      (sec)      (sec)      (msec)
30   none      none      none      1

TRM  TRAF LINK SA  SYS PU  DB  UIMRD
30   YES  YES  YES YES YES YES YES

      APP  APP
TRM  SERV SS  CARD CLK DBG GTT GWS MEAS MON MPS SEAS SLAN
30   YES  YES YES  YES YES YES YES YES YES YES NO  NO

```

Using Telnet Terminals in Place of Serial Terminals

If the Eagle OA&M IP Security feature is disabled and turned off, serial terminals must be connected to the EAGLE and provisioned in the database because Security Administration commands cannot be executed from a telnet terminal.

If the Eagle OA&M IP Security feature is enabled and on, Security Administration commands, in addition to all other commands, can be executed from a telnet terminal only if the Eagle OA&M IP Security feature is enabled and on. The ability to execute commands from a particular terminal is dependent on the terminal command class assignments for that terminal. Even with the ability to execute most EAGLE commands from a telnet terminal, it is recommended that at least two serial terminals remain connected to the EAGLE. The `act-echo`, `lock`, and `unlock` commands cannot be executed from a telnet terminal. These terminals should be configured with at least Security Administration command class privileges.

By having serial terminals connected to the EAGLE, the user would still have access to the EAGLE in the event of a telnet terminal connection failure.

Upgrades of the EAGLE from a telnet terminal are not supported. When the EAGLE is upgraded, the **MASPs** are upgraded first, followed by the various cards in the EAGLE. The cards are upgraded by taking the cards out of service, then placing the cards back into service. When the **IPSMs** are taken out of service, the telnet sessions running on the **IPSMs** are disabled. This can result in losing the telnet terminal connection to the EAGLE. The Expanded Terminal Output Groups feature can create a situation where UIMs required for the upgrade would not be displayed on the same telnet terminal that initiated the upgrade. The upgrade would be difficult to complete if the UIMs generated during the upgrade are not displayed on the same telnet terminal that initiated the upgrade.

The EAGLE upgrade procedure recommends that some method to capture command input and output during the upgrade process is used. The telnet terminals do not support capturing the input and output, nor can the EAGLE's `act-echo` command be

used on a telnet terminal. Because of this limitation, the upgrade procedure should not be executed from a telnet terminal.

For any EAGLE release, whether the Eagle OA&M IP Security feature is enabled or not, if applicable, Kermit file transfers, required for the **Security Log** feature, are not supported from telnet terminals. The Kermit file transfers can be performed only from a serial terminal.

1. Display the values of all terminals using the `rtrv-trm` command.

This is an example of the possible output.

```
rlghncxa03w 06-10-01 16:02:08 GMT EAGLE5 39.0.0
TRM  TYPE      COMM      FC      TMOUT  MXINV  DURAL
1    VT320     9600-7-E-1 SW      30     5     99:59:59
2    KSR       9600-7-E-1 HW      30     5     INDEF
3    PRINTER  4800-7-E-1 HW      30     0     00:00:00
4    VT320     2400-7-E-1 BOTH   30     5     00:30:00
5    VT320     9600-7-O-1 NONE   30     5     00:00:30
6    VT320     9600-7-E-2 SW      30     9     INDEF
7    PRINTER  9600-7-E-2 HW      30     5     00:30:00
8    KSR       19200-7-E-2 BOTH  30     5     00:30:00
9    VT320     9600-7-E-1 SW      30     7     00:30:00
10   VT320     9600-7-E-1 HW      30     5     00:30:00
11   VT320     4800-7-E-1 HW      30     5     00:30:00
12   PRINTER  9600-7-E-1 HW      30     4     00:30:00
13   VT320     9600-7-O-1 NONE   30     5     00:30:00
14   VT320     9600-7-E-2 SW      30     8     00:30:00
15   VT320     9600-7-E-2 HW      30     5     00:30:00
16   VT320     9600-7-E-2 BOTH  30     3     00:30:00

TRM  TYPE      LOC      TMOUT  MXINV  DURAL      SECURE
17   TELNET    1201     60     5     00:30:00  yes
18   TELNET    1201     60     5     00:30:00  yes
19   TELNET    1201     60     5     00:30:00  yes
20   TELNET    1201     60     5     00:30:00  yes
21   TELNET    1201     60     5     00:30:00  yes
22   TELNET    1201     60     5     00:30:00  yes
23   TELNET    1201     60     5     00:30:00  yes
24   TELNET    1201     60     5     00:30:00  yes

TRM  LOGINTMR  LOGOUTTMR  PNGTIMEINT  PNGFAILCNT
      (sec)    (sec)      (msec)
17   none     none       none        1
18   none     none       none        1
19   none     none       none        1
20   none     none       none        1
21   none     none       none        1
22   none     none       none        1
23   none     none       none        1
24   none     none       none        1

TRM  TRAF  LINK  SA  SYS  PU  DB  UIMRD
1    NO   YES   NO  YES  NO  YES  YES
2    NO   NO    NO  NO   NO  NO   NO
3    YES  YES   YES  NO   YES  YES  YES
4    YES  NO    NO  NO   NO  NO   NO
5    NO   YES   NO  NO   NO  NO   YES
6    NO   NO    YES  NO   NO  NO   NO
7    YES  YES   YES  YES  YES  YES  YES
8    NO   NO    NO  NO   YES  NO   YES
```

9	NO	YES	NO	NO	NO	YES	NO
10	NO	NO	NO	NO	NO	NO	YES
11	YES	YES	YES	YES	YES	YES	YES
12	YES	YES	YES	YES	YES	YES	YES
13	NO	YES	NO	NO	NO	NO	YES
14	NO	NO	YES	NO	NO	NO	NO
15	YES	YES	YES	NO	YES	YES	YES
16	NO	NO	NO	NO	YES	NO	YES
17	NO	NO	NO	NO	NO	NO	NO
18	NO	NO	NO	NO	NO	NO	NO
19	NO	NO	NO	NO	NO	NO	NO
20	NO	NO	NO	NO	NO	NO	NO
21	NO	NO	NO	NO	NO	NO	NO
22	NO	NO	NO	NO	NO	NO	NO
23	NO	NO	NO	NO	NO	NO	NO
24	NO	NO	NO	NO	NO	NO	NO

TRM	SERV	SS	CARD	CLK	DBG	GTT	GWS	MEAS	MON	MPS	SEAS	SLAN
1	YES	YES	YES	YES	YES	YES	YES	YES	YES	YES	NO	NO
2	YES	YES	YES	YES	YES	YES	YES	YES	YES	YES	NO	NO
3	YES	YES	YES	YES	YES	YES	YES	YES	YES	YES	NO	NO
4	YES	YES	YES	YES	YES	NO	YES	YES	YES	YES	NO	NO
5	YES	YES	YES	YES	YES	YES	YES	YES	YES	YES	NO	NO
6	YES	YES	YES	YES	YES	YES	YES	YES	YES	YES	NO	NO
7	NO	YES	YES	YES	YES	YES	YES	YES	YES	YES	NO	NO
8	YES	YES	YES	YES	YES	YES	YES	YES	YES	YES	YES	YES
9	YES	YES	YES	YES	YES	YES	YES	YES	YES	YES	YES	YES
10	NO	NO	NO	NO	NO	NO	NO	NO	NO	NO	NO	NO
11	NO	NO	NO	NO	NO	NO	NO	NO	NO	NO	NO	NO
12	NO	NO	NO	NO	NO	NO	NO	NO	NO	NO	NO	NO
13	NO	NO	NO	NO	NO	NO	NO	NO	NO	NO	NO	NO
14	NO	NO	NO	NO	NO	NO	NO	NO	NO	NO	NO	NO
15	NO	NO	NO	NO	NO	NO	NO	NO	NO	NO	NO	NO
16	NO	NO	NO	NO	NO	NO	NO	NO	NO	NO	NO	NO
17	NO	NO	NO	NO	NO	NO	NO	NO	NO	NO	NO	NO
18	NO	NO	NO	NO	NO	NO	NO	NO	NO	NO	NO	NO
19	NO	NO	NO	NO	NO	NO	NO	NO	NO	NO	NO	NO
20	NO	NO	NO	NO	NO	NO	NO	NO	NO	NO	NO	NO
21	NO	NO	NO	NO	NO	NO	NO	NO	NO	NO	NO	NO
22	NO	NO	NO	NO	NO	NO	NO	NO	NO	NO	NO	NO
23	NO	NO	NO	NO	NO	NO	NO	NO	NO	NO	NO	NO
24	NO	NO	NO	NO	NO	NO	NO	NO	NO	NO	NO	NO

If a telnet terminal is being changed, continue the procedure with [2](#).

If telnet terminals are not being added in this procedure, continue the procedure by performing one of these steps.

- If the terminal type or the communication attributes of the terminal are being changed, or the `pngtimeint`, `pngfailcnt` parameters of an EMSALM terminal are being changed, continue the procedure with [3](#).
 - If only the output message group or security parameters for the terminal are being changed, continue the procedure with [7](#).
2. If the `rtrv-trm` output in [1](#) shows terminals 1 to 16 and you wish to add telnet terminals (`type=telnet`, terminals 17 through 40), go to the [Adding an E5-IPSM](#) procedure.

Adding an **IPSM** adds eight telnet terminals to the **EAGLE**.

When an **IPSM** is added to the database, the eight telnet terminals associated with the **IPSM** are added to the database with the telnet terminal type and the default values for these parameters.

- The security (tmout, mxinv, dural) parameters.
- The output message group (traf, db, link, sa, sys, pu, uimrd, appserv, appss, card, clk, dbg, gtt, gws, meas, mon, mps, seas, slan) parameters
- The logintmr, logouttmr, pngtimeint, pngfailcnt parameters.

The only actions that can be performed on terminals 17 through 40 is changing the terminal type to either none, telnet, or emsalm, and changing the security (tmout, mxinv, dural), changing the output message group (traf, db, link, sa, sys, pu, uimrd, appserv, appss, card, clk, dbg, gtt, gws, meas, mon, mps, seas, slan) parameters, or changing the logintmr, logouttmr, pngtimeint, pngfailcnt parameters.

If no changes are being made to the telnet terminals, either to the existing telnet terminals, or to the telnet terminals that were added in this step with “[Adding an E5-IPSM](#)” procedure, this procedure is finished.

If changes are being made to the telnet terminals, continue the procedure by performing one of these steps.

- If only the output message group or security parameters are being changed, continue the procedure with [7](#).
 - If the terminal type or the logintmr, logouttmr, pngtimeint, pngfailcnt parameters are being changed, continue the procedure with [3](#).
- 3.** Display the status of the terminals by entering the `rept-stat-trm` command.

This is an example of the possible output (another **IPSM** added from [2](#)).

```
rlghncxa03w 06-10-01 15:08:45 GMT EAGLE5 36.0.0
TRM  PST          SST          AST
1    IS-NR        Active      -----
2    IS-NR        Active      -----
3    IS-NR        Active      -----
4    IS-NR        Active      -----
5    IS-NR        Active      -----
6    IS-NR        Active      -----
7    IS-NR        Active      -----
8    IS-NR        Active      -----
9    IS-NR        Active      -----
10   IS-NR        Active      -----
11   IS-NR        Active      -----
12   IS-NR        Active      -----
13   IS-NR        Active      -----
14   IS-NR        Active      -----
15   IS-NR        Active      -----
16   IS-NR        Active      -----
17   IS-NR        Active      -----
18   IS-NR        Active      -----
19   IS-NR        Active      -----
20   IS-NR        Active      -----
21   IS-NR        Active      -----
22   IS-NR        Active      -----
23   IS-NR        Active      -----
```

```

24  IS-NR      Active      -----
25  IS-NR      Active      -----
26  IS-NR      Active      -----
27  IS-NR      Active      -----
28  IS-NR      Active      -----
29  IS-NR      Active      -----
30  IS-NR      Active      -----
31  IS-NR      Active      -----
32  IS-NR      Active      -----

```

Command Completed.

If the status of the terminal that is being changed is OOS-MT-DSBLD, and the terminal type is being changed to `printer` or `none`, continue the procedure with [6](#).

If the status of the terminal that is being changed is OOS-MT-DSBLD, and the terminal type is not being changed to `printer` or `none`, continue the procedure with [7](#).

If the status of the terminal that is being changed is not OOS-MT-DSBLD, continue the procedure with [4](#).

4. Inhibit the terminal you wish to change using the `rmv-trm` command and specify the port you wish to inhibit.

```

rmv-trm:trm=4
rmv-trm:trm=8
rmv-trm:trm=19
rmv-trm:trm=23
rmv-trm:trm=21

```

When these commands have successfully completed, this message should appear.

```

rlghncxa03w 06-10-01 15:08:45 GMT EAGLE5 36.0.0
Inhibit message sent to terminal

rlghncxa03w 06-10-01 15:08:45 GMT EAGLE5 36.0.0
Command Completed.

```

5. Verify that the terminal that was inhibited in [4](#) is in the OOS-MT-DSBLD state by entering the `rept-stat-trm` command.

For this command, enter these commands.

```
rept-stat-trm:trm=4
```

This is an example of the possible output.

```

rlghncxa03w 06-10-01 15:08:45 GMT EAGLE5 36.0.0
TRM   PST           SST           AST
4     OOS-MT-DSBLD  MANUAL         -----
Command Completed.

```

```
rept-stat-trm:trm=8
```

This is an example of the possible output.

```
rlghncxa03w 06-10-01 15:08:45 GMT EAGLE5 36.0.0
TRM  PST          SST          AST
8    OOS-MT-DSBLD  MANUAL          -----
Command Completed.
```

```
rept-stat-trm:trm=19
```

This is an example of the possible output.

```
rlghncxa03w 06-10-01 15:08:45 GMT EAGLE5 36.0.0
TRM  PST          SST          AST
19   OOS-MT-DSBLD  MANUAL          -----
Command Completed.
```

```
rept-stat-trm:trm=23
```

This is an example of the possible output.

```
rlghncxa03w 06-10-01 15:08:45 GMT EAGLE5 36.0.0
TRM  PST          SST          AST
23   OOS-MT-DSBLD  MANUAL          -----
Command Completed.
```

```
rept-stat-trm:trm=21
```

This is an example of the possible output.

```
rlghncxa03w 06-10-01 15:08:45 GMT EAGLE5 39.0.0
TRM  PST          SST          AST
21   OOS-MT-DSBLD  MANUAL          -----
Command Completed.
```

If the terminal type is not being changed to either printer or none, continue the procedure with [7](#).

If the terminal type is being changed to either printer or none, continue the procedure with [6](#).

6. Display the command class values of all terminals using the `rtrv-secu-trm` command.

This is an example of the possible output.

```
rlghncxa03w 06-10-01 12:31:04 GMT EAGLE5 36.0.0

TRM  LINK SA  SYS  PU  DB  DBG
1    NO  NO  YES  NO  YES  NO
2    NO  NO  NO  NO  YES  NO
3    YES ***  YES  YES  YES  YES
4    NO  YES  NO  NO  NO  NO
5    YES  NO  NO  NO  YES  YES
6    NO  YES  NO  NO  NO  NO
7    NO  ***  YES  NO  YES  NO
8    NO  NO  NO  NO  NO  NO
9    YES  YES  YES  YES  YES  YES
10   NO  NO  NO  NO  NO  NO
11   YES  NO  YES  NO  YES  YES
12   NO  ***  NO  NO  NO  NO
```

13	NO	NO	NO	NO	YES	YES
14	NO	YES	NO	NO	YES	YES
15	NO	NO	NO	NO	YES	YES
16	NO	NO	NO	NO	YES	YES
17	NO	NO	YES	NO	YES	NO
18	NO	NO	NO	NO	YES	NO
19	YES	NO	YES	YES	YES	YES
20	NO	YES	NO	NO	NO	NO
21	YES	NO	NO	NO	YES	YES
22	NO	YES	NO	NO	NO	NO
23	NO	NO	YES	NO	YES	NO
24	NO	NO	NO	NO	NO	NO
25	YES	YES	YES	YES	YES	YES
26	NO	NO	NO	NO	NO	NO
27	YES	NO	YES	NO	YES	YES
28	NO	NO	NO	NO	NO	NO
29	NO	NO	NO	NO	YES	YES
30	NO	YES	NO	NO	YES	YES
31	NO	NO	NO	NO	YES	YES
32	NO	NO	NO	NO	YES	YES

Note: If the terminal type is being changed to either `printer` or `none`, make sure the EAGLE has at least two terminals assigned to the Security Administration command class (shown in the SA column in the `rtrv-secu-trm` output). If the terminal being changed in this procedure is being removed from the Security Administration command class, and if this change would leave the EAGLE with only one terminal assigned to the Security Administration command class, go to the [Changing Terminal Command Class Assignments](#) procedure and change the command class assignment of another terminal to include the Security Administration command class.

7. Display the UIMRD STP option value by entering the `rtrv-stpopts` command. This is an example of the possible output.

```
rlghncxa03w 10-07-17 16:02:05 GMT EAGLE5 42.0.0
STP OPTIONS
-----
UIMRD                yes
```

Note: The `rtrv-stpopts` command output contains other fields that are not used by this procedure. If you wish to see all the fields displayed by the `rtrv-stpopts` command, see the `rtrv-stpopts` command description in *Commands User's Guide*.

The EAGLE sends UIMs to the terminals based on the value of the UIMRD field in the `rtrv-stpopts` output and the UIMRD value for the terminal. The interaction of these two values is shown in [Table 4-2](#).

If you do not wish to change how the EAGLE handles sends UIMs to the terminal, continue the procedure with [11](#) and do not change the UIMRD value for the terminal.

If you do not wish to change how the EAGLE handles sends UIMs to the terminal, continue the procedure with [10](#). When [11](#) is performed, do not change the UIMRD value for the terminal.

If you wish to change how the EAGLE handles sends UIMs to the terminal, continue the procedure with 8.

8. Change the UIMRD STP option value.

To turn the UIMRD STP option on, enter this command.

```
chg-stpopts:on=uimrd
```

To turn the UIMRD STP option off, enter this command.

```
chg-stpopts:off=uimrd
```

When the command has successfully completed, this message should appear.

```
rlghncxa03w 10-07-01 15:08:45 GMT EAGLE5 42.0.0
CHG-STPOPTS: MASP A - COMPLTD
```

9. Verify the changes using the `rtrv-stpopts` command.

If the `on=uimrd` parameter was specified in 8, this is an example of the possible output.

```
rlghncxa03w 10-07-17 16:02:05 GMT EAGLE5 42.0.0
STP OPTIONS
-----
UIMRD                yes
```

If the `off=uimrd` parameter was specified in 8, this is an example of the possible output.

```
rlghncxa03w 10-07-17 16:02:05 GMT EAGLE5 42.0.0
STP OPTIONS
-----
UIMRD                no
```

Note: The `rtrv-stpopts` command output contains other fields that are not used by this procedure. If you wish to see all the fields displayed by the `rtrv-stpopts` command, see the `rtrv-stpopts` command description in *Commands User's Guide*.

If you do not wish to change the UIMRD value for the terminal, continue the procedure with 11 without specifying the `uimrd` parameter.

If you wish to change the UIMRD value for the terminal, continue the procedure with 11. Specify the `uimrd` parameter with a value, `yes` or `no`, that will change the current value for the terminal.

Continue the procedure with 10.

If you do not wish to change the UIMRD value for the terminal, when 11 is performed do not specify the `uimrd` parameter.

If you wish to change the UIMRD value for the terminal, when 11 is performed specify the `uimrd` parameter with a value, `yes` or `no`.

10. Verify the TDMs that are in the EAGLE by entering these commands.

```
rept-stat-card:loc=1114
```

This is an example of the possible output.

```
rlghncxa03w 10-12-17 16:02:05 GMT EAGLE5 43.0.0
CARD  VERSION      TYPE      GPL      PST      SST      AST
1114  -----      E5TDM                    IS-NR     Active   -----
```

Command Completed.

```
rept-stat-card:loc=1116
```

This is an example of the possible output.

```
rlghncxa03w 10-12-17 16:02:05 GMT EAGLE5 43.0.0
CARD  VERSION      TYPE      GPL      PST      SST      AST
1116  -----      E5TDM                    IS-NR     Active   -----
```

Command Completed.

E5-TDMs are shown by the entry E5TDM in the TYPE column. TDMs are shown by the entry TDM in the TYPE column. Hardware flow control (`fc=hw`) and both hardware and software flow control (`fc=both`) are not supported for the terminal if the EAGLE contains E5-TDMs. Part of the terminal output may be lost if hardware flow control is specified for the terminal when the EAGLE contains E5-TDMs.

11. Change the terminal characteristics using the `chg-trm` command.

For this example enter these commands.

```
chg-trm:trm=4:baud=9600:traf=no:link=yes:sa=yes:db=yes
chg-trm:trm=19:type=none
chg-
trm:trm=21:sys=yes:link=yes:sa=yes:db=yes:tmout=30:logintmr=3
0:logouttmr=60 :pngtimeint=1000:pngfailcnt=3
chg-trm:trm=8:type=emsalm
chg-trm:trm=23:type=emsalm
```

Note: If 4 was not performed in this procedure (placing the terminal out of service), do not specify these parameters with the `chg-trm` command:

- `baud`, `sb`, `prty`, `fc` (the communications attributes of the terminal).
These parameters cannot be specified for terminals 17 to 40.
- the terminal type (`type`).
- the `logintmr`, `logouttmr`, `pngtimeint`, `pngfailcnt` parameters

Caution: If the terminal type is being changed to `emsalm`, it is recommended that all the output message group settings for an **EMSALM** terminal are set to `yes`. Changing any of the output message group settings to `no` could prevent alarm messages controlled by the output message group from being displayed on the **EMSALM** terminal.

Caution: If a terminal dedicated to measurements collection is configured (see the [Configuring the Measurements Terminal for an EAGLE Containing 700 Signaling Links](#) procedure), it is recommended that this terminal is not changed to an **EMSALM** terminal.

When these commands have successfully completed, this message should appear.

```
rlghncxa03w 06-10-01 15:08:45 GMT EAGLE5 36.0.0
CHG-TRM: MASP A - COMPLTD
```

- 12.** Verify the changes made in [11](#) by using the `rtrv-trm` command with the terminal number specified in [11](#).

For this example, enter these commands.

```
rtrv-trm:trm=4
```

This is an example of the possible output.

```
rlghncxa03w 06-10-01 16:02:08 GMT EAGLE5 36.0.0
TRM  TYPE      COMM          FC      TMOUT MXINV DURAL
4    VT320     9600-7-E-1 BOTH    30     5     00:30:00

TRM  TRAF LINK SA  SYS PU  DB  UIMRD
4    NO  YES  YES NO  NO  YES NO

      APP  APP
TRM  SERV SS  CARD CLK DBG GTT GWS MEAS MON MPS SEAS SLAN
4    YES YES YES YES YES NO  YES YES  YES YES NO  NO
```

```
rtrv-trm:trm=19
```

This is an example of the possible output.

```
rlghncxa03w 06-10-01 16:02:08 GMT EAGLE5 39.0.0
TRM  TYPE      LOC          TMOUT MXINV DURAL      SECURE
19   NONE      1201          60     5     00:30:00  yes

TRM  TRAF LINK SA  SYS PU  DB  UIMRD
19   NO  NO  NO  NO  NO  NO  NO

      APP  APP
TRM  SERV SS  CARD CLK DBG GTT GWS MEAS MON MPS SEAS SLAN
19   NO  NO  NO  NO  NO  NO  NO  NO  NO  NO  NO  NO
```

```
rtrv-trm:trm=21
```

This is an example of the possible output.

```
rlghncxa03w 06-10-01 16:02:08 GMT EAGLE5 39.0.0
```

```
TRM TYPE LOC TMOUT MXINV DURAL SECURE
21 TELNET 1201 30 5 00:30:00 yes
```

```
TRM LOGINTMR LOGOUTTMR PNGTIMEINT PNGFAILCNT
(sec) (sec) (msec)
21 30 60 1000 3
```

```
TRM TRAF LINK SA SYS PU DB UIMRD
21 NO YES YES YES NO YES NO
```

```
APP APP
```

```
TRM SERV SS CARD CLK DBG GTT GWS MEAS MON MPS SEAS SLAN
21 NO NO NO NO NO NO NO NO NO NO NO
```

```
rtrv-trm:trm=8
```

```
rlghncxa03w 06-10-01 16:02:08 GMT EAGLE5 36.0.0
```

```
TRM TYPE COMM FC TMOUT MXINV DURAL
8 EMSALM 19200-7-E-2 BOTH 30 5 00:30:00
```

```
TRM TRAF LINK SA SYS PU DB UIMRD
8 YES YES YES YES YES YES YES
```

```
APP APP
```

```
TRM SERV SS CARD CLK DBG GTT GWS MEAS MON MPS SEAS SLAN
8 YES YES YES YES YES YES YES YES YES YES YES
```

```
rtrv-trm:trm=23
```

```
rlghncxa03w 06-10-01 16:02:08 GMT EAGLE5 39.0.0
```

```
TRM TYPE LOC TMOUT MXINV DURAL SECURE
23 EMSALM 1201 60 5 00:30:00 yes
```

```
TRM PNGTIMEINT PNGFAILCNT
(msec)
23 none 1
```

```
TRM TRAF LINK SA SYS PU DB UIMRD
23 YES YES YES YES YES YES YES YES YES
```

```
APP APP
```

```
TRM SERV SS CARD CLK DBG GTT GWS MEAS MON MPS SEAS SLAN
23 YES YES YES YES YES YES YES YES YES YES YES
```

Note: If there terminal was not inhibited in [4](#), continue the procedure with [13](#).

- 13.** When the changes are complete, and if the terminal was inhibited in [4](#), activate the terminal using the `rst-trm` command.

For this example, enter these commands.

```
rst-trm:trm=4
```

```
rst-trm:trm=8
```

```
rst-trm:trm=19
```

```
rst-trm:trm=23
```

```
rst-trm:trm=21
```

When these commands have successfully completed, this message should appear.

```
rlghncxa03w 06-10-01 15:08:45 GMT EAGLE5 36.0.0  
Allow message sent to terminal
```

14. Back up the new changes using the `chg-db:action=backup:dest=fixed` command.

These messages should appear, the active **Maintenance and Administration Subsystem Processor (MASP)** appears first.

```
BACKUP (FIXED) : MASP A - Backup starts on active MASP.  
BACKUP (FIXED) : MASP A - Backup on active MASP to fixed disk complete.  
BACKUP (FIXED) : MASP A - Backup starts on standby MASP.  
BACKUP (FIXED) : MASP A - Backup on standby MASP to fixed disk complete.
```

Figure 4-10 Changing Terminal Characteristics

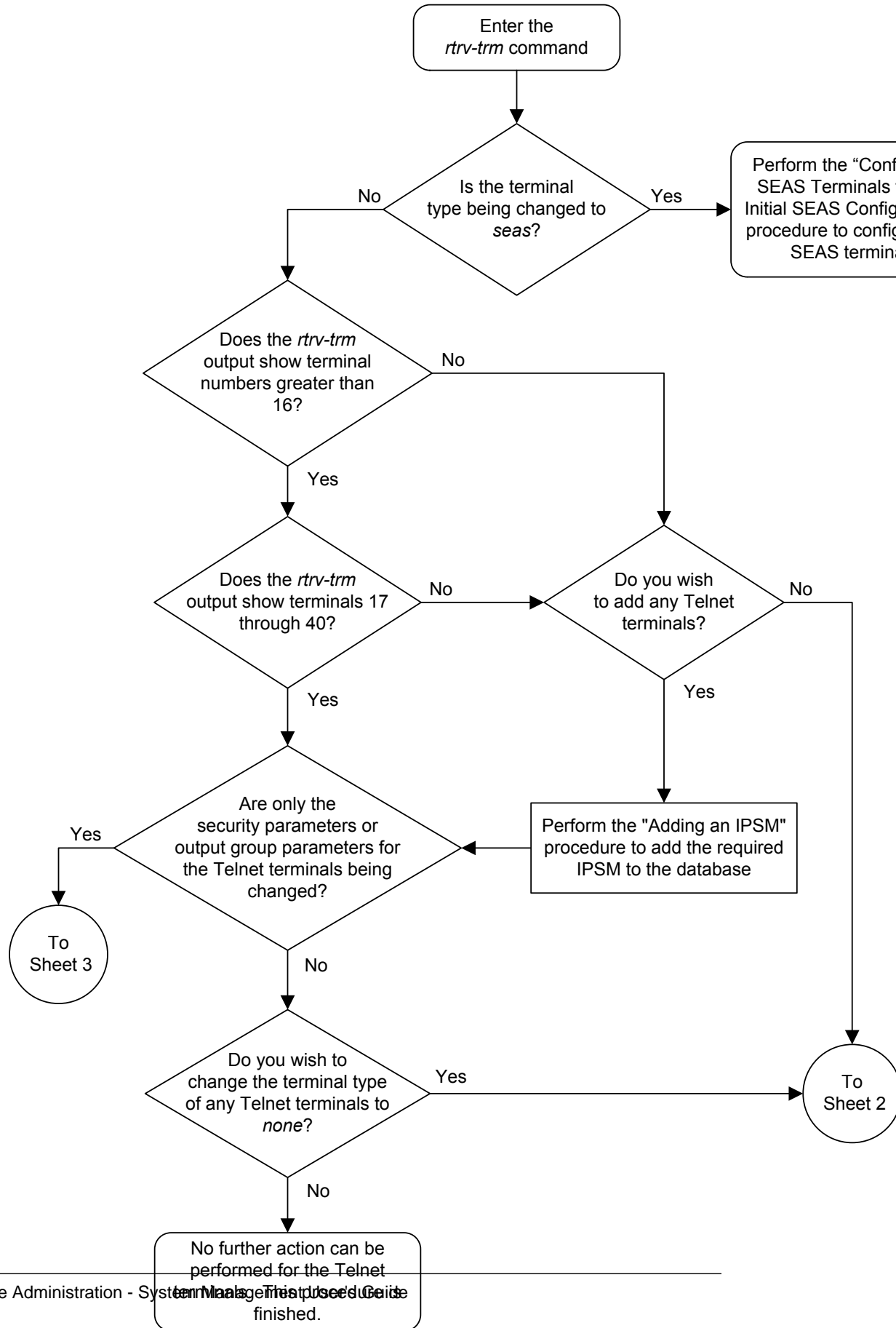

Sheet 1 of 6

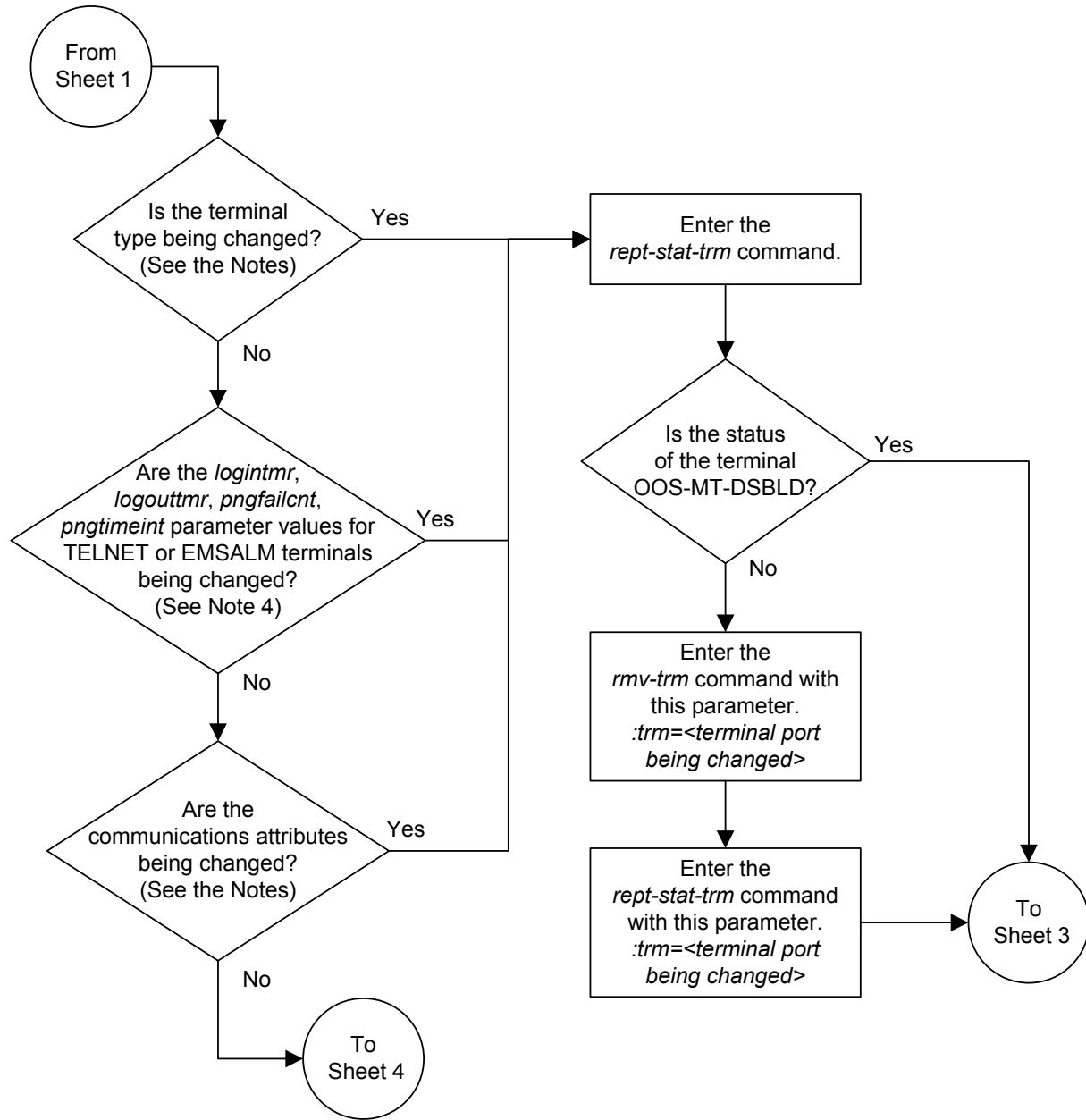

Notes:

1. If the terminal numbers are from 17 to 40, the values for the *type* parameter can be only *telnet*, *none*, or *emsalm*. The communication attributes for these terminals cannot be specified.
2. If the terminal numbers are from 1 to 16, the values for the *type* parameter can be *vt320*, *ksr*, *printer*, *sccs*, *mgmt*, *none*, or *emsalm*. The communication attributes for these terminals can be specified and changed.
3. The communications attributes are defined by these parameters: *baud* (baud rate), *prty* (parity), *sb* (stop bits), and *fc* (flow control).
4. The *logintmr* and *logouttmr* parameters can be specified only for TELNET terminals. The *pngfailcnt* and *pngtimeint* parameters can be specified only for TELNET and EMSALM terminals.

Sheet 2 of 6

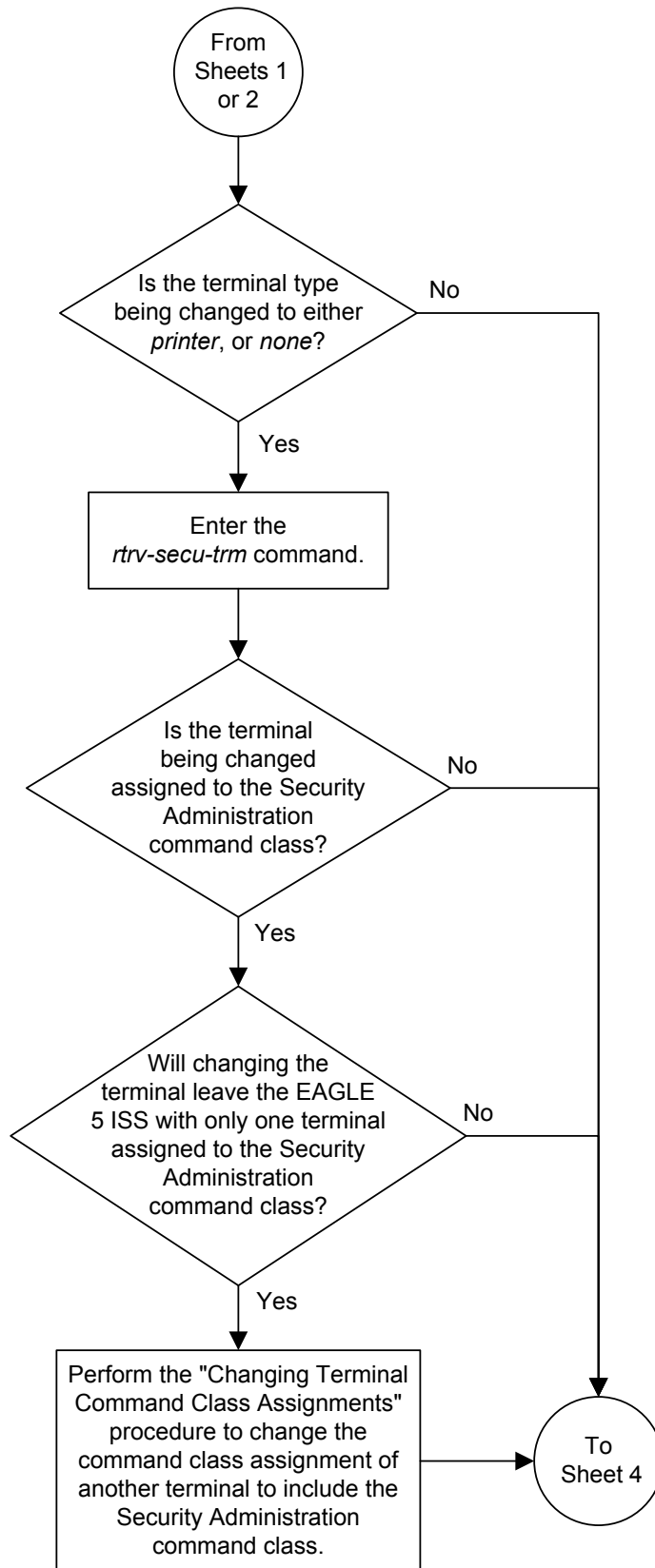

Sheet 3 of 6

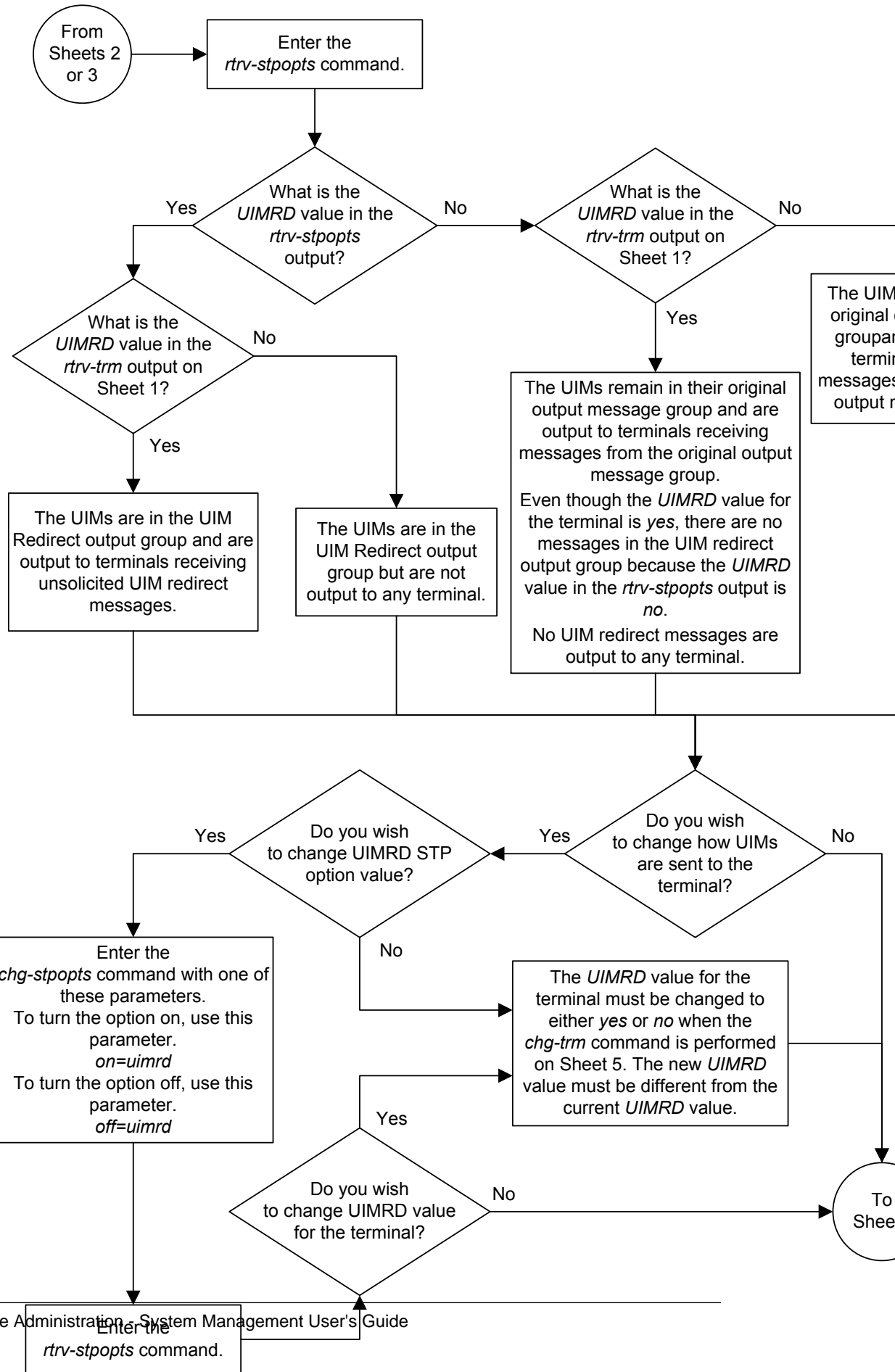

Sheet 4 of 6

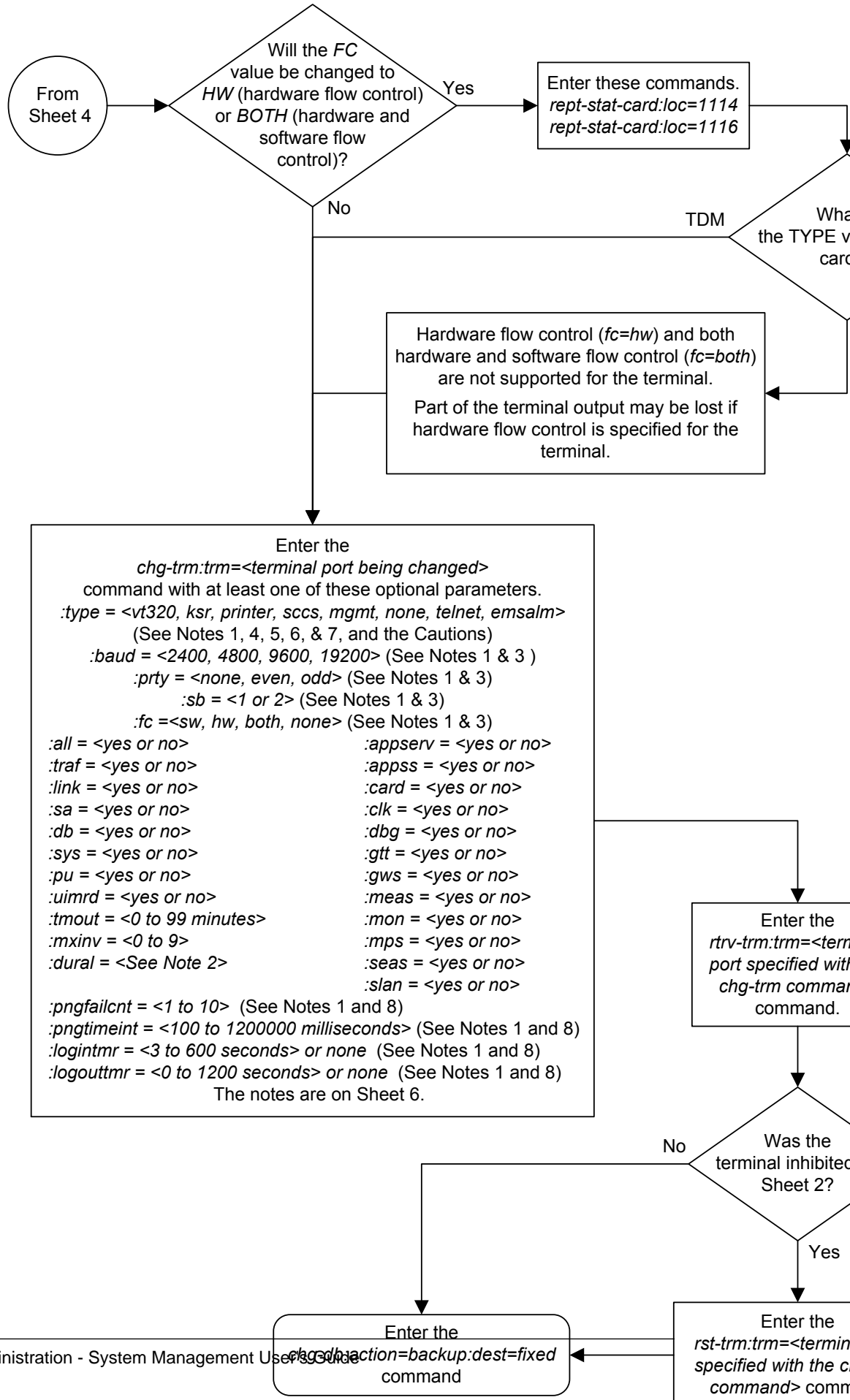

Sheet 5 of 6

Notes:

1. If the terminal was not placed out of service on Sheet 2, this parameter cannot be specified with the `change` command.
 2. The value of the *dural* parameter can be expressed in seconds (0 - 59), minutes and seconds (0 - 5959), minutes, and seconds (0 - 995959). The value 999999 for the *dural* parameter disables the terminal, when the failure threshold has been exceeded, for an indefinite period of time.
 3. This parameter cannot be specified for terminals 17 through 40.
 4. The *type=telnet* parameter cannot be specified for terminals 1 through 16. Valid terminal types for terminals 1 through 16 are *vt320*, *ksr*, *printer*, *sccs*, *mgmt*, *none*, or *emsalm*.
 5. For terminals 17 through 40, the value of the *type* parameter can be only *telnet*, *none*, or *emsalm*.
 6. The output group settings are set to *yes* when the terminal type is changed to *emsalm*. The output group settings for an EMSALM terminal can be changed.
- Caution: It is recommended that all the output message group settings for an EMSALM terminal are set to *yes*. Changing any of the output message group settings to *no* could prevent alarm messages from being displayed on the output message group from being displayed on the EMSALM terminal.**
- Caution: If a terminal dedicated to measurements collection is configured (see the “Configuring a Measurements Terminal for a 700 Signaling Link System” procedure in this chapter), it is recommended that this terminal is not changed to an EMSALM terminal.**
7. The output group settings are not changed when the terminal type is changed from *emsalm* to another terminal type.
 8. The *logintmr* and *logouttmr* parameters can be specified only for TELNET terminals. The *pngfailcnt* and *pngfailint* parameters can be specified only for TELNET and EMSALM terminals.

Changing Terminal Command Class Assignments

This procedure is used to change the assignment of command classes to a terminal using the `chg-secu-trm` command. This procedure can only be performed if you have been assigned the command class "Security Administration." This can be useful to restrict the types of commands that can be entered on an **EAGLE** terminal. This procedure can only be performed if you and the terminal have been assigned the command class "Security Administration." The **EAGLE** commands are grouped into these command classes.

- Basic
- Database Administration
- Debug
- Link Maintenance
- Program Update
- Security Administration
- System Maintenance
- 32 Configurable Command Classes

With the `chg-secu-trm` command, only six of these command classes can be assigned to a terminal. The Basic command class is automatically assigned to every terminal and to every user and is not configurable. Refer to the *Commands Manual* for a list of command classes and the commands assigned to them.

The `chg-secu-trm` command uses these parameters.

`:trm` – The terminal number 1-16.

`:all` – The commands in all non-configurable command classes (`dbg`, `link`, `sys`, `sa`, `pu`, `db`) can be entered on the specified terminal.

`:db` – Database Administration commands can be entered on the specified terminal.

`:dbg` – Debug commands can be entered on the specified terminal.

`:link` – **Link** Maintenance commands can be entered on the specified terminal.

`:pu` – Program Update commands can be entered on the specified terminal.

`:sa` – Security Administration commands can be entered on the specified terminal.

`:sys` – System Maintenance commands can be entered on the specified terminal.

`:cc1 - :cc8` – Eight configurable command classes. These parameters specify whether or not the commands in the specified configurable command class can be entered on the specified terminal. The value of these parameters consist of the configurable command class name (1 alphabetic character followed by 2 alphanumeric characters), and either yes or no. The command class name and the yes or no values are separated by a dash. For example, to allow commands in the configurable command class `db1` from terminal 5, the `cc1=db1-yes` parameter would be specified in the `chg-secu-trm` command for terminal 5.

To specify any configurable command classes, the **Command Class** Management feature must be enabled and turned on. Enter the `rtrv-ctrl-feat` command to

verify whether or not the **Command Class** Management feature is enabled. If the **Command Class** Management feature is not enabled or turned on, perform [Activating Controlled Features](#) to enable and turn on the **Command Class** Management feature. Up to 32 configurable command classes can be assigned to terminals. When the **Command Class** Management feature is enabled and turned on, the configurable command class names are given the names u01 - u32. These command class names, the descriptions of these command classes, and the commands assigned to these command classes can be changed using [Configuring Command Classes](#).

The `chg-secu-trm` command allows up to eight configurable command classes to be assigned to a terminal each time the `chg-secu-trm` command is performed.

If the `all=yes` parameter and the `db`, `dbg`, `link`, `pu`, `sa`, `sys` parameter values are specified as `no`, for example, `chg-secu-trm:trm=1:all=yes:pu=no`; all commands can be entered on the specified terminal except those commands in the command class specified with the `chg-secu-trm` command. In this example, all commands can be entered on terminal 1 except for program update commands.

The terminal command class assignments cannot be changed for the specified terminal if a user is currently logged onto that terminal. This can be verified with the `rept-stat-user` command.

At least two terminals in the **EAGLE** must always be assigned to the security administration command class to prevent the **EAGLE** from becoming unadministerable.

It is possible that a terminal with the terminal type of `printer` or `none` can be assigned to the Security Administration command class. Terminals with these terminal types are not counted as having Security Administration authority since commands cannot be administered from these terminal types and is shown in the `rtrv-secu-trm` output report as "***" instead of `yes`.

When the **EAGLE** is delivered to the user, the terminal command class assignments will be set to the system default values for these parameters.

```
all = no
db = no
dbg = no
link = no
pu = no
sa = yes
sys = no
```

The examples in this procedure are used to change the command class assignments to the terminal assigned to port 4 to these values: **Link** Maintenance = `yes`, **Security Administration** = `no`, **Program Update** = `yes`, **Database Administration** = `yes`.

1. Display the command class values of all terminals using the `rtrv-secu-trm` command.

This is an example of the possible output.

```
rlghncxa03w 06-10-01 12:31:04 GMT EAGLE5 36.0.0
```

TRM	LINK	SA	SYS	PU	DB	DBG
1	NO	NO	YES	NO	YES	NO
2	NO	NO	NO	NO	YES	NO

3	YES	***	YES	YES	YES	YES
4	NO	YES	NO	NO	NO	NO
5	YES	NO	YES	NO	YES	YES
6	NO	NO	NO	NO	NO	NO
7	NO	NO	YES	NO	YES	NO
8	NO	NO	NO	NO	NO	NO
9	YES	YES	YES	YES	YES	YES
10	NO	NO	NO	NO	NO	NO
11	YES	NO	YES	NO	YES	YES
12	NO	NO	NO	NO	NO	NO
13	NO	NO	NO	NO	YES	YES
14	NO	NO	NO	NO	YES	YES
15	NO	NO	NO	NO	YES	YES
16	NO	NO	NO	NO	YES	YES

Continue the procedure by performing one of these steps.

- If the `cc1` through `cc8` parameters are not being specified in this procedure, continue the procedure with [4](#).
 - If the `cc1` through `cc8` parameters will be specified in this procedure, continue the procedure by performing one of these steps.
 - If configurable command classes are shown in the `rtrv-secu-user` output, continue the procedure with [3](#).
 - If configurable command classes are not shown in the `rtrv-secu-user` output, continue the procedure with [2](#).
2. Verify that the **Command Class** Management feature is enabled and turned on, by entering the `rtrv-ctrl-feat` command with the `partnum=89005801` parameter.

This is an example of the possible output.

```
rlghncxa03w 06-10-01 21:15:37 GMT EAGLE5 36.0.0
The following features have been permanently enabled:
Feature Name          Partnum    Status    Quantity
Command Class Management 893005801 off      ----
```

Note: The `rtrv-ctrl-feat` command output contains other fields that are not used by this procedure. If you wish to see all the fields displayed by the `rtrv-ctrl-feat` command, see the `rtrv-ctrl-feat` command description in *Commands User's Guide*.

If the **Command Class** Management feature is enabled and turned on (status = on), continue the procedure with [3](#). If the **Command Class** Management feature is not enabled or turned on, perform the [Activating Controlled Features](#) to enable and turn on the **Command Class** Management feature.

Caution: If the **Command Class** Management feature is temporarily enabled, the configurable command classes can be assigned and used only for the amount of time shown in the `Trial Period Left` column in the `rtrv-ctrl-feat` output.

3. Display the descriptions of the configurable command classes in the database by entering the `rtrv-cmd` command.

This is an example of the possible output.

```
rlghncxa03w 09-05-01 21:15:37 GMT EAGLE5 41.0.0
CMD                CLASS
alw-slk            link, u11
ent-user           sa
unhb-slk           link
rtrv-attr-seculog sa, u31
inh-slk            link, abc
rtrv-meas-sched   link, abc, def
act-lbp            link
act-dlk            link
act-slk            link
rtrv-seculog      sa, abc, def, ghi
act-lpo            link
blk-slk            link, abc, u23, u31
dact-lbp           link
canc-dlk           link
inh-card           sys
canc-lpo           link, u01, u02, u03, u04, u05, u06, u07, u08, u09, u10,
                  u11, u12, u13
canc-slk           link
ublk-slk           link, u01, u02, u03, u04, u05, u06, u07, u08, u09, u10,
                  u11, u12, u13, u14, u15, u16, u17, u18, u19, u20, u21,
                  u22, u23, u24, u25, u26, u27, u28, u29, u30, u31, u32
inh-trm            sys, krb
rept-meas          link
.
.
.
chg-meas           link
tst-dlk            link, krb
tst-slk            link
```

If the desired configurable command class descriptions are not in the database, perform [Configuring Command Classes](#) to configure the desired command classes.

4. Verify that no users are logged onto the terminal whose command class assignments you wish to change using the `rept-stat-user` command.

If the user is logged onto the terminal, notify the user to log off the terminal. This is an example of the possible output.

```
rlghncxa03w 09-05-01 09:12:15 GMT EAGLE5 41.0.0
REPT-STAT-USER COMPLTD
USER ID            TERM #  IDLE SINCE          COMMAND          STATE
fred               3      09-04-19 05:06:43  rept-stat-user  PROCESSING
frodo               13     09-04-20 08:12:23  chg-db           IDLE
manny              1      09-04-27 04:37:56  ent-dlk          IDLE
travist            7      09-04-30 10:06:22  rtrv-meas       IDLE
```

5. If you wish to change the Security Administration command class assignment of the specified terminal to no (`:sa=no`), make sure the **EAGLE** has at least two terminals assigned to the Security Administration command class.

This is shown in the output of 1, the `rtrv-secu-trm` command output, with the entry YES in the SA field. If this procedure would leave the EAGLE with only one terminal assigned to the Security Administration command class, use the `chg-secu-trm` command and change another terminal's assignment to the Security Administration command class from NO to YES. For this example, enter the `chg-secu-trm:trm=1:sa=yes` command

6. Change the command class assignments of the terminal using the `chg-secu-trm` command.

For this example enter this command.

```
chg-secu-trm:trm=4:link=yes:sa=no:pu=yes:db=yes
```

When this command has successfully completed, this message should appear.

```
rlghncxa03w 06-10-01 12:31:04 GMT EAGLE5 36.0.0
CHG-SECU-TRM: MASP A - COMPLTD
```

7. Verify the changes made in 6 by using the `rtrv-secu-trm` command with the port number specified in 6.

For this example, enter this command.

```
rtrv-secu-trm:trm=4
```

This is an example of the possible output.

```
rlghncxa03w 06-10-01 12:31:04 GMT EAGLE5 36.0.0

TRM   LINK SA  SYS  PU   DB   DBG
4     YES NO  NO   YES YES  NO
```

8. Back up the new changes using the `chg-db:action=backup:dest=fixed` command.

These messages should appear, the active **Maintenance and Administration Subsystem Processor (MASP)** appears first.

```
BACKUP (FIXED) : MASP A - Backup starts on active MASP.
BACKUP (FIXED) : MASP A - Backup on active MASP to fixed disk complete.
BACKUP (FIXED) : MASP A - Backup starts on standby MASP.
BACKUP (FIXED) : MASP A - Backup on standby MASP to fixed disk complete.
```

Figure 4-11 Changing Terminal Command Class Assignments

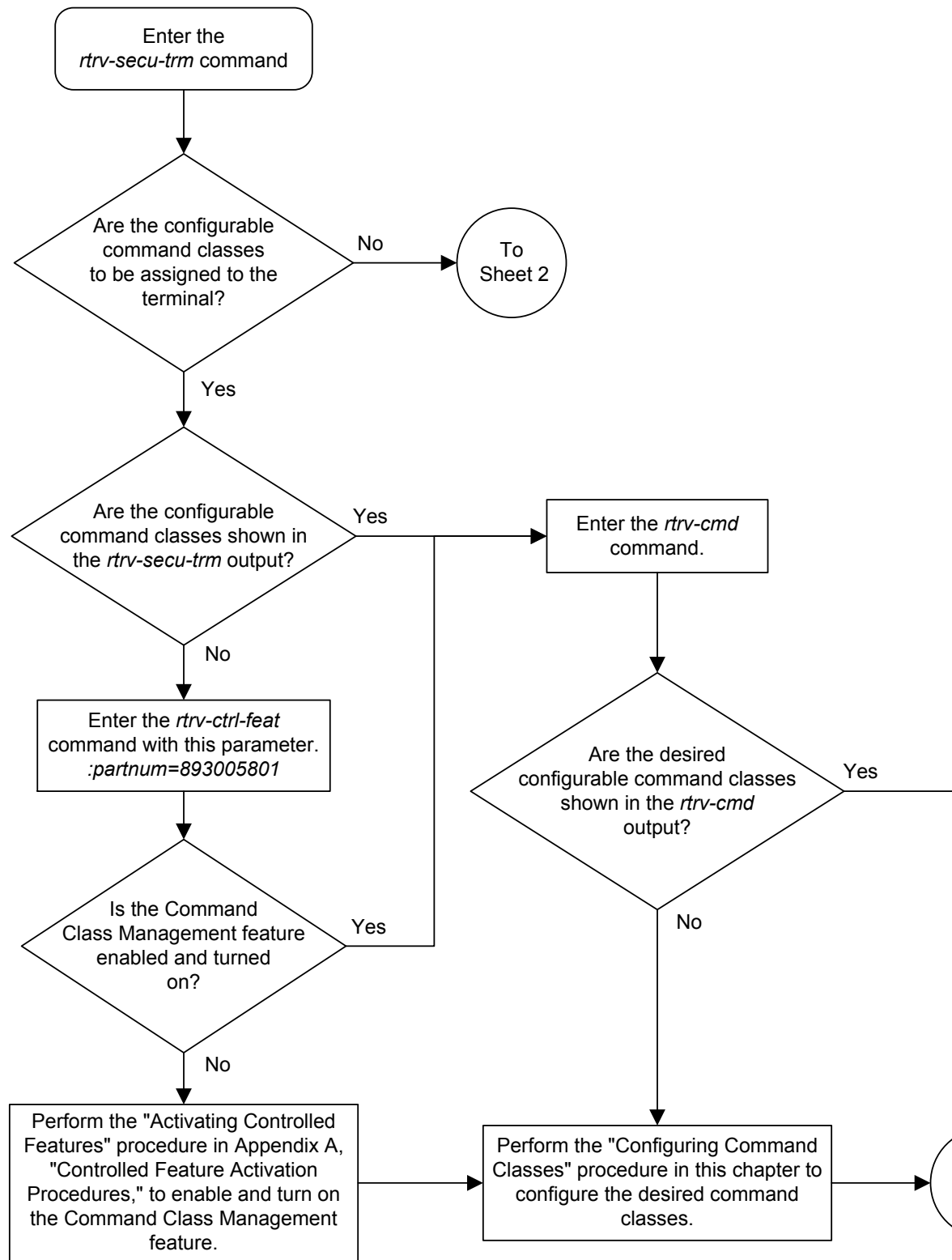

Sheet 1 of 2

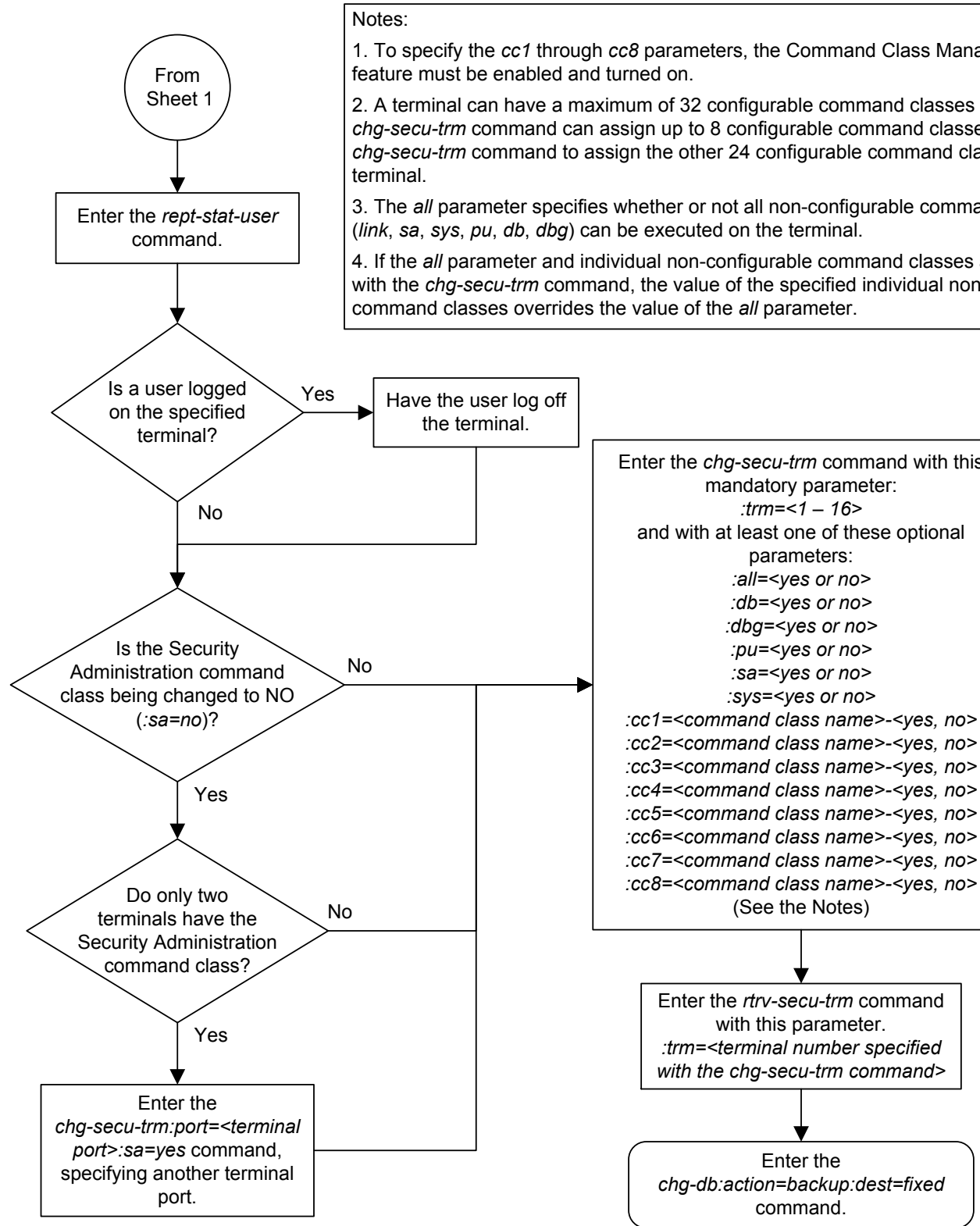

Notes:

1. To specify the *cc1* through *cc8* parameters, the Command Class Management feature must be enabled and turned on.
2. A terminal can have a maximum of 32 configurable command classes. The *chg-secu-trm* command can assign up to 8 configurable command classes to a terminal. The *chg-secu-trm* command can assign the other 24 configurable command classes to other terminals.
3. The *all* parameter specifies whether or not all non-configurable command classes (*link*, *sa*, *sys*, *pu*, *db*, *dbg*) can be executed on the terminal.
4. If the *all* parameter and individual non-configurable command classes are specified with the *chg-secu-trm* command, the value of the specified individual non-configurable command classes overrides the value of the *all* parameter.

Enter the *chg-secu-trm* command with this mandatory parameter:
:trm=<1 - 16>
 and with at least one of these optional parameters:
:all=<yes or no>
:db=<yes or no>
:dbg=<yes or no>
:pu=<yes or no>
:sa=<yes or no>
:sys=<yes or no>
:cc1=<command class name>-<yes, no>
:cc2=<command class name>-<yes, no>
:cc3=<command class name>-<yes, no>
:cc4=<command class name>-<yes, no>
:cc5=<command class name>-<yes, no>
:cc6=<command class name>-<yes, no>
:cc7=<command class name>-<yes, no>
:cc8=<command class name>-<yes, no>
 (See the Notes)

Enter the *rtrv-secu-trm* command with this parameter.
:trm=<terminal number specified with the chg-secu-trm command>

Enter the *chg-db:action=backup:dest=fixed* command.

Configuring Command Classes

This procedure is used to assign different names to the 32 configurable command classes, and to assign commands to these configurable command classes.

The **EAGLE** still has the non-configurable command classes: Basic, Database Administration, Debug, **Link** Maintenance, Program Update, Security Administration, System Maintenance.

The **Command Class** Management feature allows commands from any of these non-configurable command classes to be placed into another command class, which can be assigned to a user or terminal. This gives greater control over the commands that users can use, and to the commands that can be executed from a given terminal. For example, a user needs to use only these commands: `rtrv-card`, `rtrv-ls`, `rtrv-slk`, `rtrv-dstn`, `rtrv-rte`, `rtrv-user`, `rtrv-secu-user`, `rept-stat-db`, `rept-stat-card`, `rept-stat-slk`, `rept-stat-ls`, `rtrv-gpl`, `rept-stat-gpl`, `rept-stat-rte`, `rept-meas`.

To give this user access to these commands without the **Command Class** Management feature would require the user to be assigned to these command classes: Database, Security Administration, System Maintenance, Program Update, and **Link** Maintenance. In addition to giving access to the commands this user needs, this user has access to all the commands in these command classes. This would also allow the user to add, change, or remove database entities (cards, signaling links, routes, etc.), to inhibit signaling links, enable features with either the `chg-feat` or `enable-ctrl-feat` command that you may not want turned on.

The **Command Class** Management feature allows these commands to be placed in their own command class which can be assigned to the user. Once the new command class is configured with these commands, the commands will be in their original command classes as well as the new configured command class. The user can be restricted to executing the commands in the new configured command class.

Commands can also be removed from configurable command classes.

When the **Command Class** Management controlled feature is enabled and activated, these command classes are created with the names U01, U02, U03, ... U32. The names of these command classes, and the descriptions of these command classes can be changed with the `chg-cmdclass` command. The `chg-cmdclass` command uses these parameters.

`:class` – The current class name, shown in the `rtrv-cmdclass` command output.

`:nclass` – The new command class name consisting of 1 alphabetic character and 2 alpha-numeric characters.

`:descr` – The description of the new command class consisting of 1 alphabetic character and up to 31 alpha-numeric characters, enclosed in double quotes.

Commands can be assigned to these configurable command classes using the `chg-cmd` command. The `chg-cmd` command uses these parameters.

`:cmd` – The command being added or removed from the configurable command class.

`:class1 - :class8` – The name of the configurable command class that command is being added to or removed from with either yes (to add the command) or no (to remove the command) separated by a dash. For example, to add a command to configurable class `db1`, the `class1=db1-yes` parameter would be specified.

Up to eight configurable command classes can be specified with the `chg-cmd` command. To assign the command to more than eight configurable command classes, the repeat `chg-cmd` command until the desired number of configurable command classes, up to 32, have been specified.

To configure command classes, the **Command Class Management** feature must be enabled and turned on. Enter the `rtrv-ctrl-feat` command to verify whether or not the **Command Class Management** feature is enabled. If the **Command Class Management** feature is not enabled or turned on, perform [Activating Controlled Features](#) to enable and turn on the **Command Class Management** feature.

1. Verify that the **Command Class Management** feature is enabled and turned on, by entering the `rtrv-ctrl-feat` command.

This is an example of the possible output.

```
rlghncxa03w 06-10-01 21:15:37 GMT EAGLE5 36.0.0
The following features have been permanently enabled:
Feature Name          Partnum    Status  Quantity
Command Class Management 893005801 off     ----
```

Note: The `rtrv-ctrl-feat` command output contains other fields that are not used by this procedure. If you wish to see all the fields displayed by the `rtrv-ctrl-feat` command, see the `rtrv-ctrl-feat` command description in *Commands User's Guide*.

If the **Command Class Management** feature is enabled and turned on (`status = on`),.

If the **Command Class Management** feature is not enabled or turned on, perform [Activating Controlled Features](#) to enable and turn on the **Command Class Management** feature. After the **Command Class Management** feature is turned on, continue the procedure with 2.

Caution: If the **Command Class Management** feature is temporarily enabled, the configurable command classes can be assigned and used only for the amount of time shown in the `Trial Period Left` column in the `rtrv-ctrl-feat` output.

2. Display the descriptions of the configurable command classes in the database by entering the `rtrv-cmd` command.

This is an example of the possible output.

```
rlghncxa03w 09-05-01 21:15:37 GMT EAGLE5 41.0.0
CMD          CLASS
alw-slk      link, u11
ent-user     sa
unhb-slk     link
rtrv-attr-seculog sa, u31
inh-slk      link, abc
rtrv-meas-sched link, abc, def
act-lbp      link
act-dlk      link
act-slk      link
```



```

rtrv-seculog      sa, abc, def, ghi
act-lpo           link
blk-slk           link, abc, u23, u31
dact-lbp          link
canc-dlk          link
inh-card         sys
canc-lpo          link, u01, u02, u03, u04, u05, u06, u07, u08, u09, u10,
                  u11, u12, u13
canc-slk          link
ublk-slk          link, u01, u02, u03, u04, u05, u06, u07, u08, u09, u10,
                  u11, u12, u13, u14, u15, u16, u17, u18, u19, u20, u21,
                  u22, u23, u24, u25, u26, u27, u28, u29, u30, u31, u32
inh-trm           sys, krb
rept-meas        link
.
.
.
chg-meas          link
tst-dlk           link, krb
tst-slk           link

```

If the desired configurable command class descriptions are in the database, and the commands are in the desired command classes, no further action is necessary. This procedure is finished.

Note: If the name of a configurable command class is not being changed, continue the procedure with [6](#).

3. Display the configurable command class descriptions by entering the `rtrv-cmdclass` command.

This is an example of the possible output.

```

rlghncxa03w 09-03-01 21:15:37 GMT EAGLE5 40.1.0
CLASS          DESCR
link           link maintenance commands
sa             security administration commands
sys           system maintenance commands
db            database administration commands
dbg           debug commands
pu            program update commands
u01           configurable command class 1
krb           my command class description
u03           configurable command class 3
dab           your command class description
u05           configurable command class 5
.
.
.
u32           configurable command class 32

```

4. Change the configurable command class name or description by entering the `chg-cmdclass` command.

For this example, enter these commands.

```

chg-cmdclass:class=u01:nclass=db1:descr="retrieve database
commands"

```

```
chg-cmdclass:class=dab:nclass=s15
chg-cmdclass:class=u03:descr="user commands 3"
```

Note: The command classes `link`, `sa`, `sys`, `db`, `dbg`, and `pu` cannot be changed.

When these commands have successfully completed, this message should appear.

```
rlghncxa03w 06-10-01 21:15:37 GMT EAGLE5 36.0.0
CHG-CMDCLASS: MASP A - COMPLTD
```

5. Verify the changes by entering the `rtrv-cmdclass` command, specifying the command class name, or new command class name if the command class name was changed, used in 4.

For this example, enter these commands.

```
rtrv-cmdclass:class=db1
```

This is an example of the possible output.

```
rlghncxa03w 06-10-01 21:15:37 GMT EAGLE5 36.0.0
CLASS          DESCR
db1            retrieve database commands
```

```
rtrv-cmdclass:class=s15
```

This is an example of the possible output.

```
rlghncxa03w 06-10-01 21:15:37 GMT EAGLE5 36.0.0
CLASS          DESCR
s15            your command class description
```

```
rtrv-cmdclass:class=u03
```

This is an example of the possible output.

```
rlghncxa03w 06-10-01 21:15:37 GMT EAGLE5 36.0.0
CLASS          DESCR
u03            user commands 3
```

6. Add or remove a command from the desired command classes by entering the `chg-cmd` command.

For this example, enter these commands.

```
chg-cmd:cmd=rtrv-card:class1=db1=yes
```

```
chg-cmd:cmd=tst-dlk:class1=krb=no
```

When these commands have successfully completed, this message should appear.

```
rlghncxa03w 06-10-01 21:15:37 GMT EAGLE5 36.0.0
CHG-CMD: MASP A - COMPLTD
```

Up to eight configurable command classes can be specified with the `chg-cmd` command. If you wish to assign the command to more than eight configurable

command classes, but no more than 32 configurable command classes, repeat this step until the desired configurable command class assignments have been made.

7. Verify the changes by entering the `rtrv-cmd` command specifying the `cmd` parameter value used in step 6.

For this example, enter these commands.

```
rtrv-cmd:cmd=rtrv-card
```

This is an example of the possible output.

```
rlghncxa03w 06-10-01 21:15:37 GMT EAGLE5 36.0.0
CMD                CLASS
rtrv-card          db, db1
```

```
rtrv-cmd:cmd=tst-dlk
```

This is an example of the possible output.

```
rlghncxa03w 06-10-01 21:15:37 GMT EAGLE5 36.0.0
CMD                CLASS
tst-dlk            link
```

8. Back up the new changes using the `chg-db:action=backup:dest=fixed` command.

These messages should appear, the active **Maintenance and Administration Subsystem Processor (MASP)** appears first.

```
BACKUP (FIXED) : MASP A - Backup starts on active MASP.
BACKUP (FIXED) : MASP A - Backup on active MASP to fixed disk complete.
BACKUP (FIXED) : MASP A - Backup starts on standby MASP.
BACKUP (FIXED) : MASP A - Backup on standby MASP to fixed disk complete.
```

Figure 4-12 Configuring Command Classes

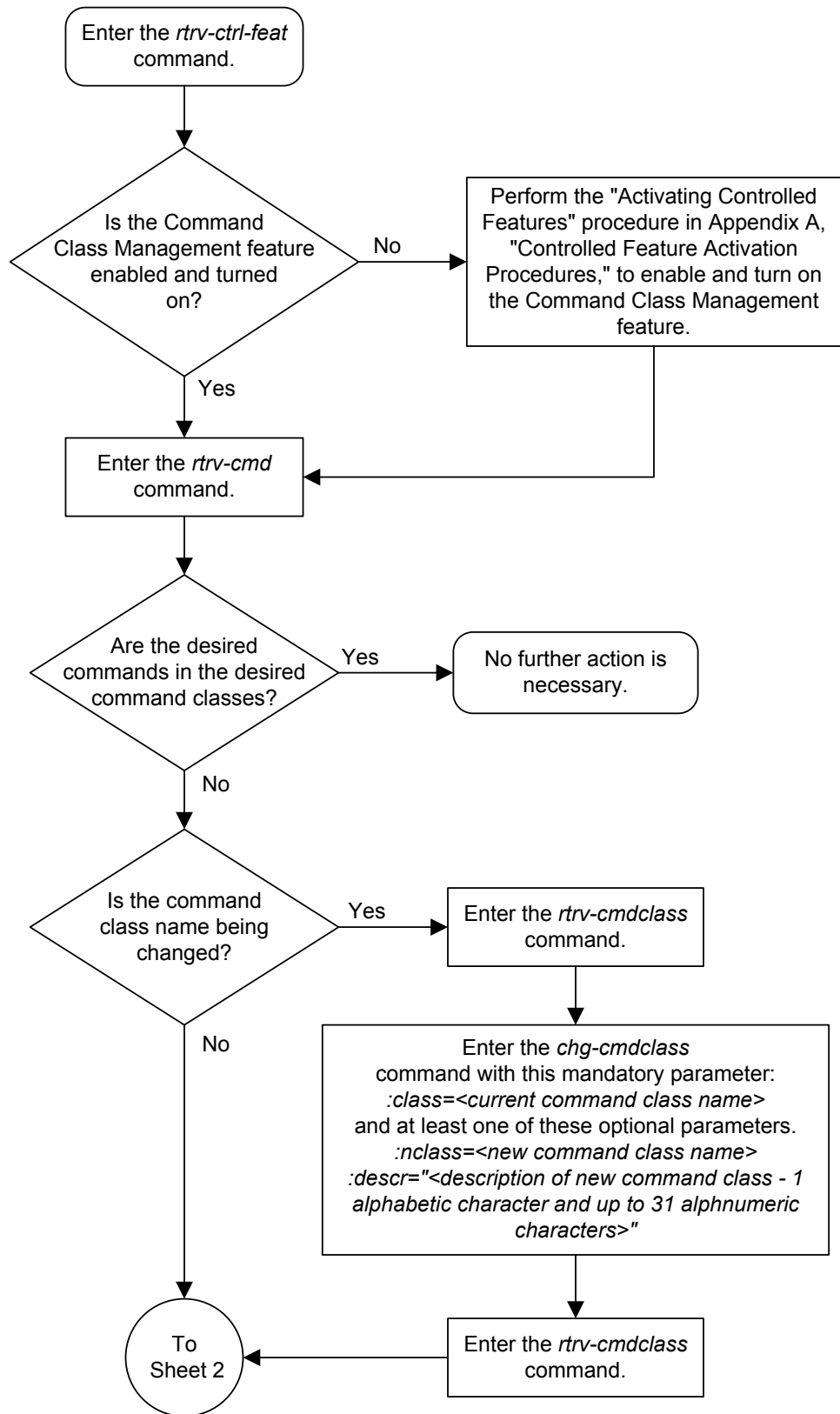

Sheet 1 of 2

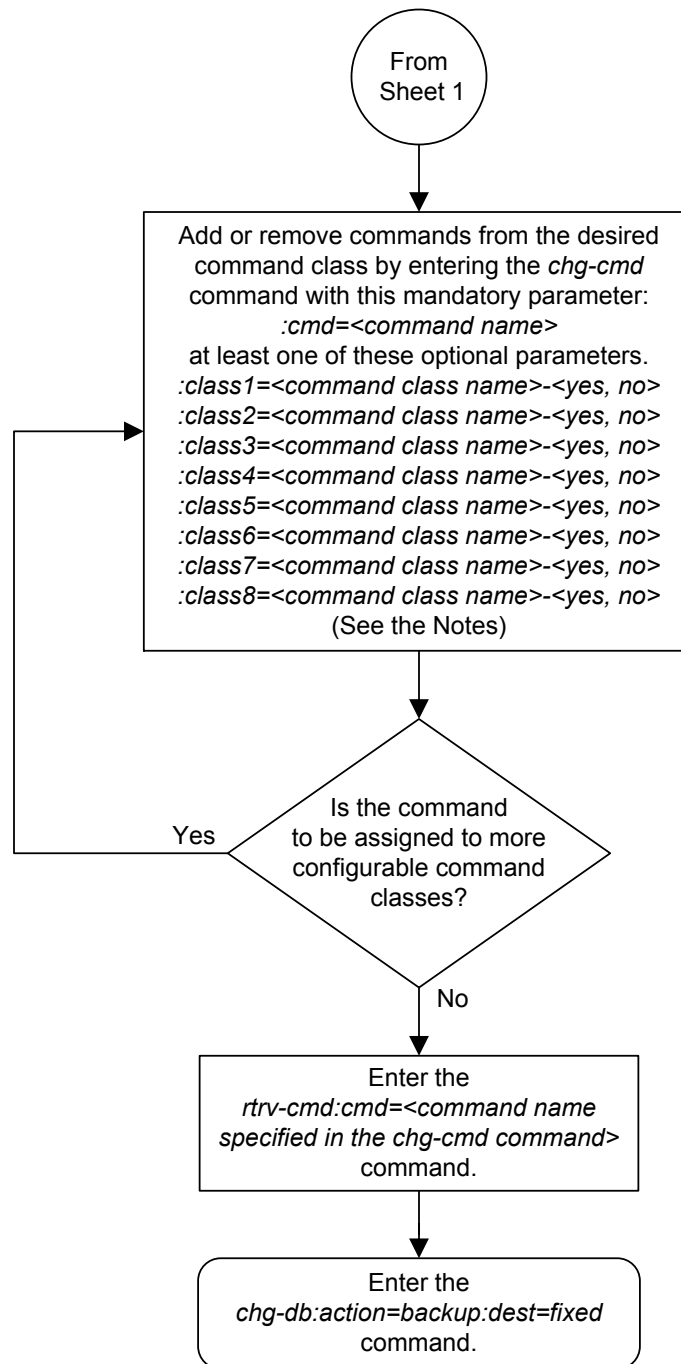

Notes:

1. Specifying the value *yes* in the *class1* - *class8* parameters adds the command to the specified configurable command class.
2. Specifying the value *no* in the *class1* - *class8* parameters removes the command from the specified configurable command class.

Adding a Shelf

This procedure is used to add a shelf to the database using the `ent-shlf` command. The shelf may not already exist in the database. The control shelf (**Shelf 1100**) cannot be added to the database. The `ent-shlf` command uses these parameters.

:`type` – The shelf type. There is only one shelf type that can be added to the database, an extension shelf, shown by the value for this parameter as `ext`.

:`loc` – The shelf location

The examples in this procedure are used to add an extension shelf to frame 3 of the **EAGLE**.

1. Display the current shelf information using the `rtrv-shlf` command.

This is an example of the possible output.

```
rlghncxa03w 06-10-01 09:12:36 GMT EAGLE5 36.0.0
SHELF DISPLAY
FRAME SHELF          TYPE
1         1          CONTROL
1         2          EXTENSION
1         3          EXTENSION
2         2          EXTENSION
```

2. Add the shelf using the `ent-shlf` command.

For this example, the shelf to be added is the first shelf in frame 3. Enter this command.

```
ent-shlf:loc=3100:type=ext
```

When this command has successfully completed, this message should appear.

```
rlghncxa03w 06-10-01 09:12:36 GMT EAGLE5 36.0.0
ENT-SHLF: MASP A - COMPLTD
```

3. Verify the changes using the `rtrv-shlf` command.

This is an example of the possible output.

```
rlghncxa03w 06-10-01 09:12:36 GMT EAGLE5 36.0.0
SHELF DISPLAY
FRAME SHELF          TYPE
1         1          CONTROL
1         2          EXTENSION
1         3          EXTENSION
2         2          EXTENSION
3         1          EXTENSION
```

4. Back up the new changes using the `chg-db:action=backup:dest=fixed` command.

These messages should appear, the active **Maintenance and Administration Subsystem Processor (MASP)** appears first.

```
BACKUP (FIXED) : MASP A - Backup starts on active MASP.  
BACKUP (FIXED) : MASP A - Backup on active MASP to fixed disk complete.  
BACKUP (FIXED) : MASP A - Backup starts on standby MASP.  
BACKUP (FIXED) : MASP A - Backup on standby MASP to fixed disk complete.
```

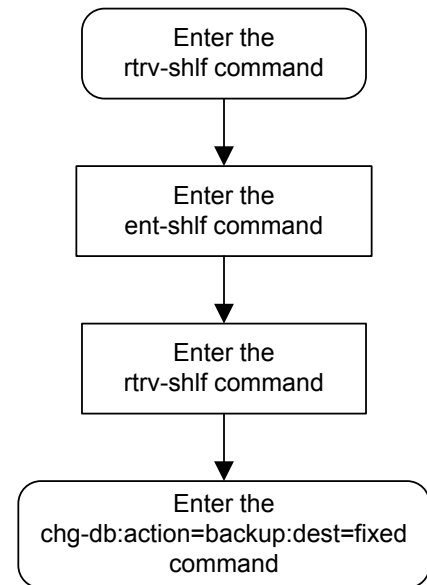
Figure 4-13 Adding a Shelf

Removing a Shelf

This procedure is used to remove a shelf from the database using the `dlr-shlf` command. If the shelf to be removed does not exist in the database, it cannot be removed. The control shelf (**Shelf 1100**) cannot be removed from the database. The `dlr-shlf` command has only one parameter, `loc`, which is the location of the shelf.

Before a shelf can be removed from the database, all of the cards in that shelf must be removed from the database. The procedures for removing these cards are based on the application that is assigned to these cards. [Table 4-3](#) shows the location of these procedures.

Table 4-3 Card Removal Procedures

Card Application	Procedure
	"Removing an SS7 LIM"
SS7ANSI, ATMANSI, CCS7ITU, ATMITU	"Removing an E1 Card" in the <i>Database Administration - SS7 User's Guide</i> "Removing a T1 Card" in the <i>Database Administration - SS7 User's Guide</i>
VSCCP	"Removing a Service Module" in the <i>Database Administration - GTT User's Guide</i>
GLS	"Removing a GLS Card" in the <i>Database Administration - GWS User's Guide</i>
STPLAN	"Removing an STP LAN Card" in the <i>Database Administration - Features User's Guide</i>
IPLIM, IPLIMI, SS7IPGW, IPGWI	"Removing an IPLIMx Card" or "Removing an IPGWx Card" in the <i>Database Administration - IP7 User's Guide</i>
IPSG	"Removing an IPSG Card" in the <i>Database Administration - IP7 User's Guide</i>
EROUTE	"Removing an STC Card" in the <i>Database Administration - Features User's Guide</i>
MCP	"Removing an MCPM"
IPS	"Removing an IPSM"

Caution: If any card in the shelf is the last card of that type in service, removing that card from the database will cause the traffic handled by that card to be lost or the feature requiring that card to be disabled. See [Table 4-4](#) for a description of the effect that removing the last card type that is in service has on the EAGLE.

Table 4-4 Effect of Removing the Last In-Service Card Type from the Database

Card type	Application assigned to card	Effect on the EAGLE
LIMDS0, LIME1, LIMT1, LIMCH	SS7ANSI	ANSI traffic is lost.
LIMATM	ATMANSI	
LIME1, LIMT1, LIMCH	CCS7ITU	ITU traffic is lost.
LIME1ATM	ATMITU	
DSM	VSCCP	Global title translation traffic is lost. If any of the GTT-related features are enabled, the traffic for those features is also lost. Refer to the "Adding a Service Module" procedure in the <i>Database Administration - GTT User's Guide</i> for a list of the GTT-related features.
TSM	GLS	Gateway screening feature is disabled.
DCM	STPLAN	STPLAN feature is disabled.
DCM	IPLIM	Point-to-point connectivity for IP7 Secure Gateway functions in ANSI networks is disabled.
	IPLIMI	Point-to-point connectivity for IP7 Secure Gateway functions in ITU networks is disabled.
	SS7IPGW	Point-to-multipoint connectivity for IP7 Secure Gateway functions in ANSI networks is disabled.
	IPGWI	Point-to-multipoint connectivity for IP7 Secure Gateway functions in ITU networks is disabled.
ENET	IPSG	Traffic carried by the IPSG card is lost.
STC	EROUTE	Monitoring of the EAGLE by the EAGLE 5 Integrated Monitoring Support feature is disabled.
MCPM	MCP	The Measurements Platform feature is disabled.
IPSM	IPS	IP Telnet sessions and the IP User Interface (Telnet) feature are disabled.

The shelf being removed in this procedure cannot be removed if the shelf is the only provisioned shelf in the frame and the frame is in the Frame Power **Alarm** Threshold table. The Frame Power **Alarm** Threshold table is shown in the `rtv-frm-pwr` command output. If the frame is shown in the `rtv-frm-pwr` output, and the shelf is the only shelf in the frame, perform the [Removing an Entry from the Frame Power](#)

[Alarm Threshold Table](#) procedure to remove the frame from the Frame Power **Alarm** Threshold table.

The examples in this procedure are used to remove shelf 2100 from the database.

1. Display the cards in the database using the `rtrv-card` command.

This is an example of the possible output.

```
rlghncxa03w 09-05-01 09:12:36 GMT EAGLE5 41.0.0
CARD   TYPE      APPL      LSET NAME      LINK SLC LSET NAME      LINK SLC
1101   DSM        VSCCP
1102   TSM        GLS
1113   GSPM       OAM
1114   TDM-A
1115   GSPM       OAM
1116   TDM-B
1117   MDAL
1201   LIMDS0     SS7ANSI    sp2             A    0    sp1             B    0
1202   LIMDS0     SS7ANSI    sp4             A    0
1203   LIMDS0     SS7ANSI    sp3             A    0
1204   LIMDS0     SS7ANSI    sp3             A    1
1205   LIMDS0     SS7ANSI    nsp3            A    0    nsp4            B    0
1206   LIMDS0     SS7ANSI    nsp3            A    1    nsp4            B    1
1211   DSM        VSCCP
1212   TSM        GLS
1215   DCM        STPLAN
1301   LIMATM     ATMANSI    lsnatm1        A    0
1305   DCM        STPLAN
1307   LIMDS0     SS7ANSI    sp2             A    1    nsp3            B    2
1308   LIMATM     ATMANSI    lsnatm1        A    1
1317   DCM        STPLAN
2101   LIMDS0     SS7ANSI    sp5             A    0    sp8             B    0
2102   LIMDS0     SS7ANSI    sp7             A    0
2103   LIMDS0     SS7ANSI    sp6             A    0
2104   LIMDS0     SS7ANSI    sp6             A    1
2105   LIMDS0     SS7ANSI    nsp3            A    0    nsp5            B    0
2106   LIMDS0     SS7ANSI    nsp3            A    1    nsp5            B    1
```

In this example, these cards must be removed from the database: 2101, 2102, 2103, 2104, 2105, 2106.

2. Based on the application assigned to the cards in the shelf to be removed, perform the appropriate procedures shown in [Table 4-3](#) and remove all the cards from the shelf.

The application assigned to the card is shown in the APPL field of the `rtrv-card` command output in step 1.

3. Display the shelves configured in the database by entering the `rtrv-shlf` command.

This is an example of the possible output.

```
rlghncxa03w 06-10-01 09:12:36 GMT EAGLE5 36.0.0
SHELF DISPLAY
FRAME SHELF      TYPE
1      1      CONTROL
1      2      EXTENSION
```

```

1      3      EXTENSION
2      1      EXTENSION

```

If the `rtrv-shlf` output shows the shelf being removed in this procedure is not the only shelf in the frame, skip step 4 and go to step 5.

4. Display the frame power alarm thresholds by entering the `rtrv-frm-pwr` command.

This is an example of the possible output.

```
rlghncxa03w 06-10-01 09:12:36 GMT EAGLE5 36.0.0
```

Frame	Power Threshold (Amps)
cf00	56
ef00	36

If the frame containing the shelf being removed in this procedure is shown in the `rtrv-frm-pwr` output, the frame must be removed from the frame power alarm threshold table (shown in the `rtrv-frm-pwr` output) before the shelf can be removed. The following list shows the frames and the shelves contained in those frames.

- Frame **CF00** – Shelves 1200 and 1300
- Frame **EF00** – Shelves 2100, 2200, and 2300
- Frame **EF01** – Shelves 3100, 3200, and 3300
- Frame **EF02** – Shelves 4100, 4200, and 4300
- Frame **EF03** – Shelves 5100, 5200, and 5300
- Frame **EF04** – Shelf 6100

Shelf 1100 is the **Control Shelf** and is in Frame **CF00**. Shelf 1100 cannot be removed.

Perform the [Removing an Entry from the Frame Power Alarm Threshold Table](#) procedure to remove the frame from the frame power alarm threshold table.

If the frame containing the shelf being removed in this procedure is not shown in the `rtrv-frm-pwr` output, go to step 5.

5. Remove the shelf from the database using the `dlt-shlf` command.

For this example, enter this command.

```
dlt-shlf:loc=2100
```

When this command has successfully completed, this message should appear.

```
rlghncxa03w 06-10-01 09:12:36 GMT EAGLE5 36.0.0
DLT-SHLF: MASP A - COMPLTD
```

6. Verify the changes with the `rtrv-shlf` command and specify the location of the shelf.

For this example, enter this command.

```
rtrv-shlf:loc=2100
```

When this command has successfully completed, this message should appear.

```
rlghncxa03w 06-10-01 09:12:36 GMT EAGLE5 36.0.0  
SHELF DISPLAY LOCATION=1200  
FRAME SHELF          TYPE
```

This shelf is UNEQUIPPED in the database.

7. Back up the new changes using the `chg-db:action=backup:dest=fixedcommand`.

These messages should appear, the active **Maintenance and Administration Subsystem Processor (MASP)** appears first.

```
BACKUP (FIXED) : MASP A - Backup starts on active MASP.  
BACKUP (FIXED) : MASP A - Backup on active MASP to fixed disk complete.  
BACKUP (FIXED) : MASP A - Backup starts on standby MASP.  
BACKUP (FIXED) : MASP A - Backup on standby MASP to fixed disk complete.
```

Figure 4-14 Removing a Shelf

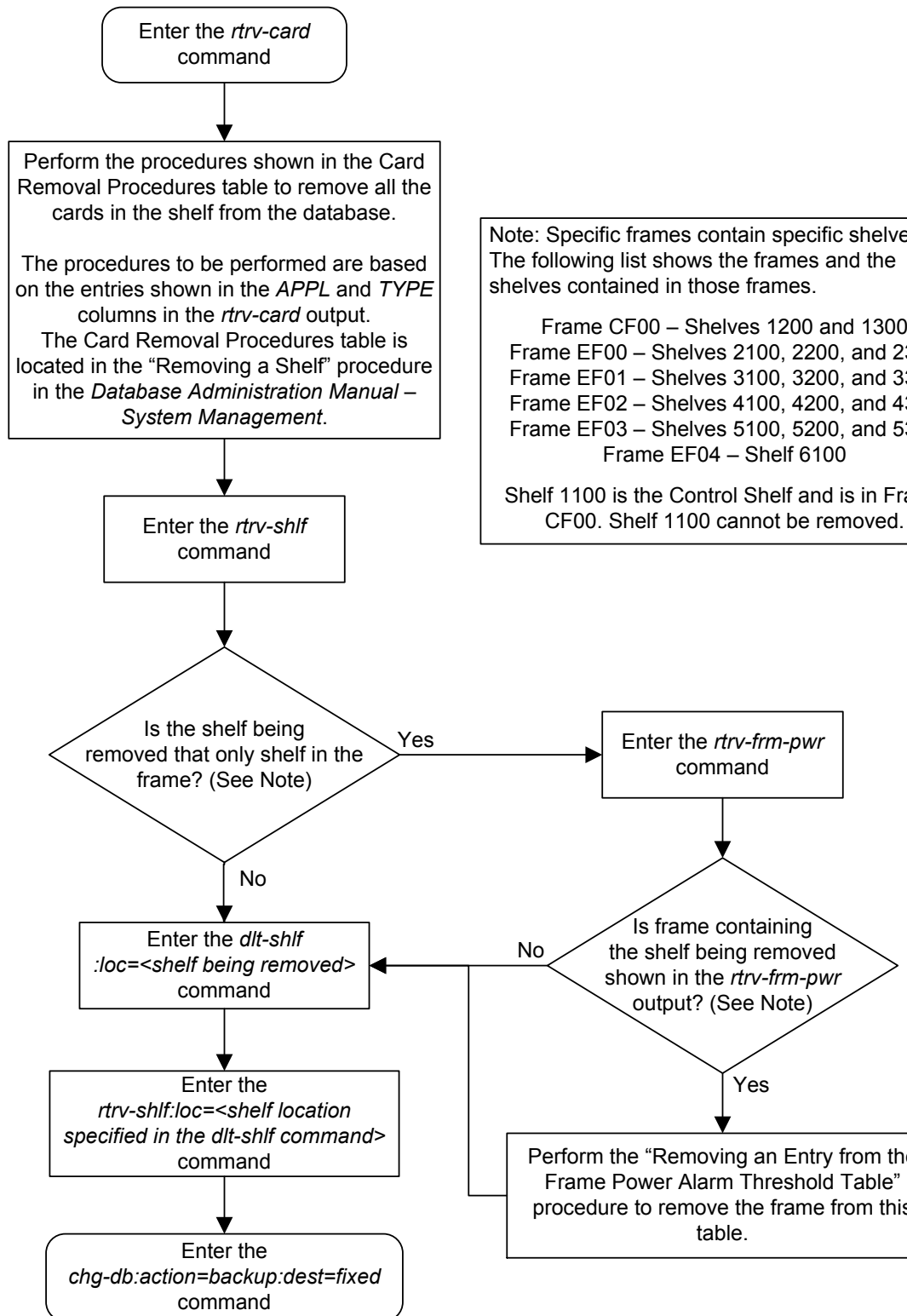

Adding an SS7 LIM

This procedure is used to add a low-speed **SS7 LIM** (link interface module) to the database using the `ent-card` command. The **SS7 LIM** cannot be added if it exists in the database.

The SS7 LIM that is being added in this procedure is the Multiport LIM, part number 870-2061-XX. The Multiport LIM can contain eight signaling links. A maximum of 63 Multiport **LIMs** can be configured in the database. See the “Determining the Number of High-Speed and Low-Speed Signaling Links” section of Appendix D, “Reference Information,” in *Database Administration - SS7 User’s Guide* for information on how to determine the quantities of the different types of signaling links the EAGLE can have. The Multiport LIM is added using these parameters.

- `:loc` – The location of the card being added to the database.
- `:type` – The type of card being added to the database - `limds0`.
- `:appl` – The application software that is assigned to the card - `ss7ansi`.

The `ent-card` command also contains the `force` parameter. If the global title translation feature is on, the `force=yes` parameter allows the **LIM** to be added to the database even if the current **SCCP** transactions-per-second threshold is unable to support the additional **SCCP** transaction-per-second capacity created by adding the **LIM**. This parameter is obsolete and is no longer used.

There are other cards that support signaling links that are provisioned with the `ent-card` command. These cards are provisioned in the following procedures. These cards can also be used to provision ITU signaling links.

- Cards for **E1** signaling links are configured in the database using the procedures in Appendix A, “E1 Interface,” in *Database Administration - SS7 User’s Guide*.
- Cards for **T1** signaling links are configured in the database using the procedures in Appendix B, “T1 Interface,” in *Database Administration - SS7 User’s Guide*.
- Cards for **ATM** high-speed signaling links are configured in the database using the procedures in Appendix C, “ATM Signaling Link Configuration,” in the *Database Administration - SS7 User’s Guide*.
- **IP** cards (cards used for **IP** links) are configured in the database using the procedures in *Database Administration - IP7 User’s Guide*.

The shelf to which the card is to be added, must already be in the database. This can be verified with the `rtrv-shlf` command. If the shelf is not in the database, see the [Adding a Shelf](#) procedure.

1. Display the cards in the database using the `rtrv-card` command.

This is an example of the possible output.

```
rlghncxa03w 09-05-01 09:12:36 GMT EAGLE5 41.0.0
CARD  TYPE      APPL      LSET NAME      LINK SLC LSET NAME      LINK SLC
1101  DSM          VSCCP
1102  TSM          GLS
1113  GSPM         OAM
1114  TDM-A
1115  GSPM         OAM
```

1116	TDM-B								
1117	MDAL								
1201	LIMDS0	SS7ANSI	sp2	A	0	sp1	B	0	
1203	LIMDS0	SS7ANSI	sp3	A	0				
1204	LIMDS0	SS7ANSI	sp3	A	1				
1206	LIMDS0	SS7ANSI	nsp3	A	1	nsp4	B	1	
1216	DCM	STPLAN							
1301	DSM	VSCCP							
1308	LIMDS0	SS7ANSI	sp6	A	1	sp7	B	0	
1314	LIMDS0	SS7ANSI	sp7	A	1	sp5	B	1	
1317	DCM	STPLAN							

The cards should be distributed throughout the **EAGLE** for proper power distribution. Refer to *Installation Guide* for the shelf power distribution.

2. Add the card using the `ent-card` command.

For this example, enter these commands.

```
ent-card:loc=1205:type=limds0:appl=ss7ansi
```

```
ent-card:loc=1305:type=limds0:appl=ss7ansi
```

```
ent-card:loc=1311:type=limds0:appl=ss7ansi
```

When each of these commands have successfully completed, this message should appear.

```
rlghncxa03w 06-10-01 09:12:36 GMT EAGLE5 36.0.0
ENT-CARD: MASP A - COMPLTD
```

3. Verify the changes using the `rtrv-card` command with the card location specified. For this example, enter these commands.

```
rtrv-card:loc=1202
```

This is an example of the possible output.

```
rlghncxa03w 09-05-01 09:12:36 GMT EAGLE5 41.0.0
CARD  TYPE      APPL      LSET NAME      LINK SLC LSET NAME      LINK SLC
1202  LIMDS0      SS7ANSI
```

```
rtrv-card:loc=1205
```

This is an example of the possible output.

```
rlghncxa03w 09-05-01 09:12:36 GMT EAGLE5 41.0.0
CARD  TYPE      APPL      LSET NAME      LINK SLC LSET NAME      LINK SLC
1205  LIMDS0      SS7ANSI
```

```
rtrv-card:loc=1305
```

This is an example of the possible output.

```
rlghncxa03w 06-10-01 09:12:36 GMT EAGLE5 36.0.0
CARD  TYPE      APPL      LSET NAME      LINK SLC LSET NAME      LINK SLC
1305  LIMDS0      SS7ANSI
```

```
rtrv-card:loc=1311
```

This is an example of the possible output.

```
rlghncxa03w 06-10-01 09:12:36 GMT EAGLE5 36.0.0
CARD   TYPE      APPL      LSET NAME      LINK SLC LSET NAME      LINK SLC
1311   LIMDS0     SS7ANSI
```

4. Back up the new changes using the `chg-db:action=backup:dest=fixedcommand`.

These messages should appear, the active **Maintenance and Administration Subsystem Processor (MASP)** appears first.

```
BACKUP (FIXED) : MASP A - Backup starts on active MASP.
BACKUP (FIXED) : MASP A - Backup on active MASP to fixed disk complete.
BACKUP (FIXED) : MASP A - Backup starts on standby MASP.
BACKUP (FIXED) : MASP A - Backup on standby MASP to fixed disk complete.
```

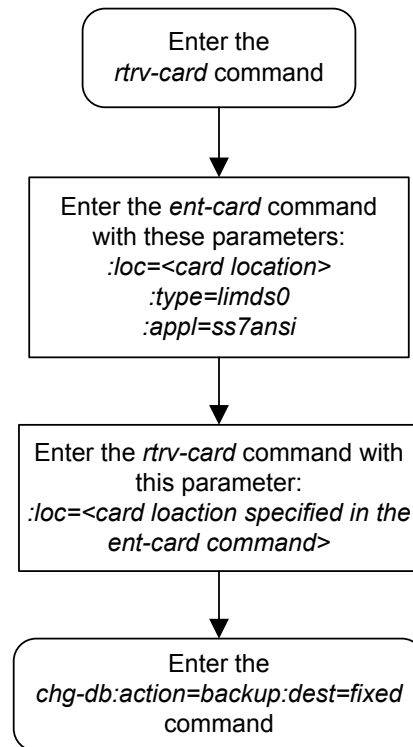
Figure 4-15 Adding an SS7 LIM

Removing an SS7 LIM

This procedure is used to remove an **SS7 LIM** (link interface module) from the database using the `dlr-card` command. The card cannot be removed if it does not exist in the database.

No **SS7** signaling links can be assigned to the card you wish to remove from the database.

Caution:

If the **SS7 LIM** is the last **SS7 LIM** in service, removing this card from the database will cause **SS7** traffic to be lost and isolate the **EAGLE** from the network.

Note:

1. **LIM-E1** or **LIMCH** cards for **E1** signaling links are removed from the database using the procedures in Appendix A, "E1 Interface" in *Database Administration - SS7 User's Guide*.
 2. **LIM-T1** or **LIMCH** cards for **T1** signaling links are removed from the database using the procedures in Appendix B, "T1 Interface" in *Database Administration - SS7 User's Guide*.
 3. **IP** cards (**DCMs** used for **IP** links) are removed from the database using the procedures in *Database Administration - IP7 User's Guide*.
-
-

The examples in this procedure are used to remove the **SS7 LIMs** in card location 1201, 1311, and 1318.

Canceling the `REPT-STAT-CARD` Command

Because the `rept-stat-card` command used in this procedure can output information for a long period of time, the `rept-stat-card` command can be canceled and the output to the terminal stopped. There are three ways that the `rept-stat-card` command can be canceled.

- Press the F9 function key on the keyboard at the terminal where the `rept-stat-card` command was entered.
- Enter the `canc-cmd` without the `trm` parameter at the terminal where the `rept-stat-card` command was entered.
- Enter the `canc-cmd:trm=<xx>`, where `<xx>` is the terminal where the `rept-stat-card` command was entered, from another terminal other than the terminal where the `rept-stat-card` command was entered. To enter the `canc-cmd:trm=<xx>` command, the terminal must allow Security Administration commands to be entered from it and the user must be allowed to enter Security Administration commands. The terminal's permissions can be verified with the `rtrv-secu-trm` command. The user's permissions can be verified with the `rtrv-user` or `rtrv-secu-user` commands.

For more information about the `canc-cmd` command, go to *Commands User's Guide*.

1. Display the cards in the database using the `rtrv-card` command.

This is an example of the possible output.

```
rlghncxa03w 09-05-01 09:12:36 GMT EAGLE5 41.0.0
CARD  TYPE      APPL      LSET NAME      LINK SLC LSET NAME      LINK SLC
1101  DSM          VSCCP
1102  TSM          GLS
1103  DCM          STPLAN
1113  GSPM         OAM
1114  TDM-A
1115  GSPM         OAM
1116  TDM-B
1117  MDAL
1201  LIMDS0      SS7ANSI   sp2            A    0    sp1            B    0
1202  LIMDS0      SS7ANSI   sp2            A    1    nsp3           B    0
1203  LIMDS0      SS7ANSI   sp3            A    0
1204  LIMDS0      SS7ANSI   sp3            A    1
1205  LIMDS0      SS7ANSI   itu1           A    0
1206  LIMDS0      SS7ANSI   nsp3           A    1    nsp4           B    0
1212  DSM          VSCCP
1214  TSM          GLS
1215  DCM          STPLAN
1301  LIMATM      ATMANSI   lsnatm1       A    0
1305  DCM          STPLAN
1308  LIMDS0      SS7ANSI   sp6            A    0    sp7            B    0
1311  LIMDS0      SS7ANSI   sp2            A    2    sp1            B    1
      sp7            A1   1    sp3            B1   2
1315  LIMDS0      SS7ANSI   sp7            A    2    sp5            B    0
1318  LIMATM      ATMANSI   lsnatm1       A    1
```

2. An **SS7LIM** is identified by the entries `SS7ANSI`, `CCS7ITU`, or `ATMANSI` in the `APPL` field.

Display the status of the **SS7** signaling links on the card you wish to remove by entering the `rept-stat-slk` command, specifying the card location and signaling link. The card location is shown in the `CARD` field of the `rtrv-card` command output.

For this example, enter these commands.

```
rept-stat-slk:loc=1201:link=a
```

This is an example of the possible output.

```
rlghncxa03w 06-10-01 09:12:36 GMT EAGLE5 36.0.0
SLK   LSN      CLLI      PST          SST          AST
1201,A sp2      ----- IS-NR          Avail        ----
ALARM STATUS      = No Alarms.
UNAVAIL REASON    = --
Command Completed.
```

```
rept-stat-slk:loc=1201:link=b
```

This is an example of the possible output.

```
rlghncxa03w 06-10-01 09:12:36 GMT EAGLE5 36.0.0
SLK   LSN      CLLI      PST          SST          AST
1201,B sp1      ----- IS-NR          Avail        ----
ALARM STATUS      = No Alarms.
```

```
UNAVAIL REASON      = --
Command Completed.
```

```
rept-stat-slk:loc=1318:link=a
```

This is an example of the possible output.

```
rlghncxa03w 06-10-01 09:12:36 GMT  EAGLE5 36.0.0
SLK      LSN      CLLI      PST      SST      AST
1318,A   lsnatm1  -----  IS-NR    Avail    ----
  ALARM STATUS      = No Alarms.
  UNAVAIL REASON    = --
Command Completed.
```

```
rept-stat-slk:loc=1311:link=a
```

This is an example of the possible output.

```
rlghncxa03w 06-10-01 09:12:36 GMT  EAGLE5 36.0.0
SLK      LSN      CLLI      PST      SST      AST
1311,A   sp2      -----  IS-NR    Avail    ----
  ALARM STATUS      = No Alarms.
  UNAVAIL REASON    = --
Command Completed.
```

```
rept-stat-slk:loc=1311:link=a1
```

This is an example of the possible output.

```
rlghncxa03w 06-10-01 09:12:36 GMT  EAGLE5 36.0.0
SLK      LSN      CLLI      PST      SST      AST
1311,A1  sp7      -----  IS-NR    Avail    ----
  ALARM STATUS      = No Alarms.
  UNAVAIL REASON    = --
Command Completed.
```

```
rept-stat-slk:loc=1311:link=b
```

This is an example of the possible output.

```
rlghncxa03w 06-10-01 09:12:36 GMT  EAGLE5 36.0.0
SLK      LSN      CLLI      PST      SST      AST
1311,B   sp1      -----  IS-NR    Avail    ----
  ALARM STATUS      = No Alarms.
  UNAVAIL REASON    = --
Command Completed.
```

```
rept-stat-slk:loc=1311:link=b1
```

This is an example of the possible output.

```
rlghncxa03w 06-10-01 09:12:36 GMT  EAGLE5 36.0.0
SLK      LSN      CLLI      PST      SST      AST
1311,B1  sp3      -----  IS-NR    Avail    ----
  ALARM STATUS      = No Alarms.
  UNAVAIL REASON    = --
Command Completed.
```

- Deactivate the links to the card that are not in an **OOS-MT-DSBLD** state using the `dact-slk` command.

For this example, enter these commands.

```
dact-slk:loc=1201:link=a
dact-slk:loc=1201:link=b
dact-slk:loc=1318:link=a
dact-slk:loc=1311:link=a
dact-slk:loc=1311:link=a1
dact-slk:loc=1311:link=b
dact-slk:loc=1311:link=b1
```

When these commands have successfully completed, this message should appear.

```
rlghncxa03w 06-10-01 09:12:36 GMT EAGLE5 36.0.0
Deactivate Link message sent to card
```

- Display the cards that are in service with the `rept-stat-card:stat=nr` command.

```
rept-stat-card:stat=nr
```

This is an example of the possible output.

```
rlghncxa03w 09-05-01 16:43:42 GMT EAGLE5 41.0.0
CARD  VERSION      TYPE   GPL      PST          SST      AST
1101  113-003-000    DSM    VSCCP    IS-NR        Active   ---
1102  113-003-000    TSM    GLS      IS-NR        Active   ---
1103  113-002-000    DCM    STPLAN   IS-NR        Active   ---
1104  113-002-000    DCM    STPLAN   IS-NR        Active   ---
1109  113-003-000    HMUX   BPHMUX   IS-NR        Active   ---
1110  113-003-000    HMUX   BPHMUX   IS-NR        Active   ---
1113  113-003-000    GPSM   EOAM     IS-NR        Active   ---
1114  -----        TDM                    IS-NR        Active   ---
1115  113-003-000    GPSM   EOAM     IS-NR        Standby  ---
1116  -----        TDM                    IS-NR        Active   ---
1117  -----        MDAL                    IS-NR        Active   ---
1201  113-003-000    LIMDS0 SS7ANSI   IS-NR        Active   ---
1203  113-003-000    LIMDS0 SS7ANSI   IS-NR        Active   ---
1204  113-003-000    LIMDS0 SS7ANSI   IS-NR        Active   ---
1205  113-003-000    LIMDS0 SS7ANSI   IS-NR        Active   ---
1206  113-003-000    LIMDS0 SS7ANSI   IS-NR        Active   ---
1209  113-003-000    HMUX   BPHMUX   IS-NR        Active   ---
1210  113-003-000    HMUX   BPHMUX   IS-NR        Active   ---
1212  113-003-000    DSM    VSCCP    IS-NR        Active   ---
1214  113-003-000    TSM    GLS      IS-NR        Active   ---
1216  113-002-000    DCM    STPLAN   IS-NR        Active   ---
1301  113-003-000    LIMATM ATMANSI   IS-NR        Active   ---
1304  113-002-000    DCM    STPLAN   IS-NR        Active   ---
1305  113-003-000    LIMDS0 SS7ANSI   IS-NR        Active   ---
1308  113-003-000    LIMDS0 SS7ANSI   IS-NR        Active   ---
1309  113-003-000    HMUX   BPHMUX   IS-NR        Active   ---
1310  113-003-000    HMUX   BPHMUX   IS-NR        Active   ---
1311  113-003-000    LIMDS0 SS7ANSI   IS-NR        Active   ---
1314  113-003-000    LIMDS0 SS7ANSI   IS-NR        Active   ---
```

```

1317 113-002-000 DCM      STPLAN  IS-NR      Active  ---
1318 113-003-000 LIMATM  ATMANSI  IS-NR      Active  ---

```

- If the signaling links on the card to be removed from the database is the last signaling link in a linkset, the `force=yes` parameter must be used with the `dlt-slk` command.

To verify this, enter the `rtrv-ls` command with the linkset name shown in step 1 (LSET NAME field) or in step 2 (LSN field). For this example, enter these commands.

```
rtrv-ls:lsn=sp1
```

This is an example of the possible output

```

rlghncxa03w 09-07-01 16:31:35 GMT EAGLE5 41.1.0

LSN          APCA  (SS7)  SCRNL  L3T  SLT          GWS  GWS  GWS
sp1          240-020-000  scr1  1    1    yes  A    2    off off off  yes  off

CLLI          TFATCABMLQ  MTPRSE  ASL8
-----      2          yes    yes

IPGWAPC  MATELSN  IPTPS  LSUSEALM  SLKUSEALM  GTTMODE
no        -----  ---    ---        ---        CdPA

          L2T          PCR  PCR
LOC  LINK  SLC  TYPE    SET  BPS    ECM  N1  N2
1201 B    0  LIMDS0  1    56000  BASIC ---  ----
1311 B    0  LIMDS0  1    56000  BASIC ---  ----

```

Link set table is (10 of 1024) 1% full

```
rtrv-ls:lsn=sp2
```

This is an example of the possible output

```

rlghncxa03w 09-07-01 16:31:35 GMT EAGLE5 41.1.0

LSN          APCA  (SS7)  SCRNL  L3T  SLT          GWS  GWS  GWS
sp2          240-030-000  scr1  1    1    yes  A    3    off off off  yes  off

CLLI          TFATCABMLQ  MTPRSE  ASL8
-----      2          yes    yes

IPGWAPC  MATELSN  IPTPS  LSUSEALM  SLKUSEALM  GTTMODE
no        -----  ---    ---        ---        CdPA

          L2T          PCR  PCR
LOC  LINK  SLC  TYPE    SET  BPS    ECM  N1  N2
1201 A    0  LIMDS0  1    56000  BASIC ---  ----
1202 A    1  LIMDS0  1    56000  BASIC ---  ----
1311 A    2  LIMDS0  1    56000  BASIC ---  ----

```

Link set table is (10 of 1024) 1% full

```
rtrv-ls:lsn=lsnatm1
```

This is an example of the possible output

rlghncxa03w 06-10-01 16:31:35 GMT EAGLE5 36.0.0

LSN	APCA (SS7)	SCRN	SET	SET	BEI	LST	LNKS	GWS	GWS	GWS	ACT	MES	DIS	SLSCI	NIS
lsnatm1	240-040-000	scr1	1	1	yes	A	2	off	off	off	yes	yes	off	yes	off

CLLI	TFATCABMLQ	MTPRSE	ASL8
-----	2	yes	yes

IPGWAPC	MATELSN	IPTPS	LSUSEALM	SLKUSEALM	GTTMODE
no	-----	---	---	---	CdPA

LOC	LINK	SLC	TYPE	LP	BPS	ATM	TSEL	VCI	VPI	LL
1301	A	0	LIMATM	SET	1544000	INTERNAL		35	15	
1318	A	1	LIMATM	SET	1544000	LINE		5	0	

Link set table is (10 of 1024) 1% full

rtrv-ls:lsn=sp3

This is an example of the possible output

rlghncxa03w 09-07-01 16:31:35 GMT EAGLE5 41.1.0

LSN	APCA (SS7)	SCRN	SET	SET	BEI	LST	LNKS	GWSA	GWSM	GWSD	SLSCI	NIS
sp3	240-050-000	scr1	1	1	yes	A	3	off	off	off	yes	off

CLLI	TFATCABMLQ	MTPRSE	ASL8
-----	2	yes	yes

IPGWAPC	MATELSN	IPTPS	LSUSEALM	SLKUSEALM	GTTMODE
no	-----	---	---	---	CdPA

LOC	LINK	SLC	TYPE	L2T	BPS	PCR	N1	PCR
1203	A	0	LIMDS0	SET	56000	BASIC	---	-----
1204	A	1	LIMDS0	SET	56000	BASIC	---	-----
1311	B1	2	LIMDS0	SET	56000	BASIC	---	-----

Link set table is (10 of 1024) 1% full

rtrv-ls:lsn=sp7

This is an example of the possible output

rlghncxa03w 09-07-01 16:31:35 GMT EAGLE5 41.1.0

LSN	APCA (SS7)	SCRN	SET	SET	BEI	LST	LNKS	GWS	GWS	GWS	ACT	MES	DIS	SLSCI	NIS
sp7	240-060-000	scr1	1	1	yes	A	3	off	off	off	yes	yes	off	yes	off

CLLI	TFATCABMLQ	MTPRSE	ASL8
-----	2	yes	yes

IPGWAPC	MATELSN	IPTPS	LSUSEALM	SLKUSEALM	GTTMODE
no	-----	---	---	---	CdPA

L2T	PCR	PCR
-----	-----	-----

LOC	LINK	SLC	TYPE	SET	BPS	ECM	N1	N2
1308	B	0	LIMDS0	1	56000	BASIC	---	-----
1311	A1	1	LIMDS0	1	56000	BASIC	---	-----
1315	A	2	LIMDS0	1	56000	BASIC	---	-----

Link set table is (10 of 1024) 1% full

- Inhibit the card using the `rmv-card` command, specifying the card location.

If the **LIM** to be inhibited contains the only signaling link in the linkset that in service, the `force=yes` parameter must also be specified. For this example, enter these commands.

```
rmv-card:loc=1201
rmv-card:loc=1318
rmv-card:loc=1311
```

When these commands have successfully completed, this message should appear.

```
rlghncxa03w 06-10-01 09:12:36 GMT EAGLE5 36.0.0
Card has been inhibited.
```

- Remove the signaling links on the specified card by using the `dlt-slk` command.

If the output of step 5 shows that the signaling link being removed is the last signaling link in a linkset, the `force=yes` parameter must be used. For this example, enter these commands.

```
dlt-slk:loc=1201:link=a
dlt-slk:loc=1201:link=b
dlt-slk:loc=1318:link=a
dlt-slk:loc=1311:link=a
dlt-slk:loc=1311:link=a1
dlt-slk:loc=1311:link=b:force=yes
dlt-slk:loc=1311:link=b1
```

When these commands have successfully completed, this message should appear.

```
rlghncxa03w 06-10-01 09:12:36 GMT EAGLE5 36.0.0
DLT-SLK: MASP A - COMPLTD
```

- Remove the card using the `dlt-card` command.

The `dlt-card` command has only one parameter, `loc`, which is the location of the card. For this example, enter these commands.

```
dlt-card:loc=1201
dlt-card:loc=1318
dlt-card:loc=1311
```

When these commands have successfully completed, this message should appear.

```
rlghncxa03w 06-10-01 09:12:36 GMT EAGLE5 36.0.0
DLT-CARD: MASP A - COMPLTD
```

9. Verify the changes using the `rtrv-card` command specifying the card that was removed in step 8.

For this example, enter these commands.

```
rtrv-card:loc=1201
```

```
rtrv-card:loc=1318
```

```
rtrv-card:loc=1311
```

When these commands have successfully completed, this message should appear.

```
E2144 Cmd Rej: Location invalid for hardware configuration
```

10. Back up the new changes using the `chg-db:action=backup:dest=fixedcommand`.

These messages should appear, the active **Maintenance and Administration Subsystem Processor (MASP)** appears first.

```
BACKUP (FIXED) : MASP A - Backup starts on active MASP.
```

```
BACKUP (FIXED) : MASP A - Backup on active MASP to fixed disk complete.
```

```
BACKUP (FIXED) : MASP A - Backup starts on standby MASP.
```

```
BACKUP (FIXED) : MASP A - Backup on standby MASP to fixed disk complete.
```

Figure 4-16 Removing an SS7 LIM

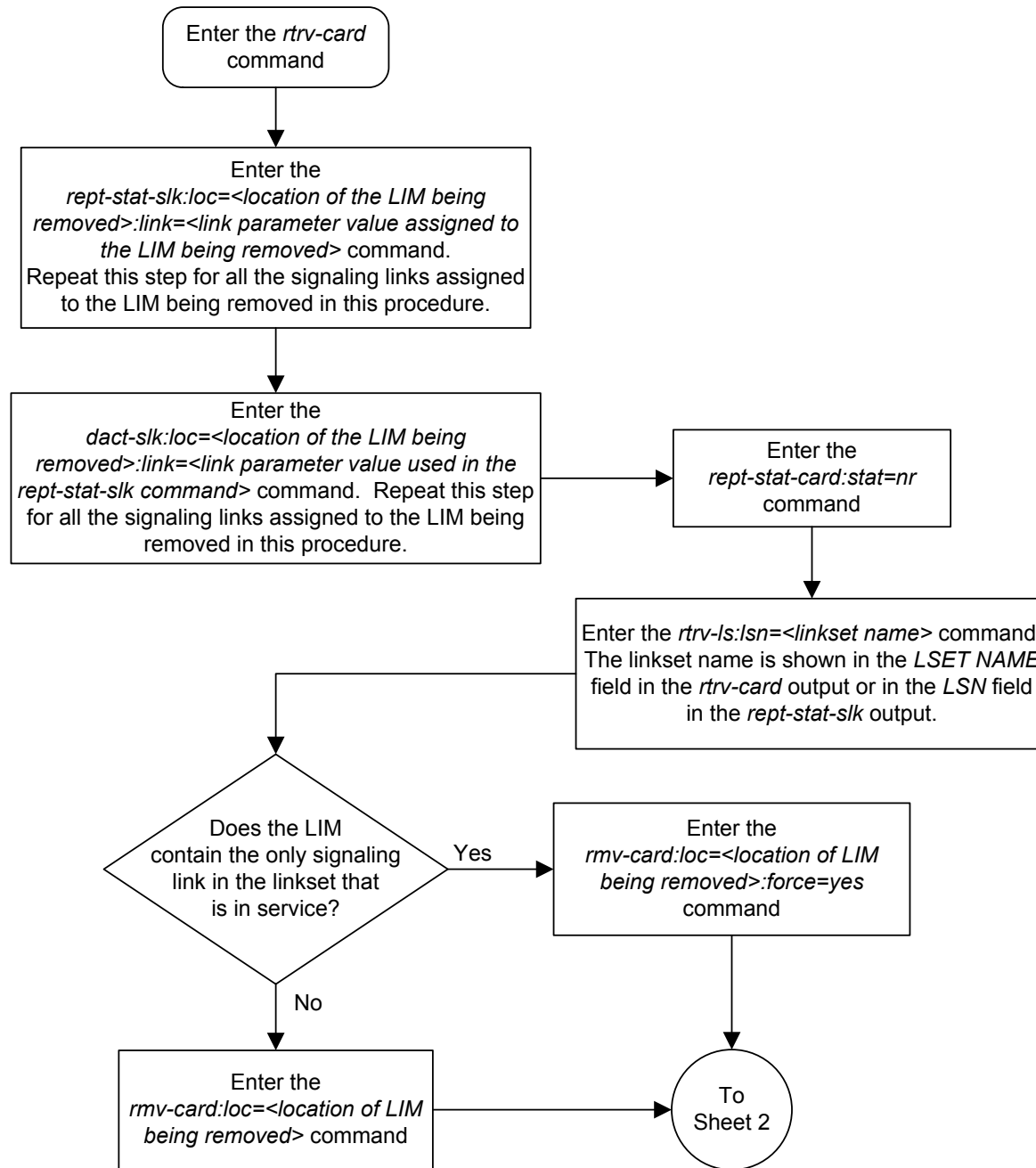

Sheet 1 of 2

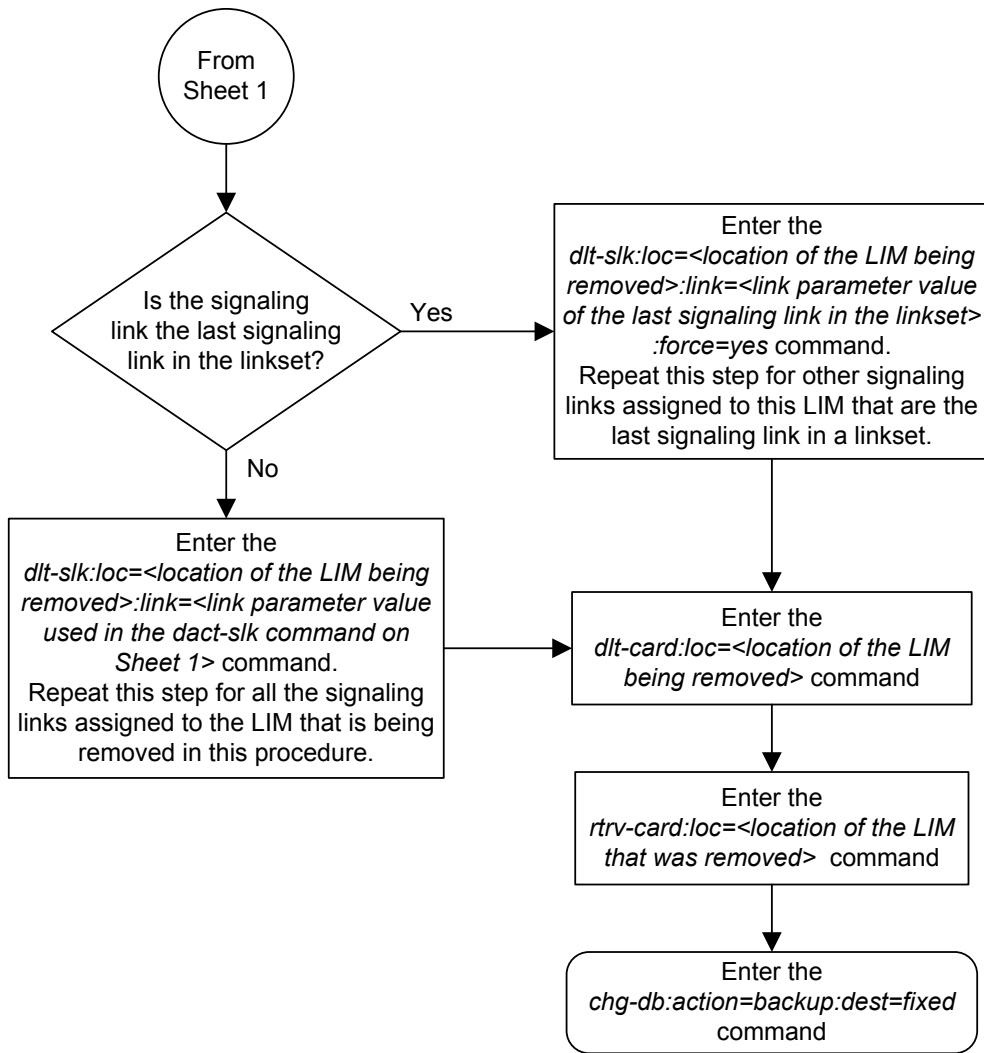

Configuring the UIM Threshold

This procedure is used to configure the threshold (the number of times during a specified period of time) a specific **UIM** (unsolicited information message) is displayed at an **EAGLE** terminal using the `set-uim-acthresh` command.

The `set-uim-acthresh` command uses these parameters.

`:uimn` – The number of the **UIM** that the threshold is being created for, or the threshold being changed. The number of the **UIM** must exist in the **EAGLE**. See *Unsolicited Alarm and Information Messages Reference* for a list of the **UIMs** that can be displayed.

`:limit` – The number of **UIMs** that can be displayed in the amount of time specified by the `intrvl` parameter.

`:intrvl` – The amount of time, in minutes, that the number of **UIMs** specified by the `limit` parameter can be displayed at the **EAGLE** terminal.

`:force` – The `force=yes` parameter allows the `limit` parameter to be set to 0 should the conditions at the **EAGLE** make this action necessary. Setting the `limit` parameter to 0 prevents the specified **UIM**, and the information contained in the **UIM**, from being displayed at the **EAGLE** terminal. It is highly recommended that the `limit` parameter value is not set to 0.

When the `limit=0` and the `force=yes` parameters are specified with the `set-uim-acthresh` command, this message appears in the scroll area of the terminal display.

Caution: Setting `LIMIT=0` suppresses **UIM** permanently

When creating a new **UIM** threshold, both the `limit` and `intrvl` parameters must be specified with the `set-uim-acthresh` command.

If you are changing an existing **UIM** threshold, either the `limit` or `intrvl` parameters must be specified with the `set-uim-acthresh` command.

The examples used in this procedure change the time interval for the existing **UIM** threshold for **UIM** 1155 from 30 minutes to 20 minutes, the number of **UIMs** displayed for existing **UIM** threshold for **UIM** 1162 from 100 to 25, and to create a new **UIM** threshold to display **UIM** 1075 for 175 times in 30 minutes. These changes are shown in [Table 4-5](#).

Table 4-5 Example UIM Threshold Configuration

UIM Number	Old Limit	Old Time Interval	New Limit	New Time Interval
1155	50	30	No Change	20
1162	100	5	25	No Change
1075	N/A	N/A	175	30

1. Display the **UIM** thresholds in the database using the `rtrv-uim-acthresh` command.

This is an example of the possible output.

```
rlghncxa03w 06-10-01 08:50:12 GMT EAGLE5 36.0.0
UIMN    LIMIT    INTRVL
1155    50        30
1162    100       5
1216    200       15
```

The UIM Threshold Table is (3 of 499) 1% full.

2. Configure the **UIM** threshold using the `set-uim-acthresh` command.

For this example, enter these commands.

```
set-uim-acthresh:uimn=1155:intrvl=20
```

```
set-uim-acthresh:uimn=1162:limit=25
```

```
set-uim-acthresh:uimn=1075:limit=175:intrvl=30
```

When each of these commands has successfully completed, this message should appear.

```
rlghncxa03w 06-10-01 08:50:12 GMT EAGLE5 36.0.0
SET-UIM-ACTHRESH: MASP A - COMPLTD
```

3. Verify the changes using the `rtrv-uim-acthresh` command.

This is an example of the possible output.

```
rlghncxa03w 06-10-01 08:50:12 GMT EAGLE5 36.0.0
UIMN    LIMIT    INTRVL
1075    175     30
1155    50      20
1162    25      5
1216    200     15
```

The UIM Threshold Table is (4 of 499) 1% full.

4. Back up the new changes using the `chg-db:action=backup:dest=fixedcommand`.

These messages should appear, the active **Maintenance and Administration Subsystem Processor (MASP)** appears first

.

```
BACKUP (FIXED) : MASP A - Backup starts on active MASP.
BACKUP (FIXED) : MASP A - Backup on active MASP to fixed disk complete.
BACKUP (FIXED) : MASP A - Backup starts on standby MASP.
BACKUP (FIXED) : MASP A - Backup on standby MASP to fixed disk complete.
```

Figure 4-17 Configuring the UIM Threshold

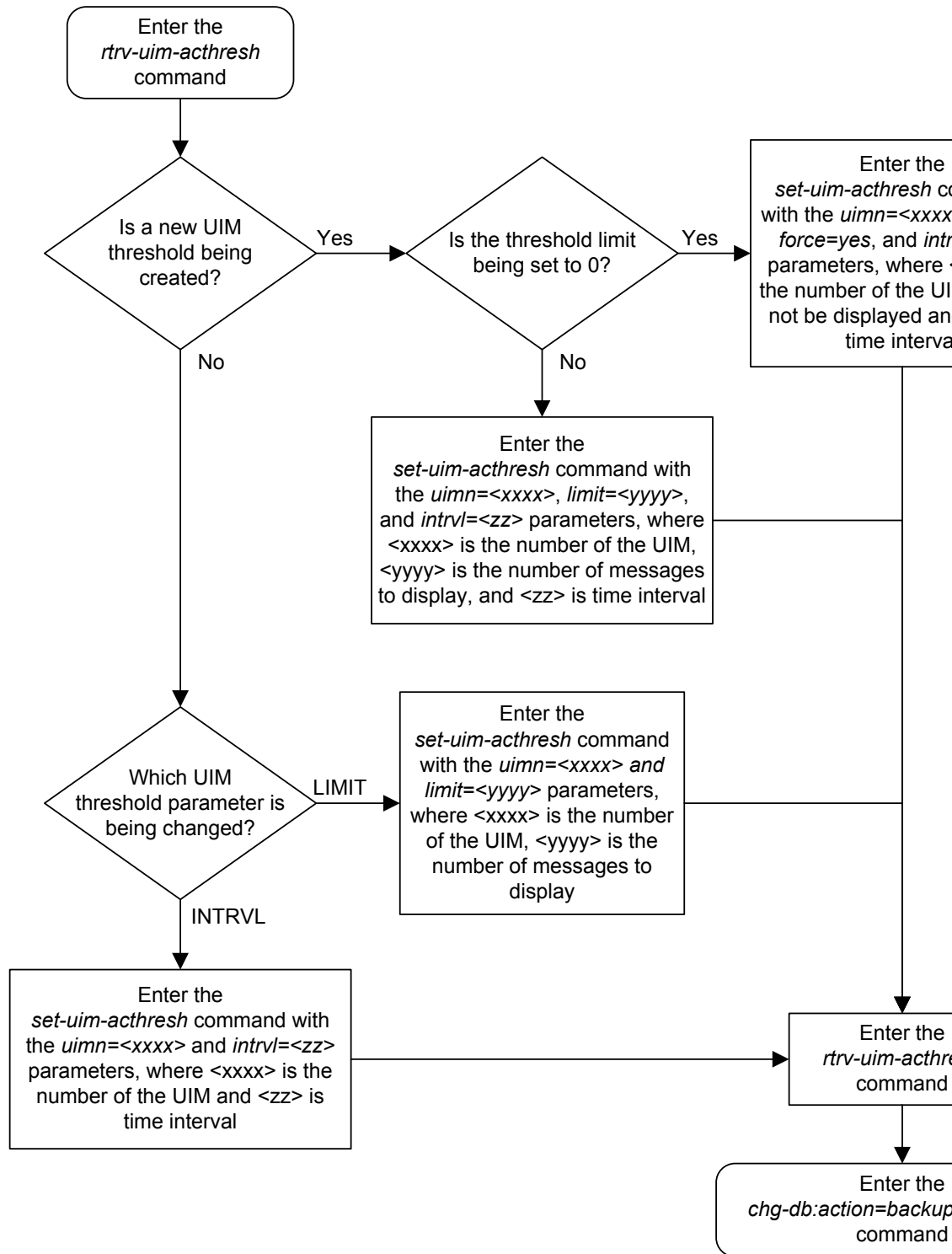

Removing a UIM Threshold

This procedure is used to remove a **UIM** threshold from the database using the `dlt-uim-acthresh` command. The `dlt-uim-acthresh` command has only one parameter, `uimn`, which specifies the **UIM** number of the **UIM** threshold that is being removed from the database.

The **UIM** threshold must be in the database.

The example in this procedure removes the **UIM** threshold for **UIM** 1216 from the database.

1. Display the **UIM** thresholds in the database using the `rtrv-uim-acthresh` command.

This is an example of the possible output.

```
rlghncxa03w 06-10-01 08:50:12 GMT EAGLE5 36.0.0
UIMN      LIMIT      INTRVL
1075      175         30
1155      50          20
1162      25          5
1216      200         15
```

The UIM Threshold Table is (4 of 499) 1% full.

2. Remove a **UIM** threshold from the database using the `dlt-uim-acthresh` command.

For this example, enter this command.

```
dlt-uim-acthresh:uimn=1216
```

When this command has successfully completed, this message should appear.

```
rlghncxa03w 06-10-01 08:50:12 GMT EAGLE5 36.0.0
DLT-UIM-ACTHRESH: MASP A - COMPLTD
```

3. Verify the changes using the `rtrv-uim-acthresh` command.

This is an example of the possible output.

```
rlghncxa03w 06-10-01 08:50:12 GMT EAGLE5 36.0.0
UIMN      LIMIT      INTRVL
1075      175         30
1155      50          20
1162      25          5
```

The UIM Threshold Table is (3 of 499) 1% full.

4. Back up the new changes using the `chg-db:action=backup:dest=fixed` command.

These messages should appear, the active **Maintenance and Administration Subsystem Processor (MASP)** appears first.

```
BACKUP (FIXED) : MASP A - Backup starts on active MASP.
BACKUP (FIXED) : MASP A - Backup on active MASP to fixed disk complete.
```

BACKUP (FIXED) : MASP A - Backup starts on standby MASP.
BACKUP (FIXED) : MASP A - Backup on standby MASP to fixed disk complete.

Figure 4-18 *Removing a UIM Threshold*

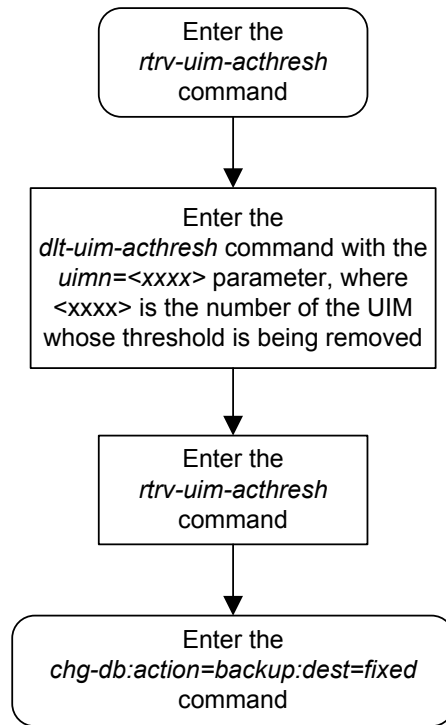

Configuring the Measurements Terminal for an EAGLE Containing 700 Signaling Links

This procedure is used to configure a terminal to collect measurement reports on an EAGLE that contains from 501 to 700 signaling links. The `chg-trm` command is used to configure this terminal and uses these parameters to configure this terminal.

Note: The terminal being configured in this procedure must be terminals 1 through 16. Telnet terminals cannot be specified in this procedure.

`:trm` – Serial port number

`:baud` – Serial port baud rate

`:sb` – The number of stop bits used in communications with the device

`:prty` – Parity used by the device

`:type` – The type of device being connected.

`:fc` – The type of flow control used between the EAGLE and the output devices (vt320 terminal, modem, printer, or **KSR** terminal).

`:tmout` – The maximum amount of time that a login session on the specified port can remain idle (that is, no user input) on the port before being automatically logged off.

`:mxinv` – The login failure threshold

`:dural` – The length of time that the terminal is disabled after the login failure threshold has been exceeded.

`:all` – All unsolicited messages are received by the specified port

`:traf` – Traffic measurement related unsolicited messages are received by the specified port

Note:

There are other parameters that can be used with the `chg-trm` command but these parameters cannot be used in this procedure. For more information on these parameters, go to [Changing Terminal Characteristics](#) procedure, or to the `chg-trm` command description in *Commands User's Guide*.

The measurement terminal must be configured with these parameter values:

- `trm=<terminal being changed>`
- `baud=19200`
- `type=ksr`
- `traf=yes` – all other output message groups must be set to no.

The other parameters listed in this procedure do not have to be specified with the `chg-trm` command. If these parameters are not specified with the `chg-trm` command, these default values will be assigned to the measurements terminal:

- `prty` – even
- `sb` – 1
- `fc` – sw (software)
- `tmout` – 30 minutes
- `mxinv` – 5
- `dural` – 100 (1 minute, 0 seconds)

The terminal must be placed out of service before it can be configured.

If the terminal being changed has output message groups other than `traf` set to `yes`, the `all=no` parameter must be specified with the `chg-trm` command. The `chg-trm` command can then be specified with the `traf=yes` parameter.

The messages assigned to the output message groups defined by the `traf` parameters are listed in *Unsolicited Alarm and Information Messages Reference*.

The `tmout`, `dural`, and `mxinv` parameters can be applied to this terminal. See the "Security Parameters" section in the [Changing Terminal Characteristics](#) procedure for more information on these parameters.

The total value of the terminals' baud rate cannot be greater than 172,032. If the total baud rate of the terminals exceeds 172,032, change the baud rates of the terminals so that the total baud rate is not greater than 172,032.

The output of the `rtrv-trm` command is displayed in two parts. The first part displays the communication security attributes of the terminal. The communication attributes of the terminal, `BAUD`, `PRTY` (parity), `SB` (stop bits), and `DBTS` (data bits), are displayed in the `COMM` field of the `rtrv-trm` output and are displayed in this format: **BAUD-DBTS-PRTY-SB**. The second part of the `rtrv-trm` command output displays the types of unsolicited messages the terminal may receive. An example of the `rtrv-trm` command output is shown in this example.

```
rlghncxa03w 06-10-01 16:02:08 GMT EAGLE5 36.0.0
TRM  TYPE    COMM          FC    TMOUT MXINV DURAL
3    VT320    9600-7-E-1 SW    30    5     99:59:59

TRM  TRAF LINK SA  SYS PU  DB  UIMRD
3    NO  YES NO  YES NO  YES YES

      APP  APP
TRM  SERV SS  CARD CLK DBG GTT GWS MEAS MON MPS SEAS SLAN
3    YES YES YES YES YES YES YES YES YES YES YES NO  NO
```

In this example, terminal 3 is running at 9600 baud with 7 data bits, even parity, and 1 stop bit.

The examples in this procedure are used to configure terminal 1 as the measurements terminal.

1. Display the values of all terminals using the `rtrv-trm` command.

This is an example of the possible output.

```
rlghncxa03w 06-10-01 16:02:08 GMT EAGLE5 36.0.0
TRM  TYPE    COMM          FC    TMOUT MXINV DURAL
1    VT320    9600-7-E-1 SW    30    5     99:59:59
```

2	KSR	9600-7-E-1	HW	30	5	INDEF
3	PRINTER	4800-7-E-1	HW	30	0	00:00:00
4	VT320	2400-7-E-1	BOTH	30	5	00:30:00
5	VT320	9600-7-O-1	NONE	30	5	00:00:30
6	VT320	9600-7-E-2	SW	30	9	INDEF
7	PRINTER	9600-7-N-2	HW	30	5	00:30:00
8	KSR	19200-7-E-2	BOTH	30	5	00:30:00
9	VT320	9600-7-E-1	SW	30	7	00:30:00
10	VT320	9600-7-E-1	HW	30	5	00:30:00
11	VT320	4800-7-E-1	HW	30	5	00:30:00
12	PRINTER	9600-7-E-1	HW	30	4	00:30:00
13	VT320	9600-7-O-1	NONE	30	5	00:30:00
14	VT320	9600-7-E-2	SW	30	8	00:30:00
15	VT320	9600-7-N-2	HW	30	5	00:30:00
16	VT320	9600-7-E-2	BOTH	30	3	00:30:00

TRM	TRAF	LINK	SA	SYS	PU	DB	UIMRD
1	NO	YES	NO	NO	NO	YES	YES
2	NO	NO	NO	NO	NO	NO	NO
3	YES	YES	YES	NO	YES	YES	YES
4	YES	NO	NO	NO	NO	NO	NO
5	NO	YES	NO	NO	NO	NO	YES
6	NO	NO	YES	NO	NO	NO	NO
7	YES	YES	YES	YES	YES	YES	YES
8	NO	NO	NO	NO	YES	NO	YES
9	NO	YES	NO	NO	NO	YES	NO
10	NO	NO	NO	NO	NO	NO	YES
11	YES	YES	YES	YES	YES	YES	YES
12	YES	YES	YES	YES	YES	YES	YES
13	NO	YES	NO	NO	NO	NO	YES
14	NO	NO	YES	NO	NO	NO	NO
15	YES	YES	YES	NO	YES	YES	YES
16	NO	NO	NO	NO	YES	NO	YES

APP		APP										
TRM	SERV	SS	CARD	CLK	DBG	GTT	GWS	MEAS	MON	MPS	SEAS	SLAN
1	YES	YES	YES	YES	YES	YES	YES	YES	YES	YES	NO	NO
2	YES	YES	YES	YES	YES	YES	YES	YES	YES	YES	NO	NO
3	YES	YES	YES	YES	YES	YES	YES	YES	YES	YES	NO	NO
4	YES	YES	YES	YES	YES	NO	YES	YES	YES	YES	NO	NO
5	YES	YES	YES	YES	YES	YES	YES	YES	YES	YES	NO	NO
6	YES	YES	YES	YES	YES	YES	YES	YES	YES	YES	NO	NO
7	NO	YES	YES	YES	YES	YES	YES	YES	YES	YES	NO	NO
8	YES	YES	YES	YES	YES	YES	YES	YES	YES	YES	YES	YES
9	YES	YES	YES	YES	YES	YES	YES	YES	YES	YES	YES	YES
10	NO	NO	NO	NO	NO	NO	NO	NO	NO	NO	NO	NO
11	NO	NO	NO	NO	NO	NO	NO	NO	NO	NO	NO	NO
12	NO	NO	NO	NO	NO	NO	NO	NO	NO	NO	NO	NO
13	NO	NO	NO	NO	NO	NO	NO	NO	NO	NO	NO	NO
14	NO	NO	NO	NO	NO	NO	NO	NO	NO	NO	NO	NO
15	NO	NO	NO	NO	NO	NO	NO	NO	NO	NO	NO	NO
16	NO	NO	NO	NO	NO	NO	NO	NO	NO	NO	NO	NO

- Inhibit the terminal you wish to change using the `rmv-trm` command and specify the port you wish to inhibit.

For this example, enter this command.

```
rmv-trm:trm=1
```

When this command has successfully completed, this message should appear.

```
rlghncxa03w 06-10-01 15:08:45 GMT EAGLE5 36.0.0
Inhibit message sent to terminal
```

```
rlghncxa03w 06-10-01 15:08:45 GMT EAGLE5 36.0.0
Command Completed.
```

3. Verify that the terminal that was inhibited in step 4 is in the **OOS-MT-DSBLD** state by entering the `rept-stat-trm` command.

For this command, enter this command.

```
rept-stat-trm:trm=1
```

This is an example of the possible output.

```
rlghncxa03w 06-10-01 15:08:45 GMT EAGLE5 36.0.0
TRM   PST           SST           AST
1     OOS-MT-DSBLD  MANUAL         -----
Command Completed.
```

4. Configure the measurements terminal using the `chg-trm` command and making sure that only the `traf` output message group is set to `yes`.
 - a. If the output of the `rtrv-trm` command output in step 1 shows that all the output message groups are set to `no`, then only the `traf=yes` parameter needs to be specified for the output message group assignments as show in this example.

```
chg-trm:trm=1:type=ksr:baud=19200:traf=yes
```

- b. If however, the `rtrv-trm` command output shows that output message groups other than `traf` are set to `yes`, the `chg-trm` command must be entered with the `all=no` and the `traf=yes` parameter as shown in this example.

```
chg-trm:trm=1:type=ksr:baud=19200:traf=yes:all=no
```

For this example enter the command shown in substep b.

When the `chg-trm` command has successfully completed, this message should appear.

```
rlghncxa03w 06-10-0115:08:45 GMT EAGLE5 36.0.0
CHG-TRM: MASP A - COMPLTD
```

5. Verify the changes made in step 4 by using the `rtrv-trm` command with the port number specified in step 4.

For this example, enter this command.

```
rtrv-trm:trm=1
```

This is an example of the possible output.

```
rlghncxa03w 06-10-01 16:02:08 GMT EAGLE5 36.0.0
TRM  TYPE   COMM      FC   TMOUT MXINV DURAL
1    KSR    19200-7-E-1 SW   30   5     00:01:00

TRM  TRAF  LINK  SA   SYS  PU  DB  UIMRD
1    YES  NO   NO  NO   NO  NO  NO
```



```

APP APP
TRM SERV SS CARD CLK DBG GTT GWS MEAS MON MPS SEAS SLAN
1 NO NO NO NO NO NO NO NO NO NO NO NO

```

6. When the changes are complete, and if the terminal was inhibited in step 4, activate the terminal using the `rst-trm` command.

For this example, enter this command.

```
rst-trm:trm=1
```

When this command has successfully completed, this message should appear.

```

rlghncxa03w 06-10-01 15:08:45 GMT EAGLE5 36.0.0
Allow message sent to terminal

```

7. Back up the new changes using the `chg-db:action=backup:dest=fixed` command.

These messages should appear, the active **Maintenance and Administration Subsystem Processor (MASP)** appears first.

```

BACKUP (FIXED) : MASP A - Backup starts on active MASP.
BACKUP (FIXED) : MASP A - Backup on active MASP to fixed disk complete.
BACKUP (FIXED) : MASP A - Backup starts on standby MASP.
BACKUP (FIXED) : MASP A - Backup on standby MASP to fixed disk complete.

```

Figure 4-19 Configuring the Measurements Terminal for an EAGLE Containing 700 Signaling Links

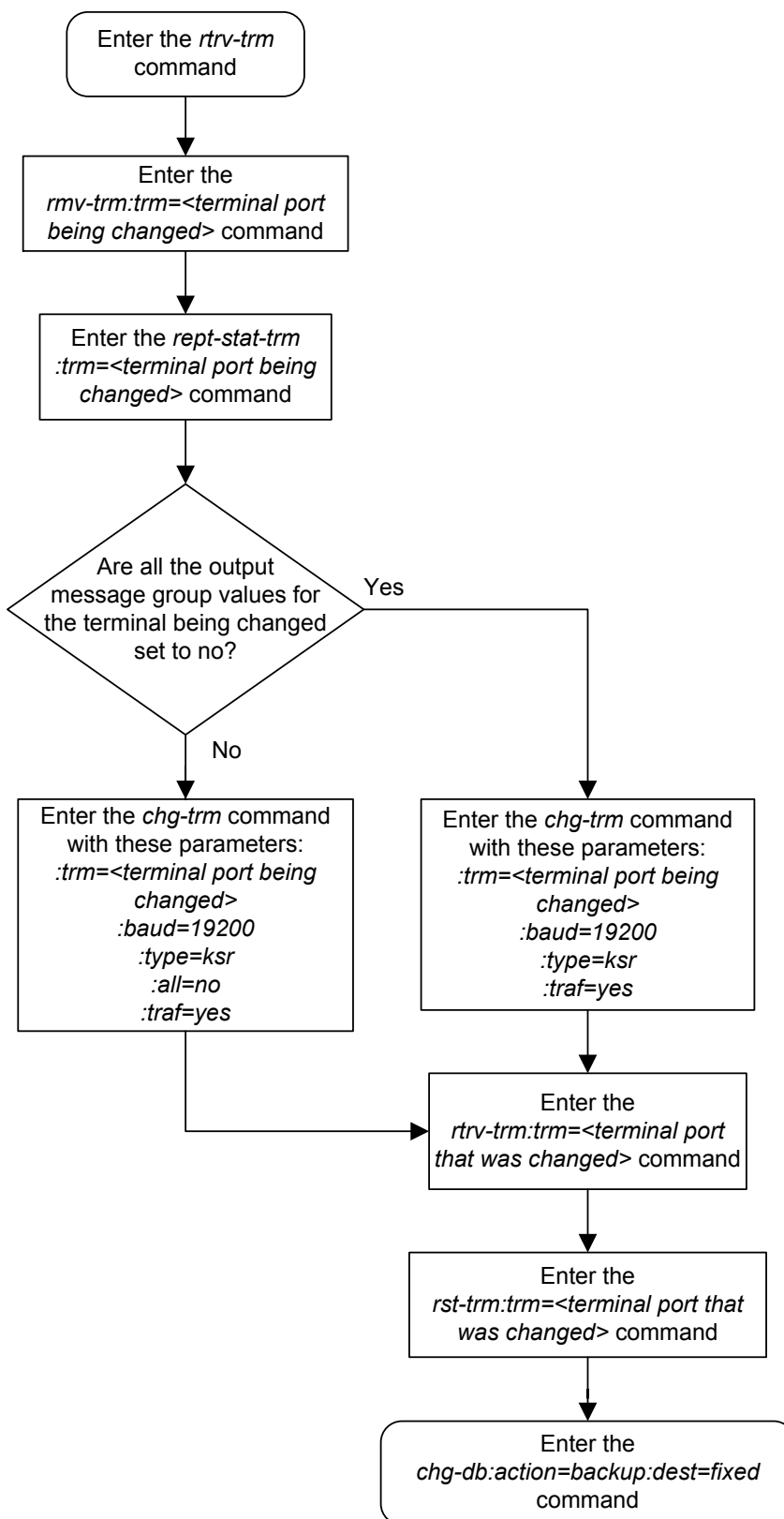

Adding a Measurement Collection and Polling Module (MCPM)

This procedure is used to add an Measurement Collection and Polling Module (MCPM), used for the Measurements Platform feature, to the database using the `ent-card` command. The **MCPM** provides an interface between the **EAGLE** and the customer's network. The Measurements Platform provides a dedicated processor for collecting and transferring measurements data to a customer supplied **FTP** server.

The `ent-card` command uses these parameters.

`:loc` – The location of the card being added to the database.

`:type` – The type of card being added to the database. For this procedure, the value of this parameter is `mcpm`.

`:appl` – The application software that is assigned to the card. For this procedure, the value of this parameter is `mcp`.

The Measurements Platform feature requires a minimum of two **MCPM** cards (part number 870-2372-03 or later) with at least 2 **GB** of memory per card or two **E5-MCPM-B** cards with at least 4 GB of memory per card. The **MCPM** and **E5-MCPM-B** cards can also be used in mixed mode.

The Measurements Platform feature must be on in order to add a **MCPM** to the database. This can be verified with the `rtrv-feat` command. To enable the Measurements Platform feature, the `measplat=on` parameter must be specified with the `chg-feat` command.

Note: The Measurements Platform feature must be purchased before turning on the feature. If you are not sure whether you have purchased the Measurements Platform feature, contact your Oracle Sales Representative or Account Representative.

The shelf to which the card is to be added, must already be in the database. This can be verified with the `rtrv-shlf` command. If the shelf is not in the database, see the [Adding a Shelf](#) procedure.

After all required **MCPMs** have been configured in the database, go to the [Configuring the Measurements Platform Feature](#) procedure and configure the **IP** links for these **MCPMs** and enable the **Measurement Platform** feature, if necessary.

The examples in this procedure are used to add an **MCPM** in card location 2107.

1. Verify that the **MCPM** (part number 870-2372-03 or later) being added to the database has been physically installed into the proper location.
2. Connect the Ethernet cables from the customer's network to Port A of the **MCPM**.
3. Display the cards in the database using the `rtrv-card` command.

This is an example of the possible output.

```
rlghncxa03w 09-05-01 09:12:36 GMT EAGLE5 41.0.0
CARD  TYPE      APPL      LSET NAME      LINK SLC LSET NAME      LINK SLC
1101  DSM          VSCCP
1102  TSM          GLS
1103  DCM          STPLAN
1113  GSPM         OAM
```

1114	TDM-A								
1115	GSPM	OAM							
1116	TDM-B								
1117	MDAL								
1201	LIMDS0	SS7ANSI	sp2	A	0	sp1	B	0	
1202	LIMDS0	SS7ANSI	sp2	A	1	nsp3	B	0	
1203	LIMDS0	SS7ANSI	sp3	A	0				
1204	LIMDS0	SS7ANSI	sp3	A	1				
1205	LIMDS0	SS7ANSI	itu1	A	0				
1206	LIMDS0	SS7ANSI	nsp3	A	1	nsp4	B	0	
1212	DSM	VSCCP							
1214	TSM	GLS							
1215	DCM	STPLAN							
1301	LIMATM	ATMANSI	lsnatm1	A	0				
1303	STC	EROUTE							
1305	DCM	STPLAN							
1308	LIMDS0	SS7ANSI	sp6	A	0	sp7	B	0	
1311	LIMDS0	SS7ANSI	sp2	A	2	sp1	B	1	
			sp7	A1	1	sp3	B1	2	
1315	LIMDS0	SS7ANSI	sp7	A	2	sp5	B	0	
1318	LIMATM	ATMANSI	lsnatm1	A	1				
2101	STC	EROUTE							
2103	STC	EROUTE							
2105	STC	EROUTE							

The cards should be distributed throughout the **EAGLE** for proper power distribution. Refer to *Installation Guide* for the shelf power distribution.

Note: If the `rtrv-card` output from step 3 shows an **MCPM** card, shown by the entries MCPM in the TYPE column and MCP in the APPL column, skip steps 4 and 5, and go to step 6.

- Verify that the Measurements Platform feature is enabled by entering the `rtrv-feat` command.

If the Measurements Platform feature is on, the MEASPLAT field should be set to on. For this example, the Measurements Platform feature is off.

Note: The `rtrv-feat` command output contains other fields that are not used by this procedure. If you wish to see all the fields displayed by the `rtrv-feat` command, see the `rtrv-feat` command description in *Commands User's Guide*.

Note: If the Measurements Platform feature is on, skip step 5, and go to step 6.

- Turn the Measurements Platform feature on by entering this command.

```
chg-feat : measplat=on
```

Note: Once the Measurements Platform feature is turned on with the `chg-feat` command, it cannot be turned off.

The Measurements Platform feature must be purchased before turning on the feature. If you are not sure whether you have purchased the Measurements Platform feature, contact your Oracle Sales Representative or Account Representative.

When the `chg-feat` has successfully completed, this message should appear.

```
rlghncxa03w 06-10-01 21:18:37 GMT EAGLE5 36.0.0
CHG-FEAT: MASP A - COMPLTD
```

6. Verify that the EAGLE has a fan unit and the fan unit is on. If the fan unit is not on, use the `chg-feat:fan=on` command to turn on the fan.
7. Add the **MCPM** using the `ent-card` command.

For this example, enter this command.

```
ent-card:loc=2107:type=mcpm:appl=mcp
```

When each of these commands have successfully completed, this message should appear.

```
rlghncxa03w 06-10-01 09:12:36 GMT EAGLE5 36.0.0
ENT-CARD: MASP A - COMPLTD
```

8. Verify the changes using the `rtrv-card` command with the card location specified in step 6.

For this example, enter this command.

```
rtrv-card:loc=2107
```

This is an example of the possible output.

```
rlghncxa03w 06-10-01 09:12:36 GMT EAGLE5 36.0.0
CARD  TYPE      APPL      LSET NAME      LINK SLC LSET NAME      LINK SLC
2107  MCPM         MCP
```

9. Back up the new changes using the `chg-db:action=backup:dest=fixed` command.

These messages should appear, the active **Maintenance and Administration Subsystem Processor (MASP)** appears first.

```
BACKUP (FIXED) : MASP A - Backup starts on active MASP.
BACKUP (FIXED) : MASP A - Backup on active MASP to fixed disk complete.
BACKUP (FIXED) : MASP A - Backup starts on standby MASP.
BACKUP (FIXED) : MASP A - Backup on standby MASP to fixed disk complete.
```

10. Go to the [Configuring the Measurements Platform Feature](#) procedure and configure the **IP** links for these **MCPMs** and enable the **Measurement Platform** feature, if necessary.

Note: Before executing this procedure, make sure you have purchased the Measurements Platform feature. If you are not sure whether you have purchased the Measurements Platform feature, contact your Oracle Sales Representative or Account Representative.

Figure 4-20 Adding a Measurement Collection and Polling Module (MCPM)

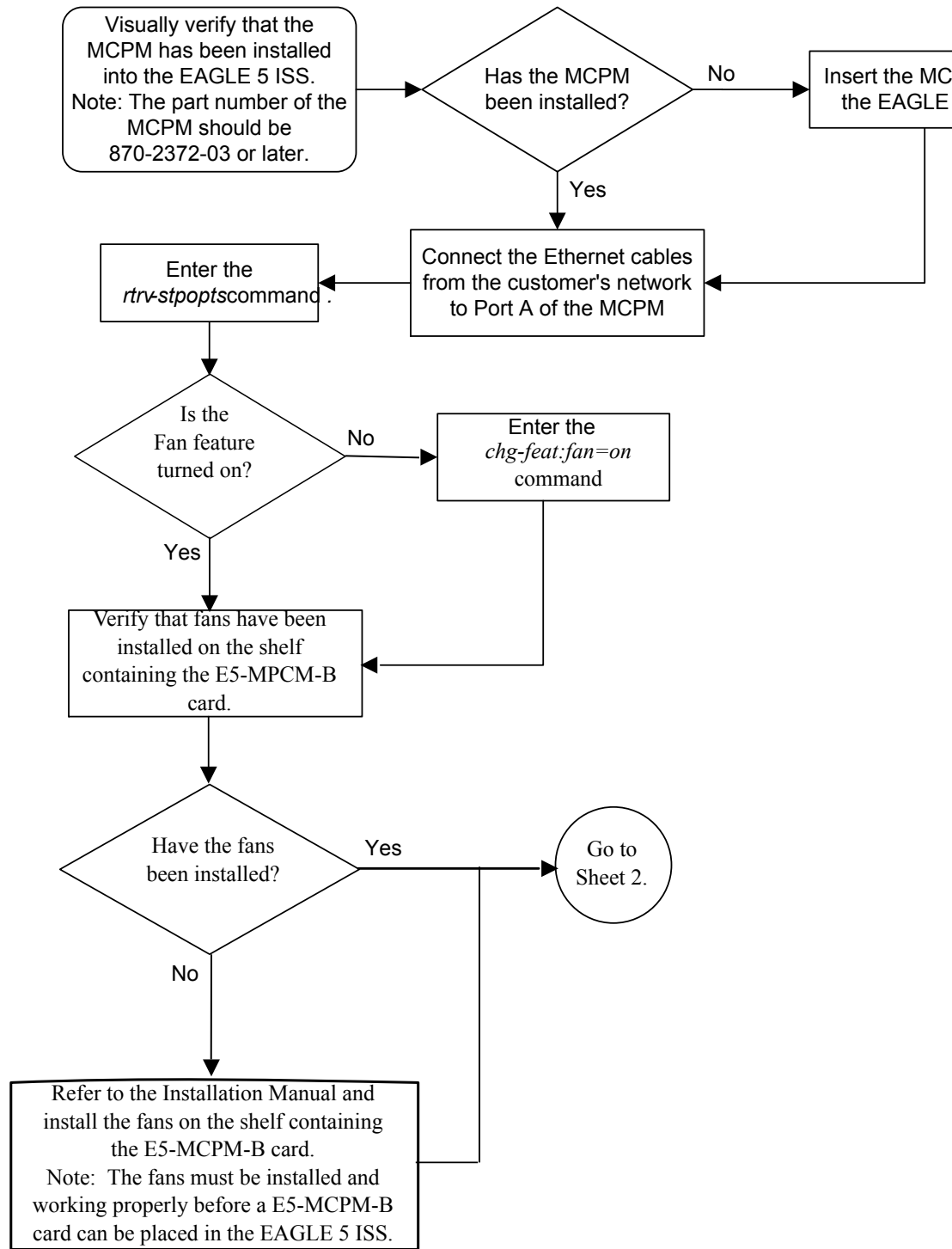

Sheet 1 of 2

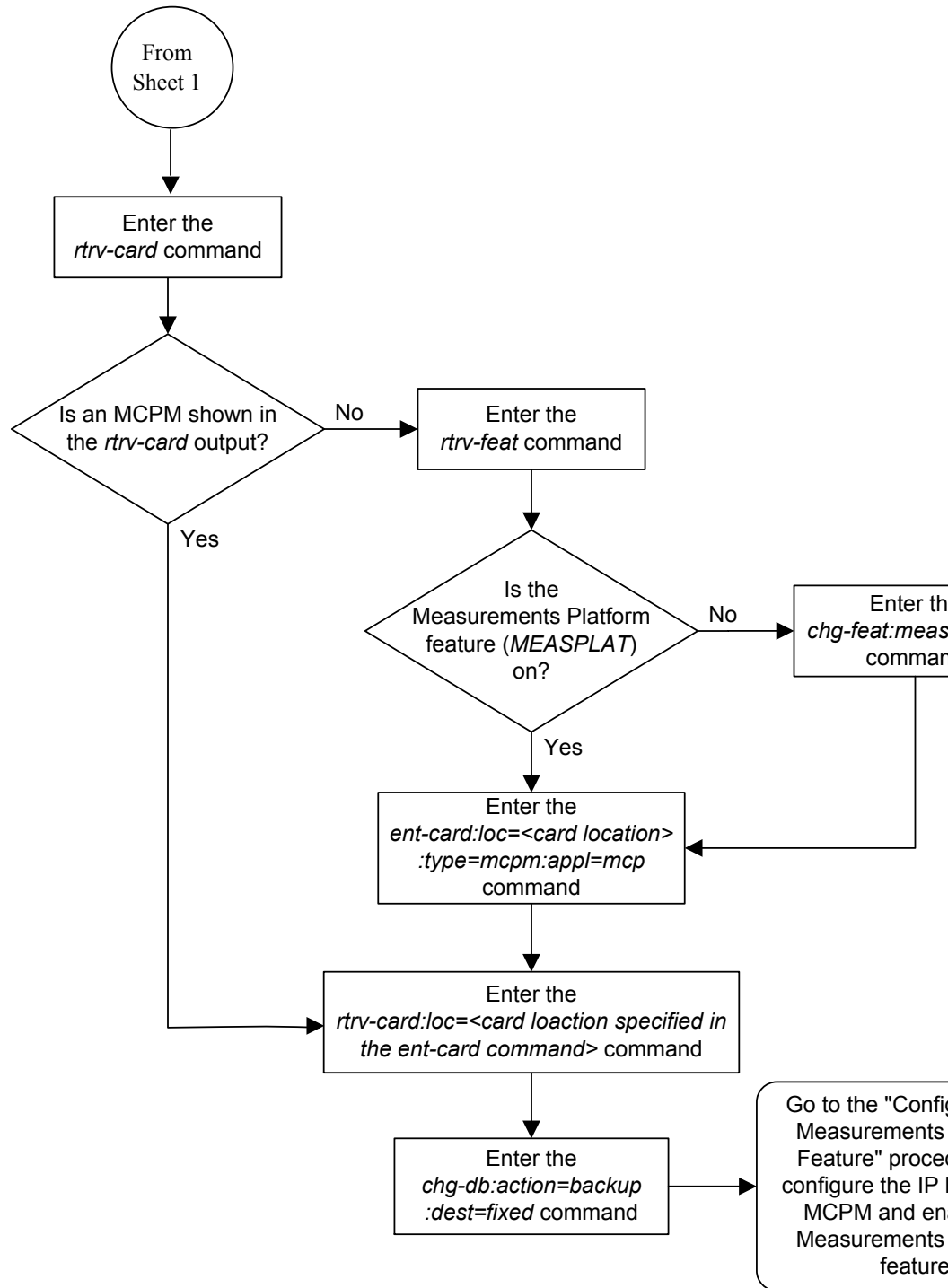

Removing an MCPM

This procedure is used to remove a Measurement Collection & Polling Module (MCPM) from the database using the `dlt-card` command.

Caution: If the MCPM is the last MCPM in service, removing this card from the database will disable the Measurements Platform feature.

The examples in this procedure are used to remove the MCPM in card location 2107.

Canceling the REPT-STAT-CARD Command

Because the `rept-stat-card` command used in this procedure can output information for a long period of time, the `rept-stat-card` command can be canceled and the output to the terminal stopped. There are three ways that the `rept-stat-card` command can be canceled.

- Press the F9 function key on the keyboard at the terminal where the `rept-stat-card` command was entered.
- Enter the `canc-cmd` without the `trm` parameter at the terminal where the `rept-stat-card` command was entered.
- Enter the `canc-cmd:trm=<xx>`, where `<xx>` is the terminal where the `rept-stat-card` command was entered, from another terminal other than the terminal where the `rept-stat-card` command was entered. To enter the `canc-cmd:trm=<xx>` command, the terminal must allow Security Administration commands to be entered from it and the user must be allowed to enter Security Administration commands. The terminal's permissions can be verified with the `rtrv-secu-trm` command. The user's permissions can be verified with the `rtrv-user` or `rtrv-secu-user` commands.

For more information about the `canc-cmd` command, go to *Commands User's Guide*.

1. Display the cards in the database using the `rtrv-card` command.

This is an example of the possible output.

```
rlghncxa03w 09-05-01 09:12:36 GMT EAGLE5 41.0.0
CARD  TYPE      APPL      LSET NAME      LINK SLC LSET NAME      LINK SLC
1101  DSM          VS CCP
1102  TSM          GLS
1103  DCM          STPLAN
1113  GSPM         OAM
1114  TDM-A
1115  GSPM         OAM
1116  TDM-B
1117  MDAL
1201  LIMDS0      SS7ANSI   sp2            A      0      sp1            B      0
1202  LIMDS0      SS7ANSI   sp2            A      1      nsp3           B      0
1203  LIMDS0      SS7ANSI   sp3            A      0
1204  LIMDS0      SS7ANSI   sp3            A      1
1205  LIMDS0      SS7ANSI   itu1           A      0
1206  LIMDS0      SS7ANSI   nsp3           A      1      nsp4           B      0
1212  DSM          VS CCP
1214  TSM          GLS
```

```

1215 DCM STPLAN
1301 LIMATM ATMANSI lsnatm1 A 0
1303 STC EROUTE
1305 DCM STPLAN
1308 LIMDS0 SS7ANSI sp6 A 0 sp7 B 0
1311 LIMDS0 SS7ANSI sp2 A 2 sp1 B 1
      sp7 A1 1 sp3 B1 2
1315 LIMDS0 SS7ANSI sp7 A 2 sp5 B 0
1318 LIMATM ATMANSI lsnatm1 A 1
2101 STC EROUTE
2103 STC EROUTE
2105 STC EROUTE
2107 MCPM MCP
2108 MCPM MCP
2111 MCPM MCP

```

An **MCPM** is identified by the entries MCPM in the TYPE field and MCP in the APPL field.

2. Display the status of the **MCPMs** in the database with the `rept-stat-meas` command.

This is an example of the possible output.

```

rlghncxa03w 09-02-01 16:43:42 GMT EAGLE5 40.0.0

MEAS SS          PST          SST          AST
          IS-NR          Active          -----
          ALARM STATUS = No Alarms

CARD  VERSION          TYPE  PST          SST          AST
2107 P 101-009-000     MCPM  IS-NR        Active        -----
      IP Link A          IS-NR        Active        Available
2108 101-009-000     MCPM  IS-NR        Active        -----
      IP Link A          IS-NR        Active        Available
2111 101-009-000     MCPM  IS-NR        Active        -----
      IP Link A          IS-NR        Active        Available

CARD 2107 ALARM STATUS = No Alarms
CARD 2108 ALARM STATUS = No Alarms
CARD 2111 ALARM STATUS = No Alarms

```

3. Inhibit the **MCPM** using the `rmv-card` command, specifying the card location of the MCPM.

If the **MCPM** to be inhibited is the last **MCPM** that is in service, the `force=yes` parameter must also be specified. For this example, enter this command.

```
rmv-card:loc=2107
```

When this command has successfully completed, this message should appear.

```

rlghncxa03w 06-10-01 09:12:36 GMT EAGLE5 36.0.0
Card has been inhibited.

```

4. Remove the card using the `dlt-card` command.

The `dlt-card` command has only one parameter, `loc`, which is the location of the card. For this example, enter these commands.

```
dlt-card:loc=2107
```

When this command has successfully completed, this message should appear.

```
rlghncxa03w 06-10-01 09:12:36 GMT EAGLE5 36.0.0  
DLT-CARD: MASP A - COMPLTD
```

5. Verify the changes using the `rtrv-card` command specifying the card that was removed in step 4.

For this example, enter these commands.

```
rtrv-card:loc=2107
```

When this command has successfully completed, this message should appear.

```
E2144 Cmd Rej: Location invalid for hardware configuration
```

6. Back up the new changes using the `chg-db:action=backup:dest=fixedcommand`.

These messages should appear, the active **Maintenance and Administration Subsystem Processor (MASP)** appears first.

```
BACKUP (FIXED) : MASP A - Backup starts on active MASP.  
BACKUP (FIXED) : MASP A - Backup on active MASP to fixed disk complete.  
BACKUP (FIXED) : MASP A - Backup starts on standby MASP.  
BACKUP (FIXED) : MASP A - Backup on standby MASP to fixed disk complete.
```

Figure 4-21 Removing a MCPM

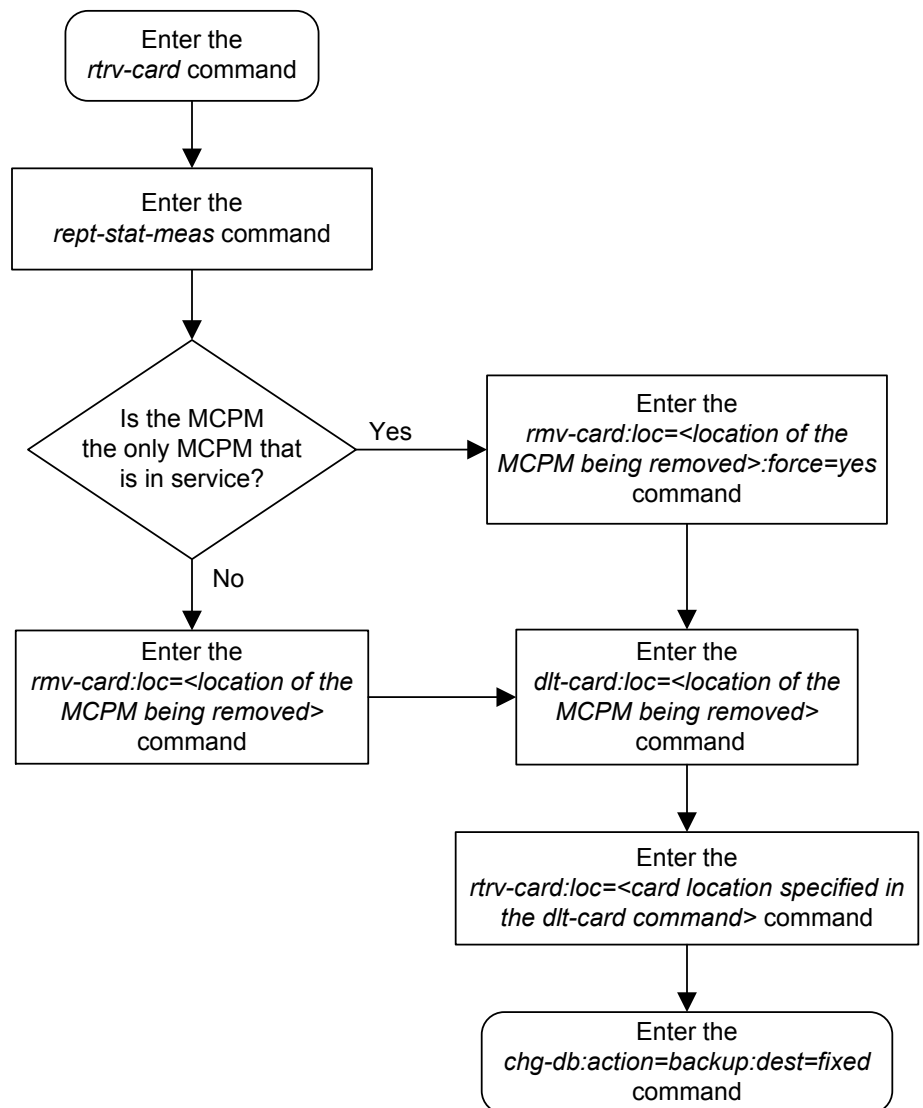

Activating the Fan Feature

This procedure is used to activate the fan using the `chg-feat` command with this parameter.

- `fan=on` - turns the fan on. When the fan is turned on, system cards and functions that generate heat in the EAGLE can function properly.

1. Enter the `rtrv-feat` command to check the status of the Fan feature.

Note: The `rtrv-feat` command output contains other fields that are not used by this procedure. If you wish to see all the fields displayed by the `rtrv-feat` command, see the `rtrv-feat` command description in *Commands User's Guide*.

2. If the fan feature is not on, use the `chg-feat : fan=on` command to turn on the fan.
3. Verify the changes using the `rtrv-feat` command.

Configuring the Measurements Platform Feature

This procedure is used to configure **IP** communications links between the EAGLE and the customer's network and enable the Measurements Platform on the EAGLE using these commands:

- `ent-ip-host` – Configuring the **IP** host of the **MCPM**
- `chg-ip-card` – Configuring the IP address of the MCPM
- `chg-ip-lnk` – Configuring the IP link assigned to the MCPM
- `chg-measopts` – Enabling the Measurements Platform option

These commands contain parameters that are not used in this procedure. *Commands User's Guide* contains a full description of these commands.

The Measurements Platform requires measurements **FTP** servers. A maximum of three measurements FTP servers can be configured with one of these procedures.

- [Adding an FTP Server](#)
- [Changing an FTP Server](#)

MCPMs must be configured in the database before this procedure can be performed. This can be verified with the `rtrv-card` command.

If a Class B IP address is specified for the `ipaddr` parameter of the `chg-ip-lnk` command, the subnet address that results from the `ipaddr` and `submask` parameter values cannot be the same as the subnet address that results from the `pvn` and `pvnmask`, `fcna` and `fcnamask`, or `fcnb` and `fcnbmask` parameter values of the `chg-netopts` command. The `pvn` and `pvnmask`, `fcna` and `fcnamask`, or `fcnb` and `fcnbmask` parameter values can be verified by entering the `rtrv-netopts` command. Choose `ipaddr` and `submask` parameter values for the IP link to the MCPM whose resulting subnet address is not be the same as the subnet address that

resulting from the `pvn` and `pvnmask`, `fcna` and `fcnamask`, or `fcnb` and `fcnbmask` parameter values of the `chg-netopts` command.

1. Display the cards in the database using the `rtrv-card` command.

This is an example of the possible output.

```
rlghncxa03w 07-13-13 09:12:36 GMT EAGLE5 45.0.0
CARD  TYPE      APPL      LSET NAME      LINK SLC LSET NAME      LINK SLC
1101  DSM          VSCCP
1102  TSM          GLS
1103  DCM          STPLAN
1113  E5MCAP       OAMHC
1114  E5TDM-A
1115  E5MCAP       OAMHC
1116  E5TDM-B
1117  E5MDAL
1201  LIMDS0       SS7ANSI   sp2             A    0    sp1             B    0
1202  LIMDS0       SS7ANSI   sp2             A    1    nsp3            B    0
1203  LIMDS0       SS7ANSI   sp3             A    0
1204  LIMDS0       SS7ANSI   sp3             A    1
1206  LIMDS0       SS7ANSI   nsp3            A    1    nsp4            B    0
1212  DSM          VSCCP
1214  TSM          GLS
1215  DCM          STPLAN
1301  LIMATM       ATMANSI   lsnatm1         A    0
1303  STC          EROUTE
1305  DCM          STPLAN
1308  LIMDS0       SS7ANSI   sp6             A    0    sp7             B    0
1311  LIMDS0       SS7ANSI   sp2             A    2    sp1             B    1
      sp7             A1   1    sp3             B1   2
1315  LIMDS0       SS7ANSI   sp7             A    2    sp5             B    0
1318  LIMATM       ATMANSI   lsnatm1         A    1
2101  STC          EROUTE
2103  STC          EROUTE
2105  STC          EROUTE
2107  MCPM         MCP
2108  MCPM         MCP
```

If no MCPMs are configured in the database, identified by the entries `MCPM` in the `TYPE` field and `MCP` in the `APPL` field, go to the [Adding a Measurement Collection and Polling Module \(MCPM\)](#) procedure and configure the required MCPMs.

2. Display the status of the MCPMs in the database with the `rept-stat-meas` command.

This is an example of the possible output.

```
e1061001 11-12-05 18:35:58 EST EAGLE5 44.0.0-64.16.0
      PST          SST          AST
MEAS SS          IS-NR          Active      -----
      ALARM STATUS = No Alarms

CARD  VERSION      TYPE  PST          SST          AST
1105  P 099-016-000  MCPM  IS-NR        Active      -----
      IP Link A          OOS-MA      Ueq          -----
1106  099-016-000  MCPM  IS-NR        Active      -----
      IP Link A          OOS-MA      Ueq          -----
```

```
CARD 1105 ALARM STATUS = No Alarms
CARD 1106 ALARM STATUS = No Alarms
```

If the status of the MCPM that the IP Link is being assigned to is OOS-MT DSBLD, continue the procedure by performing one of these steps.

- If a Class A or C **IP address** will be specified for the `ipaddr` parameter in 6, continue the procedure with 5.
- If a Class B **IP address** will be specified for the `ipaddr` parameter in 6, continue the procedure with 4.

If the status of the MCPM that the IP Link is being assigned to is not OOS-MT DSBLD, continue the procedure with 3.

3. Inhibit the MCPM using the `rmv-card` command, specifying the card location of the MCPM.

If the MCPM to be inhibited is the last MCPM that is in service, the `force=yes` parameter must also be specified. For this example, enter this command.

```
rmv-card:loc=2107
```

When this command has successfully completed, this message should appear.

```
rlghncxa03w 06-10-01 09:12:36 GMT EAGLE5 36.0.0
Card has been inhibited.
```

Continue the procedure by performing one of these steps.

- If a Class A or C **IP address** will be specified for the `ipaddr` parameter in 6, continue the procedure with 5.
 - If a Class B **IP address** will be specified for the `ipaddr` parameter in 6, continue the procedure with 4.
4. The subnet address that results from the `ipaddr` and `submask` parameter values of the `chg-ip-lnk` command cannot be the same as the subnet address that results from the `pvn` and `pvnmask`, `fcna` and `fcnamask`, or `fcnb` and `fcnbmask` parameter values of the `chg-netopts` command.

Display the `pvn`, `pvnmask`, `fcna`, `fcnamask`, `fcnb`, and `fcnbmask` parameter values of the `chg-netopts` command by entering the `rtrv-netopts` command.

If error message E3967 Cmd Rej: E5IS must be on is displayed after the `rtrv-netopts` command is executed, the `pvn`, `pvnmask`, `fcna`, `fcnamask`, `fcnb`, and `fcnbmask` parameters are not configured. Continue the procedure with 5.

This is an example of the possible output if the **E5IS** feature is on.

```
rlghncxa03w 09-02-28 21:17:37 GMT EAGLE5 40.1.0
NETWORK OPTIONS
-----
PVN          = 128.20.30.40
PVNMASK      = 255.255.192.0
FCNA        = 170.120.50.0
FCNAMASK    = 255.255.240.0
FCNB        = 170.121.50.0
FCNBMASK    = 255.255.254.0
```

Choose `ipaddr` and `submask` parameter values for the **IP** link to the **MCPM** whose resulting subnet address is not be the same as the subnet address that resulting from the `pvn` and `pvnmask`, `fcna` and `fcnamask`, or `fcnb` and `fcnbmask` parameter values of the `chg-netopts` command. Continue the procedure with 5.

5. Display the IP link assignments using the `rtrv-ip-lnk` command.

The following is an example of the possible output.

```
rlghncxa03w 08-12-01 21:20:37 GMT EAGLE5 40.0.0
LOC  PORT  IPADDR          SUBMASK          DUPLEX  SPEED  MACTYPE  AUTO  MCAST
2107 A  -----          -----          HALF    10     DIX      NO   NO
2107 B  -----          -----          HALF    10     DIX      NO   NO
2108 A  150.123.123.123 255.255.255.0   HALF    100    DIX      NO   YES
2108 B  -----          -----          HALF    10     DIX      NO   NO
2111 A  150.123.123.125 255.255.255.0   HALF    100    DIX      NO   YES
2111 B  -----          -----          HALF    10     DIX      NO   NO
```

IP-LNK table is (6 of 2048) 1% full.

6. Assign an **IP** link to the **MCPM** using the `chg-ip-lnk` command with these parameters: `loc`, `port=a`, `ipaddr`, `submask`, `speed=100`, `mcast=yes`, `duplex=full`.

For this example, enter this command.

```
chg-ip-
lnk:loc=2107:port=a:ipaddr=150.1.1.1:submask=255.255.255.0 :s
peed=100:mcast=yes:duplex=full
```

When this command has successfully completed, this message should appear.

```
rlghncxa03w 06-10-01 21:20:37 GMT EAGLE5 36.0.0
CHG-IP-LNK:  MASP A - COMPLTD
```

7. Assign a default router to the **MCPM** using the `chg-ip-card` command with these parameters: `loc`, `srchordr`, `domain`, and `defrouter`.

For this example, enter this command.

```
chg-ip-
card:loc=2107:srchordr=local:domain=nc.tekelec.com :defrouter
=150.1.1.50
```

When this command has successfully completed, this message should appear.

```
rlghncxa03w 09-07-28 21:15:37 GMT EAGLE5 41.1.0
CHG-IP-CARD:  MASP A - COMPLTD
```

8. Display the current **IP** host information in the database by entering the `rtrv-ip-host:display=all` command.

The following is an example of the possible output.

```
rlghncxa03w 07-13-13 09:12:36 GMT EAGLE5 45.0.0
LOCAL IPADDR  LOCAL HOST
150.1.1.2     GW102.NC.TEKELEC.COM
150.1.1.3     GW103.NC.TEKELEC.COM
```

```
REMOTE IPADDR  REMOTE HOST
150.1.1.5      NCDEPTECONOMIC_DEVELOPMENT.SOUTHEASTERN_COORIDOR_ASHVL.GOV
```

```
IP Host table is (3 of 4096) <1% full
```

- Assign an IP host to the MCPM using the `ent-ip-host` command.

For this example, enter this command.

```
ent-ip-host:host=gw100.nc.tekelec.com:ipaddr=150.1.1.1
```

When this command has successfully completed, the following message should appear.

```
rlghncxa03w 06-10-01 21:18:37 GMT EAGLE5 36.0.0
ENT-IP-HOST: MASP A - COMPLTD
```

- Place the MCPM back into service using the `rst-card` specifying the location of the MCPM.

For this example, enter this command.

```
rst-card:loc=2107
```

When this command has successfully completed, this message should appear.

```
rlghncxa03w 06-10-01 21:20:37 GMT EAGLE5 36.0.0
Card has been allowed.
```

- Display the FTP Server configuration using the `rtrv-ftp-serv` command.

```
rlghncxa03w 06-10-01 09:12:36 GMT EAGLE5 36.0.0
FTP Client Security: OFF
```

APP	IPADDR	LOGIN	PRI0
meas	1.255.0.100	ftpmeas3	3
Path:	~meas\local		
meas	1.255.0.101	ftpmeas2	2
Path:	mp\measurements\backup\dat		

```
FTP SERV table is (2 of 10) 20% full
```

The EAGLE allows three FTP servers for the Measurements Platform. If no FTP servers or one FTP server is in the database, go to the [Adding an FTP Server](#) procedure, and backup the FTP server. To change any of these configured FTP servers, go to the [Changing an FTP Server](#) procedure.

- Verify whether or nor the Measurements Platform option is enabled (PLATFORMENABLE = on) using the `rtrv-measopts` command.

```
e1061001 11-12-05 18:50:10 EST EAGLE5 44.0.0-64.16.0
PLATFORMENABLE = off
COLLECT15MIN   = off
CLLIBASEDNAME  = off
OAMHCMEAS     = off
-----
```

```
SYSTOTSTP      = on
SYSTOTTT      = off
```

Note: The `rtrv-measopts` command output contains other fields that are not used by this procedure. If you wish to see all the fields displayed by the `rtrv-measopts` command, see the `rtrv-measopts` command description in *Commands User's Guide*.

Continue the procedure by performing one of these steps.

- If the Measurements Platform option is enabled, continue the procedure with [15](#).
- If the Measurements Platform option is not enabled, continue the procedure with [13](#).

- 13.** Enable the Measurements Platform option using the `chg-measopts` command with the `platformenable` parameter.

For this example, enter this command.

```
chg-measopts:platformenable=on
```

When the `chg-measopts` command has successfully completed, this message should appear.

```
rlghncxa03w 06-10-01 00:22:57 GMT EAGLE5 36.0.0
CHG-MEASOPTS: MASP A - COMPLTD
```

- 14.** Verify the status of the **MCPM** using the `rept-stat-meas` command.

For this example, enter this command.

```
rept-stat-meas
```

```
e1061001 11-12-05 18:46:58 EST EAGLE5 44.0.0-64.16.0
                PST          SST          AST
MEAS SS        IS-ANR        Restrict  -----
ALARM STATUS = No Alarms

CARD  VERSION      TYPE    PST          SST          AST
1105 P 099-016-000  MCPM   IS-NR       Active       -----
      IP Link A                IS-NR       Active       -----
1106  099-016-000  MCPM   IS-NR       Active       -----
      IP Link A                IS-NR       Active       -----

CARD 1105 ALARM STATUS = No Alarms
CARD 1106 ALARM STATUS = No Alarms
```

- 15.** Back up the new changes using the `chg-db:action=backup:dest=fixed` command.

These messages should appear, the active **Maintenance and Administration Subsystem Processor (MASP)** appears first.

```
BACKUP (FIXED) : MASP A - Backup starts on active MASP.
BACKUP (FIXED) : MASP A - Backup on active MASP to fixed disk complete.
```

```
BACKUP (FIXED) : MASP A - Backup starts on standby MASP.  
BACKUP (FIXED) : MASP A - Backup on standby MASP to fixed disk complete.
```

Figure 4-22 Configuring the Measurements Platform Feature

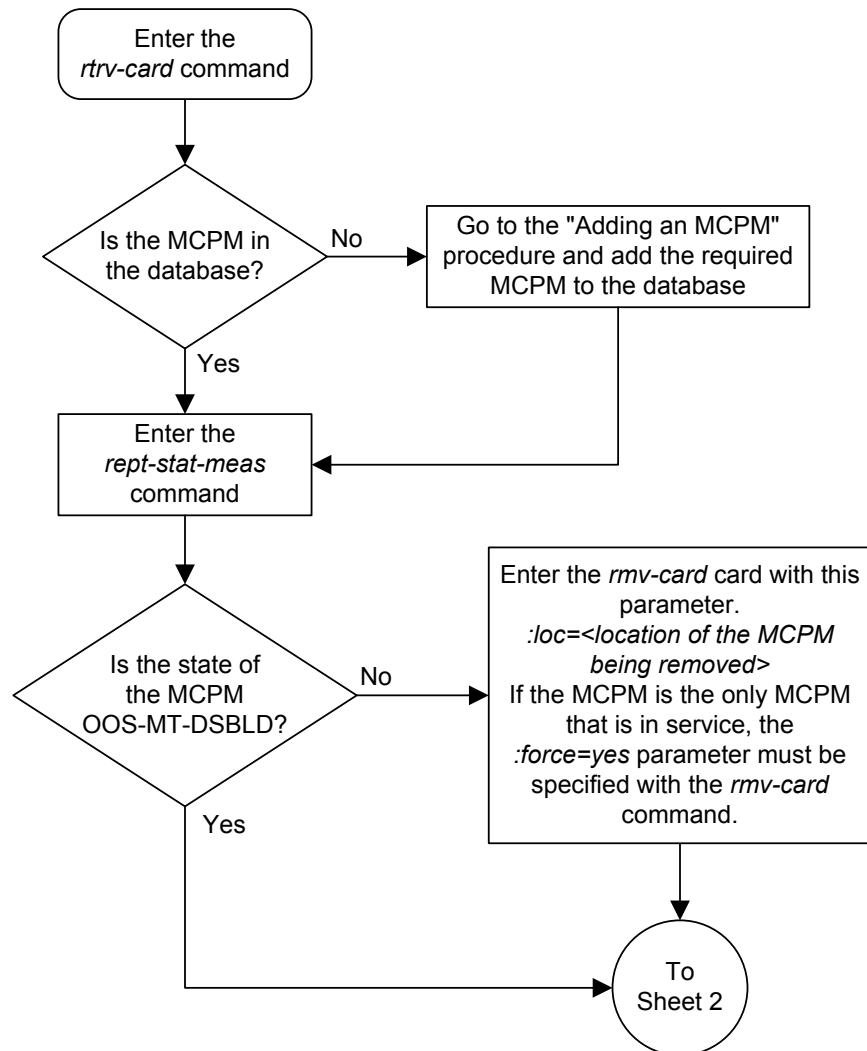

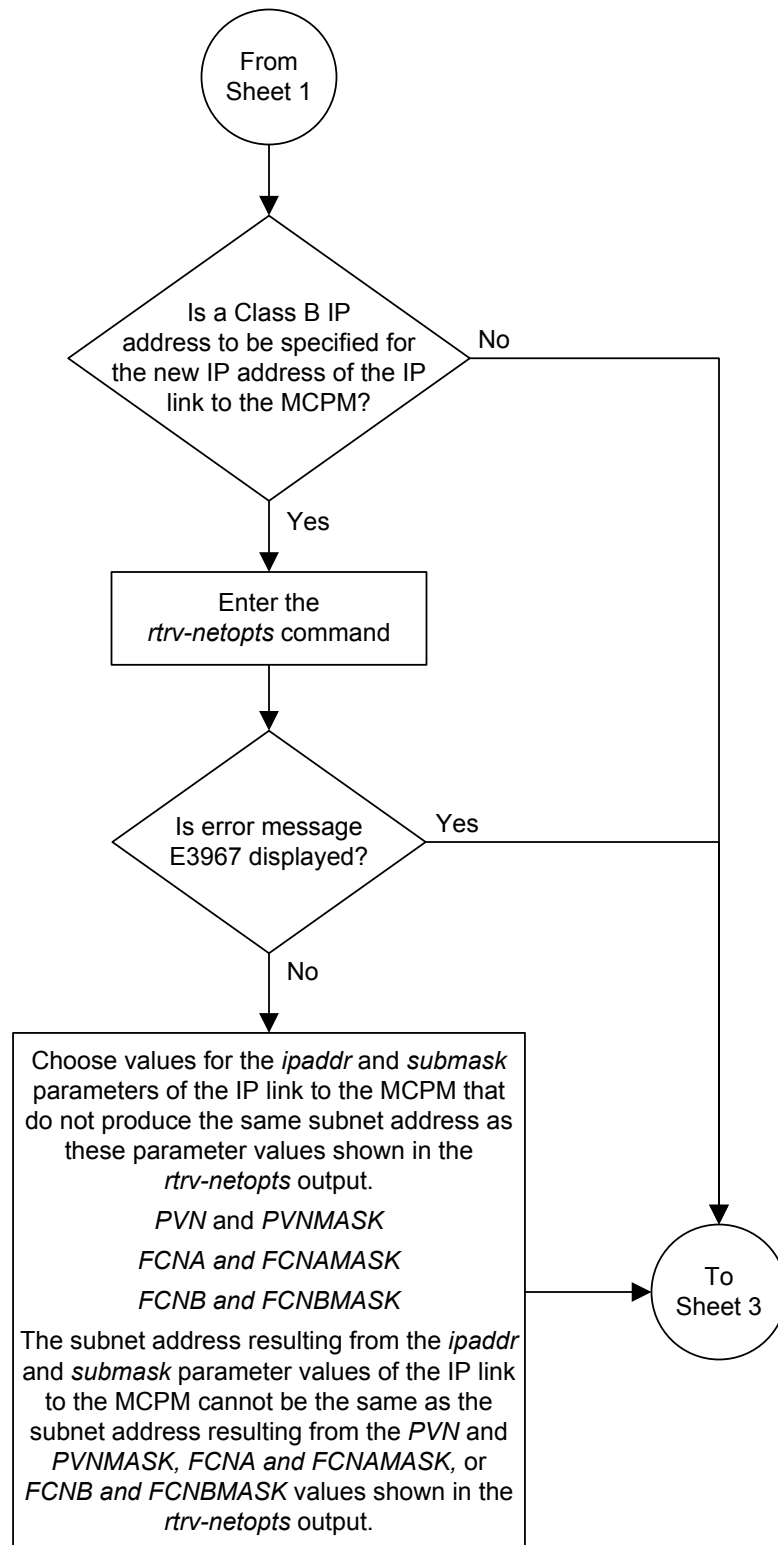

Sheet 2 of 4

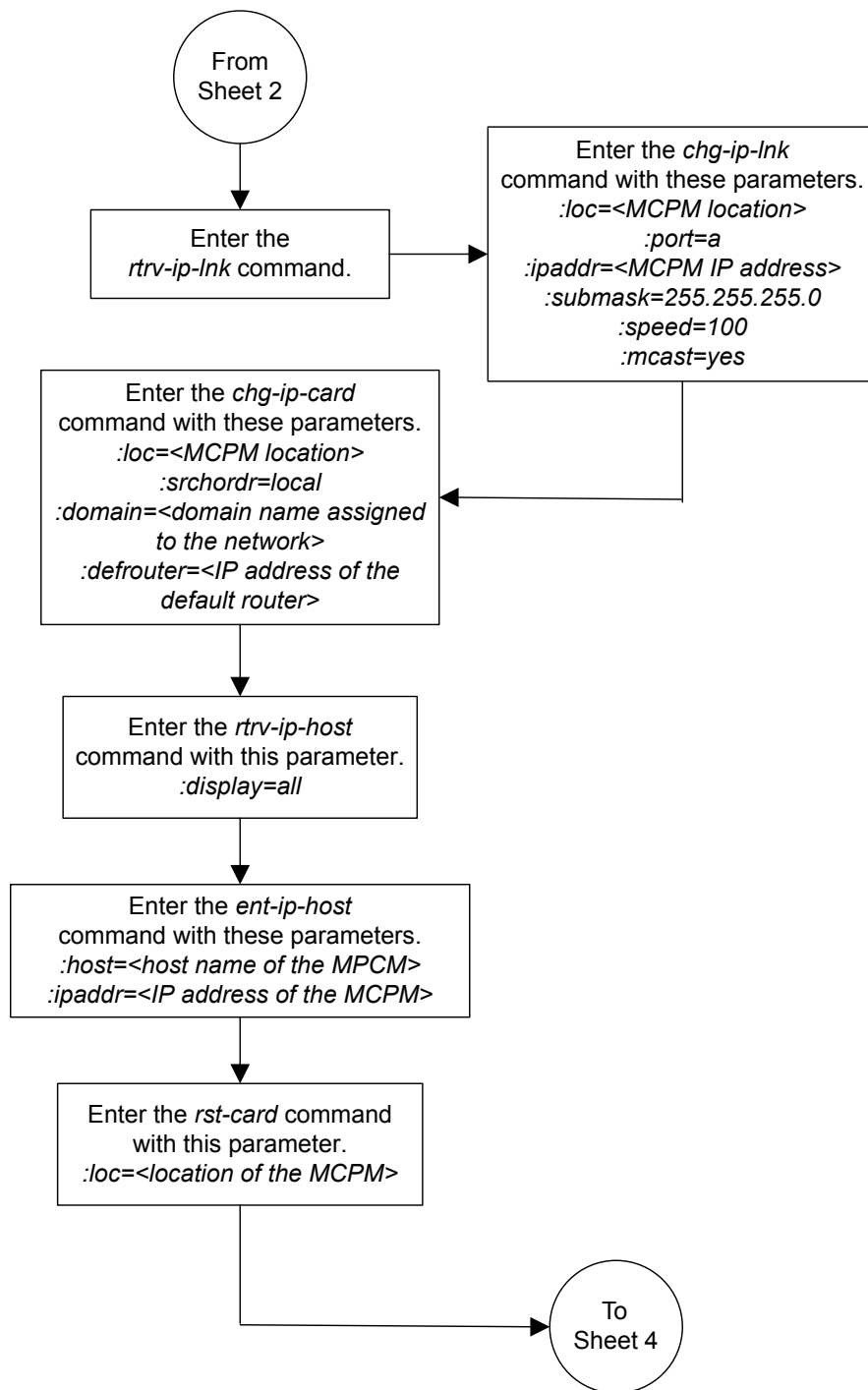

Sheet 3 of 4

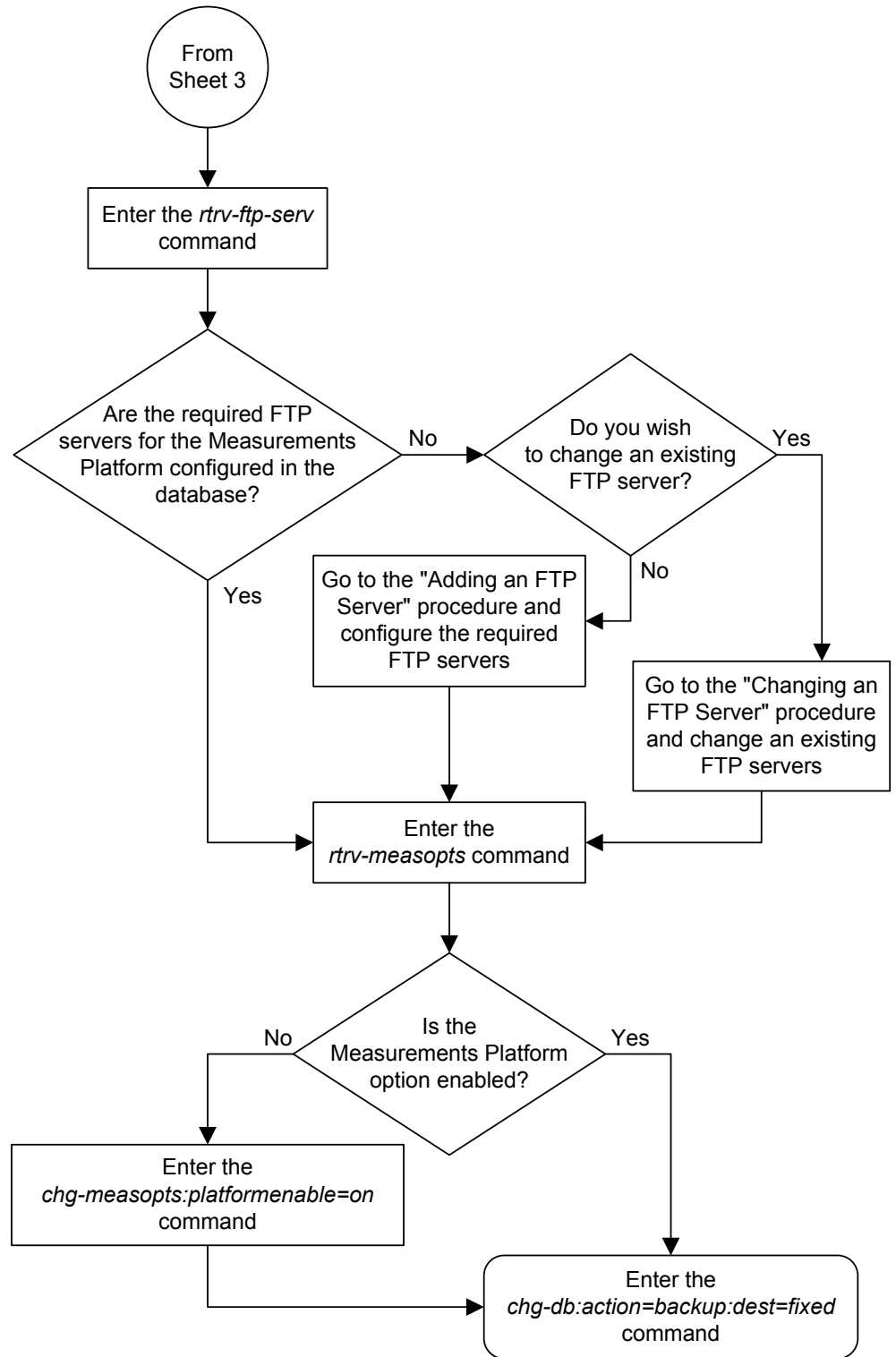

Adding an FTP Server

This procedure is used to add **FTP** servers using the `ent-ftp-serv` command.

The `ent-ftp-serv` command uses these parameters.

`:app` – The application of the **FTP** server. There are four values for the `app` parameter:

- `meas` – The **FTP** servers for the Measurements Platform. A maximum of three **FTP** servers can be configured for this application.
- `db` – The **FTP** server for the database backup/restore application. Only one **FTP** server can be configured for this application.
- `dist` – the **FTP** server for the EAGLE software release distribution application. Only one **FTP** server can be configured for this application.
- `user` – The **FTP** servers for the **FTP** Retrieve and Replace feature. A maximum of two **FTP** servers can be configured for this application.

Caution: While this procedure can be used to add a **USERFTP** server, any **USERFTP** servers entered by this procedure will be overwritten by the **FTP** server configuration information sent to the **EAGLE** by the **FTP**-Based Table Retrieve Application (**FTRA**).

`:ipaddr` – The **IP** address of the **FTP** server.

`:login` – The name of the **FTP** server client.

`:path` – The path to the file on the **EAGLE** that is to be sent to the **FTP** server.

`:prio` – The priority of the **FTP** server, from 1 to 10.

The `app/ipaddr` parameter combination must be unique in the database.

The `login` parameter value can contain from 1 to 15 alpha-numeric characters. The alphabetic characters can be both upper and lower case characters.

The `path` parameter value is a mixed-case quoted character string with a valid **FTP** path format that can contain up to 100 characters.

After the **FTP** server is added to the database with the `ent-ftp-serv` command, the user is prompted for a password for this **FTP** server. The password can contain from 1 to 15 alpha-numeric characters. The alphabetic characters must be both upper and lower case characters. The password is not shown on the terminal screen as it is being entered and is not shown in the `rtrv-ftp-serv` output.

If the **EAGLE OA&M IP Security Enhancement Controlled Feature** is enabled and activated, the **FTP** servers configured in this procedure must be secure **FTP** servers. The **FTP**-Based Table Retrieve Application (**FTRA**) and the Measurements Platform must support secure shell connections to the **EAGLE**. Enter the `rtrv-ctrl-feat` command to verify whether or not the Eagle **OA&M IP Security Enhancement Controlled Feature** is enabled and activated.

Because **CSV** measurement data files do not have unique names across multiple **STPs**, include the **CLLI** of the **STP** in the **FTP** server path for `meas` **FTP** servers.

The IP address of the FTP server cannot be shown as the IPADDR value in the `rtrv-ip-lnk` or `rtrv-seas-config` outputs, or the BPIPADDR value in the `rtrv-ip-card` output.

1. Display the **FTP** servers in the database using the `rtrv-ftp-serv` command by entering this command..

```
rtrv-ftp-serv:mode=full
```

This is an example of the possible output.

```
rlghncxa03w 08-09-01 09:12:36 GMT EAGLE5 39.2.0
FTP Client Security: ON
```

APP	IPADDR	LOGIN	PRIO
meas	1.255.0.100	ftpmeas3	3
Path: ~meas\local			

```
FTP SERV table is (1 of 10) 10% full
```

2. Add the **FTP** server to the database using the `ent-ftp-serv` command.

For this example, enter these commands.

```
ent-ftp-
serv:app=meas:ipaddr=1.255.0.101:login=ftpmeas2:prio=2 :path=
"\tmp\measurements\backup\dat"
```

```
ent-ftp-
serv:app=user:ipaddr=1.255.0.100:login=ftpuser1:prio=3 :path=
"\tmp\user"
```

```
ent-ftp-
serv:app=user:ipaddr=1.255.0.102:login=ftpuser5:prio=7 :path=
"\tmp\backup\user"
```

```
ent-ftp-
serv:app=db:ipaddr=10.20.50.102:login=dbuser1:prio=1 :path=~
/eagle"
```

```
ent-ftp-
serv:app=dist:ipaddr=100.200.50.102:login=dbuser1:prio=1 :pat
h=~ /eagle"
```

Caution: While this procedure can be used to add a **USER** FTP server, any **USER** FTP servers entered by this procedure will be overwritten by the FTP server configuration information sent to the EAGLE by the EAGLE FTP Table Base Retrieval (**FTRA**).

When each of these commands has successfully completed, the following message should appear.

```
rlghncxa03w 08-09-01 21:18:37 GMT EAGLE5 39.2.0
Enter Password :
FTP SERV table is (4 of 10) 40% full
ENT-FTP-SERV: MASP A - COMPLTD
```

```
rlghncxa03w 06-10-01 21:18:37 GMT EAGLE5 36.0.0
FTP SERV table is (4 of 10) 40% full
ENT-FTP-SERV: MASP A - COMPLTD
```

3. Enter a password for the **FTP** server added in 2 at the **PASSWORD:** prompt.

The password is not shown on the terminal screen as it is entered. The password can contain from 1 to 15 alpha-numeric characters. The alphabetic characters must be both upper and lower case characters.

4. Display the changes by entering this command.

```
rtrv-ftp-serv:mode=full
```

The following is an example of the possible output.

```
rlghncxa03w 08-09-01 09:12:36 GMT EAGLE5 39.2.0
FTP Client Security: ON
```

APP	IPADDR	LOGIN	PRI0
db	10.20.50.102	dbuser1	1
Path:	~/eagle		
dist	100.200.50.102	dbuser1	1
Path:	~/eagle		
meas	1.255.0.100	ftpmeas3	3
Path:	~meas\local		
meas	1.255.0.101	ftpmeas2	2
Path:	\tmp\measurements\backup\dat		
user	1.255.0.100	ftpuser1	3
Path:	\tmp\user		
user	1.255.0.102	ftpuser5	7
Path:	\tmp\backup\user		

```
FTP SERV table is (6 of 10) 60% full
```

5. Back up the new changes using the **chg-db:action=backup:dest=fixed** command.

These messages should appear, the active **Maintenance and Administration Subsystem Processor (MASP)** appears first

.

```
BACKUP (FIXED) : MASP A - Backup starts on active MASP.
BACKUP (FIXED) : MASP A - Backup on active MASP to fixed disk complete.
BACKUP (FIXED) : MASP A - Backup starts on standby MASP.
BACKUP (FIXED) : MASP A - Backup on standby MASP to fixed disk complete.
```

Figure 4-23 Adding an FTP Server

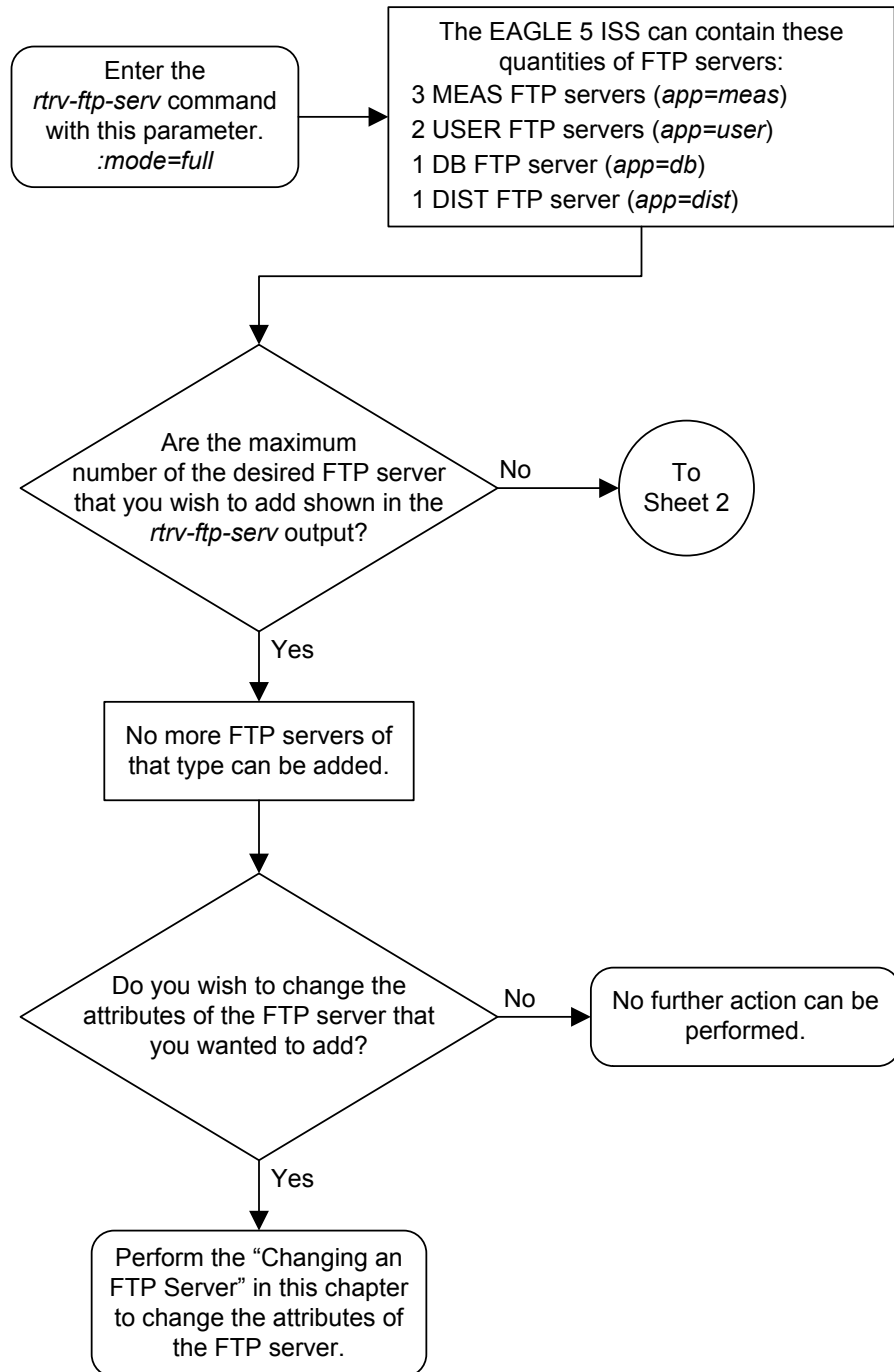

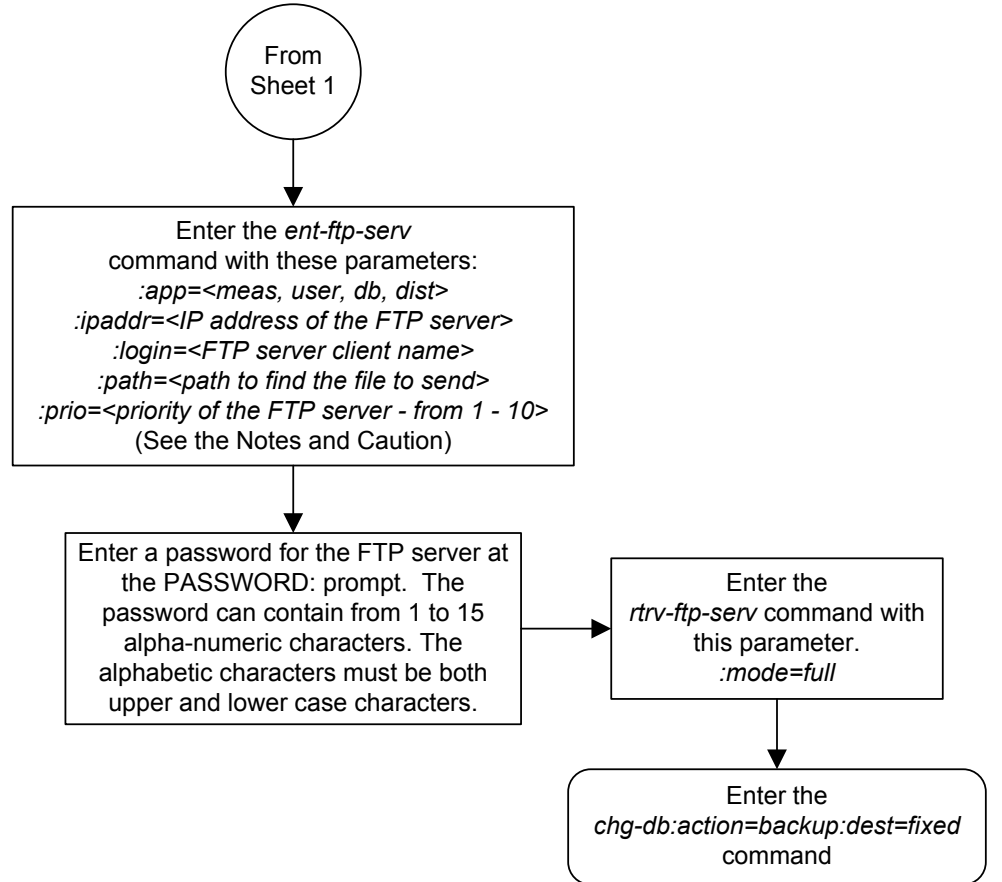
**Notes:**

1. The *login* parameter value can contain from 1 to 15 alpha-numeric characters. The alphabetic characters can be both upper and lower case characters.
2. The *path* parameter value is a mixed-case quoted character string with a valid FTP path format that can contain up to 100 characters.
3. If the Eagle OAM IP Security Enhancement Controlled Feature is enabled and activated, the FTP servers configured in this procedure must be secure FTP servers and secure shell clients must be available. The FTP-Based Table Retrieve Application (FTRA) and the Measurements Platform must support secure shell connections to the EAGLE 5 ISS. Enter the *rtv-ctrl-feat* command to verify whether or not the Eagle OAM IP Security Enhancement Controlled Feature is enabled and activated.
4. Because CSV measurement data files do not have unique names across multiple STPs, include the CLLI of the STP in the FTP server path for meas FTP servers.

Caution: This procedure can be used to add a USER FTP server, but any USER FTP servers entered by this procedure will be overwritten by the FTP server configuration information sent to the EAGLE 5 ISS by the FTP-Based Table Retrieve Application (FTRA). It is recommended that USER FTP servers be added at the FTRA. For more information on adding USER FTP servers at the FTRA, see the *FTP-Based Table Retrieve Application (FTRA) User Guide*.

Removing an FTP Server

This procedure is used to remove an **FTP** server from the database using the `dlt-ftp-serv` command.

The `dlt-ftp-serv` command uses these parameters.

`:app` – The application of the **FTP** server. There are four values for the `app` parameter:

- `meas` – The **FTP** servers for the Measurements Platform
- `user` – The **FTP** servers for the **FTP** Retrieve and Replace feature.
- `db` - The **FTP** server for the database backup/restore application.
- `dist` - the **FTP** server for the EAGLE software release distribution application.

`:ipaddr` – The **IP** address of the **FTP** server.

Caution: Removing all **FTP** servers for an application will disable the feature supported by the **FTP** servers.

1. Display the **FTP** servers in the database by entering this command.

```
rtrv-ftp-serv:mode=full
```

This is an example of the possible output.

```
rlghncxa03w 08-09-01 09:12:36 GMT EAGLE5 39.2.0
FTP Client Security: ON
```

APP	IPADDR	LOGIN	PRI0
db	10.20.50.102	dbuser1	1
Path:	~/eagle		
dist	100.200.50.102	dbuser1	1
Path:	~/eagle		
meas	1.255.0.100	ftpmeas3	3
Path:	~meas\local		
meas	1.255.0.101	ftpmeas2	2
Path:	\tmp\measurements\backup\dat		
user	1.255.0.100	ftpuser1	3
Path:	\tmp\user		
user	1.255.0.102	ftpuser5	7
Path:	\tmp\backup\user		

FTP SERV table is (6 of 10) 60% full

2. Remove an **FTP** server from the database using the `dlt-ftp-serv` command.

For this example, enter this command.

```
dlt-ftp-serv:app=meas:ipaddr=1.255.0.101
```

When this command has successfully completed, the following message should appear.

```
rlghncxa03w 08-09-01 21:18:37 GMT EAGLE5 39.2.0
FTP SERV table is (5 of 10) 50% full
DLT-FTP-SERV: MASP A - COMPLTD
```

3. Display the changes by entering this command.

```
rtrv-ftp-serv:mode=full
```

The following is an example of the possible output.

```
rlghncxa03w 08-09-01 09:12:36 GMT EAGLE5 39.2.0
FTP Client Security: ON
```

APP	IPADDR	LOGIN	PRIO
-----	-----	-----	----
db	10.20.50.102	dbuser1	1
Path:	~/eagle		
dist	100.200.50.102	dbuser1	1
Path:	~/eagle		
meas	1.255.0.100	ftpmeas3	3
Path:	~meas\local		
user	1.255.0.100	ftpuser1	3
Path:	\tmp\user		
user	1.255.0.102	ftpuser5	7
Path:	\tmp\backup\user		

```
FTP SERV table is (5 of 10) 50% full
```

4. Back up the new changes using the `chg-db:action=backup:dest=fixed` command.

These messages should appear, the active **Maintenance and Administration Subsystem Processor (MASP)** appears first.

```
BACKUP (FIXED) : MASP A - Backup starts on active MASP.
BACKUP (FIXED) : MASP A - Backup on active MASP to fixed disk complete.
BACKUP (FIXED) : MASP A - Backup starts on standby MASP.
BACKUP (FIXED) : MASP A - Backup on standby MASP to fixed disk complete.
```

Figure 4-24 Removing an FTP Server

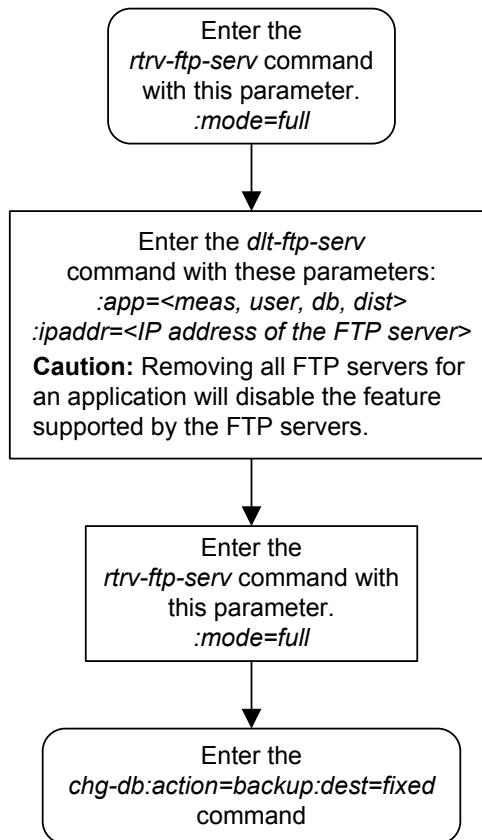

Changing an FTP Server

This procedure is used to change the values assigned to an **FTP** server using the `chg-ftp-serv` command.

The `chg-ftp-serv` command uses these parameters.

`:app` – The application of the **FTP** server. There are four values for the `app` parameter:

- `meas` – The **FTP** servers for the Measurements Platform
- `db` – The **FTP** server for the database backup/restore application.
- `dist` – the **FTP** server for the EAGLE software release distribution application.
- `user` – The **FTP** servers for the **FTP** Retrieve and Replace feature.

Caution: While this procedure can be used to change a **USERFTP** server configuration, any **USERFTP** server configurations changed by this procedure will be overwritten by the **FTP** server configuration information sent to the **EAGLE** by the **EAGLE FTP Table Base Retrieval (FTRA)**.

`:ipaddr` – The **IP** address of the **FTP** server.

`:login` – The name of the **FTP** server client.

`:path` – The path to the file on the **EAGLE** that is to be sent to the **FTP** server.

`:prio` – The priority of the **FTP** server, from 1 to 10.

The `app` and `ipaddr` parameters must be specified with the `chg-ftp-serv` command. The **IP** address of the **FTP** server cannot be changed with the `chg-ftp-serv` command. If you wish to change the **IP** address of the **FTP** server, the **FTP** server must first be removed with the [Removing an FTP Server](#) procedure, then re-entered with the new **IP** address using the [Adding an FTP Server](#) procedure.

The `login` parameter value can contain from 1 to 15 alpha-numeric characters. The alphabetic characters can be both upper and lower case characters.

The `path` parameter value is a mixed-case quoted character string with a valid **FTP** path format that can contain up to 100 characters.

If the `login` parameter value is changed, the user is prompted for a password for this **FTP** server. The password can contain from 1 to 15 alpha-numeric characters. The alphabetic characters must be both upper and lower case characters. The password is not shown on the terminal screen as it is being entered and is not shown in the `rtrv-ftp-serv` output.

If the Eagle **OA&M IP Security Enhancement Controlled Feature** is enabled and activated, the **FTP** servers configured in this procedure must be secure **FTP** servers. The **EAGLE FTP Table Base Retrieval (FTRA)** and the Measurements Platform must support secure shell connections to the **EAGLE**. Enter the `rtrv-ctrl-feat` command to verify whether or not the Eagle **OA&M IP Security Enhancement Controlled Feature** is enabled and activated.

Because **CSV** measurement data files do not have unique names across multiple **STPs**, include the **CLLI** of the **STP** in the **FTP** server path for `meas` **FTP** servers.

1. Display the **FTP** servers in the database by entering this command.

```
rtrv-ftp-serv:mode=full
```

This is an example of the possible output.

```
rlghncxa03w 08-09-01 09:12:36 GMT EAGLE5 39.2.0
FTP Client Security: ON
```

APP	IPADDR	LOGIN	PRIO
db	10.20.50.102	dbuser1	1
Path:	~/eagle		
dist	100.200.50.102	dbuser1	1
Path:	~/eagle		
meas	1.255.0.100	ftpmeas3	3
Path:	~meas\local		
meas	1.255.0.101	ftpmeas2	2
Path:	\tmp\measurements\backup\dat		
user	1.255.0.100	ftpuser1	3
Path:	\tmp\user		
user	1.255.0.102	ftpuser5	7
Path:	\tmp\backup\user		

FTP SERV table is (6 of 10) 60% full

2. Change the FTP server to the database using the `chg-ftp-serv` command.

For this example, enter this command.

```
chg-ftp-serv:app=meas:ipaddr=1.255.0.101:login=meas25:prio=1
```

When this command has successfully completed, the following message should appear.

```
rlghncxa03w 08-09-01 21:18:37 GMT EAGLE5 39.2.0
Enter Password :
CHG-FTP-SERV: MASP A - COMPLTD
```

Note: If the `login` parameter was not specified in this step, continue the procedure with [4](#).

3. Enter a password for the FTP server changed in [2](#) at the `PASSWORD:` prompt.

The password is not shown on the terminal screen as it is entered. The password can contain from 1 to 15 alpha-numeric characters. The alphabetic characters must be both upper and lower case characters.

4. Display the changes by entering this command.

```
rtrv-ftp-serv:mode=full
```

The following is an example of the possible output.

```
rlghncxa03w 08-09-01 09:12:36 GMT EAGLE5 39.2.0
FTP Client Security: ON
```

APP	IPADDR	LOGIN	PRIO
db	10.20.50.102	dbuser1	1
Path:	~/eagle		
dist	100.200.50.102	dbuser1	1
Path:	~/eagle		
meas	1.255.0.100	ftpmeas3	3
Path:	~meas\local		
meas	1.255.0.101	ftpmeas2	2
Path:	\tmp\measurements\backup\dat		
user	1.255.0.100	ftpuser1	3
Path:	\tmp\user		
user	1.255.0.102	ftpuser5	7
Path:	\tmp\backup\user		

```
db      10.20.50.102  dbuser1      1
  Path: ~/eagle
dist    100.200.50.102 dbuser1      1
  Path: ~/eagle
meas    1.255.0.100    ftpmeas3     3
  Path: ~meas\local
meas    1.255.0.101    meas25       1
  Path: \tmp\measurements\backup\dat
user    1.255.0.100    ftpuser1     3
  Path: \tmp\user
user    1.255.0.102    ftpuser5     7
  Path: \tmp\backup\user
```

```
FTP SERV table is (6 of 10) 60% full
```

5. Back up the new changes using the `chg-db:action=backup:dest=fixed` command.

These messages should appear, the active **Maintenance and Administration Subsystem Processor (MASP)** appears first.

```
BACKUP (FIXED) : MASP A - Backup starts on active MASP.
BACKUP (FIXED) : MASP A - Backup on active MASP to fixed disk complete.
BACKUP (FIXED) : MASP A - Backup starts on standby MASP.
BACKUP (FIXED) : MASP A - Backup on standby MASP to fixed disk complete.
```

Figure 4-25 Changing an FTP Server

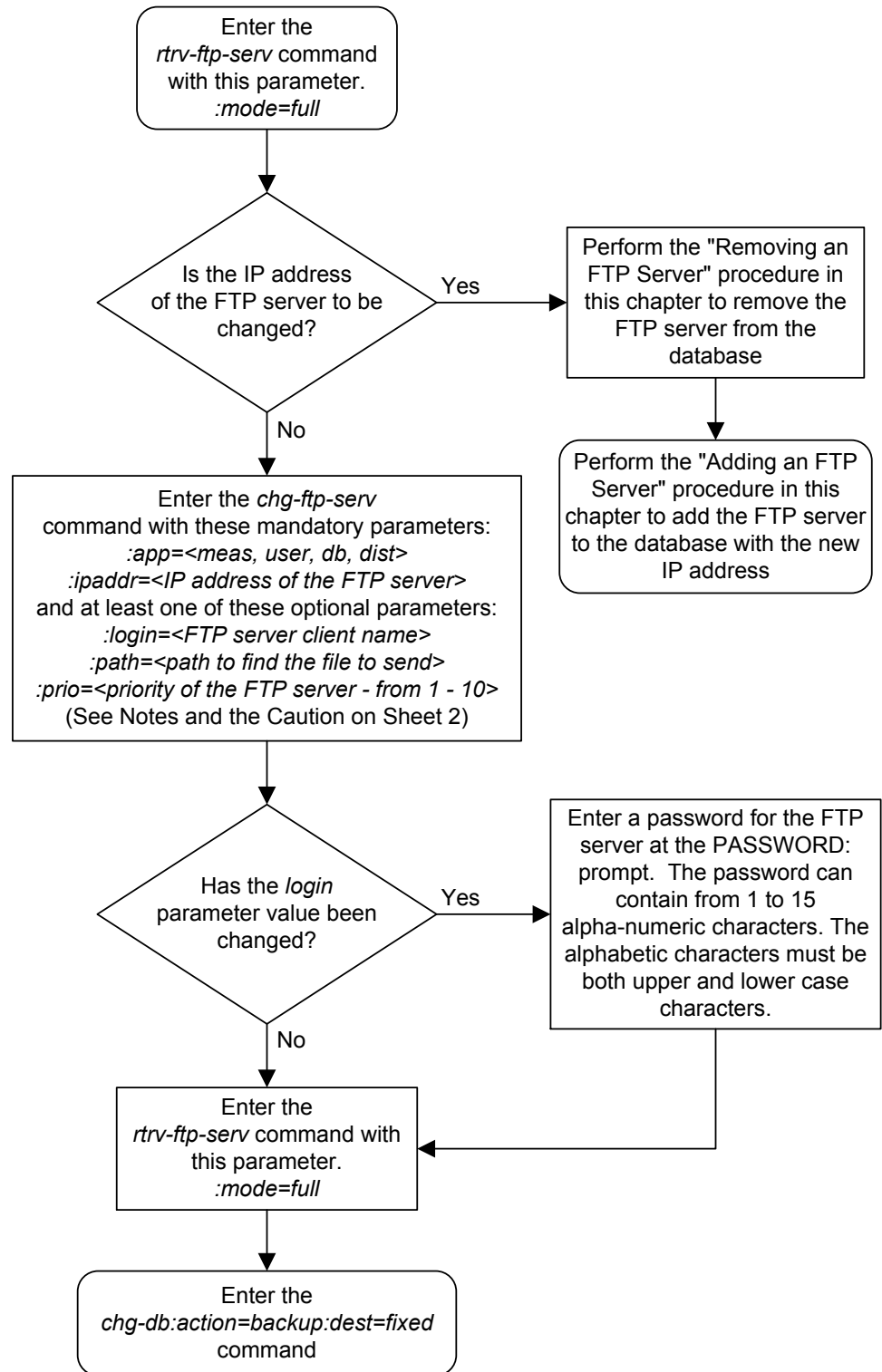

Sheet 1 of 2

Notes:

1. The *login* parameter value can contain from 1 to 15 alpha-numeric characters. The alphabetic characters can be both upper and lower case characters.
2. The *path* parameter value is a mixed-case quoted character string with a valid FTP path format that can contain up to 100 characters.

3. If the Eagle OAM IP Security Enhancement Controlled Feature is enabled and activated, the FTP servers configured in this procedure must be secure FTP servers and secure shell clients must be available. The FTP-Based Table Retrieve Application (FTRA) and the Measurements Platform must support secure shell connections to the EAGLE 5 ISS. Enter the *rtv-ctrl-feat* command to verify whether or not the Eagle OAM IP Security Enhancement Controlled Feature is enabled and activated.

4. Because CSV measurement data files do not have unique names across multiple STPs, include the CLLI of the STP in the FTP server path for *meas* FTP servers.

Caution: Changes to the USER FTP server configurations in this procedure may interfere with the operation of the FTP-Based Table Retrieve Application (FTRA). It is recommended that any changes to the USER FTP server configurations be made at the FTRA. For more information on making these changes at the FTRA, see the *FTP-Based Table Retrieve Application (FTRA) User Guide*.

Adding an E5-IPSM

This procedure is used to add an **E5-IPSM (IP Services Module)**, used for the **IP User Interface** feature, to the database using the `ent-card` command. The **E5-IPSM** provides eight **IP** based connections to the **EAGLE**'s user interface through a telnet client. As of Release 46.5, the E5-IPSM card and its functionality is replaced by the E5-ENET-B (p/n 870-2971-01) or SLIC (p/n 7094646) card. Any references to E5-IPSM and the 870-2877-01 part number should be replaced by the 46.5 and greater card and part number.

The `ent-card` command uses these parameters.

`:loc` – The location of the card being added to the database.

`:type` – The type of card being added to the database. For this procedure, the value of this parameter is `ipsm`.

`:app1` – The application software that is assigned to the card. For this procedure, the value of this parameter is `ips`.

The **IP User Interface (Telnet)** feature is not required to be enabled and activated in order to add an **E5-IPSM**, but the **IP User Interface (Telnet)** feature must be enabled and activated so that the user can use a telnet client to establish a connection to the **EAGLE**. This can be verified with the `rtrv-ctrl-feat` command. To enable and activate the **IP User Interface (Telnet)** feature, go to the [Activating Controlled Features](#) procedure.

The shelf to which the card is to be added, must already be in the database. This can be verified with the `rtrv-shlf` command. If the shelf is not in the database, see the [Adding a Shelf](#) procedure.

If an E5-IPSM is being provisioned in this procedure, **HIPR2** cards must be installed into card locations 9 and 10 in the shelf that the E5-IPSM will occupy. If HIPR2 cards are not installed in the shelf that the E5-IPSM will occupy, the E5-IPSM will not function when the E5-IPSM is inserted into the shelf. Enter the `rept-stat-gp1:gp1=hipr2` command to verify whether or not HIPR2 cards are installed in the same shelf as the **E5-IPSM** being provisioned in this procedure.

If the Eagle OA&M **IP Security Enhancement** feature is enabled and activated, shown in the `rtrv-ctrl-feat` output, when an **E5-IPSM** is installed into the **EAGLE**, **UIM 1493, SSH Host Keys Regenerated**, is displayed. **UIM 1493** contains the public host key fingerprint which is used to establish a secure connection with an **SSH** client. If the secure connection is to be made with the **FTRA**, the public host key fingerprint displayed in **UIM 1493** must be added to the `hosts.xml` file in the **FTRA**. Record the public host key fingerprint information displayed in **UIM 1493** if a secure connection to the **FTRA** will be made. For more information about editing the `hosts.xml` file on the **FTRA**, see [FTP Table Base Retrieval \(FTRA\) User's Guide](#).

An **IP** link must be assigned to the **E5-IPSM**. The **IP** links can be verified using the `rtrv-ip-lnk` command. **IP** links are configured using the `chg-ip-lnk` command.

After an **E5-IPSM** is configured in the database and placed into service, eight telnet terminals are configured in the database with default values for the security and output group parameters. If you wish to change the security and output group parameter values, go to the [Changing Terminal Characteristics](#) procedure.

If a Class B **IP** address is specified for the `ipaddr` parameter of the `chg-ip-lnk` command, the subnet address that results from the `ipaddr` and `submask` parameter

values cannot be the same as the subnet address that results from the `pvn` and `pvnmask`, `fcna` and `fcnamask`, or `fcnb` and `fcnbmask` parameter values of the `chg-netopts` command. The `pvn` and `pvnmask`, `fcna` and `fcnamask`, or `fcnb` and `fcnbmask` parameter values can be verified by entering the `rtrv-netopts` command. Choose `ipaddr` and `submask` parameter values for the IP link to the **E5-IPSM** whose resulting subnet address is not be the same as the subnet address that resulting from the `pvn` and `pvnmask`, `fcna` and `fcnamask`, or `fcnb` and `fcnbmask` parameter values of the `chg-netopts` command.

The IP address of the E5-IPSM cannot be shown as the `IPADDR` value in the `rtrv-ip-lnk`, `rtrv-ftp-serv`, or `rtrv-seas-config` outputs, or the `BPIPADDR` value in the `rtrv-ip-card` output.

The examples in this procedure are used to add an **E5-IPSM** in card location 2107.

1. Display the cards in the database using the `rtrv-card` command.

This is an example of the possible output.

```
rlghncxa03w 07-13-13 09:12:36 GMT EAGLE5 45.0.0
CARD  TYPE      APPL      LSET NAME      LINK SLC LSET NAME      LINK SLC
1101  DSM          VSCCP
1102  TSM          GLS
1103  DCM          STPLAN
1114  E5TDM-A
1116  E5TDM-B
1201  LIMDS0      SS7ANSI   sp2             A    0    sp1             B    0
1202  LIMDS0      SS7ANSI   sp2             A    1    nsp3            B    0
1203  LIMDS0      SS7ANSI   sp3             A    0
1204  LIMDS0      SS7ANSI   sp3             A    1
1205  LIMDS0      SS7ANSI   itu1            A    0
1206  LIMDS0      SS7ANSI   nsp3            A    1    nsp4            B    0
1212  DSM          VSCCP
1214  TSM          GLS
1215  DCM          STPLAN
1301  LIMATM      ATMANSI   lsnatm1        A    0
1303  STC          EROUTE
1305  DCM          STPLAN
1308  LIMDS0      SS7ANSI   sp6             A    0    sp7             B    0
1311  LIMDS0      SS7ANSI   sp2             A    2    sp1             B    1
           sp7             A1   1    sp3             B1   2
1315  LIMDS0      SS7ANSI   sp7             A    2    sp5             B    0
1318  LIMATM      ATMANSI   lsnatm1        A    1
2101  STC          EROUTE
2103  STC          EROUTE
2105  STC          EROUTE
```

The cards should be distributed throughout the **EAGLE** for proper power distribution. Refer to *Installation Guide* for the shelf power distribution.

Note: The **EAGLE** can contain a maximum of 3 **E5-IPSMs**. If the `rtrv-card` output shows that there are three **E5-IPSMs** in the **EAGLE**, this procedure cannot be performed.

Note: If the card being added in this procedure is not an **E5-IPSM** card, continue the procedure with 3.

2. Verify that HIPR2 cards are installed in card locations 9 and 10 in the shelf that will contain the E5-IPSM card being added in this procedure. Enter this command.

```
rept-stat-gpl:gpl=hipr2
```

This is an example of the possible output.

```
rlghncxa03w 09-07-01 11:40:26 GMT EAGLE5 41.1.0
GPL          CARD          RUNNING          APPROVED          TRIAL
HIPR2        1109          126-002-000     126-002-000     126-003-000
HIPR2        1110          126-002-000     126-002-000     126-003-000
HIPR2        1209          126-002-000     126-002-000     126-003-000
HIPR2        1210          126-002-000     126-002-000     126-003-000
HIPR2        1309          126-002-000     126-002-000     126-003-000
HIPR2        1310          126-002-000     126-002-000     126-003-000
HIPR2        2109          126-002-000     126-002-000     126-003-000
HIPR2        2110          126-002-000     126-002-000     126-003-000
Command Completed
```

If HIPR2 cards are installed in the shelf that will contain the E5-IPSM card, continue the procedure with [3](#).

If HIPR2 cards are not installed on the shelf that will contain the E5-IPSM card, refer to *Installation Guide* to install the HIPR2 cards. Once the HIPR2 cards have been installed, continue the procedure with [3](#).

3. Install the **E5-IPSM** into the proper card location.

If the OA&M IP Security Enhancements feature is enabled and activated, **UIM 1493, SSH Host Keys Regenerated**, is displayed when the **E5-IPSM** is installed into the card location. **UIM 1493** contains the public host key fingerprint which is used to establish a secure connection with an **SSH** client. If the secure connection is to be made with the **FTRA**, the public host key fingerprint displayed in **UIM 1493** must be added to the `hosts.xml` file in the **FTRA**. Record the public host key fingerprint information displayed in **UIM 1493** if a secure connection to the **FTRA** will be made. For more information about editing the `hosts.xml` file on **FTRA**, see *FTP Table Base Retrieval (FTRA) User's Guide*.

4. Verify that the EAGLE has a fan unit and the fan unit is on. If the fan unit is not on, use the `chg-feat:fan=on` command to turn on the fan.
5. Add the **E5-IPSM** using the `ent-card` command.

For this example, enter this command.

```
ent-card:loc=2107:type=e5ipsm:appl=ips
```

When this command has successfully completed, these messages should appear.

```
rlghncxa03w 06-10-01 09:12:36 GMT EAGLE5 36.0.0
Telnet auto-provisioning activated, 8 terminals are being added:
Telnet terminal 17 Added at location 2107.
Telnet terminal 18 Added at location 2107.
Telnet terminal 19 Added at location 2107.
Telnet terminal 20 Added at location 2107.
Telnet terminal 21 Added at location 2107.
Telnet terminal 22 Added at location 2107.
Telnet terminal 23 Added at location 2107.
Telnet terminal 24 Added at location 2107.
```

ENT-CARD: MASP A - COMPLTD

- Verify the changes using the `rtrv-card` command with the card location specified in 5.

For this example, enter this command.

```
rtrv-card:loc=2107
```

This is an example of the possible output.

```
rlghncxa03w 06-10-01 09:12:36 GMT EAGLE5 36.0.0
CARD   TYPE      APPL      LSET NAME      LINK SLC LSET NAME      LINK SLC
2107   E5-IPSM      IPS
```

- Verify that the terminals shown as added in 5 have been added by entering the `rtrv-trm` command.

This is an example of the possible output.

```
rlghncxa03w 06-10-01 16:02:08 GMT EAGLE5 39.0.0
TRM  TYPE      COMM          FC      TMOUT MXINV  DURAL
1    VT320      9600-7-E-1   SW      30    5      99:59:59
2    KSR        9600-7-E-1   HW      30    5      INDEF
3    PRINTER   4800-7-E-1   HW      30    0      00:00:00
4    VT320      2400-7-E-1   BOTH    30    5      00:30:00
5    VT320      9600-7-O-1   NONE    30    5      00:00:30
6    VT320      9600-7-E-2   SW      30    9      INDEF
7    PRINTER   9600-7-N-2   HW      30    5      00:30:00
8    KSR        19200-7-E-2  BOTH    30    5      00:30:00
9    VT320      9600-7-E-1   SW      30    7      00:30:00
10   VT320      9600-7-E-1   HW      30    5      00:30:00
11   VT320      4800-7-E-1   HW      30    5      00:30:00
12   PRINTER   9600-7-E-1   HW      30    4      00:30:00
13   VT320      9600-7-O-1   NONE    30    5      00:30:00
14   VT320      9600-7-E-2   SW      30    8      00:30:00
15   VT320      9600-7-N-2   HW      30    5      00:30:00
16   VT320      9600-7-E-2   BOTH    30    3      00:30:00

TRM  TYPE      LOC          TMOUT MXINV  DURAL      SECURE
17   TELNET    2107         60    5      00:30:00
18   TELNET    2107         60    5      00:30:00
19   TELNET    2107         60    5      00:30:00
20   TELNET    2107         60    5      00:30:00
21   TELNET    2107         60    5      00:30:00
22   TELNET    2107         60    5      00:30:00
24   TELNET    2107         60    5      00:30:00

TRM  LOGINTMR  LOGOUTTMR  PNGTIMEINT  PNGFAILCNT
      (sec)    (sec)      (msec)
17   none     none       none        1
18   none     none       none        1
19   none     none       none        1
20   none     none       none        1
21   none     none       none        1
22   none     none       none        1
23   none     none       none        1
24   none     none       none        1
```

TRM	TRAF	LINK	SA	SYS	PU	DB	UIMRD
1	NO	YES	NO	YES	NO	YES	YES
2	NO	NO	NO	NO	NO	NO	NO
3	YES	YES	YES	NO	YES	YES	YES
4	YES	NO	NO	NO	NO	NO	NO
5	NO	YES	NO	NO	NO	NO	YES
6	NO	NO	YES	NO	NO	NO	NO
7	YES	YES	YES	YES	YES	YES	YES
8	NO	NO	NO	NO	YES	NO	YES
9	NO	YES	NO	NO	NO	YES	NO
10	NO	NO	NO	NO	NO	NO	YES
11	YES	YES	YES	YES	YES	YES	YES
12	YES	YES	YES	YES	YES	YES	YES
13	NO	YES	NO	NO	NO	NO	YES
14	NO	NO	YES	NO	NO	NO	NO
15	YES	YES	YES	NO	YES	YES	YES
16	NO	NO	NO	NO	YES	NO	YES
17	NO	NO	NO	NO	NO	NO	NO
18	NO	NO	NO	NO	NO	NO	NO
19	NO	NO	NO	NO	NO	NO	NO
20	NO	NO	NO	NO	NO	NO	NO
21	NO	NO	NO	NO	NO	NO	NO
22	NO	NO	NO	NO	NO	NO	NO
23	NO	NO	NO	NO	NO	NO	NO
24	NO	NO	NO	NO	NO	NO	NO

	APP	APP										
TRM	SERV	SS	CARD	CLK	DBG	GTT	GWS	MEAS	MON	MPS	SEAS	SLAN
1	YES	YES	YES	YES	YES	YES	YES	YES	YES	YES	NO	NO
2	YES	YES	YES	YES	YES	YES	YES	YES	YES	YES	NO	NO
3	YES	YES	YES	YES	YES	YES	YES	YES	YES	YES	NO	NO
4	YES	YES	YES	YES	YES	NO	YES	YES	YES	YES	NO	NO
5	YES	YES	YES	YES	YES	YES	YES	YES	YES	YES	NO	NO
6	YES	YES	YES	YES	YES	YES	YES	YES	YES	YES	NO	NO
7	NO	YES	YES	YES	YES	YES	YES	YES	YES	YES	NO	NO
8	YES	YES	YES	YES	YES	YES	YES	YES	YES	YES	YES	YES
9	YES	YES	YES	YES	YES	YES	YES	YES	YES	YES	YES	YES
10	YES	YES	YES	YES	YES	YES	YES	YES	YES	YES	YES	YES
11	NO	NO	NO	NO	NO	NO	NO	NO	NO	NO	NO	NO
12	NO	NO	NO	NO	NO	NO	NO	NO	NO	NO	NO	NO
13	NO	NO	NO	NO	NO	NO	NO	NO	NO	NO	NO	NO
14	NO	NO	NO	NO	NO	NO	NO	NO	NO	NO	NO	NO
15	NO	NO	NO	NO	NO	NO	NO	NO	NO	NO	NO	NO
16	NO	NO	NO	NO	NO	NO	NO	NO	NO	NO	NO	NO
17	NO	NO	NO	NO	NO	NO	NO	NO	NO	NO	NO	NO
18	NO	NO	NO	NO	NO	NO	NO	NO	NO	NO	NO	NO
19	NO	NO	NO	NO	NO	NO	NO	NO	NO	NO	NO	NO
20	NO	NO	NO	NO	NO	NO	NO	NO	NO	NO	NO	NO
21	NO	NO	NO	NO	NO	NO	NO	NO	NO	NO	NO	NO
22	NO	NO	NO	NO	NO	NO	NO	NO	NO	NO	NO	NO
23	NO	NO	NO	NO	NO	NO	NO	NO	NO	NO	NO	NO
24	NO	NO	NO	NO	NO	NO	NO	NO	NO	NO	NO	NO

To change the output parameter values or the `logintmr`, `logouttmr`, `pngfailcnt`, or the `pngtimeint` parameter values for the telnet terminals added in this procedure, perform the [Changing Terminal Characteristics](#) procedure.

After this step has been performed, continue the procedure by performing one of these steps.

- If a Class A or C **IP address** will be specified for the `ipaddr` parameter in 10, continue the procedure with 9.
 - If a Class B **IP address** will be specified for the `ipaddr` parameter in 10, continue the procedure with 8.
8. The subnet address that results from the `ipaddr` and `submask` parameter values of the `chg-ip-lnk` command cannot be the same as the subnet address that results from the `pvn` and `pvnmask`, `fcna` and `fcnamask`, or `fcnb` and `fcnbmask` parameter values of the `chg-netopts` command.

Display the `pvn`, `pvnmask`, `fcna`, `fcnamask`, `fcnb`, and `fcnbmask` parameter values of the `chg-netopts` command by entering the `rtrv-netopts` command.

If error message E3967 Cmd Rej: E5IS must be on is displayed after the `rtrv-netopts` command is executed, the `pvn`, `pvnmask`, `fcna`, `fcnamask`, `fcnb`, and `fcnbmask` parameters are not configured.

This is an example of the possible output if the **E5IS** feature is on.

```
rlghncxa03w 09-02-28 21:17:37 GMT EAGLE5 40.1.0
NETWORK OPTIONS
-----
PVN          = 128.20.30.40
PVNMASK      = 255.255.192.0
FCNA        = 170.120.50.0
FCNAMASK    = 255.255.240.0
FCNB        = 170.121.50.0
FCNBMASK    = 255.255.254.0
```

Choose `ipaddr` and `submask` parameter values for the **IP link** to the **E5-IPSM** whose resulting subnet address is not be the same as the subnet address that resulting from the `pvn` and `pvnmask`, `fcna` and `fcnamask`, or `fcnb` and `fcnbmask` parameter values of the `chg-netopts` command. Continue the procedure with 9.

9. Display the **IP link** data assigned to the **E5-IPSM** using the `rtrv-ip-lnk` command with the **E5-IPSM's** location and the `port=a` parameter.

For this example, enter this command.

```
rtrv-ip-lnk:loc=2107:port=a
```

The following is an example of the possible output.

```
rlghncxa03w 06-10-01 21:20:37 GMT EAGLE5 36.0.0
LOC  PORT IPADDR          SUBMASK          DUPLEX  SPEED  MACTYPE  AUTO  MCAST
2107 A  -----  -----  HALF    10     DIX      NO    NO
```

10. Assign an **IP link** to the **E5-IPSM** using the `chg-ip-lnk` command with these parameters: `loc`, `port=a`, `ipaddr`, `submask`, `speed=100`, `duplex=full`.

For this example, enter this command.

```
chg-ip-
lnk:loc=2107:port=a:ipaddr=150.1.1.1:submask=255.255.255.0:sp
eed=100:duplex=full
```

Note: If either the `ipaddr` or `submask` parameters are specified, then both parameters must be specified, unless the `ipaddr=0.0.0.0` parameter is specified, then the `submask` parameter is not required. The `ipaddr=0.0.0.0` parameter disables the **IP** link.

When this command has successfully completed, this message should appear.

```
rlghncxa03w 06-10-01 21:20:37 GMT EAGLE5 36.0.0
CHG-IP-LNK: MASP A - COMPLTD
```

- 11.** Verify the changes made in [10](#) using the `rtrv-ip-lnk` command and specifying the card location and port values used in [10](#).

For this example, enter this command.

```
rtrv-ip-lnk:loc=2107:port=a
```

The following is an example of the possible output.

```
rlghncxa03w 06-10-01 21:20:37 GMT EAGLE5 36.0.0
LOC  PORT IPADDR          SUBMASK          DUPLEX  SPEED  MACTYPE  AUTO  MCAST
2107  A    150.1.1.1          255.255.255.0  FULL   100    DIX      NO   NO
```

- 12.** Display the current **IP** host information in the database by entering the `rtrv-ip-host` command with the **IP** address of the **IP** link shown in [11](#).

For this example, enter this command.

```
rtrv-ip-host:ipaddr=150.1.1.1
```

No **IP** address and **IP** host entry is displayed, as shown in the following example.

```
rlghncxa03w 07-13-13 09:12:36 GMT EAGLE5 45.0.0
```

```
No matching entries found
```

```
IP Host table is (2 of 4096) <1% full
```

- 13.** Assign an **IP** host to the **E5-IPSM** using the `ent-ip-host` command.

For this example, enter this command.

```
ent-ip-host:host=ip.nc.tekelec.com:ipaddr=150.1.1.1
```

When this command has successfully completed, the following message should appear.

```
rlghncxa03w 06-10-01 21:18:37 GMT EAGLE5 36.0.0
ENT-IP-HOST: MASP A - COMPLTD
```

- 14.** Display the **IP** card attributes of the **E5-IPSM** using the `rtrv-ip-card` command specifying the **E5-IPSM**'s location.

For this example, enter this command.

```
rtrv-ip-card:loc=2107
```

The following is an example of the possible output.

```

rlghncxa03w 08-06-01 21:20:37 GMT EAGLE5 39.0.0
LOC 2107
  SRCHORDR  SRVR
  DNSA      -----
  DNSB      -----
  DEFROUTER -----
  DOMAIN    -----
  SCTPCSUM  crc32c
  BPIPADDR  -----
  BPSUBMASK -----

```

- Change the **IP** card attributes of the **E5-IPSM** using the `chg-ip-card` command with these values: **E5-IPSM** card location, local search order, domain, and the default router for the **E5-IPSM**.

For this example, enter this command.

```

chg-ip-
card:loc=2107:srchordr=local:domain=ip.nc.tekelec.com:defrout
er=150.1.1.250

```

The following is an example of the possible output.

Note: The network portion of the default router's **IP** address (`defrouter`) must be the same as the network portion of the **IP** address specified in the `chg-ip-lnk` (7) and `ent-ip-host` (11) commands. The value of the last octet of the default router's **IP** address must be from 1 to 254.

When this command has successfully completed, this message should appear.

```

rlghncxa03w 06-10-01 21:20:37 GMT EAGLE5 36.0.0
CHG-IP-CARD:  MASP A - COMPLTD

```

- Verify the changes made in 15 using the `rtrv-ip-card` command specifying the **E5-IPSM**'s location.

For this example, enter this command.

```
rtrv-ip-card:loc=2107
```

The following is an example of the possible output.

```

rlghncxa03w 08-06-01 21:20:37 GMT EAGLE5 39.0.0
LOC 2107
  SRCHORDR  LOCAL
  DNSA      -----
  DNSB      -----
  DEFROUTER 150.1.1.250
  DOMAIN    ip.nc.tekelec.com
  SCTPCSUM  crc32c
  BPIPADDR  -----
  BPSUBMASK -----

```

- Verify that the **IP User Interface (Telnet)** feature is enabled and turned on, and if secure connections to the **EAGLE** are to be used, verify that the **OA&M IP Security Enhancements** feature is enabled and activated by entering the `rtrv-ctrl-feat` command.

This is an example of the possible output.

```
rlghncxa03w 06-10-01 21:15:37 GMT EAGLE5 36.0.0
The following features have been permanently enabled:
Feature Name          Partnum    Status    Quantity
Telnet                893005701 off      ----
```

Note: The `rtrv-ctrl-feat` command output contains other fields that are not used by this procedure. If you wish to see all the fields displayed by the `rtrv-ctrl-feat` command, see the `rtrv-ctrl-feat` command description in *Commands User's Guide*.

If the **IP User Interface (Telnet)** feature is enabled and turned on (`status = on`), continue the procedure with [18](#).

If the **IP User Interface (Telnet)** feature is not enabled or turned on, perform the [Activating Controlled Features](#) procedure to enable and turn on the **IP User Interface (Telnet)** feature.

If **UIM 1493** was displayed when the **E5-IPSM** was installed in [3](#), the **OA&M IP Security Enhancements** feature is enabled and turned on. If the **OA&M IP Security Enhancements** feature is enabled and turned on (shown by the entry `EAGLE OA&M IP Security` in the `rtrv-ctrl-feat` output with the `status = on`), continue the procedure with [18](#).

If the **OA&M IP Security Enhancements** feature is not enabled or turned on, and secure connections are to the **EAGLE** are to be used, perform the [Activating the EAGLE OA&M IP Security Enhancement Controlled Feature](#) procedure to enable and turn on the **OA&M IP Security Enhancements** feature.

18. Place the **E5-IPSM** into service using the `rst-card` specifying the location of the **E5-IPSM**.

For this example, enter this command.

```
rst-card:loc=2107
```

When this command has successfully completed, this message should appear.

```
rlghncxa03w 06-10-01 21:20:37 GMT EAGLE5 36.0.0
Card has been allowed.
```

If the **OA&M IP Security Enhancements** feature is enabled and activated, **UIM 1494, SSH Host Keys Loaded**, is displayed. **UIM 1494** contains the public host key fingerprint which is used to establish a secure connection with an **SSH** client. If the secure connection is to be made with the **FTRA**, the public host key fingerprint displayed in **UIM 1494** must be added to the `hosts.xml` file in the **FTRA**. If the public host key fingerprint was not recorded in [3](#), record the public host key fingerprint information displayed in **UIM 1494** if a secure connection to the **FTRA** will be made. For more information about editing the `hosts.xml` file on the **FTRA**, see [FTP Table Base Retrieval \(FTRA\) User's Guide](#).

19. Put the terminals that were created when the **E5-IPSM** was added in [5](#) into service with the `rst-trm` command. For this example, enter these commands.

```
rst-trm:trm=17
```

```
rst-trm:trm=18
rst-trm:trm=19
rst-trm:trm=20
rst-trm:trm=21
rst-trm:trm=22
rst-trm:trm=23
rst-trm:trm=24
```

This message should appear when each of these commands have successfully completed.

```
rlghncxa03w 07-05-01 15:08:45 GMT EAGLE5 37.0.0
Allow message sent to terminal
```

```
rlghncxa03w 07-05-01 15:08:45 GMT EAGLE5 37.0.0
Command Completed.
```

20. Back up the new changes using the `chg-db:action=backup:dest=fixedcommand`.

These messages should appear, the active **Maintenance and Administration Subsystem Processor (MASP)** appears first.

```
BACKUP (FIXED) : MASP A - Backup starts on active MASP.
BACKUP (FIXED) : MASP A - Backup on active MASP to fixed disk complete.
BACKUP (FIXED) : MASP A - Backup starts on standby MASP.
BACKUP (FIXED) : MASP A - Backup on standby MASP to fixed disk complete.
```

Figure 4-26 Adding an E5-IPSM

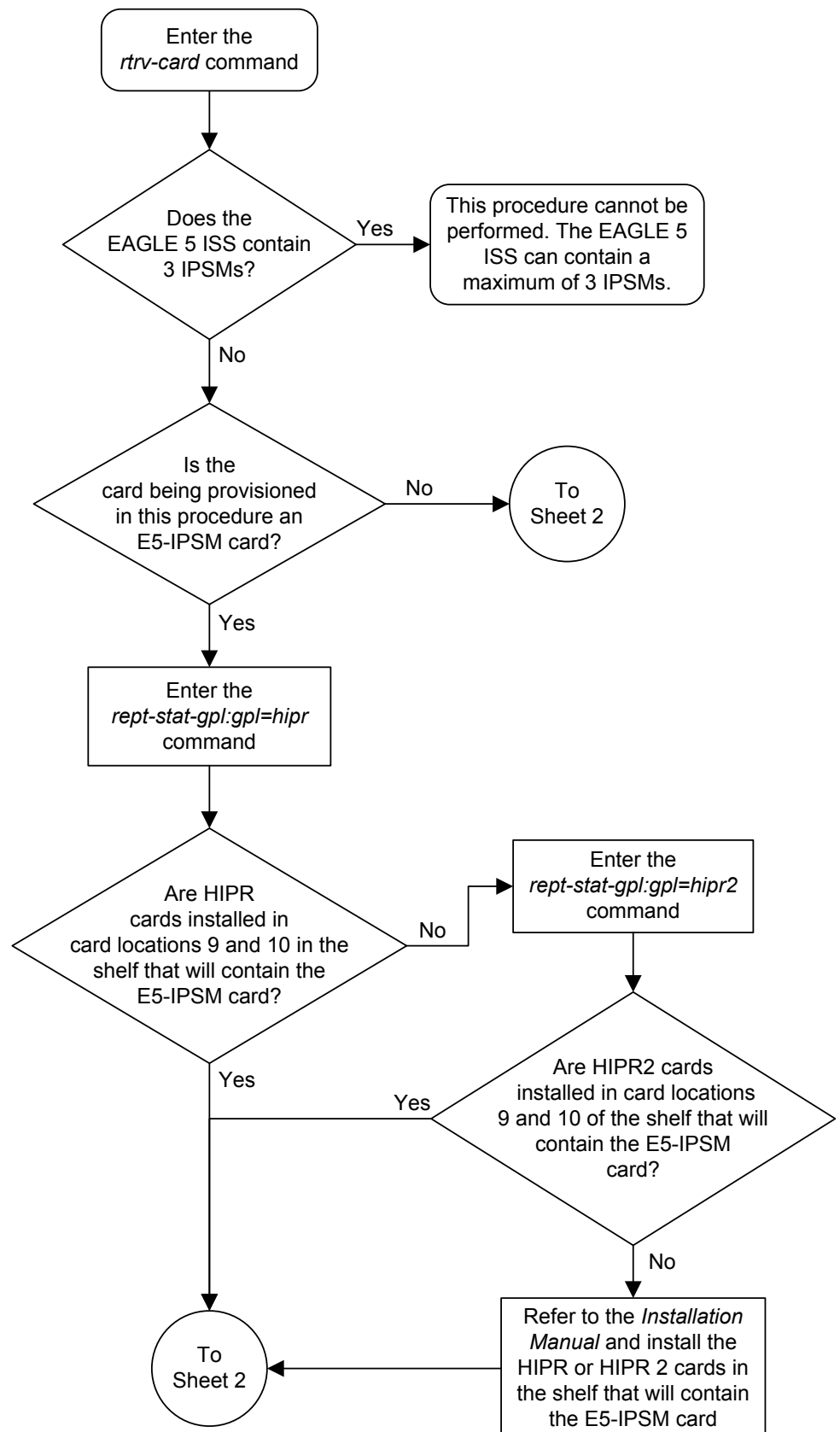

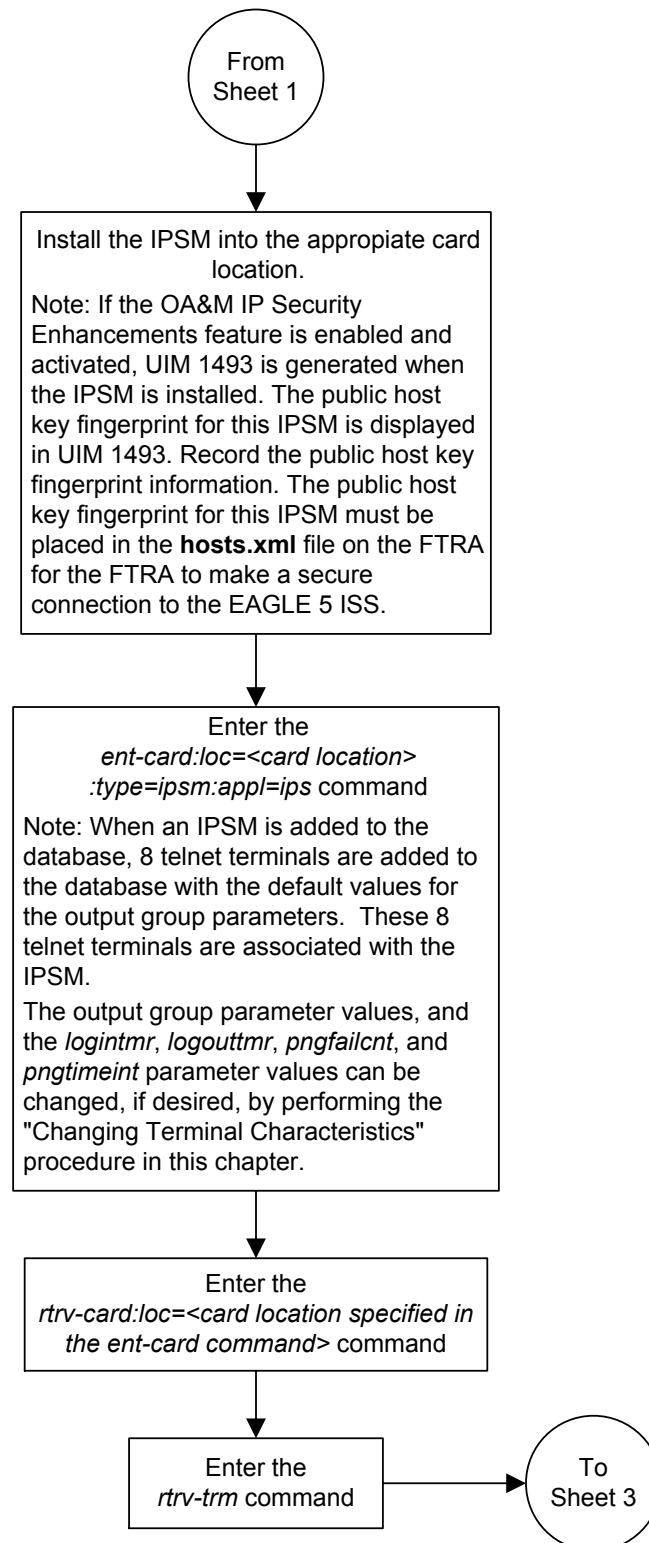

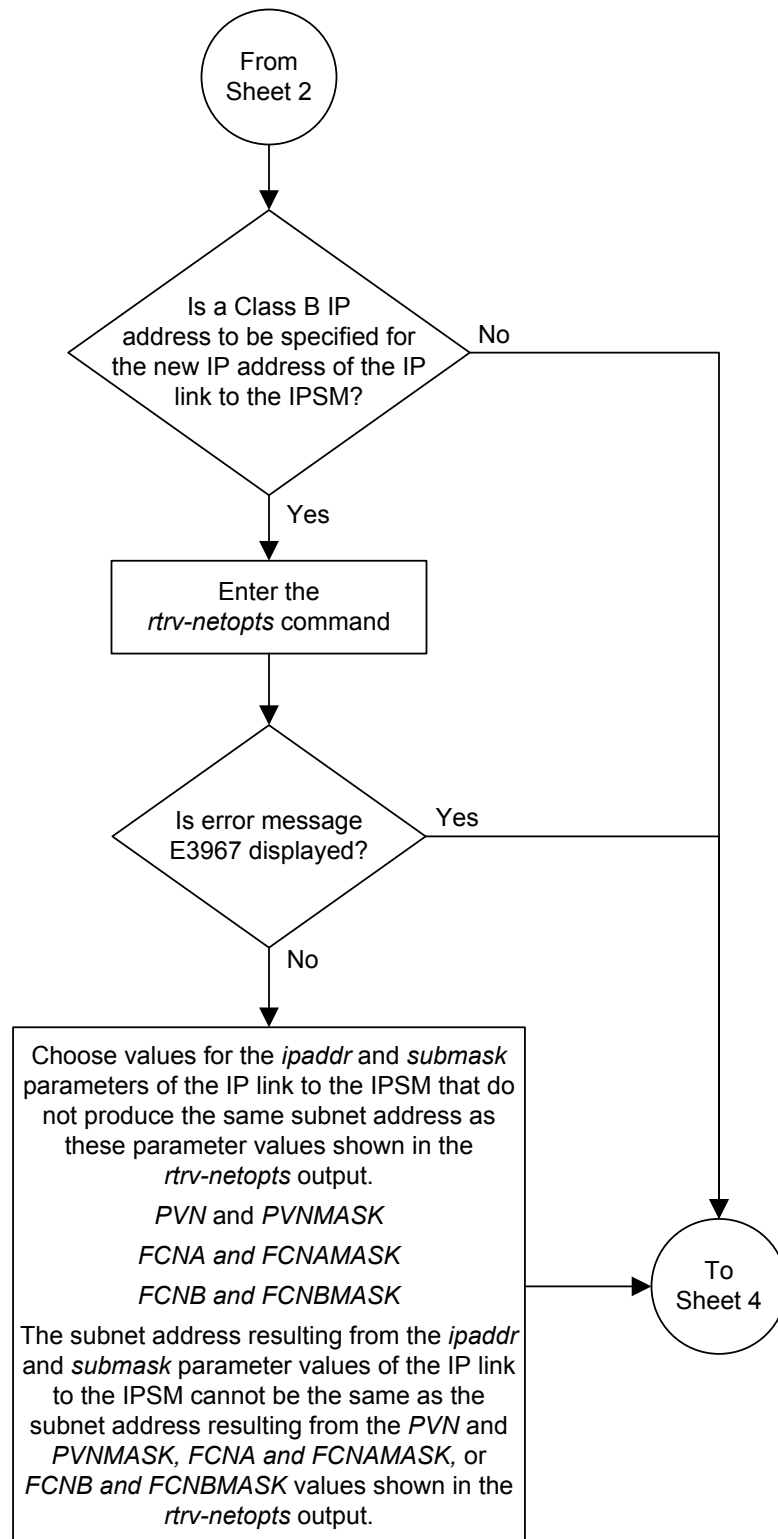

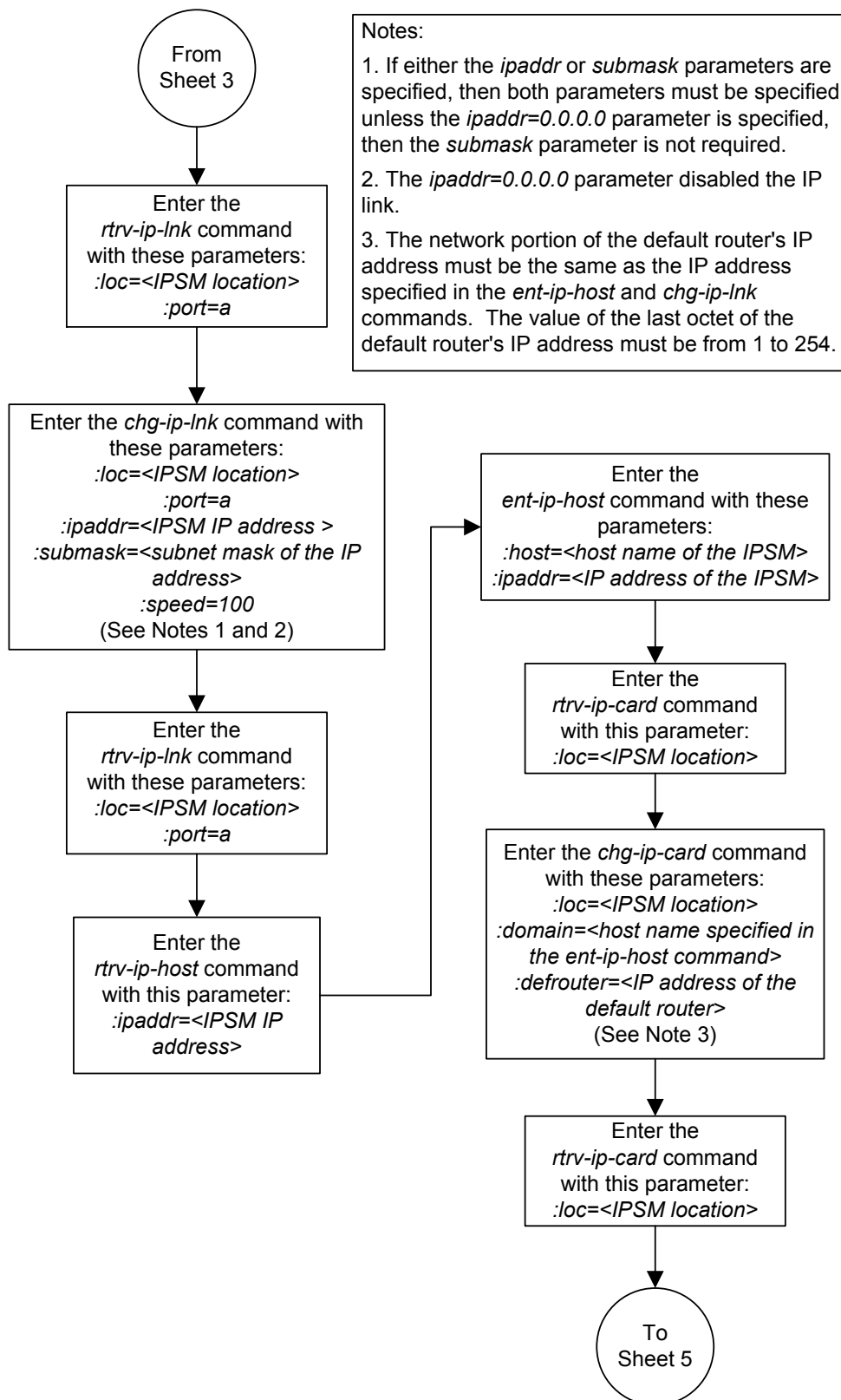

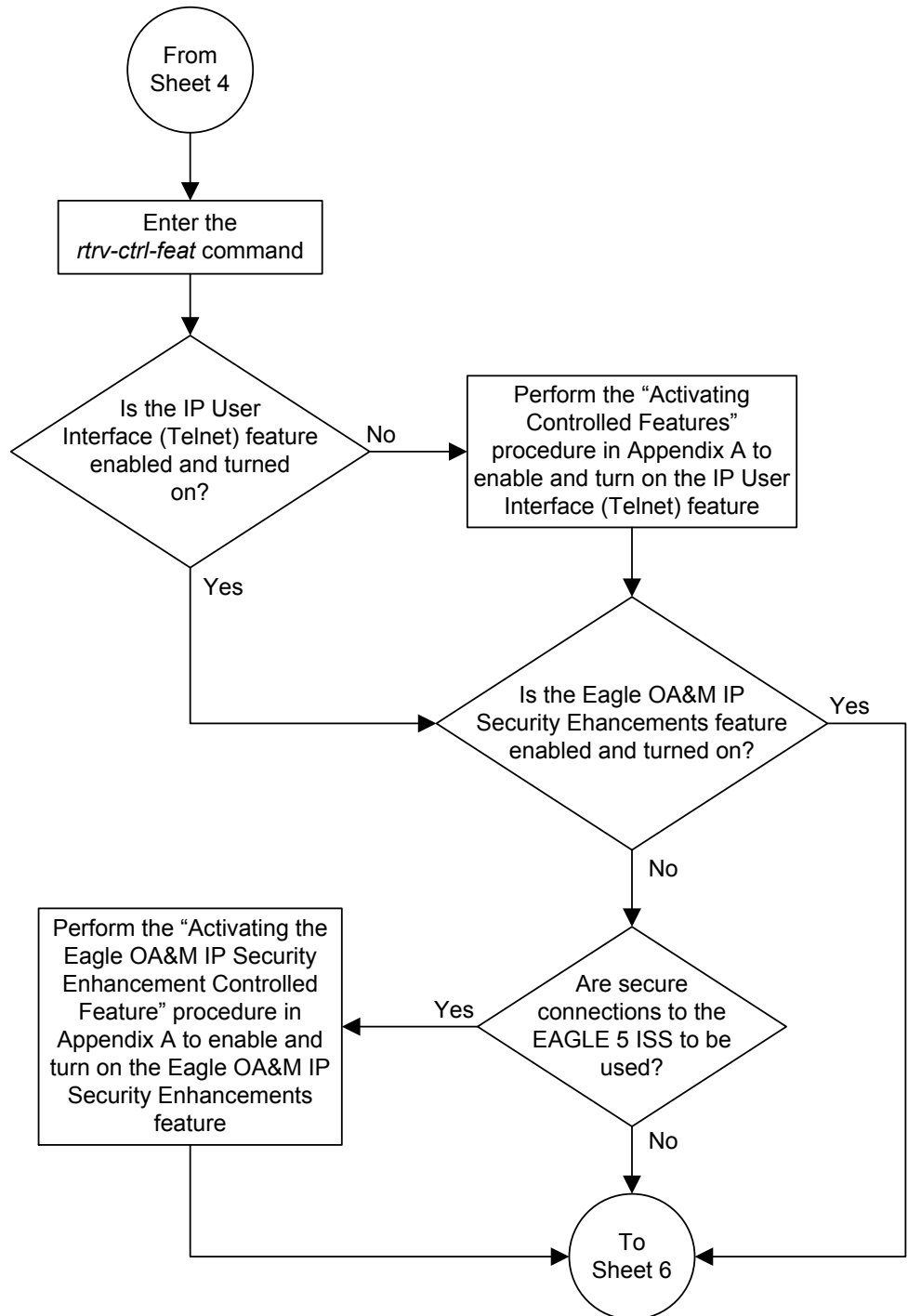

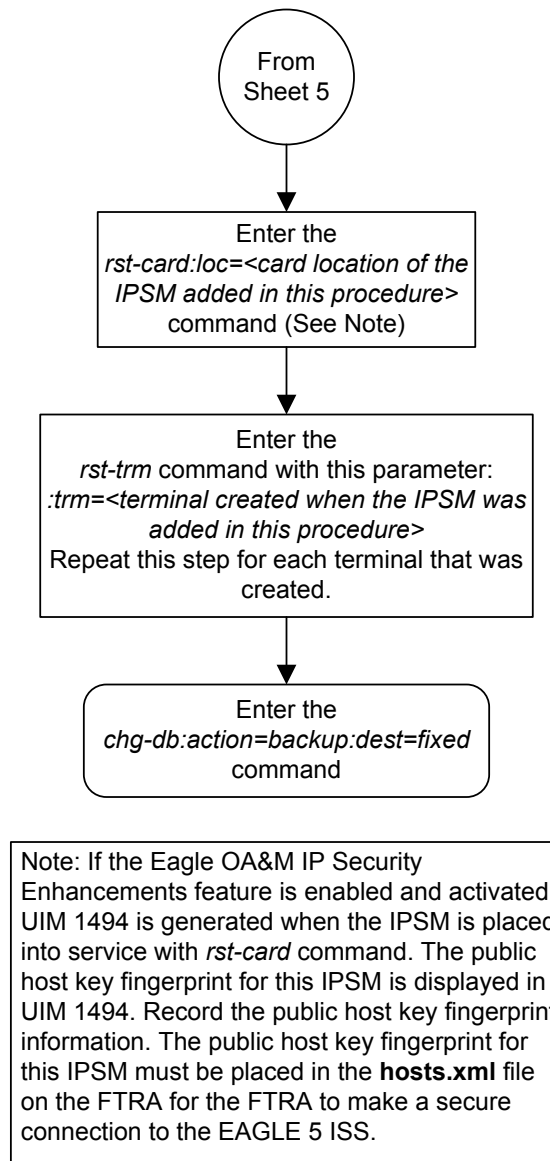

Removing an E5-IPSM

This procedure is used to remove an **E5-IPSM** (IP Services Module - a card running the `ips` application) from the database using the `dlt-card` command.

Note: As of Release 46.5, the E5-IPSM card and its functionality is replaced by the E5-ENET-B (p/n 870-2971-01) or SLIC (p/n 7094646) card. Any references to E5-IPSM and the 870-2877-01 part number should be replaced by the 46.5 and greater card and part number.

Caution: If the **E5-IPSM** is the last **E5-IPSM** in service, removing this card from the database will disable the IP User Interface (Telnet) feature.

All terminals associated with the **E5-IPSM** being removed must be out of service. The terminals are displayed using the `rtrv-trm` command. The state of the terminals is displayed using the `rept-stat-trm` command.

The examples in this procedure are used to remove the **E5-IPSM** in card location 2107.

Canceling the REPT-STAT-CARD Command

Because the `rept-stat-card` command used in this procedure can output information for a long period of time, the `rept-stat-card` command can be canceled and the output to the terminal stopped. There are three ways that the `rept-stat-card` command can be canceled.

- Press the F9 function key on the keyboard at the terminal where the `rept-stat-card` command was entered.
- Enter the `canc-cmd` without the `trm` parameter at the terminal where the `rept-stat-card` command was entered.
- Enter the `canc-cmd:trm=<xx>`, where `<xx>` is the terminal where the `rept-stat-card` command was entered, from another terminal other than the terminal where the `rept-stat-card` command was entered. To enter the `canc-cmd:trm=<xx>` command, the terminal must allow Security Administration commands to be entered from it and the user must be allowed to enter Security Administration commands. The terminal's permissions can be verified with the `rtrv-secu-trm` command. The user's permissions can be verified with the `rtrv-user` or `rtrv-secu-user` commands.

For more information about the `canc-cmd` command, go to *Commands User's Guide*.

1. Display the cards in the database using the `rtrv-card` command.

This is an example of the possible output.

```
rlghncxa03w 13-07-01 09:12:36 GMT EAGLE5 45.0.0
CARD  TYPE      APPL      LSET NAME      LINK SLC LSET NAME      LINK SLC
1101  DSM          VS CCP
1102  TSM          GLS
1103  DCM          STPLAN
1113  E5MCAP       OAMHC
1114  E5TDM-A
```

```

1115 E5MCAP OAMHC
1116 E5TDM-B
1117 E5MDAL
1201 LIMDS0 SS7ANSI sp2 A 0 sp1 B 0
1202 LIMDS0 SS7ANSI sp2 A 1 nsp3 B 0
1203 LIMDS0 SS7ANSI sp3 A 0
1204 LIMDS0 SS7ANSI sp3 A 1
1205 LIMDS0 SS7ANSI itu1 A 0
1206 LIMDS0 SS7ANSI nsp3 A 1 nsp4 B 0
1212 DSM VSCCP
1214 TSM GLS
1215 DCM STPLAN
1301 LIMATM ATMANSI lsnatm1 A 0
1303 STC EROUTE
1305 DCM STPLAN
1308 LIMDS0 SS7ANSI sp6 A 0 sp7 B 0
1311 LIMDS0 SS7ANSI sp2 A 2 sp1 B 1
sp7 A1 1 sp3 B1 2
1315 LIMDS0 SS7ANSI sp7 A 2 sp5 B 0
1318 LIMATM ATMANSI lsnatm1 A 1
2101 STC EROUTE
2103 STC EROUTE
2105 STC EROUTE
2107 IPSM IPS
2108 IPSM IPS
2111 IPSM IPS

```

An **E5-IPSM** is identified by the entries **E5-IPSM** in the **TYPE** field and **IPS** in the **APPL** field.

2. Display the status of the **E5-IPSM** being removed from the database with the `rept-stat-card` command and specifying the card location of the **E5-IPSM**.

For this example, enter this command.

```
rept-stat-card:loc=2107
```

This is an example of the possible output.

```

rlghncxa03w 06-10-01 16:43:42 GMT EAGLE5 36.0.0
CARD  VERSION      TYPE      GPL      PST      SST      AST
2107  114-001-000  IPSM      IPS      IS-NR    Active  -----

ALARM STATUS      = No Alarms.
BPDCM GPL         = 002-122-000
IMT BUS A         = Conn
IMT BUS B         = Conn
Command Completed.

```

If the **IPSM** is out of service, shown by the entry **OOS-MT-DSBLD** in the **PST** column, skip steps 3 through 5, and go to step 6.

3. Display the terminals using the `rtrv-trm` command.

This is an example of the possible output.

```

rlghncxa03w 06-10-01 16:02:08 GMT EAGLE5 39.0.0
TRM  TYPE      COMM      FC      TMOUT  MXINV  DURAL
1    VT320     9600-7-E-1 SW      30     5      99:59:59
2    KSR      9600-7-E-1 HW      30     5      INDEF

```

3	PRINTER	4800-7-E-1	HW	30	0	00:00:00
4	VT320	2400-7-E-1	BOTH	30	5	00:30:00
5	VT320	9600-7-O-1	NONE	30	5	00:00:30
6	VT320	9600-7-E-2	SW	30	9	INDEF
7	PRINTER	9600-7-N-2	HW	30	5	00:30:00
8	KSR	19200-7-E-2	BOTH	30	5	00:30:00
9	VT320	9600-7-E-1	SW	30	7	00:30:00
10	VT320	9600-7-E-1	HW	30	5	00:30:00
11	VT320	4800-7-E-1	HW	30	5	00:30:00
12	PRINTER	9600-7-E-1	HW	30	4	00:30:00
13	VT320	9600-7-O-1	NONE	30	5	00:30:00
14	VT320	9600-7-E-2	SW	30	8	00:30:00
15	VT320	9600-7-N-2	HW	30	5	00:30:00
16	VT320	9600-7-E-2	BOTH	30	3	00:30:00

TRM	TYPE	LOC	TMOUT	MXINV	DURAL	SECURE
17	TELNET	2107	60	5	00:30:00	yes
18	SEAS	2107	60	5	00:30:00	yes
19	TELNET	2107	60	5	00:30:00	yes
20	TELNET	2107	60	5	00:30:00	yes
21	TELNET	2107	60	5	00:30:00	yes
22	TELNET	2107	60	5	00:30:00	yes
23	TELNET	2107	60	5	00:30:00	yes
24	TELNET	2107	60	5	00:30:00	yes
25	TELNET	2108	60	5	00:30:00	yes
26	TELNET	2108	60	5	00:30:00	yes
27	SEAS	2108	60	5	00:30:00	yes
28	TELNET	2108	60	5	00:30:00	yes
29	TELNET	2108	60	5	00:30:00	yes
30	TELNET	2108	60	5	00:30:00	yes
31	TELNET	2108	60	5	00:30:00	yes
32	TELNET	2108	60	5	00:30:00	yes
33	TELNET	2111	60	5	00:30:00	yes
34	TELNET	2111	60	5	00:30:00	yes
35	TELNET	2111	60	5	00:30:00	yes
36	TELNET	2111	60	5	00:30:00	yes
37	TELNET	2111	60	5	00:30:00	yes
38	TELNET	2111	60	5	00:30:00	yes
39	TELNET	2111	60	5	00:30:00	yes
40	TELNET	2111	60	5	00:30:00	yes

TRM	LOGINTMR (sec)	LOGOUTTMR (sec)	PNGTIMEINT (msec)	PNGFAILCNT
17	none	none	none	1
19	none	none	none	1
20	none	none	none	1
21	none	none	none	1
22	none	none	none	1
23	none	none	none	1
24	none	none	none	1
25	none	none	none	1
26	none	none	none	1
28	none	none	none	1
29	none	none	none	1
30	none	none	none	1
31	none	none	none	1
32	none	none	none	1
33	none	none	none	1
34	none	none	none	1
35	none	none	none	1
36	none	none	none	1

```

37 none none none 1
38 none none none 1
39 none none none 1
40 none none none 1

```

```

TRM TRAF LINK SA SYS PU DB UIMRD
1 NO YES NO YES NO YES YES
2 NO NO NO NO NO NO NO
.
.
39 NO NO NO NO NO NO NO
40 NO NO NO NO NO NO NO

```

```

APP APP
TRM SERV SS CARD CLK DBG GTT GWS MEAS MON MPS SEAS SLAN
1 YES YES YES YES YES YES YES YES YES YES NO NO
2 YES YES YES YES YES YES YES YES YES YES NO NO
.
.
39 NO NO NO NO NO NO NO NO NO NO NO NO
40 NO NO NO NO NO NO NO NO NO NO NO NO

```

4. Display the status of the terminals by entering the `rept-stat-trm` command.

This is an example of the possible output.

```

rlghncxa03w 06-10-01 15:08:45 GMT EAGLE5 36.0.0
TRM PST SST AST
1 IS-NR Active -----
2 IS-NR Active -----
3 IS-NR Active -----
4 IS-NR Active -----
5 IS-NR Active -----
6 IS-NR Active -----
7 IS-NR Active -----
8 IS-NR Active -----
9 IS-NR Active -----
10 IS-NR Active -----
11 IS-NR Active -----
12 IS-NR Active -----
13 IS-NR Active -----
14 IS-NR Active -----
15 IS-NR Active -----
16 IS-NR Active -----
17 IS-NR Active -----
18 IS-NR Active -----
19 IS-NR Active -----
20 IS-NR Active -----
21 IS-NR Active -----
22 IS-NR Active -----
23 IS-NR Active -----
24 IS-NR Active -----
25 IS-NR Active -----
26 IS-NR Active -----
27 IS-NR Active -----
28 IS-NR Active -----
29 IS-NR Active -----
30 IS-NR Active -----
31 IS-NR Active -----

```

```

32  IS-NR      Active      -----
33  IS-NR      Active      -----
34  IS-NR      Active      -----
35  IS-NR      Active      -----
36  IS-NR      Active      -----
37  IS-NR      Active      -----
38  IS-NR      Active      -----
39  IS-NR      Active      -----
40  IS-NR      Active      -----

```

Command Completed.

Note: If all the terminals associated with the **E5-IPSM** being removed from the database are out of service, shown by the entry **OOS-MT-DSBLD** in the **PST** column, skip step 5, and go to step 6.

5. Place the terminals associated with the **E5-IPSM** being removed out of service using the `rmv-trm` command.

For this example, enter these commands.

```

rmv-trm:trm=17
rmv-trm:trm=18
rmv-trm:trm=19
rmv-trm:trm=20
rmv-trm:trm=21
rmv-trm:trm=22
rmv-trm:trm=23
rmv-trm:trm=24

```

Note: If the E5-IPSM that will be removed in this procedure contains the last in-service SEAS terminal, the `force=yes` parameter must be specified with the `rmv-trm` command for that SEAS terminal.

Caution:

Placing these terminals out of service will disable any Telnet sessions running on these terminals.

If the status of any terminals associated with the **E5-IPSM** being removed shown in the **PST** field in step 4 is **OOS-MT-DSBLD** (out-of-service maintenance disabled), the terminal is already out of service and the `rmv-trm` command does not need to be executed for that terminal.

When these commands have successfully completed, this message should appear.

```

rlghncxa03w 06-10-01 15:08:45 GMT EAGLE5 36.0.0
Inhibit message sent to terminal

rlghncxa03w 06-10-01 15:08:45 GMT EAGLE5 36.0.0
Command Completed.

```

6. Place the **E5-IPSM** out of service using the `rmv-card` command, specifying the card location of the E5-IPSM.

For this example, enter this command.

```
rmv-card:loc=2107
```

When this command has successfully completed, this message should appear.

```
rlghncxa03w 06-10-01 09:12:36 GMT EAGLE5 36.0.0
Card has been inhibited.
```

7. Remove the card using the `dlt-card` command.

The `dlt-card` command has only one parameter, `loc`, which is the location of the card. For this example, enter these commands.

```
dlt-card:loc=2107
```

Note: If the E5-IPSM that was removed in this step contains a SEAS terminal, the entry for that SEAS terminal is removed from the SEAS over IP configuration and is not shown in the `rtrv-seas-config` output. This message is displayed after the `dlt-card` command has been entered.

Invalidating the Terminal data in SEASCFG Table

When this command has successfully completed, this message should appear.

```
rlghncxa03w 06-10-01 09:12:36 GMT EAGLE5 36.0.0
DLT-CARD: MASP A - COMPLTD
```

8. Verify the changes using the `rtrv-card` command specifying the card that was removed in step 7.

For this example, enter these commands.

```
rtrv-card:loc=2107
```

When this command has successfully completed, this message should appear.

```
E2144 Cmd Rej: Location invalid for hardware configuration
```

9. Back up the new changes using the `chg-db:action=backup:dest=fixedcommand`.

These messages should appear, the active **Maintenance and Administration Subsystem Processor (MASP)** appears first.

```
BACKUP (FIXED) : MASP A - Backup starts on active MASP.
BACKUP (FIXED) : MASP A - Backup on active MASP to fixed disk complete.
BACKUP (FIXED) : MASP A - Backup starts on standby MASP.
BACKUP (FIXED) : MASP A - Backup on standby MASP to fixed disk complete.
```

Figure 4-27 Removing an IPSM

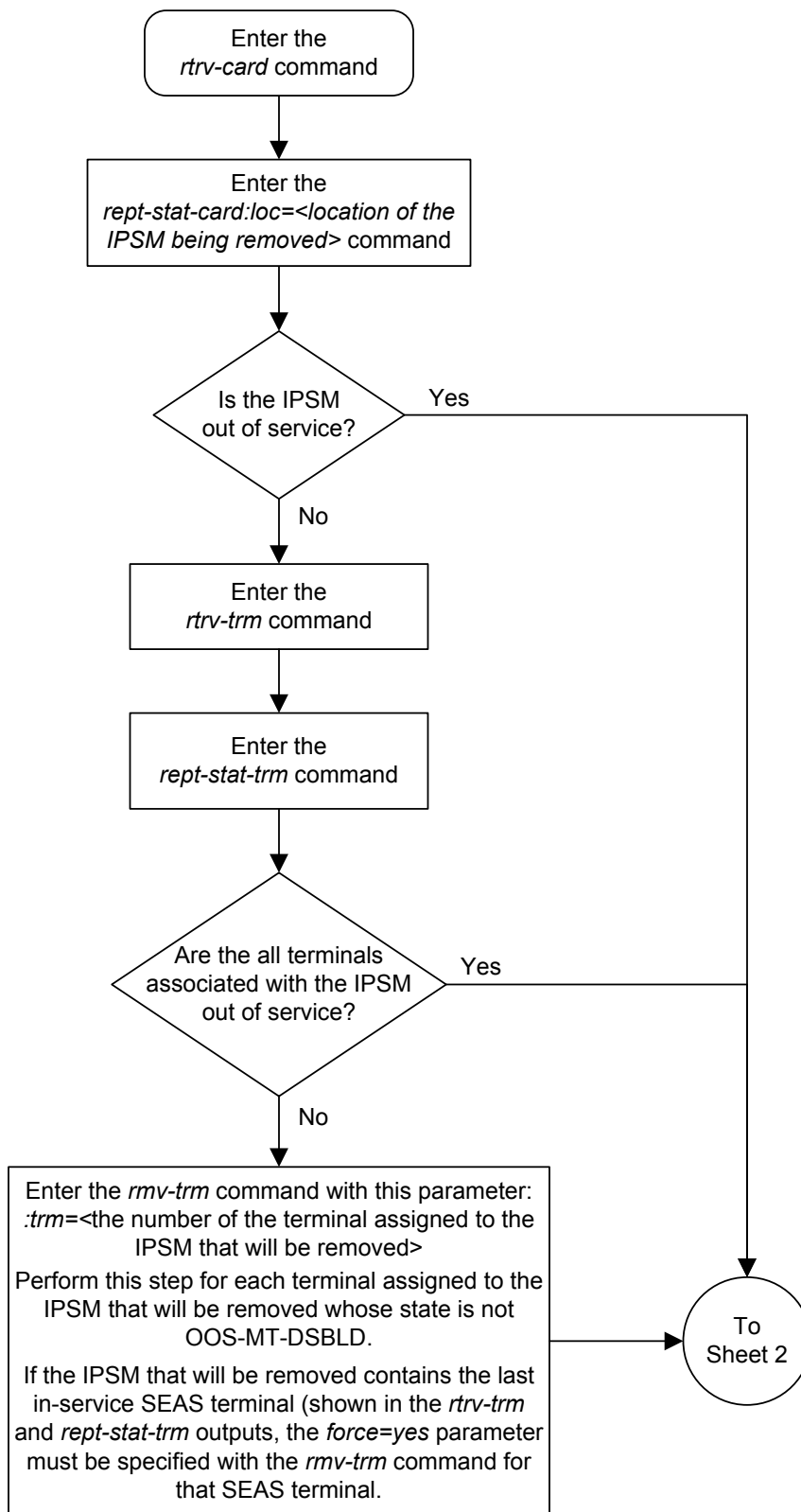

Sheet 1 of 2

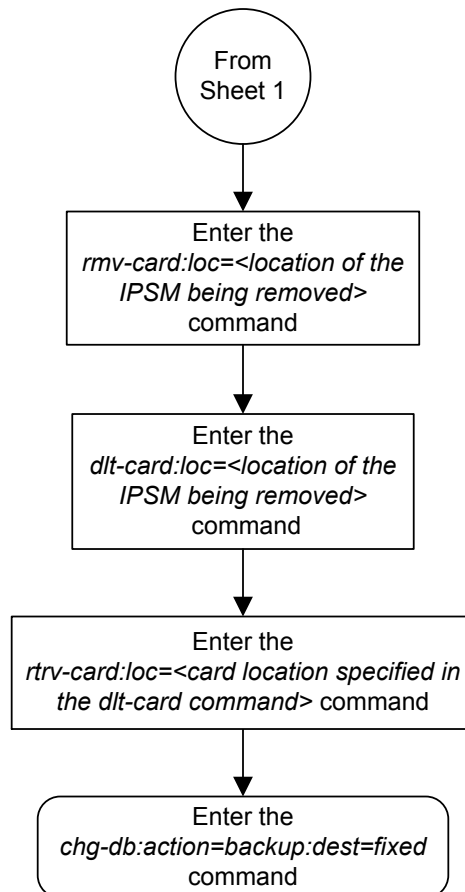

Configuring the Options for the Network Security Enhancements Feature

This procedure is used to configure the **EAGLE** to enhance its network security by discarding messages that should not be received. Four options are set using the `chg-stpopts` command to support this feature.

- **SECMTPSID** – The **EAGLE** should not receive a message where the **OPC** is equal to the **EAGLE**'s own true, secondary or capability point codes.
- **SECMTPMATE** – The **EAGLE** should not receive a message with the true, secondary, or capability point code of the mate **STP** other than across the C link.
- **SECMTPSNM** – the **EAGLE** should not receive an **MTP** network management message unless:
 - The **OPC** is an adjacent point code
 - The **EAGLE** has a route to the **OPC** of the **MTP** network management message on the linkset which the message was received.
 - The **EAGLE** has a route to the destination field in the message (if applicable to the concerned message) on the linkset which the message was received.
- **SECMTPSCMG** – the **EAGLE** should not receive an **SCCP** network management message unless:
 - The **EAGLE** has a route to the **OPC** of the **SCMG** message on the linkset, on which the message was received.
 - The **EAGLE** has a route to the affected point code in the message on the linkset on which the message was received.

This option will only apply to **SSP** and **SOR** messages. This feature will not affect the following messages: **SSA**, **SST**, **SOG**, **SBR**, **SNR** and **SRT**.

Each of these options have four values which determine how the **EAGLE** handles the messages controlled by the options.

- **NOTIFY** – The specified option is active and **UIMs** are generated.
- **SILENT** – The specified option is active, but no **UIMs** are generated.
- **TEST** – The specified option is not active, but **UIMs** are generated as if the option was active.
- **OFF** – The specified option is not active.

The system default value for each of these options is **OFF**.

To set these options, the Network Security Enhancements feature must be enabled and activated. This can be verified with the `rtrv-ctrl-feat` command. To enable and activate the Network Security Enhancements feature, go to the [Activating Controlled Features](#) procedure.

If the Network Security Enhancements feature is not enabled and activated, the Network Security Enhancement options are not displayed in the `rtrv-stpopts` output.

When the Network Security Enhancements feature is enabled and activated for the first time, each option is displayed in the `rtrv-stpopts` output with the system default value (**OFF**). When the Network Security Enhancements feature is enabled and activated after the feature was disabled, each option is displayed in the `rtrv-stpopts` output with the value that the option was assigned when the feature was disabled.

1. Display the Network Security Enhancements options using the `rtrv-stpopts` command.

This is an example of the possible output.

```
rlghncxa03w 06-10-01 16:02:05 GMT EAGLE5 36.0.0
STP OPTIONS
-----
SECMTPSID      notify
SECMPMATE      test
SECMTPSNM      silent
SECMTPSCMG     off
```

Note: The `rtrv-stpopts` command output contains other fields that are not used by this procedure. If you wish to see all the fields displayed by the `rtrv-stpopts` command, see the `rtrv-stpopts` command description in *Commands User's Guide*.

Note: If the Network Security Enhancement options are shown in the `rtrv-stpopts` output in step 1, skip step 2, and go to step 3.

2. Verify that the Network Security Enhancements feature is enabled and activated, by entering the `rtrv-ctrl-feat` command.

This is an example of the possible output.

```
rlghncxa03w 06-10-01 21:15:37 GMT EAGLE5 36.0.0
The following features have been permanently enabled:
Feature Name          Partnum    Status  Quantity
Network Security Enhance 893009101 off     ----
```

Note: The `rtrv-ctrl-feat` command output contains other fields that are not used by this procedure. If you wish to see all the fields displayed by the `rtrv-ctrl-feat` command, see the `rtrv-ctrl-feat` command description in *Commands User's Guide*.

If the Network Security Enhancements feature is not enabled or activated, go to the [Activating Controlled Features](#) procedure and enable and activate the Network Security Enhancements feature.

Caution: If the Network Security Enhancements feature is temporarily enabled, the Network Security Enhancement options can be set and used only for the amount of time shown in the `Trial Period Left` column in the `rtrv-ctrl-feat` output.

3. Change the Network Security Enhancement options.

For this example, enter this command.

```
chg-
stpopts:secmtpsid=silent:secmtpmate=notify :secmtpsnm=notify:
secmtpscmg=notify
```

When this command has successfully completed, this message should appear.

```
rlghncxa03w 06-10-01 00:22:57 GMT EAGLE5 36.0.0
CHG-STPOPTS: MASP A - COMPLTD
```

4. Verify the changes using the `rtrv-stpopts` command.

This is an example of the possible output.

```
rlghncxa03w 06-10-01 16:02:05 GMT EAGLE5 36.0.0
STP OPTIONS
-----
SECMTPSID          silent
SECMPMATE          notify
SECMTPSNM          notify
SECMTPSCMG         notify
```

Note: The `rtrv-stpopts` command output contains other fields that are not used by this procedure. If you wish to see all the fields displayed by the `rtrv-stpopts` command, see the `rtrv-stpopts` command description in *Commands User's Guide*.

5. Back up the new changes using the `chg-db:action=backup:dest=fixedcommand`.

These messages should appear, the active **Maintenance and Administration Subsystem Processor (MASP)** appears first.

```
BACKUP (FIXED) : MASP A - Backup starts on active MASP.
BACKUP (FIXED) : MASP A - Backup on active MASP to fixed disk complete.
BACKUP (FIXED) : MASP A - Backup starts on standby MASP.
BACKUP (FIXED) : MASP A - Backup on standby MASP to fixed disk complete.
```

Figure 4-28 *Configuring the Options for the Network Security Enhancements Feature*

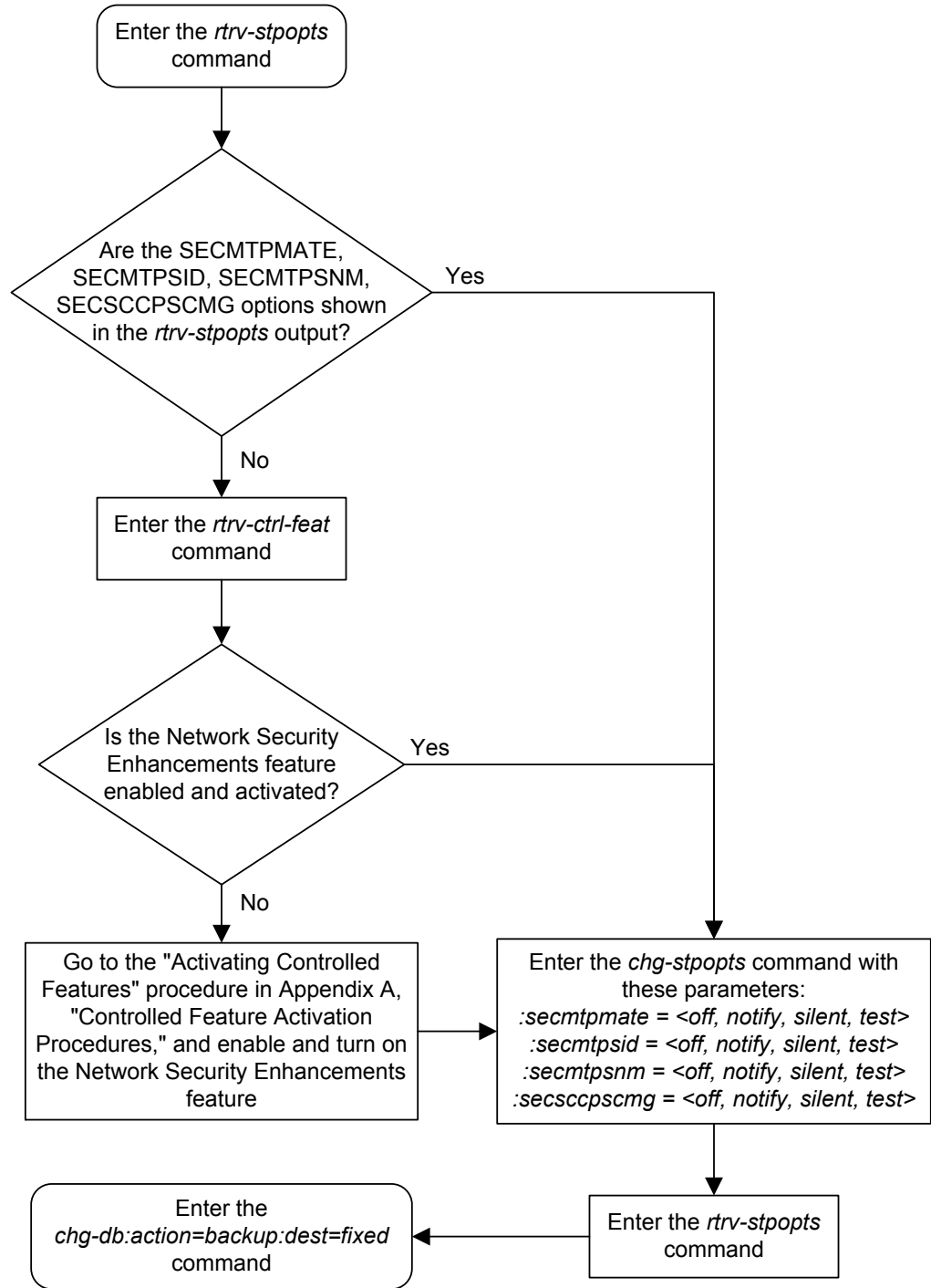

Configuring the Restore Device State Option

This procedure is used to configure the restore device state option using the `chg-stpopts` command with the `rstrdev` value for the `on` or `off` parameters of the `chg-stpopts` command. The system default value is `off`.

If the value of the restore device state option is `off` (`off=rstrdev`), the EAGLE does not retain the manually initiated state (for example, **OOS-MT-DSBLD**) for the signaling links, TCP/IP data links, cards, or the terminals after either the `init-sys` command is executed, or when a MASP role change occurs (the active MASP becomes the standby MASP and the standby MASP becomes the active MASP). After the `init-sys` command executes, the EAGLE attempts to bring all provisioned links, cards, and terminals on line, including those that were previously out of service. You will need to manually put each device back into its previous state after the EAGLE is back on line. If the `init-sys` command is being executed, it is advisable to print or electronically capture the output of the EAGLE's `rept-stat-slk`, `rept-stat-dlk`, `rept-stat-card`, and `rept-stat-trm` commands for reference before issuing the `init-sys` command. During a MASP role change, current processing for the role change occurs and the state of the out-of-service devices may change. To restore a device to its previous state, issue the appropriate inhibit/deactivate command listed in *Commands User's Guide* in the Related Commands section for each of the above `rept-stat` commands.

If the value of the restore device state option is `on` (`on=rstrdev`), the state the signaling links, TCP/IP data links, cards, and terminals is not changed after the `init-sys` command is executed or a MASP role change occurs. No manual intervention is required to put the device back into its previous state after the EAGLE is back on line.

If the restore device state option is `on` and the database is being restored with the `chg-db:action=restore` command, the state of the cards, SS7 signaling links, TCP/IP data links, and terminals before the `chg-db:action=restore` and `init-sys` commands are performed will not be maintained after these commands are performed. The persistent device state table becomes obsolete and is disabled. **UIM 1257** is generated.

```
rlghncxa03w 06-10-01 16:07:48 GMT EAGLE5 36.0.0
1234.1257 SYSTEM INFO DB Restore has cleared and disabled PDS
```

1. Display the existing values for the restore device state parameter by entering the `rtrv-stpopts` command.

The value for the restore device state parameter is shown in the `RSTRDEV` field. This is an example of the possible output.

```
rlghncxa03w 06-10-01 16:02:05 GMT EAGLE5 36.0.0
STP OPTIONS
-----
RSTRDEV          off
```

Note: The `rtrv-stpopts` command output contains other fields that are not used by this procedure. If you wish to see all the fields displayed by the `rtrv-stpopts` command, see the `rtrv-stpopts` command description in *Commands User's Guide*.

2. Change the restore device state parameter.

To change the `rstrdev` parameter to `on`, enter this command.

```
chg-stpopts:on=rstrdev
```

To change the `rstrdev` parameter to `off`, enter this command.

```
chg-stpopts:off=rstrdev
```

When this command has successfully completed, this message should appear.

```
rlghncxa03w 06-10-01 00:22:57 GMT EAGLE5 36.0.0
CHG-STPOPTS: MASP A - COMPLTD
```

3. Verify the changes using the `rtrv-stpopts` command.

If the `on=rstrdev` parameter was specified in 2, this is an example of the possible output.

```
rlghncxa03w 10-07-17 16:02:05 GMT EAGLE5 42.0.0
STP OPTIONS
-----
RSTRDEV          on
```

If the `off=rstrdev` parameter was specified in 2, this is an example of the possible output.

```
rlghncxa03w 10-07-17 16:02:05 GMT EAGLE5 42.0.0
STP OPTIONS
-----
RSTRDEV          off
```

Note: The `rtrv-stpopts` command output contains other fields that are not used by this procedure. If you wish to see all the fields displayed by the `rtrv-stpopts` command, see the `rtrv-stpopts` command description in *Commands User's Guide*.

4. Backup the new changes using the `chg-db:action=backup:dest=fixedcommand`.

These messages should appear, the active **Maintenance and Administration Subsystem Processor (MASP)** appears first.

```
BACKUP (FIXED) : MASP A - Backup starts on active MASP.
BACKUP (FIXED) : MASP A - Backup on active MASP to fixed disk complete.
BACKUP (FIXED) : MASP A - Backup starts on standby MASP.
BACKUP (FIXED) : MASP A - Backup on standby MASP to fixed disk complete.
```

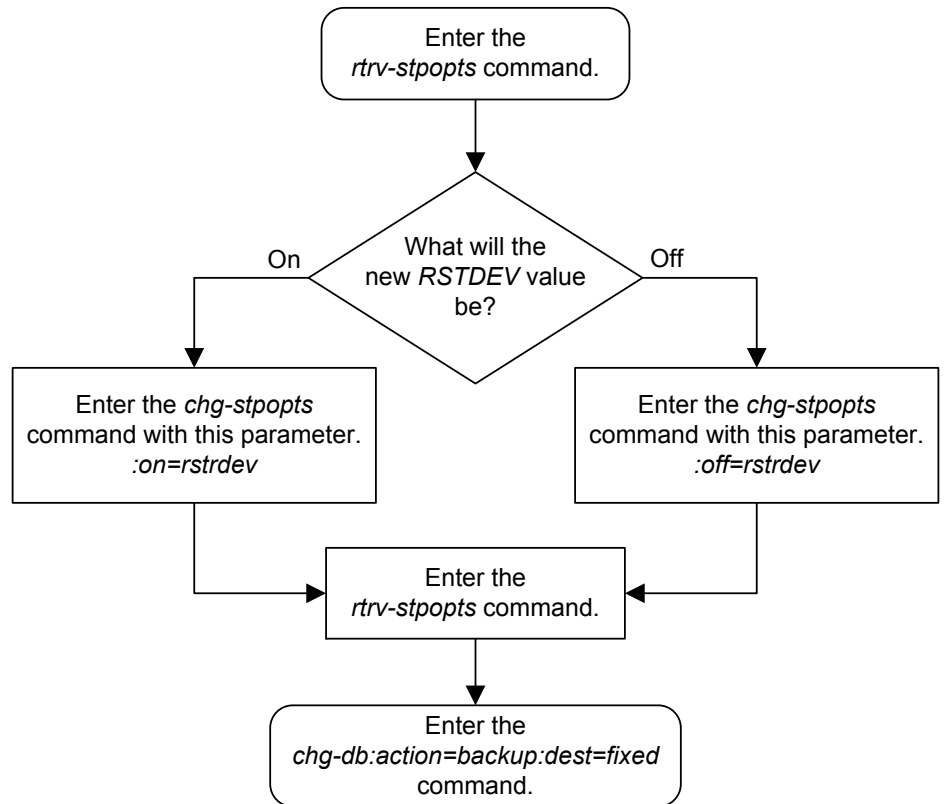
Figure 4-29 *Configuring the Restore Device State Option*

Adding an Entry to the Frame Power Alarm Threshold Table

This procedure is used to add an entry to the frame power alarm threshold table. The frame power alarm threshold table defines the power level threshold, in amps, for each frame in the **EAGLE**. The power level threshold determines when alarms regarding the amount of power used by the frame are generated. Three alarms can be generated for the power levels.

- **UAM 0522** - a minor alarm indicating that the power level for the frame has reached 90% of the threshold value.
- **UAM 0521** - a major alarm indicating that the power level for the frame has reached 95% of the threshold value.
- **UAM 0520** - a critical alarm indicating that the power level for the frame has reached 98% of the threshold value.

More information on these alarms is shown in *Unsolicited Alarm and Information Messages Reference*.

The power alarm threshold table for each frame is configured using the `ent-frm-pwr` command with these parameters:

`:frm` – The name of the frame being added to the power alarm threshold table, `cf00`, `ef00`, `ef01`, `ef02`, `ef03`, or `ef04`.

`:thrshld` – The power threshold value, from 30 to 65 amps.

The frame being added in this procedure must be configured in the database. This can be verified by displaying the shelves in the **EAGLE** with the `rtrv-shlf` command. The number assigned to each configured frame is shown in the `SHELF FRAME` column of the `rtrv-shlf` output. [Table 4-6](#) shows the name of each frame used in the Frame Power Alarm Threshold table and the corresponding frame number shown in the `SHELF FRAME` column of the `rtrv-shlf` output.

Table 4-6 Frame Power Alarm Threshold Table Frame Designations

Name of the Frame in the Frame Power Alarm Threshold Table	Frame Numbers shown in the Shelf Frame Column of the RTRV-SHLF Output
CF00	1
EF00	2
EF01	3
EF02	4
EF03	5
EF04	6

The `thrshld` parameter is optional. If the `thrshld` parameter value is not specified, the `thrshld` value is set to 30.

1. Display the frame power alarm thresholds by entering the `rtrv-frm-pwr` command.

This is an example of the possible output

```
rlghncxa03w 06-10-01 09:12:36 GMT EAGLE5 36.0.0
```

Frame	Power Threshold (Amps)
cf00	56
ef00	36

```
FRAME POWER THRESHOLD table is (2 of 10) 20% full;
RTRV-FRM-PWR: MASP A - COMPLTD
```

2. Display the shelves configured in the database by entering the `rtrv-shlf` command.

This is an example of the possible output.

```
rlghncxa03w 06-10-01 09:12:36 GMT EAGLE5 36.0.0
```

```
SHELF DISPLAY
FRAME SHELF      TYPE
1      1      CONTROL
1      2      EXTENSION
1      3      EXTENSION
2      1      EXTENSION
2      2      EXTENSION
2      3      EXTENSION
3      1      EXTENSION
```

To add an entry to the Frame Power **Alarm** Threshold table, the frame must be shown in the `rtrv-shlf` output. [Table 4-6](#) shows the name of the frames used in the Frame Power **Alarm** Threshold table and the corresponding frame numbers shown in the SHELF FRAME column of the `rtrv-shlf` output.

If the frame you wish to add to the Frame Power **Alarm** Threshold table is shown in the `rtrv-shlf` output, go to step 3.

If all the frames shown in the `rtrv-shlf` output are shown in the `rtrv-frm-pwr` output, the only actions that can be taken is to either remove an entry from the Frame Power **Alarm** Threshold table, or to change an entry in the Frame Power **Alarm** Threshold table. To remove an entry from the Frame Power **Alarm** Threshold table, perform the [Removing an Entry from the Frame Power Alarm Threshold Table](#) procedure. To change an entry in the Frame Power **Alarm** Threshold table, perform the [Changing an Entry in the Frame Power Alarm Threshold Table](#) procedure. If you do not wish to perform either of these actions, this procedure is finished.

3. Display the power consumption of the frame that will be added to the Frame Power **Alarm** Threshold table by entering the `rtrv-stp` command with these parameters:

```
display=power
```

```
frm =<frame to be added>
```

For this example, enter this command.

```
rtrv-stp:display=power:frm=ef01
```

This is an example of the possible output.

```
rlghncxa03w 06-10-01 16:02:05 GMT EAGLE5 36.0.0
```

Frame	Power Threshold		Power Consumption	
	(Amps)	(Watts)	(Amps)	(Watts)
EF01	+30	+1440	14.06	675

Card	Part Number	Revision	Power Consumption	
			(MilliAmps)	(Watts)
3101	870-1293-13	D	313	15
3102	870-1293-13	D	313	15
3103	870-2671-03	M	1563	75
3104	870-1293-13	D	313	15
3105	870-2061-01	K	542	26
3106	870-1984-13	M	646	31
3107	870-1984-13	M	646	31
3108	870-2372-14	J	521	25
3109	MUX		313	15
3110	MUX		313	15
3111	870-2061-01	A	542	26
3112	870-2061-01	A	542	26
3113	850-0549-01	A	+ 313	+ 15
3114	+ 870-2198-07	M	+ 1563	+ 75
3115	850-0549-01	A	313	15
3116	+ 870-2198-07	M	1563	75
3117	870-1293-13	B	521	25
FAN ASSYs Power Consumption			2604	125
Command Completed.				

4. Add the entry to the Frame Power **Alarm** Threshold table by entering the `ent-frm-pwr` command with these parameters.

```
frm =<frame to be added>
```

```
thrshld=<frame power threshold level>
```

A minor alarm (**UAM 0522**) is generated when the power level for the frame reaches 90% of the threshold value. A major alarm (**UAM 0521**) is generated when the power level for the frame reaches 95% of the threshold value. A critical alarm (**UAM 0520**) is generated when the power level for the frame reaches 98% of the threshold value.

The `thrshld` parameter is optional. If the `thrshld` parameter value is not specified, the `thrshld` value is set to 30.

For this example, enter this command.

```
ent-frm-pwr:frm=ef01:thrshld=35
```

When this command has successfully completed, this message should appear.

```
rlghncxa03w 06-10-01 00:22:57 GMT EAGLE5 36.0.0
FRAME POWER THRESHOLD table is (3 of 10) 30% full
ENT-FRM-PWR: MASP A - COMPLTD
```

5. Verify the changes by entering the `rtrv-frm-pwr` command with frame entry specified in step 4.

For this example, enter this command.

```
rtrv-frm-pwr:frm=ef01
```

This is an example of the possible output.

```
rlghncxa03w 06-10-01 09:12:36 GMT EAGLE5 36.0.0
```

Frame	Power Threshold (Amps)
-----	-----
ef01	35

```
FRAME POWER THRESHOLD table is (3 of 10) 30% full;  
RTRV-FRM-PWR: MASP A - COMPLTD
```

6. Backup the new changes using the `chg-db:action=backup:dest=fixed` command.

These messages should appear, the active **Maintenance and Administration Subsystem Processor (MASP)** appears first.

```
BACKUP (FIXED) : MASP A - Backup starts on active MASP.  
BACKUP (FIXED) : MASP A - Backup on active MASP to fixed disk complete.  
BACKUP (FIXED) : MASP A - Backup starts on standby MASP.  
BACKUP (FIXED) : MASP A - Backup on standby MASP to fixed disk complete.
```

Figure 4-30 Adding an Entry to the Frame Power Alarm Threshold Table

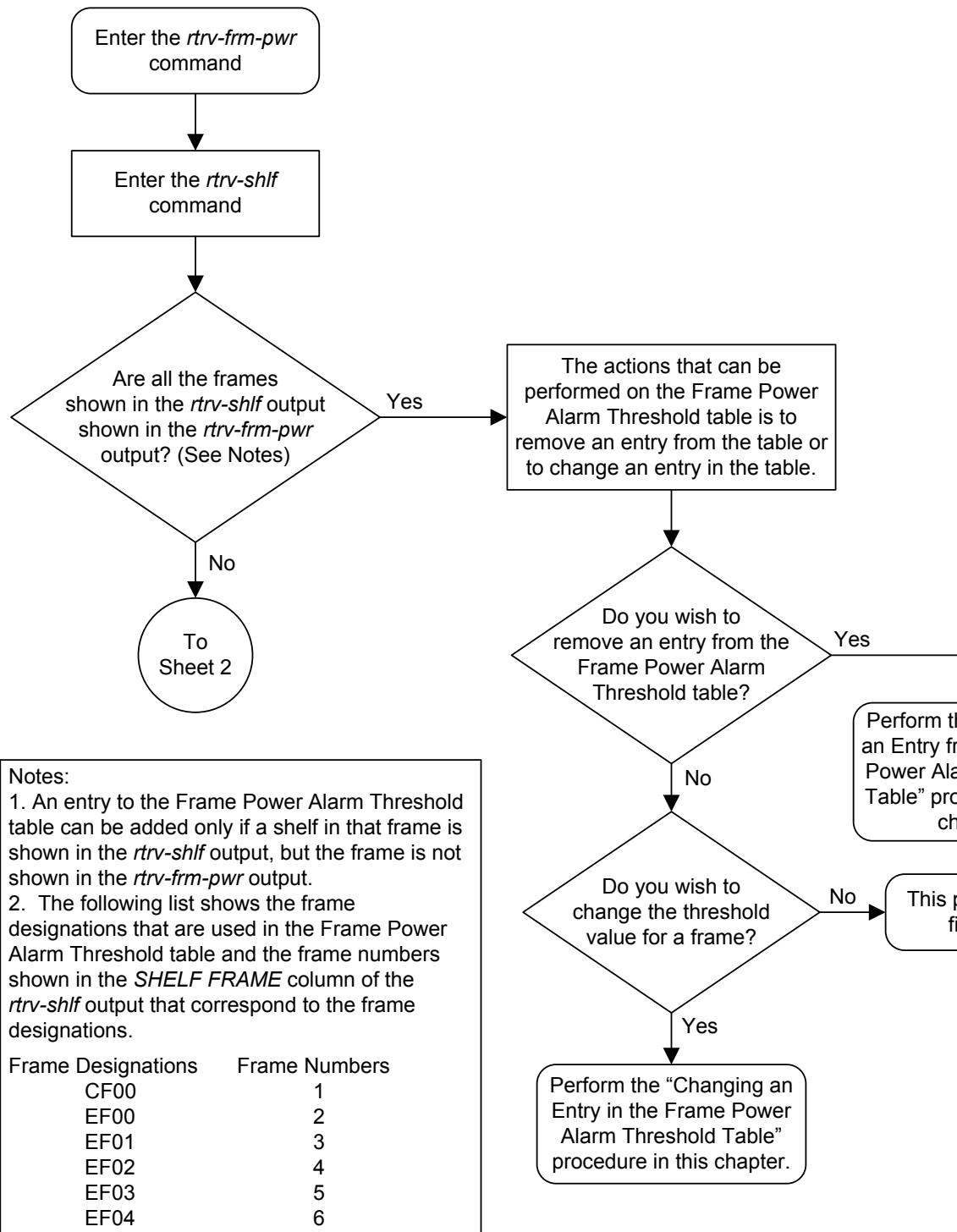

Sheet 1 of 2

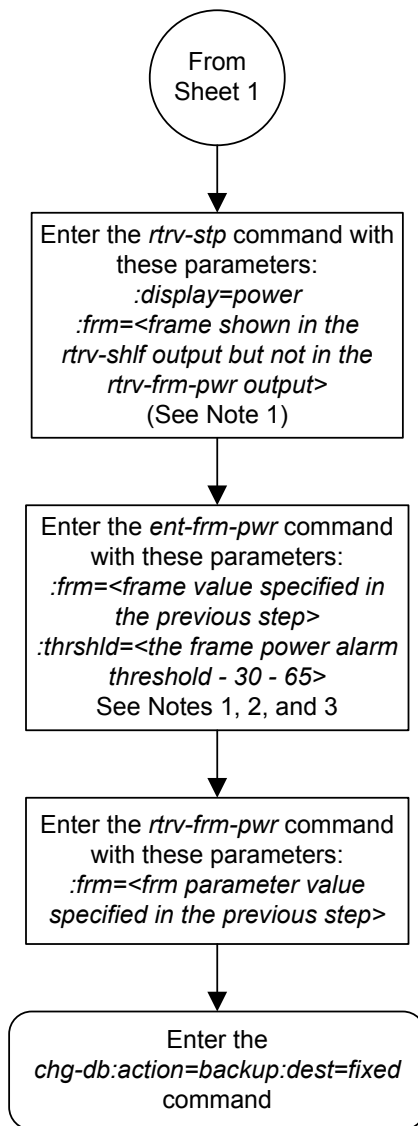

Notes:

1. The following list shows the frame designations used in the Frame Power Alarm Threshold table and the frame numbers shown in the *SHELF FRAME* column of the *rtrv-shlf* output that correspond to the frame designations.

Frame Designations	Frame Numbers
CF00	1
EF00	2
EF01	3
EF02	4
EF03	5
EF04	6

The frame designation shown in this list is the value of the *frm* parameter of the *rtrv-stp*, *ent-frm-pwr*, and *frm-pwr* commands.

2. A minor alarm is generated when the power level of the frame reaches 90% of the threshold value. A major alarm is generated when the power level of the frame reaches 95% of the threshold value. A critical alarm is generated when the power level of the frame reaches 98% of the threshold value.

3. The *thrshld* parameter is optional. If the *thrshld* parameter value is not specified, the *thrshld* value defaults to 30.

Removing an Entry from the Frame Power Alarm Threshold Table

This procedure is used to remove an existing entry from the frame power alarm threshold table. The entry in the power alarm threshold table is removed using the `dlc-frm-pwr` command with this parameter:

`:frm` – The name of the frame being removed from the power alarm threshold table, `cf00`, `ef00`, `ef01`, `ef02`, `ef03`, or `ef04`.

The frame being removed from the frame power alarm threshold table must be configured in the frame power alarm threshold table.

When a frame entry is removed, a default threshold setting of 30 amps is assigned to the frame. If the amount of power currently used by the frame is 27 amps or more, an alarm will be generated when this frame entry is removed. The alarm that will be generated will depend of the amount of power the frame is using.

- A minor alarm (**UAM 0522**) is generated when the power level for the frame reaches 90% of the threshold value.
- A major alarm (**UAM 0521**) is generated when the power level for the frame reaches 95% of the threshold value.
- A critical alarm (**UAM 0520**) is generated when the power level for the frame reaches 98% of the threshold value.

More information on these alarms is shown in *Unsolicited Alarm and Information Messages Reference*.

For example, if the frame is using 27 amps, and the frame is removed resulting in the default 30 amp threshold, minor alarm 0522 is generated because 27 amps is the threshold at which minor alarm 0522 is generated (90% of 30 amps is 27 amps).

If the frame is using 30 amps or more, and the frame is removed resulting in the default 30 amp threshold, critical alarm 0520 is generated because that amount of power used by the frame is 100% or more of the threshold value, and a critical alarm is generated at 98% of the threshold value.

The power being used by the frame is displayed in the `Power Consumption (Amps)` column in the `rtrv-stp` output.

1. Display the frame power alarm thresholds by entering the `rtrv-frm-pwr` command.

This is an example of the possible output.

```
rlghncxa03w 06-10-01 09:12:36 GMT EAGLE5 36.0.0
```

Frame	Power Threshold (Amps)
cf00	56
ef00	36
ef01	35

```
FRAME POWER THRESHOLD table is (3 of 10) 30% full;
RTRV-FRM-PWR: MASP A - COMPLTD
```

2. Display the power consumption of the frame that will be removed from the Frame Power **Alarm** Threshold table by entering the `rtrv-stp` command with these parameters:

```
display=power
```

```
frm =<frame to be removed from step 1>
```

For this example, enter this command.

```
rtrv-stp:display=power:frm=ef01
```

This is an example of the possible output.

```
rlghncxa03w 06-10-01 16:02:05 GMT EAGLE5 36.0.0
```

Frame	Power Threshold		Power Consumption	
	(Amps)	(Watts)	(Amps)	(Watts)
EF01	35	1440	14.06	675

Card	Part Number	Revision	Power Consumption	
			(MilliAmps)	(Watts)
3101	870-1293-13	D	313	15
3102	870-1293-13	D	313	15
3103	870-2671-03	M	1563	75
3104	870-1293-13	D	313	15
3105	870-2061-01	K	542	26
3106	870-1984-13	M	646	31
3107	870-1984-13	M	646	31
3108	870-2372-14	J	521	25
3109	MUX		313	15
3110	MUX		313	15
3111	870-2061-01	A	542	26
3112	870-2061-01	A	542	26
3113	850-0549-01	A	+ 313	+ 15
3114	+ 870-2198-07	M	+ 1563	+ 75
3115	850-0549-01	A	313	15
3116	+ 870-2198-07	M	1563	75
3117	870-1293-13	B	521	25
FAN ASSYS Power Consumption			2604	125
Command Completed.				

When a frame entry is removed, a default threshold setting of 30 amps is assigned to the frame. If the amount of power currently used by the frame is 27 amps or more, shown in the Power Consumption (Amps) column in the `rtrv-stp` output, an alarm will be generated when this frame entry is removed. The alarm that will be generated will depend of the amount of power the frame is using. See the introduction to this procedure for the alarm information.

If you still wish to remove this frame entry even if an alarm will be generated, go to step 3. If you do not wish to remove this frame entry, repeat this step with another frame entry from step 1.

If you do not wish to repeat this step with another frame entry from step 1, this procedure is finished.

3. Remove the frame entry from the Frame Power **Alarm** Threshold table by entering the `dlt-frm-pwr` command with this parameter.

```
frm =<frame to be removed>
```

For this example, enter this command.

```
dlt-frm-pwr:frm=ef01
```

When this command has successfully completed, this message should appear.

```
rlghncxa03w 06-10-01 00:22:57 GMT EAGLE5 36.0.0
FRAME POWER THRESHOLD table is (2 of 10) 20% full
DLT-FRM-PWR: MASP A - COMPLTD
```

4. Verify the changes by entering the `rtrv-frm-pwr` command with frame entry specified in step 3.

For this example, enter this command.

```
rtrv-frm-pwr:frm=ef01
```

This is an example of the possible output.

```
rlghncxa03w 06-10-01 09:12:36 GMT EAGLE5 36.0.0
```

Frame	Power Threshold (Amps)
-----	-----
ef01	35

```
FRAME POWER THRESHOLD table is (2 of 10) 20% full;
RTRV-FRM-PWR: MASP A - COMPLTD
```

5. Backup the new changes using the `chg-db:action=backup:dest=fixed` command.

These messages should appear, the active **Maintenance and Administration Subsystem Processor (MASP)** appears first.

```
BACKUP (FIXED) : MASP A - Backup starts on active MASP.
BACKUP (FIXED) : MASP A - Backup on active MASP to fixed disk complete.
BACKUP (FIXED) : MASP A - Backup starts on standby MASP.
BACKUP (FIXED) : MASP A - Backup on standby MASP to fixed disk complete.
```

Figure 4-31 Removing an Entry from the Frame Power Alarm Threshold Table

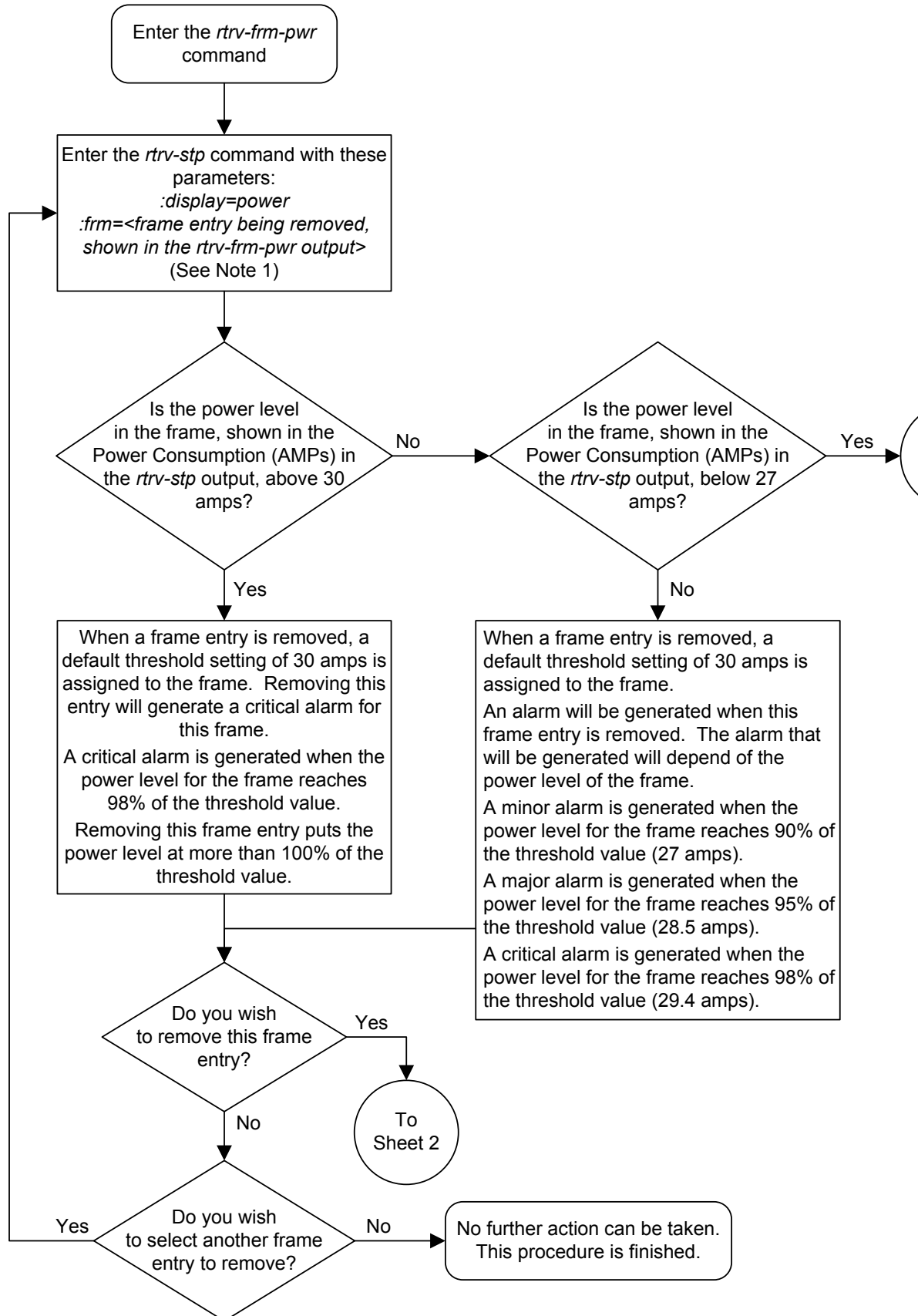

Sheet 1 of 2

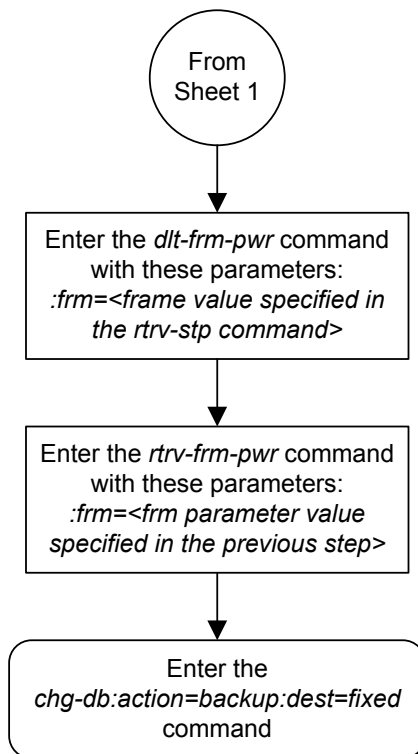

Changing an Entry in the Frame Power Alarm Threshold Table

This procedure is used to change an existing entry in the frame power alarm threshold table. The frame entry in the power alarm threshold table is changed using the `chg-frame-pwr` command with these parameters:

`:frm` – The name of the frame being added to the power alarm threshold table, cf00, ef00, ef01, ef02, ef03, or ef04.

`:thrshld` – The power threshold value, from 30 to 65 amps.

The frame power alarm threshold table defines the power level threshold, in amps, for each frame in the **EAGLE**. The power level threshold determines when alarms regarding the amount power used by the frame are generated. Three alarms can be generated for the power levels.

- **UAM 0522** - a minor alarm indicating that the power level for the frame has reached 90% of the threshold value.
- **UAM 0521** - a major alarm indicating that the power level for the frame has reached 95% of the threshold value.
- **UAM 0520** - a critical alarm indicating that the power level for the frame has reached 98% of the threshold value.

More information on these alarms is shown in *Unsolicited Alarm and Information Messages Reference*.

When setting the threshold value (the `thrshld` parameter value), the threshold value should be greater than the amount of power being used by the frame. The power being used by the frame is displayed in the `Power Consumption (Amps)` column in the `rtrv-stp` output. The threshold value should also be high enough to avoid generating any alarms.

[Table 4-7](#) shows selected threshold values and the power levels for a frame that would generate a minor alarm for that threshold value.

Table 4-7 Power Level to Generate a Minor Alarm

Threshold Value	Power Level to Generate a Minor Alarm
30	27
35	31.5
40	36
45	40.5
50	45
55	49.5
60	54
65	58.5

1. Display the frame power alarm thresholds by entering the `rtrv-frm-pwr` command.

This is an example of the possible output.

```
rlghncxa03w 06-10-01 09:12:36 GMT EAGLE5 36.0.0
```

Frame	Power Threshold (Amps)
cf00	56
ef00	36
ef01	35

```
FRAME POWER THRESHOLD table is (3 of 10) 30% full;
RTRV-FRM-PWR: MASP A - COMPLTD
```

2. Display the power consumption of the frame that will be changed in the Frame Power **Alarm** Threshold table by entering the `rtrv-stp` command with these parameters:

```
display=power
```

```
frm =<frame being changed>
```

For this example, enter this command.

```
rtrv-stp:display=power:frm=ef01
```

This is an example of the possible output.

```
rlghncxa03w 06-10-01 16:02:05 GMT EAGLE5 36.0.0
```

Frame	Power Threshold		Power Consumption	
	(Amps)	(Watts)	(Amps)	(Watts)
EF01	30	1440	14.06	675

Card	Part Number	Revision	Power Consumption	
			(MilliAmps)	(Watts)
3101	870-1293-13	D	313	15
3102	870-1293-13	D	313	15
3103	870-2671-03	M	1563	75
3104	870-1293-13	D	313	15
3105	870-2061-01	K	542	26
3106	870-1984-13	M	646	31
3107	870-1984-13	M	646	31
3108	870-2372-14	J	521	25
3109	MUX		313	15
3110	MUX		313	15
3111	870-2061-01	A	542	26
3112	870-2061-01	A	542	26
3113	850-0549-01	A	+ 313	+ 15
3114	+ 870-2198-07	M	+ 1563	+ 75
3115	850-0549-01	A	313	15
3116	+ 870-2198-07	M	1563	75
3117	870-1293-13	B	521	25

```
FAN ASSYS Power Consumption          2604          125
Command Completed.
```

3. Changed the entry in the Frame Power **Alarm** Threshold table by entering the `chg-frm-pwr` command with these parameters.

```
frm =<frame being changed>
thrshld=<frame power threshold level>
```

A minor alarm (**UAM 0522**) is generated when the power level for the frame reaches 90% of the threshold value. A major alarm (**UAM 0521**) is generated when the power level for the frame reaches 95% of the threshold value. A critical alarm (**UAM 0520**) is generated when the power level for the frame reaches 98% of the threshold value. When setting the threshold value, the threshold value should be greater than the Power Consumption (Amps) value shown in the `rtrv-stp` output in step 2, and high enough to avoid generating any alarms. See [Table 4-7](#) for some examples of threshold values and the power levels for a frame to generate a minor alarm for these threshold values.

For this example, enter this command.

```
ent-frm-pwr:frm=ef01:thrshld=45
```

When this command has successfully completed, this message should appear.

```
rlghncxa03w 06-10-01 00:22:57 GMT EAGLE5 36.0.0
FRAME POWER THRESHOLD table is (3 of 10) 30% full
ENT-FRM-PWR: MASP A - COMPLTD
```

4. Verify the changes by entering the `rtrv-frm-pwr` command with frame entry specified in step 3.

For this example, enter this command.

```
rtrv-frm-pwr:frm=ef01
```

This is an example of the possible output.

```
rlghncxa03w 06-10-01 09:12:36 GMT EAGLE5 36.0.0

Frame                Power Threshold (Amps)
-----
ef01                                45

FRAME POWER THRESHOLD table is (3 of 10) 30% full;
RTRV-FRM-PWR: MASP A - COMPLTD
```

5. Backup the new changes using the `chg-db:action=backup:dest=fixed` command.

These messages should appear, the active **Maintenance and Administration Subsystem Processor (MASP)** appears first.

```
BACKUP (FIXED) : MASP A - Backup starts on active MASP.
BACKUP (FIXED) : MASP A - Backup on active MASP to fixed disk complete.
BACKUP (FIXED) : MASP A - Backup starts on standby MASP.
BACKUP (FIXED) : MASP A - Backup on standby MASP to fixed disk complete.
```

Figure 4-32 Changing an Entry in the Frame Power Alarm Threshold Table

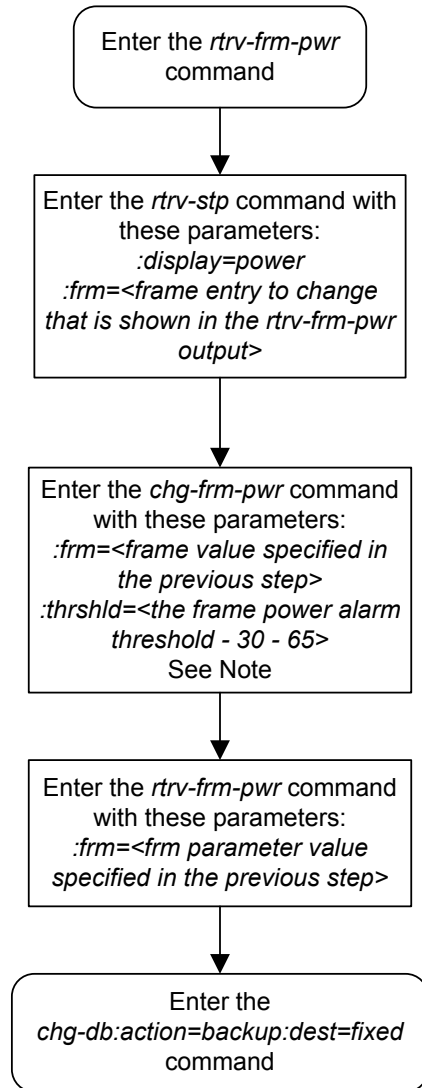

Note:
 A minor alarm is generated when the power level for the reaches 90% of the threshold value.
 A major alarm is generated when the power level for the reaches 95% of the threshold value.
 A critical alarm is generated when the power level for the reaches 98% of the threshold value.
 The following list shows selected threshold values and the power levels for a frame that would generate a minor alarm for the threshold value.

Threshold Value	Power Level to Generate a Minor Alarm
30	27
35	31.5
40	36
45	40.5
50	45
55	49.5
60	54
65	58.5

Configuring the IMT Bus Alarm Thresholds

This procedure is used to change the IMT bus alarm thresholds using the `chg-th-alm` command and these parameters.

`:imtbusutllvl1` – The percentage for the IMT bus combined utilization level 1 threshold alarm (reported on the IMT system). The percentage for the IMT bus combined utilization level 1 threshold alarm, from 35 to 70 and is shown in the `IMT Bus Combined Utilization Alarm Level 1` field of the `rtrv-th-alm` output. The system default value is 70. When this threshold is exceeded, `UAM 0027` is generated.

`:imtbusutllvl2` – The percentage for the IMT bus combined utilization level 2 threshold alarm (reported on the IMT system). The percentage for the IMT bus combined utilization level 2 threshold alarm, from 40 to 80 and is shown in the `IMT Bus Combined Utilization Alarm Level 2` field of the `rtrv-th-alm` output. The system default value is 80. When this threshold is exceeded, `UAM 0028` is generated.

After the `chg-th-alm` command is performed, the `imtbusutllvl2` parameter value must be greater than the `imtbusutllvl1` parameter value.

`:imtcongestlvl1` – The percentage for the IMT bus congestion level 1 threshold alarm (reported on the HIPR2 card). The percentage for the IMT bus congestion level 1 threshold alarm, from 35 to 70 and is shown in the `IMT Bus Congestion Alarm Level 1` field of the `rtrv-th-alm` output. The system default value is 70. When this threshold is exceeded, `UAM 0030` is generated.

`:imtcongestlvl2` – The percentage for the IMT bus congestion level 2 threshold alarm (reported on the HIPR2 card). The percentage for the IMT bus congestion level 2 threshold alarm, from 40 to 80 and is shown in the `IMT Bus Congestion Alarm Level 2` field of the `rtrv-th-alm` output. The system default value is 80. When this threshold is exceeded, `UAM 0031` is generated.

After the `chg-th-alm` command is performed, the `imtcongestlvl2` parameter value must be greater than the `imtcongestlvl1` parameter value.

For more information on these alarms, refer to *Unsolicited Alarm and Information Messages Reference*.

The `chg-th-alm` command contains other optional parameters. These parameters are not shown here because they are not necessary to configure the IMT bus alarm thresholds. These parameters are explained in more detail in *Commands User's Guide*.

1. Display the current IMT bus alarm thresholds in the database by entering the `rtrv-th-alm` command. This is an example of the possible output.

```
rlghncxa03w 09-07-28 09:12:36 GMT EAGLE5 41.1.0
IMT Bus Combined Utilization Alarm Level 1: 70%
IMT Bus Combined Utilization Alarm Level 2: 80%
IMT Bus Congestion Alarm Level 1:          70%
IMT Bus Congestion Alarm Level 2:          80%
RTRV-TH-ALM: MASP A - COMPLTD.
```

Note: The `rtrv-th-alm` command output contains other fields that are not used in this procedure. If you wish to see all the fields displayed by the `rtrv-th-alm` command, refer to the `rtrv-th-alm` command description in *Commands User's Guide*.

2. Configure the IMT bus alarm thresholds by entering the `chg-th-alm` command with at least one of the IMT bus alarm threshold parameters.

If an IMT bus alarm threshold parameter is not specified with the `chg-th-alm` command, that parameter value will not be changed. The system default values for the IMT bus alarm threshold parameters are:

- `imtbusutllvl1` - 70
- `imtbusutllvl2` - 80
- `imtcongestlvl1` - 70
- `imtcongestlvl2` - 80.

After the `chg-th-alm` command is performed, the `imtbusutllvl2` parameter value must be greater than the `imtbusutllvl1` parameter value, and the `imtcongestlvl2` parameter value must be greater than the `imtcongestlvl1` parameter value.

For this example, enter this command.

```
chg-th-
alm:imtbusutllvl1=50:imtcongestlvl1=50:imtbusutllvl2=70:imtco
ngestlvl1=70
```

When this command has successfully completed, this message should appear.

```
rlghncxa03w 09-07-28 09:12:36 GMT EAGLE5 41.1.0
CHG-TH-ALM: MASP A - COMPLTD
```

3. Verify the changes using the `rtrv-th-alm` command. This is an example of the possible output.

```
rlghncxa03w 09-07-28 09:12:36 GMT EAGLE5 41.1.0
IMT Bus Combined Utilization Alarm Level 1: 50%
IMT Bus Combined Utilization Alarm Level 2: 60%
IMT Bus Congestion Alarm Level 1:          50%
IMT Bus Congestion Alarm Level 2:          60%
RTRV-TH-ALM: MASP A - COMPLTD.
```

Note: The `rtrv-th-alm` command output contains other fields that are not used in this procedure. If you wish to see all the fields displayed by the `rtrv-th-alm` command, refer to the `rtrv-th-alm` command description in *Commands User's Guide*.

4. Backup the new changes using the `chg-db:action=backup:dest=fixed` command.

These messages should appear, the active **Maintenance and Administration Subsystem Processor (MASP)** appears first.

BACKUP (FIXED) : MASP A - Backup starts on active MASP.
BACKUP (FIXED) : MASP A - Backup on active MASP to fixed disk complete.
BACKUP (FIXED) : MASP A - Backup starts on standby MASP.
BACKUP (FIXED) : MASP A - Backup on standby MASP to fixed disk complete.

Figure 4-33 Configuring the IMT Bus Alarm Thresholds

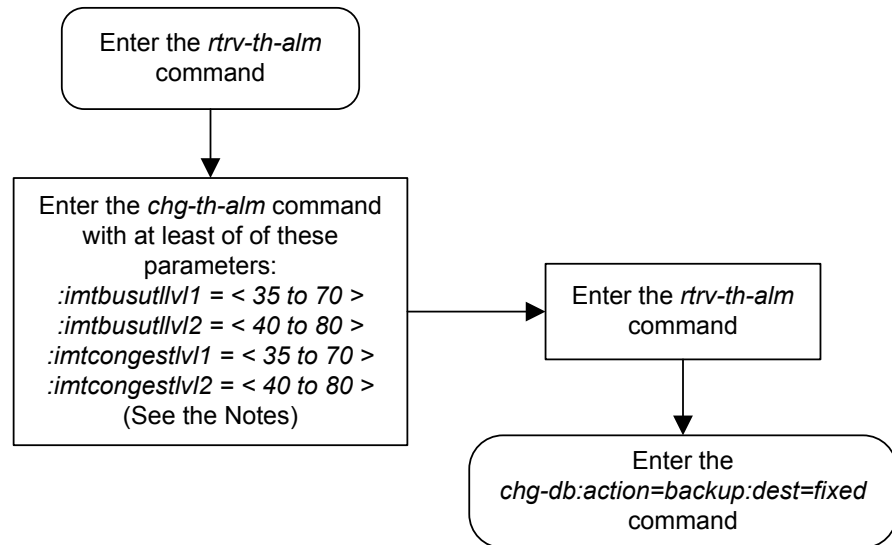

Notes:

1. If any parameter is not specified with the *chg-th-alm* command, that parameter value will not be changed.
2. The system default values for the parameters used in this procedure are:

<i>imtbusutllvl1</i> – 70	<i>imtbusutllvl2</i> – 80
<i>imtcongestlvl1</i> – 70	<i>imtcongestlvl2</i> – 80.
3. After the *chg-th-alm* command is performed, the *imtbusutllvl2* parameter value must be greater than the *imtbusutllvl1* parameter value.
4. After the *chg-th-alm* command is performed, the *imtcongestlvl2* parameter value must be greater than the *imtcongestlvl1* parameter value.

Configuring the Integrated Measurements Feature

This procedure is used to configure IP communications links between the EAGLE and the customer's network and enable the Integrated Measurements feature on the EAGLE using these commands.

- `ent-ip-host` – Configuring the IP host of the E5-MCAP.
- `chg-ip-card` – Configuring the IP address of the E5-MCAP.
- `chg-ip-lnk` – Configuring the IP link assigned to the E5-MCAP.
- `chg-measopts` – Enabling the measurement collection option for the E5-MCAP card option.
- `enable-ctrl-feat` – Enabling the Integrated Measurements feature.
- `chg-ctrl-feat` – Turning the Integrated Measurements feature on.

Some of these commands contain parameters that are not used in this procedure. *Commands User's Guide* contains a full description of these commands.

The Integrated Measurements feature requires measurements FTP servers. A maximum of three measurements FTP servers can be configured with one of these procedures.

- [Adding an FTP Server](#)
- [Changing an FTP Server](#)

This procedure can be performed only on EAGLEs that contain E5-based control cards. Refer to [Maintenance and Administration Subsystem](#) for more information about the control cards.

The Integrated Measurements feature is enabled using the `enable-ctrl-feat` command with these parameters.

`:fak` – The feature access key provided by Oracle.

`:partnum` – The Oracle-issued part number of the Integrated Measurements feature, 893037301.

Once this feature is enabled, it is permanently enabled. This feature cannot be enabled with a temporary feature access key.

The `enable-ctrl-feat` command requires that the database contain a valid serial number for the EAGLE, and that this serial number is locked. This can be verified with the `rtrv-serial-num` command. The EAGLE is shipped with a serial number in the database, but the serial number is not locked. The serial number can be changed, if necessary, and locked once the EAGLE is on-site, with the `ent-serial-num` command. The `ent-serial-num` command uses these parameters.

`:serial` – The serial number assigned to the EAGLE. The serial number is not case sensitive.

`:lock` – Specifies whether or not the serial number is locked. This parameter has only one value, `yes`, which locks the serial number. Once the serial number is locked, it cannot be changed.

Note: To enter and lock the EAGLE serial number, the `ent-serial-num` command must be entered twice, once to add the correct serial number to the database with the `serial` parameter, then again with the `serial` and the `lock=yes` parameters to lock the serial number. Verify that the serial number in the database is correct before locking the serial number. The serial number can be found on a label affixed to the control shelf (shelf 1100).

Once the Integrated Measurements feature has been enabled, the Integrated Measurements feature must be turned on with the `chg-ctrl-feat` command. The `chg-ctrl-feat` command uses these parameters:

`:partnum` – The Oracle-issued part number of the Integrated Measurements feature, 893037301.

`:status=on` – used to turn the Integrated Measurements feature on.

Once the Integrated Measurements feature has been turned on, it cannot be turned off.

The status of the Integrated Measurements feature is shown with the `rtrv-ctrl-feat` command.

If a Class B IP address is specified for the `ipaddr` parameter of the `chg-ip-lnk` command, the subnet address that results from the `ipaddr` and `submask` parameter values cannot be the same as the subnet address that results from the `pvn` and `pvnmask`, `fcna` and `fcnamask`, or `fcnb` and `fcnbmask` parameter values of the `chg-netopts` command. The `pvn` and `pvnmask`, `fcna` and `fcnamask`, or `fcnb` and `fcnbmask` parameter values can be verified by entering the `rtrv-netopts` command. Choose `ipaddr` and `submask` parameter values for the IP address assigned to the E5-MCAP card whose resulting subnet address is not be the same as the subnet address that resulting from the `pvn` and `pvnmask`, `fcna` and `fcnamask`, or `fcnb` and `fcnbmask` parameter values of the `chg-netopts` command.

The Integrated Measurements feature supports the collection and reporting of all measurement entities for EAGLEs configured with a maximum of 2400 signaling links (or 1200 links if the 15-minute measurements feature is turned on) using the E5-MCAP cards instead of the MCPM. The enhanced reporting capabilities provided by the Integrated Measurements feature support the generation of text file measurements reports in the CSV format. The reports can be sent to a customer-provided FTP server on-demand or on a scheduled basis. EAGLEs with more than 2400/1200 signaling links require the Measurements Platform for full measurements support.

1. Display the status of the controlled features by entering the `rtrv-ctrl-feat` command. The following is an example of the possible output.

```
rlghncxa03w 10-04-28 21:15:37 GMT EAGLE5 42.0.0
The following features have been permanently enabled:
```

Feature Name	Partnum	Status	Quantity
Command Class Management	893005801	on	----
LNP Short Message Service	893006601	on	----
Intermed GTT Load Sharing	893006901	on	----
XGTT Table Expansion	893006101	on	400000
XMAP Table Expansion	893007710	off	----
Large System # Links	893005910	on	2000
Routesets	893006401	on	6000
HC-MIM SLK Capacity	893012707	on	64

The following features have been temporarily enabled:

Feature Name	Partnum	Status	Quantity	Trial Period Left
Zero entries found.				

The following features have expired temporary keys:

Feature Name	Partnum
Zero entries found.	

If the Integrated Measurements feature is enabled and turned on, continue the procedure with [21](#).

If the Integrated Measurements feature is enabled but not turned on, continue the procedure with [19](#).

If the Integrated Measurements feature is not enabled, continue the procedure with [2](#).

2. Display the control cards in the EAGLE by entering this command.

```
rtrv-stp:gpl=oamhc
```

This is an example of the possible output.

```
rlghncxa03w 10-04-01 16:07:48 GMT EAGLE5 42.0.0
```

Card	Part Number	Rev	Serial Number	Type	DB	APPL	GPL Version
1113	870-2903-01	C	10206255064	E5MCAP	4096M	OAMHC	132-018-000
1115	870-2903-01	C	10206255165	E5MCAP	4096M	OAMHC	132-018-000

Command Completed.

To enable the Integrated Measurements feature, E5-MCAP cards must be installed in card locations 1113 and 1115. If E5-MCAP cards are not shown in either card location 1113 or 1115, install the E5-MCAP cards in card locations 1113 or 1115 as required. Contact the Customer Care Center before installing the E5-MCAP cards. Refer to the [My Oracle Support \(MOS\)](#) section for the contact information.

After the E5-MCAP cards have been installed, or if E5-MCAP cards are shown in card locations 1113 and 1115 in the `rtrv-stp` output, continue the procedure by performing one of these steps.

- If the `rtrv-ctrl-feat` output shows the HC-MIM SLK Capacity feature with a quantity of 64 and other features, continue the procedure with [7](#).
 - If the `rtrv-ctrl-feat` output shows only the **HC-MIMSLK** Capacity feature with a quantity of 64, continue the procedure with [3](#).
3. Display the serial number in the database with the `rtrv-serial-num` command. This is an example of the possible output.

```
rlghncxa03w 09-07-28 21:15:37 GMT EAGLE5 41.1.0
System serial number = nt00001231
```

System serial number is not locked.

```
rlghncxa03w 09-07-28 21:15:37 GMT EAGLE5 41.1.0
Command Completed
```

Note: If the serial number is not correct and not locked, continue the procedure with 4. If the serial number is correct and locked, continue the procedure with 7. If the serial number is correct but not locked, continue the procedure with 6. If the serial number is not correct, but is locked, this feature cannot be enabled and the remainder of this procedure cannot be performed. Contact the Customer Care Center to get an incorrect and locked serial number changed. Refer to [My Oracle Support \(MOS\)](#) for the contact information. The serial number can be found on a label affixed to the control shelf (shelf 1100).

4. Enter the correct serial number into the database using the `ent-serial-num` command with the `serial` parameter.

For this example, enter this command.

```
ent-serial-num:serial=<EAGLE's correct serial number>
```

When this command has successfully completed, the following message should appear.

```
rlghncxa03w 10-04-28 21:15:37 GMT EAGLE5 42.0.0
ENT-SERIAL-NUM:  MASP A - COMPLTD
```

5. Verify that the serial number entered into 4 was entered correctly using the `rtrv-serial-num` command. This is an example of the possible output.

```
rlghncxa03w 10-04-28 21:15:37 GMT EAGLE5 42.0.0
System serial number = nt00001231
```

System serial number is not locked.

```
rlghncxa03w 10-04-28 21:15:37 GMT EAGLE5 42.0.0
Command Completed
```

If the serial number was not entered correctly, repeat 4 and 5 and re-enter the correct serial number.

6. Lock the serial number in the database by entering the `ent-serial-num` command with the serial number shown in 3, if the serial number shown in 3 is correct, or with the serial number shown in 5, if the serial number was changed in 4, and with the `lock=yes` parameter.

For this example, enter this command.

```
ent-serial-num:serial=<EAGLE's serial number>:lock=yes
```

When this command has successfully completed, the following message should appear.

```
rlghncxa03w 10-04-28 21:15:37 GMT EAGLE5 42.0.0
ENT-SERIAL-NUM:  MASP A - COMPLTD
```

If the IP address for the E5-MCAP cards will be either a Class A or Class C IP address, continue the procedure with 8.

If the IP address for either E5-MCAP card will be a Class B IP address, continue the procedure with 7.

7. The subnet address that results from the `ipaddr` and `submask` parameter values of the `chg-ip-lnk` command cannot be the same as the subnet address that results from the `pvn` and `pvnmask`, `fcna` and `fcnamask`, or `fcnb` and `fcnbmask` parameter values of the `chg-netopts` command.

Display the `pvn`, `pvnmask`, `fcna`, `fcnamask`, `fcnb`, and `fcnbmask` parameter values of the `chg-netopts` command by entering the `rtrv-netopts` command.

If error message E3967 Cmd Rej: E5IS must be on is displayed after the `rtrv-netopts` command is executed, the `pvn`, `pvnmask`, `fcna`, `fcnamask`, `fcnb`, and `fcnbmask` parameters are not configured. Continue the procedure with 8.

This is an example of the possible output if the **E5IS** feature is on.

```
rlghncxa03w 10-04-28 21:17:37 GMT EAGLE5 42.0.0
NETWORK OPTIONS
-----
PVN          = 128.20.30.40
PVNMASK      = 255.255.192.0
FCNA         = 170.120.50.0
FCNAMASK     = 255.255.240.0
FCNB         = 170.121.50.0
FCNBMASK     = 255.255.254.0
```

Choose `ipaddr` and `submask` parameter values for the **IP** link to the **MCPM** whose resulting subnet address is not be the same as the subnet address that resulting from the `pvn` and `pvnmask`, `fcna` and `fcnamask`, or `fcnb` and `fcnbmask` parameter values of the `chg-netopts` command. Continue the procedure with 8.

8. Display the IP link information for both E5-MCAP cards by entering these commands.

```
rtrv-ip-lnk:loc=1113
```

The following is an example of the possible output.

```
rlghncxa03w 10-04-01 21:20:37 GMT EAGLE5 42.0.0
LOC  PORT  IPADDR          SUBMASK          DUPLEX  SPEED  MACTYPE  AUTO  MCAST
1113 A  -----
1113 B  -----
```

```
rtrv-ip-lnk:loc=1115
```

The following is an example of the possible output.

```
rlghncxa03w 10-04-01 21:20:37 GMT EAGLE5 42.0.0
LOC  PORT  IPADDR          SUBMASK          DUPLEX  SPEED  MACTYPE  AUTO  MCAST
1115 A  -----
1115 B  -----
```

9. Assign an IP link to each E5-MCAP card by entering the `chg-ip-lnk` command for each E5-MCAP card with these parameters: `loc`, `port=a`, `ipaddr`, `submask`, `speed=100`, `mcast=yes`, `duplex=full`.

For this example, enter these commands.

```
chg-ip-
lnk:loc=1113:port=a:ipaddr=150.1.1.1:submask=255.255.255.0 :s
peed=100:mcast=yes:duplex=full
```

```
chg-ip-
lnk:loc=1115:port=a:ipaddr=150.1.2.2:submask=255.255.255.0 :s
peed=100:mcast=yes:duplex=full
```

When each of these commands have successfully completed, this message should appear.

```
rlghncxa03w 10-04-01 21:20:37 GMT EAGLE5 42.0.0
CHG-IP-LNK:  MASP A - COMPLTD
```

10. Display the changes for each E5-MCAP card by entering these commands.

```
rtrv-ip-lnk:loc=1113
```

The following is an example of the possible output.

```
rlghncxa03w 10-04-01 21:20:37 GMT EAGLE5 42.0.0
LOC  PORT IPADDR          SUBMASK          DUPLEX SPEED MACTYPE AUTO MCAST
1113 A   150.1.1.1          255.255.255.0   FULL   100   DIX    NO   YES
1113 B   -----            -----            FULL   10    DIX    NO   NO
```

```
rtrv-ip-lnk:loc=1115
```

The following is an example of the possible output.

```
rlghncxa03w 10-04-01 21:20:37 GMT EAGLE5 42.0.0
LOC  PORT IPADDR          SUBMASK          DUPLEX SPEED MACTYPE AUTO MCAST
1115 A   150.1.2.2          255.255.255.0   FULL   100   DIX    NO   YES
1115 B   -----            -----            FULL   10    DIX    NO   NO
```

11. Display the current IP host information in the database by entering the `rtrv-ip-host:display=all` command.

The following is an example of the possible output.

```
rlghncxa03w 07-13-13 09:12:36 GMT EAGLE5 45.0.0
LOCAL IPADDR  LOCAL HOST
150.1.1.2     GW102.NC.TEKELEC.COM
150.1.1.3     GW103.NC.TEKELEC.COM

REMOTE IPADDR  REMOTE HOST
150.1.1.5     NCDEPTECONOMIC_DEVELOPMENT.SOUTHEASTERN_COORIDOR_ASHVL.GOV

IP Host table is (3 of 4096) <1% full
```

12. Assign an IP host to each E5-MCAP card by using the `ent-ip-host` command.

For this example, enter these commands.

```
ent-ip-host:host=gw100.nc.tekelec.com:ipaddr=150.1.1.1
ent-ip-host:host=gw200.nc.tekelec.com:ipaddr=150.1.2.2
```

When each of these commands have successfully completed, the following message should appear.

```
rlghncxa03w 10-04-01 21:18:37 GMT EAGLE5 42.0.0
ENT-IP-HOST: MASP A - COMPLTD
```

- 13.** Display the changes for each E5-MCAP card by entering the `rtrv-ip-host` command with the host name specified in the [12](#).

For this example, enter these commands.

```
rtrv-ip-host:host=gw100.nc.tekelec.com
```

The following is an example of the possible output.

```
rlghncxa03w 07-13-13 09:12:36 GMT EAGLE5 45.0.0
LOCAL IPADDR    LOCAL HOST
150.1.1.1      GW100.NC.TEKELEC.COM
```

```
IP Host table is (5 of 4096) <1% full
```

```
rtrv-ip-host:host=gw200.nc.tekelec.com
```

The following is an example of the possible output.

```
rlghncxa03w 07-13-13 09:12:36 GMT EAGLE5 45.0.0
LOCAL IPADDR    LOCAL HOST
150.1.2.2      GW200.NC.TEKELEC.COM
```

```
IP Host table is (5 of 4096) <1% full
```

- 14.** Display the IP card information associated with each E5-MCAP card by entering these commands.

```
rtrv-ip-card:loc=1113
```

The following is an example of the possible output.

```
rlghncxa03w 10-04-01 09:12:36 GMT EAGLE5 42.0.0
LOC 1113
SRCHORDR  SRVR
DNSA      -----
DNSB      -----
DEFROUTER -----
DOMAIN    -----
SCTPCSUM  crc32c
BPIPADDR  -----
BPSUBMASK -----
```

```
rtrv-ip-card:loc=1115
```

The following is an example of the possible output.

```
rlghncxa03w 10-04-01 09:12:36 GMT EAGLE5 42.0.0
LOC 1115
SRCHORDR  SRVR
DNSA      -----
DNSB      -----
DEFROUTER -----
DOMAIN    -----
SCTPCSUM  crc32c
```

```
BPIPADDR -----
BPSUBMASK -----
```

- 15.** Assign a default router to each E5-MCAP card using the `chg-ip-card` command with these parameters: `loc`, `srchordr=local`, `domain`, and `defrouter`.

For this example, enter these commands.

```
chg-ip-
card:loc=1113:srchordr=local:domain=nc.tekelec.com:defrouter=
150.1.1.50
```

```
chg-ip-
card:loc=1115:srchordr=local:domain=nc.tekelec.com:defrouter=
150.1.2.50
```

When each of these commands have successfully completed, the following message should appear.

```
rlghncxa03w 10-04-01 21:20:37 GMT EAGLE5 42.0.0
CHG-IP-CARD: MASP A - COMPLTD
```

- 16.** Display the changes for each E5-MCAP card by entering these commands.

```
rtrv-ip-card:loc=1113
```

The following is an example of the possible output.

```
rlghncxa03w 10-04-01 09:12:36 GMT EAGLE5 42.0.0
LOC 1113
  SRCHORDR LOCAL
  DNSA -----
  DNSB -----
  DEFROUTER 150.1.1.50
  DOMAIN nc.tekelec.com
  SCTPCSUM crc32c
  BPIPADDR -----
  BPSUBMASK -----
```

```
rtrv-ip-card:loc=1115
```

The following is an example of the possible output.

```
rlghncxa03w 10-04-01 09:12:36 GMT EAGLE5 42.0.0
LOC 1115
  SRCHORDR LOCAL
  DNSA -----
  DNSB -----
  DEFROUTER 150.1.2.50
  DOMAIN nc.tekelec.com
  SCTPCSUM crc32c
  BPIPADDR -----
  BPSUBMASK -----
```

- 17.** Display the FTP Server configuration using the `rtrv-ftp-serv` command.

```
rlghncxa03w 10-04-01 09:12:36 GMT EAGLE5 42.0.0
```

APP	IPADDR	LOGIN	PRI0
meas	1.255.0.100	ftpmeas3	3
	Path: ~meas\local		
meas	1.255.0.101	ftpmeas2	2
	Path: mp\measurements\backup\dat		

```
FTP SERV table is (2 of 10) 20% full
```

The EAGLE allows a maximum of three measurements FTP servers (shown by the entry meas in the APP column of the `rtrv-ftp-serv` output). If there are less than three measurements FTP servers, perform the [Adding an FTP Server](#) procedure to add the required measurements FTP server. If there are three measurements FTP servers in the database, and you wish to change any of these measurements FTP servers, perform the [Changing an FTP Server](#) procedure.

18. Enable the Integrated Measurements feature with the `enable-ctrl-feat` command specifying the part number for the Integrated Measurements feature and the feature access key. Enter this command.

```
enable-ctrl-feat:partnum=893037301:fak=<Integrated
Measurements feature access key>
```

The Integrated Measurements feature cannot be enabled with a temporary feature access key.

The value for the feature access key (the `fak` parameter) are provided by Oracle. If you do not have the feature access key for the Integrated Measurements feature, contact your Oracle Sales Representative or Account Representative.

When the `enable-ctrl-feat` command has successfully completed, this message should appear.

```
rlghncxa03w 10-04-28 21:15:37 GMT EAGLE5 42.0.0
ENABLE-CTRL-FEAT: MASP A - COMPLTD
```

19. Turn the Integrated Measurements feature on with the `chg-ctrl-feat` command specifying the part number for the Integrated Measurements feature and the `status=on` parameter. Enter this command.

```
chg-ctrl-feat:partnum=893037301:status=on
```

Note: Once this feature is turned on, it cannot be turned off.

When the `chg-ctrl-feat` command has successfully completed, this message should appear.

```
rlghncxa03w 10-04-28 21:15:37 GMT EAGLE5 42.0.0
CHG-CTRL-FEAT: MASP A - COMPLTD
```

20. Verify the changes by entering the `rtrv-ctrl-feat` command with the Integrated Measurements feature part number. Enter this command.

```
rtrv-ctrl-feat:partnum=893037301
```

The following is an example of the possible output.

```
rlghncxa03w 10-04-28 21:15:37 GMT EAGLE5 42.0.0
The following features have been permanently enabled:
```

Feature Name	Partnum	Status	Quantity
Integrated Measurements	893037301	on	----

The following features have been temporarily enabled:

Feature Name	Partnum	Status	Quantity	Trial Period Left
Zero entries found.				

The following features have expired temporary keys:

Feature Name	Partnum
Zero entries found.	

- Verify whether or not the Integrated Measurement collection option for the E5-MCAP card is turned on (OAMHCMEAS = on) using the `rtrv-measopts` command.

```
rlghncxa03w 10-04-01 16:02:05 GMT EAGLE5 42.0.0
PLATFORMENABLE = on
OAMHCMEAS      = off
```

Note: The `rtrv-measopts` command output contains other fields that are not used by this procedure. If you wish to see all the fields displayed by the `rtrv-measopts` command, see the `rtrv-measopts` command description in *Commands User's Guide*.

If the OAMHCMEAS value is on, continue the procedure with [24](#).

If the OAMHCMEAS value is on, continue the procedure with [22](#).

- Turn on the Integrated Measurement collection option for the E5-MCAP card by entering this command.

```
chg-measopts:oamhcmeas=on
```

Once this option is turned on, it cannot be turned off.

If more than 700 signaling links are provisioned, the scheduled UI measurement reports are disabled. The number of signaling links that are provisioned is shown in the `rtrv-slk` or `rtrv-tbl-capacity` outputs.

If the PLATFORMENABLE option is set to on before this command is executed, these actions occur after the command is executed.

- All of the historical measurements data on the MCPM is transferred to the E5-MCAP card. The data transfer provides continuity of data within the Measurements Subsystem and takes approximately 30 minutes to complete. UIM 1170 is displayed when the transfer has completed.

The status of the transfer is shown in the AST field of the `rept-stat-card` output for the active E5-MCAP card. The value in the AST field shows a value that represents the percentage of the measurements data that has been

transferred. When the value in the AST field is 100%, the data transfer is complete.

Note: The transition of MEAS from the OAM to the MCPM and the other way around may disrupt the MEAS collection process during the transition period. It is possible to observe incorrect measurement reports during measurement cycles covering the transition period.

- The PLATFORMENABLE option will be set to off.

When the chg-measopts command has successfully completed, this message should appear.

```
rlghncxa03w 10-04-01 00:22:57 GMT EAGLE5 42.0.0
CHG-MEASOPTS: MASP A - COMPLTD
```

23. Verify the changes by entering the rtrv-measopts command.

```
rlghncxa03w 10-04-01 16:02:05 GMT EAGLE5 42.0.0
PLATFORMENABLE = off
OAMHCMEAS      = on
```

Note: The rtrv-measopts command output contains other fields that are not used by this procedure. If you wish to see all the fields displayed by the rtrv-measopts command, see the rtrv-measopts command description in *Commands User's Guide*.

24. Verify that measurement collection is on or off using the rtrv-meas-sched command.

This is an example of the possible output. The COLLECT field shows whether measurement collection is on or off.

```
rlghncxa03w 10-04-01 12:22:55 GMT EAGLE5 42.0.0
COLLECT      = off
```

Note: The rtrv-meas-sched command output contains other fields that are not used in this procedure. Refer to the rtrv-meas-sched command description in *Commands User's Guide* to see these fields.

- If measurement collection is off, continue the procedure with [25](#).
- If measurement collection is on, continue this procedure with [27](#).

25. Turn measurement collection on by entering this command.

```
chg-meas:collect=on
```

When this command has successfully completed, this message should appear.

```
rlghncxa03w 10-04-01 00:22:57 GMT EAGLE5 42.0.0
CHG-MEAS: MASP A - COMPLTD
```

26. Verify the changes by entering the `rtrv-meas-sched` command.

This is an example of the possible output.

```
rlghncxa03w 10-04-01 12:22:55 GMT EAGLE5 42.0.0  
COLLECT      = on
```

Note: The `rtrv-meas-sched` command output contains other fields that are not used in this procedure. Refer to the `rtrv-meas-sched` command description in *Commands User's Guide* to see these fields.

27. Back up the new changes using the `chg-db:action=backup:dest=fixed` command.

These messages should appear, the active **Maintenance and Administration Subsystem Processor (MASP)** appears first.

```
BACKUP (FIXED) : MASP A - Backup starts on active MASP.  
BACKUP (FIXED) : MASP A - Backup on active MASP to fixed disk complete.  
BACKUP (FIXED) : MASP A - Backup starts on standby MASP.  
BACKUP (FIXED) : MASP A - Backup on standby MASP to fixed disk complete.
```

Figure 4-34 Configuring the Integrated Measurements Feature

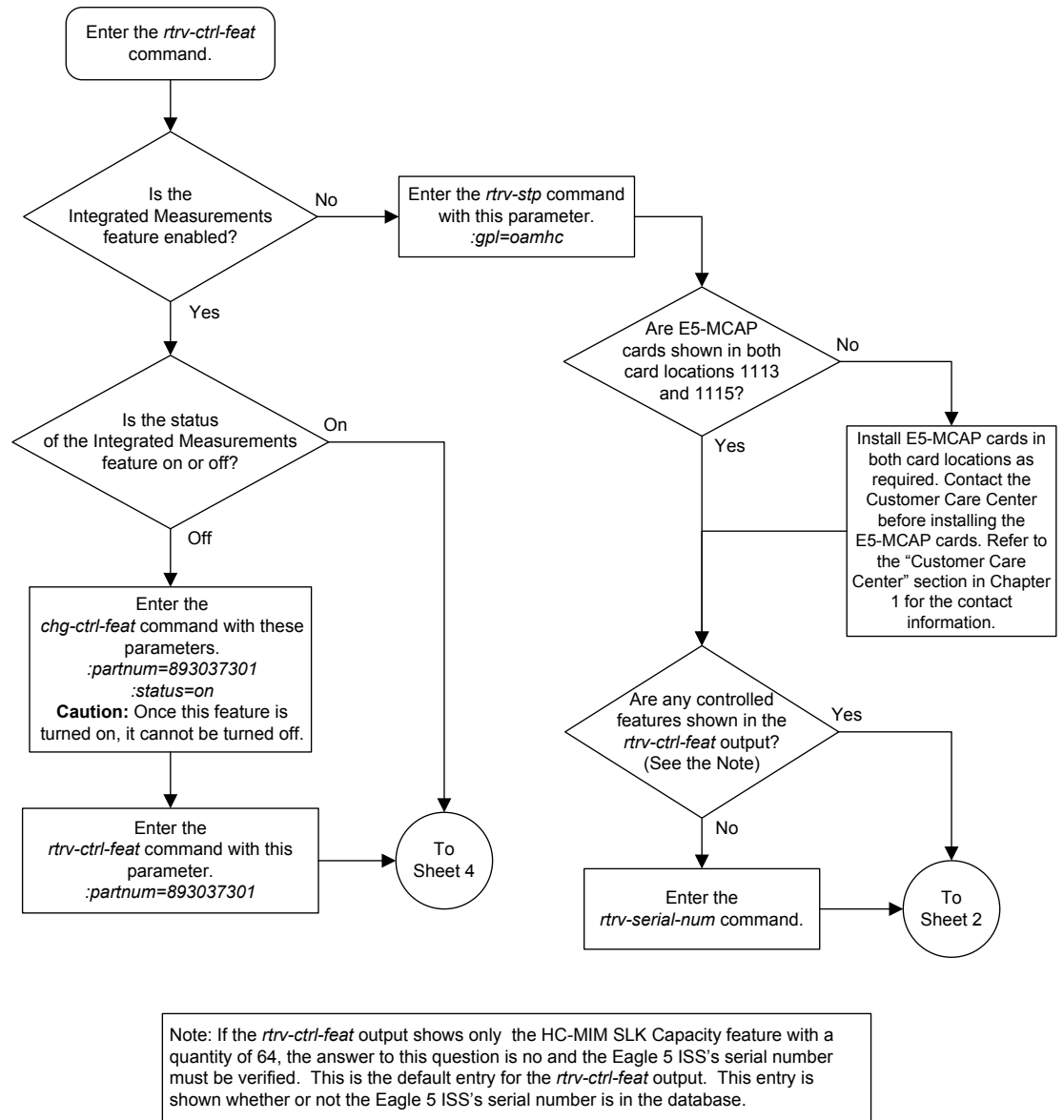

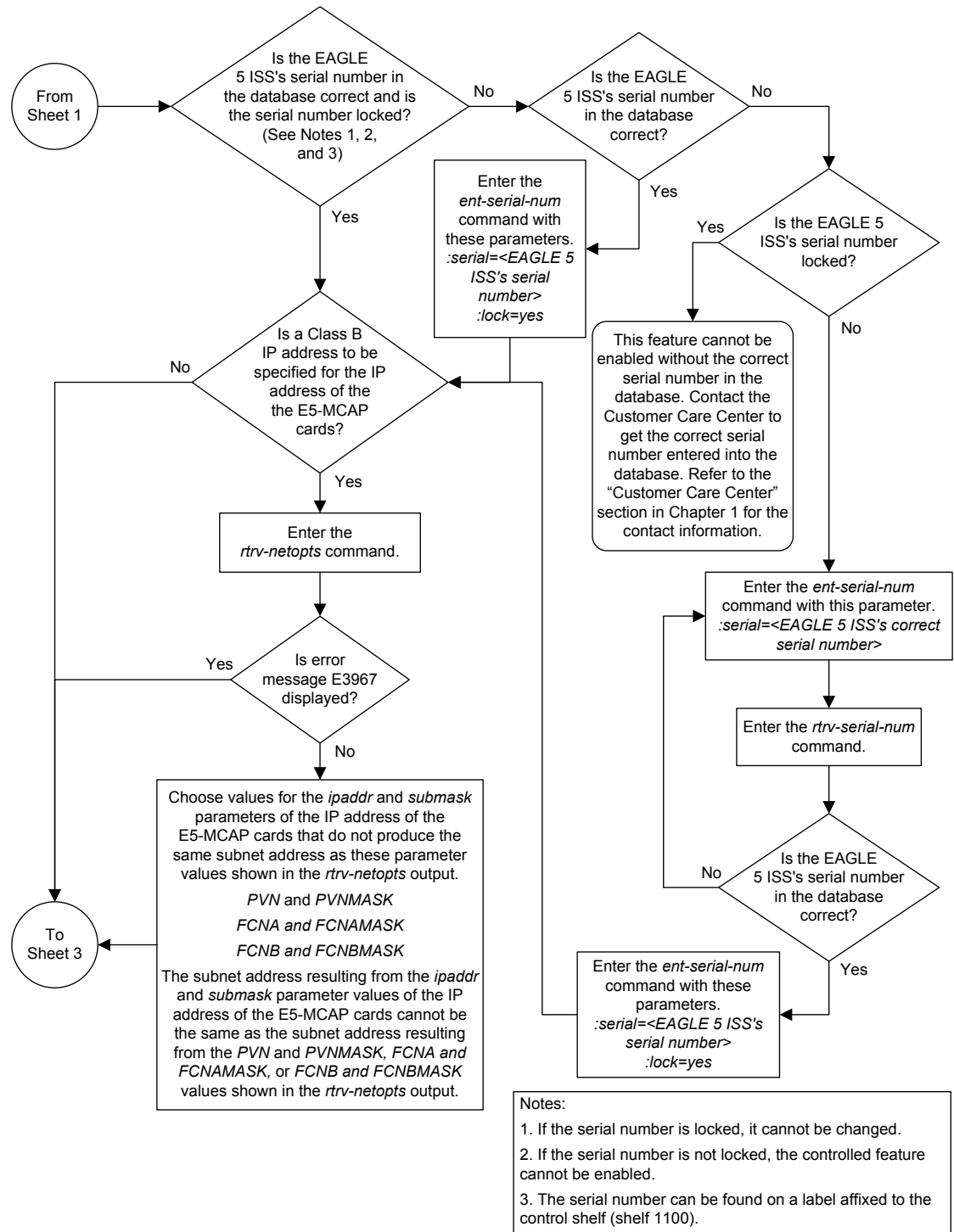

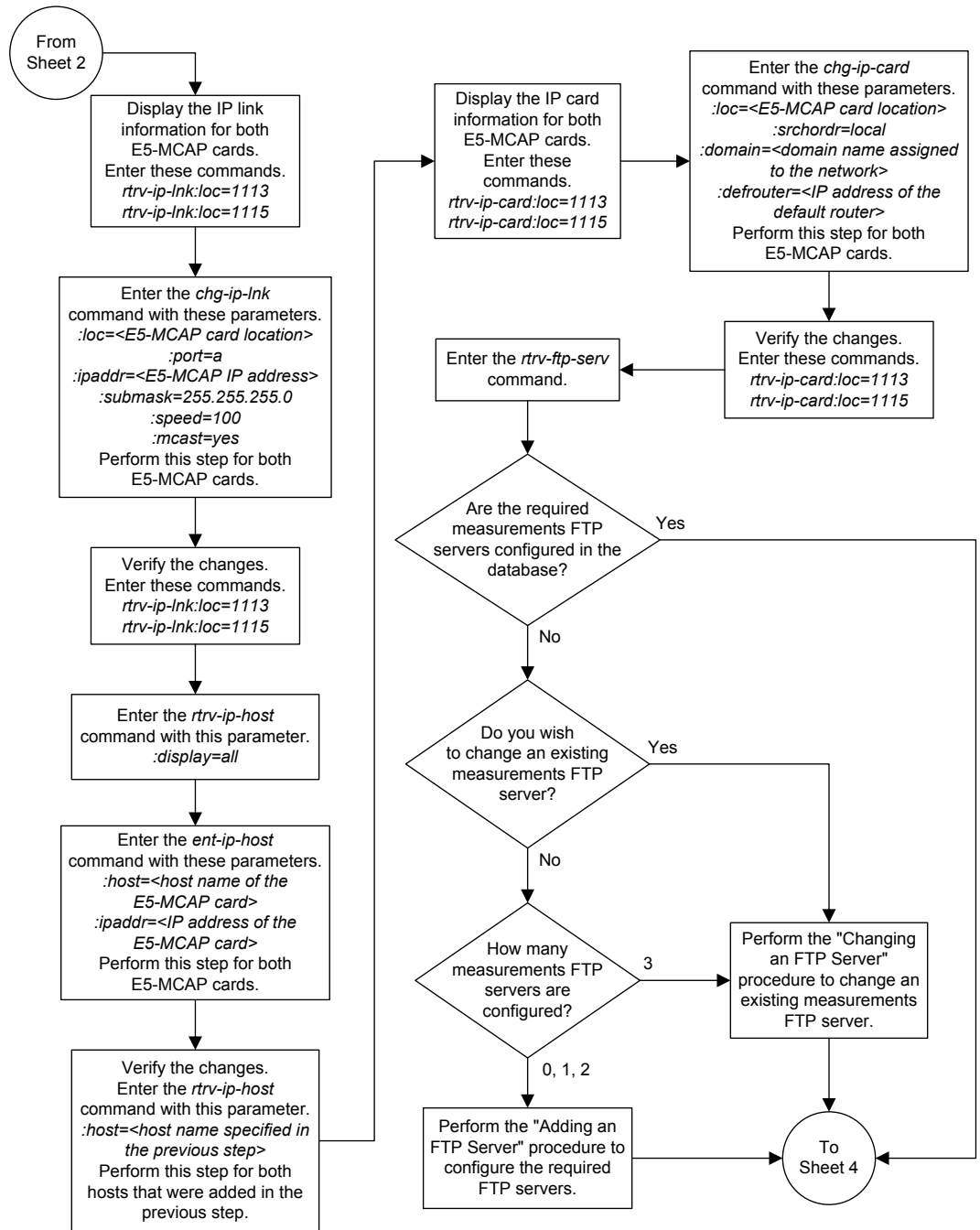

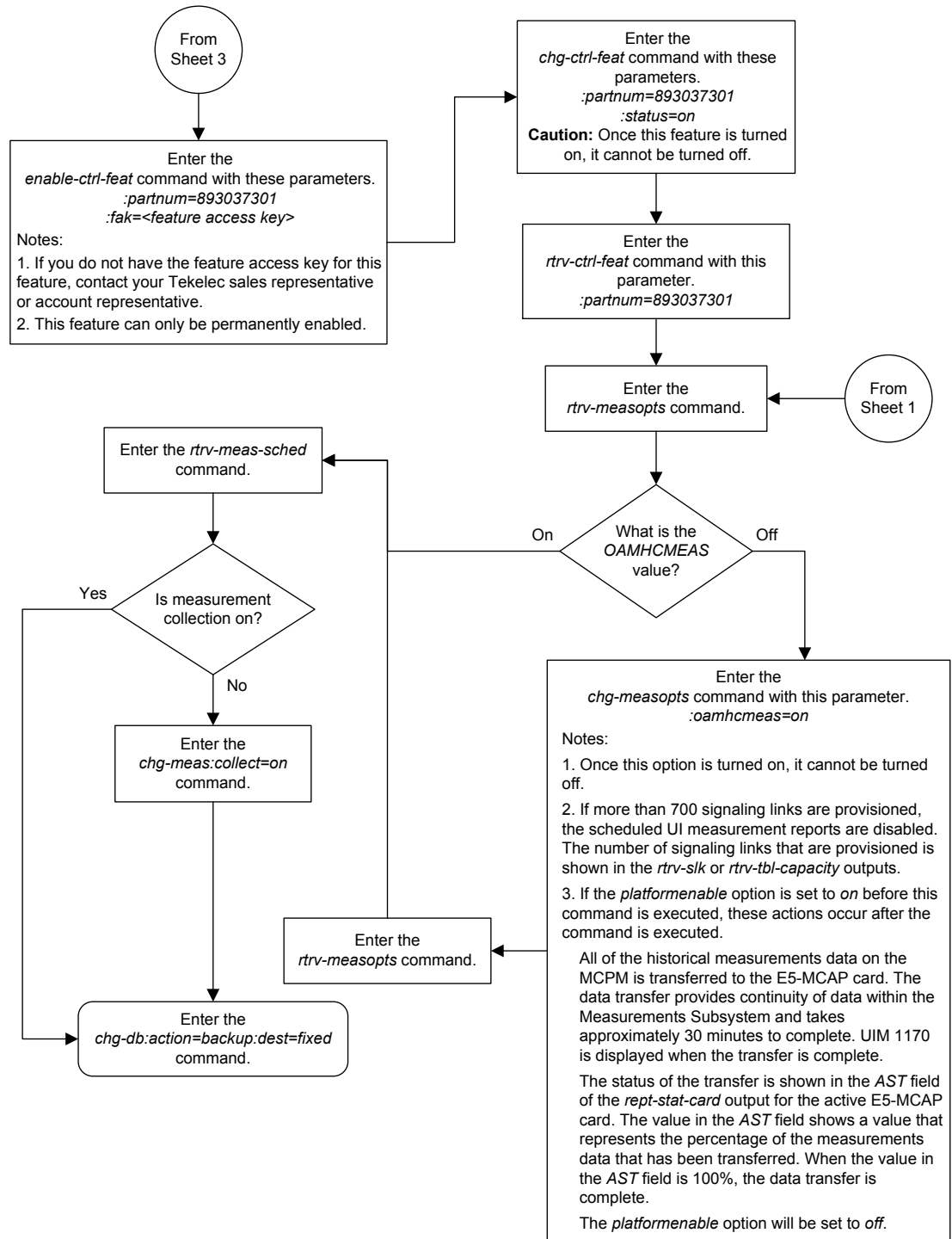

Sheet 4 of 4

Configuring the MFC Option

This procedure is used to configure the option for the EAGLE to use Message Flow Control (MFC) to control the traffic in the EAGLE instead of Group Ticket Voucher

(TVG). EAGLE Release 46.2 and later require MFC be turned on. This option is configured with `chg-stpopts` command using these parameters.

- `on=mfc` - turns the MFC option on. When the MFC option is turned on, Message Flow Control controls the traffic in the EAGLE.

Note: When turning on MFC, the following cards are not supported from EAGLE Release 44.0 or later, except during migration to the B-series cards:

- DCM card (870-1945-xx)
 - DSM card (870-1984-xx)
 - EDCM card (870-2372-xx) used for SLAN or STC functionality
 - EDCM-A card (870-2508-xx) used for **SLAN** or **STC** functionality
-

Note: A loss in MSU traffic may occur while running bi-directional traffic at 700 MSUs per second, 272 bytes on an E1-ATM or LIM-ATM card after GTT, while two STC cards are active.

Note: If another `chg-stpopts: on=mfc` or `chg-stpopts: off=mfc` command is issued within 10 seconds, the second command is rejected.

1. Enter the `rtrv-stpopts` command to display the existing value for the MFC option. The value for the MFC option is shown in the MFC field. This is an example of the possible output.

```
rlghncxa03w 10-12-17 16:02:05 GMT EAGLE5 43.0.0
STP OPTIONS
-----
MFC                               off

Command Completed.
```

The `rtrv-stpopts` command output contains other fields that are not used by this procedure. If you wish to see all the fields displayed by the `rtrv-stpopts` command, see the `rtrv-stpopts` command description in *Commands User's Guide*.

2. Turn the MFC option on by entering this command.

```
chg-stpopts: on=mfc
```

When this command has successfully completed, this message should appear.

```
rlghncxa03w 10-12-07 00:22:57 GMT EAGLE5 43.0.0
CHG-STPOPTS: MASP A - COMPLTD
```

3. Verify the changes using the `rtrv-stpopts` command. This is an example of the possible output.

```
rlghncxa03w 10-12-17 16:02:05 GMT  EAGLE5 43.0.0
STP OPTIONS
-----
MFC                               on

Command Completed.
```

The `rtrv-stpopts` command output contains other fields that are not used by this procedure. If you wish to see all the fields displayed by the `rtrv-stpopts` command, see the `rtrv-stpopts` command description in *Commands User's Guide*.

4. Back up the new changes using the `chg-db:action=backup:dest=fixed` command. These messages should appear, the active **Maintenance and Administration Subsystem Processor (MASP)** appears first.

```
BACKUP (FIXED) : MASP A - Backup starts on active MASP.
BACKUP (FIXED) : MASP A - Backup on active MASP to fixed disk complete.
BACKUP (FIXED) : MASP A - Backup starts on standby MASP.
BACKUP (FIXED) : MASP A - Backup on standby MASP to fixed disk complete.
```

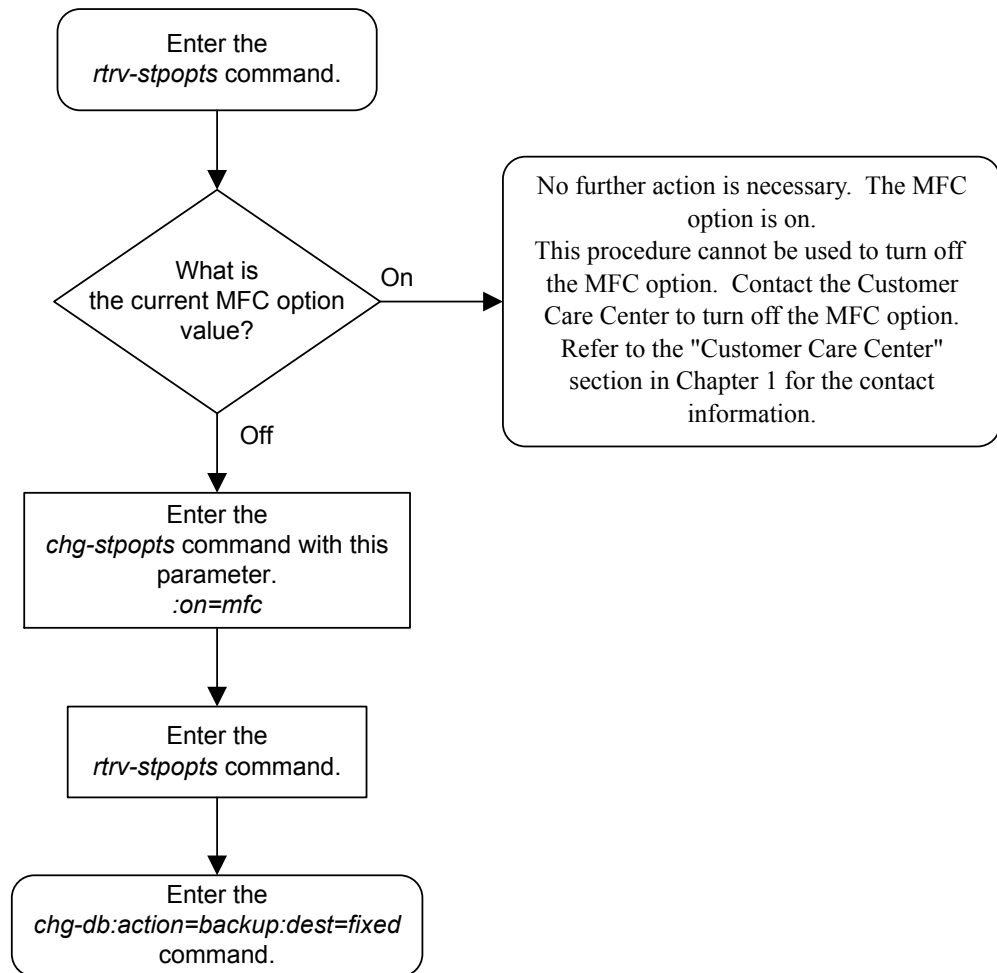

SEAS Over IP Configuration Procedures

Chapter 5, SEAS Over IP Configuration Procedures, describes the procedures used to configure the SEAS over IP feature.

Introduction

The **SEAS over IP** feature is a **TCP/IP**-based interface for SEAS that creates a path between the EAGLE and the **CCS MR** (Common Channel Signaling Message Router). The CCS MR is a stand-alone, self-contained system developed by Telcordia that provides a centralized mechanism for routing **CCS** network operations traffic between **STPs/SCPs** and existing and new **OSs**.

One of the eight telnet terminals on the E5-IPSM is used to provide the connection from the EAGLE and the CCS MR. This terminal is referred to as a SEAS terminal.

Note: As of Release 46.5, the E5-IPSM card and its functionality is replaced by the E5-ENET-B (p/n 870-2971-01) or SLIC (p/n 7094646) card. Any references to E5-IPSM and the 870-2877-01 part number should be replaced by the 46.5 and greater card and part number.

The EAGLE can contain a maximum of two SEAS terminals. Only one SEAS terminal can be assigned to an E5-IPSM. The remaining seven telnet terminals on the E5-IPSM continue to provide generic IP-based services such as **Telnet** and **FTP**.

SEAS over IP Feature Configurations

The SEAS over IP feature supports three configurations"

- Dual SEAS terminals with a single CCS MR
- Dual SEAS terminals with dual CCS MRs
- One SEAS terminal with one CCS MR.

Dual SEAS Terminals with a Single CCS MR SEAS Configuration

The two SEAS terminals are connected to a single CCS MR as shown in [Figure 5-1](#). The two SEAS terminals operate in a redundant fashion allowing a maximum of two active connections to the CCS MR. While the connection to the CCS MR is dedicated to SEAS, the other terminals on the E5-IPSM may still be used for other IP-based operations, such as Telnet and FTP, or their secure counterparts, SSH and SFTP. Different SEAS information can be transmitted and received separately over each connection to the CCS MR.

Figure 5-1 Dual SEAS Terminals with Single CCS MR SEAS Configuration

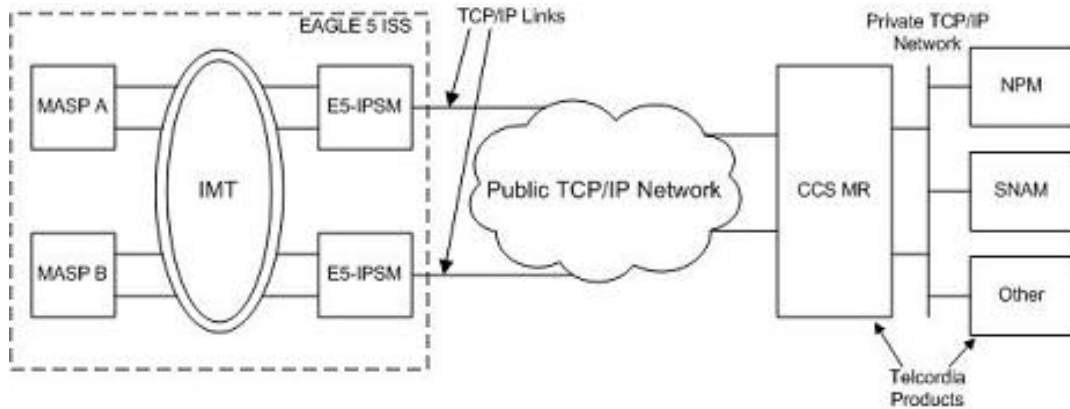

Dual SEAS Terminals with Dual CCS MRs SEAS Configuration

When the two SEAS terminals are connected to two CCS MRs, as shown in [Figure 5-2](#), the operation of the SEAS connections is similar to the "Dual SEAS Terminals with a Single CCS MR SEAS Configuration" section with the following exceptions:

- Each SEAS terminal is configured with a connection to one of the CCS MRs.
- The pair of CCS MRs operate in a round robin manner if they each have an active connection to a SEAS terminal. When the EAGLE receives a command request from a CCS MR, the response to the command request is sent to the CCS MR on the same TCP connection that the CCS MR used to send the command request.

Figure 5-2 Dual SEAS Terminals with Dual CCS MRs SEAS Configuration

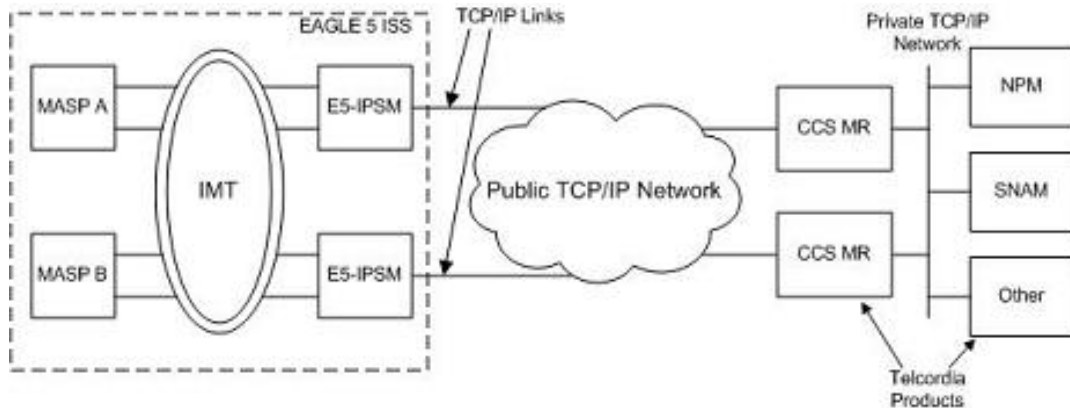

Simplex SEAS Terminal Operation

With the simplex SEAS terminal operation, there is only one SEAS terminal connected to one CCS MR. There are no redundant connections to the CCS MR and this configuration is intended to serve as a restricted mode of operation until another SEAS terminal is returned to service. The simplex mode of operation is not recommended as a standard mode of operation for the SEAS over IP feature.

- All SEAS information is transmitted over this single IP connection to the CCS MR.
- The SEAS system will be in an IS-ANR/Restricted state while the system is in the simplex SEAS terminals operation and a major alarm, UAM 0348, is generated for the SEAS system. Refer to *Unsolicited Alarm and Information Messages Reference* for more information on UAM 0348.

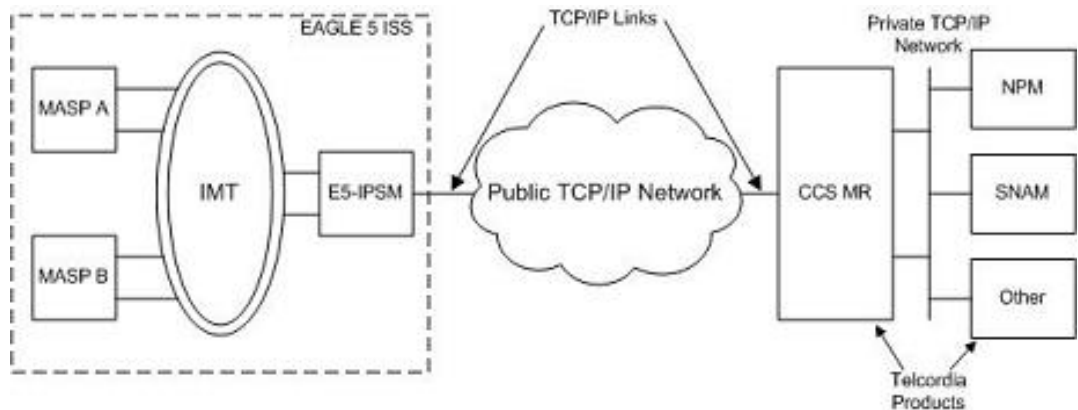
Figure 5-3 Simplex SEAS Terminal Configuration**Provisioning the SEAS over IP Feature**

To provision the SEAS over IP feature, perform these steps.

1. Add the E5-IPSMs to the database using the `ent-card` command. Perform the [Adding an E5-IPSM](#) procedure.
2. Enable the SEAS over IP feature using the `enable-ctrl-feat` command. Perform the [Activating the SEAS over IP Feature](#) procedure.
3. Configure the SEAS connections using the `chg-seas-config` command. Perform the [Performing the Initial SEAS Configuration](#) procedure.
4. Configure the SEAS terminals using the `chg-trm` command. Perform the [Configuring SEAS Terminals](#) procedure.
5. Turn the SEAS over IP feature on using the `chg-ctrl-feat` command. Perform the [Activating the SEAS over IP Feature](#) procedure.

Activating the SEAS over IP Feature

This procedure is used to enable and turn on the SEAS over IP feature using the feature's part number and a feature access key.

The feature access key is based on the feature's part number and the serial number of the **EAGLE**, making the feature access key site-specific.

The `enable-ctrl-feat` command enables the feature by inputting the feature's access key and the feature's part number with these parameters:

`: fak` – The feature access key provided by Oracle.

`: partnum` – The Oracle-issued part number of the SEAS over IP feature, 893018801.

Once this feature is enabled, it is permanently enabled. This feature cannot be enabled with a temporary feature access key.

The Telnet feature (IP User Interface), part number 893005701, must be enabled and turned on before the SEAS over IP feature can be enabled. Perform the [Activating Controlled Features](#) procedure to enable and turn on the Telnet feature.

Once the SEAS over IP feature has been enabled, the SEAS over IP feature must be turned on with the `chg-ctrl-feat` command. The `chg-ctrl-feat` command uses these parameters:

:partnum – The Oracle-issued part number of the SEAS over IP feature, 893018801.

:status=on – used to turn the SEAS over IP feature on.

Note: To turn the SEAS over IP feature on in step 5, these items must be provisioned in the database.

- The `seasccli` value must be provisioned.
- The IP address and port for at least one connection must be provisioned.
- At least one SEAS terminal must be provisioned.
- If the Eagle OAM IP Security Enhancement feature is enabled and turned on, the `login` and `hname` values for at least one connection must be provisioned.

If you wish to provision the EAGLE for the SEAS over IP feature at this time, perform these procedures.

- [Performing the Initial SEAS Configuration](#)
 - [Configuring SEAS Terminals](#)
-
-

Once the SEAS over IP feature has been turned on, it can be turned off. For more information on turning the SEAS over IP feature off, go to the [Turning Off the SEAS Over IP Feature](#) procedure.

The status of the SEAS over IP and Telnet features is shown with the `rtrv-ctrl-feat` command.

Caution: When the SEAS over IP feature is turned on, and the SEAS terminals and SEAS configuration is provisioned, SEAS traffic is sent to the CCS MR using the SEAS terminals.

1. Display the status of the controlled features by entering the `rtrv-ctrl-feat` command.

The following is an example of the possible output.

```
rlghncxa03w 06-10-01 21:15:37 GMT EAGLE5 36.0.0
The following features have been permanently enabled:
```

Feature Name	Partnum	Status	Quantity
HC-MIM SLK Capacity	893012707	on	64
Command Class Management	893005801	off	----
LNP Short Message Service	893006601	on	----
Intermed GTT Load Sharing	893006901	off	----
XGTT Table Expansion	893006101	off	----
XMAP Table Expansion	893007710	on	3000
Large System # Links	893005910	on	2000
Routesets	893006401	on	6000

The following features have been temporarily enabled:

Feature Name	Partnum	Status	Quantity	Trial Period Left
--------------	---------	--------	----------	-------------------

Zero entries found.

The following features have expired temporary keys:

Feature Name	Partnum
Zero entries found.	

If the SEAS over IP feature is enabled and turned on, no further action is necessary. This procedure does not need to be performed.

If the SEAS over IP feature is enabled and but not turned on, skip steps 2 and 3 and go to step 4.

If the SEAS over IP feature is not enabled, go to step 2.

2. To enable the SEAS over IP feature, the Telnet feature must be enabled and turned on. The Eagle OA&M IP Security Enhancement feature can also be used with the SEAS over IP feature. If the `rtrv-ctrl-feat` output in step 1 shows that the Telnet and Eagle OA&M IP Security Enhancement features are enabled and turned on, skip this step and go to step 3.

If the `rtrv-ctrl-feat` output in step 1 shows that the Telnet is not enabled or turned on, perform the [Activating Controlled Features](#) procedure to enable and turn on the Telnet feature.

The Eagle OA&M IP Security Enhancement feature can be enabled and turned on if the Telnet feature is not enabled and turned on. After the Telnet feature is enabled, and the `rtrv-ctrl-feat` output shows that the Eagle OA&M IP Security Enhancement feature is enabled and turned on, go to step 3.

If the Eagle OA&M IP Security Enhancement feature is not enabled and turned on, and you do not wish to use the If the Eagle OA&M IP Security Enhancement feature with the SEAS over IP feature, go to step 3.

If the Eagle OA&M IP Security Enhancement feature is not enabled and turned on, and you wish to use the If the Eagle OA&M IP Security Enhancement feature with the SEAS over IP feature, perform the [Activating the EAGLE OA&M IP Security Enhancement Controlled Feature](#) procedure to enable and turn on the Activating the Eagle OA&M IP Security Enhancement Controlled Feature. When the Activating the Eagle OA&M IP Security Enhancement Controlled Feature is enabled and turned on, go to step 3.

3. Enable the SEAS over IP feature with the `enable-ctrl-feat` command specifying the part number for the SEAS over IP feature and the feature access key. Enter this command.

```
enable-ctrl-feat:partnum=893018801:fak=<SEAS over IP feature
access key>
```

Note: The SEAS over IP feature cannot be enabled with a temporary feature access key.

Note: The values for the feature access key (the `fak` parameter) are provided by Oracle. If you do not have the feature access key for the SEAS over IP feature, contact your Oracle Sales Representative or Account Representative.

When the `enable-ctrl-feat` command has successfully completed, this message should appear.

```
rlghncxa03w 06-10-01 21:15:37 GMT EAGLE5 36.0.0
ENABLE-CTRL-FEAT: MASP B - COMPLTD
```

Note: To turn the SEAS over IP feature on in step 5, these items must be provisioned in the database.

- The `seascli` value must be provisioned.
- The IP address and port for at least one connection must be provisioned.
- At least one SEAS terminal must be provisioned.
- If the Eagle OAM IP Security Enhancement feature is enabled and turned on, the `login` and `hname` values for at least one connection must be provisioned.

If you wish to provision the EAGLE for the SEAS over IP feature at this time, perform these procedures.

- [Performing the Initial SEAS Configuration](#)
 - [Configuring SEAS Terminals](#)
-

After the SEAS over IP feature provisioning has been completed, skip step 4 and go to step 5.

If you do not wish to provision the EAGLE for the SEAS over IP feature at this time, skip steps 4 and 5, and go to step 6.

Note: If the SEAS over IP feature was enabled in this step, skip step 4 and go to step 5.

4. Before the SEAS over IP feature can be turned on, the SEAS over IP feature configuration must be correct (see the third note in step 3). Display the SEAS over IP configuration by entering the `rtrv-seas-config` command.

The following is an example of the possible output if the Eagle OA&M IP Security Enhancement feature is not enabled and turned on.

```
rlghncxa03w 07-01-23 18:46:01 EST EAGLE 37.5.0
SEASCLI      CONNECTION  IPADDRESS      PORT  TERMINAL
-----
TEAGLESTP001 IPMR1       192.168.25.10  2500  18
              IPMR2       192.168.25.20  2600  27
```

The following is an example of the possible output if the Eagle OA&M IP Security Enhancement feature is enabled and turned on.

```
tekelecstp 07-01-23 18:46:01 EST EAGLE 37.5.0
SEASCLI      AUTHMODE
-----
TEAGLESTP001 Password

TERMINAL      CONNECTION  IPADDR      PORT  LOGIN  HNAME
```

```
-----
18          IPMR1          198.168.25.10  2500   root    abaco-a
27          IPMR2          198.168.25.20  2600   root    abaco-b
```

To turn this feature on in step 5, the items shown in the third note in step 3 must be provisioned. If the SEAS configuration is not correct, perform the [Changing the Existing SEAS Configuration](#) procedure to make the necessary corrections to the SEAS over IP configuration. If no SEAS terminals are shown in this step, perform the [Configuring SEAS Terminals](#) procedure to configure the SEAS terminals.

- Turn the SEAS over IP feature on with the `chg-ctrl-feat` command specifying the part number for the SEAS over IP feature and the `status=on` parameter. Enter this command.

```
chg-ctrl-feat:partnum=893018801:status=on
```

Caution: When the SEAS over IP feature feature is turned on, SEAS traffic is sent to the CCS MR using the SEAS terminals.

When the `chg-ctrl-feat` command has successfully completed, the following message should appear.

```
rlghncxa03w 06-10-01 21:15:37 GMT EAGLE5 36.0.0
CHG-CTRL-FEAT: MASP B - COMPLTD
```

- Verify the changes by entering the `rtrv-ctrl-feat` command with the SEAS over IP feature part number. Enter this command.

```
rtrv-ctrl-feat:partnum=893018801
```

The following is an example of the possible output.

```
rlghncxa03w 07-05-28 21:15:37 GMT EAGLE5 37.0.0
The following features have been permanently enabled:
```

Feature Name	Partnum	Status	Quantity
SEAS over IP	893018801	on	----

The following features have been temporarily enabled:

Feature Name	Partnum	Status	Quantity	Trial Period Left
Zero entries found.				

The following features have expired temporary keys:

Feature Name	Partnum
Zero entries found.	

- Backup the new changes using the `chg-db:action=backup:dest=fixedcommand`.

These messages should appear, the active **Maintenance and Administration Subsystem Processor (MASP)** appears first

.

```
BACKUP (FIXED) : MASP A - Backup starts on active MASP.  
BACKUP (FIXED) : MASP A - Backup on active MASP to fixed disk complete.  
BACKUP (FIXED) : MASP A - Backup starts on standby MASP.  
BACKUP (FIXED) : MASP A - Backup on standby MASP to fixed disk complete.
```

Figure 5-4 Activating the SEAS over IP Feature

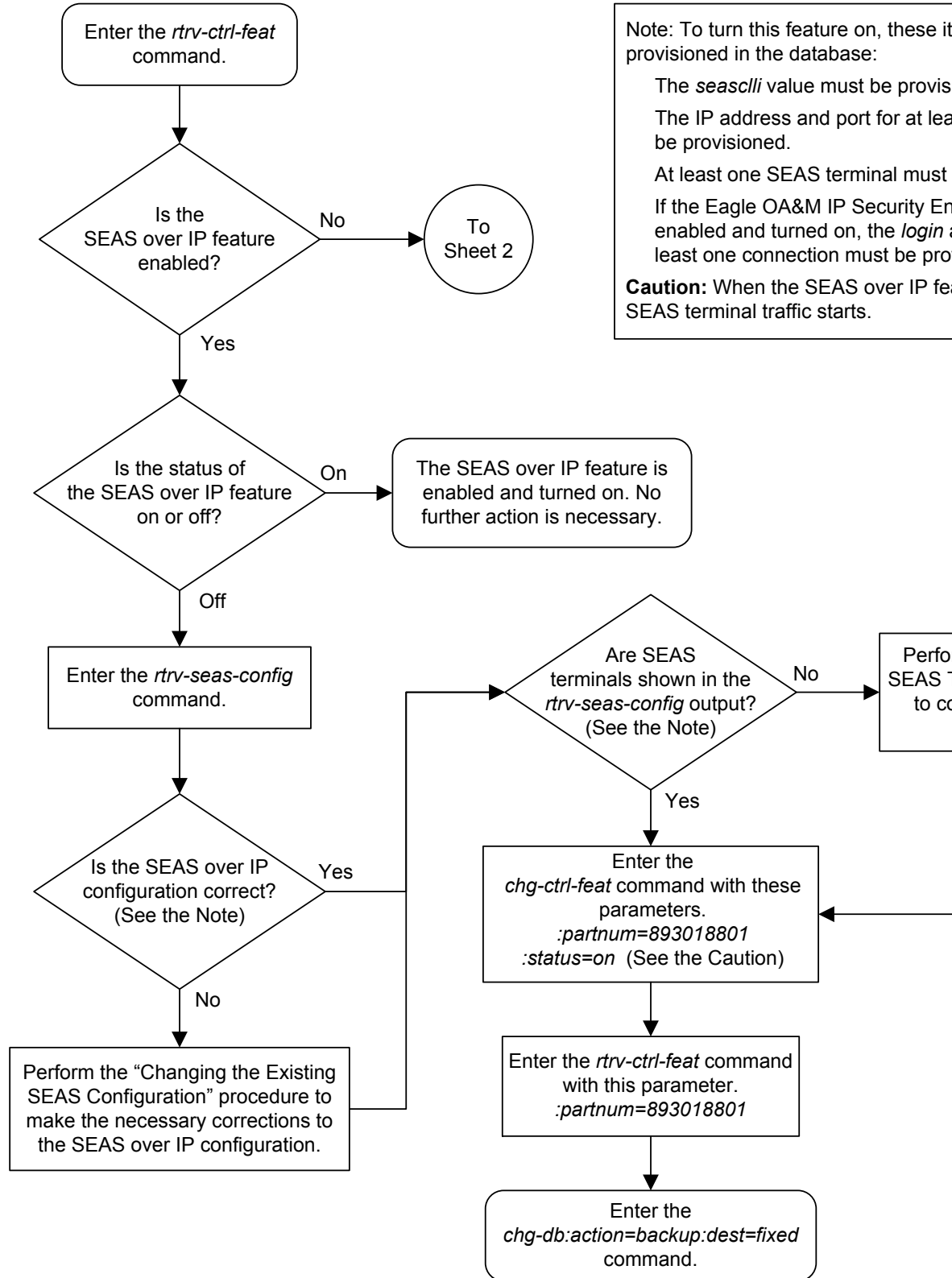

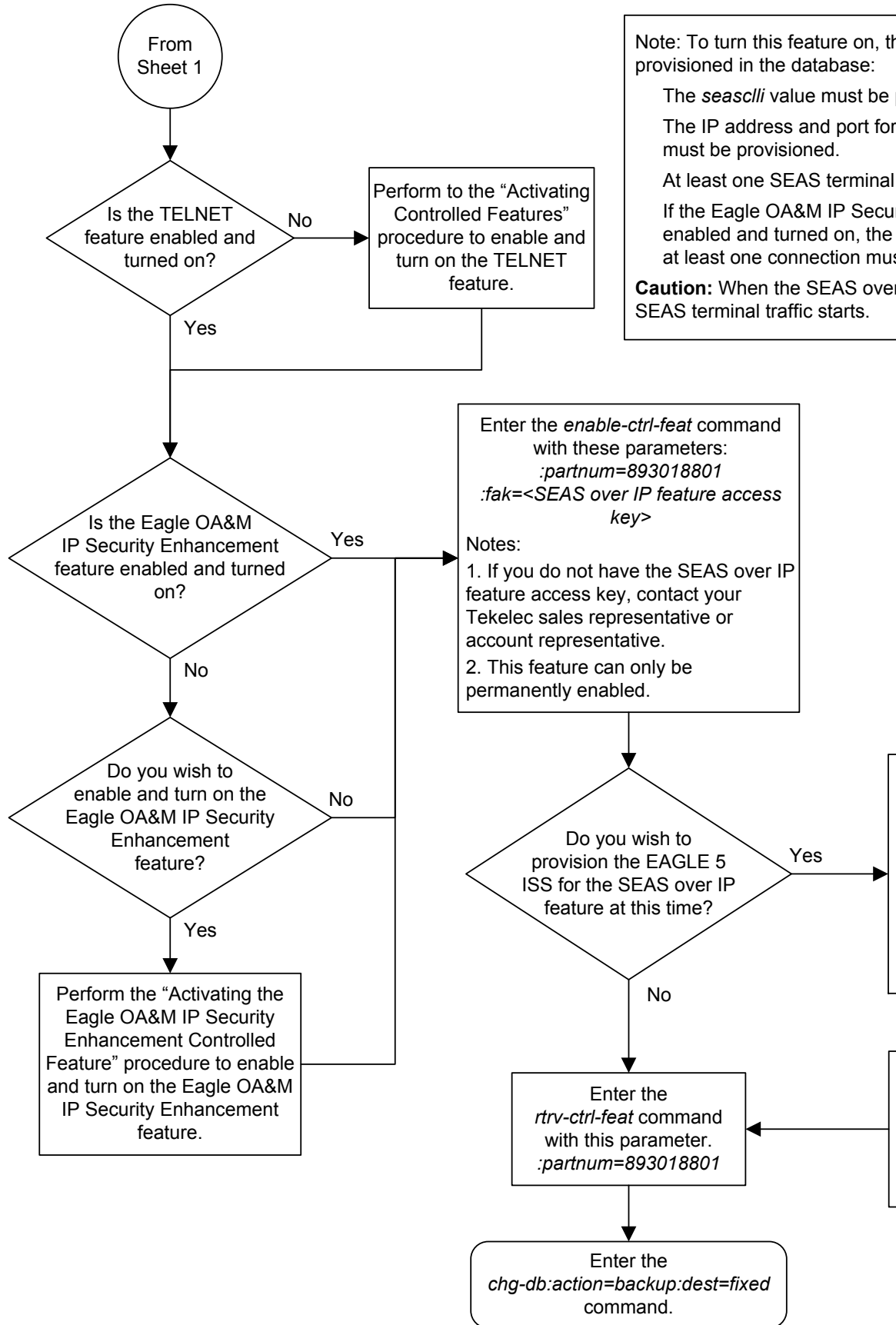

Performing the Initial SEAS Configuration

This procedure is used to configure the connections to the CCS MR using the `chg-seas-config` command. This procedure is performed only when configuring the connections to the CCS MR for the first time.

The `chg-seas-config` command can be used to change the SEAS configuration after the connections have been configured for the first time. Perform the [Changing the Existing SEAS Configuration](#) procedure to make this type of change.

The `chg-seas-config` command uses these parameters.

`:conn` – The name of the SEAS connection, either IPMR1 or IPMR2

`:seasc11i` – The CLLI part of node name of the EAGLE consisting of one alphabetic character and up to 15 alphanumeric characters. The `seasc11i` value is different from the EAGLE `c11i` value that is entered with the `chg-sid` command. The `seasc11i` value must also be configured on the Telcordia Message Router (CCS MR). Refer to Telcordia Configuration Specification "Telcordia Technologies System Documentation", *BD-SNAM-ADMIN-4 Issue 14, November 2006*.

`:ipaddr` – The IP address of the **CCS MR**.

`:port` – The port number of the **CCS MR** that the EAGLE connects to, from 1024 to 5000.

`:hname` – The name of the remote host of the **CCS MR**, 1 to 15 alphanumeric characters.

`:login` – The login name of the **CCS MR**, 1 to 15 alphanumeric characters.

`:authmode` – The method of authentication used for the connection. Currently, only password authentication is used for SEAS connections, so this parameter has only one value, `password`. This parameter is optional and does not need to be specified.

The `hname`, `login`, and `authmode` parameters are used only when the Eagle OA&M IP Security feature is enabled and turned on. The values for these parameters are displayed in the `rtrv-seas-config` output only when the Eagle OA&M IP Security feature is enabled and turned on. The status of the Eagle OA&M IP Security feature is shown in the `rtrv-ctrl-feat` output.

Caution: The IP address and `port` value combination for each SEAS connection must be unique or the `chg-seas-config` command will be rejected.

The IP address for the SEAS over IP configuration cannot be shown as the `IPADDR` value in the `rtrv-ip-lnk` or `rtrv-ftp-serv` outputs, or the `BPIPADDR` value in the `rtrv-ip-card` output.

1. Verify whether or not the SEAS over IP feature is enabled by entering this command.

```
rtrv-ctrl-feat:partnum=893018801
```

This is an example of the possible output.

```
rlghncxa03w 07-05-28 21:15:37 GMT EAGLE5 37.0.0
```

The following features have been permanently enabled:

Feature Name	Partnum	Status	Quantity
SEAS over IP	893018801	off	----

The following features have been temporarily enabled:

Feature Name	Partnum	Status	Quantity	Trial Period Left
Zero entries found.				

The following features have expired temporary keys:

Feature Name	Partnum
Zero entries found.	

If the SEAS over IP feature is enabled, continue the procedure with 2.

If the SEAS over IP feature is not enabled, perform the [Activating the SEAS over IP Feature](#) procedure in this chapter to enable SEAS over IP feature. After the SEAS over IP feature has been enabled, continue the procedure with 2.

2. Display the current SEAS configuration using the `rtrv-seas-config` command.

The following is an example of the possible output if the Eagle OA&M IP Security Enhancement feature is not enabled and turned on.

```
rlghncxa03w 07-01-23 18:46:01 EST EAGLE 37.5.0
SEASCLI      CONNECTION  IPADDRESS      PORT  TERMINAL
-----
----- IPMR1      -----
----- IPMR2      -----
```

The following is an example of the possible output if the Eagle OA&M IP Security Enhancement feature is enabled and turned on.

```
tekelecstp 07-01-23 18:46:01 EST EAGLE 37.5.0
SEASCLI      AUTHMODE
-----
-----

TERMINAL      CONNECTION  IPADDR      PORT  LOGIN  HNAME
-----
--            IPMR1      -----
--            IPMR2      -----
```

3. Enter the SEASCLI value by entering the `chg-seas-config` command with the `seascli` parameter. For this example, enter this command.

```
chg-seas-config:seascli=TEAGLESTP001
```

Note: The SEASCLI value is different from the CLI value specified with the `chg-sid` command.

4. Verify whether or not the Eagle OA&M IP Security Enhancement feature is enabled and turned on by entering this command.

```
rtrv-ctrl-feat:partnum=893400001
```

This is an example of the possible output.

```
rlghncxa03w 07-05-28 21:15:37 GMT EAGLE5 37.0.0
The following features have been permanently enabled:
```

Feature Name	Partnum	Status	Quantity
EAGLE OA&M IP Security	893400001	on	----

The following features have been temporarily enabled:

Feature Name	Partnum	Status	Quantity	Trial Period Left
Zero entries found.				

The following features have expired temporary keys:

Feature Name	Partnum
Zero entries found.	

5. Provision the first connection to the CCS MR. Enter the `chg-seas-config` command with these parameters:

- `:conn=ipmr1`
- `:ipaddr=`the IP address of the CCS MR
- `:port =` the port number of the CCS MR

Caution: The IP address and port value combination for each SEAS connection must be unique or the `chg-seas-config` command will be rejected.

If the Eagle OA&M IP Security Enhancement feature is enabled and turned on, these parameters must also be specified.

- `:hname =` The name of the remote host of the CCS MR.
- `:login =` The login name of the CCS MR.

If the Eagle OA&M IP Security Enhancement feature is not enabled and turned on, for this example, enter this command.

```
chg-seas-config:conn=ipmr1:ipaddr=198.168.25.10:port=2500
```

If the Eagle OA&M IP Security Enhancement feature is enabled and turned on, for this example, enter this command.

```
chg-seas-
config:conn=ipmr1:ipaddr=198.168.25.10:port=2500:hname=abaco-
a:login=root
```

When this command has successfully completed, this message should appear.

```
rlghncxa03w 06-10-01 15:08:45 GMT EAGLE5 36.0.0
CHG-SEAS-CONFIG: MASP A - COMPLTD
```

If the `login` parameter is specified with the `chg-seas-config` command, the `Enter Password:` prompt appears. When the `Enter Password:` prompt

appears, enter the password for the login name. The length of the password is from 1 to 15 alphanumeric characters. The password is not echoed on the screen.

6. Provision the second connection to the CCS MR. Enter the `chg-seas-config` command with these parameters:
 - `:conn=ipmr2`
 - `:ipaddr=`the IP address of the CCS MR
 - `:port =` the port number of the CCS MR

Caution: The IP address and port value combination for each SEAS connection must be unique or the `chg-seas-config` command will be rejected.

If the Eagle OA&M IP Security Enhancement feature is enabled and turned on, these parameters must also be specified.

- `:hname =` The name of the remote host of the CCS MR.
- `:login =` The login name of the CCS MR.

If the Eagle OA&M IP Security Enhancement feature is not enabled and turned on, for this example, enter this command.

```
chg-seas-config:conn=ipmr2:ipaddr=198.168.25.20:port=2600
```

If the Eagle OA&M IP Security Enhancement feature is enabled and turned on, for this example, enter this command.

```
chg-seas-
config:conn=ipmr2:ipaddr=198.168.25.20:port=2600:hname=abaco-
b:login=root
```

When this command has successfully completed, this message should appear.

```
rlghncxa03w 06-10-01 15:08:45 GMT EAGLE5 36.0.0
CHG-SEAS-CONFIG: MASP A - COMPLTD
```

If the `login` parameter is specified with the `chg-seas-config` command, the `Enter Password:` prompt appears. When the `Enter Password:` prompt appears, enter the password for the login name. The length of the password is from 1 to 15 alphanumeric characters. The password is not echoed on the screen.

7. Verify the SEAS configuration using the `rtrv-seas-config` command.

The following is an example of the possible output if the Eagle OA&M IP Security Enhancement feature is not enabled and turned on.

```
rlghncxa03w 07-01-23 18:46:01 EST EAGLE 37.5.0
SEASCLLI      CONNECTION  IPADDRESS      PORT   TERMINAL
-----
TEAGLESTP001 IPMR1      192.168.25.10  2500  18
              IPMR2      192.168.25.20  2600  27
```

The following is an example of the possible output if the Eagle OA&M IP Security Enhancement feature is enabled and turned on.

```
tekelecstp 07-01-23 18:46:01 EST EAGLE 37.5.0
```

```
SEASCLLI          AUTHMODE
```

```
-----  
TEAGLESTP001      Password
```

```
-----  
TERMINAL          CONNECTION      IPADDR              PORT    LOGIN    HNAME  
-----  
18                IPMR1                198.168.25.10      2500    root     abaco-a  
27                IPMR2                198.168.25.20      2600    root     abaco-b
```

8. Back up the new changes using the `chg-db:action=backup:dest=fixed` command.

These messages should appear, the active **Maintenance and Administration Subsystem Processor (MASP)** appears first.

```
BACKUP (FIXED) : MASP A - Backup starts on active MASP.  
BACKUP (FIXED) : MASP A - Backup on active MASP to fixed disk complete.  
BACKUP (FIXED) : MASP A - Backup starts on standby MASP.  
BACKUP (FIXED) : MASP A - Backup on standby MASP to fixed disk complete.
```

Figure 5-5 Performing the Initial SEAS Configuration

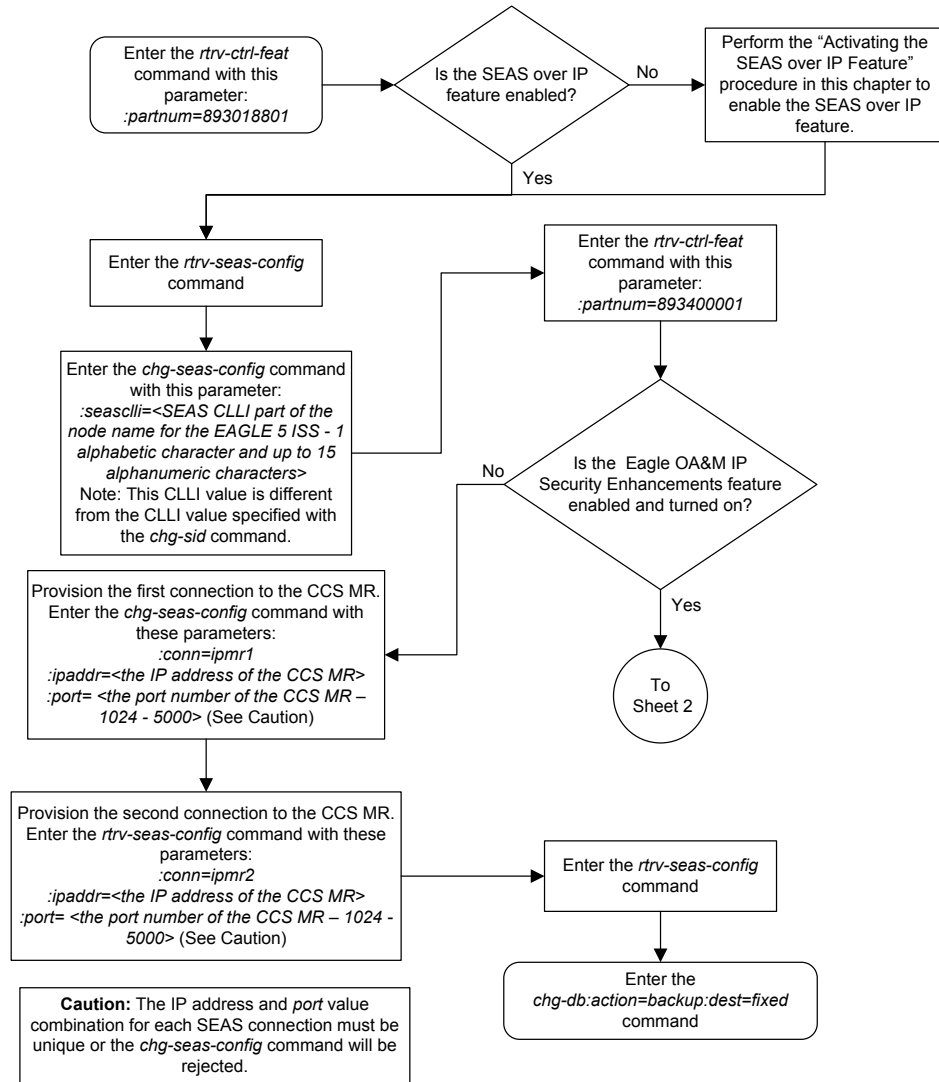

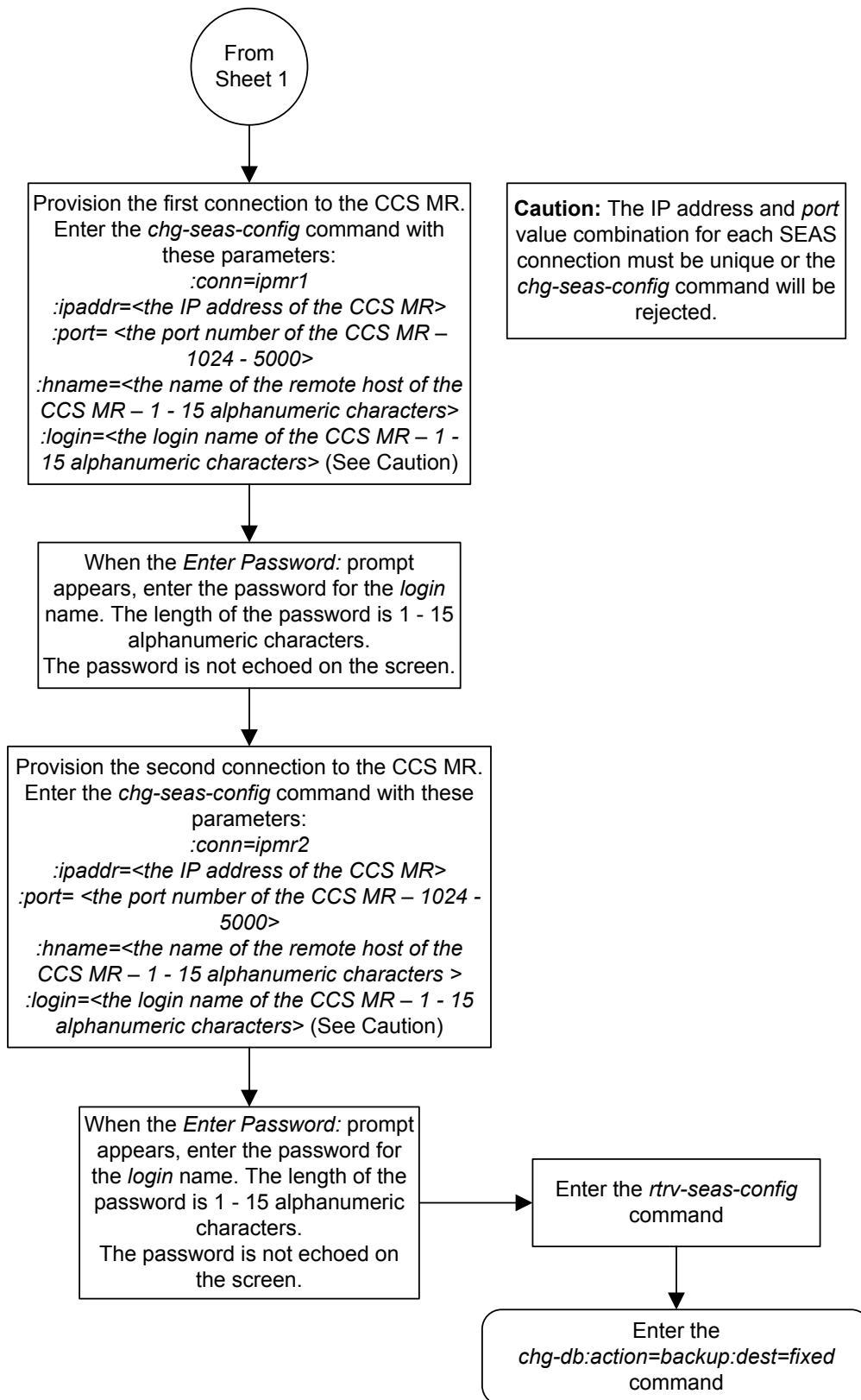

Configuring SEAS Terminals

This procedure is used to configure SEAS terminals for the SEAS over IP feature. The **SEAS terminal** can be configured only on E5-IPSMs.

Note: As of Release 46.5, the E5-IPSM card and its functionality is replaced by the E5-ENET-B (p/n 870-2971-01) or SLIC (p/n 7094646) card. Any references to E5-IPSM and the 870-2877-01 part number should be replaced by the 46.5 and greater card and part number.

The EAGLE can contain a maximum of two SEAS terminals, but only one SEAS terminal can be configured on an E5-IPSM. When an E5-IPSM is configured in the database, eight telnet terminals are created. To configure the SEAS terminal, one of these telnet terminals is changed to a SEAS terminal using the `chg-trm` command with these parameters.

`:trm` – The number of the telnet terminal being changed, 17 through 40

`:type=seas` – The SEAS terminal type.

The `chg-trm` command contains other parameters, but these parameters cannot be used in this procedure. For more information on these parameters, see the [Changing Terminal Characteristics](#) procedure in this manual, or the `chg-trm` command description in *Commands User's Guide*.

SEAS terminals can be configured only if the SEAS over IP feature is enabled. The status of the SEAS over IP feature is shown in the `rtrv-ctrl-feat` output. If the SEAS over IP feature is not enabled, perform the [Activating the SEAS over IP Feature](#) procedure in this chapter to enable the SEAS over IP feature.

When the SEAS terminal is configured, the value for the SEAS output group parameter is set to YES. The values for the other output group parameters and the `tmout`, `dural`, and `mxinv` parameters are not changed.

The other output group parameters can be changed with the specific output group parameter or the `all` parameter. If the `all=no` parameter is specified for a SEAS terminal (`type=seas`), all the output group values are changed to NO except for the SEAS output group. The SEAS output group value remains set to YES and this message is displayed.

SEAS Output Group is SET for SEAS terminal <terminal number>

1. Verify whether or not the SEAS over IP feature is enabled by entering this command.

```
rtrv-ctrl-feat:partnum=893018801
```

This is an example of the possible output.

```
rlghncxa03w 07-05-28 21:15:37 GMT EAGLE5 37.0.0
```

The following features have been permanently enabled:

Feature Name	Partnum	Status	Quantity
SEAS over IP	893018801	off	----

The following features have been temporarily enabled:

```

Feature Name          Partnum   Status  Quantity  Trial Period Left
Zero entries found.
    
```

The following features have expired temporary keys:

```

Feature Name          Partnum
Zero entries found.
    
```

If the SEAS over IP feature is enabled, go to step 2.

If the SEAS over IP feature is not enabled, perform the [Activating the SEAS over IP Feature](#) procedure in this chapter to enable SEAS over IP feature. After the SEAS over IP feature has been enabled, perform the [Performing the Initial SEAS Configuration](#) procedure in this chapter. After the [Performing the Initial SEAS Configuration](#) procedure has been performed, go to step 2.

2. Display the terminals in the EAGLE using the `rtrv-trm` command.

This is an example of the possible output.

```

rlghncxa03w 06-10-01 16:02:08 GMT EAGLE5 39.0.0
TRM  TYPE      COMM          FC      TMOUT MXINV  DURAL
1    VT320     9600-7-E-1   SW      30    5     99:59:59
2    KSR      9600-7-E-1   HW      30    5     INDEF
3    PRINTER  4800-7-E-1   HW      30    0     00:00:00
4    VT320     2400-7-E-1   BOTH    30    5     00:30:00
5    VT320     9600-7-O-1   NONE    30    5     00:00:30
6    VT320     9600-7-E-2   SW      30    9     INDEF
7    PRINTER  9600-7-N-2   HW      30    5     00:30:00
8    KSR      19200-7-E-2  BOTH    30    5     00:30:00
9    VT320     9600-7-E-1   SW      30    7     00:30:00
10   VT320     9600-7-E-1   HW      30    5     00:30:00
11   VT320     4800-7-E-1   HW      30    5     00:30:00
12   PRINTER  9600-7-E-1   HW      30    4     00:30:00
13   VT320     9600-7-O-1   NONE    30    5     00:30:00
14   VT320     9600-7-E-2   SW      30    8     00:30:00
15   VT320     9600-7-N-2   HW      30    5     00:30:00
16   VT320     9600-7-E-2   BOTH    30    3     00:30:00

TRM  TYPE      LOC           TMOUT MXINV  DURAL  SECURE
17   TELNET   1201          60    5     00:30:00  yes
18   TELNET   1201          60    5     00:30:00  yes
19   TELNET   1201          60    5     00:30:00  yes
20   TELNET   1201          60    5     00:30:00  yes
21   TELNET   1201          60    5     00:30:00  yes
22   TELNET   1201          60    5     00:30:00  yes
23   TELNET   1201          60    5     00:30:00  yes
24   TELNET   1201          60    5     00:30:00  yes
25   TELNET   1203          60    5     00:30:00  yes
26   TELNET   1203          60    5     00:30:00  yes
27   TELNET   1203          60    5     00:30:00  yes
28   TELNET   1203          60    5     00:30:00  yes
29   TELNET   1203          60    5     00:30:00  yes
30   TELNET   1203          60    5     00:30:00  yes
31   TELNET   1203          60    5     00:30:00  yes
32   TELNET   1203          60    5     00:30:00  yes
33   TELNET   1205          60    5     00:30:00  yes
34   TELNET   1205          60    5     00:30:00  yes
35   TELNET   1205          60    5     00:30:00  yes
    
```

36	TELNET	1205	60	5	00:30:00	yes
37	TELNET	1205	60	5	00:30:00	yes
38	TELNET	1205	60	5	00:30:00	yes
39	TELNET	1205	60	5	00:30:00	yes
40	TELNET	1205	60	5	00:30:00	yes

TRM	LOGINTMR (sec)	LOGOUTTMR (sec)	PNGTIMEINT (msec)	PNGFAILCNT
17	none	none	none	1
18	none	none	none	1
19	none	none	none	1
20	none	none	none	1
21	none	none	none	1
22	none	none	none	1
23	none	none	none	1
24	none	none	none	1
25	none	none	none	1
26	none	none	none	1
27	none	none	none	1
28	none	none	none	1
28	none	none	none	1
30	none	none	none	1
31	none	none	none	1
32	none	none	none	1
33	none	none	none	1
34	none	none	none	1
35	none	none	none	1
36	none	none	none	1
37	none	none	none	1
38	none	none	none	1
39	none	none	none	1
40	none	none	none	1

TRM	TRAF	LINK	SA	SYS	PU	DB	UIMRD
1	NO	YES	NO	YES	NO	YES	YES
2	NO	NO	NO	NO	NO	NO	NO
3	YES	YES	YES	NO	YES	YES	YES
4	YES	NO	NO	NO	NO	NO	NO
5	NO	YES	NO	NO	NO	NO	YES
6	NO	NO	YES	NO	NO	NO	NO
7	YES	YES	YES	YES	YES	YES	YES
8	NO	NO	NO	NO	YES	NO	YES
9	NO	YES	NO	NO	NO	YES	NO
10	NO	NO	NO	NO	NO	NO	YES
11	YES	YES	YES	YES	YES	YES	YES
12	YES	YES	YES	YES	YES	YES	YES
13	NO	YES	NO	NO	NO	NO	YES
14	NO	NO	YES	NO	NO	NO	NO
15	YES	YES	YES	NO	YES	YES	YES
16	NO	NO	NO	NO	YES	NO	YES
17	NO	NO	NO	NO	NO	NO	NO
18	NO	NO	NO	NO	NO	NO	NO
19	NO	NO	NO	NO	NO	NO	NO
20	NO	NO	NO	NO	NO	NO	NO
21	NO	NO	NO	NO	NO	NO	NO
22	NO	NO	NO	NO	NO	NO	NO
23	NO	NO	NO	NO	NO	NO	NO
24	NO	NO	NO	NO	NO	NO	NO
25	NO	NO	NO	NO	YES	NO	YES
26	NO	NO	NO	NO	NO	NO	NO
27	NO	NO	NO	NO	NO	NO	NO

```

28 NO NO NO NO NO NO NO
29 NO NO NO NO NO NO NO
30 NO NO NO NO NO NO NO
31 NO NO NO NO NO NO NO
32 NO NO NO NO NO NO NO
33 NO NO NO NO NO NO NO
34 NO NO NO NO YES NO YES
35 NO NO NO NO NO NO NO
36 NO NO NO NO NO NO NO
37 NO NO NO NO NO NO NO
38 NO NO NO NO NO NO NO
39 NO NO NO NO NO NO NO
40 NO NO NO NO NO NO NO

```

```

APP APP
TRM SERV SS CARD CLK DBG GTT GWS MEAS MON MPS SEAS SLAN
1 YES YES YES YES YES YES YES YES YES YES YES NO NO
2 YES YES YES YES YES YES YES YES YES YES YES NO NO
3 YES YES YES YES YES YES YES YES YES YES YES NO NO
4 YES YES YES YES YES NO YES YES YES YES YES NO NO
5 YES YES YES YES YES YES YES YES YES YES YES NO NO
6 YES YES YES YES YES YES YES YES YES YES YES NO NO
7 NO YES YES YES YES YES YES YES YES YES YES YES NO NO
8 YES YES YES YES YES YES YES YES YES YES YES YES YES
9 YES YES YES YES YES YES YES YES YES YES YES YES YES
10 NO NO NO NO NO NO NO NO NO NO NO NO NO NO
11 NO NO NO NO NO NO NO NO NO NO NO NO NO NO
12 NO NO NO NO NO NO NO NO NO NO NO NO NO NO
13 NO NO NO NO NO NO NO NO NO NO NO NO NO NO
14 NO NO NO NO NO NO NO NO NO NO NO NO NO NO
15 NO NO NO NO NO NO NO NO NO NO NO NO NO NO
16 NO NO NO NO NO NO NO NO NO NO NO NO NO NO
17 NO NO NO NO NO NO NO NO NO NO NO NO NO NO
18 NO NO NO NO NO NO NO NO NO NO NO NO NO NO
19 NO NO NO NO NO NO NO NO NO NO NO NO NO NO
20 NO NO NO NO NO NO NO NO NO NO NO NO NO NO
21 NO NO NO NO NO NO NO NO NO NO NO NO NO NO
22 NO NO NO NO NO NO NO NO NO NO NO NO NO NO
23 NO NO NO NO NO NO NO NO NO NO NO NO NO NO
24 NO NO NO NO NO NO NO NO NO NO NO NO NO NO
25 NO NO NO NO NO NO NO NO NO NO NO NO NO NO
26 NO NO NO NO NO NO NO NO NO NO NO NO NO NO
27 NO NO NO NO NO NO NO NO NO NO NO NO NO NO
28 NO NO NO NO NO NO NO NO NO NO NO NO NO NO
29 NO NO NO NO NO NO NO NO NO NO NO NO NO NO
30 NO NO NO NO NO NO NO NO NO NO NO NO NO NO
31 NO NO NO NO NO NO NO NO NO NO NO NO NO NO
32 NO NO NO NO NO NO NO NO NO NO NO NO NO NO
33 NO NO NO NO NO NO NO NO NO NO NO NO NO NO
34 NO NO NO NO NO NO NO NO NO NO NO NO NO NO
35 NO NO NO NO NO NO NO NO NO NO NO NO NO NO
36 NO NO NO NO NO NO NO NO NO NO NO NO NO NO
37 NO NO NO NO NO NO NO NO NO NO NO NO NO NO
38 NO NO NO NO NO NO NO NO NO NO NO NO NO NO
39 NO NO NO NO NO NO NO NO NO NO NO NO NO NO
40 NO NO NO NO NO NO NO NO NO NO NO NO NO NO

```

If no telnet terminals are shown in the `rtrv-trm` output, or only one telnet terminal is shown in the `rtrv-trm` output, perform the [Adding an E5-IPSM](#) procedure and add E5-IPSM cards to the database. A minimum of two E5-IPSMs

are required. After the E5-IPSMs have been added to the database, skip step 3 and go to step 4.

If two or three telnet terminals are shown in the `rtrv-trm` output, go to step 3.

3. Verify that the cards containing the telnet terminals shown in the `rtrv-trm` output in step 2 are E5-IPSMs. Enter the `rept-stat-card` command specifying the card location shown in the `rtrv-trm` output in step 2. For this example, enter these commands.

```
rept-stat-card:loc=1201
```

This is an example of the possible output.

```
rlghncxa03w 06-10-01 09:12:36 GMT EAGLE5 36.0.0
CARD  VERSION      TYPE      GPL      PST      SST      AST
1201  126-003-000  IPSM     IPSHC    IS-NR     Active   -----
ALARM STATUS      = No Alarms.
IMTPCI  GPL version = 126-002-000
BLVXW6  GPL version = 126-002-000
BLDIAG6 GPL version = 126-002-000
BLBEPM  GPL version = 126-002-000
BLCPLD  GPL version = 126-002-000
IMT BUS A      = Conn
IMT BUS B      = Conn
CURRENT TEMPERATURE = 32C ( 90F)
PEAK TEMPERATURE:  = 39C (103F)      [06-05-02 13:40]
Command Completed.
```

```
rept-stat-card:loc=1203
```

This is an example of the possible output.

```
rlghncxa03w 06-10-01 09:12:36 GMT EAGLE5 36.0.0
CARD  VERSION      TYPE      GPL      PST      SST      AST
1203  126-003-000  IPSM     IPS      IS-NR     Active   -----
ALARM STATUS      = No Alarms.
IMTPCI  GPL version = 126-002-000
BLVXW6  GPL version = 126-002-000
BLDIAG6 GPL version = 126-002-000
BLBEPM  GPL version = 126-002-000
BLCPLD  GPL version = 126-002-000
IMT BUS A      = Conn
IMT BUS B      = Conn
CURRENT TEMPERATURE = 32C ( 90F)
PEAK TEMPERATURE:  = 39C (103F)      [06-05-02 13:40]
Command Completed.
```

```
rept-stat-card:loc=1205
```

This is an example of the possible output.

```
rlghncxa03w 06-10-01 09:12:36 GMT EAGLE5 36.0.0
CARD  VERSION      TYPE      GPL      PST      SST      AST
1205  126-003-000  IPSM     IPS      IS-NR     Active   -----
ALARM STATUS      = No Alarms.
IMTPCI  GPL version = 126-002-000
BLVXW6  GPL version = 126-002-000
BLDIAG6 GPL version = 126-002-000
BLBEPM  GPL version = 126-002-000
BLCPLD  GPL version = 126-002-000
IMT BUS A      = Conn
IMT BUS B      = Conn
```

```

CURRENT TEMPERATURE = 32C ( 90F)
PEAK TEMPERATURE:   = 39C (103F)   [06-05-02 13:40]
Command Completed.

```

If the GPL value shown in the `rept-stat-card` output is `IPSHC`, the card is an E5-IPSM. If the GPL value shown in the `rept-stat-card` output is `IPS`, the card is an IPSM.

If there are a minimum of two E5-IPSMs shown in the `rept-stat-card` outputs, go to step 4.

If there is only one E5-IPSM or no E5-IPSMs shown in the `rept-stat-card` outputs, E5-IPSMs must be added to the database so that there are a minimum of two E5-IPSMs in the database. Remove enough IPSMs from the database so that when the E5-IPSMs are added, the EAGLE will contain a minimum of two E5-IPSMs. Perform the [Removing an E5-IPSM](#) procedure to remove the IPSMs. After the IPSMs have been removed from the database, remove the IPSM from the shelf.

When the IPSMs have been removed, perform the "Adding an IPSM" procedure in Chapter 4 of this manual to add the E5-IPSMs.

4. Select two telnet terminals. Each telnet terminal must be assigned to different E5-IPSMs. Display the status of this terminal by entering the `rept-stat-trm` command with the number of the selected telnet terminal. For this example, enter these commands.

```
rept-stat-trm:trm=18
```

This is an example of the possible output.

```

rlghncxa03w 06-10-01 15:08:45 GMT EAGLE5 36.0.0
TRM  PST          SST          AST
18   IS-NR        Active        -----

```

Command Completed.

```
rept-stat-trm:trm=27
```

This is an example of the possible output

```

rlghncxa03w 06-10-01 15:08:45 GMT EAGLE5 36.0.0
TRM  PST          SST          AST
27   IS-NR        Active        -----

```

Command Completed.

- If the state of both telnet terminals displayed in step 4 is `OOS-MT-DSBLD`, skip step 5 and go to step 6.
 - If the state of both telnet terminals displayed in step 4 is not `OOS-MT-DSBLD`, go to step 5.
5. To change the terminal type to a SEAS terminal type, the telnet terminal must be placed out of service using the `rmv-trm` command. Enter the `rmv-trm` command with the number of the terminal whose state is not `OOS-MT_DSBLD`. Perform this step only for the terminals shown in step 4 whose state is not `OOS-MT_DSBLD`.

```
rmv-trm:trm=18
```

```
rmv-trm:trm=27
```

When these commands have successfully completed, this message should appear.

```
rlghncxa03w 06-10-01 15:08:45 GMT EAGLE5 36.0.0
Inhibit message sent to terminal
```

```
rlghncxa03w 06-10-01 15:08:45 GMT EAGLE5 36.0.0
Command Completed.
```

- Verify that the terminal that was inhibited in step 5 is in the OOS-MT-DSBLD state by entering the `rept-stat-trm` command with the number of the terminal specified in step 5.

For this command, enter these commands.

```
rept-stat-trm:trm=18
```

This is an example of the possible output.

```
rlghncxa03w 06-10-01 15:08:45 GMT EAGLE5 36.0.0
TRM  PST          SST          AST
18   OOS-MT-DSBLD  MANUAL      -----
Command Completed.
```

```
rept-stat-trm:trm=27
```

This is an example of the possible output.

```
rlghncxa03w 06-10-01 15:08:45 GMT EAGLE5 36.0.0
TRM  PST          SST          AST
27   OOS-MT-DSBLD  MANUAL      -----
Command Completed.
```

- Change the terminal type of the terminals shown in step 6 to the SEAS terminal type using the `chg-trm` command with the number of the terminals shown in step 6.

For this example enter these commands.

```
chg-trm:trm=18:type=seas
```

```
chg-trm:trm=27:type=seas
```

When these commands have successfully completed, this message should appear.

```
rlghncxa03w 06-10-01 15:08:45 GMT EAGLE5 36.0.0
CHG-TRM: MASP A - COMPLTD
```

- Verify the changes made in step 7 by using the `rtrv-trm` command with the terminal number specified in step 7.

For this example, enter these commands.

```
rtrv-trm:trm=18
```

This is an example of the possible output.

```
rlghncxa03w 06-10-01 16:02:08 GMT EAGLE5 39.0.0
TRM  TYPE      LOC          TMOUT  MXINV  DURAL      SECURE
18   SEAS      1201         30     5      00:01:00  yes
```

```

TRM LOGINTMR LOGOUTTMR PNGTIMEINT PNGFAILCNT
   (sec)      (sec)      (msec)
18  none      none      none      1

TRM TRAF LINK SA SYS PU DB UIMRD
18  NO NO NO NO NO NO NO NO

APP APP
TRM SERV SS CARD CLK DBG GTT GWS MEAS MON MPS SEAS SLAN
18  NO NO NO NO NO NO NO NO NO NO YES NO
    
```

rtrv-trm:trm=27

This is an example of the possible output.

```

rlghncxa03w 06-10-01 16:02:08 GMT EAGLE5 39.0.0
TRM TYPE      LOC          TMOUT MXINV DURAL      SECURE
27  SEAS      1203          30   5   00:01:00  yes

TRM LOGINTMR LOGOUTTMR PNGTIMEINT PNGFAILCNT
   (sec)      (sec)      (msec)
27  none      none      none      1

TRM TRAF LINK SA SYS PU DB UIMRD
27  NO NO NO NO NO NO NO NO

APP APP
TRM SERV SS CARD CLK DBG GTT GWS MEAS MON MPS SEAS SLAN
27  NO NO NO NO NO NO NO NO NO NO YES NO
    
```

9. Display the SEAS configuration using the `rtrv-seas-config` command.

The following is an example of the possible output if the Eagle OA&M IP Security Enhancement feature is not enabled and turned on.

```

rlghncxa03w 07-01-23 18:46:01 EST EAGLE 37.5.0
SEASCLLI      CONNECTION  IPADDRESS      PORT  TERMINAL
-----
TEAGLESTP001 IPMR1      192.168.25.10  2500  --
                IPMR2      192.168.25.20  2600  --
    
```

The following is an example of the possible output if the Eagle OA&M IP Security Enhancement feature is enabled and turned on.

```

rlghncxa03w 07-01-23 18:46:01 EST EAGLE 37.5.0
SEASCLLI      AUTHMODE
-----
TEAGLESTP001      Password

TERMINAL      CONNECTION  IPADDR      PORT  LOGIN  HNAME
-----
--            IPMR1      198.168.25.10  2500  root   abaco-a
--            IPMR2      198.168.25.20  2600  root   abaco-b
    
```

10. Verify the connection to the CCS MR by entering the `pass:cmd="ping"` command specifying the card location of the SEAS terminal (shown in step 8) and the IP address assigned to the connection (shown in step 9). Perform this step for both connection to the CCS MR. For this example, enter these commands

```
pass:loc=1201:cmd="ping 198.168.25.10"
```

The following is an example of the possible output.

```
rlghncxa03w 07-05-28 21:15:37 GMT EAGLE5 37.0.0
PASS: Command sent to card

rlghncxa03w 07-05-28 21:15:37 GMT EAGLE5 37.0.0
PING command in progress

rlghncxa03w 07-05-28 21:15:37 GMT EAGLE5 37.0.0
PING 198.168.25.10: 56 data bytes
64 bytes from tekral.nc.tekelec.com (198.168.25.10): icmp_seq=0. time=5. ms
64 bytes from tekral.nc.tekelec.com (198.168.25.10): icmp_seq=1. time=9. ms
64 bytes from tekral.nc.tekelec.com (198.168.25.10): icmp_seq=2. time=14. ms
----tekral PING Statistics----
3 packets transmitted, 3 packets received, 0% packet loss
round-trip (ms)  min/avg/max = 5/9/14

PING command complete
```

```
pass:loc=1203:cmd="ping 198.168.25.20"
```

The following is an example of the possible output.

```
rlghncxa03w 07-05-28 21:15:37 GMT EAGLE5 37.0.0
PASS: Command sent to card

rlghncxa03w 07-05-28 21:15:37 GMT EAGLE5 37.0.0
PING command in progress

rlghncxa03w 07-05-28 21:15:37 GMT EAGLE5 37.0.0
PING 198.168.25.20: 56 data bytes
64 bytes from tekral.nc.tekelec.com (198.168.25.20): icmp_seq=0. time=5. ms
64 bytes from tekral.nc.tekelec.com (198.168.25.20): icmp_seq=1. time=9. ms
64 bytes from tekral.nc.tekelec.com (198.168.25.20): icmp_seq=2. time=14. ms
----tekral PING Statistics----
3 packets transmitted, 3 packets received, 0% packet loss
round-trip (ms)  min/avg/max = 5/9/14

PING command complete
```

- Put the SEAS terminals into service using the `alw-trm` command with the number of the SEAS terminals shown in step 8.

```
alw-trm:trm=18
```

When this command has successfully completed, this message should appear.

```
rlghncxa03w 04-01-07 11:11:28 EST EAGLE 31.3.0
Allow message sent to terminal

rlghncxa03w 04-01-07 11:11:28 EST EAGLE 31.3.0
1062.0046      TERMINAL      18      Terminal Enabled

alw-trm:trm=27
```

When this command has successfully completed, this message should appear.

```
rlghncxa03w 04-01-07 11:11:28 EST EAGLE 31.3.0  
Allow message sent to terminal
```

```
rlghncxa03w 04-01-07 11:11:28 EST EAGLE 31.3.0  
1062.0046      TERMINAL      27      Terminal Enabled
```

12. Back up the new changes using the `chg-db:action=backup:dest=fixed` command.

These messages should appear, the active **Maintenance and Administration Subsystem Processor (MASP)** appears first.

```
BACKUP (FIXED) : MASP A - Backup starts on active MASP.  
BACKUP (FIXED) : MASP A - Backup on active MASP to fixed disk complete.  
BACKUP (FIXED) : MASP A - Backup starts on standby MASP.  
BACKUP (FIXED) : MASP A - Backup on standby MASP to fixed disk complete.
```

Figure 5-6 Configuring SEAS Terminals

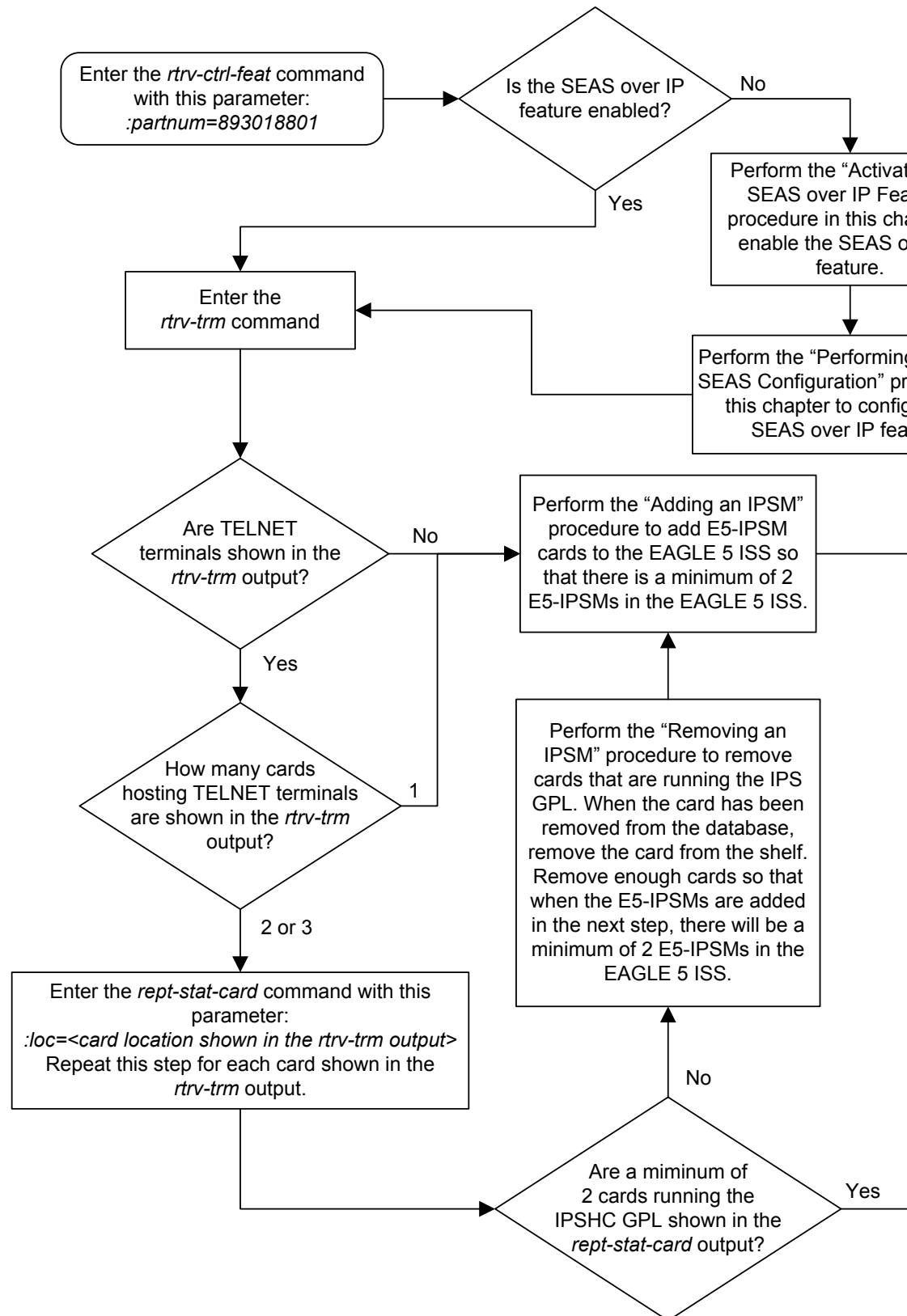

Sheet 1 of 3

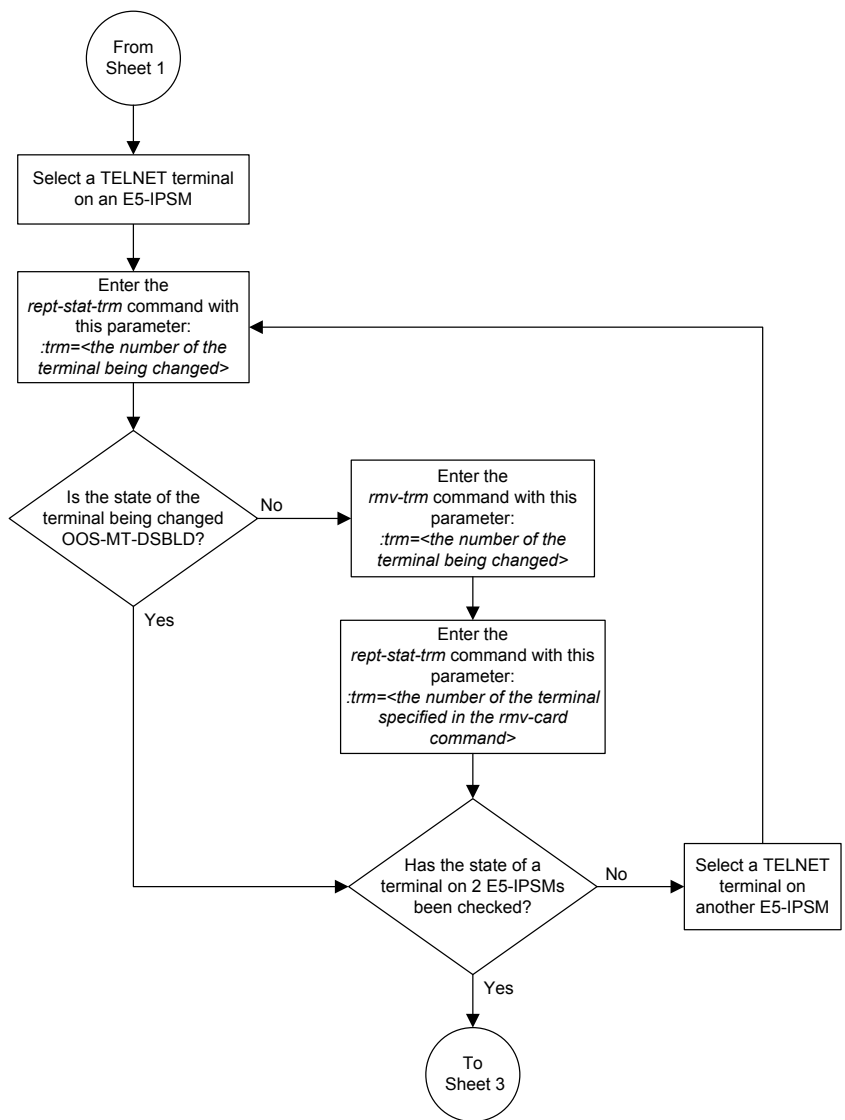

Sheet 2 of 3

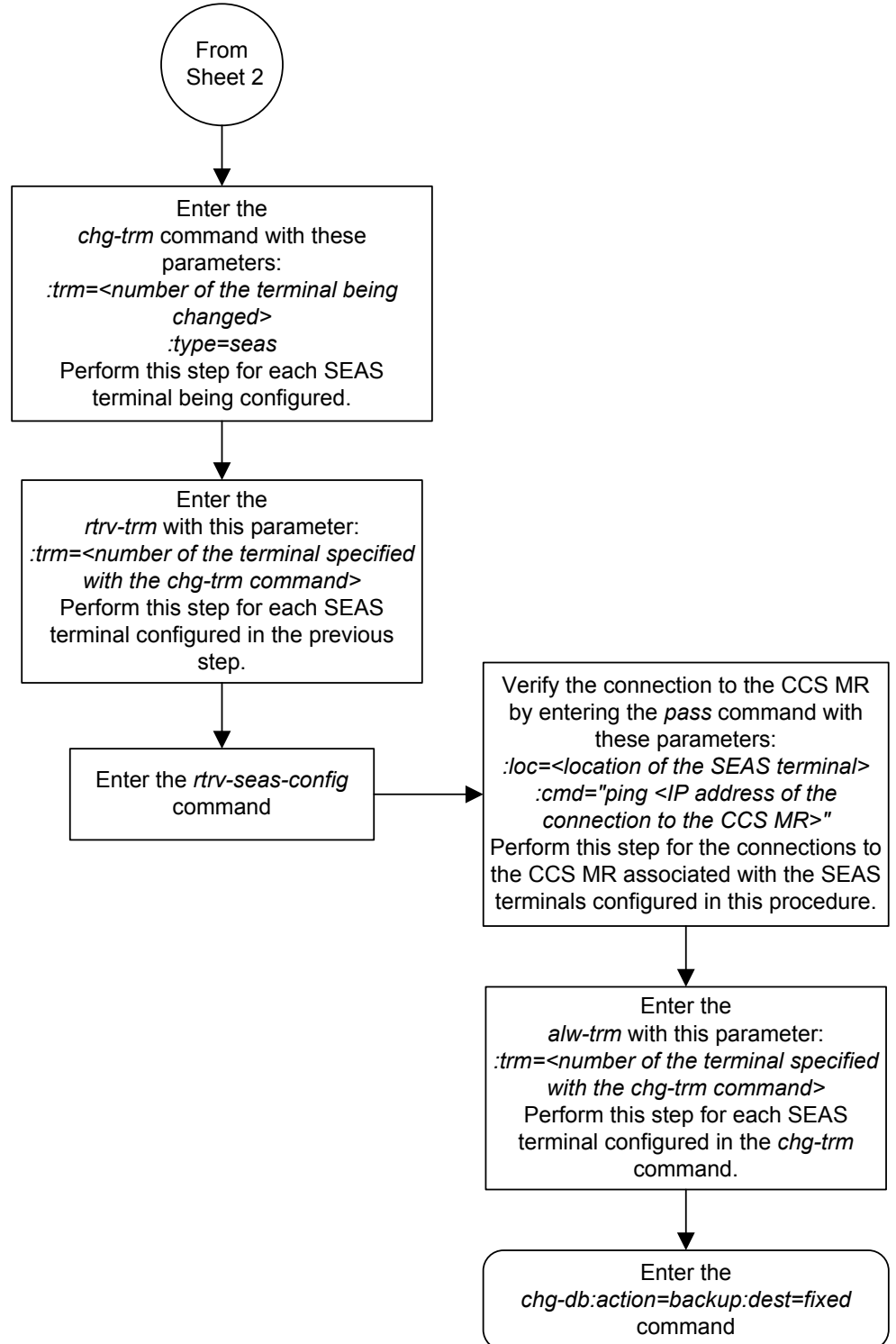

Changing the Existing SEAS Configuration

This procedure is used to change the existing SEAS configuration using the `chg-seas-config` command.

The `chg-seas-config` command uses these parameters.

`:conn` – The name of the SEAS connection, either `IPMR1` or `IPMR2`

`:seasc11i` – The CLLI part of node name of the EAGLE consisting of one alphabetic character and up to 15 alphanumeric characters. The `seasc11i` value is different from the EAGLE `c11i` value that is entered with the `chg-sid` command. The `seasc11i` value must also be configured on the Telcordia Message Router (CCS MR). Refer to Telcordia Configuration Specification "Telcordia Technologies System Documentation", *BD-SNAM-ADMIN-4 Issue 14, November 2006*.

`:ipaddr` – The IP address of the **CCS MR**.

`:port` – The port number of the **CCS MR** that the EAGLE connects to, from 1024 to 5000.

`:hname` – The name of the remote host of the **CCS MR**, 1 to 15 alphanumeric characters.

`:login` – The login name of the **CCS MR**, 1 to 15 alphanumeric characters.

`:authmode` – The method of authentication used for the connection. Currently, only password authentication is used for SEAS connections, so this parameter has only one value, `password`. This parameter is optional and does not need to be specified.

The `hname`, `login`, and `authmode` parameters are used only when the Eagle OA&M IP Security feature is enabled and turned on. The values for these parameters are displayed in the `rtrv-seas-config` output only when the Eagle OA&M IP Security feature is enabled and turned on. The status of the Eagle OA&M IP Security feature is shown in the `rtrv-ctrl-feat` output.

If the `seasc11i` value is being changed, all the SEAS terminals must be taken out of service. If the connection information for one connection is being changed, only the terminal associated with this connection must be taken out of service.

Caution: The IP address and `port` value combination for each SEAS connection must be unique or the `chg-seas-config` command will be rejected.

The IP address for the SEAS over IP configuration cannot be shown as the `IPADDR` value in the `rtrv-ip-lnk` or `rtrv-ftp-serv` outputs, or the `BPIPADDR` value in the `rtrv-ip-card` output.

1. Display the current SEAS configuration using the `rtrv-seas-config` command.

The following is an example of the possible output if the Eagle OA&M IP Security Enhancement feature is not enabled and turned on.

```
rlghncxa03w 07-01-23 18:46:01 EST EAGLE 37.5.0
SEASCLLI      CONNECTION  IPADDRESS      PORT  TERMINAL
-----      -
TEAGLESTP001 IPMR1      192.168.25.10  2500  18
              IPMR2      192.168.25.20  2600  27
```

The following is an example of the possible output if the Eagle OA&M IP Security Enhancement feature is enabled and turned on.

```
tekelecstp 07-01-23 18:46:01 EST EAGLE 37.5.0
SEASCLLI          AUTHMODE
-----
TEAGLESTP001      Password

TERMINAL          CONNECTION      IPADDR          PORT    LOGIN    HNAME
-----
18                IPMR1            198.168.25.10   2500    root     abaco-a
27                IPMR2            198.168.25.20   2600    root     abaco-b
```

2. Display the status of the SEAS terminal associated with the connection that is being changed. Enter the `rept-stat-trm` command with the terminal number shown in 1.

If the `seasclli` value is being changed, both SEAS terminals must be taken out of service. Perform this step for both SEAS terminals.

For this example, enter these commands.

```
rept-stat-trm:trm=18
```

This is an example of the possible output.

```
rlghncxa03w 06-10-01 15:08:45 GMT EAGLE5 36.0.0
TRM  PST      SST      AST
18   IS-NR    Active   -----
```

Command Completed.

```
rept-stat-trm:trm=27
```

This is an example of the possible output.

```
rlghncxa03w 06-10-01 15:08:45 GMT EAGLE5 36.0.0
TRM  PST      SST      AST
27   IS-NR    Active   -----
```

Command Completed.

3. Place the SEAS terminals displayed in 2 out of service using the `rmv-trm` command. Enter the `rmv-trm` command with the number of the terminal whose state is not `OOS-MT_DSBLD`. Perform this step only for the terminals shown in 2 whose state is not `OOS-MT_DSBLD`.

Note: If the SEAS terminal specified in this step is the last SEAS terminal that is in service, the `force=yes` parameter must be specified with the `rmv-trm` command.

```
rmv-trm:trm=18
```

```
rmv-trm:trm=27:force=yes
```

When these commands have successfully completed, this message should appear.

```
rlghncxa03w 06-10-01 15:08:45 GMT EAGLE5 36.0.0
Inhibit message sent to terminal
```

```
rlghncxa03w 06-10-01 15:08:45 GMT EAGLE5 36.0.0  
Command Completed.
```

Note: If the SEASCLLI value is not being changed, skip step 4 and go to step 5.

4. Change the SEASCLLI value by entering the `chg-seas-config` command with the `seasclli` parameter. For this example, enter this command.

```
chg-seas-config:seasclli=TEAGLESTP002
```

Note: The SEASCLLI value is different from the CLI value specified with the `chg-sid` command.

Note: If only the SEASCLLI value is being changed in this procedure, skip step 5 and go to step 6.

5. Change the connection information for a connection to the CCS MR. Enter the `chg-seas-config` command with these parameters:

- `:conn=<the name of the connection being changed, ipmr1 or ipmr2>`
- `:ipaddr=the IP address of the CCS MR`
- `:port = the port number of the CCS MR`

Caution: The IP address and port value combination for each SEAS connection must be unique or the `chg-seas-config` command will be rejected.

If the Eagle OA&M IP Security Enhancement feature is enabled and turned on, these parameters can also be specified.

- `:hname = The name of the remote host of the CCS MR.`
- `:login = The login name of the CCS MR.`

If the LOGIN column is shown in the `rtrv-seas-config` output in 1, the Eagle OA&M IP Security Enhancement feature is enabled and turned on.

Note: If you wish to specify the `login` and `hname` parameters for the connection being changed, and the Eagle OA&M IP Security Enhancement feature is not enabled and turned on, perform the [Activating the EAGLE OA&M IP Security Enhancement Controlled Feature](#) procedure to enable and turn on the Eagle OA&M IP Security Enhancement feature. Enable and turn on the Eagle OA&M IP Security Enhancement feature before performing the `chg-seas-config` command.

If the Eagle OA&M IP Security Enhancement feature is not enabled and turned on, for this example, enter this command.

```
chg-seas-config:conn=ipmr1:ipaddr=198.168.25.30:port=3000
```

If the Eagle OA&M IP Security Enhancement feature is enabled and turned on, for this example, enter this command.

```
chg-seas-
config:conn=ipmr1:ipaddr=198.168.25.30:port=3000:hname=remote
2:login=root
```

When this command has successfully completed, this message should appear.

```
rlghncxa03w 06-10-01 15:08:45 GMT EAGLE5 36.0.0
CHG-SEAS-CONFIG: MASP A - COMPLTD
```

If the login parameter was specified with the `chg-seas-config` command, the Enter Password: prompt appears. When the Enter Password: prompt appears, enter the password for the login name. The length of the password is from 1 to 15 characters. The password is not echoed on the screen.

6. Verify the SEAS configuration using the `rtrv-seas-config` command.

The following is an example of the possible output if the Eagle OA&M IP Security Enhancement feature is not enabled and turned on.

```
rlghncxa03w 07-01-23 18:46:01 EST EAGLE 37.5.0
SEASCLLI      CONNECTION  IPADDRESS      PORT   TERMINAL
-----
TEAGLESTP002 IPMR1          192.168.25.30  3000   18
              IPMR2          192.168.25.20  2600   27
```

The following is an example of the possible output if the Eagle OA&M IP Security Enhancement feature is enabled and turned on.

```
tekelecstp 07-01-23 18:46:01 EST EAGLE 37.5.0
SEASCLLI      AUTHMODE
-----
TEAGLESTP002      Password

TERMINAL      CONNECTION  IPADDR          PORT   LOGIN   HNAME
-----
18             IPMR1       198.168.25.30   3000   root    abaco-a
27             IPMR2       198.168.25.20   2600   root    abaco-b
```

Note: If only the SEASCLLI value was changed, continue the procedure with 9.

7. Display the SEAS terminal associated with the connection that was changed in 6 using the `rtrv-trm` with the number of the SEAS terminal associated with the connection that was changed.

For this example, enter this command.

```
rtrv-trm:trm=18
```

This is an example of the possible output.

```

rlghncxa03w 06-10-01 16:02:08 GMT EAGLE5 36.0.0
TRM  TYPE      LOC          TMOUT MXINV DURAL      SECURE
18   SEAS      1201          30    5    00:01:00   yes

TRM  TRAF LINK SA  SYS PU  DB  UIMRD
18   NO  NO  NO  NO  NO  NO  NO

      APP  APP
TRM  SERV SS  CARD CLK DBG GTT GWS MEAS MON MPS SEAS SLAN
18   NO  NO  NO  NO  NO  NO  NO  NO  NO  NO  YES NO

```

- Verify the connection to the CCS MR by entering the `pass:cmd="ping"` command specifying the card location of the SEAS terminal (shown in 7) and the IP address assigned to the connection (shown in 6).

```
pass:loc=1201:cmd="ping 198.168.25.30"
```

The following is an example of the possible output.

```

rlghncxa03w 07-05-28 21:15:37 GMT EAGLE5 37.0.0
PASS: Command sent to card

rlghncxa03w 07-05-28 21:15:37 GMT EAGLE5 37.0.0
PING command in progress

rlghncxa03w 07-05-28 21:15:37 GMT EAGLE5 37.0.0
PING 198.168.25.30: 56 data bytes
64 bytes from tekral.nc.tekelec.com (198.168.25.30): icmp_seq=0. time=5. ms
64 bytes from tekral.nc.tekelec.com (198.168.25.30): icmp_seq=1. time=9. ms
64 bytes from tekral.nc.tekelec.com (198.168.25.30): icmp_seq=2. time=14. ms
----tekral PING Statistics----
3 packets transmitted, 3 packets received, 0% packet loss
round-trip (ms)  min/avg/max = 5/9/14

PING command complete

```

If you wish to change the other connection, repeat this procedure from 2.

If all the changes to the SEAS configuration have been made, continue the procedure with 9.

- Put the SEAS terminals into service using the `alw-trm` command with the number of the SEAS terminals shown in 6. This step should be performed for all the SEAS terminals that were taken out of service in 3.

```
alw-trm:trm=18
```

When this command has successfully completed, this message should appear.

```

rlghncxa03w 04-01-07 11:11:28 EST  EAGLE 31.3.0
Allow message sent to terminal

rlghncxa03w 04-01-07 11:11:28 EST  EAGLE 31.3.0
1062.0046      TERMINAL      18      Terminal Enabled

alw-trm:trm=27

```

When this command has successfully completed, this message should appear.

```
rlghncxa03w 04-01-07 11:11:28 EST EAGLE 31.3.0  
Allow message sent to terminal
```

```
rlghncxa03w 04-01-07 11:11:28 EST EAGLE 31.3.0  
1062.0046      TERMINAL      27      Terminal Enabled
```

10. Back up the new changes using the `chg-db:action=backup:dest=fixed` command.

These messages should appear, the active **Maintenance and Administration Subsystem Processor (MASP)** appears first.

```
BACKUP (FIXED) : MASP A - Backup starts on active MASP.  
BACKUP (FIXED) : MASP A - Backup on active MASP to fixed disk complete.  
BACKUP (FIXED) : MASP A - Backup starts on standby MASP.  
BACKUP (FIXED) : MASP A - Backup on standby MASP to fixed disk complete.
```

Figure 5-7 Changing the Existing SEAS Configuration

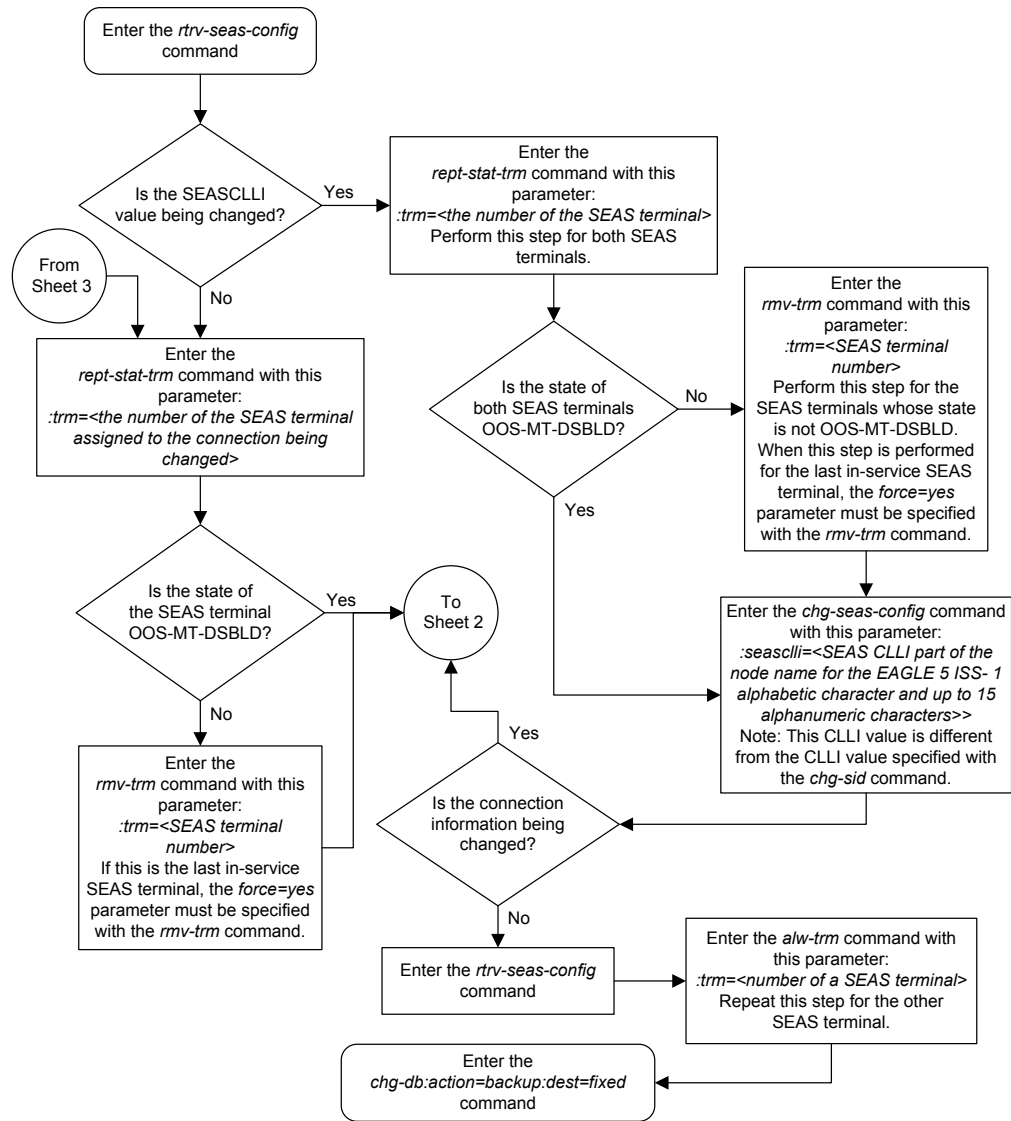

Sheet 1 of 3

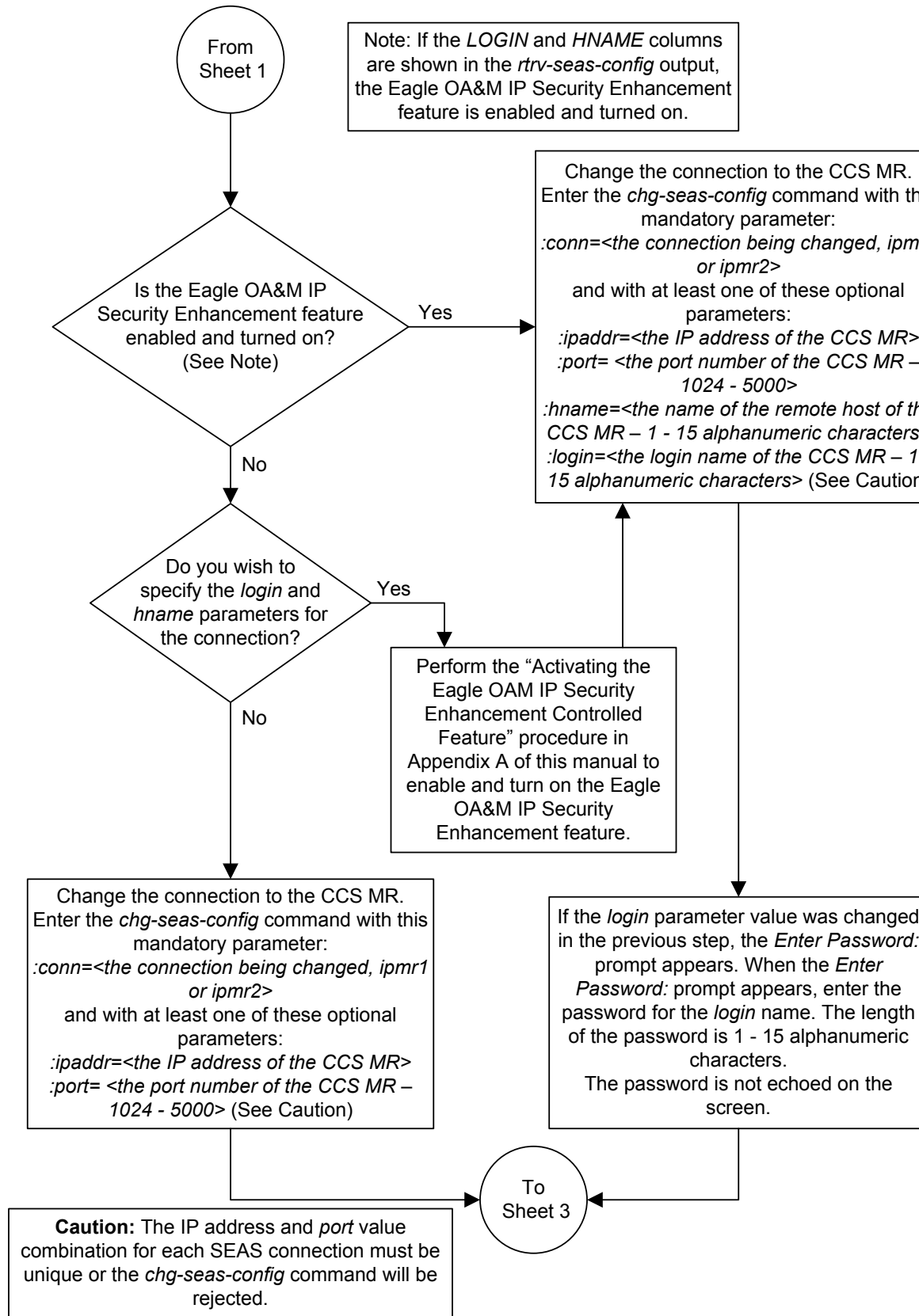

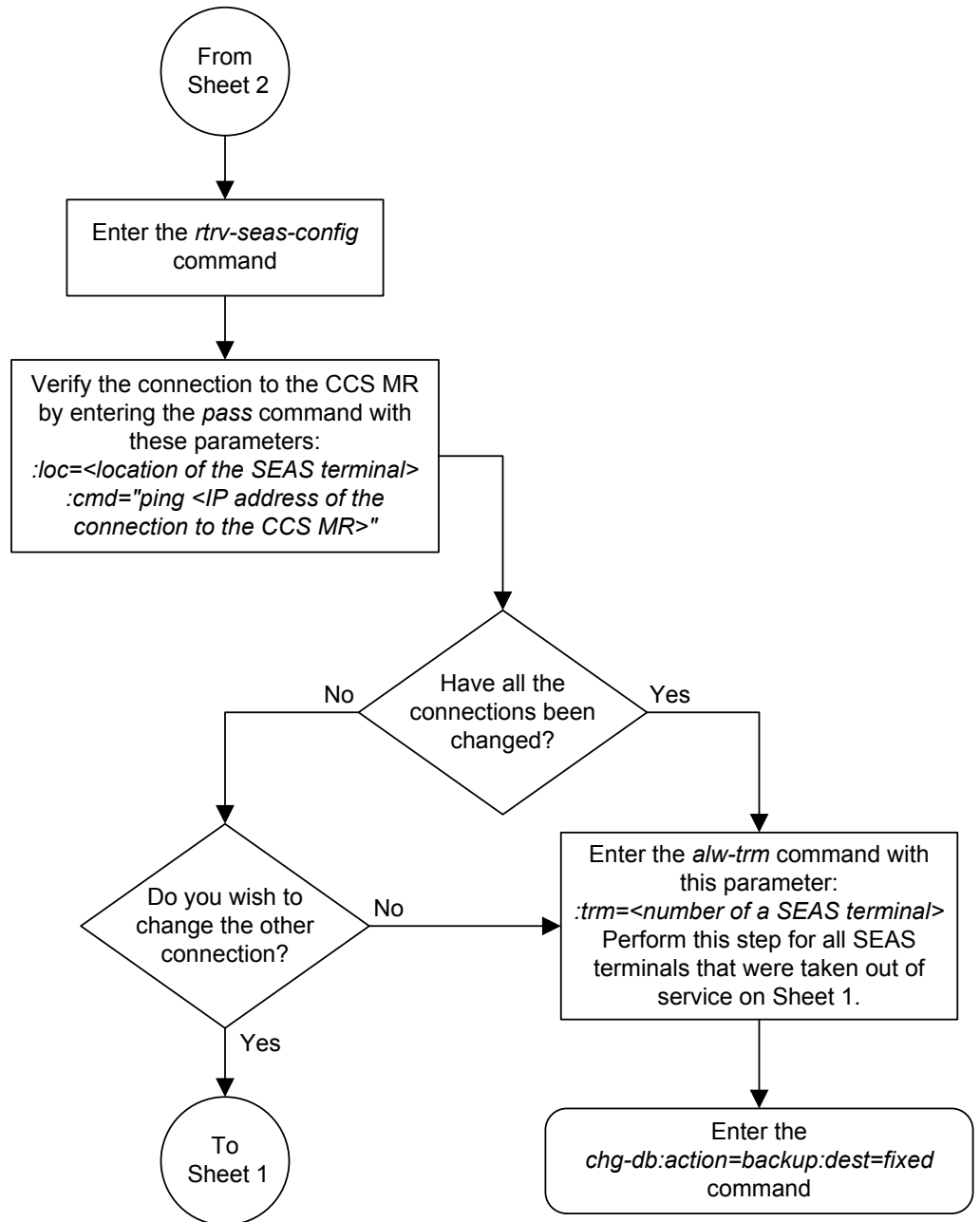

Turning Off the SEAS Over IP Feature

This procedure is used to turn off the SEAS over IP feature using the `chg-ctrl-feat` command.

The `chg-ctrl-feat` command uses the following parameters:

`:partnum` - The part number of the SEAS over IP feature, 893018801.

`:status=off` - used to turn off the SEAS over IP feature.

The status of the SEAS over IP feature must be on and is shown with the `rtrv-ctrl-feat` command.

Caution: If the SEAS over IP feature is turned off, all SEAS terminal traffic stops.

1. Display the status of the SEAS over IP feature by entering the `rtrv-ctrl-feat:partnum=893018801` command. The following is an example of the possible output.

The following is an example of the possible output.

```
rlghncxa03w 07-05-28 21:15:37 GMT EAGLE5 37.0.0
The following features have been permanently enabled:
```

Feature Name	Partnum	Status	Quantity
SEAS over IP	893018801	on	----

```
The following features have been temporarily enabled:
Feature Name      Partnum      Status  Quantity      Trial Period Left
Zero entries found.
```

```
The following features have expired temporary keys:
```

Feature Name	Partnum
Zero entries found.	

If the status of the SEAS over IP feature is off, or if the SEAS over IP feature is not enabled, this procedure cannot be performed.

2. Turn off the SEAS over IP feature by entering the `chg-ctrl-feat` command with the `status=off` parameter. Enter this command.

```
chg-ctrl-feat:partnum=893018801:status=off
```

When this command has successfully completed, the following message should appear.

```
rlghncxa03w 06-10-01 21:16:37 GMT EAGLE5 36.0.0
CHG-CTRL-FEAT: MASP A - COMPLTD
```

3. Verify that the SEAS over IP feature has been turned off by using the `rtrv-ctrl-feat:partnum=893018801` command. The following is an example of the possible output.

```
rlghncxa03w 07-05-28 21:15:37 GMT EAGLE5 37.0.0
```

The following features have been permanently enabled:

Feature Name	Partnum	Status	Quantity
SEAS over IP	893018801	off	----

The following features have been temporarily enabled:

Feature Name	Partnum	Status	Quantity	Trial Period Left
Zero entries found.				

The following features have expired temporary keys:

Feature Name	Partnum
Zero entries found.	

Note: Once the SEAS over IP feature is turned off, the SEAS terminals can be changed to TELNET terminals. If you do not wish to change the SEAS terminals to TELNET terminals, skip steps 4 through 6, and go to step 7.

4. Display the SEAS configuration by entering the `rtrv-seas-config` command.

The following is an example of the possible output if the Eagle OA&M IP Security Enhancement feature is not enabled and turned on.

```
rlghncxa03w 07-01-23 18:46:01 EST EAGLE 37.5.0
SEASCLLI      CONNECTION  IPADDRESS      PORT  TERMINAL
-----
TEAGLESTP001 IPMR1          192.168.25.10 2500  18
              IPMR2          192.168.25.20 2600  27
```

The following is an example of the possible output if the Eagle OA&M IP Security Enhancement feature is enabled and turned on.

```
tekelecstp 07-01-23 18:46:01 EST EAGLE 37.5.0
SEASCLLI      AUTHMODE
-----
TEAGLESTP001 Password

TERMINAL      CONNECTION  IPADDR      PORT  LOGIN  HNAME
-----
18            IPMR1      198.168.25.10 2500  root   abaco-a
27            IPMR2      198.168.25.20 2600  root   abaco-b
```

5. Change the terminal type of the terminals shown in step 4 to the TELNET terminal type using the `chg-trm` command with the number of the terminals shown in step 4.

For this example enter these commands.

```
chg-trm:trm=18:type=telnet
chg-trm:trm=27:type=telnet
```

When these commands have successfully completed, this message should appear.

```
rlghncxa03w 06-10-01 15:08:45 GMT EAGLE5 36.0.0
CHG-TRM: MASP A - COMPLTD
```

A warning message, "Invalidating the Terminal data in SEASCFG table", is also displayed.

- Verify the changes made in step 5 by using the `rtrv-trm` command with the terminal number specified in step 5.

For this example, enter these commands.

```
rtrv-trm:trm=18
```

This is an example of the possible output.

```
rlghncxa03w 06-10-01 16:02:08 GMT EAGLE5 36.0.0
TRM  TYPE      LOC          TMOUT MXINV DURAL      SECURE
18   TELNET     1201          30    5    00:01:00   yes

TRM  TRAF LINK SA  SYS PU  DB  UIMRD
18   NO   NO  NO  NO  NO  NO  NO  NO

      APP  APP
TRM  SERV SS  CARD CLK DBG GTT GWS MEAS MON MPS SEAS SLAN
18   NO   NO  NO   NO  NO  NO  NO  NO  NO  NO  YES  NO
```

```
rtrv-trm:trm=27
```

This is an example of the possible output.

```
rlghncxa03w 06-10-01 16:02:08 GMT EAGLE5 36.0.0
TRM  TYPE      LOC          TMOUT MXINV DURAL      SECURE
27   TELNET     1203          30    5    00:01:00   yes

TRM  TRAF LINK SA  SYS PU  DB  UIMRD
27   NO   NO  NO  NO  NO  NO  NO  NO

      APP  APP
TRM  SERV SS  CARD CLK DBG GTT GWS MEAS MON MPS SEAS SLAN
27   NO   NO  NO   NO  NO  NO  NO  NO  NO  NO  YES  NO
```

- Backup the new changes using the `chg-db:action=backup:dest=fixedcommand`.

These messages should appear, the active **Maintenance and Administration Subsystem Processor (MASP)** appears first.

```
BACKUP (FIXED) : MASP A - Backup starts on active MASP.
BACKUP (FIXED) : MASP A - Backup on active MASP to fixed disk complete.
BACKUP (FIXED) : MASP A - Backup starts on standby MASP.
BACKUP (FIXED) : MASP A - Backup on standby MASP to fixed disk complete.
```

Figure 5-8 Turning Off the SEAS Over IP Feature

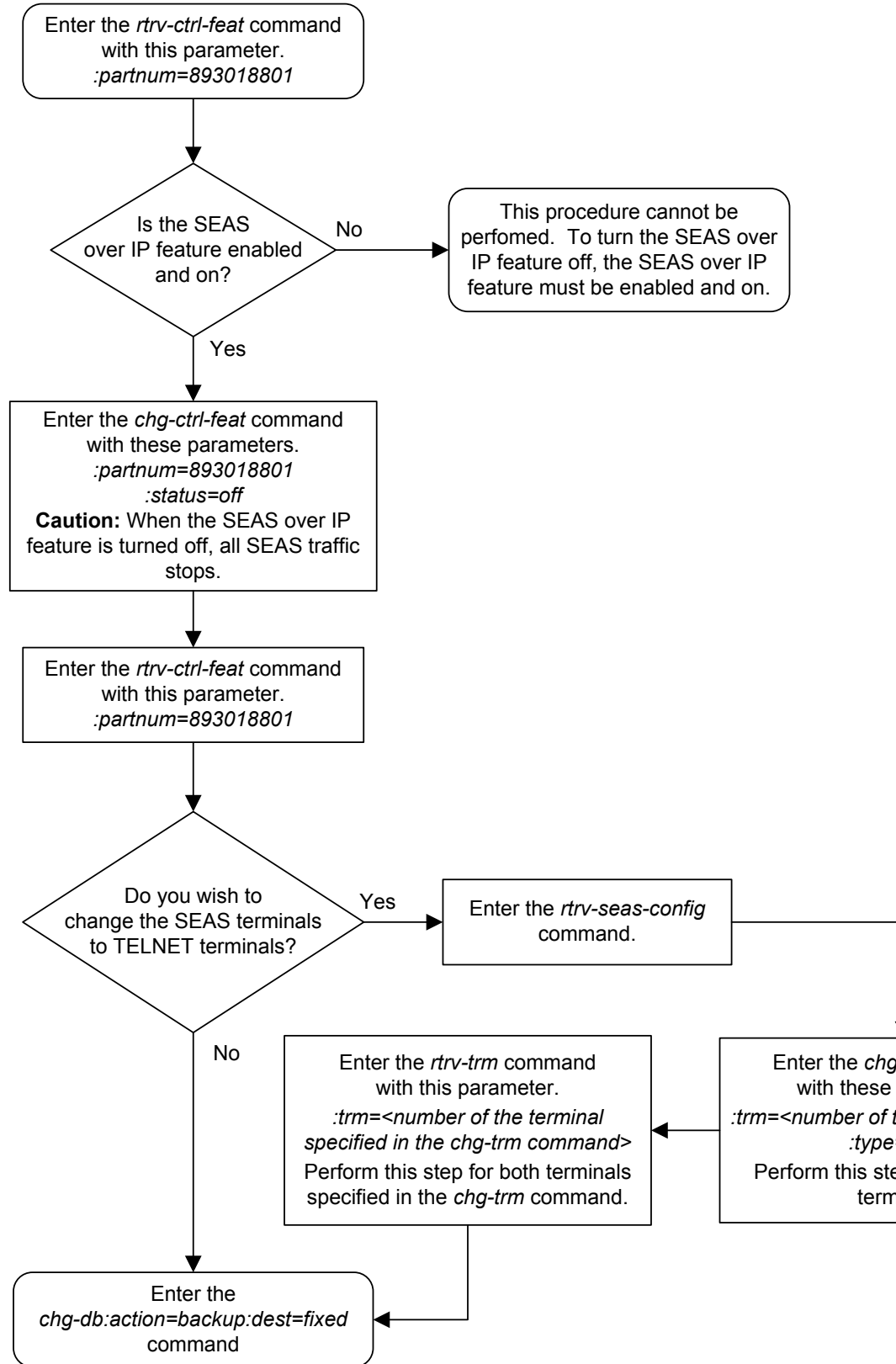

Controlled Feature Activation Procedures

Appendix A, Controlled Feature Activation Procedures, describes the procedures necessary to activate and deactivate features (features that require a feature access key to be activated) contained in this manual.

Introduction

Note: As of Release 46.3, the fak parameter is no longer required. This parameter is only used for backward compatibility.

Controlled features are features that are activated using a feature access key. These features can either be on or off, or features that operate at a particular performance level. Only the controlled features that are used in this manual are covered in this appendix.

The feature access key allows the user to enable and activate a controlled feature in the **EAGLE** by entering either a permanent feature access key or a temporary feature access key. By requiring a feature access key to enable and activate a controlled feature, unauthorized enabling and activation of a controlled feature can be prevented. The feature access key is supplied by Oracle.

Features enabled with a permanent feature access key remain enabled for as long as the **EAGLE** remains in service. Once features are permanently enabled, they cannot be disabled.

Features enabled with a temporary feature access key are enabled for only 30 days. On the twenty-third day, seven days before the temporary key expires, a major alarm (**UAM 0367**) is generated to inform the user that the one or more temporary feature access keys will expire soon.

```
0367.0181  ** SYSTEM      Temp Key(s) expiring soon.
```

If a temporary feature access key expires, the controlled feature is disabled and a critical alarm (**UAM 0368**) is generated.

```
0368.0181  *C SYSTEM      Temp Key(s) have expired.
```

Any attempts to enable the controlled feature with the temporary feature access key are rejected. The controlled feature can be enabled only by entering the permanent feature access key for the controlled feature.

To clear the critical alarm (**UAM 0368**), the user can either enter the `chg-ctrl-feat` command with the `alarm=clear` parameter, or permanently enable the controlled feature by entering the permanent feature access key for the controlled feature.

If the critical alarm is cleared with the `chg-ctrl-feat` command, the controlled feature is disabled and cannot be enabled with the temporary feature access key. The feature can be enabled only by entering the permanent feature access key for the controlled feature.

Activating Controlled Features

This procedure is used to enable and activate these controlled features, **Command Class Management**, **IP User Interface**, and **Network Security Enhancements**, using the feature's part number and a feature access key for each feature.

The feature access key is based on the feature's part number and the serial number of the **EAGLE**, making the feature access key site-specific.

The `enable-ctrl-feat` command enables the controlled feature by inputting the controlled feature's access key and the controlled feature's part number with these parameters:

`:fak` – The feature access key generated by the feature access key generator. The feature access key contains 13 alphanumeric characters and is not case sensitive.

`:partnum` – The Oracle-issued part number associated with the controlled feature. The part number is a 9-digit number, not including dashes. The first three digits must be 893 (that is, 893xxxxxx, where x is a numeric value).

If the controlled feature is being enabled with a temporary feature access key, the feature must not be in the *in-use*, *expired*, or *unavailable* state.

The `enable-ctrl-feat` command requires that the database contain a valid serial number for the **EAGLE**, and that this serial number is locked. This can be verified with the `rtrv-serial-num` command. The **EAGLE** is shipped with a serial number in the database, but the serial number is not locked. The serial number can be changed, if necessary, and locked once the **EAGLE** is on-site, with the `ent-serial-num` command. The `ent-serial-num` command uses these parameters.

`:serial` – The serial number assigned to the **EAGLE**. The serial number is not case sensitive.

`:lock` – Specifies whether or not the serial number is locked. This parameter has only one value, *yes*, which locks the serial number. Once the serial number is locked, it cannot be changed.

Note: To enter and lock the **EAGLE**'s serial number, the `ent-serial-num` command must be entered twice, once to add the correct serial number to the database with the `serial` parameter, then again with the `serial` and the `lock=yes` parameters to lock the serial number. You should verify that the serial number in the database is correct before locking the serial number. The serial number can be found on a label affixed to the control shelf (shelf 1100).

Once the controlled feature has been enabled, the controlled feature must be activated with the `chg-ctrl-feat` command. The `chg-ctrl-feat` command uses these parameters:

`:partnum` – The Oracle-issued part number associated with the controlled feature. The part number is a 9-digit number, not including dashes. The first three digits must be 893 (that is, 893xxxxxx, where x is a numeric value).

`:status=on` – used to activate the controlled features that customer has purchased and enabled.

The status of the controlled features in the **EAGLE** is shown with the `rtrv-ctrl-feat` command.

The part numbers for the **Command Class Management**, **IP User Interface**, and **Network Security Enhancements** features are:

- Command Class Management – 893005801
- Telnet (**IP User Interface**) – 893005701
- Network Security Enhancements – 893009101

1. Display the status of the controlled features by entering the `rtrv-ctrl-feat` command.

The following is an example of the possible output.

```
rlghncxa03w 06-10-01 21:15:37 GMT EAGLE5 36.0.0
The following features have been permanently enabled:
```

Feature Name	Partnum	Status	Quantity
Command Class Management	893005801	off	----
LNP Short Message Service	893006601	on	----
Intermed GTT Load Sharing	893006901	off	----
XGTT Table Expansion	893006101	off	----
XMAP Table Expansion	893007710	on	3000
Large System # Links	893005910	on	2000
Routesets	893006401	on	6000

The following features have been temporarily enabled:

Feature Name	Partnum	Status	Quantity	Trial Period Left
Zero entries found.				

The following features have expired temporary keys:

Feature Name	Partnum
Zero entries found.	

If the `rtrv-ctrl-feat` output shows that the controlled feature is permanently enabled, and its status is `on`, no further action is necessary.

If the controlled feature is permanently enabled, and its status is `off`, skip steps 2 through 4, and go to step 5.

If the controlled feature is temporarily enabled, and you wish to permanently enable this feature, or the temporary feature access key for that feature has expired, skip steps 2 and 3, and go to step 4.

If the controlled feature is to remain temporarily enabled, and its status is `off`, skip steps 2 through 4, and go to step 5. If the feature's status is `on`, no further action is necessary.

If the controlled feature is to remain temporarily enabled, and its status is `on`, no further action is necessary.

Note: If the `rtrv-ctrl-feat` output in step 1 shows any controlled features, skip steps 2 and 3, and go to step 4. If the `rtrv-ctrl-feat` output shows only the **HC-MIMSLK Capacity** feature with a quantity of 64, steps 2 and 3 must be performed.

2. Display the serial number in the database with the `rtrv-serial-num` command.

This is an example of the possible output.

```
rlghncxa03w 06-10-01 21:15:37 GMT EAGLE5 36.0.0
System serial number = ntxxxxxxxxxxxxxxx
```

System serial number is not locked.

```
rlghncxa03w 06-10-01 21:15:37 GMT EAGLE5 36.0.0
Command Completed
```

Note: If the serial number is correct and locked, skip steps 3, 4, and 5, and go to step 6. If the serial number is correct but not locked, skip steps 3 and 4, and go to step 5. If the serial number is not correct, but is locked, this feature cannot be enabled and the remainder of this procedure cannot be performed. Contact the Customer Care Center to get an incorrect and locked serial number changed. Refer to [My Oracle Support \(MOS\)](#) for the contact information. The serial number can be found on a label affixed to the control shelf (shelf 1100).

3. Enter the correct serial number into the database using the `ent-serial-num` command with the `serial` parameter.

For this example, enter this command.

```
ent-serial-num:serial=<EAGLE's correct serial number>
```

When this command has successfully completed, the following message should appear.

```
rlghncxa03w 06-10-01 21:15:37 GMT EAGLE5 36.0.0
ENT-SERIAL-NUM: MASP A - COMPLTD
```

4. Verify that the serial number entered into step 3 was entered correctly using the `rtrv-serial-num` command.

This is an example of the possible output.

```
rlghncxa03w 06-10-01 21:15:37 GMT EAGLE5 36.0.0
System serial number = nt00001231
```

System serial number is not locked.

```
rlghncxa03w 06-10-01 21:15:37 GMT EAGLE5 36.0.0
Command Completed
```

If the serial number was not entered correctly, repeat steps 3 and 4 and re-enter the correct serial number.

5. Lock the serial number in the database by entering the `ent-serial-num` command with the serial number shown in step 2, if the serial number shown in step 2 is correct, or with the serial number shown in step 4, if the serial number was changed in step 3, and with the `lock=yes` parameter.

For this example, enter this command.

```
ent-serial-num:serial=<EAGLE's serial number>;lock=yes
```

When this command has successfully completed, the following message should appear.

```
rlghncxa03w 06-10-01 21:15:37 GMT EAGLE5 36.0.0
ENT-SERIAL-NUM: MASP A - COMPLTD
```

6. Enable the controlled feature with either a permanent key or temporary key by entering the `enable-ctrl-feat` command.

For this example, enter these commands.

```
enable-ctrl-feat:partnum=893005801:fak=xxxxxxxxxxxxxxxx
enable-ctrl-feat:partnum=893005701:fak=xxxxxxxxxxxxxxxx
enable-ctrl-feat:partnum=893009101:fak=xxxxxxxxxxxxxxxx
```

Note:

The values for the feature access key (the `fak` parameter) are provided by Oracle. The feature access key determines if the controlled feature is permanently or temporarily enabled. If you do not have the controlled feature part number or the feature access key for the feature you wish to enable, contact your Oracle Sales Representative or Account Representative.

When the `enable-ctrl-feat` command has successfully completed, this message should appear.

```
rlghncxa03w 06-10-01 21:15:37 GMT EAGLE5 36.0.0
ENABLE-CTRL-FEAT: MASP B - COMPLTD
```

Note: If a temporarily enabled feature was permanently enabled in step 4, and the status of the temporarily enabled feature was on, skip step 5 and go to step 6.

7. The controlled features enabled in step 4 must be activated using the `chg-ctrl-feat` command, specifying the controlled feature part number used in step 4 and the `status=on` parameter.

For this example, enter these commands.

```
chg-ctrl-feat:partnum=893005801:status=on
chg-ctrl-feat:partnum=893005701:status=on
chg-ctrl-feat:partnum=893009101:status=on
```

When the **chg-ctrl-feat** command has successfully completed, the following message should appear.

```
rlghncxa03w 06-10-01 21:15:37 GMT EAGLE5 36.0.0
CHG-CTRL-FEAT: MASP B - COMPLTD
```

8. Verify the changes by entering the `rtrv-ctrl-feat` command with the part number specified in step 5.

```
rtrv-ctrl-feat:partnum=893005801
```

The following is an example of the possible output.

```
rlghncxa03w 06-10-01 21:16:37 GMT EAGLE5 36.0.0
The following features have been permanently enabled:
Feature Name          Partnum    Status  Quantity
Command Class Management  893005801  on      ----
```

```
rtrv-ctrl-feat:partnum=893005701
```

The following is an example of the possible output.

```
rlghncxa03w 06-10-01 21:16:37 GMT EAGLE5 36.0.0
The following features have been permanently enabled:
Feature Name          Partnum    Status  Quantity
Telnet                893005701  on      ----
```

```
rtrv-ctrl-feat:partnum=893009101
```

The following is an example of the possible output.

```
rlghncxa03w 06-10-01 21:16:37 GMT EAGLE5 36.0.0
The following features have been permanently enabled:
Feature Name          Partnum    Status  Quantity
Network Security Enhance 893009101  on      ----
```

9. Backup the new changes using the `chg-db:action=backup:dest=fixed` command.

These messages should appear, the active **Maintenance and Administration Subsystem Processor (MASP)** appears first.

```
BACKUP (FIXED) : MASP A - Backup starts on active MASP.
BACKUP (FIXED) : MASP A - Backup on active MASP to fixed disk complete.
BACKUP (FIXED) : MASP A - Backup starts on standby MASP.
BACKUP (FIXED) : MASP A - Backup on standby MASP to fixed disk complete.
```

Figure A-1 Activating Controlled Features

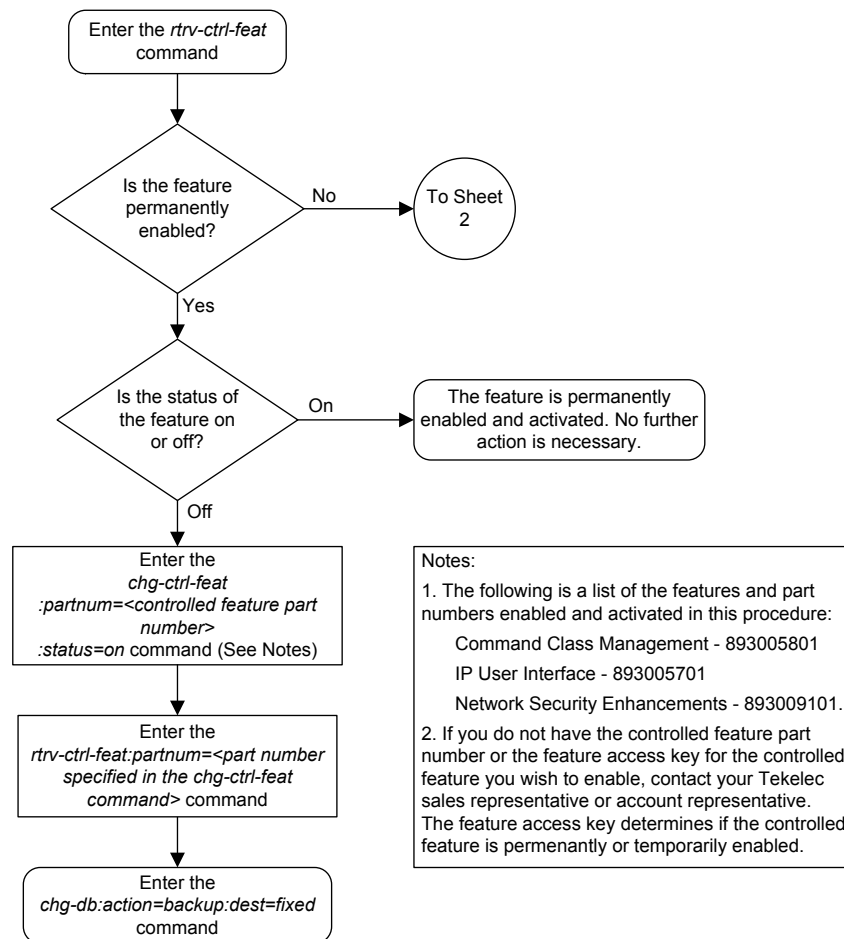

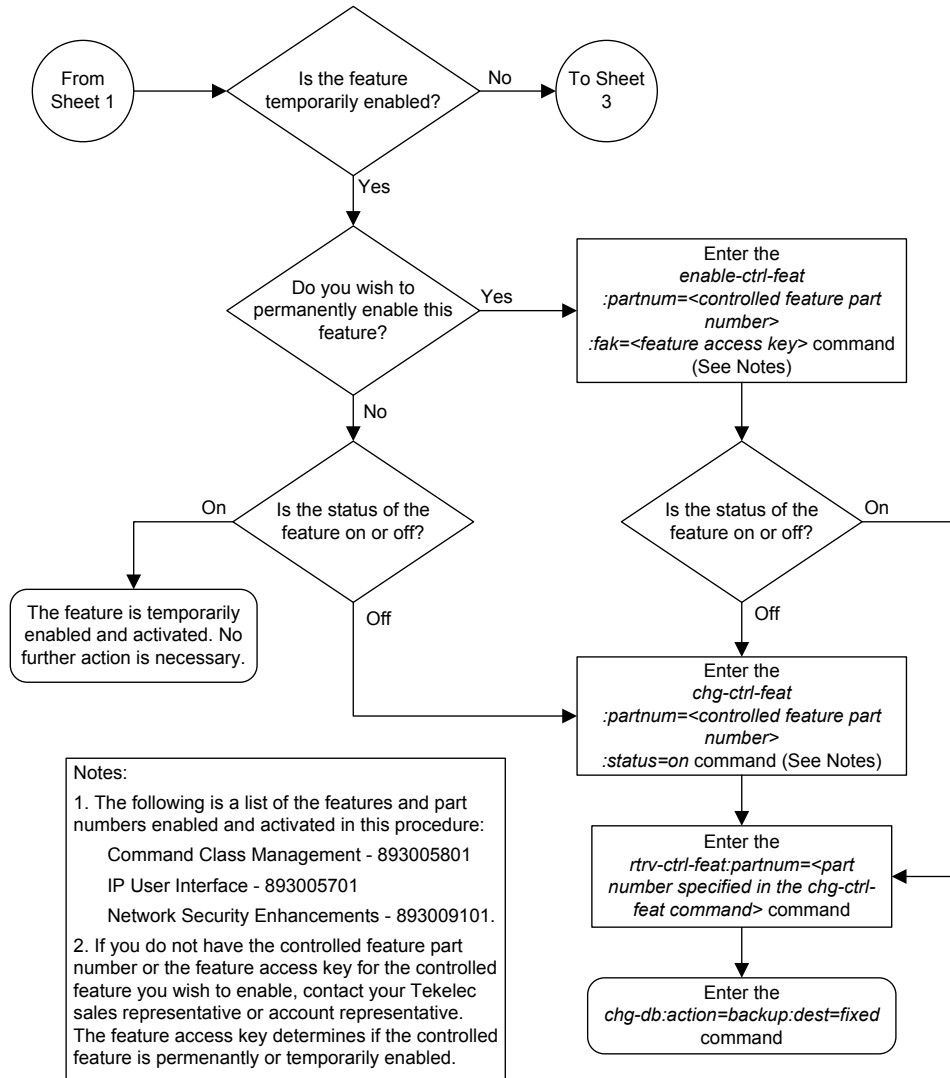

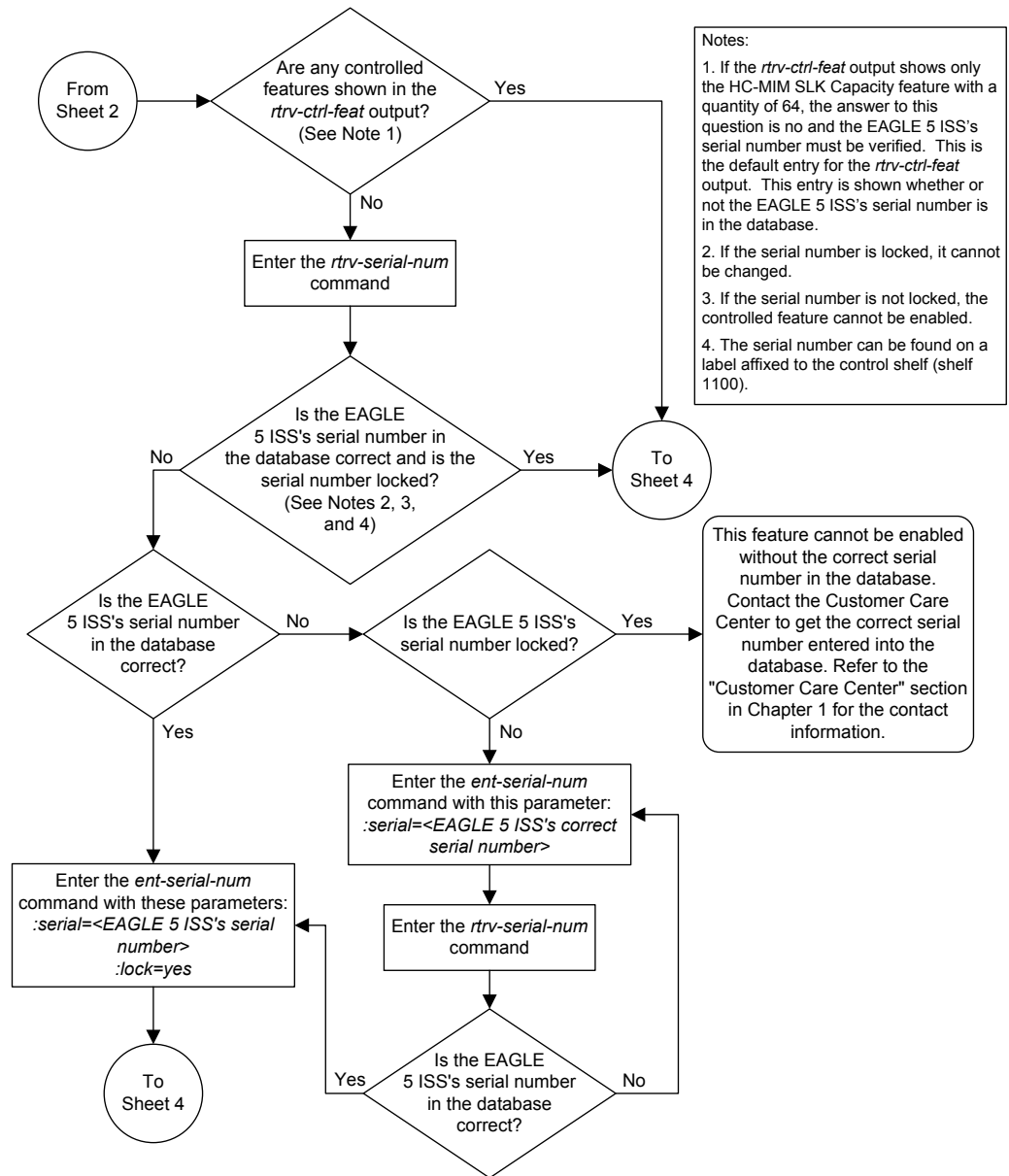

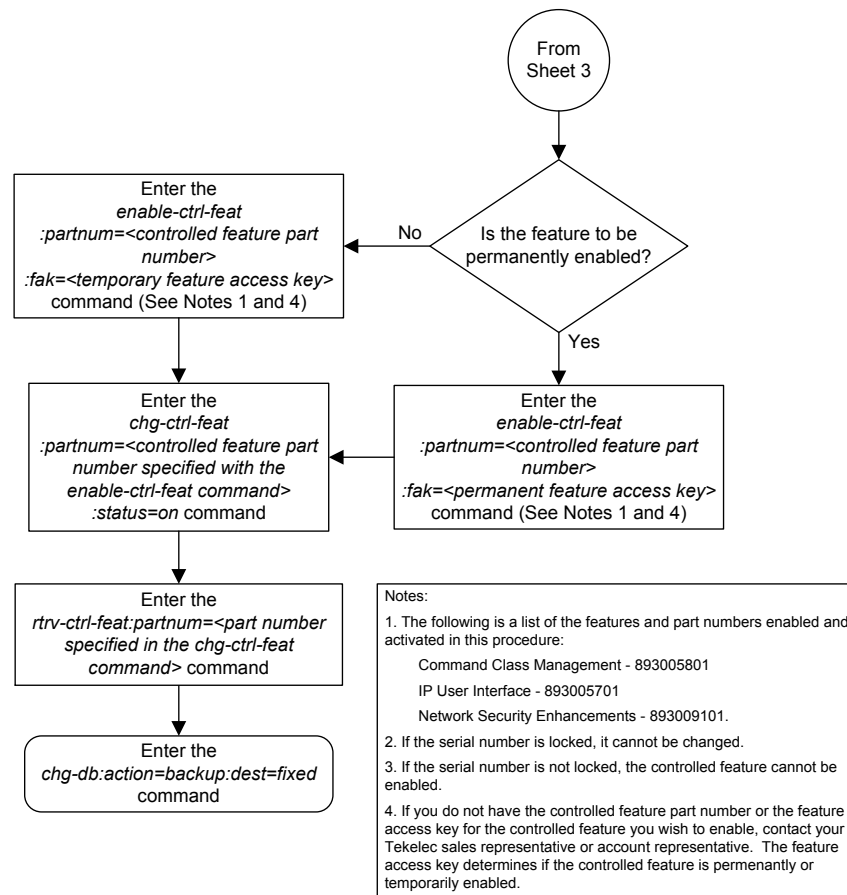

Sheet 4 of 4

Activating the EAGLE OA&M IP Security Enhancement Controlled Feature

This procedure is used to enable and activate the EAGLE OAM IP Security Enhancement Controlled Feature, using the feature's part number and a feature access key.

For Release 46.5 and later, the EAGLE OA&M IP Security feature is enabled by default and the feature entry is used to control only the alarming if the SSH for terminals or Security of FTP Server entries is OFF. SSH for terminals and Security of FTP Server entries are controlled via the SECU-DFLT: SSH parameter and SECUIRITY parameter against the FTP servers entries, respectively. The following is expected after upgrade to release 46.5 or later from release 46.4 or earlier:

1. If the OA&M IP Security feature is currently (R46.4 or earlier) OFF, then it will remain OFF after the upgrade to R46.5.
2. If the OA&M IP Security feature is currently (R46.4 or earlier) ON, and all the FTP Servers have Security ON and the Telnet terminals are using SSH, then it will remain ON after the upgrade to R46.5.
3. If the OA&M IP Security feature is currently (R46.4 or earlier) ON, and there was 1 or more FTP Servers or Telnet terminals not using SSH, then it will be turned OFF after upgrade to R46.5, so that no new alarms will be generated after the upgrade.
4. If the OA&M IP Security feature is currently (R46.4 or earlier) OFF and SECU-DFLT-SSH parameter is ON, then the SECU-DFLT-SSH parameter will be turned OFF after the upgrade to R46.5, so that the access protocol used will not be changed after the upgrade.
5. If the OA&M IP Security feature is currently (R46.4 or earlier) OFF and the SECURITY parameter is ON for the FTP server entry in the FTP server table, then the SECURITY parameter for the FTP server entry (except for the SFLOG FTP server entry) will be turned OFF after the upgrade to R46.5, so that the file transfer protocol used will not be changed after the upgrade.

With SSH for terminals ON, a secure shell connection is established between the **EAGLE** and the telnet terminals allowing passwords to be sent over the connection. This allows the **EAGLE** administrator to add new users to the **EAGLE** (with the `ent-user` command) and to change the passwords of existing users (with the `pid` parameter of the `chg-user` command) from a telnet terminal.

If the SSH for terminals is ON, the **FTRA** must be configured to support secure connections to the **EAGLE**. Go to **FTP Table Base Retrieval User's Guide**, for more information on using secure connections with the **FTRA**.

If Security of meas FTP Server entry is ON, the Measurements Platform must support secure **FTP** servers. Go to the [Adding an FTP Server](#) procedure for more information on configuring secure **FTP** servers for the Measurements Platform.

Similarly, if Security of FTP Server entry for any specific application (dist, db, user) is ON, the designated FTP server for the application must support secure FTP protocol.

Caution:

If EAGLE **OA&M IP Security Enhancements** feature is activated with a temporary feature access key and that key expires, secure shell connections will become non-secure. Passwords can be transmitted on a non-secure connection, but cannot be assigned or changed. The `ent-user` command and `pid` parameter of the `chg-user` command cannot be used. File transfers using secure **FTP** cannot be performed unless non-secure **FTP** servers are available. It is recommended that the **FTRA** and the Measurements Platform is configured with secure and non-secure **FTP** servers.

To enable and activate this feature, the `enable-ctrl-feat`, `ent-serial-num`, and `chg-ctrl-feat` commands are used. For more information on these commands, go to the [Activating Controlled Features](#) procedure, or *Commands User's Guide*.

1. Display the status of the controlled features by entering the `rtrv-ctrl-feat` command.

The following is an example of the possible output.

```
rlghncxa03w 06-10-01 21:15:37 GMT EAGLE5 36.0.0
The following features have been permanently enabled:
```

Feature Name	Partnum	Status	Quantity
Command Class Management	893005801	off	----
LNP Short Message Service	893006601	on	----
Intermed GTT Load Sharing	893006901	off	----
XGTT Table Expansion	893006101	off	----
XMAP Table Expansion	893007710	on	3000
Large System # Links	893005910	on	2000
Routesets	893006401	on	6000

The following features have been temporarily enabled:

Feature Name	Partnum	Status	Quantity	Trial Period Left
Zero entries found.				

The following features have expired temporary keys:

Feature Name	Partnum
Zero entries found.	

If the `rtrv-ctrl-feat` output shows that the controlled feature is permanently enabled, and its status is `on`, no further action is necessary.

If the controlled feature is permanently enabled, and its status is `off`, skip steps 2 through 6, and go to step 7.

If the controlled feature is temporarily enabled, and you wish to permanently enable this feature, or the temporary feature access key for that feature has expired, skip steps 2 through 5, and go to step 6.

If the controlled feature is to remain temporarily enabled, and its status is `off`, skip steps 2 through 6, and go to step 7. If the feature's status is `on`, no further action is necessary. If the controlled feature is to remain temporarily enabled, and its status is `on`, no further action is necessary.

Note: If the `rtrv-ctrl-feat` output in step 1 shows any controlled features, skip steps 2 through 5, and go to step 6. If the `rtrv-ctrl-feat` output shows only the **HC-MIMSLK** Capacity feature with a quantity of 64, steps 2 through 5 must be performed.

2. Display the serial number in the database with the `rtrv-serial-num` command.

This is an example of the possible output.

```
rlghncxa03w 06-10-01 21:15:37 GMT EAGLE5 36.0.0
System serial number = ntxxxxxxxxxxxxxx
```

System serial number is not locked.

```
rlghncxa03w 06-10-01 21:15:37 GMT EAGLE5 36.0.0
Command Completed
```

Note:

If the serial number is correct and locked, skip steps 3, 4, and 5, and go to step 6. If the serial number is correct but not locked, skip steps 3 and 4, and go to step 5. If the serial number is not correct, but is locked, this feature cannot be enabled and the remainder of this procedure cannot be performed. Contact the Customer Care Center to get an incorrect and locked serial number changed. Refer to [My Oracle Support \(MOS\)](#) for the contact information. The serial number can be found on a label affixed to the control shelf (shelf 1100).

3. Enter the correct serial number into the database using the `ent-serial-num` command with the `serial` parameter.

For this example, enter this command.

```
ent-serial-num:serial=<EAGLE's correct serial number>
```

When this command has successfully completed, the following message should appear.

```
rlghncxa03w 06-10-01 21:15:37 GMT EAGLE5 36.0.0
ENT-SERIAL-NUM: MASP A - COMPLTD
```

4. Verify that the serial number entered into step 3 was entered correctly using the `rtrv-serial-num` command.

This is an example of the possible output.

```
rlghncxa03w 06-10-01 21:15:37 GMT EAGLE5 36.0.0
System serial number = nt00001231
```

System serial number is not locked.

```
rlghncxa03w 06-10-01 21:15:37 GMT EAGLE5 36.0.0
Command Completed
```

If the serial number was not entered correctly, repeat steps 3 and 4 and re-enter the correct serial number.

5. Lock the serial number in the database by entering the `ent-serial-num` command with the serial number shown in step 2, if the serial number shown in step 2 is correct, or with the serial number shown in step 4, if the serial number was changed in step 3, and with the `lock=yes` parameter.

For this example, enter this command.

```
ent-serial-num:serial=<EAGLE's serial number>:lock=yes
```

When this command has successfully completed, the following message should appear.

```
rlghncxa03w 06-10-01 21:15:37 GMT EAGLE5 36.0.0
ENT-SERIAL-NUM: MASP A - COMPLTD
```

6. Enable the controlled feature with either a permanent key or temporary key by entering the `enable-ctrl-feat` command.

For this example, enter this command.

```
enable-ctrl-feat:partnum=893400001:fak=<feature access key>
```

Note: The values for the feature access key (the `fak` parameter) are provided by Oracle. If you do not have the feature access key for the SEAS over IP feature, contact your Oracle Sales Representative or Account Representative.

When the `enable-ctrl-feat` command has successfully completed, this message should appear.

```
rlghncxa03w 06-10-01 21:15:37 GMT EAGLE5 36.0.0
ENABLE-CTRL-FEAT: MASP B - COMPLTD
```

Note: If the feature was temporarily enabled before being permanently enabled in step 6, and the status of the temporarily enabled feature was on, skip steps 7 through 12, and go to step 13.

7. Before the status of the EAGLE OAMIP Security Enhancements controlled feature can be changed to on, all ISPMs, if present, must be taken out of service.

Before the ISPMs can be taken out of service, all telnet terminals associated with the IPSMs must be taken out of service. Enter the `rtrv-trm` command to display the terminals in the database. The following is an example of the possible output.

```
rlghncxa03w 06-10-01 16:02:08 GMT EAGLE5 39.0.0
TRM  TYPE      COMM          FC    TMOUT MXINV  DURAL
1    VT320      9600-7-E-1   SW    30    5     99:59:59
2    KSR        9600-7-E-1   HW    30    5     INDEF
3    PRINTER    4800-7-E-1   HW    30    0     00:00:00
4    VT320      2400-7-E-1   BOTH  30    5     00:30:00
5    VT320      9600-7-O-1   NONE  30    5     00:00:30
6    VT320      9600-7-E-2   SW    30    9     INDEF
7    PRINTER    9600-7-N-2   HW    30    5     00:30:00
8    KSR        19200-7-E-2  BOTH  30    5     00:30:00
9    VT320      9600-7-E-1   SW    30    7     00:30:00
10   VT320      9600-7-E-1   HW    30    5     00:30:00
11   VT320      4800-7-E-1   HW    30    5     00:30:00
12   PRINTER    9600-7-E-1   HW    30    4     00:30:00
13   VT320      9600-7-O-1   NONE  30    5     00:30:00
14   VT320      9600-7-E-2   SW    30    8     00:30:00
15   VT320      9600-7-N-2   HW    30    5     00:30:00
16   VT320      9600-7-E-2   BOTH  30    3     00:30:00
```

```
TRM  TYPE      LOC          TMOUT MXINV  DURAL      SECURE
17   TELNET     2107         60    5     00:30:00
18   TELNET     2107         60    5     00:30:00
19   TELNET     2107         60    5     00:30:00
20   TELNET     2107         60    5     00:30:00
```

21	TELNET	2107	60	5	00:30:00
22	TELNET	2107	60	5	00:30:00
23	TELNET	2107	60	5	00:30:00
24	TELNET	2107	60	5	00:30:00
25	TELNET	2108	60	5	00:30:00
26	TELNET	2108	60	5	00:30:00
27	TELNET	2108	60	5	00:30:00
28	TELNET	2108	60	5	00:30:00
29	TELNET	2108	60	5	00:30:00
30	TELNET	2108	60	5	00:30:00
31	TELNET	2108	60	5	00:30:00
32	TELNET	2108	60	5	00:30:00
33	TELNET	2111	60	5	00:30:00
34	TELNET	2111	60	5	00:30:00
35	TELNET	2111	60	5	00:30:00
36	TELNET	2111	60	5	00:30:00
37	TELNET	2111	60	5	00:30:00
38	TELNET	2111	60	5	00:30:00
39	TELNET	2111	60	5	00:30:00
40	TELNET	2111	60	5	00:30:00

TRM	LOGINTMR (sec)	LOGOUTTMR (sec)	PNGTIMEINT (msec)	PNGFAILCNT
17	none	none	none	1
18	none	none	none	1
19	none	none	none	1
20	none	none	none	1
21	none	none	none	1
22	none	none	none	1
23	none	none	none	1
24	none	none	none	1
25	none	none	none	1
26	none	none	none	1
27	none	none	none	1
28	none	none	none	1
28	none	none	none	1
30	none	none	none	1
31	none	none	none	1
32	none	none	none	1
33	none	none	none	1
34	none	none	none	1
35	none	none	none	1
36	none	none	none	1
37	none	none	none	1
38	none	none	none	1
39	none	none	none	1
40	none	none	none	1

TRM	TRAF	LINK	SA	SYS	PU	DB	UIMRD
1	NO	YES	NO	YES	NO	YES	YES
2	NO	NO	NO	NO	NO	NO	NO
.
39	NO	NO	NO	NO	NO	NO	NO
40	NO	NO	NO	NO	NO	NO	NO

TRM	SERV	SS	CARD	CLK	DBG	GTT	GWS	MEAS	MON	MPS	SEAS	SLAN
1	YES	YES	YES	YES	YES	YES	YES	YES	YES	YES	NO	NO
2	YES	YES	YES	YES	YES	YES	YES	YES	YES	YES	NO	NO

```

.
.
.
39 NO NO NO NO NO NO NO NO NO NO NO NO NO
40 NO NO NO NO NO NO NO NO NO NO NO NO NO

```

Note: If the `rtrv-trm` output in step 7 shows no telnet terminals, skip steps 8 through 11, and go to step 12.

8. Display the status of the **IPSMs** by entering the `rept-stat-card` command with the card location of each **IPSM** shown in the output of step 7.

```
rept-stat-card:loc=2107
```

This is an example of the possible output.

```

rlghncxa03w 06-10-01 16:43:42 GMT EAGLE5 36.0.0
CARD  VERSION  TYPE      GPL      PST      SST      AST
2107  114-001-000 IPSM      IPS      IS-NR    Active   -----

ALARM STATUS      = No Alarms.
BPDCM GPL         = 002-122-000
IMT BUS A        = Conn
IMT BUS B        = Conn
Command Completed.

```

```
rept-stat-card:loc=2108
```

This is an example of the possible output.

```

rlghncxa03w 06-10-01 16:43:42 GMT EAGLE5 36.0.0
CARD  VERSION  TYPE      GPL      PST      SST      AST
2108  114-001-000 IPSM      IPS      IS-NR    Active   -----

ALARM STATUS      = No Alarms.
BPDCM GPL         = 002-122-000
IMT BUS A        = Conn
IMT BUS B        = Conn
Command Completed.

```

```
rept-stat-card:loc=2111
```

This is an example of the possible output.

```

rlghncxa03w 06-10-01 16:43:42 GMT EAGLE5 36.0.0
CARD  VERSION  TYPE      GPL      PST      SST      AST
2111  114-001-000 IPSM      IPS      IS-NR    Active   -----

ALARM STATUS      = No Alarms.
BPDCM GPL         = 002-122-000
IMT BUS A        = Conn
IMT BUS B        = Conn
Command Completed.

```

If all the **IPSMs** are out of service, shown by the entry `OOS-MT-DSBLD` in the `PST` column, skip steps 9 and 10, and go to step 11.

9. Display the status of the terminals by entering the `rept-stat-trm` command.

This is an example of the possible output.

```
rlghncxa03w 06-10-01 15:08:45 GMT EAGLE5 36.0.0
TRM  PST          SST          AST
1    IS-NR        Active      -----
2    IS-NR        Active      -----
3    IS-NR        Active      -----
4    IS-NR        Active      -----
5    IS-NR        Active      -----
6    IS-NR        Active      -----
7    IS-NR        Active      -----
8    IS-NR        Active      -----
9    IS-NR        Active      -----
10   IS-NR        Active      -----
11   IS-NR        Active      -----
12   IS-NR        Active      -----
13   IS-NR        Active      -----
14   IS-NR        Active      -----
15   IS-NR        Active      -----
16   IS-NR        Active      -----
17   IS-NR        Active      -----
18   IS-NR        Active      -----
19   IS-NR        Active      -----
20   IS-NR        Active      -----
21   IS-NR        Active      -----
22   IS-NR        Active      -----
23   IS-NR        Active      -----
24   IS-NR        Active      -----
25   IS-NR        Active      -----
26   IS-NR        Active      -----
27   IS-NR        Active      -----
28   IS-NR        Active      -----
29   IS-NR        Active      -----
30   IS-NR        Active      -----
31   IS-NR        Active      -----
32   IS-NR        Active      -----
33   IS-NR        Active      -----
34   IS-NR        Active      -----
35   IS-NR        Active      -----
36   IS-NR        Active      -----
37   IS-NR        Active      -----
38   IS-NR        Active      -----
39   IS-NR        Active      -----
40   IS-NR        Active      -----
```

Command Completed.

Note:

If all the terminals associated with the **IPSMs** being taken out of service are out of service, shown by the entry OOS-MT-DSBLD in the PST column, skip step 10 and go to step 11.

- 10.** Place the terminals associated with the **IPSMs** being taken out of service using the `rmv-trm` command with the terminal number shown in step 7.

For this example, enter these commands.

```
rmv-trm:trm=17
```

```
rmv-trm:trm=18
rmv-trm:trm=19
rmv-trm:trm=20
rmv-trm:trm=21
rmv-trm:trm=22
rmv-trm:trm=23
rmv-trm:trm=24
rmv-trm:trm=25
rmv-trm:trm=26
rmv-trm:trm=27
rmv-trm:trm=28
rmv-trm:trm=29
rmv-trm:trm=30
rmv-trm:trm=31
rmv-trm:trm=32
rmv-trm:trm=33
rmv-trm:trm=34
rmv-trm:trm=35
rmv-trm:trm=36
rmv-trm:trm=37
rmv-trm:trm=38
rmv-trm:trm=39
rmv-trm:trm=40
```

Caution:

Placing these terminals out of service will disable any Telnet sessions running on these terminals.

If the status of any terminals associated with the **IPSM** being removed shown in the **PST** field in step 9 is **OOS-MT-DSBLD** (out-of-service maintenance disabled), the terminal is already out of service and the **rmv-trm** command does not need to be executed for that terminal.

When these commands have successfully completed, this message should appear.

```
rlghncxa03w 06-10-01 15:08:45 GMT EAGLE5 36.0.0
Inhibit message sent to terminal
```

```
rlghncxa03w 06-10-01 15:08:45 GMT EAGLE5 36.0.0
Command Completed.
```

11. Place the **IPSMs** out of service using the `rmv-card` command, specifying the card location of the IPSM.

For this example, enter this command.

```
rmv-card:loc=2107
```

```
rmv-card:loc=2108
```

```
rmv-card:loc=2111
```

When this command has successfully completed, this message should appear.

```
rlghncxa03w 06-10-01 09:12:36 GMT EAGLE5 36.0.0
Card has been inhibited.
```

12. The controlled feature enabled in step 6 must be activated using the `chg-ctrl-feat` command, specifying the controlled feature part number used in step 6 and the `status=on` parameter.

For this example, enter this command.

```
chg-ctrl-feat:partnum=893400001:status=on
```

When the `chg-ctrl-feat` command has successfully completed, the following message should appear.

```
rlghncxa03w 06-10-01 21:15:37 GMT EAGLE5 36.0.0
CHG-CTRL-FEAT: MASP B - COMPLTD
```

13. Verify the changes by entering the `rtrv-ctrl-feat` command with the part number specified in step 12.

```
rtrv-ctrl-feat:partnum=893400001
```

The following is an example of the possible output.

```
rlghncxa03w 06-10-01 21:16:37 GMT EAGLE5 36.0.0
The following features have been permanently enabled:
Feature Name          Partnum    Status    Quantity
EAGLE OAM IP Security 893400001  on       ----
```

Note:

If steps 7 through 11 were not performed, skip steps 14 and 15, and go to step 16.

14. Place the terminals that were taken out of service in step 10 back into service by entering the `rst-trm` command with the terminal numbers specified in step 10.

For this example, enter these commands.

```
rst-trm:trm=17
```

```
rst-trm:trm=18
```

```
rst-trm:trm=19
```

```
rst-trm:trm=20
```

```
rst-trm:trm=21
```

```
rst-trm:trm=22
rst-trm:trm=23
rst-trm:trm=24
rst-trm:trm=25
rst-trm:trm=26
rst-trm:trm=27
rst-trm:trm=28
rst-trm:trm=29
rst-trm:trm=30
rst-trm:trm=31
rst-trm:trm=32
rst-trm:trm=33
rst-trm:trm=34
rst-trm:trm=35
rst-trm:trm=36
rst-trm:trm=37
rst-trm:trm=38
rst-trm:trm=39
rst-trm:trm=40
```

15. Place the **IPSMs** back into service by entering the `rst-card` command with the card locations specified in step 11.

For this example, enter this command.

```
rst-card:loc=2107
rst-card:loc=2108
rst-card:loc=2111
```

When this command has successfully completed, this message should appear.

```
rlghncxa03w 06-10-01 09:12:36 GMT EAGLE5 36.0.0
Card has been allowed.
```

When the **IPSMs** are placed into service with the `rst-card` command, **UIM 1494, SSH Host Keys Loaded**, is displayed. **UIM 1494** contains the public host key fingerprint which is used to establish a secure connection with an **SSH** client. If the secure connection is to be made with the **FTRA**, the public host key fingerprint displayed in **UIM 1494** must be added to the `hosts.xml` file in the **FTRA**. Record the public host key fingerprint information displayed in **UIM 1494** if a secure connection to the **FTRA** will be made. For more information about editing the `hosts.xml` file on the **FTRA**, see *FTP Table Base Retrieval User's Guide*.

16. Backup the new changes using the `chg-db:action=backup:dest=fixedcommand`.

These messages should appear, the active **Maintenance and Administration Subsystem Processor (MASP)** appears first

.

```
BACKUP (FIXED) : MASP A - Backup starts on active MASP.  
BACKUP (FIXED) : MASP A - Backup on active MASP to fixed disk complete.  
BACKUP (FIXED) : MASP A - Backup starts on standby MASP.  
BACKUP (FIXED) : MASP A - Backup on standby MASP to fixed disk complete.
```

Figure A-2 Activating the EAGLE OA&M IP Security Enhancement Controlled Feature

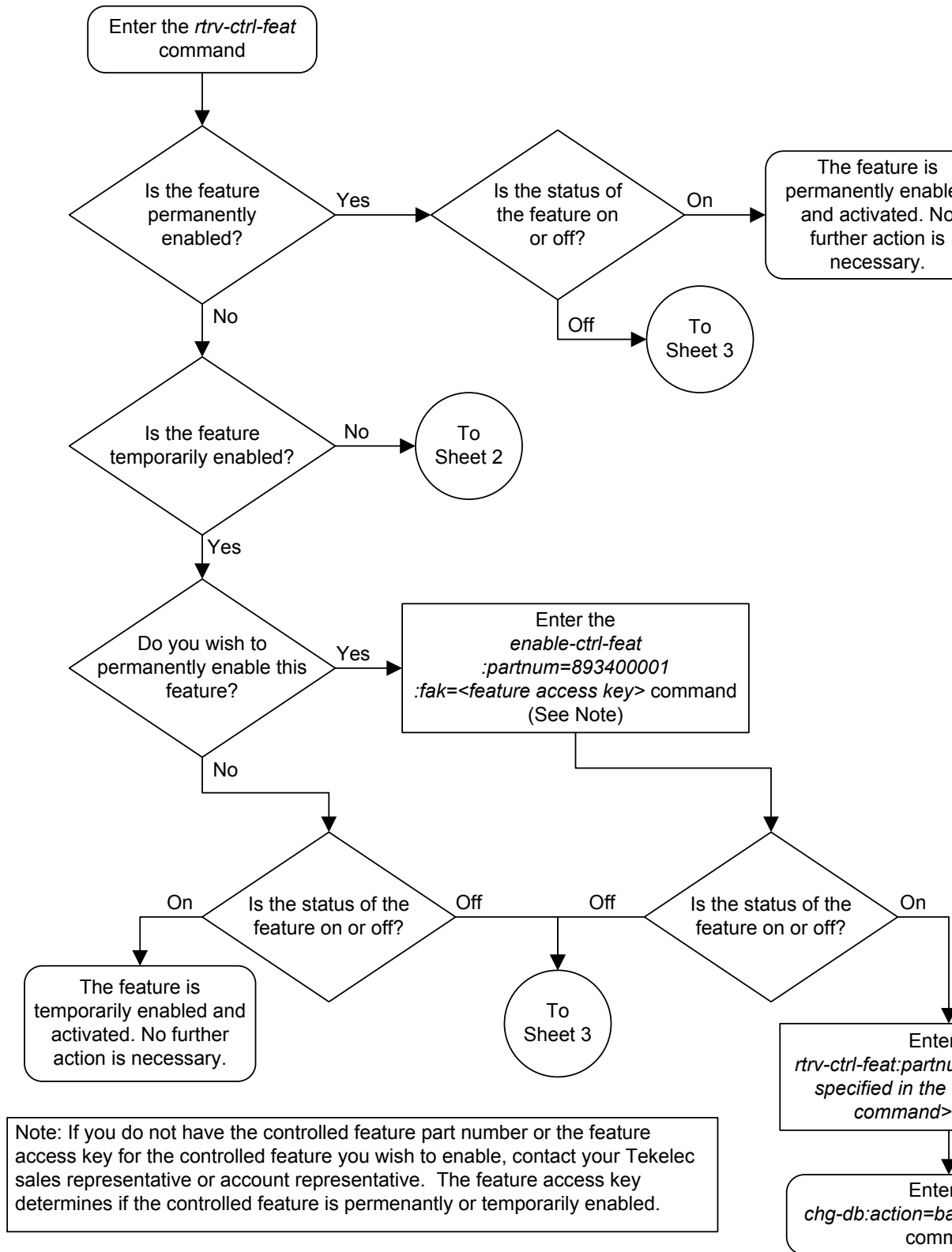

Sheet 1 of 4

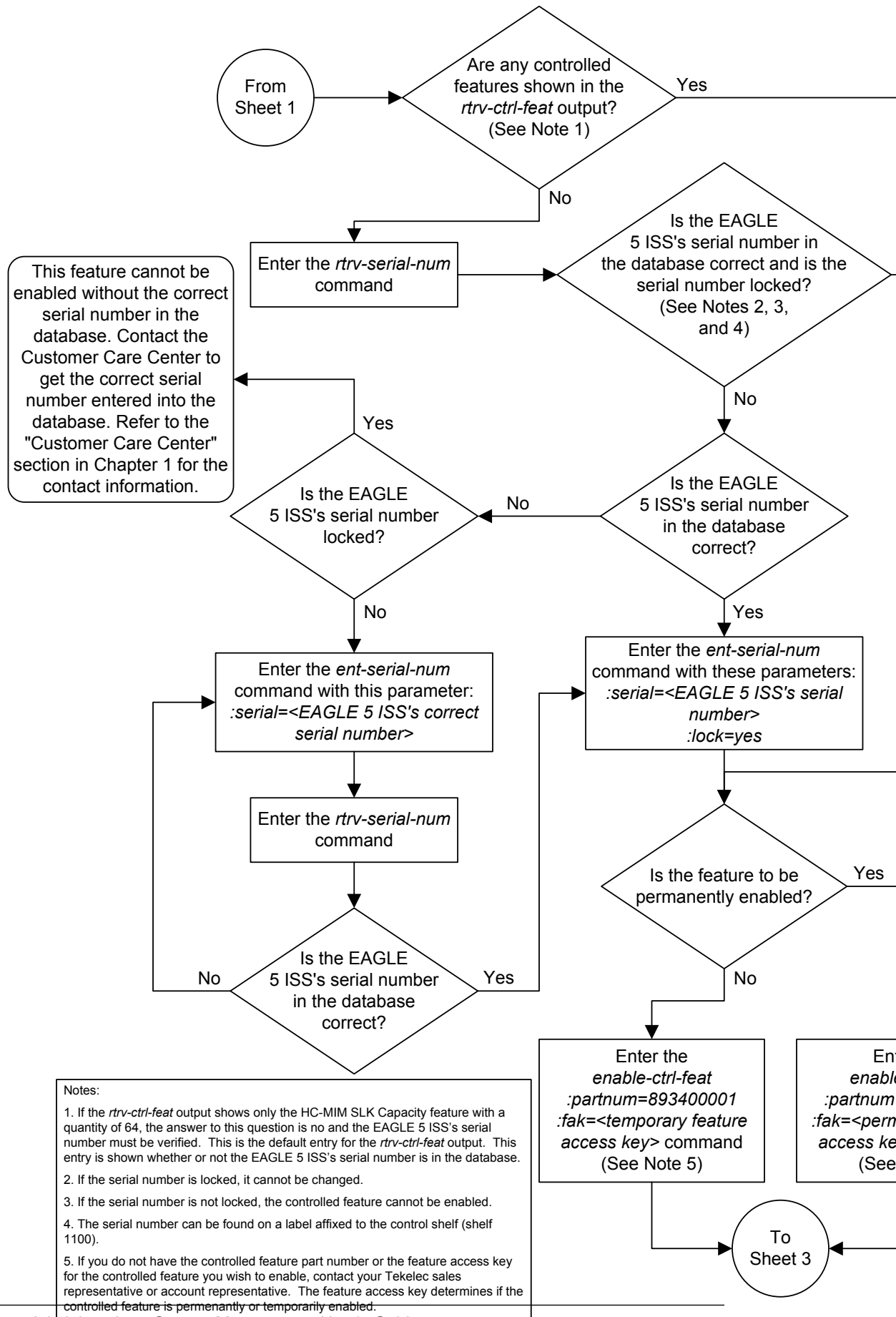

Sheet 2 of 4

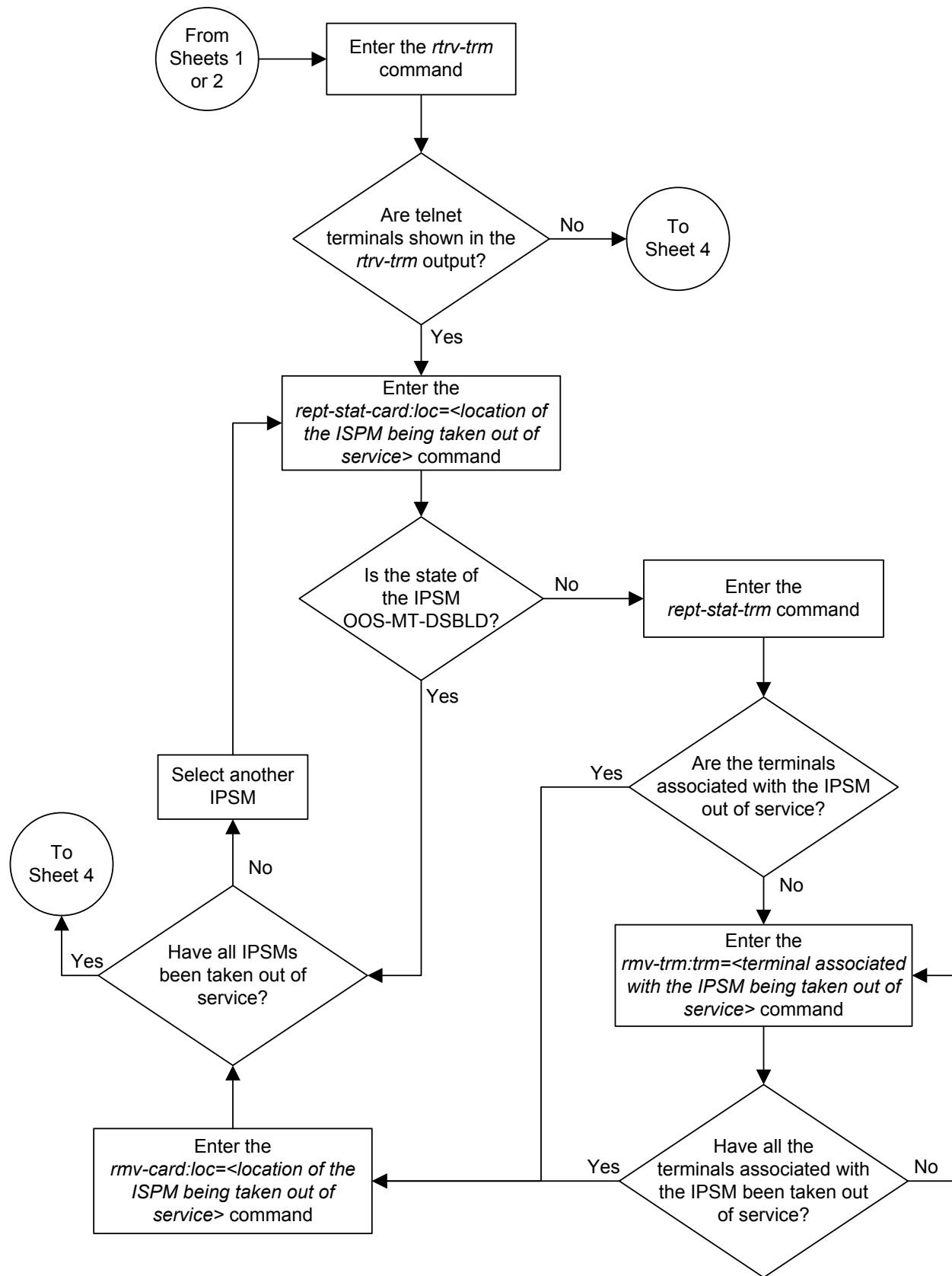

Sheet 3 of 4

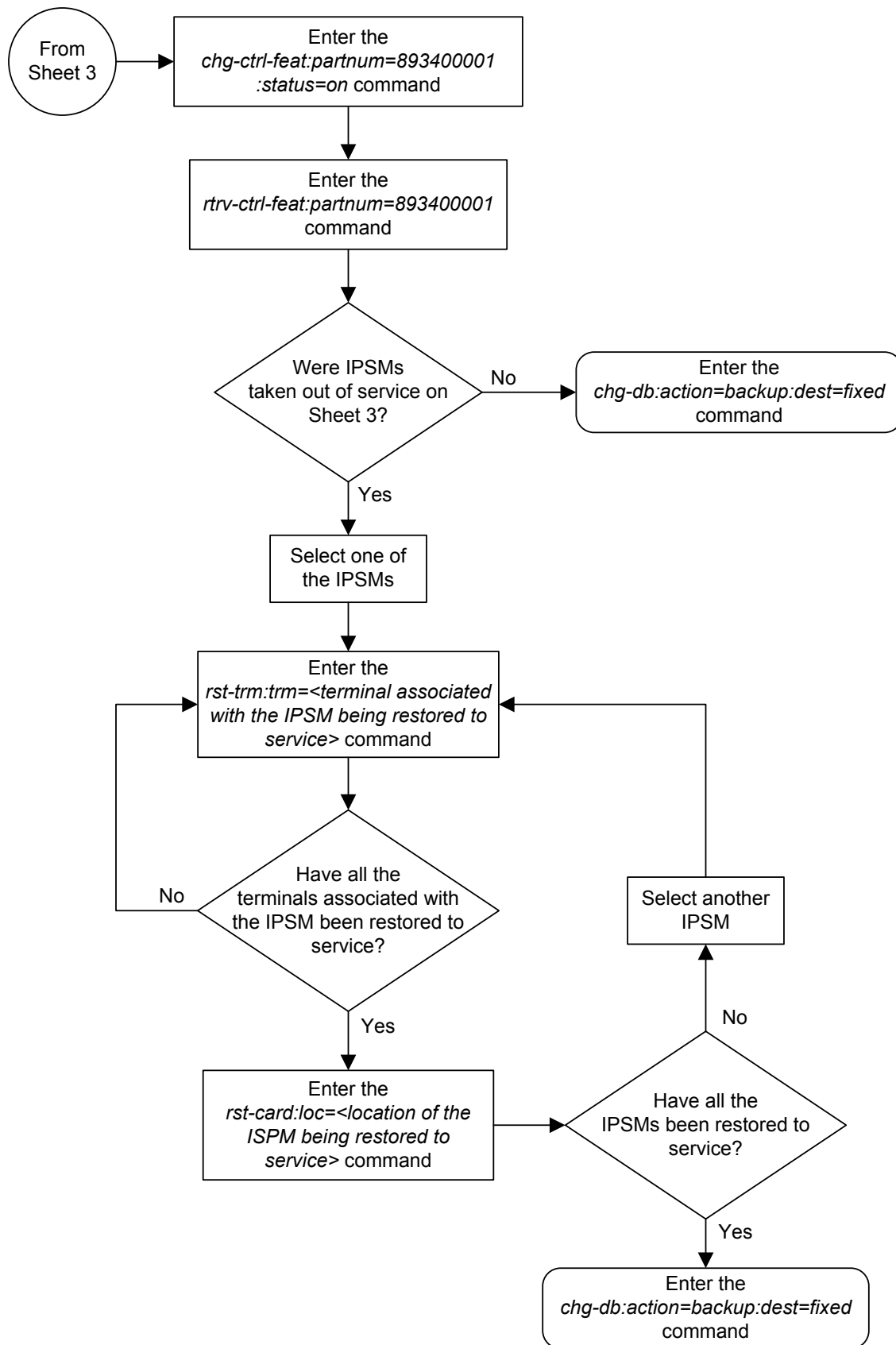

Unmate IP Security for Terminal and Measurements

EAGLE Release 45.0 provides the capability to unmate the IP Security for Telnet and FTP. The Terminal security (SSH) will be controlled by an option 'ssh' in the Security Default table. This option can be set to ON to enable **SSH** or set to OFF to disable SSH. The `chg-secu-dflt` command is modified to support the parameter 'ssh' that turns SSH ON/OFF. The parameter is optional, and defaults to ON. Example command:

```
chg-secu-dflt:ssh=on
```

Security for the FTP interfaces will be controlled by an option Security in the FTP Server table. Each option in the table defines the parameters for a specific FTP interface. The parameter Security can be turned ON/OFF for each server entry independently. When the OAM IP Security feature is ON and the FTP interface Security parameter is ON, the interface will be protected by data encryption.

The Security Parameter can be set when an interface is initially created with the `ent-ftp-serv` command, or changed for an existing interface with the `chg-ftp-serv` command. The parameter is optional, and defaults to ON. Example commands:

```
ent-ftp-
serv: ipaddr=x.x.x.x:login=user:app=dist:prio=1=login=eagle:path
="/path":security=on and
```

```
chg-ftp-serv:ipaddr=x.x.x.x:app=dist:security=on.
```

Activating the 15 Minute Measurements Controlled Feature

This procedure is used to enable and turn on the 15 Minute Measurements controlled feature, using the feature's part number and a feature access key. This feature allows EAGLE measurements to be collected every 15 minutes.

To enable and turn on the 15 Minute Measurements controlled feature, the following requirements must be met:

- The Measurements Platform feature must be on, or the Integrated Measurements feature must be enabled and turned on.
- The EAGLE must be configured to use the Measurements Platform, or the Integrated Measurements feature.
- If the Measurements Platform is being used, MCPMs must be provisioned in the database, and the state of all these **MCPMs** must be **IS-NR**.

The `enable-ctrl-feat`, `ent-serial-num`, and `chg-ctrl-feat` commands are used to enable and turn on the 15 Minute Measurements controlled feature using the feature's part number and a feature access key.

The feature access key for the 15 Minute Measurements controlled feature is based on the feature's part number and the serial number of the EAGLE, making the feature access key site-specific.

The `enable-ctrl-feat` command enables the feature by inputting the feature's access key and the feature's part number with these parameters:

: fak – The feature access key provided by Oracle. The feature access key contains 13 alphanumeric characters and is not case sensitive.

:partnum – The Oracle-issued part number of the 15 Minute Measurements controlled feature, 893012101.

The `enable-ctrl-feat` command requires that the database contain a valid serial number for the EAGLE, and that this serial number is locked. This can be verified with the `rtrv-serial-num` command. The EAGLE is shipped with a serial number in the database, but the serial number is not locked. The serial number can be changed, if necessary, and locked once the EAGLE is on-site, with the `ent-serial-num` command. The `ent-serial-num` command uses these parameters.

:serial – The serial number assigned to the EAGLE. The serial number is not case sensitive.

:lock – Specifies whether or not the serial number is locked. This parameter has only one value, `yes`, which locks the serial number. Once the serial number is locked, it cannot be changed.

Note: To enter and lock the EAGLE’s serial number, the `ent-serial-num` command must be entered twice, once to add the correct serial number to the database with the `serial` parameter, then again with the `serial` and the `lock=yes` parameters to lock the serial number. You should verify that the serial number in the database is correct before locking the serial number. The serial number can be found on a label affixed to the control shelf (shelf 1100).

This feature cannot be temporarily enabled (with the temporary feature access key).

Once this feature has been enabled, the feature must be turned on with the `chg-ctrl-feat` command. The `chg-ctrl-feat` command uses these parameters:

:partnum – The Oracle-issued part number of the 15 Minute Measurements controlled feature, 893027701.

:status=on – used to turn the 15 Minute Measurements controlled feature on.

Once the 15 Minute Measurements controlled feature has been turned on, it cannot be turned off.

The status of the features in the EAGLE is shown with the `rtrv-ctrl-feat` command.

After the 15 Minute Measurements controlled feature is enabled and turned on, the 15 minute measurement collection option in the measurement options table must be turned on.

1. Display the status of the 15 Minute Measurements controlled features by entering the `rtrv-ctrl-feat` command.

The following is an example of the possible output.

```
rlghncxa03w 06-10-01 21:15:37 GMT EAGLE5 36.0.0
The following features have been permanently enabled:
```

Feature Name	Partnum	Status	Quantity
Command Class Management	893005801	off	----
LNP Short Message Service	893006601	on	----
Intermed GTT Load Sharing	893006901	off	----
XGTT Table Expansion	893006101	off	----
XMAP Table Expansion	893007710	on	3000
Large System # Links	893005910	on	2000
Routesets	893006401	on	6000

```
15 Minute Measurements      893012101  off      ----
```

The following features have been temporarily enabled:

```
Feature Name                Partnum   Status   Quantity   Trial Period Left
Zero entries found.
```

The following features have expired temporary keys:

```
Feature Name                Partnum
Zero entries found.
```

If the `rtrv-ctrl-feat` output shows that the 15 Minute Measurements controlled feature is enabled, and its status is `on`, no further action is necessary.

If the 15 Minute Measurements controlled feature is enabled, and its status is `off`, continue the procedure with [7](#).

Note: If the `rtrv-ctrl-feat` output in [1](#) shows any controlled features, continue the procedure with [6](#). If the `rtrv-ctrl-feat` output shows only the HC-MIM SLK Capacity feature with a quantity of 64, [2](#) through [5](#) must be performed.

2. Display the serial number in the database with the `rtrv-serial-num` command.

This is an example of the possible output.

```
rlghncxa03w 06-10-01 21:15:37 GMT EAGLE5 36.0.0
System serial number = ntxxxxxxxxxxxxxx

System serial number is not locked.

rlghncxa03w 06-10-01 21:15:37 GMT EAGLE5 36.0.0
Command Completed
```

Note: If the serial number is correct and locked, continue the procedure with [6](#). If the serial number is correct but not locked, continue the procedure with [5](#). If the serial number is not correct, but is locked, this feature cannot be enabled and the remainder of this procedure cannot be performed. Contact the Customer Care Center to get an incorrect and locked serial number changed. Refer to [My Oracle Support \(MOS\)](#) for the contact information. The serial number can be found on a label affixed to the control shelf (shelf 1100).

3. Enter the correct serial number into the database using the `ent-serial-num` command with the `serial` parameter.

For this example, enter this command.

```
ent-serial-num:serial=<EAGLE's correct serial number>
```

When this command has successfully completed, the following message should appear.

```
rlghncxa03w 06-10-01 21:15:37 GMT EAGLE5 36.0.0
ENT-SERIAL-NUM:  MASP A - COMPLTD
```

4. Verify that the serial number entered into 3 was entered correctly using the `rtrv-serial-num` command.

This is an example of the possible output.

```
rlghncxa03w 06-10-01 21:15:37 GMT EAGLE5 36.0.0
System serial number = nt00001231
```

System serial number is not locked.

```
rlghncxa03w 06-10-01 21:15:37 GMT EAGLE5 36.0.0
Command Completed
```

If the serial number was not entered correctly, repeat 3 and 4 and re-enter the correct serial number.

5. Lock the serial number in the database by entering the `ent-serial-num` command with the serial number shown in 2, if the serial number shown in 2 is correct, or with the serial number shown in 4, if the serial number was changed in 3, and with the `lock=yes` parameter.

For this example, enter this command.

```
ent-serial-num:serial=<EAGLE's serial number>;lock=yes
```

When this command has successfully completed, the following message should appear.

```
rlghncxa03w 06-10-01 21:15:37 GMT EAGLE5 36.0.0
ENT-SERIAL-NUM: MASP A - COMPLTD
```

6. Enable the 15 Minute Measurements controlled feature by entering the `enable-ctrl-feat` command.

For this example, enter this command.

```
enable-ctrl-feat:partnum=893012101;fak=<feature access key>
```

This feature cannot be enabled with a temporary feature access key.

Note: The values for the feature access key (the `fak` parameter) are provided by Oracle. If you do not have the controlled feature part number or the feature access key for the feature you wish to enable, contact your Oracle Sales Representative or Account Representative.

When the `enable-ctrl-feat` command has successfully completed, this message should appear.

```
rlghncxa03w 06-10-01 21:15:37 GMT EAGLE5 36.0.0
ENABLE-CTRL-FEAT: MASP B - COMPLTD
```

7. Display the quantity of signaling links that are provisioned in the EAGLE by entering the `rtrv-tbl-capacity` command.

This is an example of the possible output.

```
rlghncxa03w 10-04-19 21:16:37 GMT EAGLE5 42.0.0
SLK      table is (      7 of      1200)  1% full
```

Note: The `rtrv-tbl-capacity` command output contains other fields that are not used by this procedure. If you wish to see all the fields displayed by the `rtrv-tbl-capacity` command, refer to the `rtrv-tbl-capacity` command description in *Commands User's Guide*.

8. To enable the 15 Minute Measurements controlled feature, either the Measurements Platform feature must be on and the Measurements Platform option (PLATFORMENABLE) must be on, or the Integrated Measurements feature must be enabled and turned on and the measurement collection option for the E5-MCAP card (OAMHCMEAS) must be on. If the EAGLE contains more than 1200 signaling links, shown in 7, the Measurements Platform feature must be used. If the EAGLE contains 1200 signaling links or less, either the Measurements Platform feature or the Integrated Measurements feature can be used. Verify whether or nor the Measurements Platform option is enabled (PLATFORMENABLE = on), or the measurement collection option for the E5-MCAP card (OAMHCMEAS) must be on using the `rtrv-measopts` command.

The following is an example of the possible output.

```
rlghncxa03w 10-04-01 16:02:05 GMT  EAGLE5 42.0.0

PLATFORMENABLE = on
COLLECT15MIN   = off
CLLIBASEDNAME  = on
OAMHCMEAS      = off
-----
SYSTOTSTP      =on
```

Note: The `rtrv-measopts` command output contains other fields that are not used by this procedure. If you wish to see all the fields displayed by the `rtrv-measopts` command, see the `rtrv-measopts` command description in *Commands User's Guide*.

If the Measurements Platform option is enabled, continue the procedure with 11.

If the Measurements Platform option is not enabled and the Measurements Platform is required, or you wish to use the Measurements Platform, continue the procedure with 9.

If the Integrated Measurements feature will be used, continue the procedure by performing one of these steps.

- If the measurement collection option for the E5-MCAP card (OAMHCMEAS) is on, continue the procedure with 11.
- If the measurement collection option for the E5-MCAP card (OAMHCMEAS) is off, continue the procedure by performing one of these steps.
 - If the Integrated Measurements feature is not enabled or turned on, shown in the `rtrv-ctrl-feat` output in 1, perform the [Configuring the](#)

[Integrated Measurements Feature](#) procedure to configure the Integrated Measurements feature. Continue the procedure with [11](#).

- If the Integrated Measurements feature is enabled and turned on, continue the procedure with [10](#).

9. Verify whether or not the Measurements Platform feature is on by entering the `rtrv-feat` command.

If the Measurements Platform feature is on, the entry `MEASPLAT = on` is shown in the `rtrv-feat` command output:

Note: The `rtrv-feat` command output contains other fields that are not used by this procedure. If you wish to see all the fields displayed by the `rtrv-feat` command, see the `rtrv-feat` command description in *Commands User's Guide*.

If the Measurements Platform feature is not on, perform the [Adding a Measurement Collection and Polling Module \(MCPM\)](#) procedure to add the required **MCPMs** and to turn the Measurements Platform feature on. After the Measurements Platform is turned on, perform the [Configuring the Measurements Platform Feature](#) procedure to configure the Measurements Platform feature. Continue the procedure with [11](#).

If the Measurements Platform is on, perform the [Configuring the Measurements Platform Feature](#) procedure to configure Measurements Platform feature and to enable the Measurements Platform option, if required. Continue the procedure with [11](#).

10. Turn the measurement collection option for the E5-MCAP card (OAMHCMEAS) on by entering this command.

```
chg-measopts:oamhcmeas=on
```

When the `chg-measopts` command has successfully completed, the following message should appear.

```
rlghncxa03w 10-04-01 21:16:37 GMT EAGLE5 42.0.0
CHG-MEASOPTS: MASP A - COMPLTD
```

11. Turn the 15 Minute Measurements controlled feature on using the `chg-ctrl-feat` command, specifying the 15 Minute Measurements controlled feature part number and the `status=on` parameter.

Note: If a 30-minute measurement collection is in progress, the `chg-ctrl-feat` command will be rejected. Wait until the 30-minute measurement collection has finished before executing the `chg-ctrl-feat` command.

For this example, enter this command.

```
chg-ctrl-feat:partnum=893012101:status=on
```

Note: Once the 15 Minute Measurements feature is turned on, it cannot be turned off.

When the `chg-ctrl-feat` command has successfully completed, the following message should appear.

```
rlghncxa03w 06-10-01 21:15:37 GMT EAGLE5 36.0.0
CHG-CTRL-FEAT: MASP B - COMPLTD
```

12. Verify the changes by entering the `rtrv-ctrl-feat` command with the part number specified in 11 .

```
rtrv-ctrl-feat:partnum=893012101
```

The following is an example of the possible output.

```
rlghncxa03w 06-10-01 21:16:37 GMT EAGLE5 36.0.0
The following features have been permanently enabled:
Feature Name          Partnum   Status   Quantity
15 Minute Measurements 893012101 on      ----
```

13. Turn the 15 Minute Measurement collection option on by entering this command.

```
chg-measopts:collect15min=on
```

When the `chg-measopts` command has successfully completed, the following message should appear.

```
rlghncxa03w 10-04-01 21:16:37 GMT EAGLE5 42.0.0
CHG-MEASOPTS: MASP A - COMPLTD
```

14. Verify that the 15 Minute Measurement collection option is on by entering the `rtrv-measopts` command.

The following is an example of the possible output.

```
rlghncxa03w 10-04-01 16:02:05 GMT EAGLE5 42.0.0

PLATFORMENABLE = on
COLLECT15MIN   = on
CLLIBASEDNAME = on
OAMHCMEAS     = off
-----
SYSTOTSTP     =on
```

Note: The `rtrv-measopts` command output contains other fields that are not used by this procedure. If you wish to see all the fields displayed by the `rtrv-measopts` command, see the `rtrv-measopts` command description in *Commands User's Guide*.

15. Backup the new changes using the `chg-db:action=backup:dest=fixed` command.

These messages should appear, the active **Maintenance and Administration Subsystem Processor (MASP)** appears first.

```
BACKUP (FIXED) : MASP A - Backup starts on active MASP.
BACKUP (FIXED) : MASP A - Backup on active MASP to fixed disk complete.
```

```
BACKUP (FIXED) : MASP A - Backup starts on standby MASP.  
BACKUP (FIXED) : MASP A - Backup on standby MASP to fixed disk complete.
```

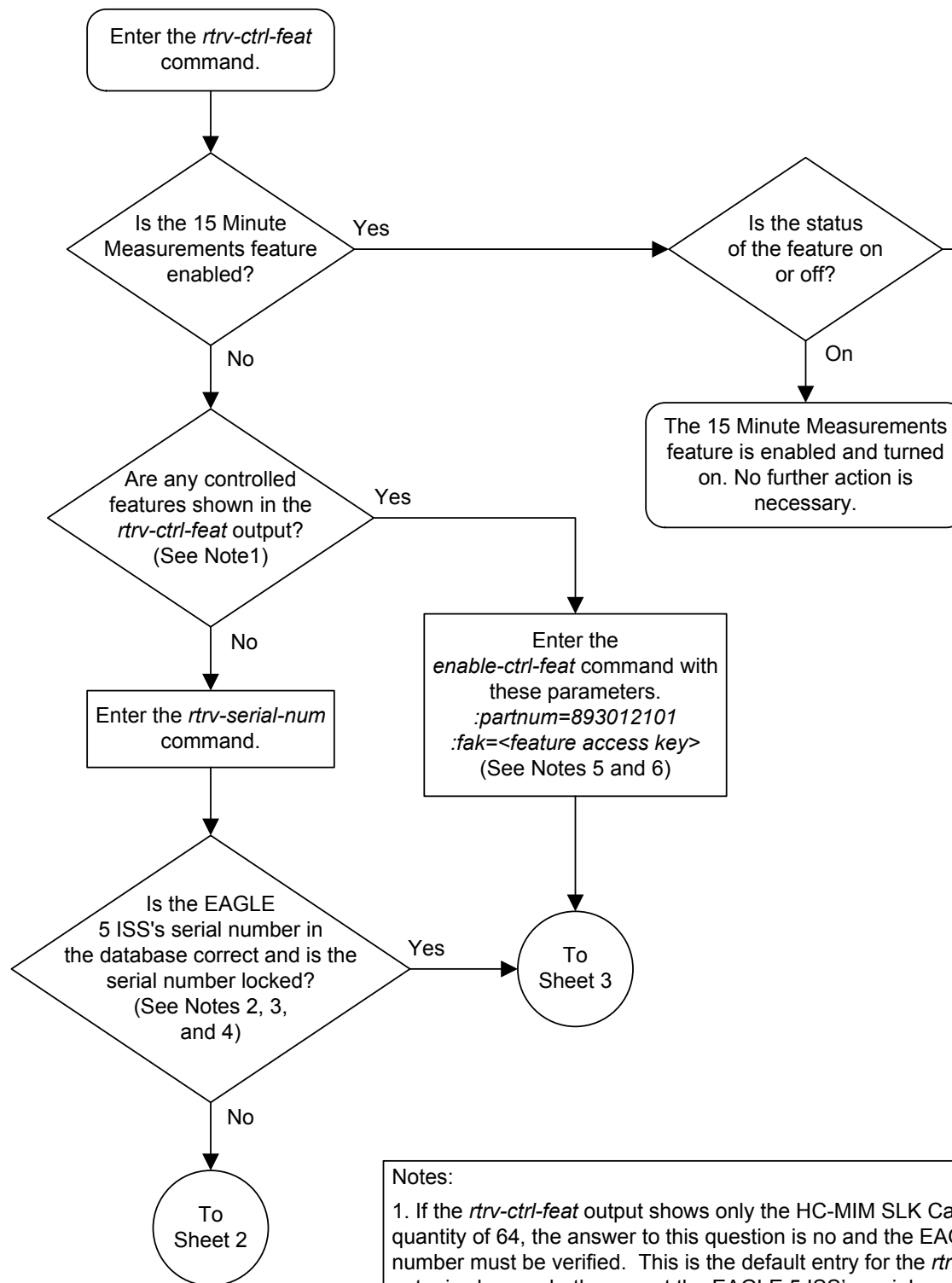
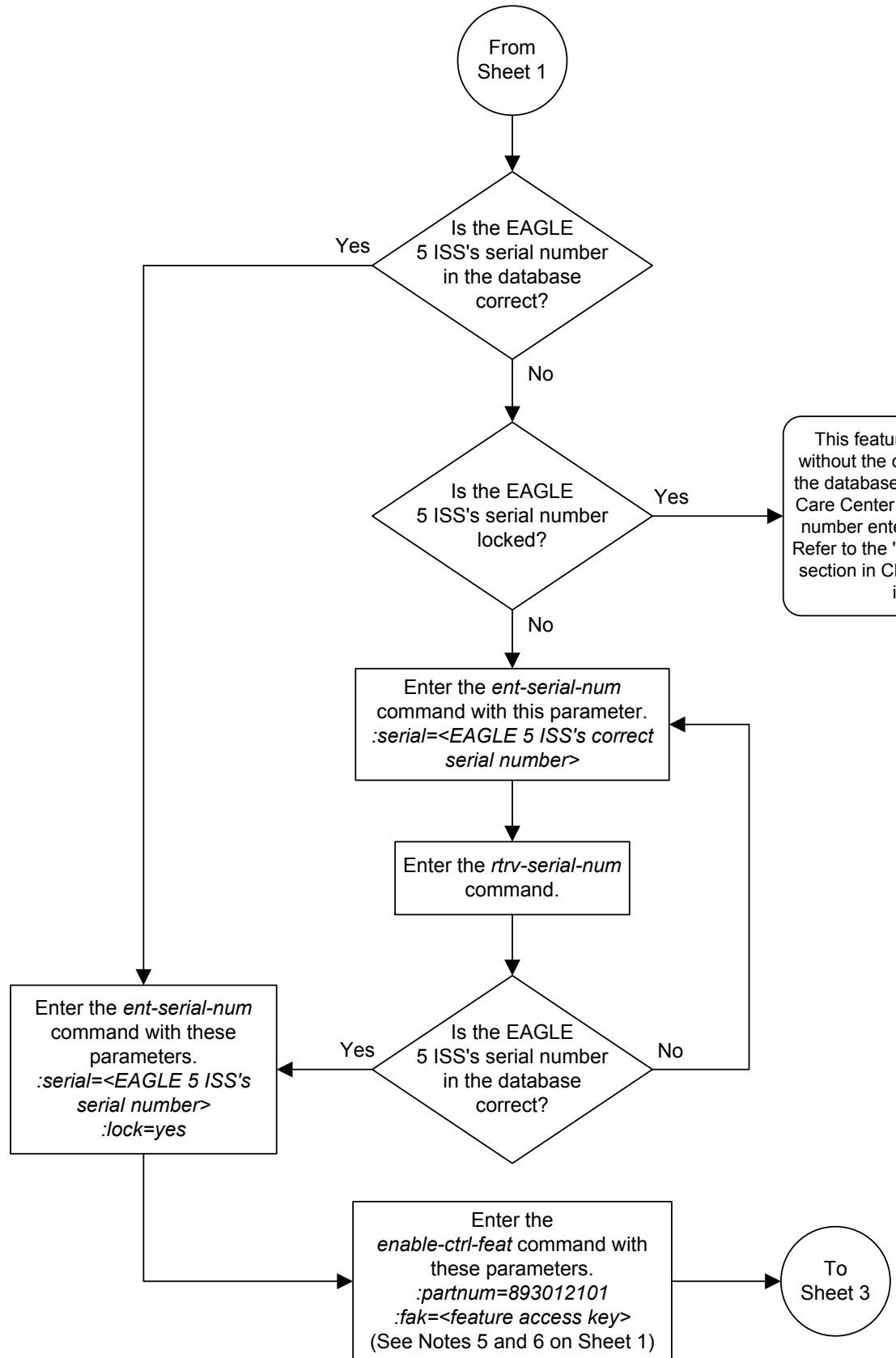

Figure A-3 Activating the 15 Minute Measurements Controlled Feature



Notes:

1. If the *rtv-ctrl-feat* output shows only the HC-MIM SLK Ca quantity of 64, the answer to this question is no and the EA number must be verified. This is the default entry for the *rtv-ctrl-feat* entry is shown whether or not the EAGLE 5 ISS's serial number is correct.
2. If the serial number is locked, it cannot be changed.
3. If the serial number is not locked, the controlled feature can be activated.
4. The serial number can be found on a label affixed to the EAGLE 5 ISS (part number 1100).
5. If you do not have the feature access key for this feature, contact your sales representative or account representative.
6. This feature cannot be enabled with a temporary feature key.

Sheet 1 of 4



Sheet 2 of 4

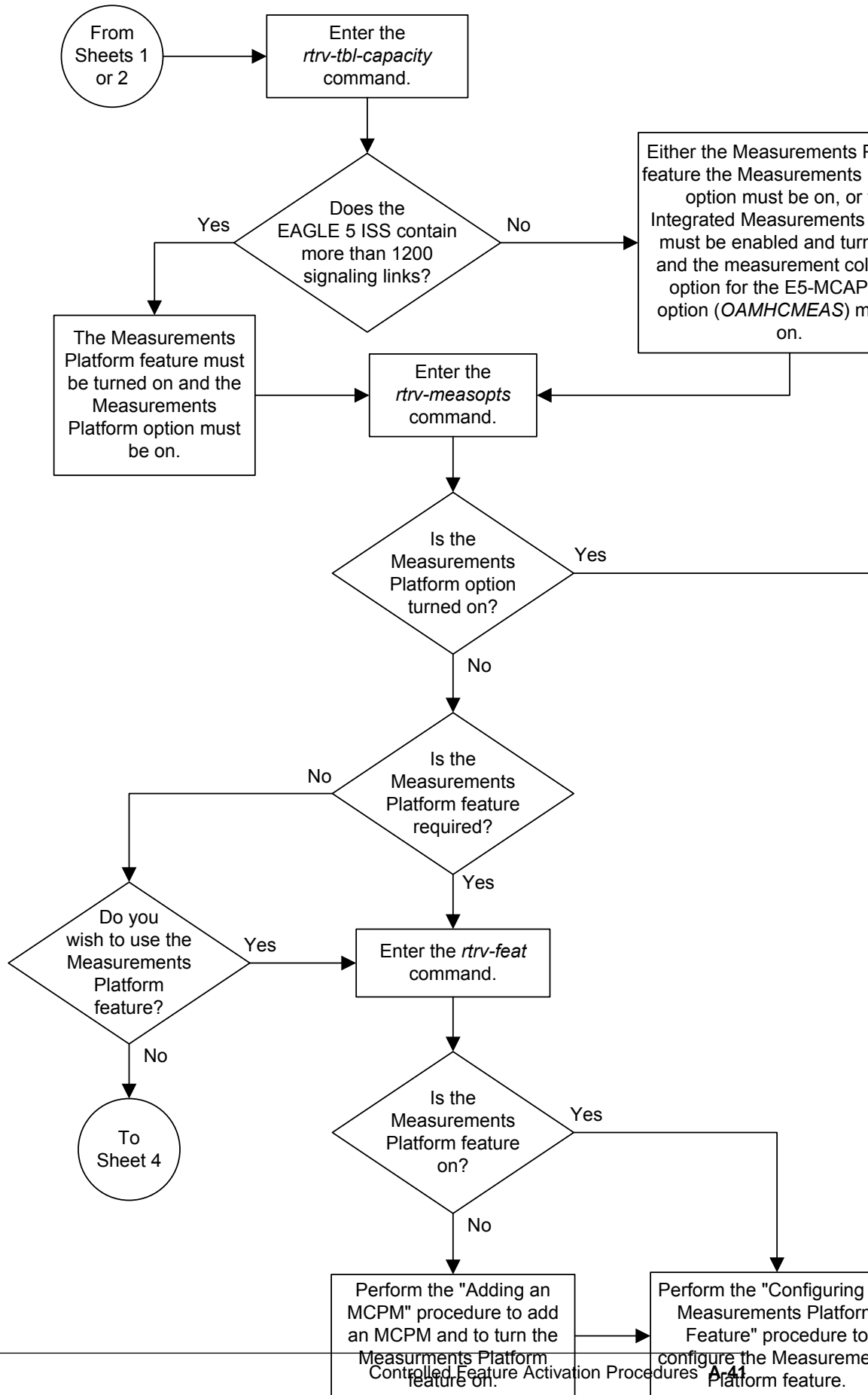

Sheet 3 of 4

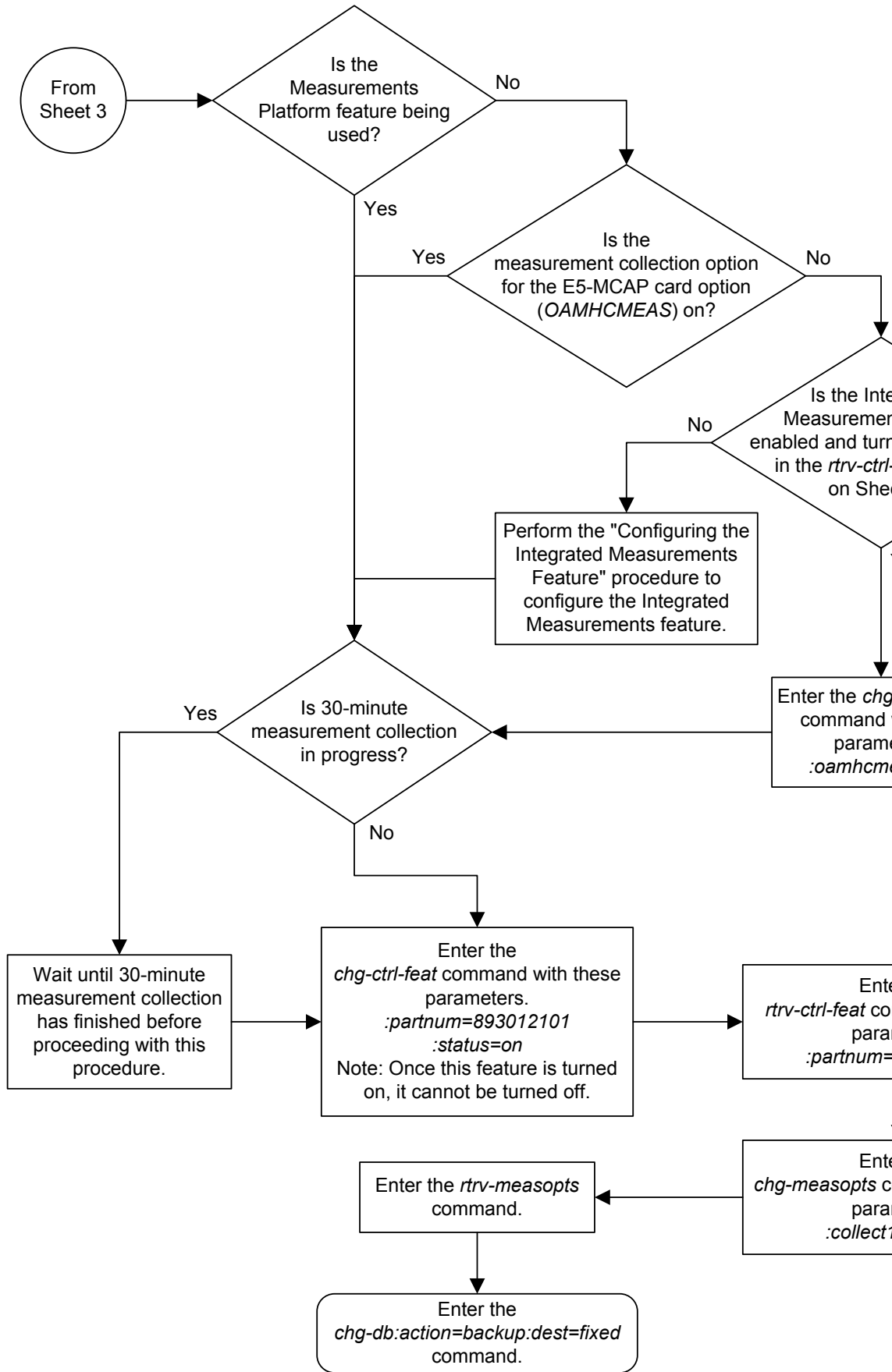

Clearing a Temporary FAK Alarm

This procedure is used to clear the critical alarm, **UAM 0368**, generated when a temporary feature access key has expired, using the `chg-ctrl-feat` command.

The `chg-ctrl-feat` command uses the following parameters:

`:partnum` - The part number of the controlled feature that was temporarily enabled and is causing the alarm.

`:alarm=clear` - Clears **UAM 0368**, Temp **Key(s)** have expired.

The controlled feature must have been temporarily enabled and is now in danger of expiration or in an *expired* state.

1. Display the controlled feature that has the expired feature access key by entering the `rtrv-ctrl-feat:expired=yes` command.

The following is an example of the possible output.

```
rlghncxa03w 06-10-01 21:17:37 GMT EAGLE5 36.0.0
The following features have expired temporary keys:
Feature Name          Part Num
Command Class Management  893005801
```

2. Clear the **EAGLE** alarm in the database by entering the `chg-ctrl-feat` command.

For example, enter this command.

```
chg-ctrl-feat:partnum=893005801:alarm=clear
```

When this command has successfully completed, the following message should appear.

```
rlghncxa03w 06-10-01 21:16:37 GMT EAGLE5 36.0.0
CHG-CTRL-FEAT: MASP A - COMPLTD
```

3. Verify that the alarm has cleared in the database by using the `rtrv-ctrl-feat:expired=yes` command.

The following is an example of the possible output.

```
rlghncxa03w 06-10-01 21:16:37 GMT EAGLE5 36.0.0
0367.0181 * SYSTEM      Temp Key(s) expiration alarm cleared.
```

4. Backup the new changes using the `chg-db:action=backup:dest=fixed` command.

These messages should appear, the active **Maintenance and Administration Subsystem Processor (MASP)** appears first

.

```
BACKUP (FIXED) : MASP A - Backup starts on active MASP.
BACKUP (FIXED) : MASP A - Backup on active MASP to fixed disk complete.
BACKUP (FIXED) : MASP A - Backup starts on standby MASP.
BACKUP (FIXED) : MASP A - Backup on standby MASP to fixed disk complete.
```

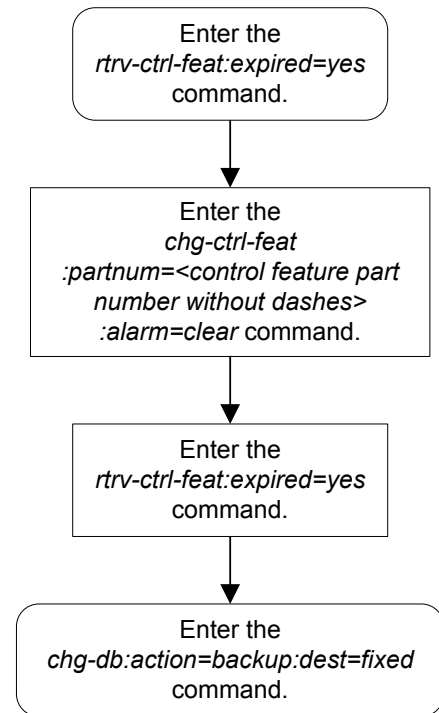
Figure A-4 Clearing a Temporary FAK Alarm

Deactivating Controlled Features

This procedure is used to deactivate these controlled features, **Command Class Management**, **IP User Interface**, and **Network Security Enhancements** using the `chg-ctrl-feat` command.

The `chg-ctrl-feat` command uses the following parameters:

`:partnum` - The part number of the controlled feature being deactivated.

- Command Class Management – 893005801
- Telnet (**IP User Interface**) – 893005701
- Network Security Enhancements – 893009101

`:status=off` – used to deactivate the controlled feature.

The status of the controlled feature being deactivated must be on and is shown with the `rtrv-ctrl-feat` command.

Caution: If the SEAS over IP feature is turned off, all SEAS terminal traffic stops.

Caution: If the **IP User Interface (TELNET)** controlled feature is deactivated, all Telnet sessions supported by this feature will be disabled. No changes can be made to the configuration of the Telnet terminals (terminals 17 through 40). Deactivating this feature will also deactivate **FTP Retrieve and Replace** feature. If the SEAS over IP feature is turned on, the TELNET feature cannot be turned off.

1. Display the controlled features whose status is on by entering the `rtrv-ctrl-feat:status=on` command.

The following is an example of the possible output.

```
rlghncxa03w 06-10-01 21:17:37 GMT EAGLE5 36.0.0
The following features have been permanently enabled:
```

Feature Name	Partnum	Status	Quantity
Command Class Management	893005801	on	----
LNP Short Message Service	893006601	on	----
Intermed GTT Load Sharing	893006901	on	----
XMAP Table Expansion	893007710	on	3000
Large System # Links	893005910	on	2000
Routesets	893006401	on	6000
Telnet	893005701	on	----
Network Security Enhance	893009101	on	----

The following features have been temporarily enabled:

Feature Name	Partnum	Status	Quantity	Trial Period Left
Zero entries found.				

The following features have expired temporary keys:

```
Feature Name          Partnum
Zero entries found.
```

The TELNET feature cannot be turned off if the SEAS over IP feature is turned on. If the TELNET (IP User Interface) is not being turned off, go to step 2.

If the TELNET feature is being turned off, and the SEAS over IP feature is not turned on (shown in the `rtrv-ctrl-feat` output in this step by the entry `SEAS over IP`), go to step 2.

If the TELNET feature is being turned off, and the SEAS over IP feature is turned on, perform the [Turning Off the SEAS Over IP Feature](#) procedure to turn the SEAS over IP feature off. After the SEAS over IP feature has been turned off, go to step 2.

2. Deactivate the controlled feature by entering the `chg-ctrl-feat` command with the `status=off` parameter.

For example, enter this command.

```
chg-ctrl-feat:partnum=893005801:status=off
chg-ctrl-feat:partnum=893005701:status=off
chg-ctrl-feat:partnum=893009101:status=off
```

When each of these commands has successfully completed, the following message should appear.

```
rlghncxa03w 06-10-01 21:16:37 GMT EAGLE5 36.0.0
CHG-CTRL-FEAT: MASP A - COMPLTD
```

3. Verify that the controlled feature has been deactivated by using the `rtrv-ctrl-feat:partnum=<controlled feature part number>` command.

For this example, enter these commands.

```
rtrv-ctrl-feat:partnum=893005801
```

The following is an example of the possible output.

```
rlghncxa03w 06-10-01 21:16:37 GMT EAGLE5 36.0.0
The following features have been permanently enabled:
```

Feature Name	Partnum	Status	Quantity
Command Class Management	893005801	off	----

The following features have been temporarily enabled:

Feature Name	Partnum	Status	Quantity	Trial Period Left
Zero entries found.				

The following features have expired temporary keys:

```
Feature Name          Partnum
Zero entries found.
```

```
rtrv-ctrl-feat:partnum=893005701
```

The following is an example of the possible output.

```
rlghncxa03w 06-10-01 21:16:37 GMT EAGLE5 36.0.0
```

The following features have been permanently enabled:

Feature Name	Partnum	Status	Quantity
Telnet	893005701	off	----

The following features have been temporarily enabled:

Feature Name	Partnum	Status	Quantity	Trial Period Left
Zero entries found.				

The following features have expired temporary keys:

Feature Name	Partnum
Zero entries found.	

rtrv-ctrl-feat:partnum=893009101

The following is an example of the possible output.

rlghncxa03w 06-10-01 21:16:37 GMT EAGLE5 36.0.0
The following features have been permanently enabled:

Feature Name	Partnum	Status	Quantity
Network Security Enhance	893009101	off	----

The following features have been temporarily enabled:

Feature Name	Partnum	Status	Quantity	Trial Period Left
Zero entries found.				

The following features have expired temporary keys:

Feature Name	Partnum
Zero entries found.	

4. Backup the new changes using the chg-db:action=backup:dest=fixedcommand.

These messages should appear, the active **Maintenance and Administration Subsystem Processor (MASP)** appears first.

```
BACKUP (FIXED) : MASP A - Backup starts on active MASP.  
BACKUP (FIXED) : MASP A - Backup on active MASP to fixed disk complete.  
BACKUP (FIXED) : MASP A - Backup starts on standby MASP.  
BACKUP (FIXED) : MASP A - Backup on standby MASP to fixed disk complete.
```

Figure A-5 Deactivating Controlled Features

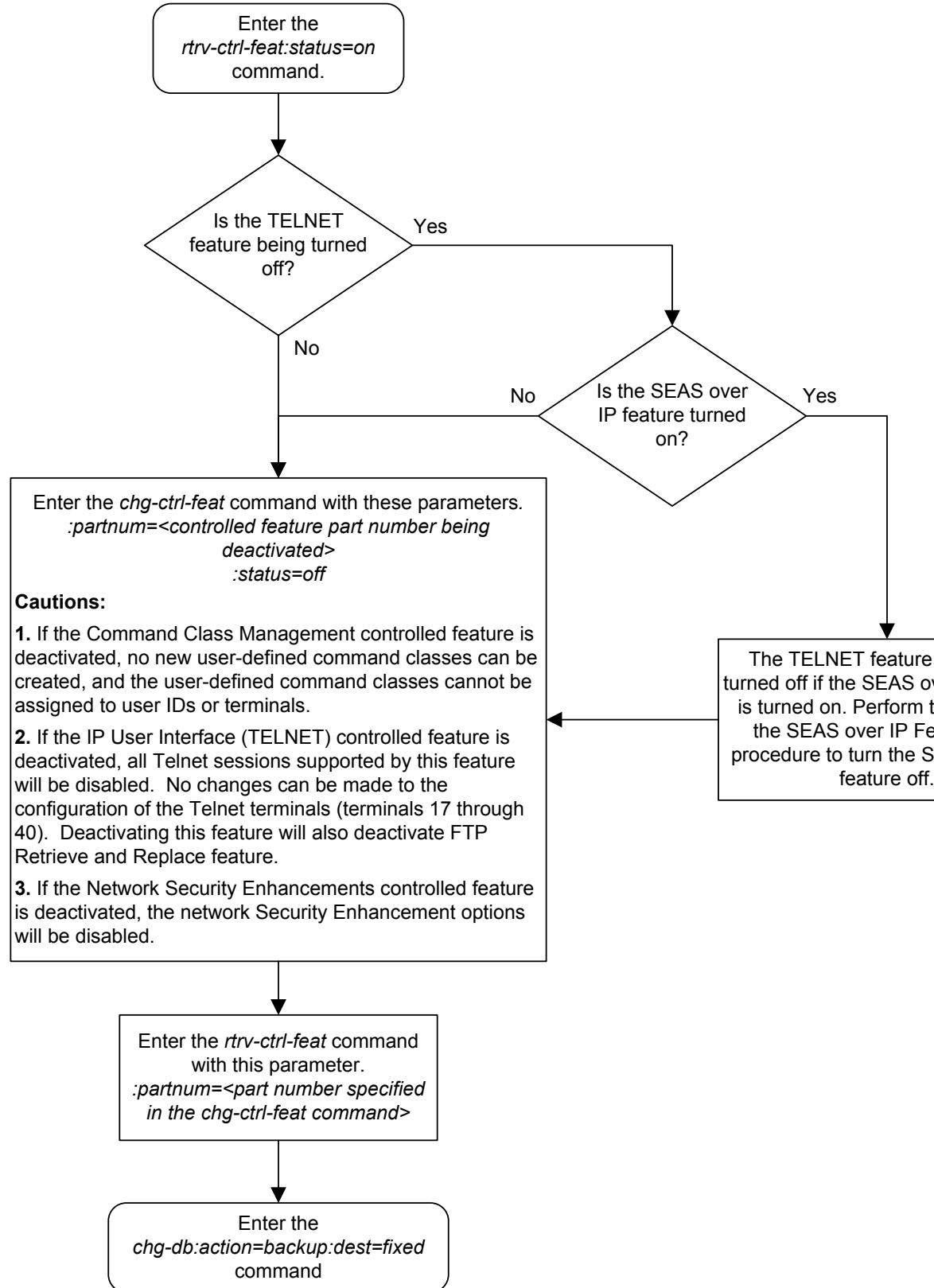

Activating the HIPR2 High Rate Mode Feature

This procedure is used to enable and turn on the HIPR2 High Rate Mode feature using the feature's part number and a feature access key.

The feature access key for the HIPR2 High Rate Mode feature is based on the feature's part number and the serial number of the EAGLE, making the feature access key site-specific.

The `enable-ctrl-feat` command enables the feature by inputting the feature's access key and the feature's part number with these parameters:

`: fak` – The feature access key provided by Oracle. The feature access key contains 13 alphanumeric characters and is not case sensitive.

`: partnum` – The Oracle-issued part number of the HIPR2 High Rate Mode feature, 893020101.

The `enable-ctrl-feat` command requires that the database contain a valid serial number for the EAGLE, and that this serial number is locked. This can be verified with the `rtrv-serial-num` command. The EAGLE is shipped with a serial number in the database, but the serial number is not locked. The serial number can be changed, if necessary, and locked once the EAGLE is on-site, with the `ent-serial-num` command. The `ent-serial-num` command uses these parameters.

`: serial` – The serial number assigned to the EAGLE. The serial number is not case sensitive.

`: lock` – Specifies whether or not the serial number is locked. This parameter has only one value, `yes`, which locks the serial number. Once the serial number is locked, it cannot be changed.

Note: To enter and lock the EAGLE's serial number, the `ent-serial-num` command must be entered twice, once to add the correct serial number to the database with the `serial` parameter, then again with the `serial` and the `lock=yes` parameters to lock the serial number. You should verify that the serial number in the database is correct before locking the serial number. The serial number can be found on a label affixed to the control shelf (shelf 1100).

This feature cannot be temporarily enabled (with the temporary feature access key).

Once this feature is enabled, the feature must be turned on with the `chg-ctrl-feat` command. The `chg-ctrl-feat` command uses these parameters.

`: partnum` – The Oracle-issued part number of the HIPR2 High Rate Mode feature, 893020101.

`: status=on` – used to turn the HIPR2 High Rate Mode feature on.

Caution: The HIPR2 High Rate Mode feature cannot be turned off if any of these conditions are present.

- The IMT Rate Change sequence is being performed.
 - The Extended Bit Rate Test (BERT) is being performed.
 - Any of the cards in card locations 9 and 10 in each shelf are being flashed with the `init-flash` command.
-

Once the HIPR2 High Rate Mode feature has been turned on, it can be turned off. For more information on turning the HIPR2 High Rate Mode feature off, perform [Turning Off the HIPR2 High Rate Mode Feature](#).

The status of the features in the EAGLE is shown with the `rtrv-ctrl-feat` command.

When the HIPR2 High Rate Mode feature is turned on, the throughput of the IMT bus is increased to 2.5 Gbps. If the HIPR2 High Rate Mode feature is not turned on, the throughput of the IMT bus is limited to 1 Gbps. To turn the the HIPR2 High Rate Mode feature on, all the cards in card locations 9 and 10 in each shelf must be HIPR2 cards.

1. Display the status of the controlled features by entering the `rtrv-ctrl-feat` command. The following is an example of the possible output.

```
rlghncxa03w 09-07-28 21:15:37 GMT EAGLE5 41.1.0
The following features have been permanently enabled:
```

Feature Name	Partnum	Status	Quantity
Command Class Management	893005801	on	----
LNP Short Message Service	893006601	on	----
Intermed GTT Load Sharing	893006901	on	----
XGTT Table Expansion	893006101	on	400000
XMAP Table Expansion	893007710	off	----
Large System # Links	893005910	on	2000
Routesets	893006401	on	6000
HC-MIM SLK Capacity	893012707	on	64

```
The following features have been temporarily enabled:
```

Feature Name	Partnum	Status	Quantity	Trial Period Left
Zero entries found.				

```
The following features have expired temporary keys:
```

Feature Name	Partnum
Zero entries found.	

If the HIPR2 High Rate Mode feature is enabled and turned on, no further action is necessary. This procedure does not need to be performed.

If the HIPR2 High Rate Mode feature is enabled and but not turned on, continue the procedure with [7](#).

If the HIPR2 High Rate Mode feature is not enabled, continue the procedure by performing one of these steps.

- If the `rtrv-ctrl-feat` output shows the HC-MIM SLK Capacity feature with a quantity of 64 and other features, continue the procedure with [6](#).
 - If the `rtrv-ctrl-feat` output shows only the **HC-MIMSLK** Capacity feature with a quantity of 64, continue the procedure with [2](#).
2. Display the serial number in the database with the `rtrv-serial-num` command. This is an example of the possible output.

```
rlghncxa03w 09-07-28 21:15:37 GMT EAGLE5 41.1.0
System serial number = nt00001231
```

System serial number is not locked.

```
rlghncxa03w 09-07-28 21:15:37 GMT EAGLE5 41.1.0
Command Completed
```

Note: If the serial number is correct and locked, continue the procedure with [6](#). If the serial number is correct but not locked, continue the procedure with [5](#). If the serial number is not correct, but is locked, this feature cannot be enabled and the remainder of this procedure cannot be performed. Contact the Customer Care Center to get an incorrect and locked serial number changed. Refer to [My Oracle Support \(MOS\)](#) for the contact information. The serial number can be found on a label affixed to the control shelf (shelf 1100).

3. Enter the correct serial number into the database using the `ent-serial-num` command with the `serial` parameter.

For this example, enter this command.

```
ent-serial-num:serial=<EAGLE's correct serial number>
```

When this command has successfully completed, the following message should appear.

```
rlghncxa03w 09-07-28 21:15:37 GMT EAGLE5 41.1.0
ENT-SERIAL-NUM:  MASP A - COMPLTD
```

4. Verify that the serial number entered into [3](#) was entered correctly using the `rtrv-serial-num` command. This is an example of the possible output.

```
rlghncxa03w 09-07-28 21:15:37 GMT EAGLE5 41.1.0
System serial number = nt00001231
```

System serial number is not locked.

```
rlghncxa03w 09-07-28 21:15:37 GMT EAGLE5 41.1.0
Command Completed
```

If the serial number was not entered correctly, repeat [3](#) and [4](#) and re-enter the correct serial number.

5. Lock the serial number in the database by entering the `ent-serial-num` command with the serial number shown in [2](#), if the serial number shown in [2](#) is correct, or with the serial number shown in [4](#), if the serial number was changed in [3](#), and with the `lock=yes` parameter.

For this example, enter this command.

```
ent-serial-num:serial=<EAGLE's serial number>:lock=yes
```

When this command has successfully completed, the following message should appear.

```
rlghncxa03w 09-07-28 21:15:37 GMT EAGLE5 41.1.0
ENT-SERIAL-NUM: MASP A - COMPLTD
```

6. Enable the HIPR2 High Rate Mode feature with the `enable-ctrl-feat` command specifying the part number for the HIPR2 High Rate Mode feature and the feature access key. Enter this command.

```
enable-ctrl-feat:partnum=893020101:fak=<HIPR2 High Rate Mode
feature access key>
```

The HIPR2 High Rate Mode feature cannot be enabled with a temporary feature access key.

The values for the feature access key (the `fak` parameter) are provided by Oracle. If you do not have the feature access key for the HIPR2 High Rate Mode feature, contact your Oracle Sales Representative or Account Representative.

When the `enable-ctrl-feat` command has successfully completed, this message should appear.

```
rlghncxa03w 09-07-28 21:15:37 GMT EAGLE5 41.1.0
ENABLE-CTRL-FEAT: MASP B - COMPLTD
```

If you do not wish to turn the HIPR2 High Rate Mode feature on at this time, continue the procedure with [9](#).

If you wish to turn the HIPR2 High Rate Mode feature, continue the procedure with [7](#).

7. To turn the HIPR2 High Rate Mode feature on, all the cards in card locations 9 and 10 in each shelf must be HIPR2 cards. Enter these commands to verify that cards that are in card locations 9 and 10 in each shelf.

- a. To verify if HIPR2 cards are in card locations 9 and 10, enter this command.

```
rept-stat-gpl:gpl=hipr2
```

This is an example of the possible output.

```
rlghncxa03w 09-07-01 11:40:26 GMT EAGLE5 41.1.0

GPL      CARD  RUNNING      APPROVED      TRIAL
HIPR2    1309  132-003-000  132-003-000  132-002-000
HIPR2    1310  132-003-000  132-003-000  132-002-000
HIPR2    2109  132-003-000  132-003-000  132-002-000
HIPR2    2100  132-003-000  132-003-000  132-002-000
Command Completed
```

If no cards running the specified GPL are installed, the `rept-stat-gpl` output shows no entries, as shown in this example.

```
rlghncxa03w 09-07-01 11:40:26 GMT EAGLE5 41.1.0
```

```
GPL      CARD  RUNNING      APPROVED      TRIAL
```

Command Completed

If card locations 9 and 10 in all shelves contain HIPR2 cards, continue the procedure with 8.

If card locations 9 and 10 in any shelves contain HMUX or HIPR cards, perform the procedures in *Installation Guide* to replace the HMUX or HIPR cards with HIPR2 cards. After the HIPR2 cards have been installed, continue the procedure with 8.

8. Turn the HIPR2 High Rate Mode feature on with the `chg-ctrl-feat` command specifying the part number for the HIPR2 High Rate Mode feature and the `status=on` parameter. Enter this command.

Caution: The HIPR2 High Rate Mode feature cannot be turned off if any of these conditions are present.

- The IMT Rate Change sequence is being performed.
 - The Extended Bit Rate Test (BERT) is being performed.
 - Any of the cards in card locations 9 and 10 in each shelf are being flashed with the `init-flash` command.
-

```
chg-ctrl-feat:partnum=893020101:status=on
```

When the `chg-ctrl-feat` command has successfully completed, this message should appear.

```
rlghncxa03w 09-07-28 21:15:37 GMT EAGLE5 41.1.0
CHG-CTRL-FEAT: MASP B - COMPLTD
```

9. Verify the changes by entering the `rtrv-ctrl-feat` command with the HIPR2 High Rate Mode feature part number. Enter this command.

```
rtrv-ctrl-feat:partnum=893020101
```

The following is an example of the possible output.

```
rlghncxa03w 09-07-28 21:15:37 GMT EAGLE5 41.1.0
The following features have been permanently enabled:
```

Feature Name	Partnum	Status	Quantity
HIPR2 High Rate Mode	893020101	on	----

The following features have been temporarily enabled:

Feature Name	Partnum	Status	Quantity	Trial Period Left
Zero entries found.				

The following features have expired temporary keys:

Feature Name	Partnum
Zero entries found.	

10. Backup the new changes using the `chg-db:action=backup:dest=fixed` command. These messages should appear, the active **Maintenance and Administration Subsystem Processor (MASP)** appears first.

```
BACKUP (FIXED) : MASP A - Backup starts on active MASP.  
BACKUP (FIXED) : MASP A - Backup on active MASP to fixed disk complete.  
BACKUP (FIXED) : MASP A - Backup starts on standby MASP.  
BACKUP (FIXED) : MASP A - Backup on standby MASP to fixed disk complete.
```

Figure A-6 Activating the HIPR2 High Rate Mode Feature

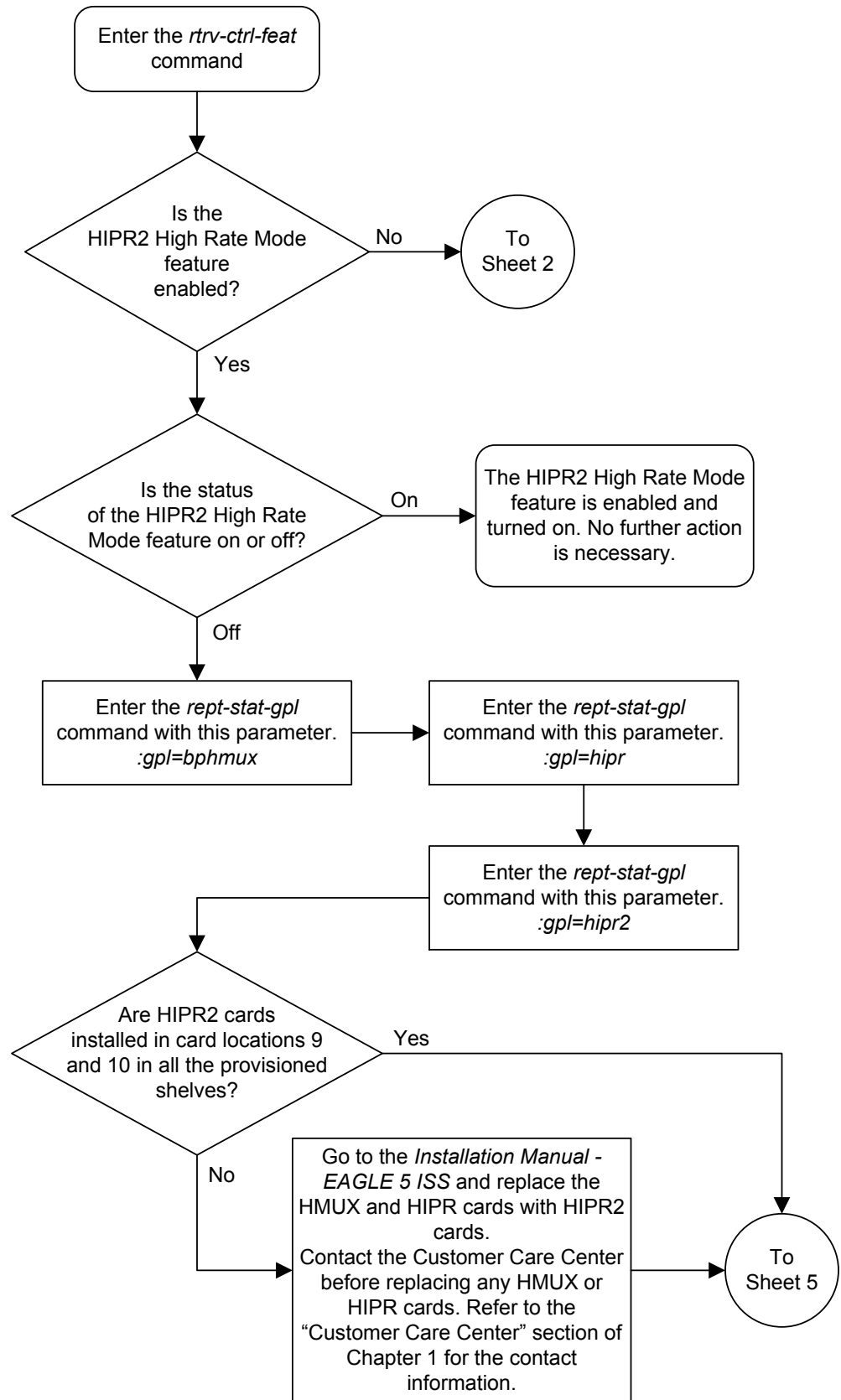

Sheet 1 of 5

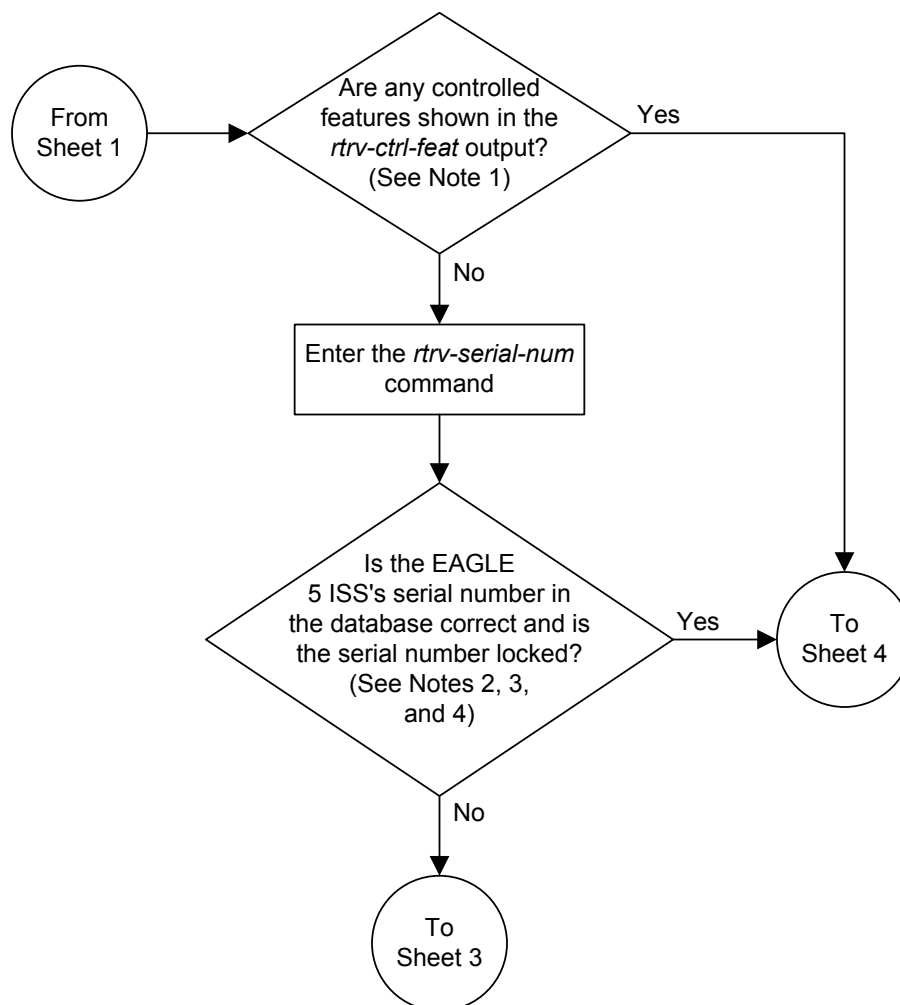

Notes:

1. If the *rtrv-ctrl-feat* output shows only the HC-MIM SLK Capacity feature with a quantity of 64, the answer to this question is no and the Eagle 5 ISS's serial number must be verified. This is the default entry for the *rtrv-ctrl-feat* output. This entry is shown whether or not the Eagle 5 ISS's serial number is in the database.
2. If the serial number is locked, it cannot be changed.
3. If the serial number is not locked, the controlled feature cannot be enabled.
4. The serial number can be found on a label affixed to the control shelf (shelf 1100).

Sheet 2 of 5

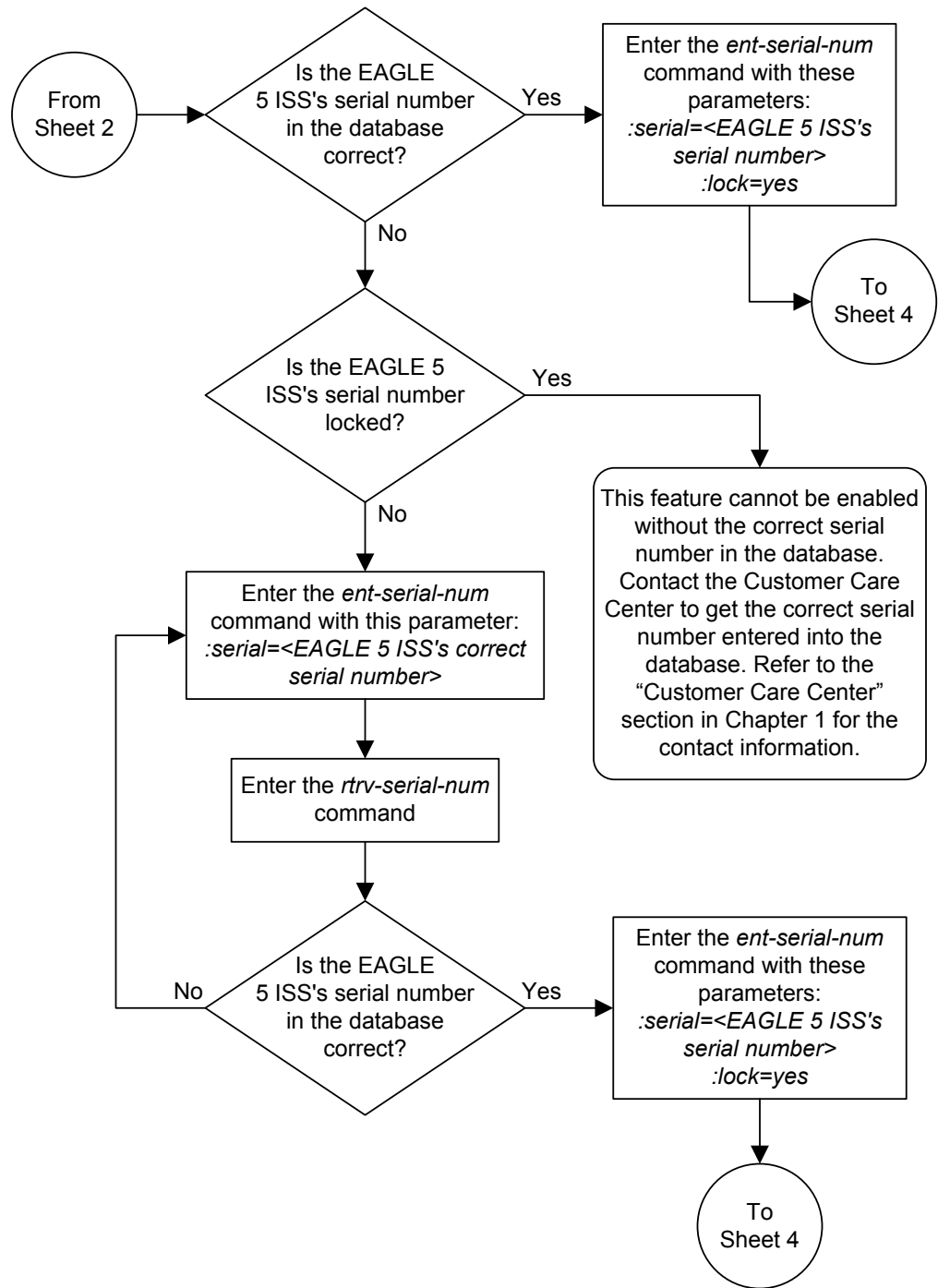

Sheet 3 of 5

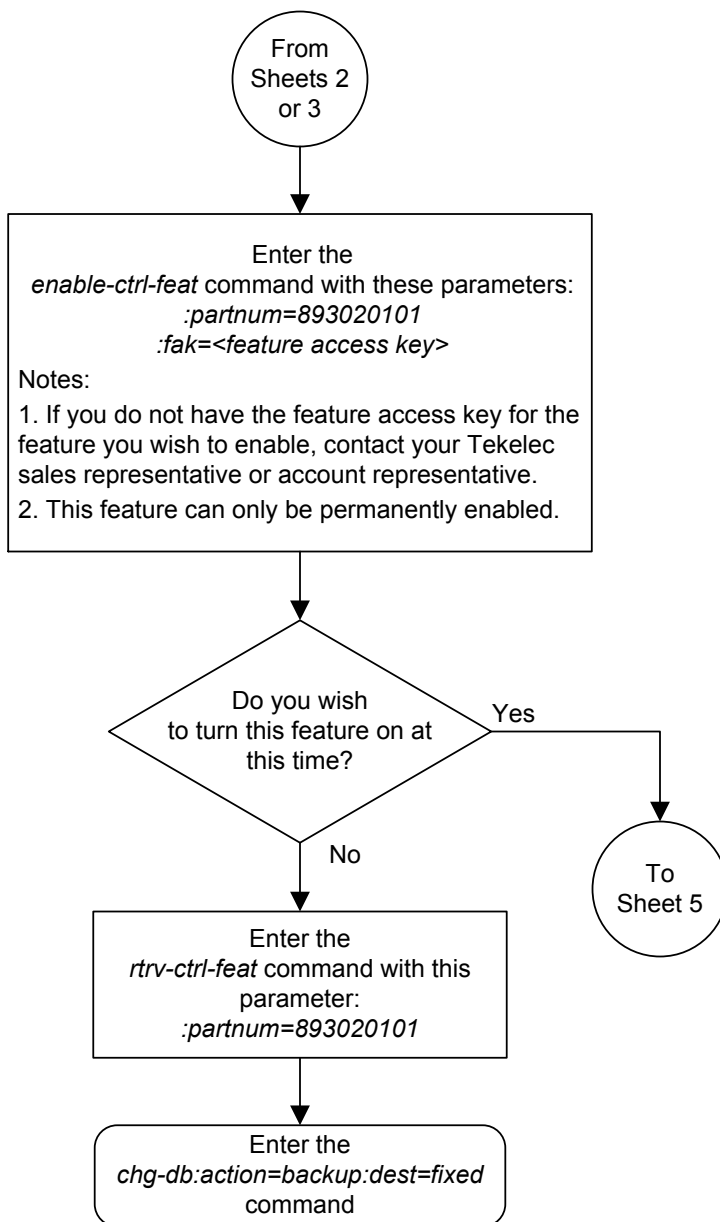

Sheet 4 of 5

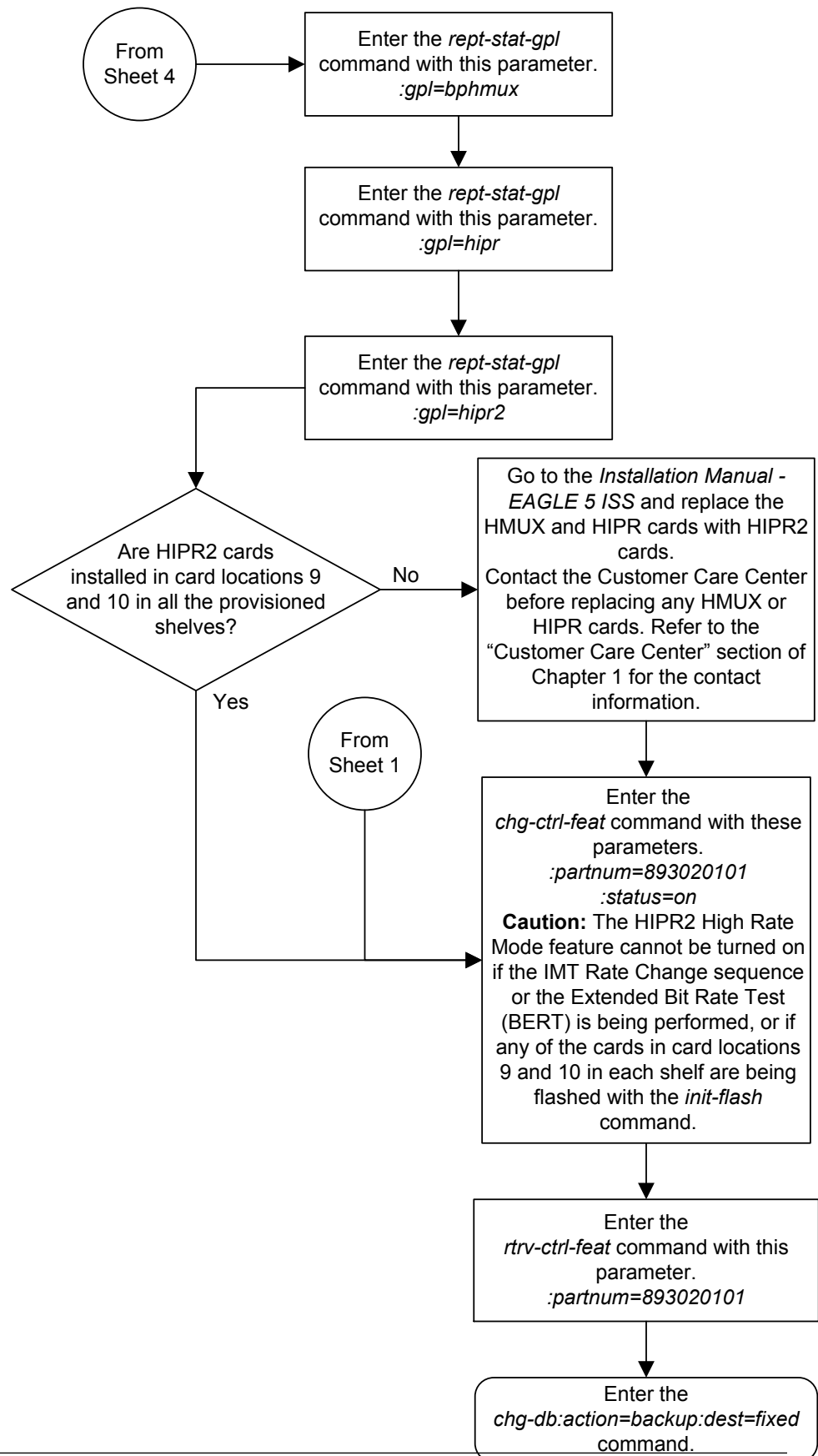

Turning Off the HIPR2 High Rate Mode Feature

This procedure is used to turn off the HIPR2 High Rate Mode feature, using the `chg-ctrl-feat` command.

Caution: The HIPR2 High Rate Mode feature cannot be turned off if any of these conditions are present.

- The IMT Rate Change sequence is being performed.
 - The Extended Bit Rate Test (BERT) is being performed.
 - The total provisioned system TPS value is greater than 500,000.
 - Any of the cards in card locations 9 and 10 in each shelf are being flashed with the `init-flash` command.
-
-

The `chg-ctrl-feat` command uses the following parameters:

`:partnum` - The part number of the HIPR2 High Rate Mode feature, 893020101.

`:status=off` - used to turn off the HIPR2 High Rate Mode feature.

The status of the HIPR2 High Rate Mode feature must be on and is shown with the `rtrv-ctrl-feat` command.

Caution: If the HIPR2 High Rate Mode feature is turned off, the throughput rate for the IMT bus is limited to 1 Gbps.

1. Display the status of the HIPR2 High Rate Mode feature by entering the `rtrv-ctrl-feat:partnum=893020101` command.

The following is an example of the possible output.

```
rlghncxa03w 09-07-28 21:15:37 GMT EAGLE5 41.1.0
The following features have been permanently enabled:
```

Feature Name	Partnum	Status	Quantity
HIPR2 High Rate Mode	893020101	on	----

```
The following features have been temporarily enabled:
```

Feature Name	Partnum	Status	Quantity	Trial Period Left
Zero entries found.				

```
The following features have expired temporary keys:
```

Feature Name	Partnum
Zero entries found.	

If the status of the HIPR2 High Rate Mode feature is off, or if the HIPR2 High Rate Mode feature is not enabled, this procedure cannot be performed.

2. Display the maximum system IP TPS value by entering the `rtrv-tps` command.

The following is an example of the possible output.

```
rlghncxa03w 10-07-28 21:15:37 GMT EAGLE5 42.0.0

CARD      NUM      NUM      RSVD      MAX
TYPE     CARDS   LINKS    TPS       TPS
-----
IPGW      9        8        32000     40000
IPSG     100      16       80000     80000
IPLIM     1         0         0         0
ATM       0         0         0         0

Total provisioned System TPS (120000 of 500000) 24%

Command Completed.
```

If the maximum system IP TPS value is greater than 500,000, this procedure cannot be performed.

3. Turn off the HIPR2 High Rate Mode feature by entering the `chg-ctrl-feat` command with the `status=off` parameter.

For example, enter this command.

```
chg-ctrl-feat:partnum=893020101:status=off
```

When this command has successfully completed, the following message should appear.

```
rlghncxa03w 09-07-28 21:16:37 GMT EAGLE5 41.1.0
CHG-CTRL-FEAT: MASP A - COMPLTD
```

4. Verify that the HIPR2 High Rate Mode feature has been turned off by using the `rtrv-ctrl-feat:partnum=893020101` command. The following is an example of the possible output.

```
rlghncxa03w 09-07-28 21:15:37 GMT EAGLE5 41.1.0
The following features have been permanently enabled:
```

Feature Name	Partnum	Status	Quantity
HIPR2 High Rate Mode	893020101	off	----

The following features have been temporarily enabled:

Feature Name	Partnum	Status	Quantity	Trial Period Left
Zero entries found.				

The following features have expired temporary keys:

Feature Name	Partnum
Zero entries found.	

5. Backup the new changes using the `chg-db:action=backup:dest=fixed` command.

These messages should appear, the active **Maintenance and Administration Subsystem Processor (MASP)** appears first.

BACKUP (FIXED) : MASP A - Backup starts on active MASP.
BACKUP (FIXED) : MASP A - Backup on active MASP to fixed disk complete.
BACKUP (FIXED) : MASP A - Backup starts on standby MASP.
BACKUP (FIXED) : MASP A - Backup on standby MASP to fixed disk complete.

Figure A-7 Turning Off the HIPR2 High Rate Mode Feature

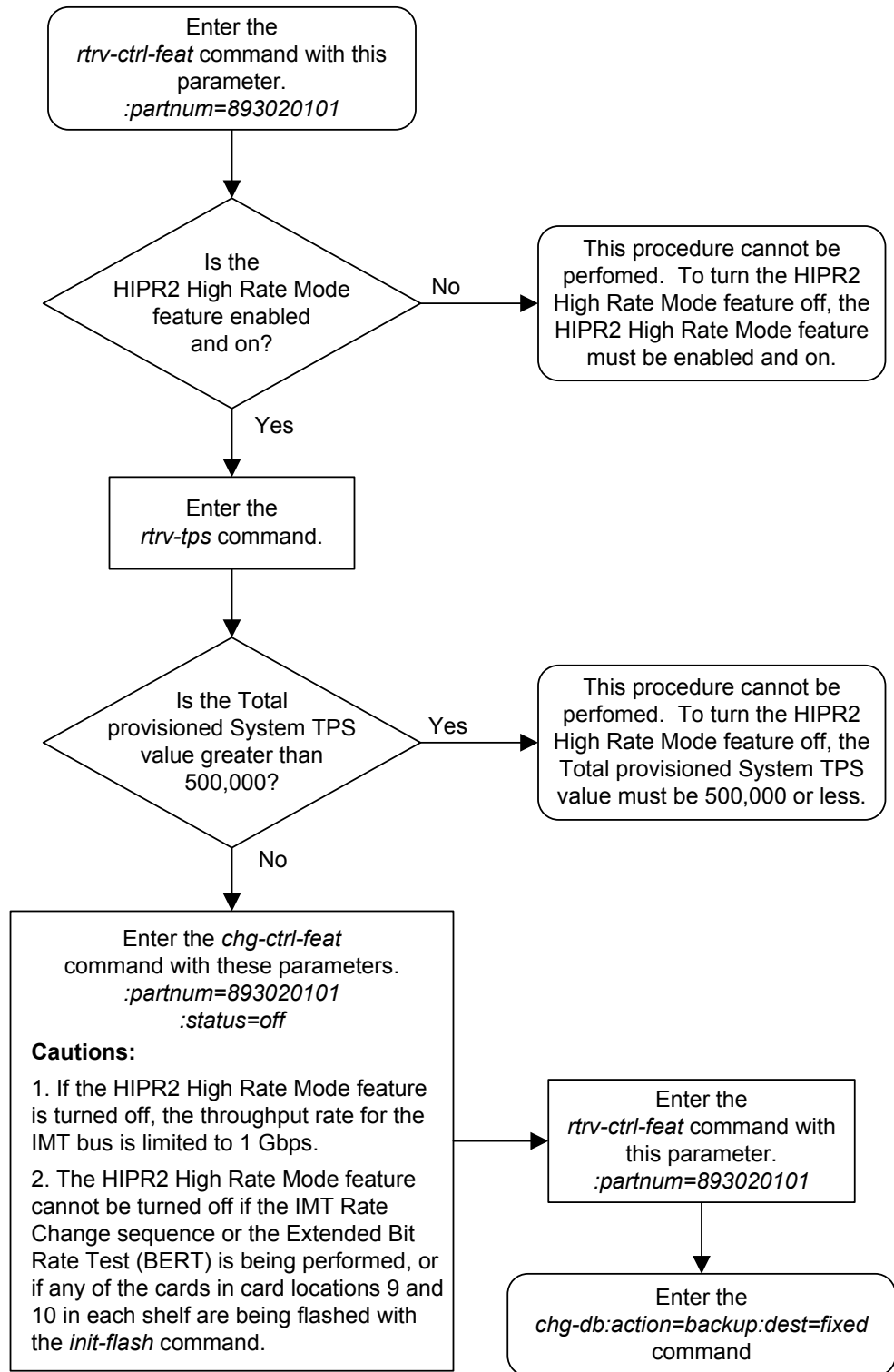

Setting Up a Secure Telnet Connection to the EAGLE using PuTTY

Appendix B, Setting Up a Secure Telnet Connection to the EAGLE using PuTTY contains the procedure for setting a secure telnet connection to the EAGLE using PuTTY.

Setting Up a Secure Telnet Connection to the EAGLE using PuTTY

This appendix describes the steps to set up a Telnet connection to to the EAGLE using the PuTTY client program.

The PuTTY client program must be installed on the machine that will be connecting to the EAGLE before this procedure can be performed. The PuTTY client program can be obtained at this website.

<http://www.chiark.greenend.org.uk/~sgtatham/putty/download.html>

Note: The examples shown in this procedure are based on version 0.58 of the PuTTY client program.

1. Start the PuTTY client program by double clicking the PuTTY icon on the desktop.

The **PuTTY Configuration Window** is displayed. See [Figure B-1](#).

Figure B-1 PuTTY Configuration Window - Initial Session Setup

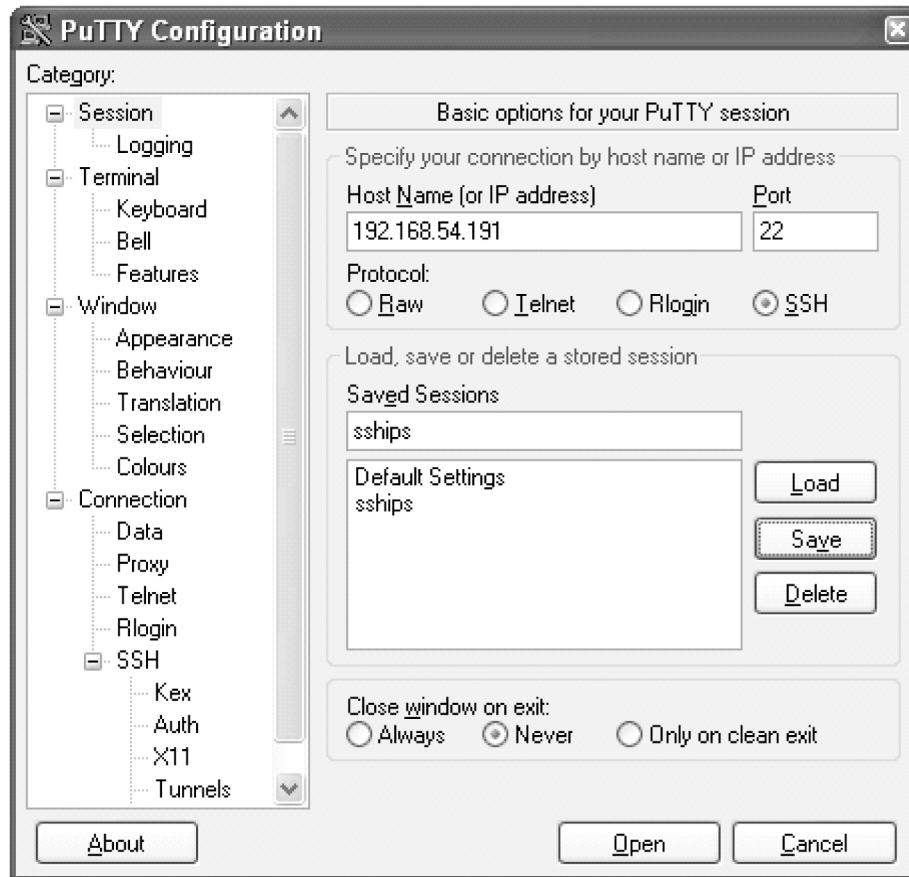

2. Select **Session** in the **Category** list window in the **PuTTY Configuration** window.
3. Enter the **IP** address of the **IPSM** in the **EAGLE** that is provisioned as a secure **SSHD** server in the **Host Name (or IP Address)** box.
Enter 22 in the **Port** box.
4. Click the **SSH** radio button for the **Protocol** selection.
5. Enter a name for this session in the **Saved Sessions** box, for example, `sships`.
6. Click the **Never** radio button for the **Close window on exit** option.
7. Click the **Save** button to save this session.

For this example, clicking the **Save** button saves the `sships` session.

8. Select **Connection > SSH** in the **Category** list window in the **PuTTY Configuration** window.

See [Figure B-2](#).

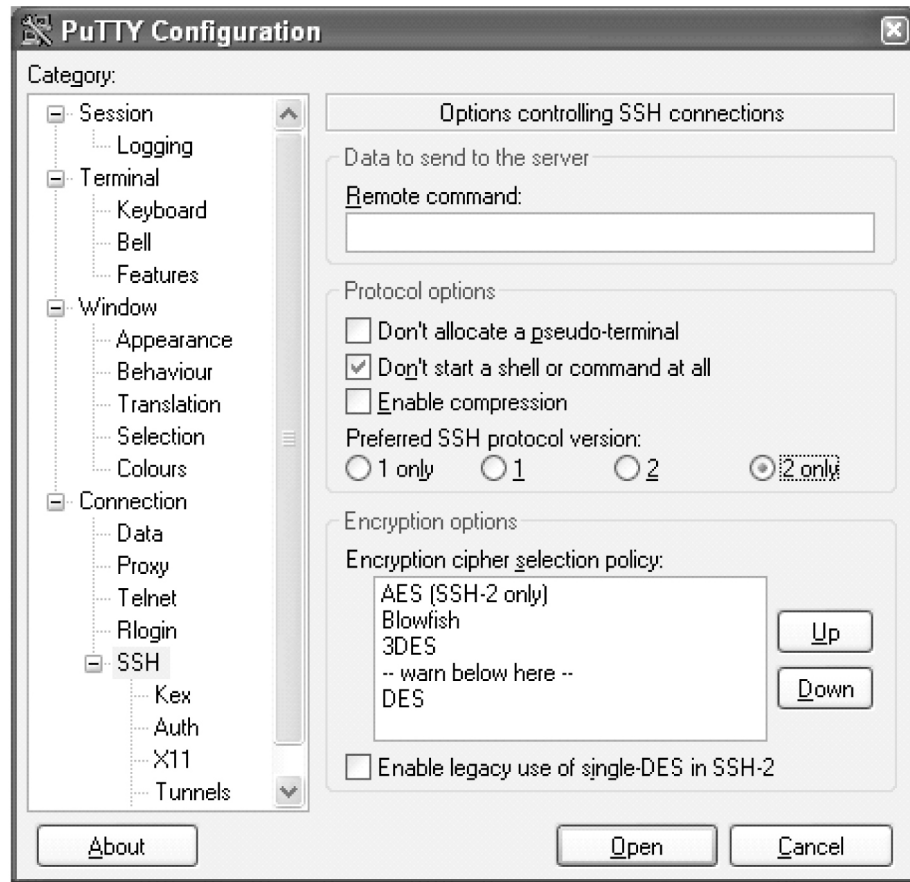
Figure B-2 PuTTY Configuration Window - SSH Connection Setup

9. Click the **2 only** radio button in the **Preferred SSH protocol version:** section of the **PuTTY Configuration** window.

Click the **Don't start a shell or command at all** checkbox in the Protocol options section of the **PuTTY Configuration** window. See [Figure B-2](#).

10. Select **Connection > SSH > Auth**.

Verify that the checkboxes are not checked. Verify that the **Private key file for authentication** text box is empty. See [Figure B-3](#).

Figure B-3 PuTTY Configuration Window - SSH Auth Setup

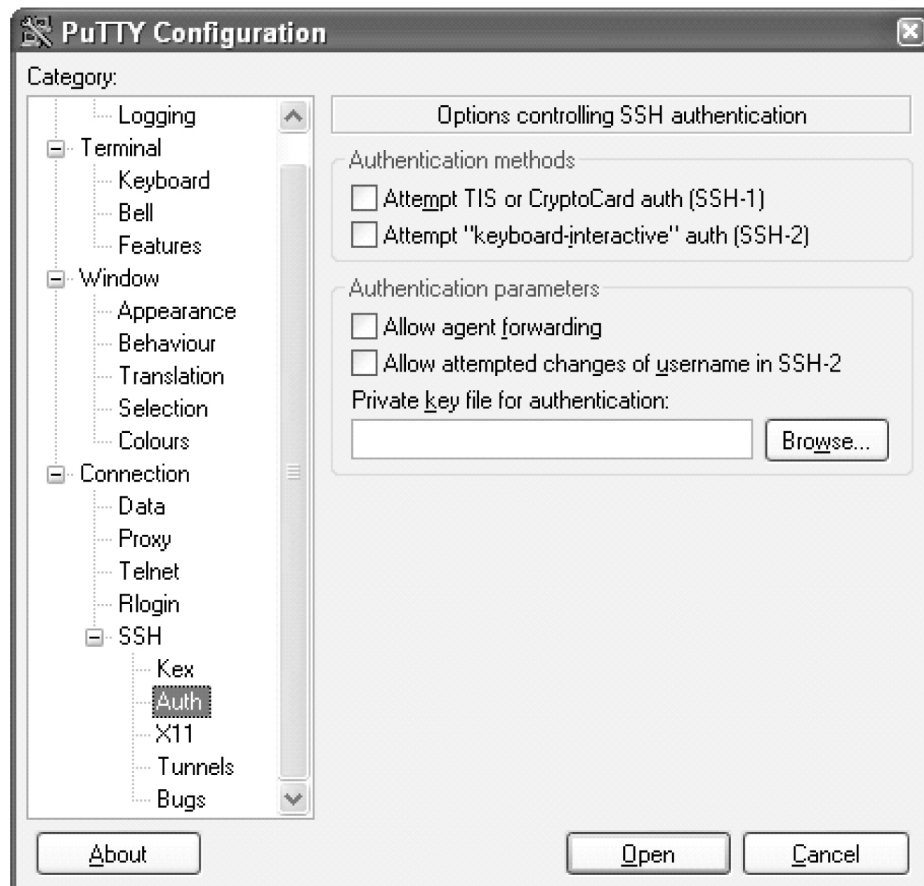

11. Select Connection > SSH > Tunnels.

Click the **Local ports accept connections from other hosts** check box in the **Port Forwarding** section of the **PuTTY Configuration** window (Figure B-4), to accept connections from other hosts.

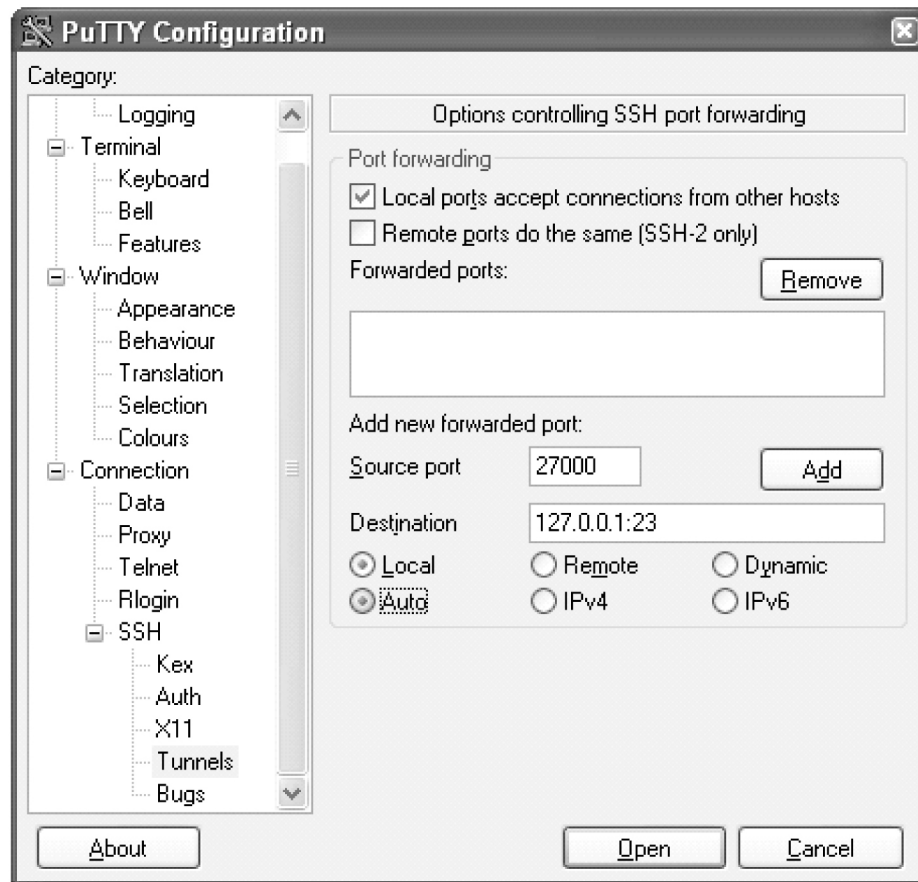
Figure B-4 PuTTY Configuration Window - SSH Tunnel/Port Forwarding Setup

12. In the **Add new forwarded port** section of the **PuTTY Configuration** window (Figure B-4), click the **Local** radio button.

Enter the forwarding port on the local machine in the **Source port** box. The **Source port** value must be greater than 1024 and must be available.

13. The **Destination** box in the **Add new forwarded port** section of the **PuTTY Configuration** window (Figure B-4) contains the IP address and port of the remote machine.

The forwarding port on the local machine communicates with the IP address and port shown in the **Destination** box. Enter the IP address and port of the remote machine in the **Destination** box.

The forwarding port on the local machine communicates with the IP address and port shown in the **Destination** box. Enter 127.0.0.1:23 in the **Destination** box.

14. Click the **Add** button in the **Add new forwarded port** section of the **PuTTY Configuration** window to complete adding the forwarded port information.

The forwarding port (**Source port** value) and the IP address and port of the remote machine (the **Destination** value) appear in the **Forwarded ports:** box and the **Source port** and **Destination** boxes are empty. See Figure B-5.

Figure B-5 PuTTY Configuration Window - SSH Tunnel/Port Forwarding Completion

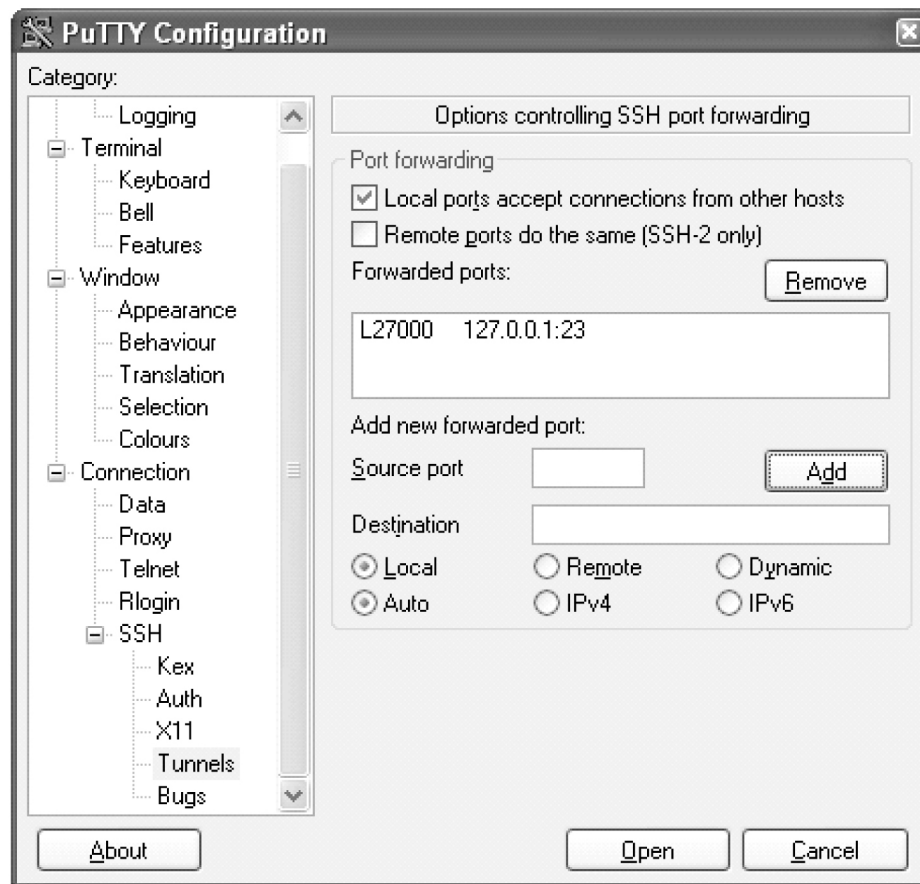

15. Select **Session** in the **Category** list window in the **PuTTY Configuration** window.

See [Figure B-1](#). Click the **Save** button.

16. Click the **Open** button in the **PuTTY Configuration** window.

The dialog box shown in [Figure B-6](#) appears. Click the **Yes** button.

Figure B-6 Key Acceptance Dialog Box



The **Login** window is displayed. See [Figure B-7](#).

Figure B-7 PuTTY Login Window



17. Press the **Enter** key.

Verify that the screen is displayed as shown in [Figure B-8](#).

Figure B-8 Logged in Window for SSH Session



Press the **Enter** key at the prompt to allow an empty login. Minimize this window.

Note: This window must not be closed until all the testing is complete and you decide to shutdown the secure shell connection to the EAGLE.

18. Initiate a telnet connection to the local host at the forwarded port configured in step 14 (see [Figure B-5](#)).

At the prompt, enter the `telnet` command with the **IP** address and Source port value shown in [Figure B-5](#). For this example, enter the `telnet` command with the **IP** address 127.0.0.1 and the source port value 27000, as shown in [Figure B-9](#). Press the **Enter** key.

Figure B-9 Telnet Connection to Local Host Forwarded Port

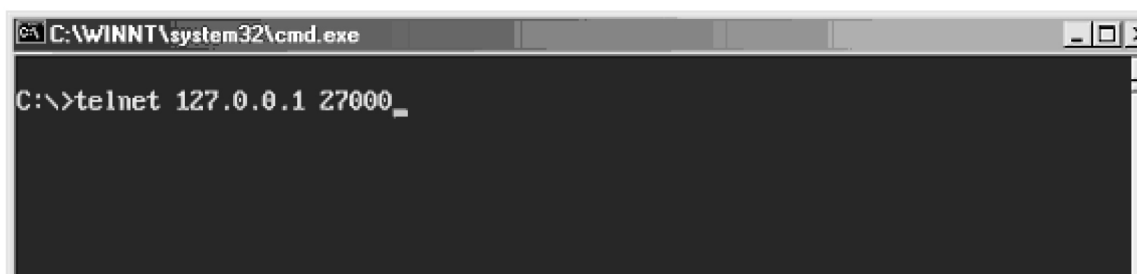

19. The connection to the EAGLE is established and functions as any other telnet terminal connected to the EAGLE.

- 20.** Verify that all the eight telnet connections assigned to this IPSM can be opened and all EAGLE commands that are allowed to be executed from a telnet terminal can be executed from the telnet terminals assigned to the IPSM.

This procedure is finished.

Setting Up a Secure Telnet Connection to the EAGLE using OpenSSH

Appendix C, Setting Up a Secure Telnet Connection to the EAGLE using OpenSSH describes the procedures for setting a secure telnet connection to the EAGLE using OpenSSH.

Introduction

This appendix contains the procedures for establishing a secure telnet connection to the EAGLE using OpenSSH. Perform these procedures.

- If a Windows machine will be used to make the connection, perform these procedures.
 - [Install the Windows OpenSSH Software](#) to install the software.
 - [Establishing a Secure Telnet Connection to the EAGLE using Windows OpenSSH](#) to establish the connection.
- If a UNIX/Solaris machine will be used to make the connection, perform these procedures.
 - [Install the UNIX/Solaris OpenSSH Software](#) to install the software.
 - [Establishing a Secure Telnet Connection to the EAGLE using UNIX/Solaris OpenSSH](#) to establish the connection.

Before establishing the secure connection to the EAGLE, the EAGLE needs to be configured with these items.

- IPSMs that are in service and containing IP addresses for each IPSM. The IP router on the IPSM must be configured if the client is using a different subnet.
- The Eagle OA&M Security Enhancement feature must be enabled and turned on.

Enter these commands on the EAGLE to verify the IPSM and feature configuration.

- `rtrv-ip-lnk` - shows the IP addresses assigned to the IPSM, in the `IPADDR` column
- `rtrv-ip-card` - shows the IP router, in the `DEFROUTER` field.
- `rept-stat-card` - shows the state of the IPSM, in the `PST` column
- `pass:loc=<IPSM card Location>:cmd="netstat -a"` - shows the state of the ports 22 and 23 on the IPSM, in the `(state)` column. If the IPSM is configured correctly, the state of these ports will be `LISTEN`.

- `rtrv-ctrl-feat` - shows whether or not the Eagle OA&M Security Enhancement feature is enabled and turned on.

Perform the [Adding an E5-IPSM](#) procedure to configure the IP addresses of the IPSM, the IP router, and to put the IPSM in service. Perform the [Activating the EAGLE OA&M IP Security Enhancement Controlled Feature](#) to enable and turn on the Eagle OA&M Security Enhancement feature.

Install the Windows OpenSSH Software

To install the software on a Windows machine, perform these steps.

1. Go to this site: http://sourceforge.net/project/showfiles.php?group_id103886&package_id=111688.
2. Select the `setupssh381-20040709.zip` file and download the file.
3. After the file has been downloaded, run the installer and install all the components.

The recommended folder for installing the components is `C:\OpenSSH`.

After installing the software, this warning may be displayed.

Figure C-1 OpenSSH Warning Window



Click the OK button and perform the [Establishing a Secure Telnet Connection to the EAGLE using Windows OpenSSH](#) procedure.

Establishing a Secure Telnet Connection to the EAGLE using Windows OpenSSH

To establish a secure telnet connection to the EAGLE using OpenSSH, perform these steps.

1. Open two DOS windows.
2. In DOS window 1, go to the `bin` folder in the folder where the OpenSSH software was installed.

For this example, enter this command

```
cd C:\OpenSSH\bin
```

3. In DOS window 1, enter the `ssh` command with these options and values.
 - `-N` - once the authentication is complete, the `ssh` program executes in the background, meaning the prompt should be returned so that the `telnet` command can be entered.
 - `-f`

- -L
- the local/forwarding port number, for this example, 23000
- the local loopback address, 127.0.0.1:23. Port 23 is reserved for `ssh`.
- The IP address of the EAGLE IPSM. For this example, 10:253.104.36.

For this example, enter this command.

```
ssh -N -f -L 23000:127.0.0.1:23 10:253.104.36
```

Note:

- a. When issuing the `ssh` command, if the IPSM on the EAGLE has undergone a hard reset, the `ssh` key stored in the `local_host` file must be purged.
 - b. If you are making the connection to the EAGLE for the first time, and you are prompted to accept the `ssh` key, accept the `ssh` key and proceed to 4
-
-

4. In DOS window 2, enter the `telnet` command with the the local loopback address, without the port number, the local/forwarding port number specified in 3. for this example, enter this command.

```
telnet 127.0.0.1 23000
```

5. When the Eagle prompt is received in DOS window 2, choose an EAGLE terminal and login with your EAGLE username and password.
6. If you wish to establish another secure telnet connection to the EAGLE, perform 3 with a different local/forwarding port number, then perform 4 using the local/forwarding port number specified in 3.
7. To logout of the EAGLE and close the secure telnet connection, perform these actions.
 - At the EAGLE, enter the `logout` command.
 - Press the `Ctrl+]` keys to receive the telnet prompt.
 - Enter `quit`.
 - The prompt in DOS window 2 goes to `C:\`.
 - The `ssh` command in DOS window 1 goes away and the prompt returns to `\C:`.

Install the UNIX/Solaris OpenSSH Software

To install the software on a UNIX/Solaris machine, perform these steps.

1. The software can also be found at various mirror sites. These sites can be found at this address:

<http://www.openssh.org/portable.html#http>

If you wish to use one of the other mirror sites, select the closest mirror site.

2. Download this file, `openssh-3.7.1p1.tar.gz`, from the site selected in 1.
3. After the file has been downloaded, run the installer and install all the components.

After the software has been installed, perform the [Establishing a Secure Telnet Connection to the EAGLE using UNIX/Solaris OpenSSH](#) procedure.

Establishing a Secure Telnet Connection to the EAGLE using UNIX/Solaris OpenSSH

To establish a secure telnet connection to the EAGLE using OpenSSH from a UNIX/Solaris machine, perform these steps.

1. Open an Xterm window.
2. In the Xterm window, go to the `bin` folder in the folder where the OpenSSH software was installed.

For this example, enter this command

```
cd <install path>/OpenSSH/bin
```

3. In the Xterm window, enter the `ssh` command with these options and values.
 - `-N` - once the authentication is complete, the `ssh` program executes in the background, meaning the prompt should be returned so that a second command can be entered following the semicolon.
 - `-f`
 - `-L`
 - the local/forwarding port number, for this example, 23000
 - the local loopback address, 127.0.0.1:23. Port 23 is reserved for `ssh`.
 - The IP address of the EAGLE IPSM. For this example, 10:253.104.36.
 - The `telnet` command with the local loopback address, without the port number, and the local/forwarding port number.

For this example, enter this command.

```
ssh -N -f -L 23000:127.0.0.1:23 10:253.104.36; telnet  
127.0.0.1 23000
```

Note:

- a. On Solaris 9 and later, SunSSH is installed. SunSSH is not compatible with the EAGLE secure Telnet terminals. If you have any questions about which version of `ssh` is being invoked, enter the Unix command `which ssh` to ensure that OpenSSH is being used instead of the Sun version.
 - b. When issuing the `ssh` command, if the IPSM on the EAGLE has undergone a hard reset, the `ssh` key stored in the `local_host` file must be purged.
 - c. If you are making the connection to the EAGLE for the first time, and you are prompted to accept the `ssh` key, accept the `ssh` key and proceed to 4.
-
4. When the Eagle prompt is received in the `xterm` window, choose an EAGLE terminal and login with your EAGLE username and password.
 5. To logout of the EAGLE and close the secure telnet connection, perform these actions.
 - At the EAGLE, enter the `logout` command.
 - Press the `Ctrl+]` keys to receive the telnet prompt.
 - Enter `quit`.

Remote Database Backup and Restore Procedures

Appendix D, Remote Database Backup and Restore Procedures, describes how to perform a backup of the database to the FTP server, and how to restore the database from the FTP server.

Introduction

This appendix contains the procedures for performing a backup of the database to the FTP server and to restore a database from the FTP server using the `chg-db` command.

To backup the database, the `chg-db` command uses these parameters.

- `action=backup` - perform a backup of the database.
- `dest=server` - the destination of the backup operation, the FTP server.

To restore the database, the `chg-db` command uses these parameters.

- `action=restore` - restore a previously backed up database.
- `src=server` - the source of the database that is being restored, the FTP server.
- `file` - the name of the TAR file on the DB FTP server that contains database that is being restored.

A removable cartridge is not required and cannot be used to backup the database to the FTP server or to restore a database from the FTP server.

To perform a backup of the database to the FTP server or to restore the database from the FTP server, these items must be provisioned in the database.

- An E5-IPSM - perform the procedure [Adding an E5-IPSM](#).

Note: As of Release 46.5, the E5-IPSM card and its functionality is replaced by the E5-ENET-B (p/n 870-2971-01) or SLIC (p/n 7094646) card. Any references to E5-IPSM and the 870-2877-01 part number should be replaced by the 46.5 and greater card and part number.

- An FTP server for the DB application - perform the procedure [Adding an FTP Server](#).

When the database is backed up to the FTP server, the database on the active partition of the active TDM is packed and compressed into a TAR file and sends the file to the FTP server through an E5-IPSM. [Figure D-1](#) illustrates this action.

Figure D-1 Backup of the Database to the FTP Server

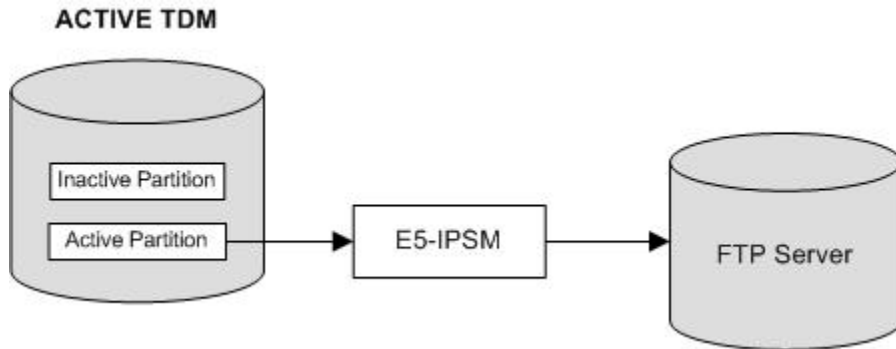

When the database is restored from the FTP server, the TAR that contains the database that is being restored is retrieved by EAGLE through an E5-IPSM. The TAR file is unpacked and uncompressed and the database files are placed on the active partition of both TDMs. [Figure D-2](#) illustrates this action. The EAGLE must be reinitialized to load the restored database to all the cards.

Figure D-2 Restoring the Database from the FTP Server

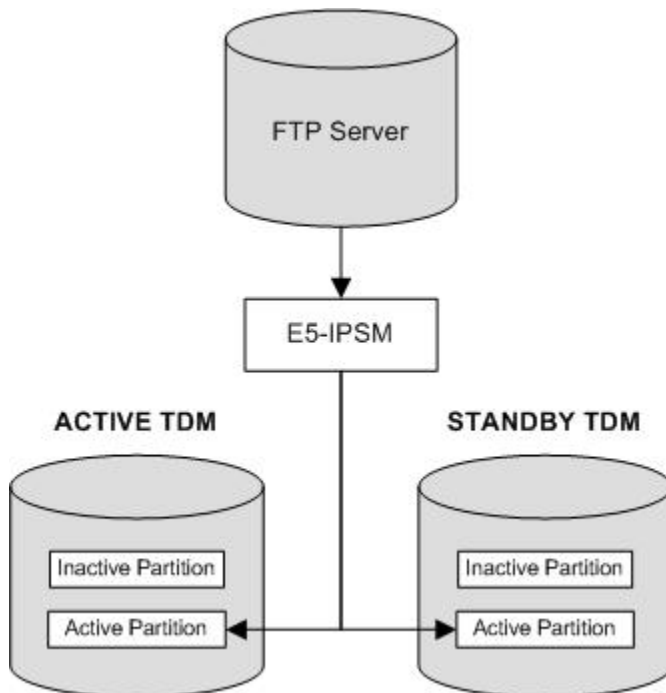

To perform a backup of the database to the FTP server, perform the procedure [Making a Backup of the Database to the FTP Server](#).

To restore the database from the FTP server, perform the procedure [Restoring the Database from the FTP Server](#).

Making a Backup of the Database to the FTP Server

This procedure is used to make a backup of the database to FTP server using the `chg-db` command with these parameters.

- `:action=backup`

APP	IPADDR	LOGIN	PRIO	PATH
db	10.20.50.102	dbuser1	1	~/eagle
dist	100.200.50.102	dbuser1	1	~/eagle
meas	1.255.0.100	ftpmeas3	3	~meas\local

If the entry db is shown in the APP column, continue the procedure with 4.

If the entry db is not shown in the APP column, perform the procedure [Adding an FTP Server](#) to add the FTP server. After the FTP server has been added, continue the procedure with 4.

4. Enter the `chg-db:action=backup:dest=server` command.

During command execution, these messages should appear.

```
BACKUP (SERVER): MASP A - Backup starts on active MASP.
BACKUP (SERVER) : Copy Database to card memory for processing.
BACKUP (SERVER) : Compress Database before archiving.
BACKUP (SERVER) : Send database archive to server.
BACKUP (SERVER): MASP A - Backup to remote server complete.
```

A file with the following naming convention is created.

```
"CLLI string"- "Release number string"- "yymmddhh".tar.gz
```

The CLI string is the CLI value shown in the output header. The release number string is the release number shown in the output header. If the `archbldid` option, shown in the `rtrv-stpopts` output, is set to `yes`, the release number string contains the build number instead of the release number. If you wish to change the `archbldid` option, perform the procedure [Configuring the Archive Build ID Option](#). The string `yymmddhh` is the year (yy - 2 digits), the month (mm), the day (dd), and the hour (hh) that the backup was performed. For example, the file name for a backup performed on September 26, 2008 at 12 noon would be:

```
r1ghncxa03w-39.2.0-08092612.tar.gz
```

The file name for the backup can contain a maximum of 39 alphanumeric characters. This file name will be needed to restore the database from the FTP server. Record this filename.

Figure D-3 Making a Backup of the Database to the FTP Server

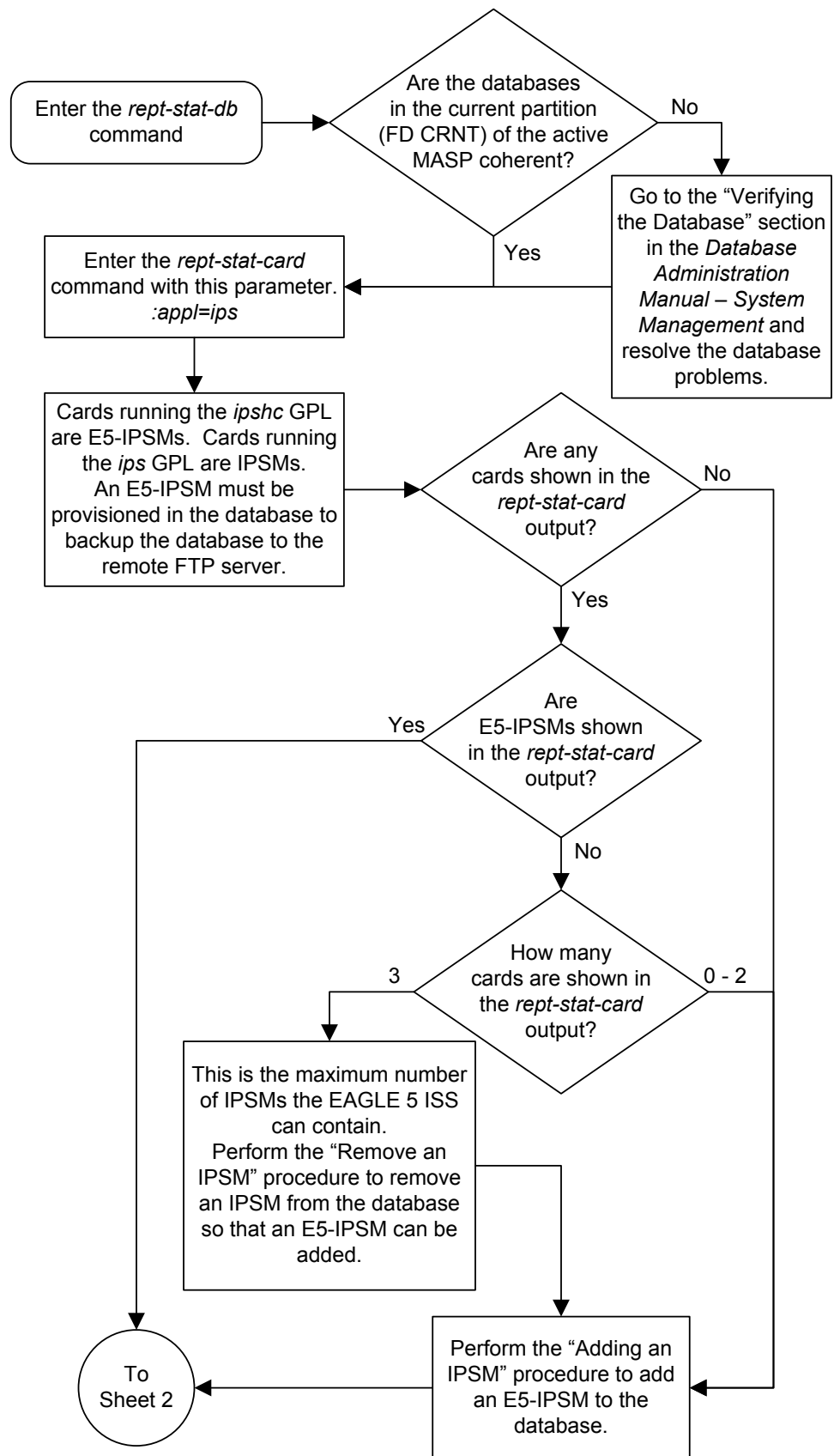

Sheet 1 of 2

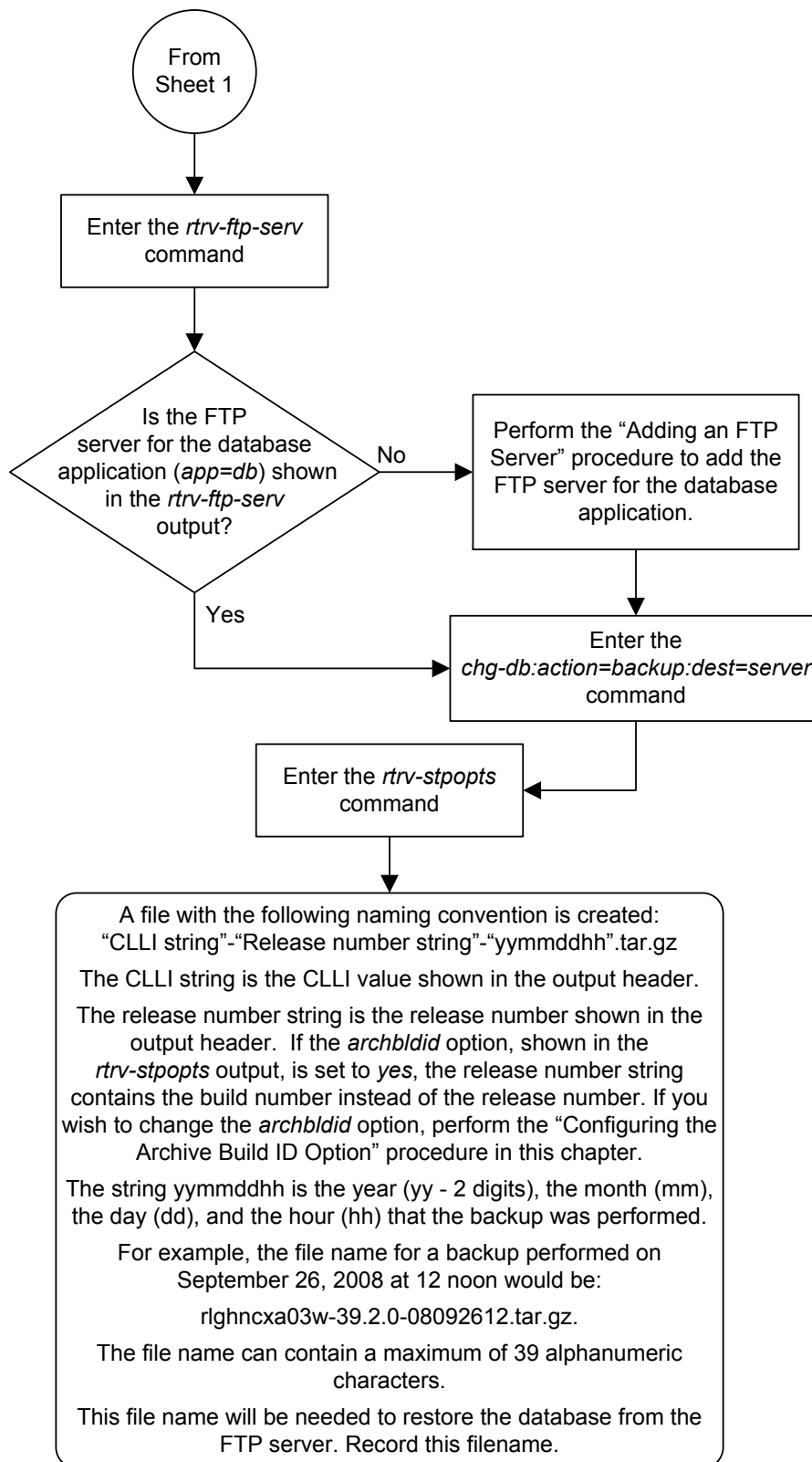

Restoring the Database from the FTP Server

This procedure is used to restore the database from the FTP server using the `chg-db` command with these parameters.

- `action=restore`
- `src=server`
- `file` - the name of the TAR file on the FTP server that contains database that is being restored. The `file` parameter value is the file name that was created when the database was backed up to the FTP server. The `file` parameter value can contain a maximum of 39 alphanumeric characters. Refer to [Making a Backup of the Database to the FTP Server](#) for more information about the file name for database backups to the FTP server.

Note: As of Release 46.5, the E5-IPSM card and its functionality is replaced by the E5-ENET-B (p/n 870-2971-01) or SLIC (p/n 7094646) card. Any references to E5-IPSM and the 870-2877-01 part number should be replaced by the 46.5 and greater card and part number.

The EAGLE must contain at least one E5-IPSM and an FTP server for the DB application. The `rept-stat-card` command with the `appl=ips` parameter displays the E5-IPSMs and IPSMs that are in the database. E5-IPSMs are shown by the entry `IPSHC` in the `GPL` column of the `rept-stat-gpl` output. IPSMs are shown by the entry `IPS` in the `GPL` column of the `rept-stat-card` output. The `rtrv-ftp-serv` command shows the FTP servers that are configured. E5-IPSMs can be added by performing the procedure [Adding an E5-IPSM](#). FTP servers can be added by performing the procedure [Adding an FTP Server](#).

The EAGLE must contain at least one E5-IPSM and an FTP server for the DB application. The `rtrv-stp` command with the `gpl=ipshc` parameter displays the E5-IPSMs. The `rtrv-ftp-serv` command shows the FTP servers that are configured. E5-IPSMs can be added by performing the procedure [Adding an E5-IPSM](#). FTP servers can be added by performing the procedure [Adding an FTP Server](#).

Caution: Using the `action=restore` parameter with the `chg-db` command is an emergency recovery procedure, and requires the `init-sys` command to download the restored database to all the cards in the EAGLE.

1. Display the E5-IPSMs that are in the database by entering this command.

```
rept-stat-card:appl=ips
```

This is an example of the possible output.

```
rlghncxa03w 08-09-01 16:07:48 GMT  EAGLE5 39.2.0
CARD  VERSION      TYPE   GPL      PST          SST          AST
1111  131-010-000  IPSM   IPSHC    IS-NR        Active       -----
1317  -----      IPSM   IPS      OOS-MT       Isolated     -----
2217  131-010-000  IPSM   IPS      IS-NR        Active       -----
```

Command Completed.

E5-IPSMs are shown by the entry `IPSHC` in the `GPL` column of the `rept-stat-card` output. IPSMs are shown by the entry `IPS` in the `GPL` column of the `rept-stat-card` output. Continue the procedure by performing one of these actions.

- If no entries are shown in the `rept-stat-card` output, add an E5-IPSM by performing the procedure [Adding an E5-IPSM](#). After the E5-IPSM has been added, continue the procedure with [2](#).
- If E5-IPSMs are shown in the `rept-stat-card` output, continue the procedure with [2](#).
- If only IPSMs are shown in the `rept-stat-card` output, continue the procedure by performing one of these actions.
 - If two or less entries are shown in this step, add the E5-IPSM by performing the procedure [Adding an E5-IPSM](#). After the E5-IPSM has been added, continue the procedure with [2](#).
 - If three entries are shown in this step, no more IPSMs or E5-IPSMs can be added. An IPSM must be removed so the E5-IPSM can be added. perform the procedure [Removing an E5-IPSM](#) to remove the IPSM. Add the E5-IPSM by performing the procedure [Adding an E5-IPSM](#). After the E5-IPSM has been added, continue the procedure with [2](#).

2. Display the FTP servers that are provisioned in the database by entering the `rtrv-ftp-serv` command. This is an example of the possible output.

```
rlghncxa03w 08-09-01 16:07:48 GMT EAGLE5 39.2.0
```

APP	IPADDR	LOGIN	PRIO	PATH
db	10.20.50.102	dbuser1	1	~/eagle
dist	100.200.50.102	dbuser1	1	~/eagle
meas	1.255.0.100	ftpmeas3	3	~meas\local

If the entry `db` is shown in the `APP` column, continue the procedure with [3](#).

If the entry `db` is not shown in the `APP` column, perform the procedure [Adding an FTP Server](#) to add the FTP server. After the FTP server has been added, continue the procedure with [3](#).

3. Enter the `chg-db` command with the `action=restore`, `src=server`, and `file` parameters. For this example, enter this command.

```
chg-
db:action=restore:src=server:file="rlghncxa03w-39.2.0-0809261
2.tar.gz"
```

During command execution, these messages appear (the active **MASP** is displayed first).

```
RESTORE (SERVER) : Retrieve database archive from server.
RESTORE (SERVER) : Validate database archive.
RESTORE (SERVER) : Restore starts on active MASP.
RESTORE (SERVER) : Restore from server on active MASP complete.
RESTORE (SERVER) : Restore starts on standby MASP.
```

```
RESTORE (SERVER) : Restore from server on standby MASP complete.
RESTORE (SERVER) : MASP(s) will reboot to load data.
```

4. When the commands have successfully completed, re-initialize the **EAGLE** using the `init-sys` command.

Note: The `init-sys` command causes a complete reload of the **EAGLE**, and should only be used during periods of low traffic. Using this command ensures that all cards are running the same database, but will interrupt service.

Note: The `init-sys` command must be entered twice within 30 seconds for the **EAGLE** to be re-initialized. If the `init-sys` command is not executed twice within 30 seconds, the attempt to re-initialize the **EAGLE** is aborted.

When the `init-sys` command is first entered, this message should appear.

```
rlghncxa03w 08-09-01 07:05:01 GMT EAGLE5 39.2.0
CAUTION: This command causes a complete system reload, and
will result in traffic loss.
Re-enter command within 30 seconds to confirm.
```

When the `init-sys` command is re-entered within the 30 second time limit, this message should appear.

```
rlghncxa03w 08-09-01 07:05:17 GMT EAGLE5 39.2.0
Init System command issued at terminal #4
```

From the time that the `init-sys` command is accepted, you must wait approximately 2 minutes before you can perform 5 (logging into the **EAGLE**). If the **EAGLE** terminal is in the **VT-100/VT-320** mode, the terminal display will be refreshed with non-zero alarm counts. During this 2 minutes interval, an intermediate screen refresh caused by the **MASPs** role change from active to standby, and from standby to active. This screen refresh is typically a partial refresh and the alarm indicators are set to zero.

If you are logged into the **EAGLE** in the **KSR** mode, the only response you will receive that you are now able to log into the **EAGLE** is that you will receive **UAM 0009**, **MASP** became active. **UAM 0009** could be issued twice due to possible transient **MASP** role change (switching from active to standby). Following the execution of the `init-sys` command, the **MASP** that was active before the `init-sys` command was entered will be the active **MASP** when the **EAGLE** has finished reinitializing.

5. Log into the **EAGLE** using the `login` or `act-user` command.

This is an example of the messages that appear when you have successfully logged into the **EAGLE**.

```
NOTICE: This is a private computer system.
Unauthorized access or use may lead to prosecution.
```

```
0 LOGIN failures since last successful LOGIN
Last successful LOGIN was on port 4 on 08-09-01 @ 05:34:56
```

Figure D-4 Restoring the Database from the FTP Server

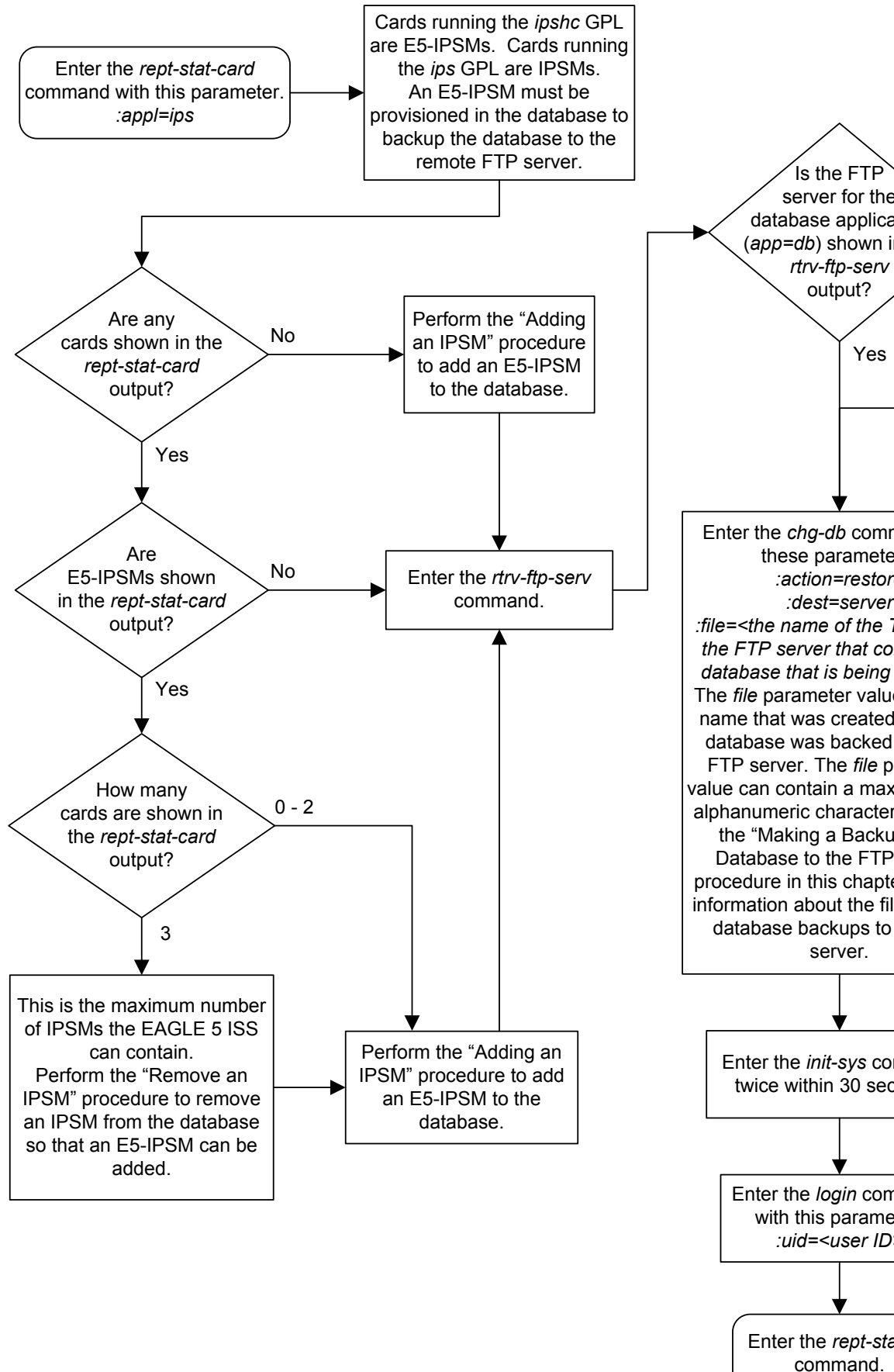

Configuring the Archive Build ID Option

When the database is backed up to the FTP server, the release number string of the file name that is created is either the software release number or the software build number. The `archbldid` value of the `on` or `off` parameters of the `chg-stpopts` command determines which number is used as the release number string.

- If the `on=archbldid` parameter is specified, the software build number is used as the release number string.
- If the `off=archbldid` parameter is specified, the software release number is used as the release number string.

The system default value for the `archbldid` parameter is `off`.

1. Display the value for the `archbldid` parameter by entering the `rtrv-stpopts` command.

The value of the `archbldid` parameter is shown in the `ARCHBLDID` field. This is an example of the possible output.

```
rlghncxa03w 10-07-17 16:02:05 GMT  EAGLE5 42.0.0
STP OPTIONS
-----
ARCHBLDID          off
```

Note: The `rtrv-stpopts` command output contains other fields that are not used by this procedure. If you wish to see all the fields displayed by the `rtrv-stpopts` command, see the `rtrv-stpopts` command description in *Commands User's Guide*.

2. Change the value of the `archbldid` parameter.

To change the `archbldid` parameter to `on`, enter this command.

```
chg-stpopts:on=archbldid
```

To change the `archbldid` parameter to `off`, enter this command.

```
chg-stpopts:off=archbldid
```

When this command has successfully completed, this message should appear.

```
rlghncxa03w 06-10-07 00:22:57 GMT  EAGLE5 36.0.0
CHG-STPOPTS: MASP A - COMPLTD
```

3. Verify the changes using the `rtrv-stpopts` command.

If the `on=archbldid` parameter was specified in [2](#), this is an example of the possible output.

```
rlghncxa03w 10-07-17 16:02:05 GMT  EAGLE5 42.0.0
STP OPTIONS
-----
ARCHBLDID          on
```

If the `off=archbldid` parameter was specified in 2, this is an example of the possible output.

```
rlghncxa03w 10-07-17 16:02:05 GMT EAGLE5 42.0.0
STP OPTIONS
-----
ARCHBLDID          off
```

Note: The `rtrv-stpopts` command output contains other fields that are not used by this procedure. If you wish to see all the fields displayed by the `rtrv-stpopts` command, see the `rtrv-stpopts` command description in *Commands User's Guide*.

4. Back up the new changes using the `chg-db:action=backup:dest=fixed` command.

These messages should appear, the active **Maintenance and Administration Subsystem Processor (MASP)** appears first.

```
BACKUP (FIXED) : MASP A - Backup starts on active MASP.
BACKUP (FIXED) : MASP A - Backup on active MASP to fixed disk complete.
BACKUP (FIXED) : MASP A - Backup starts on standby MASP.
BACKUP (FIXED) : MASP A - Backup on standby MASP to fixed disk complete.
```

Figure D-5 Configuring the Archive Build ID Option

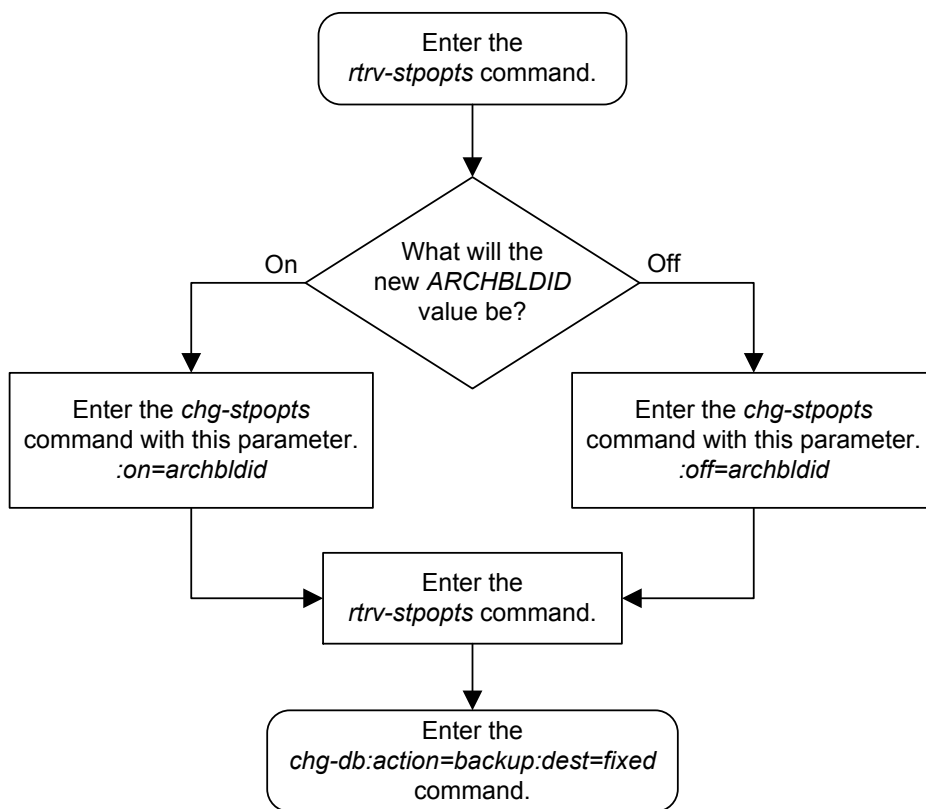

Index

A

action=backup\
 dest=fixed, [2-9](#)
 dest=server, [D-5](#)
action=restore\
 src=fixed, [2-23](#)
 src=remove, [2-28](#)
 src=server, [D-10](#)

B

backup procedures
 backup database on fixed disk, [2-8](#)

C

card
 E5-MCAP, [1-5](#)
 E5-MDAL, [1-6](#)
 E5-TDM, [1-6](#)
cards
 control, [1-5](#)
 E5-MASP, [1-5](#)
 MASP, [1-5](#)
chg-db\
 action=repair, [2-33](#)
chg-ftp-serv, [4-167](#), [4-168](#)
chg-ip-lnk, [4-149](#), [4-178](#)
control cards
 E5-based, [1-5](#)
 EAGLE ISS, [1-5](#)
credit card flash drive, [1-5](#)

D

dlt-ftp-serv, [4-164](#)
drive
 credit card flash, [1-5](#)
 E5-TDM fixed SATA, [1-6](#)
 removable media flash, [1-5](#)

E

E5-based control cards, [1-5](#)
E5-IPSM, [4-175](#)
E5-MASP cards, [1-5](#)
E5-MCAP card
 USB ports, [1-5](#)
E5-MDAL card, [1-6](#)
E5-TDM card, [1-6](#)
EMSALM terminal type, [4-57](#)
ent-ftp-serv, [4-159](#)
Ethernet, [4-135](#)

F

fan feature, [4-146](#)
fixed drive
 E5-TDM, [1-6](#)
FTP server, [4-146](#), [4-150](#), [4-158](#), [4-159](#), [4-164](#), [4-167](#),
 [4-168](#)

H

HIPR2 High Rate Mode, [A-65](#)
HIPR2 High Rate Mode feature, [A-50](#), [A-51](#), [A-53](#),
 [A-54](#), [A-65](#)

I

IP communications link
 Measurements Platform, [4-146](#)
IP host, [4-149](#), [4-179](#)
IP link, [4-178](#)
IP Services Module, [4-194](#)
IP User Interface - Telnet, [4-194](#)
IPSM, [4-194](#), [4-195](#)

K

KSR terminal type, [4-57](#)

M

Maintenance and Administration Subsystem (MAS), [1-5](#)
Maintenance and Administration Subsystem Processor (MASP), [1-5](#)
Maintenance Communication Application Processor (MCAP), [1-5](#)
Maintenance Disk and Alarm (MDAL), [1-6](#)
MAS, [1-5](#)
MASP, [1-5](#)
MCPM, [2-65](#), [2-68](#), [2-79](#), [2-82](#), [3-53](#), [4-135](#), [4-136](#), [4-142](#), [4-143](#), [4-147](#), [4-195](#)
Measurement Collection & Polling Module, [4-135](#), [4-142](#)
Measurements Platform, [2-37](#), [2-64](#), [2-65](#), [2-78](#), [4-136](#), [4-142](#), [4-150](#), [4-158](#), [4-164](#), [4-167](#)
Measurements Platform option, [2-37](#), [2-64](#), [2-65](#), [2-78](#), [4-146](#), [4-150](#)
MGMT terminal type, [4-57](#)

N

None terminal type, [4-57](#)

O

OpenSSH, [1-3](#)

P

Printer terminal type, [4-57](#)
PuTTY client program, [1-3](#)

R

removable media, [1-5](#)
rept-stat-meas, [2-65](#), [2-68](#), [2-79](#), [2-82](#), [3-53](#), [4-147](#), [4-151](#)
rtrv-ftp-serv, [4-150](#)

rtrv-ip-lnk, [4-178](#), [4-179](#)

S

SATA fixed drive, E5-TDM, [1-6](#)
SEAS terminal type, [4-58](#)
secure telnet connection
 setup with the OpenSSH, [1-3](#), [C-1](#)
 setup with the PuTTY client program, [1-3](#)
setup secure telnet connection with the OpenSSH, [1-3](#), [C-1](#)
setup secure telnet connection with the PuTTY client program, [1-3](#)

T

telnet connection - secure
 setup with the OpenSSH, [1-3](#)
 setup with the PuTTY client program, [1-3](#)
Telnet terminal type, [4-57](#)
Terminal Disk Module (TDM), [1-6](#)
Terminal type
 EMSALM, [4-57](#)
 KSR, [4-57](#)
 MGMT, [4-57](#)
 None, [4-57](#)
 Printer, [4-57](#)
 SEAS, [4-58](#)
 Telnet, [4-57](#)
 VT320, [4-57](#)

U

USB port
 flush-mounted, [1-5](#)
 latched, [1-5](#)

V

VT320 terminal type, [4-57](#)